



This is a digital copy of a book that was preserved for generations on library shelves before it was carefully scanned by Google as part of a project to make the world's books discoverable online.

It has survived long enough for the copyright to expire and the book to enter the public domain. A public domain book is one that was never subject to copyright or whose legal copyright term has expired. Whether a book is in the public domain may vary country to country. Public domain books are our gateways to the past, representing a wealth of history, culture and knowledge that's often difficult to discover.

Marks, notations and other marginalia present in the original volume will appear in this file - a reminder of this book's long journey from the publisher to a library and finally to you.

### **Usage guidelines**

Google is proud to partner with libraries to digitize public domain materials and make them widely accessible. Public domain books belong to the public and we are merely their custodians. Nevertheless, this work is expensive, so in order to keep providing this resource, we have taken steps to prevent abuse by commercial parties, including placing technical restrictions on automated querying.

We also ask that you:

- + *Make non-commercial use of the files* We designed Google Book Search for use by individuals, and we request that you use these files for personal, non-commercial purposes.
- + *Refrain from automated querying* Do not send automated queries of any sort to Google's system: If you are conducting research on machine translation, optical character recognition or other areas where access to a large amount of text is helpful, please contact us. We encourage the use of public domain materials for these purposes and may be able to help.
- + *Maintain attribution* The Google "watermark" you see on each file is essential for informing people about this project and helping them find additional materials through Google Book Search. Please do not remove it.
- + *Keep it legal* Whatever your use, remember that you are responsible for ensuring that what you are doing is legal. Do not assume that just because we believe a book is in the public domain for users in the United States, that the work is also in the public domain for users in other countries. Whether a book is still in copyright varies from country to country, and we can't offer guidance on whether any specific use of any specific book is allowed. Please do not assume that a book's appearance in Google Book Search means it can be used in any manner anywhere in the world. Copyright infringement liability can be quite severe.

### **About Google Book Search**

Google's mission is to organize the world's information and to make it universally accessible and useful. Google Book Search helps readers discover the world's books while helping authors and publishers reach new audiences. You can search through the full text of this book on the web at <http://books.google.com/>

B 50629 7

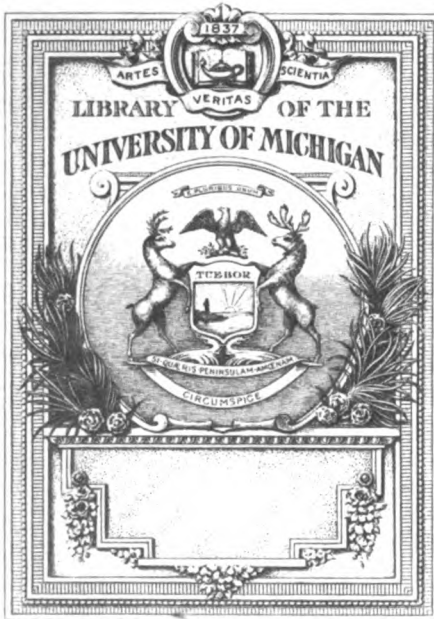

HS  
353  
.A78

*locked case*







Photogravure by Annan & Sims Glasgow from a Photograph by Turner & Drinkwater Hall.

Geo. L. Shackles

→: Ars ←  
**Quatuor Coronatorum**

BEING THE TRANSACTIONS OF THE  
QUATUOR CORONATI LODGE NO. 2076, LONDON.



*EDITED FOR THE COMMITTEE BY W. H. RYLANDS, F.S.A., P.A.G.D.C.*

VOLUME XIX.

H. KEBLE, PRINTER, MARGATE.  
1906.





Refer. - St.  
 Quatuor coronati  
 2-18-25  
 11077

## TABLE OF CONTENTS.

### LODGE PROCEEDINGS.

	PAGE.
Friday, 12th January, 1906 ... ..	1
Friday, 2nd March, 1906 ... ..	43
Friday, 4th May, 1906 ... ..	90
Monday, 25th June, 1906, St. John's Day in Harvest ... ..	110
Thursday, 5th, to Sunday, 8th July, 1906 (Summer Outing—Shrewsbury and Ludlow) ... ..	171
Friday, 5th October, 1906 ... ..	175
Wednesday, 8th November, 1906, Festival of the Four Crowned Martyrs ... ..	229

### NOTES AND QUERIES.

Masonic Female Orphan School, Dublin, 1814 ... ..	68
Survival of Templarism in Spain ... ..	69
Masonic Funeral at Cork, 1784 ... ..	69
The Missing York MSS. of the Old Charges ... ..	69
The Dunciad ... ..	70
Spanish Templars ... ..	141
The Sirr Family and Freemasonry ... ..	142
Henry Charles Sirr ... ..	142
Eulogium on Freemasonry ... ..	142
Early Use of the Term "Freemason" ... ..	143
An Old Engraved Apron ... ..	239
Certificate and Seal, A Curious ... ..	241
Arab Masonry ... ..	243

### OBITUARY.

Bergmann, T. ... ..	71
Breed, Edward Aries Thomas ... ..	71
Cole, Christian John ... ..	71
De Fabeck, William Frederick ... ..	71
Fellows, Joseph W. ... ..	146
Ferry, Charles Edwin ... ..	250
Findel, Gottfried Joseph Gabriel ... ..	71
Finnemore, Robert Isaac ... ..	251
Fooks, William ... ..	250
Frazer, Rev. W. Henry ... ..	71
Freeman, Vincent Paine ... ..	71
Gribble, James Dunning Baker ... ..	250
Hewer, Henry John ... ..	71
Hicks, Edward ... ..	71
Hopkins, R. B. ... ..	251
Howard, Sir Richard Nicholas ... ..	71
Isitt, Sidney Frederick ... ..	71
King, William Youill ... ..	145
Last, John Thomas ... ..	71
Lloyd, J. W. ... ..	145
Lockwood, Luke A. ... ..	145

**OBITUARY.—Continued.**

	PAGE.
Logan, William ... ..	71
Long, Hiram ... ..	250
Marsland, Octavius ... ..	251
Moors, Henry ... ..	251
Officer, William ... ..	145
Page, Alfred ... ..	71
Parkin, Henry ... ..	251
Pickering, Thomas ... ..	250
Rideal, George Samuel ... ..	145
Roffey, James Richard ... ..	251
Royston, Rev. Peter ... ..	250
Rupp, George P. ... ..	146
Smailes, Dr. Robert ... ..	145
Stötzer, Fritz ... ..	145
Sudworth, Samuel ... ..	145
Todman, Frank ... ..	71
Tristram, Canon Henry Baker ... ..	71
Upton, William Henry ... ..	251
Walker, Dr. Charles Rotherham ... ..	145
Warre, Charles Bamfylde ... ..	71
Welch, Louis ... ..	146
Westropp, Col. William Keilly ... ..	71
White, Hubert ... ..	71
Williams, Howard Douglas ... ..	250
Wolff, Albert ... ..	250

**PAPERS AND ESSAYS.**

<b>Old City Taverns and Masonry.</b> By J. Percy Simpson ...	8
Roman London, 9; Vintner's Houses just inside the Gates, 9; Acts of Parliament relating to Inns, 10; Yards of Inns formed the model on which Play-houses were built, 10; Tavern signs, 11; The Fountain, The Three King's, Minorities; The Dolphin, The King's Head, Czar of Muscovy's Head, Tower Street; The Ship, The Swan, The Crown and Mitre, Fish Street, 12; The Old Elephant, The King's Head, The Old Coach and Horses, The Blue Anchor, Fenchurch Street; The Crown and Anchor, The Anchor and Hope, The Ship and Turtle, Leadenhall Street, 13; The White Hart, The Admiral Vernon, The Sir Paul Pindar's Head, 14; The Catherine Wheel, The Helmet, The London Tavern, The Flowerpot Inn, The White Lion, Bishopsgate Street, 15; The Mansion House, The Castle, The Abercromby, The Bell, The King's Arms, Jonathan's Coffee House, The Old Post Boy Inn, The Mail Coach, The Royal Oak, Pontack's, The White Bear, Lloyd's Coffee House, Lombard Street, 16; The Pope's Head, The Swan, The George and Vulture, 17; The Edinburgh Castle, The Cock and Lion, The Ship, The Sun, Cornhill; The Caveac, The Hercules, The Antwerp, Threadneedle Street; The Queen's Head, 18; The Half Moon, Cheapside; Grand Chapter of the Gregorians; The King's Head, The Rose, Poultry, 19; The Rummer, The Blossoms, Cheapside; The Castle and Falcon, The Mourning Bush, The Britannia, 20; The Albion, Aldersgate; The Mitre, Paul's Head, Chapter Coffee House, The Goose and Gridiron, The Paul's Head, St. Paul's Churchyard; The West India and American Lodge (Lodge of Antiquity), 21; The Horn, Carter Laues; The King's Head, Ivy Lane; The Queen's Arms, The Sun, Tobots Dog, St. Paul's Churchyard; The Fountain, The Dolphin, Ludgate Hill, 22; The Salutation and Cat, London	

**PAPERS AND ESSAYS.—Continued.**

PAGE.

Coffee House, Newgate Street; The Old Belle Savage, Ludgate Hill, 23; The Old Blue Last, The Globe, The Green Dragon, The Griffin, The Greyhound, The Horn (Anderton's), 24; The Old Mitre, The Old Devil, Fleet Street; The Battle of Temple Bar, 25; Comments by Sir A. H. Markham, W. J. Hughan, 27; Andrew Oliver, W. B. Hextall, 28; W. H. Rylands, 29.	
<b>The Carolus of our Ancient MSS.</b> By John Yarker ...	31
The Holy Vehm of Westphalia, 31; The Legend of the Death of Renaud, 32; The Vehm Court, 33; Ceremony of Induction, 34; Qualification of Candidates, The Penalty, 35.	
<b>The Sirr Family and Freemasonry.</b> By Harry Sirr ...	36
Henry Charles Sirr, the first representative of Grand Lodge of Ireland in England, Member of Caledonian Lodge, Britannic Lodge, 36; Gooch Lodge, 37; Major Sirr initiated in No. 441 (I.C.), 39; Joseph Sirr, Grand Warden, Ireland, 1773-4, 41.	
<b>The Naimus Grecus Legend:—II.</b> The S. Alban Legend in its relation to S. Alcuin and the Naimus Grecus Legend. By Edmund H. Dring ...	45
The St. Alban Legend in the Cooke MS., 45; Albanus and Albinus, 46; Archbishop Aldberht, 47; Rebuilt York Minster, 49; Charlemagne crowned King, in conjunction with Pepin and Carloman, in 754, 50; St. Alban confused with St. Alban of Verulam, 51; Alcuin corrupted into Naimus, 52; Alcuin called Charles the Great "Solomon," 53; and "Solomon" in the Charges refers to Charlemagne, not to Solomon, King of Israel, 54; Comments by Dr. Begemann, 55; Canon Horsley, 58; W. H. Rylands, 58; Dr. Rosedale, 59; E. H. Dring's reply, 59.	
<b>Seals on "Ancients" Grand Chapter Certificates.</b>	
By J. T. Thorp ...	63
Certificate of 1792 with "In London" Seal, 63; Certificate of 1795 with same seal on scalloped paper, 63; Certificate of 1808, with "Kirk" seal on scalloped paper, 64.	
<b>A few Historic Notes relating to the Lodge of Prudent Brethren, No. 145.</b> By Harry Guy ...	65
Warrant of 1775, Meeting Places of Lodge, 65; Old Collar Jewels, 66; Sale of Furniture in 1844, 66; References to Royal Arch in Minutes, 67.	
<b>Templaria et Hospitallaria:</b> Thoughts on the Orders of the Temple and Hospital in the British Empire in connection with Esoteric matter of various kinds. Chapter I. By L. A. de Malczovich ...	73
Formation of the Teutonic Order, 73; Its constitution, 75; Clothing; Arms of the Order, 75; Help granted to Conrad of Masovia, Union with Sword-bearers of Livonia, The Prussians conquered, Colonization of Territory, End of the Crusades, 76; Troubles with the Lithvanians, The Period of greatest prosperity, 77; Internal dissensions, Defeat by the King of Poland, 78; The loss of West Prussia, East Prussia retained as a fief of Poland, 79; The Single-headed and the Double-headed Eagle, 81; The Bailliwick of Utrecht preserved as a Protestant body, 81; The office of Great Master made hereditary, 82; Abolition of the Order by Napoleon, 1809, Later Revivals, 83; Similar revival of other Orders, 84; The Apostolic Kings of Hungary, 86; The Royal Hungarian Order of St. Stephen, The Royal Bavarian Order of St. George, Archdukes of Austria, 87.	

PAPERS AND ESSAYS.—Continued.	PAGE.
<b>A Unique Engraved List of Lodges, "Ancients," A.D. 1753.</b>	
By W. J. Hughan ... ..	93
The five Grand Lodges in England, The Grand Lodge of the Ancients, Lists of its Lodges first appear in 1751, 93; The Engraved List of 1753, 94; Printed Lists of 1795 to 1799, 1804, 1807, 1813, 96; Comments by J. P. Simpson, 97; W. Wonnacott, 99.	
<b>The Sea Serjeants.</b> By W. B. Hextall ... ..	100
Traditional origin, Revival in 1726, Lady Patroness elected in 1749, 100; Portrait of Richard Gwynne, by Faber, 101.	
<b>Demit and Jewel of Antient Lodge No. 53, Liverpool.</b>	
By Geo. L. Shackles. ... ..	108
Certificate issued to Stephen Clay, 1794, 108; Warrant of "Antient" Lodge transferred to Hull in 1809, now the Humber Lodge No. 53, 109.	
<b>King Solomon and the Queen of Sheba.</b> By F. J. W. Crowe ...	112
The visit of the Queen of Sheba described by Josephus, 112; in the Koran, 113; in the Golden Legend, 114; Professor Lethaby's Paper on Wells Cathedral, 115; The figures of a King and Queen at Amiens, Rheims, Notre Dame (Paris), Chartres, 115; Corbeil, Rochester, 116; Comments by W. Wonnacott, 116; Rev. M. Rosenbaum, 121; E. Armitage, 124; Reply to criticisms, 125.	
<b>J. Morgan, and his Phoenix Britannicus, with notes about his other works.</b> By Harry Sirr ... ..	127
The Phoenix Britannicus, six numbers published, its extravagant Dedication, 127; Morgan the compiler of George Sale's "Lives and Memorable Actions," 132; and "History of Algiers," 134; William Oldys a contributor to "The Phoenix," 135.	
<b>Order of the Knights of the Holy Sepulchre of Jerusalem.</b>	
By L. A. de Malczovich ... ..	137
The Knights of the Holy Sepulchre not a continuation of the Templars, and not an Order, 137; Order of the Canons of the Holy Sepulchre founded in 1459, and united with The Order of St. John in 1489, Order of Knights of the Holy Sepulchre, said to have been founded by Pope Alexander II., 138; Knights of Malta acquired the government of the Holy Sepulchre in seventeenth century, 139; Possible descent from Templars of Orders in Spain and Portugal, 140.	
<b>Studies in Eighteenth Century Continental (so-called) Masonry.</b> By Rev. W. K. Firminger, M.A., B.D. ... ..	147
Confusion of Martinézistes with Martinistes, Martinez Pasqualis, founded a <i>Temple des Elus écossais</i> , 147; The English Lodge of Bordeaux, The <i>Loge Française</i> , 148; <i>Illuminés d'Avignon</i> , <i>Académie des Vrais Maçons</i> , and <i>Mère Loge du Contrat Venaissin</i> , 149; The teachings of Martinez Pasqualis, 150; Correspondence between Kirchberger and St. Martin, 152; Swedenborg, 158; Schröpffer, 159; Kirchberger's account of the Northern School, The Zurich (Egyptian) Lodge, Lavater, Cagliostro, etc., 159.	
<b>The Equilateral Triangle in Gothic Architecture.</b> By Arthur Bowes ... ..	165
The Equilateral Triangle in Wells Cathedral, 165; Winchester Cathedral, Baptistry at Pisa, 166; Architectural drawings on section-lined paper, 167; Methods of setting out triangles, 168; The pentacle as a basis of architectural design, 170.	

**PAPERS AND ESSAYS.**—*Continued.*

PAGE.

<b>Summer Outing, Shrewsbury and Ludlow, July 1906.</b> By W. J. Songhurst ... ..	171
Shrewsbury, Emergency Lodge of Welcome, 172; Perambulation of the town, 172; Uriconium, 172; Stokesay Castle, Ludlow, 173.	
<b>Notes on the Grand Chaplains of England.</b> By Canon J. W. Horsley ... ..	181
Institution of the office in England, 181; York, Ireland, 182; Dr. Dodd the first Grand Chaplain, 183; Members of the Apollo University Lodge, Oxford, 199; Comments by W. J. Hughan, 200; W. Watson 201.	
<b>Notes on some Eighteenth Century Masonic Documents.</b>	202
By Archdeacon Clarke ... .. Certificates of Town of Boyle Lodge, 202; No. 530, Sligo; Sion Lodge No. 3, 57th Regiment, 203; No. 3, St. Patrick's; Grand Lodge of Ireland; High Knights Templars, 204; Cork Lodge, No. 95; Army Lodges; No. 509, Crosskill; No. 156, Kinsale; Royal Arch, No. 607, Kells, 205; No. 854, Leitrim Militia; No. 495, Cork Militia; No. 744, Carrigallin; No. 767, Cloon; No. 413, Bandon, 206; No. 552, Monaghan; Receipt for Grand Lodge Dues, No. 552, Monaghan Militia; Address presented to George III. by Grand Lodge of Scotland, 1795, 207.	
<b>Enquiry into the charge of Gnosticism brought against the Freemasons and Templars.</b> By E. J. Castle ... ..	209
Statements by Hallam, based upon an essay by von Hammer, 209; Michelet's edition of the <i>Procès des Templiers</i> , 210; References to the Freemasons by von Hammer; Marks and ornaments in Templar Churches; The essay of von Hammer considered, 212; The charges against the Templars of Depravity and Idolatory, 213; Gnosticism considered, 216; Manicheism considered, 220; Essay by Edward Clarkson, 223; The Gnostics and their remains, by C. W. King, 225; Conclusions, 227.	
<b>Installation Address.</b> By Hamon Le Strange ... ..	231
<b>Toast of "The Worshipful Master."</b> By George L. Shackles ... ..	236
 <b>REVIEWS.</b>	
Freemasonry in Bengal and the Punjab, by the Rev. W. K. Firminger ... ..	W. J. Hughan ... .. 102
Masonry in London and Middlesex, by W. H. Read ... ..	W. Wonnacott ... .. 103
The Lodge of Research, Transactions, 1905-6	W. J. Hughan ... .. 244
Freimaurerische Denkmünzen und Medaillen, Band VIII. ... ..	W. J. Hughan ... .. 245
History of the Phoenix Lodge, No. 94, Sunderland, by T. O. Todd ... ..	W. J. Hughan ... .. 246
Freemasonry in Australasia, by W. F. Lamony ... ..	W. Watson ... .. 248

# INDEX.

	PAGE.
Academie des Vrais Maçons...	149
"    Russo-Suedoise ...	149
Address to George III. ...	207
Ancients, Lists of Lodges ...	93
Animals depicted in Churches ...	217
Apollo Club ...	25
Apostolic Kings of Hungary ...	86
Apprenti Coën ...	147
Apron, painted ...	43
Aprons, engraved ...	4, 43, 92, 180, 239
Arab Masonry ...	243
Assassins and Templars ...	226
Audit Report ...	4
Aymon, Four Sons of ...	32
Baphomet ...	211
Bottle, Masonic ...	2
Brilliants Club ...	24
Certificates, Early Irish ...	202
"    of Military Lodges ...	205
Chaplains, Grand ...	181
Charlemagne styled "Solomon" ...	53
Chevalier Commandeur ...	147
"    de la Clef d'or ...	149
"    de la Toison d'or ...	149
"    de l'iris ..	149
"    des Argonautes ...	149
Clandestine Masonry ...	245
Compagnon Coën ...	147
Cooke MS. ...	45
Degrees worked under Craft Warrant ...	67
Dodd, Letter by Dr. ...	200
Drawing Board ...	104
East and West, Emperors of ...	148
Eccentrics Club ...	24
Elu Ecosais ...	147
Emanation, Doctrine of ...	150
Emperors of the East and West ...	148
Engraved Aprons ...	4, 43, 92, 180, 239
"    Jewels ...	91, 109, 111
"    List of Lodges (Ancients) ...	93
Eulogium on Masonry ...	143
<b>Exhibits:—</b>	
Apron, Engraved ...	180
"    Franklin Lodge, Phila-	
delphia ...	44
"    Leather, printed from	
plate engraved by John	
Cole ...	4
"    painted ...	43
"    printed from "Hinckley"	
plate ...	92
"    printed from plate en-	
graved by W. Newman ...	43, 92
Aprons, Collection of W. H.	
Rylands ...	111
"    Lodge Fortrose, Storn-	
away ...	92
"    of Society of Old Friends	92
"    worn in a Lodge at Hong-	
kong ...	3
Badges, Souvenir, Spokane, 1906	180

## Exhibits:—

	PAGE.
Bottle with Square and Com-	
passes ...	2
Bread Basket ...	44
Card Tray ...	44
Certificate, Grand Encampment,	
Birr ...	91
"    Royal Standard	
Lodge No. 39, Hali-	
fax, Nova Scotia ...	91
"    Lodge No. 306,	
Banagher ...	91
"    Lodge No. 163, Birr	91
"    Lodge No. 258, Car-	
rickfergus ...	91
"    Lodge No. 233, Bal-	
linrobe ...	91
"    Lodge No. 307,	
Roscrea ...	91
"    Lodge No. 874,	
Athlone ...	91
"    St. Thomas' Lodge,	
No. 268, Muirkirk...	91
"    Lodge "Two Paral-	
lels," No. 329, 58th	
Regiment ...	91
"    Lodge No. 357, Rox-	
burgh ...	91
"    Grand Lodge of	
Ireland, 1804 ...	91
"    Grand Lodge of	
Ireland, 1814 ...	91
"    Grand Lodge of	
Ireland, 1822 ...	91
"    Grand Lodge of	
Ireland, 1827 ...	91
"    Lodge No. 61,	
Halifax, Nova Scotia	91
"    Lodge No. 136, 19th	
Regiment ...	91
"    Clearance of Antient	
Lodge, Liverpool ...	44
"    of Deomatic Lodge,	
before 1813 ...	111
"    Lodge Fortrose,	
Stornoway ...	92
"    Grand Lodge of	
England, 1856 ...	44
"    Knight Templar	
and Knight of	
Malta ...	2
"    Red Cross, Ark and	
Mark ...	2
"    K.T. and K.M.,	
Lodge No. 895, 71st	
Regiment ...	91
"    Royal Arch, Lodge	
No. 895, 71st Regt.	91
"    K.T. and K.M.,	
Lodge No. 163,	
Parsonstown ...	91
China Plate... ...	44
Circular, Grand Lodge of	
Ireland, 1841 ...	91
Coins of Grand Masters of St.	
John of Jerusalem ...	4

Exhibits:—	PAGE.		PAGE.
Constitutions of 1765 ...	4	Holy Sepulchre, Knights of the ...	137
Excuses for non-attendance, 1827	91	Holy Vehm of Westphalia ...	31
Glass bottle with Masonic emblems ...	2	Illuminés d'Avignon ...	149
" Tumbler ...	44	Initiation of Sir Walter Scott ...	44
Gavel of Noah's Ark Lodge, (1772) ...	2	Installation Address, Hamon le Strange	231
" used by Orange Lodge ...	2	Ishmael, Order of ...	243
Handkerchief ...	92	Ivy Club ...	22
Jewel, French ...	3	Jewel, Albion Lodge ...	111
" Centenary, Lodge Economy ...	3	" Lodge of Economy ...	3
" of J.G.W., Devonshire (1779-80) ...	3	" Oddfellows ...	4
" Engraved ...	111	Jewels, French Prisoners' Work ...	3, 180
" Engraved, Lodge No. 410	91	Jubilee, Bro. Gould's Masonic ...	175
" "Oddfellow" ...	4	Knights of the Holy Sepulchre ...	137
" Past Master's Philadelphia	44	" " Round Table ...	111
" Royal Arch, 1810, of No. 642 ...	111	Lodges referred to:—	
" Scotch P.M., set in paste ...	111	Albany ...	196
" Special Centenary of Albion Lodge ...	111	Albion ...	13, 16, 96, 111
Jewels, "French Prisoners' work ...	4, 180	Albion, Quebec ...	96
Leather Pouch for carrying the Koran ...	181	Alfred ...	199
List of Prince Masons, 1840 ...	91	Alma Mater ...	196, 198
Loving Cup ...	44	Antient Knight Templar ...	106
Match Box ...	44	Antient, Liverpool ...	44, 108
Medal, Bard of Avon Lodge ...	180	Antiquity ...	21, 22, 29, 183, 189
" Foundation stone of Edinburgh Exchange, 1753 ...	92	Apollo ...	190
Meetings of Birr Lodge No. 163 1819 ...	91	Apollo University 190, 191, 192, 193, 195, 196, 197, 199	
Mugs ...	44	Ark ...	22
Mugs, Lowestoft ware ...	4	Athol, Newcastle-upon-Tyne ...	96
Punchbowls ...	180	Ballintoy ...	244
Razors, Masonic ...	92	Bank of England ...	21
Serviette, Masonic ...	3	Berkhamstead ...	197
Spoons ...	44	Blue Mountain ...	251
Star of M.N.G. Master of Knights of the Round Table ...	111	Bowyer ...	197
Summons to Divine Service &c., Birr, 1817 ...	91	Britannia, of Industry ...	20
" to Grand Festival, London, 1828 ...	92	Britannia, Sheffield ...	92
" to Grand Festival, London, 1829 ...	92	Britannic ...	36
Tobacco Box, Society of old Friends ...	92	British Social ...	19
Vase ...	44	British Union ...	192
Vegetable Dish ...	44	Buckingham ...	194
Wine Glass ...	92	Burlington ...	104
Floorcloth ...	106	Caledonian ...	19, 26
Fratres Lucis ...	241	Candour, Delph ...	111
Freemason, Early use of the word ...	145	Canterbury ...	192
Gavel used by an Orange Lodge ...	2	Castle ...	16, 247
Gnosticism and Templary ...	209	Castle Martin ...	197
Gormorgons, references in the Dunciad	70	Castle, of Harmony ...	16, 22
Grand Elu ...	147	Cathedral ...	198
Grand Lodge MS. No. 1. ...	51	Caveac ...	18
Gregorians, references in the Dunciad	70	Cherwell ...	197
" List of Chapters ...	19, 30	Cholmeley ...	194
" Grogram" ...	27	Constitutional ...	14, 16, 19
Hand and Foot, on Masonic Medal ...	44	Country Stewards' ...	106, 108
Hangings for Lodge Jewels ...	66	Domatic ...	24
Herodim ...	247	Dunheved ...	197
		Earl of Lathom ...	190
		Economy ...	19
		Eleusis, Beyreuth ...	72
		Emulation ...	18, 20
		English, Bordeaux ...	148
		Enoch ...	96
		Faith ...	143
		Fidelity ...	95, 198
		Fortitude and Old Cumberland	14
		Fortrose, Stornoway ...	92
		Foundation ...	24, 196
		Française, Bordeaux ...	148
		Franklin, Philadelphia ...	44
		Freedom ...	25
		French, London ...	12, 23
		Friendship, Gibraltar ...	176, 189
		Globe ...	22



Lodges referred to:—	PAGE.	Lodges referred to:—	PAGE.
Good Report ... ..	190	No. 744, Carrigallin ... ..	206
Gooch ... ..	37	No. 767, Cloon ... ..	206
Grand Master's ... ..	23, 95, 187, 188	No. 854, Leitrim Militia ... ..	206
Grand Stewards' ... ..	4, 25	No. 874, Athlone ... ..	91
Happiness ... ..	247	No. 895, 71st Regt. ... ..	91
Harmony ... ..	199	Oak ... ..	15
Honour ... ..	193, 194	Economy, Winchester ... ..	3
Honour and Generosity ... ..	22	Old Dundee... ..	18
Hope and Unity ... ..	15, 191, 197, 199	Old Union ... ..	16, 20
Humber, Hull ... ..	44, 109	Orange Lodge, London ... ..	2
Humility with Fortitude ... ..	102	Palatine ... ..	247
Industry ... ..	20	Pattison ... ..	198
Inhabitants, Gibraltar ... ..	176	Peace and Harmony ... ..	15
Ionic and Prudence ... ..	22	Peace and Unity ... ..	193
Isaac Newton University ... ..	195	Perfect Observance ... ..	25
Israel ... ..	12, 13	Perpetual Friendship ... ..	193
Jerusalem ... ..	194	Philo, Philadelphia ... ..	146
Joppa ... ..	12	Phoenix, Philadelphia ... ..	44
Jordan ... ..	20	Phoenix, Leipzig ... ..	72
Jubilee ... ..	12	Phoenix, Sunderland... ..	246
Judah ... ..	12	Pilgrim ... ..	145
Kamloops, B.C. ... ..	197	Prince of Wales ... ..	192, 197
Kent ... ..	14, 96	Prosperity ... ..	14
Light ... ..	188, 194	Prudent Brethren ... ..	13, 65
Lion and Lamb ... ..	44	Rahere ... ..	197
London ... ..	23	Rectitude ... ..	193
London School Board ... ..	198	Red Cross, Unanimity, No. 992 ... ..	2
Lorne ... ..	197	Restoration... ..	247
Loyalty ... ..	193	Robert Burns ... ..	96
Marches, Ludlow ... ..	173	Robert Freke Gould ... ..	176
Marmion ... ..	196	Royal Alpha ... ..	13
Marquis of Granby ... ..	189, 247	Royal Athelstan ... ..	96
Masters' ... ..	17, 27	Royal Gloucestershire ... ..	195
Meridian, 86th Regt. ... ..	176	Royal Isle of Man ... ..	193
Methuen ... ..	197	Royal Kent of Antiquity ... ..	20
Minerva, Leipzig ... ..	72	Royal Navy, Ramsgate ... ..	176
Moira ... ..	19, 179, 192	Royal Somerset House and Inverness ... ..	193
Mount Lebanon ... ..	22	Royal Standard, Halifax, N.S. ... ..	91
Mourning Bush ... ..	20	Royal Sussex ... ..	199
Neptune ... ..	19, 96	Royal Union ... ..	106
Nile ... ..	188	Royal York of Perseverance ... ..	25, 95
Noah's Ark, No. 347 ... ..	2	Ryde ... ..	192
Norfolk ... ..	198	St. Alban's ... ..	183
No. 3, St. Patrick's ... ..	204	St. Alban's, Adelaide ... ..	195
No. 4, Dublin ... ..	36	St. Andrew's ... ..	195, 249
No. 25, Cork ... ..	69	St. David's ... ..	193
No. 38, Ballintoy ... ..	244	St. David, Edinburgh ... ..	44
No. 51, Philadelphia ... ..	44	St. George's ... ..	17
No. 61, Halifax, N.S. ... ..	91	St. George and Corner Stone ... ..	95
No. 136, 19th Regt. ... ..	91	St. James ... ..	103, 194
No. 156, Kinsale ... ..	205	St. John ... ..	247
No. 163, Birr ... ..	91	St. Martin, Liskeard ... ..	245
No. 163, Parsonstown ... ..	91	St. Mary ... ..	18
No. 179, 12th Regiment Dragoons ... ..	205	St. Mary Magdalen ... ..	194
No. 209, Dublin ... ..	205	St. Thomas, Muirkirk ... ..	91
No. 233, Ballinrobe ... ..	91	Salopian ... ..	171
No. 258, Carrickfergus ... ..	91	Salopian of Charity ... ..	171
No. 271, Limerick ... ..	2	Sanctuary ... ..	198
No. 274, Royal Irish Regt. ... ..	205	Saye and Sele ... ..	198
No. 295, 1st Horse ... ..	205	SS. Peter and Paul ... ..	195
No. 306, Banagher ... ..	91	Scientific ... ..	191, 194
No. 307, Roscrea ... ..	91	Shadwell Clarke ... ..	192
No. 329, 53th Regt. ... ..	91	Shakespeare ... ..	23
No. 338, Boyle ... ..	202, 207	Sion, No. 3, 57th Regt. ... ..	203
No. 357, Roxburgh ... ..	91	Sir Will Harpur ... ..	198
No. 410 ... ..	91	Social and Military Virtue ... ..	249
No. 413, Bandon ... ..	206	Sphinx ... ..	193
No. 441, 38th Regt. ... ..	39	Stability ... ..	15
No. 495, Cork Militia ... ..	206	Stewards', London ... ..	4
No. 509, Crossakill ... ..	205	Strong Man ... ..	14
No. 530, Sligo ... ..	203	Surrey ... ..	191
No. 552, Monaghan Militia ... ..	207	Thames ... ..	197
No. 568, Tobercurry ... ..	204	Three Grand Principles ... ..	188
No. 607, Kells ... ..	205		

Lodges referred to:—	PAGE.	Persons referred to:—	PAGE.
Tranquility ... ..	13, 16, 22	Begemann, Dr. W. ... ..	55, 233
Trinity College ... ..	192	Bell, Jacob ... ..	106
"Two Parallels," ... ..	91	Bell, Seymour ... ..	43
Tuscan ... ..	21	Bellamy, C. V. ... ..	181
Underley ... ..	195	Bensley, W. T. ... ..	244
Union ... ..	66, 190, 193, 198	Bent, Rev. Paul ... ..	190
Union Waterloo ... ..	96	Bergmann, J. ... ..	43, 72
United Mariners ... ..	14	Billings, R. B. ... ..	210
Unity ... ..	191	Blood, J. M. ... ..	180
Universal ... ..	20, 194	Boteler, J. ... ..	111
Universities ... ..	197	Boteler, W. S. ... ..	111
Vacation ... ..	24	Bowen, Rev. David ... ..	197
Virgin, Nova Scotia ... ..	196	Bowes, Arthur ... ..	165
Warden ... ..	188, 197	Bowman, Ed. ... ..	67
West India and American ... ..	21, 29	Bowyer, Rev. W. H. W. ... ..	188, 199, 200
Westminster and Keystone ... ..	20, 191, 192	Brassey, Lord ... ..	249
Wychwood... ..	197	Breed, E. A. T. ... ..	2, 71
Zetland ... ..	145	Brookhouse, J. C. ... ..	2, 111
Zum Morgenstern, Hof ... ..	72	Brown, A. Burnett ... ..	90
London Taverns ... ..	8	Brown, W. ... ..	39
Ludlow, Visit to ... ..	173	Browne, Rev. G. A. ... ..	187, 200
Luxor, Brotherhood of ... ..	241	Brownrigg, Canon ... ..	190
Maitre Coën ... ..	147	Bugby, Bro. ... ..	67
Manicheism and Templarly ... ..	209	Bullock, Rev. R. ... ..	194, 199, 201
Mark degree in Cornwall ... ..	245	Bunn, John... ..	63, 64
Martinism and Martinézism ... ..	147	Burgess, Nathaniel ... ..	104
Masonry (Continental) 18th Century ... ..	147	Burgess, Rev. James... ..	187
Masters' Lodge ... ..	247	Burton, Rev. F. M. ... ..	196
Medal, Bard of Avon Lodge ... ..	180	Bussell, Rev. V. B. ... ..	192
Mugs, Masonic ... ..	4, 44	Butler, James ... ..	91
Naimus Grecus ... ..	31, 45	Byng, Rev. F. E. C. ... ..	193, 199
Old Charges ... ..	50, 69	Cagliostro, Count ... ..	152
Old Friends, Society of ... ..	92	Carloman ... ..	50
Oliver, Unreliable as a Masonic historian ... ..	183	Carroll, Rev. John ... ..	91
Order of Ishmael ... ..	243	Carter, Thos. ... ..	65
Order of St. George, Bavaria ... ..	87	Castle, E. J. ... ..	208
Order of St. Stephen ... ..	87	Charlemagne ... ..	32, 45
Order of the Holy Sepulchre ... ..	137	Charles Martel ... ..	45
Orange Lodge in London ... ..	2	Chesterfield, Earl of ... ..	97
Past Masters to represent Master and Wardens ... ..	93	Childe, Canon ... ..	195
Pentangle, a basis of Architectural design ... ..	170	Church, Thomas ... ..	206
Persons referred to:—		Clarke, Archdeacon ... ..	202
Acton, Nathaniel ... ..	65	Clarke, Sir W. J. ... ..	249
Agar, Jas. ... ..	63	Clarkson, Edward ... ..	210, 223
Albanus ... ..	46	Clauny, Dr.... ..	248
Albinus ... ..	45	Clay, Stephen ... ..	44, 108
Alce, Bro. ... ..	67	Correstine, Bro. ... ..	207
Aleuin ... ..	31, 45	Collier, Bro. ... ..	67
Aldbehrt ... ..	46	Cochrane, Rev. Thomas ... ..	191, 199
Aldhouse, Benjn. ... ..	67	Coghlan, Rev. J. A. ... ..	182
Amphibalus ... ..	46	Coghlan, Rev. Lucius ... ..	185
Ancrum, Earl of ... ..	207	Cohu, Thomas ... ..	44
Armitage, E. ... ..	124, 199	Cokburne, Rev. L. D. H. ... ..	187
Armstrong, Robert ... ..	206	Cole, Christian John ... ..	71
Arnold, Rev. C. W. ... ..	190	Cole, John ... ..	1, 4
Ashmole, Elias ... ..	19	Coleman, James ... ..	40
Athelstone ... ..	45	Colman, Rev. S. S. ... ..	186, 200
Atholl, Duke of ... ..	65	Conder, E. ... ..	165
Augustine, Saint ... ..	221	Corker, Thomas ... ..	203, 204, 205, 207
Aymon ... ..	32	Cox, Edward W. ... ..	170
Barlow, Capt. William ... ..	100	Cox, Rev. J. E. ... ..	188, 200
Barry, Rev. E. ... ..	185	Cox, Phil ... ..	203
Bawett, John ... ..	203	Cramer, W.... ..	234
Beaumont, Canon ... ..	198	Crawford, Robert ... ..	65
Bedford, Rev. W. C. K. ... ..	197	Crawley, Dr. W. J. Chetwode... ..	96, 178
Bedford, Rev. W. K. B. ... ..	188, 199	Crease, Col.... ..	235
		Crowe, F. J. W. ... ..	112
		Curragan, John ... ..	91
		Currie, Rev. E. R. ... ..	193
		Dakeyne, Rev. J. O. ... ..	188
		Dalhousie, Marquis of ... ..	102
		Davy, Rev. C. R. ... ..	189, 199
		Davey, Rev. H. M. ... ..	197
		Day, Robert ... ..	69
		de Fabeck, W. F. ... ..	71

	PAGE.
<b>Persons referred to:—</b>	
de Hauterive, Mons. ...	152
de Pernety, Antoine Joseph ...	149
Dermott, L. ...	65, 93, 97
Dicas, John... ..	63
Dickey, W. ....	64, 65, 180
Dodd, Rev. William ...	182, 200
Doune, Viscount ...	207
Dow, J. M. ...	245
Downes, Rev. John F. ...	198
Dring, E. H. ...	31, 45, 90, 110
Duffey, Thomas ...	91
Ebblewhite, E. A. ...	90
Eccles, Rev. A. H. ...	185
Edlin, T. ...	136
Ethelbert ...	47
Evans, Jeremiah ...	94, 97
Evans, Rev. Richard ...	192
Faber, John ...	101
Fairclough, Rev. John ...	192
Fallowfield, Rev. W. ...	187
Farnfield, W. ...	44
Feeley, Pat ...	207
Fellows, J. W. ...	146
Ferry, C. E. ...	250
Fetherston, Fran. ...	204
Fetherston, Richard ...	206
Findel, G. J. G. ...	72
Finnemore, R. I. ...	251
Firminger, Rev. W. K. ...	102, 147
Fitton, John ...	69
Fitzgerald, James ...	40
Fitzgerald, Lord Edward ...	39
Fitzgerald, Valentine ...	91
Flavelle, H. E. ...	40
Fletcher, Mr. ...	25
Fletcher, W. W. ...	108
Fooks, William ...	250
Forbes, S. Russell ...	54
Foules, Sir Francis ...	207
Fox, Geoffrey ...	92
Fox, Rev. S. W. ...	182
Fox, Walter C. ...	92
Fraser, John ...	106
Frazer, Rev. A. B. ...	190
Frazer, Rev. W. H. ...	71
Freeman, V. P. ...	71
Fry, John ...	204
Gardiner, Rev. William ...	196, 199
Gardiner, E. ...	11
Garry, Canon ...	196
Gatenis, Abraham ...	105
Gay, Nicholas ...	203
Gibson, Rev. Benjamin ...	182
Gill, Robert... ..	67
Gillooly, Brian ...	202
Glave, Robert ...	97
Gleadall, Rev. J. W. ...	188
Gleason, L. R. ...	4, 111
Godwin, George ...	64
Goldsmith, John ...	206
Gould, R. F. ...	2, 176, 231
Grace, Rev. O. G. ...	194
Graham, Alexander ...	174
Grant, Rev. James ...	186
Gray, Rev. F. H. ...	195
Gribble, J. D. B. ...	250
Griffin and Lay ...	240
Grisewood, Rev. A. G. ...	198
Guy, Harry ...	65, 143
Gwynne, Richard ...	100
Hailes, Bro... ..	36
Hales, John... ..	65
Hall, Rev. A. W. ...	191
Hallam ...	209

	PAGE.
<b>Persons referred to:—</b>	
Hamilton, G. M. E. ...	90
Hammer-Purgstall ...	209
Hanbury, Rev. Barnard ...	187
Handy, Bro. ...	105
Harding, W. E. ...	172
Hardwicke, Earl of ...	68
Harper, Edward ...	64
Harper, Thomas ...	3, 63, 64, 66, 91, 96, 111
Harries, John ...	100
Hawkins, E. L. ...	180, 199
Hawksley, John ...	91
Hay, Thomas ...	207
Haycock, Bro. ...	104
Hayes, Rev. Sir J. W. ...	188, 199
Hayman, Rev. H. T. ...	198
Healy, Thomas ...	206
Heath, Rev. W. M. ...	192
Heathfield, Lord ...	39
Hemming, Rev. Samuel ...	187
Henissey, Thomas ...	91
Hennerley, J. ...	91
Herring, Charles ...	107
Hewer, H. J. ...	71
Hextall, W. B. ...	100, 144
Hicks, Edward ...	71
Hill, Rev. W. A. ...	190
Hixon, Bro. ...	240
Hockaday, W. ...	64
Hodgson, Bro. ...	104
Hole, Dean ...	195, 199
Holdford, T... ..	91
Holsworth, Bro. ...	67
Hogan, Bro. ...	67
Hope, W. St. John ...	119
Hopkins, R. B. ...	251
Horlock, Rev. D. H. W. ...	197, 199
Horsley, Canon ...	90, 92, 107, 181, 198
Houston, Andrew ...	207
Howard, C. C. ...	54
Howard, Sir R. N. ...	71
Hughan, W. J. ...	27, 93, 103, 200, 232, 245, 246
Humphreys, Richard... ..	64
Hutchinson, William... ..	247
Huyshé, Rev. John ...	188, 199, 200
Ingram, Prebendary ...	198
Irons, George ...	65
Irvine, G. D. ...	206
Isitt, S. F. ...	71
Jackson, Rev. A. ...	198
Jameson, Mrs. ...	218
Jaques, Thomas ...	202
Jeffreys, William ...	105
Jelliffe, Bro. ...	67
Jones, Bro. ...	67
Jones, R. E. ...	173
Jones, W. H. ...	244
Jowin, Bro. ...	207
Kennan, H. L. ...	180
Kennion, Bishop ...	195
Kenn, Bro. ...	66
King, C. W. ...	225
King, W. Y. ...	145
Kintore, Earl of ...	249
Kipps, W. J. ...	90
Kirchberger, Baron ...	152
Knapp, Rev. H. J. ...	186
Kupferschmidt, C. ...	54, 233
Kynaston, Rev. H. ...	194
Lambert, Rev. Brooke ...	196
Lamonby, W. F. ...	143, 248
Lane, John ...	233
Lansdell, Rev. Henry ...	194
Larkin, William ...	91

	PAGE.		PAGE.
<b>Persons referred to :—</b>		<b>Persons referred to :—</b>	
Larousse ... ..	218	Onslow, Rev. W. L. ... ..	190
Last, John T. ... ..	72	Orpen, Francis H. S. ... ..	38
Lavater ... ..	159	Onseley, Rev. Sir F. G. ... ..	189
Lawrance, Walter ... ..	90	Page, Alfred ... ..	71
le Feuvre, J. C. ... ..	44	Palmer, John ... ..	174
le Strange, Hamon ... ..	230	Palmer, Rev. J. N. ... ..	192, 199
Lee, Rev. F. B. Norman ... ..	196	Papworth, Wyatt ... ..	235
Lefroy, <i>Dean</i> ... ..	198	Parker, Bro. ... ..	67
Leigh, Rev. J. Wentworth ... ..	196	Parker, G. P. ... ..	90
Lemon, Rev. T. W. ... ..	92	Parker, Rev. John ... ..	182
Leslie, Robert ... ..	63, 64, 65, 96	Parr, Rev. E. R. ... ..	196
Lethaby, <i>Professor</i> W. R. ... ..	115	Parry, Rev. William ... ..	186
Levander, F. W. ... ..	4, 70, 180	Parkin, Henry ... ..	251
Lewes, Watkin ... ..	63	Patullo, G. ... ..	67
Lewis, <i>Bishop</i> ... ..	195, 199	Paxton, William ... ..	91
Lewis, T. Hayter ... ..	166, 232	Peek, Rev. Richard ... ..	196
Lincoln, W. S. ... ..	92	Pepin ... ..	50
Little, Wentworth ... ..	107	Perkins, Thomas Marriot ... ..	30
Lloyd, J. W. ... ..	145	Peyton, Randle ... ..	204
Lloyd, Rev. J. A. ... ..	193, 199	Peyton, William ... ..	204
Lobingier, Charles S. ... ..	69, 137	Phillipps, Sir John ... ..	100
Lock, Adam ... ..	121	Pickard, Rev. H. A. ... ..	190, 199
Lock, Thomas ... ..	121	Pickering, Thomas ... ..	250
Lockwood, Luke A. ... ..	145	Pilkington, Rev. J. H. ... ..	198
Logan, William ... ..	71	Plasted, Richard ... ..	91
Long, Hiram ... ..	250	Plunket, <i>Archbishop</i> ... ..	182
Longworth, John ... ..	91	Plunket, Rev. W. C. ... ..	182
Lynd, William ... ..	91	Pope, Rev. R. W. M. ... ..	193, 199
Lyte, Rev. W. J. ... ..	192	Portal, <i>Canon</i> ... ..	192, 199
Macbean, Edward ... ..	233	Potter, Bro. ... ..	67
McCalla, C. P. ... ..	245	Prior, E. S. ... ..	125
Macdonald, Rev. F. W. ... ..	194, 199	Purey-Cust, Rev. A. P. ... ..	191, 199
McDonogh, Patrick ... ..	204	Quennell, <i>Canon</i> ... ..	197
Mackay, Bro. ... ..	97	Rawlins, Bro. ... ..	67
Mackenzie, Kenneth R. H. ... ..	243	Randall, Rev. W. ... ..	193
McLearn, Patt ... ..	91	Ravenshaw, Rev. T. F. ... ..	189, 199
McLoud, John ... ..	108	Rayner, Bro. ... ..	104
McSorley, Rev. J. J. ... ..	182	Raynouard ... ..	209
McQuone, Joseph ... ..	91	Reed, W. H. ... ..	103
Mace, James ... ..	44	Reeve, J. ... ..	4
Maigneon, Timothy ... ..	68	Richmond, <i>Duke of</i> ... ..	128
Malcovich, L. A. de ... ..	73, 127	Rideal, G. S. ... ..	145
Markham, Sir A. H. ... ..	27	Ridgeway, Rev. C. J. ... ..	195
Marsland, Octavius ... ..	251	Riley, Rev. C. O. L. ... ..	195
Martin, Bro. ... ..	36	Riley, J. Ramsden ... ..	63
Martin, Sir R. Biddulph ... ..	90	Rimington, Bro. ... ..	143
Martin, William ... ..	91	Roberts, Rev. C. E. ... ..	198
Martinez Pasqualis ... ..	147	Robbins, Rev. John ... ..	192, 199
Martyn, Rev. C. J. ... ..	189, 199, 201	Robinson, Rev. Thomas ... ..	191, 201
Mason, John ... ..	67	Robson, George ... ..	92
Mason, Thos. A. ... ..	2	Robson, Thomas ... ..	248
Massey, William ... ..	65	Rodber, Rev. W. J. ... ..	187
Michelet ... ..	210	Rodriguez, F. de P. ... ..	142
Milford, <i>Baron</i> ... ..	100	Roffey, J. R. ... ..	251
Milman, Dr. ... ..	209	Roner, John ... ..	206
Milne, Rev. Colin ... ..	186	Rosedale, Dr. ... ..	59
Mohr, Bro. ... ..	72	Rosenbaum, Rev. M. ... ..	121
Moore, Rev. Edward ... ..	188	Rowlands, Rev. Parker ... ..	186
Moore, Samuel ... ..	108	Royston, Rev. Peter ... ..	250
Moors, Henry ... ..	251	Rupp, G. P. ... ..	44, 146
Morgan, John ... ..	93, 127	Russell, William ... ..	202
Morse, Rev. H. G. ... ..	191	Rylands, W. H. ... ..	29, 52, 58, 90, 110, 111, 170, 232
Mounsey, Bro. ... ..	104	Sadler, Henry ... ..	66, 92
Murray, Bernard ... ..	202	Sackville, Lord George ... ..	97
Naismes, <i>Duke of</i> ... ..	32	St. Maur ... ..	240
Newcomb, Bro. ... ..	67	St. Martin ... ..	147
Newman, W. ... ..	43, 111	Samuel, Ralph ... ..	108
Nicholson, Timothy ... ..	39	Sanders, <i>Canon</i> ... ..	192
Noreys, <i>Master</i> ... ..	121	Saunders, Rev. S. T. H. ... ..	198
Norman, William ... ..	2	Sanderson, Rev. R. N. ... ..	192
Oates, William ... ..	2	Savory, Rev. Sir Borradaile ... ..	197
Officer, William ... ..	145	Schuitger, F. F. ... ..	235
Oldys, William ... ..	135	Schropffer ... ..	159
Oliver, Andrew ... ..	28		

Persons referred to:—		PAGE.	Persons referred to:—		PAGE.
Scott, Bro. ...	...	67	Wakeman, Sir Offley ...	...	171
Scott, Thomas ...	...	64	Walker, Dr. C. R. ...	...	145
Scott, Sir Walter ...	...	44	Walker, George ...	...	91
Sedgwick, Rev. John ...	...	189, 199	Walker, G. Walton ...	...	2
Senior, Rev. Joseph ...	...	188	Wallace, William ...	...	91
Seton, A. ...	...	208	Ward, Rev. A. R. ...	...	188
Sewell, Bro. ...	...	67	Ware, Bishop ...	...	195
Shackles, George L. ...	...	4, 44, 108	Warre, C. B. ...	...	71
Shaw, Mr. ...	...	143	Warren, Sir Charles ...	...	232
Short, Rev. W. F. ...	...	189, 199	Watson, J. ...	...	39
Shelbourne, Hugh ...	...	4	Watson, J. Proctor ...	...	180
Shepherd, R. J. ...	...	91	Watson, William ...	...	201, 249
Silberbauer, C. F. ...	...	200	Watts, Bro. ...	...	67
Simmons, B. P. ...	...	65	Welch, Louis ...	...	146
Simpson, Canon ...	...	190	Weldon, Rev. G. W. ...	...	192
Simpson, J. P. ...	...	8, 90, 97, 110, 180	Welldon, Bishop ...	...	197
Simpson, Rev. R. J. ...	...	189, 201	West, William ...	...	203
Simpson, W. ...	...	232	Westcott, W. Wynn ...	...	232, 241
Sinclair, Archdeacon ...	...	194	Westley, Rev. H. J. ...	...	182
Sirr, Harry ...	...	36, 68, 70, 127	Westropp, Col. W. K. ...	...	71
Sirr, Henry Charles ...	...	36, 143	Wheatley, Bro. ...	...	105
Sirr, Major H. C. ...	...	39, 142	Whelan, John ...	...	202
Sirr, Joseph ...	...	41	White, Hubert ...	...	71
Smalies, Dr. R. ...	...	145, 245	White, W. H. ...	...	36, 44
Smith, Alexander ...	...	65	Whippy, John ...	...	64
Smith, Sir Gerard ...	...	249	Whythead, T. B. ...	...	234
Smith, Rev. H. R. Cooper ...	...	194, 199	Wiebe, Carl ...	...	2, 176, 246
Smith, General John Corson ...	...	202	Wiggins, Thos. ...	...	67
Smith, Sam ...	...	67	Wigram, Rev. S. R. ...	...	190, 199
Smyth, Richard ...	...	2	Wilford, John ...	...	136
Smyth, Rev. T. C. ...	...	192, 202	Williams, Howard Douglas ...	...	250
Songhurst, W. J. ...	...	1, 43, 90, 92, 94	Williams, Rev. W. H. ...	...	196, 199
Spence, Dean ...	...	195	Williams, W. ...	...	2
Spence-Gray, Rev. H. J. ...	...	195	Willoughby, Moses ...	...	97
Spencer, Rev. T. B. S. ...	...	193	Willoughby, W. H. ...	...	92
Speth, G. W. ...	...	231	Wilson, James ...	...	239
Stanfield, J. F. ...	...	247	Wilson, Sir William ...	...	19
Stanford, Charles Villiers ...	...	205	Withey, T. A. ...	...	3, 244
Stanford, John ...	...	205	Woodford, Rev. A. F. A. ...	...	188, 201, 232
Stanhope, Rev. C. W. Spencer ...	...	191, 199	Wolf, Albert ...	...	250
Stevens, Archdeacon ...	...	195	Wonnacott, W. ...	...	99, 107, 116
Stevens, Charles ...	...	92	Wren, Sir Christopher ...	...	23
Stötzer, Fritz ...	...	145	Wyatt, Rev. V. P. ...	...	198
Sudworth, William ...	...	145	Yarker, John ...	...	31, 243
Swedenborg ...	...	158	Phoenix Britannicus ...	...	127
Sweeny, Hugh ...	...	204	Plaque, Presentation to Bro. Gould ...	...	2, 175
Swiney, Shap! ...	...	39	Princes of the Royal Secret ...	...	148
Swinney, Rev. S. ...	...	185	Procession at Masonic Funeral ...	...	69
Tagg ...	...	63, 64	Punchbowls, Masonic ...	...	180
Talbot, William ...	...	91	Razors, Masonic ...	...	92
Taylor, John ...	...	67	Red Cross, Certificate of, 1808 ...	...	2
Tearman, Rev. A. J. ...	...	126	Report of Audit Committee ...	...	4
Thomas, Rev. R. J. F. ...	...	189	Roman London ...	...	9
Thompson, Rev. W. O. ...	...	191, 199	Round Table, Knights of the ...	...	111
Thornhill, John ...	...	247	Royal Arch and Rainbow ...	...	97
Thorp, J. T. ...	...	63, 92, 244, 245	Royal Secret, Princes of ...	...	148
Todman, Frank ...	...	71	St. Alban Legend ...	...	45
Tindall, W. ...	...	65	St. George, Order of ...	...	87
Todd, J. D. ...	...	246	St. Stephen, Order of ...	...	87
Todd, T. O. ...	...	246	Seals on Grand Chapter Certificates ...	...	63
Tringham, W. ...	...	30	Seals used by an Orange Lodge ...	...	2
Tristram, Canon ...	...	71, 191, 199	Sea Serjeants ...	...	100
Turner, Robert ...	...	96	Sheba, Queen of ...	...	112
Tyler, John ...	...	203	Shrewsbury, Visit to ...	...	171
Upton, William Henry ...	...	251	Smoking in Lodges ...	...	104
Vaillant, J. P. ...	...	234	Society of Old Friends ...	...	92
Vane, Rev. John ...	...	187	Solomon and Queen of Sheba ...	...	112
Venables, R. G. ...	...	173	Spanish Templars ...	...	141
Vernon, Thomas ...	...	108	Square found at Baal's Bridge ...	...	37
Villiers, Bro. ...	...	67	Stokesay Castle, Visit to ...	...	173
Vincent, Rev. Sir W. ...	...	194, 199	Strict Observance ...	...	149
Vine, James ...	...	174	Swedenborg and Masonry ...	...	148
Vogeler, G. ...	...	3, 29, 72			
von Hammer ...	...	209			

	PAGE.		PAGE.
Tavern signs ... ..	11, 28	Triangle, a Basis of Architectural Design ... ..	165
Templarism, Survival in Spain ... ..	69	Vrai Maçon ... ..	149
Templars, Charges against the ... ..	209	Watson MS. ... ..	51
Templary in Spain ... ..	141	Wine Glass, Masonic ... ..	92
Temple Church, So-called Gnostic Emblems in ... ..	210, 223	York, Missing MSS. of the Old Charges	69
Teutonic Knights, History of ... ..	73		
Theatres modelled on Tavern Court-yards ... ..	10		
Tobacco Box, Society of Old Friends...	92		

## ILLUSTRATIONS.

	PAGE.		PAGE.
Amiens Cathedral ... ..	126	Seal of Orange Lodge ... ..	2
Antwerp Bible, 1565 ... ..	126	Sheba, Queen of ... ..	126
Apron, Engraved ... ..	239	Shrewsbury, St. Mary's Church ... ..	170, 172
Biblia Pauperum ... ..	126	"    Market Hall ... ..	172
Biblia Sacra ... ..	126	"    Mardol ... ..	172
Certificate ... ..	240	"    Butcher Row ... ..	172
Certificate, Antient Lodge, No. 53, Liverpool ... ..	108	"    Grove Lane ... ..	172
Certificate, Antients, R.A., 1792 ... ..	63	"    Fish Street ... ..	172
"    "    "    1795 ... ..	64	"    Old Mint ... ..	172
"    "    "    1808 ... ..	64	"    The Raven ... ..	172
Certificate, Deomatic Lodge, No. 234 ... ..	111	"    Ship Inn ... ..	172
"    K.T. ... ..	2	"    Rowley's Mansion ... ..	172
"    Red Cross ... ..	2	"    The Castle ... ..	172
Chartres Cathedral ... ..	126	"    The Council House ... ..	172
Corbeil Church, Figures from ... ..	126	Solomon and the Queen of Sheba ... ..	126
Gavel of Noah's Ark Lodge ... ..	2	Stokesay, The Church ... ..	172
Gould Jubilee Plaque ... ..	178	"    The Castle ... ..	172
Gregorians, List of Chapters ... ..	19	"    The Gatehouse ... ..	172
History of Old and New Testaments... ..	126	Summons, Lodge of Antiquity ... ..	21
Jewel, Antient Lodge, No. 53, Liverpool ... ..	138	Summons of West India and American Lodge ... ..	21
Jewel, Engraved ... ..	111	Taverns, "Old Fountain," Minorities ... ..	12
"    R.A. of 1789 ... ..	209	"    "    "    "    London," Bishopsgate Street ... ..	13
List of Lodges, Ancients, 1753 ... ..	96	"    "    "    "    "    Old Elephant," Fenchurch Street ... ..	13
Ludlow, The Feathers ... ..	172	"    "    "    "    "    White Hart," Bishopsgate Street ... ..	13
"    The Reader's House ... ..	172	"    "    "    "    "    Sir Paul Pindar's Head," Bishopsgate Street ... ..	14
"    The Castle ... ..	172	"    "    "    "    "    Catherine Wheel," Bishopsgate Street ... ..	15
"    The Chapel ... ..	172	"    "    "    "    "    George and Vulture," Cornhill ... ..	17
Mansion House, London ... ..	16	"    "    "    "    "    Caveac," Threadneedle Street ... ..	18
Medal ... ..	44	"    "    "    "    "    Blossoms," Cheapside ... ..	20
New History of the Holy Bible ... ..	126	"    "    "    "    "    Dolphin," Ludgate Hill ... ..	22
Notre Dame, Paris ... ..	126	"    "    "    "    "    Belle Savage" ... ..	23
Plan shewing extent of fire in Bishopsgate, 1765 ... ..	16	"    "    "    "    "    Greyhound," Fleet Street ... ..	24
Portrait, Joseph Sirr ... ..	40	"    "    "    "    "    Devil," ... ..	25
"    Major Sirr ... ..	40	Triangle in Gothic Architecture ... ..	165
"    Henry Charles Sirr ... ..	40	Uriconium ... ..	172
Rheims Cathedral ... ..	126	Venice Bible, 1587... ..	126
Rochester Cathedral ... ..	126	Wells Cathedral ... ..	126, 165
		West India and American Lodge Summons ... ..	21

## CONTRIBUTORS.

	PAGE.		PAGE.
Begemann, Dr. W....	55	Malczovich, L. A. de	73, 137
Bowes, Arthur ...	165	Markham, Sir A. H.	27
Castle, E. J. ...	209	Oliver, Andrew ...	28
Clarke, Archdeacon	202	Rodriguez, F. de P.	142
Crowe, F. J. W. ...	112	Rosenbaum, Rev. M.	121
Day, Robert ...	69	Rylands, W. H. ...	29, 58
Dring, E. H. ...	45	St. Maur ...	239
Firminger, Rev. W. K.	147	Shackles, Geo. L. ...	108, 236
Guy, Harry ...	65, 143	Simpson, J. P. ...	8, 96
Hextall, W. B. ...	28, 100, 144	Sirr, Harry ...	36, 68, 70, 127
Horsley, Canon J. W.	58, 181	Songhurst, W. J. ...	171
Hughan, W. J. ...	27, 93, 102, 244, 245, 246	Thorp, J. T. ...	63
Lamonby, W. F. ...	143	Watson, William ...	248
le Strange, Hamon	231	Westcott, W. Wynn	241
Levander, F. W. ...	70	Wonnacott, W. ...	99, 103, 116
Lobingier, Charles S.	69	Yarker, John ...	31



# Ars Quatuor Coronatorum,

BEING THE TRANSACTIONS OF THE  
*Quatuor Coronati Lodge of A.F. & A.M., London,*

No. 2076.

---

VOLUME XIX.

---

FRIDAY, 12th JANUARY, 1906.



THE Lodge met at Freemasons' Hall, at 5 p.m. Present:—Bros. G. L. Shackles, W.M.; Rev. Canon J. W. Horsley, I.P.M.; E. Armitage, P.D.G.D.C., S.W.; F. H. Goldney, P.G.D., J.W.; W. H. Rylands, P.A.G.D.C., Sec.; F. J. W. Crowe, P.G.O., J.D.; W. M. Bywater, P.G.S.B., D.C.; H. Sadler, G.Ty., I.G.; G. Greiner, A.G.S.G.C., P.M., as S.Stew.; R. F. Gould, P.G.D., P.M.; S. T. Klein, P.M.; E. J. Castle, P.D.G.R., P.M.; and Bro. W. J. Songhurst, Asst. Sec. and Librarian.

Also the following seventy-six members of the Correspondence Circle:—

Bros. T. CoHu, Gr.St.B.; J. Miller, Rev. W. K. Firminger, Col. W. J. Pickance, J. P. Simpson, J. M. Prillewitz, F. Stötzer, W. Kipps, P.A.G.P.; K. Smith, jun., W. H. White, A. S. Gedge, H. B. Watson, W. J. Falkner, W. S. Boteler, W. Hammond, G. H. Lutchford, D. Bock, A. C. Mead, A. Walker, H. C. Nelthorpe, J. Murray, W. Wonnacott, T. Taylor, P.G.D.; J. J. Dixon, W. Dickenson, W. Miller, A. Oliver, S. Marsland, W. J. Allen, F. W. Neuburger, C. T. Morgan, H. Hyde, R. Herrmann, W. Metcalfe, P.G.St.B.; B. V. Darbishire, C. Gough, E. H. Pike, L. R. Gleason, L. Harding, C. E. Ferry, P.G.St.B.; J. S. Stacy, W. Busbridge, L. G. Tate, A. E. Bernays, W. J. Newstead, A. Simner, P.A.G.D.C.; J. W. Atkinson, J. D. Butler, S. Walshe Owen, A. A. Millward, W. H. Layton, G. S. King, L. Danielsson, C. F. Finzel, G. Vogeler, W. H. Brown, H. R. White, A. G. Wood, F. E. Lemon, F. J. Burgoyne, J. M. Grant, jun., G. T. Lawrence, A. E. Krauss, H. Eaborn, J. Pullen, S. Meymott, P. A. Nairne, T. Leete, B. Matveieff, C. S. Burdon, T. H. Dey, J. White, H. J. Shelbourne, W. Minhurst, Rev. T. W. Lemon, and J. C. Brookhouse.

Also the following visitors:—Bros. V. B. M. Zanchi, P.M. Regularity Lodge No. 91; J. F. Cape, W.M. Ebbisham Lodge No. 2422; S. C. Clarke, J.D. Rosemary Lodge No. 2851; F. Stubbins, J.D. Beaconsfield Lodge No. 1662; F. H. Nalder, Addiscombe Lodge No. 1556; G. H. Kinns, Saye and Sele Lodge No. 1273; and Mihill Slaughter, P.A.G.D.C., P.M. 176.

---

A Dispensation to change the date of the meeting from the 5th to the 12th of January was read.

Letters of apology for non-attendance were read from Bros. Dr. Chetwode Crawley, Gr.Treas. Ireland; W. J. Hughan, P.G.D.; H. le Strange, Prov.G.M. Norfolk; Admiral Sir A. H. Markham, P.D.G.M. Malta; J. P. Rylands, General Sir Charles Warren, P.G.D.; W. Watson, E. Macbean, E. Conder, jun., T. B. Whytehead, P.G.S.B.; Lt.-Col. S. C. Pratt, L. A. de Malczovich, and J. T. Thorp, P.A.G.D.C.

Eighty-four brethren were admitted to the membership of the Correspondence Circle.

---

The W.M. proposed and the S.W. seconded as a joining member of the Lodge, Bro. William John Songhurst, 9, Cromwell Place, Highgate, N., London. Fellow of the Chartered Institute of Secretaries. P.M. Ionic Lodge No. 227. Founder Alleyn Lodge No. 2647 and Semper Vigilans Lodge No. 3040. P.Z. Royal York Chapter of Perseverance No. 7. P.Z. Panmure Chapter No. 720. Writer of a paper on "Ragon," and of several shorter papers and notes which have appeared in the *Transactions*,



It was proposed by the W.M., seconded by the I.P.M. and carried, That official recognition be given by this Lodge to, and the permission to use the Lodge emblems on, the medal about to be issued by Bro. Carl C. Wiebe, P.G.M. Hamburg, in commemoration of the Jubilee Anniversary of W.Bro. Robert Freke Gould's initiation into Freemasonry.

Bro. R. F. GOULD, after thanking the brethren present for the honour they had done him by concurring in the proposal made by Past Grand Master Wiebe, said he wished to express his particular acknowledgments to Bros. E. J. Castle, K.C., P.D.G.R., and F. H. Goldney, P.G.D., who had been discharging important public functions at Bristol and Devizes respectively, on that very day, for succeeding in being present, though at some inconvenience to themselves. He also wished to record his sincere thanks to Bros. General Sir Charles Warren, G.C.M.G.; Colonel S. C. Pratt; W. J. Hughan, P.G.D.; T. B. Whytehead, P.G.S.B.; W. W. Westcott, P.G.D.; W. J. Chetwode Crawley, Grand Treasurer (Ireland); the Rev. C. J. Ball; Admiral Sir Albert H. Markham, K.C.B.; L. A. de Malczovich; Edward Conder; Hamon Le Strange, Prov. G.M. Norfolk; J. T. Thorp, P.A.G.D.C.; and William Watson; all of whom, though unable to attend that evening, had written to him expressing kindly felicitations on the attainment of his 50th Masonic birthday, together with their warm approval of the proposal to commemorate that occurrence in the manner that had been suggested by Past Grand Master Wiebe.

The W.M. alluded in feeling and appreciative terms to the recent loss sustained by the Lodge in the death of Bro. Edward A. T. Breed, of Brighton, and moved that the Secretary do write a letter to Mrs. Breed expressive of their sorrow and sympathy. This was seconded by the S.W. and carried unanimously.

---

#### EXHIBITS.

By Bro. Col. G. WALTON WALKER, Dep. Prov. G.M., Staffs.

GLASS BOTTLE, triangular in cross section, with Square and Compasses enclosing a trowel, stamped on shoulder. This is believed to have been found on the site of the New Gaiety Theatre, London, in 1901.

WOODEN GAVEL, very beautifully inlaid with emblems in silver. This is the property of the Noah's Ark Lodge, No. 347, Wolverhampton, and was presented to an earlier Lodge in that town in 1772. Exhibited at Worcester (No. 716) in 1884, and at Shanklin (No. 153) in 1886.

CERTIFICATE (Knight Templar and Knight of Malta) issued 27th August, 1806, to William Norman, by an assembly held under the sanction of Lodge No. 271 Limerick. The fine engraved heading, which has nothing Templar about it, is very similar in design to the frontispiece of Batty Langley's *Builder's Jewel* (1741).

CERTIFICATE (Knight of the Red Cross and Ark and Mark Mason) issued in 1808 by the "Red Cross Lodge Unanimity, 992," under what purports to be a Grand Chapter. The name of the recipient is not legible, but the Certificate is signed by Richard Smyth, Royal Master; William Oates, High Priest; W. Williams, Capt. General; and Thos. A. Mason, Grand Scribe. It is to be hoped that some further particulars in regard to this body may be forthcoming, as, of course, there was no Craft Lodge in 1808 holding so high a number as 992. These two Certificates were exhibited at Worcester (No. 717) and Shanklin (No. 154).

By Bro. J. C. BROOKHOUSE, London.

LARGE BRASS SEAL AND EBONY GAVEL. *Presented to the Lodge.*

Bro. Brookhouse sends the following particulars in regard to their former ownership. It seems, however, probable that the Seal was originally made for an Irish or "Ancient" Lodge, which worked the Templar and other degrees.

A short time ago when discussing secret societies with a friend he told me that he was in possession of a curious seal which he showed me, and upon my expressing interest in it gave it to me. I have much pleasure in handing it to you for the Quatuor Coronati Lodge Museum.

The device is contained within an eight pointed star formed of two interlaced squares surmounted by a Templar cross. At the base is a tessellated pavement upon which stand two columns bearing the letters J (on the left), and B (on the right), and supporting an arch with a large key-stone, upon the arch are the words KODES LA ADONAL (*Kodesh al Adonai*,



SEAL used in an "Orange" Lodge in London  
about 1800-1840.



OLD GAVEL in the possession of the Noah's Ark Lodge.







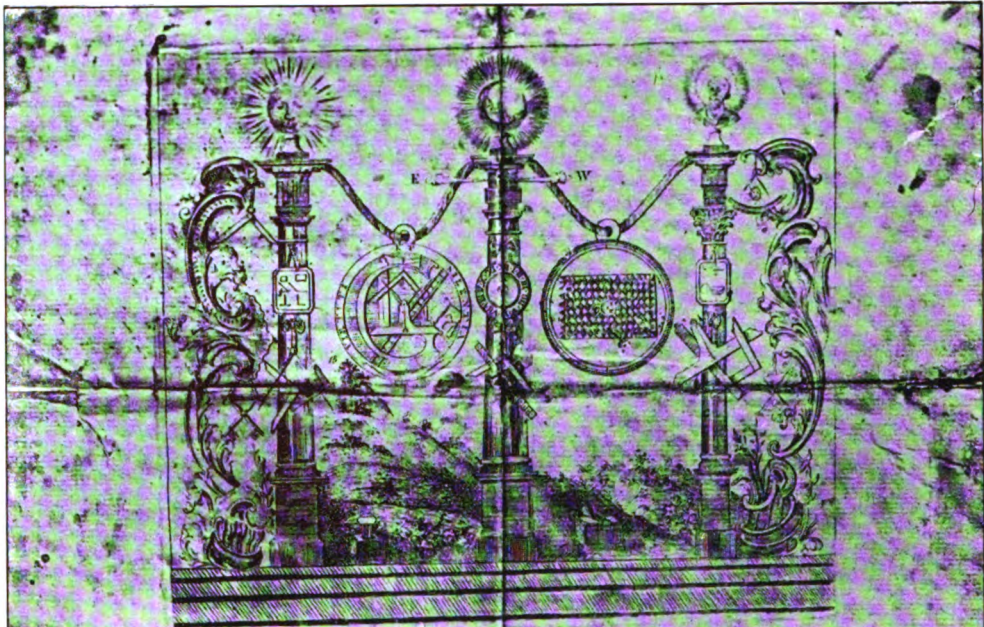

In the Name of the most holy, glorious, and undivided  
Trinity, FATHER, SON, AND HOLY GHOST

*WE the Captain General, Grand Master, and the great Assembly of Knights  
Templars and Knights of Malta, do hereby certify that the Bearer our  
faithful true and well beloved Brother Sir William Norman,  
Was by us dubbed a Knight of that most holy, invincible and  
magnanimous order of Knight Templars, and the true and faithful  
Soldier of JESUS CHRIST, as also of the order of St. John of Jerusa-  
lem, now Knights of Malta, he having with due honour and Fortitude  
supported the amazing Trials attending his Admission. And as such  
WE recommend him to all Brothers, Knights Templars, and Knights of  
Malta on the face of the Globe.—Given under our Hands and Seal of our  
General Assembly held under the Sanction of Lodge No. 271 in the City  
of Leicester, this 11th day of August 1806 and of the Order of Malta.*

*Geo. G. M. M. M.* } CAPT. GENERAL  
*Joseph G. G.* } GRAND WARDEN.  
*Wm. M. M. M.* } DEPUTY G. WARDEN.  
*Geo. M. M. M.* } SECRETARY.

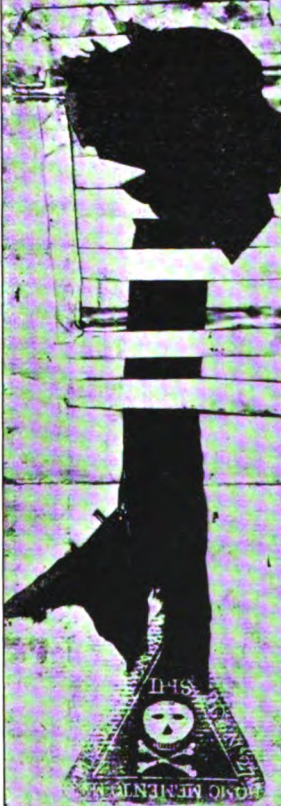

KNIGHT TEMPLAR CERTIFICATE  
In the possession of the Noah's Ark Lodge.

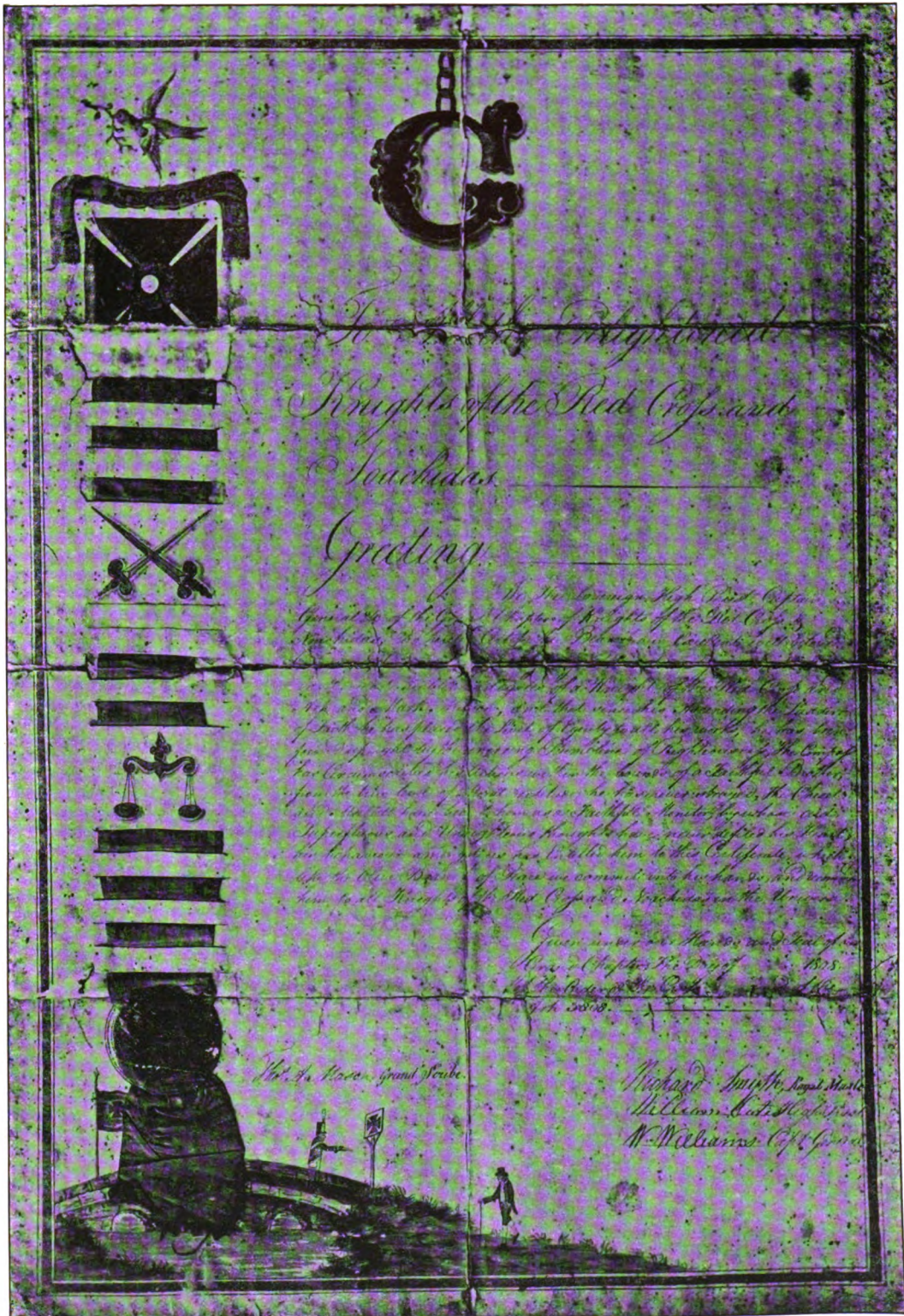

RED CROSS CERTIFICATE  
In the possession of the Noah's Ark Lodge.



Holiness unto the Lord), and on the key-stone the letters F H C (Faith, Hope, Charity). Outside the pillars and arch, between them and the border, runs the inscription IN HOC SIGNO VINCIS, which I believe to be used in more than one of the High Grades, and beneath this, on each side of the pillars, are three letters in a cypher which I translate as SKI, HKT. Within the space formed by the pillars and arch are at the top an eye with rays downwards, and beneath it a square and compasses with letter G in the form of the P.M. jewel under the Irish Constitution, flanking which are on the left, the sun, and on the right, the moon with seven stars, below the sun is a Templar cock, and below the moon the badge of the Royal Arch degree. In semi-circular form below this are the words MEMENTO MORI enclosing a skull and cross-bones which surmount a coffin upon the pavement; on the coffin are certain further letters in cypher standing for HAB and, below these, the figures 3000 very roughly cut. The words "left" and "right" used above refer to the impression.

The seal appeared to bear so many Masonic emblems and inscriptions that I made close enquiry of my friend as to its origin, and I was much surprised to find that it had no Masonic connection. I was fortunate enough to obtain its history fairly fully, and am able to state that it is the seal of a Black Lodge of the Orange Association which met in Spitalfields and ceased to exist about 40 years ago—it came originally from the South of Ireland. The organization consisted of (a) an outer circle of members who formed the ordinary Orange Lodge, and who held meetings wearing regalia much as friendly societies do to day, and (b) an inner circle who formed the Black Lodge which met masked and consisted of a very small number. The ordinary lodge continued to meet for some years after the Black Lodge had lapsed.

The Black Lodge box which came into my friend's hands contained, he tells me, besides the seal and hammer two skulls and six long bones, black cloaks or robes and black draperies for a room—there were no minute books and no masks. It is very doubtful whether this box contained all the Lodge property as there were only robes for two or three persons. The seal, it will be noticed, has an ebony handle, and I may say in passing that although the whole of the belongings of the Black Lodge were black in color the ordinary lodge wore their regalia of the orange hue which is usually associated with the body.

My friend tells me, in answer to my enquiries, that he never heard of any visitors to the Lodge, and he believes that there was no other similar body in London, further "that there was certainly no Grand Lodge or Provincial Grand Lodge in London."

I have only been able to learn the title of one of the Officers; they had a Tyler, and I may add that his name was Rice.

As to the activity of the Lodge I can only say that my friend's informant died 30 years ago at the age of 80, and, as he left Ireland when he was but 20 years old, it is practically certain that he received the degrees of the Inner Circle in London. It would therefore appear that this Black Lodge was a working organization.

Finally I think that I ought to mention that my friend from whom the above information was obtained is neither a Freemason nor an Orangeman. I have asked many careful questions as to the matter of degrees worked (if any), but have been quite unable to get any light at all upon the point.

**By the LODGE.**

OLD FRENCH BREAST JEWEL, set in paste. Square and compasses, with segment of a circle enclosing a sun and moon. This is believed to have been worn by the *Vénérable* of a French Lodge.

SPECIAL CENTENARY JEWEL adopted 29th January, 1861, by the Lodge of Economy, Winchester.

COLLAR JEWEL, J.G.W. of the Province of Devonshire, made by Thomas Harper, 1779-80.

**By Bro. T. A. WITHEY, Leeds.**

CRAFT APRON AND COLLAR AND R. A. APRON worn by the original owner of the three Hongkong jewels exhibited at the last meeting. The Craft apron formerly had three silver "levels" and emblem denoting the office of Treasurer. *Presented to the Lodge.*

**By Bro. G. VOGELER, London.**

WHITE DAMASK SERVIETTE. One of twelve made in England about fifty years ago, and now (together with the tablecloth) in the possession of a brother in Berlin.



By Bro. L. R. GLEASON, London.

TWO JEWELS in locket form. One (oval) is of the well-known French Prisoners' work. The other (circular) is probably of about the same date, but the emblems are formed of small pieces of coloured glass.

By Bro. F. W. LEVANDER, London.

SILVER LEVEL "Presented to P.G.P. J. Reeve, by the Brothers of the Star of Temperance Lodge, "I.I.O.F.S.L.U., as a mark of respect for past services, June 30th, 1887." This is an "Oddfellow's" badge, and has the following emblems engraved on it, in addition to the inscription:—Sun and Moon, an open book and a dove with olive branch, an hour-glass and a skull on crossed bones.

By Bro. G. L. SHACKLES, Hull.

GOLD, SILVER AND BRONZE COINS of the Grand Masters of St. John of Jerusalem. The Gold Coins are *sequins* dating from 1537 during the Grand Mastership of Jean de la Vallete-Parisot, *Ecu* of the reigns of Emmanuel Pinto, Emmanuel de Rohan and others.

The Silver Coins are 30 *Tari* and pieces of lower denominations of reigns of Grand Masters from 1736 to the extinction of the Order in 1778.

Amongst the Copper Coins will be noticed some so called "Siege pieces" i.e. money issued by the Grand Masters for the use of their troops during the sieges of the island of Malta by the Turks. These "siege pieces" are very interesting and some of them have been reissued as many as four or five times. From the different marks thereon it can be accurately identified under which Grand Master and for which siege they were issued. There is also a Bronze Medal of "Ioannes de Valette" dated 1557-1568. The *obv.* is the bust of Valette to the left and the *rev.* soldiers making *sortie* on a galley of the Order holding the trunk of an elephant carrying a tower in which is a Turk; behind the elephant is a palm tree; in the centre of the field is a plan of some new fortifications and a ship sailing away, above all the legend H A B E O. T E.

BOOK OF CONSTITUTIONS, 1765, originally belonging to the Stewards' (Grand Stewards') Lodge when meeting at the Horn Tavern in 1768.

By Bro. HUGH SHELBOURNE, London.

TWO OLD MASONIC MUGS, Lowestoft ware.

LEATHER APRON, printed from an engraved plate, "Dedicated to the Ancient and Honorable Society of Free and acct. Masons by Brother John Cole P.M. Fore Street, London." Edged with crimson satin ribbon, with gold lace and spangles. These aprons were advertised for sale in 1801.

---

The Report of the Audit Committee, as follows, was received, adopted, and ordered to be placed on the Minutes.

### PERMANENT AND AUDIT COMMITTEE.

The Committee met at the Holborn Restaurant, on Monday, the 8th day of January, 1906, at 5.30 p.m.

*Present*:—Rev. Canon Horsley, I.P.M., in the Chair, Bros. Greiner, Edward Armitage, W. H. Rylands, and Bro. Gedge, Auditor.

The Secretary produced his books and the Treasurer's accounts and vouchers, which had been examined by the Auditor and certified as being correct.

The Committee agreed upon the following

#### REPORT FOR THE YEAR 1905.

BRETHREN,

In presenting our Report, we once more congratulate you on the work done in the past year, and on the prosperous condition of the Lodge, which we trust may always continue. One Member has been admitted to the Inner Circle during the year, and our numbers, at the present time, are thirty-two.

In the Correspondence Circle there are a number of deaths to be deplored, and many good friends have been called from us. Three hundred and fifteen new Members have been admitted, the total number now being approximately 2946.



**PROFIT AND LOSS.—For the year ending the 30th November, 1905.**

Dr.				Cr.					
		£	s.	d.			£	s.	d.
To Salaries ... ..		327		15 0	By Balance brought forward from				
" Rent .. ..		159	4	0	last year ... ..			169	19 3
" Gas and Firing ... ..		18	5	0	" 1905 Correspondence				
" Stationery ... ..		62	6	7	Circle ... ..	540	0	0	
" Postages ... ..		286	14	8	" 1904 ditto ... ..	118	5	8	
" Office Cleaning ... ..		18	19	10	" 1903 ditto ... ..	30	9	0	
" Insurance ... ..		9	10	6	" 1902 ditto ... ..	8	17	0	
" Furniture ... ..		25	9	9	" 1901 ditto ... ..	2	2	0	
" Library ... ..		38	5	11	" 1900 ditto ... ..	0	10	6	
" Bad Debts ... ..		7	15	8	" Back Transactions...	37	19	0	
" Balance carried to Balance Sheet				954 6 11	" Sundry Publications	30	16	4	
				33 18 4	" Life Members ... ..	6	6	0	
				£988 5 3	" Interest on Consols	30	17	8	
					" Discounts ... ..	12	2	10	
								818 6 0	
								£988 5 3	

**SUNDRY CREDITORS.**

		£	s.	d.
Crawley, Dr. W. J. Chetwode	..	0	11	0
Masonic Curriculum ... ..	...	0	14	6
Kenning & Son, G. ... ..	...	11	5	0
		£12	10	6

**SUNDRY PUBLICATION CREDITORS.**

Amounts charged to Members but not executed or paid for.

		£	s.	d.
Binding Account ... ..	...	11	10	0
Medals Account ... ..	...	5	5	6
Back Transactions ... ..	...	5	15	6
Crawley, Dr. W. J. Chetwode, Book	...	0	11	0
Reprints, Burns ... ..	...	0	6	0
		£23	8	0

**SUNDRY DEBTORS FOR PUBLICATIONS.**

		£	s.	d.
Binding Account ... ..	...	11	10	0
Medals Account ... ..	...	5	5	6
Back Transactions ... ..	...	5	15	6
Reprints IX. ... ..	...	0	10	6
Crawley, Dr. W. J. Chetwode, Book	...	0	11	0
Work on Medals ... ..	...	3	13	6
		£27	6	0

**SUNDRY PUBLICATIONS, DEBTORS FOR CASH.**

		£	s.	d.
Reprints VI. ... ..	...	6	4	9
Ditto IX. ... ..	...	80	6	1
Catalogue ... ..	...	8	4	0
Work on Medals ... ..	...	3	1	11
Various Publications for sale	...	47	13	0
		£145	9	9

**GENERAL CASH ACCOUNT.—For the year ending November 30th, 1905.**

Dr.	£	s.	d.
To CASH BALANCE ... ..	160	17	4

**LODGE ACCOUNT.**

To Subscriptions ... ..	34	13	0
-------------------------	----	----	---

**1905 TRANSACTIONS.**

To Subscriptions .. ..	1132	17	8
------------------------	------	----	---

**1904 AND BACK TRANSACTIONS.**

To Subscriptions ... ..	225	12	6
-------------------------	-----	----	---

To PAYMENTS RECEIVED IN ADVANCE	92	4	6
„ MEDALS ... ..	53	18	3
„ BINDING CASES ... ..	40	6	7
„ WORK ON MEDALS ... ..	12	6	0
„ SUNDRY PUBLICATIONS ... ..	12	11	6
„ LIFE MEMBERS' FUND ... ..	56	14	0
„ SUMMER OUTING ... ..	233	12	0
„ INTEREST ON CONSOLS ... ..	30	17	8
„ DISCOUNTS ... ..	12	2	10

£2098 13 10

Cr.	£	s.	d.
-----	---	----	----

**LODGE ACCOUNT.**

By Quarterages ... ..	6	9	0
„ Rent Lodge Room... ..	9	9	0
„ Tyler's Fees ... ..	8	0	6
„ P.M. Jewel ... ..	1	10	0
„ Dispensation ... ..	0	10	6
„ Minute Book ... ..	0	13	6
	<u>26</u>	<u>12</u>	<u>6</u>

**1905 TRANSACTIONS.**

By Vol. 18, part I. and	194	12	6
„ „ „ II. ... ..	8	2	0
„ Authors' Copies ... ..	44	11	6
„ Summonses... ..	4	13	8
„ Local Expenses ... ..	35	7	8
„ Blocks ... ..	27	0	0
„ Library Catalogue ... ..	22	19	2
„ Sundries ... ..	<u>337</u>	<u>6</u>	<u>6</u>

**1904 AND BACK TRANSACTIONS.**

By St. John's Card ... ..	81	0	6
„ Vol. 17, part II. and	125	10	0
„ „ „ III. ... ..	67	7	5
„ Blocks ... ..	10	10	0
„ Audit Fees ... ..	<u>294</u>	<u>7</u>	<u>11</u>

„ PAYMENTS IN ADVANCE TRANS-	72	12	9
FERRED ... ..	42	10	6
„ MEDALS ... ..	23	6	0
„ BINDING CASES ... ..	9	10	0
„ WORK ON MEDALS ... ..	13	11	8
„ SUNDRY PUBLICATIONS ... ..	226	18	5
„ SUMMER OUTING EXPENSES ... ..	37	14	11
„ LIBRARY PURCHASES AND BINDING			

**OFFICE EXPENSES.**

By Salaries ... ..	327	15	0
„ Rent... ..	159	4	0
„ Gas and Firing ... ..	18	5	0
„ Stationery ... ..	62	6	7
„ Postages ... ..	286	14	8
„ Office Cleaning ... ..	18	19	10
„ Insurance ... ..	9	10	6
„ Furniture ... ..	25	9	9
	<u>908</u>	<u>5</u>	<u>4</u>

**CASH BALANCES.**

By Balances carried for-			
ward at London &			
County Banking	115	1	10
Company, Bromley	0	15	6
„ Ditto, in hand ... ..	<u>115</u>	<u>17</u>	<u>4</u>

£2098 13 10

Bro. J. P. SIMPSON read the following paper:—

## “OLD CITY TAVERNS AND MASONRY.”

BY BRO. J. PERCY SIMPSON, P.M. 176.



HAD proposed to entitle this Paper “Old London Taverns and Masonry,” but I had scarcely entered on the task when I found that the subject was far too wide to be treated adequately in a single Paper. I have therefore confined myself for the present to the Taverns situated within the boundaries of the City of London; and even with this limitation the work of condensing the materials before me is one of no slight difficulty.

There is something peculiarly fascinating in this subject to Masonic, and non-Masonic antiquarians alike. “Taverns” says Bishop Earle in the first half of the 17th century, “are the busy man’s recreation, the idle man’s business, the melancholy man’s sanctuary, and the stranger’s welcome”; and again we have the trite verse of old Shenstone:—

“Who’er has travelled Life’s dull round,  
Where’er his wanderings may have been  
Will sigh to think he still has found  
His warmest welcome in an Inn.”

We have further ecclesiastical authority for the pleasure not only for frequenting, but for dying in an Inn. Bishop Burnet, in his *History of our own Times*, says “Archbishop Leighton used often to say that if he were to choose a place to die in it should be an Inn. It looking like a pilgrim going home, to whom this world was all as an Inn, and who was weary of the noise and confusion of it.” The Archbishop obtained his desire, for he died in 1684 at the Bell Inn, Warwick Lane, Newgate Street.

We all indeed can call to mind many quotations from Shakespeare, Dryden, and other Poets and Writers equally apt, as well as merry episodes in the pleasant peregrinations of Pepys, Evelyn, Stukeley and other Diarists and Travellers, and quaint epigrammatic Johnsonian sayings without number. But do we need them? Even now as we sit in one of these old Taverns—alas! how few there are remaining—we can realise how greatly they entered into the life of citizens of the seventeenth and eighteenth centuries. How they supplied the place, to a great extent, of the Press of the present day, and the amenities of Club life; and promoted social intercourse and the exchange of wit, and sometimes wisdom. Taverns we are told “were the broachers of more news than hogsheads, more jests than news; which are sucked up here by some spongy brain, and thence squeezed into a Comedy.” It may be said however that without doubt they then formed the Editorial Offices of many newspapers and periodicals. The *Spectator* and the *Tutler* give us abundant evidence of this. Sir Richard Steele’s letters are often dated from a Tavern; and writing to his wife on one occasion he assures her that he will be with her “within half a bottle of wine.” The Coffee House, like the Tavern, writes Lord Macaulay, “was the Londoner’s home, and those who wished to find a gentleman commonly asked not whether he lived in Fleet Street or Chancery Lane, but whether he frequented the Grecian or the Rainbow.”

Indeed in the aggregate what a vast amount of human happiness, mirth, and genuine good-fellowship have not these old Taverns seen. With what different feelings

do we contemplate some grim old castle or prison whose stones speak only of gloom and tragedy. Who mourned when the dreary walls of Newgate passed away? But thousands sorrowed as they passed, and saw the Old Black Bull in Holborn near by gradually disappearing. And sitting in the old rooms, and thinking of these things, one's own present troubles and worries fade, and a restful soothing feeling seems to come over us. Such a feeling as Dickens had when he passed from the turmoil of Fleet Street, and sat in Fountain Court to muse of other days and the shadows of the past.

Surely these old Taverns were the fit and proper abiding places for modern Speculative Masonry, and it will be my endeavour to try—however inadequately—to recall the past in connection with some of them.

Before we enter on our travels through the City, I think it would add somewhat to our interest if I glance very briefly and generally at the development of the old City Taverns in the past, and some of the customs and traditions in connection with them.

Tacitus first mentions Londinium by name in the year 61 A.D. "Londinium a place not dignified with the name of a Colony, but famed for the number of its merchants, and the plenty of its provisions." It is certain that the City Walls were first erected by the Romans, and though the various writers differ widely as to the date it may safely be ascribed to the reign of the Emperor Constantine about 306 A.D., and the remains of the walls and bastions were to be seen in Maitland's time in the vicinity of Houndsditch and Aldgate. Our subject is however rather connected with the Gates of Roman London than the Walls. Most authorities give us seven Gates, two facing the river at Billingsgate and Dowgate, and five from east to west, namely, Aldgate, Bishopsgate, Cripplegate, Aldersgate, Newgate and Ludgate. Moorgate was added in the reign of Henry V. It is fairly certain, however, that Newgate and Ludgate were of later origin, as Pennant rightly points out, that it was part of the Roman Law that no burial place should be allowed within the City walls. In the case of London there is no doubt that there was a Roman cemetery in the north west corner of St. Paul's Churchyard. From this it would appear that the Roman Wall ran direct south from Aldersgate Street, excluding St. Paul's Churchyard and Ludgate Hill. It was the invariable custom in Roman walled towns to have the Vintners' houses, or Taverns, immediately inside the Gates. So in London travellers coming through the woods to the north of London, or the dreary Essex marshes to the east, were doubtless glad within the Gates to find immediate rest and refreshment. Thus we may look to these sites inside the Gates as the positions occupied by the oldest London Taverns; and in some instances can even trace the Houses down to our own times. In about the centre of the Roman City, in Lombard Street and Leadenhall Street, discoveries have been made on which I shall comment hereafter indicating the site of other Roman Taverns. The City Gates were pulled down in the years 1760 and 1761, and the materials sold.

William Fitzstephen, a clerk of Thomas á Becket, who died in the year 1190, wrote a life of his master, and prefaced it with a description of London of his day. He states, "Besides there is in London upon the River Bank among the wines in ships and cellars sold by Vintners, a public Cook shop. There eatables are to be found every day according to season, dishes of meat, roast, fried, and boiled, great and small fish, coarser meats for the poor, more delicate for the rich, of game, fowls, and small birds." It would seem that at this time the Taverners and Vintners were distinct, the former housing and feeding their guests, and the latter having the exclusive sale of Wines. The

two trades gradually became merged in the Tudor period; though an old custom still remained up to the middle of the last century of buying your own meat, and taking it to a Tavern selling wine to be cooked. Fitzstephen adds that the only pests in London in his time were "the immoderate drinking of fools, and the frequency of fires."

We can trace in a measure the gradual development and customs of the City Tavern in the Orders of the Corporation, and the Acts of Parliament from time to time. As early as 4 Edward III. there was an Act passed dealing with adulteration of wines, and providing penalties for the same. In the reign of Henry VIII., 1586, an Act directed that all French wines should be sold for eight pence the gallon, and Malmsey and Romney Sack and all other sweet wines for one shilling. In the reign of Edward VI., 1552, a Statute regulated the number of Taverns and Wine Vaults. The preamble states that it was enacted "for the avoiding many inconveniences, much evil rule, and common resort to misruled persons, used and frequented in many Taverns of late newly set up in back lanes, corners and suspicious places." No Taverns are to be kept for the retailing of wines except licensed, and the number of them is not to exceed 40 in London and 3 in Westminster. Later in Elizabeth's reign we find from the records that there were then however 168 Taverns in London and the suburbs. Stow writing in the year 1598, referring to the quotation made above from Fitzstephen as to drinking and fires, says, "For the first to wit of quaffing it continues as afore, or rather is mightily increased, qualified amongst the poorer sort, not of any holy abstinence but of necessity, ale and beer being small, and wines in price above their reach."

The old order however gradually changed, the ancient drawers giving way to the waiters and barmaids, and the wines to punch and spirits. And later no doubt the advent of the Coffee House, and the introduction of malt liquor had much to do with the slow but sure decline of the ancient Tavern. Probably Gin also may be quoted as an element in this deterioration. It flourished so exceedingly that in 1736 an Act was passed declaring its sale illegal. It remained defunct however only some 15 years, and it was then Hogarth painted his realistic "Gin Lane."

In the early part of the sixteenth century the Yards of the old Inns formed the Theatres of the Strolling Players, and the model on which Burbage and Alleyn built their Playhouses. There was a raised stage placed in the courtyard, and round it collected the meaner sort, or as Ben Jonson called them, "the understanding gentlemen of the ground." This was the origin of the Pit. The two tiers or galleries running round the Yard formed the dress and undress circles of to-day. Bro. Stephen Jones in the *Biographia Dramatica* (vol. i., p. xvi.) informs us that by reference to the title pages of old plays he reckons that between the years 1570 and 1629, when the playhouse at Whitefriars was finished, no less than seventeen playhouses had been built. In the second edition of Stow's *Chronicle* we are told that within the above period "five Inns or common osteryes were turned into playhouses," and Fleckno in his *Short Discourse on the English Stage* (1664) says that the remains of these ancient theatres were to be seen at "The Cross Keys," Gracechurch Street, and "The Bell," Bishopsgate Street. Doubtless most of them had been demolished during the Commonwealth.

The History of the Signs of old Taverns is interesting, and at one time they gave some indication of the class of customers frequenting them; but later all signs whether of Taverns or other trades became sadly confused.

The Roman Tavern Sign had generally a representation of Bacchus, and vine leaves introduced. Thus a sign has been found at Pompeii with a painting of Bacchus pressing a bunch of grapes. And the arms of the Vintners' Company no doubt derive

their origin from this Roman Sign. Vines were at one time grown in southern England, and even in the west end of London near Charing Cross, but often bunches of ivy or other evergreens were substituted. The "Bush" came to be the distinguishing sign of all Taverns, hence the proverb "Good wine needs no Bush." A distinctive Sign was later added to the "Bush." We have in the old ballad of 1622, *Good news and bad news*, the Landlord saying, "I rather will take down my Bush and Sign than live by means of riotous expense." These distinctive Signs sometimes referred to the class of customers, some denoted the peculiar situation of the house, and others had a political flavour. In the Roxburgh Ballads in the time of Charles II., there is a quaint rhyming list of the Taverns, their curious Signs, and the classes of customers frequenting them.

Later however the Taverns and Shops passing from one occupier to another, a strange and almost comical confusion arose. Thus Addison referring to this in the *Spectator* says, "I would enjoin every housekeeper to make use of a sign which has some affinity to the wares in which he deals. A cook should not live at 'The Boot,' or a shoemaker at 'The Roasted Pig.'" The Signs were also early recognised as a nuisance, and indeed a danger to passers by, and in the Records of the City of London (published 1868) I find that in the reign of Edward III. (1375) on complaint of certain citizens as to these Tavern signs in the Cbepe and elsewhere it was ordered that "in future no person should have an alestake bearing his sign, or leaves extending over the King's Highway more than 7 feet." In 1695 it was proposed to tax Signs, and in 1787 an order was made to remove those hanging over the roadway, and to fix them on the walls of the House.

These I think shortly stated are the leading features in the development of the City Taverns until we find them at the latter part of the seventeenth century at the very summit of their prosperity and influence. There is no book directly relating to the Taverns, and their several records must be traced not in the highways of history and literature, but in the by-ways and from obscure and curious sources. For instance, the Histories of the City by Stow, Pennant, Wilkinson and others, give us ample information as to the public buildings, streets and churches of the Metropolis, but are almost silent as to the old Taverns. Occasionally in Larwood's admirable *History of Signboards*, or Timbs' *History of Clubs*, we can glean items of interest, as also in Cunningham's *London Past and Present*. Still much is left to research into old newspapers, prints and manuscripts mostly stored at the Guildhall Library; where the courteous Librarians do all in their power to assist the searcher.

The majority of the views which I have here got together come from the invaluable collection of old engravings, etc., of London and its environs in the possession of Mr. E. Gardner. This collection far exceeds any other in the Kingdom, public or private, and to this gentleman my sincere thanks are due. And lastly I am indeed indebted to the "Masonic Records" of our late Bro. Lane without which mine would have been a hopeless task. With loving patient care for many years our Brother, assisted by Bro. Hughan, raised this monument of research alike perfect in its parts and honourable to the builders: thus leaving footprints on the sands of Masonic-time for the assistance of future generations.

In our travels through the City in search of the old Masonic Taverns, it is difficult indeed to decide as to where one should start. I have adopted the plan—at any rate Masonically orthodox—of commencing our journey in the East and ending at Temple Bar in the West.



THE TOWER is a convenient starting point. Notwithstanding the opinion of Stow it seems probable that there was a fortification in existence on this site even in Roman times. The present Tower of London was however commenced in the reign of William the Conqueror, 1078, by Gundulph, Bishop of Rochester. Just north of the Tower was a little Postern Gate in the old City Walls, and separated by an open space, but opposite to the Gate in the Minories stood an old Inn known by the Sign of "THE FOUNTAIN" (*Plate No. I.*) A favourite old sign this in pre-Reformation times. A quaint legend existed that St. Paul's head when cut off rebounded three times, and fountains gushed forth on each spot. There is near Rome a Church San Paolo delle Tre Fontane. It may also be attributed sometimes to the wells or springs to be found generally near the City Gates (see "Fountain Tavern," Aldersgate). At this Tavern the Lodge of Judah No. 221 met in 1795, the Lodge of Joppa No. 188 in 1796, and the Lodge of Israel No. 205 in 1810. It is related that when the old Tavern was pulled down the timber works were so firmly constructed, that horses had to be employed to pull them apart.

In the MINORIES also a little further north we find "The Three Kings." This sign takes its origin from the three Magi, who came from the East to do homage to our Saviour. Originally a Mercer's sign it may be found carved on a house in Bucklersbury, and also in the Guildhall Museum. This represented the Three Kings of Cologne. These monarchs were favourites in early plays and mysteries. In one of the Chester pageants by shearmen and tailors they are known as "Sir Jasper of Tars," "Sir Melchior King of Araby," and "Sir Balthazar King of Saba." Here met in 1741 that most interesting and ancient Lodge the Castle Lodge of Harmony No. 26. Close by the Jubilee Lodge No. 72 held their meetings in 1814 at "The Three Lords," a sign having doubtless the same origin and which still exists in the Minories.

Passing along "TOWER STREET" from east to west we come across several old Masonic Taverns. The famous "Dolphin Tavern" stood just at the bottom of Seething Lane. About two hundred yards up this Lane were the old Admiralty Buildings, and the residence of Samuel Pepys, Diarist, and Secretary to the Admiralty. Larwood speaks of "The Dolphin" in Aldersgate Street as the house to which Pepys resorted, but there can be no doubt it was "The Dolphin" in Tower Street. We have this entry on 11th July, 1660: "With Sir William Penn to the Navy Office (in Seething Lane) where we met and dispatched business. And that being done we all to dinner at the Dolphin." Again on the 4th September, 1666, during the Great Fire: "After supper walked in the dark down to Tower Street, and there saw all on fire at the Trinity House on that side, and the Dolphin Tavern on this side which was very near us, and the fire with extraordinary vehemence." This old Tavern was restored after the Fire and was a favourite resort of the parochial authorities, etc. It appears in the Engraved List of Lodges of 1723 and the French Lodge met there in that year. Further west in Tower Street we have "The King's Head" and "Czar of Muscovy's Head," associated with Lodges since lapsed. These survive in name, though "Ben Jonson's Head" and the "Prince of Wales' Head" have disappeared from the scene.

FISH STREET HILL had two famous Houses that have passed away, the "Ship" mentioned in the Engraved List of 1723, and the "Swan." The "Crown and Mitre" Labour-in-vain Hill, Old Fish Street, was the original home of the Strong Man Lodge No. 45.

Directing our steps northwards we pass into FENCHURCH STREET in "Langbourne Ward or Fennie About," so called as Stow asserts "from a bourne of sweet water which of old time breaking out in Fenchurch Street ran down the same Street, and Lombard Street and so through Sherbourne Lane to the Thames"; the street thus taking its

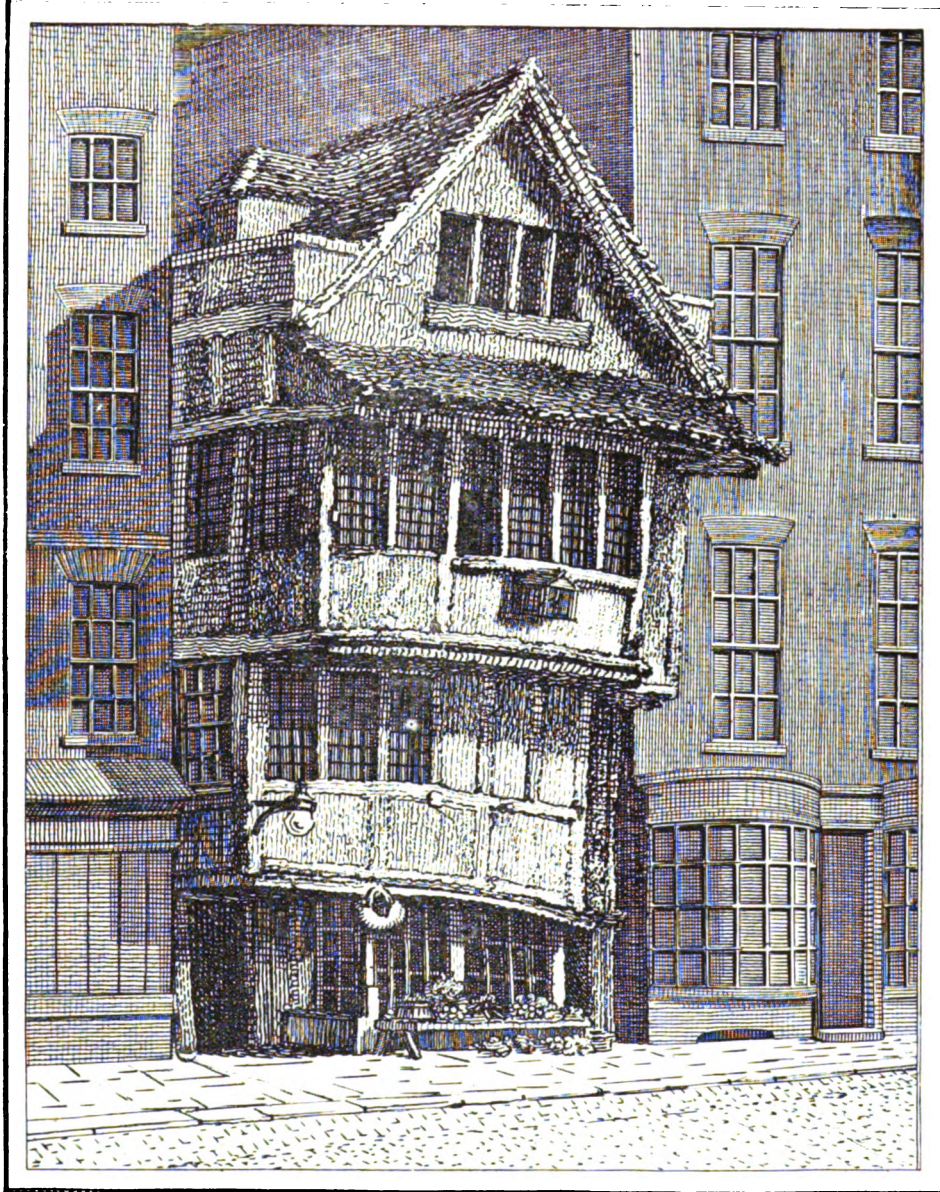

THE OLD FOUNTAIN in the MINORIES

I.—THE OLD FOUNTAIN IN 1793.





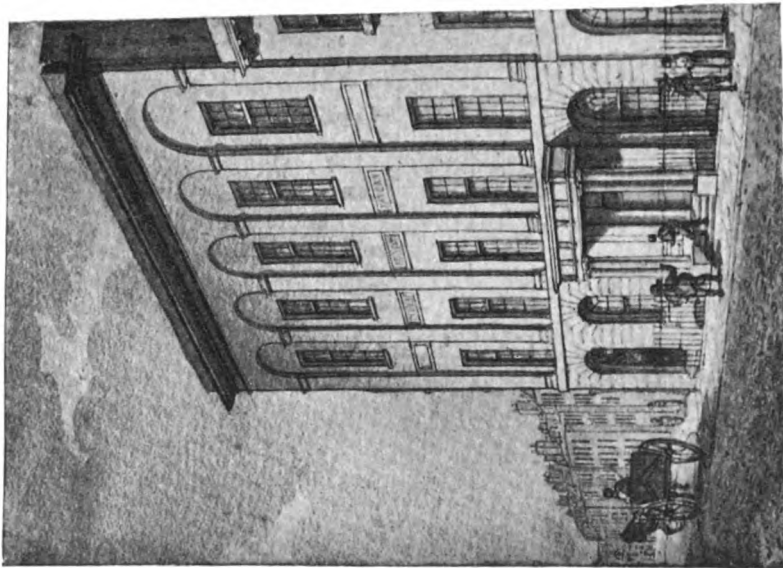

VI --THE LONDON TAVERN.  
From an Engraving in the Gardner Collection.  
(See p. 15.)

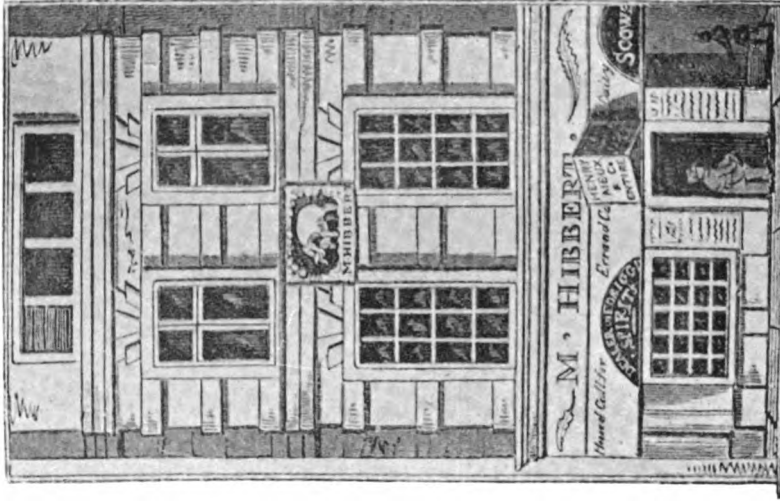

II.--THE OLD ELEPHANT.  
From a print in the Guildhall Library.

name from the fenny or moorish ground around the Bourne. Though I cannot find that "THE OLD ELEPHANT" (*Plate No. II.*) in this street ever had a Lodge meeting there, yet it is interesting to Masons as Hogarth lodged there for some years. The story runs that the parochial authorities used to hold their meetings here, but for some reason unknown deserted "The Elephant" for "The King's Head" opposite. Hogarth was annoyed and swore that he would show them up, and is supposed to have done so in his "Modern Midnight Conversation." This picture, together with his "Hudson Bay Company Porter," "Harlequin and Peirrot" and "Harlow Bush Fair," were painted here and remained in the House till it was demolished about 1810. "The King's Head" just mentioned was the home of a Masonic Lodge No. 73 in 1752, which lapsed at "The Half Moon," Cheapside, in 1761. Later the Royal Jubilee Lodge No. 72 met here in 1811, and the Albion Lodge No. 9 in 1818. "The King's Head" was a Tavern of considerable antiquity. We read in Hughson's London "That the Princess Elizabeth after her imprisonment in the Tower, on the day she was released, entered the first Church she found open, which was All Hallows Staining. She then went to the House, then and now called 'The King's Head,' Fenchurch Street, No. 53, where she dined on pork and pease pudding. The dish and cover of mixed metal yet hang over the fire place, and the portrait of the Queen copied from a painting of Holbein." When the "London Tavern" in Bishopsgate disappeared, "The King's Head" adopted its name. A curious instance of voluntarily relinquishing an old and honoured name for a comparatively modern one. I see also at "The Old Coach and Horses" in this street, the Lodge of Prudent Brethren No. 145 met in 1832, and the Lodge of Israel No. 205 at "The Blue Anchor," Bell Court, in 1794. Improvements have swept both these old Taverns away.

LEADENHALL STREET was closely connected with Fenchurch Street by many little alleys; and seems to have derived its name from the large leaden porch close to certain tenements belonging in the year 1309 under the name of Leaden Hall, to Sir Hugh Nevill, Knight, together with the advowson of the Church of St. Peter upon Cornhill. This ancient Hall was just opposite to where the Office of the P. & O. Company now stands. We find by a Request or Petition by the Commoners of the City to Henry VII., in 1503, that at that time the old Hall and the grounds adjoining it had become a public market. In 1803, opposite the East India House during some excavations, was discovered a fine Roman tessellated pavement and some drinking cups. The device of the pavement was a highly finished figure of Bacchus, reclining on the back of a tiger, with his thyrsus in his left hand, and a drinking cup in his right, with a wreath of vine leaves on his brow. Here was doubtless the site of an old Roman Tavern.

Leadenhall Street has from time immemorial been connected with shipping and naval matters. And the Taverns and Lodges there savoured of the sea. Thus we have "The Crown & Anchor," "The Anchor & Hope" and "The Ship & Turtle." At "The Old Crown" as it was then called, several Lodges found a resting place about the middle of the eighteenth century, the Royal Alpha Lodge No. 16, in 1755, the Lodge of Peace & Harmony No. 60, in 1765, and the Lodge of Tranquillity No. 185, in 1795. At the "Anchor & Hope" an old naval Lodge met in 1763: and finally disappeared in 1776, when meeting at "The Two Brewers," Wapping. Two Lodges met at the curious sign of "The Hoop & Griffin," from about 1730 to 1740, when they were erased. Signs were often carved and hung on hoops; hence the conjunction of the Hoop with various Signs having no apparent connection. Lastly we come to the good old Inn now known as "The Ship and Turtle." The "Old Ship," as it was first called, was built in 1377 in the reign of Richard II. The Ground Landlords are the Trustees of Rochester Bridge to whom with other Tenements it was demised by Sir John de Cobham and

William Wangford for the purpose of constructing and ever maintaining a stone Bridge over the Medway at Rochester. Prior to 1735 there was really no frontage to Leadenhall Street, but the entrance was through an alley known as Shafts Court. From 1735 when the premises were extended and enlarged there were a succession of noted Landladies. Mrs. Rebow from 1735 to 1752, Mrs. Beaumont 1752 to 1787, Mrs. Jones 1787 to 1810, and Mrs. Boake from 1810 to 1835. Later it came into the possession of Mr. George Painter, who about 1847 added the name of "Turtle" and made many structural alterations. It would be tedious to mention the number of Lodges that have met here from time to time, but the earliest occupants were the Lodge of Fortitude and Old Cumberland No. 12, and the Constitutional Lodge No. 55.

Let us now pass into BISHOPSGATE STREET: a street whose records contain much that is interesting both in Tavern life, and old time Masonry. The Gate Stow thinks was so called because the same was built "by some Bishop of London though now unknown, when or by whom." The best authorities concur however in giving the Gate a much more ancient origin, and that it afterwards took the name from the fact that the Bishops of London acquired land adjacent to it. According to our old friend Stow it seems even in his time well supplied with Taverns. The reason for this is probably to be found in the fact that the fields beyond the Gate formed the principal recreation ground for the youth of the City, and the place of exercise for the Trained Bands. We read without the Gate next the Parish Church of St. Botolph "is a fair Inn for the receipt of Travellers" and "the other side of the High Street from Bishopsgate to Houndsditch the first building a large Inn for the receipt of travellers, called the Dolphin of such a sign." Also within the Gate "the first of the houses towards the north was sometime a large Inn, or Court called the Wrestlers of such a Sign; and the last in the High Street towards the south was sometime also a fair Inn called the Angel of such a sign." Some Roman remains were found on the position here assigned to "The Wrestler's Inn," and seem to indicate the site of a Roman Inn.

Commencing from the north we have "THE WHITE HART INN," (*Plate No. III.*) which before it was modernised about 1829, had the date 1480 carved on the front. When the cellars were being repaired some remains of old Roman brick work were found. In its later days it was a noted Coaching Inn for the North. The Strong Man Lodge No. 45 met here in 1816, the Lodge of Prosperity No. 65 in 1855, and the United Mariners Lodge No. 30 in 1856.

"The Admiral Vernon Tavern" in this street derives its name from the gallant conqueror of Portobello, whose motto was "Ver-non semper viret." Larwood does not inform us in his History of Signboards why this Sign was so popular. It appears that the Admiral was known to his sailors as "Old Grogam," because he wore a long Grogam cloak in foul weather. His favourite beverage was a strong mixture of rum, gin and hot water. Hence the word "grog," the naval tippie. The old Admiral was dismissed from the Navy for exposing its abuses, and died 30th October, 1757. A very old Lodge, then No. 18, met here in 1753, but was erased on the 2nd April, 1755, "for refusal of its Master and Members to attend Grand Lodge." Here also No. 12 of the Antients met in 1751, and the Kent Lodge No. 15 in 1752.

The Tavern known for some years as "THE SIR PAUL PINDARS HEAD" (*Plate No. IV.*) was on the west side of the street, and formerly the residence of a noted citizen, Sir Paul Pindar, sometime the Ambassador of James I. at Constantinople. He acquired great wealth, and is said to have lent to James I. and Charles I. a large diamond worth £30,000 to wear on State occasions. This House was spared in the Great Fire, and only converted into a Tavern at the end of the eighteenth century. It

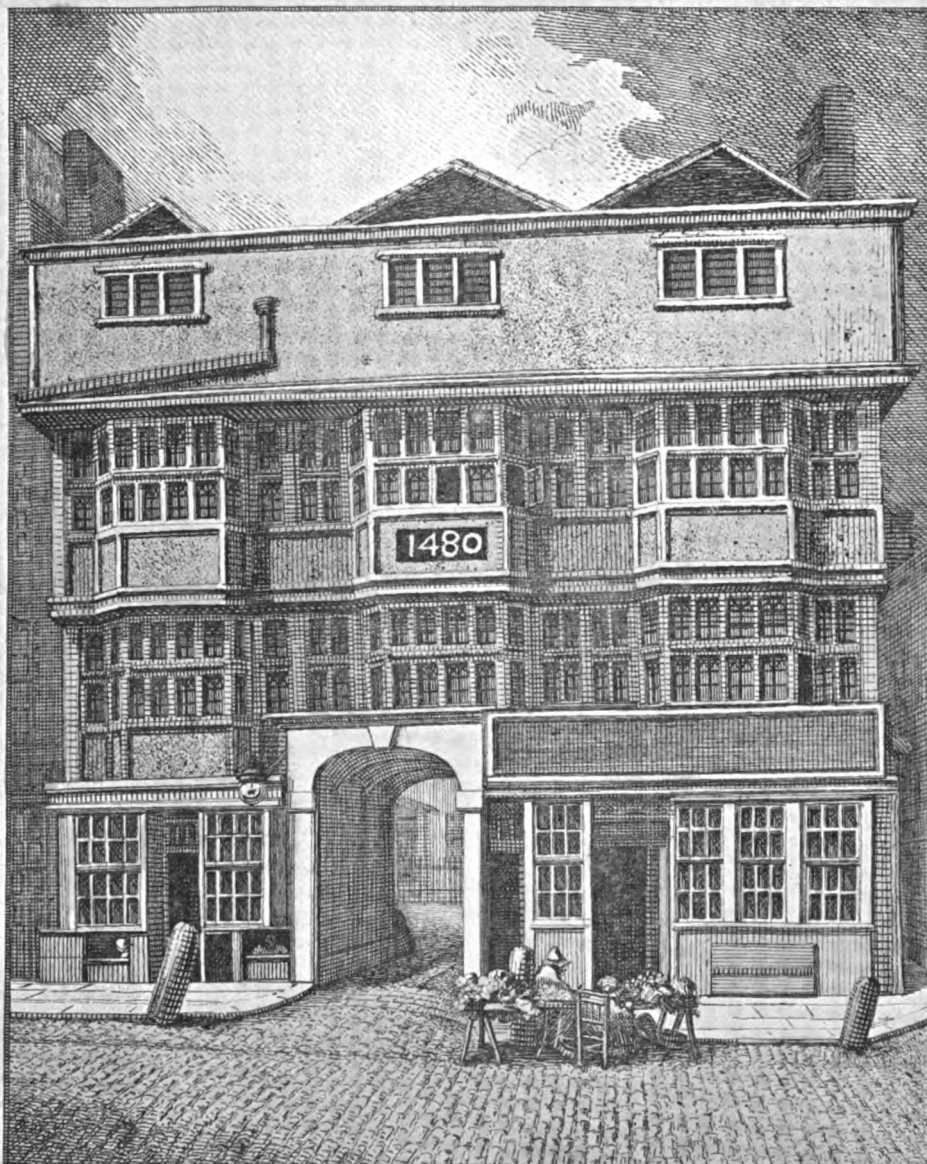

WHITE HART,  
Bishopsgate Street.

*See Pinnant*

*Pub. June 2<sup>d</sup> 1800, by John Manson, Pall Mall.*

III.—THE WHITE HART INN.





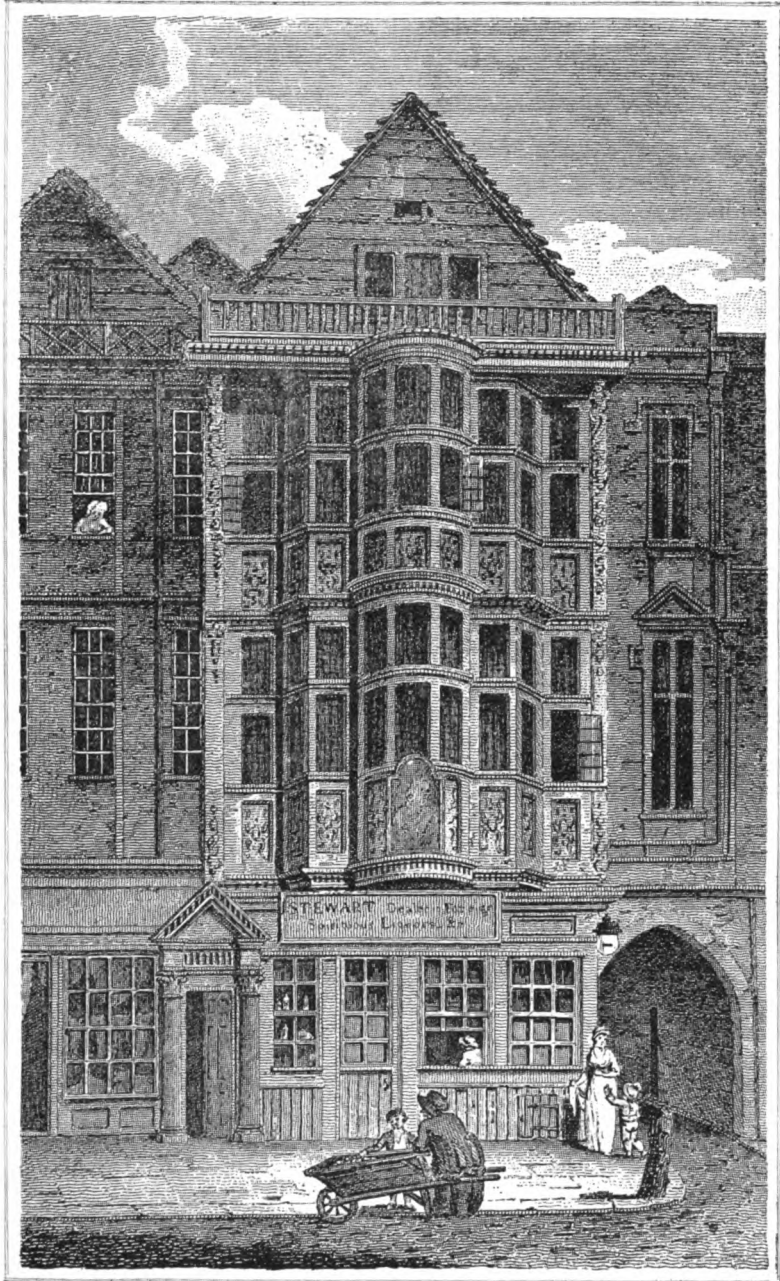

IV.—THE SIR PAUL PINDAR'S HEAD.







V.—THE CATHERINE WHEEL.  
From an Original Sketch in the Gardner Collection.

was finally demolished to make room for the Great Eastern Railway. We find the Lodge of Stability No. 217 meeting here in 1807, and the Lodge of Hope and Unity No. 214 (now at Brentwood) in 1808.

THE CATHERINE WHEEL (*Plate No. V.*) Larwood informs us was a popular Sign adopted from the Badge of the Knights of St. Catherine of Mount Sinai, created in 1063 for the protection of pilgrims on their way to the Holy Sepulchre. St. Catherine, I may add, was a Martyr about 305 A.D., and was ordered by the Emperor Maxentius to be tortured to death on cutting wheels. Hence the Badge. This old Tavern had carved upon it the date 1594, and in its latter days was a Coaching Inn. The Oak Lodge No. 190 met there in 1818.

The “Helmet” as its name denotes was a favourite resort of the London apprentice and the Trained Bands. Ned Ward says in the *London Spy*,

“For beer from the Helmet in Bishopsgate  
And why from the Helmet? Because that Sign  
Makes liquor as welcome t’a soldier as Wine.”

A carved Helmet is still fixed to a house at the end of London Wall, with the date 1668. In the reign of Charles II., on the 9th January, 1661, the Fanatics or Fifth Monarchy men rose in the City, were turned out of Threadneedle Street, and made their last desperate stand at the Helmet. In strange contrast to the martial character of this House we find the Lodge of Peace and Harmony No. 60 taking up their abode here in 1758.

The original “LONDON TAVERN” (*Plate No. VI.*) was erected in Bishopsgate Street about 1767, on the site now occupied by the Standard Bank of Scotland. It was built on the Tontine or Lottery system, an invention of Lorenzo Tonti, an Italian banker. It was for very many years the favourite public dining place in the City, being eminently respectable and dignified. On one occasion, however, I find a highly dramatic incident occurred there. It appears that late on Saturday afternoon, the 30th September, 1854, the Duke of Newcastle received a telegram from Belgrade announcing the victory of the Battle of the Alma. He sent to Messrs. Harrison, of St. Martin’s Lane, the hereditary publishers of the *London Gazette*. The head of the firm happened to be still at his office, and promised to do what he could to publish the glad news. He set to work himself with the aid of an office boy, printed a number of copies of the telegram, engaged a cab and drove to the various Theatres, leaving a copy for the Managers to read to the audience. He then sped on to the Mansion House. Lord Mayor Sydney had retired for the night, but at length appeared in a costume hardly befitting his exalted rank, and in slippers. When, however, he read the telegram, he insisted on going at once, slippers and all, to the London Tavern, where the Sheriffs were dining. Rushing into the astonished assembly, as one of the Sheriff’s was returning thanks, he read the telegram. The gathering cheered and dispersed to spread the glad tidings. This incident is referred to by Mr. Holden Macmichael in his interesting *Charing Cross and its immediate neighbourhood*. Very many of our old Lodges held their meetings here during the first half of the last century, and were doubtless sorry to see the stately old Tavern pass away.

“The Flowerpot Inn” once flourished on the site where the National Provincial Bank now stands. It was a noted starting place for the coaches and waggons to the northern suburbs, and here an old Lodge met in 1739, but was erased in 1742.

The last Inn in Bishopsgate Street that concerns us is by no means the least interesting. “The White Lion Tavern” had an entrance both into Cornhill and

Bishopsgate, and was, according to Wilkinson in his "Londinia" (1825), "A large Mansion with a garden as delineated in the older plans, and formerly occupied by Sir Samuel Barnardiston." Dr. Anderson tells us that on the 23rd April, 1723, the Grand Lodge met "in ample form at the White Lion, Cornhill, with former Grand Officers and those of thirty Lodges called over by Grand Warden Anderson, for no Secretary was yet appointed." The old Tavern was entirely destroyed in the Bishopsgate Fire of 1765. Here the Castle Lodge of Harmony held their meetings in 1763, and migrated to the "George and Dragon," Ironmonger Lane, after the Fire. A Plan of the neighbourhood published soon after the Fire, and showing Houses burnt or damaged, is now in my possession (*Plate No. VII*). It very clearly indicates the position and extent of this old House.

Let us now proceed southwards again and pass up LOMBARD STREET. This I think may be styled the High Street of the Roman Londinium, and I consider it is by no means fanciful to conjecture that the present MANSION HOUSE (*Plate No. VIII*) at its eastern extremity occupied about the site of the capitol or principal buildings of the Roman City. Certain it is that in the space between the Mansion House and Lombard Street, and for some distance down the street, a most extensive discovery of Roman remains was made in 1735. These consisted of pavements and walls of Roman masonry with much charred timber indicating a conflagration. Many coins of the reigns of Antoninus Pius and Constantine were unearthed, with drinking cups having broad brims, pointing perhaps to the site of a Vintner's premises. Dr. Harwood, writing in 1799, is of opinion that some of the remains proved that a Temple of Concord existed in the west end of the street.

An interesting little book by Mr. Hilton-Price on the Signs of Old Lombard Street, assists greatly in determining the situation of the Houses in the street. On the south side, opposite No. 58, standing a little way back from the street, was "The Castle Tavern," and we find that in 1731 the Landlord was a Mr William Plowman. From this old Tavern the Castle Lodge derived its name and met here in 1751. By a union with the Lodge of Harmony in 1776, it became the Castle Lodge of Harmony, No. 26. "The Abercrombie Tavern," situated close by, was the home of the Albion Lodge No. 9, in 1804.

At "The Bell," in Nicholas Lane, in 1738, the Old Union Lodge No. 46, then known as the Union Lodge of Freedom and Ease, met. On the north side there was a fine old House called "The King's Arms," where No. 66 now is, and in 1710 occupied by Messrs. Payne & Co., Bankers, but in 1720 turned into a Tavern. Here the Constitutional Lodge No. 55 (named in 1773) met in 1739. This old Inn appears to have been next to the famous "Jonathan's Coffee House," burnt down in 1778, and the site of both is now occupied by Messrs. Glyn's Bank.

"The Old Post Boy Inn" in Sherbourne Lane was erected on part of the site of Sir Robert Vyner's mansion, a notable inhabitant of the street in the reign of Charles II. Here a Lodge known as the Denmark Lodge met in 1741, but it was erased in 1791. The name of "The Post Boy" was later, I gather, changed to that of "The Mail Coach," and here the Lodge of Tranquillity No. 185 held its meetings in 1791.

There were other famous Taverns and Coffee Houses in the street or adjacent alleys. "The Royal Oak" where Pepys often dined, "Pontack's Head," or "The White Bear," the resort of Dryden, Swift and Defoe, and "Lloyd's Coffee House" which moved in 1714 to Pope's Head Alley.

Mr. William Harvey, in his pleasant, chatty book, *London Scenes*, describes Lombard Street as he saw it in 1805. "I have a vivid recollection of Lombard Street

**APLAN OF THE FIRE IN BISHOPSGATE STREET, CORNHILL AND LEADENHALL STREET.**

*Which began at St. Dunstons (marked A) on the 7 November 1763, and consumed 48 Houses and damaged about 25 more.*  
□ □ □ These are strong, extensive Foundations and Traces adjoining this place.

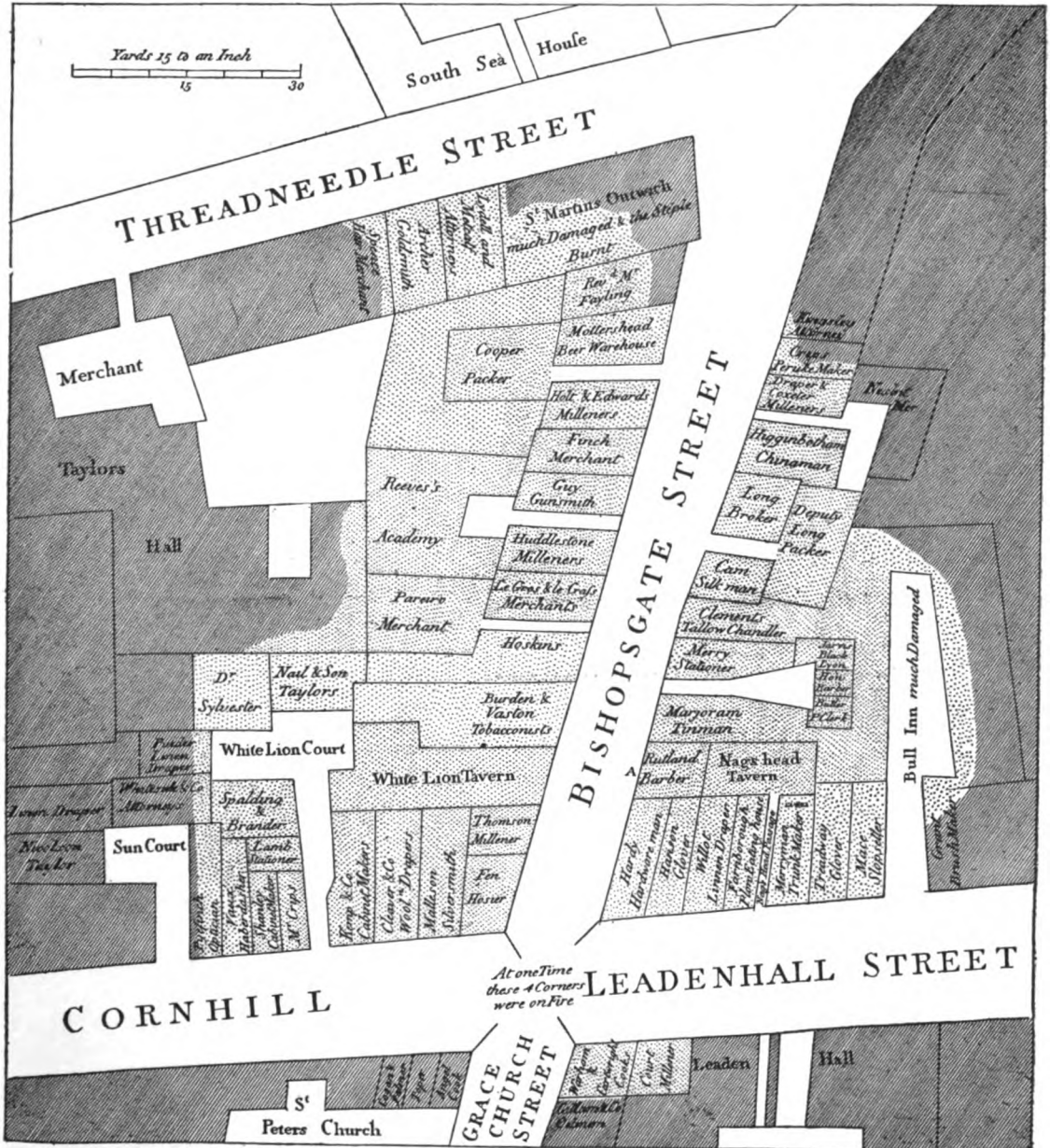

London, Published: Memory 1844, by Robert Wilkinson, and Frederick Green.





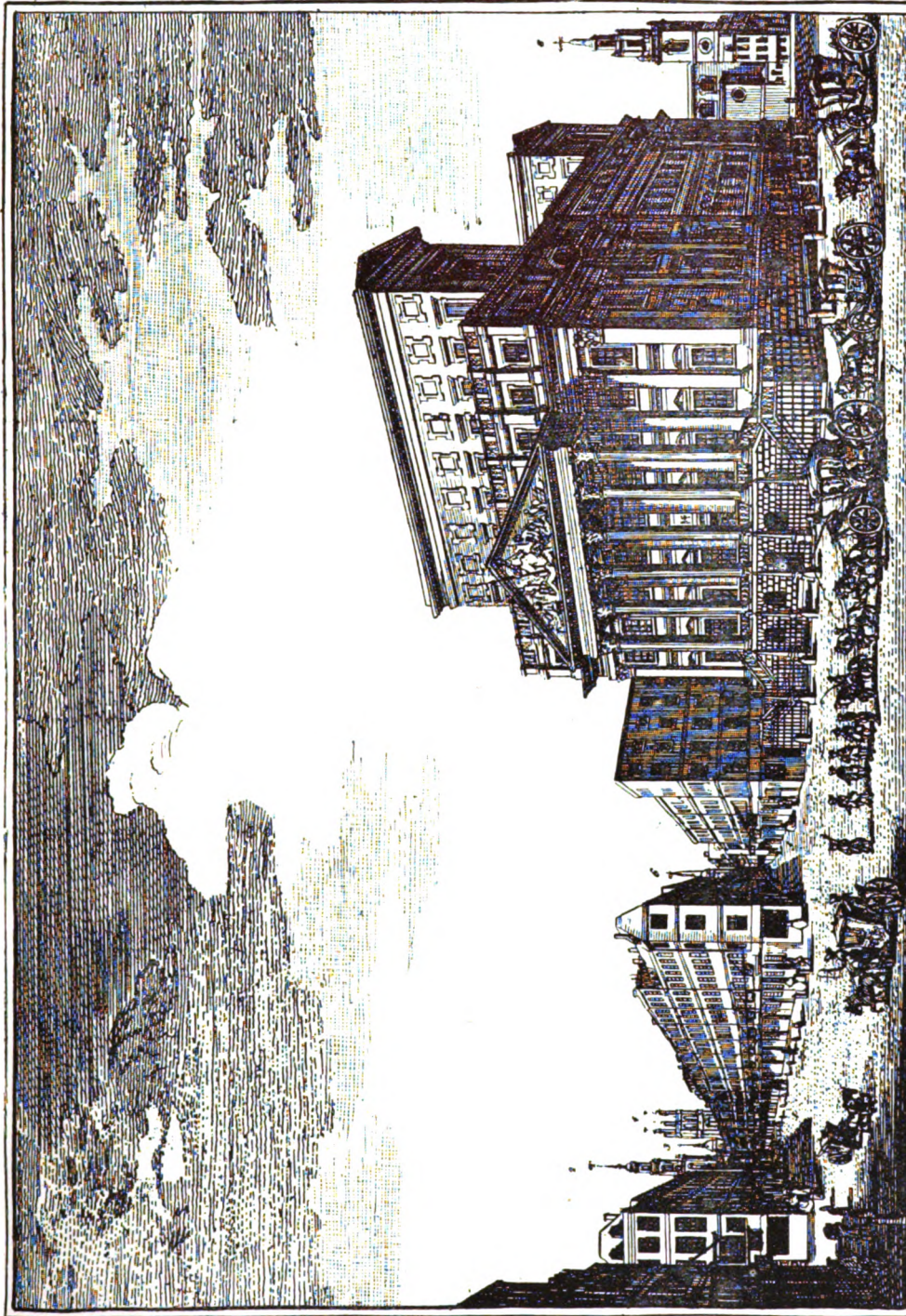

- 5. Lombard Street
- 6. St. Andrew's Church.
- 7. The Piazza
- 8. St. Stephen's Walbrook.

*A North West Prospect of  
The Lord Mayors' Mansion House*

*Printed for R. Daldry, junr, at the River-Port-Printer Rom.*

- 1. Cornhill
- 2. The Royal Exchange.
- 3. St. Peter's Church.
- 4. St. Michael's Church.







IX.—THE GEORGE AND VULTURE.  
From an Original Drawing in the Gardner Collection.

as I saw it in 1805. More than half a century has rolled away since then, yet there, sharply and clearly defined before the eye of memory, stand the phantom shadows of the past. I walked through the street a few weeks ago. It is changed in many particulars, still, enough remains to identify it in many particulars with the tortuous dark vista of lofty houses which I remember so well. Then there were no pretentious stucco-faced banks or offices, the whole wall surface was of smoke blackened brick, its colour seemed to imitate the mud in the road, and as Coach, or Waggon, or Mail Cart toiled or rattled along, the basement stones were bespattered freely from the gutters. The glories of gas were yet to be. After 3 o'clock p.m. miserable oil lamps tried to enliven the foggy street with their 'ineffectual light,' while through dingy, greenish squares of glass you might observe tall tallow candles dimly disclosing the mysteries of Bank and Counting house. Passengers needed to walk with extreme caution, if you lingered on the pavement, woe to your corns! If you sought to cross the road, you had to beware of the flying postman, or the letter bag express. As six drew near, every Court, Alley and blind thoroughfare in the neighbourhood echoed to the incessant din of letter bells." I quote the passage as it seems a graphic description of the streets of the City generally of that period.

It is now but a step and we find ourselves in CORNHILL, so called, Stow says, "of a Corn Market time out of mind holden there," and that in his time there was a "fair conduit of sweet water castellated in the midst of the Ward and Street." At the west end of the Royal Exchange, first built in 1566, and next adjoining the Exchange, "remaineth one part of a large stone house, and is now called the Castle of that Sign having a passage through out of Cornhill into Threadneedle St."

The most ancient Tavern in Cornhill was without doubt "The Pope's Head Tavern." Stow, writing in 1598, says "The Pope's Head Tavern with other House adjoining strong built of stone hath of old time been all in one pertaining to some great estate, or rather to the King and this realm as may be supposed both by the largeness thereof, and by the Arms to wit three Leopards passant gardant, which were the whole Arms of England before the reign of Edward III. that quartered them with the Arms of France three fleur-de-lis." He adds "the Pope's Head Tavern hath a footway through from Cornhill into Lombard St." In the ballad of *London Lockpenny*, in the reign of Henry V., there is an account of a country-man enticed into this Tavern by the Drawer standing at the door, and where he gets a good drink for a penny, but complains that no bread was given him with it. The Tavern was destroyed in the Great Fire, but partially rebuilt. This Tavern is frequently mentioned by Pepys in his Diary. A Masters' Lodge, originally held at the Swan and Rummer, Finch Lane in 1726, removed to the Swan, Exchange Alley in 1730, and lastly to the Pope's Head in 1751, where it seems to have lapsed. The Pope's Head was almost entirely pulled down about 1790, and the site occupied by Reeve's Chop House.

With regard to "THE GEORGE AND VULTURE," (*Plate No. IX.*) a famous Masonic House, Strype (vol. ii., p. 162), writing in 1720, says "near Balls Alley was the George Inn since the Great Fire built with very good Houses, well inhabited and warehouses being a large open Yard called George Yard the further end of which is the George and Vulture which is a large House, and of a good trade having a passage into St. Michael's Alley." The Tavern was much damaged in the fire of the 25th March, 1748, for we read in the *London Magazine* of that date that the back premises were burnt down, and other houses in the Yard entirely destroyed. The Inn was restored and enlarged, and from about 1810 to 1848 many distinguished Lodges met there. We find the St. George's Lodge (now St. George and Corner Stone No. 5) there in 1839, but it seems to have taken its

name from "The George Tavern," Commercial Road, Stepney, when it met in 1820. Amongst other Lodges, the Old Dundee Lodge No. 18 met there in 1821, and the Emulation Lodge No. 21 in 1815. It will be remembered that the "George and Vulture" was much beloved by Mr. Pickwick.

Of Taverns of lesser note we have the "Edinburgh Castle Inn" "which stood on the site of the Castle" mentioned by Stow, and the Albion Lodge No. 9 found a home there in 1774. "The Cock and Lion Tavern" where the Royal Kent Lodge of Antiquity No. 20 met in 1740, was entirely destroyed in the fire of 1748. "The Sun behind the Royal Exchange" was in the reign of Charles II. kept by John Wadlow, sometime landlord of "The Devil Tavern," Fleet Street. Pepys relates on the 28th June, 1667, "Mr. Lowther tells me the Duke of Buckingham do dine at Wadlow's at the Sun Tavern." A Lodge was meeting here in 1743, but lapsed in 1761.

The "Ship behind the Royal Exchange" appears in the Engraved List of 1723, and seems to have been chosen as a Masonic meeting place by several Lodges, the last of which became dormant in 1761. I have found a curious advertisement in the Guildhall Library inviting tenders in 1730. "The Bank of England intending to rebuild the Ship Tavern behind the Royal Exchange. This is to give notice that any workman that will undertake it according to the plan prepared which they may have at the Bank may give in their proposals sealed up to the Bank on Thursday, the 8th July next at 12 o'clock."

A little further east, where the Peabody Statue now stands in Spread Eagle Court, stood "THE CAVEAC TAVERN" (*Plate No. X.*), for some time probably the resting place of the Caveac Lodge No. 176. And proceeding down Threadneedle Street, we have "The Hercules Tavern" at the corner of Hercules Passage, and "The Antwerp Tavern," both having good Masonic records up to about 1830. Owing to the rebuilding of the Royal Exchange, and the adjacent property between the years 1835 and 1850, a great change came over this neighbourhood, and the Tavern gave place to the Bank and the Office.

Crossing the open space in front of the Mansion House, which in the 18th century presented a very different appearance to the confined thoroughfare of to-day, we pass into the more commercial quarter of CHEAPSIDE the home of the Mercer and Grocer, "so named from a Market there called West Cheping."

On the right hand we have Bucklersbury, the name being derived "from a Manor pertaining to one Buckle, who then dwelt, and kept his Courts" in a stone house or Tower called the Old Barge. This of late years Stow adds was taken down by one Buckle a Grocer to erect new premises, "but the said Buckle greedily labouring to pull down the Tower a part fell upon him, which so sore bruised him that his life was thereby shortened, and another that married his Widow set up the new prepared frame of timber, and finished the work." A sad instance of "too much haste less speed," and affording a warning to vandals for all time.

Cheapside itself was mostly occupied in the east by Grocers, and in the west by Mercers, many of the old Taverns taking up a retiring position in the alleys and passages leading into it.

Just past Bucklersbury on the south side we have Bird in the Hand Court, and "The Queen's Head" built on part of the site of the Old Barge. "The Queen's Head" became a very popular Sign in the reign of Queen Elizabeth, so much so that portraits of that Sovereign Lady became more numerous than flattering, and in 1563 she issued a Proclamation that no such sign should be set up until approved. Here the St. Mary Lodge No. 63 met in 1792. The old Tavern was purchased by Mr. Simpson, and is now known as "Simpson's, Cheapside." "The Queen's Arms" in Cheapside, lower down,

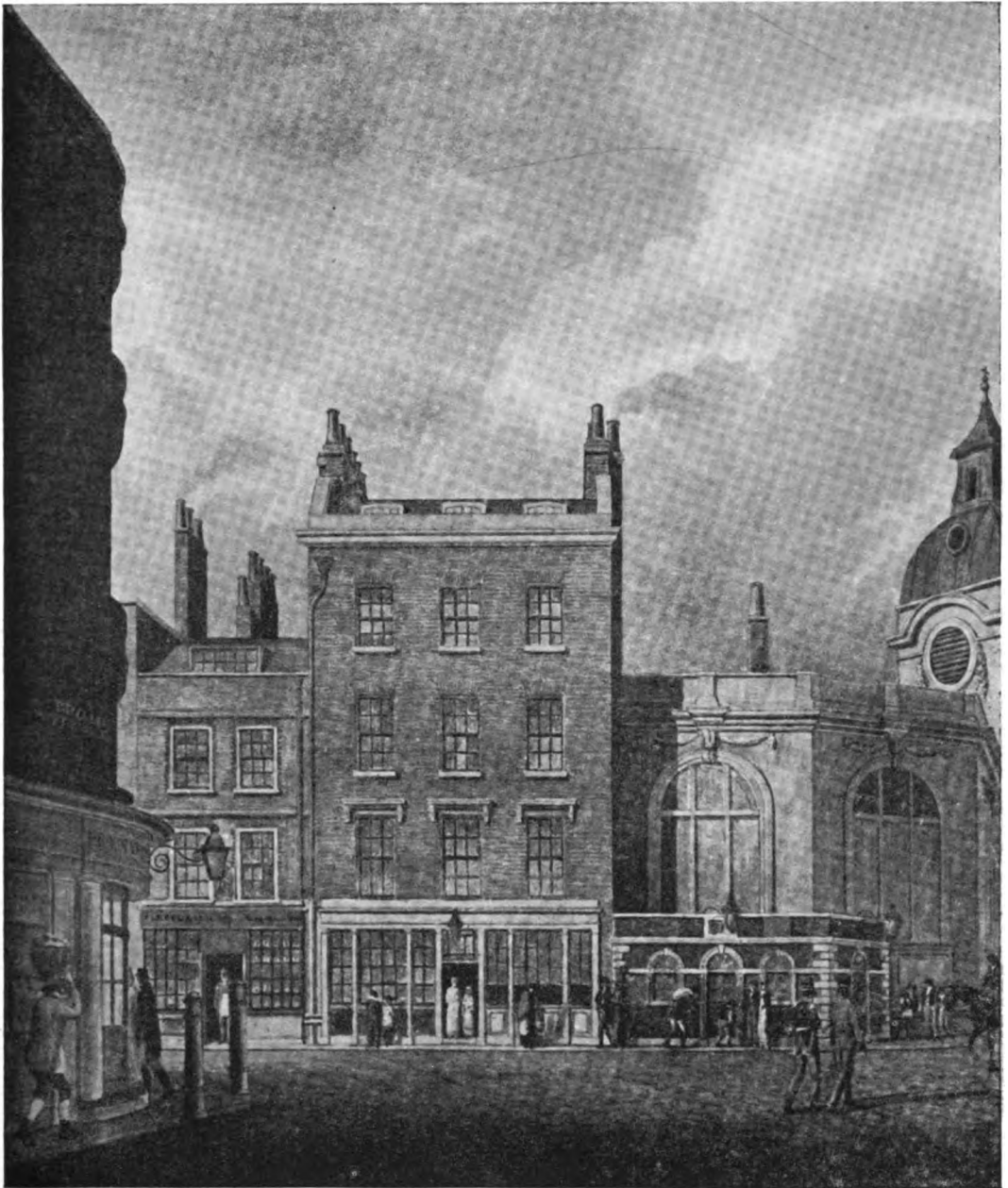

X.—VIEW OF HOUSES IN SPREAD EAGLE COURT, THREADNEEDLE STREET,  
FORMING THE OLD CAVEAC TAVERN (1800).

From a Painting in the possession of Messrs. Drew & Co.







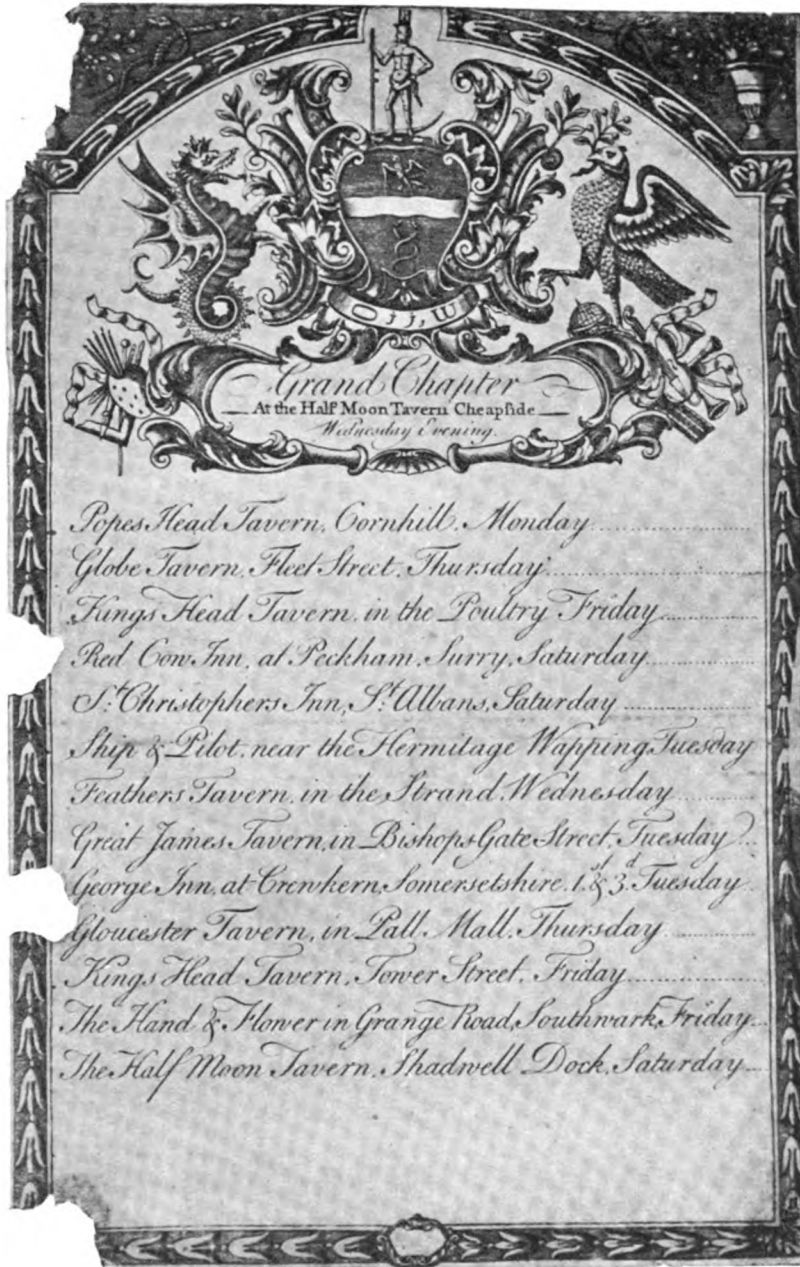

XI.—LIST OF CHAPTERS OF THE "GREGORIANS."  
 From an Engraving in the Gardner Collection.

must not be confused with this Tavern. It was the residence of the Poet Keats for some years about 1815, and here he wrote all the poems of his first little volume. "The Queen's Arms" afforded quarters to the British Social Lodge in 1823, and the Lodge of Economy in 1814 both of which have lapsed.

On the north side at the corner of Gutter Lane once stood "The Half Moon Tavern" famous—if for nothing else—as the House where Elias Ashmole dined on the 11th March, 1682, after the Lodge at which Sir Wm. Wilson, Captain Borthwick, and four Members of the Masons' Company were received into the Fellowship of Freemasons. This meeting has been fully dealt with by Masonic historians, and more recently by Bro. Hugan. In passing I would add an item or two to the information as to this Sir William Wilson. I see in Le Neve's Pedigree of Knights, p. 362, "Leicester Sir William Wilson of ye Towne & City Leicester Knighted at Whitehall 8th March 1681." And in Horace Walpole's *Anecdotes of Painters, etc.*, vol. iii., p. 139, "That he was an Architect in the reign of William III., and built the steeple of Warwick Church after it had been burned," and further, that he did a mezzotinto of Lady Newburgh, Lord Lansdown's Myra (See also Johnson's *Life of Lord Lansdown*). The Inn was of some antiquity as it is referred to by Ben Jonson, who was apparently disappointed of a drink there:—

"Since the Half Moon is so unkind  
To make me go about,  
The Sun my money you shall have,  
And the Moon shall go without."

An advertisement in the *Gentleman's Magazine*, April 1747, states, "Half Moon Tavern, Cheapside. His Royal Highness the Duke of Cumberland having restored peace to Britain by the memorable Battle of Culloden, the choice spirits have agreed to celebrate that day annually by a grand Jubilee in the Moon, of which the stars are hereby acquainted and summoned to shine with the highest lustre at 6 o'clock on Thursday next." The Sign of "The Half Moon" or Crescent represents temporal power, and the Sun spiritual. A half moon also in old slang tavern language meant a sixpence.

I have found a LIST IN THE GARDNER COLLECTION (*Plate No. XI.*) of the meeting places of certain Chapters, which seems to imply that a Grand Chapter met at the Half Moon. The date of the List is uncertain, but I think it must be prior to 1750. The Grand Lodge held a meeting there on the 24th June, 1731. The "Half Moon" appears in the Engraved List of 1723, the Constitutional Lodge No. 55 met there in 1762, and the Caledonian Lodge No. 180 in 1764. The last mention of this Tavern in the Records is in 1778, a little later it changed its name to "The New London Tavern" and under that name was patronised by the Moira Lodge No. 92 in 1803, and others. It ceased to exist in 1817.

"The King's Head Tavern," originally "The Rose Tavern," in the Poultry, had a noted landlord in the reign of Charles II., a Mr. King. When Charles was about to make his entry into the City, Mrs. King was, so to speak, about to present to her husband a little Prince of Wales. The good lady was most anxious to see the Royal procession, and was placed in front of the Inn. The gallant Monarch hearing of this stopped and kissed her hand. Then "The King's Head" was substituted for "The Rose." This Mrs. King was aunt to Mr. Bowyer, a well-known printer of the 18th century. The Tavern long survived, and we find several Lodges meeting here. The Neptune Lodge No. 22 as late as 1850.

"The Rummer" seems to have been situated at the corner of Bow Lane, for we find this advertisement in 1720. "The Rummer over against Bow Lane in Cheapside the surprising Mr. Higgins the posture master lately performing in the Queen's Theatre Royal Haymarket is to be seen every night at 6 o'clock." At this Inn the Westminster and Keystone No. 10 took up their abode in 1729.

A little further east in Lawrence Lane once stood "THE BLOSSOMS INN," (*Plate No. XII.*) one of the most ancient in the City. Stow refers to it as "among many fair houses there is one large Inn for the receipt of Travellers called Blossoms Inn, but corruptly Bossums Inn, and hath a sign, St. Lawrence the Deacon, in a border of blossoms or flowers." The legend of St. Lawrence is that he was martyred by being roasted alive on a gridiron, and that flowers sprang up on the spot. In the reign of Henry VIII., 1522, the Emperor Charles V. visited England, and an enquiry was held as to the accommodation of certain Inns for housing his retinue. "The Blossoms" is put down as having "20 beddes and stabling for 60 horses" (Rutland Papers, Camden Society). Ben Jonson also refers to it in his *Masque of Christmas* :—

"But now comes Tom of Blossoms Inn  
And he presenteth misrule."

At this Inn a Masters' Lodge met as early as 1736, the Royal Kent Lodge of Antiquity No. 20 in 1741, and the Jordan Lodge No. 201 as late as 1831. Soon after this date it was pulled down, but the name is still retained in Blossoms Yard, the receiving office of the Great Eastern Railway.

Passing out of the commercial atmosphere of Cheapside, let us take a short view of ALDERSGATE STREET, honoured at one time by many noble families, and ecclesiastical dignities. Here were Northumberland House, Shaftesbury House and Shelley House, and, within the Gate, the Collegiate Church of St. Martin's, which up to the reign of James I. afforded sanctuary.

"The Castle and Falcon Tavern" was an old Tudor house deriving its sign probably from the crest of Queen Catharine Parr, which was a crowned Falcon perched on a Castle. In the reign of Queen Elizabeth this House was occupied by John Day, the foremost printer of that period. Later it became a great coaching Inn, giving its name to Inns at Chester, Birmingham, etc. In 1775 the Universal Lodge No. 181 came here, and the Old Union Lodge No. 46 in 1829.

"The Mourning Bush Tavern" just within the Gate was before known as "The Bush or Fountain," and was of great antiquity, being built probably on the site of a Roman Tavern. It received the addition of "Mourning" from a Royalist Landlord after the execution of Charles I. A somewhat similar instance is given in *Hearne's Reminiscences*. The following anecdote is copied from a paper in the handwriting of Dr. Richard Rawlinson (the Masonic Historian), of Daniel Rawlinson, "who kept the Mitre Tavern Fenchurch St., and of whose being suspected in the Rump time I have heard much. The Whigs tell this that upon the King's murder he hung his sign in mourning. He certainly did right. The honour of the Mitre was much eclipsed by the loss of so good a parent to the Church of England. These rogues say this endeared him so much to the Churchmen that he soon throve amain and got a good estate." The connection of "The Mourning Bush" with the Emulation Lodge (once the Mourning Bush Lodge) No. 26, has been lately sketched by the able pen of Bro. Henry Sadler.

At "The Britannia," Barbican, close by, the Lodge of Industry No. 186 (called in 1819 the Britannia Lodge of Industry) held its meetings, and here it was that on the 23rd November, 1808, it was temporarily erased "for having entered, passed, and raised a black man."

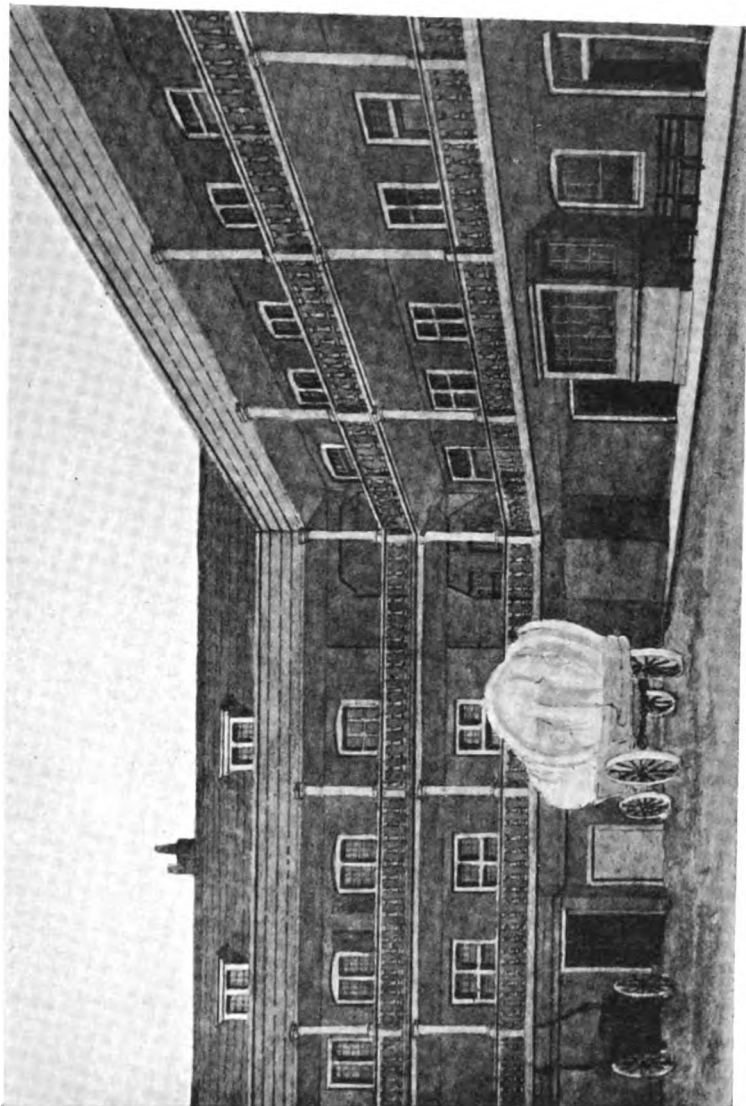

XII.—THE BLOSSOMS INN.  
From an Original Drawing in the Gardner Collection.









XIII.—SUMMONS OF THE WEST INDIA AND AMERICAN LODGE  
(LODGE OF ANTIQUITY).

From the original in the Guildhall Library.

And lastly there is "The Albion Tavern," the comfortable quarters still of a number of the old Lodges some of whom have now remained something like a century without moving. The Tavern was originally the private residence of an Alderman Harvey, and as far as I can make out stands upon part of the site of Shaftesbury House.

Passing now into ST. PAUL'S CHURCHYARD we find ourselves in Farringdon Ward, so called from William Farringdon, Citizen and Goldsmith, to whom "all the aldermanry with the appurtenances within the City of London, and the suburbs of the same between Ludgate and Newgate, and also without the same Gates" were granted in 1279. We also approach a quarter more dignified and literary, and the names of the Taverns are consistent with the character of the locality. Hence we have "The Mitre," "Paul's Head," and "Chapter Coffee House," etc., and literary and musical clubs connected with them. We come across very few of these east of St. Paul's Churchyard and in the eighteenth century the division between what may be called the City proper and the West End, was sharply defined.

The account of Society in 1701 from the Works of Francis Osborn, p. 403, is interesting: "It was the fashion in those times and did so continue till these for the principal gentry, Lords, and Courtiers, and men of all professions not merely mechanic to meet in St. Paul's Church by 11, and walk in the Middle Aisle till 12. And after dinner from 3 to 6; during which time some discoursed on business, others of news. And I being young did associate myself at those hours with the choicest company I could pick out."

"The Mitre" was an old Stuart Inn in London House Yard at the north west corner of St. Paul's Churchyard. In the latter part of the 17th century the landlord was a Mr. Robert Herbert, sometime doubtless a traveller and collector, for he issues the following advertisement. "Catalogues of many natural rarities with great industrie cost, and 30 years travel in foreign countries collected by Robert Herbert, alias Forges Gent, and sworn servant of his Majesty to be seen at the place called the Musick House at the Mitre near the West End of St. Paul's Church 1664." Most of this collection was afterwards bought by Sir Hans Sloane. The tenancy of Herbert appears to have ended in 1672, and as far as I can gather from the Parish Assessment Books one Brookes succeeded him. Music had no charm for this Landlord and he changed the name to "The Goose and Gridiron" in contradistinction to the Swan and Harp, the usual sign of a Tavern connected with musical entertainments. Later on it is spoken of as "an old Inn on the north side of the Churchyard the usual starting place for Coaches for Hammer-smith and the western villages." Here the four Old Lodges met to constitute the Grand Lodge. The Lodge of Antiquity No. 2 met here in 1717. The Masonic Records tell us this Lodge was named the West India and American Lodge in 1761. This must be a slight error as the fine ENGRAVED SUMMONS (*Plate No. XIII.*) I have found in the Guild-hall Collection of Prints gives that name in 1760. The Lodge was then meeting at "The Queen's Arms," St. Paul's Churchyard. The Tuscan Lodge had their meetings here in 1766, and the Bank of England Lodge No. 263 in 1820.

On the opposite side was "The Paul's Head," Carter Lane, at the corner of Doctors' Commons. This Tavern was of great antiquity as it is mentioned in Machyn's Diary for 1562. "The 26. May a young man did hang himself at Polles Head Inn in Carter Lane." Stow later refers to it "Near the south chain of St. Paul's Churchyard is the Paul Head Tavern, which House with the appurtenances was of old time called Paul's brew house."

Hearne informs us that the famous library of his friend Thomas Rawlinson was sold there in 1721. It afterwards became known as the St. Paul's Coffee House, and a favourite resort of Addison (Johnson's *Lives of the Poets*). Here a Lodge No. 184 met in 1756, but was erased in 1777.

There was also a noted Tavern in Carter Lane, Doctors' Commons, known by the Sign of "The Horn" where the Castle Lodge of Harmony No. 26 met in 1776, and Enoch Lodge No 11 in 1793. At this Tavern the Guy Fawkes conspirators are supposed to have held their conferences when in London, and a stone's throw off we have "The Bell Inn," where in 1598 Richard Quynney directs a letter to "My loveing good ffriend and countreymann Mr. William Shakespeare deliver these." The only known letter extant addressed to the Poet. Here Lodges now erased met in 1754 and 1762, and the Lodge of Honour and Generosity No. 165 in 1818.

At "The Kings Head," Ivy Lane, the Lodge of Friendship met in 1723. The Tavern seems to have been a favourite literary rendezvous in the latter part of the 17th century, and the beginning of the 18th. Here Dr. Johnson's "Ivy Club" met originally in 1749 every Tuesday, not in 1747 as stated by Boswell (Hawkins *Life of Johnson*, p. 360). The landlord was then one Horseman, and the members included Mr. Ryland, Dr. Hawkesworth, and Sir John Hawkins. It seems to have lapsed about 1756. In 1783 Dr. Johnson sought to revive it, but Hawkins found that "The King's Head" was shut up, so the four surviving members Johnson, Hawkins, Payne and Ryland, dined at "The Queen's Arms," St. Paul's Churchyard; but there were only three meetings the last being held at Dr. Johnson's House. "The Queen's Arms" is also mentioned in the Diary of Brasebridge the old Fleet Street Jeweller, who tells us he was a member of "the Sixpenny Card Club which held their meetings there." In 1736 we find the Lodge of Antiquity located here.

At "The Sun," at the south west corner of the Churchyard the Globe Lodge met in 1725, and to the quaint Sign of "Tobets Dog" the Mount Lebanon Lodge No. 73, went in 1802.

LUDGATE HILL forms the connecting link between St. Paul's Churchyard and Fleet Street. The idea that the Gate derived its name from a mythical British King of the name of Lud may be dismissed. The Gate Maitland (following Leland) thinks was without doubt originally "Flood Gate" or "Fleet Gate."

Ludgate Hill (formerly called Bowyer Row) seems to have been a somewhat favourite resort of Masonry in the first half of the 18th century. Beginning at the East End we have "The Fountain Tavern" where the Ionic and Prudence Lodge met in 1747, "The Kings Arms" where the Ark Lodge No. 92 met in 1732.

I cannot quite locate the position of "THE DOLPHIN TAVERN" (*Plate No. XIV.*) which is described as off Ludgate Hill, and is shewn in a photograph from the Gardner Collection as it stood just prior to its demolition. Sir John Hawkins informs us that at the Sign of "The Dolphin and Crown" at the west corner of London House Yard, at the east end of Ludgate Hill, lived early in the eighteenth century, Messrs. Young, Father & Son, noted violin makers, and players. I think however the site of the Tavern must have been where the City Bank now stands half way down the south side close to St. Martin's Court, in 1720 called "Dolphin Court." It was noted later for its "Ordinary" or Dinner at 1 o'clock, much patronised by people shopping at the Mercers in Ludgate Hill. The Lodge of Tranquillity No. 185 met here in 1797.

Half way down Ludgate Hill on the right we come to the Old Bailey, and from thence pass into NEWGATE STREET, which at one time boasted of a popular Inn known as "The Salutation Tavern," and later as "The Salutation and Cat." It dated back

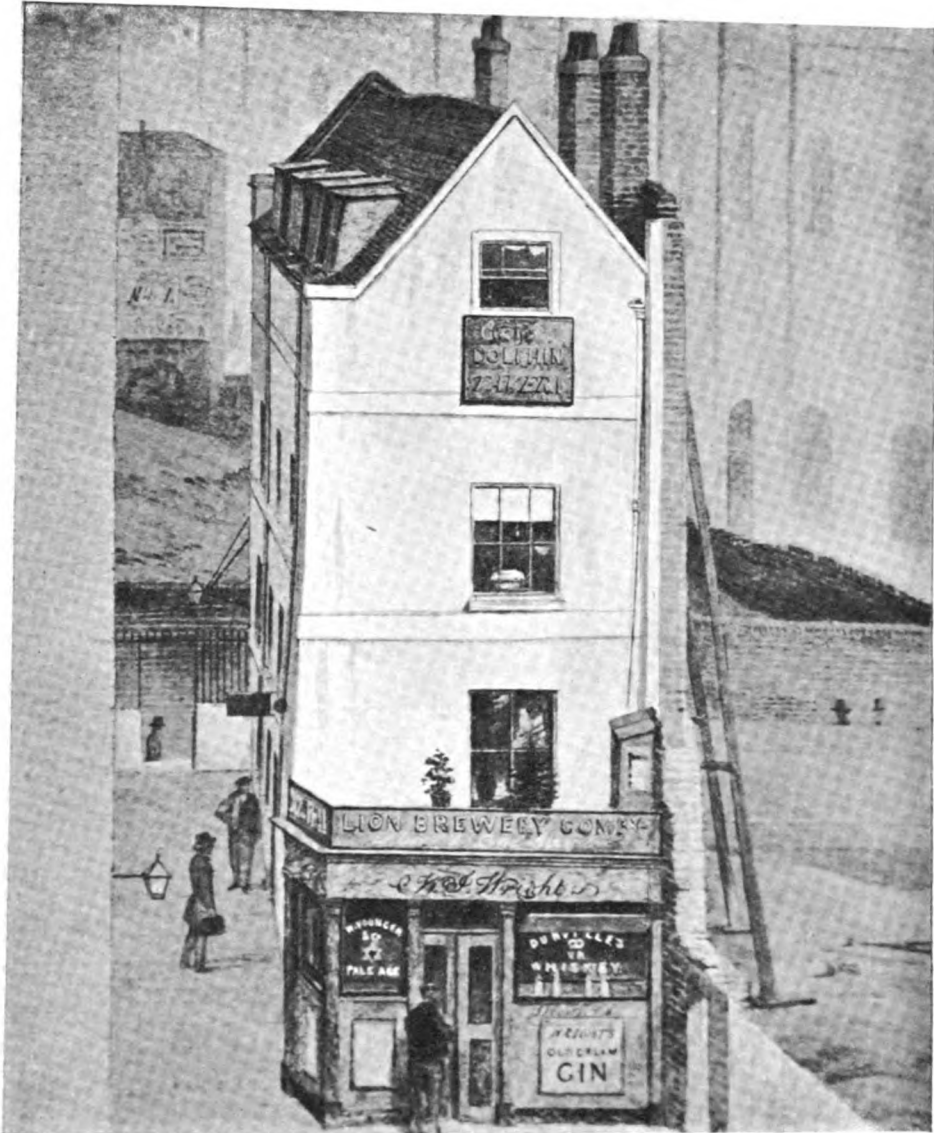

XIV.—THE DOLPHIN TAVERN.

From an Original Drawing in the Gardner Collection.







XV.—THE OLD BELLE SAVAGE IN 1828.

From a Print after an Original Drawing in the Gardner Collection.

to the seventeenth century, and the Sign of "The Salutation" was originally represented by an Angel saluting the Virgin Mary. This was changed in Puritan times to two sober citizens saluting one another. The "Cat" was, according to Larwood, added in the eighteenth century, and does not refer to the domestic animal; but to the snuff box on the top of a walking stick, called "the cat" which it was customary to offer to a friend on meeting him. Here Sir Christopher Wren used to resort for rest, and a pipe during the building of St. Paul's. We have this letter addressed by Edward Cave and William Bowyer, the publishers and printers, to their friends, 17th January, 1735. "Sir—You are desired on Monday next at the Salutation Tavern, Newgate Street, to meet—Supper will be on the table at 8 o'clock. One of St. John's and other of St. John's Gate." Coleridge, and Lamb also frequented this House.

"The London Coffee House," (originally called "The King's Head,") built on the site of the old Ludgate Prison, is by no means the oldest of the Taverns, but was celebrated from a Masonic point of view. During the building some interesting Roman remains were here unearthed, a statue of Hercules and an Altar; pointing to the possibility of a Temple on this spot. The House was occupied in 1731 by a certain James Ashley as appears by the following advertisement, (Guildhall Library), "Opened the London Coffee House, Punch House, Dorchester Beer House, and Welsh Ale Warehouse, where the finest old arrack rum and French brandy made into Punch with other of the finest ingredients will be sold. A quart of Arrack Punch for 6/-, a quart of rum and brandy made into Punch for 4/-, and small quantities in like proportion. N.B. The Salutation in Newgate Street is to be let, enquire of the London Coffee House aforesaid." In 1738 there is another advertisement describing it as "The London Punch House, of Signs Two Punch bowls on iron pedestals before the door." Ashley died in 1776 aged 78 years. The father and grandfather of John Leech, of *Punch* fame, were landlords of this House. The last tenant was Robert Clarke and it was ultimately sold to the Corporation of London for £38,000. The earliest Masonic record is in 1772, the London Lodge No. 108 going there in that year, the Grand Master's Lodge in 1787, and the Shakespeare Lodge No. 99 in 1805, followed by many others up to about 1860.

"THE OLD BELLE SAVAGE" (*Plate No XV.*) in Belle Savage Yard, Ludgate Hill, had an interesting history. In 1568 one John Craythorne demised the premises to the Cutlers' Company to provide two Exhibitions at the Universities. At No. 11 Bell Savage Yard, the famous carver in wood, Grinling Gibbons, lived. In 1838 it was pulled down and Messrs. Cassell and Co. have their printing works on the site. The French Lodge No. 270 held their meetings here in 1765, and afterwards moved to the Fountain, Ludgate Hill.

After descending Ludgate Hill we pass the Fleet Prison on our right and the ancient Bridewell Prison on the left, and thence into the classic FLEET STREET, the prospect of which delighted the heart of Dr. Johnson, and was preferred by him to the fairest landscape. It was not however always classical ground, for in the days of the Plantagenets it seems to have been mostly inhabited by Alewives, the monopoly of brewing apparently at that period appertaining to the female sex. It is possible that the numerous large and small Inns in Fleet Street and its vicinity in the 17th and 18th centuries, may have their origin in the locality being the centre of the brewing trade. In any case what the Americans now call taking a "whiskey walk," namely, sampling the liquor of each Inn as you go along, would then have been a most trying ordeal. The parish books of St. Dunstan's, Fleet Street, show us that in 1558 there were twenty-six Taverns, and in 1671 the number had increased to sixty. Mr. Noble's



*Memorials of Temple Bar* supply many details of great interest with regard to the Temple, and neighbourhood generally.

Immediately after entering the street we have on the south side Salisbury Square or Court, a place which Stow says was "so called because the Bishops of Salisbury had their house there now in possession of Sir Richard Sackville." In this square of old time there was an Inn known as "The Old Blue Last." "The Last" was a common Sign, for the proverb runs "Cobblers and Tinkers are the best Drinkers" and

All day long I have sought good beer

And at "The Last" I have found it there.

Here two Lodges known as the Vacation and Foundation met in 1758 and 1759 respectively, but both lapsed about 1806. And at "The White Swan," Shoe Lane, two other Lodges met in 1756 and 1805, but were subsequently erased.

"The Globe Tavern" was an ancient Inn having an excellent Masonic record alluded to very fully in Bro. Henry Sadler's recent *History of the Globe Lodge*. I may add however a few particulars. The Tavern was leased in 1649 to one Hothersall, for a rent of £75, and 10 gallons of canary sack. It was burnt in the Great Fire, and restored by Hothersall at the cost of about £1000. A piece of ground at the back was added "for the more commodious landing of his wines from Shoe Lane." Later a noted citizen, Deputy Thorpe, was landlord for many years; and literary clubs and lodges met there during his time. Besides the Globe Lodge we find that as early as 1738 a Lodge met here which was subsequently erased in 1743, the Lodge of Stability No. 186, in 1815, and the Royal Naval Lodge, in 1822.

Further on "The Green Dragon" still flourishes at 56, Fleet Street, near Pleydell Court. It was originally called "The Griffin," and an old Lodge, now lapsed, met there in 1748. It was chiefly noted as the meeting place of the Eccentrics or Brilliant Club, who removed there from Chandos Street, about 1760. This Club had a very numerous membership, amongst whom were Fox, Sheridan, Lords Melbourne and Brougham and Théodore Hook. I find only one Lodge meeting there in recent times, the Domestic Lodge, in 1844. Just south of this Inn was the Whitefriars, and in reference to the adjacent land there is an old Deed in the manuscripts of the Guildhall Library, dated the 4th April, 1668, by which Matthew Hunter Clarke, Rector of the Parish Church of Newbold Pacey, Warwick, and Sarah, his wife, demised unto Edward Marshall, citizen and Freemason, certain lands in the liberty of the priory house called Whitefriars, on a building lease for 53 years, at a rent of £28.

"THE GREYHOUND INN" (*Plate No. XVI.*) seems to have been a popular resort in the eighteenth century, particularly for country folk, and in one of the most curious of the Roxburgh Ballads we have a reference to it:—

"Farewell to the Greyhound,  
Farewell to the Bell,  
Farewell to my Landlady  
I do love so well."

The Ballad is entitled *A Merry Man's Resolution*, by a countryman who had apparently spent a jovial time in London, and the Bell, also referred to, was doubtless the Bell, in Bell Yard. The "Greyhound" appears in the Engraved Lists of 1723 and 1725. When it ceased to be a Tavern it appears from the engraving in the Gardner Collection to have been transformed into a police office.

"The Horn Tavern," now Anderton's Hotel, was one of the most venerable in the street. It was conveyed in 1405 to the Goldsmiths' Company, for certain charitable

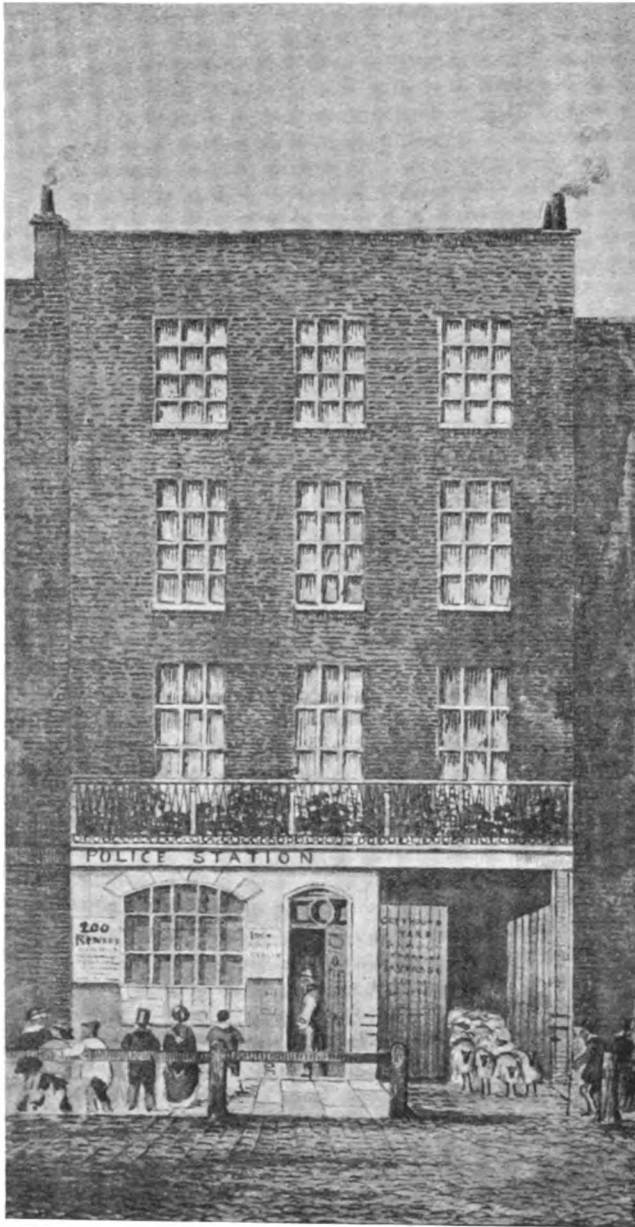

XVI.—THE GREYHOUND INN.

From an Original Drawing in the Gardner Collection.





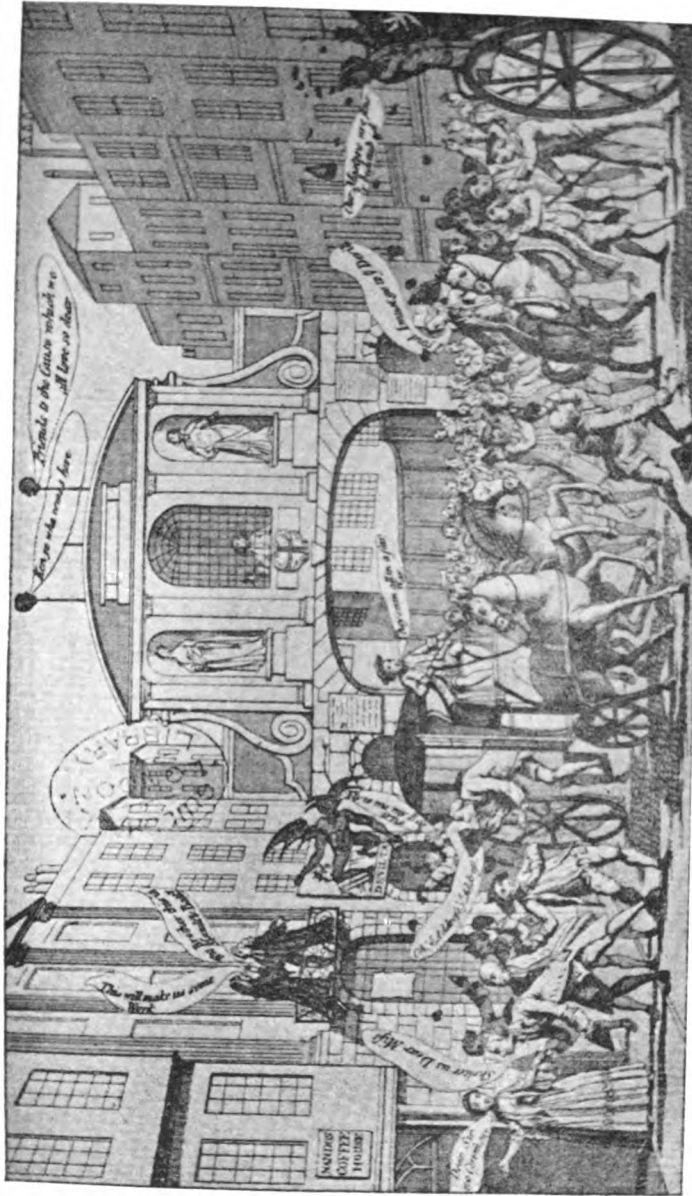

XVII.—THE BATTLE OF TEMPLE BAR.  
From an Engraving in the Guildhall Library.

purposes, and they remain, I believe, the ground landlords. Machyn mentions the house in his diary of 1551, and the Registers of St. Dunstan's have this entry 1597, "Rape was slain at the Horne buried." In Father Hubbard's Tales, 1604, we have this reference "And when they pleased to think upon us, told us that we were to dine at the Horn, in Fleet Street, being a House where their lawyer resorted." Snelling, the great authority on coins and medals lived next door. "London printed by T. Snelling next the Horn Tavern in Fleet St., 1766. Who buys and sells all sorts of coins and medals." Early in the last century it became Anderton's Coffee House, and, from an advertisement in the Guildhall Library, it appears to have been opened as an hotel in 1833. "Mr. J. Leech, who prepared the magnificent festival on London Bridge has we see reopened Anderton's. The Coffee House was one of the oldest in London, and is mentioned by Addison as the favourite resort of Sir Richard Steele, and other famous contemporaries." The house was rebuilt in 1879. An old Masonic Lodge met here as early as 1751, but was erased in 1762. The Grand Steward's Lodge went there in 1761. Since that time it has become the home of numerous, and influential Lodges.

"The Old Mitre Tavern" which occupies the site where Hoare's Bank now stands, differs from nearly all the Taverns I have referred to, in that there are so many references to it, both Masonic and otherwise, that care has to be taken to be reasonably concise. Here, of course, Dr. Johnson first dined with Boswell, and the latter relates that it was at this house the Doctor "loved to sit up late." Collier tells us that this Tavern was the resort of Shakespeare, who here wrote two songs, "From the rich Lavinian Shore" and "Give me a cup of rich Canary Wine." Hogarth often resorted thither, and his quaint invitation card to his friends, with the mitre in the centre, is well known. Lastly, the Society of Antiquaries met there in 1726, removing later, in 1753, to Somerset House. A Lodge, known then as the Lodge of Freedom, met here in 1765, the Royal York Lodge of Perseverance in 1778, and the Lodge of Perfect Observance, under the Grand Lodge of York, in 1779. The Mitre, as a tavern, ceased to exist in 1788. It then became Macklin's "Poets Gallery," later "Saunders Auction Rooms," and was pulled down in 1829. It must not be confused with the present Mitre in Mitre Court, formerly "Joe's Coffee House."

And now we are nearly at our journey's end when we arrive at "The Old Devil," next Temple Bar. Here in its palmiest days Simon Wadlow ruled, the landlord immortalised by Ben Jonson in "Old Sir Simon the King" the favourite one of Squire Western. Here also we are told that "Mr. Benjamin Jonson, Bricklayer, employed in the erection of Lincoln's Inn Garden wall in Chancery Lane, formed the celebrated 'Apollo Club.'" Again Pepys has conferred fame on his son John Wadlow, 22nd April, 1661. "The King in a most rich embroidered suit and cloak looked most noble. Wadlow the Vintner, at the Devil in Fleet Street, did lead a fine company of soldiers all young men in white doublets." Swift, in his Journal to Stella, 12th October, 1710, says, "I dined to-day with Dr. Garth and Mr. Addison at the Devil in Fleet Street, by Temple Bar, and Garth treated." After the tenancy of the Wadlows ceased, a Mr. Fletcher probably became landlord, as I find "Mr. Fletcher Master of the Devil Tavern at Temple died at Croydon, 4th July, 1757." (*Noble's Memorials of Temple Bar*).

Temple Bar has seen some curious scenes but perhaps none more strange than what was known as the "BATTLE OF TEMPLE BAR" (*Plate No. XVII.*) in 1769. "Wilkes and Liberty" was then the cry, but some of the citizens of the opposite faction drew up an address to the King, and proceeded in numerous carriages westwards to present it. At Temple Bar however the mob turned up in force and shut the gates. A few of the City deputation got to the Palace later on foot. In the Print of this occurrence the Devil

is shewn holding the sign and saying "Fly to me my bairns." About 1787 the Tavern was pulled down and Child's Bank built on the site. In the *Masonic Illustrated* for February 1905, is to be found a short article on two letters of William Reid, Grand Secretary, addressed to the Master of the Anchor and Hope Lodge, now No. 37, at Bolton-on-the-Moor, dated respectively, 2nd December, 1732, and the 20th January, 1733. Also the Minutes of the meeting of the Grand Lodge holden 21st November, 1732, at the Devil Tavern, Temple Bar. These interesting documents were found some years ago amongst a collection of old papers and are now preserved in the archives of No. 37. The Devil Tavern appears in the Engraved List of 1725, and a Lodge was meeting there in 1724, but was erased in 1745.

And now our travels have been so prolonged that the evening must have closed in upon us looking up at the traitors' heads over Temple Bar. And the Brethren of the Lodges, and the Members of the Clubs, are making the best of their way to their favourite Tavern. Dr. Johnson may be seen coming along like a man of war in full sail, touching his favourite posts, escorted by the faithful little Scotch frigate Boswell. And on a stormy night the way may not be so easy, for there are the sharp angles of the houses on one side, and the deep gutter on the other, and the flickering oil lamps give but little assistance. No wonder the Tavern door was a real harbour of refuge, and some excuse might be offered for a reluctance to leave on perhaps a still more difficult and devious return.

A few words in conclusion with regard to certain impressions that have been made upon my mind during my investigation of the Lodges and their ancient Homes. It is most curious, for instance, to remark the fluctuations of the Lodges from one locality to another. Sometimes one can trace the reason, but generally it is very obscure. And in analysing the Records we cannot but be struck by the fact that of the sixty-one Lodges of the List of 1723 but very few survive. Indeed after the formation of the Grand Lodge in 1717 we see that after a few years certain Lodges, having an element of fashion or repute, increased their numbers by leaps and bounds, while others meeting at the more obscure Taverns died away. It was a survival of the fittest doubtless. But where did these fortunate Lodges get their accession of members? I believe for the greater part from those Lodges which could not confer the same advantages and privileges, or from others wholly unrecorded, but which had in my humble opinion been working far back in the 17th century. Surely we often notice Masonic History repeating itself, and this process going on even now, especially in our provincial towns. But where are the Records of these ancient Lodges? Alas! that question may be asked of Lodges, of only fifty years standing. Perhaps, however, one plausible excuse may be put forward for the ancient City Lodges. The Great Fire and its successors in the 18th century had much to answer for, but one more crime can be laid to their account that in destroying the old Homes of Masonry they at the same time obliterated their Records for ever. Still, in the mines of manuscript treasure yet remaining unexplored in the City I feel sure there may be found some light which will enable us to penetrate the obscurity of the Masonic past. Sometimes thinking of this problem, Bishop Heber's description of the building of the First Temple ("Palestine," Oxford 1803) recurs to my mind:—

When Tiber slept beneath the cypress gloom,  
And silence held the lonely woods of Rome:  
Or ere to Greece the builder's skill was known,  
Or the light chisel brush'd the Parian stone;

Yet here Fair Science nursed her infant fire,  
 Fann'd by the artist aid of friendly Tyre.  
 Then tower'd the Palace, then in awful state  
 The Temple rear'd its everlasting gate.  
 No workman steel, no ponderous axes rung;  
 Like some tall palm the noiseless fabric sprung.  
 Majestic silence!—then the harp awoke,  
 The cymbal clang'd, the deep-voic'd trumpet spoke:  
 And Salem spread her suppliant arms abroad,  
 View'd the descending flame, and bless'd the present God."

"Like some tall palm the noiseless fabric sprung. Majestic silence!" Surely a fit emblem of the rise of Masonry through the ages, till its ritual and principles, founded on the One and Present God, now overshadow the whole earth.

---

Bro. ADMIRAL SIR A. H. MARKHAM writes:—

I have read the "Old City Taverns and Masonry" with great interest. There is, however, one statement in the paper that I would like to have corrected, had I been present. It is the one referring to Admiral Vernon, which rather implies that the old gentleman was partial to strong drinks, which was not the case. Admiral Vernon was in the habit of wearing a coat made of *grogam*, a material something like mohair. From this article of clothing he received the nickname of "Old Grogam." During the time he was Commander-in-Chief in the West Indies, the men under his command received a daily ration of a quart of wine. The stowage of this wine necessarily occupied a very large space in the ships of his squadron. Finding that rum could be obtained very cheaply in the West Indies, he substituted a gill of rum as the daily ration, instead of the quart of wine, thus gaining more space in the holds of his vessels for the stowage of other provisions, and by these means he was able to keep his ships at sea for longer periods. He also arranged that the spirit ration was not to be served out to his men *neat*, but to be diluted with water, generally in the proportion of one to two, and this concoction was called by the men "*grog*," a name that has been preserved in the Navy to the present day. The word *grog* was, of course, given by the sailors to this tipple, from the fact of its being the invention of Admiral Vernon, whose nickname was, as I have already said, "Old Grogam!"

Bro. W. J. HUGHAN writes:—

I have been exceedingly interested in reading Bro. J. P. Simpson's able paper on "Old City Taverns and Masonry," and feel assured that it will prove one of the most welcome of recent communications or compilations respecting the Craft in the Metropolis. The labour must have been considerable, as it is quite evident Bro. Simpson has spared no pains to trace every fact of any relevancy to his investigation, so we should all be grateful accordingly.

The Masters' Lodge referred to as held at the "Swan and Rummer" was in connection with the regular Lodge held there and duly constituted 2nd February, 1725-6. Four brethren "were admitted Masters" April 29th, 1727, but "the Masters' Lodge" as such is not noted until March 31st, 1729. For an account of this Lodge my paper on "The Three Degrees of Freemasonry" (A.Q.C. 1837) might be consulted.



I am not aware of any existing Records of a R.A. Chapter meeting in or about 1751 at this Tavern. The earliest trace of the "Moderns" does not begin until 1765.

I should like very much for Bro. Simpson to have that list of Chapters in the "Gardner Collection" reproduced. There could not have been a Grand Chapter held at the "*Half Moon*" so early as 1750. That of the "Moderns" was not formed until 1767, and it is questionable if the "Ancients" had a Grand Chapter any earlier, if so early.

That fine summons of A.D. 1760 in the Guildhall Collection would look well if reproduced to accompany Bro. Simpson's paper.

I think there cannot be a doubt that many more Lodges assembled in London than the four or more which established the premier Grand Lodge, and hence the number of early accessions to that Body.

*Bro. ANDREW OLIVER writes :*

With reference to the interesting paper by Bro. Simpson on the "*Old City Taverns*," a few other items connected with the various places of interest may be acceptable, at the same time it may be said that the paper throws a good deal of light upon an hitherto but little explored section in the history of London.

**BISHOPSGATE.**—The "Sir Paul Pindar's Head." The old front is now in the Victoria and Albert Museum, where it was placed on the destruction of the old building.

**CORNHILL.**—Spread Eagle Court. This occupied a site further east and nearer to Finch Lane, the Peabody Statue occupies part of the site of St. Benet Fink. Opposite to Finch Lane where now stands the Consolidated Bank, stood the French Protestant Church of which Caveac was a member.

**BUCKLESBURY.**—There is another reason for the name, viz. from the makers of bucklers being stationed there.

**ALDERSGATE STREET.**—"The Albion." After the fire of London the former house was presented to the Bishop of London and used as his residence. Shaftesbury House stood on the opposite side of the road.

**ST. PAUL'S CHURCHYARD.**—"Goose and Gridiron." This sign may possibly be a vernacular reading of the coat of arms of the Company of Musicians. These arms are "a swan with his wings expanded within a double tressure, counter flory, argent."

**LUDGATE.**—As regards the derivation of "Ludgate" Mr. W. J. Loftie<sup>1</sup> says the word Ludgate in Anglo-Saxon, properly Lydgate, denotes a postern, a small opening in a wall or fortification.

**NEWGATE STREET.**—"The Salutation Tavern" was most probably an old Inn used by those who came to the Grey Friars Monastery which was dedicated to "The Salutation of the Mother of God," and stood on the north side of Newgate Street, just opposite Warwick Lane, where the site is marked in the Ordnance Map.

*Bro. W. B. HEXTALL writes :*

Bro. Simpson, in writing that "there is no book directly relating to the taverns," has overlooked "*Old London Taverns, historical, descriptive and reminiscent*," by Edward Callow,—London: Downey & Co., Limited, 1899; an interesting work, but

<sup>1</sup> "Rambles in and near London." W. J. Loftie.

sadly wanting an index at the end, for which a fairly good contents-table fails to make amends. Of about 350 pages, nearly 300 are devoted to the City and its Taverns and Coffee-Houses. A few notes, culled from Callow's pages, may be acceptable.

Page 116. The "Old Fountain" Inn, in the Minories, is said to have been at one time the residence of Sir Walter Raleigh, and was pulled down in 1793.

Page 99. Hogarth's "A Midnight Modern Conversation" at "The Olde Elephant" in Fenchurch Street, was his first study for the afterwards engraved picture, and contained matter too broad to be even then the subject of a print. Callow gives the name of another painting as "*Barton Bush Fair*."

Page 107. It is stated that no fewer than five and twenty Masonic Lodges meet at the "Ship and Turtle," Leadenhall Street.

Page 56. The date carved on the "White Hart," Bishopsgate Street, was 1480, denoting its lucky escape at the Great Fire of 1666, when St. Botolph's Church, next door but one, fell a victim. Callow omits to notice that the front of the "Paul Pindar" tavern is preserved at South Kensington Museum.

Page 101. Only the night before the Great Fire of 1666 broke out, the sale of the "White Lion," in Cornhill, for £4000 had been agreed upon, the next day the building was consumed.

Page 123. To enable him to start fish-dinners when he bought the "Queen's Head," in Bird-in-Hand Court, Simpson, before he was asked for it, paid down £500, penalty under an agreement he had entered into upon sale of his business at Billingsgate not to purvey similar fish-dinners within a certain distance.

Page 144. As to "The Salutation and Cat," Newgate Street. "The curious concatenation of the two names has no connection with purring pussy, but arose from an old picture which formerly hung in the coffee room. It represented an old dandy of the early part of the eighteenth century saluting a friend in the street and offering him a pinch of snuff out of a box which formed the top of his clouded cane. These box knobs to walking sticks were called 'cats.'"

---

Bro. W. H. RYLANDS said:—I think our best thanks are due to Bro. Simpson for the admirable paper he has presented to us this evening, and I can only hope, and I am sure you will agree with me, that he will continue his researches, and from time to time give the Lodge the benefit of his discoveries.

Our thanks are also due to Bro. Vogeler for so materially assisting, by means of his Lantern, in bringing the pictures of many of these old Taverns before us.

Among the mass of facts contained in this interesting paper, there are few—if any—that lend themselves to discussion: there are, however, two minor points to which I may refer.

It is difficult without an examination of the original minutes of Lodges or other records to determine the exact date at which a change was made in the name of any Lodge. Bro. Laue I believe only inserted the earliest dates at which he had met with a change of name. Hence some of his dates will like the one now in question require to be changed. The very fine Summons of the "West India and American Lodge" No. 1, now the Lodge of Antiquity No. 2, marks I believe the change in the name, which took place I fancy in 1759-1760.

The inscription at the foot of the Summons states :

Thomas Marriot Perkins	} Invent.
R.W.M. of the Stewards Lodge	

on one side, and on the opposite side :

W. Tringham Sculp Castle  
Alley Royal Exchange.

Thomas Marriot Perkins signs the Summons as the W.M., and it is dated September 19th, 1760.

Another copy of this Summons in my possession is dated July 5th, 1760, calling the meeting for Wednesday next the 9th of this Instant [month.]

Thomas Maryott Perkins lived some time in the West Indies, where he was Provost Marshal General. Hence doubtless the change of name. My copy of the Summons was at the time I bought it fixed into a printed copy of the Bye Laws, unfortunately undated, though it must have been issued about the same year, 1760. Possibly it is one of the earliest printed Bye Laws known. A pine-apple was the *crest* of some families bearing the name of Perkins, and this may account for it being at the foot of the Summons.

The other engraving of the List of Chapters, does not belong to the Freemasons, but to the Gregorians, a convivial and harmonious Society founded in London about the year 1730. This I think is proved by the crest at the top, the dove and olive branch as one of the supporters of the Arms, and the word *shālôm*, or "peace" written in the Hebrew character as a motto.

It is a most interesting discovery, giving as it does a list of the Chapters meeting in London under the Grand Chapter of Gregorians : and proving that the imitators of Freemasonry also issued engraved lists.

I have for some years been collecting material for a paper on the "merry Gregs," and by the help of kind friends have gathered together a quantity of interesting information. An engraved Summons is extant : some of their songs have been printed ; and I need hardly say that I shall be much obliged for any notes however slight, connected with their history.

---

On the motion of the W.M., seconded by the S.W., a hearty vote of thanks was unanimously passed to Bro. Simpson, which he briefly acknowledged.

## THE CAROLUS OF OUR ANCIENT MSS.

BY BRO. JOHN YARKER, P.M.



THE paper of Bro. Dring, on the "Naimus Grecus" question, is a contribution of the utmost value, and I quite think that he has proved, what has been my own opinion for many years, that the Royal Patron, who was equally recognized by the building fraternities of France, England, and Germany, was the Emperor Charlemagne. We must also bear in mind that, twelfth to thirteenth century, the same legends would be current both in England and France, owing to the large number of French Masons arriving in this country.

With respect to "Naimus Græcus" we are sure to remain always in a state of uncertainty, from the almost certain fact that many MSS. between the "Cooke"—itself a copy—and the Grand Lodge MS., have disappeared, and that to the imperfect caligraphy of many such MSS. we may derive the numerous versions of this mysterious person, which have come down to us. Hence it may be very doubtful whether the Polychronicon was the authority for any of these versions, rather than some lost unreadable MSS. Equally, a badly written version of "Alcuin Flaccus" might suggest to some scribe, to hint, that it was "a man with a Greek name." It is therefore impossible to draw a hard and fast line in seeking one identical source for numerous blunders.

But the object of this paper is not so much to give Bro. Dring any well-deserved praise, as to contribute something to strengthen his theory as to the historical aspect of Charlemagne's influence on the building fraternities, which our author has done so much, in his paper, in elucidation. Amongst the things to which I desire to call especial attention, is the history of the Holy Vehm of Westphalia, and I shall not make any comparison between its ritual and that of Freemasonry, as every intelligent Mason can do that for himself. The object of the two Societies was not parallel, and how then does it arise that there is so great a resemblance in their ceremonies? If we could decide how this arises we should know a great deal more, than we do, of the mediæval history of Freemasonry. What influence had Charlemagne in organising one, or both, Societies?

It may reasonably be suggested, though personally I think it absurd, that some of the revivalists of 1717 were acquainted with the ritual of the Vehm, and introduced some of its customs into the more ancient ceremony of the Masons.

Bro. Dring has shown that Alcuin considered Charlemagne as a "wise Solomon" in erecting his Church at Aachen. We all know that the Master in the Chair is supposed to occupy the throne of Solomon, equally the Free-count of the Vehm was supposed to occupy the throne of Charlemagne, who it seems was dubbed a successor of Solomon by the Culdee Monk Alcuin. My translation of the Vehm document may be relied upon, as it has been done for me by a Brother whose native language was the Westphalian patois.

There is said to be a letter of the middle of the ninth century (not mentioned by Bro. Dring), written by Eric of Auxerre to Charles the Bald of France, in praise of certain Irish philosophers who were visiting the Court of Charlemagne, as "servants of

the wise Solomon," who, "as instruction of his countrymen," attracted thither Greeks and Irishmen. Even Haroun al Raschid sent Carolus an Embassy with presents.

The Rev. James Galloway quotes a similar document, from the St. Gaul Legend (l. 1, c. 32), to prove that artificers from every country were established to erect his magnificent church at Aix-la-Chapelle. On this matter there is a most suggestive romance of the twelfth century written in metrical form by Huon de Villeneuve, and reduced to prose two centuries later, which I am persuaded has a close bearing upon the legends of what is now known as the Compagnnonage. This work is entitled *Les Quatre fils Aymon*; in it Charlemagne returns victorious from a long and bloody war against the Saracens, in Easter 768, and has to listen to accusations against Prince Aymon of the Ardennes for failing in his fealty in this war, and Charlemagne has as his colleagues Solomon of Bretagne and his trusty friend the Duke of Naismes. Renaud, Allard, Guiscard, and Richard, in consequence of this, leave the court of Charlemagne in search of adventures. They defeat Bourgois the Saracen Chief before Bordeaux, compel him to become a Christian, and after that restore Yon King of Aquitaine to his throne, and as a reward Renaud receives the hand of his daughter Laura. After a time, Yon fears the anger of Charlemagne and persuades the four Aymons to solicit his grace, and they depart "with olive branches in their hands," but are treacherously waylaid and "the Cyprus would have been changed for the palm," but for the arrival of their cousin Maugis. After a due amount of battles peace is restored, on condition that Renaud departs for Palestine, where he meets Maugis unexpectedly, and they restore "the old Christian King of Jerusalem" to his throne.

After an interval, Renaud is recalled to France and on his arrival finds his wife dead of grief, as well as his aged father Aymon and his mother. His old antagonists, Naismes, Oger, and Roland, have been slain at Ronciveaux. Renaud, inconsolable, transfers his lands to his son, and hearing of the building of the church at Aix seeks that place and tenders his services to the Master Mason as a common labourer. His great strength arouses the jealousy of the others, as in a similar Masonic legend, and as Renaud slept upon straw under an arch, they killed him whilst asleep, *with a blow of a hammer*. After the blow Renaud opened his eyes, *crossed his arms*, and prayed for forgiveness to the murderers. Having breathed his last, the assassins put his body in a sack and threw it into the Rhine (as that of Osiris, in a similar mystery, was thrown into the Nile). Fishes supported the body, which was also illuminated by a supernatural light. It was first seen by a pilgrim, who, recognising Renaud, went and informed the three brothers and the two sons of Renaud. In this account, which is the translation of Caxton, the Archbishop erects a rich tomb, and canonises him as "St. Renaude the Marter."

In another version, probably the more modern prose version above named, the closing portion is thus given:—Charlemagne visits Aix-le-Chapel with the three brothers Aymon and their two nephews,—“Hollo!” says the Emperor, to a good woman, “what means this crowd?” The peasant answered, “I come from the village of Crosne, where died, two days ago, a holy hermit, who was tall and strong as a giant. He proposed to assist the masons to construct at Cologne the Church of St. Peter; he manœvered so well that the others, who were jealous of his ability, killed him in the night time whilst he slept, and threw his body into the Rhine where it floated surrounded by light. On the arrival of the Bishop the body was exposed in the nave, with uncovered face, that it might be recognized. Behold what it is that draws the crowd.” The Emperor approached and beheld Renaud of Montauban, and the three Aymons, and the two sons of the murdered man, mingle their tears over the corpse.

Then the Bishop said: "Console yourselves! He for whom you grieve has conquered the immortal palm." The Emperor ordered a magnificent funeral and a rich tomb.

In the time of Charlemagne, and even much later, there existed a large amount of pre-Christian and Gnostic Rites, and the Emperor is credited with erecting in Saxony,—the birth-place of Aymon, where his memory was held in great veneration down to last century, if not still,—a secret fraternity for the suppression of vice. Apart from the significance of this romance, in a Masonic sense, there are some peculiar correspondences,—the body of the murdered Osiris was thrown into the Nile, that of Renaud into the Rhine, and the closing address of the Bishop is almost identical with that of the Hierophants to the mourners for the slain sun-god. In the ancient mysteries the symbolical Branch was varied—as the erica, the ivy, the palm, the laurel, the golden-bough which was probably mistletoe, so prominent in Christmas week in our own lands. The romance also confuses the time of Charlemagne with that of a Christian King of Jerusalem, in the same way that our Masonic MSS. confuses the Emperor's time with a fictitious Naimus, Aymon, etc., "who was at the building of Solomon's temple." Some time ago a Newcastle Brother suggested that the meaning might be—at the buildings (ruins) of Solomon's Temple—or even the residence of the Knights of the Temple.

This brings me to the Vehm, which is believed to have been a secret court of the ancient Pagan priests until it was re-organized by the Emperor Charlemagne for the purpose of advancing Christianity, and the assertion that Charlemagne was its organiser seems absolutely proved by the fact that it was an ancient claim of the ceremonial rites of the Vehm. There is no prominent point in Freemasonry which does not equally find its counterpart in the Vehm, and, such being the case, is it not foolish to assert that German Masons had no ritual; and equally so for Albert Pike to say that British Masons had no ritual ceremony before 1700? He was a learned man and able writer, but seems to have been ill informed upon Masonic facts, and even of his own Scottish Rite, whose origin he attributes to Charleston, though it is now well known that Geneva had it before 1797, and the 1762 statutes of Paris and Bordeaux authorise the Grand Inspectors of the 25° to collect any new degrees. But to return to our sheep. The Vehm was held, like the Court of the Druids, in the open air, or before the eye of day. No doubt many Masons were at least Free-schoppen.

#### OPENING OF THE VEHM COURT.

The Free-count sat upon the Free-stool (*Frien Stoil*), with a sword laid on the bench (*bank*) before him. The Court was opened by Question and Answer, the Questioner, or acting Free-count, sitting in the chair of Carolus Magnus as his representative. It was of importance that it should be the right day, and the right time, to hold the Courts. Seven *Frey Schoppen* are the minimum to form the Court, and, if possible they were to be of the locality where it was opened, but not necessarily so, as genuine *Schoppen* from anywhere might assist. A sword with a rope, or cable-tow, attached was laid on the Bench.

The candidates for admission stood outside the square open space of the Court, and were only admitted within it, after announcement and acceptance.

The Free-counts and the Free-schoppen signed with the chrismon of which three samples are given herewith—



Extract of MINUTES (*Protocolli*) of the CAPITULAR CONVENTION (*conventi capitulari*) of THE VEHM HELD AT ARENSBERG IN THE YEAR 1490, before the FREE-SEAT (*Sede*) IN GEISIKE.

Original in the Archives of Furstenberg. This copy made by Criminal Judge Bachman of Paderborne, and quoted by Paul Weigand in "The Vehmische Tribunals of Westphalia," Hamm (page 265). (Schulz and Wundermann, 1825.)

FIRSTLY.—The best and truest people must be found and vouched for by *Frie-Schoppen*. (This is for Schoppen Candidates, who were a species of Jurymen to assist the Chair and the Officers of the Court.)

SECONDLY.—The *Frei-Count* (Chairman and Judge) must prove them whether they are able to discern right from wrong.

THIRDLY.—They must be inducted in a secret closed meeting, not in a chamber. (That is, the assembly was to be tyled, and this article refers to a paragraph where complaints were made that candidates had been admitted, in a room, for money.)

FOURTHLY.—They are questioned as Carolus Magnus has directed and they must answer those questions.

FIFTHLY.—They are admonished as to perjury, and the punishment of the "wall" is shown to them. (This "punishment of the wall" is referred to elsewhere, it may refer to a wall surrounding the Court, though meetings were held in the open air to hear complaints and judge them; or possibly it refers to a "stone" afterwards mentioned.)

SIXTHLY.—They must take the Oath prescribed by Carolus Magnus. They must do this sitting (kneeling) on the right knee, which has been laid bare; the head covered; the left hand, which is bared, laid upon the rope (cable-tow, used for hanging); the lock (*Schloet*) and the two swords laid cross-wise, Swearing the Oath to keep the Vehm (Secret) from wife and child, sand and wind, as this is prescribed. (The word *lock* appears to be a mistake for key, and is evidently a local symbol as it was the Arms of the City's *Frei-Graf*, who had the right to the Chair of the District. The key is referred to elsewhere, as being engraved on a "stone" in the square of the Court. *Key* is *schloetel* whilst *lock* is *schloet*, hence the omission of *el* in the first instance is clearly an error.)

SEVENTHLY.—The Count tells them, with covered head, the Holy Vehm (Secrets); Rope (*Strick*), (but some have it *Stuck* or *Stick*, as referring to the willow-wand with which some hangings took place); Stone (*stein*); Grass (*gras*); Grain (*grein*) and he explains them as prescribed. (An analogy is to be found in the black magic of Westphalia, where the sorcerer invokes as follows:—"I conjure the devil, by the God who corn and grass created has"; and again, in forswearing God and all Saints, "also grass and corn, and all that upon earth may be.")

EIGHTHLY.—He tells them the word of distress (*Nothword*), as Carolus Magnus hath given it; to wit—*Reinir dor Feweri*. (It is clear that this *Nothword* is either disguised or corrupted. From the context, and other evidence, it can be restored, and it is very evident that it is the *four elements* that are referred to,—the reply being *Lust* (air), and these four elements are subsequently named. Thus explained the actual words would be:—*Rein* (rain or water); *Irdor* (or) *Irde* (earth); *Feweri* (or) *Fewer*, *Fewer* (fire); the reply being necessarily *Lust* (or) *Laucht* (air).

NINTHLY.—He teaches the secret salute of a *Scheppe* (*Schoffe*, Latin *Scabinus*): That the arriving *Scheppe* places his right hand upon his (*i.e.* the other *Scheppen's*) left shoulder, and says:—

“I salute you dear man.           (*Eck grut ju leive Man.*)  
 What are you doing here?” (*Wo fange ji hi an?*)

Thereafter he (the other *Scheppe*) places his right hand on the other *Scheppen's* (the new arrival's) left shoulder, and the other one does the same, and says:—

“All luck come in,                   (*Alleit gluck kekire in,*)  
 Where the Free *scheppen* are.” (*Wof de freyen Scheppen sein.*)

(in the original these are evidently rhythmical, as are some of our most ancient Masonic tests.)

TENTHLY.—What belongs before the Secret, and what before the Open Court (*Ding*, Norweigan *Thing*), is explained to him, as is written down hereinbefore, in the first questions.

ELEVENTHLY.—He must pay the Free-Count 16 schillings (a small coin) and no more, and to every one of the nine *Scheppen* 8, and no more.

#### QUALIFICATION.

Candidates for *Frey Scheppen* must be so educated and made, that they are lawfully and rightly begotten from father and mother; not un-free; not prosecuted by any justice; not liable to any attainder (*bann*); nor guilty of usury; no street-vagabond (*strassen linder*); nor thieves, murderers, adulterers, or blasphemers; and they must not have sinned against their Country's Master, or Authorities. (Everyone knows that our Ancient Constitutions necessitates the same qualities for Masonhood.)

#### PENALTY.

If any one break the Oath, and betray the Secret of the *Vehm*, he was to be arrested, his hands tied behind his back, his tongue drawn out through his neck, a skewer put through it, and he was to be hung seven feet higher than any other evil doer. Such was the former penalty; now a days (*i.e.* seventeenth century) he is punished for perjury according to law, loses all his honourable positions, and is never again accepted as an honourable man.

I will conclude by suggesting that Bro. Dring's valuable paper will bear further elucidation, and I should be glad to see his views on this evidence.

I should like also to direct attention to Bro. d'Alviella's Review of Bro. Gould's "Concise History," in that part referring to the ancient Masters Fraternities, as I have suggested to Bro. Gould to write a history of these, for Masonic History is incomplete without this additional branch.



## THE SIRR FAMILY AND FREEMASONRY.

BY BRO. HARRY SIRR, F.R.I.B.A.



REVIEW of "The United Irishmen" published in a Masonic periodical at the date of the regrettable attitude of Dr. Crucefix towards the Grand Lodge of England, was most unfair to Major Sirr, whose son was then associated with the Grand Lodge officers. I had proposed simply to offer some comments upon the review, but this proved inconvenient unless I could make use of a communication never intended to become public. I found it easier to compile this paper recording not only Major Sirr's connection with Freemasonry, but also that of his father and son, and I think this explanation will make the motive clear.

Upwards of sixty years have passed since the Grand Lodge of England and the Grand Lodge of Ireland mutually agreed and determined upon the appointment and reception of a representative, one from the other, "for the cultivation of a more intimate acquaintance." The Grand Lodge of Ireland took the initiative, and the Brother entrusted with the first Diploma of Representative to the Grand Lodge of England was Henry Charles Sirr.

Henry Charles Sirr was initiated in his twenty-eighth year of age in the Caledonian Lodge, 134 (afterwards 156), London, 7th December, 1835. He was exalted in the Chapter of Lodge No. 4 Dublin, and registered 30th August, 1836, and proceeded to the degree of Knight Templar.

He became Master of his Lodge in 1838, two years after initiation, when the following notice appeared in the *Freemasons' Quarterly Review*:—

"The Caledonian (No. 156) Jan. 8. The installation of Brother H. C. Sirr, as Master of the Lodge was very ably conducted by Brother Hailes; and the Master entered upon his office by going through the full ceremonies of the three degrees, an arduous task for an experienced workman; and Brother Sirr did all this with great ability. Brother Crawford, one of the initiated, in the course of the evening delighted the Lodge by a very eloquent address, which marked his attainments to be of superior order. The Master too, on his health being proposed, deviated from the general custom in returning thanks, by entering into a detail of the history of his Lodge from its inauguration to the present time. His address would be a valuable document, and we should be happy to store it among our 'Annals of Lodges.' Brother Martin M.P. has been initiated; and The Caledonian promises well for its restoration to former splendour."

The Minutes of the Britannic Lodge No. 33 shew that in the next year (1839) on November 23rd, Bro. H. C. Sirr was present as a visitor when Bro. William H. White (G.S.) proposed him as a joining member, and that he was elected 17th December following. The next year, on January 21st, (1840,) he was installed W.M. With the usual vote of thanks, he received the past-master's jewel, 19th January, 1841, and a vote of condolence with him on the death of his father was passed. In 1842 he held the office of Secretary of the Lodge for one year, in 1847 became Treasurer,

continuing to act in that capacity until January, 1852, and remained a member of the Lodge with interruptions until 1866.

Subsequently he became a member of Gooch Lodge, No. 1238, of which he was Secretary at the time of his death, 23rd November, 1872.

At the Grand Lodge held on the 28th April, 1841, Sirr was presented to H.R.H. the Grand Master and proclaimed Representative of the Grand Lodge of Ireland; and on the 4th February, 1842, the Grand Royal Arch Chapter of Ireland appointed him Representative in the Grand Royal Arch Chapter of England. The *Freemasons' Quarterly Review* mentions that, at the English Grand Festival, on the 20th April, 1841, he responded for the Duke of Leinster and the Grand Lodge of Ireland.

The rank of Past Senior Grand Warden of England was conferred upon him by H.R.H. the Duke of Sussex, in 1841.

In this year also he was elected to the Board of Benevolence, on the 28th April, having previously been elected to the Board of General Purposes and the Finance Committee, 3rd June, 1840.

Probably his connection with the English Charitable Institutions commenced in 1838, when he became Steward and Life Governor of the R.M.I.G. In 1840 he rendered similar assistance to the R.M.I.B. Information gleaned from the *Freemasons' Monthly Magazine* and the *Freemasons' Quarterly Review*, shews that he served on the Committee of each School. In July, 1840, H.R.H. the Duke of Sussex appointed him to the Committee of the Royal Masonic Benevolent Fund, and the list of the members of the Board of Management 1842-3, includes the name of "R.W.Br. Henry C. Sirr."

Sirr communicated to the Grand Lodge of Ireland the substance of several interviews with H.R.H. the Duke of Sussex, concerning matters which were being considered between the sister Grand Lodges, and in April, 1843, it was his sorrowful duty to communicate the intelligence of the death of His Royal Highness. Until his departure from England to take up Government appointments in Asia he continued in correspondence with the Grand Lodge of Ireland and with the Representatives of the Grand Lodges of Berlin and of Hamburg respectively.

Interest in the ancient Masonic brass square found in 1830, in excavating for the foundations for rebuilding Baal's bridge in the city of Limerick, may have led him to take steps to procure a facsimile drawing of the antiquity which was much eaten away. At any rate a drawing was given to him, and his notes in pencil seem to suggest that neither full information nor an illustration of the square had then become public. The initials at the foot of the drawing convey the impression that it is the work of one of the D'Arcy's. Presumably an illustration in the *Freemasons' Quarterly Review* (p. 288, 1842) was worked up by the engraver.

Bro. H. C. Sirr also left with his effects a handsomely bound copy (presented to him in 1842 by the Grand Lodge of Ireland) of "The | Constitution | of | Freemasonry; | or, | Ahiman Rezon: | to which are added, | certain Lectures, | Charges, | and | a Masonic Ritual. | Dublin: | Printed by Brother Underwood, | Eden-Quay. | M.DCCC.XXXIX."—followed by "The | Masonic | Ritualist and Lecturer" | —&c., by Brother Archdeacon Walter Bishop Mant (undated), and "The | Ceremony | of | Dedication; | as observed at | The Dedication of | The Freemasons' Hall, | in the City of Dublin, | by Command of | His Grace The Duke of Leinster, | Grand Master of Masous in Ireland." | Also, a Bible, in French,—“Par François Perrin, pour Antoine Vincent. M.D.LXVII” containing engravings representing King Solomon's Temple, &c.

A letter, now forty years old, may be interesting to Brethren who follow the history of Freemasonry in South Africa.

Grahamstown, 12 April 1865.

My dear Uncle Henry,

When I was last in Dublin I was told that you were a S. ∴ G. ∴ I. ∴ G. ∴ 33°<sup>1</sup> and Representative in The Grand Lodge of England of The G.L. of Ireland, if so you could give me some information I want to get hold of, i.e.—we have in this Colony some 2 or 3 Dutch Lodges under the Dutch Constitution which practise what is called the Reformed French Rite, and give the following Degrees—Apprentice, Fellowcraft, Master, Perfect Master, Elu, Scotch Master, Knight of the East, Knight of the Sword, and Rose Croix and no others; also Craft Lodges and R.A. Chapters under both Scotch and English Constitutions. But Royal Arch is an English Chapter in Port Elizabeth, and what I want to find out is whether there is any means of getting up the complete organization of the 33 degrees out here where there are no people in possession of them already—by communication in cypher or otherwise—so as to have a South African Supreme Grand Council of our own and a union of all the masons here under one governing body. I suppose you can find this out for me. I know that some of the higher degrees are and have been given abroad in such a way and suppose it can be done, if one only knew how to go about it. Whenever you have time please give me all information you can on this matter. We can manage all right as far as Royal Arch but can't get further except under the Dutch and then only to the 18th degree Rose Croix. We would rather have a British origin, and complete organization, if possible.

Your affect. nephew,

Francis H: S: Orpen.<sup>2</sup>Henry Charles Sirr Esq<sup>re</sup>.

The following particulars (preceding those concerning his brother, the Rev. Joseph D'Arcy Sirr, D.D.) are taken from *Modern English Biography*, Frederick Boase, vol. iii. :—

*Sirr, Henry Charles* (son of Henry Charles Sirr 1756 (*sic*)—1841 Head of the Police in Ireland 1796-1826) Born Dublin Castle 1807; educ. Trin: Coll: Dublin, and in Switzerland; B.A. Dublin 1830, M.A. 1833; admitted M.T. 7 May 1830, called 22 Nov. 1833; admitted L.I. 17 Nov. 1836; Secretary to the Anglo-Portugese Commission 1842-3, Vice Consul China 1843, and subsequently Queen's Advocate in Ceylon, but the climate obliged him to resign both; held a Commission in the Royal Westminster Militia 1842-53, also served in The Honourable Artillery Company; a prominent Freemason, the high rank of Past Grand Warden of England was conferred upon him, 1841; author of *China and the Chinese, their religion, character, customs, and manufactures*, 2 vols. 1849; *Ceylon and the Cingalese, their history, government, religion, antiquities, etc.* 2 vols. 1850. Died 23 Nov. 1872.

<sup>1</sup> The Registers shew that the degree was not conferred in England nor in Ireland.

<sup>2</sup> Afterwards Surveyor General of Griqualand West, deceased, 1893. (*Vide* "Orpen of Ardtully," Burke's "Landed Gentry," and "Orpen of the Cape of Good Hope," Burke's "Colonial Gentry.")

Before he went abroad he was a member of the Conservative Club and of the Mansfield Society, and a few years previous to his death he had joined The Society of Arts.

The *Freemasons' Quarterly Review* (1841) copied from *The Examiner* a notice of the death of Major H. C. Sirr, followed by a notification that "he was the father of Brother H. C. Sirr of the Britannic Lodge"; but no mention was made of Major Sirr's connection with the Craft, nor is this recorded in an obituary notice in somewhat similar terms in the *Freemasons' Monthly Magazine*. Major Sirr was initiated while he was a Lieutenant in the 68th Regiment before he attained the age of twenty-one.<sup>1</sup> The certificate is boldly written by hand on a plain piece of parchment 9 inches wide by 7½ inches, with pale blue ribbon and red seal in the margin on the dexter side, and runs:—

And the light shineth in darkness, and the darkness comprehendeth it not.

We the Master, Wardens, and other Brothers of Lodge No. 441, on the Registry of Ireland, held in the 38 Regt. of Foot.

Do hereby Certify that our well beloved Brother Henry Charles Sirr, has been duly by us regularly entered, Passed, and raised to the Degree of a Master Mason and having always behaved himself as a good and worthy Brother whilst with us, we do therefore recommend him as such to all our Brethren where-soever dispersed.

Seal  
in  
margin

Given under our hands and seal of the Lodge, in our Lodge Room at Stafford this 21st day of July 1784, and in Masonry 5784

	W. Brown,	Master.
J. Watson, Sec <sup>y</sup> .	Tim <sup>y</sup> Nicholson,	S. Warden.
	Shap <sup>l</sup> Swiney,	J. Warden. <sup>2</sup>

Lieutenant Sirr, whose regiment was stationed at Gibraltar in 1784, must have been on leave at this time. He had left England with his Regiment, in 1782, to relieve the fortress, and there acted as A.D.C. to Lord Heathfield. Remaining with the regiment until it returned (*circa* 1791,) he then retired as Captain (1792), and afterwards received the Commission of Town-Major of the Garrison of Dublin, &c.

The prominent part subsequently played in performing his duty as a Staff Officer and Government official in Ireland during the Rebellion in 1798, and the Insurrection in 1803, and especially his arrest of Lord Edward Fitzgerald for High Treason, aroused the feelings of sympathisers with the movements. After his death in

<sup>1</sup> The Dictionary of National Biography is incorrect in assigning 1756 as the year of his birth, but the correct year—1764—is given in the Epitome and Index. The date of birth was 25th November 1764—*vide* "Sirr of Dublin" *Miscellanea Genealogica et Heraldica* 3rd series, vol. v., part vi.

<sup>2</sup> Timothy Nicholson registered 2nd May, 1771	} Grand Lodge of Ireland.
William Brown ditto 24th June, 1786	
Jas. Watson ditto 24th June, 1786	

The 38th Regt: or the 1st Staffordshire had been stationed in Ireland on returning }  
from America. }  
William Brown, Quarter Master 38th Regt., 19th January, 1785. } Army  
Shapland Swiney, Lieutenant ditto, 4th May, 1776. } Lists,

1841, Madden published "The Lives of The United Irishmen," 1842, and a singularly sympathetic notice of the book congratulating Dr. Madden appeared in the *Freemasons' Quarterly Review* (p. 467, 1842). This notice, evidently written by a very credulous person, was expanded by quotations from a fanciful history of Major Sirr (given in an appendix to the book<sup>1</sup>). The "Dictionary of National Biography" has made it clear that Mr. Lecky's estimate of Madden on all matters connected with the United Irishmen is just ("History of Ireland," vol. iv., footnote p. 316). The summing-up concerning Major Sirr in the Dictionary, after considering the reputation Madden gave him, proceeds:—"But he was, as Sir Robert Peel testified in the House of Commons, "unswervingly loyal, religious, and humane." The Dictionary then refers to grudging testimony in Thomas Moore's Diary of the esteem in which Major Sirr was held by Lord Edward Fitzgerald's near relative, the third Duke of Leinster, the nobleman who, as Grand Master of Irish Freemasons selected Major Sirr's son for Masonic distinction; and likewise to the dispatch in The Castlereagh Correspondence, wherein the Chief Secretary, supporting the Lord Lieutenant's recommendation for promotion in 1798, stated that Major Sirr had "been constantly employed by Government, on every occasion which called for great personal exertions, discretion and courage."

Besides the Lodge Certificate little else, except the following letter, has been forthcoming concerning Major Sirr's connection with the Craft.

Lodge No. 441.	Grand Secretary's Office, Freemasons' Hall, Dublin, 11 day of Nov <sup>r</sup> . 1898.
-------------------	--

Dear Sir,

Three of the four names signing the certificate of which you sent me a copy, are duly registered in our books the fourth (Shap<sup>l</sup> Swiney) does not appear nor any name at all like it. The evidence of Major Sirr having been initiated in the Lodge is to [my] mind quite conclusive. The registration of members was very irregularly made by military lodges in those days as may be seen in the certificate itself signed in 1784 by two members not registered until 1786. However to place the matter beyond doubt I find that in the year 1790 a Warrant No. 714 was issued to establish a Lodge in the 1st Batt. 68th Regiment<sup>2</sup> in the names of:—

James Coleman.  
James Fitzgerald.  
Henry Charles Sirr.

It is quite evident that all three were members of the Masonic Order or a warrant would not be issued to them. There is no record of what became of this warrant, nor are there any other names of members recorded save the three to whom it was originally issued.

Yours faithfully,  
H. E. Flavelle  
D.G.S.

To Harry Sirr, Esq<sup>re</sup>.

<sup>1</sup> Correspondence in *The Weekly Irish Times* (9th March to 22nd June, 1901) following "Recollections of Major Sirr." dealt with this, and the obvious unfairness in ignoring the full reports of the State Trials and relying upon "Curran's speeches."

<sup>2</sup> Lieut.-Col John Bridges Schaw of the 68th Regiment was, in 1791, Provincial Grand Master of the "Antients," at Andalusia, or Gibraltar. (Bro. Sadler's Masonic Reprints, p. 86).

ARS QUATTOR CORONATORUM.

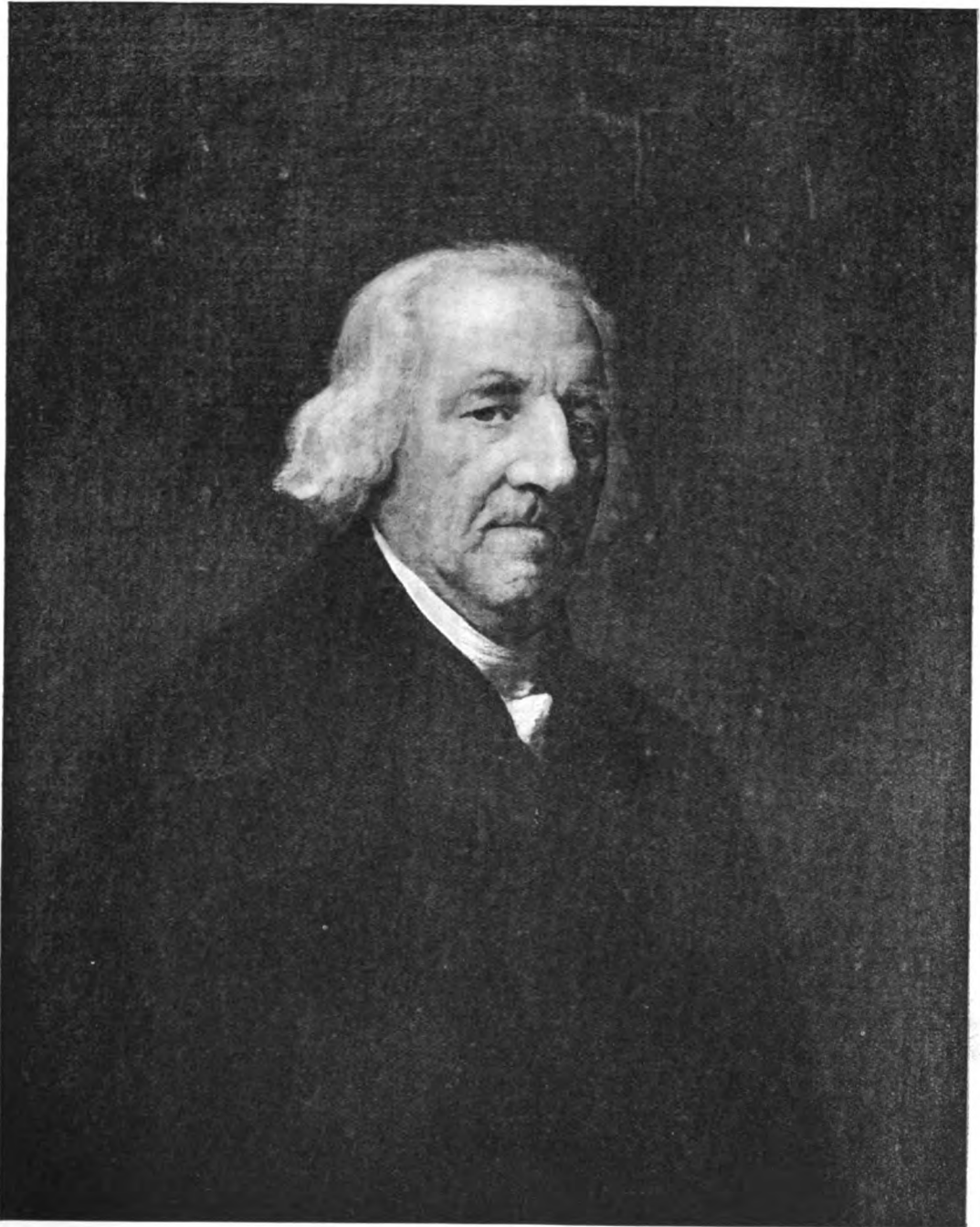

JOSEPH SERR.  
(1715-1799)



ARS QUATUOR CORONATORUM.

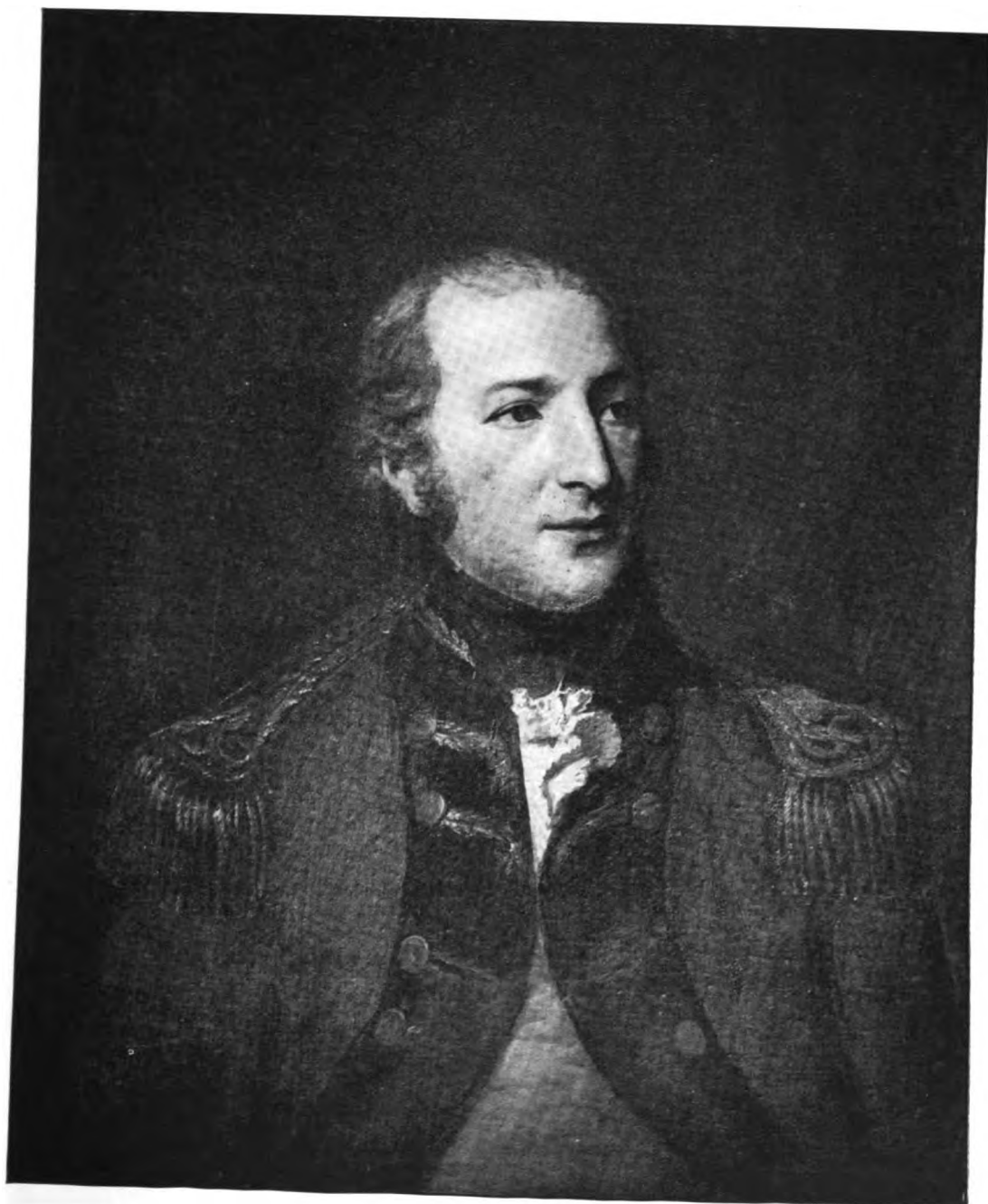

MAJOR SIRR (*circa* 1797).  
(1764-1841).





ARS QUATUOR CORONATORUM.



MAJOR SIRR (1818).



ARS QUATUOR CORONATORUM.

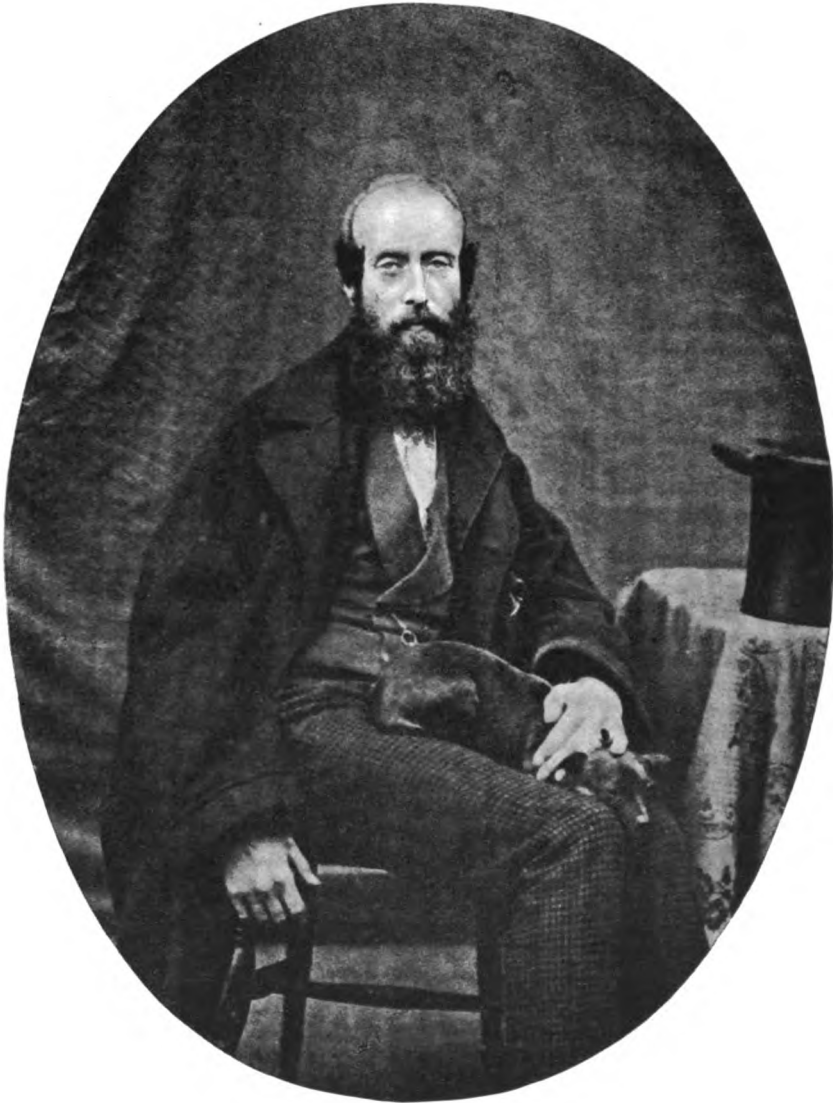

HENRY CHARLES SIRR.  
(1807-1872)



Major Sirr's life was a very busy one, and he did not take an active interest in Masonic affairs for many years previous to his death. He chiefly frequented a Club connected with the Benevolent Society of the Friendly Brothers of St. Patrick.

He was cultivated and scholarly, with refined tastes, possessing a good knowledge of Greek, Latin, and French, devoted to art and a great collector, and very fond of music. History and geology were two of the subjects to which he gave attentive study in his leisure; Thorpe Porter in "Gleanings and Reminiscences," gives an account of a narrow escape he once had at the Killiney quarries when in quest of spar formations. His collection of Irish antiquities, which was of considerable value, was acquired, after his decease, by the Royal Irish Academy. The printed catalogues of this and of his other collections of minerals, shells, paintings, etc., are in the Libraries of the British Museum and Trinity College, Dublin. Many of his papers, which are of considerable historical interest, are also in the latter Library.

Experience of personal conflict led him to trust more in a sword than in a pistol. During the troublous years at the end of the eighteenth and commencement of the nineteenth century his life was in serious peril, and he barely escaped assassination on several occasions—Madden mentions three, Thomas Moore also, in his Diary, records one which Mr. Lecky refers to in the "History of the Eighteenth Century."

Joseph Sirr, Major Sirr's father, held high Masonic rank in Ireland. The list of Irish Grand Officers in Bro. Chetwode Crawley's "Caementaria Hibernica," shews that he was Junior Grand Warden in 1773, and Senior Grand Warden in 1774. For want of documents and records it is difficult to discover his previous connection with the Craft. Born in 1715, he had been in his early years Equerry to Frederick, Prince of Wales, and it is therefore likely he was initiated in England, but he was quartered in Ireland with the Royal Regiment of Ireland from about 1739 or 1740 onwards. Crofton Croker's "Popular Songs of Ireland," first published in 1839, quotes his opinion that "The Kilruddery Hunt" could not have been the work of Mozeen, and mentions that White-law (the Historian of Dublin, 1818,) described him in 1796 as his "worthy old friend, intimate with the parties mentioned in the song, and particularly with the Earl of Meath." To this Crofton Croker adds his own footnote:—"Major Sirr went to Ireland in 1757, with the Duke of Bedford. He was then a Captain in Sebright's, the 83rd regiment. Major Sirr was subsequently appointed Town Major of the city of Dublin, and Pratique Master of the Port. He was High Sheriff of the county of Dublin (1770), and Deputy-Judge-Advocate-General of Ireland; and Governor of most of the Institutions of the Irish Metropolis. He was the father of the present well-known Major Sirr of Dublin." Sirr was very intimate with Lord Heathfield, the defender of Gibraltar, (where his son as mentioned above, was Heathfield's A.D.C.), and they were very much alike in appearance, so much so, that sometimes one was taken for the other. Heathfield, as General Elliott, had been Commander of the Forces in Ireland, but they were connected also by a family tie, for Heathfield's brother, Archibald Elliott, married Sirr's sister, Frances, in 1737.

Father Nicholas Sheehy, who was implicated in Whiteboy proceedings, has left a tribute to the kindly disposition of Joseph Sirr, to whom he wrote the day before his execution in March 1766:—"I beseech the Great Creator that for your benevolence to me He will grant you grace to make such use of your time here that you may see and enjoy Him hereafter." This extract is taken from the letter referred to by Mr. Lecky in his History, which is given in Madden's "United Irishmen."—(vide also "Dictionary of National Biography," under Sheehy and Sirr.)

The Dublin obituary notice refers to Joseph Sirr as "a gentleman esteemed by all ranks of people." (*Saunders' News Letter*, 13th November, 1799.)

The "Sirr Papers" (Trinity College, Dublin) shew that in his 82nd year he joined the "French Street Protective and Defensive Association," of which the Lord Lieutenant approved, and which consisted of Dublin residents. His son, Major Sirr, was a promoter, and also his son-in-law, Humphry Minchin, of Woodville, Tipperary, an active County Magistrate and Officer of Yeomanry, and High Sheriff of the City the previous year. These circumstances in conjunction with other loyal proclivities produced a sequel, in the following year, on the night of the 23rd May, 1798, recorded by Sir Richard Musgrave, the contemporary Historian ("Memoirs of Rebellions in Ireland," pp. 224-5). A party of rebels, headed by the lodge-keeper and gardener, entered and plundered the house at Grange, in the country outside Dublin, when Joseph Sirr was there alone. The wife of the gate-keeper was successful in dissuading another from attempting to murder him and also a female servant, while the rebels were disappointed that Humphry Minchin did not return that evening up the avenue which led to the house where, in this expectation, they had posted men to shoot him. But Joseph Sirr had to be conveyed to Dublin afterwards to give his evidence. He became blind in his old age, having resigned the Inspectorship of the Royal Hibernian Military School in 1784 in consequence of failing sight.

---

The portrait of H. C. Sirr first mentioned herein is by Dixon of Albany Street, from an old print of a negative taken in the early days of photography by the late Major-General Henry Schaw, C.B. and Col. R.E. (a nephew of H. C. Sirr), who was Superintendent of Photography in 1858 at Chatham. The negative is lost.

There is another portrait in oils of Major Sirr (similar to that of which an orthochromatic photo, by Walker and Boutall, of Clifford's Inn, is reproduced) at Hyde Park, Co. Westmeath, the seat of Bro. G. J. Norman D'Arcy, also a bust taken late in life very like though by Prospero, not a first-rate sculptor.

The profile by "W. Ewing, 1818," is the real size of the ivory relief from which the photograph was taken by Dixon.

Ewing's work is scarce. Once only he exhibited at the R.A. (in 1822), and then four works viz., portraits in ivory,—of Canova, done in Rome in 1820, of Pius the Seventh, done in Rome in 1821, and another of a "young lady," and a study in ivory from the head of an antique statue of Antonius in the Borbonico at Naples.

## FRIDAY, 2nd MARCH, 1906.



THE Lodge met at Freemasons' Hall, at 5 p.m. Present—Bros. G. L. Shackles, W.M.; Canon J. W. Horsley, I.P.M.; E. Armitage, P.D.G.D.C., S.W.; H. le Strange, Pr.G.M. Norfolk, Treas.; W. H. Rylands, P.A.G.D.C., Sec.; J. T. Thorp, P.A.G.D.C., S.D.; F. J. W. Crowe, P.G.O., J.D.; H. Sadler, G. Tyler, I.G.; G. Greiner, A.G.S.G.C., P.M.; E. J. Castle, P.D.G.B., P.M.; and W. J. Songhurst, Asst. Sec. and Librarian.

Also the following members of the Correspondence Circle—Bros. T. Cohu, G.St.B.; H. Brown, J. Harrison, L. R. Gleason, G. P. G. Hills, E. H. Dring, Sir John Cockburn, P.G.D.; A. Simner, P.A.G.D.C.; W. Lawrance, H. Guy, G. Robson, D. Bock, I. W. H. Sargeant, B. Pflug, H. Y. Mayell, R. Colsell, F. W. Levander, W. A. Tharp, G. H. Richardson, C. T. Morgan, H. B. Watson, G. Elkington, A. A. Millward, W. H. Bamlet, W. J. Newstead, A. E. Turner, C. H. Knuth, G. Vogeler, P. J. Woods, W. Wonnacott, J. I. Moar, G. H. M. Vine, P. R. Simner, G. H. Lutchford, W. Busbridge, J. A. Richards, F. Raby, G. S. King, C. F. Finzel, J. W. Dring, L. Danielsson, S. Meymott, W. S. Boteler, H. Saunton, Major J. Rose, H. King, S. Walsh Owen, C. W. Sponneck, T. Leete, H. Burrows, W. F. Stuttaford, H. James, W. H. Brown, Rev. L. Drapes, J. E. Pecknell, G. H. Beamish, and A. Bioknell.

Also the following visitors:—Bros. P. Walker, S.D. West Kent Lodge No. 1297; T. Drapos, P.M. Enniscorthy Lodge No. 270 (I.C.); O. C. Bean, S.W. Lodge No. 94 New South Wales; J. S. Gregory, I.G. Kingsland Lodge No. 1693; E. Doggett, Royal Albert Hall Lodge No. 2986; C. H. Watson, Queen's Westminster Lodge No. 2021; Rev. H. G. Rosedale, Chaplain West Kent Lodge No. 1297; and T. Coulson, J.W. West Kent Lodge No. 1297.

Letters of apology for non-attendance were received from Bros. T. B. Whytehead, P.G.S.B.; E. Conder, jun., Admiral Sir A. H. Markham, P.D.G.M. Malta; W. J. Hughan, P.G.D.; Dr. Chetwode Crawley, Gr.Treas. Ireland; J. P. Rylands, E. Macbean, R. F. Gould, P.G.D.; S. T. Klein, W. M. Bywater, P.G.S.B.; F. H. Goldney, P.G.D.; L. de Malczovich and W. Watson.

On ballot taken W. Bro. William John Songhurst, P.M. Ionic Lodge No. 227, Founder of Alleyn Lodge No. 2647, and Semper Vigilans Lodge No. 3040, writer of a paper on "Ragon," and of several shorter papers which have appeared in the *Transactions*, was elected a joining member of the Lodge.

One Lodge and seventy-six brethren were admitted to the membership of the Correspondence Circle.

### EXHIBITS.

By Bro. SKYMOUR BELL, Newcastle.

APRON (about 2ft. by 1ft. 6in.) of coarse dark blue linen, with emblems painted on. The central portion contains a representation of Adam and Eve in the Garden of Eden. At the foot of the tree are an open book and square and compasses. Columns on left and right bear respectively the letters A. and S. An arch is formed by a rainbow having immediately below it the letter G, an ark and dove with olive branch, while above it are the all-seeing eye, sun, moon and seven stars. The apron is edged with orange gimp fringe. Bro. Bell thinks it is probable that it belonged to one of the androgynous societies and points out that in the pamphlet, *Freemasonry for the Ladies*, dedicated to H.B.H. the Duchess of York, in 1801, the "first dignity" in the ceremonial is Amice, the "second dignity" largely consisting of a practical representation of the Fall of Man. The particular virtue on which the greatest emphasis is laid throughout is Silence, and Bro. Bell hazards the suggestion that these may account for the letters on the pillars.

By Bro. J. BERGMANN, London.

APRON, with arms of the Grand Lodge of the Ancients, printed from a plate engraved by W. Newman. Presented to the Lodge.



By Bro. J. C. LE FEUVRE, Southampton.

SILVER MEDAL, showing amongst a great number of Masonic emblems a right hand and left foot. Two specimens of this medal are in the Grand Lodge Museum. They all appear to have been struck from the same dies or perhaps cast in the same mould but in each there seems to have been a certain amount of subsequent tooling. In this specimen the field has been roughened, in the other two it is perfectly plain. Nothing is known of the history in either case, and there does not seem to be another instance of a hand and foot appearing on a medal, although it will be remembered that they figured on the Apron exhibited at the Lodge in October, 1904 (See *A.Q.C.* vol. xvii., p. 179).



By Bro. GEO. P. RUPP, Philadelphia.

GLASS TUMBLER, VEGETABLE DISH and PLATE, part of a service purchased in London, in 1810, by Lodge No. 51, Philadelphia.

APRON worn about 1830 in the Franklin Lodge No. 134, Philadelphia.

TWO SASHES worn at the ceremony of laying the corner-stone of the Masonic Temple, Philadelphia, in 1868.

SILVER PAST MASTER'S JEWEL, set in paste, of Lodge No. 51, Philadelphia (about 1820).

SILVER PAST MASTER'S JEWEL of the Phoenix Lodge No. 130, Philadelphia, (about 1840).

SOUVENIR PLATES, MUGS, LOVING CUP, VASE, SPOONS, BREAD-BASKET, CARD-PLATE, MATCH-BOX, ETC., of Solomon's Lodge, Franklin Lodge, Philo Lodge, Apollo Lodge, Ivanhoe Lodge, Mitchell Arnold Lodge, Oriental Lodge, University Chapter, Melita Chapter, Siloam Chapter, Zembo Chapter, Syria Temple, Eastern Star Lodge, etc. *Presented to the Lodge.*

By Bro. GEO. L. SHACKLES, Hull.

CLEARANCE CERTIFICATE issued on the 10th September, 1794, by the Antient Lodge No. 13, Liverpool, to Stephen Clay. This Lodge was constituted in 1775, in Liverpool, and the warrant was transferred by endorsement to Hull, in 1809, and is now the Humber Lodge No. 57. The certificate has been presented to the Humber Lodge by a grandson of Stephen Clay, who resides in Charlestown, South Carolina.

PRINT of engraved jewel belonging to the same Brother.

By Bro. THOMAS COHU, Bromley.

CERTIFICATE issued by the Grand Lodge of England, on 22nd March, 1856, in favour of Bro. James Mace, who had died one year previously. The certificate is signed *P. Pro.* William H. White, G. Sec., W. Farnfield, Asst. G. Sec. It has recently been presented by the St. David Lodge No. 36, Edinburgh, to the Lion and Lamb lodge, London (now No. 192), in which Bro. Mace was initiated.

PHOTOGRAPH of Minutes of an Emergency meeting of Lodge St. David, No. 36, Edinburgh, on Monday, 2nd March, 1801, at which Sir Walter Scott was admitted a member.

A hearty vote of thanks was passed to the exhibitors, and for the donations to the Lodge Museum.

Bro. E. H. DRING read the following paper:—

## THE NAIMUS GRECUS LEGEND:

### II.

The S. Alban Legend in its relation to S. Alcuin and the Naimus Grecus Legend.

BY BRO. EDMUND H. DRING.

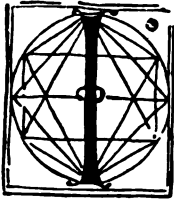

IN the concluding sentences of the first part of this paper I promised to draw your further attention to two important points connected with the life of Alcuin, viz., that the latinised form of his name was Albinus and that he was ordained deacon by Archbishop Aldberht, or Ethelbert of York in 766 or 767.

This will necessitate an examination of the St. Alban Legend, and a consequent consideration of its connection with the Naimus Grecus Legend.

The first mention we have of the St. Alban Legend, and at the same time the least adulterated account, is to be found in the Cooke MS. which I reprint together with its context:

Line 576. Sumtyme ther was | a worthy kyng in | Franus pt was clepyd  
Ca- | rolus scd'us pt ys to sey | Charles pe secunde. And ps | Charlys was  
elyte kyng | of Frauns by the grace of | god & by lynage also. And |  
sūme men sey pt he was | elite by fortune pe whiche | is fals as by cronycle  
he | was of pe kyngys blode | Ryal. And ps same kyng | Charlys was a  
mason | bifore pt he was kyng. And | afte pt he was kyng he louyd |  
masons & cheischid<sup>1</sup> them | and yaf<sup>2</sup> hem chargys and | maney<sup>3</sup> at his devise  
pe whiche | sū ben yet used in fraunce | and he ordeynyd that pey | scholde  
haue a semly onys | in pe yere and come and | spēke to gedyr and for to  
be | renled<sup>4</sup> by masters & felows | of alle thyngys amysse. | And soñe afte  
pt come | seynt ad habelle in to Englund | and he cōuertyd seynt Albon |  
to cristendome. And seynt | Albon lovyd welle masons | and he yaf hem  
fyrst here | charges & maners fyrst | in Englund. And he or- | deyned  
cōuenyent to pay | for pr | traunyaile. And afte | pt was a worthy Kyng |  
in Englund pt was callyd | Athelstone . . . line 614.

In this quotation the portion relating to "Seynt Albon" may be reduced to the following terms:—

1. S. Albon was converted to Christendom by S. Ad habelle.
2. S. Ad habelle came to England before the conversion of S. Albon.
3. These events occurred between the time of Charles Martel who, as I showed in my first paper was Charles the Great, and that of Athelstane, *i.e.* between 742 and 895, the dates of their respective births. There is also a further inference that the events occurred subsequently to Charles becoming King, not to his birth.

<sup>1</sup> Cherished.

<sup>2</sup> Gave.

<sup>3</sup> Manners.

<sup>4</sup> Ruled.

The S. Albon mentioned in the Cooke MS. (and the subsequent MSS.) has generally been identified with S. Alban of Verulam,<sup>1</sup> the first martyr of Great Britain, who is supposed to have met his death somewhere about 300 A.D. This identification however, of recent years has been often doubted, for any and everyone reading the MSS. must be struck by the anomaly of S. Alban's existence being post-dated three hundred and fifty years and placed in sequence between Charles the Great and Athelstane. But there is no doubt whatever that at an early date—presumably later than the date of the Cooke MS.—S. Albon became identified with S. Alban of Verulam, and that S. Ad habelle became corrupted into S. Amphibalus the pseudo-associate of S. Alban and thus gave rise to the ire and contumely of old Dr. Plot.

Although it is quite a subsidiary point, and carries no weight, I would point out that the first mention we have of S. Alban is not S. Alban but S. Albon. There is no doubt, however, that the name Alban was variously spelt in English, Alban and Albon, according to the time and surroundings in which the writer lived.

Throughout the middle ages the similarity of the two names Albanus and Albinus caused confusion,<sup>2</sup> and in the MS. of the *Speculum Historiale Vinc. Bellovacensis*, which I have been using, the name Albanus is on the same page written Albanus and Albinus. The relics of S. Alban at Cologne in the Church of S. Mary<sup>3</sup> have always been called the relics of S. Albinus, while in the earliest printed separate life of S. Alban, printed in 1502, we have the title *De incliti et gloriosi protomartyris Anglie Albani, quē in germania et gallia Albinū vocāt : cōversione : passione : trāslatione et miraculorum choruscatione.*<sup>4</sup> This will show how easily the two names were confused, but when it is remembered that there were at least eight Saints bearing the name of Albinus in addition to the celebrated Albinus, the friend and co-worker of Bede, the difficulties are increased.

Of these Saints, three stand out prominently :—

1. S. Albanus of Verulam, protomartyr of Great Britain.
2. S. Albinus, martyr, of Mentz.
3. S. Albinus<sup>5</sup> (sometime of York) or as we know him, Alcuin.

I suggest that the S. Albon of the Cooke MS. is no other than the last mentioned Albinus Flaccus or S. Alcuin.

The first term in the proposition I deduced from the Cooke MS. is that :—  
“S. Ad habelle converted S. Albon (*i.e.* Alcuin) into Christendom.”

I would ask you to notice the fact that the MS. does not say S. Ad habelle converted S. Albon to Christendom *from paganism* but simply converted S. Albon to Christendom, *i.e.* the Christian Church.

<sup>1</sup> For the sake of expediency I shall designate S. Alban protomartyr of England, S. Alban of Verulam.

<sup>2</sup> I think that originally they were distinct names.

<sup>3</sup> These relics were presented to Germanus, Bishop of Auxerre, about A.D. 429. Towards the end of the tenth century they came into the custody of the Church of S. Pantaleon, Cologne, where they remained until the beginning of the last century, when they were translated to their present resting place at the Church of S. Mary, Cologne. An interesting account will be found in the reports of Associated Architectural Societies . . . 1850. p. 198-207.

<sup>4</sup> There are two copies of this interesting and rare book in the British Museum. It was written by the Abbot of S. Pantaleon and by him dedicated and presented to Henry VII.

<sup>5</sup> It is possible Alcuin was canonised as he is found in the *Acta Sanctorum Bolland* : under the date of May 19th, but I have not been able to ascertain the date of his canonisation. Aldberht was not canonised. In both cases it is probable that the ascription of saintship was due to their popularity, rather than to any special canonisation.

I drew attention in my last paper to the fact that Alcuin was ordained deacon by Aldberht, the Archbishop of York, about 766 or 767. We learn this from the anonymous biographer of Alcuin. "Growing in virtue he was ordained deacon on the day of Purification,"<sup>1</sup> and from the context that this was performed by Archbishop Aldberht, (who was elected to the See in 766 and consecrated in 767,) *after* he had been elected.

The word "conversion" does not necessarily imply "proselytism," and it especially did not in the fifteenth century. It then still possessed its original meaning of "turning." In the mediaeval church it had a technical meaning somewhat analagous to the modern word ordination, and implied a change from the secular to the religious life, or entry into monastic life.<sup>2</sup> Dr. Murray, in the Oxford Dictionary, gives a quotation which aptly illustrates this point: "*Circa 1340, Hampole (Prick of Conscience) Prose trans. 1866. 'When I had taken my syngulere purpos and lefte pe seculere habyte . . . it fell one a nyghte . . . in the begynnynge of my conversyone.'*" With this definition in my mind I apply the phrase "cōuertyd to cristendome" to the fact that Alcuin was ordained deacon by Aldberht.

The second term in my proposition is that:—

"S. Ad habelle came to England before the conversion of S. Albon."

I would ask you particularly to notice the wording of this phrase: "And soñe after pt (*i.e.* after Charles became King) come seynet Ad habelle in to England." At first sight one would think it meant that S. Ad habelle was a foreigner and came to England from abroad. But the passage says simply "come seynet Ad habelle in to England." This will entail a short study of Aldberht's career.

We should be entirely ignorant of any details regarding Archbishop Aldberht were it not for the writings of Alcuin,<sup>3</sup> as no mention of him is made by other writers except in regard to details such as his consecration and his death.

There is great uncertainty as to the exact spelling of his name, and in Smith's Dictionary of Christian Antiquities the following spellings are given: Ethelbert, Adalberht, Aelberht, Alberht, Aldberht, Aluberht, Eadberht, Elchbert, Albert. In the Dictionary of National Biography, when he is mentioned (under the heading Alcuin) he is called Ethelbert, and the list of variant spellings could easily be enlarged. I do not think it at all unreasonable to suggest that "Ad habelle" is a further corrupt variant, especially when we remember that the original form of the name was probably Æðælberht. The two forms of the Anglo-Saxon "th", ð and þ, have always been a stumbling block to English writers since the twelfth century.<sup>4</sup> "What were the precise meanings of þ and ð, or rather how the meanings 'th' 'dh' were distributed over them, it does not seem possible to elicit from the confused state of existing manuscripts. It is generally accepted that þ is 'th' and ð is 'dh' . . ."<sup>5</sup>

In any case, this confusion of sounds and letters is responsible for the fact that two distinct modern names claim descent from Æðælberht, thus:—

<sup>1</sup> Migne 100, p. 97.

<sup>2</sup> See also *Du Cange, Glossarium*; "*conversio, dicitur praeterea de iis qui abjurandae vitae secularis proposito facto, ad strictius vitae genus pervenire student.*"

<sup>3</sup> If my theories be accepted this is, I think, a further confirmation of my deduction that the author of the charges had access to Alcuin's works (or a book founded on them which has not come down to us).

<sup>4</sup> It is owing to this confusion that we get that pseudo-archaic but typographically barbaric form of "ye" for the word "the," which is so much affected by compilers of bazaar programmes and menus,

<sup>5</sup> Ellis on Early English Pronunciation, part 2, p. 515.

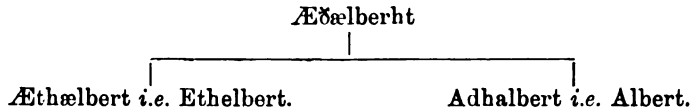

In the longer form, the ð has become the hard "th," and retained almost its original form; in the shorter form the "dh" became softened into a pure 'd,' and the first syllable eventually dropped. The soft form Adalbert was especially used on the Continent. In one Dictionary of Biography I counted no less than thirty Adalberts, all of whom lived between A.D. 700 and A.D. 1000.

I cannot resist the temptation to once more emphasise the fact that in secular mediæval manuscripts, and in Masonic MSS. in particular, a great allowance must be made for the illiteracy of the scribes. Those who take any interest in early English MSS. admit that there was a class of copyists whose sole knowledge was that of writing, and whose avocation was purely that of copying. This was specially the case with secular MSS. or those authors whose writings did not appeal to the monastic *scriptores*. Those brethren who have any knowledge of mediæval palæography and who have carefully read the early MS. Charges must admit that no class of MSS. is so illiterately, even ignorantly, copied as the Masonic Charges. It would be idle of me to waste your time in adducing examples which are apparent on every page, one might almost say every line, of our early Charges.<sup>1</sup>

I do not refer to the differences in the orthography, which are common to all early English MSS., owing to their being no recognised standard of spelling until the invention of printing forced it upon authors. I refer to the consummate ignorance of many of the fifteenth and sixteenth century scribes, who not understanding, or taking no interest in, what they were set to copy from a badly written MS., wrote down some approximation to the original, however unintelligible.

As Ethelbert, or Aldberht as I prefer to call him, is so little known, and so little referred to in current authorities, I will give a rather fuller account of his life than is requisite for the purposes of this paper. In doing so I shall simply make extracts from his life published in Smith's Dictionary of Christian Biography, which contains the best account of his career that has yet been published, written by the late learned antiquary, Canon Raine, and make a few additions germane to our present study, which are drawn from the same sources as the Canon's article.

"Ethelbert, generally called Albert, Archbishop of York, a pupil in the school of York, and a kinsman and favourite scholar of Archbishop Egbert. He was a person of so much ability that he was soon marked out for eminence and distinction. Egbert ordained him priest, and associated him with himself in his teaching, making him master of the schools. Albert also held another office, that of *defensor cleri*, which probably involved diocesan work, perhaps that of an Archdeacon or of the vice-domnus or abbas within the walls of the Minster.

"Albert's most noted pupil was Alcuin, and to him we are indebted for a description of Albert (*magister meus* he affectionally calls him) which is the main charm of his poem on the Saints of the Church of York. The scholar dwells not more on the genius of his teacher than on his tact, his energy, his loving kindness.

"Albert was called by Dean Gale, and with justice, the fourth founder of the Church of York, because, in addition to his restoration of the Minster, he was the chief collector of its once famous library. It was begun, indeed, by Egbert but Albert was

<sup>1</sup> The first two lines in my transliteration of the passage in the Cooke MS. is not a bad example. "Frauns" is spelt "Franus," "Carolus" is spelt "Carolins," simple errors due to a bad copyist.

practically its author. He sought for MSS. everywhere. More than once did he go abroad, with Alcuin as his companion, not only to gain hints for his educational work, but to acquire books for his collection at home. Alcuin in a well-known passage enumerates many of the works which the library contained. He mentions forty-one authors, a few out of many, whose works were in the collection at York.

"In A.D. 766 Archbishop Egbert died, and Albert, by the popular voice, was appointed his successor. He was consecrated on 24th, April, A.D. 767 and in A.D. 773 Pope Adrian sent him the pall. Albert made an excellent Archbishop. He was a strict disciplinarian, but was considerate and genial at the same time. His exaltation made no difference in his personal habits. He was as frugal and simple as before.

"Albert, however, was by no means sparing in what he did for God's house. In A.D. 741 the Minster of York had been burnt. What mischief the fire actually did, we do not know. It is probable that the building, which was of stone, would be temporarily patched up for the celebration of divine service. Albert, however, took in hand the erection of what must have been a new building. The old Minster contained as its most precious feature, the chapel, or oratory, in which King Eadwine had been baptized in A.D. 627.

"The new Basilica, or Cathedral Church—Minster it has always been called in York, although it has never been tenanted by monks—was built under the superintendence of Eanbald and Alcuin, and it is to the pen of the latter that we owe the only description of it which we possess. (Alcuin's description of this temple will be found in part 1 of this paper.)

"About two years before his decease, Albert retired from the cares of office to end the remnant of his days in solitary devotion. In preparation for this he made Eanbald his coadjutor in the see, consecrating him bishop; the charge of his school and books he gave to the faithful Alcuin. He died at York on the 8th of November, A.D. 781 or 782, at the sixth hour of the day, and was laid to rest in his Cathedral, a large procession of ecclesiastics and laymen accompanying him to his grave.

"Albert was undoubtedly one of the most able men in Europe in the eighth century. His learning, his educational powers, his widespread sympathies and acquaintance with the scholars and great men of other countries gave him a position and a power for good which no one, perhaps, possessed to a greater degree. Under him the city of York became the centre of a great educational system which developed in every direction."

Canon Raine, it will be noticed, refers to the fact that Aldberht travelled abroad more than once in the search of MSS. and that he took Alcuin with him as companion.

One such journey, probably the first, he made before he became Archbishop in 767. This we learn from lines 1453-1466 of Alcuin, *Poema de Pontificis*, of which I give a rough translation.

"Not only once did he (*i.e.* Aldberht), led by the love of knowledge, make circuitous journeys in foreign lands, searching for tracks of books or studies that he might pursue. During his travels in the holy places, he, rich in the love of God, came to the city of Romulus (*i.e.* Rome). On his journey home, this learned man, highest in honour, was received in every place by kings and high officials. These great kings wished to retain him, that he, overflowing with divine dew, might moisten their lands, but, by the grace of God, the master came back again to his native land. Shortly after his arrival hither, he was called upon in appropriate terms to receive the pastoral charge . . . ."

I suggest that it is the return from this journey, which took place after the coronation of Charles (*vide infra*) and before Aldberht ordained Alcuin, which is referred to in the phrase "come seynet ad habelle in to Englund."

Furthermore, Frobenius in his Commentary on the Life of Alcuin, prefixed to Alcuin's Works, (Migne, vol. 100, cap. v., sec. 56), shews conclusively that Alcuin must have visited Rome (and consequently Frankland *en route*) about the year 762, and I would add that the great probability is that Alcuin was the companion of Aldberht in the journey spoken of in the passage from the *Poema de pontificis* I have just quoted. The learned scholar was trying to shew that it was on this occasion that Alcuin first met Charles the Great, and although Frobenius knew nothing of the old MS. Masonic Charges, we have in the Cooke MS. a tacit confirmation of his argument. For a direct inference to be drawn from the Cooke MS., is that S. Albon, influenced by the charges and manners that Charles had given to the Masons in Frankland, bestowed the same on the Masons in England on his coming to England, and I consider that it must have been on the return from *this* journey (*circa* 762 A.D.) that Alcuin is supposed to have bestowed these favours. It is the only probable occasion, for although it is true Alcuin returned at least on two (possibly three) other occasions to England, viz. in 781, when he returned after having received Eanbald's pallium from the Pope, and again in 790, when he came bearing a letter from Charles to Offa, on each of these visits his stay in England was brief and may be counted in months; on the other hand, it was after his return from the continent between 760 and 766 that he, as co-worker with Eanbald, rebuilt York Minster, (to which I referred in part I of this paper,) which must have taken some years and fully occupied his time between 767 and 780.

This rebuilding would also have afforded Alcuin an opportunity to grant to the masons employed, manners and charges similar to those bestowed by Charles.

The third term in my proposition is:—

“That these events occurred between the time of Charles the Great and Athelstane.”

The Cooke MS. states that

“afte pt he (*i.e.* Charles) was kynge he louyd masons . . . . And soñe afte pt come seynet Adhabelle into Englonde . . . .”

From which I think we must also infer that the sequence of these events is relative to Charles becoming King. It may be said that as his father, Pepin, did not die until 768, Charles did not become King until that date. But this is not quite the fact, for it must be remembered that Charles was crowned as King in 754, at the same time as his father Pepin and his brother Carloman. I do not remember any other occasion when a reigning king was crowned in conjunction with his two heirs-apparent, but there is no doubt Pepin with his two sons Charles and Carloman were crowned as Kings, by Pope Stephen II. on July 28th, 754.<sup>1</sup> The occurrence is memorable in ecclesiastical history as the act by which the Pope defiantly cut himself adrift from the powers at Byzantium. Although the beginning of Charles' reign is now always calculated from the death of Pepin in 768, it was not so in earlier times. Even Higden, in his *Polycronicon*, writes as follows:—

“For to brynge storyes to acorde that semeth out of acorde spekyng of the empyre and of the kyngdome of Charles. Take hede that this Charles whiche he was yonge was enoynted kynge of the seconde pope Steuen the yere of our lorde seven hondred LIIII which his fader Pipinus was alyue and regned with his fader and under hym XV yere unto his faders deth thenne after his faders deth that deyed the yere of our lorde seven hondred and eyght and syxty yere . . . .”<sup>2</sup>

<sup>1</sup> The regal power of the two sons must have been circumscribed, but they were, without doubt, all three crowned as “Kings.”

<sup>2</sup> Higden, *Polycronicon*, ed. 1527, fol. 220.

If we thus put back the date of Charles' becoming King to 754, it synchronises with my chronology, which I will now put before you.

In 754 Charles who "afte pt he was kynge he louyd masons and cheischid them and yaf hem chargys" became king.

That before 766 Aldberht journeyed to Rome and "come . . . . into Englund."

That before 766 Alcuin went to Rome (probably in company with Aldberht,) where he became acquainted with the science of Rome, which he subsequently transferred to Paris.

That in 766-767 Alcuin was "cōuertyd . . . to cristendome" by Aldberht.

I think that this sequence of circumstances is a sufficient basis for me to maintain that S. Albon of the Cooke MS. is Albinus Flaccus, *i.e.* Alcuin, and that S. Ad habelle is no other than Archbishop Aldberht of York.

I have no hesitation in saying that it would be difficult to produce such a succession of events in the lives of any other cotemporaries, that would be in accordance with the facts and the chronological sequence of the Cooke MS.

It may well be asked, "Whatever has this to do with the *Naimus Grecus Legend*?" and it may be said, "I am surely stultifying my previous paper by attempting to prove that Alcuin was S. Albon as well as *Naimus*." But it is to this precise point that I have endeavoured to lead you. For my reply is that what I have written above confirms my contention that *Naimus* and Alcuin are identical.

If we follow the S. Alban Legend through to the Watson MS., which is generally considered to be a recension of a text, earlier than the Grand Lodge MS. No. 1, dated 1583, we find

" . . . old charges of St. Albanes time & King Ethelstane declared yt Amphabell came out of France into England & he brought St. Albone into Christendome & made him a Christian man & he brought wth him ye charges of Masons as they were in France & in other Lands and & in that time ye King of ye Land yt was a Panem dwelled there as St. Albans is now . . . ."

It will be seen that S. Albon has become firmly established as S. Alban of Verulam and that S. Ad habelle has become identified with S. Amphibalus, the pseudo-companion Saint of S. Alban of Verulam, but whose historical existence cannot be traced further back than the twelfth or thirteenth century.

In Grand Lodge MS. No. 1, the chronological successor to the Cooke MS., but the offspring of a MS. collateral with the progenitor of the Watson MS., we also find S. Albon firmly established as S. Alban of Verulam.

The only inference we can draw is that between the date of the Cooke MS. (or possibly a generation earlier) and at least a generation earlier than the Grand Lodge MS. No. 1, *i.e.* roughly between 1400 and 1550, S. Albon became firmly established as S. Alban of Verulam.<sup>1</sup>

Now it is the fact that *Naimus* does not appear in the legendary history until S. Albon is specifically identified with S. Alban of Verulam.

<sup>1</sup> It may be pointed out as a coincidence that the "Lyfe and passion of Saint Albon, prothomartyr of Englande, and also the lyfe and passion of Saint Imphabel, which converted Saint Albon to the fayth of Christe," by John Lydgate, was printed for the first time at St. Albans, in 1534.



It is my contention that the re-introduction of Alcuin in the guise of Naimus Grecus is the consequent result of the metamorphosis of S. Albinus into S. Alban of Verulam.

This re-introduction of Alcuin may be due to either or both of the following reasons:—

1.—That there was a tradition, even if of recent origin, that Albinus (*i.e.* Alcuin) was the introducer of Masonry into England, and that owing to his having been deposed by ignorant copyists transforming him into S. Alban of Verulam (which fact was not easily recognised) he was re-introduced into the legendary history, and by a misreading the name Alcuinus was corrupted into Naimus or Maimus as we find it written in facs. a. of part 1 of this paper, and the error was continued through all the subsequent MSS.

2.—In the same manner as it is my conviction that Alcuin (as Albon) was introduced into the Cooke MS., or probably a predecessor of the Cooke MS., as a connecting link between Charles the Great and England, so later on S. Alban of Verulam, having deposed him and become the connecting link between Charles and England, a further link in the genealogical chain was forged connecting Charles the Great with the earlier ages. In doing this the editor (as in the previous proposition) had recourse to Higden's Polycronicon (or Capgrave),<sup>1</sup> and finding in the former the sentence I quoted in my first paper beginning "*Alcuinus scientiā clarus,*" which relates how Alcuin brought the science of Rome to Paris, adopted the passage and introduced it into his version of the charges. That in doing so he, differing from the earlier writers of the legend, reintroduces Alcuin as teaching Masonry to Charles, instead of bringing Masonry from Charles to England, is a variation which may be in strict accordance with the various chroniclers, although it may not be in strict accordance with the earlier form of the legendary history as we find it in the Cooke MS. Such a discrepancy would entirely depend upon the aim the editor had in view when re-introducing him.

I place these two hypotheses before you, as indeed I place the whole of this paper, for investigation and discussion. I cannot assume the power of coming to a definite decision on a debateable point. Both arguments are tenable, but I do not think that either invalidates my theories as to the identification of Alcuin with Naimus.

So far as my personal convictions are concerned, I must say I view with suspicion the theory of the legendary history being pure tradition. To my mind there is not the slightest doubt, as Bro. W. H. Rylands has several times pointed out, that the legendary history was a gradual development, and I feel sure that his contention that it was written in reply to the demand for a Return of Writs in 1388 has a solid foundation. I hope shortly to write a few words on this subject, and also on the reasons that led to the introduction of Charles the Great into the legend, but as the subject does not arise in the elucidation of the Naimus Grecus legend I refrain from introducing it into this paper.

I must make one addition to the first part of this paper. It will be remembered that I questioned or rather contradicted the statement in Smith's Dictionary of Christian Biography, that Alcuin called Charles the Great "Solomon." I was in error, in spite of three careful searches through Alcuin's letters. West, in his Life of Alcuin,<sup>2</sup> referring to the pseudonyms Alcuin bestowed upon his friends writes "Charles is usually called David after the warrior king of Israel, and sometimes is styled Solomon for his

<sup>1</sup> A similar passage is found in Capgrave's Chronicle.

<sup>2</sup> Alcuin and the Rise of the Christian Schools, by Andrew F. West, London, 1893; pp. 44, 47.

wisdom," and confirms this statement by a reference to Alcuin's treatise *de animae ratione*,<sup>1</sup> which I translate in full:—

"I have written these verses for thee in the noble six rhythm, hoping that as this metre is perfect in its parts so will it be perfect to thy understanding. The most wise emperor can very easily make clear to your sagacity the principle of this and the other metres; he whose nobility of mind is marvellous, for amid the many duties of the palace and the responsibilities of the kingdom he has taken care to become fully acquainted with the hidden mysteries of the philosophers, of which scarce anyone dulled with the languor of leisure, strives even to have knowledge. Nor need'st thou ask of us the causes of things, or the occult reasons of physical science whilst daily thou makest use of his most renowned wisdom and beholdest his venerable countenance. Thou needest no long and tiring journey from Ethiopia to Jerusalem if thou wishest to see Solomon disputing on the nature of things. Behold he is with thee, he whom the Queen of the South (*i.e.* Sheba) sought through such great difficulties of the way. And thou shalt utter the same praise (as she uttered): "Happy are thy men, happy are these thy servants which stand continually before thee and hear thy wisdom. Blessed be the Lord thy God, which delightest in thee, to set thee on the throne of his people, because the Lord loved his people for ever" (I. Kings, x., 8, 9).

O daughter of Jerusalem, behold our Solomon in the shining diadem of wisdom; imitate his most noble deeds; eschew wickedness; practice virtue. If thou wishest to be sincere, there is great necessity that thou livest righteously, for thou art in his presence day by day, thou hast in him a pattern of all probity; and in so far as by the influence of his holy character thou mayest deserve to come into his presence, concerning whom the Book of Wisdom said: "King Solomon made himself a chariot (or litter) of the wood of Lebanon. He made the pillars thereof of silver, the bottom (or reclining portion) thereof of gold, the covering thereof of purple, the midst thereof being paved with love for the daughters of Jerusalem" (Cant. iii., 9, 10).

<sup>1</sup> Hoc carmen tibi cecini senario numero nobile, qui numerus perfectissimus [Al., perfectus] est in suis partibus, te optans esse perfectam in sensibus tuis. Cujus numeri rationem, sicut et aliorum, sapientissimus imperator tuae perfacile ostendere potest sagacitati; cujus mentis miranda est nobilitas, dum inter tantas palatii curas et regni occupationes philosophorum pleniter arcana curavit scire mysteria, quod vix otio torpens alius quis modo cognoscere studet. Nec tibi a nobis necesse est causas quaerere rerum, vel rationes physicae occultas scientiae, dum illius clarissima quotidie uteris sapientia, ac venerandam intueris faciem. Nec tibi longo laboriosoque itinere de Aethiopia Hierosolyma visitanda est, ut videas Salomonem de rerum disputantem naturis. Ecce juxta te est, quem per tantas terrarum difficultates regina quaesivit Austri. Sed cum eadem celebri laude tibi dicendum est: "Beati viri tui, et beati servi tui, qui stant coram te semper, et audiunt sapientiam tuam. Sit Dominus Deus tuus benedictus, cui complacuit, et posuit te super thronum populi tui, eo quod dilixerit Dominus populum suum in sempiternum." (III. Reg. x., 1, et seqq.)

O filiae Jerusalem, cernite Salomonem nostrum in diademate fulgentem sapientiae; imitamini mores illius nobilissimos; avertamini vitia, colite virtutes. Magna vobis incumbit, si dissimulare non vultis, optime vivendi necessitas, dum apud eum quotidie versamini, in quo totius honestatis habetis exemplar, quatenus per praesentes illius sacratissimos mores ad ejus cum eodem pervenire mereamini praesentiam, de quo ipsa cecinit Sapientia: "Ferculum sibi fecit rex Salomon de lignis Libani; columnas ejus fecit argenteas, reclinatorium aureum, ascensum purpureum media charitate constravit propter filias Jerusalem (Cant. iii., 9, 10).

This treatise on the Nature of the Soul, which is followed by two poems to which is appended the sentences I have quoted, was written by Alcuin for the edification of Gundrada whom he called Eulalia. She was a cousin of Charles the Great, by some authorities she is called "*consobrina*," *i.e.* a cousin-german, but according to *Anselme, Histoire de la maison royale de France, tome i.*, her pedigree is as follows:—

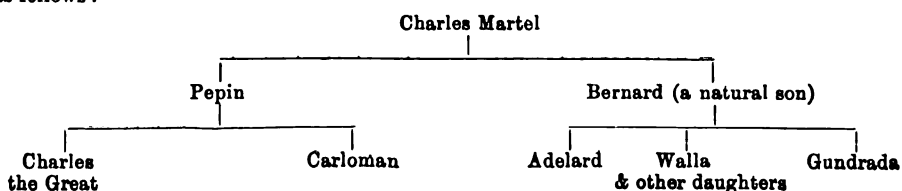

With this establishment of Charles having been called Solomon by Alcuin, I have no hesitation in suggesting that the Solomon, mentioned in the passage I quoted in my previous paper (p. 187) which speaks of "the temple at Aachen which is being constructed by the art of the most wise Solomon," is intended to designate Charles the Great and not the Solomon of Israel. And the opinion I had formed that the Temple of Solomon mentioned in the Naimus legend was identical with the Cathedral at Aachen is thus confirmed if not substantiated.

A first attempt like the present to reconcile and reconstruct on new lines a legendary history which has become hidden by the accumulated excrescences of four hundred years must necessarily be tentative. I have throughout tried to base my theories on a series of honest deductions, founded on the basis which seems to be generally accepted, that "Carolus secundus" or "Charles Martel" is identical with Charles the Great. I have been content to place the bare unsophisticated arguments before you, for the purpose of discussion, rather than follow the natural inclination to indulge in literary flights.

But I have the less hesitation in bringing my theories forward, because I feel that they are precisely consonant with mediæval sentiment. As Guizot<sup>1</sup> points out, Alcuin shews in his letters to Charles, that the King looked upon him as a magazine of knowledge, plying him incessantly with questions on history, moral philosophy, theology, astronomy, chronology, and grammar. The high esteem in which Charles held him only served to increase that halo of fame which was accorded to Alcuin as the middle ages rolled on, and his influence on the eighth and the successive centuries stood out in bolder relief. Eventually he became regarded as a second Hermes, and if not as the author, at least as the regenerator of every branch of learning and culture. Among many other legendary ascriptions with which he was credited was the founding of Paris University; had it been true it would have made him the originator of the present system of University education. To him has been ascribed that Carolingian renovation in writing, which is the direct ancestor of our present calligraphy and typography. It is not surprising then that in the dark ages, in the same way as he had been made the foster parent of many other branches of knowledge, Alcuin should have been made the foster parent of Masonry, especially when we remember that he was greatly responsible for the rebuilding of the renowned York Minster. There is in the human mind a pronounced tendency, whether from pure sentiment or, as is probably the case in the present instance from some interest, to trace the authorship of all temporalities to an individual hero or genius, and in their selection of Alcuin as their hero—if not their patron saint—the old stone masons were peculiarly happy and apposite. I know that in bringing forward these theories I am increasing the weight already resting on the overburdened shoulders of Alcuin, but I have no alternative if my interpretation of the Masonic legend be correct.

Before closing I may say that several writers on the subject have quite independently of the arguments I have adduced, initiated some of the conclusions I have placed before you. Our late Bro. Kupferschmidt was of the opinion that S. Alban of Verulam had become confused with Albinus, but I believe that the Albinus he had in his mind was the co-worker of Bede, who died in 732. Bro. S. Russell Forbes<sup>2</sup> has suggested that the legendary King Solomon's temple, was the Cathedral at Aachen. Bro. C. C. Howard<sup>3</sup> also tried to shew that S. Ad habelle was Ethelbert, but he had in mind the

<sup>1</sup> "Histoire de la civilisation en France," 1840, tome ii., p. 190.

<sup>2</sup> A.Q.C. vol. v., p. 20.

<sup>3</sup> A.Q.C. vol. iv., p. 84.

King and Saint Ethelbert, not Ethelbert or Aldberht the Archbishop. But in each of these cases only the bare suggestion was made and not critically followed up on historical lines. Ethelbert the King has also for the last two hundred years been mentioned in the legendary history, but whether this be through the supposition that Ad habelle and Ethelbert were identical I cannot say.

However I hope that so far as the arguments of these writers agree with mine they will be confirmed, and if I have carried their currents into channels somewhat different to those that the authors intended, I hope that the deviations I have made in their course will also meet with your approval.

---

Bro. Dr. W. BEGEMANN writes :

CHARLOTTENBURG, February 25th, 1906.

WILMERSDORFERSTR. 14.

DEAR SIR AND BROTHER,

According to the wish expressed by Bro. Dring, I send you a few remarks on his new views as to Charles Martell and Maymus (Naymus) Grecus in the youngest version of the MS. Constitutions. I quite admire the deep research as well as the ingenious manner of interpreting, but am sorry that I cannot agree with his results at all. The "Carolus Secundus" whom we meet with in the Cooke MS. and the William Watson MS., cannot in any way be identified with Carolus Magnus, who never and nowhere is styled otherwise than Carolus Magnus, Charlemagne in France and England, in the middle ages. I think it quite impossible that a learned author of the fourteenth or fifteenth century could have called him "Carolus Secundus"; there cannot be any doubt that he would have named him "Charlemagne", because everybody would have known who was meant, whilst under the name of "Carolus Secundus", nobody in England could have had an idea that the well known "Charlemagne" was intended. That the later reading, "Charles Martell", is a voluntary change of the name by a later author, appears to be certain; perhaps this author of the sixteenth century did not know anything of "Carolus Secundus", and therefore inserted "Charles Martell", who, perhaps, or probably, was better known to him, and whose surname seemed to him more acceptable for a *Mason* King. I am of opinion, the author of the Cooke version did not think at all of Charlemagne, but meant his later namesake, Carolus Secundus, who was surnamed Charles the Bald, the youngest son of Charlemagne's son, Louis le Débonnaire or Lewis the Pious. When Lothaire the second son of Lothaire I., who was the eldest son to Lewis the Pious had died, Charles the Bald went to Rome in 815, and was crowned by the Pope as Roman Emperor, and obtained the name Carolus Secundus. He is said to have won over the Pope and the Roman nobility by gifts, and thus petitioned for the Roman crown. The Cooke MS. says:—"and this Charlys was elyte kyng of Frauns by the grace of god & by lynage also. And summe men sey that he was elite by fortune whiche is fals as by cronycle he was of the kynges blode Royal." We are told that Charles the Bald's brothers, because he was from a second wife, would not acknowledge him as having any right of inheritance, and put him into prison, but were afterwards obliged to acknowledge him. Look at the Polychronicon, vol. vi., p. 302, as well as vol. i., p. 282, where he is given as a member of the Carolingian royal family. In a later work, the "Chronicle of England," by Capgrave, we are told that Charles the Bald went to Rome, and gained

the Roman crown by means that were not fair, (p. 110). And the same Capgrave tells that Charles the Second built many churches in France as well as in Italy, (p. 111). Now, the author of the Cooke version cannot well have made use of Capgrave's work, which was written between 1460 and 1464, but there must have been other writings in former times, from which Capgrave got his information, and wherefrom the author of the Cooke version might also have taken his statement about Charles encouraging architecture or Masonry and Masons. All these particulars do not permit me to accept Bro. Dring's new theory about "Carolus Secundus" in the Cooke and William Watson MSS.

I am also quite unable to agree with him in identifying St. Alban with Alcuin. The reading "seynt ad habell" in the Cooke MS. is, no doubt, simply misread and miswritten for "Amphabell" as the name is rightly given in the William Watson MS. And "St. Albon," there is likewise no doubt, was really meant to be the famous protomartyr of England, as is told, in a more embellished manner, in the William Watson version. The name "Amphabell" is to be found twice in this version, and I see no possibility of putting it aside in order to substitute "Aldberht", whom Bro. Dring wishes to put in his place. No doubt the author of the Cooke version knew the then well-known legends of St. Albon and St. Amphabell, whose lives were translated from French and Latin into English by Lydgate, the monk of Bury, in 1439. A somewhat modified form of this translation was printed in St. Albans in 1534, of which print there is an imperfect copy in the British Museum, which has been reprinted by a German scholar (Horstmann) at Berlin in 1882, the readings of the Cambridge MS. being added. The "protomartyr" is spelt "Albon" or "Albanus", the other name in most places "Amphibalus", but sometimes, "Amphybalus", "Amphiball", "Amphibell", "Amphabell" and "Amphabel." From this fact I am sure that "Amphabell" in the William Watson MS. is the genuine form of the name as intended by the author of the version, and "ad habell" is evidently only an error of the transcriber, one of the very many mistakes the transcriber is guilty of. The embellishing writer of the William Watson version must have made use of the legend as translated by Lydgate, for this version must have been manufactured say about 1480, or perhaps a few years earlier, as Henry VI. who was killed in 1471, is styled "our late sovereign Lord". The legend tells of a king of the land that was a "paynym", named Asclepeodot of Cornewaile, who after a victory over the Romans was made king of the Britons, and acknowledged by the emperor Diocletianus; when he was crowned, St. Albon was installed "prince of knightes" and "steward soueraine". Afterwards St. Albon became "gouvernoure of Verolamye", made statutes and laws that nobody should do any harm to another, and sustained calm and peace. Several times St. Albon is characterised as "prince & steward", "knight" or "lord of that citie" (Verolamy, afterwards St. Albans).

It is a pity that so much time and labour should have been spent by Bro. Dring in vain, but I cannot help confessing that his two new theories do not seem acceptable to me.

Please give my hearty greetings to all brethren present, especially to Bro. Dring, to whom I feel deeply obliged for sending me proof of his paper.

I am, Dear Sir and Brother,

Yours sincerely and fraternally,

DR. W. BEGEMANN.

CHARLOTTENBURG, February 26th, 1906.

WILMERSDORFERSTR, 14.

DEAR SIR AND BROTHER,

I now send you, in addition my letter of yesterday, some more remarks on Bro. Dring's views. He appears inclined to admit more possibilities of scribes' errors than I think a sound criticism will allow. He considers it to be possible that the very compiler of the later version might have misread "*Maymus*" for "*Alcuinus*" and "*adhabelle*" for "*Aldberht*." I was ever of opinion that the original compilers of the different versions were learned men who could not easily commit such mistakes as Bro. Dring is obliged to impute to them. No doubt, a great many faults have been made by the transcribers, but they are quite different from those assumed by Bro. Dring as made by an independent author who compiled a new version with the help of his own knowledge. Such a learned man, most probably a priest, was the compiler of the Masonic poem, and so was the author of the Cooke version, most probably a priest too, who had access to a pretty great number of learned writings, namely Isidorus, Beda, Methodius, the Polychronicon, and Petrus Comestor's *Historia Scholastica*, for the "*Magister in Historiis*", with Higden, and "*Maister of Storyes*", with Trevisa, and "*Master of Stories*", in the Cooke MS. is Petrus Comestor. And the compiler of the William Watson version is also proved to have been a learned man by his making use of Lydgate's legend of St. Alban. So I think it impossible that the learned author of the Cooke version could have been able to confound Charlemagne, the renowned emperor, with Carolus Secundus, so that he erroneously called Charlemagne, Carolus Secundus. I doubt very much if the author ever saw the *Chronica Majora* of Matthew Paris, and in Higden's *Polychronicon*, which he expressly cites as a source of his information, Charles and Charleman are correctly distinguished, and as the compiler undoubtedly was *not* "an ignorant man", as Bro. Dring is inclined to suppose, he could in no way easily be induced to introduce the well known Charlemagne as Carolus Secundus.

From all this I am convinced that the author of the Cooke version really meant Carolus Secundus, when he wrote down the name, and so there remains no acceptable possibility, that the curious Mason called Maimus Grecus might be a mistake for Alcuinus, the famous scholar, who was never coupled with Carolus Secundus, or Charles Martell, whose name was in the later version interpolated for Carolus Secundus. The Grand Lodge MS., it is true, reads Naymus, but as it is a transcript, no doubt the N is not quite sure, but as the Tew version, which is an intermediate one between the William Watson and the ordinary versions, has an M at the head of the name of the curious Mason, I am inclined to believe that the M is more original than the N and the name must be read *Maimus Grecus*, though I am quite unable to give any clue to this fabulous name, or to the other form Naimus.

Therefore I am sorry to say that in spite of all industry and painstaking of Bro. Dring the question is to me, still far from an acceptable solution of the riddle.

I am, with best wishes,

Yours faithfully and fraternally,

DR. W. BEGEMANN.

Bro. J. W. HORSLEY said:—Though unable to follow Bro. Dring as far as he would take us, or to accept as conclusive all his arguments, yet most will no doubt agree in thinking that his identification of Charles Martel as Charlemagne and his evidence of his being named Solomon by his contemporaries, have cleared the legend from unnecessary and incomprehensible obfuscations. Further, that Ad habelle is identical with Aldberht, Archbishop of York, may now be clear. But I still stumble at the twisting of Naimus Grecus into Alcuinus Anglicus, nor have I found or been introduced to any instance of "Grecus" meaning simply "a learned man." The phrase "converted to Christendom" might be the equivalent of "passed from the secular into the religious life," but that it can mean as Bro. Dring requires "was ordained deacon" is to me inconceivable. Nor is there a shred of evidence that Alcuin ever stood in need of being converted to Christianity in the literal sense of the phrase. All honour and all thanks to Bro. Dring for having cleared away the debris superincumbent on a monumental slab, but still the inscription thereon is, in my poor opinion, too much worn to be legible.

Bro. W. H. RYLANDS said:—Our best thanks are due to Bro. Dring for his two papers: the amount of labour he must have devoted to them, only those who have pursued similar researches can realize.

And now that the second part of his carefully arranged arguments is before us, it is clear that to place a proper value on the theory he advances it is necessary to consider the whole as pieced together by Bro. Dring, and see how well the various parts fit with one another in explanation of the Legend of Naimus Grecus.

The point to be decided is, has this story, which as it stands in the MSS. is as untrue as it is absurd, been made more consecutive and clearer than before: and is it explained in such a manner that it may fairly be considered likely to have formed a portion of any original legendary history? I think there can be no doubt that it has: and Bro. Dring has shown to a large extent, by a perfectly legitimate argument, how the errors which have crept into and confused the text may have arisen.

Bro. Dring has taken a new course and avoided the very usual mistake of considering that the MS. Old Charges or Constitutions were the work of scholars or well educated copyists: doubtless the writers of them worked to the best of their ability, but that was of very uncertain quality.

The original Legendary History was no doubt as carefully put together, as circumstances and the necessities of the case demanded: but we do not possess this original, and the earliest MSS. we have are made up books, and at best only compilations.

I have sometimes quoted one copy of the seventeenth century MSS. Rolls, as a specimen of what did occur. In this when the scribe came to write Charles Martell, it is clear he had never heard of such a character, so he wrote down Charles Martyr, of whom he evidently had heard.

The same kind of ignorance appears in other instances, and I cannot help thinking that no *educated* scribe *could* have written the form Ad Habell, any more than another could have written Maymus Grecus or Naymus Grecus, or any of the hundred and one forms in which the words appear. These must have been the work of copyists, who read what they were copying as imperfectly as they understood it.

Bro. DR. ROSEDALE said that after some experience with manuscripts he found that even in ecclesiastical and monastic documents there was a great deal of bad copying, which tended to prove the apparent correctness of Bro. Dring's remarks, as the secular copyist would be inferior to the monastic. He thought that Alcuin's cognomen Flaccus was a very probable explanation of Grecus or Graccus, into which words it might easily be transformed by an ignorant copyist, especially when the context referring to the study of the Greeks being transferred to Paris was taken into consideration.

*In reply, Bro. DRING said :*

I am very pleased that Bro. Dr. Begemann has been able to find time to criticise my paper and thank him for so doing. The past history of Masonic theories shews, I think, how necessary criticism is for their welfare, for it is difficult without discussion to arrive at finality in a subject such as the present.

The nearest analogies we have to the Masonic Legendary History are the many Legendary Romances that were current in the Middle Ages, and which were built around the great popular heroes of earlier generations. One of the chief authorities on this subject is Léon Gautier, *les Épopées françaises, études sur les origines et l'histoire de la Littérature nationale* (Paris 1878, *et seq.*) and I should recommend to all students of our early Charges the perusal of the first volume of this work and especially of chapters 3 and 4 of *livre II*.

Bro. Begemann's remarks are directed to two principal points, the first of which is that (a) Carolus Secundus cannot be identified with Carolus Magnus *because* (b) the author of the Cooke MS. was a learned man inasmuch as "he had access to a pretty great number of learned writings," etc.

Since writing the first part of my paper, I find that it was hardly necessary for me to have gone into such details to shew that Carolus Secundus was Charles the Great, for it appears that the same confusion was by no means unusual in the Middle Ages. But part of my original scheme was to shew that Higden was the chief, and with the exception of a volume of Alcuin's writings the only authority on which the Cooke MS. was based.

In support of my contention Gautier (*op. cit.* vol. i., p. 14) writes "Charles Martel alone would have deserved to be the hero of a national epic, had not Charles the Great caused him to be forgotten, Charles the Great with whom our old poets have more than once confounded him."

F. W. Bourdillon,<sup>1</sup> another eminent authority writes, "We find Charlemagne credited with stories told of his grandfather Charles Martel and with the doings of his grandson Charles the Bald."

These are entirely disinterested and independent confirmations of my arguments which seem to Bro. Begemann incredible *because* (b) the author of the Cooke MS. was a "learned man" inasmuch as he cites various learned writers. Bro. Begemann has been of this opinion for the last fifteen years or so, but he has never attempted to substantiate his dictum by following up the various references the Cooke Compiler makes to these different authorities.

If Bro. Begemann will refer to chapter 2 of Higden, he will find mentioned in the long list of works which Higden consulted, every authority quoted by the Cooke

<sup>1</sup>The Genesis of a Romance Hero as illustrated by the development of Taillefer de Léon (Folk Lore, vol. vii., p. 253).



Compiler, and moreover throughout the Polychronicon, Higden is careful to quote his authorities, and his pages are studded with their names. But in those instances where the Cooke Compiler quotes authorities for a statement not recorded by Higden, it will be found that, wherever there is a remote possibility of a quotation having been made, the statement is so greatly distorted that nobody could recognize it, or, that the statement is a complete fiction, and that the supposed authorities are introduced purely with the aim of supporting a "terminological inexactitude." In addition, where to lend an air of exactness the reference is specifically made to a particular chapter or book, it will be found that the chapter specified relates to an altogether different subject. For instance, in lines 452-4 and again in line 516, Isidorus is quoted as referring to Euclid. Isidorus does not mention Euclid once in his *Etymologiarum*. This is not the occasion to go into fuller details, but later on I hope to go seriatim through all the references made by the Cooke Compiler, and shew that every one that was not taken from Higden was an *ex parte* statement or fiction, and to draw conclusions therefrom.

Moreover, had the compiler been a so "learned man" that it was impossible for him to err about Carolus Secundus, surely his Chronology would not have been so seriously at fault as to make SS. Alban (of Verulam) and Amphibal live contemporaneously with or after Charles the Bald, when they are supposed to have been resting in their tombs for at least four hundred years.

I therefore cannot agree with Bro. Begemann that because the Cooke Compiler was a "learned man" his chronology and his statements are indisputable.

I quite admit that the Charles the Bald track is most inviting on account of the difficulty Charles encountered in getting recognised as legitimate, but on the other hand, this very point may have caused some confusion between Charles the Great and Charles the Bald in the mind of the author of the Cooke MS. I tried for a long time to follow up this track, and when I remind Bro. Begemann that cotemporary with Charles the Bald were Haimo, Bishop of Halberstadt, and three Bishops of Constance called Solomon, the third of whom, Solomon of S. Gall was a very renowned *architect*,<sup>1</sup> he will see how very promising the clue appears. If Bro. Begemann care to follow up this path he may be more successful than I. I abandoned it, as I could find no connecting links that would make the personages or the history harmonise with the Cooke legend.

Capgrave does not state that "Charles the Second *built* many churches," the word in the original is "repaired;" and one of the chief authors from whom Capgrave got his information was Higden, (see Capgrave, edited by F. C. Hingeston, 1858, p. xxii.) and there is little difficulty in tracing the others.

The second principal point on which Bro. Begemann disagrees with me is that S. Alban cannot be Alcuin, and that "seynt ad habelle" cannot be Aldberht, because "ad habelle" is clearly written Amphabell in the W. Watson MS.

This argument must fail altogether, for it must be remembered that the Watson MS.—whatever may be the date of the original from which it was copied—is dated 1687, at least two hundred and fifty years after the Cooke MS. During those two hundred and fifty years, one cannot say what amplifications and alterations were made. In so far as a later MS. confirm an earlier one, it may be called as evidence with very little hesitation, but it is certainly not legitimate to base a negative argument on the later MS. It could prove nothing.

Amphabell is no doubt the genuine form of the name intended by the author of the Watson MS. and possibly also of its parent which was probably written about the

<sup>1</sup>Heideloff, *die Bauhütte des Mittelalters*, 1844, p. 4, 5; Mabillon, *Annales*, vol. ii., pp. 261, 299, 608, etc.

middle of the sixteenth century. But I humbly submit that this gives us no ground whatever to judge of the intention of the author of the Cooke MS. which was written one hundred years or so earlier, or of its parent. By the time the Watson MS. (or its parent) was written S. Albon had indubitably become firmly established as S. Alban of Verulam, and therefore it would be only natural for the scribe to alter "ad habelle" into Amphibal the well known associate of St. Alban. My argument that Adhalbert was mis-copied Adhabelle and this was misunderstood to mean Amphibal in accordance with the scribe's interpretation of the context is, I submit, more logical than Bro. Begemann's contention.

With regard to the point that because Henry VI. is styled "our late sovereign Lord" in the Watson MS., that version in its entirety implied "must have been manufactured say about 1480 or perhaps a few years earlier," the deduction is false. It only shews that a *portion* of the version, including that *particular passage* was written about that date; even assuming that "late" then signified, as at present, *recently* deceased. Every scrap of evidence shews that the Legendary History was a gradual development, gaining a passage from one editor, another passage from a second editor and so on, as Bro. Begemann himself has helped us to realize. If the text had been kept with veneration as the Bible was, or as some of the classical writers were, the point might be open to discussion, but in this instance all the evidence is to the contrary.

But Bro. Begemann does not appear to have remarked that if his views be correct the legend still remains incoherent and devoid of any sequence or connection, which would certainly have been carefully avoided had the author been a "learned man" as he would wish us to believe. Whereas I do think that even if some minor details be still obscure, the broader view I have tried to give of the old legend is preferable to Bro. Begemann's.

On one point I agree with my Brother when he thinks that Maimus is an earlier form of the name Naimus, and it will be seen I have given it this preference on p. 182.

I have had a curious corroboration of my theory that *Alc* was liable to be misread *Ma*, to which opinion Bro. Conder also demurred (p. 193.) In F. Madan's Catalogue of the Western MSS. in the Bodleian Library, (vol. v. just published, April 1906), Mr. E. B. W. Nicholson, Bodley's Librarian, draws attention (p. xxvii.) to a scribe's error of *Alathee* for *Mathee*. This occurs in the Ormesby Psalter which is considered one of the finest English MSS. at Oxford. If such an error as misreading the name of an Evangelist by an accomplished scribe be possible, how much more likely might such an unusual name as Alcuinus be misread by an ignorant scribe Maimus. I was not *obliged* to impute these mistakes to these copyists; I imputed them because they were in accordance with what my modest experience would lead me to think probable.

I should be pleased if Bro. Begemann would give his reason for suggesting that Petrus Comestor is identical with the "Maister of Storyes." I have spent much time in trying to clear up this point, and eventually concluded it must be Josephus who is meant. I may have overlooked the passage in Higden, and Bro. Begemann be correct.

I am glad that Bro. Canon Horsley has been convinced to some extent by my paper, but I think his memory is somewhat treacherous when he thinks I suggested that Naimus Grecus had been twisted into Alcuinus Anglicus. I suggested "Alcuinus sciã clarus" had been twisted into "Naimus græciã clarus" or "Naimus grecus clarus," and thence into "a curious man (called) Naimus Grecus."

The transition of the phrase "ordained deacon," through its equivalent "converted to the church" (inasmuch as it implied a turning from the laity to the church)

into "converted to Christendom," seems to me very simple instead of being inconceivable. I should not feel capable of judging whether Alcuin stood in need of conversion "in the literal sense of the word." I can only bow to the decision of my very learned and deeply esteemed brother, who is better qualified than I to decide on such a point.

Even if these questions be only academic, I do not think that the inscriptions should be deemed "too worn to be legible," until such fact had been proved by open discussion. I, at least, do not think they have yet become illegible.

Bro. Rosedale confirms what I said at the end of the first part of the paper, that Flaccus is a good alternative for Grecus or Graccus. I should have laid more stress on this point had I not wished to shew so far as possible that Higden was the great authority on which the Cooke compiler relied, and I could find no instance where Higden calls Alcuin, Flaccus.

To Bro. Rylands' remarks I can say but little except to thank him for the encouragement he has given me in writing on the subject. He has spent so many years in this kind of study, that he is able to look at it from a comprehensive and broad standpoint, and not allow the view of the parent trunk to be interfered with by minor growths which a little imagination would efface.

In my opinion this is the manner in which a factitious legend or romance, entwined with the accretions of several centuries, should be examined. It is hardly to be expected that every little twig, and above all every little parasitic growth can be accounted for, but we can at least try to outline the original trunk and main branches of that tree, whose shadow now covers the whole world.





ARS QUATUOR CORONATORUM



R.A. CERTIFICATE (ANCIENTS) ISSUED 1792.

## SEALS ON "ANTIENTS" GRAND CHAPTER CERTIFICATES.

BY BRO. JOHN T. THORP, P.A.G.D.C.



THE valuable work on Masonic Certificates, written by Bro. J. Ramsden Riley, and published in 1895 under the auspices of the Quatuor Coronati Lodge, is so accurate and exhaustive that it has not been possible hitherto to seriously amend or add thereto. I think, nevertheless, that collectors of Certificates will consider the matter of sufficient importance, to warrant me calling attention to a variation in the Seals affixed to some early specimens, issued by the "Antients" Grand Royal Arch Chapter, which I have recently added to my collection of these very interesting documents.

Bro. Riley informs us in his book, that although he had heard of existing specimens of these Certificates, representing several years between 1790 and 1795, he had not actually seen a specimen of earlier date than 1796, which fact will doubtless account for some of the errors into which he has fallen respecting the Seals used upon them.

Judging from specimens in my collection, three different plates seem to have been used for printing these Certificates, two prior to the year 1800, and one in or about that year; on the last plate the date figures were altered in 1810 from "180—" and "580—" to "18—" and "58—."

It is also contrary to fact that the "Kirk" Seal was exclusively used on these Certificates prior to 1813, as stated by Bro. Riley, inasmuch as the "In London" Seal, impressed on a lozenge-shaped paper, and also scalloped, appears on one or other of my early specimens.

The earliest "Antients" Royal Arch Certificate I have been able to obtain was issued in the year 1792, and fortunately is in an excellent state of preservation. The engraved portion measures  $14\frac{3}{4}$ -inches by  $8\frac{5}{8}$ -inches, and the engraving is very beautifully executed, the two figures and the eye at the top being particularly fine. The document was issued to John Dicas and is signed by Jas. Agar, Z., Watkin Lewes, H., John Bunn, J., Robt. Leslie and Thos. Harper, Scribes. The Seal in the right-hand margin is attached to the usual three ribbons, light-blue, crimson and purple, and is that named by Bro. Riley the "In London" Seal, because the legend thereon is "GRAND LODGE IN LONDON OF FREE AND ACCEPTED MASONS ACCORDING TO THE OLD INSTITUTION." This Seal is impressed on a white lozenge-shaped paper with plain edges, and is exactly the same as that used on the "Antients" Craft Certificates from about 1791 to 1810, and given as fig. iii. on plate iv. of Bro. Riley's book. Beneath the engraving, at the right-hand corner is the engraver's name, "Tagg, sc.," but no register numbers are given as was customary from 1795 onwards. A Royal Arch Certificate with this Seal may be said to constitute a fresh variety, one apparently quite unknown to Bro. Riley.

The second of these Certificates was issued in 1795, and appears to be from a fresh plate, measuring full  $8\frac{7}{8}$ -inches in width, compared with  $8\frac{5}{8}$  of the earlier issue. The engraving differs only very slightly from the 1792 plate, but as the document has been cut close both at the top and bottom, the name of the engraver in this instance

cannot be ascertained. This Certificate was issued to George Godwin and is signed by Wm. Dickey, Z., John Bunn, H., Wm. Hockaday, J., Robt. Leslie and Thos. Harper, Scribes, while at the left bottom corner is the register number "13," and at the right the number "188." The Seal used upon this Certificate is again the "In London" Seal, but in this instance the paper is cut circular and scalloped. Bro. Riley had never seen a Royal Arch Certificate with this Seal, for he declares that "such a fraud as a scalloped 'In London' is unknown."

The third of the trio of Certificates, to which I desire to call attention, was issued in 1808, and seems to be from still another plate, the engraved portion measuring  $14\frac{7}{8}$ -inches by  $8\frac{1}{4}$ -inches. The engraving, which is coarse and poor, differs in several details from the older specimens. At the bottom are the words "T. Harper, Inv. et Del. 207 Fleet Street" on the left, and "Tagg sc." on the right. This class of Certificate is illustrated on plate x. of Bro. Riley's book, but for what reason he styles it a *Dermott* Certificate, when it is claimed by Thos. Harper, seems to require some explanation. This document was issued to John Whippy and is signed by Thos. Harper, Z., Rd. Humphreys, H., Thomas Scott, J., Robt. Leslie and Edw. Harper, Grand Scribes (not simply "Scribes" as in the two earlier issues) and the register number "B 21" is placed in the left bottom corner. The Seal used on this specimen is that known as the "Kirk," on a circular white paper scalloped, with the legend "GRAND LODGE OF FREE AND ACCEPTED MASONS ACCORDING TO THE OLD INSTITUTIONS," and which was used upon all "Antients" R.A. Certificates from 1796 up to the year 1813, when another Royal Arch Seal was prepared and used until about the middle of the year 1817.

There were thus three different Seals used upon these Certificates within a very few years. There is not the slightest appearance of their having been "faked," but they seem to be exactly as issued by the Grand Chapter of the "Antients," and as Royal Arch Certificates sealed with two out of the three Seals are unknown to collectors and students of these documents, or at any rate unrecorded, it seems desirable to place these particulars upon our Lodge records for future reference.







ABS QUATUOR CORONATORUM.



R.A. CERTIFICATE (ANCIENTS) ISSUED 1795

ARS QUATUOR CORONATORUM.

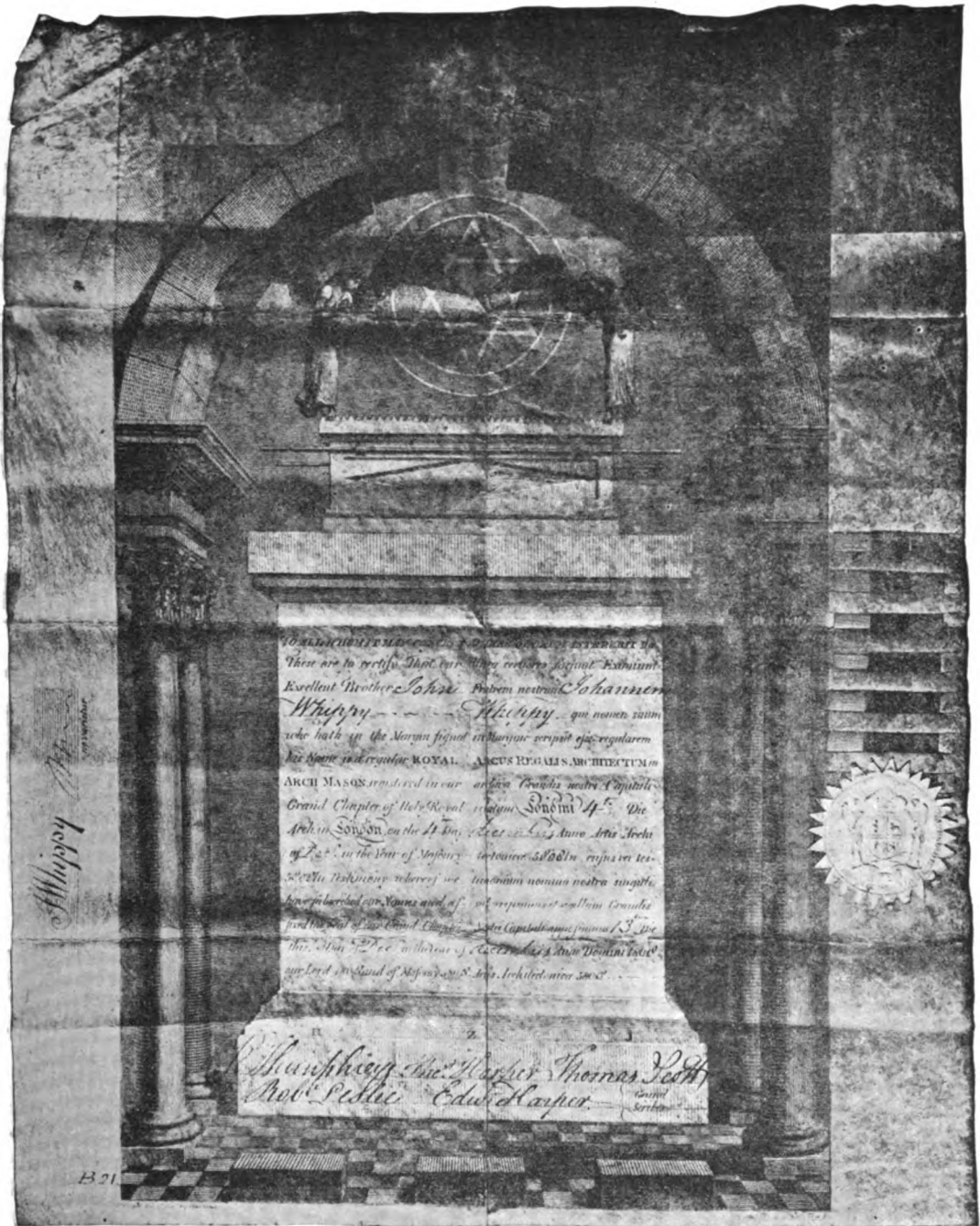

R.A. CERTIFICATE (ANCIENTS) ISSUED 1808.



**A FEW HISTORIC NOTES RELATING TO  
THE LODGE OF PRUDENT BRETHREN, No. 145.**

*BY W. BRO. HARRY GUY, P.M., Treasurer, No. 145.*



THE recent discovery by Bro. Sadler of the existence of a "Scottish" Grand Lodge in London in about 1770 (see *A.Q.C.*, vol. xviii., p. 69) has prompted me to write a few notes regarding one of the Lodges which assisted in its formation.

The Prudent Brethren Lodge works under a Warrant which was granted by the Grand Lodge of the Antients and Signed on December 14th, 1775, by the Duke of Atholl, Grand Master, W. Tindall, S.G.W., Law. Dermott, D.G.M., Thos. Carter, J.G.W., and Wm. Dickey, G. Secretary.

It empowers W. Alexander Smith, one of our M.M., W. George Irons, his Senior Warden, and W. William Massey, his Junior Warden, to form, and hold a Lodge of Free and Accepted Masons, aforesaid, at the Bedford Head, Maiden Lane, Covent Garden, or elsewhere in London upon the first and third Thursday of each Kalendar month.

The old Warrant is numbered No. 195 and registered in the Grand Lodge.

The seal has attached to it the combined blue and yellow ribbons threaded through the parchment.

On the back of the Warrant is endorsed permission to remove the Lodge to Spitalfields, and runs as follows:—

Transferred to our trusty and well beloved Brethren, viz., John Hales one of our Master Masons, Nathaniel Acton our Senior Warden and Robert Crawford his Junior Warden and their successors, (being first duly registered to the Statue) to be held at the Ship, Brick Lane, Bethnall Green upon the second Monday in every month, and on other lawful occasion, subject to the previsoos, and conditions within mentioned and pay due respect and obedience to the Right Worshipful Grand Lodge by whom the within Warrant is granted.

ROBERT LESLIE.

B. P. Simmons, S.G.W.

The following places are mentioned where the Lodge used to meet, viz:—

The Bedford Head, Maiden Lane, Covent Garden, 1775.

The Robin Hood, Great Windmill Street, Haymarket, 1789.

The Globe, Market, Pall Mall, 1792.

The Crown Tavern, S<sup>t</sup> Dunstan's Passage, 1794.

The Hole in the Wall, Fleet Street, 1800.

The Goose and Gridiron, S<sup>t</sup> Pauls Church Yard, about 1800.

The Ship, Brick Lane, Spitalfields, 1806.

The Lion and Spread Eagle, High Street, Spitalfields, 1819.

The Duke of Clarence, Commercial Road, St. George's East, 1822.

The Duke's Head, Commercial Road, St. George's East, 1826.

The King's Head, Commercial Road, St. George's East, 1829.  
 The Coach & Horses, Northumberland Alley, Fenchurch Street, 1832.  
 The George & Vulture, Cornhill, 1842.  
 The Brunswick Tavern, Blackwall, 1844.  
 The Crown Tavern, Wapping Wall, 1844.  
 The George & Vulture, Cornhill, 1844.  
 The Freemasons' Tavern, 1845.  
 The Turk's Head, Motcomb Street, Belgravia, 1849.  
 The Prince of Wales, Exeter Street, Belgrave Square, 1851.  
 The Freemasons' Tavern, 1851.  
 The Freemasons' Hall, 1867.

W. Bro. Sadler, G.T. and Sub-Librarian of Grand Lodge, kindly examined the Atholl Collar Jewels, and gave me the following information respecting them :

The Master's Jewel (made by E. M.), date 1812.

The Senior Warden's (made by T. D.), modern, 1839.

The Treasurer's—crossed keys—(made by T. Harper), 1809.

The Secretary's—pens tied—(made by T. Harper), 1809.

The Senior and Junior Deacons' (made by T. Harper), 1798, have the figure of Mercury with Caduceus in the left hand.

The rest of the jewels are modern.

When the Lodge was constituted in 1775, it was only known by the number 195, as seen on the Warrant. In 1814, after the Union, it became No. 241.

In the year 1817, it took the name of "Prudent Brethren." It would be interesting to trace the origin. The names of the original members being unmistakably Scottish, and those people being proverbially careful, that may have been the reason they took the name of *Prudent* for their Lodge. In 1832, it became No. 169, and in 1863, at the last closing up, No. 145.

As far as can be traced at present, there are one hundred and sixteen names recorded of Masters who have been installed in the chair of K.S.

In the year 1844, the Lodge funds were very low and the furniture of the Lodge had to be sold to defray the expenses of a law-suit and rent. The chairs of carved oak of W.M. and S.W. were bought by the Lodge of Union No. 414, where they are still in use.

The following paragraph may be interesting as it relates to the *hangings* for the jewels.

On June 13 1808 the following resolutions & regulations of the Grand Lodge relating to a general procession & festival commemoration of St John the Baptist on June the 27<sup>th</sup> were read & approved that the officers have new hangings for the jewels at the Grand Festival.

Bro Kenn proposed that the blue ribbon shall be worn only and that the trimmings now on the same be taken off which was agreed to.

The following interesting records appear relating to the Royal Arch Degree :

Oct 10 1808. B<sup>ro</sup> Watts was recommended by this Lodge to the R<sup>o</sup> Worshipful the Holy Royal Arch Chapter, as a candidate for one of the Nine Excellent Masters for the ensuing year. B<sup>ro</sup> Aldhouse (Tyler), Exalted to the Degree of Excellent, and High Excellent Masons the following Brethren viz B<sup>ro</sup> Smith, Watts, Hogan, Parker, Rawlins, Jones, Patullo, Holsworth, Scott, Villiers, Potter, Jelliffe, Collier, and Alce.

Bro. Smith was the only Brother who had been W.M. of the Lodge.

There is another interesting entry on September 28th, 1807, relating to the Royal Arch Degree, Lodge No. 195, and Holy Royal Arch Chapter, held under the sanction and authority of the Warrant of this Lodge.

Chapter convened in due form.

Present

B<sup>ro</sup> Robert Gill, Grand Chief  
B<sup>ro</sup> Ed Bowman Grand Chief  
B<sup>ro</sup> Thos Wiggins Grand Chief  
B<sup>ro</sup> John Mason  
B<sup>ro</sup> John Taylor  
B<sup>ro</sup> Benj Aldhouse.  
B<sup>ro</sup> Sam Smith, Scribe.

B<sup>ro</sup> G. Patullo &c &c &c all of this Lodge having produced recommendatory certificates from this Lodge, countersigned by the Grand Secretary, underwent regular examination by the Grand Chief, and were found duly qualified to be Exalted to the Supreme Degree of Excellent Royal Arch Masons. Paid the usual fine and were exalted accordingly.

Dec 17 1809. B<sup>ros</sup> Sewell Newcomb and Bugby this day passed the chair for the benefit of the Holy Royal Arch, and at the next meeting on Jan 8<sup>th</sup> 1810, the Lodge was opened in the further Degrees of Excellent, and High Excellent, when the Brethren above mentioned were exalted to the same.



## NOTES AND QUERIES.



**THE Masonic Female Orphan School, Dublin, 1814.**—A copy of Resolutions passed by Governors and Subscribers, 27th November, 1814, bound with the Hardwicke Papers, Addl. MS. 35,651, British Museum, is written upon one side of a sheet of foolscap—the matter being much underlined.

This copy is directed (in the address on the fly leaf) to the Earl of Hardwicke, at St. James' Square, London.

Lord Hardwicke had been Lord Lieutenant of Ireland at the time of the Union, 1801, and the Insurrection of 1803. A letter of Lady Hardwicke in Mr. Hare's "Two Noble Lives" gives an insight into the Society of Dublin at this period, mentioning—"great wealth does not get a man forward here as in London: the Society is small and the individuals proud."

"At a most numerous meeting of the Governors of and Subscribers to the Free-mason Orphan School, held in the Chapter Room of the Cathedral of St. Patrick immediately after Divine Service on Sunday the 27<sup>th</sup> of November, 1814—

Resolved unanimously—That our most unqualified thanks are hereby offered to the Very Rev<sup>d</sup>. John Will<sup>m</sup>. Keatinge, D.D., Dean of St. Patrick's for the essential benefit he afforded the Masonic Orphan Charity in kindly granting the use of his Cathedral (a Church hitherto unused for any Charity Sermon) as the place in which their cause should be advocated, thereby from its novelty materially aiding the cause.

Resolved unanimously—That our thanks are not due and are therefore most justly with-held from the Very Rev<sup>d</sup> the Dean of Christ Church, Dr. Lindsay, for his unkind, illiberal, unchristian, uncharitable, and ungentlemanlike attempt tho' fortunately unavailing to deprive the Charity of the benefit of the professional exertions of the gentlemen of the United Choir of St. Patrick & Christ Church by his most malicious mandatory circular requiring their attendance to the latest possible moment on that day *only* thereby endeavouring to prevent their performing the anthem as advertized and in consequence aiming at deteriorating the collection.

Resolved unanimously—That our thanks are justly due and are therefore given to the gentlemen of the United Choir of St. Patrick and Christ Church for the promptitude they have uniformly evinced to further the cause of the Masonic Female Orphan School.

Resolved unanimously—That our most particular thanks are hereby given to Mess<sup>rs</sup> Storay, Hooper, and Jager for the splendid exertion of their talents in the short anthem which under the above circumstances they were necessitated to give & which if time had been permitted them by the Very Rev<sup>d</sup> the Dean of Christ Church would have afforded more ample satisfaction to the very numerous and respectable auditory then assembled in the Godlike cause of Charity.

Resolved unanimously—That our sincere and cordial thanks are justly due to the Rev<sup>d</sup> Doctor Hancock for the impressive and effectual eloquence with which he advocated the cause of helpless female youth and indigence tho' endeavoured to be defeated maliciously and uncharitably.

29<sup>th</sup> Nov<sup>r</sup> 1814.

Signed by order  
Timothy Maigneen  
V. Sec<sup>r</sup> "

HARRY SIRR.

**Survival of Templarism in Spain.**—In *A.Q.C.*, vol. xvii., p. 215, appears a learned paper on the chivalric orders by Bro. Malczovich, an eminent Hungarian Masonic scholar, in which he suggests that the Order of Christ in Portugal “is, in some sense, at least, a continuation of the Templars.” This leads me to inquire whether the same is not true in Spain as to “Caballeros de la Orden Militar del Santo Sepulcro de Jerusalén” (Knights of the military order of the Holy Sepulchre of Jerusalem)? Some time since the Madrid pictorial magazine *Blanco y Negro* (White and Black) described a meeting of the chapter of this order “for the reception of a new knight, Don Gaspar Castellano de la Peña, Count of Castellano. The President,” continues the account, “propounded the questions of the ritual and the oath was administered by the Lord Archbishop and he (the candidate) was invested with cloak, cap, sword and other “insignia.” The illustration accompanying the account shows the ceremony in progress in the presence of a large concourse, including ladies, and the Maltese Cross inscribed on a banner is prominent in the foreground.

Manila, P.I.

CHARLES S. LOBINGIER.

**Masonic Funeral at Cork.**<sup>1</sup>—July 2nd, 1784, John Fitton, Esq., B.L., was buried at the Cathedral of St. Fin Barre’s with Masonic honours. Order of procession:—1. Freemasons (No. 25) in pairs, their emblematic instruments hung in mourning. 2. The Band of the Cork Union Volunteers with muffled drums. 3. Eight single file of the same Corps, with arms reversed. 4. Three clergymen. 5. The body covered with a velvet pall on which were deposited his apron, hat and bayonet. 6. Twelve mourners. 7. Twenty double file of the Union.

ROBERT DAY.

**The Missing York MSS. of the Old Charges.**—In the well-known inventory of the Property of the York Lodge, made on 15th September, 1779, mention is made of a “Parchment Roll of Charges on Masonry, 1630.” This Roll is now missing, nor does it appear that there is any later record of its existence than that of the date of the above-mentioned inventory. Of the five York Rolls still extant the oldest dates from about 1600. Evidence was, however, brought forward last year that the York Lodge did at one time possess a still earlier Roll, for the writer of the Levander-York MS. states that it was copied from a York Roll of 1560. There are, then, two York Rolls missing, instead of one—that of 1560 and that of 70 years later. From a comparison of the Papworth and the Levander-York MSS., it may be reasonably inferred, as Bro. Hughan has remarked, that both the Papworth and that of 1560 had a common origin through at least one intermediate manuscript: what that was still remains to be ascertained. It is probable that the Roll of 1560 was in the possession of the York Lodge at least as late as 1726. It will be remembered that the date assigned to both the Papworth and the Levander-York MSS. is the first half of the eighteenth century. Bro. Francis Drake, in his published “Speech deliver’d to the Worshipful and Ancient Society of Free and Accepted Masons at . . . York, on St. John’s Day, December 27, 1726,” states in a footnote that he obtained his information as to St. Alban from “an old Record preserv’d in our Lodge.” He had just mentioned “one who was actually at the building of Solomon’s Temple,” whose name he gives as Ninus. It is not unreasonable to suppose that this information came also from the same “old Record.” Now, he who is most commonly known as Nymus Graecus is called Ninus in, I believe, only the Aberdeen MS. and in Krause’s Old Charge, which is considered apocryphal.

<sup>1</sup> Edward’s Cork Remembrancer, 1796.



He is called Nimus (interlined Naymus) in Sloane 3848, in the Papworth and in the Levander-York MSS. If Drake was quoting from the Sloane, he would probably have said "Nimus or Naymus," but if from the MS. of 1560, it does not seem too much to assume that Drake, who was a learned antiquary, coming across the word Nimus, substituted Ninus for it, a known for an unknown name.

F. W. LEVANDER.

**The Dunciad.**—In the interesting paper by Bro. R. F. Gould on the Duke of Wharton and the Gormogons (see *A.Q.C.*, vol. viii., pp. 114-155) a quotation is given from Pope's *Dunciad* with the explanatory note on the Gregorians and the Gormogons. It may perhaps be convenient to record the "Remarks" upon the allusions, with the stanza, as given by Bowles in his edition of Pope's works of 1806.

Next bidding all draw near on bended knees,	565
The Queen confers her <i>Titles and Degrees</i> .	
Her children first of more distinguish'd sort,	
Who study Shakespear at the Inns of Court,	
Impale a Glow-worm, or Vertú profess,	
Shine in the dignity of F.R.S.	570
Some, deep Free-Masons, join the silent race	
Worthy to fill Pythagora's place :	
Some Botanists, or Florists at the least,	
Or issue Members of an Annual feast.	
Nor pass the meanest unregarded, one	575
Rose a Gregorian, one a Gormogon.	
The last, not least in honour or applause,	
Isis and Cam made DOCTORS of her LAWS.	

REMARKS.

VER. 571. *Some, deep Free-Masons, join the silent race.*] The Poet all along expresses a very particular concern for this *silent Race*: He has here provided, that in case they will not waken or open (as was before proposed) to a *Humming-bird*, or a *Cockle*, yet at worst they may be made Free-Masons; where *Taciturnity* is the only essential qualification, as it was the chief of the disciples of Pythagoras.—POPE.

VER. 576. *A Gregorian, one a Gormogon.*] A sort of Lay-brothers, two of the innumerable *Slips* from the Root of the Freemasons.—POPE.

From the works of Alexander Pope, Esq. By the Rev. William Lisle Bowles, A.M. In Ten Volumes. Vol. v., page 323 [Book iv. of the *Dunciad*.] London, 1806.

HARRY SIRR.

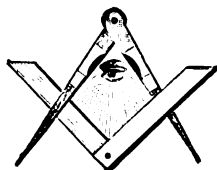

## OBITUARY.

---

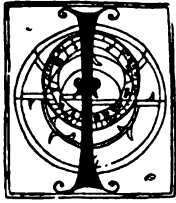

It is with regret that we have to announce the death of Brothers :

**Sir Richard Nicholas Howard**, of Greenhill House, Weymouth, on the 25th November, 1905. He joined the Correspondence Circle in January, 1894.

**Christian John Cole**, of Box 468, Cape Town, on the 5th of September, 1905. He joined the Correspondence Circle in March, 1899.

**Sidney Frederick Isitt**, of Little West Hatch, Chigwell, Essex, on the 8th of December, 1905. He joined the Correspondence Circle in March, 1902.

**Edward Aries Thomas Breed**, of 13, Buckingham Place, Brighton, on the 13th of December, 1905. He joined the Correspondence Circle in January, 1894, and was elected a full member of the Lodge on the 9th of November, 1903.

**William Logan**, of Langley Park, Durham, on the 19th of November, 1905. He joined the Correspondence Circle in February, 1887.

**Alfred Page**, of Long Row, Nottingham, on the 18th November, 1905. He joined the Correspondence Circle in January, 1899.

**Charles Bampfylde Warre**, of 19, Brunswick Place, West Brighton, in September, 1905. He joined the Correspondence Circle in January, 1893.

**Edward Hicks**, of Sunnyside, Sutton, Surrey, on the 21st of May, 1905. He joined the Correspondence Circle in October, 1898.

Surgeon-Major-General **William Frederick De Fabeck** (I.M.S., retired), M.D., of Bangalore, Madras. He joined the Correspondence Circle in January, 1893.

**Henry John Hewer**, M.D., of Blackall, Queensland, on the 24th of December, 1905. He joined the Correspondence Circle in May, 1896.

**Frank Todman**, of 15, Chanctonbury Road, Hove, Sussex, on the 18th of December, 1905. He joined the Correspondence Circle in June, 1898.

**Rev. W. Henry Frazer**, D.D., of the Constitutional Club, S.W., London, on the 25th of January, 1906. He joined the Correspondence Circle in January, 1899.

**Hubert White**, of 1, Wickham Road, St. John's, S.E., London, on the 29th of January, 1906. He joined the Correspondence Circle in May, 1898.

Rev. Canon **Henry Baker Tristram**, of the College, Durham, on the 8th March, 1906. He joined the Correspondence Circle in February, 1887, and was one of the earliest members, his number on the roll being "13." He was the Dep.Pr.G.M. for Durham, and also a P.G.Chap. England.

**Vincent Paine Freeman**, of 25, Queen's Road, Brighton, on the 17th January, 1906. He joined the Correspondence Circle in October, 1894.

**Col. William Keilly Westropp**, of 6, Shorncliffe Road, Folkestone, on the 27th November, 1905. He joined the Correspondence Circle in June, 1898.

**John Thomas Last**, of 48, Sundridge Road, Bradford, in February, 1906. He joined the Correspondence Circle in March, 1887.

**T. Bergmann**, of Newlands, Oakleigh Park, N., London, on the 11th March, 1906. He joined the Correspondence Circle in March, 1902.

### BRO. FINDEL.

Bro. Gottfried Joseph Gabriel Findel was born at Kupferberg in Oberfranken on October 21st, 1828, and was educated at the College at Bamberg. In 1848 he published a small collection of poems, which enabled him to continue his studies at the University of Munich, but before long he (with many others) came into conflict with the Government of the day, and suffered ten months' imprisonment for his outspoken criticism on certain political matters. After his release he was apprenticed to Bro. Mohr, a bookseller of Heidelberg, by whom undoubtedly his attention was first directed to the Craft.

He was initiated on the 19th October, 1856, in Lodge Eleusis zur Verschwiegenheit at Bayreuth, where for some time he edited the *Tagblatt*, subsequently removing to Leipzig to found the *Bauhütte*, which speedily attained the position of the leading organ for German Freemasons. In 1858 he joined the Lodge Minerva zu den drei Palmen, but shortly afterwards resigned and re-joined his mother Lodge at Bayreuth. In 1861 he took a prominent part in the formation of the Verein Deutscher Freimaurer. In 1861-2 he published his well-known "History of Freemasonry," which has since been translated into several languages, a seventh edition being printed in 1900.

In 1872 he joined the Lodge Zum Morgenstern at Hof, and in 1874 he published his "Geist und Form der Freimaurerei." In 1878 he resigned his membership of the Verein Deutscher Freimaurer, and six years later founded the Lessingbund, which however received but little support. Other publications during this period were "Lessing's Ansichten über Freimaurerei," "Die Grundsätze der Freimaurerei in Völkerleben," "Vermischte Schriften," "Die Papstkirche und die Freimaurerei," "Die Freimaurerei und die moderne Weltanschauung," "Dunkle Punkte im Maurerleben."

The Taxil fraud caused him to issue a number of essays, amongst which may be mentioned "Katholische Schwindel," "Die Germania und der Gokelhahn des Teufels Bitru," "Die katholische Klerisei auf der Leimrute."

In 1897 he was compelled to give up the *Bauhütte* after thirty-three years of untiring work in connection with that periodical. Two years earlier he had started the *Signale für die Deutsche Maurerwelt*, and in 1897 he was commissioned by the Grand Lodge "Zur Sonne" to write its history. In the following year he joined the Lodge Johannes zum wiedererbauten Tempel in Ludwigsburg, and published his celebrated essay, "Der freimaurerische Gedanke und seine Berechtigung."

He subsequently joined the Lodge Phoenix at Leipzig, and during the remaining years of his life wrote a number of papers on various Masonic subjects.

The principle embodied in the motto which he adopted when only 22 years of age "One must be prepared to sacrifice everything for a great and good cause" was acted upon by him during the whole of his long career. Feeling within himself the absolute justice of the cause he championed, he became at times very bitter towards those who held contrary opinions. To this may be attributed the fact that he alienated the sympathies of many good and true friends, and some who were of his own way of thinking would have been glad if certain passages in his books had been omitted.

During his later years, however, he adopted a more conciliatory tone, and even those who were his bitterest opponents joined his supporters in a tribute of deep sorrow when his long and useful life came to an end.

G. V.

## TEMPLARIA ET HOSPITALARIA.

THOUGHTS ON THE ORDERS OF THE TEMPLE AND HOSPITAL IN THE  
BRITISH EMPIRE, IN CONNECTION WITH ESOTERIC MATTER  
OF VARIOUS KINDS.

BY FRATER LADISLAS DE MALCZOVICH,

Knight of the United Religious and Military Orders of the Temple, and of St. John of Jerusalem, Palestine, Rhodes and Malta, in England and Wales; Preceptor and Prior of "Royal Sussex" Preceptory and Priory No. 25 Torquay, Devon; Great Chamberlain of England; Provincial First Constable of Devonshire.

(Continued from Vol. xvii., pp. 204-218.)

### CHAPTER I.

#### THE TEUTONIC ORDER IN CONNECTION WITH THE ORDERS OF THE TEMPLE AND HOSPITAL.



THIS chapter will be devoted to the Teutonic Order so far as it (and its old rituals which have been handed down to us) may be found to be connected with Templary in general and modern British Templary in particular. I shall not attempt to give a detailed account of the Order of the Teutonic Knights, but it may be instructive if before communicating its old Rituals, I give an outline sketch of its outer history and inner organization.

The Order of the Teutonic Knights or "Knights of St. Mary" or "Knights of the Teutonic House of our Blessed Lady at Jerusalem" was the third and last great Chivalric Order of the Crusades, and was modelled on that of the Knights of the Temple, although its origin more closely resembled that of the Hospitallers of St. John of Jerusalem, the starting point in each case being a Hospital or "*Hospitium*."

In the year 1128 a pious German founded at Jerusalem a hospital for the reception of poor and sick German pilgrims proceeding on their way to the holy places, together with a chapel dedicated to the Holy Virgin. During the Crusades the brethren to whose care this Teutonic Hospital of St. Mary was committed, faithfully devoted themselves to works of Christian charity and thereby attained a high degree of consideration and esteem. At the same time they greatly increased in wealth, rich gifts and possessions being from time to time bestowed upon them in furtherance of their pious purposes. It was, however during the Third Crusade, at the memorable siege of Acre (1189-91), that this modest society of hospitallers entered upon a new and most important phase of its existence. As is well known, the combined forces of English, French, and German Crusaders having met there, laid siege to Acre, which was valiantly defended by the Infidels. Whilst the siege was in progress a pestilence broke out in the camp of the Christians, who fell in crowds by the disease. It was then that the Teutonic Hospitallers of St. Mary greatly distinguished themselves by conscientiously ministering to the sick and wounded, exercising such an amount of self-denial that they gained universal admiration. In consequence, men of various ranks of society joined the association of the Hospital of St. Mary, prominent among them being merchants of

North Germany, particularly from the rich cities of Bremen and Lübeck, who had accompanied the Count of Holstein when going to his Crusade.

It is interesting to notice how during the period in question these members were eager to help their suffering brethren who were in need of assistance. They landed a large merchant vessel, which they placed at the disposal of the brethren of St. Mary's Hospital, and which was forthwith transformed into a temporary hospital. Soon afterwards Knights and others of noble birth and high social position also attached themselves to St. Mary's Hospital, and conceived the novel idea of transforming the Society into a Chivalric Order on the model of the Knights of St. John of Jerusalem, or of the Knights Templar. This idea received the approval of Frederick, Duke of Suabia, who in succession to his father, the late Emperor Frederick Barbarossa, had taken the chief command of the German Crusaders.

Here I must pause in order to make the following parenthetical note. The Emperor Frederick Barbarossa had made up his mind, in spite of his greatly advanced age, to undertake a Crusade to which he had long been pledged. Having gathered a very considerable army he led it by way of Hungary to Constantinople and thence crossing the Bosphorus, to Asia Minor. He was, however, not destined to see the Holy Land, as death overtook him when crossing or bathing in the Saleph River. His eldest son, Frederick, Duke of Suabia, who had accompanied his father, was then given the command of the German troops, and he succeeded in leading them to the walls of Acre.

Another point must also be mentioned. The Emperor Frederick had in a great measure been ill-affected towards the Knights Templar, who by that time had become great and powerful, and in the Emperor's contests with the Pope had sided with the latter, and taken up a hostile attitude to the Emperor, thereby causing him much mischief and trouble. For that reason Barbarossa determined to crush them by all means in his power (so far at all events as the German Empire was concerned), and he contemplated the foundation of a similar organization of a purely German and national character, which he hoped would prove a faithful and reliable ally in his and his successors' far-reaching policy. However, as in so many other things, he failed in this favourite project. He died before the execution of the scheme, and it fell to the lot of his son, the Duke of Suabia, as has been mentioned above, to carry on his policy.

The idea of converting the association of the Hospitallers of St. Mary into a Knightly organization gained at once the full approval of the Duke, who energetically carried it into execution even before the walls of Acre. This was done in the month of November, 1190. Thus "The Order of the Teutonic Knights" or "Knights of the Teutonic Hospital of St. Mary of Jerusalem" sprang into being. The Duke moreover induced the Pope to issue a *breve* (in February, 1191) by which the Order was also confirmed as an Ecclesiastical Order. Soon after the foundation of this new Order of Chivalry, the noble Duke's career was cut short. He died in the flower of his life, another victim of the pestilence raging in the camp of the Crusaders.

The new Order of the Teutonic Knights added to their primary object of ministering to the poor and sick, that of protecting the Holy Land against the Infidels and spreading the Christian faith "by Cross and Sword." Their first Master was HEINRICH WALPOT VON BASSENHEIM. On the recapture of Acre by the Christians, a castle, including a Convent, a Hospital, and a Church dedicated to the Holy Virgin, was erected there by the Teutonic Knights and this became the first headquarters of the Order. Briefly it was called "The Teutonic House" (*Das Deutsche Haus*) and in after times all convents of the Order wherever erected took the same appellation. The Holy

Virgin was the patron saint of the Order, and the Knights considered themselves as soldiers in her special service. Hence they called themselves "Knights of St. Mary" or "Knights of the Holy Virgin Mary and Brethren of the Teutonic House of our dear Lady at Jerusalem" (although the headquarters were at Acre). Also "Brethren of the Teutonic Hospital," "Hospitallers of our dear Lady of the Teutons," or more briefly "Knights of Mary" (*Marien-Ritter*, *Marianische Ritter*) or even "Marians" (*Marianer*) and "Teutonic Knights" (*Deutsche Ritter*), "Teutonic Gentlemen" (*Deutsche Herrn*), "Crossbearers" (*Kreuzherrn*) in Latin "*Equites crucigeri Ordinis Teutonici*," "*Equites Ordinis Sanctæ Mariæ Teutonicorum*" and so on.

Although in its evolution the Order up to the time in question much resembled that of the Hospitallers of St. John, it was nevertheless the Order of the Temple which had been taken as the model for the Teutonic Order.

This was shown at once by their assuming a *white mantle* (much to the vexation of the proud Knights Templar who considered the privilege of wearing the white mantle exclusive to their Order), which they adorned with a *black cross*, in distinction to the red cross of the Templars and the white cross (on black mantle) of St. John. Originally there were only two classes amongst them, viz.: (1) Knights, being those of a noble birth, and (2) Hospitallers devoted to the service of the sick. Some years after the foundation we find that priests were attached to the Order, forming a third class. They were *secular* priests and not *monks*. In 1221 a fourth class was added to the Order, namely, half-brethren, corresponding not only to the *Servientes* but also to the *donates* and *oblates* of the two other Knightly Orders. In course of time we find even Princes and Kings coveting the honour of being admitted to the benefices of the Order as half-brethren. All members, however, were to be freeborn, honest men and of German blood. Thus we see that the Teutonic Order was a distinctly national organization, whilst we know that the Knights of the Temple as well as the Knights of St. John were cosmopolitan, receiving into their ranks sons of nearly all Christian nations. The Teutonic Order rapidly advanced in wealth and fame. It acquired large estates not only in the Holy Land and in various parts of Upper and Lower Germany but also in Italy, the Netherlands, and for a very short time in Hungary. From the thirteenth century there was a special Provincial Master of Germany residing at Frankfort on the Main, and also one for Italy.

The fourth Master of the Order, the active and energetic HERMANN VON SALZA (1210-39) obtained for himself, and his successors in office, the rank and privileges of a Prince of the Holy Roman Empire, and the title of "Grand" or "Great" Master (in the German language, "*Hochmeister*," literally "High Master.")<sup>1</sup> In the year 1215 the Emperor and the Pope granted to the Order the same standing and privileges as had been enjoyed by the Orders of the Temple and St. John. All this was chiefly due to the goodwill and protection of Frederick II., the grandson of Frederick Barbarossa, and the greatest emperor of the House of HOHENSTAUFEN, who proved a mighty protector and well-wisher of the Teutonic Knights. As a special mark of his favour the Emperor granted the Order the right of placing an escutcheon, *or*, with the *then single-headed imperial eagle, sable*, in the centre of the Arms of the Order, which were:—a shield, *argent*, with a plain cross, *sable*. King John, of Jerusalem, better known as John de Brienne, bestowed on the Order a heraldic distinction in the shape of a cross, *argent*, (some authorities say a cross, *or*), charging the cross *sable* in the shield of the Order,

<sup>1</sup> It will be convenient if in future I translate the title "*Hochmeister*" as "*Great Master*," in distinction to the *Grand* Masters of the other Chivalric Orders, which in German are called "*Grossmeister*." The distinction is important for one historical reason, as we shall see hereafter.

and King Louis IX. of France permitted them to adorn the four points of the cross, *argent* (or *or*) just mentioned, with the French fleur-de-lys, *or*. It must be noted, however, that the *full arms of the Order* and crosses with all the distinctions just described, were and are worn by the *Great Masters only*, whilst all other Knights wore and wear only the simple black cross *patée*, similar in shape to the Templar cross.

It was also under the rule of the Great Master Hermann von Salza that the foundation of the future greatness and glory of the Order was laid. This came about in the following manner:—

A petty Polish Prince, Conrad, Duke of Masovia, being troubled by repeated incursions into his territory by the heathen Prussians, a Slavonic tribe, solicited in his distress the aid of the Teutonic Order against this enemy. This was in the year 1226. He promised the Order, as a reward, the grant of a small tract of land, the so-called Culmer-land. This may at first sight seem a point of but little significance, but in course of time it proved an historical event of the utmost importance, being the first step towards the formation of the state of Prussia, and the powerful influence of the House of the Hohenzollerns, which has in our days led to the re-establishment of the German Empire.

To return to Conrad of Masovia. The Great Master of the Teutonic Order readily granted his request and sent the valiant warrior, Hermann Balk, as Provincial Master with other Knights to the North, 1230. First of all the Teutonic Knights settled a great number of Germans in the country thus won by them, namely *nobles*, to whom the land was parcelled out according to the Feudal system then in vogue, as well as *traders*, *artisans*, and *peasants*. The Order founded towns and raised a number of fortified castles, amongst them the famous and magnificent castle Marienburg, on the banks of the Nogat, about the year 1280.

Then the Teutonic Knights united with the Order of the Sword-bearers of Livonia, 1237, and by this powerful combination commenced a war of extermination against the heathen Prussians. This being considered a Crusade, they were joined by great numbers of Crusaders, coming from all countries of Europe. Omitting details I simply state the result. After bloody wars lasting over fifty years the Order gained what it fought for. *All Prussia was conquered*. The heathen Prussians who had valiantly defended themselves were for the most part exterminated, some left for ever the land of their forefathers, while others remained and submitted to the Teutonic Order, after having been Christianised and Germanised; in a word they disappeared as a nation, and their country was by the efforts of the Order won for Christian and German civilization. The Order claimed and maintained full sovereignty over the territory gained by their arms. It was governed by Provincial Masters who had taken up their residence at the Marienburg. These Masters of Prussia must not, however, be confounded with the Provincial Master of Germany residing at Frankfort, as already mentioned.

It must be borne in mind that whilst these scenes were going on in Prussia, the Great Master of the Order had his headquarters at Acre, and that the wars between the Christians and Moslems continued in the Holy Land. But the end of the Crusades drew near. The infidels laid siege to Acre, the last bulwark of Christianity, which during a long and embittered siege was manfully defended by the Crusaders. The Teutonic Knights fighting side by side with the Knights of the Temple and St. John performed marvellous acts of bravery, but all in vain. No succour from Europe came to their deliverance, and finally the remnant of Christian warriors was compelled to surrender Acre in the year 1291. The Crescent had overcome the Cross, and the

followers of Christ evacuated Palestine for the possession of which streams of blood had been shed during nearly two hundred years. The Crusades had come to an end. The chief object had ultimately proved a failure. The Christian power in the East was finally broken.

Having left their headquarters and lost the Holy Land for ever, the Great Master of the Teutonic Order with his staff sought and found a temporary retreat in Italy, where he took up his residence at Venice, and in fact all the Christian Orders had to look for new fields for their activity. As is well known, the Knights Templar went first to Cyprus and then to France with proud hopes which, however, were soon turned to shame, as instead of the dreamed-of greatness, a sudden and unexpected downfall was to befall them there. The Knights of St. John repaired to Cyprus, then to Rhodes, then, after a longer lapse of time, to Candia and finally to Malta. As for the Teutonic Knights, their position was the most favourable amongst the three Knightly Orders. What the Templars vainly dreamed of, what the Knights of St. John were only to obtain long afterwards, the Teutonic Order was already in possession of, namely a large territory, comprising over 3,000 German square miles, 55 towns, 20,000 villages, 48 fortified castles, and 2,000 manors, held in uncontested sovereignty, and which the Knights were eager to maintain so as to keep up a distinguished position amongst Sovereign princes and countries.

Prussia and the adjacent countries were before them, a free and open field for their future labours. Thus it was but natural that the Great Master SIEGFRIED VON FEUCHTWANGEN left Venice, repaired to Prussia, and took up his residence at the Marienburg Castle, which thenceforward became the headquarters of the Order. This was in 1309.

During the fourteenth century the Order had to contend with the Lithuanians, who frequently invaded the territory of the Order. They being pagans, like the exterminated Prussians, the Order caused Crusades to be preached against them, and with the aid of great numbers of foreign Crusaders succeeded to some extent in mastering them.

The second half of the fourteenth century and particularly the period of the Great Mastership of WINRICH VON KNIPRODE (Knieprode 1351-1382) marks the flourishing period of the Order. He was the greatest of the Masters of the Teutonic Knights, and not only a great warrior, but also a first-class statesman and ruler. He defeated the Lithuanian princes in the famous battle of Rudau in 1370 and forced them to keep peace. Then he set to work to arrange the internal affairs of the country. He fixed the rights and liberties of the various classes of the inhabitants, more especially of the nobility, and of the burghers of the towns and cities where industry and commerce developed to such an extent that many cities and towns joined the powerful Hanseatic confederation. Agriculture was also promoted by the draining of vast tracts of marsh land, whereby much fertile soil was won for cultivation. Education was also promoted by the establishment of schools in every village, and two high schools were founded at Marienburg and Königsberg. Good roads were laid out and measures taken to ensure the free passage of traffic. The whole country enjoyed the blessings of a wealthy, prosperous and well-governed state. It throws an interesting light on the favourable state of the country of the Teutonic Order that whilst traffic was endangered and stopped in Germany by robber knights and highwaymen, Prussia could at the same period be traversed without harm or hindrance. Such was the state of things during the Great Mastership of Winrich von Knieprode. Soon after his death, however, there came a change for the worse, and the period of decay set in. Strange to say this was caused by a marriage of great political importance. The



prince of Lithuania, by name Jagello, solicited the hand of Hedwig the Christian heiress of the realm of Poland, who accepted his suit on condition that Jagello and all his people should embrace the religion of Christ. This was peacefully effected. Poland and Lithuania became by the marriage of their rulers united for ever, in the year 1386, but the event proved fatal for the Teutonic Order, as the wars the Order had hitherto waged with the Lithvians as long as they had been pagans were now deprived of their religious character, and in consequence the wanderings of the Crusaders who had come in crowds to the assistance of the Order, came to an end. Once more the Order which had fought for the spread of Christianity and Christian civilization, had outlived itself and lost its religious right of existence. The Order thus stood quite alone and was reduced to its own unaided strength. It was obliged to keep an army of hired soldiers and provide for their payment, and the inhabitants were ground down by heavy taxes and impositions. The rule of the Order, which had been very mild, became more and more rigorous and violent. This soon led to internal troubles and dissensions, particularly among the nobles (chief-tenants of the Order) and the rich burghers of the towns, and finally culminated in open revolts, the state of affairs being accelerated by another evil from within. Ever since the Great Masters had transferred their residence to Prussia they were eager to change the aristocratic constitution of the Order into that of an absolute and military monarchy. Their constant endeavour was to reduce and weaken the rights of the Knights and to strengthen and increase the power of the Great Master, whom they wished to have a right to claim unconditional obedience from all members of the Order, he himself being responsible to none. It is but natural that this endeavour of the Great Masters created much disgust in the very heart of the Order which was split into factions and divided into various contending parties. The assassination of the Great Master WERNER VON ORSELEN, which took place in the year 1330, was one of the results of the internal discords. On the other hand the inhabitants who had enjoyed self-government being now deprived of their privileges and loaded with heavy tributes, demanded with ever-increasing firmness a share in the government of the country, which was as continually and obstinately refused by the proud heads of the Order. Then too the hired soldiers became mutinous for want of pay. Thus a general confusion and discontent prevailed in the country inside as well as outside the Order. The nobles (that is to say, the chief-tenants of the Order) formed a league under the quaint appellation of the Society of the Lizard (der Eidechsenbund) in defence of their rights and liberties, A.D. 1397.

They applied for assistance to the King of Poland which was most willingly promised, as Poland had long watched for an opportunity to interfere with the affairs of the neighbouring state of the Order. Having secured the aid of Poland, the Society of the Lizard at once took up arms against the Teutonic Knights, on whom they looked with scorn as foreign beggarly nobles who had come to Prussia to plunder and suck the country. Thus the Order was compelled to act on the defensive. In the bloody battle of Tannenberg, 1410, it suffered a total defeat. The Great Master ULRICH VON JUNGINGEN with the flower of the Order perished on the field, and many of the Knights were taken prisoners. This battle sealed the fate of the Order which never again recovered from such a decisive blow. The fortresses and castles were one by one taken by the Polish troops. The towns joyfully opened their gates and freely did homage to the king of Poland. It seemed that the last hour of the Order had struck. But at this juncture there arose a man who was destined to save it from total annihilation. This was the Commander HEINRICH REUSS VON PLAUEN who with a small band of faithful followers threw himself into the Marienburg which he valiantly held with

great spirit against the troops of the king of Poland, who after two months was compelled to raise the siege. By the first treaty of Thorn concluded 1411, the whole territory was restored to the Order. The valiant Plauen had meantime been elected Great Master, but even he was unable to prevent the downfall which was but a question of time. The Order was doomed. The nobles and towns had hoped in vain to acquire political rights so as to enable them to take an active part in the government of the country. They therefore entered into a covenant called the Prussian confederation in the year 1440. Later on, they formally renounced in a solemn document their allegiance to the Teutonic Order, and elected the King of Poland sovereign of the country, who accordingly declared war against the Teutonic Knights. In this war which lasted 13 years (from 1453 to 1466), the Order was step by step practically stripped of all its territory. In the year 1457 the then Great Master LUDWIG von ERLICHSHAUSEN was compelled to leave the castle of Marienburg which for 148 years had been the proud residence of 17 Teutonic Great Masters. The seat of the Great Master was removed to Königsberg. Lastly in the year 1466 the Order was compelled to obtain a shameful peace by the *second* treaty of Thorn. By its terms they were obliged to resign all West Prussia to Poland and to retain East Prussia as a fief of the Polish kings.

Still the Order hoped to regain the lost lands, and with a view to this end members of the ruling house of Germany were elected Great Masters. Thus in 1498, the Margrave FREDERICK OF MEISSEN became Great Master, and on his death in 1511 the Margrave ALBRECHT VON BRANDENBURG-ANSPACH. It was quite natural that the Order which so unwillingly bore the Polish yoke, should be slow in the fulfilment of its duties to the king of Poland as its liege lord, and it was oftentimes most persistent in its refusals. Thus the wars between Poland and the Order were constantly renewed, and carried on with varying success, till they came to a very unexpected and definite conclusion, which was really the cutting of a Gordian knot.

First, the Crown of Poland declared that the rights of the Teutonic Order to East Prussia were forfeited by reason of the reiterated refusals of obedience to the Polish Crown, and East Prussia was created a secular dukedom. Next, the Great Master Albrecht von Brandenburg surprised the world by embracing the Evangelical religion, and was then invested with East Prussia as hereditary fief by the Roman Catholic King of Poland, who by the way was a near relative of his. This was in 1525. Next year Albrecht, now Duke of Prussia, married a Danish princess. Many of the Knights of the Teutonic Order followed the example of their former Great Master. They became Protestants, obtained fiefs out of the territory formerly belonging to the Order, and founded families. Thus the Teutonic Order for ever lost all these vast territories which its members had conquered and won to Christianity with sword in hand and through streams of blood. As in Palestine, so here, all their efforts had turned out failures, and in like manner they were obliged to evacuate the territory which their predecessors had conquered. A small number of the Teutonic knights remaining faithful to their vows and to the faith of their forefathers protested against the above proceeding, but as they could do nothing more they left the country where they had become merely foreigners. They repaired to Germany, where as will be remembered there was a Provincial Master, at this time Dietrich von Clee. On his death Walther von Kronberg was elected his successor. The Provincial Masters of Germany or "German Masters" (*Landmeister von Deutschland*, briefly *Deutschmeister*) had in the internal troubles of the Order always been at the head of the conservative party which strongly opposed the curtailment of the rights of the Knights, and the increase

of the monarchical power of the Great Masters as projected by the latter. Through a long period in the history of the Order the Great Master and the Provincial Master of Germany were natural opponents, leaders of two hostile parties, representatives of opposite principles, the one striving for an absolute monarchy, and the other for a constitutional aristocracy. At this time, however, the Order had lost the greater part of its possessions outside of Germany, and the dignity of a Provincial Master of Italy (*Landmeister in den wälschen Landen*) having ceased to exist in the fifteenth century, it seemed convenient to combine the greatest dignities of the Order in one person. Thus the Deutschmeister WALTER VON KRONBERG was elected Administrator of the Great Mastership, and was confirmed by the Emperor Charles V. in the year 1527 as "Administrator of the Great Mastership in Prussia and Master of the Teutonic Order in the German and Italian countries." Three years later the Emperor invested Walter with Prussia at the memorable Imperial Diet at Augsburg, 1530, thereby declaring that Prussia belonged of *right (de jure)* to the Teutonic Knights, in spite of the fact that the Order had already resigned West Prussia to Poland, received East Prussia as a fief of Poland, and forfeited its rights thereto by disobedience. But inasmuch as the Emperor was not able more effectually to assist the Order in making good the claim, it remained but a virtual right. Walter von Kronberg resided at *Mergentheim* in Franconia (now belonging to Würtemberg), which continued to be the centre and headquarters of the Order during the succeeding centuries. Walter's successors in office retained the long title I have mentioned, which was occasionally abbreviated to "Hoch- und Deutschmeister." The Order hoped to regain Prussia, but in vain. The Duke Albrecht, although excommunicated by the Church and outlawed by the Empire, retained possession of the country. He was succeeded by a son who left no male heir, and in consequence the *dukedom* of Prussia or *East Prussia* came to the electoral line of the House of Brandenburg, 1618. In the year 1660 Poland resigned her suzerainty, and Prussia became an independent and sovereign dukedom, and in the year 1701 was made a kingdom, the electors of Brandenburg being thenceforward better known in history as kings of Prussia. The further destinies of Prussia belong to universal history and form no part of the present sketch. As for West Prussia with the Marienburg, it remained a part of Poland until the first division of that country in 1772, when it was reunited with the former East Prussia, then the kingdom of Prussia.

Before continuing our narrative I must make a remark which may interest readers who are fond of heraldry, and strange to say, is of importance from a Masonic point of view. It has been stated that the Emperor Frederick II., in the thirteenth century, had granted to the Order the privilege of wearing the *single-headed* imperial eagle, which continued in use from that time.

Now when Albrecht von Brandenburg made himself Duke of Prussia, he adopted (or rather retained) this single-headed black eagle, which he placed on a silver (*argent*) shield as the arms of the new dukedom. He retained also the colours of the Teutonic Order, black and white, as the colours of Prussia. Perhaps this was the reason why he changed the gold shield of the Great Masters into a silver one, to make the tinctures of the arms (*sable* and *argent*) correspond with the above colours (black and white). Others maintain that being but a feudatory and not a sovereign duke he was not entitled to wear a golden shield, but only a silver one. When Prussia was raised to a kingdom the single headed eagle was royally crowned and had added to it a sceptre and orb in the claws and thus it has remained ever since. It should be noted that the royal Prussian single-headed black (*sable*) eagle on a shield *argent* is not to be confounded with the single-headed red (*gules*) eagle of Brandenburg also on a shield *argent*, nor with the

single-headed Imperial eagle of the present German Empire having the claws empty, on a shield, *or*, with the Imperial crown over its head.

To return to the Prussian single-headed eagle, it was borne by all kings of Prussia, including Frederick the Great. Neither he nor any other king of Prussia ever bore a double-headed eagle, nor was the Prussian eagle white. It is an idle tale that the double-headed eagle used in the A. and A. Rite is commemorative of the arms of Frederick the Great, who in reality was *not* the founder of that rite, nor of the 33rd degree. This *heraldic* blunder alone is sufficient to prove that the whole tale of the foundation of the 33rd degree by King Frederick the Great of Prussia has no real historical foundation, but is an invention of persons, who, to say the least, were very bad historians, were not even clever inventors, and had but little knowledge of heraldry.

Another *historical* blunder has been perpetrated in the Rituals of a certain degree of the A. and A. Rite. There a crusade is projected by Frederick II., called the Great, of Prussia, who lived in the eighteenth century, was a Protestant and a free-thinker, and who most likely would have laughed at the idea of undertaking a crusade. Perhaps the inventors of that degree confounded Frederick II., king of Prussia, with the Emperor Frederick II. of the house of Hohenstaufen, who lived in the thirteenth century, and who really was a Crusader. It seems that the inventors of certain degrees knew little and cared less for the history of Germany, and heraldry. Of course I do not suggest that the degrees in themselves are valueless in other respects. I must add that I know very well that the double-headed eagle is a symbol of very ancient origin, but it has nothing whatever to do with Frederick the Great, nor with Prussia, where the A. and A. Rite was never in existence. Had Frederick the Great really been the founder of the 33rd degree, it would be most astonishing to find the A. and A. Rite everywhere outside of Prussia and Germany, but not existing either in Prussia or other German countries. The obvious reason is that the assertion of the foundation of the 33rd degree by Frederick the Great is entirely unwarranted.

To return to the Teutonic Order in the sixteenth century. It soon had, quite apart from Prussia, to suffer another heavy loss. The possessions of the Order formed twelve bailliwicks, the twelfth of which, called the Bailliwick of Utrecht, had its property in a part of the Netherlands. As I mentioned in my introduction, the whole bailliwick of Utrecht embraced the reformed religion in the year 1537, but at the same time the members maintained and preserved the Order as one of secular Protestant knights. The official communications with the Roman Catholic headquarters at Mergentheim were finally broken off in 1619, but the Dutch branch continued to exist under the protection of the state.

As I have already hinted this affords an interesting instance of a branch of a half-chivalric, half-monastic Order which had originally been Roman Catholic becoming Protestant and secular, and continuing to exist after having been severed from, and ceasing intercourse with, the Roman Catholic centre. This is *mutatis mutandis*, an interesting and important analogy for the possible preservation of the Scottish combined Orders of the Temple and St. John after the secularization of its estates in the sixteenth century, just as the proceedings of Albrecht of Brandenburg bear some likeness to those of Sir James Sandilands, at Torpichen, and those of the faithful Teutonic Knights repairing to Germany to David Seton's Chapter. What was possible in the case of the Dutch bailliwick of the Teutonic Order (*i.e.* the preservation of the Order as an independent Protestant chivalric society, without any connection with the Official Centre which had remained Roman Catholic and ecclesiastic), was certainly possible in Scotland and England.

The Teutonic Order continued to exist in Germany on the original basis, and even after the loss of the Netherlands, or rather the twelfth bailliwick, its possessions were still very considerable, the whole territory covering forty German square miles, with a population of about 90,000 souls. This territory formed eleven bailliwicks, as follows:—(1) Alsace and Burgundy, (2) Austria, (3) Of the River Thees (Etsch) and Tyrole, (4) Of Coblenz on the Rhine, (5) Franconia with the Seat of the Great Master at Mergentheim, (6) Of Biessen, or Alten-Bisen (Vieux Joncs) near Maestricht in Brabant, (7) Westphalia, (8) Lorraine, which were all exclusively Roman Catholic, (9) Hussia, (10) Thuringia, and (11) Saxony, which three bailliwicks consisted mostly of Knights professing the Evangelical faith. Though Protestants, and permitted to marry, they were fully recognised by the Roman Catholic Centre and bailliwicks, and on their part they recognised the authority of the Hoch-und Deutschmeister, and sent representatives to the Chapters of the Order, in the same manner as the Roman Catholic bailliwicks. The bailliwicks were at this period governed by *Provincial Commanders* (*Land-Comthure*) and were divided into a number of Commanderies governed by *Commanders* (*Comthure*).

Little remains to be said about the external destinies of the Order. It enjoyed great political rights and privileges in the German Empire. The Hoch-und Deutschmeister was a Prince of the H.R.E., and even several provincial commanders had seats and voted in the Imperial Diet. Amongst the Great Masters succeeding Walter von Kronberg, we meet with scions of the most ancient and proudest princely houses of Germany. From the end of the sixteenth century we several times find Archdukes of Austria amongst the Teutonic Great Masters. But in spite of its high and exalted position and its riches the Order was doomed, and it never again played an important part in history.

It continued to lead a splendid but not very active life until the beginning of the nineteenth century, when the Napoleonic wars sealed its fate as they sealed that of the Order of Malta. Long had the estates of the Order been an eyesore to the German Princes in whose territory they were situated. With the assistance of the Emperor Napoleon they contrived to take possession of the greater part of them. All the territory on the left bank of the Rhine was by the terms of the treaty of Luneville, 1801, ceded to France, and in consequence the respective princes as well as the Teutonic Order who thus lost their territories, were indemnified by secularised estates elsewhere. The Teutonic Order also obtained a number of secularised chapters, abbeys and monasteries as indemnity, in the year 1803.

Of signal importance to the Order however was the treaty of Pressbourg (Posonium) concluded in 1805, which practically put an end to its independence. By the terms of that treaty Francis (then Roman-German Emperor as well as self-created "*Emperor of Austria*," ) was invested with the right to appoint some prince of the Austrian house to the head of the Teutonic Order, which dignity was to be made hereditary in the direct male line of the same prince. As will be seen however the latter condition was never carried into effect. This Austrian prince was also to enjoy the revenues of the estates of the Order. Accordingly the Emperor Francis appointed his brother the ARCHDUKE ANTHONY VICTOR to be *Grand Master* of the Teutonic Order and invested him with Mergentheim as a *secular* and *hereditary* principality. It is obvious that by this measure great changes took place within the Order. It was deprived of sovereignty and independence, as instead of the free election of the Great Master which had until then prevailed, the chief dignity of the Order was made hereditary in the house of Austria, and became a sinecure for a younger prince of that house and his

descendants. This was quite a new creation, and it effected an interruption in the line of the *freely elected Hoch-und Deutschmeisters*. That this was so, was felt even by the Emperor, who accordingly bestowed upon the Archduke Anthony a *new* title, namely that of *Grand Master (Grossmeister)*, quite unknown and unheard of in the history of the Teutonic Order, instead of the time-honoured title of *Hoch-und Deutschmeister*. This was done in the year 1806.

Finally in 1809 at Ratisbonne the Teutonic Order was, chiefly by the efforts of Napoleon, totally and formally *abolished*. The rest of its estates were given up to the princes in whose respective territories they were situated. They had long been eager to seize them, and that they were now successful was entirely due to the powerful will of the French Cæsar. The estates in Austria and Tyrole devolved upon the Emperor Francis. He bestowed them upon the Archduke Anthony, now "*Grand Master of the Teutonic Order in Austria*," who enjoyed the revenues until his death, in 1835.

By this decision arrived at at Ratisbonne in 1809, the Order ceased to exist, *de facto et de jure*. *This was the real end of the Order.*

The Protestant bailliwick of Utrecht was similarly abolished by Napoleon in 1811. It was however revived soon after, in 1815, when it was re-established by William I., king of the Netherlands. It was reorganized in 1827, and has been in existence ever since. Hence it is a *direct descendant* of the Old Order. The King is the Grand Master of the Order which consists of a Grand Commander, 10 Commanders, and a body of Knights. They have to prove nobility for 200 years, and have possession of the revenues of the bailliwick. There are also "*expectants*" of the Order who are subject to the same proofs of ancestry, and are bound to pay a fee of honour (760 florins) to the Order whereby they obtain the right of promotion to the rank of Knight in due course.

In Austria, however, there was an interval of about thirty years. In 1834-5 the old Order was re-established in principle and the old Statutes confirmed by the Emperor Francis. In 1839-40 new Statutes were drawn up which in 1840 were confirmed by the Emperor Ferdinand, who meantime had succeeded his father. By these new Statutes the Order received a new organization in Austria, and was thereby declared to be an independent chivalric and ecclesiastical institution directly subject to the Emperor of Austria. The time-honoured title of *Hoch-und Deutschmeister* was also *revived*, and it was enacted that a member of the ruling house of Austria was to join the Order as a professed knight (hence he was to remain unmarried) and was to be *formally elected* as "*Hoch-und Deutschmeister*" for life, the election being however subject to imperial confirmation. This is only another form of Imperial *appointment*. Another *younger* imperial and royal Prince was also to join the Order and be elected coadjutor of the Great Master (*cum jure successionis*).

On the death of the Archduke Anthony, the ARCHDUKE MAXIMILIAN JOSEPH was "*elected*" Great Master, 1835. He died in 1863. Then ARCHDUKE WILLIAM was elected. During his Great Mastership considerable alterations were made in the organization of the Order, especially during the years 1865 and 1871. In 1886 a Papal *breve* was issued making important innovations with respect to the Order. We shall refer to these again in the course of the paper. On the death of the Archduke William, in the year 1894, his nephew, the Coadjutor ARCHDUKE EUGENE became *Hoch-und Deutschmeister*, and he still holds the position.

It may be mentioned incidentally that the modern Austrian branch of the Teutonic Order has since its establishment, in 1840, down to the present time done good and charitable work in the interest of suffering mankind. It has founded and maintained hospitals for the sick and poor, nunneries for the gratuitous instruction of poor girls,

and other excellent charities. In 1875 it organized a voluntary sanitary service in case of war, and it has also, in conjunction with the Order of St. John, done signal service to humanity, by tending the wounded in nearly every war which has since been waged in the East of Europe.

With this I close my sketch of the history of the Teutonic Order, and before going further and giving details in regard to its organization and its old Rituals, I must make a few remarks which from various points of view, especially from a Templar standpoint, I believe to be of importance.

I am neither an Austrian, nor a German, nor a Roman Catholic, and therefore I am able quite impartially and without prejudice to consider the whole question, and I believe every impartial student if reviewing the important events which took place in the history of the Order in the nineteenth century, will agree with me that from a strictly *historical and legal* point of view the branch at present existing in Austria *cannot* be considered a *real continuation* of the Order, which was officially abolished in 1809, nor the Austrian *Hoch-und Deutschmeisters* created after 1835, the real successors of those whose line came to an end in 1804, 1809, or even let us say 1835. The Austrian branch is from every point of view a *new creation*, being, at best, linked to the old Order by very slender threads.

I must refer to two different opinions on the subject, viz.:—(1) *German (not Austrian)* writers generally close the history of the Order at the official abolition in 1809. In their opinion the reorganized branch of Austria is a *new* institution, a representation or imitation of the old Order, but *not* the real one nor even its direct continuation. I believe this view to be perfectly correct, and I consider that the Germans are the best judges of this *their* national Order of Chivalry, of its history, and of all matters connected with it. (2) *Austrian* writers on the contrary, in giving the history of the old Teutonic Order, *pass silently over the official abolition in 1809*. Some it is true briefly mention it, others do not even say a word on the subject, but on the other hand claim to establish an uninterrupted line of the *Hoch-und Deutschmeisters*, from Walter von Kronberg down to their time. The interval of 1805-1809 to 1835-1840 is simply ignored. They only mention the Archduke Anthony as the eighteenth *Hoch-und Deutschmeister* (and not as "Grand Master"—*Grossmeister*) reigning from 1804 (not 1805) to 1835, *as if nothing extraordinary or remarkable happened during this most important period*, and by so ignoring this fatal gap they simply continue the line as follows:—Nineteenth *Hoch-und Deutschmeister*, the Archduke Maximilian, 1835-63, twentieth *Hoch-und Deutschmeister*, the Archduke William, 1863-94, twenty-first *Hoch-und Deutschmeister*, the Archduke Eugene. Of course on paper all this looks most simple and incontestible. Then the Austrian official and semi-official sources merely state that the Order was reorganized in 1839-40, but they pass over in silence the most important point, namely, how and by whom this reorganization was effected. It is of course of the very greatest importance to know who formed the reorganized Order. Were they Knights regularly professed and created according to the regulations of the old Order? One is curious to know whether in 1839-40 there were still alive Knights of the Teutonic Order created prior to 1809, and if so whether it was *they* who formed the stock of the revived Austrian branch? If so, how many of the old regularly created Knights joined the new Order? Did they form a legal "quorum"? And after the abolition of 1809 were they entitled to represent the old but abolished Order and to act *in its name and on its behalf* and to claim for a *new* institution, called into life by an Imperial edict, the right of being considered the lineal descendants of the Old Order, and if they did so *upon what authority* they acted?

The whole point as to whether the present Order is actually the continuation of the old one hinges upon all these questions, which are and must be left open for discussion. But on these the Austrian sources and authors so far as they are generally accessible are absolutely silent, and every serious and honest historian or man of law will consider such silence significant and characteristic.

That the Teutonic Order in Austria succeeded in securing the archives of the old Order; that they drew up new statutes on the basis of the old ones; that they assumed the time-honoured clothing and crosses; and adopted the ancient rituals of the old Order, weigh but little in the scale of historical truth.

It is not my object to enter into further details on the question, but as will be seen hereafter, it is important to state the facts.

I may add that nearly the same is applicable to the question of the continuation of the Roman Catholic Order of St. John. When some writers claim that this Order ceased to exist after the loss of the island of Malta and the death of the Grand Master Hompesch, they are in some respects and to some extent correct. The election of the Emperor Paul of Russia as Grand Master by a small number of Knights was quite irregular and illegal. The legality of the succeeding Grand Masters who could not be elected by a lawful representation of the Order and who were *appointed by the Pope*, is, to say the least, disputable, and so also is that of the succeeding Lieutenants of Grand Mastership, elected *by the Council* of the Order. Then came the re-establishment of the Grand-Mastership by a Papal *breve*, and an edict of the Emperor of Austria.

The same may also be said in reference to different branches of the Order of St. John, whether Protestant or Roman Catholic, which after the abolition of the old Order and confiscation of its estates were often after long lapses of time re-established by the respective sovereigns and so obtained royal recognition. I have shewn elsewhere that the Protestant branch of Johannite Knights of Prussia is a new Royal institution and has no direct connection with the old Bailliwick of Brandenburg.

In Spain the Order of St. John was likewise made a Royal Order, the Knights being appointed by the King, who had made himself its chief. The ancient chivalric Orders of Alcantara, Calatrava, St. Iago de Compostella and Monteza in Spain, and those of Christ (the continuation of the Templars), and of Avis in Portugal, became secularized, and their estates were confiscated. The Grand Mastership of the Orders was vested in the Crown, and in consequence these once proud Orders descended in course of time to the low level of simple Royal Orders of decoration, some being bestowed upon *non-Christians*. In all these cases one may reasonably ask whether the Orders, having made such essential modifications, are in fact the actual Orders whose *names* and *insignia* they have taken?

If one carefully follows up the different phases of evolution in connection with the re-establishment of Ancient Orders of chivalry, one may and indeed ought at each step to ask the question, "*On what authority* was this or that done?" If we take this course we shall see matters in a different light. Thus it is quite clear that the declaration of a pope or sovereign to re-establish such an Order and recognize a new creation as its continuation does not settle the matter, nor does it mean much from a strictly historical or legal standpoint. Not even a royal or papal word is able to give new life to a corpse or a mummy! History teaches us what official abolitions, restorations and recognitions are really worth, as we have just seen in the history of the Teutonic Order, and many other instances might be quoted to the same effect. I will only mention a few remarkable cases which may not be generally known to English readers.



## (1). "APOSTOLIC KING OF HUNGARY."

As an historical fact, the Hungarian kings from A.D. 1000 down to the middle of the eighteenth century never officially used the title of "Apostolic Kings." Unofficially however, the term was sometimes used, and this appellation was traditionally based upon a *pretended* bull of Pope Sylvester II., issued A.D. 1000, when this Pope sent a royal crown to Stephen, the first Christian King of Hungary (afterwards canonized). The original of the papal bull in question has *not* been preserved, but the wording of it was (or is said to have been) discovered and produced and reproduced *long afterwards* (say the sixteenth or seventeenth century). But even such wording does not contain any mention of the title of Apostolic King, much less its being conferred upon Stephen and his successors. Perhaps this may be considered by some an argument in favour of its authenticity. According to the text in question the Pope states in terms of praise that Stephen has performed Apostolic work in preaching Christ, and converting the heathen Hungarian people to Christianity.

For that reason the Pope transfers his (the Pope's) *Apostolic* rights with respect to the Church in Hungary upon Stephen and his successors who are to be crowned with the crown sent by the Pope. As an outward sign, Stephen and his successors were granted the right of having carried before them "the cross, the sign of Apostleship" (*crucem, Apostolatus insigne*). So much for the wording of the bull. Supposing it to be genuine, the inference seems logical that the Kings of Hungary by virtue of their Apostolic rights, which they continually exercised and carefully maintained against Papal pretensions, were incidentally and unofficially called "Apostolic Kings," although the bull does not confer such title *expressis verbis*, and although the Hungarian kings did not use the title officially in any documents or privileges which they issued. Finally, Queen Maria Theresa (also *Roman* Empress) expressed (*optimâ fide*) the desire to have the title confirmed, and accordingly Pope Clement XIII. solemnly confirmed, A.D. 1758, by virtue of the bull of Sylvester, the title of "Apostolic King of Hungary" for her and her successors on the Hungarian throne, and *since that date only* the Apostolic title has been and is *officially* used by the Kings of Hungary and the countries of the crown of St. Stephen.

But now comes the point of my argument. Recent researches have made it probable, or at least possible, that the wording produced was a clerical fabrication of a much later date, not older than the fifteenth, or possibly even the sixteenth or seventeenth century. It is most likely that Pope Sylvester really issued a bull in the year 1000, when sending a royal crown to Stephen, but it does not follow that it was worded as stated. Hence it may be that the papal confirmation of 1758 was based upon a document which possibly never existed at all, or the wording of which did not exist, or at all events of which no *authentic* copy was in existence, the copy produced being of doubtful authenticity.

On the other hand, however, it must be stated as an historical fact that the Hungarian kings did exercise exceptional rights in ecclesiastical matters, and energetically maintained them at different times against the pretensions of the Holy See. Also the custom of carrying the Apostolic (double) cross before the King was continually and is until now observed from very early times, possibly even from the time of St. Stephen himself. The Apostolic double cross (*argent*) on a shield (*gules*) became also the Royal Arms of Hungary, and combined with other heraldic devices ever formed and still forms an essential part of the arms of the realm.

I may add for the information of those interested in Heraldry, that amongst other Kings the liberal minded and most energetic King Matthias Corvinus successfully

defended the rights of the Hungarian crown (as exercised since St. Stephen) of conferring archbishoprics, bishoprics and other ecclesiastical benefices. In one of his disputes with the Holy See, A.D. 1483, he even threatened to sever from Rome altogether rather than give up the rights of the Hungarian crown and nation. He expressed that intention by using the phrase that he would sooner "triple the double cross of the realm" than consent to the ecclesiastical benefices in Hungary being conferred by the Pope. I will quote the passage at length in its mediæval Latin:—"Pontifex debet scire, quod gens Hungarica crucem illam duplicatam quæ insigne Regni nostri est, velit libentius triplicare, quam in id consentire, quod beneficia et prælaturæ ad jus Coronæ spectantes, unquam a sede apostolicâ conferantur." This was really a noble and regal speech, which secured the desired result. There was no need for carrying out the menace, as the Pope gave in.

#### 2.—THE ROYAL HUNGARIAN ORDER OF ST. STEPHEN.

The above-named Queen Maria Theresa of glorious memory, decided as sovereign of Hungary to found a special Royal Order of Merit. This was done in A.D. 1764, and in order to give it additional splendour the Queen, at its formation, announced that it was intended as a re-establishment of the Order of the Knights of St. Stephen, which had existed in Hungary centuries before. It is noteworthy that the eighteenth century chroniclers, especially the official ones, always call the Order the revived or re-established Order of St. Stephen, whilst modern (even official) sources simply state that the Order was *founded* by Maria Theresa, in the above-mentioned year. This Order is a very high political Order, is very sparingly conferred, and only upon persons of very high social or official position and high merit. Its Grand Cross ranks equally with the highest Orders of foreign states, and hence is conferred upon foreign sovereigns also, His Most Gracious Majesty King Edward VII. being for instance a Grand Cross of the Royal Hungarian Order of St. Stephen.

#### 3.—THE ROYAL BAVARIAN ORDER OF ST. GEORGE.

This is also one of highest distinction. The foundation of this Order by Charles Albert, then Prince Elector of Bavaria, A.D. 1729 (afterwards Charles VII., Roman Emperor) was also declared to be a re-establishment of the old Mediæval chivalric Order of St. George of the fifteenth century, which had been long extinct at the time of the new foundation at the beginning of the eighteenth century. The Order has very interesting ceremonies and Rituals of reception, in full mediæval costume and armour.

#### 4.—ARCHDUKES OF AUSTRIA.

In the fourteenth century a Duke of Austria surprised the world by assuming the quite unique and never heard of title of "Archduke" (Archidux) by virtue of a privilege which was said to have been issued by the Emperor Frederick Barbarossa in favour of Henry (formerly *Margrave*) afterwards created *Duke* of Austria by the same Emperor, A.D. 1156. This document, the so-called *Privilegium Fridericianum Majus* (so termed in distinction to another privilege of Emperor Frederick which is called *Privilegium Fridericianum Minus*) proved to be a forgery of the *fourteenth* century dated back to the twelfth century, but in spite of that the title was maintained, recognized, and afterwards, A.D. 1453, extended to all members, whether male or female, of the Austrian House.

Many other similar instances might be quoted from the histories of the different nations. These few will however at present suffice, and we may therefore return to our original subject.

In summing up what has been said, we arrive at the following conclusions. In nearly every case of re-established and officially recognised Orders the question of legality of succession is doubtful and the historical connection between the old and the new Orders, *if any*, is at the best a loose and disputable one. All in fact rests here upon shifting ground. It is of great importance to impress this especially upon those who may not have a full knowledge of such matters and who easily take the outward appearance for the real thing, and may be imposed upon by statements which seem *rock-founded* if viewed from afar, but which *Fata-Morgana-like* vanish, as one comes nearer to them.

But the points are of greater importance when one has in view the vexed question of the connection of the present British Orders of the Temple and Hospital with those of bygone days. If we critically view the different phases of evolution of a number of Orders, officially abolished, then partly reorganized, re-established, revived, and officially recognised, in fact, patched and glued and pasted together, we shall at once see the question of a possible connection of our Orders with the old Chivalry of the Temple and St. John, in a different and more favourable light. If other Orders have been able to produce—with respect to an uncontested, indisputable, and legitimate descent—so very little evidence which really stands the tests, it is but fair that some indulgence should be extended to our case also. Why call upon *us* to produce *full documentary evidence* for a succession which has never been interrupted, if such evidence is not demanded from, nor produced by other Orders, which often proudly and boastfully pretend to a lawful succession not because they are able to prove it, but only because the all-covering cloak of Royal or Papal recognition has been thrown over them.

The arguments which may be brought forward by us *in favour* of our connection with the old Orders, are really neither worse nor weaker (rather the contrary) than the claims and pretensions of other Orders, chiefly based upon official re-establishment or recognition. I believe we might say much in favour of our descent, not only of greater historical value than all *their* pretended proofs, but which would form a more solid ground than that upon which they stand.

The links which in all probability (and as I believe in all *certainty*) connect us with the mediæval Orders are in many respects much stronger and more valuable than *theirs*. Apart from other matters, I would particularly call attention to our gem, to wit: our old Ritual, a part of which is undoubtedly of most ancient origin, and formed the basis of a mediæval ritual. This for reasons which I shall mention hereafter could not have been invented in later times, nor could it simply have been adopted *en bloc* by a society of much later origin, because it was strictly kept secret by its original authors and owners, never divulged, never written, but handed down orally from one generation to another in legitimate succession. It may be admitted that alterations took place in course of time but this does not affect the point. I can see no probable way, (not even an illegal one) by which such ritual could have been transmitted and come into the possession of a society of, say the seventeenth or eighteenth century, if the latter was not a legitimate or at all events a genuine and real offspring of the former. I cannot see where a fault can be found in this simple chain of thought and fact. I shall refer to the question again, but now I need only state my belief that these rituals are of the greatest historical value, much more so than a heap of documents of doubtful origin and doubtful acquisition. At any rate they form a stronger evidence than the official galvanising of mummies into pretended life or the creation by official declaration of new institutions which may not have any connection with the old ones from which they claim to derive their origin.

In my opinion the proof from these ancient rituals of the connection of old and new Orders is not merely a proof by *deduction*, but rather one by *induction*, as the rituals themselves are in many respects as good evidence as documents. Again, is any one entitled to say that the Cymric tales of Peredwr ab Ewrac, or Wolfram's Parcial (twelfth century) which I shall show in another chapter contain matter connected with our Templar ritual, are not mediæval documents?

I propose in my next paper to give some additional particulars of the organization of the Teutonic Order, and also some information concerning its old rituals which are preserved and practised up to the present day, and are of special interest to every Knight Templar and every Templar student.

(*To be continued.*)

---

NOTE.—A small error crept into the introduction to my paper, *A.Q.C.*, vol. xvii., page 215. Lines 3 and 4 should read "The learned prelate, Kerchelich, who lived in the eighteenth century," etc.

This does not in any way alter the conclusions which I drew from the passage quoted.

L. DE M.



FRIDAY, 4th MAY, 1906.



THE Lodge met at Freemasons' Hall, at 5 p.m. Present—Bros. G. L. Shackles, W.M.; Rev. Canon J. W. Horsley, Gr.Chap., I.P.M.; J. T. Thorp, P.A.G.D.C., S.D. as S.W.; W. Watson, Stew. as J.W.; W. H. Rylands, P.A.G.D.C., Sec.; Dr. W. Wynn Westcott, P.G.D., P.M.; and W. J. Songhurst, Asst. Sec. and Librarian.

Also the following members of the Correspondence Circle—Bros. T. Cohn, P.G.St.B. as I.G.; C. L. Mason, O. H. Bate, P.Dis.G.W., South Africa, E. Div.; A. G. Boswell, G. Robson, W. Wonnacott, H. N. James, A. C. Mead, H. C. Nelthorpe, L. Harding, J. J. Dixon, O. F. Bergann, W. B. Hextall, H. B. Watson, S. Walsh Owen, D. Book, J. W. Dring, J. P. Simpson, G. H. Luetchford, R. G. Hammond, H. Dörvaldt, S. Meymott, E. H. Dring, H. Guy, A. E. Bernays, W. H. Brown, J. A. Richards, R. J. Harrison, J. T. Moar, W. R. Poole, T. E. Shuttleworth, J. G. Ellis, W. S. Boteler, F. Kessler, J. Anley, jun., I. Danielsson, A. E. Krauss, F. R. Heath, Major J. Rose, W. Fisher, F. Mella, A. Simner, P.A.G.D.C.; H. Hyde, and P. R. Simner.

Also the following visitors—Bros. T. Stokes, P.M., Lion and Lamb Lodge No. 192; C. H. Watson, Queen's Westminster Lodge No. 2021; W. A. Todd, Shadwell Clerke Lodge No. 1910; C. F. Hooper, Marine Lodge No. 232; and H. P. Waller, P.M., St. Martin's Lodge No. 2455.

Letters of apology for non-attendance were received from Bros. R. F. Gould, P.G.D.; W. J. Hughan, P.G.D.; H. le Strange, Pr.G.M., Norfolk; G. Greiner, A.G.S.G.C.; J. P. Rylands, E. Macbean, E. Conder, jun., H. Sadler, Gr.Tyler; T. B. Whytehead, P.G.S.B.; Sir Charles Warren, P.G.D.; Admiral Sir A. H. Markham, P.D.G.M., Malta; Dr. W. J. Chetwode Crawley, Gr.Treas, Ireland; L. A. de Malcovich, F. J. W. Crowe, P.G.O.; W. M. Bywater, P.G.S.B.; F. H. Goldney, P.G.D.; S. T. Klein and E. Armitage, P.D.G.D.C.

Seven Lodges and seventy-seven brethren were admitted to the membership of the Correspondence Circle.

The W.M. proposed, and the S.W. seconded, as joining members of the Lodge :

Bro. JOHN PERCY SIMPSON, (B.A. Oxon, 1884) 4, New Court, Lincoln's Inn. Solicitor. Initiated in the Caveac Lodge No. 176 in 1890, P.M. Exalted in the Caveac Chapter No. 176 in 1899, P.Z. Masonic writings:—"The Origin and History of an old Masonic Lodge." "Moses Mendez, Grand Steward, 1783;" "Old City Taverns and Masonry;" read at the Quatuor Coronati Lodge recently : and

Bro. EDMUND HUNT DRING, Cadeleigh, Guildersfield Road, Streatham Common. Publisher. Initiated in Lodge of Humility with Fortitude, Calcutta, No. 229 (E.C.), 2nd December, 1889. Exalted, Yerburch Chapter, January, 1904. Member of the West Kent Lodge, 1297. Joined the Correspondence Circle in January, 1899. Masonic writings:—"The Naimus Grecus Legend."

A vote of congratulation was passed to Bros. Canon J. W. Horsley, Sir R. Biddulph Martin, E. A. Ebblewhite, A. Burnett Brown, W. Lawrance, G. P. Parker, W. J. Kipps, and G. M. E. Hamilton, on their having received Grand Lodge honours at the Grand Festival held on the 25th of April last.

The W.M. then announced that at the Committee meeting which had just been held, Bro. Rylands had resigned his office of Secretary of the Lodge, and Bro. W. J. Songhurst had been appointed in his place.

The W.M. proposed that a very hearty vote of thanks be accorded to Bro. Rylands for the eminent services rendered by him during the past five years. This was seconded by the acting S.W. and carried with acclamation.

Bro. W. J. Songhurst was then presented and invested as Secretary.

EXHIBITS.

By Bro. R. J. SHEPPARD, Parsonstown, Ireland.

An interesting Collection of MASONIC CERTIFICATES and other documents, as follows :—

Printed Circular, Grand Lodge of Ireland, 19th February, 1841, for delivery of list of members to Clerk of the Peace.

Blank printed Certificate, with wax seal of Grand Encampment, Birr, No. 163.

Clearance Certificate of Mark Master Mason, Royal Standard Lodge No. 39, Halifax, Nova Scotia, to Thomas Duffy, 18th September, 1823.

Ditto, Lodge No. 306, Banagher, to John Longworth, 12th May, 1800.

Blank Ditto, Lodge No. 163, Birr.

Printed Circular, Grand Lodge of Ireland, 3rd June, 1824 (removal of interdiction).

Clearance Certificate, Lodge No. 258, Carrickfergus, to William Talbot, 2nd December, 1796.

Ditto, Lodge No. 233, Ballinrobe, to William Lynd, 24th June, 1779.

Ditto, Lodge No. 307, Roscrea, to William Martin, 4th February, 1822.

Ditto, Lodge No. 874, Athlone, 4th May, 1801.

Ditto, St. Thomas's Lodge, No. 268 (No. 200) Muirkirk, to William Paxton, 19th September, 1849 (engraved).

Ditto, Lodge No. 306, Banagher, to James Butler, 12th May, 1800.

Ditto, Lodge No. 233, Ballinrobe, to Bro. Patt McLearn, 4th June, 1799.

Ditto, Lodge No. 329, "Two Parallels," 58th Regiment to Richard Plasted, 11th June, 1804.

Ditto, Lodge No. 357, Roxburgh, to Joseph McQuone, 3rd October, 1793.

Certificate, Grand Lodge of Ireland, to Valentine Fitzgerald (Lodge No. 677), 6th November, 1804.

Ditto, Grand Lodge of Ireland, to John Curragan (Lodge No. 116), 5th February, 1814.

Ditto, Grand Lodge of Ireland, to Rev. John Carroll (Lodge No. 163), 20th June, 1822.

Ditto, Grand Lodge of Ireland, to William Larkin (Lodge No. 946), 12th June, 1827.

Certificate, No. 61, Halifax, Nova Scotia: "according to the Union established in London, 27th December, 1813," to Thomas Duffy, August 4th, 1823 (T. Harper Invt. et delint). (J. Hennerley, sculp.).

Clearance Certificate, Lodge No. 136 (formerly No. 191), English Constitution, 19th Regiment, to George Walker, at Valenciennes, France.

Certificate, Knight Templar and K.M., Lodge No. 895, Irish Constitution, 71st Regiment to Thomas Hennissey, 15th April, 1817, at Norrent-Faute, France.

Ditto, Grand Chapter Royal Arch, etc., Lodge No. 895, Irish Constitution, 71st Regiment, to Thomas Hennissey, 15th April, 1817, at Norrent-Faute, France.

Ditto, K.T. and K.M., Lodge No. 163, Parsonstown, to John Hawksley, October, 1836.

MS. Summons to Divine service, festival, and dinner, St. John's Day, 27th December, 1817 (Birr Lodge).

Printed list of meetings, in 1819 (Blue Masonry, R.A., K.T.). Lodge No. 163, Birr, and dispensation No. 17.

Printed list of Prince-Masons, April 20th, 1840.

Two rhyming excuses for non-attendance, by William Wallace, 1827.

Silver Engraved Jewel, originally the property of T. Holdford, of Lodge No. 410. The shape is similar to No. 1, on page 69, *A.Q.C.*, vol. xvii., but in design it is almost identical with the diamond shaped jewel illustrated in vol. xi., p. 137, which curiously enough belonged to a brother of the same Lodge No. 410.

By Bro. WALTER C. FOX, Sheffield.

APRON, printed from an engraved plate. It originally belonged to Bro. Godfrey Fox, initiated January 12th, 1803, in the Britannia Lodge No. 189 (now No. 139) Sheffield. Bro. Fox was 54 years of age at the time of his initiation, and he is registered as No. 49 on the roll of members. He continued a member until his death in 1832. He was appointed in January, 1812, as Scribe of the R.A. "Encampment," at Sheffield, and continued to act as Secretary of the Chapter until October 17th, 1824, after which the Chapter did not meet again for 16 years. During the interval he died. Bro. Fox had been created Liberty Bailiff, in 1791, by the then Duke of Norfolk. The actual plate from which the apron is printed was discovered by Bro. J. T. Thorp, at Hinckley, Leicestershire, in 1904, and was exhibited at this Lodge, 4th March, 1904 (See *A.Q.C.*, vol. xvii., p. 36).

By Bro. CHARLES STEVENS, London.

WINE GLASS, engraved with Masonic emblems.

By Bro. REV. T. W. LEMON, D.D., Bude, Cornwall.

Large Silk HANDKERCHIEF, printed in black, with a great number of emblems apparently referring to the Craft only. *Presented to the Lodge.*

By Bro. W. S. LINCOLN, London.

CERTIFICATE, issued by Lodge Fortrose (Stornoway) No. 104 (S.C.) formerly No. 135, on 3rd November, 1846, to Bro. William Henry Willoughby. An endorsement certifies that Bro. Willoughby "entered as an associating member" of the Fort William Lodge No. 43 (S.C.), on the 7th April, 1847, and that "he was passed as a Past Master of same Lodge."

Two APRONS belonging to same brother. The older one is made of twilled linen, bound and ornamented with light blue watered ribbon. In the centre are two columns, surmounted by an arch, in which are the square and compasses over three steps.

The second Apron is of leather, bound with light blue watered silk, and is, practically speaking, the *English Master Mason's* apron of the present day.

By Bro. W. JOHN SONGHURST, London.

TWO LARGE APRONS, printed on silk from engraved plates.

COPPER TOBACCO BOX.

These have been identified as belonging to the Society of Old Friends, which appears to have been started in Mile End about the year 1825. It subsequently moved to Pimlico, and at one time there were probably a dozen Lodges meeting in various parts of London. One of these was in existence at No. 14, St. Martin's Lane, down to about eight years ago, and another met at the Rose and Crown, in Cleveland Street, as late as 1902. The Society appears to have worked four degrees, which are indicated on the aprons by the four designs at the corners of the aprons, as well as by the four rungs of the ladder. There is little doubt that the small brass figure exhibited by Bro. Sydney R. Clarke, on the 8th November, 1904 (See *A.Q.C.*, vol. xvii., p. 221) is also a relic of this Society. *Presented to the Lodge.*

By Bro. J. T. THORP, Leicester.

APRON, printed from a plate engraved by R. Newman.

ENGRAVED SUMMONSES to the Grand Festival at Freemasons' Hall, London, on April 30th, 1828, and April 29th, 1829.

By Bro. GEORGE ROBSON, London.

A pair of RAZORS made by Joseph Elliott, of Sheffield. The blades are handsomely decorated with Masonic emblems.

By Bro. HENRY SADLER, London.

MEDAL, struck to commemorate the laying of the foundation stone of Edinburgh Exchange, in 1753 (*H.Z.-C.*, 382).

A vote of thanks was proposed by Bro. Rylands and seconded by Bro. Watson to those brethren who had lent objects for exhibition, and also for the donations to the Library and Museum.

In the absence of Bro. HUGHAN, Bro. the Rev. CANON J. W. HORSLEY read the following paper:—

## A UNIQUE ENGRAVED LIST OF LODGES,

"ANCIENTS" A.D. 1753.

BY BRO. W. J. HUGHAN, P.G.D.

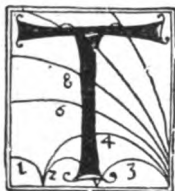

THE *Irish* Grand Lodge in England, styled the "Ancients," is considered to date from 17th July, 1751, and was the *third* organization of the kind formed in this country; the *first* being the *original* Grand Lodge of A.D. 1717, the *second* known as the Grand Lodge of *All England*, at York (1725-1795), the *fourth* the *Scottish* Grand Lodge in London (1770-5), as lately discovered by Bro. H. Sadler, and the *fifth* the *York* Grand Lodge in the Metropolis (1779-1789), *five in all*.

As to the third, Dr. W. J. Chetwode Crawley declares that Bro. Sadler "has demonstrated the true origin of the Grand Lodge of the Antients, and showed its close connection with Irish Freemasonry." This view of the matter is now generally accepted, but in a "Defence of Free-Masonry," A.D. 1765, it is stated that the brethren were chiefly "Natives of Ireland, assisted by some honest Yorkshire-men"; so that the same opinion was held about a century and a half ago; but subsequently overlooked until recent years.

It has generally been assumed, however, that these brethren did not assemble in Lodges prior to the year 1751, but the "Rules & Orders to be Observ'd By the Most Ancient and Hon<sup>ble</sup> Society of Free and Accepted Masons," agreed to 17th July, 1751, rather suggest a prior origin. *Past* Masters were permitted to represent Masters or Wardens in their absence, and members of "a regular Lodge of Ancient Masons, who had been Regularly Install'd" were allowed to attend the "Monthly Committee" (evidently additional to the Lodges which started the Grand Lodge in 1751). It is scarcely likely that some eighty brethren refrained from meeting in Lodges until 17th July, 1751; but the point need not be discussed now, though such an enquiry would doubtless prove very interesting.

It is not easy now to decide when the title of *York* Masons was first used by the "Ancients." In 1751 the term is not met with in the Rules, etc., and I think it likely that the unauthorised use of the prefix may be credited to Grand Secretary Dermott; who would not have utilised that honoured name had the Grand Lodge of *All England* been active in A.D. 1752-3. At least I think not.

With respect to the Lists of Lodges assembling under the denomination of "Ancients," they begin in 1751. On July 17th of that year, in "Morgan's Register," is the premier Record consisting of 10 and 9 Lodges, in the first and second portions respectively. List ii. has 36, and List iii. contains Nos. 2 to 64 inclusive, but there are several vacancies. According to Bro. John Lane's "Handy Book to the Lists of Lodges" (1889), in 1751, there were six active Lodges, in 1752 the number had increased to 13, in 1753 to 28, and to 30 in 1754.

This invaluable Register was compiled by Bro. John Morgan, the predecessor of Laurence Dermott. The latter was elected Grand Secretary on 5th February, 1752, when he was in his 31st year, having been born 24th June, 1720, and initiated in 1741; so that these Compilations were the work of the two Grand Secretaries, 1751-4.



Until quite recently no other Lodge-Lists of the "Ancients" of that period were known, but early this year Bro. W. John Soughurst (P.M. in 2076) became the fortunate purchaser of an *engraved* List of 1753, which is not only unique, but is a little gem of great value and interest. He has, in the kindest manner, made it over to our Library, so we may well congratulate ourselves on being the possessors of this great curiosity. These engravings will bear comparison with the finest of the kind published by the "Moderns," from 1723 to 1778.

It is very strange that no account has ever appeared of this special List, of such beauty and excellence, either in the minutes or accounts of the Ancient Grand Lodge, or in any other way; its advent being wholly unexpected and a great surprise to us all. The List is a real work of art, and consists of nine engraved plates, numbered 1 to 9 inclusive, the first page being as follows:—

" To the R<sup>t</sup> Worshipful  
 Masters, Wardens & Brethren  
 of the  
 Regular York Lodges  
 of  
 Free and Accepted  
 Antient Masons  
 London  
 This List (according to  
 their seniority & Constitution :)  
 is most humbly Dedicated  
 by their most Obedient Serv<sup>t</sup>  
 and faithful Brother  
 Lau. Dermott, Sec."

The dedication is arranged within a handsome design, having a number of Tools artistically grouped at foot, and the words below

"Engrav'd & Publish'd by Bro<sup>r</sup> Evans  
 in Bear Street Leicester Fields"

" *Anno Dom. 1753.* According to Act of Parliam<sup>t</sup>. *Anno Lap 5753.*"

On page 2 are two pretty designs, dividing the page equally, having the first portion devoted to the "Grand Committee, behind the New Church in the Strand. *First Wednesday in every Month*"; the sign at the Head being that of the "Five Bells." Unfortunately someone has added to the contraction "N<sup>o</sup>" the figure 1 in ink, which in the original was left blank; doubtless waiting until times were ripe for the chartering of the "Grand Master's Lodge," following the example set by the Grand Lodge of Ireland in 1749.

The second portion relates to Lodge No. 2, with a space left, for the "M.W.W." (*i.e.* Master and Wardens), having the *Sign* at the top, and then the place and day of meeting, with the number and date of constitution across the head of the elaborate enclosure, each of the latter, as with all the others, being of a different design, two on a page.

N <sup>o</sup> 2	Cons <sup>d</sup>	July 17 <sup>th</sup> 1751	Church Court, Strand, 2 <sup>d</sup> & 4 <sup>th</sup> Wednesday ( <i>"Thistle and Crown"</i> )
N <sup>o</sup> 3	,,	do.	St. Paul's Church Yard, 1 <sup>st</sup> & 3 <sup>d</sup> Tuesday ( <i>"Crown"</i> )
N <sup>o</sup> 4		do.	Shear Lane, Temple Bar, 2 <sup>d</sup> & 4 <sup>th</sup> Tuesday ( <i>"Temple &amp; Sun"</i> )
N <sup>o</sup> 5		do.	Ludgate Hill, 2 <sup>d</sup> & 4 <sup>th</sup> Thursday ( <i>"Horse Shoe"</i> )
N <sup>o</sup> 6		do.	In the Strand, 1 <sup>st</sup> & 3 <sup>d</sup> Monday ( <i>"Brown Bear"</i> )
N <sup>o</sup> 7	Cons <sup>d</sup>	Jany 29 <sup>th</sup> 1752	Wyche Street, 2 <sup>d</sup> & 4 <sup>th</sup> Thursday ( <i>"Angel"</i> )
N <sup>o</sup> 8	Cons <sup>d</sup>	Jany 30 <sup>th</sup> 1752	Bishopgate Street Without, 2 <sup>d</sup> & 4 <sup>th</sup> Tuesday ( <i>"Vernon"</i> )
N <sup>o</sup> 9	Cons <sup>d</sup>	June 12 <sup>th</sup> 1752	Church Court, Strand, 2 <sup>d</sup> & 4 <sup>th</sup> Friday ( <i>"Thistle &amp; Crown"</i> )
N <sup>o</sup> 10	Cons <sup>d</sup>	Sept <sup>r</sup> 15 <sup>th</sup> 1752	Bishopgate Street without, 1 <sup>st</sup> & 3 <sup>d</sup> Tuesday ( <i>"Vernon"</i> )
N <sup>o</sup> 11	Cons <sup>d</sup>	Nov <sup>r</sup> 13 <sup>th</sup> 1752	on the Broadwall, Southwark, 2 <sup>d</sup> & 4 <sup>th</sup> Monday ( <i>"Mitre"</i> )
N <sup>o</sup> 12	Cons <sup>d</sup>	Nov <sup>r</sup> 14 <sup>th</sup> 1752	Carlisle Arms, Queen Street, Soho, 2 <sup>d</sup> & 4 <sup>th</sup> Wednesday
N <sup>o</sup> 13	Cons <sup>d</sup>	Dec <sup>r</sup> 7 <sup>th</sup> 1752	in the Borough of Southwark every Thursday ( <i>"Marshalsea"</i> )
N <sup>o</sup> 14	Cons <sup>d</sup>	Dec <sup>r</sup> 11 <sup>th</sup> 1752	East Street, Red Lion Square, 2 <sup>d</sup> & 4 <sup>th</sup> Monday ( <i>"Turk's Head"</i> )
N <sup>o</sup> 15	Cons <sup>d</sup>	Jan <sup>y</sup> 9 <sup>th</sup> 1753	Mary Le Bone Street, 2 <sup>d</sup> & 4 <sup>th</sup> Tuesday ( <i>"King's Head"</i> )
N <sup>o</sup> 16	Cons <sup>d</sup>	Jan <sup>y</sup> 10 <sup>th</sup> 1753	Capel Street, 2 <sup>d</sup> & 4 <sup>th</sup> Wednesday ( <i>"King &amp; Queen"</i> )

The place of meeting of No. 4 is stated to be "Shire Lane" in the first MS. List, and No. 12 was November 4th (*not* 14th) A.D. 1752. A new enumeration of 1752 raised the original 8, 9, 11 and 12 to 7, 8, 9 and 10 respectively, the first No. 7 of 29th July, 1751 and No. 10 of February 1st, 1752, being removed from the Roll "for their disobedience of the 21st Rule of the Grand."

The "Grand Master's Lodge," or a Lodge numbered 1, is referred to in the minutes of 2nd September, 1756, and 13th March, 1757, according to a memo of my lamented friend, John Lane, in his working copy of the most valuable "Masonic Records 1717-1894."

No. 2 was declared vacant in 1783, and allotted in the following year, now the "Lodge of Fidelity" No. 3, which was originally No. 32 of 18th February, 1754. No. 3 ceased to meet soon after the issue of the Engraved List, and the number was subsequently taken by No. 55 of A.D. 1756, being now No. 5 the "St. George and Corner Stone." No. 4 held on for some 15 years, and was re-started in 1769, its present name and number being the "Royal York Lodge of Perseverance No. 7." No. 5 lapsed about 10 years after its Constitution, then it was revived in 1762 and again fell through, but

was established in 1769, becoming eventually the "Albion No. 9." The No. 6 was in a poor condition, apparently from its origin, as the last entry is dated in August, 1753, so in 1754-5 the number was transferred to No. 37, which from 1819 has been known as the "Enoch" No. 11. The 7th of the Engraved List, after some vicissitudes, was obtained by No. 86, in 1788, for five guineas to the funds of the Grand Lodge, and from 1814 has been No. 13, its name, the "Union Waterloo," being selected about 1826. No. 8 is the "Kent," so called in 1820, and, probably, is the oldest Lodge of the "Ancients" on the "United Grand Lodge" Register of 1906, by continuity from January 30th, 1752.

The 9th on the List was revived in 1756, then in 1771, and again in 1787, being really new Lodges in the four instances. It became 17 at the "Union," joined the Grand Lodge of Canada in 1869, and continues as the "Albion No. 2," under the Grand Lodge of Quebec. The 10th (*original* 12) was inactive from 1768, and the number was bestowed on No. 159, in the next year, being the "Royal Athelstan" No. 19. Numbers 11 and 12 were short-lived, but 13 was transferred to No. 64, of A.D. 1757, in 1759, becoming 23 in 1814, and 22 from 1832, its name, "Neptune," having been chosen about that time. No. 14 was contumacious in 1770, and so was eventually erased and 15 was given to No. 131 in 1813, thereafter being known as the "Athol," now 24, Newcastle-on-Tyne. The "Robert Burns" No. 25 dates from 1810, when it was allotted the vacant 16, this number concluding the Lodges enumerated and described in the List of A.D. 1753.

It is noteworthy that whereas *three* out of the four Lodges, credited with forming the premier Grand Lodge, are still on the Roll as Nos. 2, 4 and 12, *all* the founders of the "Ancients" ceased to work, their places now being held by later Lodges, which were granted their numbers.

The first Grand Master was not elected until December 5th, 1753, when "Bro. Robert Turner, Master of No. 15, was nominated and Unanimously chosen," but when the Engraved List was published, a Grand Committee regulated the affairs of the Grand Lodge.

How soon it became the custom to publish a printed List of the "Ancient" Lodges, it is impossible now to decide. Probably there was not another Engraved List issued, at all events none have been traced; but in 1795, Bro. Thomas Harper, Jeweller, had "A Calendar or printed List of the Lodges for the current year" for sale at one shilling each, and a similar notice appears in the Grand Lodge Proceedings, 1796-1799, but I am not aware that any are preserved. In P. Boyle's "View of London and its Environs," of 1799, I found "A Correct List of all the Lodges in London according to the most Ancient and Honourable Fraternity of Free and Accepted Masons" etc., and there is also another of the "Moderns" in the same volume.

The List of 1804 was printed for Grand Secretary, Robert Leslie, and was also published in Dublin as a part of the "Ahiman Rezon" of the Grand Lodge of Ireland, reproduced by Dr. W. J. Chetwode Crawley in No. viii. of the most important series of "Notes on Irish Freemasonry" (*A.Q.C.* 1904), by that gifted Masonic Historian.

There are also the official Lists of 1807 and 1813 in the English "Ahiman Rezens," with a separate pagination, the former being also partly reproduced by A. Neil, Hull, in his "Vindication of Masonry," A.D. 1810.

For fuller information as to all these points, I must refer my readers to Bro. Sadler's "Masonic Facts and Fictions," 1887, and Bro. Lane's "Masonic Records, 1717-1894," both being reliable works on the subject.

ARS QUATUOR CORONATORUM.





ARS QUATUOR CORONATORUM.





ARS QUATUOR CORONATORUM.







ARS QUATUOR CORONATORUM.

4

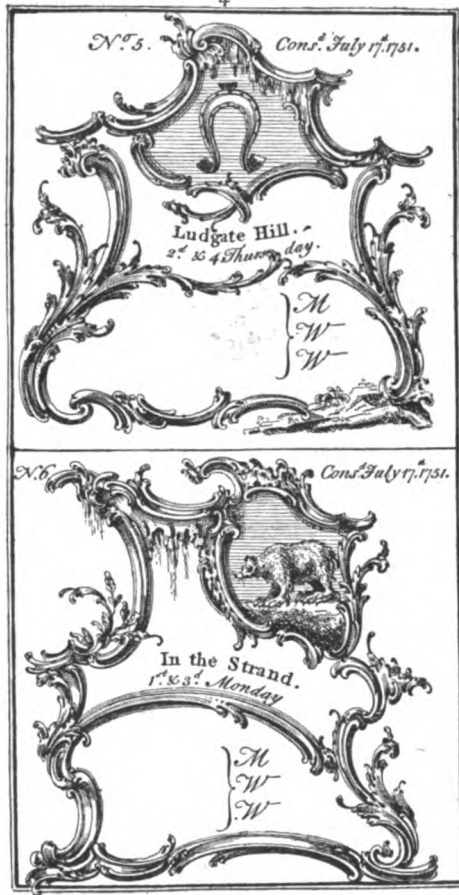



ARS QUATUOR CORONATORUM.

5





ARS QUATUOR CORONATORUM.

6

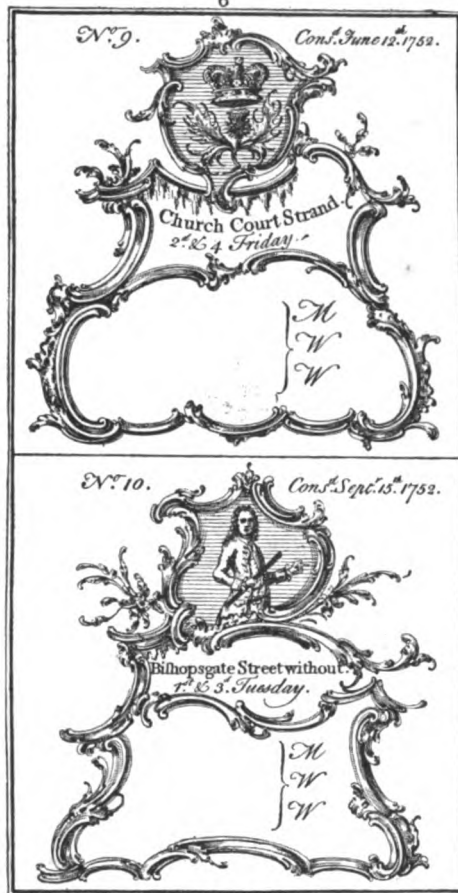



ARS QUATUOR CORONATORUM.







ARS QUATOR CORONATORUM.





ARS QUATUOR CORONATORUM.

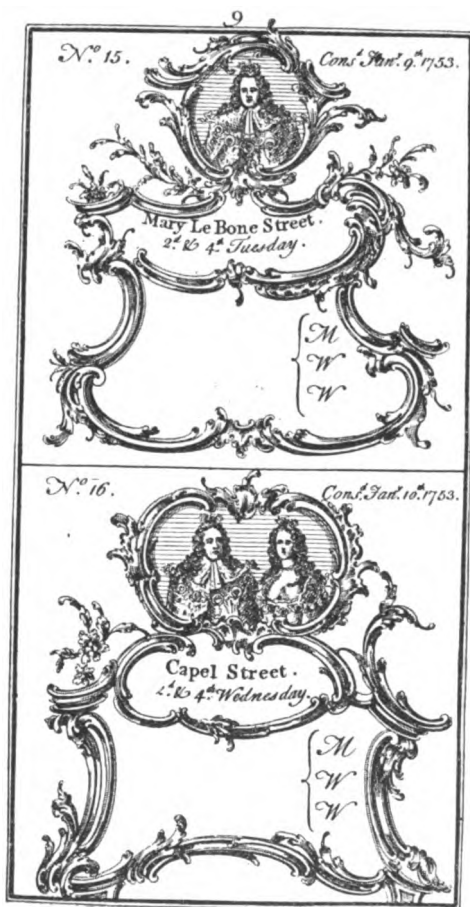



Bro. J. P. SIMPSON said:—As Bro. Hughan has stated in his most interesting paper, Bro. Sadler has made the History of the Antients his peculiar study. In his enforced absence, I am permitted to say a few words on the subject of the paper before us.

Now referring generally to the Engraved List, I have little doubt it was designed by Laurence Dermot himself. He is known to have been a man of taste and experience in these matters, and I see in the Minutes of the Grand Committee that, in January, 1754, a special Jewel was voted to him for his many eminent services during the past year, the said Jewel to be left to Dermot himself to design. The designs in the List also bear a remarkable resemblance in many respects to other engravings in his works. The Engraver, we see, was Bro. Evans, of Bear Street, Leicester Fields. Who was this Bro. Evans? Bear Street is a small street still existing, leading from Cranbourne Street to the present Charing Cross Road. It takes its name from the Bear and Ragged Staff, the ensign of the noble families of Neville and Dudley, and in the Vestry Minutes of St. Martin's in the Fields for 1677, it is called "Little Leicester Street alias Bear Street." "The Bear and Staff" Public House is at the corner leading into Charing Cross Road. The immediate locality was famous in the eighteenth century for Artists and Engravers. Hogarth was apprenticed to Ellis Gamble, the Jeweller of Cranbourne Street, and resided, in 1753, in Leicester Fields. Bro. Evans cannot have been an Engraver of note, as he does not appear in the Directories of Engravers such as Bryan, or in Walpole's Anecdotes and the Supplements. Bro. Sadler has, however, found his name in No. 340 Register A (Antients) "Evans Jeremiah Engraver 'Blue Last' Bear Street Leicester Fields." I then searched the Minutes of the Grand Committee of the Antients and found Jeremiah Evans attending on the 4th of April, 1753, at the Five Bells as the Senior Warden of No. 12, then meeting at the Carlisle Arms, Queen Street, Soho.

The Minutes of the Grand Committee commence in 1752, when they were meeting at the Griffin Tavern, Holborn, and here on the 5th February, 1752, Laurence Dermot was elected Grand Secretary. These Minutes of 1752 and 1753 afford much quaint and interesting reading. They are very impressive in their simplicity and instructive as to the manners and customs of the eighteenth century. Charity is freely dispensed to the deserving, and misdemeanours are punished. Bro. Mackay for instance, having pretended to initiate and even exalt to the Royal Arch degree certain persons for the reward of a leg of mutton, is examined by the Grand Secretary and found wanting. His sole idea of the Royal Arch apparently being that it had something to do with a rainbow. He is expelled. Again, a Bro. Moses Willoughby is arraigned for defrauding another brother of 9s., in respect of a *loomb*. Alas! Bro. Moses is not penitent, but defies the Grand Committee, and it is on record that this unworthy brother said that 9s. was of more value to him than any Society whatsoever. He also is expelled. And so on. Rough times, Brethren, and rough Masonry, yet none the less I think real and genuine.

I rather wonder that the Grand Committee, or some of the Lodges in the List, were not meeting in Fleet Street, at the Globe Tavern or the Green Dragon for instance, where at that date Irishmen most congregated, and where Goldsmith, Burke, Glover, Kelly and Macklin gathered their fellow-countrymen around them. However, the Grand Committee moved to the Temple and Sun, Shire Lane, close by, in June, 1752, a Tavern then kept by a Bro. Robert Glave.

The question was then being raised as to the desirability of getting a noble Lord to act as Grand Master, and the Committee approached Lord George Sackville and the famous Earl of Chesterfield. In anticipation of one of these peers accepting the office, Bro. Dermot moved on the 6th of December, 1752, that the Grand Committee should

hold their meetings in future at "The Five Bells," Strand, as a more fitting place for the Installation of a Grand Master. The Motion was carried by 16 votes to 11. "The Five Bells" is the Tavern where the Committee met when this Engraved List was issued, and the Landlord was a Mr. Richard Huntridge. I have looked in Larwood, and other authorities, for some explanation of the sign of "The Five Bells," but cannot find any. Personally I think the explanation is as follows:—

Before the Reformation and suppression of the monasteries the older and more respectable Taverns aided in some measure in dispensing food and charity to poor travellers, and even the neighbouring parishioners, to an extent not sufficiently recognized. The Clergy visited them, and often the Vestry Meetings were held in them up to a late date. These Taverns generally had names of some ecclesiastical significance, such as "The Mitre," "The Angel," and "The Salutation." The number Five in the Church of the Middle Ages was a very sacred number, having reference to the Five Wounds of Our Lord. Hence, I think, we have such names as "The Five Angels," "The Five Bells," etc. Curiously enough, Diprose mentions that in connection with the Parish of St. Clement Danes there is in the Record Office, Edward VI. (c. Midd. Roll 34, No. 132), a Deed of Gift by one Thomas Newbrughe, of five houses in the said Parish to the use of the poor, "in honour of the five blessed wounds." "The Five Bells" stood just on the borders of this Parish, as appears in Hatton's "New View of London," *circa* 1692. "This Parish (St. Clement Danes) extends westwards to two houses from the Five Bells Tavern." The Engraved List describes the Tavern as "behind the New Church," that is the Church of St. Mary le Strand built in 1714. At this Church David Hume says that the Young Pretender on a secret visit to London in 1751 renounced the Roman Catholic faith. The old Church stood on the south side of the Strand, and was demolished by the Protector Somerset to make way for Somerset House. The new Church was built on the site of the famous Maypole set up there on the Restoration in 1661. Thus the Ship and Fox Tavern is described in 1711 as "next door but one to the Five Bells Tavern next the Maypole in the Strand."

I would like to refer to one other Tavern in the List, namely, "The Angel behind St. Clement Danes." A very old and famous Inn, for in the Plumpton correspondence we find a Letter addressed on the 6th February, 1503, "To Sir Richard Plumpton Knight being lodged at the Angel Tavern behind St. Clement Danes without the Temple Bar in London."

And Bishop Hooper of Gloucester, condemned to death, was lodged there in 1555, before setting out for Gloucester, where he was burnt at the stake. In the middle of the eighteenth century it had also a famous "Ordinary" almost as good as Pontack's in Lombard Street, where the charge was £1 1s. 0d., a great price in those days. But the brethren will scarcely wonder at it when they are told that the Menu boasted such a delicacy as "an Entree of fatted snails and chickens two hours from the egg."

Many Coaches started from "The Angel," and in an advertisement on the 5th April, 1762, I find "On Monday will set out from the Angel Inn behind St. Clement Danes in the Strand a neat Flying Machine on steel springs to carry 4 passengers at 4 o'clock in the morning and goes to Salisbury the same evening, Fare 23/-." A crowd collected to see the start and viewed the first venturesome passengers with contempt and pity. Contempt I presume for their intelligence and pity for their certain and untimely fate. Nor were these fears wholly groundless for some days afterwards the machine I presume skidded going down a hill in Surrey and landed or rather embarked the passengers in the safe but soft depository of a village pond.

I can find but one representation of this old Inn, a rather imperfect print from an old parish Magazine of St. Clement Danes. The Inn was sold in 1853 for £6,800 and Danes Inn built on its site. This has now in its turn been pulled down.

I hope I may be able at some later date to refer to one or two of the other Taverns in this most interesting Engraved List.

---

Bro. WONNACOTT expressed his opinion that there were some grounds for believing that the Engraved List under consideration, the book plate of Laurence Dermott, and the sheets of designs of Thomas Chippendale were all probably the work of one hand, or the production of the same atelier, though, as he had not looked up these evidences for the purposes of comparison, he could not say at present that the connection of the three were to be attributed with certainty to one author: but when we came to the presumed handiwork of Laurence Dermott, he thought the evidence of such was not only extremely weak, but that it would be very difficult to trace these engraved plates of the 1753 list to him as artist. He (Bro. Wonnacott) was not aware of any similar work of Laurence Dermott, who, though a man of taste, could not be said to be an artist or a designer of applied ornament.

---

Remarks followed from Bros. SONGHURST, HORSLEY, E. H. DRING and the W.M.

---

Bro. W. H. RYLANDS proposed a vote of thanks to Bro. Hughan for the interesting paper, and to Bro. Songhurst for his kindness in presenting the "List" to the Lodge. This was seconded by Bro. Thorp and carried unanimously.

---





## THE SEA SERJEANTS.

BY BRO. W. B. HEXTALL.



HIS body appears to have been regarded as pseudo-masonic, and particulars of it are afforded by "A Historical Tour through Pembrokeshire, by Richard Fenton, Esq., F.R.S., London, 1811;" a notice in "The Freemasons' Magazine," vol. v. (1858), p. 396; and an article, signed by Mr. John Parvin Phillips of Haverford West, in "Notes and Queries," 3rd series, II., p. 1, (1862), which seem to comprise all the materials available. Tradition had it that the "Serjeants" originally sprung from the Knights Templars who, until the dissolution of monasteries, held the commandery of Slebech, Pembrokeshire, and some of whom then retreated to the Precelly Mountain in that county, gradually intermarrying with the families of the local chieftains, their descendants taking part in the Wars of the Roses on the Yorkist side. Fenton says "Some trace its origin back so far as to suppose it a leaven of one of the York and Lancaster factions that, continuing to foment in a few families, held them together long after the cause of their first union was lost, creating a kind of Freemasonry, which still caused them, when any great jarring of national interest took place, to espouse the same party and principles, as in the time of the Reformation, the Civil Wars, or the Revolution. Whatever was the actual origin, a revival of the "Sea Serjeants" took place in 1726, when rules and regulations were drawn up, limiting the number of members to twenty-five. These were gentlemen belonging to the four maritime counties of South Wales, holding annual meetings which lasted for several days, at a seaport town, or at one within reach of tidal influence. They had a form of initiation, and a year's period of probation before admission to the full degree of Serjeant. The Officers comprised a President, Secretary, Examiner and two Stewards. When there was a call of the Serjeants, the members attended in coifs and proper habits of the order: and during the week of the annual meeting, a silver star, with figure of a dolphin in the centre, was to be worn as a badge upon the coat of every member. Meetings are recorded at Hubberston, Tenby and Swansea, the last three being—July, 1760, at Haverford West; June, 1761, at Cardigan; and July, 1762, again at Haverford West. The Presidents were (1) Colonel William Barlow, (2) Richard Gwynne of Taliaris, who first presided in 1733 and died in 1752, (3) Sir John Philipps, Baronet, who remained in office during the continuance of the Society, there being no record of any successor in the chair, and 1762 being apparently the last year of meeting. Sir John Philipps, in a Parliamentary Candidature at Bristol in 1754, when the Serjeants were attacked as a political body, spoke of them as being "as good and as well affected subjects as any in His Majesty's whole dominions, and whose delight it always will be to see a great Prince and a free and flourishing People mutually striving to render each other happy."

In 1749, a resolution was come to, to elect a Lady Patroness.

Fenton says that the last surviving member of the Sea Serjeants was John Harries, Esq., of Priskilly, "who died about seven years ago," (*circa* 1804): but Mr. J. P. Phillips, in "Notes and Queries," writes "Sir Richard Philipps, Baron Milford, of

the Kingdom of Ireland, was the last surviving member of the Society, and he died at Picton Castle, 28<sup>th</sup> June, 1823, in the 83<sup>rd</sup> year of his age." Chaloner Smith's "British Mezzotints Portraits" (1884), describes a print by John Faber, jun., of "Richard Gwynne Esqr of Taliaris, President of the Society of Sea Serjeants," dated 1747, showing a decoration on the breast: also another by Faber, dated 1748, of Sir John Philipps, the inscription giving date of his death as 22<sup>nd</sup> June, 1764, but containing no reference to the Order. Faber was himself a Freemason, and dedicated a print of Frederick, Prince of Wales, in 1740, to the Grand Master, etc., "of the Antient Society of Free and Accepted Masons, and the Master and Wardens of all Regular Lodges by their faithful Brother and most obedient servant, John Faber." It is noticeable, as the first President of the Society was Colonel Barlow—no doubt a local magnate—that in a list of establishments of the Knights Hospitallers confiscated by Henry VIII. at the dissolution of Religious Houses, occurs, "A House at Slebagh, Pembrokeshire, granted to R. and T. Barlow. Rental £184 10 11."

"The Freemasons' Magazine" (*suprà*) states that "A series of the portraits of Sea Serjeants exist in an ancient mansion on the banks of Towy, between Llandilo and Carmarthen."



## REVIEWS.

FREEMASONRY IN INDIA.<sup>1</sup>

WING to the peculiar circumstances of the case, a complete History of Freemasonry in India has yet to be written; each successive partial History paving the way for the exhaustive work yet to be compiled. The pioneer of this most desirable consummation was Bro. D'Cruz, an initiate of Lodge "Humility with Fortitude" (No. 229 from 1863), Calcutta, in 1858, who did his utmost to discover and make known particulars respecting the old Lodges, his "History of Freemasonry in Bengal," 1866, being the result of his indefatigable labours.

Since then, two other brethren went to work, to supplement, as far as possible, D'Cruz's researches: Bro. John Lane's discoveries being enshrined in his great work, "*Masonic Records*," of 1887 and 1895 (1717-1886, and 2nd edit. 1717-1894); and those of the Rev. Canon Malden's being embodied in his "*History of Freemasonry on the Coast of Coromandel*," 1895.

For a time it seemed as if all the evidence obtainable had been utilized, but happily another zealous investigator has come to the front, and lately published a most welcome volume entitled

## "FREEMASONRY IN BENGAL AND THE PUNJAB."

This most interesting and valuable volume is by the Rev. Walter Kelly Firminger, M.A.; the Publishers being Messrs. Thacker, Spink & Co., of Calcutta, (A.D. 1906), who have provided as frontispiece, a reproduction of the painting in the Freemasons' Hall, Calcutta, of the Most Noble the MARQUIS OF DALHOUSIE, Lord Patron of Freemasonry in Bengal, 1848, the Governor-General, (Grand Master of Scotland, 1836-7).

I am very pleased that Bro. Firminger has entered on a study of all the Existing Records concerning the Craft in Bengal and the Punjab, for already through his enquiries, documents have been found which throw considerable light over a period, hitherto almost unknown to the present generation. It is remarkable how MSS. so long neglected or unknown, keep revealing themselves to earnest, patient and intelligent investigators, India being no exception to such an experience, and the result is seen in the fuller information supplied in this the latest work respecting the Lodges in the two provinces concerned.

The volume is D'Cruz's really *with valuable additions*, and especially an excellent Introduction by Bro. Firminger which gives in "a nutshell" the chief of the authenticated facts respecting the Fraternity in the two Provinces or Districts; the remainder of the information being supplied in the succeeding Chapters.

Some idea of what is involved in the task of doing justice to India, *Masonically*, may be gathered from the particulars found in my lamented friend Lane's great book; the premier Lodge having been started so early as 1730 at Fort William in Bengal, followed by many others hailing from the original Grand Lodge, later on by the "Ancients," and still later by the Scottish Grand Lodge, and last of all that of Ireland. No one Brother can grapple with all these Organizations, so there is plenty of work to

<sup>1</sup> *Freemasonry in Bengal and the Punjab*: by W. K. Firminger, Calcutta, 1906.

do by other competent Brethren, who may be inclined to follow the excellent example thus set by our Reverend Brother, and I hope they may be equally fortunate in unearthing valuable records.

I dare not attempt a review of Bro. Firminger's very handy and readable volume for nothing less than a long paper would suffice, but I offer my hearty congratulations on his success as a Masonic Historian. It is to be hoped however in his next effort that more careful proofing will be exhibited.

W. J. HUGHAN.

---

### MASONRY IN LONDON AND MIDDLESEX.<sup>1</sup>

THIS recent work by Bro. Reed, in spite of the comprehensive title he has selected, consists mainly of the histories of the old St. James', and of the Royal Union, its successor, both of Uxbridge. In apologising for his own shortcomings in writing this history, "in the absence of anyone else willing to do so," our Brother pleads he has done his best. Again, at the close of the work, after quoting the ideal of an American historian, Bro. Morcombe, the author says,—“Brethren, although I am well aware “that this volume may fall short of the ideal set out in the above extract, yet I hope “you will give me credit for trying in some measure to realize it.” We do, and we congratulate him on the appearance of this modest volume, which is well printed and bound, and affords much entertaining and interesting reading to the Masonic Student. It suffers in places from the want of careful editing, and in a future edition (which we trust will soon be called for) the trivial mistakes and lapses should be amended, and an index added.

It is unwise to repeat the story that “the first Lodge was formed by St. Alban in 287 A.D.”—and similar statements of the old school, as if they really were history; for we know in this age, from the researches of such Masonic Historians as Hughan, Gould, Whytehead, and so on, that most of the time-honoured stories in Anderson's account rest on no historical basis.

The sequence of events is occasionally broken by lengthy interpolations on various subjects, more or less connected with the minutes under consideration, such as “Aprons,” pp. 45-49: Masons' Marks, 69-73: the Red Apron Lodges, 39-43: the Masonic Charities (nineteen pages): such might have been relegated to an appendix, or better still, brief footnotes or references to standard works might have been supplied.

*The St. James' Lodge*, probably one of the Lodges in or about the year 1740 working independently, was constituted in 1754 at the Lord Craven's Arms, near Golden Square, London, but in 1796 was moved to Uxbridge and worked there till about 1806, when it died out. No account remains now of the proceedings of this Lodge prior to the year 1783, and the first Book of Minutes now available (which also contained the early history of the Royal Union Lodge) was fortunately recovered from a brother Mason in Uxbridge.

In 1783 the St. James' met at the “Three Compasses and Punch Bowl,” in Silver Street, Golden Square, London, W., in which neighbourhood it had located itself since

<sup>1</sup> *Masonry in London and Middlesex*: By W. Bro. W. H. Reed. 1906, 248 pp. “The Hornsey and Tottenham Press, Ltd.” Muswell Hill, N.

its constitution in 1754, with but one remove to another coffee house close by, viz:—Rustall's, in Sherard Street. After 1783 it had many habitations in the Soho and Golden Square district, a list of these being given on p. 78 of this volume.

This list shows that the temporary habitations were not only very numerous, but exceedingly transient, from various reasons which are mentioned. One instance in 1796 gives us an explanation, "owing to the insolent conduct of the Landlord of this house " it was agreed not to assemble here any more"—which is brief and to the point.

It was not till 1785 (December 8th) that the Lodge received its name, it being proposed "that as the Lodge has no name that some Brother or Brothers would " propose a name by wh<sup>ch</sup> it might be called in future," when the name of St. James' Lodge was adopted.

In March, 1796, the Lodge was in a bad way (it had not met for six months), when we found it recorded "On account of the Lodge not meeting sufficiently numerous " to support it with propriety, it was moved, seconded, and carried, that the Brethren " of the Lodge do unite with the Burlington Lodge." It is not mentioned in subsequent minutes that such a union was effected, but the Treasurer's book proves circumstantially that the warrant was sold (at the time of the removal of the Lodge from London to Uxbridge), for none of the old members ever attended again, and each of the new members paid in two guineas to raise the sum required for the final settlement with the late R.W. Master and Treasurer, the sum of fifteen guineas being handed over. Its life in Uxbridge was but short, for in 1800 we find the last minute recorded (December 5th, 1800), but there were other meetings, the Treasurer's book showing one on February 27th, 1801, and dues were paid to Grand Lodge down to 1806; it was finally erased at the Union in 1813. Such in brief is the history of the old St. James' Lodge; and the Royal Union Lodge (the present Uxbridge Lodge) commences its story in the same minute book, dating from March 29th, 1826.

The perusal of old minutes is always a fascinating, and even entertaining, task, and those contained in this little work prove to be no exception. There are many quaint passages, and we cannot refrain from giving a very few.

1796. "A motion was made by Brother Haycock that no smoaking of Tobacco " be admitted during the Lodge, which motion was duly seconded and " carried nem. con."

1798. December. "Bro. Rayner proposed that smoaking of Tobacco be admitted " for the ensuing Quarter, which motion was seconded by Brother Hodgson " subject to a ballot, which ballot immediately took place, and smoaking " of Tobacco was carried by a majority."

1799. March. "Brother Mounsey proposed that no Brother be suffered to go to " the Closet in the Lodge during a Lecture."—the explanation being probably that a certain bottle was kept there.

Quaint as these statements are, what must be thought of the dear old Treasurer, Bro. Burgess? Having entered in error a payment on the wrong side of the book (March, 1798), he adds a note:—"What a confounded stupid dog I must be, to make the " above mistake. N.B." (i.e. Nathaniel Burgess).

These accounts are often as valuable as the minutes, and throw side lights on Lodge occurrences. "Paid for letter from Grand Lodge 9<sup>d</sup>" (and never less than 4<sup>d</sup>) being a common entry. Visiting fees, at first 1/-, were raised to 1/6 in 1786, and at a later date to 2/6.

1796. September 15th. "Paid for a drawing board ... 2/6."  
"Paid for Bro. Lewes' apron ... 2/6."

In October, 1796, the Treasurer debits three new brethren 2/6 each, "for badges supplied to them by the Lodge."

1787. Jan. The R.W.M. (as customary in those days) was allowed 5/- expenses for attending Grand Lodge, and conveying the usual charity of one guinea, from Berwick Street, Soho, to Great Queen Street.

The minutes, although confirmed always at the subsequent meeting, were never signed by the R.W.M., differing from the practice of the Royal Union Lodge in later times, when they were signed by the W.M., both Wardens and often the Secretary as well.

There is no mention throughout of the appointment of Deacons, or Inner Guard: although the Antients, in 1753, had them. Neither is there anything said about an Installation ceremony, the Master merely taking the chair when he was elected, and proceeding to appoint his officers, as was apparently customary under the lax regime of the "Moderns" until 1809.

There are frequent entries of two degrees being conferred on the same candidate in one evening, and even of all three degrees, in one case. "1787, March, M<sup>r</sup> William Jeffreys was made a mason, it being a case of emergency he was passed the three degrees and paid the usual fees." Also, in another case, "Four brethren were raised to the third and fourth degrees," (1784).

Charity, as usual, plays a large part in the proceedings. It is recorded (1784, June) "A brother Abraham Gatenis, who signed his name in English and Arabic, petitioned and received six shillings charity," probably he was a travelling Greek. "1797, July, Proposed that the sum to be given to distressed Brethren should not exceed two shillings and sixpence, and that the R.W. Master should be applied to for the relief, and that the Treasurer pay the same."

The Master was elected at intervals of three or six months, generally the latter. "1784. This being Electioning night, Bro. Earl was chose Master for six months, and was pleas<sup>d</sup> to request the old officers to continue."

Proposition fees of 10/6 were insisted upon when a candidate's name was brought forward, and this was forfeited if he failed to present himself. After initiation it did not necessarily follow that the newly made brother became a member, for in accordance with the custom of the time, he had to apply for membership, and if he did not, it was a time honoured custom for him to attend as a visitor at the Lodge where he was made. "1785, November, Mr. Wheatly was made a Mason, and passed the first and second degrees. He paid the usual fees and likewise became a member." On another occasion there were no less than four newly made brethren who attended their Lodge as visitors. One brother, Handy, "who was Initiated in this Lodge in 1796, was this evening (Jan., 1800) pronounced a member of this Lodge."

When working the M.M. or Arch Degrees, the Lodge was usually opened direct as a Masters' Lodge, then afterwards it was opened in the first degree for general business. The "Sublime degree" went by another name:—1796, August. "The Lodge was opened in the Masters' Degree in due form. Brother Burgess (the Treasurer above spoken of) proposed that Brothers . . . . be raised to the respectable degree of Master Masons, they were accordingly raised to this same degree. The "Masters' Lodge was then closed in due form, and afterwards opened in the first degree," etc. Several entries in 1797 are similar.

Resignations were reported in various ways.

1791. "Brother . . . . sent and paid his arrears and stop't."

1799. "Brother Mounsey proposed that Brother Rayner be discontinued a "member of this Lodge,"

the said Bro. Rayner being a frequent visitor after this, and held in high esteem. But we shall see later, in the minutes of the Royal Union Lodge, an entry which is worthy of a Hibernian Secretary.

Instances occur, as they always did in the period of the rival Grand Lodges, of Antient Masons being re-made in Modern Lodges, and *vice versa*. 1790, October "Mr. Jacob Bell of the description of Ancient Masons was transferred and admitted to the "mysteries of Masonry in this Lodge"—the price of his experience being 21s. 9d. The more usual term for the operation was "translated," and this occurs frequently in the St. James' Lodge minutes. The price had risen by the following year, for (1791, January) "Mr. John Fraser, an Ancient Mason was modernised for £1 11s. 6d."

There is a curious instance of a Brother being accepted as a joining member, elected to the chair of the Lodge, and resigning all connection, within the space of two months.

It would be a singular sight now to see a Brother in the uniform of the Country Stewards' Lodge (1789-1802), but the minutes give an instance of the presence of a visiting brother in his green apron, the privilege granted his Lodge in 1795 but cancelled in the following year.

*The Royal Union Lodge.*—As its name indicates, this takes its title from the great event of 1813, although it was not till 1825 that the Uxbridge brethren petitioned for, and obtained, the warrant for this Lodge, twelve years after the St. James' had died out. It will be remarked that the list of names attached to the petition contains many Irish ones, which is explained by the fact that the town of Uxbridge was, until quite recent times, a garrison station, and therefore many of these brethren were quartered there at the time.

Being comparatively modern, we do not expect to find matters of such antiquarian interest in connection with the Royal Union, as we found in the St. James' records, but, nevertheless, there are a few points worth recalling, particularly in connection with the inventory, such as the transparencies. (1830) "Paid to M<sup>r</sup> Wigginton, of Windsor, for "boxes for transparencies, Two Pounds, Eight Shillings." These are supposed to have been peep show arrangements, in which were seen the principal features of the ceremonies, and Bro. Reed believes some of them to be still existing among the relics possessed by one brother of the town. In 1827 the inventory informs us the Lodge possessed "2 Large Transparencies

"4 Small Boxes for do.,"

and also "1 Transparency and Box (the Eye)."

"Agreeable to the resolution of last Lodge night an inventory of the whole of the "property of the Lodge was taken—and deposited in the Ark."

One item appears curious, till explained:—

"13 Satin Blue Suspenders,"

which refers to the officers' collars, as we now know them. Among the other properties were:—"1 Floor cloth, Printed Emblem."

also "1 Masonic Floor Cloth.

"10 Aprons.

"A Trowell.

"1 Flannel Gown.

"1 Pr. Drawers,"

the two latter items being for the person most concerned in the ceremony. The Treasurer enters, in another place, "Paid Bro. Hopping by W.M. Williamson's order "for a dress, one Pound,"—probably the Tyler's uniform.

This is the whimsical method of recording a brother's resignation, referred to "above:—" "No communication having been received from Brother P. M. Horsley, "respecting his resignation, it was agreed that it be received with regret."

Installation night is thus described (1839) "the following Brothers were then "appointed as officers and duly invested with the appropriate Jewels. The Brethren "present then adjourned to celebrate St. John," which is significant.

Concerning the Master's Light, the letter of the Grand Secretary (December 1839) is attached to the minutes, in which the practice of extinguishing it, and introducing "a Lanthorn with a Star, etc.," is forbidden.

Another letter, concerning the first ceremony, is also entered, directing that where more than one candidate is admitted, "they must be Initiated separately, up to "the end of the O.B."

Among the notable brethren of this Lodge we must not fail to mention Bro. Wentworth Little, while among the Masters were Bro. Charles Herring, nephew of the famous animal painter, and connected with a large firm of brewers. He is the reputed father of the following lines, which are quoted in full in Bro. Reed's book:—

When Julius Cæsar landed here  
 He drank a glass of Southwark beer.  
 He said "This Liquor's very fine ;  
 I like it better than our wine."  
 Cassius, looking thin and pale,  
 Thought he'd like to taste the Ale,  
 And when it sparkled in the Glass,  
 "Yes, this does our wine surpass."  
 Brutus said, "I'll try the Stout,  
 But that I fear 'twill bring the Gout."  
 He looked around at the Brewer's Men,  
 And saw them sleek and fat, "Why, then,  
 Of Treble X bring me a pot,"  
 And very soon he drank the lot.

with more in the same refrain.

Bro. Reed's effort has been a successful one, and it is to be hoped he will be rewarded with such support as will enable him to send a goodly sum to the Masonic Charities, to which the profits of the work are to be devoted.

W. WONNACOTT.



**“DEMIT” AND JEWEL OF ANTIENT LODGE****No. 53, LIVERPOOL.***BY BRO. GEO. I. SHACKLES, W.M.*

THE following is a copy of a “demit” granted to Bro. Stephen Clay by the Antient Lodge No. 53, Liverpool, on his emigrating to America in 1794, and an engraved Jewel of the same date which also belonged to him.

*Antient Lodge No. 53, Liverpool.*

To all Worshipful Masters Wardens and Brethren of the Antient and Honorable Society of Free and accepted Masons, of all regular and constituted Lodges. We the Master Wardens and Brethren send Greeting the bearer hereof Brother Stephen Clay one of our trusty and well beloved Brethren is a regular Member of our Lodge in the First Second and Third degree in Masonry. He is Likewise a regular Member of our Excellent Super Excellent Royal Arch Lodge and has always behaved himself as a worthy Brother amongst us wherefore we recommend him to the Friendship and Brotherly care of all Brethren whom these presents may reach

Given under our hands and Seal of our  
Lodge the Tenth day of September  
1794, A L 5794



Ralph Samuel W. G. Master  
Samuel Moore Senior G.  
John McLoud Junior G.

Thos. Vernon Secretary G.

Some few months ago, through the courtesy of Bro. W. W. Fletcher, of Hull, I was permitted to inspect the original both of the “demit” and Jewel, and also to peruse the correspondence which had passed between himself and the owner Bro. Allen M. Clay, Secretary of The Bank of California, San Francisco, who was endeavouring to trace the Masonic history of his Grandfather, Bro. Stephen Clay. Unfortunately the records of the Antient Lodge No. 53 are not now in existence, so that it is impossible to trace any personal Masonic history of the original owner of this interesting “demit” and Jewel. From the correspondence however, I gather that Bro. Stephen Clay was born in New London, Connecticut, U.S.A., on the 6th January, 1765, and was the fourth eldest son in descent from his great, great-grandfather, (a prior) Stephen Clay who was born in Gloucester, Massachusetts, in 1690. The latter was the eldest son of a still earlier Stephen Clay, the eldest of four brothers who emigrated to America from Derbyshire, in the year 1682-3, leaving a fifth and the youngest brother at home, from whom are descended the family of the same name now living in Derbyshire. The Stephen

*Ancient Lodge N<sup>o</sup> 53 Liverpool*

To all Honourfull Masters, Wardens, and Brethren  
of the Ancient and Venerable Society of Free and  
accepted Masons, of all regular and constituted Lodges  
We the Master Wardens and Brethren and (Quorum)  
the bearer hereof Brother Stephen Clay, one of our  
trusty and well beloved Brethren is a regular Member  
of our Lodge in the first second and third degree in  
Masonry. He is likewise a worthy Member of our  
Excellent Super Excellent Royall Arch Lodge  
and has always behaved himself  
Brother amongst us wheatefore we wish to be  
to the Friendship and Brethly care of all Brethren  
Whom these presents may reach

Given under our hands and Seal of our  
Lodge this Tenth day of September

1794, A.L. 5794, . . . . .

Paul Samuel W. G. Master

Samuel W. G. Secretary

Brother Stephen Clay

The Warden Secretary &

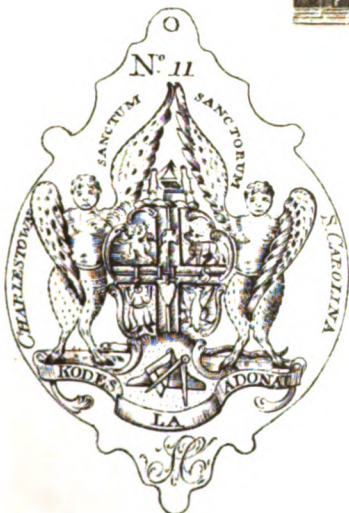

*Demit and Jewel  
of Ancient Lodge N<sup>o</sup> 53  
Liverpool.*

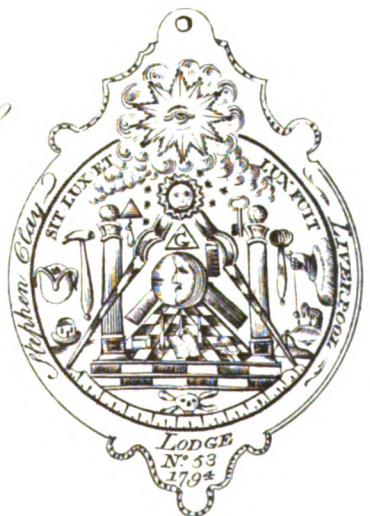



Clay, the original owner of the "demit" and Jewel, was a Master Mariner, as had been his forbears for several generations, and commanded for many years his own Sailing Ship in the Liverpool and New York trade. He retired from a seafaring life in 1830, and for some years afterwards was engaged in Mercantile pursuits in New York, where he died on the 19th October, 1843, in his 78th year.

His affiliation with the Masonic Order in Liverpool was probably owing to his frequent visits to England. The jewel indicates that he joined Chapter No. 11, in Charlestown, South Carolina, which was subsequently amalgamated with the Adoniram Chapter No. 1.

The Antient Lodge No. 53, of Liverpool, has had an eventful career. According to Lane's "Masonic Records" it was an "Athol" Lodge, constituted on the 19th May, 1756, and met (place unknown) at Liverpool, but lapsed soon afterwards. It was revived on the 17th April, 1775, and met at "The Buck & Dog" Strand Street, Liverpool, migrating from there however, to "The Cheshire Coffee House," Old Dock Gate, Liverpool, in 1786. On the 4th February, 1807, the warrant was withdrawn "for unmasonic conduct," but shortly afterwards, viz., on the 16th March, 1809, it was transferred to Hull, and the name appears to have been changed to "The Antient Knight Templars Lodge" No. 53. Its first place of meeting in Hull was "The Fleece Inn," Market Place, which is still in existence. In 1810 the name was again changed to the "Humber Lodge," and it met at various Hotels and Taverns until 1827, when the Lodge was so prosperous that the brethren purchased and built their own premises, then and still known as "Freemasons Hall," in Osborne Street. The records of the Humber Lodge do not go back prior to 1809, but enquiries have been made with some of the earlier numbered Liverpool Lodges, and of the Provincial Grand Secretary for West Lancashire, to ascertain whether any records of the "Antient Lodge No. 53" are still in existence at Liverpool, but all such efforts to trace them have been thus far unsuccessful.

It will be seen that the design of the Jewel, which is engraved, is of the ordinary type of the period. It is in an excellent state of preservation, and the owner is to be congratulated on having such an interesting specimen which he can accurately trace backward through his family to the original possessor.

He has most kindly presented the original "demit" to the Humber Lodge No. 59, Hull, who are now the possessors of, and are working under the original Warrant of Constitution of the Antient Lodge No. 53, which granted the "demit," and it has been suitably framed and is hanging in an honoured place in their Lodge.

# St. John's Day in Harvest.

MONDAY, 25th JUNE, 1906.



THE Lodge met at Freemasons' Hall, at 5 p.m. Present—Bros. G. L. Shackles, W.M.; E. Armitage, P.D.G.D.C., S.W.; F. H. Goldney, P.G.D., J.W.; W. J. Songhurst, Secretary; W. M. Bywater, P.G.S.B., D.C.; G. Greiner, P.A.G.D.C., P.M., as I.G. and Steward; W. H. Rylands, P.A.G.D.C., P.M.; E. J. Castle, P.D.G.R., P.M.; and W. Wynn Westcott, P.G.D., P.M.

Also the following members of the Correspondence Circle—Bros. T. Cohn, P.G.St.B.; E. L. Hawkins, R. V. S. Houghton, W. Howard Webb, W. F. Woods, Sir Joseph Sykes Rymer, M. Rosenbaum, C. W. Finch, C. H. Bestow, W. H. Cox, C. L. Eales, G. T. Phillips, W. S. Boteler, E. L. Horne, W. Wonnacott, C. Letch Mason, W. R. A. Smith, C. F. Silberbauer, A. C. Mead, A. E. Winter, J. P. Simpson, H. N. James, W. H. S. Humphries, L. Simon, D. Bock, F. R. Taylor, H. Bradley, F. W. Levander, W. H. Brown, W. W. Mangles, P. J. Woods, L. R. Gleason, H. M. Baker, S. Meymott, C. H. Knuth, P. T. Goodman, Percy R. Simner, A. Noel, S. R. Clarke, W. S. Lincoln, W. R. Poole, J. S. Stacy, H. W. Slater, H. F. Hann, H. Guy, John Thompson, A. Simner, P.A.G.D.C.; H. Tipper, P.G.P., M. Mendelssohn, Walter Lawrance, A.G.Sup.Wks.; J. L. Barrett, P.G.St.B.; Thos. Leete, F. Kessler, E. Glaeser, G. Vogeler, Dr. S. Walshe Owen, Hugh James, J. F. Moor, John White, L. G. Tate, J. Johnson, and C. E. L. Wright, P.G.D.

Also the following visitors—Bros. W. H. Harris, J.W., Commercial Temperance Lodge No. 3144; H. Scott, Temperance Lodge No. 2557; T. S. A. Evans, Lodge of Prudent Brethren No. 145; D. Harlow, P.M., Prosperity Lodge No. 65; C. H. Hart, P.A.G.P.; H. C. Sandars, Earl's Court Lodge No. 2765; N. T. Pegge, Lodge of Concord No. 757; Frank Swift, Raymond Thrupp Lodge No. 2024; J. S. Gregory, Kingsland Lodge No. 1693; A. van der Gon, P.M., Kilburn Lodge No. 1608; W. A. Mills, Cannon Lodge No. 1539; W. Burton, Kilburn Lodge No. 1608; E. A. Herbert, S.W., Harringay Lodge No. 2763; G. Sutton, J.W., Borough of Greenwich Lodge No. 2333; T. R. Thompson, Lodge Australia No. 3 (S.A.C.); P. Wriede, Gudrun Lodge, Hamburg, and Walter Woodd, Temora Lodge No. 168 (N.S.W.).

The W.M. referred to the eminent services which had been given to the Lodge by Bro. W. H. Rylands, particularly during the time he had acted as its Secretary, and he asked his acceptance of a clock, which, together with a brooch for Mrs. Rylands, had been subscribed for by members of the Lodge, as a small token of their appreciation of his work. Bro. Rylands thanked the brethren for their kind gifts.

On ballot taken, Bro. JOHN PERCY SIMPSON (B.A., Oxon.) 4, New Court, Lincoln's Inn, Solicitor, writer of papers on "Moses Mendez, Grand Steward, 1783," "Old City Taverns and Masonry," and "The Origin and History of an old Masonic Lodge," and Bro. EDMUND HUNT DRING, Cadeleigh, Guildersfield Road, Streatham Common, Publisher, writer of papers on "The Naimus Grecus Legend," were elected joining members of the Lodge.

Fifty-eight brethren were admitted to the membership of the Correspondence Circle.

Letters of apology for non-attendance were received from Bros. Sir A. H. Markham, P.D.G.M., Malta; E. Conder, jun., L. A. de Malczovich, F. J. W. Crowe, P.G.O.; T. B. Whytehead, P.G.S.B.; W. Watson, J. T. Thorp, P.A.G.D.C., W. J. Hughan, P.G.D., Col. S. C. Pratt, J. P. Rylands, E. Macbean, R. F. Gould, P.G.D.; and Canon J. W. Horsley, G.Chaplain.



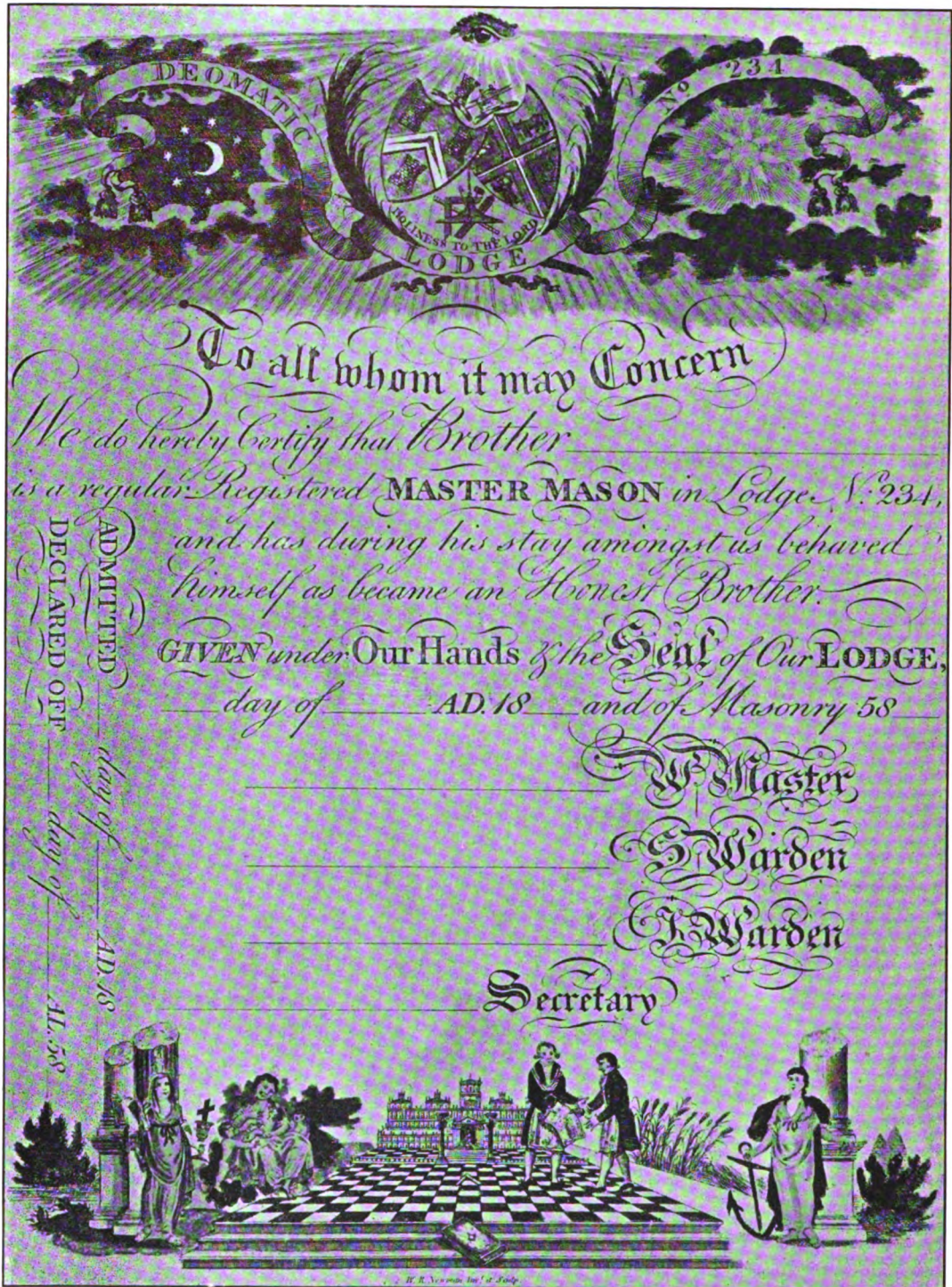

CLEARANCE CERTIFICATE USED BY THE DEOMATIC LODGE, No. 234,  
(now Domatic, No. 177) before 1813.

EXHIBITS.

By W. S. BOTELEER, London.

BLANK ENGRAVED CERTIFICATE (hand coloured) of the Deomatic Lodge No. 234 (now the Domatic No. 177), designed and engraved by Robert Newman. *Presented to the Lodge.*

STAMPED SILVER STAR, worn by J. Boteler, as M.N.G. Master of the Knights of the Round Table, an office to which he was elected on 19th September, 1826.

By Bro. J. C. BROOKHOUSE, London.

ROYAL ARCH JEWEL, made by Thomas Harper in 1810. The number engraved upon the jewel is 642, which was borne by the Lodge of Candour (now No. 337) at its constitution, at Delph, in Yorkshire, on 12th February, 1812. *Presented to the Lodge.*

SPECIAL CENTENARY JEWEL adopted by the Albion Lodge No. 9, in 1857. *Presented to the Lodge.*

By THE SECRETARY.

ENGRAVED OVAL JEWEL, with two pillars, that on the left bearing the level, and that on the right the plumb-rule. Between the pillars are the square and compasses, the all-seeing eye, a cornucopia, and tessellated pavement. Over all is the word "Economy," and at the foot the word "Prudence."



By Bro. L. R. GLEASON, LONDON.

Small P.M. JEWEL (Scotch pattern) set in paste.

By Bro. W. H. RYLANDS.

An interesting collections of APRONS—Craft, R.A., Rose Croix, &c. *Presented to the Lodge.*

A vote of thanks was proposed by the W.M., seconded by the S.W., and carried unanimously, to the brethren who had kindly lent objects for exhibition, and for the donations to the Lodge Museum.

---

The following paper by Bro. F. J. W. CROWE was read by the Secretary :—



## KING SOLOMON AND THE QUEEN OF SHEBA.

BY BRO. FRED J. W. CROWE, P.G.O.



DOUBTLESS it has been a matter of surprise to many brethren that the Queen of Sheba should be mentioned in certain variants of some of our ceremonies. Our Institution is so exclusively masculine in every way that this solitary inclusion of a reference to a female would seem to have connection with some especial Masonic legend, and I wish to offer a few suggestions on this interesting point.

The Biblical story of her famous visit to our Royal Grand Master is of course too well known to need repetition, but one or two other versions are worth recording.

The first is the account of Josephus in his *Antiquities of the Jews*, which I quote from the translation of Sir Roger L'Estrange, Knight, (fourth edition, London 1725).

“The Fame of *Solomon's* Virtue and Wisdom was so advantageously represented upon this occasion to *Nicaulis* the Queen of *Agypt* and *Æthiopia*, that being a Princess of wonderful understanding her self, and a person every way extraordinary, the very Glory of her Character gave her a longing Impatience to hear and see the Original. For says she to her self, what signifies all this Heresay without experimental Proof? Illustrious Rumours speak but the sense or Affection of the Reporter: And after all, their splendid Pretensions fall flat perhaps, and come to nothing in the conclusion. When she had been ballancing a while upon these thoughts, she took-up a Resolution, in Contempt of all the Risques and Difficulties of a long Voyage to give him an honourable Visit, for the satisfaction of her Curiosity, as well as of her Inclination and Judgment; and to enjoy the Fruit, and comfort of that Wisdom she had heard such Wonders of. In this Determination she set forward to-wards *Jerusalem*, with a Train and Equipage suitable to her royal Dignity; taking along with her a Number of Camels, laden with Gold; Variety of rich Perfumes, and of precious Stones. Upon her Arrival the King receiv'd her with all possible Honour, Courtesy, and Respect; and with so much Ease and Clearness solved all the Difficulties she propos'd, that it put her into an Amazement to find his Excellencies, in Truth and Effect, so much beyond what she had heard of them in Fame and Report. She stood in great Admiration at the Majesty and Curiosity of his Palace, the Order and Disposition of the Buildings and at the King's incomparable Prudence upon the main, through the whole Contrivance and Conduct; But she was mov'd at nothing more than at the Master-piece of that Fabrick called the *Grove of Libanon*; The magnificent, and the regular Course of his Entertainments; The *Discipline* and *Economy* of the Family and the doing every thing with so peculiar a Grace. She was likewise infinitely pleased with the Spectacle of the daily Sacrifices and to see with what Application, Care and Veneration the *Priests* and *Levites* perform'd their Part in the Worship. The constant Course and Practice of this orderly Reverence, ran in her Head Day and Night, and her Heart was so set upon it, that the more she consider'd it, the more she found it to be still her Wonder and Delight: Nor did she make any Difficulty of owning as much to the King himself.

*Great Prince*, says she, *the Credit of Reports is so doubtful and uncertain that without a demonstrative and experimental Confirmation of the Truth of what we hear, we are*

forced to suspend our assent for want of knowing what to believe, especially where the Fume of Things bypasses towards either extreme of Good or Evil: But in the question of your incomparable Faculties and Greatness; that is to say, the internal Advantages of the Mind in a superlative Degree of Knowledge and Understanding, and the Glory of your outward State, the Rumour has been so far from partial, that it falls short even of a common Justice: For though common Fame said as much to your Honour as could be put in Words, I have yet the Happiness at this present to see much more than I heard. Blessed are the Hebrews: Blessed the Friends and People of Solomon, that stand ever before him, and hear his Wisdom; and blessed be God for his Goodness to this Land and Nation, in placing them under the Government of so excellent a Prince.

Having proceeded thus far, the generous Princess did not stop here at Words and Professions, but follow'd her Speech with more substantial Effects as a further instance of the high respect she had for the King. She made him a present of *twenty Talents of Gold, aromatical Spices, rich Perfumes, and Precious Stones*, to a prodigious value. They speak also of a Root of *Balsam* that she brought with her, which (according to a Tradition we have) was the first Plant of the Kind that ever came into *Judæa* where it hath propagated so wonderfully ever since. Neither was *Solomon* wanting, on the other hand, in a suitable Return of whatever he thought might be to the Queen's liking, and satisfaction; for he deny'd her nothing, and was much readier to give than she to ask, even to the preventing of her Askings. After this reciprocal Interchange of Presents, given and taken, the Queen went back again into her own country."

Next I would notice the version in the *Koran* (translated by George Sale, Gent., London 1836), in the curious chapter entitled "The Ant." Solomon called together an assembly of his armies "consisting of Genii, and men, and birds." The eastern legend is that he travelled on an enormous green silk carpet on which his throne was placed, the men being on his right hand, the genii on his left, whilst the birds flew overhead, forming a canopy from the heat of the sun. This carpet was, on command, lifted by the wind and transported wherever the King desired. On this occasion the lapwing was absent, and Solomon threatened to kill her on her return unless she had some good excuse for her absence. She brought back news of a country called *Saba*, ruled over by a woman (called *Balkis* by Arabian writers, instead of *Nicaulis* as by Josephus) who kept great state and had a magnificent throne, but worshipped the sun as well as God.

Solomon, to test the truth of the story, wrote the following letter: "From the servant of God, Solomon, the son of David, unto *Balkis*, queen of *Saba*. In the name of the most merciful God. Rise not up against me, but come and surrender yourselves unto me." This he ordered the lapwing to return with, and cast it down to the Queen, and wait to know what answer would be returned. She consulted her nobles as to whether she should fight or obey, and, on their leaving the decision to her, decided to send an embassy, with gifts, to Solomon. The account now becomes extremely vague as to what happened, but from Eastern commentators it appears that the ambassadors were sent home with their gifts rejected. The Queen herself then came and submitted to Solomon and embraced the religion of Islam. Before starting she had, as she supposed, secured her throne, made of gold and silver, and adorned with precious stones, in a strong castle with a guard to defend it. Solomon wished this throne brought to him before she arrived, having been informed of its existence by the lapwing. This feat was accomplished by his Vizier, who knew the secret and ineffable Name of God, and by pronouncing it caused the throne to appear. *Balkis* was shewn the throne and

asked if hers was like it. She replied that it might have been the same. And her astonishment at finding it really was the throne she had left behind her, was another factor in securing her submission. Some Arabian writers say that Solomon married her, and others that she wedded another prince. This account naturally differs considerably from the Hebrew version, and brings the Queen in answer to a direct command, instead of voluntarily on hearing of the King's wisdom and might, for it gives no hint of any intention to "rise up against him."

The third and last account I shall quote is from *The Golden Legend*, and is more in accord with the Books of 1st Kings and 2nd Chronicles than either of the others.

*fol. lxxiii.*

"Salamon was ryche and gloryous that the fame raune of hys sapyence & Wysedom, and of hys byldyng and dyspense in hys hows thurgh the World is so moche that the quene of Saba cam fro fer contreys to see hym & to tempte hym in demaundes and questyons. And she cam in to Jherusalem with moche peple & Richessis with camellee charged with Aromatykes and gold Infynyte. And she cam & spack to Kyng Salamon alle that ever she had in her herte. And Salamon taught her in all that ever she purposed to fore him. She coude saye nothyng but that the kyng answerd to her, ther was nothyng hyd fro hym. The quene of Saba thenne seeyng alle the Wysedom of Salamon, the hows that he had bylded, and the mete and servyse of hys table, the habytacles of his servautes, the ordre of the mynystres, theyr clothyng and araye, hys botellers and offycers, and the sacrefyses that he offred in the hows of our lord Whan she sawe all thyse thynges she had no spyrite to answeere but she said to kyng Salamon. The word is trew that I herde in my lande of thy Wordes and thy Wysedom. And I belevyd not them that told it to me, vnto the tyme that I my self come and have seen it with myn eyen. And I have now wel seen and provyd that the half was not told to me. Thy sapyence is more and thy werkis also than the tydynges that I herde. Blessyd be thy servantes, and blessyd ben thyse that stande alwaye to fore the and here thy sapyence, and wysedom. And the lord god be blessyd whom thou hast plesid & hath sette the vpon the trone of Israhel, for so moche as god of Israhel loveth the & hath ordeyned the a kyng for to do rightwysnes & Justyse. She gaf thène to the kyng an c & xx besautes of gold, many aromatykes & geñes precious. There were never seen to fore so many aromatykes ne so sweete odours smellyng, as the quene of Saba gaf to kyng Salamon.

Kyng Salamon gaf to the quene of Saba alle that ever she desyred and demaunded of hym. And after rotorned in to her contre and londe."

All these accounts assign the visit of Queen Nicaulis, or Balkis, to a general desire to see the famous King and his works, but the paragraph to which I first alluded (and let me say it contains nothing improper to be quoted in print) makes it on account of the Temple alone, thus:—"The sovereigns of surrounding nations sent ambassadors to congratulate the King on the completion of that stately edifice, whose regal splendour and unparalleled lustre are said to have surpassed all imagination; but there was one to whom the fame of that magnificent Temple had reached, who, not content with sending an ambassador, as the other sovereigns had done, herself journeyed to Jerusalem.

This was the Queen of Sheba, attended by a numerous retinue, and with many costly presents. On arriving at Jerusalem, she was received by King Solomon, who accompanied her to view the Temple."

I cannot trace the origin of this legend, nor is there any mention of such embassies in the sacred chronicle, nor in *Josephus*. On the face of it, it is improbable that kings of other faiths would congratulate him on such an event. However, the operative masonic association of the Queen with the Temple seems to have been long recognised by the Temple builders of another dispensation as evinced in the sculptures of many great Cathedrals. Special attention has recently been drawn to this by Professor W. R. Lethaby in a valuable paper of "Suggestions as to the Identifications of the Wells Sculptures and Imagery" in *ARCHAEOLOGIA*, vol. 59, part 1 (the organ of the Society of Antiquaries).

Those who know that glorious West Front of Wells Cathedral will remember its splendid statuary, and in the most important position of the whole, standing in the window piers above the "Coronation of the Virgin," which surmounts the great central porch, are two fine figures, turning towards each other, which have been supposed to be those of the Founder, Ina, King of the West Saxons, and his Queen. Professor Lethaby, however, is certain from analogies elsewhere that they are intended for Solomon and Balkis, or as he prefers to name her, Saba.

He refers first to the well-known pair at Amiens. This Cathedral was commenced in 1220 by Robert de Luzarches, and probably the sculpture is near that date. The figures are at the south door of the western portal on the left side jamb, and under them are small explanatory reliefs, showing them to be King Solomon and the Queen of Sheba. In one panel under the King, he sits on his throne, and in the other is the consecration of the Temple, whilst those under the Queen show respectively the King at table, and he and the Queen conversing. The Professor says: "The meaning of the reliefs and statues is so obvious that it has never, I believe, been forgotten; alike in early guide books and the latest monographs no doubt is expressed of the interpretation." The whole of this western front with its magnificent porches is very rich and elaborate. In the vaulting of the central porch alone there are 150 statues representing the heavenly hierarchy, whilst those on its right and left are little inferior.

At Rheims two similar figures are on the two buttresses of the great central portal, thus occupying the most prominent place in the facade, as well as being the most beautifully finished pair of all on the front. The date of this work is about 1250. Fergusson says of this superb front that it is "perhaps the most beautiful structure produced in the middle ages. Nothing can exceed the majesty of its deeply recessed portals, the beauty of the rose-window which surmounts them, or the elegance of the gallery which completes the facade, and serves as a basement to the light and graceful towers that crown the composition."

There were twelfth century figures at the south-west porch of Notre Dame at Paris, which included Solomon and Saba. These were destroyed during the Revolution, but have been replaced.

Chartres has not only a twelfth century triple porch lavishly adorned with sculpture in the west front, but two still finer triple porticoes of thirteenth century work on the north and south sides, and at the right hand door of the northern are again statues of Solomon and Saba, very similar to those at Amiens. "The noble style of the large statues, the wonderful expressiveness of the statuettes, the variety and life of the bas-reliefs, and the finish of the mouldings, combine to range these portals amongst the most splendid examples of monumental sculpture."

A fine pair of the same statues, originally from the Church of Our Lady of Corbeil, are now at Saint-Denys.

Professor Lethaby instances King Solomon (identified by his name on a scroll) at Le Mans (in the twelfth century lateral porch on the south side), also at Angers (again twelfth century carvings), in each case accompanied by David and by two Queens. He also points out that two figures on the south door of the Baptistry at Parma are named as Solomon and Saba in Venturi's *Storia dell' Arte Italiana*. The Baptistry is a Lombard-Romanesque building, commenced in 1196 and completed in 1270, and the sculptures are attributed to Benedetto Antelami, but show French influence.

The same authority considers that the pair of figures on the west door of Rochester Cathedral, usually styled Henry I. and Matilda, are Solomon and the Queen of Sheba. He argues that the doorway is "a certain offshoot of the Chartres School," and the resemblance of the sculptures to the French type cannot be questioned. On these architectural matters I, as an amateur in their study, can only respectfully accept Professor Lethaby's conclusion, but if there should be any differences of opinion I trust that some of our professional brethren of the Correspondence Circle will have something to say in the discussion.

From all these facts it appears to me that there is ground for believing that the Sheba allusion is of great antiquity, and though rejected in part in some recognised workings, it is, or was until recently, used in many very old Lodges, and is not unworthy of retention. If the statues were seven hundred years ago considered by the Cathedral Builders to be specially appropriate for the prominent positions they occupy in so many stately and superb edifices, it seems feasible that some particular legend suggested such appropriateness, and would therefore account for the mention in our speculative ceremonies.

It is worthy of note that the great Queen should be the heroine of the "Masonic Opera," by Gounod, of which Bro. J. T. Thorp recently gave us such an interesting account.

For the illustrations in this article my grateful thanks are due to the Society of Antiquaries, for the loan of the blocks of sculptures at Amiens, Chartres, Rochester and Wells; to Count de Laskeyrie, for the Corbeil block; to the Rev. Prebendary Fraser, Cathedral Librarian, Chichester, for permission to copy woodcuts from *Biblia Pauperum*, the *Basil Bible*, and Stackhouse's *History of the Bible*; to the Rev. Canon Deedes, for the Venetian Bibles; to the Rev. F. Barrett, Vicar of Barnham, for other Bibles; and to Mrs. Lopresti and the Rev. Prebendary Rickard, for other photographs.

---

BRO. WM. WONNACOTT, in moving a vote of thanks to Bro. Crowe for his paper, said he would like to respond to the author's invitation to offer a few remarks as one of the professional brethren present. Bro. Crowe had by no means exhausted all the Masonic allusions and references to the legends of King Solomon and the Queen of Sheba, and he would draw attention to the following four points:—

1. The F.C. tracing board, referred to by Dr. Oliver in his "Book of the Lodge," chapter v., where he opens by saying "The Tracings Boards of the Second Degree are "two in number,"—and goes on to describe them. . . . "In the second Tracing Board we are favoured with a perspective view, looking from between the pillars into "the Holy Place, with the Sanctum Sanctorum at the farthest extremity; and the "meeting of Solomon and the Queen of Sheba with Hiram, King of Tyre, which have "been introduced as figures, that an adequate idea may be formed of the magnitude of

“the pillars and the dimensions of the most Holy place.” In a footnote to this paragraph Oliver adds:—“As the name of the queen of Sheba has been connected with Freemasonry from the earliest times, it may not be uninteresting to ascertain who she was. Bruce says that among the Arabs her name was Belkis; while the Abyssinians called her Macqueda. Our Saviour denominates her queen of the South; and says that she came from the uttermost parts of the earth to bear the wisdom of Solomon. It is uncertain whether she were a Jewess or a Pagan; but it is clear that she visited Solomon with the intention of puzzling him by hard and unanswerable questions. She appears to have been a person of learning; because the reason she assigned for coming to him was to try whether fame had not exaggerated the report of his wisdom.” From this account we perceive that her intent was to puzzle Solomon, and later, in discussing the mediæval sculptures, we see this idea kept alive in the representations of the queen which adorn the great portals of the continental cathedrals.

2. An allusion to the Queen of Sheba is preserved in the ritual of the degree of Most Excellent Master (but only in the American Jurisdictions), while in England a certain sign in one of the degrees (closely allied to Royal Arch Masonry) is derived from the visit of the Queen of Sheba to the Temple.

3. A further allusion is found in Oliver, “The Revelations of a Square,” p. 381, where he relates the story of the anointing of Solomon by David. The former person requested that the ceremony might be repeated under the gate at Bethlehem, which was supported by the two pillars that Boaz himself had erected. The legend further says that he was sleeping under this gate and between the pillars, “when he was favoured by that most remarkable vision where the Most High condescended to offer him his choice of wisdom, long life, or riches, when he preferred the former. Between these pillars he married his Egyptian wife; and here H.A.B. was first introduced to him by the noble Prince Adoniram. In the same place he received the Queen of Sheba, when she came to view the magnificent Temple at Jerusalem, and to ascertain by personal communication whether the miraculous traditions of his wisdom, and penetration were founded in fact.”

4. A fourth reference, also to be found in the book last quoted, is the Cabalistic legend of the building of the Temple, with precise details of the cost involved, which Oliver gives as a traditional history (preserved at the time of his writing) in one of the Lodges of which he was a member. He tells us he was initiated in a “Modern” Lodge, but afterwards joined one of the “Ancients,” so it is perfectly easy to discover to which he refers, on looking up the context of this passage.

“The workmens’ wages amounted to 140 millions sterling, and the inferior materials to 150 millions. The expense of the whole building was 69,869,832,500 pounds. After all these expenses had been incurred and satisfied, as the legend asserts, the funds subscribed by David, Solomon, Hiram, the Queen of Sheba and others, were unexhausted, for David himself contributed 911,416,207 pounds; and the Queen of Sheba 80,000 millions. It appears, therefore, that the sum of 11,041,583,707 pounds remained as an available surplus after the work was finished, for Solomon to amuse himself with in the erection of palaces and towns at his pleasure.”

“This perilous stuff,” the Square observed, “which is indebted for its origin to the Jewish cabalists, has very properly become obsolete.”

In the “Testament of Solomon,” published in the *Jewish Quarterly* some years ago, is another version of the Sheba legend:—

“ Among them also the queen of the South, being a witch, came in great concern and bowed low before me to the earth. And having heard of my wisdom, she glorified the God of Israel, and she made formal trial of all my wisdom, of all the love in which I instructed her, according to the wisdom imparted to me.”

“ And she beheld the Temple of the Lord being builded. And she gave a shekel of gold and 100 myriads of silver and choice bronze, and she went into the Temple. And she beheld the altar of incense and the brazen supports of this altar, and the gems of the lamps flashing forth of different colours, and of the lamp stand of stone, and of emerald—and hyacinth—and sapphire: and she beheld the vessels of gold, and silver, and bronze, and wood—and the folds of skins dyed red with madder. And she saw the bases of the pillars of the Temple of the Lord. All were of one gold.”

One might expatiate at great length on the probable locality whence this famous personage came, and it would be interesting to have this point settled. There are three places where Sheba, or Saba, might be located, with an approximation to the truth. 1. In the Southern part of Arabia, in Yemen, where the great trade routes from the East and from the ports of Phœnicia converged, passing down the valley of the Euphrates. The kingdom of the Sabœans, at first ruled by priests and later by kings, had its centre in S. Arabia, and their influence extended far to the North, for their trading settlements and garrison stations were found in the immediate neighbourhood of Midian, at Tema (Teimah) and elsewhere. It may at first sight appear strange that no Phœnician inscriptions are to be found in these districts earlier than the seventh or eighth century B.C., but we must remember that earlier than this the Phœnicians were like their neighbours, the Canaanites and the Israelites, rude, uncultured people, with no knowledge of letters other than the hieroglyphs and cuneiform script of their Egyptian, Hittite, and Cretan neighbours.

A second place which might have been the home of the Queen of Sheba is the northern part of Abyssinia, included in the ancient kingdom of Ethiopia. At one time both this and Egypt were under one ruler, and the arts and civilisation of one country naturally found its way into the other. The Hebrews had much intercourse with it in early times, and during and after the Captivity many Jews settled here, and brought a knowledge of the Jewish religion. According to the Abyssinians themselves, the Queen of Sheba was a monarch of their country, and from her son Menelik the present dynasty descends. A third theory, and a very likely one, places Sheba in the mineral region known now as Mashonaland, between the rivers Limpopo and Zambesi, of which Great Zimbabwe was the capital. From recent discoveries we can trace a close connection between this gold producing centre and the southern coast of Arabia (probably by way of Madagascar), and the positions of Ophir, the emporium of oriental trade, and of the port of Havilah can fairly accurately be placed. The latter seems to have been the modern Sofala, the ancient Tharsish, and in the district are to be found monuments and remains of the S. Arabian Himyarites (of the age before they produced inscriptions) dating apparently from about 2000 B.C., followed in the time of Solomon, say *circa* 900 B.C., by the Jews and Phœnicians and later by Arabs who traded there.

In the particular domain of Bro. Crowe, where I must not venture, there is no reference to De Nerval's story, although reference is made to Bro. Thorp's recent paper on Gounod's opera. This story was produced in 1848 for Meyerbeer to set to music, in the form of an opera, and was entitled “The History of the Queen of the Morning, and Soliman, Prince of Djinnr,” which afterwards was sandwiched into his later work, “Voyage en Orient.” In 1875 this was pirated by Heckthorne and produced as his own invention in his book, “Secret Societies of all ages and countries.” The history of all

this has been traced out by Bro. Rylands, in the discussion of Rev. Bro. Windle's paper in vol. xiv. *A.Q.C.*

Bro. Crowe also modestly refrains from mentioning his own contribution concerning Mozart and his accidental connection with Freemasonry, related in vol. xvi. *A.Q.C.*, where Bro. Thorp's paper on "Freemasonry in Gounod's opera" is to be found.

It is not difficult for us to understand the veneration of Masons, both Operative and Speculative, for the name of King Solomon, for there is no other more prominent in connection with our ritual and lectures. The building of the Temple by Solomon forms a mighty landmark in the history of the operative art, and down to the time of Anderson the legend was preserved and cherished by the Masons and handed down in a more or less perfect form. "Long before 1717, at any rate, the speculative guilds "upheld the Solomonic parentage of the great building art," observes Woodford. "When the Solomonic origin of Masonry was first propounded it is difficult to say, but "we fancy that, as long as there has been any mystical teaching, the tradition of "Solomon and Hiram has been carefully preserved. Oliver seems to think that the "Solomonic theory is Rosicrucian: in this we differ entirely from our good old teacher. "We see no reason why the Solomonic tradition may not itself be substantially true. "At any rate it is very ancient: and as the traditions preceded the constitutions, we "obtain a very venerable antiquity for it."

Whenever, or wherever, the Masonic legend originated, we see the fame and splendour of King Solomon standing out, in great prominence, the greater because none of his successors could rival him, and the passage of time has only exaggerated the proportions of so striking a figure. One of his passions was architecture, and in this he tried to rival other oriental sovereigns of his time, just as with his gorgeous court and immense harem he endeavoured to outshine his Egyptian father-in-law. To satisfy this passion he required copious means, so he encouraged in every possible way a closer intercourse with other nations and thus widened the intellectual horizon of the people.

Of his great work, the Temple,—though we should not lose sight of his other work, the Palace, which took twice as long in building as the former,—we have the best and most detailed account in the Books of Kings, the second division of which (out of three) is the history of Solomon and his doings. The main source of this account was the "Acts of Solomon," (1. Kings xi., 41), which was not a regular chronicle, as the narrative is not continuous, nor due to a single hand. For the account of the dedication of the Temple the original author used the book of Jashar, and evidently had access to some exact particulars as to dates, the artist Hiram, etc., which may have been contained in the temple records.

Of the "Operative Masonic Association" of Biblical narrative with sacred buildings, we find numberless instances in all ages. During mediæval times the Masons continually presented their versions of Bible story, and endeavoured to carve in stone what we now have in print, for all the world to read in times when no books existed, and manuscripts were scarce. Ruskin wrote some stirring passages in his "Bible of Amiens," and describes there the soulful task of the operative, the facility with which he expressed himself, and the wonderful fertility of his ideas.

Turning now to the examples of mediæval art referred to by Professor Lethaby, I must first draw attention to the fact that the paper referred to by Bro. Crowe is one supplemental to a "catalogue raisonnée" (if I may so term it) by Mr. W. St. John Hope, F.S.A., the title of his critical review being "The imagery and sculptures on the west front of Wells Cathedral," and Prof. Lethaby's contribution is an endeavour to ascertain (chiefly by analogy) the names of some of the statues,



I must take exception to the description of the position of the so-called Solomon and Sheba statues at Wells as being "in the most important position of the whole (west front)," and in spite of the reasoning of Prof. Lethaby, for whose learning and research I have a profound respect, I am inclined to think that Prof. Cockerell was not far wrong when he gave to these the names of King Ina of Wessex and his Queen. Further, the standing figures appear to be divided into two series, all on the north side of the axis being Bishops (or ecclesiastics) and all on the south side Kings, and it is hard to say why Solomon should be placed here on the dividing line. It is not safe to reason by analogy solely, for although the famous examples at Paris, Rheims and Amiens were in progress about the same time that Bishop Jocelyn was at work on the Wells front, it is clear that no French precedent was followed in the design of this façade, for it lacks the immense portals of the others, and the doorways have been kept small, almost ludicrously so, and the sculptures decorating them are on a small scale also. Again there is no precise analogy between the pair of figures at Wells, as regards their position in the scheme, and those of Chartres and the others, where they seem to have been placed haphazard, and without any definite scheme.

I do not wish to deny that there are figures of Solomon and Sheba at Chartres or Amiens, but to emphasise the fact that no analogy as to position or scheme can be traced.

At Amiens the small explanatory reliefs below the statues indicate the names without question, for under Solomon is shown his consecration of the Temple, and under Sheba are the King and Queen conversing, "he pointing upwards and she "listening in admiration." These may be dated as 1225-1235, on the authority of M. Georges Durand. In contrast to the position of the figures at Wells, it should be noted that the Amiens examples occur in the South doorway of the West portal (there being three doorways), and on the left hand jamb of that particular doorway.

But when we come to Chartres, the figures are not on the West front at all, but are placed on the jamb of the right hand doorway (of three) in the North porch. In this case the index sculptures below them indicate without any uncertainty that Solomon and his visitor are intended. Here the sculptor shows below the figure of the Queen, an Ethiopian carrying a vase full of coins and a long purse or bag of money, in allusion to the great wealth she brought with her to Jerusalem,—the "Golden Legend" version says "She then gave to the King 120 bezants of gold."—These figures are dated by Viollet-le-Duc as between 1230-1240, though many authorities affirm they are much earlier, 1215 to 1220.

At Rheims also we see no proof in support of the argument for Wells, although the figures there are finer and the sculpture takes its position on a higher plane than those at Chartres and Amiens. At Angers (about 1160-70) and at Le Mans (about the same date) one is justified in saying that the figures there referred to are not Solomon and the Queen at all.

But when we arrive at the example quoted from Rochester, there is not only a want of analogy but a decided difference in type also. All the former examples are of portals decorated with profuse sculpture, in "orders"—or varying planes, but at Rochester we have an example of a single door decorated with but one pair of statues, one on either hand. What proof is there here of the Professor's argument? None, I venture to say, and his case breaks down for want of evidence. There is no doubt that the figures at Rochester are those of Henry I. and his Queen Matilda, and if this instance is quoted in favour of Wells I am of opinion that Cockerell is supported in his

contention that the figures now under discussion are those of Ina, King of Wessex and his Queen.

The Queen of Sheba is represented in these mediæval sculptures, as we have already seen, as being the possessor of great wealth, which she brought with her to Jerusalem, the vase full of "bezants" being an instance from Chartres, so also is the long purse or money bag another reference to her riches, and in others, alluding to the hard and puzzling questions she put to Solomon, is the notebook, or rather tablets she is often holding in her hand.

It is interesting to note that at Wells we have preserved the names of some of the masons, unearthed through the untiring researches of Canon Church. They are (1) Adam Lock, and his son (2) Thomas Lock, 1224-34, and (3) Master Noreys, 1235-49. In other cases where they are not named, the masons are termed "operarius" and "imaginator," perhaps a sort of designer, or probably the one who made the models for the carver, in fact, the real sculptor.

In differing from the theory of Professor Lethaby, I do not wish in the least to detract from the value of the paper written by Bro. Crowe, but to offer him in the name of the Lodge our very hearty thanks for his remarks, and for placing before us a subject it will be well to follow up in our masonic research.

Bro. the Rev. MORRIS ROSENBAUM, P.P.G.C. Northumberland, said:—I note that Bro. Crowe has made no mention of the Jewish version of the story recording the visit of the Queen of Sheba to King Solomon. This is to be found in the "Targum Shêni," (Second Aramaic Paraphrase) to the Book of Esther, and is as follows.

"When King Solomon's heart was merry with wine, he was wont to assemble in his banquetting hall kings & princes, & caused all living animals and birds to dance before them. On one occasion the King observed that the mountain-cock, or hoopoe, was absent. Having been brought & asked the reason of its absence, the bird replied that for three months it had been flying hither & thither in order to discover some country not yet subjected to the King of Israel. Such a land he had at length discovered in the East, the capital of which was Kitor. The dust of that land was precious as gold, silver lay scattered in the streets like dirt; the trees dated from the six days of Creation, its waters flowed from the Garden of Eden. The inhabitants were unaccustomed to war, knowing not guile or falsehood. They were ruled by a woman who was called the Queen of Sheba. The hoopoe suggested that it should fly to the Queen & bring her & her ministers to King Solomon. The King, therefore, had a letter tied to the bird's wing, in which he commanded the Queen of Sheba to come to him. When, one morning, she was making her adoration to the sun she beheld a flock of birds which shut out the light of heaven. As she looked in amazement at the sight a hoopoe flew towards her, & she saw the letter beneath its wing. Having taken it, she read Solomon's command & the threat that unless she obeyed it he would send against her hosts of beasts, birds, spirits & devils & the demons of the night.

In her terror she consulted her elders & princes who, however, declared that they had never heard of King Solomon & advised her to ignore that monarch's commands. She, however, collected her ships, loading them with costly woods & precious stones, & sent to King

Solomon six thousand boys & girls, all born in the same hour, of equal stature, all clothed alike in purple, & with them a letter stating that she would appear before him within a period of three years, although Kitor was seven years' journey from Jerusalem.

On her arrival at the appointed time the King received her in his "glass house." Thinking that Solomon was sitting in the water, she raised her skirt, whereupon noticing hair upon her legs, he said: "Thy beauty is a woman's beauty, but thy hair is a man's hair; hair adorneth a man, but disfigureth a woman." The Queen of Sheba put three riddles (*so this version*) to King Solomon in order to test his wisdom. To these he replied correctly, and the Queen said: "I refused to believe what I had heard concerning thee until I had seen with mine own eyes: and now I find that I have not heard even one half of thy glory & wisdom. Happy are thy men & thy servants." The King brought her into his palace & when she saw its splendour she gave thanks & praise to God, & said "Blessed be thy God who hath placed thee on the throne to execute righteousness & judgement." She gave the King gold & silver in abundance, & he gave her all her desire.

This version, as the Arabic, represents the Queen as coming in answer to Solomon's summons: yet her own remarks refer distinctly to her having previously heard of his wisdom and glory, and suggest that she came for the purpose of proving whether report was well-founded or not.

Perhaps some of the riddles which the Queen of Sheba is stated to have propounded to King Solomon may prove of interest to the brethren. The Bible does not mention what they were, but Rabbinical writers give them in different forms. There are three versions of the riddles: The Targum Shèni, quoted above, gives three riddles; the Midrash on Proverbs i., 1, four riddles; and a MS. of the fifteenth century (see *Folk-lore*: vol. i., p. 347 ff) gives nineteen. Many of these are of the "naughty" class and therefore unquotable: others are only Biblical questions of a genealogical character

- (1) A well of wood, a pail of iron which draws up stones and pours out water.
- (2) What is that which comes from the earth as dust, the food of which is dust, which is poured out like water, and which yet adhereth to the house?
- (3) What land is that which hath but once seen the sun?
- (4) When living it moves not: when its head is cut off it moves.
- (5) What is that which is produced from the ground yet man produces it, while its food is the fruit of the ground?
- (6) In the storm it moves and gives forth a loud and bitter cry, bending its head like a bullrush; it is the glory of the rich, the shame of the poor; an ornament to the dead, a mockery of the living: the joy of the birds, the sorrow of the fishes.

The answers are (1) A tube of cosmetic. (2) Naphtha. (3) The land forming the bed of the Red Sea, upon which the sun shone only on that day when the Israelites passed through it on dry land. (4) A ship—the living tree has no motion; the trunk from which the crowning branches have been severed, supplies the material for the moving vessel. (5) A wick. (6) Flax.

With regard to No. 1. A Jewish comment runs:—"It is a tube made of wood in which is put a dye made for colouring the eyes: the dye is very hard like a stone: the dye is taken out from the tube by means of an iron spoon and when it is smeared

over the eye the water runs out." The same author explains No. 2: "Naphtha is extracted from the earth like water because it is thin and it will stick to a house" (cf. also Rosenmüller, *Biblische Naturgeschichte*, I. Theil, p. 14). The MS. containing No. 5 has also an Arabic gloss: "Men plait the wick and then light it; for if it had not been plaited it would not burn evenly. Therefore it is considered as if man had created it, i.e. made it." The following explanation of No. 6 has been given: "As a sail flaps violently in the storm, it gives forth a loud shriek, and the linen made of flax bows low its head like a rush. Linen is a cause of dignity to the rich, who wear byssus; a cause of shame to the poor, who wear rags; an ornament for the dead in their shrouds, which are white as angels, and a mockery to the living (the rope of flax): a joy to the birds, which pick up the seeds of flax, and a vexation to the fish on account of the nets." (cf. Pliny in his Introduction to Book 19, where he says of flax: "*Andax vita, scelerum plena, aliquid seri, at ventos procellas recipiat.*")

I believe that the Arabic Versions have but one riddle, although they state that the Queen tested Solomon's wisdom by asking him to thread a pearl through which a hole had been bored in a crooked direction. Tabarî gives the riddle thus: "Tell me what water is that which comes not from heaven above nor from the earth beneath." Alkisâi has it in a slightly different form: "He was to fill a goblet with water which neither fell from heaven nor sprung forth from the earth." The water is the sweat of a runner, (cf. C. Landberg: *Proverbes et dictons*; I., 163, No. 91).

Whilst it must be confessed that there is no hint in the Scriptures that it was the fame of the Temple which induced the Queen of Sheba to pay a visit to King Solomon, yet it should not have been difficult for writers of the seventeenth or eighteenth centuries who had some acquaintance with the Biblical history to find some grounds for ascribing to her a visit to the Temple. In I. Kings, x., and in II. Chronicles, ix., we read that the Queen of Sheba saw all "Solomon's wisdom and the house that he had built. And the meat of his table . . . and his ascent by which he went up into the house of the Lord." This ascent appears to be referred to again in verse 12 in Kings and verse 11 in Chronicles: "The King made of the alnum trees terraces (or stairs) to the House of the Lord and to the King's palace." This seems to have been a private staircase leading from the royal palace into the Temple, by means of which the King used to enter the sanctuary.

The Targum (or Aramaic Paraphrase) to Chronicles was first published by Beckius, that to the first Book in 1680, that to the second Book in 1683. It was accompanied by a Latin translation and notes. The statement that the Queen saw the House which King Solomon had built, is assumed by the Paraphrast to refer to the Temple, for he renders it by *Bêt Mikd'sha*, which Beckius translated by "sanctuarium." In 1715, David Wilkins printed a version of this Targum from a MS. at Cambridge. The Aramaic, as in Beckius, gives "*Bêt Mikd'sha*" for "the House," although the Latin translation with which Wilkins accompanied his edition overlooked the Targumist's addition, and gives only "*domum quam aedificaverat.*"

These editions of Hebrew works with Latin translations were much read during the seventeenth and eighteenth centuries, and it may have been from Beckius' or Wilkin's Targum to Chronicles that the statement was worked up that the Queen of Sheba went with King Solomon, perhaps by means of his private means of access, to view the Temple. Even without the aid of such publications it would not require a very lively imagination to assume that during her visit to Jerusalem the Queen would visit all the sights of the capital, amongst them the Temple. A step onwards in imagination would lead to her being accompanied on her visit to the Temple by the

King himself; and—more particularly at a time when people were flocking to view models of King Solomon's Temple in London and on the Continent, and were beginning to regard it as the most wonderful building of antiquity—another step would result in the fabrication of the statement that the very purpose of the Queen's visit to Jerusalem was to see the beautiful Temple, the fame of which had reached her.

Curiously enough Oliver seems to have known or heard something about the 1715 edition of the Targum to Chronicles. In the "Freemasons' Treasury" (p. 288), he says that the legend of the Master Builder's death is to be found in a translation of the Targum to Chronicles, published at London in 1715. So far as I can discover, there has never been an English translation of this Targum published. As I have mentioned, the Aramaic Targum, together with a Latin translation of it, was printed in 1715, but at Amsterdam, not at London. It was edited by an Englishman, David Wilkins, and was dedicated to Charles, Duke of Somerset, Chancellor of the University of Cambridge, and so may have been well known to scholars in this country. I have, however, read this through most carefully, and find that it contains nothing at all bearing upon the Builder's death. Yet the very incorrectness of detail in Oliver's categorical statement almost makes one believe that he did not invent it, but that he had heard that something similar to the Hiramic legend had been printed in a translation of a Hebrew work about the time of the establishment of the First English Grand Lodge, *i.e.*, only six or seven years, I believe, before we have any definite and certain reference to a Third Degree. A search amongst such works published about that period might prove profitable, and help to throw some light upon the traditional history of this degree.

Bro. E. ARMITAGE said:—I have great pleasure in seconding the vote of thanks to Bro. Crowe for his interesting paper. I think we might with advantage have in full the quotation from the Koran which deals with Solomon and the Queen of Sheba. It is very quaint, and from it we may gather the character of the numberless tales woven by the Eastern story-teller of this illustrious pair. Let me quote a little interlude from Edward Fitzgerald's translation of the "Salámán and Absáh" of Jami, a well-known Persian poet and Sufi doctor of the fifteenth century.

"Once upon the Throne together  
Telling one another secrets,  
Sate Sulaymán and Balkís;  
The Hearts of both were turn'd to Truth,  
Unsullied by Deception.  
First the King of Faith Sulaymán  
Spoke—'However just and wise  
Reported, none of all the many  
Suitors to my palace thronging  
But afar I scrutinize;  
And he who comes not empty-handed  
Grows to Honour in mine Eyes.'  
After this, Balkís a secret  
From her hidden bosom utter'd,  
Saying—'Never night or morning  
Comely Youth before me passes  
Whom I look not after, longing.'  
If this, as wise Firdausí says, the curse  
Of better women, what then of the worse?"

Bro. F. J. W. CROWE writes in reply :—

I am gratified to find that my paper led to such a very interesting discussion, and I greatly regret that an important professional engagement rendered it impossible for me to read it myself.

In reply to those who spoke on the subject I will first notice the comments of Bro. Rosenbaum. I find that the *Targum Shēni* version he quotes differs from the *Koran* in calling the bird a mountain-cock, or hoopoe, and also as to the letter being tied to the bird's wing. Jallalo'ddin says that the Queen was in the midst of her army, and the lapwing threw the letter into her bosom. Other Arabian writers say that it flew into an open window of the palace. They also say that she sent "five hundred slaves of each sex," instead of a total of six thousand.

I cannot find any record of the riddles Balkis asked the King, but it is stated that he received a pearl not drilled, and an onyx (not pearl) drilled with a crooked hole. He ordered one worm to bore the pearl, and another to thread the onyx.

The "glass house" in the Arabic version is supposed to be a courtyard before the palace, built by King Solomon against her arrival, the floor being of glass, over running water in which fish were swimming. He had been told that her legs and feet were covered with hair like those of an ass, and hence he contrived this plan to ascertain the truth. One of his Genii removed the hair by means of a depilatory, and the King then married her.

In the foregoing I have practically complied with the wish of Bro. E. Armitage for the full quotation from the *Koran*.

I am conversant with the other Masonic allusions quoted by Bro. W. Wonnacott, and only omitted them with other matters through pressure of time. Although the idea of my paper had been in my mind for a considerable period, I finished it somewhat hurriedly to fill a gap in our promised list of papers to be read.

The version of the "Testament of Solomon" is quite new to me, and I am obliged to Bro. Wonnacott for unearthing it.

As to the locality of Sheba, I believe Eastern writers favour the first place named by him, Yaman or Yemen. Dr. Pocock has placed Balkis as twenty-second in the list of the Kings of Yaman; and she is said by all Arabic writers to be a descendant of Yârab Ebu Kahtân.

On the architectural points, I am, as I explained in my paper, only an appreciative student, and do not feel competent to take a firm stand, but I laid Bro. Wonnacott's opinions before my friend, Mr. E. S. Prior, M.A., F.S.A., who is a well-known writer on these subjects, although, to my regret, not a Freemason. I may mention that it was a chance conversation with Mr. Prior which first directed my attention to this subject from a Masonic standpoint, and hence led to my paper, so that I think I may fairly quote him.

Mr. Prior says :—"Mr. Wonnacott extracts information from Professor Lethaby, but fails to understand his argument. In the first place that argument was not supplemental to, but part of, a joint investigation made together by Professor Lethaby and Mr. St. John Hope of the statues at Wells, at close quarters, from the scaffolding put up along the front in 1904. The contentions of their argument are indeed clear enough. There remain in France and England, certain twelfth and thirteenth century doorways upon which are sculptured figures, usually in the jambs, of a King and Queen, evidently designed to be in connection. It is quite immaterial whether these doorways happen to be west, or south, or north, but what is material is the establishment by Professor Lethaby of the fact that these king and queen figures

are in prominent attendance on a scheme of iconography, which glorifies the Christ or the Virgin with the Christ. Now anyone who has given attention to the sculptures of the middle ages is aware of the widespread uniformity and permanence of its motives. France, England, Germany, Italy and Spain, from A.D. 1000 to 1500 carved the same subjects, with the same dispositions and arrangements. Therefore when these kings and queens are clearly proved to have been intended for Solomon and Sheba, at Amiens and Chartres, the presumption is strong that they have the same meaning in the earlier works, whether in England or France. In fact, the theory can only be contraverted by some fresh discovery which will disprove it. Mr. Wonnacott says he has no doubt that the figures at Rochester are meant for Matilda and Henry I., and is of opinion that those at Wells are Ina and his Queen. Has he made some new discovery? I fear not. Such ascriptions were made at Rochester and Wells sixty years ago, and belonged to an archæology of very ancient odour, which consisted of guess work when there were no grounds for conjecture. Is it then that Mr. Wonnacott has discovered that the fronts of Rochester and Wells are not on the pattern of Chartres and Amiens? But this is hardly relevant to the point—Apple trees are sometimes standards and sometimes espaliers, but the difference in the trees is no proof against the apples! Nor can I see how it helps Mr. Wonnacott's opinion that he stumbles over 'operarius' and 'iminator'—well discussed terms by Wyatt Papworth and others, this long time back. In fact Mr. Wonnacott's discoveries seem to be only of the obvious, and leave Professor Lethaby's contention untouched."

This opinion from the author of "The Cathedral Builders in England" seems thoroughly reasonable and quite bearing out the contentions I named in my paper. As to Rochester, the opinion of the Rev. A. J. Tearman of that city may be considered to have some weight, and he is by no means as decided as Bro. Wonnacott. He says that, as for the opinion that the figures are King Henry and Matilda, it can be said that they were the reigning sovereigns at the time the west front was built, and that the King was sufficiently interested in the work to be present in person at the dedication. Again, on the other side, the design of the west front is French, more or less, and the figures bear a resemblance to those of Solomon and Sheba in foreign cathedrals. He concludes "In the existing state of the evidence it appears to me impossible to come to a positive conclusion. I know of nothing to make either theory absurd." There I must leave the argument as far as I am concerned.

I omitted to express my thanks to Messrs. Dawkes & Partridge, of Wells, and Mr. A. F. Eastmead, of Rochester, for their kind permission to reproduce the photos of those Cathedrals.

FRED. J. W. CROWE.

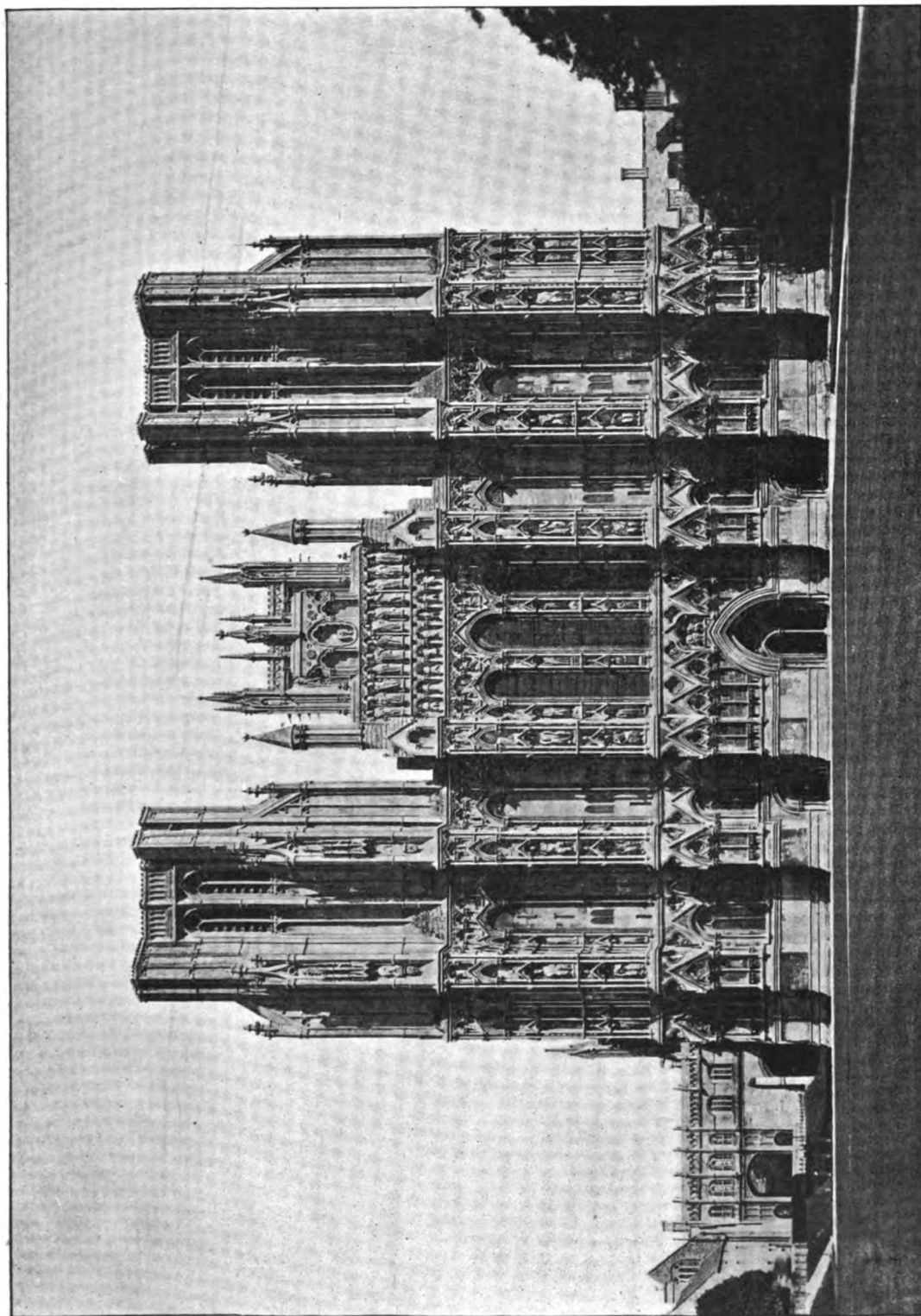

**KING SOLOMON AND THE QUEEN OF SHEBA.**

(The two lower figures on either side of centre light of window.)

WELLS CATHEDRAL. WEST FRONT.





ARS QUATUOR CORONATORUM.



KING SOLOMON AND THE QUEEN OF SHEBA.  
(WELLS CATHEDRAL.)





**KING SOLOMON AND THE QUEEN OF SHEBA.**

(The figures inside the porch. Unfortunately only one is visible.)

**ROCHESTER CATHEDRAL. WEST FRONT.**





KING SOLOMON AND THE QUEEN OF SHEBA.  
(ROCHESTER CATHEDRAL.)





**KING SOLOMON AND THE QUEEN OF SHEBA.**

(The figures are on the central buttresses.)

RHEIMS CATHEDRAL. WEST FRONT.





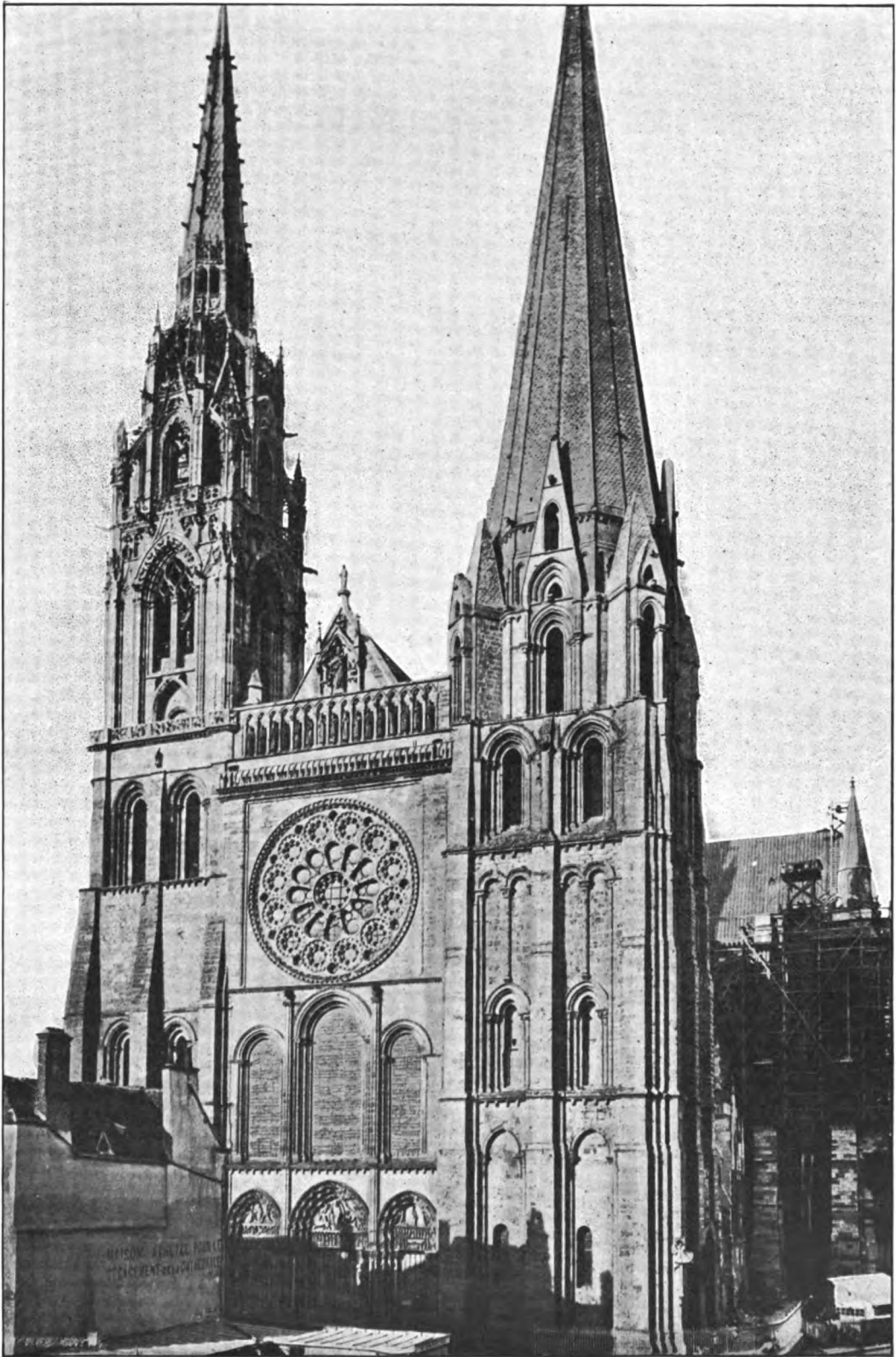

*From Photo. by F. Fritth & Co., Ltd.*

**KING SOLOMON AND THE QUEEN OF SHEBA.**

(This shows the greater importance of the lateral porch as compared with the western.)

**CHARTRES CATHEDRAL. WEST FRONT.**



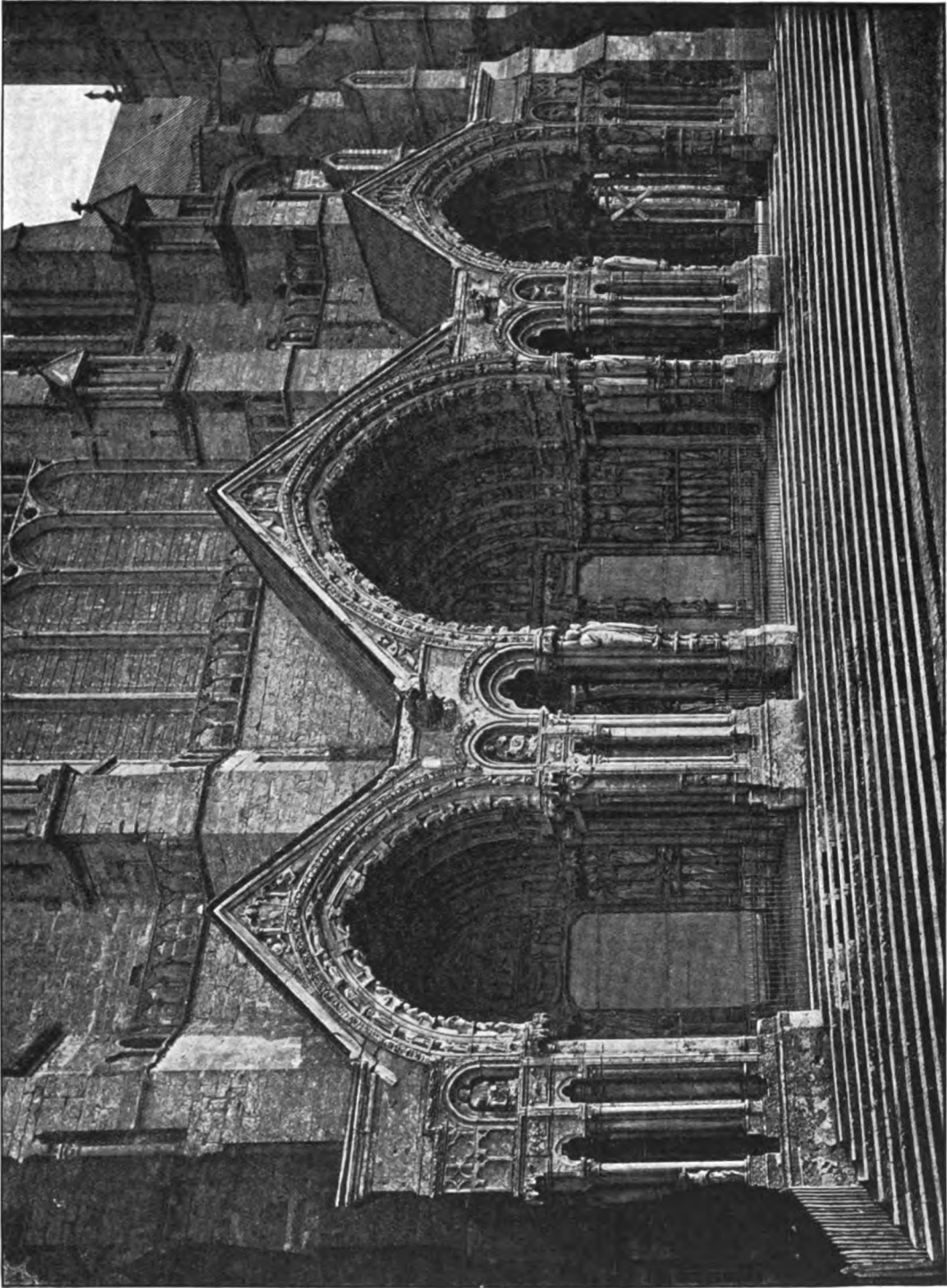

**KING SOLOMON AND THE QUEEN OF SHEBA.**  
(Figures at the right-hand door.)  
**CHARTRES CATHEDRAL. NORTH PORTAL.**



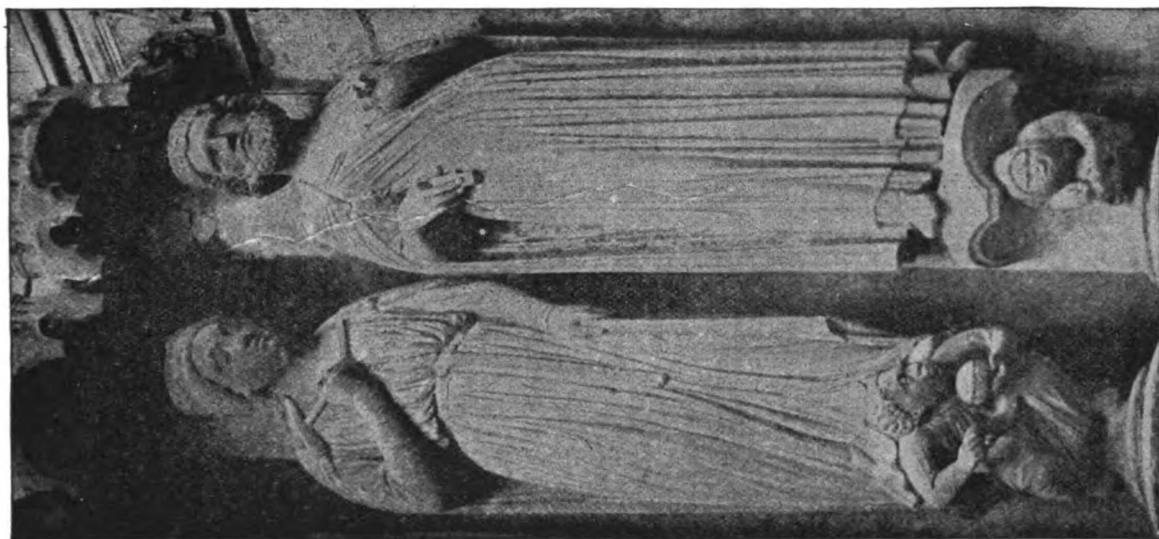

KING SOLOMON AND THE QUEEN OF SHEBA.  
(CHARTRES CATHEDRAL.)



(AMIENS CATHEDRAL.)



ARS QUATUOR CORONATORUM.



**KING SOLOMON AND THE QUEEN OF SHEBA.**  
(At the south door of the Western Portal, on the left side jamb.)  
**AMIENS CATHEDRAL. WEST FRONT.**





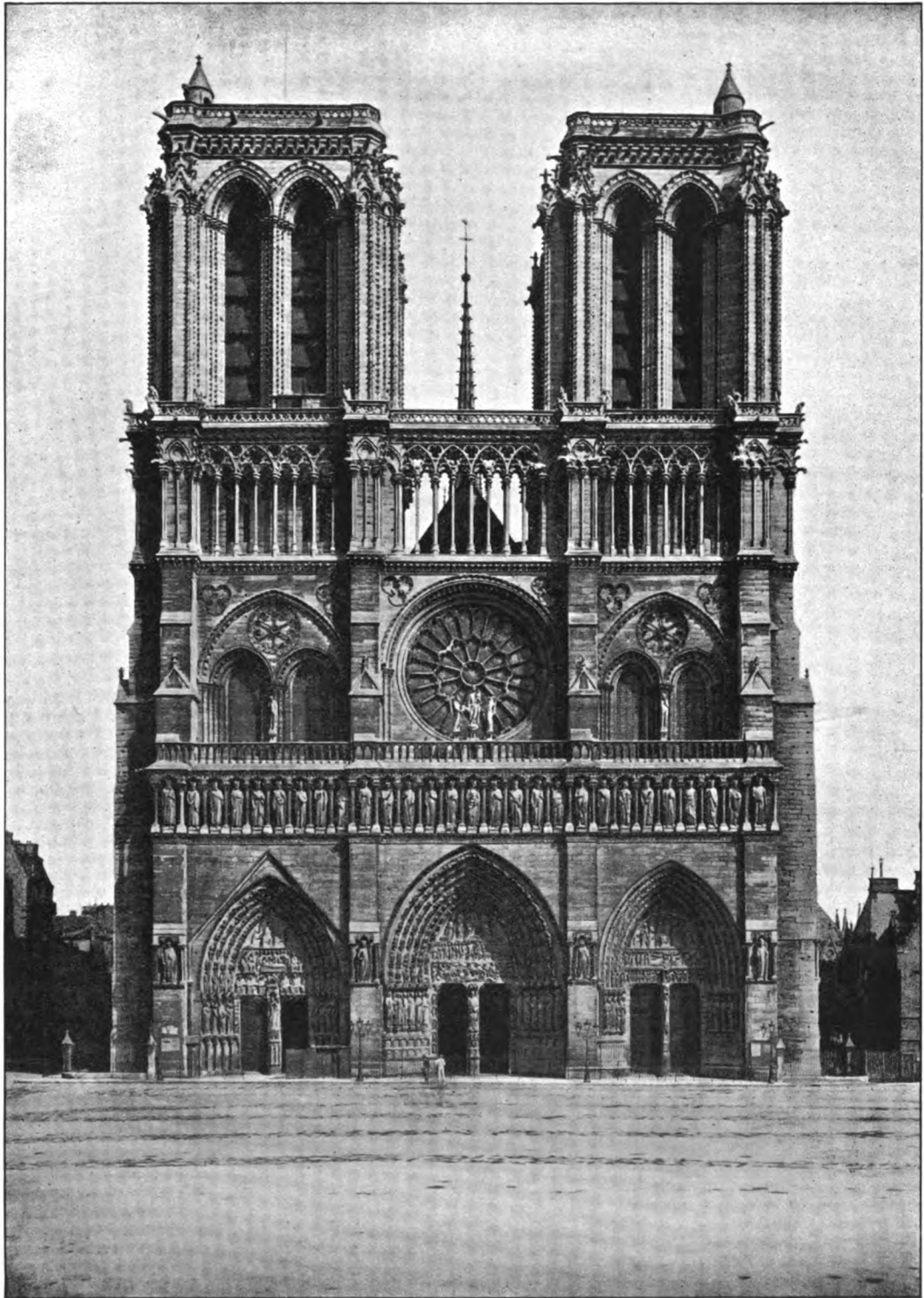

KING SOLOMON AND THE QUEEN OF SHEBA.

(Figures on the South-west porch.)

CATHEDRAL CHURCH OF NOTRE DAME, PARIS. WEST FRONT





KING SOLOMON AND THE QUEEN OF SHEBA.

From the Church of Our Lady of Corbeil. (Now at St. Denys.)

(By kind permission of M. le Comte de Lasteyrie.)





KING SOLOMON AND THE QUEEN OF SHEBA.

(The right-hand group.)

From the "BIBLIA PAUPERUM," XV. Century.





KING SOLOMON AND THE QUEEN OF SHEBA.

(The right-hand group.)

From the "BIBLIA PAUPERUM," XV. Century.





ARS QUATUOR CORONATORUM.



**KING SOLOMON AND THE QUEEN OF SHEBA.**  
From "Biblia Sacra. Vulgatæ Editionis."  
Venetiis, MDCXCVII.



**KING SOLOMON AND THE QUEEN OF SHEBA.**  
From "Biblia Sacra. Veteris et novi Testamenti;  
Secundum editionem vulgatam."  
Basileæ MDLXXVIII.





KING SOLOMON AND THE QUEEN OF SHEBA.

From "Den Bibel Inhondende, hetonde ende  
nieuwe Testament." MDLXV.

Probably printed at Antwerp. Illustrated by Cip. van Sichem.



KING SOLOMON AND THE QUEEN OF SHEBA.

From "Biblia ad vetustissima exemplaria."

Venetis, MDLXXXVII.





**KING SOLOMON AND THE QUEEN OF SHEBA.**

From "The History of The Old and New Testaments,"  
translated by several hands from the Sieur de Royaumont,  
London, MDCCIII.





KING SOLOMON AND THE QUEEN OF SHEBA.

A Reproduction of Raphael's Picture, from "A New History of The Holy Bible" etc.,  
by Thomas Stackhouse, A.M., London, MDCCLII., vol. II.





## J. MORGAN, AND HIS PHENIX BRITANNICUS, WITH NOTES ABOUT HIS OTHER WORKS.

BY BRO. HARRY SIRR, F.R.I.B.A.



OWARDS the end of that period with which the vitality of the so-called "Order" of Gormogons is identified, in fact, in January, 1731, J. Morgan started in periodical form, with the suggestive title, "Phœnix Britannicus," an interesting collection of scarce and curious tracts compiled by himself. The scheme was excellent, the paper and printing of the best, and the price moderate. The high standard of his selections will be understood from the estimate of the whole periodical, in the Dictionary of National Biography, which describes it concisely as one of "great merit." Yet it was discontinued after six numbers had been published, from want of encouragement we are told by the Dictionary.

Perhaps all might have been well but for the extravagance of the Dedication, a feature of the miscellany, which must arouse curiosity amongst Freemasons who are interested in the period of the early eighteenth century. Plainly, it was intended to arrest attention, and no fault can be found with the large and beautiful type. But when allowance is made for the times and excess of adulation, it is hard to believe a "curiously slavish tone" would have been helpful to J. Morgan, the interested author, who by very reason of the position he assumed, did not leave it to be inferred that he belonged to the Masonic Order. Immediately concerning Masonic affairs he promulgated his own loyal animadversions, calling attention to contemporary insults which had been impudently directed and published against the Order. With the advancement of his project in the forefront, his wisdom in doing so independently was especially open to question.

If the mode of expression, and its occasion, do not predispose in his favour, his candour is so evident that want of diffidence may now be passed over, and the absolute loyalty of the sentiments declared can, of course, be put to his credit.

It is quite evident he spared neither trouble nor expense; naturally he was anxious to secure good support, and there is room here for fellow-feeling. It is impossible to estimate the amount of time consumed merely in searching for materials which bear upon British history, biography, and kindred subjects. But recognition of the fact that it must be considerable will bring regret that Morgan was obliged to discontinue this most interesting periodical which collected such information in convenient form so that it could be readily accessible. As the published volume appears to be scarce, a reprint would doubtless be welcomed in the present day.

The Dedication, it should here be stated, was subsequently shortened; the following copy presents it in the original form.

The impracticability of reproducing in the contemporary type will be understood, but, to give some idea of the scale, attention may be directed to the fact that the name CHARLES (just as in the title-page, shortly to be noticed, the word COLLECTION) is printed in letters which are no less than half-an-inch in height though the book is but quarto size.

TO HIS GRACE  
**CHARLES,**  
 DUKE OF  
**RICHMOND and LENOX, &c, &c,**  
 Knight of the Most Noble Order of the  
 GARTER, &c, &c, &c,

*My* LORD!

THE experimental Knowledge I have of that *rare* Candor and Humanity, which so conspicuously accompany and adorn the amiable *rest* of Your GRACE's beautiful Qualifications, emboldens me to this Intrusion; nay without farther Apology: Since to say more would be rather Arrogance, and Aggravation of the Presumption.

Yet, in some *Regards*, My Lord, I cannot but, in great Measure, deem it a Duty, indispensibly incumbent on me, to lay at Your GRACE's Feet this *Trifle*; and am only sorry at my not having any *Offering* of more Value or Merit to tender.

Of these Considerations, My Good Lord, this may be granted to be none of the least; viz. The undeserved Honour, by me unworthily enjoyed, of *belonging* immediately to a *Place*, so illustriously enobled by the *Condescension* of a Right Noble *Duke* of RICHMOND, who *there*, peculiarly, sits PRESIDENT!

The *Scheme* of this, in a different Garb, Humbly *Inscribed* to my R.W.M. Your GRACE has seen before: And because the then *Title*, &c. were, by *indifferent* Persons, looked on as somewhat too *particular*, it now again begs Your GRACE's Patronage, under a *Title* more *general*. And whither else ought I to conduct it, or indeed can I, with a better prospect of Success?—Under your GRACE's Auspices it cannot surely miscarry.

With the Great Name of RICHMOND in its Front, how can I despair of a favourable Reception? More especially among the *Members* of that most Ancient and Honourable SOCIETY, at whose Head, so to their Honour and Benefit, and with such universal Applause, Your GRACE has once vouchsafed to appear?

Nay, it would be unpardonably injurious to the very Efsence of that worthy *Fraternity*, whereof I have the Happinefs of being a *Member*, to harbour the least Diffidence of a kind Concurrence from so beneficent a *Community*, so conspicuously and exemplarily remarkable for their Pronenefs to countenance and assist their *Brethren*, if industrious, and in any Degree worthy of Favour. How then can a well-meaning *Brother* doubt of a *Brotherly* Reception? especially one who, while he addresses them in order to receive in one Hand a *Fraternal Benevolence*, is no less ready, with the other, to return somewhat of an Equivalent? —And so far I am from looking on it as an *Impossibility*, that I cannot quite think it even an *Improbability*, but that as gallant a *List* of my benevolent *Brethrens* Names may appear, in the Front of my First *Volume* (Patronized by Your GRACE) as personally did, with Emulation, at our now Right Noble GRAND-MASTER's late auspicious INAUGURATION.

None knows better than You, My Lord, that the real *Characteristic* of the SOCIETY (which is not only so illustriously adorned with the *Countenance* and *Protection*, but also splendidly supported by the munificent *Benefactions* of Your GRACE, and so many others of the Prime Nobility and Gentry of the three Realms) lie scouched (*or ought so to do*) in these Lines;

*If all the social Virtues of the Mind ;*  
*If an extensive Love to all Mankind ;*  
*If hospitable welcome to a Guest ;*  
*If speedy Charity to the Distrefs'd ;*

*If due Regard to Liberty and Laws ;*  
*Zeal for our King, and for our Country's cause ;*  
*If these are Principles deserving Fame,*  
*Let MASONS then enjoy the Praise they claim.*

Possibly, My Lord, to some People, all this may be a *Matter* of *Indifferency*: But, surely, to none it ought to be *Matter* of *Offence*. It is from Your GRACE alone that I am to crave Pardon for the *Contents* of this *Half Sheet*: All *indifferent* Persons having, exclusive of *this*, their full allotted *Quota*, of 100 *Pages*.

Should fifty mercenary Wretches, for a miserable *Pittance*, nefariously, not to say perjuringly, attempt to *bespatter* those who would only answer them with the Scorn they deserve, they would only *be-mire* themselves with their own *Filth*. And what mighty *Feats* of *Chivalry* have they done, who, thro' Excess of *Gormogonian* Smartnefs, *exquisitely* insinuate, in the *New-Papers*, That *they are glad at not finding any thing* greatly Indecent in MASONRY! Have they done more than *turn* the *Tables* upon their own *inconsiderable* Selves? Are not the MASONS, obviously in the eye of the Sun, a very numerous, a respectable BODY of MEN?

Would a MONTAGUE, a NORFOLK, a RICHMOND, a BEDFORD, a LOVEL  
 connive at *Indecencies*! Would a DALKEITH, a INCHQUIN, a PAISLEY, a  
 KINGSTON, a COLRAINE, a SUNDERLAND, a PORTMORE, and abundance more  
 of our Right worthy Chieftains, Countenance Immoralities! Barbarous  
*Nonsense*! But, pardon me, My Lord; and permit me, with the most  
 unfeigned Sincerity, to wish an uninterrupted Series of Prosperity to  
 You and Yours, and submissively to remain,

Your GRACE'S  
 Most dutifully obedient and ever  
 devoted humble Servant, &c.

J. MORGAN.

Mr. Morgan scarcely could have been more outspoken. How unmistakable too  
 his adhesion to Past Grand Masters—English, Irish, and Scotch, though he refrains,  
 significantly, from mentioning “a WHARTON.”

In the above copy the final clauses subsequently omitted have been distinguished  
 with a vertical marginal line. Thus shortened, the Dedication still concludes with  
 “But,” apologetically adding “not to intrude longer,” and then takes up the former  
 thread “pardon me, My Lord,” etc., until “submissively to remain” becomes “sub-  
 missively to subscribe myself.” The clause following the verse is revised;—“Possibly,”  
 with which it starts, becomes “Probably,” and there is a slight variation in its last  
 sentence.

Why did Morgan shorten the Dedication? Is it likely that he had been  
 upbraided for unseasonable repudiation of mendacious statements about Masons and  
 Masonry? Or, was he influenced by the knowledge of the Duke of Wharton's death,  
 which had occurred 31st May, 1731, just five months after the publication of the  
 original Dedication? So far as we gather, the Gormogons are no longer heard of as an  
 existing Society after the Duke's decease.

There are three copies of “The Phoenix” in the British Museum. One of these,  
 the Grenville, has preserved the Title-pages and Tables of Contents of the Numbers,  
 with the original Dedication (the Table of Contents of Number I. printed on the back of  
 the lastpage). This copy, however, is imperfect; the Sixth Number and the Index and  
 Table of Contents for the whole volume are wanting, and it merely commences with the  
 Title page belonging to Number I., which reads as follows:—

Phoenix Britannicus | Being A | Miscellaneous Collection |  
 of Scarce and Curious | Tracts. | Some of very *Ancient* Dates,  
 and most of the rest long | Since out of Print. | Also, | Occasion-  
 ally, will be interspersed some choice originals, in | Prose and  
 Verse, on various Useful and Entertaining Subjects. |

Number I.

By J. Morgan. Gent.

London.

Printed for the Compiler, and T. Edlin, at the Prince's Arms,  
 against Exeter-Exchange in the Strand, MDCCXXXI.

(Price. Two Shillings & Six Pence).

The other copies (one of them in the King's Library) are complete, apparently in the form Morgan finally intended for the binder, each with Table of Contents, Index, shortened Dedication and a Title-page, which reads:--

# Phoenix Britannicus:

Being a MISCELLANEOUS

## COLLECTION

Of SCARCE and CURIOUS

### TRACTS,

*Historical, Political, Biographical, Satirical,  
Critical, Characteristical &c Prose and Verse.*

Only to be found in the *Cabinets* of the CURIOUS.

Interperfed with Choice PIECES from Original MSS.

---

VOL. 1.

Containing NUMBERS I, II, III, IV, V & VI.

---

Collected by *J. MORGAN*, GENT.

---

L O N D O N:

Printed for the COMPILER, and T. EDLIN, at the *Prince's Arms*,  
againft *Exeter Exchange* in the *Strand*; and J. WILFORD, at  
the *Three Golden Flower-deLuces*, behind the *Chapter-Houfe*,  
*St. Paul's* MDCCXXXII.

*Price* (Unbound) *Fifteen shillings.*

A "Post-Script to the Preface" (in Number II.), briefly acknowledging the receipt of some approval of his project, replies at length to objections which are recapitulated.

"Fourthly & lastly & worst of all," he was informed, "some had expressed a sort of disgust at the quotations from Catholic books in Number I. Intimating as if "Such may breed ill Blood, and all that!" And this is how the objection is met—"Answer—Bless us! How can this be?" \* \* \* "The Pens of ingenious *Romanists* entertain me as agreeably as those of any others, and doubtless will do the like to at least some of my *Readers*; and why may they not therewith be gratified? Besides; how can any of us well take Exceptions at *Extracts* given us from *Writings* of approved *Authors* of our own *Belief*?"

"In short, once for all, I would be understood to be absolutely a *Neuter* in *Party-Affairs*: But shall not fail of *reviving* what I judge will best take with my *Readers*. A *Neuter* I say; and that not without some ground: Since, were nothing farther to be considered, such I am as a *FREE-MASON*. For at once to let-in the *Curious* into one of the *Grand Secrets* and *Mysteries* of *Masonry*, we *Brethren*, strictly speaking, are of no *Party*.——Thus much for *Answering to Objections*."

"But a *propos* of my *Brethren* the *MASONS*. Being not unapprized of the *Precariousness* of getting off a very large *Impression* of almost any *Book*, I cautiously determined not to glut the *Town* with my *PHENIX*, nor over-print myself; so only ventured on 500: And surely, one need not fear being much to seek for so moderate a number of *Lovers of Reading*. Besides, I say in case of the worst, we have, among *that* our numerous *Fraternity*, some *Hundreds* of *Gentlemen-Masons*, whom the *Royal Craft* has taught to be no less in-love with *Polite Literature* than with *Secrecy*, *Morality* and *Good-Fellowship*. Of these, tho' I have not yet *gone* my *Rounds*, I have several, already, in my *List of Subscribers*: And it is well known, how exemplarily zealous the whole *Body* is, in doing *good offices* to *Brethren*."

Clearly, at the date of the second number, Morgan still hoped for support from members of the Craft; subsequently he intimated, after the "Contents" of Volume I., that for the present he thought it expedient to postpone the List of Subscribers until it was "fuller." [Those who chose to pay the market price, 2/6 per number, rather than subscribe 2/- per number, were asked to direct communications of this nature for the Compiler at Will's Coffee House, opposite to the Admiralty.]

It was Morgan's delight, he tells his patrons at the outset, to peruse uncommon tracts; and it was his willingness to communicate what delighted him, and also "an averseness to pass my time in a quite useless inactivity which suits neither my Disposition nor conveniency," which chiefly induced him to engage in a project which should exclude profaneness, obscenity, scandal, and modern party-disputes. For material, he appealed to "some great men who are abundantly stocked with the best curiosities of the kind" he desired. They were requested to direct for J. Morgan to Mr. Burton, Printer, near St. John's Gate, Clerkenwell, or with Mr. Edlin, at the Prince's Arms against Exeter Exchange.

Very little information in the way of biographical details has come to light about the Compiler of "The Phoenix." The Dictionary of National Biography, which cannot supply his Christian name, only identifies him as the compiler, in 1739, of an entertaining volume, called "The Lives and Memorable Actions of Many Illustrious Persons of the Eastern Nations," 12mo., chiefly from what purported to be the papers

of George Sale the Orientalist. The article on Sale also states that Morgan *completed* the "Lives" designed and begun by this distinguished man.

The Catalogue of the British Museum Library places the work (but, as to the Christian name, on what authority does not appear) under the heading of "MORGAN, JOHN." Six pages of Dedication to "The Right Honourable Lord Vere Beauclerc, One of the Lords Commissioners of The Admiralty &c.," are simply subscribed "J. Morgan;" and the author's name is absent from the title-page, which is set out in form as follows :

The | Lives | and | Memorable Actions | of many | Illustrious  
Persons | of the Eastern Nations, | Such as | Khalifas, Soltans,  
Wazirs, | or Prime-Ministers, Generals, | Philosophers, Poets,  
&c. |

Who have distinguished themselves, either by | War, Learning,  
Humanity, Justice, &c. |

---

Extracted from the most authentick—Oriental Chronologers and  
Historians, | Never before Englished.

---

London : |  
Printed for J. Wilcox, at Virgils Head, |  
opposite the *New Church* in the Strand. |

---

M,DCC,XXXIX.

---

Morgan carefully points out in the Dedication what parts he supplied, being in all about a fourth of the whole, as distinguished from the loose papers which came into his hands "quite unrevised and in sad disorder," and mentions that the bookseller who purchased the papers "fancies he has good grounds to believe they appertained to the late most ingenious Mr. George Sale." "I am herein thus particular for two Reasons; one, because, if these Papers were really that Learned Gentleman's (which I do not however assert) I would not let any Attempt of mine pass undistinguished from his; the other, to satisfy YOUR LORDSHIP, that your humble Servant had at least some Hand in that for which he presumes to beg your Protection."

We must believe that unwillingness to vouch for Sale's MSS., proceeded from inability to do so, but the remarks appear to be those of a nervously candid man, and almost suggest a doubt as to the authenticity. This could not have been very pleasing to every one concerned, and it would therefore seem that more than mere capriciousness accounts for another issue of this book, *without* the Dedication, of which a copy is likewise in the British Museum—Grenville Library—indexed under "SALE, GEORGE," but with an Advertisement in the following form :—



## ADVERTISEMENT.

These short MEMORIALS of the LIVES of the most Eminent Persons of the *Eastern Nations* was design'd, and begun to be Translated into *English*, by the late ingenious M<sup>r</sup>. GEORGE SALE, Editor and Translator of *The KORAN*: And Several of the Books in MSS. mentioned in particular Lives herein, are now in the Hands of M<sup>r</sup>. *William Hammerton*, a Merchant in Lothbury, London; and since his Death, the Translations have been completed by a Gentleman who resided in *Turky* near Twenty Years.

The Dictionary of National Biography states that Mr. Hamerton was administrator of the will of George Sale, whose manuscripts passed into his possession.

It is interesting that George Sale numbered amongst his acquaintances Sir Hans Sloane—the great collector of manuscripts, to whom Freemasons are peculiarly indebted, though incidentally, for the preservation of several valuable documents in the Sloane Collection, British Museum.

Perhaps Morgan was acquainted with Sale, and one of his band of helpers with the extensive work "An Universal History, etc." 1736, etc. On this hypothesis it is still easy to understand that a man of Morgan's temperament, though willing to complete the design of "The Lives and Memorable Actions," would be cautious lest he should appear also to guarantee manuscripts which he felt he was not in a position to account for.

Residence abroad may have helped or fitted J. Morgan to undertake another work with which he is credited in Lowndes's Bibliographer's Manual (Böhn) viz., a "History of Algiers; to which is prefixed an Epitome of the General History of Barbary, from the earliest Times. Lond. 1728, 4to—1731, 4to." The entry mentions "The Phoenix" also, but goes no further, and therefore makes no reference to his share in completing and editing "The Lives & Memorable Actions." On the other hand it is noticeable that though the Dictionary of National Biography recognises his labours in the compilation of "The Lives," not a single word is said regarding the "History of Algiers"; and the British Museum Catalogue connects neither J. Morgan nor John Morgan with such a history. None the less, the bookseller's announcement is extant and will presently be noticed.

Possibly the bent for compilation which distinguishes J. Morgan (for so the editor of "The Phoenix" must continue to be styled) led to activities in that direction which are unacknowledged on the title-pages of some resulting works with which in consequence he has never been identified.

Broadminded, frank, somewhat whimsical, with a taste for wholesome literature, and possessed of literary attainment—these seem to have been some of Morgan's characteristics, and withal he was a Mason. The glimpses make us feel we should like to know more about his personality. The world outside the Masonic Order can see how very guarded he was. Direct assertions he would not make, unless of his own full knowledge—hence, if any were needed, his contemporary support in repudiating insinuations so long ago mendaciously published against the Order, may now be pointed to with eminent satisfaction.

If Morgan's Christian name could be determined, and it transpired that J, the initial, stands for John, the subjoined notes very kindly supplied by Bro. Henry Sadler would seem to be very near the mark indeed. All that can be said is that most likely

they do indeed point to the authorised Masonic coteries to which the Brother who projected "The Phœnix" belonged.

"The Phœnix" evidently was not the first publication in which Morgan had a hand. An allusion is made in the Dedication, in both its forms, to the scheme of "The Phœnix" "in a different garb," which the Duke had seen before. The Preface also commences—"It is requisite, that I, previously, unimadvert to all such as may have met with the Proposals, by me exhibited, with relation to this Miscellany (first under a different Title, and next in a somewhat different Method) and might reasonably have expected the Appearance of this Specimen some Weeks since; 'That as well what Variations, from the said Title and Method, they here find, as also this scarce-excusable Delay, are wholly owing to certain Obstructions, not only unforeseen but unavoidable: And that I am now determined to proceed briskly, and am in Hopes, according to my original Design, of finishing Volume I (consisting of Six of these Numbers) before the Summer is over.'"

Morgan asserts, also in the Preface to "The Phœnix," that he had been responsible for some compilation published in the previous year (1730). Acknowledging himself alone responsible for all that should be inserted in "The Phœnix," "good, bad or indifferent," it was "an advantage," he remarks, "I had not in carrying on a late Monthly Pamphlet (which, for six successive Months, went by my name, till July last, and is since Defunct) wherein, tho I put only authentic Pieces, for which I had the best Authorities, none of which I ever heard censured, yet I was obliged to father all, while another was authorized to foist in false Facts, from the lying News-Papers, with other Trash, from the Lord knows whence; for which I fear I may have incurred the Displeasure of some Persons I should be extremely unwilling to disoblige. Thus much I judged proper to say on this Head: For why should not the Saddle be laid on the Back it best fits?"

A letter, bearing the initials W. O., inserted in Number I. of "The Phœnix," evidently written at Morgan's invitation, enters into the bibliography of Sir Robert Cotton's "Short View of the Long Life of King Henry III, 1627," which is reprinted in the Number. Morgan promises to find place eventually for an Essay upon Pamphlets by the "obliging Author" of the letter to whom he afterwards refers as "a very ingenious Gentleman." The promise was fulfilled in Number VI. The Essay, subscribed with the initials W. O. at the end, is entitled

A

DISSERTATION

UPON

PAMPHLETS,

And the UNDERTAKING of

*PHŒNIX BRITANNICUS*,

To Revise the most EXCELLENT among them.

In a LETTER to a NOBLEMAN: From the Original M.S.

Most probably the author, William Oldys, the antiquary, (b. 1696; d. 1761), was one of Morgan's personal friends. Oldys was subsequently appointed Norroy King of Arms in 1755. The valuable library he formed was purchased by Edward Harley, second Earl of Oxford—probably the nobleman to whom the Dissertation is addressed. Some "pulls," evidently from "The Phœnix" reprint of the Dissertation, account for an

independent issue, dated 1731, with the pagination altered to suit, though overlooked in a footnote where a correction has been made by hand in the British Museum copy.

T. Edlin and John Wilford, the fellow-publishers of the "Phoenix," are the subjects of a comical account of a dispute at Castle Tavern, Paternoster Row, as to whether there was money to be made out of a Roman History in weekly parts. (D.N.B. under Wilford, John, fl: 1723-1742). Edlin strongly advocated the attempt, but Wilford's talk all ran upon the remunerative properties of devotional tracts and family directors. Wilford, whose name does not appear on the first number of "The Phoenix," came before the public in his "Monthly Catalogue," wherein he advertised in December, 1723, "The Grand Mystery of the Free Masons discover'd" etc.—"printed for J. Payne, near Stationers' Hall. Price 6d."

Then in January, 1726, he advertised "The Free-Mason's Accusation & Defence, in six Genuine Letters, between a Gentleman in the Country, and his Son a Student in the Temple. Wherein the whole Affair of Masonry is fairly debated, and all the Arguments for and against the Fraternity, are curiously and impartially handled. Printed for J. Peele in Pater-noster-Row. Price 6d."

Another announcement, in February, 1729, bears out the entry in Lowndes's Bibliographer's Manual, and may be recorded for the sake of the further particulars—"Mr. Morgan's second Volume of the History of Algiers, from the earliest to the present Times. In 4<sup>to</sup>. Price 8s in Quires. Sold by J. Clarke and G. Strahan near the Royal Exchange; R. Knaplock, T. Astley, and S. Austen in St. Paul's Churchyard; A. Bettesworth, & J. Batley in Pater-noster-row; J. Pemberton and J. Hooke in Fleet Street; D. Brown and F. Clay without Temple-Bar, where the first volume may be had."

We see in the last quotation Morgan's style set out simply as "Mr. Morgan" without initials. In the index to Nichols's "Literary Anecdotes" 1812, a Christian name is given—"Morgan, John, his 'Phoenix Britannicus' iv.98.110."; but at the reference supplied there is nothing to throw light upon this. Mention of the Phoenix Britannicus is merely incidental, in a heading as follows—"History of the Origin of Pamphlets. (From a Dissertation, signed W. O. [William Oldys, Esq.] annexed to Morgan's 'Phoenix Britannicus 1732, 4<sup>o</sup>.)"

It is tantalising to be left in the dark concerning the evidence upon which the Christian name John finds place in the two instances which have been quoted from reputable sources;—one, previously noticed, appertaining to the Library of the British Museum, the other, this entry in Nichols's "Literary Anecdotes." Searches in many directions bring no further particulars to light.

Even Musgrave's Obituary, a most useful work of reference which covers a great deal of ground, does not appear to include the compiler of "The Phoenix Britannicus," who left on record that he pioneered its forerunner under disadvantages, and yet did not disclose the title for the information of posterity.

---

Bro. Henry Sadler, who cheerfully searched the Grand Lodge Registers, writes:—  
 "A John Morgan was a member of a Lodge held at 'The Crown behind the Royal Exchange,' in 1725, which Lodge is now No. 10, The Westminster and Keystone Lodge. Lodges were not distinguished by numbers prior to 1729. A Brother of the same name (probably the same person) was returned as a member of No. 11 in 1730—now the Fortitude and Old Cumberland Lodge, No. 12, but he certainly never held office in Grand Lodge.

The Duke of Richmond did not preside in Grand Lodge after 1725."

---

## ORDER OF THE KNIGHTS OF THE HOLY SEPULCHRE OF JERUSALEM.

BY BRO. L. DE MALCZOVICH

---



RO. CHARLES S. LOBINGIER, in a kind reference to my paper on "Templaria et Hospitallaria" (see *ante* p. 69) enquires whether there may not be a survival of Templarism in the Spanish branch of the Knights of the Holy Sepulchre of Jerusalem. In reply to Bro. Lobingier's remarks, I may briefly state that in my opinion, the Knights of the Holy Sepulchre *cannot* be considered as a continuation of the Order of the Temple, in fact, the Order of the *Knights* of the Holy Sepulchre cannot claim an origin earlier than 1496. It is true that the question of its origin has never been properly solved, and in all probability it never will be solved. I shall therefore give a short account of the facts to show how the matter stands at present.

Some authors have ascribed a very great antiquity to the chivalric Order of the Holy Sepulchre. Some have pretended that it was founded by the Apostle James. Others give the Empress Helena or Charlemagne as founders, while still others are content with Godfroi de Bouillon, or his successor King Baldwin, who as they pretend, established the chivalry of the Holy Sepulchre in 1099 or some years later, respectively. This story is even found in diplomas of the Order, but it is mere tradition and has not the slightest historical foundation; on the contrary history puts it in an entirely different light and shows that some individuals undertook pilgrimages to the Holy Land in order to receive the accolade at the Holy Sepulchre. This occurred frequently during the Crusades and even later, but the Knights did not form a special Order of Knighthood. They were simply secular knights, who happened to be dubbed at the Holy Sepulchre as others in like manner happened to be dubbed, say at Westminster Abbey. We have the testimony of eye-witnesses, but they do not say anything about the *Knightly* Order of the Holy Sepulchre, still less about the five-fold cross of Jerusalem, which is the badge of the Knights of the Holy Sepulchre.

The reason why the traditions arose appears to be that in course of time the *Knights* of the Holy Sepulchre were confounded and identified with the *regular Canons* of the Holy Sepulchre as I shall at once show. There are hundreds of documents in existence of the times of the Crusades and of later date which refer to the Canons (they are always spoken of as *Prior et fratres in ecclesiâ Sancti Sepulchri canonicam vitam profesi*) but there is not one document referring to the *Knights* of the Holy Sepulchre during the time of the Crusades and the Middle Ages. The reason is obvious, because no Knights of the Order then existed, nor do contemporary historians who witnessed the great events then taking place in the Holy Land say a single word about the Order of Knights of the Holy Sepulchre as undoubtedly would have been the case had such Knights been in existence.

Let me now say a few words on the regular Canons of the Holy Sepulchre. We know from the writings of such historians as William of Tire, James of Vitry, etc., as well as from documents collected in the Monasticum Anglicanum that the founders of

the Order of the Temple were closely associated with the regular Canons of the Holy Sepulchre. The canons gave them a piece of ground on which to build, in precisely the same manner as did King Baldwin and other princes and barons. As long as the Templars were poor and had no church of their own they held their services in the church of the Holy Sepulchre with the Canons as their priests, and it is for this reason that the rule of St. Augustine as observed by the Canons was adopted by the Knights Templar. Even the *Regula Trecensis* given to the Templars at the Council of Troyes in 1128 mentions this fact. Later on when the Knights Templar had become great and powerful and when they had established a class of special chaplains, the connection with the Canons was relaxed, although it did not even then altogether cease, but at the best the connection was only similar to that of the Templars with other Orders, as for instance with the Cistercians, that is to say they were quite separate Orders.

Long after the official abolition of the Order of the Temple and after the Turks had taken Constantinople in 1453, Pope Pius II. had in contemplation the foundation of a new military Order on the model of the Templars to wage war with the Turks. He therefore abolished a number of smaller and insignificant Orders, amongst them being the Order of the Canons of the Holy Sepulchre, the Order of Lazarus, and others, which he desired to merge into his new order. A bull or *breve* was issued in 1459 by virtue of which the new Order was to take the name of Brethren of the Holy Virgin of Bethlehem, and their habit was to consist of a white mantle with a red cross. Unfortunately, however, for want of money and interest, this Order never really came into existence, and in consequence the Orders which had been abolished, were reconstructed. Finally Pope Innocent VIII. abolished the *Canons* of the Holy Sepulchre and united them with the Order of St. John in 1489. It is stated in many books that this Pope united the *Knights* of the Holy Sepulchre with those of St. John and that Pope Alexander VI. revived the Knights of the Holy Sepulchre, but this is an error, as the bull of 1489 clearly states "*Ordo sancti Sepulchri dominici Jerosolymitani (ordinis) sancti Augustini,*" but not of Knights, (*Milites, equites*).

Another fact is that Pope Alexander VI. founded, or is said to have founded (some say re-established) the Order of the Knights of the Holy Sepulchre, declaring himself to be Grand Master of the Order, and that he conferred (some say orally confirmed) upon the guardian of the Franciscan convent at Jerusalem, the right of dubbing Knights at the Holy Sepulchre as his, the Pope's vicar-general. The statutes and privileges of this Order were confirmed in the years 1515, 1561, 1665, and 1727.

Pope Pius IX. conferred the right of dubbing Knights upon the Latin patriarch of Jerusalem in 1847, and this right was confirmed in 1868, when he established three classes of the Order. The badge is the cross of Jerusalem, that is the red cross potent, with four small crosses in the four angles, and hence it is often called the five-fold cross. It is worn on a black-watered ribbon. Some maintain that the abolished Order of the *Canons* of the Holy Sepulchre was replaced by a chivalric Order by Alexander VI. in 1496. This may be so, but as we do not know the wording of the bull or *breve* of foundation, we are not able to decide the question. It seems, however, that no document was issued on the occasion, or if it was it is lost, as not even the wording of such document has ever been produced. If any knowledge of it is in existence it should undoubtedly be at the Vatican, and it is characteristic that the instruction sent to the Patriarch of Jerusalem by Pope Pius IX. says with reference to the Order, "*L'Origine di quest'ordine equestre si perde nella notte dei tempi*" (the origin of this Knightly Order is lost in the night of time), no mention being made of the *Canons* being replaced by

the *Knights*. However this may be it is quite clear that we cannot go further back than 1496 for the origin of the Knights of the Holy Sepulchre, and indeed if it could be proved that the Knights replaced the Canons, which certainly is possible, there would still be only a very loose and external connection with the Order of the Temple.

Another theory and perhaps even a possibility is that the Knights of the Holy Sepulchre were not a new creation in 1496, but that prior to that date the Order had sprung into existence by evolution, that is to say, that the Knights who had been created at the Holy Sepulchre closely associated themselves with each other and in this way formed an Order which was in existence long before 1496, when it was officially established by Pope Alexander VI. This theory is not an impossible one, but it is an hypothesis only for which no evidence is forthcoming.

We may however say something in regard to the connection of the Order of St. John or Knights of Malta with the Holy Sepulchre. At the beginning of the 17th century under the Grand Mastership of Frater Alofe de Wignacourt (1601-1622), the government of the Holy Sepulchre was acquired for the Grand Master of the Order of Malta and his successors. We do not know the exact year of its acquisition, but the epitaph of this Grand Master records the fact in these words "*Sanctissimi Sepulchri præfectura sibi posterisque adjuncta.*" His immediate successor, Frater Anthony de Paula (1623-1636) is styled on one of his coins "*Magnus Magister Hospitalis et S. Sepulchri Hierosolymitani.*" Although the Latin Christians lost the guardianship of the Holy Sepulchre in the last year of the rule of this Grand Master, we find that Frater Annet de Clermont Gessan uses the same title, that is "Grand Master of the Hospital and of the Holy Sepulchre of Jerusalem," on a similar coin struck in the year 1660.

Then the title of "Holy Sepulchre of Jerusalem" again disappeared until we find it readopted under the Grand Master Frater Gregory Caraffa and his successor Frater Adrien de Wignacourt (1690-1697), and after that time all Grand Masters used it down to the last Grand Master Hompesch.

It is difficult to decide what is the actual meaning of the title which was used, but it seems to imply that the Order of the Holy Sepulchre was in some part united with the order of Malta, but how can we account for the confirmation of the statutes of the Order of the Knights of the Holy Sepulchre in the years 1665 and 1727 mentioned above? It is difficult to suppose that the mere title was used by the Grand Master of Malta, whilst the chivalric Order of the Holy Sepulchre was independent. Yet by the term "Holy Sepulchre" it seems quite evident that a chivalric Order is meant, as the Grand Masters of Malta called themselves "Grand Master of the Hospital and of the Holy Sepulchre," and the term "Grand Master" necessarily implies a chivalric Order. The Grand Master Frater Emmanuel de Rohan (1775-1797) called himself quite clearly in French "*Grand Maître des Ordres* (i.e., of the *Orders*) *de St. Jean de Jerusalem et du St. Sepulchre,*" that is to say Grand Master of both Orders. After the loss of Malta, the Order of the Holy Sepulchre may have become independent, as is evinced from the measures of Pope Pius IX. mentioned above, still the point is not quite clear and some elucidation is needed in regard to the relation existing at various times between the Order of Malta and that of the Holy Sepulchre.

So much however is certain, that the two Orders were united in some way in the seventeenth and eighteenth centuries. If therefore, as Bro. Lobingier informs us, a banner adorned with the cross of Malta is used at ceremonies of the Spanish branch of the knightly Order of the Holy Sepulchre, this would account for the former connection of the two bodies.

I think it is clear from the above that the chivalric Order of the Holy Sepulchre as now existing cannot be considered a continuation of the Order of the Knights of the Temple. There was undoubtedly a loose connection between the Canons of the Holy Sepulchre and the Knights Templar, but none with the Knights of the Holy Sepulchre, this Order being of much later date than the Templars, but there was a closer connection between the Knights of the Holy Sepulchre and the Knights of Malta.

There is another interesting question in connection with the above, which also requires elucidation. It has been mentioned by some authorities that the *Canons* of the Holy Sepulchre who were associated with the Knights Templar wore a red double cross, which is now worn by the preceptors of our Order. I do not know from what source this statement arose, and therefore cannot decide upon its authenticity. If however proper evidence were forthcoming it would be of great interest and value from a Templar point of view.

I must now revert to the question of the survival of Templarism in Spain and Portugal.

In addition to the Order of Christ in Portugal founded in 1319 by King Dionysius with *quondam* Templars (the King himself being an affiliate of the Order of the Temple, on which Order he bestowed the Templar estates in his realm), there is the Order of the Holy Virgin at Montesa, in Spain, which may also claim a Templar descent. After the downfall and final abolition of the Order of the Temple, King James II. of Arragon, a protector and well-wisher of the Temple, established a chivalric Order in 1316 on which he conferred the Templar lands situated in the kingdom of Valencia. The centre of the Order was the seat of the former Templar bailliwick of Montesa in that kingdom. The habit of the Knights was a white mantle with a red cross, the same as the Templars. King Ferdinand of Castile on the other hand treated the Templars of his kingdom very harshly, and for this reason they left his country, some joining the Order of Montesa and some the Order of Christ. Thus in both of these Orders we see that the stock consisted of *quondam* Templars.

Later on the Order of Montesa was united with the Order of Calatrava, but again separated in course of time.

As for the Spanish and Portuguese Orders they were of ancient origin, although many times united, afterwards separated, at one time wholly abolished, and then again re-established. It is therefore extremely difficult to say whether they can really be considered as legitimate offsprings of the ancient chivalric Orders whose names they bear. Moreover nearly all of them were considerably modified and altered and were finally brought to the level of simple Royal Orders of decoration, bestowed even upon non-Christians.

At any rate, the members of the Orders of Christ and of Montesa may, if they choose, claim a Templar descent, but as they are mostly composed of Roman Catholics, I doubt if they would find it advisable to boast of a descent from an Order which has been abolished and anathematized by the Pope. Some of the Spanish Orders have special habits and ceremonies, but so far as I know, only exoteric ones, outsiders, even ladies, being allowed to attend at the Chapters of reception, as is the case with similar Orders in other countries.

The present King of Spain was solemnly invested and installed as Grand Master of the four chivalric Orders of Calatrava, San Iago de Compostella, Alcantara, and Montesa, in a common chapter held by the four Orders at the same time on the 30th May, 1902.

## NOTES AND QUERIES.



**SPANISH TEMPLARS.**—In *A.Q.C.*, vol. xix. p. 69, Bro. Lobingier, of Manila, P.I., inquires whether the Order of the Holy Sepulchre of Jerusalem is not a remnant of the classic Knights Templar. I am pleased to refer the studious brother to a short article of mine published last year in our masonic paper, *La Gran Logia*, where the history of Spanish Templarism is shortly related.

The Order of the Holy Sepulchre had nothing to do with the Templars, except that both were established during the twelfth century at Jerusalem by King Baldwin, the Templars first. Their original *rule* is the same: that of St. Augustine. While the statutes of the Templars were approved by Pope Honorius II., those of the Knights of the Holy Sepulchre were not until afterwards by a later Pope, Innocent III. The white habits of the Templars were adorned with their typical red cross, while those of the others, though also white, had for their jewel the arms of Jerusalem, a Greek cross between four crosslets. The Superior of the Franciscans is the principal head of the present Order, the branch of which in Spain is, of course, presided over by the King. The Holy Sepulchre is one of the many chivalric orders which existed in Europe during the middle ages, now reduced to an honorary distinction for Roman Catholics.

The Order of Christ, of Portugal, is truly a remnant of the ancient Templars, as at the time of the dissolution of the Order in the fourteenth century King D. Dionis changed the name of the primitive Order for the present one, and thus kept it in existence in a passive form.

Templarism has left many traces in Spain. It has existed in that country since the year 1128, and has greatly helped its kings, not only to uphold Christianity, but also to deliver the land from the hands of the Moors. It was at times connected with some of the ancient Spanish chivalric orders, Calatrava for instance. Two Templar provinces, so called, existed, namely Castille and Aragón. Many of their kings were professed Templars, the properties of the Order being enormous. King D. Alfonso I., of Aragón, having no legitimate heirs, left, in his last will and testament, his whole kingdom to the Templars, which, of course, was not complied with. It may be stated, for the honour of the Spaniards, that when the trials of the Knights Templar were ordered, as preliminary steps towards the dissolution of the Order, the councils assembled at Salamanca and Tarragona declared the members innocent of the charges, thus assuming a marked opposition to the Pope.

The following is a complete list of Spanish Templar Provincial Grand Masters, taken from my article in *La Gran Logia* to which I have referred.

## ARAGÓN

- 1 Fray D. Pedro de Ravera, 1143.
- 2 „ „ Berenguer de Aviñón, 1149.
- 3 „ „ Pedro de Rueira, 1149.
- 4 „ „ Arnaldo de Jorroja, 1174.
- 5 „ „ Hugo Jofre, 1176.
- 6 „ „ Arnaldo Claramonte, 1196.
- 7 „ „ Ramón de Gurb, 1198.
- 8 „ „ Pedro de Montagudo.



- 9 Fray D. Guillén de Montedosa, 1214.
- 10 „ „ Aldemaro de Clarero, 1216.
- 11 „ „ Ponce Mariscal, 1218.
- 12 „ „ Guillén de Allaco, 1218.
- 13 „ „ Francisco Monperat, 1227.
- 14 „ „ Bernardo Champan, 1230.
- 15 „ „ Ramón Patot, 1233.
- 16 „ „ Hugo de Monlauro, 1235.
- 17 „ „ Ramón Berenguer, 1238.
- 18 „ „ Astruque de Claramonte, 1239.
- 19 „ „ Guillén de Cardona, 1250.
- 20 „ „ Guillén de Pontos, 1265.
- 21 „ „ Antonio de Castelnou, 1272.
- 22 „ „ Pedro de Moncada, 1276.
- 23 „ „ Berenguer de Cardona, 1291.
- 24 „ „ Bortolomé Belvis, 1312. (In his day the Order was suppressed.)

## CASTILLA

- 1 Fray D. Pedro de Robera, 1152.<sup>1</sup>
- 2 „ „ Guido de Garda, 1178.
- 3 „ „ Juan Fernández, 1183.
- 4 „ „ Gutierre Hermildes.
- 5 „ „ Esteban de Belmonte.
- 6 „ „ Gómez Ramírez, 1212.
- 7 „ „ Pedro Alvarez Aluito, 1221.
- 8 „ „ Martín Martínez, 1243.
- 9 „ „ Gómez Ramírez, 1248.
- 10 „ „ Pedro Gómez, 1248.
- 11 „ „ Martín Núñez, 1257.
- 12 „ „ Lope Sánchez, 1266.
- 13 „ „ Guillén, 1269.
- 14 „ „ Garci Fernández, 1277.
- 15 „ „ Juan Fernández Cay, 1283.
- 16 „ „ Ferrán Pérez, 1286.
- 17 „ „ Gómez García, 1286.
- 18 „ „ Sancho Ibáñez, 1295.
- 19 „ „ Ruy Díaz, 1296.
- 20 „ „ Gonzalo Yáñez, 1296.
- 21 „ „ Pedro Yáñez, 1296.
- 22 „ „ Rodrigo Yáñez, 1310.<sup>2</sup>

Havana—Cuba.

F. DE P. RODRIGUEZ.

**The Sirr Family and Freemasonry.**—Major Sirr is referred to in Moore's *Life and Death of Lord Edward Fitzgerald*, namely, in a letter from the Duke of Portland (dated May 23rd, 1798,) to Mr. W. Ogilvie (Lord Edward's stepfather), in which the part played by the Major in the arrest of the unfortunate nobleman is

<sup>1</sup> May not this be the same as No. 1 of Aragón?<sup>2</sup> Was present at the Council of Salamanca.

detailed. Also, in Gerald Campbell's *Edward and Pamela Fitzgerald*, published in 1904, Major Sirr and Major Swan are introduced on the evidence of an actual eye-witness of the arrest, and the distressing circumstances connected therewith. Further, Charles Lever, in *The Knight of Gwynne*, associates the two Majors with a Dublin street ballad of the Union period, which opens with the line, "Says Major Sirr to Major Swan."

W. F. LAMONBY.

**Henry Charles Sirr.**—I have recently had occasion to examine some of the old Minute Books of the Lodge of Faith, and find the following reference to Bro. H. C. Sirr under date 27th December, 1836, when the Lodge met at the Gun Tavern, Pimlico :

" Bro. Henry Charles Sirr, Three Stone Buildings, Lincoln's Inn, Member of  
" the Caledonian Lodge No. 212 (*sic*) was regularly proposed by Bro. Robert  
" Sargent and seconded by Bro. Rimmington P.M. as a joining member of  
" the Lodge which was carried unanimously."

Bro. Sirr was invested as J.W. at the Installation Meeting on 31st January, 1837, and withdrew his name from the list of members on 28th December, 1838.

HARRY GUY.

**Eulogium on Freemasonry.**—This prologue does not appear to be included in any collection of Masonic verse, and may be acceptable for the columns of the *A.Q.C.*

From "*Poems on various subjects*," by William Pinn, Chatham, 1800.

" An eulogium on Masonry, written by desire of Mr. Shaw, and recited by him on his Benefit Night at the Theatre, Rochester, January 9th, 1800.

Ladies and Gentlemen,

with pure delight,

Your humble servant meets you here to-night,

Who has a secret sound, nor dare indulge it,

So tortured is my mind, I must divulge it ;

By Heav'n's I must and will, you need not doubt,

I dread no consequence, I'll blab it out :

Yes, blaze that now, which pretty plain appears,

Has been envelop'd full five thousand years,

In shades impenetrable, and still unknown,

Except to Masons, and to them alone.

But now the cat comes out the bag, d'ye see,

I'll mouth the arts and parts of Masonry.

Silence now reigns in gallery, box, and pit,

Since all are proud I have the benefit :

If so, 'tis generous duty bids me show

I can be grateful ; nay, 'tis what I owe.

Well, out it comes.—Attention while I read,

From manuscript, the Mason's mystic Creed ;

But look around, my friends, for fancy's sake,

Observe, with fear now all my brothers quake :

No wonder, since they've heard I'll bring to light

The precious gem which yields them much delight,

To crown your wishes with my own this night.

}  
}

Then friends believe, it is a Mason's theme,  
 To own, to love, to serve one Great Supreme :  
 See Him the builder of this motley ball,  
 The Great, Kind, Common Father of us all ;  
 And hold it good, his sons a temple raise  
 In which the whole should render grateful praise.

Next, every Brother proves a Brother's care  
 Each boasts his compass, level, line, and square ;  
 His thought, his word, within due compass moves,  
 And all that's virtuous on a level loves.  
 His line he plumbs with caution and delight,  
 And squares his actions by the rule of right :  
 Nor once disturbed with feuds, or church or state,  
 Alike he loves and serves the low and great.  
 Religion, nation, name, place, or complexion,  
 Ne'er can fortend a Mason's kind protection.

And you, ye Fair, whate'er you would discover,  
 Believe a Mason's bound to be a Lover :  
 Tho' of his care each Brother takes a part,  
 He must reserve for you a faithful heart.

Thus have I told their secrets by oration,  
 Nicely reflecting on each obligation ;  
 And hope we all admire the sacred plan,  
 Admitting a good Mason's a good man.

Then I've accomplish'd full my noblest ends,  
 And bow with pleasure to my gen'rous friends.

W. B. HEXTALL.

**An Early Use of the Term "Freemason."**—The following is from "A Description of Leicestershire," by William Burton, 1622, p. 315.

"*Woodhouse*, so called for that it stood upon the skirt of Clarnwood Forest. . . . In this place Henry Beaumont, Earle of Boughan, and Alice his wife, by the licence of the Abbot of Leicester, built here a very faire and stately Chappell of ashler Stone, 1338, 13 Ed. III. It was againe repaired in the 28 of Henry the Sixt, for I have seene a Deede of Couenants made betweene Robert Farnham of Quardon of the one part and a certaine free-Mason, for the new building of the Steeple, and the repaire of the Church dated the said 28 Henry the Sixt.<sup>1</sup> It was then new glazed and repaired as I should guesse by the armes of King Henry the Sixt, standing in the East window of the Chappell."

W. B. HEXTALL.

<sup>1</sup> 28 Hen. vi., 1449-50.

## OBITUARY.

---



It is with regret that we have to announce the death of Brothers:—

**William Officer**, of 21, Castle Street, Edinburgh, on the 11th April. He joined the Correspondence Circle in October, 1894.

**Samuel Sudworth**, of 33, Greenside Road, West Croydon, Surrey, on the 25th March. He joined the Correspondence Circle in January, 1903.

**Fritz Stötzer**, of 195, Upper Thames Street, London, E.C. Bro. Stötzer was born at Gotha, on 7th December, 1844, and died in London, on the 6th May, 1906. He became a Member of the Pilgrim Lodge No. 238, in 1892, and served as its W.M. in 1902. He joined the Correspondence Circle in January, 1902.

**Dr. Charles Rotherham Walker**, of Abydos, Longfellow Road, Worthing, on the 28th March. He joined the Correspondence Circle in March, 1896.

**Luke A. Lockwood**, of 115, Broadway, New York, U.S.A., on the 21st November, 1905. He joined the Correspondence Circle in May, 1903.

**J. W. Lloyd**, of Burma Police, Maubin, Burma. He joined the Correspondence Circle in June, 1903.

**Dr. Robert Smailes**, of Glen Esk, Alma Road, Headingley, Leeds, on the 21st June, 1906. Born at Whitby, on 20th October, 1853, he was the son of Bro. Thomas Smailes, an old Freemason and Shipowner of that town. A Leeds student of medicine, he took the degrees of L.R.C.P. and L.R.C.S., Edinburgh, and during his many years as a Leeds practitioner, won the respect and esteem of his colleagues in the profession. He was initiated in the Zetland Lodge, No. 1311, on 19th December, 1890, and installed W.M. in 1896, and being of considerable literary ability, and animated with love and zeal for Freemasonry, he became a valuable worker for the Craft, and a prominent light in the Lodge. On the retirement of Bro. J. L. Atherton from our Local Secretaryship for the West Riding, in 1904, he was appointed to the post, subsequently becoming joint Local Secretary with Bro. J. Banks Fearnley, of Huddersfield, and rendering good service in extending the scope and increasing the membership.

**George Samuel Rideal**, of Johannesburg, in June. He joined the Correspondence Circle in May, 1895.

**William Youill King**, of 3, Corrennie Drive, Edinburgh. He joined the Correspondence Circle in March, 1898.

**George P. Rupp**, Librarian of the Masonic Temple, Philadelphia, U.S.A. This appointment Bro. Rupp held for over ten years, having previously held similar positions in the Philadelphia Library, the Board of Education of Philadelphia and Girard College. He was an authority upon Masonic matters, and an ardent collector of Masonic insignia. He was at the time of his death the W.M. of Philo Lodge No. 444, and Scribe of Philadelphia Chapter R.A., No. 169. He joined the Correspondence Circle in October, 1903, and has since acted as Local Secretary for Pennsylvania, besides presenting many valuable and interesting books and curios to our Library and Museum.

**Joseph W. Fellows**, of Manchester, New Hampshire, U.S.A., on the 26th April. He joined the Correspondence Circle in January, 1903.

**Louis Welch**, of Delaware, Ohio, U.S.A., on the 24th June. He joined the Correspondence Circle in October, 1899.



## STUDIES IN EIGHTEENTH CENTURY CONTINENTAL (SO-CALLED) MASONRY.

BY BRO. WALTER K. FIRMINER, M.A., B.D.

### I.—MARTINEZ PASQUALIS.



O students of French Masonic, or pseudo-Masonic systems, no person is quite so important or so obscure as Martinez Pasqualis. His influence is everywhere felt, but we seldom get a clear view of the man himself. His great disciple, Louis Claude, Marquis de Saint Martin, who strangely enough described himself as "le philosophe inconnu," lived in a blaze of notoriety, and it is not therefore strange that the world in general has confused Martinézistes with Martinistes.

At some unknown date, in the early years of the eighteenth century, the father of Martinez, a Portuguese Jew, settled at Grenoble. M. Ad. Franck has very reasonably conjectured that Pasqualis senior, following the example of his co-religionists who remained in Portugal after the edicts of banishment, professed Catholicism while remaining a Jew by conviction. In this way we can account for the isolation in which Martinez was brought up—he seems to have always spoken the language of his adopted country with difficulty,—and his familiarity with the principles of the Jewish Kabbala, which re-appear in his Masonic system, and probably represent a secret tradition clung to with pathetic loyalty by this family of persecuted descendants of Abraham. It should be observed, as M. Franck observes, "the principal Kabbalists were of Spanish origin, and their secret traditions adapted themselves marvellously to the mystery which enveloped the life and thought of these sad victims of the Inquisition, obliged, in order to save their heads, to dissimulate their faith."<sup>1</sup> Tradition, however, as it comes down to us in works of the character of Clavel's *Histoire Pittoresque* fearlessly assert that Martinez himself was a convert to Catholicism.

Martinez makes his entrance into Masonic history, as far as we can tell, in the year which witnessed the foundation of the Chapter of Clermont (1754). His first field of activity was at Bordeaux where he is said to have founded a "Temple des Elus écossais" which practised a rite comprising the following nine degrees:—

- |   |   |                      |
|---|---|----------------------|
| 1 | { | Apprenti             |
|   |   | Compagnon            |
|   |   | Maitre               |
|   |   | Grand Elu            |
|   |   | Apprenti Coën        |
|   |   | Compagnon Coën       |
| 2 | { | Maitre Coën          |
|   |   | Grand Architecte     |
|   |   | Chevalier Commandeur |

<sup>1</sup> *La Philosophie Mystique en France à la Fin du XVIIIe. Siècle. Saint-Martin et Son Maitre Martinez Pasqualis.* Par Ad. Franck, Membre de l'Institut, Professor au Collège de France. Paris, 1866. P. 11.

Our late Bro. Speth in a paper read before our Lodge has dealt in some detail with the history of the *Loge Anglaise* 204 E.C., at Bordeaux.<sup>1</sup> This Lodge, it will be remembered, acted as a sort of informal Grand Lodge, and in 1740 gave birth to the *Loge Française* of Bordeaux, which seems to have established a connection with the *Council of the Emperors of the East and the West*, and apparently in 1758 a "Grand Council of Princes of the Royal Secret" was formed at Bordeaux.

At a date which I have been unable to fix, we find that Martinez assembled some members of the *Loge Française*, and exhibited a warrant covered with indecipherable hieroglyphics which he stated had been granted to him and his descendents by Charles Stuart (the young Pretender?).<sup>2</sup> He also presented the following petition:

Supplie très humblement la très respectable loge de vouloir bien faire l'honneur de l'affilier, et il fera en reconnaissance des voeux au G.: A.: de l'U.: pour la prospérité des maçons répandus sur la surface de la terre et de cette R.: L.:"

"Signé: Martinez, Ecuyer."

Thory, in his *Histoire de la Fondation du Grand Orient*, gives the following account of the system which Martinez propounded to the brethren of the *Loge Française*.

"The idea of this system has been borrowed from Swedenborg. The creation of man, his disobedience, his punishment, the pains of body, and of spirit which he experiences, form the body of the doctrine of initiation in the rite of Elus-Cœns.

"His regeneration and reintegration in his primitive innocence, as also in the rights which he has lost by the original sin, are the end it places before itself.

"According to this system, the person who presents himself for reception, is in the eyes of the sect, but a composition of mud and clay. The chiefs of this theocratic society give him life on condition that he will abstain from tasting the fruit of the life-giving tree. He is seduced, he forgets his promise, he is punished and cast into the flames. But now he is reborn to a new life: he is re-instated in his new dignity, if useful labour and a holy and exemplary life render him worthy.

"This is what is taught to initiates of the first class in the three degrees which are called *apprentissage*, *compagnonage*, and *maitrise*; for which, as one can see from what has been said, *Genesis* has furnished the programme.

"Man having recovered his primitive rights, and having, by a speculative way returned to his Creator, is animated by the Divine breath. He becomes fit to know the most sacred secret of nature; the *haut chimie*, the Kabbala, divination, the ontological sciences, are for him but ordinary matters of knowledge in which he can be easily instructed.

"These privileged beings form the second class in the Order of Elus-Cœns. These classes split into several others, in which the initiates, according to their tastes or dispositions, are taught the occult sciences in all their parts."

Having received this doctrine, the *Loge Française* adopted the name *Française-Elue-Ecosaise*. These very marked tendencies of the *Loge Française* no doubt account for the ultra-conservative attitude assumed by the *Loge Anglaise*.

Martinez is said to have established Lodges of his rite at Toulouse in 1760 and at Paris in 1768. He then suddenly disappears from France, and we hear of his death in 1779 at Port-au-Prince.

<sup>1</sup> A.Q.C., vol. xii., p. 6.

<sup>2</sup> Surely this claim to Stuart patronage is remarkable. It looks as if there was at least a convention in this respect amongst the founders of systems of "higher degrees."

It would be interesting if we could discover the relationship of Martinez Pasqualis' rite to the rite of the *Illuminés d'Avignon*, with which the names of Dom Antoine Joseph de Perety, a learned Benedictine, and the Count Grabianca, an exile Polish staroste, are attached. Perety is said by some to have composed his rite in 1760: others give the date 1766. The name of this quite well-known person is so variously spelt by writers on Masonic matters that I am inclined to doubt whether they really knew much about a person of whom they write with no small confidence. It is known that in 1765, Perety, after some trouble with his co-religionists at Paris, fled to the Court of Frederick the Great, who appointed him his librarian. Perety's visit to Germany must have exactly coincided with the occasion of the downfall of the adventurer Johnson, who after winning to the *Strict Observance* the allegiance of the Clermont Chapters, had been too tardily and detected and exposed by Von Hund. It is my present belief that between the Templarism of the *Strict Observance* and the French *Illuminés* there is a distinction but no real difference. In France, where traditions of the mediæval Templars and their condemnation for grave offences against morality were strong, the name would be avoided for very obvious reasons. The Perety rite is said to have been practised at Avignon in 1778, and a year later it was transferred to Montpellier where it flourished under the title of the *Academie des Vrais Maçons*. That most of the seemingly diverse rites and degrees of a hermetic nature which Ragon and others describe as working at this time in the South of France were in reality very much one and the same thing is illustrated by the fact that the Montpellier Academy is said to have been founded by a member of the *Mère Loge du Contrat Venaissin*. The advanced degrees of the *Academie des Vrais Maçons* and the *Mère Loge du Contrat Venaissin* are in names at least identical.

1. Vrai Maçon.
2. Vrai Maçon dans le voie droit.
3. Chevalier de la Clef d'or.
4. Chevalier de l'iris.
5. Chevalier des Argonautes.
6. Chevalier de la Toison d'or.

The *Academie*, at one time, bears the name—*Academie Russo-Suedoise*, which recalls the hermeticism of Starch's Russo-Swedish clerical rite in advance of the *Strict Observance*. The *Academie* notoriously comprised followers of the systems of Zinnendorff (Elenberger) and Swedenborg.

To return to Martinez Pasqualis. Although his disciples, as might have been expected, do not tell us much about the actual transactions of their Lodges, it is by no means difficult to discover the nature of their Master's teaching. Martinez himself has left behind a treatise *Sur la ré-intégration des êtres dans leurs premières propriétés, vertus et puissances spirituelles et divines*. M. Matter<sup>1</sup>, into whose possession the manuscript passed, has described this treatise in his work—*Saint-Martin : le Philosophe Inconnu*, and M. Franck has published some of the opening chapters as an appendix to his *La Philosophie Mystique en France à la Fin du XVIII<sup>e</sup> Siècle : Saint-Martin*. The treatise leads off boldly with the doctrine of emanation. "Before the commencement of time, God, by His own glory, in His Divine Immensity caused spiritual beings to emanate. These had to practice a worship which God had fixed for them by laws, precepts and eternal commandments. They were then free and distinct from the Creator, and they could not be denied free will, with which they had been emanated, without destroying

<sup>1</sup> *Saint Martin : Le Philosophe Inconnu ; Par M. Matter. Paris, 1862.*



in them the faculty, the property, the personal and spiritual virtue which were necessary to them in order for them to work with precision in the limits in which they were to exercise their power. The first beings could not deny or ignore the conventions which the Creator had made with them in giving them laws, precepts and commandments, since it was on these conventions alone that their emanation was founded. It will be asked what were these first beings previous to their divine emanation: did they or did they not exist? They existed in the bosom of the Divinity, but without distinction of action, thought, and individual understanding: they could act or fall by the will alone of the Superior being who contained them, and within whom all was moving which could not truly be said to exist. This existence in God is an absolute necessity: it is that which constitutes the immensity of the Divine power: God would not be the Father and Master of all things, if He had not innate in Himself an inexhaustible source of beings which He causes by pure volition to emanate when He pleases. It is by this multitude of emanations and spiritual beings outside of Himself, that he bears the name of Creator, and His works bear the name of the divine creation, spiritual and animal, spiritual-temporal."

It is scarcely necessary to point out that, despite a marked tendency in this direction on the part of writers such as the Jesuits, Suarez and Vasquez, and their school, the Christian doctrine of the Infinitude of God and of His omnipresence is carefully safeguarded against this idea of a corporeal presence throughout a material immensity. St. Augustine, in his *Confessions*, tells us how he held some such idea—the presence of all things in God as water in a sponge—in his days as a heathen philosopher, and how he came to abandon a view according to which there would be more of God in an elephant than a man, simply because an elephant occupies more room in space.

"The first spirits emanated from the bosom of the Divinity were distinguished among themselves by their virtues, powers, and their name: they occupied the immense divine circumference vulgarly call 'domination'; and which bears its name *denaire*, according to the following figure (1), and it is there that every *superior* spirit 10, *major* 8, *inferior* and *minor* 4, ought to act and operate for the greater glory of God. Their demonstration or their number proves that their emanation really comes from the *quatriple essence divine*: the names of these four classes of spirits were more powerful than those we vulgarly give to the Cherubims, Seraphims, Archangels and Angels, which were only emanated later on. Moreover these four first chiefs of spiritual beings have in them, as we have said, a part of the divine domination, a superior power, major, inferior and minor, by which they know all that may exist or may be enclosed in the spiritual beings which have not yet come forth from the bosom of the Divinity. How, it will be said, can they have knowledge of things which as yet do not exist distinctly and outside the breast of the Creator. The reason why is because these first chiefs emanated from the first circle, mysteriously named *cercle denaire*, and could read clearly and with certainty what passes in the Divinity, as well as all that was contained in it."

Martinez then, in the same magisterial manner, describes the fall of these high first emanated beings, and propounds his view as to the origin of evil. Into these depths of Kabbalistic tradition we must not now descend. This material universe was emanated from the divine immensity to be the place of refuge of the perverted first spirits and the limit of their evil operations. Man, the minor, was then emanated, and received the "august name of God-man of the universal earth, since from him should spring a posterity of God and not a carnal posterity." "It must be observed that at the first operation Adam received the law, at the second he received the precept, and at the

third the commandment. By these three kinds of operations we should see clearly, not only what were the limits of the power, virtue and strength which the Creator had bestowed on His creature, but also those which He had prescribed to the perverted first spirits." Misled by those "proud rebel hosts who had angelic life," Adam attacks the tree of life, which is in reality the Spirit of the Creator, and, in consequence, becomes a "mineur des mineurs demoniaques," and will remain so until he has been replaced by the Creator in the same virtues and powers which he formerly possessed against the evil fallen spirits.

"If," continues Martinez, "you understand the nature of Adam's prevarication, and the harvest he has reaped from it, you will not regard as unjust the penalty which the Creator has imposed on us in bringing us to birth, and which he has rendered reversible on our posterity to the end of the ages. Adam was the last emanated of any creature; he was placed at the centre of universal, general, and particular creation; he was invested with a power superior to that of every emanated being; relative to the employment for which the Creator designed him, the angels even were subjected to his great virtue and powers. It was in reflecting on a state so glorious that Adam conceived and operated his evil wish, at the centre of his first glorious couch, which is vulgarly named the earthly Paradise, and which we mysteriously call *terre élevée au-dessus de tout sens*. This *emplacement* is so-called by the *amis de la sagesse*, since it was in that place known under the name of Mor-ia, where Solomon's temple was afterwards erected. The construction of that Temple really figures the emanation of the first man. To convince oneself of this, it need only be observed that Solomon's temple was constructed without the use of tools composed of metals, which shows everyone that the Creator formed the first man without the assistance of any material physical operation."

These extracts from the *Traité sur la réintégration des êtres*, published by M. Franck, do not take us beyond the fall of Adam. M. Matter tells us that the *Traité* stopped abruptly at the reign of Saul, and, he adds, that had Martinez dealt with the words of the prophets, of our Lord, and of his disciples, to the same extent with which he has dealt with those of Moses, he would have left us a library. M. Matter does not incline to the view that Martinez's treatise is much indebted to either the Gnostic schools or to the Kaballa, although he draws a comparison between Martinez's method and that of Philo. M. Franck, on the other hand, writes: "It is impossible for me not to recognise the essential elements of the Kaballa in the doctrine later on taught by Martinez Pasqualis, and the very form in which it is developed in his treatise *De la Réintégration*, those discourses placed in the mouths of the principal persons of the Old Testament are nothing but an imitation of the *midraschim* or allegorical and mythical commentaries on the Holy Scripture."

The fall of man is then the fact from which the system of Martinez makes its point of departure. "To this vast theory of a fall, taken place in the heavens as on the earth," writes M. Matter, "to this teaching of a *tribut solidaire* paid to the divine justice by the dwellers of the divine world and by those of the earthly world are attached acts, works, prayers, a kind of cult. Between the earthly and the heavenly spirits, the community of eternal destinies and high aspirations guaranteed to the eyes of Martinez a community in the work of reintegration imposed on all, and, to obtain the result, it followed by consequence the community of labours. The assistance of *majors* or superior spirits was therefore assured to the *minors*, if these latter knew how to interest the former in their fortunes and to acquire their benevolence by means of *sage practices*."

This passage brings us into the heart of the system Martinez sought to attach to the Lodges under the spell of his influence. It is from scattered passages in the correspondence of Saint-Martin that we learn something of the theurgic *operations* of the Martinezist Lodges. Saint-Martin seems from the very first to have turned from what he calls the "second and exterior" way practised with many ceremonies in the Lodge at Bordeaux to the practice of the "quiet gospel" way of contemplation. But he writes to his friend, Kirchberger, "I do not hide from you that in gonebye times I advanced in this second and exterior way, which is that which opened the door of my career." Of Martinez he writes: "He who introduced me to it had very active virtues." "I believe as you do that the divine Wisdom makes use of agents and of virtues to make us understand His Word in our interior." "I look on all that pertains to these exterior ways as but preludes to our work. For our being being central—in the theory of Martinez all beings are emanated from the Centre, or, to adopt his style, the Centre of all has caused all beings to emanate from its bosom—our being being central, it ought to find in the centre in which it is born all the aids necessary for its existence." Saint-Martin's impatience with the ceremonies he never ceased to think useful as preludes, is exhibited in the anecdote he himself relates to Kirchberger:—

"I will not conceal from you that I formerly walked in this fruitful external way, and by it the door of the career was opened to me. My leader therein was a man of very active virtues, and most of those who followed him, with myself, received confirmations thereby, which may have been useful to our instruction and development. Nevertheless, I, at all times, felt so strong an inclination to the intimate secret way, that this external one never further seduced me, even in my youth; for, at the age of twenty-three, I had been initiated into all those things; so that, in the midst of what was so attractive to others, in the midst of means and formulas and preparatives of all sorts, in which we were trained, I, more than once, exclaimed to our master, 'Can all this be needed to find God?' and the proof that it was all a mere substitution was that the master answered, 'We must now be content with what we have.'"

Kirchberger writes to Saint-Martin: "The school you passed through in your youth reminds me of a conversation I had two years ago with a person who came from England, and who knew a Frenchman living there, Mons. de Hauterive. He told me that this de Hauterive enjoyed, physically, the acquaintance of the active and intelligent Cause, which he arrived at after sundry preparatory operations during the equinoxes, by means of a species of disorganization in which he saw his own body motionless, as it were, separated from his own soul; but that this disorganization was dangerous on account of the visions which then have more power over the soul thus separated from the covering which served it as a shield against their action. You can tell me whether, according to your former master's teaching, these proceedings of M. de Hauterive were error or truth." Kirchberger goes on to ask for information in regard to "the Marchioness de Croix, who must have had manifestations. I am told she had them even when in company, and that she suspended the conversation to hear what her friends in another circle said to her. You, doubtless, have heard of Madame de Lacroix; was she under a delusion or in the truth?"

In reply, Saint-Martin writes hurriedly (11th August, 1792): "I will merely say that I knew M. de Hauterive; we were at school together.<sup>1</sup> I have also known Madame Lacroix: they are both estimable persons." In a letter dated August 25th of the same year, Baron Kirchberger repeats his enquiries, and on the same day, Saint-Martin, in a

<sup>1</sup> "School"—that is the Lodge.

letter which must have crossed the Baron's in the post, writes: ". . . I never had much taste or talent for *operations*. M. de Hauterive, whose master was the same as mine, gave himself more to the operative part; and although he had more fruit than some of us, I confess I never saw anything he did, in this way, to cause me to alter my mind. He has other merits in my eyes. Madame de Lacroix, also, is a very estimable person; she is believed, by many minds, to be possessed of efficient spiritual gifts. She tried them before me, but I never had any but negative proofs from her. Be this, Sir, as it may, the matter of free communications is not so rare a thing as not to be open to almost anything when forced by these operations. The world is full of both these orders of facts, and I doubt not Madame Lacroix may have had them as well as others. But it would be silly and unwise in me to undertake to distinguish between facts which are unknown to me. Independently of the innumerable difficulties in the matter itself, the doings which really concern us are those only which are personal to ourselves; or I have, I believe, already told you, that, in these things the light ought to accompany all our steps—and will, if, in humble attentive simplicity, we are faithful as we advance, and do not take too long strides. As to the belief in the existence of all these things, it rests on the belief in our spiritual nature, and the right and connexions with which this title of spirit establishes in and around us. When we have once felt our own souls, we can have no doubt about these possibilities; and it was on account of the proofs of this divine character of our being, that the school through which I passed was so valuable, for it gave us the most convincing demonstrations of this proof." In a later letter, he adds: "Your 7th question about M. de Hauterive obliges me to say that there is an exaggeration in what you may have heard of him. He does not put off his corporeal envelope, any more than others who, like him, have enjoyed, more or less, the same favours have put off theirs. The soul leaves the body only at death; but during life, the faculties may extend beyond it, and communicate with their exterior correspondents without ceasing to be united to their centre, as our bodily eyes and all our organs correspond with surrounding objects, without ceasing to be connected with their animal principle, the forms of all our physical operations. It is not, however, the less true, that if this experience of M. de Hauterive is of the secondary order, it is only figurative of the great work which occupies us; and if it is of the higher order, it is the great work itself."

In a letter dated 29th March, 1793, the Baron writes: "An essential remark which will weigh greatly with me, till you convince me to the contrary, is, that the manifestations which your school received were probably assumed forms. For this reason, since these communications fall upon the external sense of sight, I believe they can take such superb outlines, forms so imposing, and signs so awful, that it is hardly possible not to take them as true, even when they may be only counterfeits. A remarkable instance of this kind, which I heard of, about two years ago, is what occurred at the consecration of the Egyptian Masonic Lodge at Lyons, 27th July, 5556, according to their reckoning—which I believe to be incorrect. The labours lasted three days, and the prayers fifty-four hours; there were twenty-seven in the meeting. While the members were praying to the Eternal to manifest His approbation by a visible sign, and the Master was in the middle of his ceremonies, the Repairer appeared, and blessed the members assembled. He came down in a blue cloud, which served for vehicle to this apparition; gradually, he ascended again, on this cloud, which, from the moment of its descent from heaven to earth, acquired a splendour so dazzling that a young girl, C., who was present, could not bear its light. The two great prophets and the lawgiver of Israel also gave signs of their benevolence and approval. Who could reasonably

doubt the fervour and piety of these twenty-seven members? Yet who was the institutor of the Lodge?—who, though absent, ordained the ceremonies? Cagliostro! This one word suffices to show that error and counterfeit forms may follow the religious intentions and good faith of twenty-seven members met together. Thus, as it is not enough to be honest, or even religious, to be secure from error of this kind, the greatest happiness, beyond question, a mortal could have would be the physical communication of the active and intelligent Cause; but, as you will admit, error and illusion almost always take the forms of truth in a manifestation of this importance. And how are we to distinguish the true from the counterfeit? You say ‘unless a thing comes from the centre itself, I give it no confidence.’ On this, so true and important an assertion, I take the liberty to ask one question. Are there visible manifestations which come from the centre? Or, in other words, the centre being open, are we still in a position to receive visible communications? The three kingdoms which your school called *natural, spiritual, and divine*, might we not call them *natural, astral, and divine*? Do not all these manifestations, which come through initiations, belong to the astral kingdom? And as soon as we place a foot in this domain, do we not enter into association with all the creatures which inhabit it, and who, for the most part, are not at all desirable company? Do we not enter into society with creatures who may excessively torment the operator who lives in this crowd, even to such an extremity as to drive him to despair, and suggest suicide—witness Schröpfer and Count Cagliostro? . . . I will repeat my question: Do you believe in physical communications, emanating from, or produced in the centre?”

To these questions Saint Martin replies: “I had heard of all these adventures in Lyons of which you speak: I do not hesitate to class them with the most suspicious order of things, notwithstanding that the good souls who were present may have received some happy transports, fruits of their piety and true desires: God continually brings good out of evil. I know also the histories of Schröpfer and many others of the same sort, on whom a definitive judgment has been passed long ago. As for the manifestations which took in my school, I believe them to have been much less tainted than the above, or if they were tainted, there was a fire of life and desire in us all that preserved us, and even took us graciously on our way; but we knew then little of the centre. What I have known by this centre, and about which you inquire, is limited to delicious internal transports which are found here and there in my writings, printed and manuscript. . . . I have had some physical communications also, since these central affections, but less abundantly than when I followed the proceedings of my school: and even in those school proceedings I had less of the physical than most of my comrades. It was easy for me to perceive that my part lay more in intelligence than in operation, which Böhme has enabled me to understand well, in his *Fifth Point*, on magic, where I have clearly seen the difference between *magus* and *magia*. This physical, which I have experienced, though rarely, since my central affections, commands no more my confidence than all the rest; I pay little attention to it; thus neither on that head, nor on any central openings, can I satisfy your curiosity.”

In the early days of their correspondence Kirchberger repeatedly sounds Saint-Martin on Masonic points, but he always gets either the vaguest of replies or advice to the effect that as only personal experience of the centre avails, the one thing needful is to cast oneself “*à corps perdu*, into the arms of our Benefactor and Saviour.” “I have told you also,” writes Kirchberger, on 14th June, 1794, “of my having given another direction to the studies of a school in Bâle instituted by Cagliostro. You have never told me whether I do well to undertake this sort of rectification of lodges; certain it is

that the most interesting persons of that house, as also our young *Zurichose*, are at present altogether of my mind, although I have never seen this last. It is not long since I saw this young person's uncle; he is a man of great acquirements; he is the chief Mason of Switzerland. He was at the Congress of Wilhelmsbad, and is acquainted with all the ramifications of masonry. . . . Speaking of Masonry, I have another question to ask of you. Do you know a lodge called the Lodge of *the Holy Ghost*? It has a sun instead of the phosphoric fire of the *Northern* lodge, and this sun performs the same functions as the phosphorous light of Copenhagen. If you know that lodge, please to tell me what country it is in?" On July 12th, Kirchberger adds to this: "To this Saint Martin, almost churlishly replies: As for the Lodges, I care little to know what they are called or what they are doing."<sup>1</sup>

It is clear, from the passages of the Saint-Martin—Kirchberger correspondence, that the *operations* of the Bordeaux school were very much what Kirchberger conjectured them to be—not the "misgivings," but the more or less confident "movings" of souls "in worlds not realised." Saint-Martin had, by the time of this correspondence, turned from the "preludes" of the school of Martinez Pasqualis to the Strasbourg school of Böhme. He had, in 1792, written and published his *Ecce Homo*, with a view to draw people—his friend the Duchesse de Bourbon in particular—from the taste for dabbling in the mysteries of somnambulism, magnetism, etc. But it is also clear that the *Philosophe Inconnu* has had his experiences, and that "in his school" he has been acquainted with those "operations" which rendered Masonry of this kind, if Masonry it be called, a "happy hunting ground" for charlatans like Cagliostro, or demi-charlatans like Mesmer. To Saint-Martin I propose to devote a future paper. His influence, real or imaginary, in the history of Masonry, and in the movements which prepared the way for the French Revolution, is one of the historical subjects, frequently dealt with by anti-Masonic writers, but one which requires, and apparently has not yet obtained a careful handling by any genuinely qualified Masonic historian.

We have, however, a very much more vivid picture of the master of Bordeaux than these extracts from the *Traité de Réintégration*, and the writings of Saint-Martin can supply, and it is with the witness of the Abbé Fournié the present paper must close. I have not myself seen the extremely rare book in which the Abbé gives his experiences, but I rely on M. Matter's extracts.

"As for me, God's frail instrument, in writing this treatise, of which I to-day publish the first part, I announce, without any disguise, for His greater glory and for the salvation of us all—men past, present, and to come, that, by God's grace, I have no knowledge of human sciences, without being for that cause opposed to their culture, that I have never made any studies,<sup>2</sup> and that I have read no other books than the Sacred Scriptures, the *Imitation of our Divine Master, Jesus Christ*, and the little book of prayers in use amongst Catholics, under the title of *Petit Paroissien*. To which I should add that I have read about a year ago two or three volumes of the works of the humble servant of God, Madame Guyon.

"After having passed my youth in a manner calm and obscure as concerns the world, it pleased God to inspire me with an ardent desire that the future life should be a reality, and that all I had heard said of God, of Jesus Christ, and His Apostles should also be realities. About eighteen months rolled by in all the agitations which these

<sup>1</sup> In a study on Cagliostro I hope to deal with some exceedingly interesting portions of the Saint-Martin—Kirchberger correspondence which I must pass over here. In a later letter Saint-Martin apologises for his petulance.

<sup>2</sup> On his title page he describes himself as *clerc tonsuré*.

desires caused me, and then God granted me the grace to meet a man who familiarly said to me: 'You should come and see us; we are fine people. You would open a book, you would look at the first page, at the middle, and at the end, reading only some words, and you would know all it contained. You see all sorts of people walking in the streets; ah! well, those persons do not know why they walk, but you would know.'

"This man, whose introduction to me might seem extraordinary, was called Don Martinets de Pasquallys.

"At first I was seized with the idea that the man who had spoken to me was a sorcerer or even the devil in person. To this first idea soon succeeded another, at which I stopped myself. 'If this man is the devil,' I said within myself, 'then there is a real God, and it is to God alone that I wish to go; and, as I only desire to go to God, I will so make my way towards God that the devil will believe he is making me go towards him. In this manner, I went to M. de Pasquallys' home, and he admitted me into the number of those who followed him.

"His daily instructions were: to direct ourselves unceasingly towards God, to increase from virtue to virtue, and to work for the general good. They answered exactly to those which it seems that, in the Gospel, Jesus Christ gave to those who walked in His steps, without ever forcing anyone to believe under pain of damnation, without imposing other commandments than those of God, without imputing other sins than those which are expressly contrary to the law of God, and leaving us often in suspense as to whether he were true or false, good or evil, angel of light or demon. This uncertainty burned me so powerfully within, that, night and day, I cried to God, that, if He really existed, He would come to my aid. But the more I appealed to God, the more I felt myself imprisoned in the abyss, and for all interior reply I heard only these despondent ideas: 'there is no God, there is no other life, there is only death and emptiness.' Finding myself surrounded by nought but these ideas, which burned me more and more powerfully, I cried even more ardently to God and without leaving off, scarcely sleeping any more, and reading the Scriptures with great attention, without ever seeking to understand them by myself. From time to time it happened that I received from on high some light and rays of intelligence; but all this disappeared with the rapidity of lightning stroke. At other times, but rarely, I had visions, and I believed that M. de Pasquallys had some secret to make these visions pass before me, although nevertheless they realised themselves, a few days after, even as I had seen them.

"I spent thus more than five years of fatiguing uncertainties, mingled with great agitations, always desiring that God exists and to escape myself annihilation, but always plunged in a dark abyss, and seeing myself surrounded only by the opposite of the reality of God's existence, and, consequently, of the other life; so that I was tormented in the extreme, and melted by my desire of God and by the contradiction of that desire.

"At last, one day, when I was prostrate in my room crying to God to succour me, about ten o'clock in the evening, I suddenly heard the voice of M. de Pasquallys, my director, who was corporeally dead more than two years, and who spoke distinctly outside my chamber, the door of which was shut, as well as the windows and the shutters. I looked on the side whence came the voice, that is to say, the side of a large garden adjacent to the house, and at once I saw M. de Pasquallys, who set himself to speak with me, and with him my father and my mother, who were also all corporeally dead. God knows what a terrible night I passed. I was, among other things, lightly struck on my soul by a hand which struck it across my body, leaving me an impression of grief which human language cannot express, and which to me seemed to

belong less to time than to eternity. O my God! if it be Thy will, grant that I may be never again smitten in this way! For this blow has been so terrible that, although twenty-five years may have passed since then, I would with a cheerful heart give the whole universe, all its pleasures and all its glory, with the assurance of enjoying them during a life of a thousand milliards of years, to avoid being stricken again only a single time.

"I saw then in my room M. de Pasquallys, my director, with my father and my mother, speaking to me, and myself speaking to them as people in ordinary speak amongst themselves. There was there, however, one of my sisters who was also corporeally dead twenty years since, and lastly another being who was not of human kind.

"A few days after, I distinctly saw pass before and close to me our divine Master, Jesus Christ, crucified on the tree of the Cross. Then, at the end of some days, this divine Master appeared to me anew and came to me in the state in which He, all living, had left the tomb in which His dead Body had been buried.

"Finally, after another interval of a few days, our divine Master, Jesus Christ, appeared to me for the third time, all glorious and triumphant over the world and Satan, and his pomps, walking before me with the blessed Virgin Mary, His Mother, and followed by different persons.

"That is what I have seen with my corporeal eyes, more than twenty-five years ago, and that is what I am now publishing as veritable and certain. It was immediately after I had been favoured with these visions or apparitions of our divine Master, Jesus Christ, in his three different states, that God granted me grace to write with an extraordinary rapidity the treatise of which you now read the first part. Consequently, I wrote it some years before one in France had heard that there was a Swedenborg in the world, and before one had heard of the existence of magnetism."

Those who have studied Professor James's *Types of Religious Experience* will not require the assurance that Fournié was not dependent on Swedenborg, but the statement in the last sentence of the foregoing quotation will scarcely stand examination. Pasqualis died, as we have seen, in 1779, and it was two years after his death that he appeared to Fournié—that is to say, in 1781. Long before 1781 the visions of Swedenborg had become famous all the world over. Fournié's treatise, however, was published in 1801, and, as he then puts his visions back twenty-five years, we should have to put back the death of Martinez to 1776, and the vision to 1778: but even this would not bring the visions back behind Swedenborg's time.

It is, of course, clear that Fournié tells us nothing as to the Martinezist lodges and their operations, which, as Saint-Martin puts it, afforded sensible proofs of "the divine character of our being:" but, our extracts may very well lead us to accept the conclusion framed by Professor Franck. "We possess in its most essential elements the doctrine of Martinez Pasqualis. It is composed of two very distinct parts: the one, interior, speculative, spiritual, to which ancient tradition are attached, if indeed it is not entirely those very traditions: the other, exterior, practical, and even to a certain point material, or at least symbolical, which depends, as Saint-Martin shows us, on the hierarchy of virtues and powers or the degrees of the spiritual world interposed between God and man. These two parts of the doctrine of Martinez, which are also met with in the School of Alexandra, in Gnosticism, and in the Kabbala, have not had, and could not have, the same destiny. The latter, which is not else than theurgy, after having produced visionaries such as the Abbé Fournié, the Comte d'Hauterive, the Comte de Divonne, the Marquise de Lacroix, ended by losing itself in the school of Swedenborg,



dethroned in its turn by somnambulism and spiritualism. The former, under the name of theosophy, that is to say, the science which not only has God for its object, but which emanates from God, has captivated especially the mind of Saint-Martin, and is rejuvenated by the breath of a beautiful soul and the light of a noble intelligence."

---

## APPENDICES.

---

### I.—SWEDENBORG.

Bro. Richard Greeven in his pamphlet on *Our Lady Guests*, has truly said that the whole subject of the systems of (so-called) Masonry in which Cagliostro moved so brilliantly and, for a time, so profitably to himself, requires investigation in the light of the teaching of Swedenborg. M. Henri d'Alméras writes: "Affilié à la Franc-Maçonnerie, c'est sur elle que comptait Svedenborg, pour répandre sa réforme religieuse, qu'il avait exposée dans le plus célèbre de ses livres, la *Jérusalem Céleste* ou le *Monde Spirituel*. La *Jérusalem Céleste* devait être l'Évangile des Svendeborgians. D'après cet ouvrage si rempli de rêveries extravagantes qu'il en devient presque inintelligible, c'est en Tartarie, 'pays encore régi par des patriarches,' que la *parole perdue* devait être cherchée et retrouvée. La parole perdue signifiait l'innocence primitive, et les Tartares restaient le seul peuple qui ne s'en fût pas complètement écarté. L'ensemble des Mondres reconnaissait pour créateur et pour maître Jésus Christ, Dieu unique, 'qui était vie, amour, sagesse, chaleur et lumière. L'homme ne mourait jamais. Ce qu'on prenait pour la mort était le commencement de la véritable vie. Dégagé de ses liens terrestres 'l'homme devenait un ange.'" *Cagliostro*, p. 119.

I hope in another paper to deal with the subject of the alleged influence of Swedenborg on Masonry. In the meanwhile I should like to ask any of our brethren, who are learned in Swedish Masonry, if they can throw any light on the assertion that Swedenborg himself was "affilié à la Franc-Maçonnerie." The courteous Secretary of the Swedenborgian Society tells me that "there is a very circumstantial account of his (Swedenborg) having joined a Lodge in London in 1706, when 18 years of age, made by L. P. Regnell of the Lund Lodge of Freemasons, taken from the archives of the Chapter in "Christianstad," but, as he points out, Swedenborg did not visit London till 1710, and if for "London" we are to read Lunden or Skone, we are met with the difficulty that Masonry was not introduced into Sweden till 1736. To the Secretary of the Swedenborg Society I am indebted for the following quotation from Dr. Kahl's (the Dean of Lund) book—*The New Church and its Influence on the Study of Theology in Sweden*. "The agreement between the dogmas of Freemasonry and the *New Jerusalem* has no doubt led Reghellini di Schio to the idea that Swedenborg was one of the most celebrated reformers among the Masons, and had himself founded a Lodge of nine degrees. This assertion, however, which is made in Raghellini's work—*La Maçonnerie considérée comme le Résultat des Religions Égyptienne, Juive, et Chrétienne*, lacks every historical basis, so far as it has been possible to investigate this matter. Swedenborg did not found, but some of his friends and disciples, e.g. Chastanier and Percy, have founded Masonic Lodges; and one result attained by their efforts is that within the ranks of Freemasonry they have directed the ideas of men to the doctrines of the *New Jerusalem*, so that

these doctrines have really exercised an influence upon the progress and development of the Order in Sweden, as well as in other countries."

A work has been published in America by S. Beswick, entitled *Swedenborg as a Mason*, and this has been adversely criticised by Dr. Tafel in his *Documents concerning the Life and Character of Swedenborg*.

## II.—SCHRÖPFER.

Monsieur H. d'Alméras gives the following account of this adventurer:—

"Schröpffer had opened a café at Leipzig, 29th October, 1768, but the profession of a tavern-keeper seemed to him unworthy of his merit. He had the idea of founding, at his own house, a lodge and new masonic rite based on the evocation of the dead. In midnight assemblies he caused to appear to his disciples the souls of their friends—blessed or damned. Some adepts thought that they recognised in the ranks of the dead, parents or friends, and went mad. The reputation of Schröpffer gained much from this. Encouraged by this vogue, he spread his teaching, and converted his café into a private hotel, at which he received only persons of distinction. He then assumed the title of Colonel in the French service, and called himself a bastard of the Prince de Conti. From Leipzig he left for Dresden, where he succeeded in duping a number of high personages, among whom was the Duc de Courland, to whom he made appear his father, the late King of Poland. Unfortunately the French Resident, M. de Marbois, committed the indiscretion of asking for his brevet as colonel: unable to reply in a satisfactory manner, Schröpffer hastened to regain Leipzig. It is there that he died in a tragic manner.

"On the 7th of October, 1774, Schröpffer gave a great supper to some of his most faithful partisans and invited them to walk on the following day at the Rosenthal in the suburbs of Leipzig. When they had reached the rendezvous, he announced to them that he knew the bad things that were said of him, but that he was about to confound his enemies by a prodigy more extraordinary than those he had already achieved. At the entrance of the Rosenthal he arranged his companions in a cross, and bid them watch carefully what was to happen. He slipped away under a hedge. Some seconds after a pistol shot was heard. Schröpffer had blown out his brains." *Cagliostro: La Franc-Maçonnerie et l'Occultisme.* pp. 118-19. Note.

## III.—KIRCHBERGER'S ACCOUNT OF THE NORTHERN SCHOOL, THE ZURICH (EGYPTIAN) LODGE, LAVATER, CAGLIOSTRO, ETC.

24th Dec., 1793. *From Kirchberger.* "I found some old acquaintances at Bâle, who, to my surprise, were very advanced in the theory and practice of communications. They told me of an event which has just occurred to a celebrated ecclesiastic of Zurich, whom I formerly knew; his name is Lavater. He has received an invitation to go to see some persons of the highest rank in a northern court; not the one you mentioned in one of your letters, whose Cabinet could not move without physical consultations<sup>1</sup>: the one in question is further north.<sup>2</sup> Lavater arrived there last summer; he met with men of education, engaged in public business and living in the world, occupying high positions—men of acknowledged probity, who, in inviting him, could have no motive but one of goodness, for they even defrayed the expense of his journey. These men assure him

<sup>1</sup> Berlip. (?)

<sup>2</sup> Copenhagen,

that they have immediate communications with the active intelligent Cause; they assure him that one of his friends, dead some time ago, will, through his medium, enter their society. These men promise to enlighten him on subjects on which he prayed for light for a long while—on the doctrine of the heavenly food, the great mystery, where it is said, ‘Take, eat, this is my body; drink, this is my blood: he that eateth not the flesh I have given for life, the bread which came down from heaven, will not have life in him.’ In L’s narrative, dated 26th October, 1793, which has been sent to me here, and I have before my eyes, he says on this subject: ‘He who understands these words understands the deepest mystery and most essential part of Christianity; he will be perfectly convinced of an union, real, positive, and intimate *mit der gekreuzigten Menschen person J.C.*’ These men tell him that, when they are assembled, and even when some of them are alone, they receive, at once, answers to questions they ask; at least a *yes* or a *no*, which leaves room for no mistake; that often, even without a preliminary inquiry, they receive communications and revelations by which several important matters have been cleared up. They tell him also, what is very remarkable, that whenever they are together they have a most intimate experience of the truth of the promise, ‘Where two or three are met together in my name there I am in the midst of them’; since, then, a cloud, white as snow, descends about half-an-hour, rests upon them. They were convinced that these manifestations were signs and emanations of the active and intelligent cause:

“1. Because these communications were always had after prayer had been offered to that Cause, and the answers came immediately after the petitions.

“2. Because these manifestations enjoined their love for that Cause.

“3. Because the manifestation which they called, *Lord, Spirit of the Lord, Image and Symbol of the Lord*, received their adoration, which no good *virtue* would have dared to do.

“4. Because the answers were given at the same time, in many places, to different persons, and in the same manner.

“5. Because it judged them with severity, and on their sincere repentance, it immediately blessed them, and that visibly.

“6. Because whenever they asked it, Art thou the active intelligent Cause? they were answered Yes! which no power, good or bad, would have dared to say.

“7. Because they were able to distinguish him from the good and evil intermediate beings which surrounded him.

“These are significant signs and characters. The only thing which greatly embarrassed our Lavater was a singular doctrine which he finds established in this circle, that of the return of souls. All men now alive, said the members of this school of new Pythagoreans, have already lived under many forms and different names; the holiest of men being obliged to appear again in the world in the form of the most ordinary. I confess I am like our Zurich friend; this doctrine, on the part of a society of elect, who believe that they are living in real union and intimacy with the active intelligent Cause, embarrasses me also, etc., etc.”

6th Jan., 1794. *St. Martin to Kirchberger.* “. . . I knew of the Zurichers’ journey to the Court of D[enmark], but I did not know its object. This Zurichers and I know each other only by name; he, like you, Sir, honours me with his kindly feelings. What he has learnt by his journey must have pleased him without surprising him, for he must have known of all these things long ago. I cannot form a very decisive idea of this new branch of commerce which you bring to my acquaintance; only I think I

can see a great similarity to that of Avignon, of which you have heard me speak. Though all the characters of this new branch do not seem to me to be defective, still I think it might become more central; our much-prized readings lead me to think so. The ruling doctrine of that circle will then be purged of its metempsychosis, a system which never fails being taught in the lower schools, and is daily by our somnambulists, but which agrees with none of the great principles of the divine spiritual theory, unless you call metempsychosis the possible and repeated return of God's great Elect, such as Elijah, Enoch, Moses, etc., who may indeed appear at different epochs, to bear witness to, and assist sensibly, the advancement of that great work, because good always flows in the channels it has once selected. . . . "

15th Jan., 1794. From K. " . . . I thank you for elucidating the new branch of intercourse going on in the North. The great difficulty remains as to the conclusions of our Zurichers: 'Art thou the active, intelligent Cause?' They were answered, 'Yes! which no intermediate power, good or bad, would have dared to say.' Is this conclusion right or not? that's the question. I have seen a letter of twenty pages written by the daughter of Lavater to one of her intimate friends, on the occasion of her journey to Copenhagen, where she accompanied her father. This daughter is an angel; but, as she does not believe in the metempsychosis, any more than you or I, she is greatly perplexed. . . . There are some initiates here who pretend that the dazzling white cloud which appeared in the phenomenon of the North is a characteristic and inimitable sign of the truth of the phenomenon. . . . "

[In a letter of 26th Jan., 1794, Saint-Martin gives his reasons for holding that "those at Copenhagen do not seem to me to have sufficient proof to justify their confidence":—"I do not believe they are elects of the first degree mentioned above, for if they were, they would have had no uncertainty, and had no need to ask questions; 2nd, I notice that they are passive in their work—acted upon, not acting—therefore without the needful actual virtuality to 'bind the strong one' and 'clear out the house.' . . . ." As to the argument based on the mysterious phenomenon of the cloud, "the enemy can imitate every thing . . . it is to discern these terrible imitations that the use and practice of true theurgic operations lead. . . . The internal who teaches all things . . . protects from danger."]

12th Feb., 1794. From Kirchberger. "Your observations on the intercourse in the North appear to me perfectly correct; one amongst the rest, ought, I think, to be printed in letters of gold: *The internal teaches everything and protects from danger.* The substance of this theory has been communicated to the young lady at Zurich. It was her friend's father, who is here, who showed me her letters, in which there reign a frankness and purity of mind which have pleased me greatly. I am intimate with the two sisters, who, especially the elder, of about twenty, are friends of our young lady of Zurich (Lavater); they have been initiated themselves, and assisted at all the proceedings. Their mode of intercourse was by means of one of such pupils, who was consecrated at each *séance*, and who, after prayer was offered, entered alone into direct communication. The master of the lodge directed the questions, and the answers were communicated to the pupil, who was the third youngest sister.

"I have succeeded in proving to them, and *convincing* them, that, notwithstanding the plausible appearance of these transactions, they were often of very doubtful, and sometimes very dangerous character. I have also made them see that the central road, the road of love, was infinitely preferable to these external fascinations. The father,

notwithstanding his attachment to these subaltern initiations, has been gradually led round to my way of thinking by his daughters. What completely gained me the confidence of these young ladies, who may yet open all their souls to the truth, was reading the xii. and xiii. chapters of I. Cor., which the eldest of them opened accidentally. But with the other men, members of this society, nothing of consequence can be done. They are infected with the idea of the prerogative of having this direct intercourse with the powers. The first master they all had was Count Cagliostro, who was intimately connected with the father of the pupils. This father is the younger brother of M. Serazin,<sup>1</sup> whose address you put on my letters."

30th April, 1794. " . . . I have since received through that channel further news of Miss Lavater: her father seems to be still enchanted with his journey, although in reality he still has some doubts. That School in the North carries its idea of metempsychosis so far as to pretend that St. John is still living bodily amongst them. They have even announced that he will probably make a journey to Zurich, to visit our young lady's father. Judge from this what they are about. I have received a quire full of details of the experiences at Copenhagen. They still glorify themselves in the belief that the light, which, after their questions, gives out the sign *yes* or *no*, is a whitish phosphorus colour, and not red, because red, or the colour of fire, would be of a bad species. Just as if it were not as easy to ape a whitish colour as a fiery colour! Sometimes they see a star by the side of the light which is their oracle; they know this star represents a *virtue*. Then they ask: 'dare it remain there?' According to the answer, *yes* or *no*, the scholars order, the star obeys.

"They sometimes put questions on points of doctrines; for instance, they ask, 'Is there any passage in Scripture which indisputably proves the metempsychosis, *yes*, and *no*.' Some understand this to mean that such passages may be found in the Old Testament, and they again ask: 'Is there any in the New Testament? *Yes*. In the four Evangelists? *Yes*. In St. Matthew? *Yes*. In the 1st chapter? *No*. In the 2nd? *No*. In the 4th? *No*. In the 11th? *Yes*. . . .'

"What mainly contributes to make immovable their belief as to the nature of this miraculous light, which they take for the active Cause Himself is that several predictions, which appeared to them very improbable, have been accomplished. . . . They also receive a sign of benediction when the oracle is pleased with what they have done or proposed doing."

14th June, 1794. *From Kirchberger.* " . . . I told you also of my having given another direction to the studies of a school in Bâle, instituted by Cagliostro. You have never told me whether I do well to undertake this sort of rectification of lodges; certain it is that the most interesting persons of that house, as also our young Zurichoise, are at present altogether of my mind, although I have never seen this last. It is not long since I saw this young person's uncle; he is a man of great acquirements; he is the first mason of Switzerland. He was at the congress of Wilhelmstad, and is acquainted with all the ramifications of Masonry. He lately saw a M. de Gleichen, who is travelling in Switzerland. As this De Gleichen may possibly come to see me at Morat, *en passant*, be good enough to tell me what you think of him, if you know anything of him, and the sooner you let me know the better I shall be pleased.

<sup>1</sup> Sarazin, a Swiss banker, who in 1787 offered Cagliostro a place of refuge in Switzerland. See Almérás: *op. cit.* pp. 311-12.

“Speaking of Masonry, I have another question to ask you. Do you know a lodge called the Lodge of the *Holy Ghost*? It has a sun instead of the phosphorous fire of the *Northern Lodge*, and this sun performs the same functions as the phosphoric light of Copenhagen. If you know that lodge, please tell me what country it is in.”

1st July, 1795. *From Kirchberger.* “. . . I met at an inn a Frenchman, formerly established at Lyons, called Gabriel Magneval. As he found that I was connected with one of his intimate friends at Bâle, who was present, he was very open. We spoke of Lyons in 1784 and 1785. He was one of the first directors and contributors to that sort of temple which cost them 130,000 francs. I did not conceal from him my doubts as to the soundness of their doings; doubts founded principally on the immorality and want of Christian faith in their master. He readily agreed as to their worthlessness, and especially to the unbridled pride of their teacher; but he argued that the truth might, like the gifts of the Roman Church, pass through the channel of an impure priesthood, without losing its value; that they themselves were of good faith, and full of respect for our divine Repairer. I found by his conversation that their master, notwithstanding his low morality, worked by the word (*paroles*), and that he even transmitted to his disciples the knowledge how to work in the same way in his absence. I observed that they had probably produced forms in effigy only, and not real things. He then asked me how I thought I could distinguish real manifestations from such as were only counterfeit? I told him that I thought the best guide in this was to have a perfect inward disposition. Our conversation was interrupted; but the remarkable fact remains that an impostor like Cagliostro was in possession of the word.<sup>1</sup>”

---

#### POSTSCRIPT.

Since my article on M. Pasqualis has been printed, I have become acquainted with two books on the subject:—

1. [Bibliothèque Martiniste.] *Martinésisme, Willermoisme, Martinisme et Franc-Maçonnerie.* Par Papus, Président du Suprême Conseil de l'Ordre Martiniste. Paris, 1899.
2. *L'Illuminisme en France, 1767-1774, Martines de Pasqually—Sa Vie—Ses Pratiques Magiques—Son Œuvre—Ses Disciples.* Suivis des Catéchismes des Élus Coens. D'Après des documents entièrement inédits. Par Papus. Paris, 1902.

The second of these two books is of very great importance to any student who wishes to investigate the still obscure subject of the rise of Illuminism in France and its relation to Freemasonry. Unfortunately the letters of Martinez dealt with in this volume do not commence before June 19th, 1769, that is to say, nearly fifteen years after he is said to have commenced the foundations of his order at Bordeaux. They consequently throw no light on the relations between *Martinésisme* and such rites as those established by Pernety at Avignon.

<sup>1</sup> *Selections from the recently published Correspondence between Louis Claude Saint-Martin and Kirchberger, Baron de Liebistorf. 1792-97.* Translated and Edited by Edward Burton Penny. Exeter, 1863.

In the first of these two books by Dr. Papus, we find it confidently asserted that "the sole real creator of high grades was Swedenborg, and these grades are attached exclusively to Illuminism." Dr. Papus even says that Martinez was himself initiated by Swedenborg at London, but there is nothing in the documents given in the Doctor's second and later book to support this statement, which apparently has no other authority than Reghellini as quoted by Ragon. *Martinésisme, Willermoisme, Martinisme* contains some very valuable information, but it strikes me that the book is by no means to be received without severe criticism. For instance, what reliable authority is there for the ascription to Fénelon of a share in Ramsay's (alleged) Templar activities? Yet Dr. Papus writes (p. 11) as if the fact were completely established. Then, again, he asserts (p. 67) that Von Hund ("de Hundt," Dr. Papus writes), emanated from the Chapter of Clermont, which he dates 1754 on p. 11 and 1752 on p. 67. In the second book (p. 149) Von Hund, "créateur de la haute maçonnerie allemande ou illuminisme," is again said to have been an offspring of the Clermont Chapter. It is, of course, well known that Von Hund was organising his order in Germany in 1750. This is not the only thing in these two books which would lead one to conjecture that Dr. Papus has not been at pains to master his subject outside the limits of his own motherland.

The letters of Martinez which Dr. Papus has published throw a lurid light on the character of the *operations* in the Martinezist lodges; they, in fact, establish in detail the description of these *operations* which I have sketched in general in my paper. In future papers I hope to make use of some of the materials Dr. Papus has provided.

As to biographical details, Dr. Papus shows:—

1. The name should be written either Don Martines de Pasqually or Depasqually de la Tour.
2. Martines — I accept the correction — was undoubtedly a professed Catholic.

Here I will quote from the letter of 25th November, 1768. "Je me transportai chez mon curé et lui demandai ce que lui avait été dit de la part de ce drôle contre moi. Il ne m'en fit point mystère, il me dit tout. Et je lui fis voir que j'étais dans ma religion, mes certificats de catholicité, et mes devoirs exacts et essentials d'un zèle chrétien et fut convainçu de la vérité que je lui dis, de même que du faux exposé de ce monstre." Dr. Papus has been able to procure a copy of the Baptismal certificate of the great Occultist's son at the parish of Ste. Croix, Bordeaux, June 20th, 1768.

3. In September, 1767, Martines married Marguerite Angélique de Colas, the daughter of a major in the "regiment de Foix," in which the Count Claude de Saint Martin was a captain.
4. The date of Martines' death was August 3rd, 1774.

W.K.F.

## THE EQUILATERAL TRIANGLE IN GOTHIC ARCHITECTURE.

BY BRO. ARTHUR BOWES, Sec. 2155.



IN Cressy's *Encyclopedia of Civil Engineering*, published in 1872, attention was directed to some curious features in the design and planning of old ecclesiastical buildings, and it was shown that the equilateral triangle had been largely used as a basis of design. Further illustrations of the same idea were contributed by Bro. Edward Conder to *A.Q.C.* vol. xvi. in a remarkably interesting paper on "William of Wykeham." The writer of the present paper, having satisfied himself of the truth of the theory by an examination of the published plans of many of the most important Gothic buildings, has attempted in the following pages to set forth what he conceives to have been the reasons why this system was adopted as one having practical advantages in the operative work of designing and building.

In the twelfth, thirteenth and fourteenth centuries there developed that wonderful change from the heaviness of the Norman architecture, with its semi-circular arches, to the lofty and slender construction, high pointed arches and acutely pitched roofs which constitute the special features of the Early English style, or Gothic.

Now, amidst all the exuberance which marks the craftsman's delight in the newly found style, it is curious to note that there are many points of similarity to be found in the designs of these buildings: similarities of proportion and of ornament so marked that although the structures may be in Italy or Germany, Scotland or France, it is clear that the same principles and canons of art guided the artists, however far apart their works might lie. A careful examination of the proportions of some of these beautiful buildings brings to light some strange and unexpected properties. Take, for example, the vertical section through the chapter house of Wells Cathedral, erected between the years 1293 and 1302. Fig. 1. The main proportions of width to height

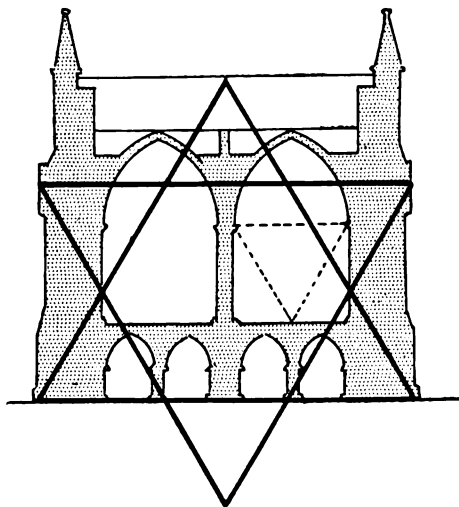

Fig. 1.



are here determined by the extreme points of two equilateral triangles superimposed in such a way as to make a six-pointed star. The thickness of the outer walls is fixed by the points of intersection of the sides of these triangles. The height and width of each of the open spaces surrounding the central pillar are also determined by two equilateral triangles applied base to base, and there are many other similar proportions in the same building which cannot be shown on the small scale of the illustration.

From the days of Pythagoras geometrical figures had been held to convey a deep moral significance, revealing as they did precise and everlasting truths. The six-pointed star, under the name of the Shield of David, or sometimes, erroneously, as Solomon's Seal, has for ages had a reputation for magical virtues. It was a symbol of the deity, and in the Christian church of to-day is supposed to represent the two-fold nature of Christ. In the Eastern cults it is the sign of Vishnu and the Sri-Antara of the Brahmins, having also a mystical significance of the six forces or powers of nature. It is known to have been in use amongst the Saracens, and Bro. T. Hayter Lewis has recorded that he saw it displayed as the chief charge on a splendid banner borne at the funeral of a distinguished Arab. It is evidently, then, by no mere accident that this figure is found to have such an important bearing on the proportions of the building above named. The double triangle has undoubtedly formed the keynote of the design.

As an example of the manner in which the same figure was used in determining the proportions of smaller parts of a building, take the illustration fig. 2 which is a plan showing two of the mullions of the windows in the clerestory of Winchester Cathedral. Here it is obvious that the spacing, the size and proportions of the mullions have been determined by the use of some geometrical figure.

Consider, now, an example from Italy, fig. 3. The baptistery at Pisa was commenced about the middle of the twelfth century. It is a circular building of 100ft. diameter inside, and it is curious to find that all its principal proportions have been decided by the use of three equilateral triangles.

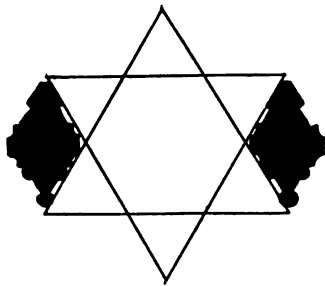

Fig. 2.

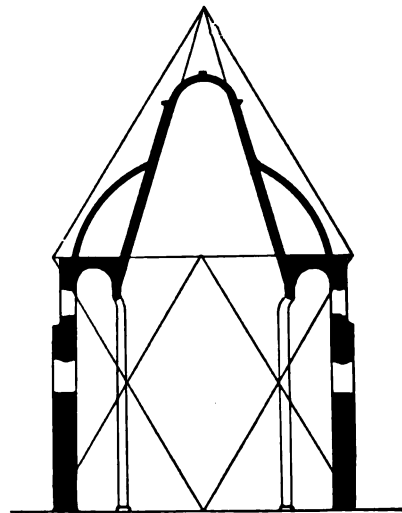

Fig. 3.

Not only are the widths and heights of prominent features fixed by the methods already shown, but the same principles have been employed in arriving at the proportions which the length and breadth of the building bear to one another. In some cases

these have been laid down in the very simple manner shown in fig. 4, where we find the same omnipresent equilateral triangle playing such an important part in the general proportions of the building that it is obviously not an accidental feature but rather the basis of the whole design. Without multiplying instances, figs. 5, 6 and 7 will serve to show that the same root system may be detected in very various features of the buildings. An examination of the proportions of the cathedrals and churches of Lichfield, Hereford, York, Westminster, Salisbury, Norwich, or the Norman structures of the same period will reveal the fact that the designs of these buildings were founded on certain fixed principles of order and proportion which must have been familiar to those great artists whose works remain to-day as the finest examples of Gothic architecture.

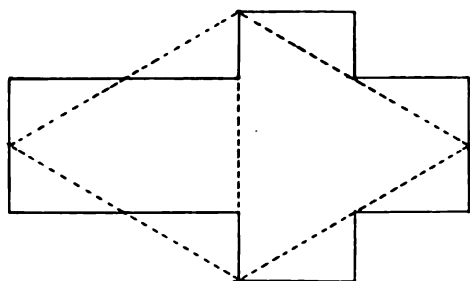

Fig. 4.

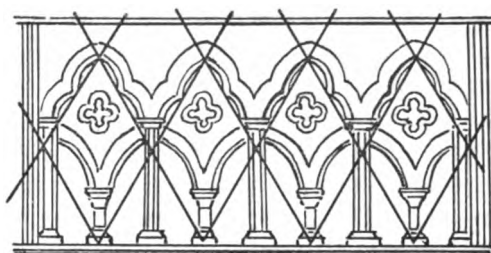

Fig. 5.

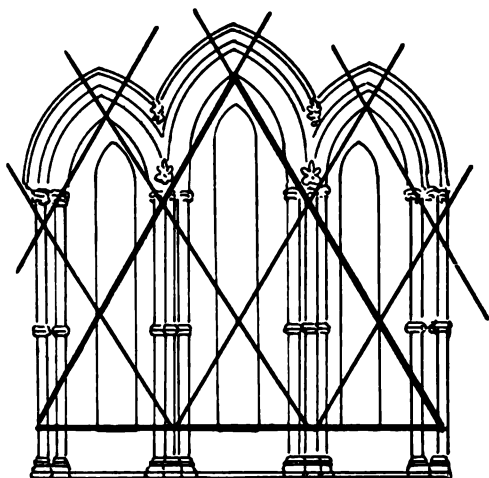

Fig. 6.

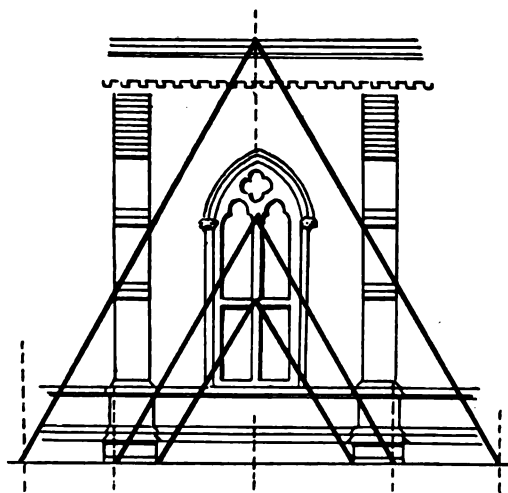

Fig. 7.

How does it come about that this strange figure, the equilateral triangle—so entirely unnoticed by the careless observer and yet so obviously prominent when once pointed out—should be found playing such an important part in all these designs? The natural explanation that first offers would appear to be, because of the symbolical character of the triangle and its mystical significance. Spiritual and religious views might be held responsible for its presence, for we know that amongst many ancient nations the triangle was a symbol of many trinities of transcendental principles, ranging from Hydrogen, Oxygen and Nitrogen, Ether, Matter and Energy, to the Sacred Trinity of the Christian religion and the Buddhist interpretation thereof. Amongst the Hebrews a jod or comma in the centre of a triangle was one of the modes of expressing the unpronounceable name of Jehovah. But is it not possible that this

esteem of the triangle may be based on properties more connected with expediency and pure utility? Or, rather, may not the veneration in which it was held be the outcome of a previous recognition of its utility? The ancient craftsmen may have kept as a "trade secret" their method of using the triangle, just as they concealed in a few lines of doggerel verse their rough and ready mode of squaring the circle. For, when we consider in detail the processes involved in the preparation of the designs for these old buildings, and in the setting out of the measurements on the ground for the actual building operations, it is found that the equilateral triangle is a figure which would be of singular use to the architect of those days, and even in modern times, when the draughtsman's appliances are perfected by modern ingenuity and machinery, it is just possible that a return to the methods hereafter described might be found to have certain points of convenience.

It is the practice of the architect of to-day to make his drawings, and of the builder to set out the work on the ground, on a basis of right angles and squares. The architect's T squares and set-squares are designed primarily to afford facilities for setting out right angles; the builder's square is a large right-angled triangle made of wood, or perhaps he makes use of the Pythagorean triangle, with sides in the ratio of 3, 4 and 5, as the Egyptian land measurers did two thousand years before him. To the ancient craftsman the equilateral triangle would be equally useful as a basis on which to construct his work, and had at the same time the important advantage that it could be constructed with perfect accuracy even with the most rudimentary appliances. This valuable property was, no doubt, known to the Freemasons of the middle ages and is the explanation of the all-pervading presence of the equilateral triangle.

The method in which it was used is probably a modification of much older methods. Just as many drawings to-day are sketched out first on the well-known "squared paper,"—paper divided by faint blue lines into small squares,—so the same system was in use amongst ancient architects and artists. The practice was known ages ago in the East, and at the present time some nations, as the Persians, make use of it, and, their bricks being square and flat, each square on the paper is taken to represent one brick or two or four according to the scale. Suppose, now, instead of using paper ruled into squares we were to rule it in equilateral triangles, thus, fig. 8, should we gain

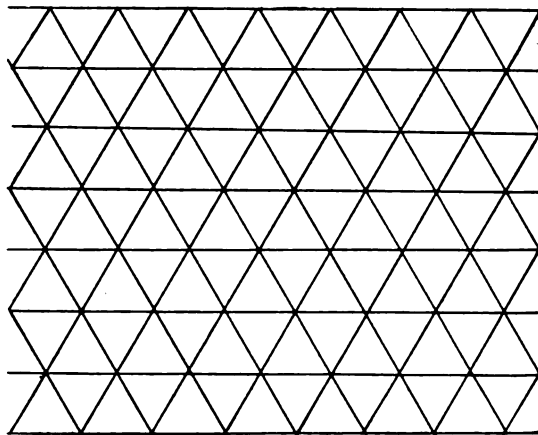

Fig. 8.

anything in the operations of the drawing office or on the site of the building? To the architect of modern times there would, perhaps, be little gain, but to him of the twelfth or thirteenth century there would be advantages in greater facility of setting out both

design and structure. To set out the system of triangles requires only a pair of compasses and a straight-edge for the smaller work, as shown in fig. 9, while for larger operations on the ground a trammel or lath of wood with two nails in it would serve, as

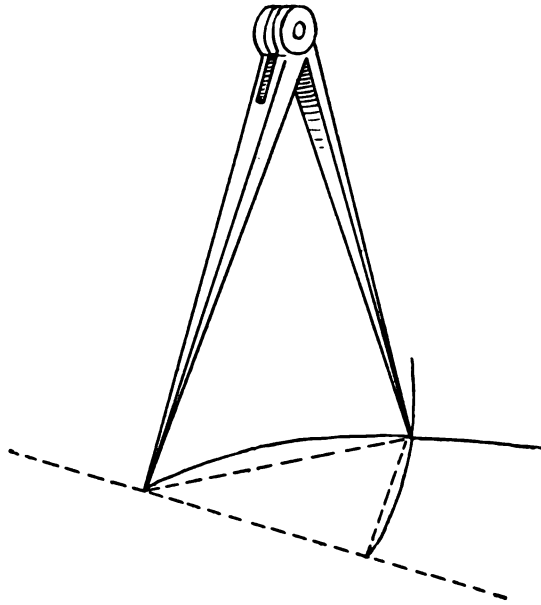

Fig. 9.

shown in fig. 10. For large triangles having sides of 40ft. or 50ft., a well stretched cord could be used, and although there might be some inaccuracy from the elasticity of the cord, the final result would still be as free from error as could be obtained by any other methods available at that time. The setting out of the necessary right angles as,

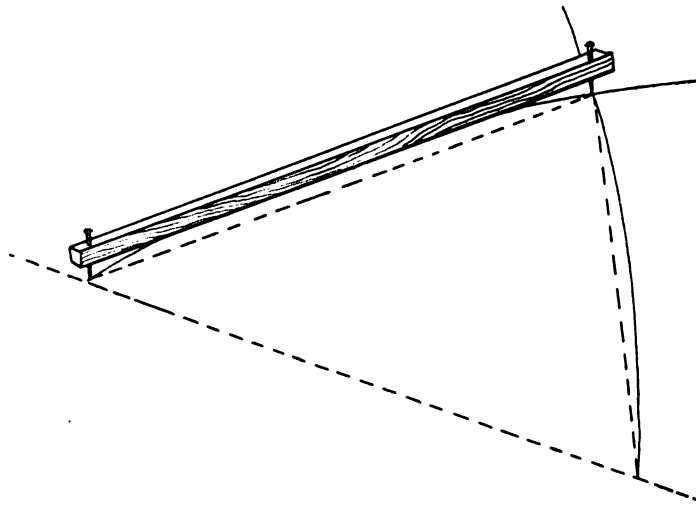

Fig. 10.

for instance, at the end walls of the building, would be a matter of simplicity, and great accuracy could be insured even with very crude instruments. Suppose it were desired in fig. 11 to set out the position of the end wall at the point **A** on the centre line running along the principal axis of the building. All that would be necessary would be to extend the centre line, mark off two points, one on either side of **A** and at equal

distances from it, then with the trammel or string describe the arcs shown in the illustration and thus construct two triangles. A line joining their apices will, of course, be at right angles to the original centre line.

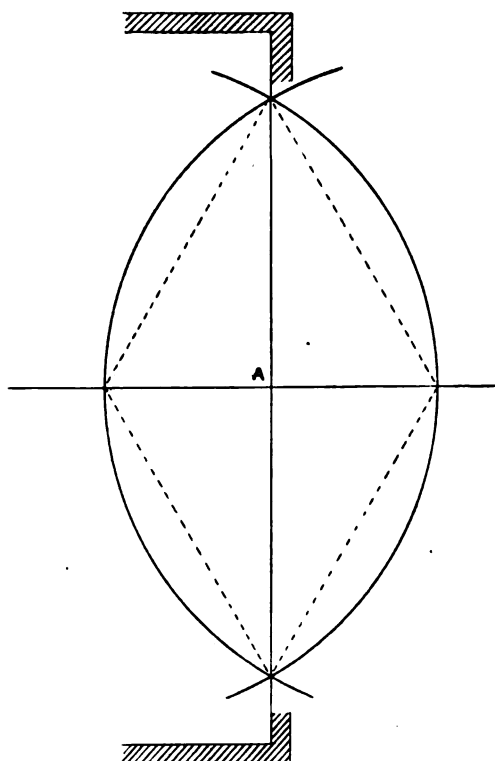

Fig. 11.

It is unnecessary to detail here any further examples of the many forms in which the above principle can be traced in the old buildings. If the reader will take the trouble to rule a piece of tracing paper in the manner shown in fig. 8, and will then place it over scale plans of the buildings, or over the detailed drawings of the various parts, he will be able to demonstrate the extensive use which has been made of the above methods, or at all events of the equilateral triangle. The explanation of the manner in which the triangle has come to be so largely used is an inference which certainly seems highly probable, and the ancient veneration for the figure appears to have been based on properties of the utmost practical value to the old builders. It is easy to understand too, how the compasses, which would be so constantly in use, are to-day found to figure so largely in Masonic symbolism.

The use of the pentacle, or five-pointed star, as a basis for the planning of Liverpool Castle, Chester Castle and other buildings, has been pointed out by Mr. Edward W. Cox in the Transactions of the Historical Society of Lancashire and Cheshire in 1892 and 1895, and reference was made to his researches in this direction by Bro. W. H. Rylands in "Notes on Some Masonic Symbols." (*A.Q.C.* vol. viii.)

SHREWSBURY.

Plate I.

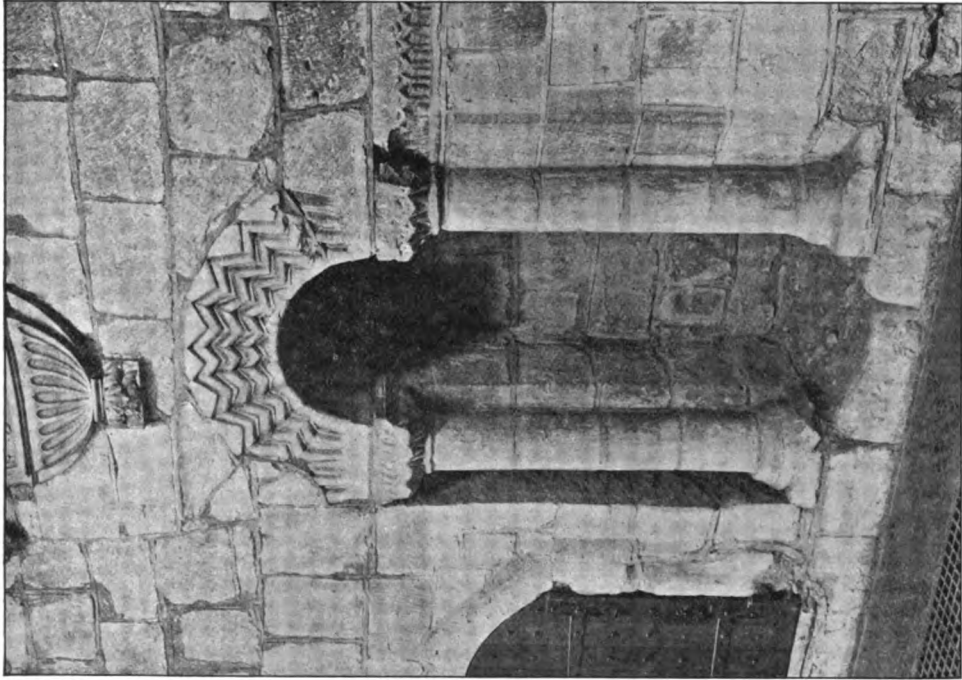

W. Wonnacott.  
St. Mary's Church. South side of Chancel.



S. Walshe Owen.  
St. Mary's Church.



S. Walshe Owen.  
St. Mary's Church.  
Interior of South Porch.



## SUMMER OUTING, JULY 1906.

## SHREWSBURY AND LUDLOW.

BY BRO. W. J. SONGHURST, Secretary.



SOON after our return from Chester last year a pressing invitation was received from brethren at Shrewsbury to make a visit to their town in 1906. Some doubts were at first expressed as to whether it would form a suitable centre, our outings hitherto having been made almost without exception to Cathedral Cities. The decision to *accept* was undoubtedly a wise one, for nothing could have been more enjoyable than our visit to Shropshire, nor could any welcome have been more hearty than that which we received from our brethren throughout the Province. We journeyed from Euston on Thursday, 5th July, in two special saloon carriages attached to the 2.40 train, and were cordially received at Shrewsbury station by members of the local committee, our own party including Bros. G. L. Shackles, W.M.; Canon J. W. Horsley, Grand Chaplain, I.P.M.; J. T. Thorp, P.A.G.D.C., S.D.; Dr. Wynn Westcott, P.G.D., P.M.; G. Greiner, P.A.G.D.C., P.M.; J. P. Simpson; W. J. Songhurst, Secretary; J. M. Bruce, Newcastle; W. H. Brown, London; O. H. Bate, Grahamstown; T. A. Bayliss, King's Norton; F. W. Brazil, London; John Bodenham, P.A.G.D.C., Newport, Salop; W. Busbridge, Plumstead; W. N. Cheesman, Selby; H. J. Collins, Birmingham; G. S. Criswick, Burton-on-Trent; G. Chillingworth, London; G. S. Collins, London; A. Darling, Berwick; G. T. Devonshire, London; E. A. Ebbelwhite, Asst.G.Reg., London; C. L. Edwards, St. Albans; C. E. Ferry, P.G.S.B., Isleworth; A. Fairley, Birmingham; J. W. Gieve, P.A.G.D.C., Portsmouth; F. Goodacre, Liverpool; W. Hammond, London; W. B. Hextall, London; R. P. Hughes, London; H. J. Hazel, London; E. L. Horne, London; J. Johnson, London; A. Joyce, Madras; W. S. Lincoln, London; W. Lawrance, Asst.G.Sup.Wks., London; T. Leete, London; W. Metcalfe, P.G.St.B., Cheshunt; A. Monk, London; H. W. Noakes, Crowborough; Dr. S. Walshe Owen, London; R. Orttewell, Malden; F. A. Powell, P.G.St.B., London; F. Parker, Liverpool; T. J. Ralling, P.A.G.D.C., Colchester; J. E. Rubie, Bath; J. H. Retallack Moloney, London; W. W. J. Sharpe, Falmouth; W. F. Stuttaford, Worcester Park; J. W. Stevens, Dulwich; C. F. Silberbauer, Cape Town; J. Thompson, London; T. R. Thompson, Sydney, N.S.W.; G. Withers, Uttoxeter; W. H. Welsh, Blockley; Col. G. Walton Walker, Dep.P.G.M., West Bromwich; W. Wonnacott, London; C. L. Williams, Castlemaine, Victoria; J. Procter Watson, Castle Carrock; and G. Wilkinson-Pimbury, London.

At 8 o'clock we made our way to the Music Hall Building, the headquarters of Shrewsbury Masonry, where an Emergency Lodge was opened by R.W. Bro. Sir Offley Wakeman, Bart., Prov.G.M., assisted by the Masters of the Salopian Lodge and the Salopian Lodge of Charity, and a large number of brethren from various parts of the Province. Kind words of welcome were given from all sides, and an address by the R.W. Prov.G.M. was especially appreciated, as it foreshadowed the various objects of interest which were to be presented to our view in the succeeding days. It was pointed



out that whatever our tastes might be, whether inclining to an appreciation of the beauties of nature or the works of man, whether directed to history, architecture, or archæology, all would find ample material for study in and around the old Town.

This point was again brought very forcibly to our minds when, later in the evening, a number of lantern slides were thrown on the screen by Bro. R. J. Irwin. These had been for the most part prepared from old and scarce prints of Shrewsbury and the neighbourhood, and were therefore of exceptional interest. Bro. W. E. Harding, P.Prov.G.W., very kindly explained the views, and we were glad to gather from his remarks that, although much of the "old" had in former years been ruthlessly demolished, the local authorities of the present day are fully alive to their duties in preserving what still remains of the interesting antiquities of the town. Some of us, by the way, were prepared to question the word "town," especially in view of the important strategic position, and the fact that considerable portions of the walls are still standing, but tradition has it that former inhabitants refused a charter of incorporation as a City, and thus acquired the name "Proud Salopians."

Without attempting to ascertain if the tradition has any historical basis, we must admit that the townsmen have a right to be "proud" of their home, and of the part it has played in the making of English History. Its situation on a hill, almost encircled by the river Severn, made it a place of great importance in early days, particularly so as, being on the Welsh borderland, it had to take its share in the struggles which disturbed that part of the country until the famous battle of the 21st July, 1403, as well as during that later national crisis when, held by King Charles I., it was surprised and captured by the Parliamentary forces. Going back however to a still earlier period it seems strange that the Romans should not have discovered and utilized the exceptional natural advantages of the site, but it is certain that nothing has yet been found to warrant a suggestion that they settled nearer than the famous Uriconium barely five miles distant. Many of our brethren were able to drive there and inspect what still remains above ground of a city which covered a greater area even than Roman London. But although Shrewsbury itself cannot claim a Roman origin, there is no doubt that it was a flourishing town in Saxon times, and became an important stronghold under Norman rule.

Friday was devoted to a perambulation of the town, under the able guidance of the Rev. W. G. D. Fletcher, and Bros. the Revs. Prebendary Poyntz and C. H. Drinkwater. Shrewsbury has been particularly unfortunate in the matter of its Churches. At the end of the seventeenth century there were in existence within the walls four fine buildings, dating from Norman or even earlier times, namely, St. Chad's, St. Alkmund's, St. Julian's and St. Mary's. Of these the first to go was St. Julian's, which was rebuilt in 1750. Then in 1788 the tower of St. Chad's fell, wrecking the nave and transepts so completely that it was decided to erect another Church on a different site. The south chancel aisle alone remains to testify to the beauties of the edifice which was then destroyed. The Church is said to have been founded by King Offa, and a Saxon crypt, which we examined with much interest, was excavated in 1889, on the north side of the churchyard.

Then the parishioners of St. Alkmund, fearing a like fate for their own edifice, decided to pull it down and rebuild, while in 1894 a similar catastrophe actually befel St. Mary's, the top of the spire being blown down in a gale, crashing through the fine old oak roof into the nave. In this instance there was fortunately no talk of rebuilding but only of repair, and St. Mary's therefore remains the most interesting of the Shrewsbury Churches. It contains many features of great architectural interest, and

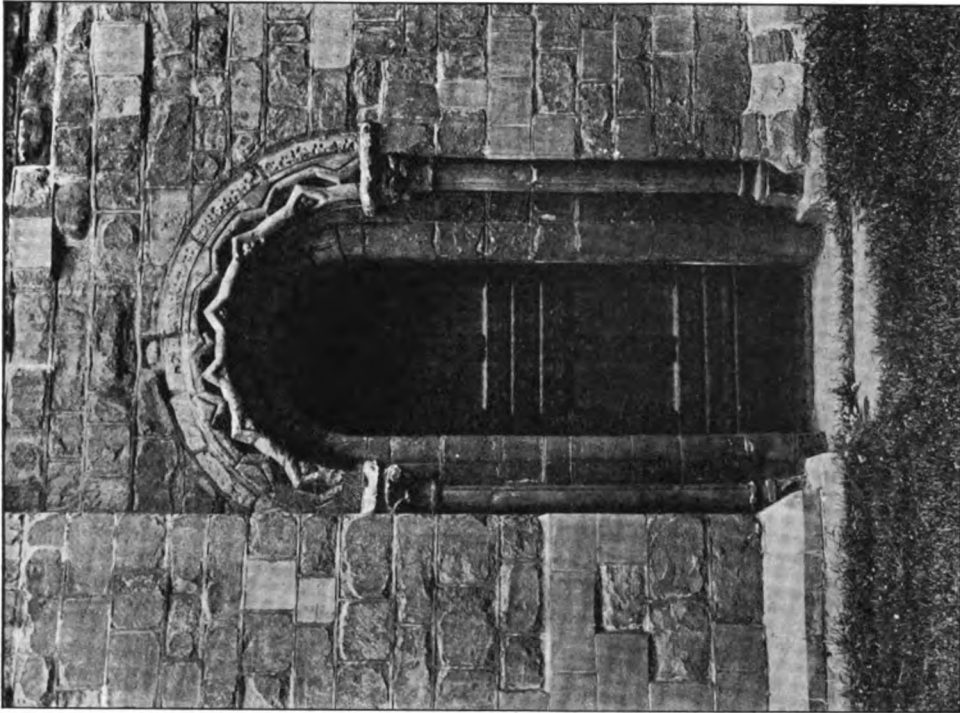

W. Wonnacott.  
St. Mary's Church. South Transept Door.

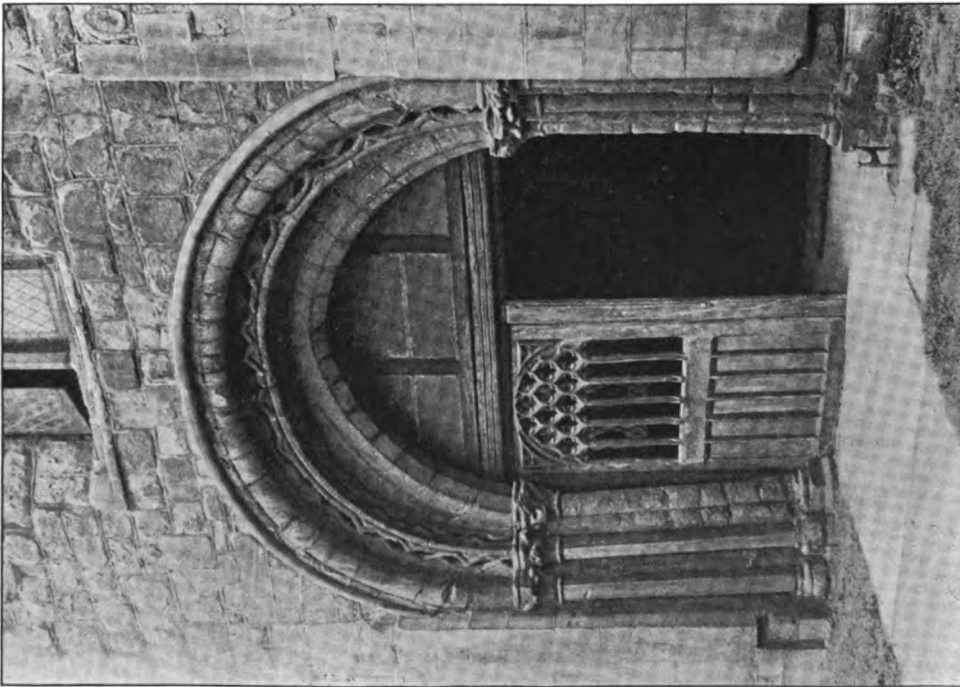

W. Wonnacott.  
St. Mary's Church. South Porch.



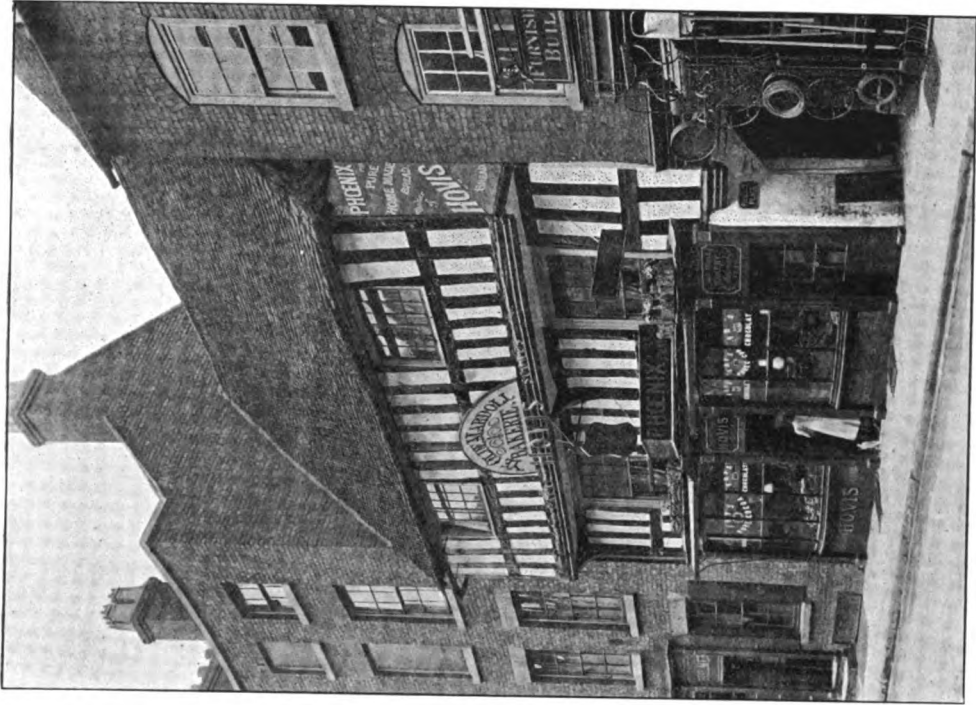

W. Wonnacott.

Old House in Mardol.

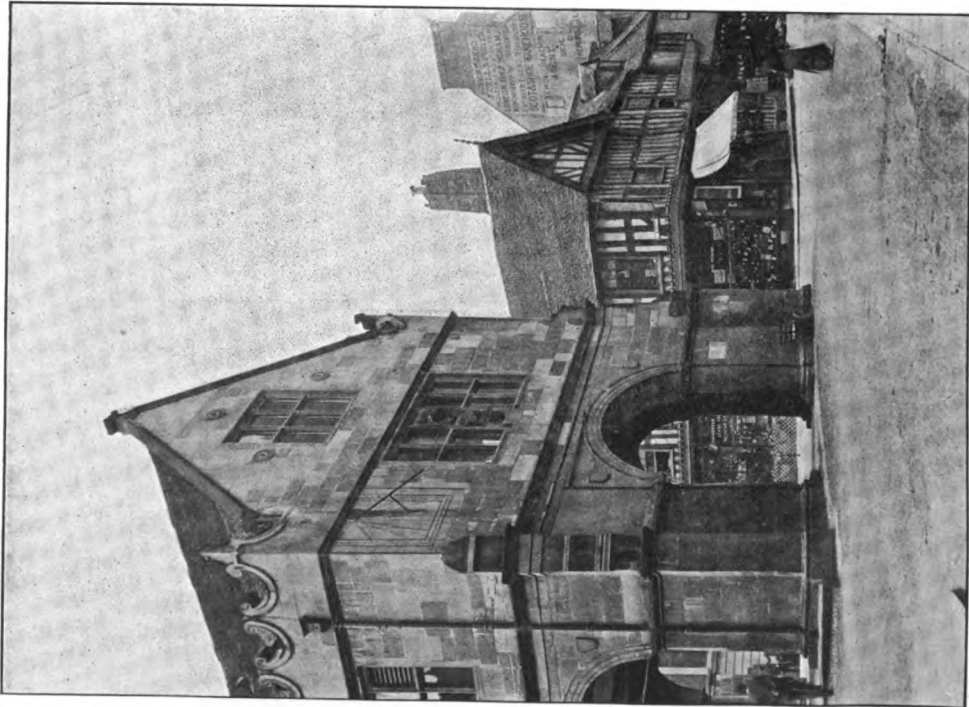

W. Wonnacott.

Market Hall. West End.



is particularly rich in stained glass, most of which is German and Flemish, though some was fortunately rescued from the ruined St. Chad's.

During our wanderings through the town we were delighted with the many fine specimens of domestic architecture which are still standing. More particularly do we remember those in Butcher Row, High Street, Mardol, The Square, and Fish Street. The New Ship Inn, too, in Hill's Lane, adjoining Rowley's Mansion and Cole Hall, is an exceptionally interesting building. At the Guildhall we were received with great cordiality by the Mayor (Alderman R. E. Jones) who most kindly produced for our inspection the valuable records of the town, as well as the interesting plate and regalia, and gave us a hearty official as well as a personal welcome.

In the afternoon we paid a visit to the Museum and Free Library, formerly the home of Shrewsbury School, and afterwards inspected the Castle. Of the Norman stronghold only the Gateway remains, the two towers of the Keep with connecting guard-room, now converted into a private residence, having been constructed in the time of Edward I. The views from the roof, over the town and country, are particularly fine, and our hearty thanks were given to the Misses Downward, for their great kindness in not only allowing us to inspect the buildings, but in so graciously acting as our guides. Then to the Council House, also converted into residences. Some of us were here enabled to inspect the very beautiful oak panelling in some of the rooms, and also the fine carved bedstead in which Charles I. is said to have slept. Then passing down Wyle Cop, with its many quaint buildings, we crossed the English Bridge to the Abbey Church, interesting from several points of view. It is actually the nave of a Benedictine abbey, founded in 1083, though much of the Norman work was replaced by Perpendicular in the fourteenth century; while it is particularly fortunate in having been the repository of a number of monuments from other churches in the neighbourhood. Some fragments of the Monastic buildings are still visible, and the well-known fourteenth century Reader's Pulpit in an adjoining coal yard marks the position of the Refectory.

Recrossing the Bridge we were able to inspect the remains of the Franciscan Friary, and the only Tower still standing on the walls (out of fourteen which were erected for purposes of defence), while on our way back to the Hotel we did not fail to note the picturesque buildings in Grope Lane, nor the old building off Pride Hill, where money is said to have been coined during the Civil War.

Friday evening was most enjoyably spent at the Music Hall Building where we were entertained by our hosts at an excellent smoking concert, under the genial presidency of Bro. R. G. Venables, R.W.Dep.Prov.G.M., many brethren coming from long distances to take part in the proceedings.

On Saturday a special train conveyed us first to Craven Arms for Stokesay Castle, an exceedingly interesting example of fourteenth century work, and then to Ludlow, where again a most cordial welcome awaited us. With Bro. Palmer and other brethren as our guides we proceeded direct to the Masonic Hall, to inspect the valuable relics preserved by the Lodge of the Marches, and then continued our walk around and through the town, examining much, and reluctantly hurrying away to fresh objects of interest. The programme laid down for us was an excellent one, but Ludlow requires considerable time to properly appreciate all its beauties, and we could unfortunately devote but little. Probably of all we saw, the Castle and the Church of St. Lawrence most impressed themselves on our minds, and in the former the old Templar Chapel was naturally the main attraction, as only four other early churches of circular form are now standing in this country.

The Feathers Hotel, useful to us as a halting place for lunch, is a fine example of half-timber work and contains much interesting carved oak.

Having feasted our eyes and stored our memories, so far as time permitted, we hurried back to Shrewsbury, and, dinner over, endeavoured to entertain our hosts at a "smoker." Although, as usual on such occasions, very few of our own members were found to be gifted with musical abilities, the few were most kind in giving their able assistance, and equally kind were some of the local brethren, who added much to the pleasure of the evening. The chair was taken by the W.M. of No. 2076, Bro. G. L. Shackles, and on his leaving to take train for Hull his place was taken by Bro. G. Greiner, P.M., who will be long remembered for his vivacity and *bonhomie*.

On Sunday many of us were glad of an opportunity of quietly re-visiting the quaint nooks and corners in the town, some enjoyed the lovely walks on the banks of the river, while others were to be found in the Quarry, where the "Shoemakers' Arbour" is now placed, the only remaining relic of the old Guild Pageants which were formerly held in the meadows opposite.

Then came the inevitable leave-taking and renewed thanks to those whose labours had been so unselfishly given on our behalf. The members of the two Committees had indeed worked hard, but upon Bros. Alexander Graham and James Vine at Shrewsbury and John Palmer at Ludlow much of the burden must have fallen. In addition to the general arrangement of the programme and its execution, there has to be taken into account the immense amount of work entailed in the preparation of the illustrated itineraries which delighted us all by their careful planning and beautiful appearance, and were of so much assistance to us in our peregrinations. The Ludlow itinerary was prepared by Bros. Palmer and Roese, while that for Shrewsbury was revised by the Rev. W. D. G. Fletcher and Bro. the Rev. G. H. Drinkwater, and printed and illustrated by Bro. W. A. Wilding. Many other brethren rendered good and useful work in carrying out the arrangements for our comfort, and though we would fain place their names on record, we must respect their modesty and assure them that we all thoroughly appreciated the individual and collective efforts which made our visit to the Province of Shropshire such a complete success.



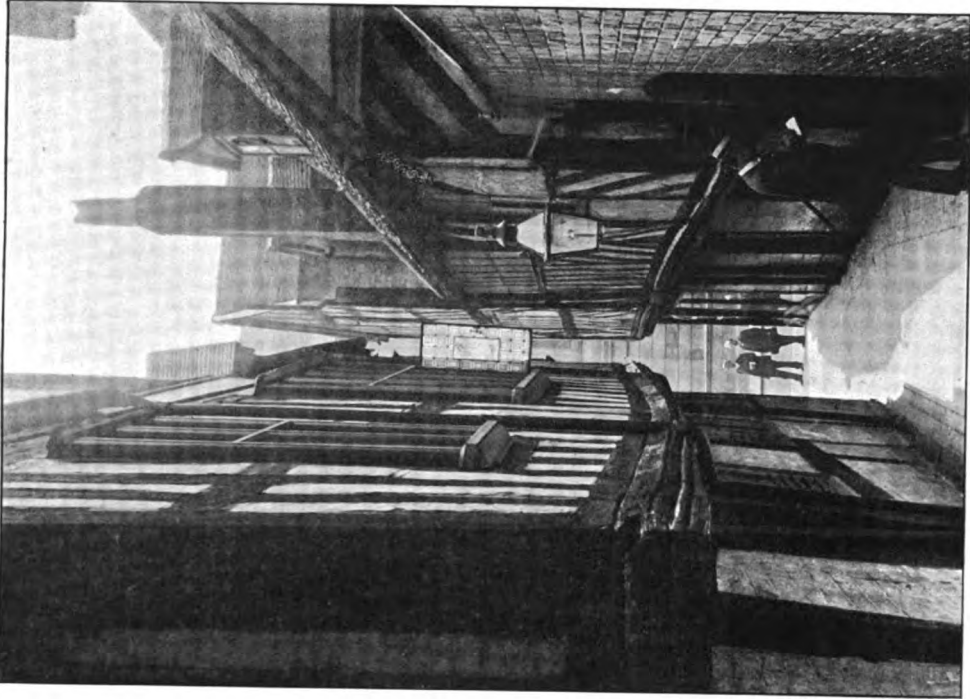

Grope Lane.

W. Wonnacott.

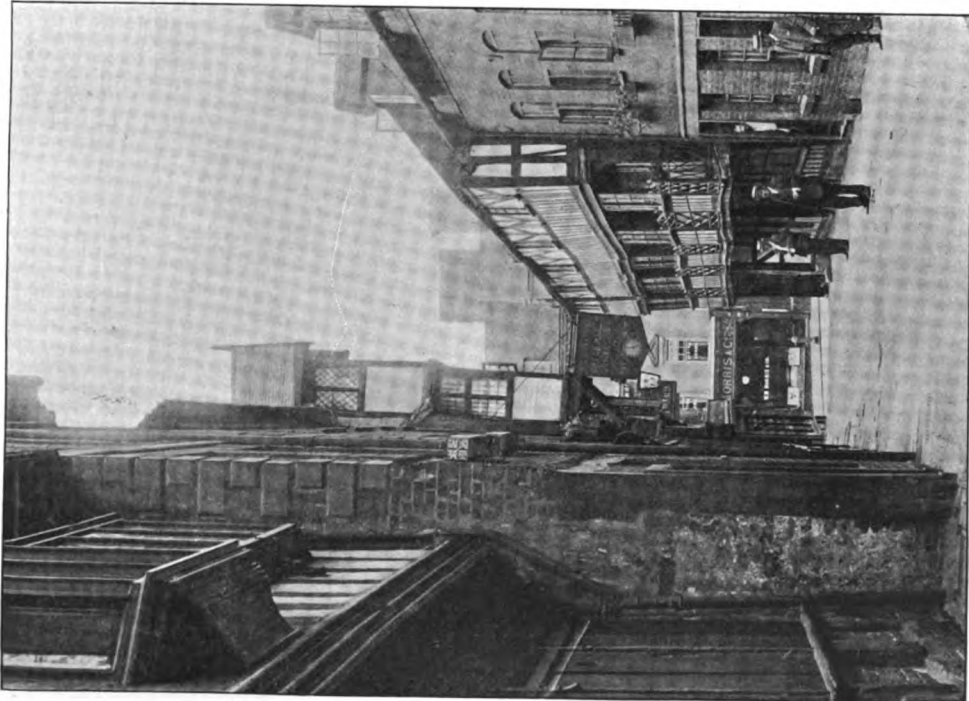

Butcher Row.

W. Wonnacott.





SHREWSBURY.

Plate V.

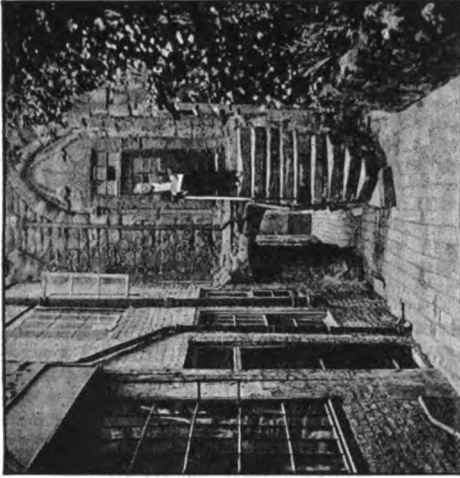

S. Walsh Owen.  
Old Mint.

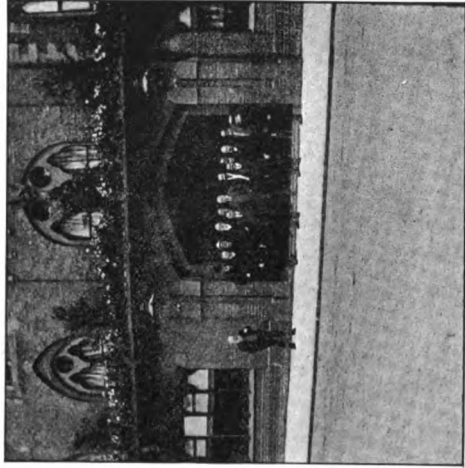

S. Walsh Owen.  
The Raven.

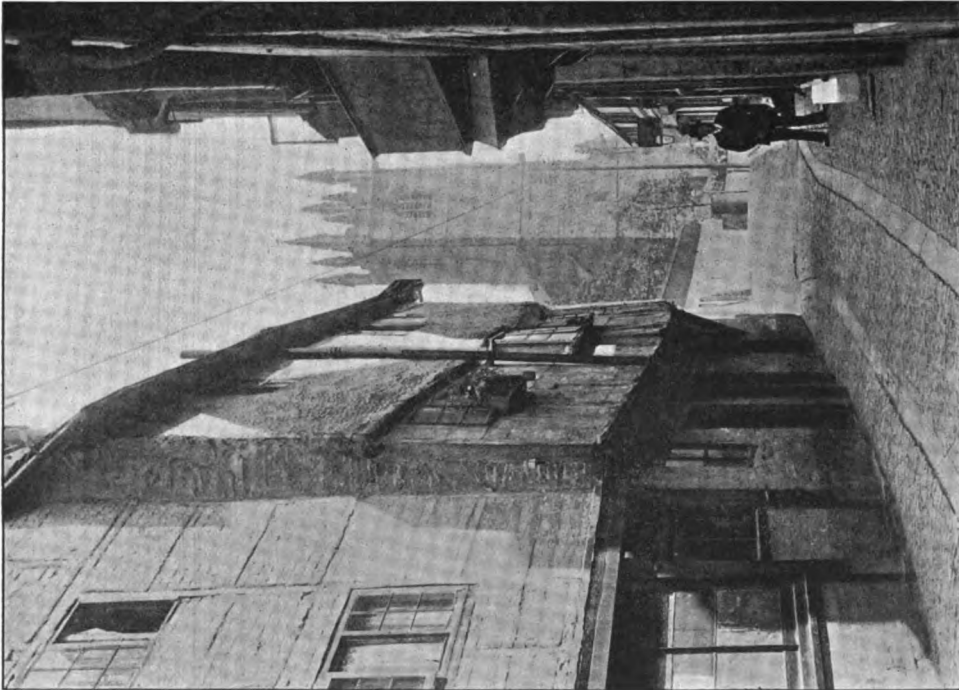

W. Wonnacott.  
Fish Street.



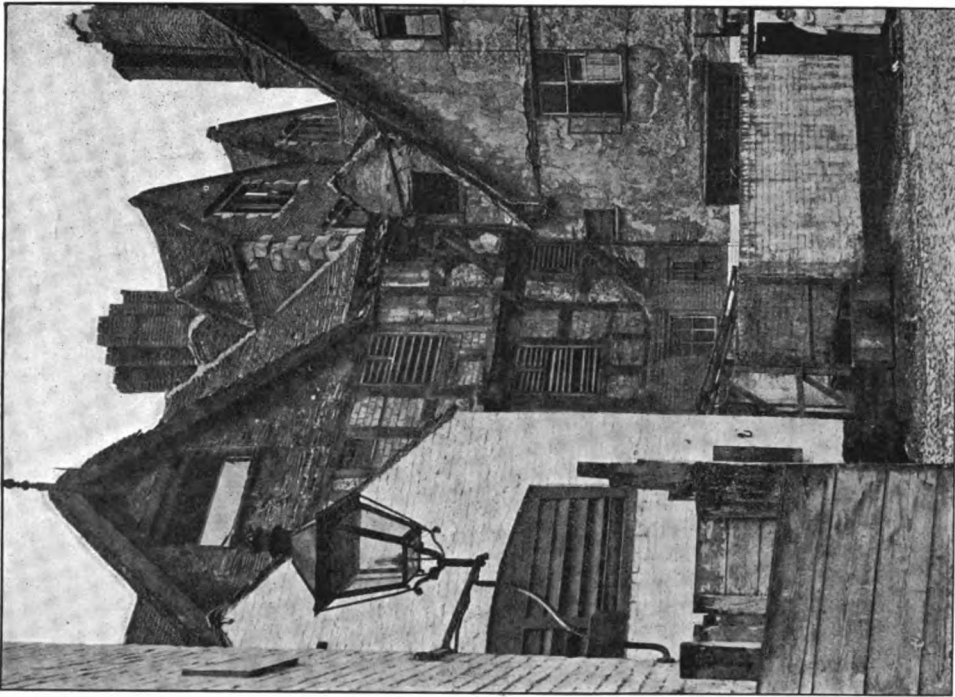

W. Wonnacott.  
Rowley's Mansion from Ship Inn Yard.

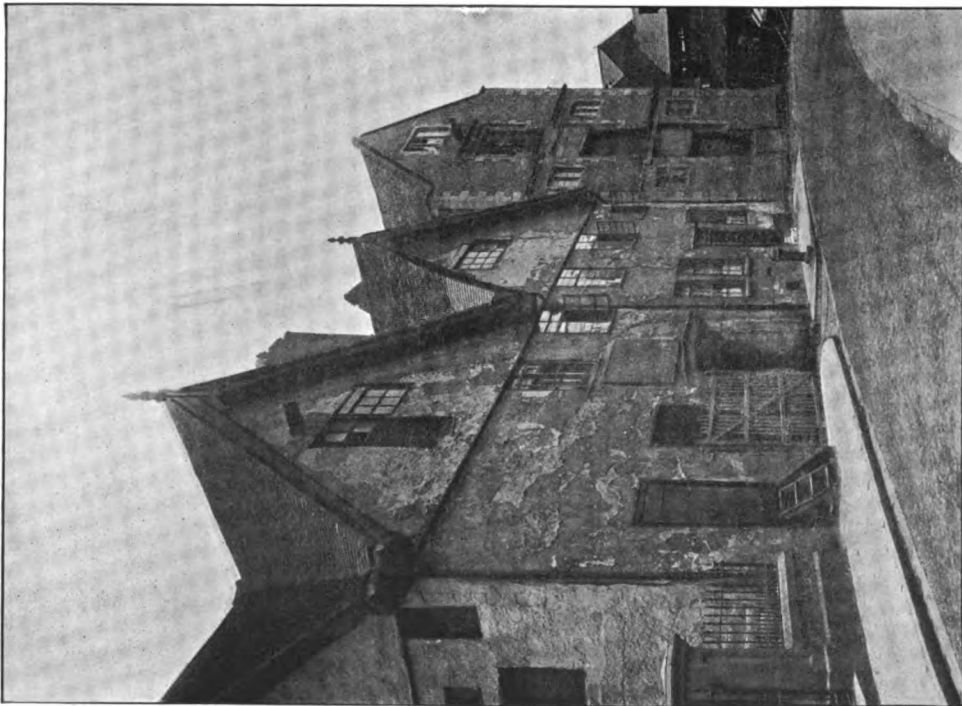

W. Wonnacott.  
New Ship Inn and Rowley's Mansion.



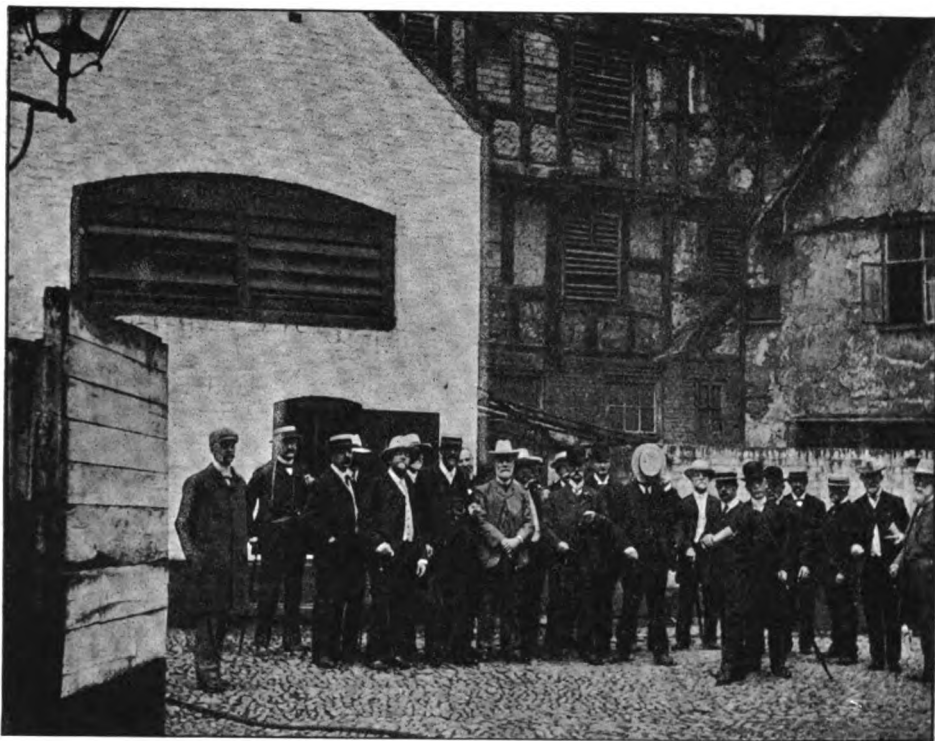

G. Chillingworth

Ship Inn Yard.

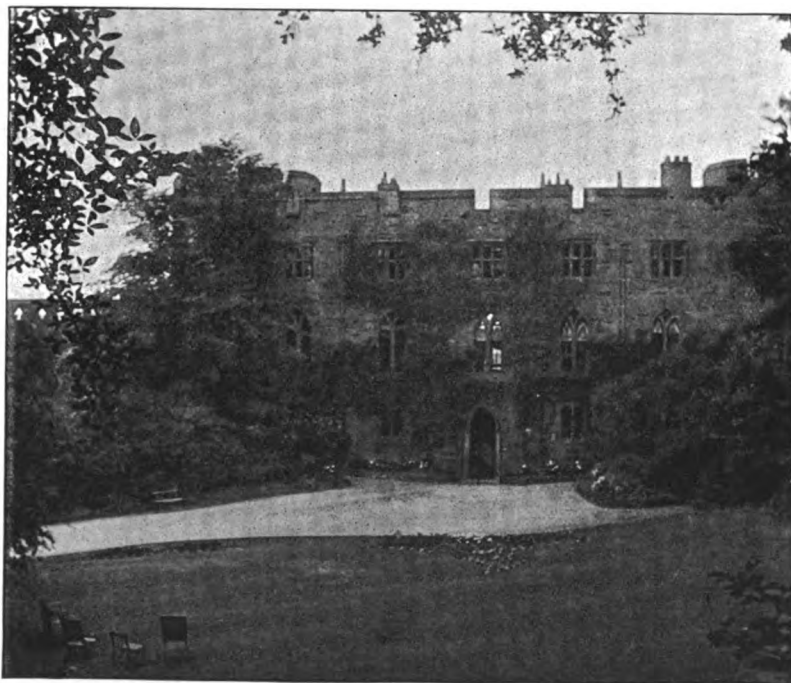

S. Walshe Owen.

The Castle.



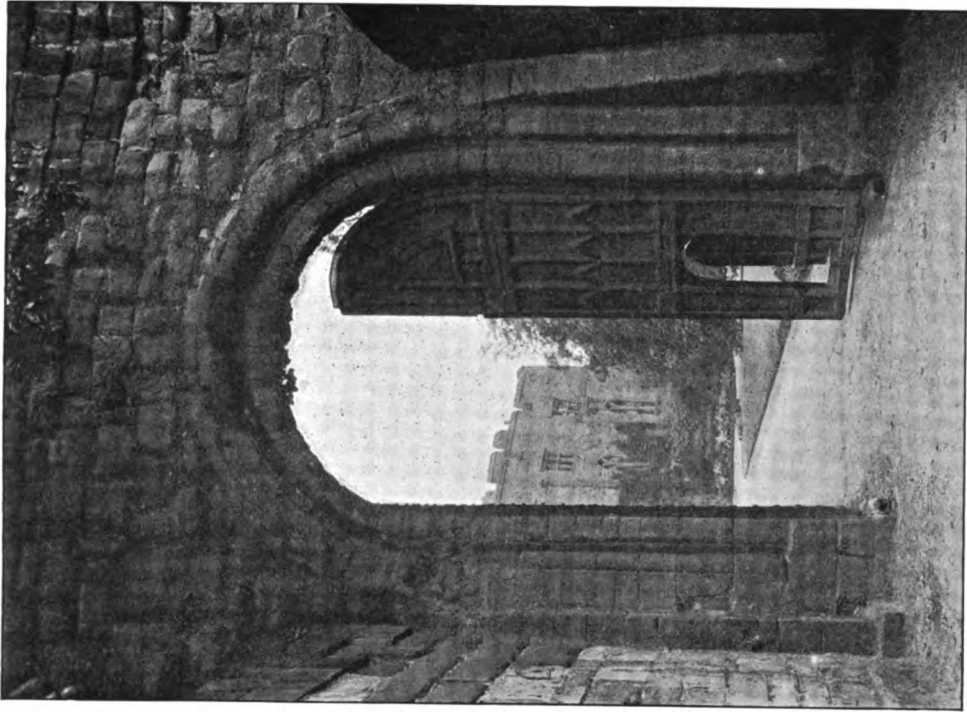

W. Wonnacott  
The Castle Gateway.

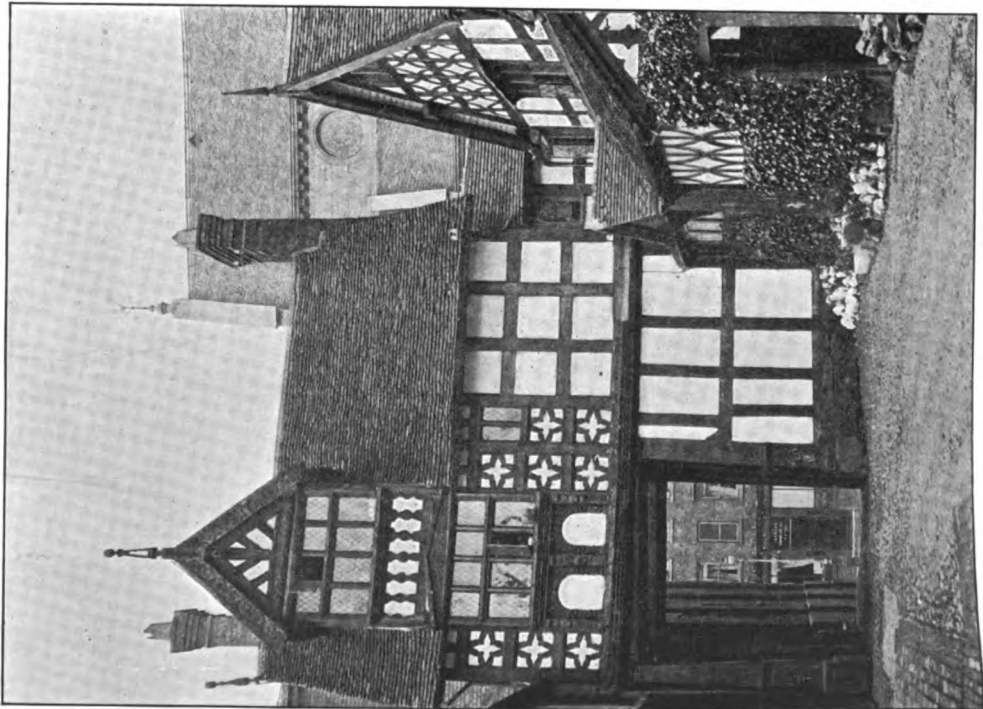

W. Wonnacott.  
The Council-House Gateway.







S. Walsbe Owen.

The Church.



W. Wonnacott.

The Castle from Churchyard.





W. Wonnacott.

The Gatehouse.





W. Wonnacott.

The Gatehouse.





W. Wonnacott.

The Gatehouse.





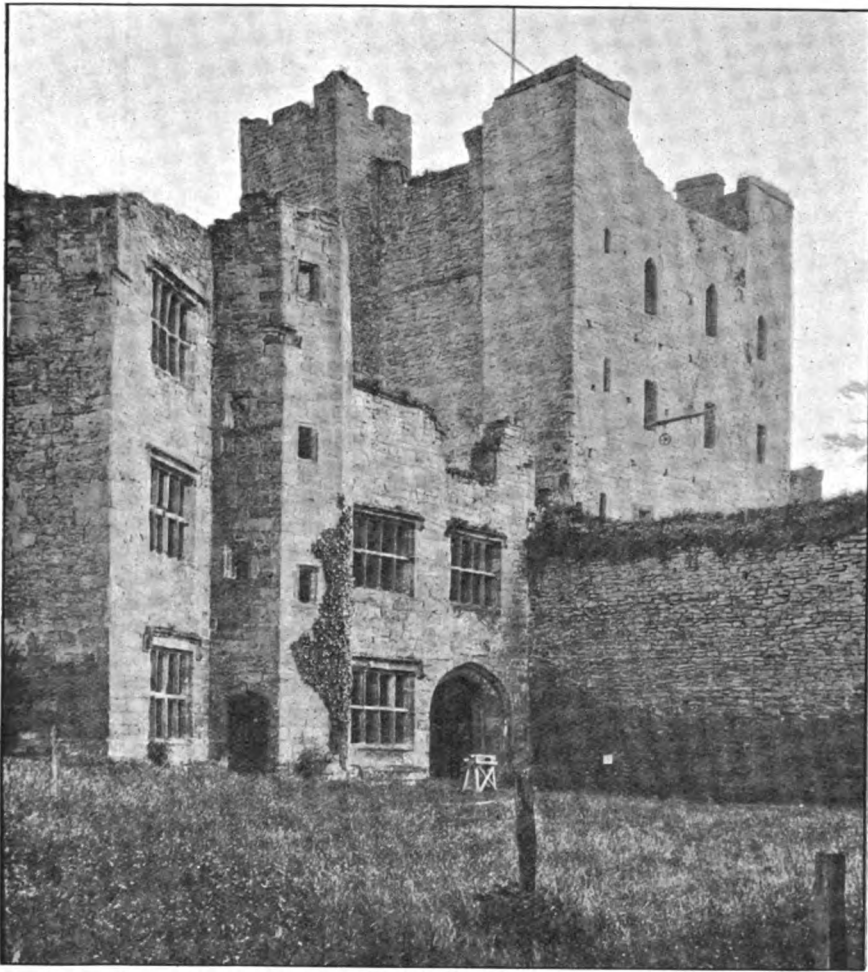

W. Wonnacott.

Ludlow Castle. The Keep.

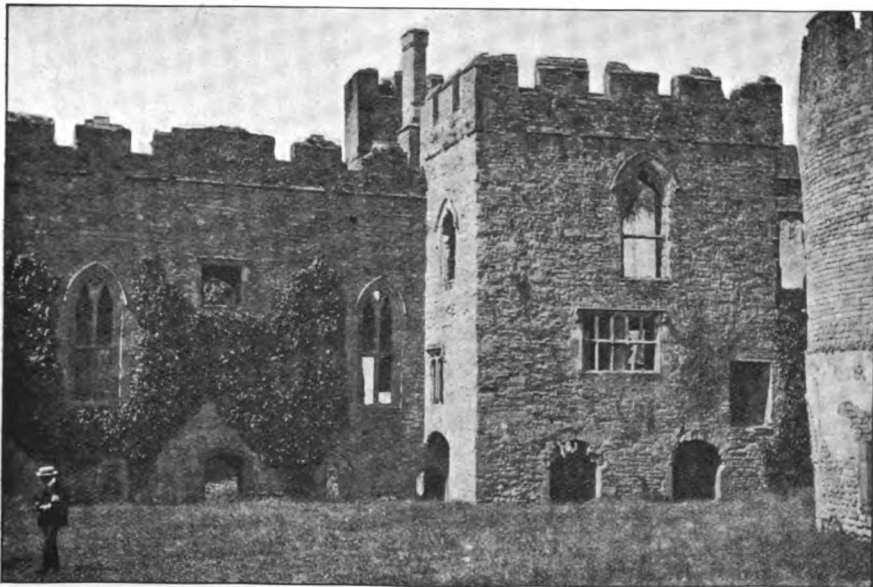

G. Chillingworth.

The Castle.



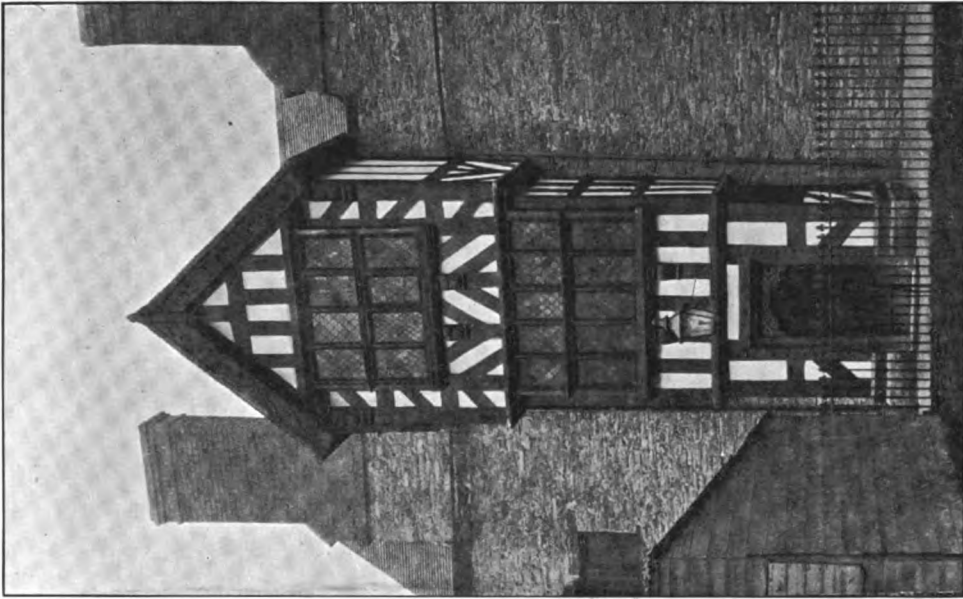

W. Wonnacott.  
The Readers' House.

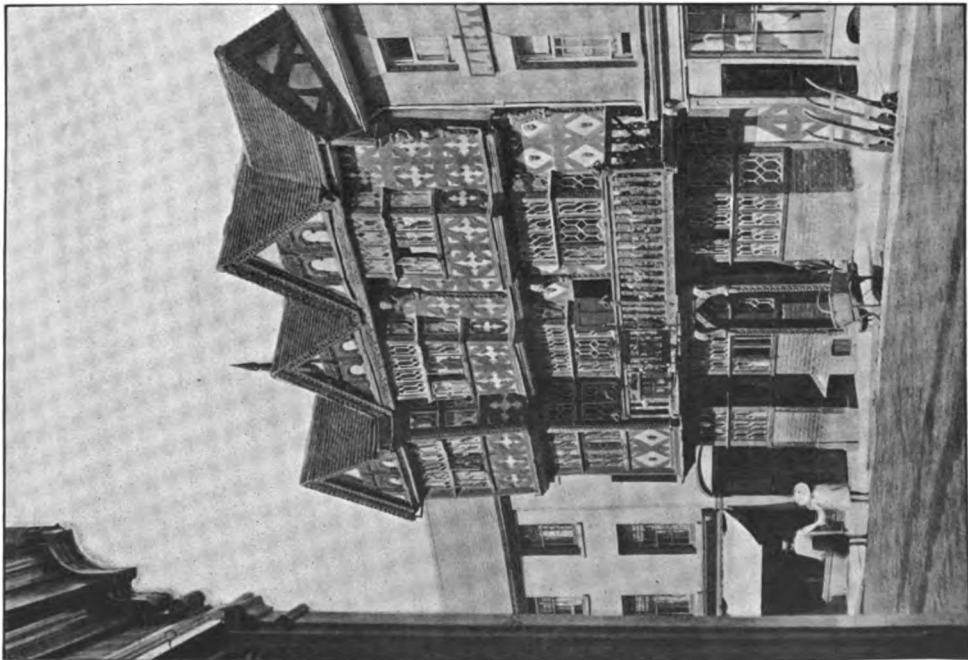

W. Wonnacott.  
The Feathers.



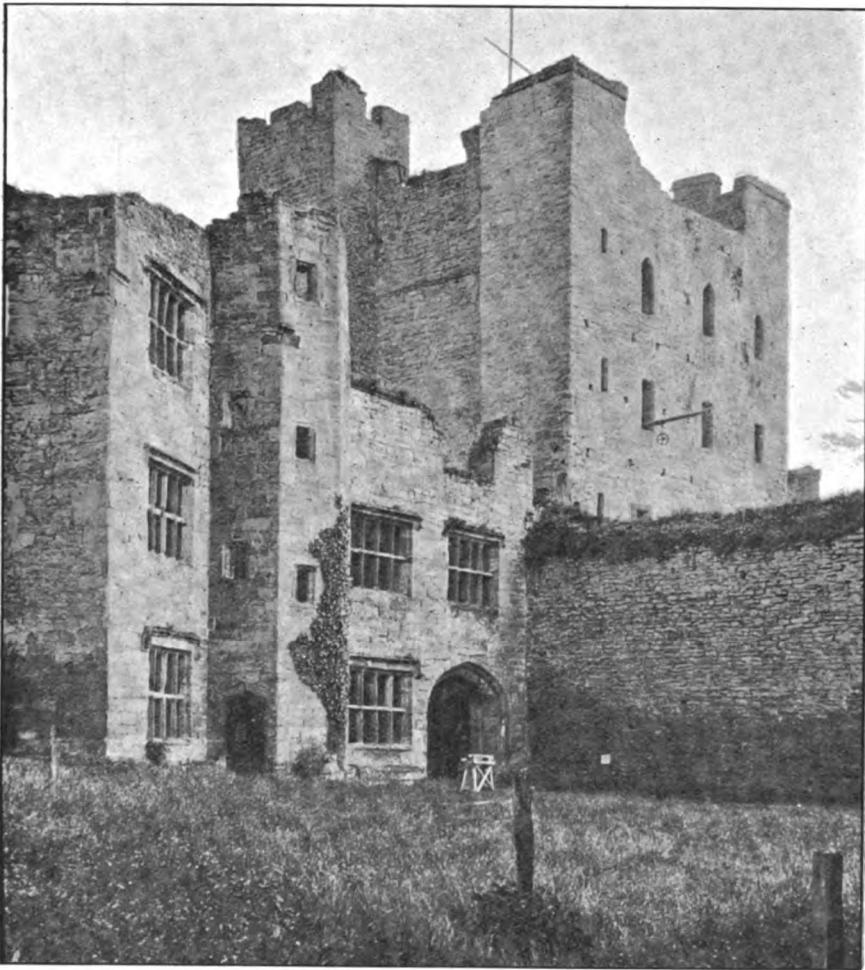

W. Wonnacott.

Ludlow Castle. The Keep.

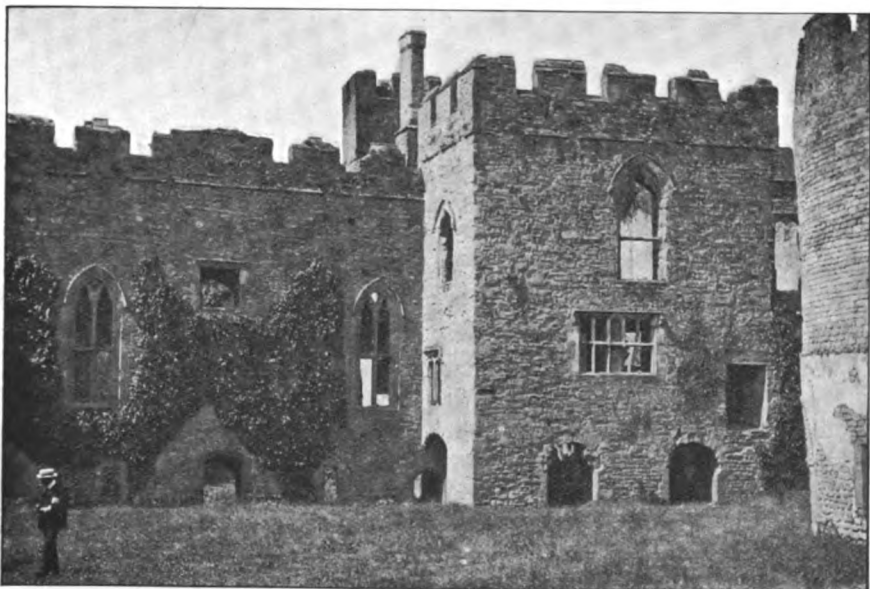

G. Chillingworth.

The Castle.



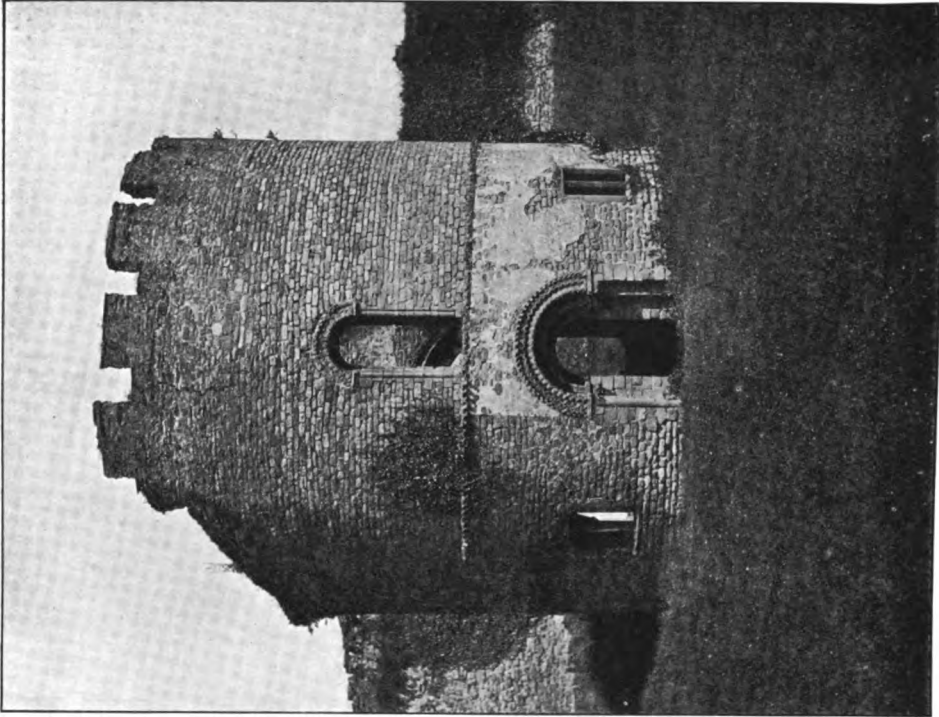

The Chapel.

W. Wonnacott.

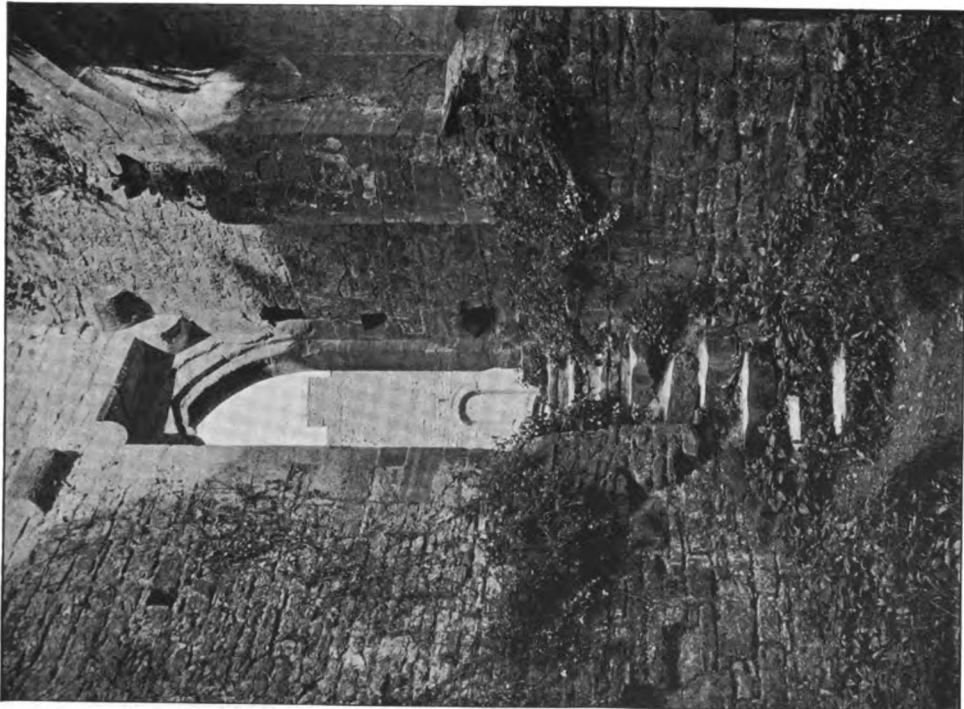

The Castle.

W. Wonnacott.





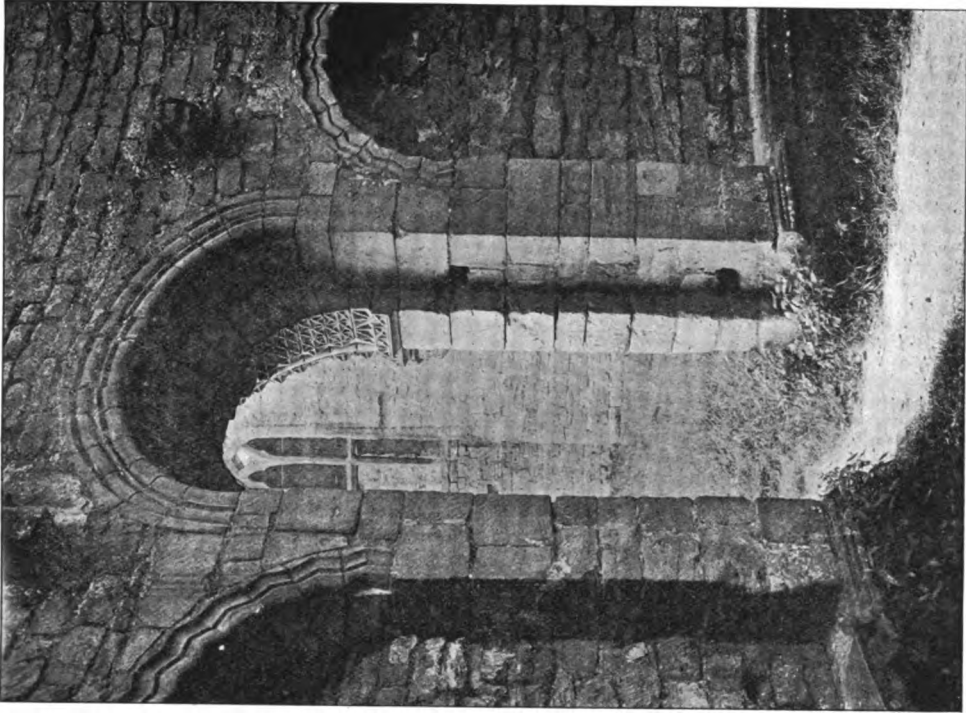

W. Wonnacott  
Chapel Doorway. Inside.

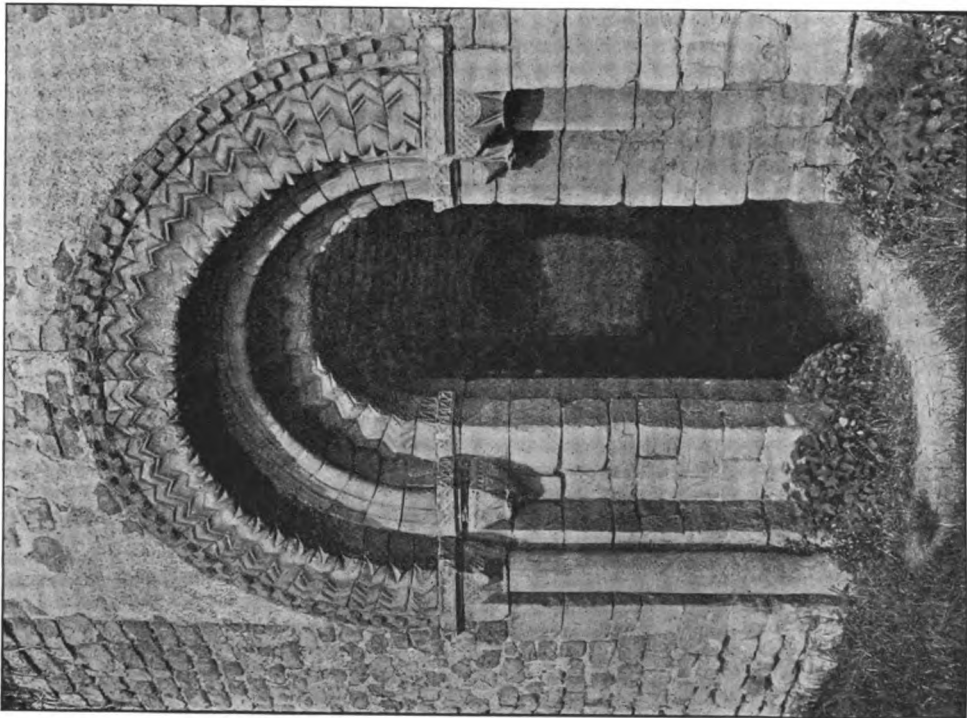

W. Wonnacott.  
Chapel Doorway. Outside.



ARS QUATUOR CORONATORUM.

URICONIUM.

Plate XVI.



H. J. Collins.



H. J. Collins.



H. J. Collins.



FRIDAY, 5th OCTOBER, 1906.

---



THE Lodge met at Freemasons' Hall, London, at 5 p.m. Present:—Bros. G. L. Shackles, W.M.; Canon J. W. Horsley, Grand Chaplain, I.P.M.; E. Armitage, P.A.G.D.C., S.W.; F. H. Goldney, P.G.D., J.W.; Hamon le Strange, Prov. G.M. Norfolk, Treasurer; W. J. Songhurst, Secretary; J. T. Thorp, P.A.G.D.C., S.D.; H. Sadler, Grand Tyler, I.G.; W. Watson, Steward; W. Wynn Westcott, P.G.D., P.M.; E. J. Castle, P.A.G.Reg., P.M.; R. F. Gould, P.G.D., P.M.; G. Greiner, P.A.G.D.C., P.M.; E. Macbean, P.M.; E. H. Dring and J. P. Simpson.

Also the following members of the Correspondence Circle:—Bros. Robert P. Angel, H. J. Oldroyd, W. F. Stuttaford, Robert Manuel, H. Guy, W. B. Hextall, E. L. Hawkins, Harry Sirr, F. J. Burgoyne, C. F. Silberbauer, J. Johnstone, W. G. Soltall, W. J. Allen, W. M. Chambers, J. Murison, H. Chown, M. P. Percival, G. H. Lutchford, J. Harrison, F. Mella, T. S. Lee, H. B. Watson, Geo. Elkington, H. Bradley, W. S. Pegge, Henry Taylor, W. H. Harris, B. V. Darbishire, W. Wonnacott, Archdeacon F. E. Clark, Frank Swift, S. E. Baxter, K. Smith, C. H. Bestow, D. J. Williams, E. A. Ebbelwhite, S. Walshe Owen, W. Burton, F. E. Everard, W. J. B. Reid, R. J. Harrison, C. T. Morgan, John Thompson, Joseph Johnson, S. Lloyd, D. Shephard, H. Eaborn, W. W. Mangles, A. J. Wood, H. P. White, F. H. Nalder, Rev. H. G. Rosedale, Rev. C. E. L. Wright, W. Minhurst, F. J. C. Gillmor, A. F. Robbins, S. Meymott, F. A. Hazzledine, R. J. Reuter, F. W. Mitchell, D. Book, G. Vogeler, H. Burrows, G. Robson, L. Danielsson, Hugh James, H. W. Slater and W. S. Lincoln.

Also the following visitors:—Bros. J. A. Maolean, Whittington Lodge, No. 862; C. V. Bellamy, St. George's Lodge, No. 3065; N. R. Pringle, P.M., Moira Lodge, No. 92; M. R. Hall, Needles Lodge, No. 2838; Canon A. J. Ingram, Grand Chaplain; Chas. H. Watson, Queen's Westminster Lodge, No. 2021; D. Northall-Laurie, Marquis of Dalhousie Lodge, No. 1159; O. Bradley, Westminster and Keystone Lodge, No. 10; J. T. Johnstone, King's Court Lodge, No. 2689; H. Dawkes, London Lodge, No. 108; W. W. W. Lee, Bushey Park Lodge, No. 2381; D. Shepherd, Zambesia Lodge, No. 86 (D.C.); J. F. Downes, Canterbury Lodge, No. 1635; G. W. Brown, Alexandra Lodge, No. 1511; and A. H. Elliott, Kingsway Lodge, No. 3027.

Letters of apology for non-attendance were received from Bros. W. J. Hughan, P.G.D.; W. M. Bywater, P.G.S.B.; Admiral Sir A. H. Markham, P.D.G.M. Malta; Belgrave Ninnis, P.G.D.; L. A. de Malcovich; J. P. Rylands; E. Conder, jun.; Dr. W. J. Chetwode Crawley, G.Treas., Ireland; and F. J. W. Crowe, P.G.O.,

Bro. Hamon le Strange, Prov.G.M. Norfolk, was elected Worshipful Master for the ensuing year, Bro. W. H. Rylands was elected Treasurer, and Bro. J. W. Freeman was re-elected Tyler.

One Grand Lodge, two Lodges and eighty-five brethren were admitted to the membership of the Correspondence Circle.

The W.M. then said:

BRETHREN,—Before proceeding with our work this evening I would ask your indulgence for a short time as I have been requested by the brethren of the Hamburg Zirkel Correspondenz to make a presentation of a unique and very pleasing character. Many of you will be aware that the late Grand Master of the Grand Lodge of Hamburg, Bro. Wiebe, together with other prominent members of the Craft in Germany, have from time to time in recent years seized the opportunity of presenting to some distinguished Mason a Medal in appreciation of any services he may have rendered to the Craft. It will serve no purpose my giving a list of such, as that would not interest you,

Many of you will likewise remember that Bro. Robert Freke Gould, a Past Master and Founder of this Lodge, attained his Masonic Jubilee on the 8th of December last. Such an opportunity as this could not in the opinion of the German brethren be allowed to pass unnoticed and accordingly they have had dies prepared and a Medal struck in honour of that event and I have been asked to publicly present it to Bro. Gould this evening. Before doing so, however, I feel sure that you will like to hear some few details of a biographical character which has led up to the pleasing presentation which I am shortly about to make.

Bro. Gould was born in 1836 and at the age of 19 entered Her late Majesty's Service as Ensign in the 86th Foot Regiment. In the same year he was transferred to the 31st Regiment at the same time receiving his commission as a Lieutenant. The year 1855 was evidently a memorable one for Bro. Gould, for on the 8th December in that year, whilst stationed at Walmer Garrison, he first saw Masonic Light in the Royal Navy Lodge No. 429, at Ramsgate. His enthusiasm for Masonry at that early stage in his career was evidently of no mean order for he induced four subalterns to accompany him through the ordeal of initiation the same evening. Of this quintet three are dead and but two remain, viz. :—Bro. Gould and Bro. Lieut.-Col. Wm. Hill James. His interest in the Craft was evidently deeply aroused from the first as on his Regiment being ordered to Gibraltar he successively joined the following Lodges,

The Friendship, Gibraltar, in 1857,

The Inhabitants, „ 1858,

and of the latter he was the first Master after its revival. He was also the first Master of the Meridian Lodge No. 743, a Military Lodge attached to his Regiment. In 1859 his regiment was ordered to India and subsequently to China, in both of which countries he either joined existing or founded new Lodges. On his return to England in 1866 he joined the Moira Lodge No. 92, of which he became the Master in 1874. Last but not least he was one of the Founders of this Lodge and the second Master, being installed in this chair on the 8th November, 1887, as the successor to Col. Sir Charles Warren.

Time will not permit me to allude to the great services he has at all times freely given to the Craft and other degrees further than stating that in consequence of those services he was appointed Prov.G.S. Warden of Gibraltar in 1858, Senior Grand Deacon of the Grand Lodge of England in 1880, and Past G.S. Warden of the Grand Lodge of Iowa in 1888, besides being for many years on the Board of General Purposes of the Grand Lodge of England, and also on the Colonial Board.

To show that the name of our Brother was for many years a household word in Gibraltar, it is interesting to place on record that the Inhabitants Lodge No. 153, which owed its revival to him in 1858, was found in 1901 to have become too large and unwieldy and therefore a new Lodge was formed from amongst its members and such Lodge was named the "Robert Freke Gould" Lodge No. 2874.

It is not however so much as a Ritualist that Bro. Gould is known all over the world as for the very eminent services he has rendered to the historical and archaeological side of Freemasonry and for his fame as an author in all classes of Masonic Research, and the great and critical interest he has taken in Masonic literature. His first essays in the ranks of Masonic journalism began as a contributor to the columns of the *Freemasons' Magazine* in the month of March, 1858, and he continued to write articles for that Journal until 1865.

In 1879 he brought out "The Four Old Lodges," which was designed primarily to elucidate the history and status of the survivors of the Four Old Lodges which on the Festival of St. John the Baptist, A.D. 1717, met and instituted the premier Grand Lodge

of the world. In the same year he issued "The Atholl Lodges," a work on the same lines. From 1882 to 1887 he was engaged on that monumental work which will for all time be associated with his name. I refer to his "History of Freemasonry." The time and labour he bestowed on it was immense, he spent many of the best years of his life in preparing for its publication and it is, and ever will be, a standard work of reference on the subject. Subsequent discoveries may have made it necessary to qualify some of the theories he therein laid down, but these do not in any way detract from the great value of the work as a whole nor from the obligation the Craft is under to him for undertaking its publication.

In 1899 he brought out a work "Military Lodges," a subject on which no one so well as he was more competent to write, on account of his early connection with Military life and Military Lodges. In 1903, in consequence of the almost universal desire amongst the ever enlarging band of Masonic Students for a smaller and more compact History of the Craft, he wrote and published "A Concise History of Freemasonry." This work has been favourably received both in the Masonic and ordinary press, and it may be confidently said, that by including the latest discoveries, it is fully brought up to date, and I feel I am expressing the desire of the Outer as well as of the Inner Circle of this Lodge in recommending it as the most critical and luminous history of our Antient Institution that has ever been published.

To the *Transactions* of our own Lodge Bro. Gould has ever been a diligent contributor, and perhaps the articles which have evoked the most interest are the series of literary portraits in which will be found critical biographies of some of the foremost Craftsmen of our own and of a past age. There is also his scholarly Commentary on the Regius MS. that appeared in the first volume of our Antiquarian Reprints, for the exclusive preparation of which he devoted more than a year of his life.

To show the esteem in which Bro. Gould is held in America I have already stated that he has been made a Past Grand Warden of the Grand Lodge of Iowa, a Grand Lodge I may say in passing that has done more than any other in that Continent to foster Masonic historical and archæological research by founding and subsidizing a splendid library and museum at Cedar Rapids. I may also mention that one of the greatest Masonic lights of our own time, the late Albert Pike, who was regarded as the uncrowned King of High degrees, completed shortly before his death a manuscript book entitled the "Symbolism of the Craft Degrees of Freemasonry." It consists of an Introductory Chapter, five principal Lessons and of Fragments. Of this two copies were made and the original manuscript was then destroyed. One copy was retained by the writer but is now carefully preserved in the Archives of the Supreme Council 33° of the United States (Southern Jurisdiction), the other was entrusted by Bro. Albert Pike for safe keeping to Bro. Gould and was presented by him to our Library and now in our safe custody at 61, Lincoln's Inn Fields.

Such, brethren, is very shortly the career of the man the members of the Hamburg Zirkel Correspondenz and Bro. Wiebe, Past Grand Master of Hamburg, wish to honour.

Bro. Gould,—in asking you to accept the Medals I now hand you from the members of the Hamburg Zirkel Correspondenz and Bro. Wiebe, will you accept on their behalf as well as on behalf of all the members of this your own Lodge their and our warmest congratulations on the consummation of such an unusual event as the celebration of your Masonic Jubilee, and will you allow me to add that it has been a very great pleasure to me that this Medal should have been struck and presented during my year of office as W.M. of this Lodge, the more so as you are, and have been for many



years, aware of the great interest that I have taken in Masonic Numismatics, and that such an unusual and happy event should have happened during my Mastership of this Lodge will be one of the most pleasing recollections of my Masonic career.

I may add that I have received the following letter from Bro. Dr. Chetwode Crawley:—

From W. J. Chetwode Crawley,  
Grand Treasurer.

Freemasons' Hall,  
Dublin.

To the W.M. Quatuor Coronati Lodge.

My Dear Bro. Shackles,

It is with the most sincere regret I find myself unable to be present at the presentation to our good Bro. R. F. Gould. The Quarterly Communication of my own Grand Lodge claims my official attendance in Freemasons' Hall, Dublin, to-night.

I regard the occasion as one that does honour not only to the recipient but to the Lodge that numbers him among its members. No man of our time has done more to establish the history of the Craft on a sure basis: no man has displayed more profound antiquarian knowledge than Bro. R. F. Gould. Surely then, it is a privilege to call myself a member of the same Lodge and to share in the honour of this public presentation.

Faithfully and fraternally yours,

W. J. CHETWODE CRAWLEY.

Other brethren have also written expressing regret for unavoidable absence, and congratulations to you on the presentation which I now make.



Bro. R. F. Gould, P.G.D., in responding, said.—Worshipful Master, it affords me much pleasure to receive at your hands the impressions of the Dedication-Plaque which have been presented to me this evening.

To one and all of the kind friends and Brethren by whom the idea of commemorating the completion of my 50th year of Masonic life has been favourably received, I am deeply grateful.

My good fortune has indeed been in the ascendant, when the Freemasons of Hamburg and the Brethren of the Quatuor Coronati Lodge, have united in wishing me "God speed," in entering upon—though, of course, in the ordinary course of nature, it can only be the threshold of—my second half-century as a member of the Craft.

Of this expression of goodwill, this Dedication-Plaque is a visible embodiment, and here again I have experienced great good fortune, and my warmest thanks are due, in the first place, to Bro. Carl Wiebe, Past Grand Master of Hamburg, the originator of the scheme, and only in a slightly lesser degree, Worshipful Master, to yourself, for the design which has been so beautifully and artistically carried out, owes its complete success as a work of art to the joint and fraternal labours of your two selves, who are admittedly the highest authorities and the leading experts in the science of Masonic Numismatics in Germany and Great Britain respectively.

You have been kind enough, Worshipful Master, in your eloquent address, while reviewing my career, to look through a lens of the strongest possible magnifying power, when describing my services as a Freemason. But the eulogium of a friend is very gratifying to one's feelings, although it may not be deserved.

I am, I think, as having been a contributor to Masonic periodical literature in the fifties, the oldest living journalist of the Craft, and in a retrospect of my long Masonic life, if there is any particular feature of it upon which, on the present occasion, I can look back with particular satisfaction, it is that I was a founder and took a very active share in the formation of the Quatuor Coronati Lodge.

You have reminded the Brethren that I followed Sir Charles Warren in the chair, and I hope to be excused for referring to a passage in my inaugural address. I pointed out the benefit to be derived from now and then touching Mother Earth, or in other words, the desirability of occasionally subjecting the position and prospects of the Lodge to an analysis, whereby we might estimate how far it fulfilled, or fell short of fulfilling, all the purposes for which it was established.

It may indeed be urged that, at the present moment, the constant expansion of our Outer Circle, is, of itself, an ample assurance that there is no room for improvement in the labours of the Lodge. But, I venture to submit, that the mission of this Lodge, as an educational body, will never be fully or adequately discharged, until the quality of its publications is brought up to a standard that will compel the serious attention of scholars and men of intelligence who are not members of our Fraternity.

I shall conclude by saying, that the object dearest to my heart has been to lift the study of Freemasonry to a higher level, and to prove the right of our ancient and honourable Society to the consideration and respect of men of intellect and scholarship. I do not pretend to have done much, but perhaps I may lay claim to have done a little, towards carrying this object into effect, and throughout my labours in the cause I have been associated most agreeably, in past years, with several dear friends who still are, and others who in their lifetime were, my fellow-workers and valued colleagues in the Quatuor Coronati Lodge.

I have nothing more to say, except to repeat my thanks to the Hamburg Zirkel Correspondenz and the members of this Lodge, and to communicate on behalf of Bro. Carl Wiebe his fraternal regards to the Brethren, together with an expression of his sincere regret at inability to be present this evening. I am also charged with a similar message from Count Goblet D'Alviella, of Belgium; and last, but by no means least, I have been asked by my very dear friend, William James Hughan, to state that nothing but distance and imperative considerations of health, could have prevented him from attending to-night and witnessing the presentation to his life-long colleague as a student of the Craft.

---

The W.M. proposed, and the S.W. seconded, as a re-joining member, Bro. Edward Lovell Hawkins, of Barham House, London Road, St. Leonard's-on-Sea, M.A., Oxon. P.M. Apollo University Lodge, No. 357; P.M. Churchill Lodge, No. 478; W.M. St. Leonard's Lodge, No. 1842; P.Prov.S.G.W. and P.Prov.G.Sec., Oxon.; P.Z. Apollo University Chapter, No. 357; P.Prov.G.Sc.E., Oxon.

## EXHIBITS.

By Bro. J. M. BLOOD, Huntley.

A very interesting ENGRAVED APRON. In the centre is an open book from which, on the left, project two columns, and on the right, a plumb-rule, 24in. gauge and level, below it being two interlaced triangles with the letter "G" in the centre. On the triangular flap there are the square and compasses. The apron was originally lined and edged with light blue silk. At a subsequent date the narrow green ribbon was added inside the blue, and the whole, including the flap, edged with green fringe. The tie-ends coming from under the flap are of gold lace with red fringe. It seems that at a still later period the blue silk at the bottom of the apron was completely hidden by a strip of red watered ribbon, and at the sides by more gold lace also having the remains of red fringe. Nothing is known positively of the original ownership of the apron, but it is believed to have belonged to a Brother who died at Cardiff about fifty years ago. It has been suggested that it may have been worn by a member of the Country Stewards' Lodge, and that when permission to wear green was withdrawn, the Brother added the red in order to bring himself into line with the Grand (or Provincial Grand) Stewards.

By Bro. J. P. SIMPSON, London.

MEDAL, presented to him, in 1877, by the Bard of Avon Lodge, No. 778, Stratford-on-Avon. This was the first medal (five only being struck) which was presented by the Lodge for the encouragement of the study of Shakespeare, Modern History and the English Language, at Trinity College School, Stratford-on-Avon. The medal appears as No. 335 in Band III. of the Hamburgische Zirkel-Correspondenz Medaillenwerk, but the reverse does not correspond to the illustration there given. In this example the centre is engraved:—

THE  
TRINITY COLLEGE SCHOOL  
STRATFORD-ON-AVON  
JOHN PERCY SIMPSON

1877

the whole surrounded by a wreath of laurel.

By Bro. H. L. KENNAN, Spokane, Washington.

Set of SOUVENIR BADGES (Craft, R.A., Cryptic, K.T., and Eastern Star) struck to commemorate the dedication of the Masonic Temple at Spokane, in June, 1906. *Presented to the Lodge.*

By Bro. F. W. LEVANDER, London.

"FRENCH PRISONERS" JEWEL in stamped silver frame, similar to the one illustrated in *A.Q.C.*, vol. xi., p. 137.

By Bro. J. PROCTER WATSON, Castle Carrock.

TWO OLD JEWELS, R.A. and Mark.

By the SECRETARY.

PUNCHBOWL, Sunderland ware, with arms of the Grand Lodge of the Ancients and the verse:—

"Signs of state that feed our pride,  
Distinctions troublesome and vain,  
By Masons true are laid aside,  
Arts free-born sons such toys disdain.  
Ennobled by the name they bear  
Distinguish'd by the badge they wear."

PUNCHBOWL, Lowestoft ware, with arms of the Grand Lodge of the Antients, and below, the letters "W.D.D.G.S." It is suggested that these stand for "William Dickey, Deputy Grand Secretary." This office was held by Bro. Dickey from 1767 to 1771. In the latter year he was appointed Grand

Secretary in succession to Laurence Dermott, and held the office down to 1777, when he was appointed Deputy Grand Master. He was re-appointed to the same office down to 1781. In 1782 he was given the office of President of the General Committee. In 1794 he was again re-appointed D. Grand Master, and held that office until his death in 1800.

LEATHER POUCH with ornamentation beautifully worked on the flap, below are at each corner a pentalpha. Bro. C. V. Bellamy identified this as a satchel used by the Haussas—a tribe of Mahomedans from Northern Nigeria—for carrying MS. copies of, or extracts from, the Koran.

---

A hearty vote of thanks was passed to the exhibitors and donors on the proposition of the W.M., seconded by Bro. Canon Horsley.

---

Bro. Canon J. W. HORSLEY read the following paper:—

## NOTES ON THE GRAND CHAPLAINS OF ENGLAND.

BY BRO. CANON J. W. HORSLEY,  
*Grand Chaplain.*

---



SOME years ago it occurred to me that it might be useful to put together some notes concerning all those who have held the office of Grand Chaplain since its institution, though then it had never entered my mind that I should be called to that honour myself. When, however, I was added to the list of those whose history and work I had begun to investigate, it seemed not unfitting that I should finish the undertaking during my year of office. Not, however, that these notes can be looked upon as a finished work. Others besides myself will, no doubt, from time to time come across new matter concerning some Grand Chaplains, yet then it will be convenient that I have provided certain labelled pigeon-holes, into which such items may be put. Especially this may be the case with regard to the earlier Grand Chaplains, who lived long before there was a Crockford's Clerical Directory to give a summary of their career and writings, or the *Freemason* paper to give each year some account of the Masonic status and labours of those who were annually appointed. Nor can it be said that the majority of our brethren were so generally known as to be the subject of notes in the Dictionary of National Biography, or works of a similar character. And, throughout, there is the difficulty that the sources of information as to the clerical career of a man rarely record anything as to his Masonic life, while Masonic records say little as to his work or position in the Church. All the more reason, perhaps, that what I now attempt should be done, and that the foundation should be laid of what may become, by additions, a more useful work.

The intimate connection of Masonry with religion, whether we regard its operative or its speculative origin, is so obvious and indeed necessary, that it is not surprising that Chaplains and Grand Chaplains should exist, although such an office is not so ancient, so necessary, or so universal as those of Master, Wardens, and Tyler. As soon as the Craft ceased to be purely operative a few clerics joined it, and their services were utilized for the common worship once so usual on St. John's Day in summer and St. John's Day in winter. But they were not necessarily Chaplains to the Lodges to which

they belonged. Further, as it is not necessary that a Lodge should have a Chaplain, neither is it of necessity that the office of Chaplain should be discharged by one who is a minister of religion. There is a priesthood of the family as well as a priesthood of the Church or Temple, and the Master of a Lodge is by no means out of his place when offering the stated prayers, as is usual in America, and as of course he does, and should do, when there is no Chaplain, or none present. There is no record of a Grand Chaplain having been appointed before the year 1775, although in that year the office is said to have been "revived." I find that in 1776 the York "Grand Lodge of All England" appointed as its Grand Chaplain the Rev. JOHN PARKER, Vicar of St. Helen's, York, who had been initiated on February 12th of that year. It was no doubt felt that none could reasonably think, or honestly suggest, that Masonry was an irreligious, or even non-religious body, when a clergyman was always appointed by Grand Lodge, and very frequently by private Lodges, as a minister and remembrancer of the theocratic element in the constitution of the Order.

The Grand Lodge of Ireland "revived" the office of Grand Chaplain in 1813, and the Rev. J. A. COGHLAN, B.A., was appointed. It is curious that two of the same name should have been appointed to the same post in England and in Ireland. He held office until 1832. Thenceforward there were two Grand Chaplains who were commonly re-appointed year after year. Thus the Rev. SMYTH W. FOX, M.A., held office from 1833 to 1846; the Rev. H. J. WESTLEY, M.A., from 1847 to 1858; the Rev. JOHN JAMES MCSORLEY, M.A., from 1858 to 1884; the Hon. and Rev. WILLIAM C. PLUNKET (later the Most Rev. Lord Plunket, Archbishop of Dublin) from 1868 to 1897; and the Rev. BENJAMIN GIBSON, M.A., from 1888 to 1900, if not later. Thus six Grand Chaplains cover nearly a century of service.

With these preliminary observations I now proceed to give such notes as I can concerning those who have held the office of Grand Chaplain in the Grand Lodge of England. In many cases little is known—at any rate by me—concerning them; but as regards the first it may be said that too much is known. His history is interesting, but sad and tragic, and I have, therefore, given it in some fulness, adding some points of interest to Masons as have not appeared to my knowledge in other books by or concerning this unhappy predecessor of mine.

The Reverend WILLIAM DODD, LL.D., was born in 1729, in Bourne Vicarage, Lincolnshire, and entered Clare College, Cambridge, as a sizar, in 1745. He took his degree of B.A. in 1750, having obtained high honours in mathematics, his place in the mathematical Tripos being 15th. He then took up literary work in London, but at once showed his devotion to balls and fashionable life generally. In the following year, though only twenty-two, he married the daughter of a domestic servant, and developed the extravagance of his life. His father intervened with counsel and probably pecuniary assistance. He seems to have altered his ways in consequence, and, on October 19th, 1751, he was ordained deacon, though not yet of the age legally required, since he was born on May 29th, 1729. Probably a Faculty was granted in consideration of his academic distinction. He became curate of West Ham, and increased his income by taking pupils. In the following year he was made lecturer there, and became a popular preacher, holding also the lectureship at St. James, Garlick Hill. In 1754 he exchanged this for the lectureship of St. Olave, Hart Street. In 1758 he did what was, perhaps, the redeeming point in his life, by becoming a promoter of the Magdalen Home, at Streatham, for fallen women, a beneficent and still extant institution, which he helped in various ways up to the time of the tragic ending of his career. In 1759 he proceeded to the degree of Master of Arts, and, in 1766, to that of LL.D. In 1763 he was made

Chaplain in Ordinary to King George III., owing, no doubt, to the assiduity of his courtship of the aristocracy, as well as to his popularity as a preacher. In the following year he was promoted to be Chaplain to the King, and also was made a prebendary, or Canon, of Brecon. In 1766 he left West Ham, and took a house in Southampton Row, and a country house at Ealing. His connection with fashionable circles supplied him with many aristocratic pupils, but also plunged him again into extravagance. Winning a prize of a thousand pounds in a State lottery, he built a Proprietary Chapel for himself, and ran another in Bloomsbury. Dr. Oliver, in his "Revelations of a Square," says that Dr. Dodd joined the Lodge (presumably the "Antiquity") and was installed in 1772, and implies that he was Chaplain. In the "Revelations of a Square," chapter vii., will be found an eulogistic account of Dr. Dodd's ruling of the Lodge with punctuality, regularity and discipline, and of his teaching that "although the morality of Freemasonry is more particularly adapted to the genius of Christianity than to any other religion, it is, in reality, neither exclusively Jewish, Patriarchal, nor Christian, but cosmopolite; and, amongst all peoples where it ever flourished, it circulated the morality of their peculiar religion, and selected its patrons, or parallels, from eminent men of their own tribe and kindred." As Bro. Sadler has very kindly pointed out to me, these statements only serve to emphasize the fact that Dr. Oliver is absolutely unreliable as a Masonic Historian. Dr. Dodd was never registered as a member of the Lodge of Antiquity. He was not even a Mason in 1772, but was initiated in the St. Alban's Lodge on 3rd April, 1775, one month before his appointment as Grand Chaplain. In 1772 he was made Rector of Hockcliffe and also Vicar of Chalgrave, both in Bedfordshire. These benefices were shortly after consolidated, and are only six miles from Wing, which he also held from 1775 by dispensation. The present Rector of Hockcliffe informs me that "he appears to have resided not at all at Wing, and very little at Hockcliffe, but I have seen one entry in the registers—I think a baptism—signed by him." In this year also a highwayman was hung for shooting into his carriage at St. Pancras—a better aim would have saved another execution! Lord Chesterfield, who had been one of his pupils, now made him his chaplain, and he was at the zenith of his popularity and reputation, though (or perhaps therefore) much in debt through extravagance. He must have been a man of remarkable power and versatile talent, having found time, in addition to his clerical work, his pupils, his philanthropic business, and his immersion in fashionable life, to have written a "Commentary on the Bible," besides "Sermons to Young Men," and other similar productions. But in 1774 came the moral crisis of his life. The important and lucrative living of St. George's, Hanover Square, having become vacant, he caused an anonymous letter to be sent to Lady Apsley, offering her £3,000 if, through her influence, he should be appointed. I do not know why the Bishop of London did not take the proper steps to have him unfrocked for this sin and ecclesiastical offence of simony; but that it was notorious is obvious from the contemporary invective and satire of both press and stage, and from his name having been promptly removed from the list of Royal Chaplains. Here his career should have ended, and well for him had it done so. He hurried, however, to see his old pupil and recent patron, Lord Chesterfield, at Geneva, and by him was presented to a third living, that of Wing, in Bucks. The present Vicar kindly informs me that he is said to have been instituted to the living in 1775, but there is no record of his having resided, or even of his ever having officiated at the Church. Presumably he put a curate there, after the fashion of that age of pluralism. The income was no doubt large, for even in 1885 it was returned as worth £600, though now it is only £350 gross. He attempted to be whitewashed by

bankruptcy proceedings, but failed; and then comes the comment of a biographer, which seems quaint, if not libellous, now—"he descended so low as to become the editor of a newspaper."

Here now comes the matter that is of special interest, and perhaps of equal astonishment, to us as Masons. In spite of these notorious proceedings in 1774, in the following year he was chosen to be Grand Chaplain, the first to hold such office. Bro. Rylands suggests that the brethren of that day were "moles, burrowing in their own warren, as usual" and that they did not know much about what happened in the ecclesiastical world. This however is difficult to believe in the face of the notoriety of the man and of the matter, his removal from the list of King's Chaplains, and the ventilation of the scandal in the press and on the stage. The minutes of Grand Lodge, under date May 1st, 1775, record that "the office of Grand Chaplain having been discontinued for several years" (this does not mean that there had been Grand Chaplains before, but the Masons of that day were not accustomed to admit that anything could be new in Masonry) "was this Day revived; and Dr. William Dodd was by the Grand Master appointed to that Office, with the unanimous approbation of the Brethren present." Lord Petre, the Grand Master, was present, and nearly three hundred other brethren, the occasion being the laying of the foundation stone of Freemasons' Hall in Great Queen Street, the room which now is our Grand Lodge Room. Preston, in his *Illustrations of Freemasonry*, records that "After the ceremony, the company proceeded in carriages to Leathersellers' Hall, where an elegant entertainment was provided on the occasion; and at this meeting the office of Grand Chaplain was first instituted." The meeting in the City was not simply for refreshment; but the business of Grand Lodge was here transacted, though no doubt the "elegant entertainment" followed. In the following year, 1776, he was present, I see from the Grand Lodge documents, at the Quarterly Communications in February and April, and at Grand Lodge on May 23rd, when the new Hall was dedicated with solemn ceremony, and, according to the official records, an oration suitable to the occasion was delivered by the Grand Chaplain. Preston says, "an exordium on Masonry, not less elegant than instructive, was given by the Grand Secretary [James Heseltine], and an excellent oration delivered by the Grand Chaplain." This oration was "published by general request, under sanction of the Grand Lodge," any profits arising from its sale to be given to the Hall Fund. It is dated from Hockcliffe Rectory, August 1st, 1776. The formal request for its publication came from Grand Lodge at Grand Feast, June 3rd, when Dr. Dodd was re-appointed for a second year as Grand Chaplain. It is a flowery composition typical of the age, full of sound and mainly empty of significance, claiming for Masonry that it is synonymous with civilisation. Three passages only seem to me worthy of quotation, and these not all for the same reason. Eulogizing the Craft, he says, "In whatsoever else men may dispute and disagree, yet they are all unanimous to respect and support a singularly amiable institution, which annihilates all parties, conciliates all private opinions, and renders those who by their Almighty Father were made of one blood to be also of one heart and one mind; brethren, bound, firmly bound together by that indissoluble tie—'the love of their God, and the love of their kind.'" Again, quoting Antony and Cleopatra, Act iii., Scene 3, he claims the words of Antony:

" My Octavia,

Read not my blemishes in the world's report,

I have not *kept my square*; but that to come

Shall all be *done by rule*."

as "plainly shewing that the immortal Bard was one of our Brethren." And, thirdly, in a prophetic vision, not only of our meeting here, but of our adjournment elsewhere for refreshment after labour, he prays that "when the sacred solemn rites are done, when festive hilarity assumes his social seat, may decent politeness, and sweetly smiling innocence, for ever wreath the chaplet for his brow, and command his song!"

This, as far as I can ascertain, was his last appearance at Grand Lodge. Going to Paris, he made himself conspicuous by extravagance and foppish dress at the races and other places of amusement, but returned to England at the beginning of 1777 and preached his last public sermon (his unique sermon to his fellow condemned in Newgate is well known) in the Chapel of the Magdalen Home which he had so continuously helped. This was on February 2nd. Two days afterwards he forged a bond from Lord Chesterfield, his patron, for £4,200, and though he raised much money on it he was speedily detected and arrested, and the end of the month found him in the Old Bailey. The Craft lost no time, for in the minutes of an Extraordinary Grand Lodge held on Monday, April 7th, 1777, I find "It being represented to this Grand Lodge that the Reverend William Dodd, LL.D., Grand Chaplain, had been convicted of Forgery, and was at present in Newgate—Resolved unanimously—That the said Doctor be expelled this Society." His name was also obliterated from contemporary copies of the Book of Constitutions wherever it occurred. The sad record alone remains that after delay arising from various legal points he was sentenced on May 26th to be hanged. Extraordinary efforts were made on his behalf. Petitions from thirty thousand people, from several charities on whose behalf he had been active, and from the City of London in its corporate capacity, were sent to the King, and Dr. Samuel Johnson was especially active to obtain a commutation of sentence. But in vain. The Privy Council on June 15th ordered his execution, which was carried out on June 27th, his body being interred in the churchyard of Cowley in Bucks. Thus in what should have been his prime—he was only forty-eight—there passed away in shame a man of brilliant parts but little character. Not simply the Boanerges of an ignorant mob, not merely a successful toady of the rich and highly placed, must have been the man who, in a life spent entirely in the public eye in London, in spite of the faults of extravagance and worldliness, and still more of simony and fraud, was selected as Grand Chaplain and from his philanthropy and geniality gained and retained to the last the love of many who could hardly have accorded their respect.

Not unnaturally, the office remained vacant for four years, no cleric perhaps being willing to accept the position so recently discredited; but in the minutes of Grand Lodge held on April 30th, 1781, we read: "The office of Grand Chaplain being vacant the Grand Master was pleased to appoint the Reverend SYDNEY SWINNEY, Doctor in Divinity, Grand Chaplain for the year ensuing." He had been initiated in Lodge No. 24 in January, 1769, and was a Mason of some standing.

It seems that he only held the office for one year, and that there was again an interregnum until at Grand Feast, May 4th, 1785, the Rev. A. H. ECCLES, M.A., Rector of St. Mary, Stratford, Bow, Middlesex, was appointed and invested by the Earl of Effingham, Acting Grand Master. He was re-appointed each year down to May 13th, 1801.

At Grand Feast, May 12th, 1802, the Rev. LUCIUS COGHLAN, D.D., Dublin, was appointed and invested. He retained his office until the union in 1813, appearing as one of the three Grand Chaplains in the Calendar for 1814 in conjunction with the Rev. EDWARD BARRY, M.A., M.D., who had been Grand Chaplain of the "Ancients" or Atholl



Masons from 1791 onwards, and the Rev. HENRY J. KNAPP, who had been Deputy Grand Chaplain of the Ancients from 1809. Dr. Coghlan was also Grand Chaplain in 1815 and 1816. He published a volume of sermons in 1810, and died in 1833.

This may be the place to record those who were Grand Chaplains of "the Ancients" or Atholl Masons.

1772-5. The Rev. JAS. GRANT, LL.D. (For several years before the appointment of a Grand Chaplain, Bros. Rowlands and Grant had preached to the brethren on St John's Day in Midsummer.)

1775-8. The Rev. PARKER ROWLANDS. He was of St. John's College, Oxford, where he matriculated in 1744 at the age of 21.

1779-82. The Rev. Dr. WILLIAM PARRY.

There seems to have been an hiatus of four years.

1786-91. The Rev. Dr. COLIN MILNE, LL.D., F.R.S., was appointed. He was born at Aberdeen and educated at the Marischal College there, under his uncle Dr. Campbell. Thence he removed to Edinburgh, after which, on becoming tutor to Lord Algernon Percy, he took holy orders in the Church of England, and was presented to the rectory of North Chapel in Sussex. He was also chosen lecturer of Deptford, and obtained the degree of Doctor of Laws from Aberdeen. He died in 1815, aged 71. He was well known as a divine and a naturalist, having published a Botanical Dictionary—*Linnaei Institutiones Botannicæ—Indigenous Botany, or the habitats of English Plants*, and a volume of sermons.

1791-1813. The Rev. EDWARD BARRY, M.A. and M.D. of St. Andrews. He was Curate of St. Marylebone, and published a number of works on medicine, divinity, and politics in London from 1783 to 1809. He died in 1822. See his life in the Dictionary of National Biography.

There is considerable confusion in the Masonic Calendar and elsewhere, as sometimes a Henry Isaac and sometimes a Henry John Knapp is recorded as Grand Chaplain. I have come to the conclusion that there were not two of the same surname, and that there was no Isaac. Henry John, born in 1779, matriculated when sixteen at Pembroke College, Oxford. He took his M.A. in 1804, and B.D. and D.D. in 1840, only ten years before his death. Minor Canon of St. Paul's in 1817, Priest of the Chapel Royal in 1821, Vicar of Willesden in 1833, he was next Vicar of Kingsbury, in 1834, and until his death on July 18th, 1850. He was initiated in Grand Master's Lodge in 1807, and is called on the list of that Lodge, Grand Chaplain of the Antients. He seems, however, to have been only Deputy Grand Chaplain, and there is no record of his having been actually appointed either Deputy Grand Chaplain or Grand Chaplain by Grand Lodge, at or after the Union, although probably he was looked upon as an acting Grand Chaplain of the Antients, and so given *ad eundem* rank. His name does not appear in the list of Grand Officers after 1817, although, as we have seen, he lived until 1850.

At the Union, in 1813, the Revs. Barry and Knapp, "Ancient" officers, were conjoined with the Rev. Dr. Coghlan, the fourth Grand Chaplain, as a triad of Grand Chaplains for the united body, and were reappointed in the following year. At the Grand Assembly of Freemasons, for the Union of the two Grand Lodges of England, on St. John's Day, 27th December, 1813, after the Act of Union had been read by the Director of the Ceremonies, the Rev. Dr. Coghlan, Grand Chaplain to the Fraternity under the Duke of Sussex, proclaimed aloud, after the sound of trumpet:—"Hear ye; This is the Act of Union, engrossed, in confirmation of Articles solemnly concluded between the two Grand Lodges of Free and Accepted Masons of England, signed, sealed,

and ratified by the two Grand Lodges respectively; by which they are to be hereafter and for ever known and acknowledged by the style and title of the United Grand Lodge of Ancient Freemasons of England. How say you, Brothers, Representatives of the two Fraternities? Do ye accept of, ratify, and confirm the same?" To which the Assembly answered:—"We do accept, ratify, and confirm the same." The Grand Chaplain then said:—"And may the Great Architect of the Universe make the Union perpetual." To which all the Assembly replied, "So mote it be." The two Grand Masters and six Commissioners signed the Instruments, and the two Grand Masters then affixed the Great Seals of their respective Grand Lodges to the same. Dr. Barry (Grand Chaplain of the Fraternity under the Duke of Atholl) after the sound of trumpet, then proclaimed:—"Be it known to all Men, that the Act of Union between the two Grand Lodges of Free and Accepted Masons of England is solemnly signed, sealed, ratified, and confirmed, and the two Fraternities are one, to be henceforth known and acknowledged by the style and title of 'The United Grand Lodge of Ancient Freemasons of England,' and may the Great Architect of the Universe make their Union Eternal!" And the Assembly said "Amen." Thus did the two Grand Chaplains consecrate the happy marriage.

In 1815 Dr. Coghlan was reappointed, but his two "Ancient" colleagues disappeared, and the Rev. GEORGE A. BROWNE (printed as Browle in the Masonic Calendar) was the other Grand Chaplain.

In 1816 the Grand Chaplains were the veteran Dr. Coghlan and Henry John Knapp.

In 1817 there were three installed, namely, the Revs. SAMUEL HEMMING, D.D., L. D. H. COKBURNE, LL.D., and (for the last time) H. J. Knapp.

In 1818 Dr. Cokburne appears alone.

In 1819 he has the Rev. JAMES BURGESS, M.A., as his colleague.

From 1820 to 1826 the Rev. SAMUEL S. COLMAN and Dr. Cokburne were Grand Chaplains, the latter thus having been honoured for nine years in succession. He is, however, eclipsed in this respect by his colleague, who, appointed first in 1820, retained his collar until 1835, dying in 1842.

In 1827 the Rev. S. S. Colman had the Rev. BARNARD HANBURY as his colleague, and they remained in office till 1831.

In 1832 there was only one Grand Chaplain, namely the Rev. S. S. COLMAN. He had been Prov. G.M. of Norfolk in 1810.

In 1833, 4 and 5, he re-appears with the Rev. WILLIAM FALLOFIELD as his colleague, but then retired, and died in 1842. Mr. Fallofield was the last of those who had a long tenure of office, the growth of Masonry, and of the number of clergymen who were brethren of the Craft, rendering it desirable that the office should only be held for two years; while from 1882 no one has been Grand Chaplain for more than a year. Mr. Fallofield, however, was in office from 1833 to 1847. He died in 1858.

From 1836 to 1840 the Rev. JOHN VANE (who died in 1870) shared the duties and honour with Mr. Fallofield. I find both visiting Grand Master's Lodge No. 1, in May, 1841, the former as Past Grand Chaplain, the latter as Grand Chaplain. Mr. Vane was M.A. Cantab, Fellow of Magdalene, Rector of Wrington, Somerset, and Deputy Clerk of the Closet to the Queen.

From 1841 to 1843 the Rev. WILLIAM J. RODBER (who died in 1844) was Mr. Fallofield's colleague. He was initiated in the Grand Master's Lodge No. 1, on February 20th, 1837, and was its W.M. in 1840 and 1841.

From 1844 to 1846 the Rev. Sir JOHN WARREN HAYES, Bart., M.A. Oxon. (who lived till 1896) was the second Grand Chaplain. He had the remarkable record of being Provincial Grand Chaplain for half a century. He was Rector of Arborfield, Oxon.

In 1847 Mr. Fallofield is in office for the last time, with the Rev. JOHN OSMOND DAKEYNE as his colleague.

In 1848 the system began, which continued generally till 1881, of the second Grand Chaplain of one year becoming the first of the ensuing year. Mr. Dakeyne therefore becomes first in precedence, and Dr. JOHN EDMUND COX, D.D., Oxon. is with him. He was an F.S.A., Vicar of St. Helen's, Bishopsgate, and author of many anti-Romanist books.

In 1849 Dr. Cox has the Rev. JOHN W. GLEADALL as his coadjutor, and both were re-appointed in 1850. Mr. Gleadall was a Cambridge M.A., Fellow of St. Catherine's, Preacher at the Foundling Hospital, etc. He was initiated in Grand Master's Lodge No. 1, in 1843, and was its W.M. in 1849 and 1850, thus copying the example of his predecessor, Mr. Rodber.

In 1851 Dr. Cox (who seems to have been much valued as Grand Chaplain) was re-elected and given the Rev. EDWARD MOORE as a colleague, and this pair continued in office until 1857. Five Edward Moore's appear in the first edition of Crockford's Clerical Directory, which was published in 1858.

In 1858 the Rev. Edward Moore appears for the last time, and no one henceforth holds the office for more than two years. His colleague was the Rev. ARTHUR R. WARD, M.A., Cantab., Curate of All Saints', Cambridge, and only ordained in 1856. Subsequently he became Vicar of St. Clement's, Cambridge.

For 1859 and 1860 we find the Rev. A. R. Ward and the Rev. WILLIAM H. WENTWORTH BOWYER, S.C.L. Oxon, Rector of Clapham and Lord of the Manor of Clapham. The former died in 1884, the latter in 1872.

In 1861 the Rev. JOSEPH SENIOR, LL.D. Glasgow, and the Rev. WILLIAM KIRKPATRICK RILAND BEDFORD, M.A., Oxon, were Grand Chaplains, and it is a unique occurrence that the son of the latter was made Grand Chaplain in 1901, his father being then still alive, and much honoured as a Masonic student. Dr. Senior was Vicar of St. Mary's, Wakefield. Mr. Bedford was Rector of Sutton Coldfield and Rural Dean of Worcester.

Dr. Senior, son of a Mason and father of a Mason, was a great light in West Yorkshire. Initiated in 1836 in the Lodge of Three Grand Principles No. 251, Dewsbury (now 208), he ruled it in 1838, 1839 and 1840 by special dispensation, being also W.M. of the Nelson of the Nile Lodge No. 330, Batley (now 264). He held the Provincial honours of G. Sup. Works, Grand Chaplain, Junior and Senior Grand Warden. He also rose high in the Royal Arch. Bro. Bedford was initiated in the Apollo University Lodge in 1846. Master of the Lodge of Light No. 689, Birmingham (now 468), and of the Warden Lodge No. 1096, Sutton Coldfield (now 794); he was Prov. Grand Chaplain of Warwickshire 1858 to 1860. He devoted much attention to heraldry, and published "The Blazon of Episcopacy."

In 1862 the Rev. JOHN HUYSHE, M.A. Oxon., was second to Mr. Bedford. He was Rector of Clyst Hydon, Devon. He took a first-class in mathematics at Oxford, and was author of a treatise on Logic, published in 1822, and of a sermon preached in Devonport Dockyard in 1862. He was Prov. G.M. of Devon in 1866.

In 1863 Mr. Huyshe had as his colleague the Rev. ADOLPHUS F. A. WOODFORD, M.A., one of the greatest of Masonic students. Born in 1821, the eldest son of Field-Marshal Sir Alexander Woodford, he served for three years as lieutenant in the Coldstreams, but then proceeded to Durham University, and was ordained Deacon in 1846

and Priest in 1847, receiving at once the rectory of Swillington, near Leeds, which he held until 1872. Initiated in the Lodge of Friendship, Gibraltar, No. 278, in 1842, while visiting his father, then Governor of Gibraltar, he was afterwards W.M. (twice) of the Marquis of Granby Lodge, Durham, No. 124, of the Philanthropic Lodge, Leeds, No. 304 (twice), Deputy Master of the Lodge of Antiquity, London, No. 2, in 1873, under H.R.H. the Duke of Albany. In 1847 he was Prov. Grand Chaplain of Durham, and in 1863 of West Yorkshire. Editor of the "Freemason" and of the "Masonic Magazine" from 1873 to 1886, he was also author of "Kenning's Cyclopædia," "Defence of Freemasonry," "The Sloane Manuscript," as well as of the learned introduction to Hughan's "Old Charges of the British Freemasons." He delivered the oration when the foundation stone of the new buildings at Freemasons' Hall was laid by the Earl of Zetland on April 27th, 1864. Bro. R. F. Gould, as W.M. of Quatuor Coronati Lodge in the year of the passing away of Bro. Woodford, remarked, "The institution of the Quatuor Coronati Lodge gratified a wish that he had expressed many years previously, and happily he was not summoned to his final rest without being afforded the intense satisfaction of seeing crowned with perfect success the daring experiment of founding a Lodge on the joint basis of Masonry and intellectuality—in which beyond the shadow of a doubt, there belonged to him a priority of conception, over and above all the other charter members." The night before his death he was reading our *Transactions*, and of the Lodge he spoke much during the same night, and expressed the great affection he entertained for its members.

In 1864 Mr. Woodford had the Rev. Sir FREDERIC GORE OUSELEY, Bart., as his colleague. Sir Frederic was a M.A. and Mus. Doc. at Oxford, and Professor of Music in that University. Perpetual Curate of St. Michael's, Tenbury, he founded a College there, and was author of many musical works. He died in 1885.

In 1865 the Grand Chaplains were the Rev. JOHN SEDGWICK, D.D. Oxon., Fellow of Magdalen, Chaplain of High Leigh, Cheshire, and author of historical works; and the Rev. CHARLES RAIKES DAVY, M.A. Oxon., Rector of Adel, near Leeds, to 1858, and then of Tracey Park, near Bristol. The former died in 1885, the latter in 1874.

In 1866 Mr. Davy had with him the Rev. RICHARD J. F. THOMAS, M.A. Oxon., Vicar of Yeovil, and previously Head Master of Bancroft's Hospital, Stepney.

In 1867 to Mr. Thomas was conjoined the Rev. ROBERT J. SIMPSON, M.A., Oxon., Vicar of Slough, and afterwards well-known in London as Rector of St. Clement Danes, and then incumbent of Curzon Chapel. After being Provincial Grand Chaplain and Prov.G.S.W. of Durham, and Provincial Grand Chaplain of Berks and Bucks, he was, at the time of his death in 1900, Chaplain or Honorary Member of some twenty-five London Lodges. He delivered the oration at the re-opening of Freemasons' Hall in 1869.

In 1868 the Rev. THOMAS FITZARTHUR RAVENSHAW was Mr. Simpson's colleague. M.A. Oxon., Rector of Penzey, and distinguished as a botanist and a learned exponent of Gregorian music.

In 1869 the Rev. CHARLES JOHN MARTYN, M.A., served with Mr. Ravenshaw. He was of the Foundation Lodge, Cheltenham, and Curate of St. Luke's, Cheltenham. He was probably best known as Grand Superintendent for Suffolk from 1877 to 1901.

In 1870 a very popular Oxford tutor and oarsman, in the person of the Rev. WALTER F. SHORT, M.A., was associated with Mr. Martyn. He was Subwarden, Fellow, and Tutor of New College and P.M. of the Apollo University Lodge, which, as we shall see, contributed many names to the list of Grand Chaplains. I have noted thirty, and append a list kindly compiled by Bro. Darbishire.

In 1871 the Rev. Canon BROWNRIGG is the second Grand Chaplain, well known henceforward and still for his labours in Masonry and allied Orders. After long and honourable service as Secretary of the National Society he was made Dean of Bocking in 1903. His father, General Brownrigg, was P.G.W. and Prov.G.M. of Surrey.

In 1872, to Canon Brownrigg (the first Grand Chaplain by-the-bye who possessed that title) was added the Rev. ARTHUR BRUCE FRAZER, M.A., Cantab., Vicar of Haversham, Newport Pagnell, from 1856 to 1895.

In 1873 the Rev. PAUL BENT, M.A. Oxon., was installed as a colleague to Mr. Frazer. He was Vicar of Melchbourne, near Higham Ferrers. The *Freemason* unkindly remarks, "Bro. Bent, the new Grand Chaplain, is simply un homme inconnu." But in a later number we learn that he was in 1849 initiated in the Apollo Lodge No. 340, and became well-known in Norfolk, where he was Provincial Grand Chaplain in 1866. His father was in his 91st year when his son became Grand Chaplain, an old Peninsular officer who entered both the Army and the Craft at the very beginning of the century.

In 1874 Canon JAMES SIMPSON, D.C.L. (not LL.D. as in Calendar) became second Grand Chaplain. Long and well known as a Cumberland and Westmoreland Mason, initiated in No. 129 Union, Kendal, he had filled various Provincial offices. He was a scholar and prizeman at Durham University, Vicar of Kirkby Stephen and Hon. Canon of Carlisle. Author of pamphlets on Poor Law, Friendly Societies, Thrift, Antiquities, etc.

In 1875 to Canon Simpson was added the Rev. SPENCER ROBERT WIGRAM, M.A. Oxon., on the occasion of the Installation of the Prince of Wales as Grand Master. He was Vicar of Prittlewell, Provincial Grand Chaplain of Essex, P.M. and P.Z. No. 214, Hope and Unity, Romford, in which he was initiated.

In 1876 the Rev. CHARLES WILLIAM ARNOLD, M.A. Cantab, was second Grand Chaplain. He was Headmaster of the Royal Naval School at New Cross, and had been a Wrangler at Cambridge. Having held the headship of various educational establishments, he went to the American diocese of Florida in 1887.

In 1877 the second Grand Chaplain was the Rev. WILLIAM LAKE ONSLOW, M.A., Cantab., and later in the year, in December, the Rev. HENRY ADAIR PICKARD, M.A. Oxon., was added as a third. We go back to 1817 for a precedent for there being three Grand Chaplains. He was appointed in December in the place of the Rev. W. L. Onslow, who had died during his year of office, an incident which is unique. Bro. Pickard, an Oxford first-class man and Tutor of Christ Church from 1857 to 1864, was well known in the educational world as H.M. Inspector of Schools. Thrice W.M. of the Apollo University Lodge, amongst those he initiated were the late Earl of Lathom and others who rose very high in the Craft. On quitting office in the Apollo University Lodge he installed H.R.H. Prince Leopold as his successor, and he was also Chaplain when H.R.H. the Prince of Wales was W.M. As early as 1857 (six years after his initiation) he was appointed Prov.G.S.W., which shows in what high estimation he was held. Bro. Onslow was Rector of Sandringham, and a Fellow of the Royal Astronomical Society. A Chaplain in the Royal Navy from 1846, his last service afloat was in H.M.S. Ariadne in 1868-9, during the visit of the Prince and Princess of Wales to the East.

In 1878 with Mr. Pickard served the Rev. WILLIAM ALFRED HILL, M.A. Oxon., Vicar of Throwley, Kent, initiated in 1844 in the Lodge of Good Report No. 135. He was in turn Provincial Grand Chaplain of Worcestershire (1854) and of Kent (1860),

being presented at the Grand Festival at Canterbury in 1878 with a testimonial of money and plate in recognition of his long service. He was a barrister on the Oxford Circuit before ordination.

In 1879 the Rev. CHAS. WILLIAM SPENCER STANHOPE, M.A. Oxon., Vicar of Crowton, near Northwich, helped Mr. Hill. In the following year, in succession to Dean Purey-Cust, he became Deputy Grand Master of Berks and Bucks.

In 1880 Mr. Stanhope received a distinguished colleague, the Very Rev. ARTHUR P. PUREY-CUST, D.D. Oxon, Dean of York, the first Dean to be a Grand Chaplain, thereafter to be followed in his life-time by Dean Spence-Jones of Gloucester, Dean Hole of Rochester, Dean Lefroy of Norwich, Dean Leigh of Hereford, and Dean Ridgeway of Carlisle. Always an enthusiastic Mason, his interest is not abated in 1906, more than a quarter of a century after his appointment as Grand Chaplain. He has also served as Deputy Prov. Grand Master of Berks and Bucks.

In 1881 Dean Purey-Cust had the Rev. AMBROSE WILLIAM HALL, M.A. Cantab, late Rector of Debden, as a colleague. Initiated in the Surrey Lodge No. 416, he became Prov. Grand Chaplain of Surrey and of Middlesex.

In 1882 the Grand Chaplains were the Rev. THOMAS ROBINSON, M.A. Cantab., and Thomas Cochrane, M.A. Oxon, and now the custom of holding office for two years ceased. Bro. Robinson was Bell's University scholar at Cambridge, and after ordination spent twenty years in Jamaica. Initiated in the Scientific Lodge No. 88 (then 105) in 1841, he became its W.M. in 1843 and (apparently at once) the Prov. Grand Chaplain of Cambridgeshire. In 1874 he settled in Kent, and became Prov. Grand Senior Warden of Kent, and was most active in consecrating Lodges and Chapters. Bro. Cochrane, ordained in 1859, became in 1867 Rector of Stapleford Abbots in Essex. Initiated in the Apollo University Lodge, in 1867 he became W.M. of the Unity Lodge No. 567, Warwick; in 1877 of the Hope and Unity Lodge No. 215, Brentwood; and in 1878 of the Westminster and Keystone Lodge No. 10. In 1873 he became Prov. Grand Chaplain of Oxfordshire.

In 1883 the Grand Chaplains were the Rev. HERBERT GEORGE MORSE, M.A. Cantab, Rector of Littleham, Bideford, and the Rev. WILLIAM OSWELL THOMPSON, M.A. Oxon, Vicar of Hemel Hempstead. Bro. Morse was initiated in the Scientific Lodge No. 88, at Cambridge, by dispensation, as being not of full age. There were then not half-a-dozen undergraduate Masons, and therefore Bro. Morse helped to found the Isaac Newton University Lodge No. 859, and became its first Senior Warden, the Duke of St. Alban's being W.M. The next year he succeeded to the chair, and also was appointed Prov. Grand Senior Warden of Cambridgeshire. Bro. Thompson came from the Apollo University Lodge, and was its Senior Warden for two years and W.M. of the Churchill Lodge No. 478. He became Prov. Grand Chaplain for Oxfordshire, and subsequently for Berks and Bucks and for Hertfordshire. He was founder and first W.M. of the Lodge King Henry VIII. in Hemel Hempstead, of which parish he was Vicar.

In 1884 the Senior Grand Chaplain was Canon HENRY B. TRISTRAM, Hon. D.D. of Durham, LL.D. of Edinburgh, M.A. Oxon, F.R.S., author of many books on the topography and natural history of Palestine. His chief books were "The Great Sahara," "Land of Israel," "Natural History of the Bible," "Scenes in the East," "Daughters of Syria," "Seven Golden Candlesticks," "Bible Places of Palestine," "Land of Moab," "Fauna and Flora of Palestine," "Rambles in Japan," etc. Still Canon of Durham, he died in 1906, aged 83. For many years he was Deputy Prov. Grand Master of Durham, and Grand Superintendent in the Royal Arch.

The second Grand Chaplain was the Rev. JOHN ROBBINS, D.D. Oxon., Rector of Farmfield, and subsequently Vicar of Hemel Hempstead and of S. George's, Kensington. Initiated when a minor in the Apollo University Lodge he later joined the Westminster and Keystone Lodge No. 10, and also became founder and W.M. of the Canterbury Lodge No. 1635, Trinity College Lodge No. 1765, and Shadwell Clerke Lodge No. 1910. He was also Provincial Grand Chaplain of Middlesex.

1885. The Grand Chaplains were Canon PORTAL, M.A. Oxon., Rector of Burghclere, and the Rev. R. N. SANDERSON, M.A. Oxon., Rector of Wyverstone, and previously a master in Ipswich School, a scholar and Greek verse prizeman at Oxford. Canon Portal was initiated in the Apollo University Lodge in 1848, and two years later was its W.M., becoming in the same year Prov.G.J.W. of Oxfordshire. In 1855 we find him reviving the ancient Westminster and Keystone Lodge No. 10 as a London home for Masons from Oxford. Its muster roll then contained only five members—all Past Masters—and not a single initiate or joining member had been received for nearly ten years. He became its Secretary and W.M. in 1862. Though later beneficed in Hants and Prov. Grand Chaplain for Hampshire, he was a constant attendant at Grand Lodge. In 1856, when the Mark Grand Lodge was established he became its first Grand Chaplain. He was the founder of the large and useful National Deposit Friendly Society, an organization for the promotion of thrift and insurance.

Bro. Sanderson was initiated in the Moira Lodge No. 92 in 1856, but his Masonic career was chiefly in the Province of Suffolk in which he was Provincial Grand Chaplain from 1858 to 1865. Later he became W.M. of one Ipswich Lodge, Prince of Wales No. 959, and Chaplain of another, the British Union No. 114. He was seven times Z. of the Royal Alexandra Chapter No. 959, Ipswich.

In 1886 the Grand Chaplains were the Revs. JAMES NELSON PALMER, M.A. Oxon., Rector of Yaverland, Isle of Wight, and WILLIAM MORTIMER HEATH, M.A. Oxon., Rector of Lytchett Maltravers, since 1850. The former was initiated in the Apollo University Lodge in 1859, and in 1865 became Provincial Grand Chaplain of Oxfordshire. In 1869 we find him W.M. of the Ryde Lodge No. 698, and in 1870 Prov.G.S.W. of Hants and the Isle of Wight, and in 1880 W.M. of the Westminster and Keystone Lodge. Bro. Heath was initiated in 1863 in the St. Cuthberga Lodge No. 622 at Wimborne and became W.M. in 1867 and afterwards its Chaplain. In 1864-5 he was Provincial Grand Chaplain of Dorsetshire (though not an installed Master), and five years later Prov.G.S.W.

In 1887 there is a new departure, for in addition to the rank of Grand Chaplain being conferred in April on the Revs. THOMAS CARTWRIGHT SMYTH, D.D., Dublin, and LL.D., Cambridge, and GEORGE WARBURTON WELDON, M.A., Past Rank as Grand Chaplains was bestowed upon the Rev. RICHARD EVANS, M.A., Canon SAMUEL J. W. SANDERS, LL.D., FREDERICK VERNON BUSSELL, M.A., WILLIAM JOHN LYTE of Stradling, LL.M., and JOHN FAIRCLOUGH. Seven simultaneous Grand Chaplains, or, rather, that rank given to seven who had not received it before. The reason for this unprecedented step was that the Jubilee of Queen Victoria should be marked, and the appointments were made at a Special Meeting of Grand Lodge, held in the Royal Albert Hall, London, on Monday, June 13th. Mr. Evans represented the Herefordshire Province, of which he was Dep.Prov.G.M.; Canon Sanders, Northants and Hunts, being Chaplain of the Pomfret Lodge No. 360, Northampton; Mr. Bussell, Nottinghamshire; Fairclough, Burmah, where he became District G.M. in 1890; and Stradling, South Wales (Western Division), wherein he had served twice as Provincial Grand Chaplain and had also been Dep.Prov.G.M. He was initiated in 1860, in the Lodge of Perpetual

Friendship No. 135, and was thrice W.M. of St. David's Lodge No. 366. Coming back to the two stated Grand Chaplains for this year, Dr. T. Cartwright Smyth had an illustrious Masonic career in different parts of the world. Initiated in 1843 in the Royal Isle of Man Lodge No. 338, under the Grand Lodge of Scotland, he was ordained next year, and, joining Newcastle Lodges, he became Provincial Grand Chaplain of Northumberland. Appointed in 1849 to a Bengal Chaplaincy, he became District Grand Chaplain of Bengal and W.M. of Lodges in Agra and Mussorie. A renegade Brother having published an attack on the Craft, Bro. Cartwright Smyth so ably answered it that he was made S.G.W. of the District. He was active in his calling at Meerut during the Mutiny, and we next find him Dep. Dis. G.M. of the Eastern Archipelago, being stationed at Singapore, where he held concurrently, under dispensation, two Worshipful Masterships. Returning to England in 1867 he became Vicar of Far Headingley, Leeds, and Provincial Grand Chaplain of West Yorks. His colleague, the Rev. G. W. Weldon, was initiated in the Sphinx Lodge No. 1329, in 1871, and, after an absence from England, joined the Royal Somerset House and Inverness Lodge No. 4, of which he was W.M. in 1883. He died in 1889.

In 1888 the collars were given to the Rev. RICHARD WILLIAM MASSY POPE, D.D. Oxon, who had a long and varied career of usefulness at Oxford in many offices, including those of Proctor and Public Examiner; and the Rev. JOHN AUGUSTUS LLOYD, M.A. Oxon, Vicar of Broad Henton, Wilts. Dr. Pope was initiated in the Apollo University Lodge in 1868, by dispensation, at the age of 19, was Prov. J.G.D. of Oxfordshire in 1872, and Provincial Grand Chaplain in 1875 and 1876, in which latter year he was D.M. to H.R.H. Prince Leopold, W.M. of the Apollo University Lodge. He became W.M. of the Apollo University in 1887, and P.Prov. S.G.W. at the Jubilee. Bro. Lloyd was also initiated in the Apollo University Lodge in 1871, and became Provincial Grand Chaplain of Oxfordshire in 1874. We find him in Marlborough in 1881, and W.M. of the Lodge of Loyalty No. 1533, and thenceforward its Chaplain. Then at Corsham, Chaplain of the Lodge of Rectitude No. 335, since 1885. He was also Provincial Grand Chaplain of Wilts, in 1880, 1881 and 1886. Joining the Lodge of Honour No. 379, at Bath, he was elected W.M. in 1886, and in 1887 was appointed Provincial Grand Chaplain of Somersetshire. Chapter honours were also conferred on him in three different provinces.

In 1889 the Hon. and Rev. FRANCIS E. C. BYNG, M.A. Oxon, Vicar of St. Peter, South Kensington, Chaplain to the House of Commons, and Chaplain in Ordinary to the Queen, was invested. He became Earl of Strafford in 1889. He was initiated in the Apollo University Lodge in 1853. Joining the Canterbury Lodge No. 1635, he became its W.M. in due course, and was appointed Past G.W. of England at the Masonic celebration of the Queen's Jubilee. His colleague was the Rev. THOMAS BARTON SPENCER, M.A. Cantab, Vicar of St. James', Preston, who died in 1906, having held that benefice for twenty-five years. He was well-known at all important Masonic gatherings in Liverpool and West Lancs. Son of a doctor who was twice Mayor of Preston, he was initiated in the Lodge of Peace and Unity No. 314, Preston, in 1875; and was elected its W.M. in 1880. He also held high office in the Royal Arch.

In 1890 the Very Rev. EDWARD REID CURRIE, D.D. Oxon, Dean of Battle, was Grand Chaplain. Initiated in 1882, in the Union Lodge No. 38, Chichester, he was its W.M. in 1885, and Provincial Grand Chaplain of Sussex in 1883, 4, 5, 8 and 9. With him was the Rev. WILLIAM RANDALL, D.D. Dublin, Rector and Rural



Dean of Handsworth, Staffs. He was initiated in Ireland in 1844. Thirty years later he joined the Lodge of Light No. 468, Birmingham, and became its W.M. in the following year. In 1885 he was W.M. of St. James' Lodge No. 462, Handsworth. Provincial Grand Chaplain of Warwickshire in 1875, and of Staffordshire in 1879, he was S.G.W. of the latter Province in 1890. He died in 1901.

In 1891 the Grand Chaplains were the Rev. OLIVER JAMES GRACE, M.A. Cantab., who had been curate and then rector of Saunderton, Bucks, since 1856; and the Rev. HENRY LANDSDELL, D.D. Cantuar, Chaplain of Morden College, Blackheath, author of books descriptive of his travels in Russia, Siberia and Asia, and (in 1901) of the "Sacred Tenth," 2 vols., S.P.C.K. Masonically, the Rev. O. J. Grace was initiated in the Scientific Lodge No. 105 (now 88) Cambridge, and was thrice W.M. of the Buckingham Lodge No. 591. He also served as Provincial Grand Chaplain of the late Province of Berks and Bucks, and as its Prov.S.G.W. Dr. Landsdell was initiated in the Royal Somerset House and Inverness Lodge No. 4 in 1873, and became its Master in 1882. He was Provincial Grand Chaplain of Devonshire in 1876.

In 1892 the Rev. Sir WILLIAM VINCENT, Bart., M.A. Oxon., late Rector of Postwick, Norfolk, J.P. for three counties, came into office with the Rev. HENRY R. COOPER SMITH, D.D. Oxon., Vicar of Basingstoke. Sir William Vincent, born in 1834, was initiated in the Apollo University Lodge in 1855, and the following year served as Prov.G.Steward of Oxfordshire. Joining later the Lodge of Union, Norwich, No. 52, he was W.M. in 1887 and Provincial Grand Chaplain of Norfolk. Dr. Cooper Smith was also an Apollo University Lodge man, initiated by dispensation in 1871. Joining the Churchill Lodge in 1872 he was its W.M. in 1875 and received Provincial honours in 1873 and 1875. He became also Master of three London Lodges, University No. 1118, St. Mary Magdalen No. 1523, and Cholmeley No. 1731.

1893. The Rev. FREDERICK WILLIAM MACDONALD, M.A. Oxon., Vicar of Stapleford, Salisbury, was another Apollo University Lodge Mason, initiated in 1866. His first Mastership was in the Lodge of Honour, No. 379, Bath, in 1868. He was Provincial Grand Chaplain of Wilts in 1884 and 1891; of Somerset in 1889 and 1890; and of Oxfordshire in 1892. His colleague, the Rev. Prebendary RICHARD BULLOCK, M.A. Oxon., Vicar of Holy Trinity, Leeds, and Prebendary of Lincoln, was another Apollonian, initiated in 1859. In 1884 he was Provincial Grand Chaplain of West Yorks, and in 1890 and in 1891 W.M. of the Goderich Lodge No. 1211, Leeds. We may note that four consecutive Grand Chaplains all came from the same great Oxford Lodge, and further that this year not only the Grand Chaplains but also the J.G.W., one of the J.G.Deacons, the Grand Organist (and possibly other Grand Officers) all claimed Apollo University Lodge as their mother.

In 1894 the title "Archdeacon" first appears in the roll, the Venerable WILLIAM MACDONALD SINCLAIR, D.D. Oxon, Canon of St. Paul's and Archdeacon of London, Hon. Chaplain to the Queen, having been appointed. With him was a scholar of great renown, the Rev. Dr. HERBERT KYNASTON, D.D. Cantab, (Persian Scholar and Senior Classic.) Professor of Greek and Classical Literature in the University of Durham, formerly Principal of Cheltenham College. Archdeacon Sinclair was initiated in the Jerusalem Lodge No. 197, and afterwards joined the Universal Lodge No. 181, of which he was W.M. at the time of his appointment as Grand Chaplain. Dr. Kynaston was initiated in 1857 in the Scientific Lodge at Cambridge, P.M. of the Foundation Lodge No. 82, Cheltenham, and of the Universities' Lodge, Durham, No. 2352; he is also P.P.S.G.W. of Gloucestershire.

In 1895 a Bishop for the first time becomes Grand Chaplain in the person of the Right Rev. HENRY WARE, D.D. Cantab, Suffragan Bishop of Barrow-in-Furness, and formerly Archdeacon of Westmoreland. His colleague was another Church dignitary, the Very Rev. HENRY DONALD SPENCE, D.D. Cantab, Dean of Gloucester, author of the *Pulpit Commentary* (44 vols.) and other theological and historical works, well-known in London as for nine years Vicar and Rural Dean of St. Pancras. Bishop Ware was initiated in 1865 in the Underley Lodge No. 1074, Kirkby Lonsdale, and was its W.M. in 1872 and 1888. In 1869 he was Provincial Grand Chaplain of Cumberland and Westmoreland, and in 1873 Prov. G.J.W. in the same province. Dean Spence (afterwards Spence-Jones) was initiated in the Royal Gloucestershire Lodge No. 839, Gloucester, in 1888, and was W.M. of the St. Andrew's Lodge No. 222, at the time of his being made Grand Chaplain. In 1889 he was Provincial Grand Chaplain of Gloucestershire.

In 1896 the first diocesan Bishop becomes Grand Chaplain—the Right Rev. RICHARD LEWIS, D.D. Oxon, Bishop of Llandaff, Rector of Lampeter, Velfry, Pembrokeshire, for thirty-two years; he was also Archdeacon of St. David's from 1875 to 1883. He died in 1905. His colleague was the Ven. Archdeacon THOMAS STEVENS, D.D. Cantab, Vicar of St. John's, Stratford, and Archdeacon of Essex, who afterwards became Suffragan Bishop of Barking. The Bishop of Llandaff, born in 1821, was initiated in the Apollo University Lodge in 1843. Archdeacon Stevens was initiated in the Isaac Newton University Lodge, Cambridge, in 1861. In 1885 and 1886 he was Provincial Grand Chaplain of Essex.

In 1897 the Rev. THOMAS HOLE, D.D. Oxon, Dean of Rochester, an eminent preacher, lecturer and horticulturist, who had been Vicar of Cauntton, Notts, from 1850 to 1887, was appointed. His colleague was Canon CHARLES VENN CHILDE, LL.D. Cantab, lecturer and examiner in law at Cambridge, and Vicar of St. Mary's, Kilburn. Dean Hole, who died in 1904, was initiated in the Alfred Lodge No. 340, Oxford, in 1842, when the Duke of Sussex, grand uncle of our King and Protector, was Grand Master. Next year he joined the Apollo University Lodge. Dr. Childe's mother Lodge is the Isaac Newton, Cambridge, where he was initiated in 1871. In 1875 he was W.M. of the Lodge SS. Peter and Paul No. 1410, Newport Pagnell, and also Prov.G.Reg. of Berks and Bucks. In 1892 he was W.M. of the Foundation Lodge No. 82, Cheltenham, and in 1891 he served as Provincial Grand Chaplain of Gloucestershire.

In this year, 1897, following the precedent set in 1887, what was called the Diamond Jubilee of Queen Victoria was marked by the giving of Past Rank to six ecclesiastics as Past Grand Chaplains. At the Albert Hall meeting of Grand Lodge, on June 14th, the Rev. JOSEPH HENRY GRAY, M.A. Cantab, Fellow of Queen's College, and editor of various classical works, received Past Rank, representing the Province of Cambridgeshire; the Rev. Prebendary CHARLES JOHN RIDGEWAY, M.A. Oxon, Vicar of Christ Church, Lancaster Gate (and subsequently Dean of Carlisle), author of various devotional books, representing London; the Right Reverend CHARLES OWEN L. RILEY, D.D. Cantab, formerly Vicar of St. Paul's, Preston, Bishop of Perth, representing Western Australia; and the Rev. HENRY JAMES SPENCE-GRAY, M.A. Cantab, Chaplain of Leicester County Asylum, representing the Punjab District.

In addition to the sixty brethren to whom Past Rank was given, H.R.H. the M.W. Grand Master announced that he had also given Past Rank as Grand Chaplain to the Right Rev. GEORGE WYNDHAM KENNION, D.D. Oxon, Lord Bishop of Bath and Wells, and formerly Bishop of Adelaide. He was initiated in the St. Alban's Lodge at Adelaide, in which also Dr. Harmer the present Bishop of Rochester entered the Craft.

In 1898 the Very Rev. WATKIN HERBERT WILLIAMS, D.D. Oxon, Dean of St. Asaph, was appointed. In the following year he was consecrated Bishop of Bangor. With him was the Rev. BROOKE LAMBERT, M.A. and B.C.L. Oxon, Vicar of Greenwich, a man eminent for labours in connection with Poor Law administration and reform. He was Educational Secretary of the Social Science Association, member of the London University Extension Society, and served on Departmental Committees of Parliament, on Poor Law Schools and on Industrial Schools. He published "Sermons on Pauperism" and "Sermons on the "Lord's Prayer." He was initiated in the Marmion Lodge No. 1060, Tamworth (of which town he was then Vicar) in 1873, and became its W.M. five years later. In 1882 he was W.M. of the Alma Mater Lodge No. 1644, Birmingham. He was Provincial Grand Chaplain of Staffordshire in 1875. Moving to Greenwich he joined four London Lodges. He was Prov.G.Reg. in Royal Arch Masonry in 1878. The Dean of St. Asaph entered the Apollo University Lodge in 1868, and subsequently was W.M. of the Royal Denbigh Lodge, No. 1143, Denbigh, in 1883, Provincial Grand Chaplain of North Wales and Salop in 1883; he has also served as Prov. S.G.W. of the Province of North Wales.

In 1899 the Rev. WILLIAM GARDINER, M.A. and B.D. Oxon, Vicar of St. Mary's, Marlborough, and Rural Dean; and the Rev. F. BETHUNE N. NORMAN LEE, M.A. Cantab, Chaplain to the Forces from 1884, were the Grand Chaplains. The Rev. W. Gardiner began his Masonic life in the Apollo University Lodge in 1869, but his first occupancy of the chair of King Solomon seems to have been in 1892, when he ruled the Lodge of Loyalty No. 1533, Marlborough. He was however Prov. Grand Chaplain of Oxfordshire in 1872, and of Wilts in 1890. The year of his appointment as Grand Chaplain saw him also Prov. G. Registrar in R.A. Masonry.

The Rev. F. B. N. Norman Lee was initiated in Pentangle Lodge No. 1174, Chatham, in 1884. His first Mastership was in 1894, when he presided over the Virgin Lodge No. 3, Nova Scotia, and was also Grand Chaplain of Nova Scotia. In 1897 he was Prov. Grand Chaplain of Hants and the Isle of Wight.

In commemoration of this year being the twenty-fifth anniversary of the installation of Albert Edward, Prince of Wales, as Grand Master, Past Rank was conferred on twenty-five brethren, and amongst them were three who became Past Grand Chaplains. These were the Hon. and Very Rev. JAMES WENTWORTH LEIGH, Hon. M.A. Cantab, Dean of Hereford, formerly Vicar of Leamington, and Rector of St. Mary's, Bryanston Square, an enthusiastic temperance and social reformer, and an equally zealous Mason. In 1906 he became the R.W. Prov. Grand Master of Herefordshire. Other clerics who preceded him in a similar high honour were the Hon. and Rev. F. Egerton, Prov. G.M. of Salop in 1786, and Staffs. in 1791; Rev. W. Peters, of Lincolnshire, in 1792; Rev. S. S. Colman, of Norfolk, in 1810; Rev. G. A. Browne, of Cambridgeshire, in 1832, and of Hunts. in the same year; Rev. C. J. Ridley, of Oxfordshire, in 1844; Rev. E. C. Ogle, of Northumberland, in 1848; and Rev. J. Huyshe, of Devon, in 1866. The other two Past Grand Chaplains were the Rev. RICHARD PEEK, M.A. Cantab, Rector of Drewsteignton, Devon, and the Rev. EDWARD R. PARR, M.A. Dublin, Vicar of Chertsey.

In 1900 the Grand Chaplains were the Rev. FREDERICK MARTIN BURTON, LL.D. Cantab, Rector of Cowden and Domestic Chaplain to Lord de L'Isle and Dudley; and the Rev. HERBERT WILLIAM TURNER, M.A. Oxon, Rector of Sutton. Past Rank was conferred again this year in commemoration of the completion of the Grand Master's quarter of a century in office, and Canon GARRY, M.A. Oxon, Vicar of St. Mary's, Reading and Hon. Canon of Oxford, was made Past Grand Chaplain.

Dr. Burton was initiated in the Albany Lodge No. 151, Newport, Isle of Wight, in 1888. Chaplain of this Lodge, he became Prov. Grand Chaplain of Hants and the

Isle of Wight in 1889. Ten years later he was W.M. of the Cherwell Lodge No. 599, Banbury, and Prov. Grand Chaplain of Oxfordshire. The Rev. H. W. Turner was initiated in the Lorne Lodge No. 1347, Sutton, in 1879, and became its W.M. in 1888, being before Prov. Grand Chaplain of Surrey.

1901. The Rev. Sir BORRADAILE SAVORY, M.A. Cantab, Rector of St. Bartholomew, Smithfield, (in the restoration of which ancient church he long carried on what his predecessors began in the nineteenth century) and Chaplain of the Order of St. John of Jerusalem from 1890. He died in September, 1906. His father was a famous surgeon who received a baronetcy in recognition of his skill and knowledge. Initiated in the Rahere Lodge No. 2546, in 1895, he was W.M. in 1899 of the Methuen Lodge No. 631, Taplow, having been made Provincial Grand Chaplain of Buckinghamshire in the previous year.

With him was invested the Rev. WILLIAM CAMPBELL RILAND BEDFORD, M.A. Cantab. It is remarkable that his father held the same office in 1861 and 1862, and lived to see his son invested, being at that time the senior surviving Grand Chaplain and dying only in 1906. Bro. Bedford was initiated in the Warden Lodge No. 764, Sutton Coldfield, and became its W.M. in 1881. Three years later he was appointed Prov. S.G.W. of Warwickshire.

Past Rank was given this year to the Most Rev. J. E. C. WELLDON, D.D. Cantab, Metropolitan Bishop of Calcutta, formerly Head Master of Dulwich College and then of Harrow. Subsequently returning from India he became Canon of Westminster Abbey, and in 1906 was made Dean of Manchester.

He was the fifth bishop to be made Grand Chaplain, two other Grand Chaplains having been elevated to the episcopate after their year of office.

In 1902 the Rev. Canon WILLIAM QUENNEL, M.A. Oxon, Rector of Shenfield, Essex; and the Rev. DAVID BOWEN, B.A. Lampeter, Vicar of St. Nicholas, Monckton, Pembroke, were invested. Canon Quennell was initiated in the Lodge of Hope and Unity No. 214, Brentwood, in 1878, and installed as its W.M. in 1892. Joining the Berkhamstead Lodge No. 504, he ruled it in 1895. He is a Past Provincial Grand Chaplain of Essex and of Herts. Bro. Bowen was, when appointed Grand Chaplain, Dep.Prov.G.M. for South Wales (Western Division). Initiated in the Prince of Wales Lodge No. 671, Llanelly, in 1868, ten years later he became a founder and first W.M. of the Castlemartin Lodge No. 1748, Pembroke, remaining in the chair until 1880. He is a Past Provincial Grand Chaplain and P.Prov.G.W. of South Wales (Western Division).

In 1903 there were invested the Rev. DARRELL HOLED WEBB HORLOCK, M.A. Oxon, Curate in charge of Milton-under-Wychwood, Oxon; and the Rev. Chancellor HENRY MAHONEY DAVEY, M.A. Cantab, F.S.A., Vicar of Oving and Chancellor of Chichester Cathedral.

The former was initiated in the Apollo University Lodge in 1859. Eight years afterwards he joined the Bowyer Lodge No. 1036, Chipping Norton, and was its W.M. in 1869, in 1889, in 1890, and in 1898. Founder and first W.M. of the Thames Lodge No. 1895, Henley-on-Thames, he was installed for a second time in 1895. Again, in 1892, he helped to found the Wychwood Lodge No. 2414, Burford, and was its Master during its two first years. Twice also was he W.M. of the Dunheved Lodge No. 789, Launceston. His first chair as W.M. was, however, in 1866, when he helped to found the Kamloops Lodge in British Columbia. This is a remarkable record to have occupied a W.M.'s chair no less than eleven times. Amongst other honours in 1869, he was Prov.G.Reg. of Oxfordshire, and in 1877, Prov.S.G.W. of Cornwall.

Chancellor Davey was initiated in the Union Lodge No. 38, Chichester, in 1874, became its W.M. in 1879, and was Provincial Grand Chaplain of Sussex in 1877. In Royal Arch Masonry he has been Prov.G.J. and Prov.G. Second Principal H.

In 1904 we find the sixth Dean to hold office as Grand Chaplain in the person of the Very Rev. WILLIAM LEFROY, D.D. Dublin, Dean of Norwich, author of various theological works. His colleague was the Rev. JAMES HOLME PILKINGTON, M.A. Cantab (9th Wrangler), Rector of Framlingham, and late Fellow of Pembroke College, Cambridge. Dean Lefroy was a young Mason, having only been initiated in the Union Lodge No. 52, Norwich, in 1899. Joining the Norfolk Lodge No. 2852, he was installed as W.M. in 1903. In 1899 he became Provincial Grand Chaplain of Norfolk. Bro. Pilkington was initiated in the Lodge of Fidelity No. 555, Framlingham, in 1888, and became its W.M. ten years later. Provincial Grand Chaplain for Suffolk in 1892, Prov.S.G.W. in 1901, and Dep.Prov.G.M. in 1902, he has done much for the Craft in Suffolk. He has also held three high Provincial offices in R.A. Masonry.

Past Rank was also given this year to the Revs. AUGUSTUS JACKSON, M.A. Cantab, Vicar of all Saints, Perry Street, Northfleet; HENRY TELFORD HAYMAN, M.A. Cantab, Vicar of Edwinstowe, Newark; and CHARLES EDMUND ROBERTS, M.A. Oxon, of Tring.

In 1905 the Rev. SYLVANUS TAYLOR HINGSTON SAUNDERS, M.A. Oxon (where he obtained three first classes), M.Phys.Sc. of London, F.R.A.S., Mathematical Master in Merchant Taylor's School; and the Rev. VITRUVIUS PARTRIDGE WYATT, M.A. Cantab, Vicar of S. Leonard, Bedford, and for twenty years in the diocese of Brisbane, were the Grand Chaplains, while Past Rank was conferred on the Rev. Canon BEAUMONT, M.A. Oxon, Vicar of Holy Trinity, Coventry, Rural Dean, late Fellow of St. John's College, Oxford. The V.W. Bro. Saunders was initiated in the Yarborough Lodge No. 551, in 1878, and in 1884 was W.M. of the Sir Francis Burdett Lodge No. 1503. He was appointed Provincial Grand Chaplain of Middlesex in 1884, 1885, 1895 and 1896. V.W. Bro. Wyatt, initiated in the Sir Will Harpur Lodge No. 2343, in 1890, became its W.M. in 1896. In 1895 he was appointed Past Provincial Grand Chaplain of Bucks, and in 1904, Past Provincial Grand Chaplain of Bedfordshire.

In 1906 the Grand Chaplains were CANON HORSLEY, M.A. Oxon, Rector of St. Peter's, Walworth and Hon. Canon of Southwark Cathedral, at that time I.P.M. of the Quatuor Coronati Lodge and Chaplain for many years of the Saye and Sele Lodge, Belvedere, No. 1973, author of several books and many papers on various subjects, including some on Masonic subjects read before the Quatuor Coronati Lodge, which he joined in 1891, being elevated to its Inner Circle in 1896. He was initiated in the Pattison Lodge, Plumstead, No. 913, in 1891. His colleague was Prebendary INGRAM, M.A. Cantab, Rector, since 1882, of St. Margaret's, Lothbury, and previously for eighteen years Assistant Secretary, and Secretary of the Additional Curates' Society. He was initiated in the London School Board Lodge No. 2611, and became its W.M. He was also the first joining member of the Cathedral Lodge, and one of the founders of the Sanctuary Lodge No. 3051, and is also a member of the Alma Mater Lodge No. 1402, Cambridge. In 1904 he was Prov. Grand Chaplain for Cambridgeshire. This year a new departure was made by the appointment of two Assistant Grand Chaplains. They were the Rev. ARTHUR GEORGE GRISEWOOD, M.A. Oxon, Rector, from 1882, of Daylesford, Oxon, and the Rev. JOHN FARRINGTON DOWNES, M.A. Cantab, Chaplain of Chelsea Workhouse, the Cancer Hospital and other public institutions.

I am much indebted to Bro Darbishire, of Oxford, for the following list :

APOLLO UNIVERSITY LODGE No. 357, OXFORD  
GRAND CHAPLAINS.

			Year of Initiation or Joining Apollo Lodge.
1844	Rev. Sir J. W. Hayes, Bart.	Wadham	1819
*1859	Rev. W. H. W. Bowyer.	B.N.C. Lodge of Harmony 255.	1856
1861	Rev. W. K. R. Bedford	B.N.C.	1846
1863	Rev. John Huyshe	B.N.C.	1823
1865	Rev. John Sedgwick	Magdalen	1846
*1866	Rev. C. R. Davy	Balliol Royal Sussex Lodge 55.	1863
1868	Rev. T. F. A. T. Ravenshaw	Oriel	1851
1869	Rev. C. J. Martyn	Christ Church	1856
1871	Rev. W. F. Short	New College	1851
*1875	Rev. S. R. Wigram	Balliol Hope and Unity Lodge 214.	1880
1877	Rev. H. A. Pickard	Christ Church	1851
1879	Rev. C. W. Spencer Stanhope	Merton	1862
1880	Very Rev. A. P. Purey-Cust	B.N.C.	1848
1882	Rev. T. Cochrane	Oriel	1859
1883	Rev. W. O. Thompson	Exeter	1858
1884	Rev. H. B. Tristram	Lincoln	1844
„	Rev. J. Robbins	Christ Church	1852
1885	Rev. J. R. Portal	Christ Church	1848
1886	Rev. J. N. Palmer	St. John's	1859
1888	Rev. R. W. M. Pope	Worcester	1868
„	Rev. J. A. Lloyd	St. John's	1871
1889	Hon. and Rev. F. E. Byng	Christ Church	1853
1892	Rev. Sir W. Vincent, Bart.	Christ Church	1854
„	Rev. H. R. Cooper Smith	Magdalen	1871
1893	Rev. F. W. Macdonald	Queen's	1865
„	Rev. R. Bullock	Oriel	1859
1896	Rt. Rev. R. P. Lewis Bishop of Llandaff.	Worcester	1843
*1897	Very Rev. S. R. Hole	B.N.C. Alfred Lodge 340.	1843
1898	Rt. Rev. W. H. Williams Bishop of Bangor.	Christ Church	1868
1899	Rev. W. Gardiner	Exeter	1869
1903	Rev. D. H. W. Horlock	Wadham	1859

The names starred are those of joining members.

A hearty vote of thanks was unanimously passed to Bro. Horsley for his interesting paper, on the proposition of Bro. Armitage, seconded by Bro. E. L. Hawkins.

Bro. C. FRED. SILBERBAUER mentioned that one of the most interesting and valuable works written by Dr. Dodd was the "Beauties of Shakespeare," which appeared in the year 1751. The preface contains an apology for its publication, and an expression of his intention henceforth to devote his attention to better and more important things.

Bro. SADLER also took part in the discussion, and the SECRETARY read the following, from the original written by Dr. Dodd a couple of months before sentence was passed upon him.

Sr.

Having had occasion to write to Lady Chesterfield, I requested her Ladyship to be so kind, as to interest you in my Behalf. I am too well acquainted with your Humanity & Goodness, to doubt, that you feel for me in my sore & bitter Distress. And I flatter myself, that from some Circumstances in my Case, you may be inclin'd to pity and assist me. I have been—& indeed am rigidly & severely pursued!—But I humbly submit to Gods will; & most freely forgive all, who have thought it right to *press* me even unto Death!—I know, Sir, that as no man has the Heart, so no man has the Head & hand more capable to do me service: your Interest is great & extensive! For Mercy's sake, Good Sir, exert it, if you can for me!—There is a young Man, a Town's-man of mine, who with the most friendly assiduity has served me, like a Brother in all this Trouble—Mr. Hardwick of the Custom-House; If you be so condescending, He will wait your appointment any time to convey my sentiments on this melancholy affair, with every Circumstance of which & of my situation He is acquainted. & will be ready to give you, all necessary Information.

My unhappy and much afflicted partner, in much Distress & weakness of Body added to our other Calamities—desires most humbly to unite in every respectful Wish to yourself & your Lady—& I am

Sr.

yr truly afflicted &  
much obligd Sert.

W. DODD.

March. 30. 1777

*Bro. W. H. Hughan writes:*

I consider the list of Grand Chaplains compiled by the I.P.M. is both interesting and valuable, needing but a few additions, apparently, to make it practically complete. No doubt members can assist Canon Horsley as to details of a few not fully represented.

1815.—Rev. G. A. Browne was Provincial G.M., Camb., 1832, and of Hunts the same year.

1820-6.—The Rev. S. S. Colman was Provincial G.M., Norfolk, 1810.

1848.—Rev. J. E. Cox, D.D., was Editor of Spencer's most useful reprints of the "Old Constitutions," A.D., 1871.

1859-60.—Rev. W. H. W. Rowyer, S.C.L., was Grand Chaplain of the A. and A. Rite, 1865-1872.

1862.—Rev. John Huyshe, M.A., was a most enthusiastic Mason, and was initiated in the "Apollo," Oxford, 1822, W.M., No. 39, Exeter, Provincial J.G.W. of Devon, 1835, and several times since, obtaining the Senior Warden, 1839 and 1844, Deputy-Provincial G.M. from 1850 to 1866, when he became Provincial G.M.

On his retirement he was succeeded by the grandson of the second Earl of Fortescue, once Provincial G.M., who was invested by his immediate successor with the costly gold chain presented to him in 1866, which is an heirloom of the Province. Bro. Huyshe was also Grand Supt. of the R.A., Provincial G.M. of the Mark, and Provincial G. Com. of the K.T., and also D.G.M. of England for the latter degree. I gave his portrait and a memoir in my Devon and Cornwall Masonic Calendar, 1865, (J. H. R. Spry, Devonport).

1867.—W.M. 478 in 1858, and 1,224 in 1870-1-4, Deputy-Provincial G.M. Suffolk, 1878, and Grand Supt. of Suffolk, 1877, etc.

1867.—Rev. R. J. Simpson, M.A., was initiated in No. 97, Sunderland, 1849, and was Chaplain of the Lodge; W.M. No. 111, Darlington; Provincial G.Chap. and Provincial S.G.W. of Durham; Provincial G.Chap. of Berks and Bucks, etc. Delivered the oration at Foundation Stone Laying of the New Buildings of Freemasons' Hall, London, and whilst Rector of St. Clement Danes from 1870, became Founder and Chaplain of several Lodges, and Chaplain to No. 10, No. 176, etc. He was pre-eminently a peacemaker. I remember well in the debates in Grand Lodge, 1876-7, relative to the "German Question," and the return of H.R.H. the Prince of Wales from India (*re* Thanksgiving), what an important part was taken by the late Bro. Simpson, and how beautifully he bore victory or defeat. His son, Bro. John Percy Simpson, was recently admitted to full membership in our Lodge, and has done some good masonic work.

1869.—The Rev. C. J. Martyn, M.A., an Initiate of the "Apollo" (Oxon), in 1856, Prov. Sec., Oxfordshire, 1857, Prov.J.G.W., Gloucester.

1882.—My lamented friend, Rev. T. Robinson, M.A., was a learned and zealous Brother, and Prov. G.M. of Kent for the Mark Degree for many years.

1892.—Prebendary Bullock, M.A., is D.Prov.G.M. of Lincoln; the Rev. J. H. Grey, M.A., is D.Prov.G.M., of Cambridge; the Rev. H. T. Hayman, M.A., is D.Prov. G.M. of Notts; and the Rev. C. E. Roberts, M.A., is Prov.G.Sec., for Bucks.

---

*Bro. W. Watson writes:—*

The ground taken up by our distinguished brother is very extensive indeed, and the labour in bringing such a mass of data together simply enormous. The subject is, however, worthy of it, and I should like to suggest that instead of the paper appearing in our *Transactions* as it is intended to be read, that the learned Canon be invited to give the more extended information which he doubtless has acquired by research in the case of a number of Past Grand Chaplains, and to spread his paper over two or three numbers of the *Transactions*, thus keeping on permanent record in our archives a large amount of interesting information which may possibly be lost to the Craft of the present and the future. Of course, the Canon may have in mind doing something of the kind in a separate form, but still, as he has allowed us to taste of the dish, we should like to have the plateful for our Lodge first. I am thinking of one venerable and distinguished Past Grand Chaplain in particular, who will attain his *eighty-sixth* year on the 9th of December next, and who has been *sixty-three years a Freemason*. As an Indian Army Chaplain he not only faithfully performed the duties of his sacred office, but rendered splendid service to his country at Meerut when the Mutiny broke out.

As the Canon relates, he was a prominent authority on Freemasonry both as a writer and a ruler in the Craft, and up to that time had filled with great ability many offices in various degrees.



Coming to England in 1867 he settled in Leeds, where he still remains, his activity as a minister of religion and a zealous worker for Freemasonry continuing unabated until very recently. His wide circle of friends and admirers will be glad to learn that he is well on the way to recovery from a serious illness, with which he was lately seized.

In his lifetime I had also the privilege of knowing our lamented Bro. the Rev. A. F. A. Woodford, a Founder of No. 2076. He resided in the vicinity of Leeds, and was a member of Philanthropic Lodge No. 304 in that city. He was far and away the greatest authority we ever had in the province of West Yorkshire.

---

Bro. Archdeacon F. E. CLARKE then read the following paper :—

## NOTES ON SOME EIGHTEENTH CENTURY MASONIC DOCUMENTS.

BY R.W. VEN. ARCHDEACON CLARKE, LL.D., M.R.I.A., *etc.*,  
P.G.M. North Connaught.

---

WORSHIPFUL MASTER,



T affords me pleasure to lay before the Quatuor Coronati Lodge a series of thirty-six Certificates all dated within the eighteenth century. Most of them possess no features of external attractiveness, but many of them are of interest apart even from the antiquity of their origin.

The scarcity of Ancient Irish Certificates is well known, and their rarity was dealt with by our learned Brother Doctor Chetwode Crawley some three years ago in the "TRANSACTIONS," when he stated that he doubted whether any collection could boast of even half a dozen Irish Craft Certificates bearing dates prior to 1800. Of the series of Certificates, all belonging to the eighteenth century, which I have the honour to exhibit, one is a Lodge Certificate issued prior to the introduction of "Grand Lodge Certificates," or at any rate to their coming into general use. Two others come nearly under the same category, and five are Grand Lodge Certificates. I propose taking them in chronological order and making a few observations, either singly or in groups, as circumstances may suggest, and I will be as brief as possible.

No. I.—This Certificate I have already referred to. It was issued by Lodge No. 338 of Boyle, and runs as follows :—

We, the undernamed Master and Wardens of the Town of Boyle Lodge No. 338

Do certify that the bearer, Brother "Brian Gillooly" is a regular registered Mason in said Lodge, and always behaved as such. Given under our hand and seal of office this 8th day of January, 1760, and in Masonry 5762.

To all whom it may concern,

(Secretary) Bernard Murray.

(Master) John Whelan.

(Wardens) { Thomas Jaques.  
William Russel.

Thus the Certificate belonged to the reign of George II., and is only three years later than the American Certificate of General Corson Smith, of Chicago, and it is older

than either of the two specimens of certificates prior to Grand Lodge Certificates figured in facsimile in Doctor Crawley's work.

In some old Minutes of Lodge No. 338, which unfortunately have not been preserved so far back as 1760, I find Brother Gillooly, to whom this Certificate was granted, did not then finally leave the Lodge, as he became Worshipful Master in 1775, and his name appears in 1777 and 1779, and it is interesting to remark that John Whelan, who signed the old Certificate as Master, as also Thomas Jaques and William Russel as Wardens, appear on the records for many years, and very frequently as holding the higher offices. Curious, at this period the prefix of Mr. seems to be put in the minutes to the name of whoever acted as Master. Bernard Murray, who signed as Secretary, continued so for many years, and the hand writing of the Certificate and of the Minutes is identical. The seal on the Certificate is undecipherable, the wax being badly cracked and broken, but it overlies a double ribbon, blue and orange. If Brother Crawley was correct in his assumption of 1903 (I doubt not the accuracy of that very erudite Masonic critic), and that no earlier Certificate has been discovered since he wrote, this Certificate which I possess and now exhibit would seem to be the earliest extant in Great Britain and Ireland, being one hundred and forty-six years old on the 8th of last January. It is written on thick parchment, and is prior to the general issue of Grand Lodge Certificates, and of considerable antiquarian interest.

No. II.—This certificate is also Manuscript but on thinner parchment, issued by Lodge 530 in Sligo on the 6th May, 1778, a year remarkable for the death of the great Earl of Chatham and the loss of America. It is as follows, and has a very distinct seal (bearing Lodge No. 530 Sligo with dexter Hand and Trowel), "To all whom it May Concern. We do certify that Brother William West is a regular registered Master Mason in the Lodge No. 530, and has during his stay with us behaved himself as an honest Brother. Given under our hands & seal of our Lodge in Sligo the 6th day of May 1778 in Masonry 5778.

Thos. Russel (secretary)

John Tyler (Master)

John Bawett (Senior Warden)

Phil Cox (Junior Warden)."

This would appear to be a clearance certificate, as in the margin thereof it is endorsed "admitted on the 11th day of June 1777, declared off on the 6th day of May 1778"—The words "*honest Brother*" are quaint but significant, I have met with the same phraseology on several old Certificates of a Manuscript form, and the same appears in the last issue of our *Transactions*.

No. III.—Is a Manuscript, on paper, with the seal attached and blue ribbon, dated 12th September, 1783, from "Sion Lodge No. 3 held in His Majesty's 57th Regiment of foot under the Registry of New York." This is interesting as belonging to an English Regiment, under American Registration, in the year of the "Treaty of Versailles," when the Independence of the United States was universally recognised. At the top of the Certificate are the words "And the darkness comprehended it not." "In the East a place of Light where reigns Silence and Peace."

No. IV.—A Grand Lodge of Ireland Certificate of Lodge No. 338 Boyle, dated 10th May, 1785, signed Nich<sup>s</sup> Gay, Grand Secretary, and Thomas Corker, Deputy Grand Secretary.

It is in Latin as well as English, and there is evidence of its having borne a seal which has fallen off. The signature of the recipient is at the head of the document on the English side, but there is no NE VARIETUR.

No. V.—A Manuscript dated 4th June, 1785, from No. 3 Lodge, St. Patricks, “held in the City of Quebec in North America under the Provincial Grand Lodge warranted from the Grand Lodge of England.” There is no reference to the 57th Regiment, nor is the Lodge Sion referred to, but it bears the same motto as my New York Certificate (No. 3), and also seal on a blue ribbon. The seal is oval, with well defined Masonic Symbols, whereas that on the former Certificate is undecipherable, but circular, and consequently not the same seal. Which Grand Lodge of England is it that is referred to? I imagine the *Ancients*.

No. VI.—Another Grand Lodge of Ireland Certificate, dated 1788, presented to me by the widow of the grandson of the recipient, who himself bore the same name. The site of the Seal is perfect, and, to a certain extent, indented and enveloped with tongued-cut paper; It is signed Fran Fetherston, Grand Secretary, and Thomas Corker, Deputy Grand Secretary, but there is no *NE VARIETUR* Signature. The Degrees were given in No. 568, held in Tobercurry, County Sligo, in my Province of North Connaught, where for many years past there has been no Lodge.

No. VII.—A most beautiful Certificate, and so far as I know unique; it is dated 1789, on parchment, printed both in English and Latin, issued to the same Brother “Randle Peyton” as the last described. It is peculiar from being of such a composite character as to Certify to the following Degrees having been conferred, viz., Entered Apprentice, Fellow Craft, Master and Past Master, Sublime Degree of Excellent, Super Excellent, Royal Arch and Most Sublime Degree of High Knights Templar. As such he was recommended by the GRAND LODGE OF HIGH KNIGHTS TEMPLAR, held in Boyle (as the Certificate designates it). “To all the sublime Lodges and Brethren who understand the Angle and Squares of Three by Three.” It continues, “Blessed be the name of those who shall be in any wise useful to him, may they be recorded in the Book of the Celestial Grand Lodge.”

Between the English and Latin there are blue, red and black bands of ribbon, referring to the Craft, Capitular and Knights Templar Grades, and it bears the three Seals appertaining to each respectively. It is signed William Peyton, E.G.M. (I believe, a relative of the recipient), and evidently designated Eminent or Excellent Grand Master.

Patrick McDonogh, S.W., Hugh Sweeny, J.W. and S. (I presume for Secretary), and last of all the signature of recipient. This remarkable document is almost one hundred and seventeen years in existence. I have the pleasure to be able to exhibit two blank forms of the same Certificate, but none of the three are absolutely identical with the other. They each have 17..., showing that they were for eighteenth century use, and they must have gone far back in the century when there was necessity for three editions to be issued by a Masonic body in a small town in the West of Ireland. But on the other hand it must be recollected that the number of Lodges and Brethren was throughout Ireland much greater one hundred years ago than now. Before passing on I would draw attention to the peculiar dedication of the document, viz.:—To the enlightened Free and Accepted Masons, by the SEVENTY TWO, the Salutation of Peace, Love and Harmony.

This Brother was evidently permitted to pass the chair (nominally), the year of his Initiation, or the year after, to qualify for the Royal Arch, such then being necessary.

This accounts for Past Master being amongst the enumerated Degrees.

No. VIII.—A Grand Lodge of Ireland Certificate, dated 26th of June, 1789, signed by John Stanford, Grand Secretary (who I believe to have been of the same family as the great composer, Charles Villiers Stanford), and Thomas Corker, Deputy Grand Secretary. This Certificate emanated from Lodge No. 209, then in Dublin; the recipient, John Fry, signed his name at the head of the document; I had the pleasure of being acquainted with his grandson, a very zealous Mason only lately deceased, and his great grandson is at present a member of the Order in my Province. The Seal has gone and the *Ns VARIETUR* does not appear.

No. IX.—Is a certificate from Cork Lodge No. 95, dated October, 1790, manuscript; two Seals one on blue ribbon the other impressed on the Parchment.

Nos. X., XI. and XII.—Are Military Certificates; number ten from No. 295 Lodge, of the 1st Horse, then at Carlow; and numbers eleven and twelve from Lodge No. 85 on the registry of Ireland, but assembled at Liverpool. These three Certificates are all dated 1792, and the two Liverpool documents evidently act as Grand Lodge Certificates, because it is specified in each that the holder was Just and Lawfully Entered Apprentice, passed Fellow of Craft and raised Master Mason.

Nos. XIII., XIV. and XV.—Are Lodge Certificates dated 1793, from No. 274, held in the Royal Irish Regiment of Artillery; No. 523 at SIX-MILE-CROSS, in County Tyrone, and No. 179 held in His Majesty's 12th Regiment of Light Dragoons in Bandon. It is interesting to remark Masonry being so actively carried on in the Army in Ireland during that very disturbed period, the closing years of the eighteenth century.

No. XVI.—Is parchment manuscript, dated May, 1795, and certifies from Lodge, No. 156, Kinsale, that the holder was regularly entered, passed and raised to the sublime degree of Master Mason. It bears a wax seal on blue ribbon.

No. XVII.—From Lodge 509 in the small village of Crossakill in Meath; a clearance certificate dated April, 1795; no Lodge has sat there for many years.

No. XVIII. and XIX.—Are both on parchment and appear to have been engrossed by a skilled penman. The one is distinctively a Royal Arch Certificate; it commences "We the Royal Master and High Priest, etc., etc., of the Royal Encampment or Grand Council of the Nation of Royal Arch Super-Excellent Masons, held under the sanction of Lodge, No. 607, in the Town of Kells on the Registry of Ireland. It is signed under the 'Hands and Seal of our Grand Chapter' on the 16th October, 1795, and of Royal Arch SUPER-EXCELLENT MASONRY, 3795. This latter is worth observation. The ribbon which bore the seal has evidently been cut out.

The other one is a distinctly Knight Templar certificate, the recipient being the same as the former, only two days different in date, viz., 14th October, 1795, and strange that it should precede the Royal Arch, being the inverse order always found in Ireland. (I would regard this as the error of the scribe, and that the Royal Arch Certificate should have been the fourteenth, and the Knight's Templar the sixteenth, a very possible clerical error to have occurred.) This Certificate testifies to the holder being a Knight Templar, also a member of "The Order of St. John of Jerusalem, now Knights of Malta."

The year, 1795, is stated to be of the order of Knights Templars, 3795, and of the Order of Malta, 677; it has a large black ribbon bearing a triangular seal with Templar symbols. These are VERY EARLY DISTINCTIVE Royal Arch and Knights Templar Certificates. As usually at that period, 1795, these degrees were coupled with the craft, and separate Certificates are rare (1795).

Nos. XX. to XXX. inclusive.—Are all dated 1797, remarkable for the battle of “St. Vincent,” and preceding the Irish Rebellion. Five of these are Lodge Craft Certificates, and six of them what are now called Clearance Certificates.

Five of them are signed in Bandon, two in Cork, one each in Sligo, Manor-Hamilton, Limerick, and Kinsale. The Limerick Certificate emanates from the Royal Tyrone Regiment of Militia, and is a printed form, very neatly got up with spaces for names and dates. Some of these Certificates are signed by the holder on the back, and almost all are military and from the south of Ireland, where so many regiments were engaged in service at the time.

No. XXXI.—Is a Grand Lodge of Ireland certificate of Lodge 854, which formerly belonged to the Leitrim Militia regiment, and now is located in Carrick-on-Shannon in the same county. It is similar to the other Grand Lodge Certificates, dated 1799, the year noted for the battle of Seringapatam and the defeat of Buonaparte at Acre by Sir Sydney Smith. The seal of the Certificate is gone, it has no *NE VARIETUR*, nor did the recipient sign. The Grand Secretary at the time was *George G. Irvine*.

No. XXXII.—Is a Lodge Certificate from No. 495 held in the South Cork Regiment of Militia, but at the time (January 2nd, 1799) sitting in Enniscorthy in the County Wexford, doubtless on duty there against the insurgents who had been defeated a few months before at “Vinegar Hill” in the same County. In the margin of the Certificate it is recorded that the holder, Thomas Church, *joyned* November 16th, 1794. It is signed by John Roner (Master), John Goldsmith (Senior Warden), Richard Fetherston (Junior Warden) and Thomas Healy (Secretary). Church is a Leitrim and Roscommon name; likewise Healy; and Goldsmith was, up to a few years ago, a Roscommon name; and if these Brethren were Connaught men, as I imagine, serving with the South Corks, I am almost certain that the Senior Warden belonged to the family of the great Irish Poet, who was born about half a mile from Elphin Cathedral, with which I am connected, and in my own Masonic Province. The blue ribbon, with wax seal attached, is perfect, and there is also an impressed Seal of the Lodge.

No. XXXIII.—Is a Lodge Certificate from 744 “Carrigallin.” The Lodge Seal spells it *Carrigallan*, but the body of the Certificate *CARRIGALLINE*. It is a small village in the County of Leitrim, and for years no Lodge has sat there. The seal and ribbon are perfect, the latter very faded; date, 1st May, 1800.

No. XXXIV.—Is similar to the one preceding from Lodge No. 767, held in “Cloon” in the County of Leitrim, where now there is no Lodge.

No. XXXV.—Is a Grand Lodge Certificate, but a different issue from the previous Grand Lodge Certificates in this collection. The place where the seal was affixed is at the foot instead of at the head, and the figures on the columns are somewhat different. The words *NE VARIETUR* are in the margin at the foot of the line-space where the recipient “Robert Armstrong” signed his name. The Degrees had been conferred in Lodge No. 413 Bandon; G. D. Irvine was the Grand Secretary signing, but strange to say I see no similarity in his signature to that of the Certificate of the year before. A. SETON was now the Deputy Grand Secretary in the room of “Thomas Corker” so long in office. It is dated 23rd March, 1800. All the Grand Lodge of Ireland Certificates that I have exhibited (that is FIVE) of the 18th Century are both in Latin and English, but the 1800 Certificate is the first to have the words *NE VARIETUR* where the Grantee was expected to sign.

No. XXXVI.—Is a Lodge Certificate from Lodge No. 552, Monaghan Regiment of Militia, sitting in Sligo. It is neatly printed in clear distinct type having the Arms of England with the motto “*Dieu et Mon Droit*” at the top. Wax seal on blue ribbon and the Lodge impressed seal as well; it is dated 10th December, 1800, exactly twenty-one days before the Act of Parliamentary Union between Great Britain and Ireland took effect. This is the last of my series of 36 Certificates of the eighteenth century, but I crave a minute or two longer to lay before my brethren two other eighteenth century documents. One is an original receipt for Grand Lodge dues payable by Lodge No. 338, Boyle, for the year 1776, as follows:—“Received from Brother “Pat Feely Master of Lodge N<sup>o</sup> 338 one P<sup>d</sup> English in full for Grand Lodge Dues to the “27<sup>th</sup> day of December last. Dublin the 12<sup>th</sup> day of August 1777.

“£1 . 1 . 8

Tho<sup>s</sup> Corker, D.G.Sec.

“I also received two shillings Eng<sup>sh</sup> for regestring Bro<sup>s</sup>. Correstine & Jowin to said “No. 338

“£0 . 2 . 2

Tho<sup>s</sup> Corker.”

This shows the rate of Grand Lodge dues at the period payable by country Lodges, viz., £1 a year and one shilling for registration of brethren. Also the difference in currency is noted between Ireland and England, an Irish shilling being nominally worth thirteen pence by a proclamation of 1689. The document is neatly printed with blanks and I should say cut out or torn out of a book of such forms. Perforation was unknown for seventy-one years after, the invention of Mr. Henry Archer in 1848. The other document is a copy of an address presented to George III. by the Grand Lodge of Scotland, subsequent to an attempt made upon his Majesty's life by a hostile rabble on October 29th, 1795, when he was proceeding to open Parliament. It was a period of a very inflamed condition of society. The document reads as follows:—

“The humble address of the Right Hon<sup>ble</sup> and most Worshipful, ‘William, Earl of Ancrum,’ Grand Master Mason of Scotland.

“‘Francis Lord Viscount Doune,’ Deputy Grand Master

“‘Thomas Hay, Esq<sup>re</sup>,’ Substitute Grand Master

“Sir James Foulis of Collington, Burt.

“Andrew Houston, Esq<sup>re</sup>, of Jordonhill } Grand Wardens

with the Brethren in Grand Lodge assembled on the anniversary of St. Andrew.

“We, your Majesty's most dutiful subjects, the Grand Lodge of Scotland, humbly request permission to approach your Majesty with the most sincere expressions of that attachment and loyalty for which our ancient and respectable order has ever been distinguished.

“Your Majesty's late deliverance from the hands of wicket and sanguinary men, while it recalls to us the recollection of your Majesty's Virtues, impresses us with gratitude to that providential care which, by watching over your Majesty's life, has averted the Most alarming calamities from your people.

“We have on this occasion witnessed the interposition of Heaven for the safety of your Royal Person, that it may never cease to extend its guardian protection to your Majesty and to your illustrious house is our united prayer.

“Signed by appointment and in our presence when in Grand Lodge assembled, this 30th day of November, One Thousand Seven Hundred and Ninety-five.”

W.M. and Brethren, I trust that the spirit of Loyalty to the Throne and Constitution expressed in this document of One hundred and eleven years ago, may never be extinguished from our hearts.

GOD SAVE THE KING.

---

A hearty vote of thanks was passed to Bro. Clarke for the interesting paper and exhibits, and comments were added by the W.M., the S.W. and Bro. J. T. Thorp.

---

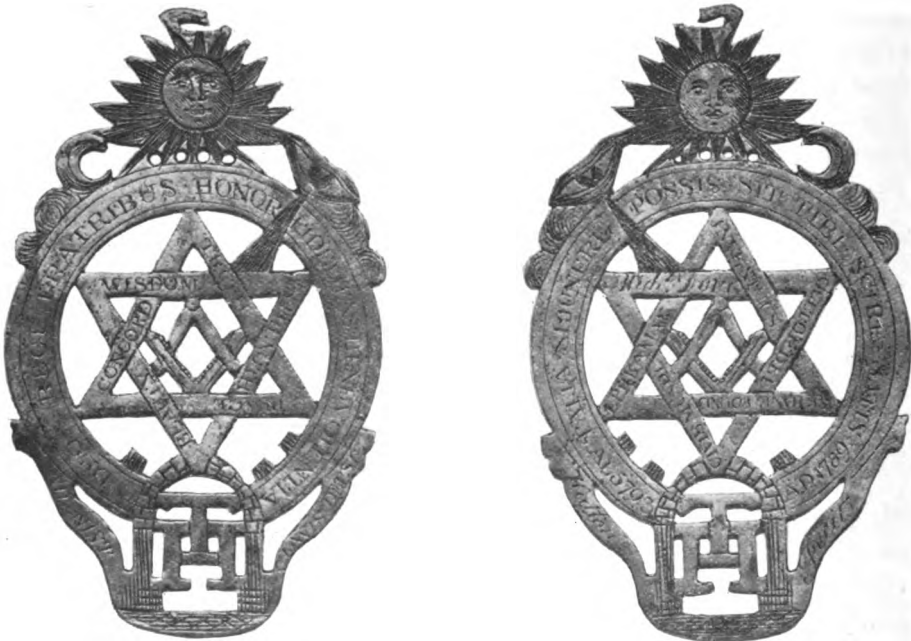

JEWEL IN THE POSSESSION OF BRO. F. G. SWINDEN.

## ENQUIRY INTO THE CHARGE OF GNOSTICISM BROUGHT AGAINST THE FREEMASONS AND TEMPLARS.

BY BRO. E. J. CASTLE, K.C., P.M.

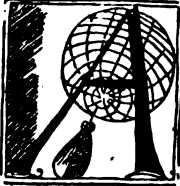

ABOUT the beginning of the last century considerable excitement was raised in the literary world by discoveries of hidden signs and symbols alleged to have been found in certain churches and cathedrals, which in the opinion of the discoverers, pointed to the heresy and, as some averred, depravity, of the builders of those edifices.

These charges principally affected the Freemasons and the Knights Templars. Owing to the former not keeping written records we have not the same opportunity of enquiring into their case as we have in that of the Templars, who have left considerable information behind them. Instead of everything being oral and traditional, as was the case with the Masons, we have very clear documentary evidence of the Proceedings, the Rule, and the Mode of Reception of the Templars. But it was said that these were only on the surface, and that there was a hidden cult below—a cult supposed to be based upon the heresies of the Gnostics. From this an inference was drawn that the Templars were guilty not only of such heresies, but also of the depravity and other crimes which were assumed to be practised by that sect.

These theories have been refuted before. Still they have crept into the literature on the subject, and we find writers, even in modern days, directly or indirectly referring to them as if they were more or less true. As a member of the Society of Lawyers, who are the successors of the Knights of the Temple, the author has from time to time considered the question of the truth of these accusations, and the result has been the following article, which shows that in his opinion there is an entire want of proof to support them.

Mr. Hallam tells us in a note to his first volume of his book on the Middle Ages that, "Up to the beginning of the nineteenth century, it seems to have been generally admitted that the Knights Templars had been unjustly persecuted by Philip the Fair, and that the Order was innocent of the charges brought against it. About the commencement of that century, however, a new light was supposed to be thrown on the question by an essay, written by Hammer Purgstall, a distinguished Oriental scholar, who produced what he stated was evidence that the Templars were Gnostics," etc.

Von Hammer's essay produced a great sensation. It is to be found in the proceedings of a society of amateurs, published in Vienna, called "Mines de l'Orient." Von Hammer's suggestions seem to have been very much discussed; to some he was a great discoverer, to some he was an enthusiast who had made a great mistake, and there were some who, as we shall see, like Hallam, remained in doubt.

Writers, like Raynouard, based their belief in the Templars' innocence, on the circumstances of the case. Raynouard urged that Philip the Fair and his party stood alone in their condemnation of the unhappy knights, that it was the King's interests that prompted him to secure the abolition of the Order so as to enjoy its vast wealth and possessions. Dr. Milman, in his history of Latin Christianity, unhesitatingly expressed the strongest belief in their innocence, basing his belief, as so many must do, on the



gross improbability of any large body of men leading such a common life of depravity as was imputed to the Templars. Some writers and thinkers tried to compromise the matter, by suggesting that some might be bad, others good. But Philip's great accusation was that the Order was in its corporate capacity bad, that is to say, it was part of the regulations of the Order (*de punctis ordinis*) that the blasphemous denial and the insult of the Cross were to take place at each Initiation or Reception, and Hallam, as will be seen, speaking of this suggestion, that some might be bad and some good, says such a compromise means an acquittal of the Order. There was another writer, Edward Clarkson, who in 1838 wrote an essay on a work edited by R. B. Billings, on the Temple Church, where he professed to find "visible to the eye and palpable to the touch," signs and symbols which supported the view of Von Hammer that the Templars were heretics.

Matters seem to have remained in this condition till about the middle of the century, when M. Michelet, the French historian, edited the *Procès des Templiers*. This was a copy of the depositions taken before the Papal Commissioners, in 1309-1311. The first volume was published in 1841. Michelet, in his preface to this volume, expresses no opinion of the guilt or innocence of the Templars. He only gives an account of the document, the desirability of publishing it, etc. He had previously written in his History of France on the side of the Templars, but it appears that during the publication of the first volume he came to the conclusion that they were guilty, for reasons which he gives. It is, of course, a very serious decision, when a person of the reputation and ability of M. Michelet, on the perusal of the original notes, taken day by day by responsible but indifferent persons, at the time of the examination, came to the conclusion that he must reverse his previously formed opinions and decide against those whose innocence he had before supported. Everyone feels that such an opinion must be of great weight, and too much importance can hardly be given to it. In his preface to the *Second Volume* he says: "What one is about to read, which we only know up to now imperfectly, is of a nature to modify in many respects the hypothesis we have made in vol. iii. of the History of France in favour of the Order of the Temple. For whatever opinion one adopts about the Rule of the Templars, and the primitive innocence of the Order, it is not difficult to come to a decision (*d'arrêter un jugement*) on the disorders of its last years (*de son dernier âge*), disorders similar to those of other religious Orders. It is sufficient to observe in the enquiries, which we publish, *that the denials are nearly always identical*, as if they were dictated following an agreed formula, *that on the contrary the avowals are all different*, varied with special circumstances, often very naive, which give them a special character of truth. The contrary ought to be found, if the avowals were dictated, or the result of torture; they would be in a great degree alike, the differences rather found in the denials."

The italics are M. Michelet's. But, as I have the presumption to differ entirely with him, it may seem more right if I give what he actually said in his own words, of which mine are but a free translation.

After saying he is waiting for some important documents before giving a general introduction, he continues:—"Celles qu'on va lire et qui ne nous étaient connues jusqu'ici qu'imparfaitement sont de nature à modifier sous plusieurs rapports les hypothèses que nous avons émises au tome III. de notre *Histoire de France* en faveur de l'ordre du Temple.

Du reste, quelque opinion qu'on adopte sur la règle des Templiers, et l'innocence primitive de l'ordre, il n'est pas difficile d'arrêter un jugement sur les désordres de son dernier âge, désordres analogues à ceux d'autres ordres religieux. Il suffit de remarquer

dans les interrogatoires que nous publions *que les dénégations sont presque toutes identiques*, comme si elles étaient dictées d'après un formulaire convenue, *qu'au contraire les aveux sont tous différents* variés de circonstances spéciales, souvent très naïves que lui donnent un caractère particulier de véracité, le contraire devrait avoir lieu, si les aveux avaient été dictés ou arrachés par les tortures ; ils seraient à peu près semblables, et la diversité se trouverait plutôt dans les dénégations."

Besides the statement of Von Hammer and this adverse opinion of Michelet, we have the following views expressed by Hallam. In his *Middle Ages*, vol. i., p. 137, he says, in 1848, in a note, that he had not made mention of the Knights Templars in dealing with the reign of Philip, as when he first attended to the subject, almost forty years since, he could not satisfy his mind on the disputed problem, etc., and that notwithstanding all that had been published on the subject, he was perhaps not even then more prepared to give an absolute determinate judgment than at first. It is clear from this statement that Hallam (writing in 1848, that forty years before he could not satisfy his mind, that is in 1808, before Von Hammer wrote, which was in 1818) doubted before he heard of this new evidence, which may account for the weight he gives to it as confirming his original view.

He then goes on to say, "The general consent of popular writers in the eighteenth century was in favour of the innocence of the Templars, in England it would have been absurd, paradoxical, to doubt it," and gives as the reason the unprincipled character of Philip, the incredulity of the charges from their monstrousness, the just prejudice against confessions obtained by torture, etc. He gives the writers who thought the Templars innocent, but mentions Michelet's adverse opinion, and then says:—"But the great change that has been made in this process, as carried forward before the tribunal of public opinion from age to age, is owing to the production of fresh evidence," and then mentions that the deeply learned Orientalist, M. Von Hammer, now Count Hammer Purgstall, has published a work in Vienna, in 1818, in which he has inserted an essay "designed to establish the identity of the idolatry ascribed to the Templars with that of the ancient Gnostic sects, and especially with those denominated Orphites or worshippers of the serpent, and to prove also that extreme impurity which forms one of the revolting and hardly credible charges adduced by Philip as similar in all its details to the practice of the Gnostics."

Hallam then states what he considers to be the effect of Von Hammer's contention, viz., the identity of certain Gnostic degrees, idols or amulets, with the description of what are called Baphometric in the proceedings against the Templars (presumably the *Procès*), which, he says, is sufficient of itself to raise a considerable presumption, i.e., he says, "we find the word *mētis* continually on those images of which Von Hammer is able to describe twenty-four. Baphomet is a secret word ascribed to the Templars. But the more important evidence is that furnished by comparison of sculpture extant on some Gnostic and Orphitic tombs with those in the Churches built by the Templars." Hallam then mentions that we find (in Churches) images and symbols concealed from the common observer, extremely obscene, etc. He also mentions that the Gnostic emblems exhibit a peculiar form of cross T, and this is common in the Churches built by the Templars, etc.

On the other side, Hallam, as already referred to says, "some have endeavoured to steer a middle course, and discrediting the charges brought generally against the Order, have admitted that both the vice and the irreligion were truly attributed to a great number. But," he says, "this is not at all the question ; and such a pretended compromise is nothing less than an acquittal. The whole accusations which destroyed

the Order of the Temple relate to its secret rites, and to the mode of initiation. If these were not stained by the most infamous turpitude, the unhappy Knights perished innocently, and the guilt of their death lies at the door of Philip the Fair."

This reference to the Freemasons arises from the fact that Von Hammer includes them in his accusation of Gnosticism. Hallam says earlier that the Freemasons, or that society of architects to whom we owe so many splendid Churches, do not escape Von Hammer's ill opinion any better than the Templars, as he states that, "though he conceives them to be of earlier origin, they had drunk at the same foul spring of impious and impure Gnosticism;" and Hallam then quotes what Hammer says of them, that "being initiated in the middle ages in all the mysteries of the most depraved Gnosticism they delighted (*se plaisaient*) in multiplying symbols, outside and within their Churches, of which the true meaning was only understood by the adepts, and remained veiled to the eyes of the profane."

The statement that it was the architects, or Freemasons, who put these symbols within and without the Churches they built, seems completely to exonerate the Templars in respect of the alleged marks in their Churches, unless it could be shown that they knew of and authorised them. Why should the Templars be more guilty than the Monks, who authorised the building of our Cathedrals? In fact the latter were more liable to know what was going on, as many of the Monks acted as architects, but the Templars were soldiers.

There is no doubt that there are many features or ornaments in architecture, that those who are learned on these matters consider have a veiled and sometimes impure meaning. There is a well known moulding which is considered to be a remnant of Phallic worship. There are, no doubt, hidden away matters that are repugnant to our modern notions, but these are attributed to the mischief and audacity of individual workmen, who thought it amusing and clever to place these kinds of decorations where they were not likely to be seen. There is in the Temple Church a Monk with a little devil holding his ear. Gurgoyles are often fashioned as devils, and one can understand indecent representations being made, without accusing the whole body of worshippers of having "drunk at the foul spring of impious and impure Gnosticism."

But before discussing this matter further it may be as well, as Hallam seems to accept at least in part Hammer's evidence, to see what that "deeply learned Orientalist" does say.

The essay or treatise by Von Hammer, was written at the commencement of the nineteenth century. It is in Latin, and is, comparatively speaking, a rare book. A copy of it is to be found in the Oriental room of the British Museum. The effect of its being difficult of access is that many modern writers have accepted its statements at second-hand, and an impression has been conveyed from one author to another that Gnosticism did not die in the third century, but survived up to the fourteenth, and that the Templars, owing to their connections with the East, had been imbued with Gnosticism, and all the vices imputed to the Gnostics; and so the idea got "in the air," as some one expresses it, and a belief grew up that there might be some foundation for the idea that the Templars were Gnostics and impure, a belief difficult for the ordinary reader to test, owing to the inaccessibility of Von Hammer's work. And even when one sits down to read it the difficulty is not removed.

The case put forward by Von Hammer rested upon two descriptions of evidence. The first was that of certain coins, vases, etc., which he came across, I believe, in the cabinet of some collector. These he considered to be the work of the Templars, and to have a Gnostic meaning. There is a large page filled with engravings of these coins

given in his essay. The second class of evidence was the alleged presence in the Churches built by the Templars of certain marks, symbols and monuments which, he says, were also Gnostic. Some of these were said to be obscene, some were occult and only to be understood by the initiated.

The appearance of this essay by Von Hammer provoked considerable opposition. Hallam says :—"The novel evidence furnished by sculpture against the Templars has not been universally received. It was early refuted, or attempted to be refuted, by Raynouard and other French writers." "Il est reconnu aujourd'hui même en Allemagne," says M. Chambrure, editor of the *Règles et Statuts Secrets des Templiers*, "que le prétendu culte baphometique n'est qu'une chimère de ce savant fondée sur une erreur de numismatique et d'architectonographie." And Mr. King, in his "History of the Gnostics," says, speaking of the coins, etc., which Von Hammer said were Gnostic, and the work of the Templars, "There is one point sufficient to upset all Von Hammer's elaborate structure, the Arabic legends being cut in current Neski character betray their modern manufacture. For had they been contemporary with the flourishing times of the Templars, the primitive Cufa, as a matter of course, would have been used." He also points out that the figures Von Hammer tries to interpret as Gnostic idols are copies of the Roman Jupiter, Hercules-Silenus, etc., classical types entirely unknown to the cult of the twelfth or thirteenth centuries, and his conclusion is that the Arabic lettering on the vases, upon which Von Hammer so much relies, "shew them to be a portion of the paraphernalia of those Rosicrucians or alchemist quacks who fattened upon that arch virtuoso, Rudolph."

I think it may be said that no one with any idea of judicial fairness would express any opinion upon the value of this class of evidence without having the particular monuments, marks, symbols, etc., pointed out, in order to see how far they support the theory that the Templars were Gnostics and depraved. But, as this is impossible, the theory may be dealt with in another way. It is not necessary to see whether Von Hammer's facts are right if it can be shown that his conclusions are and must be wrong. As already stated, Mr. Hallam says that "Von Hammer's essay is designed to establish the identity of the idolatry ascribed to the Templars, with that of the ancient Gnostic sects, and especially with those denominated Orphites, or worshippers of the serpent, and to prove also that extreme impurity, which forms one of the revolting and hardly credible charges."

Here are two charges, one of Idolatry and the other of Depravity. But the Templars were never charged with Idolatry. There was one woman, I believe, who said something about a cat that talked, which she said she saw through a crack. This was in England. And there was some talk about a head in France, the mystery of which was cleared up. But the Templars were really charged with insulting the Second Person of the Trinity; that was the substantial charge, nothing to do with Gnosticism. This was pressed home with all the force of the ecclesiastical mind, determined by hook or by crook to get a confession. And it took the form of the denial of the Saviour and spitting on the cross, which all who wished to earn freedom and escape torture were obliged to confess they had been induced to do, though they were allowed a compromise, and to say, "They denied with their mouth, not mind, and did not spit on the cross, but near." This is their continuous parrot-like reply, as one by one they came before the Pope's examiner. To the questions about denying, they said "Sed ore non mente," and to the spitting "Non supra sed juxta." To my mind it seems clear that these knights and serving brethren after holding out between five and six years, to get their liberty were willing to say they had done what they knew they had not, but would not do

so without insisting upon these saving clauses. This agreement in form Michelet seems to think a proof of their guilt, but to me it seems a strong corroboration of their innocence.

In England, it may be remarked, Edward II. at first refused to believe the charges, and wrote himself, on their behalf, to the King of Portugal. For a time he resisted the Pope's wish that he should arrest the Templars, as had been done in France. But finally he gave way, and the Knights were seized and kept in custody till Philip and Clement had settled their dispute about Boniface, and arranged that if Clement sacrificed the Templars Philip would not press his charges against the deceased Pope. The Pope kindly sent over two Inquisitors to teach the English how to torture them. But no such admissions were obtained as in France, nothing like the denial, or the insult to the cross. As for the alleged depravity, no one seems to have thought of it. How could it be so, when it was the case of English gentlemen judging the conduct of other English gentlemen, their relatives and friends. It is true that a question was put by the French:—Why, if there was nothing wrong in your Chapters, were the proceedings secret? "On account of our folly," was the celebrated reply of Himbert Bancke, "*propter stultitiam.*" The result seems to have been that all the English Templars would admit, or of which they were found guilty, was, that the head of a Chapter sometimes gave absolution, even when he was not a priest. It seems that according to a practice that appears to be followed up to the present day in religious Orders, each member had to confess his faults before the Chapter, the juniors in order do so first and receiving their penance, leave, etc. It appears after these confessions, in the case of the Knights Templars, the Priest, if there were one, gave a general absolution for those offences, and any others that the Knights might not have chosen to confess: and, if there were no Priest then the head of the Chapter gave it. The defence of the Templars about this charge was that the absolution given by a Templar not a Priest was not intended to absolve from sins, but military offences, which it was for him to punish or pardon. Be this as it may, the English Templars, no doubt, finding the Order was doomed, seemed to have been willing to admit this was an offence, and it was for this, and this only, that the Order was suppressed in England.

But, to return to the French, the difficulty is to see how the evidence that the Templars were Gnostics and Orphite worshippers proves that they denied our Saviour and insulted his Cross, which was what they were charged with, or proves their depravity. When we come to see what Gnosticism was, it will be evident that there is no relation between it and the charges brought against the Templars; though it may be said that, if the Templars were Gnostics (neither Philip the Fair nor the Grand Inquisitors of France knew anything of their being so, and it was left to Von Hammer to discover the fact), they were unfit to continue as an Order which professed Catholicism and invited devout Catholics to bring themselves and their property, to swell their numbers and increase their wealth.

But then comes the next question, *i.e.*, supposing that these marks, symbols, etc., found in the Temple Churches were Gnostic, does that afford any proof that the Templars were themselves Gnostics? Even if these marks were confined to the Temple Churches, which is not so, as we shall see, there appears to be no evidence that the Templars knew of their existence, any more than the world generally did, till Von Hammer discovered them, or thought he did.

I have already pointed out that Hammer says, in more than one place, that the Architects, or Freemasons, were Gnostics, and that they were earlier than the Templars,

and "were in the habit of multiplying these symbols, within and without the Churches, of which the true meaning was only understood by the adepts."

It is possible, therefore, that the Temple Churches might have been ornamented with these symbols, without there being a proof that the Templars were either a party to this being so, or were adepts who understood the true meaning of these symbols. Mr. King, in his work on the Gnostics, says that Mr. Clarkson, in his article on the Temple Church in London, "endeavours to prove the Manicheism of the Templars by means of architectural evidence deduced from the Members of the Edifice, and the geometrical relations discoverable on the ground plan, but dispassionately considered, these are of little weight, inasmuch as they could be found, if looked for, under a similar prepossession in many other buildings, both mediæval and modern, having no connection whatever with the brethren of the Temple." And subsequently the same author, speaking of Von Hammer, says "But as for the obscene sculptures taken from the Temple Churches, which he refers to the rites of the Venus Mascula celebrated therein, these are to be found in equal abundance and shamelessness amongst the carvings of other Churches, notably at Cercueil, near Paris." These he attributes either to "some moral grossly expressed, according to the taste of their barbaric age, the censure of some particular vice, or may be no more than the ebullition of the brutal humour of the beery artist."

These indecencies, to which Hallam makes allusion, are therefore not peculiar to the Templars. And whether they are taken as symbols, of which the true meaning is only known to the adepts, the gross illustrations of moral truths, or the work of the indecent artist, work which is to be found in Indian Temples and in Pompeian houses, there is no proof that the Templars knew or approved of them. On this point dates are material. The Order was founded in 1117. The Templars were arrested in 1307. The Temple Church, in London, was consecrated in 1185. If the architects put in these Gnostic symbols in 1185, can that be a proof that the Templars were rightly condemned for Gnosticism and the alleged consequent depravity, in 1307? The supposition is that they, the Templars, were originally good soldiers and catholics, but had of late years fallen away. But if there is anything in the architectural evidence, they must have been Gnostics, etc., before the year 1185. So that for 130 years at least, the Order had been steeped in this life of heresy and depravity before being found out. This may have been so, but it makes the accusation the more improbable. It is difficult to believe that such an existence could have lasted so long unexposed.

Von Hammer's proof depends not only upon the conclusions he has drawn from his alleged facts about the Temple Church, but upon the coins and vases already mentioned. But experts say he is wrong here also. He has brought forward one matter, upon which he relies as proving his theory, with which I and the reader can properly deal. It is from the fact that, as some of the monuments (four out of nine) in the Temple Church have their feet resting on an animal, dog, bear or leopard, as the case may be, he is entitled to say the Templars were Gnostics, and therefore guilty of the charges brought against them.

It must be remembered that Hallam, Von Hammer and others, seem to take for granted that Gnosticism and depravity are convertible terms, so that if the Templars were Gnostics they were depraved; this point will be considered later. At present, in order to understand Von Hammer's contention, it is necessary to refer to what Gnosticism was supposed to be. According to Mr. King and other writers on the subject, it appears that though the accounts we have of the early Gnostics come from their enemies, Christian and Jewish writers, Gnosticism was by no means a debased or depraved

religion, but a great advance on Pagan mythology, and seems to have been an attempt to incorporate the religion of the Jews with that of the Greeks. It was a great advance on the old beliefs in the gods of Olympus, as it was based upon a spiritual idea of a Deity. But it was perhaps to the Jew, and later on to the Christian, more blasphemous and objectionable than the old mythology, as while it approached their religious beliefs, the creation of this world was attributed not to the Supreme God of the Universe but to an inferior deity or demiurgos. It is supposed by some that this new religion existed before the Nativity, or at least was flourishing before Christianity was well known. From the low artistic qualities displayed in the seals, etc., of which specimens are given in Mr. King's work, it seems clear that they are not the work of the Greeks. Primitive men seem to have soon been divided into those who can draw and those who cannot. There are carvings on trees by Neolithic man of animals almost worthy of Landseer. There are South Sea Island idols which are rude and ugly, not even grotesque. The Gnostic seals seem to be worthy of the South Sea Islanders. It is said that the principal home of Gnosticism was in Syria, and that one Barsanes, who dated from about A.D. 150, was the chief prophet. As far as is known Gnosticism died out by the end of the third century. If it survived for a little longer in Syria it was not known to the rest of the world, and every trace of it must have expired under the fierce armies of Mahommed.

Some writers say that St. Paul himself in his later Epistles shewed that he was acquainted with the tenets of Gnosticism. It is supposed that no longer satisfied with their old pagan mythology the Gnostics turned to the Jews. But as Sir Walter Scott and others have pointed out, the Gods of an old religion often become the devils of a new one; Deus and Devil are derived from the same root. The Gnostics looking at the many vices and other imperfections which they saw, or thought they saw in this world, conceived that they could improve upon the Jewish religion by believing the creation of the world was not the work of the supreme deity whom they called Sophia, the highest Wisdom sometimes named Achamet, and that this world's creator was only the son of Sophia, or a still more inferior demiurgos, or Eon, the emanation of the third or fourth degree from the Divine Sophia. This demiurgos was known as the God of this World, or the God of Sabaoth, or by the Gnostic name of Jaldabroath.

The Gnostics also took the story of the Serpent tempting Eve, and again apparently desiring to improve upon the old religion of the Jews they turned the story round. They made the Serpent the good genius of mankind, leading him to Sophia the higher wisdom and teaching the knowledge of good and evil; and Jaldabroath was made the evil adviser who was keeping man from wisdom. The Orphites held that man could only arrive at perfection by overcoming Jaldabroath, whom they represented as a lion, dragon, bear, dog, etc., by the help of the serpent; hence their name.

This appears to be the commonly accepted view of what the tenets of the Gnostics were, but as stated, anything known about them is derived principally from the statements of their enemies the Jews and Early Christians. But it is a question whether it is fair to deal with this question from the point of view of the Jew or Christian, but whether we should not consider it as an attempt, apart from revelation, to account for the difficulty of the existence of evil, misery and misfortune. At all events there seems nothing in these tenets which would lead us to suspect that the Gnostics of the first three centuries were guilty of the depraved crimes which Hammer and others seem to attribute to them as a matter of course. I do not know whether they were so accused by their cotemporaries, but if they were it was probably due to the power of the Catholic priests who knew that the Asiatics in those days and before, did not look with

the same horror upon those vices which—to her credit be it said—the Roman Catholic Church taught the Modern World to look, and Gnosticism being the creation of the East, the Catholics may not have hesitated in their determination to crush Gnosticism to impute to its members that they universally practised such vices. In the same way, in later times, they either accused or allowed the people to think that the Jews sacrificed Christian infants at the Passover. It is difficult otherwise to account for the Gnostics being picked out from all other religions as being depraved, and guilty not as individuals but universally as a body. But Gnosticism was stamped out within the first three centuries or so of the Christian era, and except from the suggestion of Von Hammer there has been no revival of the idea of an inferior Eon creating this world, either before the Templars or since. On the contrary, Mahomedanism has chosen a religion which says there is no God but one God. And this has been accepted as we know by a large part of the human race, and if the Templars took their heresy from the Saracens they might have become Deists, not Gnostics, which is more opposed to the one God of Mahomed than even it is to the Trinity of Christianity.

But to return to Von Hammer. His work is very learned, and he relies a great deal upon the alleged Gnostic doctrine that man if he wishes to reach perfection has to overcome Jaldabaoth, who is represented under the form of some animal. Hammer therefore assumes that any illustration, in sculpture or otherwise, where a man is represented as killing or overcoming some animal, is a Gnostic emblem.

For instance, in one example he gives, a man is about to strike an animal on the head in a manner resembling the figure in Raphael's cartoon, where a sacrifice is being prepared to St. Paul and Barnabas. Hammer says this is a Gnostic emblem. He also says that about the time of the institution of the Order of the Temple the "Dragon" was taken from the Gnostics, and the story made part of the life of St. George, and the two together, though without the child, were adopted by the English.<sup>1</sup> This, for reasons to be shortly given, seems an admission against his own views. For it is said that it was the Templars who introduced St. George to England. That having found that he was the Knight of soldiers with the Saracens, they adopted him as their warrior saint. Hammer also says that the figures in the Temple Church, which have their feet upon a dragon, leopard, etc., in some cases piercing the same with their sword, are all examples of Gnosticism, which proves the Templars to be Gnostics, and therefore, is his weak *sequitur*, were guilty of the same vices as, he says, the original Gnostics were charged with. But Hammer thinks otherwise; he says, "here is the dragon which the Templars carved on their tombs in the Temple at London trampled under foot."<sup>2</sup> The ordinary explanation, I believe, is that when an effigy has the feet trampling on the leopard, etc, it was to show that the deceased had served against the infidels.

It seems difficult to understand Mr. Hallam's belief in this kind of evidence. It is by no means uncommon to find tombs with recumbent figures, with their feet sometimes resting on a cushion, sometimes on an animal. The author of an article, called "Animals at Church," in the *Windsor Magazine* for March, 1902, has given several examples. He says the favourite creature to be portrayed in such places and circumstances is, first, the dog, and next, the lion, and in Bedale Church, North Yorkshire, Fitzallan, Earl of Arundale, has his feet resting on a lion, and his wife by his side has her feet on a dog. But, alas for Gnosticism, the dog is supposed to be the favourite

<sup>1</sup> Hic denique idem est draco, qui tempore institutionis Militiæ patrum templi ex commentis Gnosticis in vitam Sancti Georgii ac cum eo sed sine infantâ in insignia Britannia transit.

<sup>2</sup> Hic est draco quem Templarii eorum sepulchris inscripta in Templo Londiniensis conculcant.



spaniel of the lady, and the lion is the crest of the Howard family, to which the earldom belongs. This author gives other examples, and says that the dog is chosen because he is a friend of man, and the lion, because in the Scriptures he is the model of power and sovereignty. In the Temple Church, as stated, there are nine recumbent Knights, four of them have their feet on an animal, five have not. Is the converse of what Von Hammer says true? If so these five were not Gnostics. There can be little doubt that if looked for many examples might be found where the feet are on the dog, lion, etc., and that these examples are to be found subsequently to the abolition of the Templars. Why should the Templars alone be stigmatized with being Gnostics?

Von Hammer, it may be remembered, mentions St. George and the Dragon, and says that the latter was introduced into the life of the Saint, at the time of the institution of the Templars, and it was also introduced into the English emblems. The "George" was, it is said, given by Edward III. to his newly-made Knights of the Garter. If this Order had been destroyed, and now only existed as a historical memory, what distinction could Von Hammer draw between the Templars using monuments, which he considers Gnostic, and the Knights of the Garter, who use the "George."

But is he right in saying the dragon was the production of the Templars, or at least of their times. Von Hammer has so impressed his views on English authors that they seem to take what he says for truth, and we find Mrs. Jameson, in her "History of Legendary Art," says that "it is generally considered that the George and the Dragon are of Arian or Gnostic origin," though she contradicts this, by saying "The legend of St. George comes to us from the East, where, under various forms, as Apollo and the Python, as Bellerophon and the Minerva, as Perseus and the sea monster, we see perpetually recurring the mythic allegory, by which was figured the conquest achieved by beneficent power over the tyranny of wickedness, and appears in Christian art as the legend of St. Michael and half a hundred other Saints. At an early period we find this time consecrated myth transplanted into Christendom, and assuming by degrees a peculiar colouring in conformity with the spirit of a mediæval and religious age, until the classical demigod appears before us transformed into that doughty slayer, the slayer and redresser of human wrongs."

There is not much connection between this view and that which Von Hammer says comes from "drinking at the impure and unholy font of Gnosticism." That the George and the Dragon represents the struggle of man with Jaldabroath is, therefore, only Von Hammer's idea. The rest of the world accepts it as of classical origin, taken from Perseus and Andromeda, representing the victory of right over wrong, of good over wickedness. Mrs. Jameson, forgetting all about the Gnostics, says that the mediæval Catholics embodied the same idea in their representation of St. Michael, and half a hundred other saints. And in Larousse we find under the title of St. George:—

"D'anciennes peintures grecques le représentaient même perçant ce monstre, dragon ou crocodile, à coups de lance et monté sur un cheval culle, épisode qui paraît une reconnaissance de Perse mythologique."

We have not the dates of these ancient Greek painters. But Larousse informs us that the St. George and the Dragon are to be found on Byzantine coins, given by Du Cange, in his "Famous Byzantines," all of which seem to prove that St. George and the Dragon was not the invention of the Templars.

This shews that Von Hammer, when he implied that the dragon was the creation of the Templars, or their times, was only saying what suited his theory, but without any foundation for such statement. There is not much distinction in the ideas intended to be conveyed by the "George," and the archangel, St. Michael, who is generally

represented standing armed, setting his foot on Lucifer, either on the half-human or the dragon form, about to transfix him with his lance or to chain him down in the infernal abyss. Such Mrs. Jameson says "is the most frequent and popular representation of St. Michael when placed before us as the universally received emblem of the great victory of good over evil," vol. i., p. 66.

It seems, therefore, that from early classical times there has been an expression of the triumph of good over evil in the Apollo and the Python, Perseus and Andromeda, the George and the Dragon, St. Michael and Lucifer, etc., as the world believed till Von Hammer gave a different interpretation on the recumbent figures trampling on the dog or lion. But Von Hammer has no right to make exceptions. If there is a mystery or unholy meaning in one case, why not in the other. He has no right to treat the Templars differently from others. Mrs. Jameson quotes from the Psalms (xcii., 13), "the young lion and the dragon shalt thou trample underfoot." One wonders how far Von Hammer would carry his theory. If the trampling on an animal, etc., is a proof of Gnosticism, then the Jews might be charged with being Gnostics, for Moses lifted up the serpent in the wilderness, and David spoke of trampling the dragon; the ancient Greeks and Romans, because of their representations of Apollo and the Python, and of Perseus and the Monster; the Mediæval Catholics, because of the pictures, etc., of the Archangel Michael and Lucifer; the Knights of the Garter for using the George; and in fact the whole English people, for using coins with the George and Dragon.

But it may be said that Von Hammer does not rely upon one proof, he has several, and, as Hallam puts it, the multiplicity of examples increases the probability. The answer is, Von Hammer does bring forward other proofs, but they have all been answered more effectually than I have tried to answer his statement about the trampling effigies of recumbent Templars in the Temple Church. The question of the coins and vases with their modern lettering are shewn not to be the work of the Templars. Hallam quotes this as having been said by M. Chambrure, and Mr. King in his history of Gnostics, repeats, as we have seen, that marks, indecent and otherwise, are found in other Churches, and Von Hammer himself says it was the practice of the Architects to put them. Then there is the alleged worship by the Templars of a cat. Many old women in England we know have been burnt as witches, and have been supposed to have had a guardian in the shape of a black cat. It is true some such silly charges were brought against the Templars, and were, I believe, treated by the Pope's Commissioners with the contempt they deserved. The cat was supposed to speak and advise the Templars. Von Hammer makes also a great point of a beast called baphomet, which charge was also gone into at the enquiry before the Commissioners. The reader, as to these, is referred to the account of this enquiry.

There is another emblem which Von Hammer says is to be found in the Temple Churches, to which Hallam also refers, and that is the tau T called the *crux truncata*. This, according to Hammer, is an emblem of fearful import, for it is a decapitated cross, the god-head removed, and all sorts of terrible ideas are imputed to its use. Hallam says: "The presumption of course from the absolute identity of many emblems in churches with the Gnostic superstition in the worst form grows stronger and stronger by multiplication of instances, and though coincidence might be credible in one, it becomes unfortunately impossible in so many. One may be mentioned, though among the slightest resemblances, the Gnostic emblems exhibit a peculiar form of cross T, and this is common in the churches built by the Templars."

But no one that I have heard mentions the finding of a T in the Temple Church in London: of course an upright supporting a horizontal is one of the commonest and

most necessary features in architecture. Any pillar that supports a beam gives the T; so does a workman's hammer or a navvy's pickaxe, and therefore one would require some definite proof, to shew that this particular emblem was intended. I shall shortly have to refer to an essay on the Temple Church, by Edward Clarkson, who amongst all his wild—and it seems to me reckless and absurd—theories makes no mention of anything justifying Hallam's statement that this is common in Temple Churches. Whether it is to be found in other Temple Churches I know not, but if it had been in the Temple in London who put it there? if the architects, then it was put in 1185; was the congregation, who were supposed to have recently fallen away, responsible one hundred and thirty years after? If the time should come when Europe has lost her civilization and her cities are in ruins, would a deeply learned Occidentalist (to wit, Macaulay's New Zealander) be justified in assuming that the congregation of Notre Dame were devil worshippers because he found devils or demons used as gargoyles?

Mr. King says these emblems or marks are found universally in churches not built by the Templars, particularly at Cercueil. He says, however, gross as some of them may be they often represent some moral idea according to the rude manner of the times, though in some cases they may be due to the beery workman.

We need not press this point: but every one knows that there are many Temples in India, many houses in Pompeii, many walls in our great cities, with drawings, etc., as Montaigne has remarked, and founded a curious argument upon which need not be further referred to.

But there appears to be a more complete answer to the charge of Gnosticism, one that goes to the root of the whole matter, and that, already referred to, is:—Gnosticism died out in the first three centuries of our era, and the world had not heard of it for a thousand years when the Templars were suppressed.

Michelet takes this view, and while condemning the Templars upon the view he takes of the evidence given to the Papal examiners in 1309-11, says this seems clearly established. Mr. King, who with others, is tainted with Von Hammer's views, says the latter is mistaken in considering the Templars were Orphites, the form of Gnosticism imputed to them, as that ceased to be known in the first three centuries when the civil as well as the religious arms put down Gnosticism. Since then there is no historical evidence of its revival, there are no buildings left, no marks nor evidences of persecution, nor as far as I can learn any mention made by any writer of Gnosticism as a living religion or heresy; and it is not likely that there would be. Gnosticism was a very peculiar form of belief, *sui generis*, and, as far as I know, having no sympathy or similarity with any other of the world's religions. Degrading the "Creator of this world" to a second place is a tenet unknown to any other religion before or after the comparatively short life of Gnosticism.

The followers of Von Hammer have therefore invented a further theory. The Templars were not Gnostics but Manichees, and in order to bring this view into harmony with Von Hammer, they speak of Manicheism as being the form in which Gnosticism survived at least down to the times of the Templars.

But this change of front will not do. It must be remembered that Von Hammer brings the charge of Gnosticism as supporting the view that the Templars were guilty of the depravity with which it is said they were accused by Philip, and Hallam, as stated, takes this view. Now both he and Von Hammer are to be taken as knowing the distinction between Gnosticism and Manicheism, and that speaking of the first they did not mean the second. In addition to the fact that Manicheism has nothing in common with Gnosticism and is a different religion with a different origin, Gnosticism being

supposed to be derived from India and Manicheeism from a Persian sect, there is no suggestion that the Manichees were depraved and all Von Hammer's theories based upon the vases, coins, trampling on animals, etc., though they have some plausibility in presuming a connection with Gnosticism have nothing to do with Manicheeism.

But as the ordinary reader may not know the difference between the two religions which are perhaps as distinct and opposed to one another as any two religions, such as the Jewish and the Catholic ones, I have therefore ventured on giving a description of Manicheeism to compare with that of Gnosticism already given.

The following account of some of the known and admitted facts connected with the religion known as Manicheeism may satisfy the reader of the difference between it and Gnosticism. The written records of the Manichees were destroyed when the religion was suppressed, or intended to be. And as in the case of Gnosticism what we know about it is derived from its enemies. But it happens that St. Augustine, the great light of the Catholic Church, was himself an "auditor," or member of a Manichee congregation for nine years, and his writings are full of allusions to the Manichee tenets. It appears that the sect was divided into two divisions, the Elect and the Auditors, the latter presumably the congregation. Whilst Augustine was an auditor he was himself teaching pupils at Carthage, and he himself tells us that to all his enquiries about the difficulties he found in the religion he was told to wait for the coming of a certain Manichee bishop, one Faustus. Upon Faustus's arrival Augustine had long disputes with him. Faustus gave his explanations. But Augustine was not satisfied, and it is said that he gave up the errors of this religion and for a time fell into scepticism, but was afterwards converted by the teaching of St. Ambrose, by whom he was baptized. It appears that he left the Manichees in the year 383 having been, as he says, a careful and diligent "hearer" of them; and a considerable part of his writings, sermons, epistles, etc., are taken up with his explanation and refutation of their tenets.

Attached as a note to the confession of St. Augustine in Parker's "Library of the Ancient Fathers," is a long essay upon the Manichees which is described *in a footnote*. In this brief statement of the chief points of Manicheeism the main object was to illustrate those parts of the system touched upon by St. Augustine, and chiefly out of St. Augustine himself, and in his own words. As the author tells us in his text, "The allusion to the Manichean errors, scattered up and down in the confessions, may for the most part be more clearly illustrated by being taken in the order in which they lie in the system rather than as they happen to be mentioned in the several books."

From this account to which the reader who wants fuller information is referred, we learn "the whole is an attempt to solve the question of the origin of evil."

I think the following facts taken from this essay and the confessions, will be sufficient to show how clearly Manicheeism differs from Gnosticism, remembering that the latter accounted for the presence of evil by degrading the creator of this world, whereas the Manichees suppose that God is good but that he is opposed by the principle of evil which is matter.

We know from general history that Manes was the founder of Manicheeism, and the essay says that he based it on the system of Zoroaster, who taught that there were two contending principles of good and evil, Ormuzd and Ahriman. It will be seen that Augustine contended that by these two principles Manes meant two gods. The author of the essay seems to think that Manes' idea was Pantheistic, and that good and evil were two substances pervading the material world.

Augustine reports a discussion he had with Faustus. Augustine says when he did propound his doubts "Faustus modestly shrunk from the burthen. For he knew that he knew not these things and was not ashamed to confess it." Finding this so, they read literature together with the effect that Faustus, "to so many a snare of death had now, neither willing nor witting it, begun to loosen that wherein I was taken."

It appears, however, that they did discuss matters, for Faustus said: "We confess two principles, but one of these we call God, but the other Hyle, or to speak in ordinary language Dæmon. I teach two principles, God and Hyle. All maleficent influences we ascribe to Hyle, all beneficent to God as fitting." But Augustine writing in later years discussing this statement says: "Tyrbo related to them how Manes' two origin of things themselves unoriginated, being eternally and never ceasing to be opposed to each other, and that to one he gave the name Light and to the other Darkness and Evil. God namely and the devil, and sometimes he calls both gods, a good god and an evil god. Both God and matter are equally personified and equally matured, one is the illustration of light the other of darkness."

"The question" said Augustine "is not about the name but the works. In your discussions we commonly hear of two Gods, which though you first denied soon after yourself confessed, when you ask what he means by Hyle you will have a second God described, etc. They confess that the world was formed by the nature of good, i.e. of God, not out of the intermingling of good and evil when the two natures fought. In order to subdue these, five evil elements were sent of the kingdom and substance of God—air with vapour, light with darkness, with evil fire good fire, with evil water good water, with evil wind good wind" (Aug. Hær, 46).

This account says the whole is an attempt to solve the question, "Whence is evil?" and Manes devised this system saying "whereby could everything in the whole mass of creation be thus unequal, black and white, fiery red and pale, wet and dry, good and evil, just and unjust, but these things are compounded of two several substances."

The world, according to Manes, was formed by the blending of a portion of God with matter. In his Pantheistic system life wherever found was not the gift of God, but rather a portion of God vivifying matter, and that man's soul was a part of God. From this was the excuse which St. Augustine often charges them with using, that it was not they who sinned but the nature of darkness within them. Augustine in one of his sermons alludes to this view at great length (Sermon 183) principally upon the point that to make God a part of man makes him a part of sin, etc. "Thou confessed thou hast erred. Did therefore the nature of God err? Did the nature of God plunge into wickedness? Blush for shame, give glory to God. How can I call him poor in spirit as to believe his own soul to be God and not blush at its being held captive, etc."

Manes considered that not only man and animals but even the vegetable and mineral kingdoms were permeated by the principle of good opposing the matter of which they were composed being part of the principle of evil, and it appears that it was only by the destruction of matter as the end of life that this part of good could return. This seems to have led to certain curious observances, which the Elect had to keep, though Augustine says in his nine years as auditor he had never known one of the Elect free from sin, or the suspicion of it in respect of this.

In this short account of the dispute between Augustine and the Manicheans it must be remembered that their records having been destroyed we have only Augustine's account, that he had been nine years a member of their congregation, had discussed matters with Faustus their bishop, of whom he speaks favourably as a man, and if any one knew them Augustine did; and that from first to last there is no accusation brought

against them by him except upon matters of theology, nor the faintest suggestion of impropriety. Now the sting of Von Hammer's charge is the depravity of the whole Order of Templars, the rulers and the rank and file, and this he supports by the suggestion that the Templars were Gnostics, which is explained by others as meaning that they were Manichees.

Whatever the Gnostics might have been I think we see from the silence of Augustine there were no such charges to be brought against the Manichees: they, we are told, outlived Augustine, who died on 28th August, 430, whereas the Manichees were not driven out of the Eastern Empire by the Emperor Theodosius till 841, and then after fifty years war. That they are said to have continued as a secret society, and that in the year 1017 ten canons were burned at Orleans, and, by some writers, they were the origin of the numerous heresies of the twelfth century, the Albigenses, Catharides, etc.

Some writers believe that the Old Man of the Mountains and his followers the Assassins were also Manichees. But there seems to be no proof of this though Clarkson, King, etc., suggest there were relations between them and the Templars owing to the similarity of their respective constitutions. This brings us to the consideration of what Clarkson and King have written on the subject. It will be seen both authors correct Von Hammer and say that the Templars were Manichees.

It has been already mentioned that there is an essay, published in a work on the Church by R. B. Billings, on the symbolic evidence of the Temple Church, by Edward Clarkson, and on the question: Were the Templars Gnostic Idolators, as alleged? In it Clarkson says, "We are bound to infer, from the facts and evidences produced by Von Hammer, and from facts and evidences which we consider as peculiar to ourselves, that there is much truth in his proposition that a large proportion of the body of the Templars were imbued with the Gnostic and Manichee heresies, that they adopted the initiations of a corrupted and mangled Freemasonry, such as was used by the latter, and that they were chiefly connected with the chief of the Assassins, who occupied strongholds in the immediate neighbourhood of their fortresses in Syria, and who also adopted the initiations of a secret Freemasonry similarly corrupted, in order to train his fanatical adepts (the *Fedavee*) for the ambitious purposes at which he unscrupulously aimed."

I do not propose to deal with Mr. Clarkson's views about the connection between the Templars and the Assassins, sufficient for the day is the evil thereof, we are only considering whether the Templars were Gnostics and therefore depraved. But Clarkson follows Hammer, and thinks the identity of the two may be inferred from the similarity of their dress, organization and existence in the same localities, etc. To make this suggestion of any value it would be necessary to have an authenticated description of the points of similarity relied upon. Clarkson in some degree attempts to supply a means of comparison, but his statements are entirely unsupported, for instance he writes—

"It is obvious, provided logic be correct, that we must seek in the architectural copy, *i.e.* the Temple Church in London for symbols, signs and muniments expressive of the doctrines, social, moral or religious, of the Knights Templars, whose Masonic lineage has been briefly, though we think indirectly, traced to its Masonic origin in the First Egyptian Grand Lodge. That position we have now to investigate. That truth it is our firm conviction, by an appeal to tangible evidence open to every one's eye and palpable to every touch, we shall be able to manifest and prove."

Clarkson first deals with the round Church. He says "the object of the architect appears to have been to exhibit a circle of twelve columns twice over—the extraordinary coincidence of these two circular ranges of pillars with the Druidical ranges

of pillars cannot fail to impress the most inexperienced observer at the first glance.—” He says, “The geometrical and numerical symbols which the Gnostics received by the clearest lineage from the latter platonists, who owned that they derived them from the secret Freemasonry of the Egyptian Freemasons, are too obvious to evade notice or to escape conviction. Here are twelve pillars in a circle. It will be recollected that a similar Temple was erected by Moses, who, as Josephus says, set up twelve stones in a circle as a memorial. Joshua set a circle of twelve stones in commemoration of the passage of the Jordan, and called the place Gilgal, a term analogous to the British appellation of a Druidical circle. At Avesbury there is one subordinate circle consisting of twelve stones. In the Island of Thesus there is moreover an exact counterpart of the Roman memorial; there is a circle of twelve stones, with a cromlech in the middle.”

So far Mr. Clarkson seems to prove that the Templars were not only Gnostics, but Jews and Egyptians, not to mention Neoplatonists and Druids. But he has by no means exhausted his learning about the number twelve, for he continues:

“Antiquarian scholars who have followed the various links of the enquiry to its result, who recollect the twelve stones described by Pausanias in the market place of Egina, as dedicated to the twelve Gods; who recollect the anointed stone at Delphos; the anointed stone of Jacob; the Gods represented as Bœlylia, or demon stones, and finally that the sepulchral King of the Egyptian mysteries and initiations, Osiris, has a fourfold column like the six interior columns of the Temple Church, cannot doubt the idolatrous character of these columns. They are the opposing genii of the Manichee’s six against six in the interior circles, they are the twelve great Gods in the exterior circle, to whom the twelve months in the year were divided, precisely as they were in the five Temples of the Druids.”

It must be remembered what Mr. Clarkson had undertaken to prove was that the Templars were Gnostics, not Druids, nor Egyptians, etc. And it is to be noticed how finding twelve pillars in an interior circle with twelve in an exterior circle, making a kind of cloister in the round Church, he divides the interior twelve pillars in two parties of genii and in opposition to one another. But the twelve exterior pillars, he says, are twelve great gods or months, etc.

It seems clear that Clarkson wishes the reader to understand that there are twelve pillars in the interior circle and twelve in the exterior, though he has some glimmerings of the truth when he speaks of the six interior pillars. For there are only six massive columns that support the roof, and its groined arches, and the wall of the second storey. But he speaks also of their being twelve, and says they are the opposing genii of the Manichees, six against six in the interior circle. It is true he could have divided the six, and said there were three against three. But what has Manicheism to do with twelve or six genii, the spirits or substances of good and evil are two and two only. With regard to the twelve pillars in the outer circle, which he calls gods or the months of the year, why is this Manicheism “visible to the eye and palpable to the touch”? Mr. Clarkson seems to have as accurate use of words as the writer who said “an actor literally brought the house down.” Visible to the eyes, etc., means something objective. But Clarkson is only subjective, the connection between the twelve pillars, and twelve gods (the Manichees were accused by Augustine of having two deities, this they strenuously denied) is purely subjective—especially as strictly speaking there are no pillars at all in the outer circle. The arches are carried by the outside wall, and there is only a slight upright half cylinder of marble let into the wall, no doubt to suggest a pillar, and, as the original round wall had three openings broken through to communicate with the more modern part, it is not quite clear

whether there are twelve or fourteen of these ornamental stones. But, assuming that these pillars represent Gods or months, this might prove the Templars Pagan worshippers of classical mythology, but neither Gnostics nor Manichees, who had no twelve Gods.

All this arises because he finds twelve pillars. But he also finds some arrangement of pillars in seven, and says, "This arrangement proves that the exhibition of all the sacred numbers pervaded the design, and prompted the execution of the architect. It is scarcely necessary to go through all the proofs of the veneration in which the number seven was held, not only in the Christian Church, but in all the Pagan churches of the world. The seven candlesticks of the Revelation, the seven eyes of the head exhibited to Zerobabel, in conjunction with the Masonic symbols of the plummet and the level, the seven branches of the Jewish candlestick, the seven circles of the Cabalistic Septuoth, all imply the same thing, namely, the angelic spirits presiding over the seven planets, over the seven metals, and over the seven days of the week," and so on, and concludes, "Here at all events is manifested the design of exhibiting the sevenfold combination of pillars ascribed by Solomon to the Temple of Wisdom. 'Wisdom has built her house of seven pillars, Prov. ix., 1.'" Clarkson seems to have forgotten all about the Gnostics, and we have now the Temple of Wisdom, and so it is with whatever number he finds.

For instance, he says there are eight pillars in the extension of the Church, and he says every Egyptian antiquary "will remember the eight caryatides." What has Egypt got to do with the Templars? And when we take the trouble to count the pillars we find there are twenty-four, not eight. It is true that the eight pillars stand alone, and the sixteen are built against the wall, but they are all pillars carrying the arches of the roof.

I do not propose to trouble the reader any further, and I should not have referred to this hysterical nonsense, except that the essay has had its effect on the literature of the Templars. We shall see Mr King, in his work on the Gnostics, quotes from it, and though he does not hesitate to expose many of Clarkson's fallacies, yet he still tries to support him, and to shew it was possible that the Templars might have had their religion affected by the Manicheism of the Assassins, with whom he follows Clarkson in trying to connect the Templars.

"The Gnostics and their Remains" is a work by Mr. C. W. King, M.A. It has already been referred to by me. It is my authority for the statements as to the tenets of the sect. The author tells us in his introduction that "In order to obtain a clearer view of the principal forms of Gnosticism, as well as escape relying upon second-hand information (in this case more than elsewhere untrustworthy) he commenced collecting materials for his work by reading the vast Panarion of Epiphemus, a history of the Gnosis, in all its developments in the first three centuries." Mr. King says after his (Epiphemus's) days nothing new sprang up in the field of religious philosophy before so diversified with the vigorous and more curious flowers (or weeds) of the Gnosis, the civil now combining with the ecclesiastical power to cut down and root out all such daring and irregular growths of the human mind. Mr. King then gives us the authorities, earlier to Epiphemus, which he consulted for the second edition.

There is a chapter specially devoted to the question of the Templars, Rosicrucians, Freemasons, etc., and the author is sufficiently at home in his subject, to say positively that, speaking of Von Hammer, "the gravest error into which this too sagacious interpreter has fallen, is the attempt to identify the heresy of the Templar with the Orphite--that primitive form of the Gnosis swallowed up so many ages before the foundation of the Order in the overwhelming flood of Manicheism, a flood



indeed that may, even at its flood, have carried away as many inquiring spirits among the Knights, as it was simultaneously intoxicating in Italy and Provence."

This shews that whilst our author points out the error of Von Hammer in thinking the Templars were Orphites, he considers there was a possibility of some of these enquiring spirits being carried away by the flood of Manicheism. In this he confirms the view taken by Clarkson in his essay on the Temple Church. But Mr. King cannot get away from the influence of Von Hammer, and he states, as we shall see, that the Manichees had drawn within their own circle every older form of Gnosticism between Constantine and Justinian, and, again, he says that "Gnosticism, in one shape or another, was still surviving in the very head quarters of the Order, amongst their closest allies or enemies, the Mountaineers of Syria, an imperium founded by Hassan, who having captured the Hill Fortress, or Vultures' Nest (1090 A.D.) set himself up there as an independent Prince, his followers being known as the Assassins." Mr. King says Von Hammer has been successful in showing that the constitution of the Order of the Templars is a servile copy of that of the detested Assassins, and that the statutes of the latter prove the fact beyond all gainsaying. They were found when their capital was taken, in the year 1335.

I cannot test how far the statement of the description of the constitution of the Assassins is correct, but if it were, and also that of the Templars, it may have only have been a coincidence, and if not, the Templars may have copied the Assassins constitution, or *vice versâ*. The latter seems the more probable as the Templars were long prior, and their rule was given to them by St. Bernard, and adopting the constitution is not adopting the religion. The Assassins are not shewn to be Manichees, and, if they were, the Manichees are not shewn to be anything but an ascetic sect mistaken in their religion which contains many ideas which have come down to us, as when we speak of the spirit of a man returning to his creator, and as for the suggested antagonism between good and evil, Milton's "Paradise Lost" seems to have followed out this idea.

Mr. King states that "the Assassins and Templars had similar offices," and two tables are given:—

<i>Templars.</i>	<i>Assassins.</i>
The Grand Master.	The Grand Master, or Prince of the Members.
The Three Grand Priors.	Dais al Rabii.
The Provincial Prior.	The Three Grand Viceroy.
The Chaplains.	The Dais, or Provincial Master.
The Knights.	The Refek, or Chaplains.
The Esquires.	The Lugek, or Military Body.
The Serving Brethren.	The Federvæ, or death-devoted.
The Donati or Male.	The Bahlunee, or Secret Brethren; <i>i.e.</i> those
The Affiliate.	affiliated to the Order.

This comparison shows resemblance, but is it a resemblance more than is to be expected between two Orders; they are all constituted on the same plan. They have a General at Rome, Provincials, Heads of Homes, Rectors, Ordinary Brethren, Serving Brethren, Novices, etc. We know the Templars were living under the rule given to them by St. Bernard, did he send to the Prince of the Assassins for a copy of the latter's constitution? But supposing it was the fact that the Templars took their constitution from the Assassins (*Credat Judæus*) that does not show they took their religion, and if they did then it was Manicheism and not Gnosticism dead and defunct for nearly one thousand years.

Mr. King, however, seems continually trying to reconcile his views with Von Hammer's. He says, Manicheism has been so repeatedly referred to in the foregoing pages as to make it necessary to give a brief explanation of the way in which that strange creed may finally have affected the religion of the Templars. And here, he says, all is either assertion of enemies or modern theory, hardly any memorials remaining that can be with certitude attributed to the Manicheans, though so numerous in their time, for they have drawn within their own circle every older form of Gnosticism between Constantine and Justinian.

This is the sort of observations so difficult to meet. On what evidence does Mr. King say that Manicheism incorporated Gnosticism? On what does he base this *modern theory*? We have examined what St. Augustine said about them. He must have, as a religious enquirer, known them after his nine years experience better than Mr. King, and St. Augustine makes no mention of any leaning on their part to Gnosticism, the two religions having, as I have tried to show, nothing in common.

Mr. King says their sole religious monuments were sacred books, prayers and spells committed to perishable materials, parchment and papyrus, diligently sought out and destroyed by every persecutor. After speaking of the persecution of Gnosticism, he says, "it appears that Manicheism was made a capital offence by Theodosius, his edict being the first statutable infraction of the old Roman principle of universal religious toleration," and adds, the absence of Manichean relics may be accounted for by the rigid character of "the creed itself, the offspring of Magism, therefore regarding all imagery as idolatrous and sinful, a tenet latterly carried out by the iconoclastic Albigenes."

These extracts from Mr. King's works show the difficulty there is in fixing with precision any particular statement. He says first that the monuments of the Manicheans were so numerous in their time as they had absorbed every older form of Gnosticism, that the latter left behind many seals and that the former left only documents, which have been destroyed. If so, and the Manichees had no images, what becomes of Von Hammer's suggestion that the Templars were Gnostics, which Clarkson, King, etc., says must mean Manicheans.

To sum up and make clear what has been said, Von Hammer says that the Templars were really guilty of all the charges brought against them.

1. Because of the coins, vases, etc., which he attributes to the Templars and says are Gnostic.

*Ans.*—This is answered by experts who say that he is mistaken, the lettering on the coins, etc., is modern and the subjects are too classical.

2. Because there are certain marks found in the Churches built by the Templars.

*Ans.*—This if it proves anything proves the builders were Gnostics, not necessarily the congregation. Besides, these marks are found on many churches not built by the Templars.

3. That the recumbent Templars trampling on animals are proof of Gnosticism.

*Ans.*—The emblem was known to the ancient Greeks and Romans, as well as to the Catholic Church, and is found in the George and Dragon, the Archangel St. Michael, etc.

To the objection that Gnosticism ceased to exist by the end of the third century, and that there has been no revival, it is said for Gnostics we must read Manichees,

But St. Augustine himself a Manichee for nine years makes no suggestion of Gnosticism, if so whence comes this suggestion. King says either from their enemies or modern theory—the former being silent we must attribute the Gnosticism of the Manichees to modern theory.

But the reader may, like Hallam, say “these matters are outside my knowledge and that as there is no smoke without some fire, I cannot say my doubts or the effect of Von Hammer’s arguments are removed,” etc. In a criminal case the prisoner has a right to claim the benefit if there is a reasonable doubt, but in matters of history there are many problems that cannot be proved but on which an opinion may be formed “*un conviction intime*.” But when the guilt or innocence of a large body of men is concerned there is a right to expect something more than an opinion given without any sense of responsibility, even when we are dealing with the past, and I think no one who cares to consider the question, whether he, *i.e.*, the particular reader, or Von Hammer, Hallam, or any other man, would send a person to prison for one day upon such evidence as Hammer has brought forward. Evidence and argument should proceed by steps in order to convict, on Von Hammer’s evidence we must go by leaps and bounds, jump from one violent assumption to another, and assume matters to be proved which are either incapable of proof or are shewn to be the opposite.

There is, however, one more proof of the weakness of what Von Hammer has put forward and that is the report of the proceedings before the Papal commission, the *Procès des Templiers*. There is not one suggestion therein either of Gnosticism or Manicheism. It must be remembered that the charges against the Templars were originally made by two of the brethren who were under sentence of death. They did not hesitate to accuse the Order of blasphemy and depravity, but not one word about Gnosticism or Manicheism, of which they had probably never heard. The suggestion was that the Templars through one of their Grand Masters, De Bello Joco, had promised the Arabs that the candidates at their initiation should be made to deny Christ, and insult his Cross. The Saracens were Mahomedans, theists like the Jews, holding “There is no God but one God.” They would not have wished the Templars to be Gnostics to degrade that God, or Manichees to give him a co-equal opponent in the spirit of evil. And I think no one can read the depositions without coming to the conclusion that the Templars were ignorant Catholics, so unlettered that they would only be taught to say the Pater Noster, which they were told to repeat over and over again, and whatever their faults may have been, that they had no more idea of such subtle forms of religion as Gnosticism or Manicheism than they had of Egyptian hieroglyphics or Chinese metaphysics.

---

# Festival of the Four Crowned Martyrs.

WEDNESDAY, 8th NOVEMBER, 1906.



THE Lodge met at Freemasons' Hall, at 5 p.m. Present:—Bros. G. L. Shackles, W.M.; Rev. Canon J. W. Horsley, Grand Chaplain, I.P.M.; E. Armitage, P.D.G.D.C., S.W.; Dr. W. W. Westcott, P.J.G.D., P.M. as J.W.; Hamon le Strange, Prov.G.M., Norfolk, Treasurer; W. John Songhurst, Secretary; J. T. Thorp, P.A.D.D.C., S.D.; F. J. W. Crowe, P.G.O., J.D.; H. Sadler, Grand Tyler, I.G.; R. F. Gould, P.G.D., P.M. as D.C.; W. Watson, Steward; W. H. Rylands, P.A.G.D.C., P.M.; S. T. Klein, P.M.; G. Greiner, P.A.G.D.C., P.M.; Admiral Sir A. H. Markham, P.D.G.M., P.G.Sup., Malta, P.M.; J. P. Simpson and E. H. Dring.

Also the following members of the Correspondence Circle:—Bros. Col. Craster, H. Higgins, T. W. Allsop, Percy T. Goodman, Leonard R. Strangways, W. J. B. Reed, F. E. Everard, H. A. Badman, W. L. Smith, C. L. Eales, A. C. Mead, J. Leach Barrett, S. Walshe Owen, C. W. P. Hollingbury, C. Lewis Edwards, W. F. Woods, J. W. Lawson, Frank Caster, John W. Hall, Frank W. Spalding, W. J. Hodge, Edwin Fox, H. W. Sexton, H. Guy, L. Simon, John Walker, Thomas Coth, C. Butcher, H. A. James, H. Chown, Jr., Frank Hughes, T. J. Ralling, W. Truslove, F. J. Burgoyne, A. J. Solomon, W. H. Wolsey, E. L. Hawkins, G. W. Brown, H. M. Baker, E. H. Jones, R. Manuel, W. Wonnacott, J. Dudgeon, J. Jenkin, R. Colsell, J. H. Cragie, H. Pike, J. Harrison, W. J. Hawkins, J. Johnson, G. T. Phillips, C. G. Bestow, P. J. Woods, D. Northall-Laurie, G. Elkington, W. Busbridge, W. H. Harris, C. Gough, O. Papworth, Rev. C. E. L. Wright, G. Michael, F. J. McMurray, J. S. Stacy, A. G. Boswell, J. A. Sweatman, J. M. Bruce, W. S. Pegge, J. H. Tatham Armitage, F. W. Ball, F. Rickard, W. W. Mangles, R. F. Robertson, Herbert Burrows, Sydney R. Clarke, M. P. Percival, F. J. Asbury, J. J. Moar, R. J. Harrison, A. Davis, S. W. Morris, H. J. Houndle, E. Hall, Walter H. Brown, G. W. Sheppard, H. Eaborn, S. D. Wade, A. Turner, O. M. Thomson, A. Simner, W. Burton, J. M. Bastone, W. R. Pooley, Herbert Y. Mayell, E. Glaeser, H. W. Slater, Sydney Meymott, J. A. Richards, F. R. Heath, W. H. Fox, A. E. Bernays, R. Orttewell, H. St. John Oliver, Major John Rose, W. S. Lincoln, J. Peschek, G. T. Lawrence, W. Hammond, H. G. Warren, J. White, J. Pullen, L. Wild and A. Y. Mayell.

Also the following visitors:—Bros. Rev. Austin le Strange, Philanthropic Lodge, No. 107, P.Pr.G.Chap., Norfolk; F. Cozens, P.M., Royal Oak Lodge, No. 871; G. W. Warne, Prosperity Lodge, No. 65; Herbert F. Jones, Earl of Mornington Lodge, No. 2000; G. G. Lean, Albion Lodge, No. 9; H. C. Price, Bate Lodge, No. 960; P. Colville Smith, P.G.D.; W. A. Mills, Cannon Lodge, No. 1539; Percy Still, P.M., Caveac Lodge, No. 176; W. C. P. Papper, Borough of Stepney Lodge, No. 2884; H.

Harrison, Thomas Balling Lodge, No. 2505; E. T. Creasy, Wood Green Lodge, No. 2426; E. W. Hider Royal Kensington Lodge, No. 1627; H. J. Freeman, St. Peter's Lodge, No. 1024; Alfred Holdwards, P.M., Sanctuary Lodge, No. 3051; Edwin Olsen, Westcliff Lodge, No. 2903; A. M. Barnard, Clerkenwell Lodge, No. 1964; W. H. Miles, Domatic Lodge, No. 177; G. W. Lacy, Harrow Lodge, No. 1310; Herbert Passmore, Iris Lodge, No. 2545; Fred. Sanders, P.M., Royal Sussex Lodge, No. 342; Alfred S. Thompson, Commercial Temperance Lodge, No. 3144; H. Ground, P.M., Eleanor Lodge, No. 1707; and Charles Fox, P.M., St. John's Lodge, No. 90.

---

Two Lodges and forty-seven brethren were admitted to the membership of the Correspondence Circle.

---

Apologies for non-attendance were received from Bros. Sir Charles Warren, J. P. Rylands, W. J. Hughan, W. M. Bywater, T. B. Whythead, Dr. W. J. Chetwode Crawley, E. J. Castle, F. H. Goldney, L. A. de Malczovich and E. Conder, Jun.

---

R.W. Bro. Hamon le Strange, the Master elect, was then regularly installed as Worshipful Master of the Lodge by Bro. G. L. Shackles, assisted by Bros. R. F. Gould and E. Armitage.

---

The W.M. appointed his officers as follows:—

I.P.M.	Bro. G. L. Shackles.
S.W.	„ E. Armitage, P.D.G.D.C.
J.W.	„ F. H. Goldney, P.G.D.
Treas.	„ W. H. Rylands, P.A.G.D.C.
Secretary	„ W. John Songhurst.
S.D.	„ J. T. Thorp, P.A.G.D.C.
J.D.	„ F. J. W. Crowe, P.G.O.
D.C.	„ W. M. Bywater, P.G.S.B.
I.G.	„ H. Sadler, G. Ty.
Chaplain	„ Canon Horsley, Grand Chaplain.
S. Steward	„ W. Watson.
J. Steward	„ J. P. Simpson.
Tyler	„ J. W. Freeman.

---

The W.M. proposed, and the Chaplain seconded, "That Bro. George L. Shackles having completed his year of office as W.M. of the Quatuor Coronati Lodge, the thanks of the Brethren be and hereby are tendered to him for his courtesy in the Chair and his efficient management of the affairs of the Lodge, and that this resolution be suitably engrossed and presented to him," which was carried by acclamation.

---

The W.M. delivered the following Installation Address:—

## INAUGURAL ADDRESS.

---



BEFORE proceeding to address the Lodge at large, it is only due that I should publicly say a few words of thanks to my Brethren of the Inner Circle for the honour which they have conferred on me by placing me in the Chair of the Lodge, without my having worked my way thereto by filling any of the subordinate offices except that of Treasurer. To come up to the level of erudition and proficiency in Masonic lore which has been reached by those who have sate here before me is an ideal which I may keep in view, though I know full well that I cannot hope to attain to it. I can at least give expression to the profound satisfaction which I feel at this mark of your esteem, which comes entirely unsolicited, as all Masonic honours should do, as a most gratifying climax to my Masonic career.

It has been customary for my predecessors in this Chair to devote their Inaugural Address either to a review of the principal Masonic occurrences of the year, or to the elucidation of some field of inquiry which they had made peculiarly their own. Nothing special suggesting itself to me in either of these two subjects, it has occurred to me that the short time at my disposal on this twenty-first anniversary of our existence might be usefully employed by taking stock, so to say, of what was accomplished, during the earliest years of that existence, towards carrying out those objects for which the Lodge was founded. I am not going to make invidious comparisons between our work then and now—much has been done, and so well done that it can hardly require doing again.

I propose to confine my present remarks to the first five years of our working, the record of which is given in the first three volumes of our *Transactions*. At the close of that time our Correspondence Circle, though already flourishing, was reckoned only by hundreds, whereas now it contains thousands; and there must be a very large proportion of our present members who have never had the time or the opportunity to look into those early records of our proceedings. I need, therefore, make no apology for bringing a short *résumé* of them to the notice of the majority at least of those present here to-night.

The first paper read before the Lodge was by our distinguished Bro. R. F. Gould, to whom we paid a special tribute of honour at our last meeting. The Lodge had been constituted on the 12th January, 1886, and on the 12th April following Bro. Gould read a paper on "*Some Old Scottish Masonic Customs*." After disposing of the theory that the so-called Higher Degrees of Scots Masonry were derived from Scotland, he went on to show that some of the customs of old Scottish Lodges were survivals of usages pre-dating the Era of Grand Lodges, and that others came down from a time when Masonry was mainly operative in its procedure.

At the next meeting, on the 2nd September, an important paper, "*On the Steinmetz Theory*," was read by our first Secretary, Bro. G. W. Speth, whose untimely death has been the greatest loss that the Lodge has sustained. Bro. Gould, in his monumental history, had already done much to disprove the once widely received theory that our English system of Freemasonry was derived from the German Guild of Steinmetzen, or Stone-cutters; Bro. Speth contended that, although there was a similarity of

Trade Organization, these latter had no esoteric doctrines or ritual, and could not, therefore, have taught our forefathers that of which they were themselves ignorant.

A short paper, read on the 8th November, 1886, by Bro. Hayter Lewis "*On an Early Version of the Hiramic Legend*," led to the first of many discussions between Brothers Gould and Speth as to the antiquity of the Third Degree, the former contending that it was unknown both in Scotland and England until after the constitution of their respective Grand Lodges, while Bro. Speth accepted the evidence of its earlier existence.

On the 2nd of December, 1886, Bro. the Rev. A. F. A. Woodford, one of the deepest read of our members in early Masonic lore, gave us a paper tracing "*The influence of Hermeticism on Freemasonry*," which again drew some very illuminating remarks from Bro. Gould.

At the first meeting in 1887, on the 3rd of March, the Correspondence Circle, which has since assumed such vast proportions and aggregated a world-wide membership to the Lodge, was started into existence on the initiative of our untiring Secretary, Bro. Speth. The paper of that evening was by our first W.M., Sir Charles Warren, on the "*Orientation of Temples*," with especial reference to the Temple of Solomon and the Master Mason's Lodge; he argued that "we are the direct descendants from the ancient Phœnicians, who first moulded Masonry into its present form, and who were unable to openly worship the true God for fear of the people." Professor Hayter Lewis added some very apposite remarks on the architectural side of the subject.

A paper was contributed by Bro. W. J. Hughan to the June meeting, 1887, on "*Connecting Links between Ancient and Modern Freemasonry from a Non-Masonic Standpoint*," in which he adduced proof of the continuity of the Craft during the transition period from the operative to the speculative Lodges.

Bro. Dr. W. Wynn Westcott read a paper on the 8th September, 1887, in which he endeavoured to shew that the "*Religion of Freemasonry*," the Unity of God, was primarily and directly derived from the *Jewish Kabbalah*, but his views did not obtain much acceptance from the members who took part in the discussion.

Bro. R. F. Gould was installed as W.M. in succession to Bro. Sir Charles Warren on the 8th November, 1887, and, after a short Inaugural Address, he read a paper on "*English Freemasonry before the Era of Grand Lodges (1717)*." He gave detailed evidence under three heads: (1) Oral Traditions from St. Alban down to about 1390; (2) the old Manuscript Charges from 1390 to 1646; and (3) Symbolical Masonry from Ashmole's time onwards; the point on which he particularly insisted was that there was no positive evidence concerning the Craft before the earliest of the old Charges, the Regius or Halliwell MS., of *circa* 1390.

At the first meeting in 1888 (January 6th), Bro. W. Simpson read a paper on the "*Threefold Division of Temples*," illustrated with diagrams and references to many lands, ranging from Egypt to Salt Lake City, his leading idea being that all forms of worship are based on the mystic number three.

On the 2nd March following, Bro. W. H. Rylands gave the first part of an instructive account of one of the Societies analogous to Freemasonry, the "*Compagnonnage*." It consisted of the skilled workmen of almost every sort of Trade in France; each member, by following certain prescribed steps, rose gradually in credit and experience, and became qualified to take his place at the head of his trade.

At the May meeting of the same year Bro. Speth followed up Bro. Gould's paper of the previous November, by one on "*Scottish Freemasonry before the Era of Grand Lodges*," treated under the same threefold heads, viz.: Oral tradition, written tradition and documentary evidence; it is especially interesting owing to the great superiority of the Scottish documentary evidence over our own.

Following thereon is printed a very important and useful communication from a foreign Brother, Dr. W. Begemann, Provincial Grand Master for Mecklenburg, entitled "*An Attempt to Classify the Old Charges of the British Masons*." By a laborious and accurate collation of the texts line by line, he established their greater or lesser degrees of relationship, dividing them into four principal families, each again sub-divided into several branches. The present paper is concerned only with two of the four families, viz., the Spencer and the Roberts groups.

At the Festival of St. John in June, 1888, Bro. John Lane read a paper on "*Masters' Lodges*" during the first half of the eighteenth century. His explanation of their existence was that, as in many Lodges only the first and second degrees were worked, new Lodges were probably formed for developing the principles and ceremonial of the third degree, which were subsequently placed on the list of regular Lodges, although they had never been formally constituted.

A short account follows of a Masonic visit paid to the Hague and Brussels by the W.M. Bro. Gould, and the Secretary of the Quatuor Coronati, Bro. Speth. I desire to call attention to the fact that, in this account, Bro. Speth confines himself strictly to the Masonic proceedings, and expressly says that he does not inflict upon his readers an account of the cities visited, as, in these days descriptions of travel are more numerous than novel.

In continuation of Bro. Gould's paper on early Scottish Freemasonry, Bro. Edward Macbean gave, on the 5th October, 1888, a brief review of "*Scottish Freemasonry in the Present Era*," showing the many and important differences between the ceremonials, regulations, and observances practised on the two sides of the river Tweed.

At the following meeting, after the Inaugural Address of Bro. W. Simpson, Bro. Kupferschmidt contributed a paper on the "*Relations between the Grand Lodges of England and Sweden during the last (eighteenth) century*," which, as Bro. Gould said in moving a vote of thanks "cast a new and much needed light on a very obscure portion of Masonic History." This brings us to the conclusion of the first volume of our *Transactions*, extending over three years' working, from 1886 to 1888. I have omitted noticing a few less important communications, and many interesting Reviews of Masonic Works, but I think that it will readily be admitted that all the papers and proceedings contained in this volume kept strictly in view that ideal of Masonic research for which the Lodge had been mainly founded.

Since the year 1888 each year's proceedings have had a volume to themselves; that for 1889 opens with a long paper by the W.M., Bro. W. Simpson, entitled "*The Worship of Death*." It is really an able review of many different forms of religion, extending over all parts of the world, from primitive times down to the present, each of them pervaded by the central idea of faith in another world and longing for immortality, which has preserved and developed ceremonies and symbolical rites founded on the transition from life to death. The lengthy discussion which followed this paper, and the addenda thereto, shew the great interest taken in this complex subject, so closely co-related to much of our Masonic symbolism.



On the 1st March, 1889, Bro. W. H. Rylands continued his account of the "*Compagnonnage*." As the result of much patient research, he criticized the legend of the three first *Compagnons*, Maitre Jacques, Solomon and the Père Soubise, coming to the conclusion that it was of no very remote antiquity.

At the following meeting, on the 3rd May, Bro. Speth took up the story of Masonry in England from 1717, where Bro. Gould had left it off in his Installation Address two years before, and depicted the events which gave rise to our present system of Freemasonry, and their consequences in England, until the beginning of the nineteenth century.

Bro. Speth's researches were not confined to our own country; he translated a paper by Bro. J. P. Vaillant, Grand Secretary of the Grand Lodge of the Netherlands, on "*Freemasonry in Rotterdam 120 years ago*;" and another by Bro. W. Cramer, of Berlin, on "*The Origin of Freemasonry*." About this time, also, the first volume of the valuable series of "*Masonic Reprints*," issued by the Lodge, made its appearance: it contained, among other things, a facsimile and transcript of the Regius MS., in the British Museum, circa 1390, the earliest document in existence relating to the Craft. It was accompanied by an exhaustive commentary thereon by Bro. Gould, the result of nearly twelve months research and hard work.

The 24th June, 1889, was signalized by a paper read by Bro. T. B. Whytehead, on "*The Grand Lodge at York*." He showed that there is no proof that any ruling Masonic body held an existence at York prior to 1725, and that it was not in fact till 1761 that the Grand Lodge of All England at York really assumed the position of a Mother Lodge, and issued authorities for dependent bodies. It only flourished for about twelve years, and finally died out in 1792.

On the 20th July, 1889, the first summer outing of members of the Lodge took place; a one day's excursion to St. Alban's, the particulars of which are succinctly and modestly recorded in little over two pages of the *Transactions*. Here I cannot refrain from entering a protest against the unduly bulky and wholly undesirable proportions to which the record of these Summer Outings has now grown in our *Transactions*. Of late years they have usually taken up from seven to ten pages of letterpress, besides a large number of plates of photographs; as an extreme instance the Worcester Excursion of 1904 was illustrated by twenty-five plates, containing nearly sixty different photographs of places visited. I humbly submit that this practice is reducing our *Transactions* to the level of a common guide book, which certainly was not the purpose for which they were intended. I am glad to note the fact that for the last two years these descriptions have been reduced by the present Editor to much more reasonable limits, and I may express the hope that the former long notices will not recur. Against the excursions themselves I have not a word to say, and I hope that they will always remain a feature of our summer holiday; I have myself derived a great deal of pleasure, and, I hope, some instruction from those which I have been able to attend; but such pleasure and instruction is mainly if not entirely confined to those who take part in the outing, and the three thousand recipients of our annual volume do not in the least want a detailed account of where we walked and slept and ate, embellished by pages of reproductions of snapshot photographs taken by members of the party. I believe that this self-glorification detracts very much from the literary value of our *Transactions*; and, believe me, Brethren, if we do not take ourselves seriously, we shall not be taken seriously by others.

On the occasion of the inaugural meeting of the 8th November, when Bro. Colonel S. C. Pratt was installed as W.M., a paper was read by Bro. W. H. Rylands

on Hogarth's picture "*Night*," which contains the well-known representation of the drunken Freemason and the Tyler. Bro. Rylands examines judiciously all the details of what he rightly designates one of the most interesting of our early Masonic prints.

At the first meeting in 1890 (January 3rd) Bro. Gould read a paper, well deserving careful study, on the "*Antiquity of Masonic Symbolism*," shewing how greatly it antedates our oldest records, and how our comparatively modern Ritual abounds with Archaisms, survivals of ancient forms of speech.

At the March meeting Colonel Crease, C.B., endeavoured to establish the "*Masonic character of the Roman Villa at Morton, Isle of Wight*," but his views met with little assent during the discussion which followed, save from Bro. Speth, who, without admitting that the building was strictly Masonic, believed that it might have been designed for analogous rites.

In May following, Bro. T. Hayter Lewis read a paper on "*Masonry and Masons' Marks*" from the earliest times down to the thirteenth century; it was illustrated by examples from pre-Christian as well as mediæval times, and was especially interesting as shewing the Eastern influence of the Crusades on Western Architecture. Two short papers follow on the same subject from the pens of Bro. W. Wynn Westcott, and Bro. F. F. Schnitger.

On St. John's day in Harvest an important paper on "*Brahminical Initiation*" was communicated by Bro. W. Simpson; though not perhaps directly connected with Freemasonry, it throws instructive side lights on some of the ceremonies and usages of our Craft.

Here it is well worth while to draw the special attention of our younger members to the short paper at p. 116 of the third volume of our *Transactions*, by Bro. G. W. Speth, entitled "*A Masonic Curriculum*"; he gives a list of about a dozen books, which he recommends to young English students desirous of mastering the rudiments of Masonic History.

A special and memorable meeting of the Lodge was held on the 4th September, 1890, to meet the Grand Masters of Canada and Pennsylvania, and the Past Grand Master of Louisiana, all three members of our Correspondence Circle, and to hear a paper by one of them, Bro. C. P. McCalla, on "*Freemasonry in America*." He traced it from the earliest regular Lodge in America, established in his own State of Pennsylvania, the St. John's Lodge at Philadelphia, which possesses records dating from 1731, and he gave particulars of some of the differing usages prevailing in certain of the fifty-seven independent Grand Jurisdictions now existing in the United States and Canada.

At the regular meeting in October was read a long and extremely well illustrated paper by Bro. W. H. Rylands, on the "*Noble Order of Bucks*," one of the several now forgotten rivals of Freemasonry which sprang into existence during the eighteenth century. The Lodge still awaits a long promised paper from the same able pen on the kindred Order of the Gregorians.

A short paper, or rather a series of notes, follows by Mr. Wyatt Papworth, who was not a Craftsman, on a subject which has only recently engaged anew the attention of the Lodge, viz.: the identity of "*Naymus Grecus*." Mr. Papworth tabulated upwards of fifty variants of the spelling, and suggested several different sources whence the corruption may have arisen.

A third paper on "*Scottish Freemasonry*" was contributed at the November meeting by Bro. E. Macbean; it was intended as a complement to Bro. Speth's paper of the 4th May, 1888, and gave a full account of the circumstances which led up to the formation of the Grand Lodge of Scotland in 1736. Bro. Hughan, in commenting

thereon, remarked that Bro. Macbean's intimate acquaintance with the Craft in that country, as well as in England, peculiarly fitted him to appreciate and estimate the chief differences in the two bodies.

This brings to a close the narrative of the work of the first five years of our existence, and here considerations of time and space oblige me to stop. I have brought our history down to a period at which I believe that a large number of our present members of both circles can bring their own personal reminiscences to bear, and we may well wait a few years for some future W.M. to take up the tail of this retrospect from the point at which I leave it. One by one the original workers may drop off, but others step in and take their places, and the work goes on; there is no fear of any failure, either in the supply of subject matter for them to deal with, or in the succession of active and intelligent Brethren to carry on the useful work which the Founders of the Quatuor Coronati Lodge were the first to co-ordinate.

---

At the subsequent banquet, Bro. George L. Shackles, I.P.M., proposed the "Toast of the Worshipful Master."

BRETHREN,

The day of our annual Festival has again come round and as it was my duty as the retiring W.M. to instal our present W.M. so now it also falls to my lot to ask you to join with me in drinking his health. I do so with very great pleasure and I am sure you will all agree with me that in this the twenty-first year of the Lodge's existence we are specially favoured in having W. Bro. le Strange as our official head during such an important year of our Masonic existence.

It has been customary for many years in this Lodge for the retiring W.M. to give a short biographical sketch of his successor's Social and Masonic Career, and although this may be somewhat distasteful to the person in question, (at least I felt it so in my own case) it has its advantages, in as it were introducing him, not only to you who are present to do him honour, but through the medium of our *Transactions* also to the far more numerous members both of our Inner and Outer Circle, who cannot attend here to-night.

Bro. Hamon le Strange is the eldest son of the late Henry L. Styleman le Strange of Hunstanton Hall, Norfolk, and was born on the 25th November, 1840. He was educated at Eton College and Christ Church, Oxford, where he took a B.A. degree in 1861, and first-class in Law and Modern History in the following year. In the same year he was appointed a Deputy Lieutenant and J.P. for the County of Norfolk. On the 20th June, 1864, he entered the Diplomatic Service, and after serving at Mexico and Paris obtained his Commission as third Secretary on the 13th July, 1868, being subsequently engaged at H.M. Legation at Washington during the momentous years between 1869-71, when the Alabama claims were being put forward. In consequence of his intimate knowledge of these claims, he was specially employed in the Foreign Office during the years 1871-2, retiring from the Service when those claims were finally adjusted between the two countries in the latter year. In the year 1880 he served the office of High Sheriff of Norfolk, and on the 25th October, 1893, was elected the Chairman of Quarter Sessions for that County. He is an Alderman of his County, and has been an active Member and Chairman of the Highways, Allotments and Licensing Committees and has also been the Chairman and guiding hand since its foundation of the Eastern Sea Fisheries Committee which has one of the largest districts on the East Coast under its jurisdiction.

From a literary point of view our W.M. is no less distinguished, as he is the author of the "History of Freemasonry in Norfolk," which from his early training and position in the County he was eminently fitted to write. He further, in conjunction with Lord Amherst of Hackney, compiled the "History of The Union Lodge of Norwich" and he is also the author of "The Norfolk Official Lists." In 1902 he was elected a Fellow of the Society of Antiquaries, and has contributed from time to time various and interesting papers to our *Transactions*.

But Brethren, it is not only from the eminence he has attained in the social, literary and municipal life of his Country and County that he has won our suffrages to-night, but also by his distinguished Masonic Career, the details of which I will not weary you with to-night. There are certain leading characteristics, however, which it would be unpardonable of me to pass over. Our esteemed Brother was initiated in the Apollo University Lodge, Oxford, on the 27th November, 1861, whilst undergoing his Academic career. On leaving the University he joined the Westminster and Keystone Lodge, No. 10, and the Union Lodge, No. 52, at Norwich, of both of which he is still a Subscribing Member. He served all the subordinate offices in the former Lodge, and was elected its W.M. in 1875, and was also the W.M. of the latter Lodge in 1897.

On his arrival in Mexico in 1865, our brother's interest in the Craft in nowise abated, for I find he joined the "Union Fraternal" Lodge, No. 20, working in Spanish, and the Lodge "Zur Eintracht" working in German, and was Treasurer of the latter for two years. In June 1866 he was appointed a Member of the first Supreme Council of the Antient and Accepted Rite, and having received the 33° became M.W.S. of the Rose Croix Chapter which works the degree in Spanish in that country. This interest in Masonry was no passing phase, as when at the Legation at Washington in 1871 he was present on the 10th April in that year at the Masonic Reception given by the Grand Lodge of the District of Columbia to the then M.W. Grand Master of England, the Earl de Grey and Ripon, at which Masons from every State in the Union took part, and he shortly afterwards assisted the late Lord Tenterden in giving an exemplification of the English working of the third degree in that Country.

On retiring from the Diplomatic Service and returning to England, he devoted his energies and abilities to Masonry under the different Grand Constitutions of this Country, and, as it will be seen hereafter, attained the highest rank in each, for in 1876 at the Installation of Lord Suffield as Prov.G.M. of Norfolk by his present Majesty the then G.M., our W.M. was nominated as the Prov.G.J. Warden of Norfolk, and was subsequently annually elected the Prov.G.Treasurer of the same province for the years 1880-1890. In the latter year he was appointed Dep.Prov.G.Master of his province and continued that office until 1898 when he was appointed to the higher rank of Prov. G.Master of Norfolk, which office he holds at the present time.

He also obtained Grand Honours in 1891 when he was appointed Junior Grand Deacon.

Before leaving this branch of Freemasonry in which he has shone so conspicuously, it is hardly necessary to remind you of his connection with our own Lodge. He was elected a Member of the Correspondence Circle in June, 1890, attained the honours of full membership of the Inner Circle on the 1st October, 1897, and was elected Treasurer in 1901, on the lamented death of Sir Walter Besant who had held that office since the inception of this Lodge.

In Royal Arch Masonry our Master has attained similarly high rank, for I find he was elected Z. of the Westminster and Keystone Chapter in 1878, and the following

year was appointed Prov. Grand J. of Norfolk. In 1881 he was installed Prov. Grand H. of the same Province and since 1891 has held that office permanently, and finally he was made Assistant Grand Sojourner in Grand Chapter in 1891.

Turning to the so-called higher degrees it will be found that Bro. le Strange has been equally if not more zealous, for in 1880 he took the 31° of the Ancient and Accepted Rite, the 32° in the following year, and the 33° in 1882, when he was appointed Inspector General for the East Central District, which comprises amongst other places the two important Universities of Oxford and Cambridge.

In Knight Templary he has attained similar honours, for after joining the Cabbell Preception at Norwich in 1882, when it was resuscitated, he, two years afterwards, was appointed its Preceptor, and in the same year was appointed Sub-Marshal of East Anglia, and subsequently was nominated Prov. Marshal of the Knight Templars of East Anglia, and held the office of Herald in Great Priory, in 1885.

In Mark Masonry he has also given yeoman service, for after being advanced in the Carnarvon Lodge No. 7, in 1882, he was installed W.M. of the same Lodge in 1894, appointed Grand Master Overseer in 1894, and made D.Prov.G.M. of East Anglia in 1901.

Such, Brethren, is the Masonic biography of the brother whom we are here to honour to-night. It is a record of which any Mason may justly be proud, although I have reason to believe our Master, from his retiring and diffident disposition, would much rather that the numerous and distinguished services he has rendered to the Craft should not be recapitulated and that this toast should have been omitted. It is, however, one of the traditions of this Lodge that the newly installed Master's Masonic life should be passed in review before you, and that you should be made acquainted with the reasons that have actuated the members of the Lodge in electing him to the honourable position in which he has been placed. I am betraying no secret when I say that it has been with some reluctance that our W.M. has been induced to undertake the responsible office to which he has been to-night installed. Enough has been said to convince you that Bro. le Strange is thoroughly qualified to undertake the position of Ruler of this important Masonic body. From the experience he has gained in presiding over large bodies of Masonic Assemblies, from the confidence which we find has been reposed in him by the Grand Rulers in the Craft and other degrees of Freemasonry, there cannot be a doubt but that he will rule and govern this Lodge with dignity, tact and discretion, and that he will further endear himself, not only to those who have known and appreciated his many virtues in the past, but also to that vast body of Masons all over the Globe, which comprises the backbone of this the foremost and most intellectual Lodge under the Grand Lodge of England or any other similar body in the world.

---



ARS QUATUOR CORONATORUM.



## AN OLD ENGRAVED APRON.



At the June meeting of the Rosicrucian College (*Societas Rosicruciana in Anglia*) at Newcastle-upon-Tyne, there was exhibited an old Masonic apron—a plain white leather apron,  $16\frac{1}{2}$  in. by  $14\frac{1}{2}$  in., much worn and very dirty down the right-hand side of the wearer. The semi-circular leather flap,  $5\frac{3}{4}$  in. deep at the centre, is stitched on across the whole width of the top, while at either corner are leathern thongs to tie round the waist.

This apron was formerly the property of Bro. James Wilson, of Berwick-on-Tweed, and is now in the possession of his daughter's son, who, though not a member of our mystic fraternity, values this relic of his maternal grandfather, and preserves it with duteous care.

Bro. James Wilson fought at the Battle of Waterloo, and is authentically reported to have had this identical apron in his possession on the field—"the Badge of Innocence and the Bond of Friendship"—at the Armageddon of the nineteenth century! A tradition of the family has it that the apron was worn by the owner during the battle, which, though possible, is extremely improbable, but, as confirmatory evidence, attention is drawn to a circular hole about the size of two-thirds of a five shilling piece, at the top edge of the apron, behind the flap, with which it does not interfere in the slightest, and therefore can only be seen from the back. To the agricultural mind this is suggestive of a warble hole, or defect in the skin, and the stitching goes straight across it, as complete stitches in the flap only.

Further, assuming the premises as to the wearing to be correct, irrefutable argument for the negative view is forthcoming on anatomical grounds, and the venerable old age at which Bro. Wilson ultimately died. No matter—it is regarded as a "bullet hole," and certain other marks of a reddish colour are "bloodstains."

Masonically the engraving, or rather engravings (for there are two on this plain white apron) are the chief points of interest. On the flap is a group (about 5 in. by 5 in.), a female figure with three children, and a draped pedestal slightly to the left rear—"the Distinguishing Characteristic of a Freemason's Heart," naturally placed at the top and above everything else.

On the apron itself,  $2\frac{1}{2}$  in. below the centre of the flap is the main design, also from an engraved plate, extending to within  $\frac{3}{4}$  in. of the bottom of the apron, and nearly its full width. The principal feature of this is a flight of three steps, the lowest of which is  $13\frac{1}{2}$  in. long. On the top step, at either end, stands a female figure about  $6\frac{1}{2}$  in. in height, that on the right of the wearer, "Hope" with anchor, and pointing upward with the left hand; opposite "Faith" with cross, carried sceptrewise, on the right arm, and clasping V.S.L. with the left. Between these figures, and still on the top step, are (reading from left to right) three candlesticks; a perfect ashlar with a lewis in it, and panelled on the front, a six-pointed star (double triangle) forming the centre; a small irregular looking object, presumably a rough ashlar, but out of all proportion to the perfect ashlar at the other side (it might represent a trowel full of mortar); a trowel; and common gavel. Resting on the uppermost point of the double triangle is a large V.S.L., open at 2nd Chronicles, chapters ii. and iii. On the open book, square and compasses, in



the third position, the points of the compasses and the angle of the square are towards the top. Rising from behind the book the sun in splendour, with human face, visible only from the eyes upward. Springing from behind the sun and inclined to the left of the observer is a ladder, of which four rungs only are in view, the lowest of these having upon it the letter "H," and the highest the letter "C." The "All-seeing Eye" occupies the top centre of the design and on the field at the back between the elbow of "Hope" and the ladder, is a half moon with human face looking towards the centre, while correspondingly at the opposite side, *i.e.*, near the cross and shoulder of "Faith," are seven stars arranged hexagonally with one in the middle. Below the moon and projecting from behind the side of the V.S.L. towards the figure of "Hope" are two columns, only partly seen, the upper one Corinthian (?) fluted, the lower rather like a factory chimney and plain; and similarly placed at the side of the V.S.L. towards "Faith," are a level, plumb, and 24-inch gauge.

Close up to the base of the bottom step mentioned above there is a single line of very small type, which reads, "Drawn & Engraved by Brother Hixon, No. 13 Bridges Street, Covent Garden, & sold by Griffin & Lay, No. 117, Oxford Street, London." At the extreme left of the same line is the word "Published," and at the extreme right the date "Augt. 1. 1794."

Curiously enough in a copy of the itinerary for the Lodge visit to Ludlow on the 7th July last, received by me since these notes were written, the second illustration represents a similar "Engraved Lambskin Apron," by the same maker, but different in that the flap is triangular, and there are still remnants of ribbon, or some other material with which the apron has been edged round—mine is perfectly plain, and has never had any such border—the inscription also differs slightly. In mine the word "and" is invariably hieroglyphic "&," the word "Brother" is *not* abbreviated, "Bridges" is in the plural (13 Bridges Street, not Bridge Street), and lastly the date is "Augt. 1. 1794," instead of *August 1791*.

This is suggestive that the demand for these aprons was sufficiently large to warrant Brother Hixon's publishing more than one edition with slight variations, while, taking the earlier date of publication, and that of the Battle of Waterloo, it is manifest they were in use not only over a period of quarter of a century, but also subsequent to the union of the opposing Grand Lodges.

ST. MAUR.

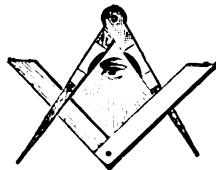





In the name of the Ancient Bull. O.U.M.

We who take care of the Bees and watch their  
movements, who guard that which is the centre, and  
have seen the three: request you good wise ones  
who have done the same things and who have seen the  
same things: to receive and cherish the bearer of this  
whenever he be, provided he can explain what is here  
written & sealed: otherwise you are bound to consider him  
as one who has been stung by the Scorpion

Let him eat a cymbal and drink a kempes, and  
follow the winged ball Give him also for food

The Golden Egg.  
and having gone with him seven steps crown him on  
Mount Meru. Farewell.

Anno Tauri . 6449 . Nov. 16 .

## NOTES ON A CURIOUS CERTIFICATE AND SEAL.

BY BRO. WM. WYNN WESTCOTT, P.M. 2076, P.Z. 329, P.G.D.



THIS document is a certificate of membership of some private Society, probably composed of Freemasons. I have not been able to trace its name, date or place of origin, and have never seen another example. I consider it was drawn about the beginning of the nineteenth century, and the Seal seems to be of English workmanship.

From 1740, onward, very numerous small private societies were started, almost entirely among Freemasons, and they disappeared generally with their inventors. In my own time I have known half-a-dozen so-called Secret Societies founded, and they have died out; the "H.B. of L.," for example, which first saw the light in Yorkshire about 1885, and not in Luxor, and the "Fratres Lucis," which had a clientele about Bristol, *circa* 1870.

The Anno Tauri, 6449, does not give much help in fixing the date; there are Masonic Rites which add 4000 and others which add 4004 years to the Christian era to make a private calendar; but there is no very obvious reason for adding any number between 2600 and 2650; unless indeed one calls to mind an old-fashioned notation, called the "Julian Period," which fixed 4714 years before Christ; this would give 1735, a possible but improbably early date.

The idea that the year of Taurus has any reference to a period when the Vernal Equinox fell in the Sign Taurus, would be, of course, to consign the date to a mythical pre-historic antiquity, such as the legendary "Lemuria," which preceded the "Atlantis" of Plato. Degree-makers have very often been unreasonable, and have put together incongruous materials, and have shown how dangerous a possession is a little learning. In this seal we see a square and compasses for modern Freemasonry, a very European looking key, and a modern candlestick, in juxtaposition with a pseudo-Egyptian figure having a man's body, arms and legs, with the head replaced by an Egyptian *tat* or *ded* as a head-dress (such as is seen in "Wilkinson's Egyptians," vol. vi.)<sup>1</sup> but surmounted by a disc and horns, so often seen upon Isis and other goddesses in ancient Egyptian figures.

In the right hand is an Ankh, quite Egyptian. The Moon is of English type, but the Sun is of Hindoo figure, and the O.V.M. is a transliteration from the Sanscrit, also often written in English letters A.V.M., which was, and is still, considered by Hindoos to be a holy and magical Word of Power, a Mantram in fact. Then we have a motto in Latin to suggest mediæval European culture: *lucem tenebras non comprehe . . . nt.*

The man stands in waves of water, and is drawn full face, or rather front view, both points rare in Egyptian designs.

<sup>1</sup> See also Plate XVI. of the *Pantheon Egyptien* of Champollion the Younger (1825), in which he shows the design on a figure he calls Phtah of Stability: the design *tat* or *ded* has been variously called an altar, a Nilometer, and a part of the spinal column of Osiris.

The use of the Bee as an emblem of associates, and of a Beehive as a type of the ark and of a Lodge are found in the older Masonic writers. To be stung by a scorpion means a cowan and un-initiate, while the phrases, eating a cymbal, drinking a knife, following the winged ball, and feeding on a golden egg, are borrowed from the rituals of French sodalities, which appear to have taken their ideas from the "Symbols of Pythagoras."

The no doubt worthy if discursive Brother, who drew up this Certificate, then ends with a reference to Mount Meru, having gone back to Hindostan for a symbol. This Meru was an imaginary mountain upon which the Swarga or Pantheon of the Hindoo trinity assembled after the manner of the Olympus of Ancient Greece. Meru was the Land of Happiness of the earliest times of the Vedas. Some modern Indian theosophists say that Mount Meru meant the North Pole of the Earth, ever sacred because inaccessible.

If the Ritual of this Society was as polyglot as its Seal and Certificate are polymorphous it would indeed be a quaint production.



## ARAB MASONRY.

BY BRO. JOHN YARKER

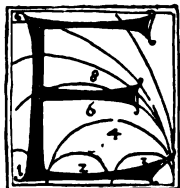

VERY reading Mason is aware that from the time of the original of the "Cooke" MS. Constitutions, say A.D. 1400, it has been handed down that the hunter King, Nimrod, was one of our Grand Masters, and that Abraham, who is said to have fled from him, taught the Egyptians geometry. It is not worth while to attempt to refute the latter statement, as according to Biblical chronology Abraham was not in Egypt until about 1925 B.C., but it would be worth while to ascertain, if we could, what ancient writer, probably Oriental, is responsible for the Abrahamic origin of geometry in Egypt. I am led to put this question because I am aware, of what I have never yet seen mentioned by any Masonic writer, that amongst the Moslems, throughout the world, there is a very ancient Secret Society which claims to derive from the Koreish, or Guardians of the Kaaba, who were a superior Arab race and the descendants of Ishmael, and of which Mohammed was a scion. In the 1st and 2nd degrees of this system precisely the same assertions are made as in our MS. Constitutions, whilst the 3rd degree is devoted to the erection of the Kaaba by Ibraham, Ismael, and Isique, as the three presiding Chiefs. I need not take up your space by describing this Temple, as Sale, in his "Preliminary Observations" to his translation of *Al Koran* gives a full account of the legend as to Abraham's erection of a square temple similar to one destroyed in the deluge, the plans of which were etherially let down from Heaven on the prayer of Adam. I am inclined to give credit to the alleged great antiquity of these three degrees of the Sons of Ibraham, for two reasons, or rather three. In the first place Mohammed himself confirms the basis of the legend in treating of Abraham; in the second place the thirteenth century account of the erection on "Salvation Mount" of the square temple of the San Graal, the plans being similarly heaven designed, is admittedly, by the writer himself, taken from Moslem sources; and, in the third place, I believe, with Ashmole, that our present system was a thirteenth century reform of an older system of Christian Masonry. In 1872 the late Bro. Mackenzie organised the "Order of Ishmael," of 36°, the basis of which, he informed me, he had from an Arab in Paris, and in 1884 I was myself in relation with Prince Moustafa ben Ismael, ex-Prime Minister of Tunis, then in Paris. But Mackenzie's idea seems to have been that our Biblical legends were the transmission of the "Order of Ishmael," of which the "Sons of Ibraham" were a very ancient branch, or, as he terms it, the oldest secret society in the world.

## REVIEWS.

## THE LODGE OF RESEARCH No. 2429, LEICESTER.

Transactions for the Year, 1905-6.



HIS is another volume, of considerable interest and value, edited by Bro. John T. Thorp, F.R.Hist.S., etc., who has ably discharged that duty from the advent of this literary Lodge; and what is surely remarkable, the volumes are of equal merit of late to those of earlier years; the local and general talent appearing to be inexhaustible under the influence of the esteemed Editor, who knows so well on whom to pitch to supply the needed articles and lectures.

The illustrations are of a very suggestive character, one of the most attractive being a French Masonic apron of A.D. 1819, which was lent for exhibition by Bro. T. A. Withey, of Leeds; another specimen being of Newman's design, 1798 ("Ancient"). There are also the Ballintoy Lodge Jewels, the chief three (those of the Wardens, also of silver, having the field cut out; both light and graceful) making a handsome combination. Such reproductions are features of each volume, the articles being either from Bro. Thorp's valuable Library, or lent by other Collectors and Lodges, the particulars supplied being most useful.

The Ballintoy Lodge, No. 38, Ireland, has been sketched by Bro. Thorp, all too briefly. "At the east end of the long village street, composed principally of houses, in which many of the Irish peasants seem content to dwell, but which are not models either of comfort or cleanliness, is a neat, well-built two storied stone structure, with a slab let into the wall, recording as follows:—

Lodge No. 38,  
Erected by the  
Members, A.D. 1805,  
of the Masonic  
Order."

The Masonic Hall is in the upper part, "reached by a winding staircase," but lacking an ante-room. The Lodge Warrant, in a frame, is duly cared for, and is dated 1817, as per revival order of A.D. 1816; the Jewels and clothing being distributed about the Hall, which is about thirty feet square. These three Jewels (W.M. and Wardens) are "veritable gems, the possession of which by a Lodge in so remote a place as Ballintoy is difficult to account for."

The paper by Bro. W. H. Jones (Norfolk) is on "The Cathedral Masons." The author modestly styles it "the bare outline of an attempt, upon his part, to demonstrate the continuity of Freemasonry from the operative period to the speculative, and until to-day, based upon purely local evidences." The period treated extends from the end of the thirteenth century to the dissolution of the Monastery. There are nearly *thirteen hundred* separate Rolls of Accounts, etc., many apparently not having been opened for centuries, until Bro. Jones' visit and examination by consent of the Dean of Norwich, and under the supervision of the Registrar, Dr. W. T. Bensly, F.S.A. These researches have yielded considerable fruit, and brethren interested therein should qualify as members of the Correspondence Circle, 2429 Leicester, by payment of only a *crown* per annum. The Paper will repay most careful study, the statements made

should be duly noted and tested, and I feel assured that my fellow students will much appreciate Bro. Jones' efforts to give a concise account of these valuable MSS.

Bro. Thorp's Paper, this time, was devoted to "Masonic Convivialities," being in part supplemental of one by Bro. Knowles in 1898-9, only chiefly regarding the *after work* customs of Lodges of the *post-Grand Lodge* era. Bro. Thorp mentions that the Festival, in early times, was *before* the business meetings, not subsequently, as later on; but any way, the assemblies were always more or less of a convivial character, and he wisely remarks that "It is not the proper use, but the *abuse* of good things provided, that is deserving of condemnation."

An address was given by Bro. R. Smailes at the November gathering, 1905, on "King Solomon's Temple and the Story of the Third Degree," who well deserved the vote of thanks accorded, because he furnishes a fair digest of the latest information on that important subject. Bro. Dow's racy sketch of the Liverpool Cathedral will be heartily welcomed, and I hope my replies to the twenty-one questions propounded to me for solution and read at the last January meeting, will prove helpful, as it is my earnest desire to further the interest of the Lodge as much as possible, and incite to further study and research. It was a novelty, and seems to have taken well as a change.

An old *Mark Certificate* of 1846, granted by the "Lodge St. Martin," Liskeard (has been reproduced for this volume), under the fictitious authority (or supposed sanction) of No. 750, now 510, the original having been presented to the author of the sketch on the subject (Bro. J. J. Thorp) by Dr. Hammond, a well known and esteemed Craftsman of that town. The Mark and many other Degrees were worked at Redruth, in the same County, about thirty years earlier.

Another paper by the respected Secretary, was devoted to "Irregular Makings and Clandestine Lodges," in March last, the hope expressed by the Author being shared by all of us that

"Clandestine Masonry may soon become a thing of the past, and  
Masons everywhere united in one brotherhood."

The facsimile of the 1753 "Ancient" *engraved List (unique)* exhibited at the same meeting, was produced for the "Quatuor Coronati Lodge," the original being the gift to No. 2076 by our indefatigable Secretary, Bro. W. J. Songhurst.

Other attractive features call for mention, but time and space rebel, so I have to pass over such as the interesting MISCELLANEA MASONICA, etc.

The *Table of Contents* and *List of Plates* are welcome additions to the volume.

W. J. HUGHAN.

---

## FREIMAURERISCHE DEUKMUNZEN UND MEDAILLEN.

*Band VIII. Deutschland, 1742-1905.*

This, the eighth volume of the remarkable and invaluable series on Masonic Medals, will be welcomed by many students, not only because it contains reproductions of the whole of those issued in Germany from 1742 to the present time, but also from the fact that the first volume, devoted to that country, is now out of print. Other plates and descriptions of German pieces in some of the other volumes are likewise inserted and the numbers have been retained as originally allotted to the various plates.

Medals struck since 1903 are also given, so that the collectors have now a reliable and most useful handbook, complete in one volume, of all the German issues. The



M.W. Bro. Carl Wiebe, Grand Master of Hamburg, in his brief but very interesting introduction, wisely observes that the value of a collection depends upon its completeness, and hence the usefulness of such a work as this, in shewing what any collection lacks, and also noting specimens that are doubtful as to their Masonic reference or character. "Our eighth volume claims to be a suitable handbook as it contains all German Medals, from the oldest *Absolom* of 1742 to the newest of the end of 1905, also the *Mozart* plaquette of January 27th, 1906." To avoid even the appearance of any omission "the medal-shaped fellowship or fraternal marks" have been added. The latest Medals run from 1344 to 1387. The arrangement of the numerous pieces is on the alphabetical principle.

The remarks of the Grand Master as to the lamentable ignorance of not a few Craftsmen in regard to Masonic Medals, not only of their own Grand Lodge but even of the Lodges to which they belong will, I hope, be carefully read and heeded by those to whom they are addressed, and his advice to Lodges to commence at once to form Collections should certainly be followed, and for the best of reasons, for some of the pieces struck are but few in number, and are soon snapped up. Bro. Wiebe notes the important fact that "the older pieces get rarer and rarer, year by year, and of the newer ones only a limited number are published, which soon become scarce, because there are more Collectors than formerly."

The whole of the introduction is worth reproduction, and proves how intimate is the knowledge of Bro. Wiebe in respect to the attractive subject of Masonic Medals generally.

In the seven volumes and including the new specimens at the end of the latest issue, there are some 1386 pieces represented (mostly obverses and reverses); surely a wonderful achievement of the *Hamburgische Zirkel-Correspondenz*, and reflecting the greatest credit on all concerned. It is really a wonderful work to have done so much and so well. The Craft throughout the world is much indebted to M. W. Bro. Carl Wiebe and his co-adjutors for this important and invaluable book, which cannot be too warmly appreciated.

W. J. HUGHAN.

---

"THE HISTORY OF THE PHENIX LODGE, NO. 94, SUNDERLAND."

(J. D. Todd, Sans Street Printing Works, Sunderland. Price 5/-.)

The author of this very interesting and ably compiled volume is Bro. Thomas Olman Todd, P.M., 94, son of the veteran Craftsman, Bro. J. D. Todd (who was W.M. of the Lodge, thirty years ago, and has been the indefatigable Secretary from 1884). This Brother has had the gratification of initiating two of his sons into the Lodge, both of whom have passed the chair; probably a unique experience. The handsome book is dedicated to Lord Barnard, the esteemed Prov.G.M.

There is no lack of material from which to make a selection for the history of No. 94, as Bro. J. D. Todd states. "Facts—the chief requirement in History—have been very carefully verified and no speculation hazarded." My lamented friend, William Logan, took great interest in the progress of the work, and placed all the information he had gleaned on the subject at the author's service, a kindness quite in keeping with that dear Brother's conduct generally, and warmly acknowledged by Bro. Todd.

Of the 45 Lodges working in Durham, the Industry, No. 48, dates from its 1753 Warrant, *though it existed long before*, and is the oldest on the Register, the second

oldest being the "Phoenix" No. 94, chartered October 7th, 1755. It is third on the Roll, however, as "St. John" No. 80 is of "Atholl" origin, warranted in 1776, there being, strange to say, three others of an older date than this St. John's, all having "Modern" Warrants, viz., "Palatine," No. 97, of 1757, "Restoration," No. 111, of 1761, and the "Marquis of Granby," No. 124, of 1763 (which also was at work some-time prior to its Charter).

Brethren were "made" in Sunderland before 1755, though the "Phoenix" was the first warranted for that busy spot, as minutes of the "Marquis of Granby," Durham, testify, during the period the members met as an independent Lodge.

The list of Masters of No. 94 is as complete as possible, some of the names being unknown during a few of the early years, but those supplied form a goodly roll of about eighty. The first known was John Thornhill, a remarkable man and a timber importer in a large way. He was exceedingly generous in many ways, especially ecclesiastically.

The first Register, happily, is preserved, containing also the By-Laws of 1755, a Master's Lodge is likewise provided for. Certain portions of Initiation and other Fees and subscriptions were ear-marked for the "Pedestal," the remainder apparently being spent for "the good of the house."

A Masonic Hall was built and dedicated in 1778, the oration being delivered by Bro. William Hutchinson, author of the "Spirit of Masonry," very popular for many years by the Historian of the County. A name was found for the Lodge in the same year, "King George's Lodge" being first of all favoured, but changed to the "Phoenix" later on.

The Hall, alas, was destroyed, but the members soon set about having another built on the old site, and probably the re-building led to the present name of the Lodge being chosen. The foundation stone of the second Hall was laid 5th August, 1784, within nine months of the disastrous fire. Personally, I was agreeably surprised, on my visit to No. 94, to find such a large and commodious Building in a neighbourhood not suggestive of such a fine home for the members.

Bro. Todd refers to three kinds of Lodge meetings being held:—1. General Lodge. 2. Masters' Lodge. 3. Extra Lodge—and states that "it has always been the impression that at the Masters' Lodge only work of the third degree was performed, but a perusal of the minutes shows this supposition to be an error." I think it likely that, as the third degree got to be more generally known, the "Masters' Lodge" was not confined to that ceremony, but the previous degrees were worked, and finally such separate Lodges ceased to be held.

It is a pity that its oldest Book of Constitution is of the year 1815, as there must have been in use those of 1738, 1756, 1767-76 and 1784, all curious, scarce and valuable at the present time.

It is noteworthy that the "Herodim" was worked by the Lodge so early as 1756 and onwards to 1809, during which period 150 members were admitted to that ceremony in special meetings convened for the purpose.

Bro. J. F. Stanfield, who joined in 1789, was a very enthusiastic and capable Brother, who previously belonged to an *unnamed* Lodge, which met at the Bell, in Fleet Street, London. I find that this Lodge was called "Happiness" some years after its constitution, in 1765 as No. 332, and as No. 222 joined the "Castle" in 1821, which was erased later on.

The Lodge took part in some important functions, which are duly noted by its Historian, but cannot well be recorded now, neither must I stay to mention the names

of the members and visitors who were prominent socially, Masonically and generally in Sunderland, such as Dr. Clauny, "indissolubly associated with the Miners' Safety Lamp," and Thomas Robson, the renowned engraver, initiated in the "Phoenix" A.D. 1810.

The R.A. was warranted in 1797, but the Degree is noted some ten years earlier.

The Confirmation Charter of the Lodge is dated 29th September, 1821, and is reproduced in the work. It was granted by H.R.H. the Duke of Sussex, M.W.G.M., who laid the Foundation Stone of the Athenæum on the 12th November, 1839, with Masonic honours; an elaborate account being given.

A Centenary Jewel Warrant was issued in 1899, and the sesqui-centennial of the Lodge was celebrated on October 4th, 1905.

The volume is full of interesting details and admirable biographies, and numerous illustrations are scattered throughout the volume, and is a credit to the Author and Publisher. It should have a large sale.

W. J. HUGHAN.

---

### SOME NOTES ON FREEMASONRY IN AUSTRALASIA FROM THE EARLIEST TIMES TO THE PRESENT DAY.

*By W. F. LAMONBY, P.D.G.M. of Victoria, P.G.D. of Ceremonies of England.*

ANOTHER gap on the library shelf has been filled by the welcome arrival of a volume bearing the above title. Very few of us, indeed, at this side of the world have any idea of Masonry at the Antipodes, either as to its extent, organization, or work, and the information which the learned and distinguished author now affords us comes as a striking revelation as to the magnificent position Freemasonry has attained there, not by the pre-eminent genius of one man in a brief period, but by the steady, persevering efforts over a long period of a large body of zealous rank and file led forward by many of our most gifted craftsmen. The author, in his few brief lines of preface, tells us that of the twenty-three years during which he compiled his notes for the work, nearly one half was spent in Australia, and, as will be gathered from the title page, the high position of Masonic authority he held in that continent gave him many opportunities for acquiring exceptionally valuable information for his future publication. He also tells us that the entire profits of the sale of his work will be devoted to the funds of the Melbourne Masonic Home. His great labour is therefore disinterested as regards personal gain, but this fact should not disarm fair criticism, and I am sure the gifted author would not desire that it should, although it might induce us to look more kindly upon faults, if any there be.

He commences by relating how Captain Cook gave the name to New South Wales when he landed there in 1770, although it was not officially proclaimed until Captain Philip landed at Sydney Cove 26th January, 1788 and became the first Governor. After several successors to this office we find that in 1803 a Captain King was in authority. We have then the advent of Freemasonry in Australia. A number of brethren started a lodge undaunted by the new Governor withholding his sanction. A defiant proceeding quickly followed by the arrest of several of the offenders. As to this act of apparent severity, the author rightly calls to our minds the difficulties surrounding the Governor of a new and far distant colony in those days, and not the least would be the considerable infusion of dangerous and unruly elements amongst the population who had to be dealt with in a firm and decided manner on the least appearance of insubordination. Any sign of leniency on his part in this affair might easily have been construed into weakness

and have brought about disaster to the colony. There were also the echoes from the old country of the influence of the recently enacted Secret Societies Act, which at that time was seriously exercising the minds of the authorities at home.

We assume that the Lodge, promoted under such discouraging circumstances, ceased to work as the author proceeds to relate the origin of the first *regular* Lodge in Australia, established by the authority of the Grand Lodge of Ireland and opened in 1813 under the wing of the Lodge of *Social and Military Virtue* No. 227 (Irish Constitution), chartered A.D. 1752, and attached to the 46th Regiment, which was then stationed in Sydney. This Lodge, No. 227, had a distinguished history and eventually became No. 1 on the Roll of the Grand Lodge of Canada, and its offspring No. 1 on the Roll of the Grand Lodge of New South Wales. A remarkable circumstance for mother and daughter to be each holding such a proud position.

Bro. Lamonby then gives a lengthy and interesting sketch of the evolution of the Grand Lodges in Australasia shewing the entrance on the scene of individual Lodges of divers nationalities and at various periods, warranted and working under different constitutions; the creation of Provincial or District Grand Lodges; and finally the severance from the control of the parent authorities and the erection of distinct and independent Grand Lodges. In doing this he presents a large and valuable mass of details shewing a painstaking accuracy as to facts in the sequent and lucid arrangement of his narrative—a characteristic of our brother—which will render his volume a standard authority, not only to those who are interested in Australasian Masonry but to the diligent student of Masonry Universal who desires to extend his view beyond his own limited home horizon. In addition to the exceedingly valuable data contained in the text he gives also a large number of well executed illustrations, mainly portraits of living and deceased brethren of high Australasian Masonic rank. Amongst them we recognize those of the late Sir Wm. Jno. Clarke (to whose memory this volume is dedicated), first Grand Master of Victoria; Lord Brassey, the second Grand Master; the Earl of Kintore, second Grand Master of South Australia; and Sir Gerard Smith, first Grand Master of Western Australia; who, by the way, had a high reputation in Hull, years ago, for great public spirit and local patriotism. In all some forty or more faces greet us of brethren eminent in social, public and Masonic life who have had the welfare and prosperity of the Craft sincerely and thoroughly at heart.

The steady flow of the writer's text is occasionally enlivened by the mention of incidents which appeal to the reader's sense of humour. Here, for instance, is the opening of the Lodge St. Andrew's No. 1 on the Roll of the Tasmanian Grand Lodge in 1876. Let the author give it in his own words. "It seems the officers' collar jewels were "not to hand on the (opening) day; but nothing deterred, the appendages were hastily "cut out of *tin plate* for the occasion." As might easily be gathered, a Lodge which, at its very opening, proved so apt at meeting an unexpected difficulty would be equal to coping successfully with others, and a very amusing confirmation of this is related a little later—how the brethren outwitted their District Grand Master when he imagined that he had them 'in a tight corner.' However, the reader is referred to the volume itself to learn all about this affair and much else both instructive and entertaining. We have not the least misgiving that if the merit of Bro. Lamonby's work is appreciated as it well deserves to be, a second edition will soon be demanded, that is, if not already in prospect. Bound in cloth, 8vo., pp. 158. Fine toned paper and beautifully *clear* and *readable* type. Printed and published by Warrington & Co., 23, Garrick Street, London, W.C. Price Five Shillings.

WILLIAM WATSON.

## OBITUARY.

---



It is with regret that we have to announce the death of Brothers:—

**William Fooks**, LL.B., of 2, Brick Court, Temple, London, E.C., in June, 1906. He joined the Correspondence Circle in October, 1891.

**Thomas Pickering**, of 43, Osborne Road, Newcastle-on-Tyne, on the 28th June. Our Brother had a remarkable Masonic record and held high office in the Provincial Grand Lodge of Northumberland, the Provincial Grand Mark Lodge of Northumberland and Durham, the Provincial Grand Chapter of Northumberland, the Provincial Priory of Knights Templar, the Divisional Conclave of the Red Cross of Constantine, the Provincial Grand Lodge of the Royal Order of Scotland, and the Societas Rosicruciana in Anglia. He joined the Correspondence Circle in June, 1892.

**The Rev. Peter Royston**, M.A., of Orton Longueville, Peterborough, on the 7th August. Our Brother was a Past Provincial Grand Chaplain of Norths. and Hunts. In 1873 he published the "History and Antiquities of Rudston." He joined the Correspondence Circle in May, 1897.

**Hiram Long**, of 5, Egerton Road, Greenwich, S.E., on the 12th July. He joined the Correspondence Circle in January, 1903.

**Howard Douglas Williams**, of Sefton House, Hardwick Road, Eastbourne, on the 6th July. He joined the Correspondence Circle in June, 1894.

**James Dunning Baker Gribble**, of Secunderabad, India, on the 28th August. Our Brother was initiated at Secunderabad, under the Scotch Constitution, and took his third degree in Roumania, subsequently joining several Lodges in India, under the English Constitution. He attained the rank of Grand Master Depute of the Grand Lodge of all Scottish Freemasonry in India. He was the author of a "History of the Deccan," and "Masonic Lodges of Hyderabad." He joined the Correspondence Circle in October, 1893.

**Charles Edwin Ferry**, Past Grand Standard Bearer, Past Grand Assistant Director of Ceremonies, (R.A.), of Beverleys, Thornby Road, Spring Grove, Isleworth, on the 6th October. Our Brother was well known in London as a lecturer on Masonic subjects. He was one of the first to join the Correspondence Circle, in February, 1887, his number on the register being No. 17.

**Albert Wolff**, of Brisbane, Queensland, on the 30th July. He joined the Correspondence Circle in June, 1903.

**Octavius Marsland**, of 15 Seething Lane, London, E.C., on the 28th September. He joined the Correspondence Circle in November, 1895.

**Henry Parkin**, of 64, Devereux Road, New Wandsworth, London, S.W., on the 16th October. He joined the Correspondence Circle in November, 1903.

**Robert Isaac Finnemore**, J.P., Past District Grand Master, Past Grand Superintendent, Natal, of Pietermaritzburg, Natal, on the 22nd July. He joined the Correspondence Circle in January, 1889.

**Henry Moors**, of 498, Punt Hill, South Yarra, Victoria, on the 19th September. He joined the Correspondence Circle in October 1892.

**R. B. Hopkins**, of 17, Kellett Road, Brixton, London, S.W., on the 8th November. He joined the Correspondence Circle in October, 1905.

**James Richard Roffey**, of 106, Leeds Street, Liverpool, on the 11th November. He joined the Correspondence Circle in March, 1889.

**The Hon. William Henry Upton**, M.A., LL.M., F.R.S.A., of Walla Walla, Washington, U.S.A., on the 3rd November. Our Brother was a lawyer of distinction, and was admitted to the Bar in Washington, D.C. in 1880. A few years later he was elected Judge of the State of Washington, holding the office until 1897. He was a Fellow of the Royal Society of Antiquaries of Ireland, and local Secretary of the Harleian Society. He was initiated in the Blue Mountain Lodge, No. 13, and became its Master in 1891. In the following year he was largely instrumental in forming the Walla Walla Masonic Library, and was a frequent contributor to the Masonic Press, several interesting papers written by him having appeared in *A.Q.C.* In 1897 he compiled and annotated the Constitutions of the Grand Lodge of Washington. He joined the Correspondence Circle in March, 1893, and acted as Local Secretary for Washington for thirteen years.

---

#### ERRATA.

- Page 34, last line, for "*lust*" read "*luft*."  
 „ „ line 4 from bottom, for "*lust*" read "*luft*."  
 „ 100, line 9, for "*monasteries*" read "*their order*."  
 „ 144, "An early use of the word Freemason," line 1, for "*Clarnwood*" read "*Charnwood*."
-









HEARTY GOOD WISHES  
TO THE  
MEMBERS OF BOTH CIRCLES  
FROM THE  
W.M. AND OFFICERS  
OF THE  
QUATUOR CORONATI LODGE No. 2076,  
St. JOHN'S DAY IN WINTER,  
A.D. 1906.



# ST. JOHN'S CARD

OF THE

Quatuor Coronati Lodge, No. 2076,  
London,



**27th December, 1906.**

H. KEBLE, PRINTER, MARGATE.  
1906.



HUNSTANTON HALL, NORFOLK,

ST. JOHN'S DAY IN WINTER, 1906.

BRETHREN,



AM proud of the honour of having been placed in the Chair of the Quatuor Coronati Lodge in the year in which it has attained its majority and celebrated the twenty-first year of its existence. During those twenty-one years the Lodge has done much to carry out the nine objects for which it was founded, as set forth inside the cover of each number of our *Transactions*. Of the work accomplished in the first five years after its foundation I have given a short *résumé* in my Inaugural Address; it would be too much, perhaps, to assert that the high level attained in those early years has always been kept up, but we may at least claim that no volume has been issued which does not contain a considerable proportion of original research, that does not enshrine much of past Masonic history which, without such a store-house, would be in danger of being forgotten and perhaps irretrievably lost. But though much has been done, much remains to do, and we eagerly invite the assistance of members, especially of those of the Correspondence Circle, to contribute towards building up the temple of Masonic learning. Nothing is too small, no fragment too insignificant. Let us, one and all, industriously and diligently collect materials, leaving perhaps to master-minds in the future the task of fitting them into their proper places in the structure.

In one respect we may fairly congratulate ourselves, namely, that the Lodge has recovered the ground lost to us by the South African War, which cost us so many members from both sides, and temporarily arrested our growth. A glance at the list of our present members, issued herewith, will shew that we have enrolled the largest numbers that we have ever attained, and it was a great satisfaction to hear from our Secretary, at the Installation Banquet, that he had received a number of letters from former South African members, expressing their ability and their desire to resume their connection with the Lodge.

I must leave to our Bro. Henry Sadler, Sub-Librarian of Grand Lodge, whose stores of information are now, as always, freely at the disposal of every student, the task of giving biographical details respecting the Earl of Crawford, a former Grand Master, whose portrait adorns our St. John's Card. It only remains for me, on behalf of all the Officers, to convey the heartiest of greetings to all Brethren, known to me or unknown, who are comprised in the ever widening Circle of our Good Fellowship.

With every good wish for the welfare of each and all,

I remain,

Yours very fraternally,

HAMON LE STRANGE, W.M.

## FRONTISPIECE.

---

JOHN, EARL OF CRAUFURD, Grand Master of English Freemasons, 1734. Born 1702, succeeded as 20th Earl 1713, died 1749.

**“John Lindesay, Earl of Craufurd and Lindesay; Lord Lindesay of Glenesk; and Lord Lindesay of the Byers. One of the Sixteen Peers for Scotland; Lieut.-General of His Majesty's Forces; and Colonel of the Royal North British Grey Dragoons,”**—Is the description given of the subject of our Frontispiece, by Richard Rolt, the writer of his memoirs in 1753. The Earl of Craufurd, as may be gathered from his military titles, was a distinguished soldier, and one might say a born fighter—for when not fighting for his own King and country his sword was ever ready in the quarrels of others. He served with great distinction in the German Army, in the war between Germany and France, and subsequently on behalf of Russia in its war with Turkey. In the year 1739 a musket ball shattered his left thigh-bone, which put a stop to his fighting for a considerable time. Nevertheless he joined the British Army in Flanders, in 1743, and took part in the battle of Dettingen, on which occasion he received special commendation. At Fontenay he is said to have held the post of honour, and covered the retreat with great gallantry.

His biographer relates several anecdotes of his early youth, illustrative of his fiery and daring disposition, one of which, being of a somewhat amusing nature, seems worth repeating.

Having finished his home education, he was sent to Paris, and, like the generality of Scottish noblemen of the period, was well received at the French Court. The King of France, Louis XV., then in the thirteenth year of his age, naturally required amusement of a different character to that provided for his predecessors of more mature years. Hence, “The ceremony and dinner being over at Court, it was so ordered that a fish-pond should be drawn in the gardens of Versailles, for the amusement of His Majesty, where a great concourse of spectators attended, together with the nobility in their robes. On the approach of His Majesty, near the pond, the multitude pressed eagerly forwards to gratify their view, for which the Earl of Craufurd was equally anxious with the rest: but he happened to stand by a courtier, who was a marquis in his ceremonial robes; and who, apprehending that his lordship stood somewhat to his inconveniency, gave him a disrespectful push, accompanied with an insolent reprimand; which so irritated the young Earl, that, conscious of his own quality, and the indignity offered to him, he instantly took up the French marquis in his arms, and violently threw him, robes and all, headlong into the pond, in presence of the King; which created a prodigious laughter among the spectators, and particularly to his Majesty, who, on making enquiry into the affair, was informed of the nature of the affront, and that it was a young British nobleman who had so warmly shown his resentment; whereupon no notice was taken of the affair, either by his majesty, or the poor marquis, whose insolence received so seasonable a damp.”

The Earl of Craufurd has left several graphic and soldierly descriptions of the principal battles wherein he was engaged, which have been duly copied from his journals and are incorporated in his memoirs. It is, however, with his Masonic, rather than with his public career that we are at present concerned.

His lordship was initiated in the Lodge of Edinburgh (now known as Mary's Chapel), No. 1, August 7th, 1733, under the temporary presidency of the Earl of Strathmore, then Grand Master of the Grand Lodge of England. On the 13th December following his initiation the Earl of Craufurd attended a meeting of the Grand Lodge of

England, and again on 18th March, 1734, when the Deputy Grand Master, in the absence of the Earl of Strathmore, on urgent business in Scotland, proposed John, Earl of Craufurd as Grand Master for the ensuing year, "which proposal was kindly received and unanimously approved of." The following description of his lordship's investiture at the Grand Feast, held at Mercers' Hall, is copied from the Grand Lodge Minute Book.

"Saturday March 30th, 1734

"At the House of the R<sup>t</sup>. Hon<sup>ble</sup>. The Earle of Craufurd in Great Marleburgh Street, where mett a splendid Appearance of Noblemen and Gentlemen of the first Rank (being Masons) all clothed in White Aprons and Gloves, who proceeded in a regular manner in Procession to Mercers Hall in Cheapside, and being withdrawn into a Convenient Room, The Masters and Wardens of the respective Lodges were called in. Then the Deputy Grand Master proposed the R<sup>t</sup>. Hon<sup>ble</sup>. The Earle of Craufurd to be Grand Master for the year ensuing, who was unanimously accepted of with great applause."

"Adjourned to Dinner.

"After Dinner the Deputy Grand Master &c. walked round the Hall in Procession and took leave of the Brethren in the name of the Earle of Strathmore last Grand Master, and being returned and seated, Then the Deputy Grand Master invested The R<sup>t</sup>. Hon<sup>ble</sup>. The Earle of Craufurd, Grand Master with the proper Badge of his Office and desired him to proceed to the Election of his Officers.

"Whereupon his Lordship taking the Chair, proceeded to the Election of his Officers in manner following, viz<sup>t</sup>.

Sir Cecil Wray, Bart., D.G.M.  
 John Ward, Esq<sup>r</sup>., Senior Grand Warden  
 Sir Edward Mansell, Junior Grand Warden  
 Mr. John Revis, Grand Secretary  
 Mr. George Moody, Sword Bearer."

From our present day point of view this would appear to be a case of very rapid promotion indeed, but such cases were not unusual at this period, when a new Grand Master was chosen every year, and as it was considered desirable to have a nobleman in that position, the supply was not always equal to the demand.

No other meeting of the Grand Lodge was held during the year 1734—the next meeting being on the 24th February, 1735, when the Earl of Craufurd presided and proposed for his successor the Viscount Weymouth, who was duly elected and invested on the 17th April following.

The Earl of Craufurd was no mere figure-head of the Grand Lodge, but during his connection with it he evinced a keen interest in its concerns and those of the Craft generally. The last occasion of his presiding, prior to the Grand Festival of the year, when he invested his successor, was on the 31st March, 1735. He then made several important suggestions, which were evidently highly appreciated by the Brethren, as, at the close of the proceedings, "The General Healths being drunk, and his Lordship's in particular, with the greatest unanimity and affection, attended with Thanks for his Excellent and acceptable administration, which his Lordship was pleased to return in good wishes for the Prosperity of the Craft, and was pleased to say that what he had done in this matter he took to be no less his Duty than it had been his Inclination."

Further particulars of the Masonic and military career of the Earl of Craufurd may be found in the "History of the Lodge of Edinburgh," by David Murray Lyon, also in "Military Lodges, The Apron and the Sword," by Robert Freke Gould.

HENRY SADLER.



## Founders and Past Masters :

- \* SIR CHARLES WARREN, *G.C.M.G.*, Lieut.-General, *P.D.G.M.*, Eastern Archipelago, Past Master.
- \* WILLIAM HARRY RYLANDS, *F.S.A.*, *P.A.G.D.C.*, Past Master.
- \* ROBERT FREKE GOULD, *P.G.D.*, Past Master.
- \* REV. ADOLPHUS F. A. WOODFORD, *M.A.*, *P.G.C.* (Died 23rd December, 1887.)
- \* SIR WALTER BESANT, *M.A.*, *F.S.A.* (Died 6th June, 1901.)
- \* JOHN PAUL RYLANDS, *F.S.A.*
- \* SISSON COOPER PRATT, Lieut.-Col., *R.A.*, Past Master.
- \* WILLIAM JAMES HUGHAN, *P.G.D.*
- \* GEORGE WILLIAM SPETH, *F.R.Hist.S.*, *P.A.G.D.C.* (Died 19th April, 1901.)
- WILLIAM SIMPSON, *R.I.*, *M.R.A.S.*, Past Master. (Died 17th August, 1899.)
- WITHAM MATTHEW BYWATER, *P.G.S.B.*, Past Master.
- THOMAS HAYTER LEWIS, Professor, *F.S.A.*, *F.R.I.B.A.*, Past Master (Died 10th December, 1898).
- WILLIAM WYNN WESTCOTT, *M.B.*, *P.G.D.*, Past Master.
- REV. CHARLES JAMES BALL, *M.A.*, Past Master.
- EDWARD MACBEAN, Past Master.
- GUSTAV ADOLPH CÆSAR KUPFERSCHMIDT, *A.G.S.G.C.*, Past Master (Died 30th Oct., 1901.)
- SYDNEY TURNER KLEIN, *F.L.S.*, *F.R.A.S.*, Past Master.
- SIR CASPAR PURDON CLARKE, *C.I.E.*, Past Master.
- THOMAS BOWMAN WHYTEHEAD, *P.G.S.B.*, Past Master.
- EDWARD CONDER, Junr., *J.P.*, *F.S.A.*, Past Master.
- GOTTHELF GREINER, *A.G.S.G.C.*, *P.A.G.D.C.*, Past Master.
- EDWARD JAMES CASTLE, *K.C.*, *P.D.G.Reg.*, Past Master.
- SIR ALBERT HASTINGS MARKHAM, Admiral, *K.C.B.*, *P.D.G.M.*, Malta, Past Master.
- REV. CANON JOHN WILLIAM HORSLEY, *M.A.*, *G.Chap.*, Past Master.
- GEORGE LAWRENCE SHACKLES, Past Master.

---

## Officers of the Lodge and Committee :

Worshipful Master	HAMON LE STRANGE, <i>M.A.</i> , <i>F.S.A.</i> , Prov. <i>G.M.</i> , Norfolk.
Immediate Past Master	GEORGE LAWRENCE SHACKLES.
Senior Warden	EDWARD ARMITAGE, <i>M.A.</i> , <i>P.D.G.D.C.</i>
Junior Warden	FRANCIS HASTINGS GOLDNEY, <i>P.G.D.</i>
Treasurer	WILLIAM HARRY RYLANDS, <i>F.S.A.</i> , <i>P.A.G.D.C.</i>
Secretary	WILLIAM JOHN SONGHURST, <i>F.C.I.S.</i>
Senior Deacon	JOHN THOMAS THORP, <i>F.R.Hist.S.</i> , <i>P.A.G.D.C.</i>
Junior Deacon	FREDERICK JOSEPH WILLIAM CROWE, <i>P.G.O.</i>
Director of Ceremonies	WITHAM MATTHEW BYWATER, <i>P.G.S.B.</i>
Chaplain	REV. CANON JOHN WILLIAM HORSLEY, <i>M.A.</i> , <i>G.Chap.</i>
Inner Guard	HENRY SADLER, <i>G.Tyler.</i>
Steward	WILLIAM WATSON.
Steward	JOHN PERCY SIMPSON, <i>B.A.</i>
	WILLIAM JOHN CHETWODE CRAWLEY, <i>LL.D.</i> , <i>D.C.L.</i> , Gr. Treas. Ireland.

---

## Tyler :

JOHN W. FREEMAN, *P.M.*, 147. Freemasons' Hall, Great Queen Street, W.C.

\* Founders.

# MEMBERS OF THE LODGE

## IN THE ORDER OF THEIR SENIORITY.

---

- 1a **Warren**, Sir Charles, G.C.M.G., K.C.B., F.R.S., Lieut-General. 10, Wellington Crescent, Ramsgate. 278, 1417, 1832, P.M. Founder and First Worshipful Master. **Past Grand Deacon, Past District Grand Master, Eastern Archipelago.**
- 1b **Rylands**, William Harry, F.S.A. 61, *Lincoln's Inn Fields, London, W.C.* 2. P.M. Founder and First Senior Warden. Past Master. Treasurer. **Past Assistant Grand Director of Ceremonies.**
- 1c **Gould**, Robert Freke, late 31st Regt., Barrister-at-Law. *Kingfield, Woking, Surrey.* 92, 153, 570, 743, P.M. Founder and First Junior Warden. Past Master. **Past Grand Deacon.**
- 1d **Rylands**, John Paul, Barrister-at-Law, F.S.A. *Heather Lea, Charlesville, Birkenhead.* 148, 1354. Founder.
- 1e **Pratt**, Sisson Cooper, Lieut.-Colonel, Royal Artillery. *Gloucester Mansions, Harrington Gardens, S.W., London.* 92. Founder. Past Master.
- 1f **Hughan**, William James. *Dunscove, Torquay, Devon.* 131, P.M. Founder. P.Pr.G.Sec., P.Pr.G.W., Cornwall. **Past Grand Warden, Iowa. Past Grand Deacon.**
- 7 **Bywater**, Witham Matthew. 33, *Telford Avenue, Streatham Hill, S.W., London.* 19, P.M. Past Master and Director of Ceremonies. **Past Grand Sword Bearer.** Joined 7th April 1886.
- 8 **Whytehead**, Thomas Bowman. *Acomb House, York.* 1611, 2328, P.M., P.Pr.G.W., North and East Yorks. **Past Grand Sword Bearer. Past Grand Warden, New Zealand.** Past Master. Joined 7th April 1886.
- 9 **Westcott**. William Wynn, M.B., Lond. 396 *Camden Road, N.W. London.* 814, P.M., P.Pr.G.D.C., Somersetshire. **Past Grand Deacon.** Past Master. Joined 2nd December 1886.
- 10 **Crawley**, William John Chetwode, LL.D., D.C.L., F.R.G.S., F.G.S., F.R.Hist.S. Member of the Senate, Dublin University. *Ely Place, Dublin.* 357 (I.C.), P.M., Elected Grand Secretary of the G.L. of Instruction, and Past Registrar of the Grand Chapter of Instruction, Ireland. **Grand Treasurer, Ireland.** Member of Permanent Committee. Joined 2nd June 1887
- 11 **Ball**, Rev. Charles James, M.A. Oxon., Clerk in Holy Orders. *Blechingdon Rectory, Oxford.* 1820. Past Master. Joined 8th September 1887.
- 12 **Castle**, Edward James, late Royal Engineers, Barrister-at-Law, K.C. 1, *Temple Gardens, Temple, E.C., London.* 143, P.M. **Past Dep. Grand Registrar.** Past Master. Joined 4th May 1888.
- 13 **Macbean**, Edward, F.R.G.S., F.R.S.L. 31 *Athole Gardens, Kelvinside, Glasgow, W.* 1 (S.C.), 2029, P.Z. Past Master. Joined 4th May 1888.
- 14 **Goldney**, Frederick Hastings. *Camberley, Surrey.* 259, 335, 626, P.M., Pr.G.Treas., P.Pr.G.W., Wiltshire. **Past Grand Deacon.** Junior Warden. Joined 4th May 1888.
- 15 **Clarke**, Sir Caspar Purdon, C.I.E., F.S.A. *Metropolitan Museum, New York, U.S.A.* 1196. Past Master. Joined 4th January 1889.
- 16 **Klein**, Sydney Turner, F.L.S., F.R.A.S. *Hatherlow, Raglan Road, Reigate, Surrey.* 404. Past Master. Joined 8th November 1889.
- 17 **Markham**, Sir Albert Hastings, K.C.B., Admiral, A.D.C., F.R.G.S. 12 *Petersham Terrace, South Kensington, S.W., London.* 257, 1593, P.M. **Past District Grand Master, Past Grand Superintendent, Malta.** Past Master. Joined 24th June 1891.

- 18 **Ninnis**, Belgrave, M.D., Inspector General, R.N., F.R.G.S., F.S.A. *Brockenhurst, Aldrington Road, Streatham, S.W., London.* 259, 1174, 1691, P.M., P.Dis.G.D., Malta. **Past Grand Deacon**, Joined 9th November 1891.
- 19 **Malczovich**, Ladislas Aurèle de. *Belügyministerium, Budapest, Hungary.* Lodge Szent Istvan. Member of the Council of the Order, Hungary. **Representative of Grand Lodge, Ireland.** Local Secretary for Hungary. Joined 5th January 1894.
- 20 **Conder**, Edward, jun., J.P., F.S.A. *The Conigree, Newent, Gloucestershire.* 1036, 1074, 280. Past Master. Local Secretary for Oxfordshire and Gloucestershire. Joined 5th January 1894.
- 21 **Greiner**, Gotthelf. 10 & 12 *Millon Street, Cripplegate, E.C., London.* 92, P.M. **Past Assistant Grand Director of Ceremonies. Assistant Grand Secretary for German Correspondence.** Past Master. Joined 24th June, 1896.
- 22 **Horsley**, Rev. Canon John William, M.A., Oxon., Clerk in Holy Orders. *St. Peter's Rectory, Walworth, S.E., London.* 1973. **Grand Chaplain.** Past Master and Chaplain. Joined 24th June 1896.
- 23 **Shackles**, George Lawrence. "*Wickersley*," *Brough, East Yorks.* 57, 1511, 2494, P.M., 1511, P.Z. P.Pr.G.D., P.Pr.G.R., North and East Yorkshire. Immediate Past Master. Local Secretary for the North and East Ridings of Yorkshire. Joined 7th May 1897.
- 24 **Le Strange**, Hamon, M.A., F.S.A. *Hunstanton Hall, Norfolk.* 10, 16, 52, 2852, P.M., 10, 52, 2852, P.Z., P.P.G.W., P.Pr.G.Treas., P.D.Pr.G.M., Pr.G.H., Norfolk. **Provincial Grand Master, Norfolk. Past Grand Deacon.** Worshipful Master. Joined 1st October 1897.
- 25 **Armitage**, Edward M.A. *Greenhills, Tilford, Farnham, Surrey.* 859, 1074, 1492, 2851, P.M., 859, 1074, 1 (S.C.), P.Z. **Past Deputy Grand Director of Ceremonies.** Senior Warden. Joined 7th October 1898.
- 26 **Crowe**, Frederick Joseph William. *Marsden, Chichester.* 328, P.M., 710, P.Z., P.Pr.G.Reg., P.P.G.Sc.N. **Past Grand Organist** (Craft and R.A.). Junior Deacon. Joined 8th November 1898.
- 27 **Thorp**, John Thomas, F.R.Hist.S. 57 *Regent Road, Leicester.* 523, 2429, P.M., 279, P.Z., Pr.G.W., Pr.G.J., Leicestershire and Rutland. **Past Assistant Grand Director of Ceremonies** (Craft and R.A.). Senior Deacon. Joined 8th November 1900.
- 28 **Hovenden**, Robert, F.S.A., F.R.Hist.S. *Heathcote, Park Hill Road, Croydon, Surrey.* 21, 2140, P.M. **Past Grand Steward.** Joined 24th June, 1901.
- 29 **Sadler**, Henry. *Freemasons' Hall, Great Queen Street, W.C., London.* 147, 2148, P.M., 7, 169, P.Z. **Grand Tyler.** Sub Librarian Grand Lodge of England. Inner Guard. Joined 1st May 1903.
- 30 **Robertson**, John Ross. 291 *Sherbourne Street, Toronto, Canada.* 28, 369, P.M. **Past Grand Warden, England; Past Grand Master, Canada.** Joined 6th May 1904.
- 31 **Watson**, William, 105 *Victoria Road, Headingley, Leeds.* 61, P.M., P.Pr.G.W., P.Pr.G.So., Librarian, West Yorks. Senior Steward. Joined 3rd March 1905.
- 32 **Songhurst**, William John, F.C.I.S. 61 *Lincoln's Inn Fields, W.C., London.* 227, 2647, 3040, P.M., 7, 720, P.Z. Secretary. Joined 2nd March 1906.
- 33 **Simpson**, John Percy, B.A. 4 *New Court, Lincoln's Inn, W.C., London.* 176, P.M., 176, P.Z. Junior Steward. Joined 25th June 1906.
- 34 **Dring**, Edmund Hunt. *Cadeleigh, Guildersfield Road, Streatham Common, S.W., London.* 1297. Joined 25th June 1906.
- 35 **Hawkins**, Edward Lovell, M.A. Oxon. *Barham House, London Road, St. Leonard's-on-Sea.* 357, P.M., 478, P.M., 1842, W.M., P.Prov.S.G.W., P.Prov.G.Sec., Oxon., 357, P.Z., P.Prov.G.Sc.E., Oxon. Re-joined 8th November 1906.

---

### HONORARY MEMBER.

- H.R.H. Prince Friedrich Leopold of Prussia, Berlin.** Ordens Meister. National Grand Lodge of Germany. **Past Grand Master, England.** Honorary Member. Joined 4th January 1901.



# MEMBERS of the CORRESPONDENCE CIRCLE.<sup>1</sup>

## GOVERNING BODIES.

		Joined.
1 United Grand Lodge of England, Library	London	September 1887
2 Grand Lodge of Ireland, Library	Dublin	November 1903
3 Grand Lodge of Scotland	Edinburgh	June 1905
4 Provincial Grand Lodge of Staffordshire	Stafford	May 1889
5 Provincial Grand Chapter of Staffordshire	Stafford	May 1890
6 Provincial Grand Lodge of West Yorkshire, Library	Leeds	October 1889
7 Provincial Grand Lodge of Norfolk	Norwich	November 1901
8 Provincial Grand Lodge of West Lancashire, Library	Aughton, Ormskirk	October 1905
9 District Grand Lodge of Gibraltar	Gibraltar	March 1889
10 District Grand Lodge of Malta	Valetta	January 1890
11 National Grand Lodge of Norway	Christiania	March 1904
12 District Grand Lodge of Natal	Pietermaritzburg	June 1889
13 District Grand Lodge of Punjab	Lahore	May 1888
14 District Grand Lodge of Burma	Rangoon	June 1890
15 District Grand Lodge of Madras	Madras	May 1894
16 District Grand Lodge of the Argentine Republic	Buenos Aires	January 1891
17 District Grand Lodge of Eastern Archipelago	Singapore	October 1890
18 District Grand Lodge of Northern China	Shanghai	May 1895
19 District Grand Lodge of Queensland (E C.)	Brisbane	June 1895
20 District Grand Lodge of South Africa, W. Div.	Cape Town	June 1899
21 Grand Lodge of Alabama	Montgomery, Alabama	May 1904
22 Grand Lodge of the District of Columbia	Washington, D.C., U.S.A.	October 1903
23 Grand Lodge of Iowa, Masonic Library	Cedar Rapids	October 1888
24 *Grand Lodge of Kansas	Topoka	October 1903
25 Grand Lodge of Kentucky, Library	Louisville	May 1889
26 Grand Lodge of Maine	Portland	January 1905
27 Grand Lodge of Manitoba	Winnipeg	September 1887
28 Grand Lodge of Massachusetts	Boston	January 1890
29 Grand Lodge of Montana	Helena, Montana	March 1898
30 Grand Lodge of New York, Masonic Library	New York	November 1890
31 Grand Lodge of Pennsylvania, Library	Philadelphia	May 1900
32 Grand Lodge of Virginia	Richmond	January 1893
33 *Grand Lodge of Florida	Jacksonville	January 1902
34 Grand Lodge of Wisconsin	Milwaukee, Wis.	October 1906
35 *Grand Lodge of British Columbia	Victoria, B.C.	January 1903
36 Grand Lodge of Canada	Hamilton, Ontario	October 1903
37 Grand National Lodge of Germany, Library	Berlin	May 1887

<sup>1</sup>Owing to the continually increasing length of our member-list, it has become impossible to await the November elections before going to press. The list has, consequently, been drawn up immediately after the October meeting, and Correspondence Members admitted in November will be found in a supplementary list. Any alterations for subsequent issues should, therefore, reach the Secretary before October of each year.

		Joined.
38	Grand Lodge of Hamburg, Library	Hamburg May 1895
39	Provincial Grand Lodge of Lower Saxony, Library	Hamburg January 1894
40	Grand Lodge of the Netherlands	The Hague October 1899
41	Provincial Grand Lodge, Netherlands, South Africa	Capetown January 1899
42	Grand Lodge of the Republic of Costa Rica	San José June 1902
43	Grand Lodge of New Zealand	Wellington November 1891
44	Grand Lodge of South Australia	Adelaide January 1890
45	United Grand Lodge of Victoria	Melbourne November 1890
46	United Grand Lodge of New South Wales	Sydney June 1894
47	Supreme Council A. and A.S.R., England	London May 1888
48	Supreme Council, A. and A.S.R., Belgium	Brussels May 1887
49	Supreme Council, A. and A.S.R., S. Jur., U.S.A.	Washington March 1892
50	Supreme Council, A. and A.S.R., Canada	Hamilton March 1896
51	The Grand Council of the Order of the Secret Monitor in England	London June 1888

### LODGES AND CHAPTERS (ON THE ROLL OF THE GRAND LODGE OF ENGLAND.)

		Joined.
52	No. 19 Royal Athelstan Lodge	London January 1890
53	" 39 St. John the Baptist Lodge	Exeter October 1890
54	" 48 Lodge of Industry	Gateshead, Durham June 1895
55	" 57 Humber Lodge	Hull May 1889
56	" 61 Lodge of Probity	Halifax, Yorkshire November 1890
57	" 75 Lodge of Love and Honour	Falmouth November 1901
58	" 107 Philanthropic Lodge	King's Lynn, Norfolk October 1890
59	" 117 Salopian Lodge of Charity	Shrewsbury January 1889
60	" 121 Mount Sinai Lodge	Penzance, Cornwall January 1903
61	" 133 Lodge of Harmony	Faversham, Kent November 1890
62	" 150 Lodge Perfect Unanimity	Madras October 1893
63	" 174 Lodge of Sincerity	London March 1894
64	" 195 Lodge Hengist	Bournemouth March 1891
65	" 227 Ionic Lodge	London June 1895
66	" 236 York Lodge	York October 1888
67	" 238 Pilgrim Lodge	London November 1905
68	" 253 Tyrian Lodge	Derby January 1888
69	" 262 Salopian Lodge	Shrewsbury January 1889
70	" 278 Lodge of Friendship	Gibraltar October 1888
71	" 297 Witham Lodge	Lincoln March 1891
72	" 316 Lodge Unity Peace and Concord, 2nd Battalion The Royal Scots	Kamptee, India October 1901
73	" 345 Lodge Perseverance	Blackburn May 1897
74	" 354 Sussex Lodge	Kingston, Jamaica May 1906
75	" 374 St. Paul's Lodge	Montreal, Canada June 1888
76	" 391 Lodge Independence with Philanthropy	Allahabad, N.W. Prov. January 1896
77	" 393 St. David's Lodge	Berwick-on-Tweed October 1896
78	" 418 Menturia Lodge	Hanley, Staffordshire May 1889
79	" 422 Yarborough Lodge	Gainsboro', Lincolnshire March 1890
80	" 438 Lodge of Harmony	Cawnpore, Bengal January 1901
81	" 450 Cornubian Lodge, "Coombe" Library	Hayle, Cornwall November 1887
82	" 465 Lodge Goodwill	Bellary, Madras October 1893
83	" 466 Lodge of Merit	Stamford October 1898
84	" 508 Lodge Zetland in the East	Singapore October 1890
85	" 510 St. Martin's Lodge	Liskeard, Cornwall March 1890
86	" 525 Lodge Zetland	Hong Kong October 1888
87	" 540 Stuart Lodge	Bedford May 1900
88	" 542 Lodge of Philanthropy	Moulmein, Burma October 1890

No.	Lodge Name	Location	Joined.
89	546 Etruscan Lodge	Longton, Staffords	October 1906
90	551 Yarborough Lodge	Ventnor, I.W.	May 1893
91	555 Lodge Fidelity	Framlingham, Suffolk	June 1903
92	566 Lodge St. Germain	Selby, Yorks	October 1893
93	587 General Lodge of Instruction	Birmingham	May 1900
94	611 Lodge of the Marches	Ludlow, Shropshire	January 1889
95	614 Lodge Star of Burma	Rangoon	June 1890
96	617 Excelsior Lodge	Buenos Aires	May 1890
97	630 St. Cuthbert's Lodge	Howden, Yorks	January 1905
98	637 Portland Lodge	Stoke-on-Trent	October 1888
99	696 St. Bartholomew Lodge	Wednesbury, Staffords	January 1889
100	711 Goodwill Lodge	Port Elizabeth, South Africa	June 1887
101	726 Staffordshire Knot Lodge	Stafford	March 1888
102	792 Pelham Pillar Lodge	Grimsby, Lincolnshire	May 1890
103	804 Carnarvon Lodge	Havant, Hampshire	November 1887
104	809 Lodge of United Goodfellowship	Wisbech, Cambridgeshire	March 1892
105	828 St. John's Lodge	Grahamstown, Cape	March 1895
106	832 Lodge Victoria in Burma	Rangoon	June 1890
107	859 Isaac Newton University Lodge	Cambridge	May 1891
108	876 Acacia Lodge	Monte Video	June 1890
109	877 Royal Alfred Lodge	Jersey	January 1897
110	882 Midland Lodge	Graaff Reinet, South Africa	May 1906
111	897 Lodge of Loyalty	St. Helens, Lancashire	November 1888
112	904 Phœnix Lodge	Rotherham, Yorkshire	January 1891
113	988 Lodge Wahab or Benevolent	Sialkote, Punjab	October 1897
114	1008 Royal St. Edmund Lodge	Bury St. Edmunds	May 1902
115	1010 Kingston Lodge	Hull	November 1889
116	1022 Rising Star Lodge	Bloemfontein	October 1900
117	1025 Lodge Star of the South	Buenos Aires	June 1890
118	1039 St. John's Lodge	Lichfield, Staffordshire	January 1890
119	1060 Marmion Lodge	Tamworth, Staffordshire	May 1889
120	1152 Lodge St. George	Singapore	October 1890
121	1198 Lodge Pitt-MacDonald	Vepery, Madras	October 1893
122	1244 Marwood Lodge	Redcar, Yorks	June 1898
123	1248 Denison Lodge	Scarborough	November 1889
124	1249 Lodge Pioneer	Gympie, Queensland	May 1898
125	1283 Byburn Lodge	Sowerby Bridge, W. Yorks	November 1895
126	1285 Lodge of Faith, Hope and Charity	Ootacamund, Madras	January 1895
127	1301 Brighouse Lodge	Brighouse, Yorkshire	November 1902
128	1324 Okeover Lodge	Ripley, Derbyshire	May 1905
129	1402 Jordan Lodge	Torquay, Devonshire	January 1888
130	1415 Campbell Lodge	Hampton Court, Middlesex	November 1891
131	1428 United Service Lodge	Landport, Hampshire	January 1889
132	1432 Wharnccliffe Lodge	Penistone, Yorkshire	March 1888
133	1469 Meridian Lodge	Cradock, Cape Colony	June 1889
134	1521 Wellington Lodge	Wellington, New Zealand	November 1887
135	1544 Mount Edgcombe Lodge	Cambourne, Cornwall	March 1891
136	1545 Charters Towers Lodge	Charters Towers, Queensland	January 1894
137	1553 Lodge Light of the South	Rosario de Santa Fé, Argentine Republic	May 1898
138	1554 Mackay Lodge	Mackay, Queensland	May 1894
139	1596 Townsville Lodge	Townsville, Queensland	October 1895
140	1603 Worcester Lodge	Worcester, Cape Colony	January 1899
141	1611 Eboracum Lodge Library	York	May 1887
142	1644 Alma Mater Lodge	Birmingham	November 1891
143	1665 Natalia Lodge	Pietermaritzburg, Natal	March 1889

No.	No.	Lodge Name	Location	Joined.
144	1680	Comet Lodge	Barcaldine, Queensland	June 1892
145	1721	Manawatu Lodge	Palmerston, New Zealand	March 1897
146	1746	Lodge Fraternity and Perseverance	Benares, India	March 1900
147	1792	Tudor Lodge	Harborne, Staffordshire	March 1889
148	1824	Buffalo Lodge	East London, South Africa	May 1896
149	1838	Tudor Lodge of Rifle Volunteers	Wolverhampton, Staffs.	January 1889
150	1850	Raphael Lodge	Roma, Queensland	May 1893
151	1884	Chine Lodge	Shanklin, Isle of Wight	March 1888
152	1896	Audley Lodge	Newport, Shropshire	January 1888
153	1915	Graystone Lodge	Whitstable, Kent	March 1889
154	1960	Stewart Lodge	Rawal Pindi, Punjab	May 1869
155	1991	Agricola Lodge	York	November 1887
156	2069	Prudence Lodge	Leeds	November 1887
157	2074	St. Clair Lodge	Landport, Hampshire	January 1889
158	2088	Cango Lodge	Outshoorn, Cape Colony	January 1899
159	2089	Frere Lodge	Aliwal North, Cape Colony	May 1891
160	2109	Prince Edward Lodge	Heaton Moor, Lancashire	May 1891
161	2149	Gordon Lodge	Hanley, Staffords	November 1902
162	2155	Makerfield Lodge	Newton-le-Willows, Lancs.	May 1889
163	2158	Boscombe Lodge	Boscombe, Hants	May 1899
164	2188	Lodge Kerala	Calicut, India	October 1900
165	2208	Horsa Lodge	Bournemouth, Hampshire	January 1888
166	2225	Lodge Perak Jubilee	Taiping, Malay Peninsula	October 1890
167	2263	St. Leonard's Lodge	Sheffield, Yorkshire	January 1896
168	2267	Lodge Laidley	Laidley, Queensland	October 1898
169	2277	St. Paul's Lodge	Limassol, Cyprus	May 1899
170	2288	Sitapur Lodge	Sitapur, India	October 1896
171	2300	Aorangi Lodge	Wellington, New Zealand	November 1891
172	2314	El Dorado Lodge	Zeerust, V.R.C.	June 1892
173	2337	Read Lodge	Kwala Lumpur, Selangor	May 1895
174	2356	Lodge Pandyan	Madura, India	November 1896
175	2433	Minerva Lodge	Birkenhead, Cheshire	November 1892
176	2478	Gold Fields Lodge	Johannesburg, Transvaal	May 1895
177	2479	Rhodesia Lodge	Salisbury, Rhodesia	November 1904
178	2481	Jeppestown Lodge	Johannesburg, Transvaal	May 1895
179	2494	Humber Installed Masters Lodge	Hull	May 1898
180	2517	Lodge St. John's	Buenos Aires	June 1898
181	2527	Lodge Dharwar	Dharwar, Bombay	June 1902
182	2538	Metropolitan Lodge	Cape Town	January 1899
183	2546	*Rahere Lodge	London	October 1898
184	2592	Lodge Waltair	Vizagapatam, Madras	May 1898
185	2678	Lodge Manica	Umtali, Rhodesia	November 1900
186	2706	Foster Gough Lodge	Stafford	May 1893
187	2726	Lodge Light on the Surma	Silchar, Assam	October 1900
188	2727	St. Audrey Lodge	Ely	January 1905
189	2735	Lodge United Service	Bangalore, Madras	March 1901
190	2746	Lodge Tambo	Tambo, Queensland	October 1899
191	2869	Blyth Lodge	Butterworth, Cape Colony	May 1906
192	2933	Lodge St. Michael	Singapore	October 1904
193	3100	Brand Lodge	Rouxville, O.R.C.	May 1906
194	3135	St. George's Lodge	Nikosia, Cyprus	May 1906

LOGGES, &c., NOT UNDER THE GRAND LODGE OF ENGLAND.

		Joined.
195	Acacia Lodge, No. VII. (I.C.)	Belfast May 1905
196	Duke of Leinster Lodge, No. 283 (I.C.)	Brisbane, Queensland June 1894
197	Lodge Temple, No. 318 (I.C.)	Mackay, Queensland January 1897
198	Lodge Toowoomba, No. 346 (I.C.)	Toowoomba, Queensland June 1903
199	Prince Frederick William of Prussia L., No. 431 (I.C.)	Ballymena January 1889
200	Mount Morgan Royal Arch Chapter, No. 227 (S.C.)	Mount Morgan, Queensland June 1891
201	Saltcoats & Ardrossan St. John's R.A.L., No. 320 (S.C.)	Ardrossan, Ayrshire June 1893
202	Southern Cross Lodge, No. 398 (S.C.)	Cape Town October 1889
203	St. Andrew's Lodge, No. 651 (S.C.)	Grahamstown, Cape March 1895
204	Lodge Level, No. 702 (S.C.)	Kirkee, Bombay November 1900
205	Lodge Caledonian, No. 737 (S.C.)	Mackay, Queensland January 1896
206	Golden Thistle Lodge, No. 744 (S.C.)	Johannesburg, Transvaal March 1895
207	Mount Morgan Lodge, No. 763 (S.C.)	Mount Morgan, Queensland June 1891
208	Mylne Lodge, No. 769 (S.C.)	Charters Towers, Queensland May 1897
209	Lodge Pretoria Celtic, No. 770 (S.C.)	Pretoria, Transvaal October 1894
210	Douglas Lodge, No. 799 (S.C.)	Johannesburg, Transvaal January 1895
211	Lodge Braemar, No. 816 (S.C.)	Gympie, Queensland October 1901
212	Lodge Warrego, No. 835 (S.C.)	Cuunamulla, Queensland June 1899
213	Lodge Gympie, No. 863 (S.C.)	Gympie, Queensland May 1898
214	Lodge Rosewood, No. 878 (S.C.)	Rosewood, Queensland November 1901
215	Cheshire Lodge, No. 883 (S.C.)	Inglewood, Queensland March 1903
216	Lodge Heather, No. 928 (S.C.)	Munaor, South India January 1903
217	Simon's Town Kilwinning Lodge, No. 960 (S.C.)	Simon's Town, Cape Colony January 1904
218	Lodge de Goede Hoop (D.C.)	Cape Town September 1887
219	Star of the Rand Lodge (D.C.)	Johannesburg, Transvaal June 1896
220	Lodge Oranje (D.C.)	Paarl, Cape Colony January 1899
221	Lodge San Jan (D.C.)	Malmesbury, Cape Colony January 1899
222	Lodge de Goede Trouw (D.C.)	Cape Town January 1899
223	Lodge Frere (D.C.)	Riversdale, Cape Colony October 1899
224	Lodge de Ster in het Oosten (D.C.)	Batavia, Java November 1899
225	Lodge La Flamboyante	Dordrecht, Holland June 1905
226	Lodge de Noord Star	Alkmaar, Holland June 1905
227	Lodge La Compagnie Durable	Middleburg, Holland June 1905
228	Anglo-Beige Lodge	Antwerp January 1897
229	L. Les Amis du Commerce et la Persévérance Réunis	Antwerp June 1898
230	Lodge Archimedes zu den drei Reissbretern	Altenburg, Saxo-Altenburg November 1890
231	Lodge Indissolubilis	Berlin June 1889
232	Lodge Carl zur Gekrönten Säule	Brunswick, Germany May 1896
233	Lodge Nos Vinxit Libertas	Amsterdam March 1902
234	Lodge Ultrajectina	Utrecht, Holland March 1902
235	St. John's Lodge Olaf Kyrre til de gyldne Kjoede	Christiania June 1901
236	Lodge Baldwin zur Linde	Leipsic, Germany March 1901
237	Medicine Hat Lodge, No. 31 (Assa. C.)	Medicine Hat, Assa, Canada May 1901
238	Bow River Lodge, No. 28 (Man. C.)	Calgary, Alberta, Canada October 1903
239	Battle Lodge, No. 96.	Battleford, N.W.T., Canada May 1906
240	Palestine Lodge, No. 357 (Mich. C.)	Detroit, Michigan October 1898
241	Mankato Lodge, No. 12 (Minn. C.)	Mankato, Minnesota May 1900
242	Fidalgo Lodge, No. 77 (Wash. C.)	Anacortes, Washington March 1896
243	Crescent Lodge, No. 109 (Wash. C.)	Enumclaw, Washington, U.S.A. May 1900
244	Lodge of Fidelity, No. 5 (S.A.C.)	Gawler, South Australia May 1892
245	Lodge of St. John's, No. 15 (S.A.C.)	Strathalbyn, South Australia May 1892
246	Emulation Lodge, No. 32 (S.A.C.)	Norwood, South Australia October 1892
247	Lodge St. Alban, No. 38 (S.A.C.)	Adelaide, South Australia October 1890



		Joined.
248	Naracoorte Lodge, No. 42 (S.A.C.)	Naracoorte, South Australia October 1900
249	Barunga Lodge, No. 43 (S.A.C.)	Snowtown, South Australia March 1900
250	Clare Lodge, No. 12 (S.A.C.)	Clare, South Australia October 1906
251	Lodge of Otago, No. 7 (N.Z.C.)	Dunedin, New Zealand January 1894
252	Southern Cross Lodge, No. 9 (N.Z.C.)	Invercargill, New Zealand January 1903
253	Lodge Ashley, No. 28 (N.Z.C.)	Rangiora, New Zealand January 1903
254	Lodge Victory, No. 40 (N.Z.C.)	Nelson, New Zealand January 1889
255	Lodge Robert Burns, No. 50 (N.Z.C.)	Reefton, New Zealand October 1889
256	Lodge Dunstan, No. 103 (N.Z.C.)	Clyde, New Zealand March 1902
257	Lodge Winton, No. 108 (N.Z.C.)	Winton, New Zealand October 1905
258	Zeehan Lodge, No. 20 (T.C.)	Zeehan, Tasmania November 1902
259	La Luz Lodge, No. 3 (Costa Rica Cons.)	San José, Costa Rica November 1901
260	Phoenix Lodge, No. 5 (C.R.C.)	Port Limon, Costa Rica November 1902

### OTHER ASSOCIATIONS.

		Joined.
261	Masonic Hall Library	Leicester November 1887
262	Bureau of Ethnology, Smithsonian Institute	Washington, U.S.A. November 1889
263	The Anthropological Institute of Great Britain and Ireland	London June 1900
264	York College of Rosicrucians	York March 1890
265	Newcastle College of Rosicrucians	Newcastle-on-Tyne October 1890
266	Glasgow College of Rosicrucians	Glasgow March 1899
267	Portland Masonic Library	Portland, Maine, U.S.A. October 1891
268	Masonic Library and Historical Society	Duluth, Minnesota, U.S.A. June 1892
269	Masonic Library Association	Tacoma, Washington, U.S.A. January 1894
270	Masonic Library	Walla Walla, Washington January 1898
271	Masonic Library	Los Angeles, California March 1898
272	Masonic Library	Detroit, Michigan March 1899
273	Masonic Library	Quetta, Baluchistan October 1902
274	Bournemouth Lodge of Instruction	Bournemouth October 1897
275	Holmesdale Lodge of Instruction	Tunbridge Wells May 1899
276	Masonic Club	Shanghai, China May 1895
277	Ottawa Masonic Library	Ottawa, Canada May 1895
278	The Tyler—Keystone	Ann Arbor, Michigan October 1899
279	Brighton Masonic Library	Brighton January 1901
280	United Lodge of Instruction	Pietermaritzburg, Natal October 1901
281	Masonic Temple Board of Management	Guernsey March 1905
282	Masonic Library Association	Des Moines, Iowa May 1905
283	The Acaocia Chapter (University of California)	Berkeley, California, U.S.A. October 1905
284	Germantown Lodge of Instruction	Philadelphia, Penns., U.S.A. March 1906
285	Masonic Library Board	Seattle, Washington May 1906

### BROTHERS.

(\*The asterisk before the name signifies that the Brother is a Life-Member; the Roman numbers refer to Lodges, and those in italics to Chapters.)

286	<b>Abud</b> , Lt.-Col. Henry Mallaby, I.C.S. 9, <i>Pall Mall, S.W., London.</i> 456, 90 (S.C.) June 1896.
287	<b>*Aburrow</b> , Charles. P.O.B. 534, <i>Johannesburg, Transvaal.</i> <b>Past Grand Deacon, Past Grand Standard Bearer (R.A.)</b> October 1888.
288	<b>Acford</b> , Richmond James. <i>Lyndale, Linden Road, Bognor, Sussex.</i> 38, 1786. January 1906.
289	<b>Achard</b> , A. L., M.D. 34a <i>Gloucester Place, Portman Square, W., London.</i> 2045. May 1899.
290	<b>Ackers</b> , Arthur E. <i>Gill Street, Charters Towers, Queensland.</i> 845 (S.C.) October 1900.
291	<b>Acworth</b> , E. Cecil B. <i>The Cairn, Anstey Road, Umballa Hill, Bombay.</i> 549, P.M., 549. March 1900.
292	<b>Adair</b> , A. P.O.B. 3327, <i>Johannesburg, Transvaal.</i> 2539. June 1898.
293	<b>Adams</b> , Alfred John. <i>Hildesay, 3rd Avenue, East Adelaide, South Australia.</i> 47, 32, May 1905.

- 294 **Adams, Alfred W.** P.O.B. 467, *Kimberley, South Africa*. 2383, P.M. Dis. G. Treas. Local Sec. for Kimberley. March 1897.
- 295 **Adams, Arthur W.** *Lynhales, Broad Road, Acock's Green, Birmingham*. P.Pr.G.S.W., 739, P.Z. Local Secretary for Warwickshire and Worcestershire. January 1892.
- 296 **Adams, Ernest H.** *Gattens, Hockley, Esser*. 2621. March 1905.
- 297 **Adams, Thomas Smith.** *Maes Teg, Mold, North Wales*. P.P.G.S.B., 721, P.Z. January 1896.
- 298 **Adamson, Dr. Kilgour.** P.O. Box 22, *Springs, Transvaal*. 2653, W.M. June 1906.
- 299 **Adcock, Edwin John.** Box 198, *Krugersdorp, Transvaal*. 2643, 2643. June 1905.
- 300 **Adcock, William Henry.** *Herberton, North Queensland*. 655 (S.C.), P.M. October 1901.
- 301 **Adkin, W. Ryland D.** *Springfield, Northampton*. 1911. January 1894.
- 302 **Adler, Elkan N., F.D.B.** 48 *Cophthall Avenue, E.C., London*. 1997. March 1895.
- 303 **Adrianyl, Emile.** *Wodenstrasse, 71, Nuremburg*. Lodge Matthias Corvinus. Local Secretary for Bavaria. October 1893.
- 304 **Agar, A. P. D.S.P., St. Thomas' Mount, Madras. 1198. May 1905.**
- 305 **Aitken, Thomas.** 23 *Mount Pleasant Road, Rothesay, N.B.* 510, 163. January 1906.
- 306 **Alcock, John White.** 21 *St. Peter's Road, Handsworth, Stofords*. 1782, P.M., 1016. October 1901.
- 307 **Alcock, W. D.** Box 1248, *Johannesburg, Transvaal*. 268 (I.C.) October 1902.
- 308 **Alden, Charles Ames.** 401 *Pine Street, Skelton, Pa., U.S.A.* 21, W.M., 21. November 1905.
- 309 **Alexander, Major William Patrick, R.A.** *Fort St. George, Madras, India*. 1394. October 1901.
- 310 **\*Allan, Ebenezer, F.R.C.S.** *Duke Street, Barrow-in-Furness, Lancashire*. 0, W.M. May 1901.
- 311 **\*Allan, Francis John, M.D.** *Lincluden, Fairfax Road, Teddington*. 1768, 2029. January 1897.
- 312 **Allan, Walter Thomas.** *The Piplars, Beamish, R.S.O., Co. Durham*. 2929, P.M., 83 (S.C.) Jan. 1903.
- 313 **Allen, George.** 163 *Ramsden Road, Balham, S.W., London*. 144, P.M., 186, P.Z. September 1887.
- 314 **Allen, George Herbert.** 9 *Bonham Road, Brixton Hill, S.W., London*. 2395, 7. October 1906.
- 315 **Allen, Harry.** *Umtali, Rhodesia*. 2678. October 1905.
- 316 **Allen, Percy James.** *Equitable Buildings, Sydney, New South Wales*. 2613, P.M., 1546, P.Z. October 1900.
- 317 **Allen, Philip Spelman.** *The Forehill, Ely*. 2727. January 1904.
- 318 **Allen, Samuel.** *West Oak, Hagley Road, Edgbaston, Birmingham*. 2654, P.M. January 1905.
- 319 **Allen, W. J.** 798 *Glenmore Avenue, Brooklyn, N.Y., U.S.A.* 638, P.M. May 1898.
- 320 **Allen, William John.** 57a, *Farringdon Road, E.C., London*. 1604, J.W. January 1906.
- 321 **Aller, Charles William.** *Elmwood, Emerson Park, Hornchurch, Essex*. 2005. May 1897.
- 322 **Allom, George Arthur Edward.** *Toowoomba, Queensland*. 824 (S.C.), P.M., 194 (S.C.) March 1896.
- 323 **Allsop, T. W.** *Holywell, Madeley Road, Ealing, W., London*. 2429. March 1899.
- 324 **Ambler, Thomas.** 29, *Cookridge Street, Leeds*. 1311. January 1905.
- 325 **Amherst of Hackney, The Right Hon. Lord.** *Didlington Hall, Brandon, Norfolk*. **Past Grand Warden.** May 1894.
- 326 **Amphlett, George Thomas.** *Standard Bank, Capetown*. Goede Hoop Lodge. October 1891.
- 327 **\*Amphill, The Right Hon Lord, G.C.I.E.** *Amphill Park, Bedfordshire*. **Past District Grand Master, Madras, Provincial Grand Master, Bedfords.** May 1904.
- 328 **Amsberg, S. E.** *Messrs. Guthrie & Co., Singapore*. 2933. March 1904.
- 329 **Anderson, A.** *Maghaliem P.O., Basutoland, South Africa*. 2089. November 1897.
- 330 **Anderson, A.** *Salisbury, Rhodesia*. 2479. October 1906.
- 331 **Anderson, Alexander, M.A.** *Queen's College, Galway*. 14 (I.C.), P.M. March 1901.
- 332 **Anderson, Edward John.** Box 76, *Grahamstown, Cape Colony*. 389, 389. May 1906.
- 333 **Anderson, George Reinhardt, F.R.C.S.** 18, *Hoghton St., Southport, Lancashire*. 2505 P.M. Jan 1902.
- 334 **Andrews, John.** *Homewood, Rondebosch, Cape Town*. 398 (S.C.), P.M., 86 (S.C.), P.Z. Oct 1889.
- 335 **Andrews, Michael Corbet.** 52 *Elmwood Avenue, Belfast*. VII. (I.C.), VII. March 1905.
- 336 **Andrews, S.** Box 78, *Rodepoort, Transvaal*. 2539. Local Secretary for Rodepoort. May 1898.
- 337 **Andrews, Samuel.** *The Danes, Eastrop, Basingstoke*. 694, P.M., 694, P.Z. January 1904.
- 338 **Andrews, William Henry.** *Portland, Connecticut, U.S.A.* P.D.D.G.M., New York. November 1897.
- 339 **Andy, S. Pulney, M.D.** 1 *Ritherden Road, Egmor, Madras*. P.D.G.D., P.D.G.J. October 1893.
- 340 **Angel, Robert Parsons.** 38 *Hungerford Road, Camden Road, N., London*. 183, P.M., 179. Jan 1893.
- 341 **Anley, John.** 34 *Colvestone Crescent, St. Mark's Square, N.E., London*. 177, P.M. May 1904.
- 342 **Apelt, Emil.** 49 *Lichfield Grove, Finchley, N., London*. 186, P.M. June 1894.
- 343 **Appleby, Frederick Henry, M.D., J.P.** *Barnby Gate, Newark-on-Trent*. P.P.G.W., P.P.G.J., Notts. January 1900.

- 344 **Appleton**, Charles Frederick. *Portugal House, Lincoln's Inn Fields, W.C., London.* 2722. October 1903.
- 345 **Appleton**, J. 29 *Bridge Street Row, Chester.* 721, P.M., 721, P.Z. October 1905.
- 346 **Aravamuthu**, Iyengar, Vathanta. P.W.D., *Saidapet, Madras.* P.D.G.A.D.C., 1906. March 1895.
- 347 **Arlen**, Charles Rufus. 5, *Arundel Street, Strand, W.C., London.* 2763, 1538. October 1906.
- 348 **Armitage**, Samuel Harris Tatham, M.D. 39 *Grosvenor Street, W., London.* **Past Junior Grand Deacon, Past Asst. Grand Sojourner.** March 1902.
- 349 **Armitage**, W. J. *Storth Holme, Ranmoor, Sheffield.* 859. October 1896.
- 350 **\*Armington**, Arthur Herbert. *City Hall, Providence, R.I., U.S.A.* **Deputy Grand Master, Past Grand High Priest, Rhode Island; Representative of Grand Lodge of Louisiana, and Grand Chapter of Colorado.** May 1893.
- 351 **\*Armstrong**, Thomas John. 14 *Hawthorne Terrace, Newcastle-on-Tyne.* P.Pr.G.St., P.Pr.G.R. (R.A.). February 1890.
- 352 **Arnold**, Arthur William. *Rhinefield, Arlington Road, Eastbourne.* 2676, W.M. October 1906.
- 353 **Asbury**, Frederick John. *Finbury Pavement House, E.C., London.* 3040. March 1905.
- 354 **Ashdown**, Charles John. 19 *Lombard Street, E.C., London.* 1427, P.M. June 1898.
- 355 **\*Aspland**, W. G. 1138. May 1899.
- 356 **Atherton**, Jeremiah Leech. *Beech Grove, Bingley, Yorks.* P.Pr.G.D.C., P.Pr.G.H., West Yorks. November 1887.
- 357 **Atkins**, Rev. Alfred Cuthbert. *Cliff House, Hove, Sussex.* 706. November 1904.
- 358 **Atkins**, Henry John. *The Firs Glen, Bournemouth.* P.Pr.G.W., Northamptonshire and Huntingdonshire, P.Pr.G.J., Hants and Isle of Wight. March 1887.
- 359 **Atkinson**, Rev. Christie Chetwynd, D.D. *Ashton-upon-Mersey, Cheshire.* P.Pr.G.C. June 1894.
- 360 **Atkinson**, George. *Victoria Buildings, St. Mary's Gate, Manchester.* 1458. March 1906.
- 361 **Atkinson**, John Wilson. 16 *Lucas Avenue, Upton Park, E., London.* 65. January 1906.
- 362 **Atkinson**, Robert Fisher. *Hawick, N.B.* 111, D.M., 89, Z. May 1900.
- 363 **Atwell**, George Washington, jun. *Lima, Livingstone Co., New York.* Dis.Dep.G.M. October 1887.
- 364 **Atwell**, Benjamin Booth. *Grahamstown, Cape Colony.* 828, P.M. March 1895.
- 365 **Attwood**, Jabez. *Hayley Road, Stourbridge.* 564, P.M., 1031, P.Z. January 1906.
- 366 **Audagna**, Antonio. 28 *Panton Street, Haymarket, W. London.* 2687, P.M. June 1904.
- 367 **Austen**, Arthur Elvey. *Cradock, Cape Colony.* **Past Grand Deacon.** Dep.Dis.G.M., E.Div. South Africa. May 1887.
- 368 **Austen**, Rev. Edward Gilmore. *Berrow Vic., Burnham, Somerset.* P.Pr.G.Ch., Dorset. June 1890.
- 369 **Austin**, William. *Dennistoun, Halton, near Leeds.* 27, 50. January 1898.
- 370 **Ayling**, Robert Stephen, A.R.I.B.A. 23 *Old Queen Street, S.W., London.* May 1894.
- 371 **Ayres**, George V. *Deadwood, South Dakota, U.S.A.* **Past Grand Master, Past Grand High Priest, South Dakota.** October 1894.
- 372 **Bache**, T. Foley. *Churchill House, West Bromwich, Staffords.* 2784, S.D. March 1903.
- 373 **Bachert**, Augustus Ellsworth. *Robertsdale, Pa., U.S.A.* 327, 201. May 1906.
- 374 **Bacon**, Col. Alexander S. 101 *Rugby Road, Prospect Park, S., Flatbush, Brooklyn, N.Y., U.S.A.* 656. May 1897.
- 375 **Bacon**, Henry Matthew John. 7 *Jedburgh Gardens, Kelvinside, N., Glasgow.* 2645, 832. May 1902.
- 376 **Bacon**, Robert. 9 *Victoria Terrace, Coleraine, Ireland.* 235 (I.C.), P.M., 414 (I.C.), K. June 1904.
- 377 **Baddeley**, William. *C.S.R. Co. Ltd., Lautoka, Fiji.* 2238. October 1904.
- 378 **Badman**, Harry Alfred. 85 *Highburg Hill, N, London.* 1298, P.M. June 1906.
- 379 **Baelz**, Robert. *The Mount, Queen's Road, Forest Hill, S.E., London.* 238, P.M. May 1897.
- 380 **Baildon**, James Owen. *Supreme Court, Rockhampton, Queensland.* 677 (S.C.). November 1900.
- 381 **Bailey**, B. S. 95 *Caledonian Road, Leeds.* 2369, P.M. March 1898.
- 382 **Bailey**, Frederick W. 25 *Claremont Road, Cricklewood, N.W., London.* 2398, S.D. May 1904.
- 383 **Bailey**, Henry Grant. *Wadenhoe, Hough Green, Chester.* 1199, 721. March 1905.
- 384 **Bain**, George Washington. *Tunstall View, Ashbrooke Road, Sunderland.* P.P.G.R., P.P.G.Sc.N. Durham. Local Secretary for Province of Durham. March 1889.
- 385 **Bain**, J. Wilson. 45 *Hope Street, Glasgow.* 510, P.M., 296, P.Z. January 1894.
- 386 **\*Baines**, Arthur. *Lichfield House, Hanley, Staffords.* 2149, P.M., P.Pr.G.D. March 1901.
- 387 **Baird**, Hugh. Box 191, *Bulawayo, Rhodesia.* 86 (D.C.), J.W. June 1906.
- 388 **Baird**, Reed McCollock, M.D. 1137, *Chapline Street, Wheeling, West Virginia.* 33, 1. May 1895.
- 389 **Baird**, Robert Craik. Box 359, *San José, Costa Rica.* 3 (C.R.C.). May 1902.
- 390 **Baker**, Alfred. *Brenda, Woodlands Road, Moseley, Birmingham.* 2034. January 1905.

- 391 **Baker**, George Comstock. 441 Broadway, Albany, N.Y., U.S.A. 5, P.M., 242, P.H.P. June 1887.
- 392 **Baker**, Henry M. 10 Cale Street, Chelsea, London, S.W. 1539. January 1906.
- 393 **Baker**, William. Eastern Road, Romford, Essex. 1437, P.M., 1437. January 1904.
- 394 **Baker**, William. The Bank House, West Bromwich. P.P.G.Treas., P.P.G.N. May 1905.
- 395 **Baker**, William King. Tredorwin, Towednack, Penzance. P.Pr.G.W., P.P.G.J. January 1890.
- 396 **Baker**, Willis Edwards. Casilla 42, Rosario de Santa Fé, Argentine Republic. P.Dis.J.G.W., Dis.G.P.Soj. May 1902.
- 397 **Bakhsh**, Shaikh Miran. 9-34th Street, Rangoon, Burma. 832. October 1903.
- 398 **Balch**, Ralston. 10 Stonecutter Street, E.C., London. 1671. November 1905.
- 399 **Bale**, W. H. Drakefell Lodge, St. Catherine's Park, S.E., London. 87, P.M. November 1901.
- 400 \***Balfour**, Charles Barrington, M.P. Newton Don, Kelso, Scotland. **Substitute Grand Master**, Scotland. March 1892.
- 401 **Balfour**, Keith M. Agent, Allahabad Bank, Bareilly, India. 1066, J.W. November 1905.
- 402 **Ball**, Francis William. 55 Crab Tree Lane, Fulham, London, S.W. 2029. January 1906.
- 403 **Ball**, William Thomas. Harbledown, The Avenue, Beckenham, Kent. 435, P.M., 1260, P.Z. Nov. 1893.
- 404 **Ballantine**, Thomas J. P.O.B. 480, Denver, Colorado, U.S.A. March 1896.
- 405 \***Ballantyne**, Henry Norman. Innerleithen, N.B. 856, P.M., 56. March 1899.
- 406 **Bamford**, William Brokaw, C.E. Corner of Chestnut and Hamilton Avenue, Trenton, New Jersey, U.S.A. 5. Nov. 1900.
- 407 **Bamlet**, William Henry. Floradale, Argyle Road, Westcliff-on-Sea. 183, P.M. Local Secretary for Essex. October 1897.
- 408 **Banham**, Joseph. Calle Belgrano 650, Buenos Aires. 2517, P.M., 617, J. May 1902.
- 409 **Banker**, S. M. Helvellyn, Brownlow Road, N., London. P.Pr.G.St.B., Herts. June 1894.
- 410 **Bannatyne**, Brice McAlister. Springfield, The Hyde, Kingsbury, London, N.W. 216, P.M., 216. May 1891.
- 411 **Barber**, George. Newstead, Waikato, Auckland, New Zealand. 1930, P.M. October 1904.
- 412 **Barber**, Captain Sidney. 76 Ritherdon Road, Upper Tooting, S.W., London. 549, 549. June 1900.
- 413 **Barchus**, T. J. 72 Exchange, Memphis, Tennessee, U.S.A. May 1895.
- 414 **Barclay**, George. Palmerston, Otago, New Zealand. 844, P.M., P.Dis.G.W., Dis.G.Sec. Oct. 1906.
- 415 **Barefoot**, James William. The Bank House, Enfield, Middlesex. 2536. October 1900.
- 416 **Barker**, Claude. 87 Westbourne Road, Sheffield. 2558, P.M., P.P.G.Tr., W. Yorks. January 1905.
- 417 **Barker**, Ernest Marriott. 33 Marina, St. Leonard's-on-Sea. 1842, P.M. October 1906.
- 418 **Barker**, Jacob. High Stanners, Morpeth, Northumberland. P.P.G.O. Durham, P.P.G.S.B. (R.A.), Northumberland. January 1895.
- 419 **Barker**, Captain John. Brettargh House, Albert Park, Lancaster. 1715, P.M., 995, P.Z. Oct. 1904.
- 420 **Barlet**, Stephane. 97 St. Mark's Road, North Kensington, W., London. 2060. June 1904.
- 421 **Barley**, J. E. 114 Edenbridge Road, Bush Hill Park, Enfield, London, N. 2694. March 1906.
- 422 **Barlow**, G. R. 41 West Street, Congleton, Cheshire. 900. March 1901.
- 423 **Barlow**, George. 26 Bridge Street Row, Chester. 721, 721. October 1905.
- 424 **Barlow**, Capt. John, J.P. Wellfield, Bury, Lancashire. **Past Grand Treasurer**. 42, P.Z. May 1902.
- 425 **Barlow**, William, L.L.D. Morialta Chambers, Victoria Square, W., Adelaide. 38, P.M. Jan. 1896.
- 426 **Barlow**, W. Tillott, A.R.I.B.A. Willowmead, Bognor, Sussex. 1464, P.M., 829, P.Z. June 1903.
- 427 **Barnard**, George William Girling. 4 Surrey Street, Norwich. **Past Assistant Grand Director of Ceremonies**. June 1890.
- 428 **Barnes**, John Walter. 27 Clements Lane, E.C., London. 19. June 1895.
- 429 **Barnes**, William A. Westland, Kells, County Meath. P.Pr.G.Sec. March 1901.
- 430 **Barnes**, William Chpman. 89 Brigstock Road, Thornton Heath, Surrey. 19. June 1895.
- 431 **Barnet**, John. Shildon, R.S.O., County Durham. P.P.S.G.D., P.P.G.St.B. (R.A.). January 1901.
- 432 **Barnett**, James Robert. 94 Bishop Street, Moss Side, Manchester. 1458. October 1905.
- 433 **Barrett**, J. Leach. 70 Belsize Park Gardens, Hampstead, N.W., London. **Past Grand Standard Bearer**. June 1892.
- 434 **Barron**, Edward Jackson, F.S.A. 10 Endsleigh Street, Tavistock Square, W.C., London. **Past Grand Deacon**. May 1890.
- 435 **Barrow**, Charles James. Stalbridge Chambers, Chancery Lane, Melbourne, Victoria. **Past Grand Warden**. 8, P.Z. March 1894.
- 436 **Barry**, David J. Ledbury, Reigate. 1362. October 1899.
- 437 **Bartlett**, George. 10 Buckingham Gate, S.W., London. 2030, P.M. January 1900.
- 438 **Basch**, E. Bulawayo, Rhodesia. 2792, W.M. June 1905.

- 439 **Basham**, Septimus. 3, *Higham Place, Newcastle-on-Tyne*. 2995, 2260. October 1906.
- 440 **Baskett**, Samuel Russell. *Evershot, Dorchester*. P.Pr.G.W., Dorset. March 1887.
- 441 **Bass**, William Henry. 6 *Millicent Road, West Bridgford, Nottingham*. 1179, P.M., 506, J., P.Pr.G.A.P., Derbyshire. January 1906.
- 442 **Bassett**, John. *Endcliffe Crescent, Sheffield*. 296, P.M. January 1905.
- 443 **Bastone**, John Millard. *Goodrest, St. Botolph's Road, Sevenoaks*. 186, P.M., P.Z. March 1897.
- 444 **Bate**, Osborne Hambrook. *Standard Bank, Grahamstown, Cape Colony*. P.D.G.W., South Africa E.Div., Pr.G.M., South Africa (D.C.). June 1889.
- 445 **Bate**, Thomas Frederick. 9 *Park Street, Haslingden, near Manchester*. 345. January 1895.
- 446 **Bateman**, Arthur Charles. *Asthal, Burford, Ozon*. P.P.G.W. November 1899.
- 447 **Battersby**, Charles. *Georgetown, Queensland*. P.D.G.St.B. October 1894.
- 448 **Battersby**, William Maxwell, J.P. 11, *Clyde Road, Dublin*. **Past Grand Deacon, Ireland**. June 1896.
- 449 **Baxter**, Sidney B. *South Eastern Wharf, Stoney Street, Southwark, London, S.E.* 3077. Oct. 1906.
- 450 **Bayliss**, Thomas Abraham. *The High House, King's Norton, Worcester*. P.Pr.G.D., 587, P.Z. Nov. 1899.
- 451 **Beak**, Henry. *Pennard, Rockhampton, Queensland*. 767 (S.C.), P.M., 205 (S.C.). June 1891.
- 452 **Beaman**, Harris Samuel. 61 *St. Quintin's Avenue, N. Kensington, W., London*. 227, P.M. Oct. 1905.
- 453 **Beamish**, Robert Jeffreys. 141 *Parrock Street, Gravesend*. P.P.A.G.D.C., P.P.G.St.B. (R.A.). November 1903.
- 454 **Beamish**, William H. *Caaleen, Glanmire, Co. Cork*. P.D.Pr.G.M., Munster. June 1898.
- 455 **Bean**, Harold. *Kelsey House, Burstwick, near Hull*. 2134. May 1899.
- 456 **Bean**, Joseph Henry, J.P. *Gas Works, Cairns, North Queensland*. 2670, P.M. May 1898.
- 457 **Bean**, William Henry. 158 *Briggate, Leeds*. 306, 306. March 1906.
- 458 **Beard**, Edgar John. 2 *Geraldine Road, Wandsworth, S.W., London*. 1839. June 1903.
- 459 **Beardsall**, James Albert. 131 *Great Bridgewater Street, Manchester*. 1458. October 1905.
- 460 **Bebbington**, George William. *Beaton Road, Knutsford, Cheshire*. P.Pr.G.O. (C. & R.A.). May 1902.
- 461 **Beck**, Rudolph Carl, *Humbold Strasse 6a., Eschwege, Hessen*. **Past Grand Orator and Librarian, Saxony**. March 1887.
- 462 **Becker**, Pitt. 18 *Fenchurch Street, E.C., London*. 238. January 1896.
- 463 **Bedford**, James P., I.C.S. *Tanjore, Madras*. 150. March 1900.
- 464 **Beer**, Thomas James. 207 *Great Brunswick Street, Dublin*. 77, 250. March 1901.
- 465 **Beer**, William A. *Garth View, Pen Hill, Cardiff*. P.P.S.G.W., 2547. January 1896.
- 466 **Beerend**, Franz Philipp. *Jena, Germany*. Zur Akazie am Saalstrande. Dep. M. March 1896.
- 467 **Beever**, Cyril Howard. 27 *Palatine Road, Withington, Manchester*. P.Pr.G.Reg., P.Pr.G.J. March 1893.
- 468 **Begemann**, Dr. Georg Emil Wilhelm. *Charlottenberg, Wilmersdorfer Strasse 14, near Berlin*. **Past Provincial Grand Master of Mecklenberg**. February 1887.
- 469 **Belcher**, William Henry. *Newbury, Berkshire*. 574, P.M., 574, P.Z. January 1905.
- 470 **Bell**, Anthony. *La Maisonette, Veytaux, Canton Vaud, Switzerland*. 398 (S.C.). May 1904.
- 471 **Bell**, James Richard. *Hazeldene, Ightham, Kent*. P.Dis.G.W., Punjab. June 1898.
- 472 **Bell**, Seymour. 7 *Summerhill Grove, Newcastle-on-Tyne*. P.Pr.G.W. June 1891.
- 473 **Bellamy**, Charles Vincent. 12, *Thornhill Road, Plymouth*. 3065, 2649. October 1906.
- 474 **Bellew**, Thomas Acheson. *Underwriters' Association, Liverpool*. 1380. May 1892.
- 475 **Bellingham**, Augustus William Harvey, A.M.I.C.E. *Teintsin, North China*. 1951, P.M. June 1896.
- 476 **Belstead**, Arthur Henry. 5 *Highbury Gardens, Highbury Crescent, N., London*. 108. Nov. 1903.
- 477 **Belton**, William. 6a *Castle Street, Shreusbury*. 262, 117, P.M., P.Pr.G.W., 262, P.Z. Oct. 1906.
- 478 **Bender**, Lewis Albert. *Bremerton, Washington, U.S.A.* 117, P.M., 27, H.P. March 1906.
- 479 **Bendle**, Frank. 36 *Springwell Avenue, Harlesden, N.W., London*. 973, 1602. November 1903.
- 480 **Bennett**, George Eric Oliver. *Eaton, Rosebank, near Capetown*. **Past Dep. Dis G.M., W.Div., South Africa. Past Grand Warden, England**. January 1901.
- 481 **Bennett**, William Henry. *Education Offices, Pietermaritzburg, Natal*. P.D.A.G.D.C., D.G.2nd.A.So. October 1897.
- 482 **\*Bennon**, Thomas. *Ophir Cottage, Croydon, North Queensland*. 768 (S.C.), P.M., P.Z. **Local Secretary for Croydon and vicinity**. June 1892.
- 483 **Bennison**, William. 66 *Ashley Road, Crouch Hill, N., London*. 173, P.M. May 1904.
- 484 **Bergann**, Otto F. C. *Hydro Hotel, Eastbourne*. 2434, W.M. March 1906.
- 485 **\*Bernays**, Albert Evan, M.A. 3 *Priory Road, Kew, Surrey*. 2851. January 1905.
- 486 **Berry**, Carey Edward Ernest. 311 *Hay Street, Perth, West Australia*. 2281. January 1899.

- 487 **Berry**, Clement Harris. *Devonia, Stopford Road, Upton Manor, E., London.* 860, P.M., P.Z. Oct. 1899.
- 488 **Berry**, Frederick Gorton. *10 Swinton Avenue, Plymouth Grove, Manchester.* 44, P.M. May 1900.
- 489 **Berry**, Henry F., M.A., M.R.I.A., B.L., I.S.O. *51 Waterloo Road, Dublin.* 357, P.M., 33, K. January 1895.
- 490 **Berry**, Mattias. *Burghersdorp, Cape Colony.* 2828, P.M. January 1903.
- 491 **Best**, Richard, M.A. *88 Lower Baggot Street, Dublin.* Grand Masters Lodge, P.M. October 1905.
- 492 **Bestow**, Charles Horton. *43 Upper Clapton Road, N.E., London.* P.Pr.G.Pt., P.Pr.G.Sw.B., Essex. March 1894.
- 493 **Beu**, John Charles Frederick. *Box 203, G.P.O., Wellington, New Zealand.* 32 (N.Z.C.) Jan. 1903.
- 494 **\*Bevington**, Richard George. *P.O.B. 1091, Johannesburg, Transvaal.* Sub. D.G.M., Transvaal (S.C.) October 1892.
- 495 **Beynon**, John Henry. *Garfield House, Liscard, Cheshire.* 2657, P.M., 2433. May 1900.
- 496 **Bhawanidas Batra**, Rai Bahadur Lala, M.A. *Revenue Minister, Jammu and Kashmir State.* 1495. May 1906.
- 497 **Bice**, W.P. *415 Lonsdale Street, Melbourne, Victoria.* Past Grand Treasurer. 8, J. May 1898.
- 498 **Biebuyck**, Julien François. *P.O. Laingsburg, Cape Colony.* 1469, 2379. May 1902.
- 499 **Biggs**, Rev. Henry Sylvanus, B.A. *64, Highfield Street, Leicester.* 523, P.M., P.P.G.S.W. May 1902.
- 500 **Billingham**, Henry. *18-22 Wigmore Street, W., London.* 2508. May 1901.
- 501 **Billson**, Frederick William, LL.B. *The Bungalow, Gotha Street, Leicester.* 1391, P.M. Jan. 1902.
- 502 **Bilson**, John. *23 Parliament Street, Hull.* 1010, P.M., 1010, P.Z. March 1889.
- 503 **Bindley**, William Allen. *Armstrong Works, Chester Street, Aston, Birmingham.* P.Pr.G.W., Warwickshire. October 1892.
- 504 **Bingham**, Frederick Henry. *5 Bolton Street, Piccadilly, W., London.* 1669, P.M. May 1905.
- 505 **Bingham**, Col. Sir John E., Bart. *West Lea, Sheffield.* P.Pr.G.W. June 1906.
- 506 **Bingham**, Sydney Clifton. *202 Durham Street, Christchurch, New Zealand.* Past Assistant Grand Secretary. 1, P.Z. Local Secretary for Christchurch. October 1901.
- 507 **Binney**, Joseph. *Bank Street, Sheffield.* 139, P.M., P.Pr.G.R. Local Secretary for Sheffield. October 1890.
- 508 **Bishop**, Frederick William. *11 Queen Victoria Street, E.C., London.* 2823, P.M. March 1898.
- 509 **Bishop**, John Herbert. *117 Mount Pleasant Lane, Clapton, N.E., London.* 2923. November 1900.
- 510 **Bissell**, Ernest. *Elmcroft, Turney Road, Dulwich, S.E., London.* 1339. October 1896.
- 511 **Bithell**, Walter. *Bickly Wood, Malpas, Cheshire.* 2992. May 1905.
- 512 **Bixby**, Charles Sumner. *Osawatomie, Kansas, U.S.A.* Dis.Dep.Gr.Master, Representative Grand Chapter, New Zealand. June 1897.
- 513 **Black**, Charles William. *Mossel Bay, Cape Colony.* D.G.S.B. May 1899.
- 514 **Black**, William, Falkirk, N.B. Provincial Grand Master, Stirlingshire; Past Grand Architect; Past Depute Grand Zerrubabel. October 1888.
- 515 **Black**, W. P. M. *136 Wellington Street, Glasgow.* 510 (S.C.). March 1905.
- 516 **Blackbeard**, C. A. *P.O. Box 118, Klerksdorp, Transvaal.* 1832, P.M., P.Z. October 1890.
- 517 **Blackden**, Marcus Worsley. *16 Allison Road, Acton, W., London.* 2430. March 1902.
- 518 **Bladon**, Harry. *16 Clerkenwell Road, E.C., London.* 2523, 2501. October 1901.
- 519 **Blair**, George. *Glenrossal, 55, Langside Road, Newlands, Glasgow.* 344 (S.C.). October 1906.
- 520 **Blair**, William Robert. *Wood Gate, Uttoxeter, Staffords.* P.Pr.G.W. May 1899.
- 521 **Blake**, Arthur. *2 Halkin Road, Rangoon, Burma.* 1362. District Grand Treasurer. May 1898.
- 522 **Blake**, Col. Charles John, R.A. *4 Sergeant's Inn, E.C., London.* P.Dis.G.J.W., P.Dis.G.Reg. (R.A.) Malta. March 1892.
- 523 **Blake**, Henry Daniel. *Annacy, Overhill Road, Dulwich, S.E., London.* 2729, P.M. November 1905.
- 524 **Blaker**, Walter C. *63 St. James' Street, S.W., London.* P.P.G.W., Surrey. October 1900.
- 525 **Bland**, William Edward. *5 Park Avenue, Southport, Lancs.* P.P.G.D., P.Pr.G.S.B. (R.A.). June 1894.
- 526 **Blewes**, Alexander. *Kelvin Cottage, Maryhill, Glasgow.* 510, 296. March 1906.
- 527 **Blinkhorn**, Edward. *64 Coleman Street, E.C., London.* 1471, P.M. October 1898.
- 528 **Blizard**, John H. *Lansdowne House, Castle Lane, Southampton.* 394, P.M. May 1904.
- 529 **Blood**, John Neptune, M.A., B.C.L. *Huntley Court, Gloucester.* 839. November 1899.
- 530 **Bluett**, Rev. Charles Courtney. *Longhurst, Wigan, Lancashire.* 2326, P.M., 1335. October 1895.
- 531 **Blunden**, Arthur Edward. *9 Strada Mercanti, Valletta, Malta.* 2755, P.D.G.A.D.C. January 1902.
- 532 **Board**, George. *Whalley Avenue, Sale, Cheshire.* P.Pr.G.D., East Lancashire. March 1894.
- 533 **Bock**, Johann Daniel. *Houghton, Colney Hatch Lane, Muswell Hill, N., London.* 238. June 1903.
- 534 **Boden**, E. G. *North Street, Romford, Essex.* 1437. January 1902.

- 535 \***Bodenham**, John. *Edmond, Newport, Salop.* **Past Assistant Grand Director of Ceremonies.** November 1887.
- 536 **Bodilly**, R. T. H., M.R.C.S., L.R.C.P. *Woodbury, South Woodford, Essex.* 453, P.M., 2410, J. January 1903.
- 537 **Boffey**, Harry Satton. *Box 796, Capetown.* De Goede Trouw, P.M., 334. March 1901.
- 538 **Bolton**, George Edward. *Supt. of Excise, Pegu, Lower Burma.* 542, 542. October 1904.
- 539 **Bomeisler**, Louis Edwin. *27 Pine Street, New York.* June 1898.
- 540 **Bomeisler**, Paltiel R. *East Orange, New Jersey.* 124. June 1898.
- 541 **Bonar**, William Macadam. *Herberton, North Queensland.* P.D.G.S.B. October 1895.
- 542 **Bond**, E. E. *7 Wood Lane, Highgate, N., London.* 1232, P.M. P.Pr.G.D., Lincs. March 1898.
- 543 **Bond**, G. M. *Alrewas House, Ashbourne, Derbyshire.* 850, P.M., P.P.G.S.W. March 1903.
- 544 **Book**, Dr. R. D. *Corning, Ohio, U.S.A.* 485, P.M., 149. October 1904.
- 545 **Booth**, A. B. *Santoy, Salisbury Road, Moseley, Birmingham.* 2034. March 1905.
- 546 **Booth**, Major John. *Hazel Bank, Turton, Bolton, Lancashire.* P.Pr.G.W., P.Pr.G.A.So. Nov. 1889.
- 547 **Booyesen**, I. J. *Graaff Reinet, Cape Colony.* 882. March 1902.
- 548 **Bosustow**, Henry. P.O., *Fimiston, Western Australia.* 896 (S.C.), P.M. November 1902.
- 549 **Boswell**, Arthur George. *31 Tankerville Road, Streatham, S.W., London.* 1339, P.M., P.Z. May 1894.
- 550 **Boswell**, Major-General John James, C.B. *Darnlee, Melrose, N.B.* P.D.D.G.M., Punjab, P.D.P.G.M., Roxburgh and Selkirk, P.D.G.C. (R.A.). March 1892.
- 551 **Boteler**, William Stewart. *c/o Howerth, Erskine & Co., Singapore.* P.Dis.G.D.C., Eastern Archipelago, P.D.G.St.B. (R.A.), Madras. October 1893.
- 552 **Boulton**, James. *267 Romford Road, Forest Gate, E., London.* **Past Grand Standard Bearer.** October 1891.
- 553 **Bourne**, John Kemp. *The Grove, Atherstone, Warwickshire.* P.Pr.G.W. October 1896.
- 554 \***Bourne**, Robert William. *18 Hereford Square, S.W., London.* 32, P.M., 32. June 1890.
- 555 \***Boutell**, Frank Hepburn Chevalier. *645 Avenida Mayo, Buenos Aires.* D.A.G.Sec., 617. Oct. 1901.
- 556 **Bowe**, William Fairbanks. *Augusta, Georgia, U.S.A.* 412, 2, P.H.P. Local Sec. for Georgia. Oct. 1897.
- 557 **Bowen**, John Evan. *Appletons, Stoke Green, Slough.* **Past Assistant Grand Director of Ceremonies.** Dep.Pr.G.M., Bucks. May 1905.
- 558 **Bowles**, Brig.-Gen. Frederick Augusta, R.A. *Poona, India.* P.Dep.Dis.G.M., P.Dis.G.H., Punjab. October 1891.
- 559 **Boyd**, Rev. Thomas Hunter. *Waweig, New Brunswick.* 28 (S.C.). January 1893.
- 560 **Bradly**, William. *158 Fenchurch Street, E.C., London.* 140. June 1896.
- 561 **Bradley**, Herbert. *Monclair, New Jersey, U.S.A.* 447. January 1904.
- 562 \***Bradley**, Herbert, I.C.S. *The Albany, Nungumbaukum, Madras.* **District Grand Master, District Grand Superintendent.** October 1893.
- 563 **Bradley**, J. Wallace. *151 Smith Street, Durban, Natal.* 731, 175 (S.C.), J. October 1895.
- 564 **Braine**, Woodhouse. *76 Wimpole Street, Cavendish Square, W., London.* **Past Grand Deacon, Past Assistant Grand Sojourner.** March 1892.
- 565 **Braithwaite**, Edward A. *Edmonton, N.W.T., Canada.* **Past Grand Master, Manitoba.** November 1900.
- 566 **Bramble**, Col. James Roger, F.S.A., J.P. Hon. Sec., Som. Arch. and N.H.So. *Seafeld, Weston-super-Mare, Somerset.* **Past Assistant Grand Director of Ceremonies (Craft) and Past Grand Sword Bearer (R.A.), England, Provincial Grand Master, Bristol.** February 1887.
- 567 **Brand**, Dr. A. T. *Driffield, Yorks.* 1040, W.M. June 1904.
- 568 **Brand**, Fred J. *Holmesdale, Oakfield Road, Ilford, Essex.* 1457, P.M. May 1905.
- 569 \***Brand**, Koeniglicher Justizrath Alfred. *Herford, Westphalia, Germany.* Zur Rothen Erde, W.M. March 1903.
- 570 **Brandzaeg**, Nils Christian. *Appelvaer, Throndhjem.* Lodge Nordlyset. October 1906.
- 571 **Brayshaw**, John Lund. *Settle, Yorkshire.* 209, 265. January 1889.
- 572 **Brazil**, Frank W. *12 High Street, Deptford, S.E., London.* 1924, P.M., 140, Z. January 1905.
- 573 \***Brentnall**, Ernald James. *80 Clarence Road, Wimbledon, S.W., London.* 2513. March 1905.
- 574 **Brewer**, Charles Samuel, L.R.C.S., L.R.C.P. *7, Park Road, E. Birkenhead.* P.P.G.D., P.P.A.G.So. January 1895.
- 575 **Brewster**, William Henry. *Middlebury, Vermont, U.S.A.* **Past Grand Deacon**, 22, P.H.P. March 1900.
- 576 **Briant**, William. *51 York Street, Buckingham Gate, S.W., London.* 101, P.M., 1329. January 1896.
- 577 **Brice**, Albert Gallatin. *Hennen Building, New Orleans, Louisiana.* **Past Grand Master.** March 1891.
- 578 **Brickdale**, Robert James. *Crown Hotel, Potchefstroom, Transvaal.* 796 (S.C.). June 1905.

- 579 **Brickhill, James.** *Zeehan, Tasmania.* **Past Dep. Grand Secretary, Tasmania.** P.Z. May 1895.
- 580 **Bridger, Percy Louis Grey.** 1169 *Calle Alsina, Buenos Aires.* Dis.G.P., P.Dis.G.D.C. Mar. 1902.
- 581 **Bridgman, John Henry.** *Avon Cottage, Harpenden, Herts.* P.P.D.G.D.C., Essex, 1326. Oct. 1903.
- 582 **Bridgman, William Henry.** 5 *Milton Villas, Aylesbury, Bucks.* Pr.G.S.D. March 1901.
- 583 **Briers, Frank Ellis.** Box 17, *Salisbury, Rhodesia.* 2479. November 1900.
- 534 **Briggs, Herbert J.** Box 101, *Providence, Rhode Island, U.S.A.* 1 Providence, 1. P.H.P. November 1902.
- 585 **Briggs, William, LL.D., D.C.L.** *Owlbrigg, Cambridge.* 45, P.M., P.Pr.G.W., 45, P.Z., P.Pr.G.S.B. October 1906.
- 586 **Bright, John Henry Robert.** 10a *Great Portland Street, W., London.* 194, P.M. October 1904.
- 587 **Brindley, Charles Frederick.** *Beechwood, Brincliffe, Sheffield.* 2491, P.M. May 1898.
- 588 **Briscoe, Edward John.** 114 *Caiza, Pernambuco, Brazil.* 1601. March 1900.
- 589 \***Broadbent, Claude Davos.** *Nicola Lake, P.O., British Columbia.* 10 (B.C.C.), 2738. June 1902.
- 590 **Broadsmith, Frederick.** *Somer Lease, Ashley Road, Hale, Altrincham.* P.P.G.W., P.P.G.P. January 1904.
- 591 **Brockaway, Charles A.** 1065 *Prospect Place, Brooklyn, New York, U.S.A.* 719. November 1905.
- 592 **Broderip, Edmund Francis, J.P.** *Filey, Weston-Super-Mare.* 1363, P.M., P.P.A.G.D.C. June 1900.
- 593 **Bromet, Henry.** *Highfield, Tadcaster, Yorkshire.* 2677, P.M. January 1905.
- 594 **Bromwich, Joseph.** c/o *J. Crook, 61 Chiswell Street, E.C., London.* 424 (S.C.). Nov. 1902.
- 595 **Brookhouse, John Charles.** 239 *Lewisham High Road, St. John's, S.E., London.* 3021, 79. May 1905.
- 596 **Brooking, William.** *Northlew, near Beaworthy, Devon.* 2486. October 1895.
- 597 **Brooking, William Francis.** *Brougham Street, New Plymouth, New Zealand.* P.P.G.W. (I.C.). October 1895.
- 598 **Brooks, Arthur David.** 15 *Waterloo Street, Birmingham.* 587, P.M., P.Pr.G.Reg. June 1899.
- 599 **Brooks, Francis Augustus, M.D.** *St. Felix, Felixstowe, Suffolk.* 2371, P.M., 376. October 1895.
- 600 \***Brough, Bennett-Hooper, F.G.S., F.C.S.** 28 *Victoria Street, S.W., London.* 777. November 1895.
- 601 **Brough, James R.** 29 *Alexandra Villas, Seven Sisters' Road, N., London.* 2397. January 1899.
- 602 **Brough, William Henry.** 57 *Harold Road, Upton Park, E., London.* 1343, P.M. October 1903.
- 603 **Broughton, Henry jun.** 21 *Nicolas Road, Chorlton-cum-Hardy, Manchester.* 1458. Oct. 1905.
- 604 **Brown, Albert.** 19 *Fairholt Road, Stamford Hill, N., London.* 1024. November 1894.
- 605 **Brown, Alexander Burnett, F.S.I.** *Melrose, Teddington.* **Grand Superintendent of Works. Assistant Grand Director of Ceremonies (R.A.).** January 1901.
- 606 **Brown, Frederick.** 10 *Fairholt Road, Stoke Newington, N., London.* 1365. October 1899.
- 607 **Brown, George Hernaman.** *Park Lodge, Alperton, Middlesex.* 1216. May 1904.
- 608 **Brown, G. R.** *Burt Street, Boulder, West Australia.* 903 (S.C.). October 1902.
- 609 **Brown, G. W.** *Hull.* 1511, P.M. October 1906.
- 610 **Brown, Harold E. Haig.** *County Hall, Lewes, Sussex.* 2885, P.M. November 1903.
- 611 **Brown, Harry, I.S.O.** 6 *Ravenworth Terrace, Durham.* P.Pr.G.D., P.Pr.G.Reg. (R.A.). May 1896.
- 612 **Brown, James.** *Park Lodge, Rawal Pindi, Punjab.* 1960, P.M. June 1888.
- 613 **Brown, James Marshall.** *Thames Street, Oamurn, New Zealand.* 52 (N.Z.C.) P.M. **Past Grand Zerrubabel.** January 1906.
- 614 **Brown, Hon. James W.** *Keystone Bank Buildings, Pittsburg, Penna., U.S.A.* **Grand Master.** 268, P.H.P. November 1905.
- 615 **Brown, Julius L.** 1 & 2 *Brown Block, Atlanta, Georgia, U.S.A.* 96, 16. June 1892.
- 616 **Brown, Macdonald, F.R.C.S.** 2 *Frognaal, Hampstead, N.W., London.* 2408, P.M. January 1900.
- 617 **Brown, Robert Smith.** 75 *Queen Street, Edinburgh.* **Grand Scribe Ezra, Scotland.** Local Secretary for Edinburgh and vicinity. May 1889.
- 618 **Brown, Thomas.** *Linthorpe, Middlesborough, Yorks.* 602. January 1901.
- 619 **Brown, Thomas, Surgeon.** 236 *Kennington Park Road, S.E., London.* 1597, P.M. June 1904.
- 620 **Brown, Walter Herbert, F.R.G.S.** 236 *Kennington Park Road, S.E., London.* 23. June 1900.
- 621 **Brown, William Alban Haig.** c/o *King, King & Co., Bombay.* 549, P.M., 549. March 1901.
- 622 **Brown, Capt. William Henry.** *Rock Life Insurance Company, Capetown.* 398 (S.C.). June 1902.
- 623 **Browne, Bernard Frederick.** *Calle Cuyr, 947, Buenos Aires.* 2329, 2329. May 1906.
- 624 **Browne, Charles Rhodes.** *Marine Building, Galveston, Texas, U.S.A.* 16, P.M. June 1906.
- 625 **Browne, George Duncan.** Box 458, *Manilla, Philippine Islands.* 373. January 1900.
- 626 **Browne, Dr. Herbert Henry.** *The Bungalow, Bethlehem, O.R.C.* 2522, P.M. Local Secretary for Orange River Colony, North. June 1895.



- 627 **Browne**, Major Henry Buxton. Box 17, *Durban, Natal*. P.S.G.W., D.G.J., Natal. November 1889.
- 628 **Browne**, John. *Parr's Bank, Wigan*. 1335, 2226, P.M. June 1894.
- 629 **Browne**, Matthew Frederick. *Burlington, Kansas, U.S.A.* 66, P.M., 77, P.H.P. May 1906.
- 630 **Browne**, William Peter. 3 *Austin Friars, E.C., London*. **Past Grand Standard Bearer**. June 1897.
- 631 **Browning**, A. G., F.S.A. *Spencer Lodge, Wandsworth Com., S.W., London*. 83, P.M., P.Z. Jan. 1891.
- 632 **Browning**, Charles W. R. 7 *Buddle Park, St. Thomas, Exeter*. 1254. May 1903.
- 633 **Browning**, Robert William. *Concord Junction, Mass., U.S.A.* Corinthian Lodge, Walden Ch., K. January 1899.
- 634 \***Bruce**, Alexander. *Clyne House, Pollokshields, Glasgow*. **Past Second Grand Principal**. June 1894.
- 635 **Bruce**, J. McPhail. 83 *Osborne Road, Newcastle-on-Tyne*. 481 P.M., 481. October 1898.
- 636 \***Bruennich**, Johannes Christian. *Daheim Taringa, Queensland*. 2624, P.M., P.D.G.Sup.W. October 1893.
- 637 **Brummerstaedt**, H. W. 29 *Sarre Road, West Hampstead, N.W., London*. 238. March 1902.
- 638 **Brunot**, Hilary Breton. *Brevard, North Carolina, U.S.A.* 267. June 1905.
- 639 **Brunton**, Gerald Henry. 61 *Hoole Road, Chester*. 755. October 1905.
- 640 **Bruton**, James. *Wotton Hill Cottage, Gloucester*. **Past Assistant Grand Director of Ceremonies** (Craft and B.A.). June 1890.
- 641 **Bryant**, James. 48 *Osborne Road, Southsea*. 1069. June 1900.
- 642 **Buchanan**, Francis C. *Clarinish, Row, Dumbartonshire*. **Past Prov. Grand Master**. May 1894.
- 643 **Buchanan**, James Isaac. *Conestoga Building, Pittsburg, Pennsylvania*. 219, P.M., 162. Nov. 1896.
- 644 **Buchanan**, John. 1 *Moselle Villas, St. Peter's Road, Margate*. 1853, P.M., 1928. March 1901.
- 645 **Buchanan-Dunlop**, Capt. A. H. *The Barracks, Bury, Lancs*. 1022. October 1901.
- 646 **Buck**, Edward H. 10 *St. Andrew's Road, Southsea*. 2153. October 1892.
- 647 **Buckham**, George Milward. *Hill View, North Berwick, N.B.* 1184, 40. January 1899.
- 648 **Buckeridge**, Edward Henry. *Bancroft Road, E., London*. 15, P.M., 2191. March 1898.
- 649 \***Buckley**, Llewellyn Edison, I.C.S. *Madras*. 150, 150. June 1896.
- 650 **Budden**, Horace. *Boscastle, Iddesleigh Road, Bournemouth*. P.P.A.G.D.C., Dorset. Nov. 1895.
- 651 **Bugler**, Thomas. 43 *Morley Road, Lewisham, S.E., London*. 171. March 1895.
- 652 **Buist**, George Alexander. *Gympie, Queensland*. 816 (S.C.), P.M., 260 (S.C.), P.Z. May 1898.
- 653 **Bullen**, John Henry. 3 *New China Bazaar Street, Calcutta*. P.D.G.R., Bengal. October 1905.
- 654 **Bumstead**, Alfred. 9 *Strada Mercanti, Valletta, Malta*. D.J.G.W., D.G.Sc.N. October 1896.
- 655 **Bungay**, Edward H. 160 *Astonville Street, Southfields, S.W., London*. 2740. May 1905.
- 656 **Burdon**, Major Aug. E., J.P. *Hartford House, Bedlington, R.S.O., Northumberland*. **Prov. Grand Master**. October 1906.
- 657 **Burdon**, Charles Sambrook. 29 *Derwent Road, Palmer's Green, N., London*. 2738, P.M., 2738, P.Z. October 1898.
- 658 **Burger**, Daniel Pieter. *Graaff Reinet, Cape Colony*. 882. October 1906.
- 659 **Burgess**, Henry. *Craigengillan, Layton Road, Hounslow*. 1556, P.M. January 1900.
- 660 **Burgess**, S. W. *Old Bank House, Tonbridge, Kent*. 859. January 1904.
- 661 **Burgess**, Thomas. 12 *Fouberts Place, Regent Street, W., London*. 201, P.M., 2346, P.Z. March 1906.
- 662 **Burgoyne**, F. J. *Tute Central Library, Brixton Oval, S.W., London*. 2941. June 1904.
- 663 \***Burkitt**, Hon. William Robert, Judge, B.C.S. *Allahabad, India*. D.G.M., D.G.H., Bengal. October 1898.
- 664 **Burlingham**, Joseph Cooper. *Mont Cenis, Chatsworth Road, West Norwood, S.E., London*. 2272, 1624. May 1906.
- 665 **Burn-Callander**, Edward. 23, *High Street, Warwick*. P.P.G.S.W., Pr.G.Sc.E. January 1905.
- 666 \***Burnard**, Alphonse A. 1103 *Emerson Street, Denver, Colorado*. **Past Grand Master**. **Past Grand High Priest**. March 1891.
- 667 **Burrows**, Herbert. 99 *Sotheby Road, Highbury Park, N., London*. 2920. January 1904.
- 668 **Burrows**, Horace Giffard. 3 *College Road, Winchmore Hill, N., London*. 2920. January 1904.
- 669 **Burtchall**, George Dames, M.A., LL.B., B.L. 44 *Morehampton Road, Dublin*. Pr.G.Sw.B., Wicklow and Wexford, 25, P.K. January 1895.
- 670 **Burton**, William. 84 *Manor Park Road, Harlesden, N.W., London*. 1608. June 1906.
- 671 **Busbridge**, Walter. *Grasmere, Herbert Road, Plumstead, Kent*. 913, P.M. October 1893.
- 672 **Butcher**, Charles. *The Grange, Tressillian Road, St. John's, S.E., London*. **Past Assistant Grand Pursivant**. **Past Assistant Grand Director of Ceremonies** (R.A.) March 1906.

- 673 **Butler**, Charles. 104 *Craven Park, Willesden, N.W., London.* 2489, P.M., 2489, P.Z. March 1898.
- 674 **Butler**, Charles McArthur. *Staple Inn Buildings (South) Holborn, W.C., London.* 195, 195. May 1897.
- 675 **Butler**, Rev. G. Corly. *Wesley Manse, Dongarra, West Australia.* Dis.G.B.B. June 1900.
- 676 **Butler**, J. Dixon. 11 *Redcliffe Gardens, S.W., London.* 34, P.M. June 1904.
- 677 **Butterworth**, John. *Easingwold, Smedley Lane, Manchester.* 2387, P.M., 204. May 1901.
- 678 **Buxton**, Frank C. *Angus Hotel, New Bridge Street, E.C., London.* 2528, P.M. June 1906.
- 679 **Byles**, Francis Wyman. 13, *Glenton Road, Lee, S.E., London.* 2005, P.M. March 1904.
- 680 **Byrne**, William Samuel, M.B. *Anne Street, Brisbane, Queensland.* D.Pr.G.M. (I.C.). Nov. 1892.
- 691 **Caddick**, A. A. *Nicholls Street, West Bromwich, Staffords.* 2784, J.W. June 1903.
- 692 **Cadmus**, Henry C. 1261 *Waverley Place, Elizabeth, New Jersey, U.S.A.* 33, P.M., 16, P.H.P. January 1906.
- 683 **Callaghan**, Samuel William. 17th *D.C.O. Lancers, Meerut, India.* P.Dis.G.S.B., P.Dis.G.Soj., Punjab. October 1906.
- 684 \***Cama**, Dorabjee Pestonjee. 3 *Great Winechester Street, E.C., London.* **Past Grand Treasurer.** September 1887.
- 685 **Cameron**, Sir Charles Alexander, M.D. 51 *Pembroke Road, Dublin.* **Past Grand Deacon.** May 1896.
- 686 **Campbell**, Archibald John. Lieut. 19th Hussars. *Charing, Kent.* 434. January 1898.
- 687 \***Campbell**, Archibald Young Gipps, I.C.S. *Madras Club, Madras.* 150, P.M., 150, P.Z. June 1906.
- 688 **Campbell**, Henry Johnstone, M.D. *Manningham Lane, Bradford.* 974. March 1900.
- 689 **Campbell**, John Lorne. *Melita, Manitoba, Canada.* P.M. January 1899.
- 690 **Campbell**, John MacNaught, C.E., F.Z.S., F.R.S.G.S. 6 *Franklin Terrace, Glasgow.* **Past Grand Bible Bearer; Grand Representative, Dakota; Past Grand Joshua; Grand Representative of G.C. of Maryland.** March 1889.
- 691 **Campbell-Everden**, William Preston. *Suffolk House, Cannon Street, E.C., London.* 19. May 1901.
- 692 **Campkin**, Harry Herbert. *Indian Head, Assa., Canada.* P.Dep.Dis.G.M. March 1901.
- 693 **Campling**, George Herbert. *Stracey House, Thorpe Hamlet, Norwich.* 1500. October 1902.
- 694 **Cane**, Arthur Herbert. 25 *Savage Gardens, E.C., London.* 188. March 1902.
- 695 **Caney**, Stanley. 44 *Cheapside, E.C., London.* 1415, 720. October 1899.
- 696 **Canham**, George Masters. 19 *Great Winchester Street, E.C., London.* 2694. May 1902.
- 697 **Capel**, George William. 186 *Strand, W.C., London.* 19, P.M. May 1894.
- 698 **Carew**, Walter Alexander. *Christchurch, New Zealand.* 4. October 1898.
- 699 **Carey**, Frank Russell, L.D.S. 22 *London Street, Basingstoke.* 694, 694. January 1904.
- 700 **Carey**, James. 203 *Shakespeare Crescent, Manor Park, E., London.* 179, 179. January 1893.
- 701 **Carmon**, William Francis. 3 *Queen Street, Newcastle-on-Tyne.* 481, P.M., P.Z. November 1889.
- 702 **Carnell**, James. *Ormond, Florida, U.S.A.* **Past Grand Master, Past Grand High Priest.** May 1894.
- 703 **Carnis**, Arthur Augustus. *The College, Harrogate.* 2695. January 1906.
- 704 **Carpenter**, A. J. 49 *Havelock Road, Brighton.* Pr.A.G.Sec., P.P.G.So. January 1901.
- 705 **Carpenter**, Arthur. *Elmsleigh, Staines, Middlesex.* 2536, 135. June 1900.
- 706 **Carpenter**, Lieut.-Col. G. J. 1 *Northumberland Avenue, Charing Cross, S.W., London.* 569. January 1906.
- 707 **Carpenter**, Colonel John Austin. 15 *Belsize Crescent, South Hampstead, N.W., London.* P.P.G.D., Bucks., P.P.G.J., Middlesex. June 1900.
- 708 **Carr**, Buckley. 41 *Oldham Road, Miles Platting, Manchester.* 1161, P.M., P.Pr.G.W., Pr.G.J, E. Lancs. March 1906.
- 709 **Carrick**, William Lowther. *Stokesley, Yorks.* P.Pr.G.R., North and East Yorks. March 1897.
- 710 **Carruthers**, John. 8 *Firpark Terrace, Dennistoun, Glasgow.* **Past Senior Grand Deacon; Grand Representative of Connecticut; Past First Grand Sojourner; Representative of G. C. of Dakota.** May 1892.
- 711 **Carsberg**, George Ridsen. 8 *Meredith Street, E.C., London.* 19. May 1893.
- 712 **Carson**, Joseph Lougheed. *Alexandra Terrace, Enniskillen, Ireland.* P.P.G.S.W., Tyrone and Fermanagh. March 1890.
- 713 **Carson**, B. T. *Battlefields, Rhodesia.* 2479, P.M. June 1903.
- 714 **Carstens**, C. *Moulmein, Burma.* Dis.G.Sw.B. March 1899.
- 715 **Cart**, Rev. Henry Thomas. 49 *Albert Court, Kensington Gore, S.W., London.* 2705. May 1900.
- 716 **Carter**, C. A. 36 *Clyde Street, Port Elizabeth, S.A.* P.Dis.G.W., P.Dis.A.G.So., E.Div. Oct. 1888.
- 717 \***Carter**, Elmer Josiah. Box 496, *Missoula, Montana, U.S.A.* 40, 25. October 1899.

- 718 **Cartwright**, Ernest H., D.M., B.Ch., Oxon. *Myskyns, Ticehurst, Sussex*. P.Pr.G.P.T., P.Pr.G.Sc.N., Oxon. January 1891.
- 719 **Cartwright**, Rev. Caupon Harry Beauchamp. *St. Augustine's College, Canterbury, Kent*. 776. October 1901.
- 720 **Carus-Wilson**, Edward Willyams. *Penmount, Truro, Cornwall*. 331, P.M. March 1889.
- 721 **Casler**, C. C. 302 *Butler Street, Port Huron, Michigan, U.S.A.* 58, P.M., 27, P.H.P. May 1904.
- 722 **Caslon-Smith**, Harold Arthur. 53 *Northfield Road, Stamford Hill, N., London*. 569. June 1906.
- 723 **Casper**, Ezekiel. *Perth, Western Australia*. P.D.G.W. (S.C.), Queensland. May 1891.
- 724 **Cass**, Rev. Frederick Charles Guise. *Conservative Club, St. James' Street, S.W., London*. 622. May 1888.
- 725 **Cassal**, Lieut.-Col. Charles Edward, F.I.C., F.C.S. *Brenne House, Routh Wood, Wandsworth Common, S.W., London*. P.Pr.G.W., Middlesex, 1642, P.Z. March 1891.
- 726 **Castello**, James. 36 *Percheater Terrace, Hyde Park, W., London*. 227, P.M., 7, P.Z. Jan. 1891.
- 727 **Caster**, F. *Devon House, Park Road, Peterborough*. P.P.G.A.D.C., P.P.G.So., Norths. and Hunts. May 1898.
- 728 **Caster**, G. C. *Medehamsted, Peterborough, Northamptonshire*. P.P.G.W., P.G.J. March 1892.
- 729 **Castro**, Q. Antonio. *San José, Costa Rica*. 1. **Past Grand Treasurer**. October 1904.
- 730 **Cauthorne**, Edward Everett. 665 *Flatbush Avenue, Brooklyn, New York, U.S.A.* 106, 76. March 1902.
- 731 **Cave-Brown**, William Charles. *Trichinopoly, South India*. 260, P.M., P.Dis.G.A.P., Madras. October 1906.
- 732 **Cave**, William Henry. 4 *The Triangle, North Kensington, W., London*. 1767. January 1899.
- 733 **Cawley**, Richard. *Seagirt Cottage, Deal*. May 1902.
- 734 **Cawthorn**, John Elston. *Elmete House, Sherburn, South Milford, Yorks*. 1221, P.M., P.P.G.D.C. May 1897.
- 735 **Chabot**, Clement. 50 *Old Broad Street, E.C., London*. 11, P.M. June 1900.
- 736 **Chamberlin**, Dr. Jehiel Weston. *Lowry Arcade, St. Peter's Street, St. Paul, Minnesota*. 163, 45. March 1893.
- 737 **Chambers**, James. 120 *Broadway, New York, U.S.A.* 746, P.M., 8, P.H.P. June 1903.
- 738 **Chambers**, Paul Bell. 564 *Cangallo, Buenos Aires*. 2517, P.M., 617. May 1902.
- 739 **Chambers**, William. *Capel-Cot, South Ealing, W., London*. 2662. January 1901.
- 740 **Chant**, Thomas Whitmore. *Stone Lodge, St. Andrew's, Watford, Herts*. 2128. June 1896.
- 741 **Chaplin**, W. J. 4 *Devereuz Road, Clapham Common, London, S.W.* 199. May 1906.
- 742 **Chapman**, A. C. 38 *Primrose Hill Road, Hampstead, N.W., London*. 2397. November 1898.
- 743 **Chapman**, Arthur. *Durban, Natal*. D.G.Tr., East Africa. October 1895.
- 744 **Chapman**, Charles Adolphus. 93 *Bunhill Row, E.C., London*. 179. March 1904.
- 745 **Chapman**, D. S. 19 *Prudhoe Terrace, Tynemouth*. 431, P.M., P.P.G.St.B. January 1899.
- 746 **Chapman**, John Midelton. 8 *Hutt Street, Springbank, Hull*. 907, P.M., P.Z. May 1898.
- 747 **Charan**, Isa, L.R.C.P., L.R.C.S. *General Hospital, Rangoon, Burma*. 36 (S.C.). November 1903.
- 748 **Chard**, Ernest James. *Messrs. King, King & Co., Fort, Bombay*. 490 (S.C.). May 1905.
- 749 **Chard**, Gerald Lionel. 55 *Bentinck Street, Calcutta*. 1100, 757. May 1906.
- 750 **Charlesworth**, Edwin. *Croft Villa, Gomersal, Yorkshire*. 603. May 1906.
- 751 **Charlton**, William, J.P. *Burnage House, Levenshulme, Manchester*. Pr.G.J.D., E. Lancs. March 1901.
- 752 **Chatterton**, Francis. *c/o Messrs. Best & Co., Madras*. 150. June 1906.
- 753 **Chatterton**, William Lincoln. 10 *South Street, Pawtucket, Rhode Island, U.S.A.* **Senior Grand Warden. Representative Grand Lodge of New Zealand**. June 1905.
- 754 **Cheese**, John Edward. *Pownall Crescent, Colchester*. 51, P.M., P.P.G.D. March 1905.
- 755 **Cheesman**, William Norwood, F.L.S. *The Crescent, Selby, Yorks*. P.P.G.W., P.P.G.J. Jan. 1893.
- 756 **Chesterton**, Lewis Birch. Box 2210, *Johannesburg, Transvaal*. 72. October 1891.
- 757 **Chick**, Frank. 83 *Queen Street, Exeter*. 2659. June 1899.
- 758 **Childe**, Rev. Canon C. V., LL.D. 8 *York Gate, Regent's Park, N.W., London*. **Past Grand Chaplain**. January 1898.
- 759 **Chillingworth**, George. *Foleshill, Beacontree Avenue, Forest Road, Walthamstow*. 1228, P.M. May 1902.
- 760 **Chinn**, Thomas Morton. *Sharia Emad El-Din, Abdin, Cairo*. G.J.D., G.Sc.N., Egypt. March 1902.
- 761 **Chirgwin**, Percy Teague. *Market Place, Penzance, Cornwall*. P.P.G.W., P.P.G.Treas. (R.A.) May 1890.

- 762 **Chisholm, Edward A.** 96 *George Street, Edinburgh.* **Grand Treasurer.** October 1900.
- 763 **Chown, Harry.** 47 *Ingleby Road, Ilford, Essex.* 1421, S.W. June 1906.
- 764 **Christison, James T.** *Endicott Building, St. Paul, Minn., U.S.A.* 163, P.M. October 1906.
- 765 **Citroen, David.** *Melrose, Shoot-up Hill, Brondesbury, N.W., London.* 1681. March 1905.
- 766 **Clark, Charles Crabb.** *Durban, Natal.* 731 (S.C.), P.M. November 1898.
- 767 **Clark, Cumberland.** 29 *Chepstow Villas, Bayswater, W., London.* 1297. January 1904.
- 768 **Clark, David R., M.A., F.S.A., Soot.** 8 *Park Drive, W., Glasgow.* O., P.M. June 1890.
- 769 **Clark, Henry Lewis.** *Maid's Head Hotel, Norwich.* 93. October 1902.
- 770 **Clarke, Albert Edward.** 40 *Long Street, Cape Town.* 2379, 2379. June 1897.
- 771 **Clarke, Allan Aiken.** *Sharrow Lane, Sheffield.* 2268. January 1904.
- 772 **Clarke, Ven. Archdeacon Francis Edward, M.D., LL.D., M.R.I.A.** *The Rectory, Boyle, Ireland.* Pr.G.M., North Connaught. March 1892.
- 773 **Clarke, Sydney Richard.** 18 *Grove Terrace, Highgate Road, N., London.* 1415, 142. January 1904.
- 774 **Clarke, William.** *Sidmouth, Holmdens Avenue, Herne Hill, S.E., London.* 190, P.M. March 1905.
- 775 **\*Clendinning, James Hermon.** 95 *Hill Street, Lurgan, Ireland.* 134, P.M., 602, P.K. May 1890.
- 776 **Clement, Charles Maxwell.** 22 *1st National Bank Building, Sunbury, Penna., U.S.A.* 632, 174. May 1905.
- 777 **Clements, James.** *The Ark, Fozrock, Co. Dublin.* 232 (I.C.), 93 (I.C.). May 1903.
- 778 **Cleveland, Arthur.** *St. Michael's House, Basinghall Street, E.C., London.* 1728. May 1905.
- 779 **Clifford, Arthur William.** 1022, 1574. January 1904.
- 780 **Clifford, C. L.** *Huldibarie Tea Estate, Gairkatta, P.O., Julpaigurie, Bengal.* 2439. March 1903.
- 781 **\*Clifford, Henry John.** *Morrinsville, New Zealand.* 52. October 1898.
- 782 **Clift, William Edwin.** *Port Elisabeth, Cape Colony.* 711. March 1901.
- 783 **Clough, G. T.** 73 *Earlham Grove, Forest Gate, E., London.* 2077. March 1895.
- 784 **Cluness, William Ross, jun., M.D.** *San Francisco, California, U.S.A.* 260, 5. November 1905.
- 785 **Coates, Arthur Robert.** *Labasa, Vanua Levu, Fiji.* 1931, P.M. October 1899.
- 786 **Coates, Harold Oliphant.** 103 *Hornby Road, Bombay, B.I.* 737, P.M., Dis.G.Treas., 1100, P.Z. October 1906.
- 787 **Coates, Thomas Charles.** 337 *Park Street, Akron, Ohio, U.S.A.* 57, 11, P.H.P. May 1904.
- 788 **\*Cobham, Charles, F.S.I.** *The Shrubbery, Gravesend.* P.P.G.Sup.W., Durham, P.Z. June 1900.
- 789 **\*Cobham, George W.** 4 *Woodville Terrace, Gravesend.* 1464, 829. January 1902.
- 790 **Cochran, Sam P.** Box 119, *Dallas, Texas, U.S.A.* 760, P.M., Past Grand Scribe. High Priest. June 1899.
- 791 **Cochrane, W. N.** 2 *Dr. Johnson's Buildings, Temple, E.C., London.* 1379, P.M. January 1897.
- 792 **Cochrane, William Percy.** *Rezzola, Lericci, Sarzana, Italy.* 1448, 602. November 1890.
- 793 **Cock, William, M.D.** 147 *Queen's Road, Peckham, S.E., London.* **Past Assistant Grand Director of Ceremonies, Past Grand Standard Bearer.** November 1889.
- 794 **Cockburn, Sir John Alexander, K.C.M.G., M.D.** 10 *Gatestone Road, Upper Norwood, S.E., London.* **Past Deputy Grand Master, South Australia. Past Grand Deacon, Past Assistant Sojourner, England.** November 1900.
- 795 **Cockburn, Brigade Surgeon J. Balfour, M.D.** *Elm House, Guernsey.* **Provincial Grand Master, Guernsey and Alderney.** October 1890.
- 796 **Cockson, Edward Herbert.** *Engcobo, Tembuland, South Africa.* 2451. June 1893.
- 797 **Cockson, William Vincent Shepstone.** *Engcobo, Tembuland, South Africa.* May 1889.
- 798 **Codding, James H.** 133 *Stewart Building, Broadway, New York.* 108, P.M., Dis.D.G.H.P. May 1890.
- 799 **Coffin, Surgeon Major Maitlaud, M.D.** 94, *Sinclair Road, W., London.* **Past Assistant Grand Director of Ceremonies, (Craft and R.A.).** October 1900.
- 800 **Coghill, W.** *Valparaiso, Chile.* 1411, P.M. June 1903.
- 801 **Cohen, Arthur P.** 40 *Colville Terrace, Bayswater, W., London.* 395. March 1902.
- 802 **Cohen, Isaac.** 20 *Craven Park Road, Harlesden, London, N.W.* 188, P.M., 1615. March 1906.
- 803 **Cohen, S. Charles.** 42 *Kensington Palace Mansions, W., London.* 185. January 1903.
- 804 **Cohn, Albert.** 84 *Canfield Gardens, W. Hampstead, N.W., London.* May 1897.
- 805 **Cohu, Thomas.** 56 *Lansdowne Road, Bromley, Kent.* **Past Grand Standard Bearer, Past Assistant Grand Director of Ceremonies (R.A.).** November 1890.
- 806 **Cole, Charles William.** 55 *Dafforne Road, Upper Tooting, S.W., London.* 2105, P.M. May 1899.
- 807 **Coles, Samuel G.** *Casilla 69, Talcahuano, Chile.* 2599, 2599. October 1903.
- 808 **Collens, William James.** 2 *Gresham Bldgs., Guildhall, E.C., London.* P.Pr.G.Sc.N., Kent. Jan. 1896.

- 809 **Collingridge**, John. 130 Coldharbour Lane, S.E., London. 2191. May 1904.
- 810 **Collingwood**, David Foulk. 203 Columbia Bank Building, Pittsburg, Penna., U.S.A. 576, P.M. 257, P.H.P. October 1904.
- 811 **Collingwood**, George Meadows. St. David's Hill, Exeter. 1437. June 1899
- 812 **Collins**, Algernon Lionel. 246 Gloucester Terrace, Hyde Park, W., London. 1460. January 1902.
- 813 **Collins**, George Sherrington. 149 High Street, Notting Hill Gate, W., London. 2192, P.M., 1471. January 1897.
- 814 **Collins**, Howard J. General Hospital, Birmingham. P.P.G.D., P.P.G.D.C. (R.A.). January 1894.
- 815 **Colman**, Thomas W. 29 Castle Meadow, Norwich. 93, W.M. October 1902.
- 816 **Colman**, Walter Stacey, M.D. 9 Wimpole Street, W., London. 2870. March 1902.
- 817 **Colsell**, Robert. 98 The Common, Upper Clapton, N.E., London. 2694, P.M. January 1905.
- 818 **Colyer**, Alfred Maurice. 1 Clements Inn, Strand, W.C., London. 1987. May 1903.
- 819 **Comber**, Frank P. Cavehill & Whitewell Tramways Co., near Belfast. 2083. May 1905.
- 820 **Condell**, Thomas de Rensy. Christchurch, New Zealand. Dis.G.Sec. June 1899.
- 821 **Conder**, Edward. New Court, Colwall, Malvern, Herefordshire. 1204. May 1893.
- 822 **Coningham**, Capt. H., B.A. Plinlimmon, Shooter's Hill, S.E., London. 1789. May 1905.
- 823 **\*Conner**, William Tate, A.R.I.B.A. Box 5615, Johannesburg, Transvaal. 510 (S.C.), 50 (S.C.). January 1902.
- 824 **Connor**, James Alexander. P.W.D., Tavoy, Burma. 834 (S.C.), 832. October 1903.
- 825 **Conor**, Col. Cecil. Elmhurst, Festing Road, Southsea. 61, P.M. March 1905.
- 826 **Cook**, John Oliver. Wrottesley Road, Plumstead, Kent. 913, P.M., 913, P.Z. May 1898.
- 827 **Cook**, Joseph. The Poplars, Codnor Park, Alfreton, Derbyshire. P.P.G.W., P.P.G.J. March 1905.
- 828 **Cook**, Thomas. Box 105 Durban, Natal. P.D.G.W., P.D.G.J. Local Sec. for Natal. March 1889.
- 829 **Cooke**, Frank Krinks. 15 Station Road, Levenshulme, Manchester. 1140, P.M., 1375. June 1906.
- 830 **Cooper**, A. J. Bullen. Grimston Lawn, Ealing, W., London. 2394. March 1904.
- 831 **Cooper**, Edward, Staff-Surgeon, R.N. Portchester Lodge, Dean Park, Bournemouth. 278. Jan. 1897.
- 832 **Cooper**, Edwin Ernest. Berrydown Court, Overton, Hants. **Past Grand Deacon. Past Grand Standard Bearer (R.A.).** May 1894.
- 833 **Cooper**, Frederick Albert. Box 344, Krugersdorp, Transvaal. 1747, 1747. June 1905.
- 834 **Cooper**, Percy Stephen. 192 Trinity Road, S.W., London. 1694. May 1901.
- 835 **Cooper**, Raymond Willoughby. Karachi, Sind, India. 767, W.M. May 1906.
- 836 **Cooper**, Richard Edward. Box 1877, Johannesburg, Transvaal. 2481, 2481. June 1905.
- 837 **Corbett**, John W., M.D. Camden, South Carolina, U.S.A. 29, P.M., 4. June 1896.
- 838 **Corcoran**, William St. Clair Denny. Pittsburgh, Penna., U.S.A. 221, P.M. October 1906.
- 839 **Cordner**, Edward Ellis. Casilla 1386, Buenos Aires. P.D.G.P., 2329, H. March 1905.
- 840 **Corey**, Robert Harris. 727 Betts Street, Cincinnati, Ohio, U.S.A. 141, 2. October 1903.
- 841 **Cork**, Charles Robert. 15 Seething Lane, London, E.C. 157, P.M. January 1906.
- 842 **Corkill**, F. P. New Plymouth, Taranaki, New Zealand. **Grand Superintendent, Past Grand Chancellor.** Representative Grand Lodge of Indian Territory. May 1902.
- 843 **Cornish**, William Delbi. Warren Lodge, Bury Street, Lower Edmonton. 1579. October 1906.
- 844 **Corsham**, Reuben. 28 Kingsland Road, N.E., London. 183, P.M. November 1891.
- 845 **\*Cory-Wright**, Dudley. Caen Wood Towers, Hampstead Lane, N.W., London. 375, 375. Oct 1897.
- 846 **Cosgrave**, E. MacDowel, M.A., M.D. 5 Gardiners Row, Dublin. P.M., P.K. October 1905.
- 847 **Couch**, Richard Pearce. Roseandown, Alexandra Road, Penzance, Cornwall. P.P.G.W., Pr.G.Sc.N. March 1890.
- 848 **Coulson**, T. Egmont, Tankerville Road, Streatham Common, London, S.W. 1297. May 1906.
- 849 **Coveney**, A. E. 76 Park Road West, Cloughton, Birkenhead. 605. P.M. March 1905.
- 850 **Coveney**, Frank. The Brents, Vicarage Road, Hoole, Chester. 721, P.M. October 1906.
- 851 **Cowan**, James Bryce. Commercial Bank, Hawick, N.B. 111, P.M., 89. Pr.Gr.Treas., Roxburgh, Peebles and Selkirk. Local Secretary for South Scotland. January 1892.
- 852 **Cowell**, Sidney George. Eroica, Harcourt Street, Brisbane, Queensland. P.A.D.G.D.C. March 1894.
- 853 **Cowins**, Henry Somerfield. Bound Brook, New Jersey, U.S.A. 3, 27. October 1897.
- 854 **Cowley**, Arthur Ernest. Wadham College, Oxford. 357. January 1902.
- 855 **Cowx**, William Fairfield. Dunelin, Hornsea, near Hull. 1511, P.M. November 1903.
- 856 **Cox**, Capt. Arthur D. 69th Punjabis, Dera Ismail Khan, Punjab, India. October 1906.
- 857 **Cox**, Charles Henry. 61 Acre Lane, Brixton, S.W., London. 163, 141. May 1890.
- 858 **Cox**, Claude Collins. Rosario de Santa Fé, Argentine Republic. 2960, 1553. May 1905.

- 859 **Cox, F. J.** *Lustleigh, Dorville Road, Lee, Kent.* 190, P.M. March 1898.
- 860 **Cox, John Samuel.** 198 *St. Vincent Street, Glasgow.* P.Dis.G.B., Hong Kong and South China. February 1887.
- 861 **Cox, W. Herbert.** 12 *Lebanon Gardens, Wandsworth, S.W., London.* 2920, W.M., 2182. March 1899.
- 862 **Coxen, William George.** 21 *Priory Park Road, N.W., London.* 183. March 1899.
- 863 **Crabtree, Charles.** *Hillside Villas, Bradford.* P.Pr.G.D., P.Pr.G.So., West Yorks. March 1888.
- 864 **Cradwick, William.** *Anchovy P.O., Jamaica.* 354. March 1905.
- 865 **Craig, Charles Taylor.** 97 *Queen Victoria Street, E.C., London.* 2562. October 1904.
- 866 **Craig, William.** *G.P.O. Singapore.* 508, P.M., 508. March 1902.
- 867 **Craigie, Colonel J. W. S.** 11 *Rozburghe Mansions, Kensington Court, London, W.* P.G.J.W. January 1903.
- 868 **Crampton, Harry Robert.** *Crampton's Hotel, Ramsgate.* 429, S.W. May 1906.
- 869 **Crane, D. B.** 28 *Mincing Lane, London, E.C.* 2398, P.M. June 1906.
- 870 **Crane, Robert Newton.** 1 *Essex Court, Temple, E.C., London.* 2397. November 1895.
- 871 **Crane, Stephen.** 69 *Mezfield Road, East Putney, S.W., London.* 2664. October 1899.
- 872 \***Cranswick, William F.** *Kimberley, South Africa.* Dep.Dis.Gr.M., C.S.Africa. March 1888.
- 873 **Craster, Lieut.-Col. James Cecil Balfour.** *c/o Messrs. H. S. King & Co., 9 Pall Mall, London, S.W.* P.P.Dis.B.G.P., P.D.G.A.Sc.H., Bengal. May 1896.
- 874 **Craven, Ernest George.** *London.* 757 (S.C.), 2 (S.C.) June 1905.
- 875 **Craven, Rev. James Brown.** *St. Olaf's Episcopal Church, Kirkwall, Orkney.* Pr.G.Depute Master, Caithness, Orkney and Zetland. February 1887.
- 876 **Crawford, George.** 21 *St. Andrew's Square, Edinburgh.* **Past Grand Deacon.** Nov. 1897.
- 877 **Crawford, John W. R.** 28 *Broadway, New York, U.S.A.* January 1906.
- 878 **Creasy, Lionel.** 15 *Wensum Street, Norwich.* 213. October 1902.
- 879 **Creerae, John.** *Melita P.O., Manitoba, Canada.* **Grand Registrar, Manitoba.** Jan. 1898.
- 880 **Creswell, Frank O.** 4 *Bedford Road, Walton, Liverpool.* 823. March 1901.
- 881 **Cresswell, Frank P. S.** 24 *Windsor Place, Cardiff.* 2570, 36. May 1905.
- 882 **Cresswell, George John.** *Salop Street, Kensington, Adelaide, South Australia.* 31. May 1905.
- 883 \***Cresswell, John.** 957. January 1894.
- 884 **Crick, William Clifton.** 51 *Carey Street, W.C., London.* P.Pr.G.St.B., Middlesex. October 1898.
- 885 **Crider, George A.** 917 *Filbert Street, Philadelphia, U.S.A.* 91, 52. May 1897.
- 886 **Cripps, C. J.** 118 *Terminus Road, Eastbourne.* 2434. January 1906.
- 887 **Criswick, George Strickland, F.R.A.S.** *The Wedge, 3a Eliot Place, Blackheath, S.E., London.* 1593, P.M., 1593, P.Z. January 1891.
- 888 **Crombie, Walter G.** *Junior Constitutional Club, S.W., London.* 574. October 1899.
- 889 **Crone, John Mann.** *St. Anne's-on-Sea, West Lancashire.* 1375, 1387. January 1899.
- 890 **Crookshank, Robert Percy, M.D.** Box 125, *Rapid City, Manitoba.* D.D.G.M., 105. June 1900.
- 891 **Cross, Edward William.** *Old Bank, Portland, Dorset.* P.P.G.D., P.P.G.Sc.N., Hants. March 1887.
- 892 **Cross, Frederick William.** 45 *Bradford Street, Walsall.* 539, P.M., 539, P.Z. March 1904.
- 893 **Cross, Reginald Farleigh Bloomfield.** 7 *Bournevale Road, Streatham, London, S.W.* 179, 179. January 1906.
- 894 **Crossie, Francis C., M.B.** 11 *Trevor Hill, Newry, Ireland.* Pr.Dep.G.Master, Down. Jan. 1893.
- 895 **Crossthwaite, Lawrence.** *Ivy Cottage, Ballasalla, Isle of Man.* 1289, P.M., 537. October 1898.
- 896 **Cruesemann, Dr. Edward.** 85 *Gracechurch Street, E.C., London.* 238. June 1903.
- 897 **Crundall, Arthur William.** *Vilela, F.C. Sud., Argentine Republic.* 617, 617. October 1900.
- 898 **Cuckow, Walter Mason.** *The Lodge, Walton, Suffolk.* P.P.G.St., Suffolk. November 1895.
- 899 **Cullen, J. F.** *Inverell, New South Wales.* 48, P.M. March 1895.
- 900 **Cumming, John Arthur, I.C.S.** *c/o Messrs. Arbuthnot & Co., Madras.* 2356. October 1901.
- 901 **Cummings, William Hayman, Mus. Doc.** *Sydcote, West Dulwich, S.E., London.* **Past Grand Organist.** November 1900.
- 902 **Cundill, Thomas Jordan.** *Gladstone, De Beers, Kimberley.* 2486. November 1894.
- 903 **Cunningham, Rev. Wm., D.D.** *Trinity College, Cambridge.* P.Pr.G.Ch., Cambridge. May 1896.
- 904 **Cunningham, W. M.** 174 *N. 4th Street, Newark, Ohio, U.S.A.* Chairman of Committee on Foreign Correspondence. May 1905.
- 905 **Curtis, James, F.S.A.** *Glenburn, Worcester Road, Sutton, Surrey.* 3109. October 1905.
- 906 **Curtis, William Edward.** *Bundaberg, Queensland.* 752 (S.C.), 246 (S.C.). March 1894.
- 907 **Cuthbert, R. F.** *Winney, Oxfordshire.* 1703, J.W. October 1906.
- 908 **Cutts, George Winttingham.** *High Street, Bognor, Sussex.* 1726, P.M. May 1906.

- 909 **Daley, G. J.** *Mossel Bay, Cape Colony.* 1938, P.M. October 1902.
- 910 **Daley, W.** *Mossel Bay, Cape Colony.* 1938, P.M. October 1902.
- 911 **Dalrymple, James D. G., F.S.A.** London and Scotland, F.R.S.E. *Meikelwood, Stirling, N.B.* **Past Grand Master Depute, Past Dep. Grand Zerubbabel, Scotland.** June 1888.
- 912 **Dance, Major Charles E.** *Abbey Lodge, St. Alban's, Herts.* 2006. January 1905.
- 913 **Dangerfield, Frederick.** *Haslemere, Beaconsfield Road, St. Alban's.* 1260, P.M., P.Z. May 1894.
- 914 **Dangerfield, Rev. George.** *Milton House, Newbury, Berks.* 574, Chap., 574. May 1906.
- 915 **Daniels, L. E.** 1104 *Main Street, La Porte, Indiana, U.S.A.* 124, 31. May 1887.
- 916 **Danielsson, Leonard.** 64 *Antrim Mansions, Haverstock Hill, N.W., London.* 1471. June 1897.
- 917 **Dansie, Brandon.** 45 *Devonshire Chambers, Bishopsgate Street, E.C., London.* 529, P.M. Jan. 1896.
- 918 **Dansie, Crown.** *Durban, Natal.* March 1897.
- 919 **Danvers, Ernesto.** 475 *B.Mitre, Buenos Aires.* D.G.D.C., Craft and R.A. October 1905.
- 920 **Darbishire, Bernhard Vernon, M.A.** 202 *Tiffley Road, Oxford.* 238. January 1903.
- 921 **Darley-Hartley, W., M.D.** *Mayfield, Gilmour Hill Road, Kloof Road, Cape Town.* P.Dis.G.W., P.Dis.G.R., East Division, South Africa. October 1888.
- 922 **Darling, Alexander.** *Governor's House, Berwick-on-Tweed.* 393, P.M., 393. October 1895.
- 923 **Darlington, George.** *Amersham, Bucks.* 2421, P.M. May 1899.
- 924 **Davey, Arnold E.** *Currie Street, Adelaide, South Australia.* 38. June 1905.
- 925 **Davey, Rev. H. M.** *Cawley Priory, Chichester, Sussex.* **Past Grand Chaplain.** March 1899.
- 926 **Davidson, Frank A.** 182 *Mount Vernon Street, Boston, Mass., U.S.A.* Doric Lodge. January 1902.
- 927 **Davies, Charles.** *Ivy Dene, Alderley Edge, Cheshire.* 467. March 1898.
- 928 **Davies, Charles H.** 3 *Hamilton Street, Hoole, Chester.* 1576, P.M., 721. May 1901.
- 929 **Davies, F. Trehawke.** 9 *Cavendish Square, W., London.* 2771. October 1900.
- 930 **Davies, J. C.** 27 *Vauzhall Street, Kennington Lane, S.E., London.* June 1906.
- 931 **Davies, J. Hudson.** *Yockleton, near Shrewsbury.* 117. January 1898.
- 932 **Davies, James John.** *Gwynnecote, Sanderstead Hill, Surrey.* P.Dis.G.Treas., Punjab. Oct. 1892.
- 933 **Davies, John Pitt.** *Staff Lines, Secunderabad, India.* 434, P.D.G.O., Bombay. May 1904.
- 934 **Davies, John William.** *Audrey Lodge, Ditton Court Road, Westcliff-on-Sea.* 511. May 1902.
- 935 **Davies, Neander Warburton.** *Portwood Estate, Kandapolla, Ceylon.* 2991, P.M., 2656, M.E.Z. October 1905.
- 936 **Davies, Richard Cecil.** *Yorton, Hoole, Chester.* 1576, P.M. October 1905.
- 937 **Davies, W. H.** 15 *St. John's Street, Chester.* 2609, P.M. May 1905.
- 938 **Davis, A.** *Bellevue, St. Augustine's Avenue, South Croydon, Surrey,* 1693. May 1903.
- 939 **Davis, F. B.** *Shawford, Winchester.* 1873, P.M. November 1899.
- 940 **Davis, John McNaught.** *Farndon, Newark, Notts.* P.P.G.P., Derbyshire. October 1903.
- 941 **Davis, W. H.** *The Beehive Hotel, Bull Street, Birmingham.* 1782, P.M. May 1901.
- 942 **Davison, T.** 28 *Great Ormond Street, W.C., London.* 200. June 1899.
- 943 **Davy, F. D.** 18 *St. James' Mansions, West Hampstead, N.W., London.* P.Pr.G.W., P.Pr.G.A.So., Lincoln. June 1896.
- 944 **Dawson, William.** 8 *Marlborough Road, Lee, S.E., London.* P.D.G.D.C., Middlesex, 2048, P.Z. October 1901.
- 945 **Dawson, William.** *Seton House, Tweedmouth.* 393, P.M. June 1904.
- 946 **Day, Edward, P., M.D.** 3 *Holles Street, Cavendish Square, S.W., London.* 1636. June 1894.
- 947 **Day, Edward Harry.** *Assiout, Upper Egypt.* 1982. October 1898.
- 948 **Day, Henry Shadforth.** 5 *Sutherland Place, Bayswater, W., London.* 2337, P.M. October 1905.
- 949 **Day, Jack C., C.E.** *Samallout, Egypt.* 1982. October 1896.
- 950 **Day, Robert, F.S.A., M.R.I.A., V.P.R.S.A., J.P.** *Myrtle Hill House, Cork.* 8, P.M., 1 (I.C), P.K. October 1898.
- 951 **D'Amer-Drew, J.** 69 *Park Street, West Melbourne, Victoria.* **Past Deputy Grand Master, Past Grand Zerubbabel.** May 1898.
- 952 **Deacon, Charles William.** *Cardiff Villa, Luton, Beds.* 1677, P.M. November 1905.
- 953 **Deacon, Rev. Ernest W.** *Chaplain, Horton, Epsom.* October 1900.
- 954 **Dean, Marshall H.** *Glenwood Springs, Colorado, U.S.A.* **Past Grand Master.** October 1903.
- 955 **Dear, Lawrence Hart.** 2 *Algiers Road, Lewisham, S.E., London.* 49, S.W. June 1906.
- 956 **Dearden, Verdon George Steade.** *Bush House, Attercliffe Common, Sheffield.* P.P.G.D., 139, P.Z. March 1890.

- 957 **Dearman, Richard.** *East Bank, Heaton Norris, Stockport.* 1458. October 1905.
- 958 **Deats, Hiram Edmund.** *Flemington, New Jersey, U.S.A.* 37, P.M., 37. May 1897.
- 959 **Debenham, Edward Percy.** *Ennerdale, Carlisle Avenue, St. Alban's.* P.P.G.Reg., Herts. January 1893.
- 960 **Denholm, William Munro.** *6 Charing Cross, Glasgow.* **Past Senior Grand Warden. Past Grand Joshua, Scotland; Grand Representative of G.C. of Delaware and Grand Lodge, Utah.** March 1891.
- 961 **Denny, Charles Hill.** *18 Wood Street, E.C., London.* 1671, P.M. May 1897.
- 962 **Dentith, Arthur W.** *Ecclesbourne, Park Road, West Dulwich, S.E., London.* 859. June 1898.
- 963 **Denton, John Burton.** *38 Filey Avenue, Stoke Newington, N., London.* 1001. May 1900.
- 964 **Derbyshire, John Stanley.** *Ashfield Road, Altrincham, Cheshire.* P.P.G.D.C., Craft and R.A. May 1896.
- 965 **Derrick, George Alexander.** *Masonic Hall, Singapore.* **Deputy District Grand Master, Eastern Archipelago.** October 1890.
- 966 **Desborough, William Henry, Baron.** *Taplow Court, Taplow, Bucks.* **Junior Grand Warden.** October 1906.
- 967 **\*Dessen, Hans Falck.** *6 North Grove, Highgate, N., London.* 28, P.M. June 1903.
- 968 **Deutsch, Franz.** *4 Whitehall Court, S.W., London.* 2108. June 1897.
- 969 **Devonshire, George Thomas.** *6, Stone Buildings, Lincoln's Inn, W.C., London.* 95, 1677. Oct. 1905.
- 970 **Dewdney, Francis Worthy Rigbye.** *83 Upper Thames Street, E.C., London.* 2562. October 1905.
- 971 **\*Dewell, James D.** *New Haven, Connecticut, U.S.A.* 1. January 1888.
- 972 **Dewhurst, William.** *Elm Bank, Moor Lane, Kersal, Manchester.* 1458, P.M. October 1905.
- 973 **De Wolf Smith, William Andrew.** *New Westminster, B.C., Canada.* 9, P.M., 124, P.G.O., Gr. Hist. (R.A.). June 1901.
- 974 **\*Dey, Thomas Henry.** *23 Douglas Road, Canonbury, N., London.* 2021, 2738. May 1902.
- 975 **Dibdin, W. J.** *2 Edinburgh Mansions, Victoria Street, S.W., London.* January 1899.
- 976 **Dick, J. B. G.** *Byes End, Sidford, Sidmouth, S. Devon.* 859. January 1906.
- 977 **Dickens, John.** *11, The Drive, Northampton.* 2431, P.M. November 1904.
- 978 **Dickens, Vernon W. Frank.** *The Oaks, Arkwright Road, Hampstead, N.W., London.* 822, 29. May 1898.
- 979 **Dickinson, William.** *Sunnymount, Austen Road, Guildford, Surrey.* 1395. October 1898.
- 980 **Dickson, Robert.** *Slottsbacken 4, Stockholm, Sweden.* **Grand Secretary, Sweden.** Sept. 1887.
- 981 **Diercks, Dr. Gustav.** *Berlin, S. 14, Splittgerbergasse 5.* **Grand Keeper of the Archives.** March 1898.
- 982 **Diggins, A. E.** *476 Chatsworth Road, Chesterfield.* 2373, 681, Sc.N. May 1906.
- 983 **\*Dill, James Brooks.** *27 Pine Street, New York, U.S.A.* 124. June 1898.
- 984 **Dinwiddie, William Alexander.** *Bridge Bank, Dumfries, N.B.* **Past Grand Warden.** P.Pr.G.M., Dumfries. May 1892.
- 985 **Dixon, Rev. Edward Young.** *Mount Ayliff, East Griqualand.* 2113. November 1889.
- 986 **Dixon, G.** *6 North Street, Melton Mowbray.* 1130, W.M. March 1906.
- 987 **Dixon, James John.** *10 St. Alban's Villas, Highgate Road, N.W., London.* P.P.G.S., P.P.G.D.C., Middlesex. November 1896.
- 988 **Dobrovich, Venceslao.** *27 South Parade, Bangalore, Madras.* 1043, 71 (S.C.). May 1902.
- 989 **Dobson, Albert.** *4 Princes Street, Hanover Square, W., London.* 2105. May 1906.
- 990 **Dobson, James William.** *The Elms, Garforth, Leeds.* 1311, W.M. January 1905.
- 991 **Dodd, Matthew Henry.** *41 Devonshire Place, Jesmond, Newcastle-on-Tyne.* P.Pr.G.R., Durham. March 1890.
- 992 **Dodds, William.** P.O.B. 33, *Johannesburg, Transvaal.* 2481, P.M., 2313. May 1897.
- 993 **Doe, George Mark.** *Enfield, Great Torrington.* P.Pr.G.Reg., Devon, 251. October 1897.
- 994 **Doe, Herbert William, A.R.I.B.A.** *54 Elborough Street, Southfields, S.W., London.* January 1901.
- 995 **Donovan, Fergus.** *Royal Colonial Institute, Northumberland Avenue, W.C., London.* 744 (S.C.). October 1889.
- 996 **Doolittle, John C. M.D.** *Des Moines, Iowa, U.S.A.* 87. May 1905.
- 997 **Doral, Raj, Gnanaprakasam Vedamonikam.** 1-13, *Oilmongers' Street, Georgetown, Madras.* 465. May 1902.
- 998 **Dorman, Thomas Phipps.** *Renicliffe House, Northampton.* **Past Assistant Grand Director of Ceremonies.** March 1889.
- 999 **Dorwaldt, Hermann.** *17 Lime Grove, Shepherd's Bush, W., London.* **Lodge Zu den drei Sternen.** May 1906.



- 1000 **Dow, J. M.** 16a *Abercrombie Square, Liverpool.* 1013. May 1901.
- 1001 **Dowden, W. J. M.** 41 *Bermondsey Square, S.E., London.* 2208, P.M. March 1897.
- 1002 **Dowding, Major H. Hewitt.** *Birchfield, Roehampton, S.W., London.* 2439. January 1898.
- 1003 **Downes, Jonathan.** 96 *St. Julian's Farm Road, West Norwood, S.E., London.* 857. January 1905.
- 1004 **Dowse, Francis.** *Godalming, Surrey.* 2101, P.M., 777, P.Z. May 1895.
- 1005 **Dowsett, G. H.** 1 *Gloucester Street, Portman Square, W., London.* 79. May 1900.
- 1006 **Drapes, Rev. Lambert.** 32 *Rathmines Road, Dublin.* 270 (I.C.). January 1906.
- 1007 \***Dressel, Otto.** *Ilmenau, Thuringen, Germany.* November 1904.
- 1008 **Drew, Eric.** *Brightside, Royapet, Madras, India.* 150, P.M., 150. October 1906.
- 1009 **Drew, William George.** 69 *Richmond Road, Islington, N., London.* 765, 1602. November 1899.
- 1010 **Dreyfuss, J.** 1 *Wilbury Gardens, Hove, Sussex.* 1693. May 1903.
- 1011 **Dring, John Whitford.** 22 *Billiter Square, E.C., London.* 1297, P.M. June 1899.
- 1012 \***Dru-Drury, Edward Guy, M.D.** *High Street, Grahamstown, Cape Colony.* 2546. May 1904.
- 1013 **Drummond, Charles James.** 21 *Dalmore Road, West Dulwich, S.E., London.* 1541, P.M., 1269, P.Z. January 1899.
- 1014 **Drummond, Peter.** *Khartoum, Soudan.* Z (S.C.). November 1905.
- 1015 **Drysdale, J. W.** *Hurstleigh, Howard Road, South Norwood, S.E., London.* 263, P.M. June 1898.
- 1016 **Du Cros, Alfred.** *Mailand House, Church Street, Kensington, W., London.* 2108. March 1902.
- 1017 **Dudfield, Reginald S. Orme, M.B.** 19 *Blomfield Road, Maida Vale, W., London.* 1974. Oct. 1898.
- 1018 **Duffield, Albert John.** Box 74, *Grahamstown, Cape Colony.* 828, P.M., 711. June 1895.
- 1019 **Duffill, John Henry.** *Durban, Natal.* 730 (S.C.), 175 (S.C.), P.Z. May 1899.
- 1020 **Dumolo, William.** 20 *Bridge Street, Aberdeen, N.B.* P.Pr.G.I.G., Munster. October 1888.
- 1021 **Dunaway, H. J.** *Glan Mor, Keyes Road, Cricklewood, N.W., London.* 2698. May 1901.
- 1022 \***Durell, Captain A. J. V.** 3 *Whitehall Place, S.W., London.* 2537. October 1901.
- 1023 **Durose, Charles Edward.** Box 1111, *Pretoria, Transvaal.* 770 (S.C.), P.M., 231 (S.C.). Oct. 1903.
- 1024 **Dutt, Prosonno Coomar.** 14 *Sectarim Ghose's Street, Calcutta.* P.D.D.G.M., P.Dis.G.H. (R.A.). March 1887.
- 1025 **Dyer, William John.** 14 *Morden Road, Blackheath Park, S.E., London.* 14, P.M. November 1903.
- 1026 **Dyson, John William.** 38 *Jesmond Road, Newcastle-on-Tyne.* 2520, P.M., 24. October 1898.
- 1027 **Eaborn, H.** *Glen Helen, Heber Road, Dulwich, S.E., London.* 1539. November 1898.
- 1028 \***Eales, C. L. M., I.C.S.** *Brambledown Road, Wallington, Surrey.* 836, P.M., P.D.S.G.W., Bengal. October 1900.
- 1029 **Eames, Robert H.** 94 *Tressillian Road, St. John's, S.E., London.* 2500. May 1904.
- 1030 **East, Fred J.** 42 *St. Kilda Road, Stoke Newington, N., London.* 11, P.M. June 1902.
- 1031 **Eaton, Alfred W.** 8 *Linwood Avenue, Warren, Pennsylvania, U.S.A.* 560. May 1902.
- 1032 **Eaton, Charlie D.** 109 *Colmore Row, Birmingham.* 560, P.M., P.P.G.D.C., Worcestershire. P.Z. May 1906.
- 1033 \***Ebblewhite, Ernest Arthur, Barrister-at-Law, F.S.A.** *Tintern, Christchurch Road, Crouch End, N., London.* **Assistant Grand Registrar.** January 1898.
- 1034 **Eden, Charles Stockwell.** *Toowoomba, Queensland.* 775 (S.C.), 187 (S.C.). May 1896.
- 1035 **Edgar, W. J.** *St. John's, Newfoundland.* 579, J.D. March 1906.
- 1036 \***Edlin, Edward Frederick Holbeiton.** 10 *College Quay, Singapore.* P.D.G.D.C., 1152. June 1904.
- 1037 **Edmunds, Henry Eustace.** *Reservoir House, Chesterfield.* 3055, S.W. June 1906.
- 1038 **Edwardes-Evans, Rev. John, M.A.** *The Grammar School, Lymm, Cheshire.* P.P.G.Chap. May 1901.
- 1039 \***Edwards, Charles Lewis, F.S.S.** *Santa Lucia, Battlefield Road, St. Alban's.* 617, P.M. Oct. 1897.
- 1040 **Edwards, Charles Lund Fry.** *The Court, Axbridge, Somerset.* **Past Grand Deacon.** October 1888.
- 1041 **Edwards, Joseph Hughes, M.D.** *Wylam, Alabama, U.S.A.* 492, P.M., 108. January 1902.
- 1042 **Edwards, P. G.** 33 *Ardbeg Road, Herne Hill, S.E., London.* 1627, P.M., 1194, P.Z. January 1896.
- 1043 **Edwards, Percy J.** 32 *Waldegrave Road, Upper Norwood, S.E., London.* 2105. January 1898.
- 1044 **Edwards, W. G. A.** 3 *Coleman Street, E.C., London.* 2500. January 1899.
- 1045 **Eedle, F. J.** 8 *Railway Approach, London Bridge, S.E., London.* P.Pr.G.Sup.W., Essex. June 1898.
- 1046 **Egan, Charles James, M.D.** *Grey's Hospital, King Williams Town, South Africa.* **District Grand Master, Eastern Division of South Africa.** January 1889.
- 1047 **Eggs, William George.** *P.O. Kingston, Jamaica.* 354. March 1906.
- 1048 **Eisenmann, J.** 46 *Basinghall Street, E.C., London.* 185, P.M., P.Z. May 1899.

- 1049 **Eland**, George. 85 *Finsbury Pavement, E.C., London*. 2834, 112. June 1904.
- 1050 **Elgee**, Richard Waddy. *The Cottage, Uarcur Road, Weaford*. 935 (I.C.), P.M. March 1901.
- 1051 **Elkington**, George, F.R.I.B.A. 7 *Laurence Pountney Hill, Cannon Street, E.C., London*. 2146, P.M., P.Z. January 1898.
- 1052 **Ellington**, Charles Sampson. 13 *Cleveland Terrace, Middlesboro', Yorks*. 602. March 1905.
- 1053 **Elliot**, Henry E. *Shortland Street, Auckland, New Zealand*. 1930, P.M. October 1904.
- 1054 **Ellis**, John Gardener. 109 *Florence Road, Wimbledon, S.W., London*. 3098, 1155. May 1903.
- 1055 **Ellis**, J. W. Hay. *Pettigrew Street, St. John's Hill, Bangalore, India*. 1841. May 1899.
- 1056 **Ellis**, Lilley. 9 *Rock Park, Rock Ferry, Birkenhead*. **Past Assisstant Grand Director of Ceremonies, Past Grand Standard Bearer**. November 1893.
- 1057 **Ellis**, Col. Richard Sidney. 11 *Savile Row, W., London*. 2242, P.M. May 1896.
- 1058 **Ellis**, Robert John. 64 *Foregate Street, Chester*. 721. October 1905.
- 1059 **Ellis**, William Symons. *Sherwood, Nottingham*. 2553, P.M., 47. May 1904.
- 1060 **Ellor**, Andrew. *Oak Bank, Highfield, Gorton, Manchester*. 104, P.M. January 1898.
- 1061 **Elstob**, Arthur Charles Frank. *Durban, Natal*. 738, 738. October 1895.
- 1062 **Emary**, F. H. *Barclay's Bank, Eastbourne*. 2434. January 1906.
- 1063 **Embleton**, Henry C. *Central Bank Chambers, Leeds*. 269. January 1895.
- 1064 **England**, Frederick. *Baxter Avenue, Southend-on-Sea*. 2442, P.M., 1000, P.Z. June 1901.
- 1065 **England**, Harry. 2 *Iverna Gardens, Kensington, W., London*. 1216. March 1903.
- 1066 **Enoch**, Elmer Ellsworth. *Wichita, Kansas, U.S.A.* 86, P.M. March 1906.
- 1067 **Ernst**, Waldemar Frederick Carl. *Umtali, Rhodesia*. 401 (S.C.). January 1902.
- 1068 **Esslemont**, Alfred Sherwood. 33 *Leazes Terrace, Newcastle-on-Tyne*. 2260. May 1904.
- 1069 **Evans**, A. W. Charles. *Royal Chambers, Port Said, Egypt*. P.A.G.D.C., P.G.D., Egypt, 342. June 1899.
- 1070 **Evans**, Major George Alfred Penrhys. *Furzedene, Budleigh Salterton, South Devon*. P.D.G.St.B., Punjab. January 1897.
- 1071 **Evans**, Jenkin William. *Lyncombe, Middleton Hall Road, King's Norton, Worcestershire*. 2897, J.W., 1016. March 1906.
- 1072 **Evans**, Marthinus Andreas. Box 49 *Potchefstroom, Transvaal*. 766 (S.C.), P.M., 245 (S.C.). June 1899.
- 1073 **Evans**, Oliver Rhys. *Port Fairy, Victoria*. **Past Grand Deacon**. October 1892.
- 1074 **Evans**, Tom Lloyd. *Crindau House, Newport, Monmouth*. 683, P.M., 683, P.Z. October 1905.
- 1075 **Evans**, William Joseph. *Bank of Madras, Madras*. 150, P.M., 465, P.Z. June 1905.
- 1076 **Evekink**, Huibert, jun. *Ravenstraat 2, Zutphen, Holland*. Karel van Zweden. May 1900.
- 1077 **Evens**, Richard. 81 *Bromfelde Road, Clapham, S.W., London*. 1949, P.M., 1589, P.Z. Jan. 1893.
- 1078 **Everard**, Frederick Edward. 57 *Shirley Road, Southampton*. 871, P.M. November 1905.
- 1079 **Everett**, Herbert Southwell. Box 146, *Cape Town*. Dep.Dis.Gr. Master, P.D.G.H., S. Africa, W.Division. January 1898.
- 1080 **Eversley**, William Pinder. 13 *Upper King Street, Norwich*. Pr.G.Sec., P.Pr.G.J. June 1893.
- 1081 **Eves**, Charles. *Fairfield, Norfolk Road, Regent's Park, N.W., London*. 183, W.M. March 1906.
- 1082 **Ewbank**, Rev. Thomas Cranmer. *Sedgbrook, Grantham*. Pr.G.Chap., 1094. January 1901.
- 1083 **Ewen**, Alfred. 2 *St. Paul's Terrace, Northampton*. 475, P.M., P.P.G.Reg. Bedfords. March 1898.
- 1084 **Exham**, Francis R. *Calgary, Alberta, Conada*. 28 (G.R.M.), P.M. October 1903.
- 1085 **Ezard**, Edward Henry, M.D., B.Sc., F.R.Hist.S. 220 *Lewisham High Road, S.E., London*. 2140, P.M., 25, P.Z. January 1891.
- 1086 **Fairburn**, Henry. *Market Place, Northallerton, Yorks*. 1337, P.M., 236. March 1902.
- 1087 **Fairley**, Alfred. 314 *Birchfield Road, Birmingham*. 1782. June 1906.
- 1088 **Falconer**, William. 67 *Hope Street, Glasgow*. **Past Junior Grand Deacon**. June 1890.
- 1089 **Falkner**, William J. 19 *Ludgate Hill, E.C., London*. 507. May 1904.
- 1090 **Falshaw**, P. S. *Government Veterinary Surgeon, Singapore*. 2933, P.M., D.A.G.D.C. March 1904.
- 1091 **Fanshawe**, Henry Horatio. 2589. January 1906.
- 1092 **Farmer**, William Arthur. 200 *Old Kent Road, S.E., London*. 1571, P.M. June 1904.
- 1093 **Farrar**, Jacob Rushton. 120 *Calabria Road, Highbury, N., London*. 1339. May 1896.
- 1094 **\*Fawcett**, John E., J.P. *Low Royd, Apperley Bridge, near Bradford*. 974, P.M., P.Z. Nov. 1900.
- 1095 **Fearnley**, James Banks. *Spring Mount, Springwood Avenue, Huddersfield*. 2321, P.M., P.P.G.D. Local Secretary for West Yorkshire. January 1899.
- 1096 **Felton**, William. *Hill View, Stanmore, Middlesex*. 1549. November 1903.

- 1097 **Fennell**, George H. 50b Romford Road, Stratford, E., London. 1805, P.M. October 1899.
- 1098 **Fenwick**, R. Sweet Briar, Plough and Harrow Road, Edgbaston, Birmingham. 1016, P.M. May 1901.
- 1099 **Ferguson**, James Finley. Durban, Natal. 731, P.M. May 1897.
- 1100 **Ferguson**, T. E. 112 Fore Street, Upper Edmonton, N., London. 192. May 1903.
- 1101 **Ferrier**, Richard Frederick Ernest. The Lodge, Hemsby, Norfolk. P.P.S.G.W. November 1901.
- 1102 **Festing**, John Edward Grindall, c/o Grindlay, Groom & Co., Bombay. 415, 68 (S.C.) May 1906.
- 1103 **Fick**, William Charles. 4 Raeland Street, Capetown. De Goede Hoop Lodge. May 1899.
- 1104 **Field**, Charles. 47 Collingwood Avenue, Muswell Hill, N., London. 148. January 1904.
- 1105 **Figg**, Arthur O'dell. Colombo, Ceylon. 2170. October 1904.
- 1106 **Fillingham**, Rev. Robert Charles. Hexton Vicarage, Ampthill, Bedfordshire. 393, 393. June 1890.
- 1107 **Fitt**, Thomas. c/o Fitt Bros. & McDonald, Salisbury, Rhodesia. 2479, P.M. October 1901.
- 1108 **Finch**, Charles William. Umtali, Rhodesia. 2878, 201. October 1901.
- 1109 **Finney**, Maurice E. Harrisburg, Pennsylvania, U.S.A. 21, 21. May 1897.
- 1110 **Finnis**, Philip Richard. 149 Folkestone Road, Dover. 1625. 199. March 1905.
- 1111 **Finzel**, C. F. 91 Fore Street, E.C., London. 2562. March 1905.
- 1112 **Firminger**, Rev. Walter Kelly. Kidderpore Vicarage, Calcutta. Local Secretary for Bengal. 229, P.M., D.G.J.W., Bengal. March 1900.
- 1113 **Firth**, Oliver. Hawkeswood, Baildon, near Shipley, Yorks. 1545, P.M. May 1891.
- 1114 **Fischer**, Paul. Landrichter, Gera-Untermhaus, Germany. Editor of "Latomia." June 1905.
- 1115 **Fischer**, B. E. 7 Parbutti Villas, Poona, India. 415. October 1906.
- 1116 **Fishel**, John. Federal Building, St. Paul, Minnesota, U.S.A. 190, P.M. May 1905.
- 1117 **Fisher**, A. 55 Victoria Road South, Southsea. 1834, 342. January 1901.
- 1118 **Fisher**, Walter. 31 Abbey Road, West Ham, E., London. 2411, P.M. 192, P.Z. May 1906.
- 1119 **Fisk**, Frank. Steinmann's Hotel, Grahamstown, Cape Colony. March 1904.
- 1120 **Fitch**, Stanley Fox. 60 Bishopsgate Street Within, E.C., London. 1827. January 1903.
- 1121 **Fitton**, Edgar. Rookwood, Northfields, Dewsbury, Yorkshire. 827, P.M. 827, J. March 1906.
- 1122 **FitzGibbon**, Gerald, jun., B.A., B.L. Smith's Buildings, Upper Ely Place, Dublin. January 1895.
- 1123 **FitzHerbert**, Arthur Hugh Francis. 28 St. Mary's Grove, Chiswick, W., London. 1461. 2425. March 1899.
- 1124 **FitzMaurice-Kelly**, Maurice. St. Mary's Hospital, Paddington, W., London. 2682. October 1905.
- 1125 **Flather**, David. Standard Steel Works, Love Street, Sheffield. 2268, P.M., 139. November 1903.
- 1126 **Flather**, W. T. The Elms, Ranmoor, Sheffield. 2268, P.M., 139, P.Z. March, 1905.
- 1127 **Fletcher**, Elliott G. Riversdale, Southend-on-Sea, Essex. P.P.G.R., P.G.J., Essex. May 1900.
- 1128 **Fletcher**, James. Bellair, Natal. Dis.G.A.Sec., Natal. October 1888.
- 1129 **Flintoff**, J. Rokeby Road, Subeaco, Perth, West Australia. 880 (S.C.). November 1898.
- 1130 **Flouch**, Arthur. 79 Quai de Chartrons, Bordeaux, France. 1523. October 1906.
- 1131 **Flowers**, Frank, C. E., F.R.C.S., F.R.A.S. Leeuc-Kop, Devon Station, via Springs, Transvaal. 980 (S.C.), P.M., 225 (S.C.), P.Z. October 1903.
- 1132 **Foley**, Thomson. Westwood Road, Beverley, Yorks. P.Pr.G.Sup.W., P.Pr.G.Soj. June 1899.
- 1133 **Folker**, Herbert Henry. Bedford Villa, Shelton, Stoke-on-Trent. 2149. 418. June 1902.
- 1134 **Footer**, Thomas. Cumberland, Maryland, U.S.A. Past Junior Grand Warden. Oct. 1895.
- 1135 **Foppoli**, L. 20 Finsbury Street, E.C., London. 2687. January 1899.
- 1136 **Forbes**, Henry. Port Elizabeth, Cape. 711, P.M. May 1895.
- 1137 **Forbes**, Henry. Lloyds, E.C., London. 822. June 1904.
- 1138 **Forbes**, Samuel Russell, Ph.D. 76 Via della Croce, Rome. Lodge Universo. November 1887.
- 1139 **Forbes**, Rev. William. Rondebosch, Cape Town. 398 (S.C.), P.M., 86. January 1898.
- 1140 **Ford**, James H. 11 South Parade, Leeds. 1221, P.M., P.P.G.D.C. (R.A.). January 1894.
- 1141 **Fordham**, C. H. Chaloner Street, Guisborough, Yorks. 561, P.M. June 1901.
- 1142 **Fornet**, Dr. E. IV. Vadoszkürt, Budapest, Hungary. May 1903.
- 1143 **Forrester**, Alexander C. 35 Old Queen Street, Westminster, S.W., London. 1965. October 1905.
- 1144 \***Forrester**, William. Storrington, Pulborough, Sussex. 2660, 599. October 1901.
- 1145 **Forsyth**, William Thomas. Box 1724, Capetown. 1581, 2379. January 1906.
- 1046 **Fortescue**, George West. Fermain, Kewick Road, Putney, S.W., London. 2437, P.M., 946. November 1898.

- 1147 **Fortmeyer**, George William. *East Orange, New Jersey, U.S.A.* **Past Grand Master.** March 1895.
- 1148 **Foster**, Charles Ross. *Armaside, Hampton Hill, Middlesex.* P.Pr.G.D., Sussex. May 1900.
- 1149 **Foster**, Frank Oswald. *Rockhampton, Queensland.* P.Dis.G.D. June 1899.
- 1150 **Foster**, Redmond Clarence Hall, M.D. *Narromine, New South Wales.* 236 (N.S.W.). May 1906.
- 1151 **Foster**, Walter A. *Glyn Menai, Bangor, North Wales.* P.Pr.G.St.B., P.Pr.G.S.B. (R.A.). May 1894.
- 1152 **Foster**, Wilbur Fisk. *Nashville, Tennessee, U.S.A.* **Past Grand Master, Past Grand High Priest, Tennessee.** March 1892.
- 1153 **Foulkes**, Arthur David. *44 Braithwaite Road, Birmingham.* 2654, W.M. January 1905.
- 1154 **Fowler**, C. J. *14 King William Street, E.C., London.* 39. May 1905.
- 1155 **\*Fowler**, Thomas Benjamin Davis. *441 Calle Piedad, Buenos Aires.* P.D.S.G.D. October 1890.
- 1156 **Fowler**, William. *2 Wilson Road, Southend-on-Sea.* 1728. March 1902.
- 1157 **Fox**, Edwin. *93 Gresham Street, E.C., London.* **Past Assistant Grand Director of Ceremonies, Past Grand Standard Bearer.** June 1899.
- 1158 **Fox**, Walter Caughey. *Park Villa, Grange Crescent, Sheffield.* P.P.G.A.D.C. 1260, P.Z. May 1891.
- 1159 **Fox**, William Henry. *9 Austin Friars, E.C., London.* 176, P.M. October 1905.
- 1160 **Fox-Thomas**, Egbert. *Hill Top Hall, Bramley, Leeds.* **Past Grand Standard Bearer, Past Assistant Grand Director of Ceremonies (R.A.).** March 1896.
- 1161 **Francis**, Charles King. *Lock Box 4055, West Philadelphia Station, Philadelphia, U.S.A.* 610, P.M. February 1887.
- 1162 **Francis**, Léon Albert, F.S.I. *8 John Street, Adelphi, W.C., London.* Pr.G.S.Wks., Middlesex, 1339, P.Z. May 1903.
- 1163 **Francis**, Thomas. *The Croft, Ropley, Alresford, Hants.* P.Pr.G.D., Sussex. May 1887.
- 1164 **Francis**, Wesley. *Pietermaritzburg, Natal.* **District Grand Master and Grand Superintendent, Natal.** March 1889.
- 1165 **Fraser**, Alexander O. *Namoli, Lautoka, Fiji.* 1204, P.M., P.P.G.Sw.B., Worcester. June 1905.
- 1166 **Fraser**, James. *Box 1223, Johannesburg, Transvaal.* 2313. January 1903.
- 1167 **Fraser**, Dr. John Sutherland. *Messrs. King, King & Co., Fort, Bombay.* P.G.Pt., Scotch Masons in India. May 1905.
- 1168 **Fraser**, Thomas. *3 Norfolk Road, St. John's Wood, N.W., London.* 2488, P.M. March 1904.
- 1169 **Frazer**, James W. *Saltwell Vale House, Low Fell, Gateshead-on-Tyne.* 2260, P.M. November 1903.
- 1170 **Freedman**, Rev. D. J. *Brisbane Street, Perth, West Australia.* Dis.G.Chap., 274 (S.C.), H. November 1903.
- 1171 **\*Freer**, Richard, M.D. *Church Street, Rugeley, Staffords.* P.P.G.P., 1941, P.Z. March 1899.
- 1172 **Freer**, William J. *Stoneygate, Leicester.* P.P.G.W., P.P.G.J. May 1903.
- 1173 **Frenkel**, Emil. *8 East 81st Street, New York, U.S.A.* 279, P.M. June 1903.
- 1174 **Frewer**, Rev. G. Herbert. *Fenstanton Vicarage, St. Ives, Hunts.* P.P.J.G.W., P.P.G.Ch. Jan. 1905.
- 1175 **Friend**, B. J. *Mazal House, Morgan Street, Bow, E., London.* 1349. October 1905.
- 1176 **Frigout**, August A. *43 Wickham Road, Brockley, S.E., London.* P.P.G.S. Wks., Kent, 25, P.Z. March 1903.
- 1177 **Fripp**, John Trade, L.D.S., B.C.S. *Station Road, Willesden Junction, N.W., London.* 2098. June 1899.
- 1178 **Frost**, Fred Cornish, F.S.I. *5 Regent Street, Teignmouth, Devon.* P.Pr.G.Sup.W., P.Pr.G.Treas. (R.A.), Devon. June 1891.
- 1179 **Fry**, George Charles Lovell. *74 Coleman Street, E.C., London.* 2427. March 1896.
- 1180 **Fullbrook**, George. *49 Queen Victoria Street, E.C., London.* 1471. March 1898.
- 1181 **Fuller**, Rev. A. S., D.D. *24 Leeson Park, Dublin.* **Representative of Grand Lodge, Hamburg.** May 1899.
- 1182 **Fuller**, Capt. Henry James. *53 Enys Road, Eastbourne.* 51. March 1902.
- 1183 **Fuller**, W. G. *Merrymead, Warrington Road, Harrow.* 1549. March 1904.
- 1184 **Furby**, William Stafford, M.I.E.E. *G.P.O. Wellington, New Zealand.* 1338, P.M. November 1893.
- 1185 **Gade**, Frederick Theodore. 1626, 1644. June 1903.
- 1186 **Gairdner**, Edward James. *43 Chancery Lane, W.C., London.* 1351. January 1904.
- 1187 **Gallienne**, William. *Adrain Road, Durban, Natal.* 447 (S.C.). October 1905.
- 1188 **Gammon**, Victor Emmanuel. *94 Lamb's Conduit Street, W.C., London.* 177. March 1898.
- 1189 **Gane**, William James. *Sandhill House, Pembury, Tunbridge Wells.* 874, 3015. March 1899.
- 1190 **Garbutt**, Matthew, A.M.I.C.E., A.R.I.B.A. *4 Queen Square, Bloomsbury, W.C., London.* 2416. January 1898.

- 1191 **Garden, John.** *National Bank, Winburg, O.R.C.* Unity Lodge (D.C.), P.M. October 1893.
- 1192 **Gardner, Charles.** *Holbrook, Barkly East, Cape Colony.* 2252. January 1906.
- 1193 **Gardner, Frederick Leigh.** *14 Marlborough Road, Gunnersbury, W., London.* 1017. March 1895.
- 1194 **Gardner, Herbert.** *Manor House, Chichester Road, Bognor, Sussex.* 1726. November 1904.
- 1195 **Gardner, James Cardwell.** *Church House, Westminster, S.W., London.* March 1901.
- 1196 **Gardner, Joseph Goodes.** *Box 1461, Johannesburg, Transvaal.* 862. January 1901.
- 1197 **Gardner, Rev. Richard Titley.** *Church House, Westminster, S.W., London.* 2421. June 1903.
- 1198 **Garnon, Edward William.** *701 High Road, Tottenham, Middlesex.* 1777. May 1902.
- 1199 **Garrard, Robert.** *19 Weston Place, Worthing.* 192. May 1906.
- 1200 **Garrard, Stanley Ricardo.** *Salisbury, Rhodesia.* 2479. May 1905.
- 1201 **Garraway, Major Charles William.** *R.I. Regt., Fermoy, Ireland.* P.Dis.G.A.D.C. January 1897.
- 1202 **Gathercole, William Henry Joseph.** *5 South View Villas, Alexandra Park, N., London.* 2664. November 1898.
- 1203 **Gaukrodger, David William.** *Katandra, Stamford, North Queensland.* 2207. May 1901.
- 1204 **Gaunt, The Hon. W. Freemantle.** *4 Lansdowne House, Lansdowne Road, Bayswater, W., London.* 10. October 1905.
- 1205 **Geary, Percival Falle.** *Cobham Lodge, Cobham Road, Westcliff-on-Sea.* 2744. January 1903.
- 1206 **Gedge, Alfred Sydney.** *Endsleigh, Holwood Road, Bromley, Kent.* 1692. January 1901.
- 1207 **Gedge, Dr. Donald McCulloch.** *2924 Steiner Street, San Francisco, U.S.A.* 260. May 1904.
- 1208 **Gee, Albert Frederick.** *Tamerton, Stamford Hill, Durban, Natal.* 1192. November 1902.
- 1209 **Gensan, A. Von.** *P.O.B. 25, Heidelberg, Transvaal.* 2345, P.M. June 1897.
- 1210 **George, Dr. W. H.** *9 Osnaburgh Street, Regent's Park, N.W., London.* 538, P.M. May 1903.
- 1211 **Gerstenkorn, Karl Andreas.** *Esk Street, Invercargill, Southland, New Zealand.* P.G.St.B., 3, P.Z. Local Secretary for Southland, New Zealand. May 1901.
- 1212 **Ghislain, Louis.** *18 Rue du Mont de Piété, Mons, Belgium.* Lodge Parfaite Union. October 1895.
- 1213 **Gibbins, George William.** *Salisbury, Rhodesia.* 2479. May 1902.
- 1214 **Gibbon, R. Perceval.** *Salisbury, Rhodesia.* 2479. June 1903.
- 1215 **Gibbons, Albert.** *Boulevard, Oreño No. 93, Rosario de Santa Fé, Arg. Rep.* 1553. June 1905.
- 1216 **\*Gibbons, Hubert.** *Old Grammar School Works, Wolverhampton.* 526. March 1906.
- 1217 **Gibbs, Major James Alec Charles.** *Roseneath, Goring, Ozon.* 1040, P.M., 1383. January 1898.
- 1218 **Gibbs, Harris Hornsby.** *Sylvanway, Bognor.* 1726. May 1906.
- 1219 **Gibson, Rev. J. George.** *The Rectory, Ebchester, R.S.O., Co. Durham.* 2279, P.M. January 1904.
- 1220 **Gibson-Sugars, John Sugars.** *H.M.S. Vernon, Portsmouth.* P.D.G.St.B., P.D.G.S.B. (R.A.) Malta. Local Secretary H.M. Navy. March 1889.
- 1221 **\*Gieve, John William.** *High Street, Portsmouth.* **Past Assistant Grand Director of Ceremonies, Past Grand Standard Bearer.** January 1889.
- 1222 **Gilbert, Arthur.** *4 Walbrook, E.C., London.* 15. January 1900.
- 1223 **Gilbert, H. P.** *22 Lime Grove, Shepherd's Bush, N.W., London.* 1828, P.M. June 1898.
- 1224 **Gilbert, Harry.** *Government Railway Extension Department, Sierra Leone, West Africa.* 2374. May 1903.
- 1225 **Gilks, William J.** *15 Lincoln's Inn Fields, W.C., London.* 2201, P.M. November 1894.
- 1226 **Gill, Henry Frederick.** *P.O.B. 242, Bloemfontein, O.R.C.* 1022, P.M., 241 (S.C.), P.Z. Jan. 1894.
- 1227 **Gill, Herbert Ernest.** *63 Endymion Road, Brixton Hill, S.W., London,* 1638. June 1905.
- 1228 **Gill, Richard.** *Mount Pleasant, Heckmondwicke, Yorkshire.* 258, P.M. 258, P.Z. P.P.G.Sup.Wks, W. Yorks. May 1906.
- 1229 **Gill, W. S.** *105 West End Lane, W. Hampstead, N.W., London.* 1851. 2840. March 1906.
- 1230 **Gillespie, Rev. Canon Henry John, D.D.** *Finnoe Rectory, Borris O'Kane, Tipperary.* P.G.Chap., Midland Counties. Pr.G.Sup. (R.A.). May 1900.
- 1231 **Gillmor, Rev. F. J. C.** *Ardington Vicarage, Wantage, Berks.* 3053, W.M. 945, P.M. P.Pr.G.Chap. October 1906.
- 1232 **Gillott, Arthur G. M.** *Box 395, San José, Costa Rica.* **Past Grand Master.** Representative Grand Lodge of England and New Jersey. Local Secretary for Costa Rica. November 1901.
- 1233 **Giraud, Francis Frederick.** *Faversham, Kent.* P.Pr.G.W., P.Pr.G.J. May 1891.
- 1234 **Glaeser, Edward Nicholas.** *Cairngorm, Ullathorn Road, Streatham, S.W., London.* 1627. May 1893.
- 1235 **Glaeser, F. A.** *Hurstcomb, Buckhurst Hill, Essex.* 238, P.M. May 1897.
- 1236 **Glasman, Harry.** *162 Spring Bank, Hull.* 57, P.M. January 1906.
- 1237 **Glass, John.** *4 Lordship Park, Green Lanes, N., London.* P.Pr.G.S.W., Essex. May 1890.
- 1238 **Gleason, Louis Routledge.** *490 Uxbridge Road, Shepherd's Bush, W., London.* 1791. Jan. 1906.
- 1239 **Glen, George.** *Yoker Holm, Yoker, by Glasgow.* 426, P.M., 114, P.Z. January 1902.

- 1240 **Goblet D'Alviella**, Le Comte, Membre de l'Academie Royale. *Court St. Etienne, Brabant Belgium. Past Grand Master, Belgium.* February 1890.
- 1241 **Godding**, J. W. S. 22 *Wyndham Square, Plymouth.* P.P.G.St.B., Oxon. March 1890.
- 1242 **Godfray**, Arthur Walter. 67 *St. John Road, Jersey.* P.Pr.G.D.C. March 1897.
- 1243 **Goldstein**, Oscar. 4 *Whitehall Court, S.W., London.* 2108. June 1897.
- 1244 **Gomley**, Dr. Harry Harte. 6 *Roseworth Villas, High Street, Gosforth, Newcastle-on-Tyne.* 1628, S.D. March 1904.
- 1245 **Gooden**, John Thomas. 59 *Chiswell Street, E.C., London.* 1489. October 1905.
- 1246 **Goodinge**, James W. 10 *Gower Street, W.C., London.* 1818, P.M., 1269. June 1899.
- 1247 **Goodman**, Arthur Frank. Box 39, *Ladysmith, Natal.* 2401, 1778. May 1905.
- 1248 **Goodman**, G. H. *Maiwand, Brockhurst, Gosport.* March 1898.
- 1249 **Goodman**, Percy Tranter. 75 *Brick Lane, Spitalfields, E., London.* 1900. May 1906.
- 1250 **Goodman**, W. H. 187 *Brownhill Road, Catford, S.E., London.* 1326. October 1904.
- 1251 **Gordon**, George. 81 *Liddiard Street, Hawthorn, Melbourne, Victoria.* P. Gr. Registrar, S. Australia. May 1888.
- 1252 **Gordon**, Thomas. P.O. *Herberton, Queensland.* 685 (S.C.), P.M. January 1902.
- 1253 **Gorgas**, William Luther. *Harrisburg, Pennsylvania, U.S.A.* D.D.G.M. May 1896.
- 1254 **Gorham**, William Hills. *Seattle, Washington, U.S.A.* 9, W.M., 3. January 1905.
- 1255 **Gotthold**, Professor Dr. Christian Christoph Karl. Editor of *Bauhütte, Frankfort-on-Main, Germany.* W.M. Lodge Einigkeit. January 1896.
- 1256 **Gough**, Charles. *Holmwood, Grove Hill, South Woodford, Essex.* 2508, P.M., 2397. January 1904.
- 1257 **Gould**, Joseph. 4 *Bouverie Place, Exeter.* 39, P.M. March 1899.
- 1258 **Gove**, Royal A., M.D. 9502½ *Pacific Avenue, Tacoma, Wash., U.S.A.* 51, P.M. Dis.J.G.W. May 1906.
- 1259 **Gowan**, Hyde Clarendon, I.C.S. *Assistant Commissioner, Nagpur, Central Provinces, India.* 2323. March 1902.
- 1260 **Gowan**, Robert A. *National Liberal Club, S.W., London.* 2029, P.Pr.G.St.B., Surrey. May 1888.
- 1261 **Gowing**, Lionel Francis. 109 *Worples Road, Wimbledon.* 1928, P.M., 1928, P.Z. May 1902.
- 1262 **Graddage**, Stephen Albert. *The Wellington, Archway Road, Highgate, N., London.* 1708, P.M., 1385. May 1896.
- 1263 **Graham**, George W. 83 *Beech Street, Arlington, New Jersey, U.S.A.* 159. 9. June 1906.
- 1264 **Grant**, Donald John. 4 *High Street, Shrewsbury.* 117. January 1897.
- 1265 **Grant**, John Miller, jun. 24 *Dryden Chambers, Oxford Street, W., London.* 176, P.M. March 1900.
- 1266 **Grant-Wilson**, Dr. C. W. *St. Winnow's, London Road, Bromley, Kent.* 2233, J.W., 2879. January 1906.
- 1267 **Grasé**, Jan Carl Gysbert. 65 *Fr. v. Mierisstraat, Amsterdam.* Nos Vinxit Libertas, P.M. Local Secretary for Holland. January 1901.
- 1268 **Gray**, Joseph. *Hooding Estate, Singapore.* D.G.J.W., E. Archipelago. 508, P.Z. March 1901.
- 1269 **Gray**, Thomas. 835 *Raleigh Street, Portland, Oregon, U.S.A.* Past Grand Master, 3. Jan. 1904.
- 1270 \***Gray**, Thomas Lowe. *Tacuari 1783, Buenos Aires.* 1025, 617. October 1899.
- 1271 **Gray**, William Edwards. 2 *Rutland Park, Sheffield.* P.P.G.D., West Yorks, 296, P.Z. June 1902.
- 1272 **Gray**, William Riddell. Box 114, *Springs, Transvaal.* 794, 193. November 1904.
- 1273 **Graystone**, Frederick Russ. 71 *Lewis Street, Rangoon, Burma.* 2924, P.M., 1394. May 1904.
- 1274 **Greatbatch**, D. W. *Kimberley, South Africa.* D.G.Sup.W., C.S. Africa. May 1892.
- 1275 **Greaves**, A. R. 45 *Church Road, Homerton, N.E., London,* 2698. January 1905.
- 1276 **Green**, David. P.O. Box 45, *Potchefstroom, Transvaal.* 766 (S.C.). J.W. October 1906.
- 1277 **Green**, Edward Thaddeus. *Georgetown, Queensland.* 2366, P.M. October 1894.
- 1278 **Green**, F. M. *Witney, Oxfordshire.* 1703. October 1906.
- 1279 **Green**, J. Samuel. 2 *New Square, Lincoln's Inn, W.C., London.* 198. March 1904.
- 1280 **Green**, William Lawton. Box 1208, *Pretoria, Transvaal.* 952 (S.C.), S.W. January 1906.
- 1281 **Greene**, John Herbert. 1163 *Calle Santa Fé, Rosario de Santa Fé, Argentine Republic.* 2960, W.M., 1553, H. March 1905.
- 1282 **Greenfield**, Joseph C. *Atlanta, Georgia, U.S.A.* P.M. June 1898.
- 1283 **Greening**, Robert. 60 *Fenchurch Street, E.C., London.* 1426. November 1900.
- 1284 **Greenleaf**, Lawrence N. *Denver, Colorado, U.S.A.* March 1899.
- 1285 **Greenstreet**, William John, M.A., F.R.A.S. *Marling School, Stroud, Gloucestershire.* P.P.G.D.C., 702. January 1897.
- 1286 **Greenwood**, Charles. 26 *Akeds Road, Halifax, Yorks.* 448. Local Secretary for Halifax. November 1888.

- 1287 **Greenwood**, Thomas. *Aldertury, Salisbury*. 26, P.M., 357, P.Z. March 1888.
- 1288 **Greever**, Charles O. 1345 *East Ninth Street, Des Moines, Iowa, U.S.A.* 110, P.M., 14, P.H.P. **Representative, Grand Chapter of Canada.** March 1899.
- 1289 **Gregory**, George. 112 *St. Paul's Road, Canonbury, N., London.* P.Pr.G.D., P.Pr.G.T. (R.A.), M'sex. October 1889.
- 1290 **Gregory**, George Ernest. 9 *Stamford Street, S.E., London.* 1539. January 1900.
- 1291 **Gregory**, Thomas. *Traffic Supt., Great Southern Railway, Buenos Aires.* 2329, W.M. March 1905.
- 1292 **Greiner**, Ernest. 10 & 12 *Milton Street, E.C., London.* 92, P.M. November 1894.
- 1293 **Grey**, Arthur. *Lahore, Punjab.* P.D.G.W. October 1898.
- 1294 **Griffith**, Frank. *The Gables, Plaistow Lane, Bromley, Kent.* **Past. Dep. Grand Sword Bearer.** May 1902.
- 1295 **Griffiths**, Arthur. Box 5834, *Johannesburg, Transvaal.* 2481. May 1898.
- 1296 **Griffiths**, C. J. W. *The Barton, Blenheim, New Zealand.* **Past Deputy Grand Master, Grand Joshua. Representative Grand Lodge of North Carolina.** March 1899.
- 1297 **Griffiths**, Harold. *Fulgefonten, Lansdowne Road, East Croydon, Surrey.* 1347, P.M. May 1893.
- 1298 **Grigg**, William Henry. 11, *Oxberry Avenue, Fulham, S.W., London.* 2664. January 1898.
- 1299 **Grimston**, Viscount James Walter. *Gorhambury, St. Albans.* **Past Jun. Grand Warden.** March 1903.
- 1300 **Gripper**, Walter, M.D. *The Poplars, Wallington, Surrey.* **Past Deputy Grand Director of Ceremonies, Past Grand Sword Bearer.** November 1894.
- 1301 **Gundelfinger**, Isaac. 13, *Heath Drive, Hampstead, N.W., London.* Lodge Star of the Band. P.M. October 1892.
- 1302 **Gunner**, William Anson. 89, *Perry Hill, Catford, S.E., London.* 1538, P.M., 1056. March, 1903.
- 1303 **Gunson**, Rev. Herbert, E., M.A. *Middlesex Hospital, W., London.* 2843. October 1901.
- 1304 \***Gunther**, Gustav Carl Hermann. 28 *Cleveland Road, Brighton.* 1198, 1198 March 1896.
- 1305 **Gurner**, Herbert Thornton. 8 *Mattison Road, Harringay, N., London.* 2043, P.M., 2048 P.S. March 1906.
- 1306 **Guthrie**, Adam White. *Port Elizabeth, South Africa.* Dis. G. Sup.W., East Div., S.A. June 1887.
- 1307 **Guthrie**, James. 11, *Weensland Road, Hawick, N.B.* 424. March 1894.
- 1308 **Guy**, Harry. 8, *Burghley Road, Highgate Road, N.W., London.* 145, P.M., 145. May 1905.
- 1309 **Haarburger**, Ivan H. *Bloemfontein, Orange River Colony.* 1022, P.M. **Past Assistant Grand Director of Ceremonies.** October 1895.
- 1310 \***Haarhoff**, Daniel Johannes. *Kimberley, South Africa.* **Past Assistant Grand Director of Ceremonies.** D.D.G.M., C.S. Africa. January 1889.
- 1311 **Hackett**, Sir John Winthrop, M.A. *St. George's Terrace, Perth, West Australia.* **Grand Master. Past Grand Warden, England.** October 1901
- 1312 **Haes**, David. 28 *Bassett Road, North Kensington, S.W., London.* 1056. June 1898.
- 1313 **Haines**, John Edgar. *Federal National Bank, Pittsburgh, Penna, U.S.A.* 390, P.M., 193. March 1905.
- 1314 **Hale**, Albert H. 3 *York Street, Broadstairs, Kent.* P.Pr.G.A.D.C. November 1892.
- 1315 **Halford**, Edward E. 42 *Clarendon Road, Notting Hill, W., London.* 134. March 1903.
- 1316 **Halford**, Major Frederick Benjamin. 2 *Woodchurch Road, West Hampstead, N.W., London.* 1. June 1904.
- 1317 **Hall**, Albert Ernest, F.E.S. *Norbury, Pittsmoor, Sheffield.* 1779, 1296. May 1898.
- 1318 **Hall**, Charles Robert. 32 *Moyser Road, Streatham, S.W., London.* 1815, 1507. June 1899.
- 1319 **Hall**, Edward. 4 *Glenton Road, Lee, S.E., London.* 1793, P.M., Pr.G.D.C., Middlesex. March 1899.
- 1320 **Hall**, Fred. *Eastlands, Court Lane, Dulwich, S.E., London.* 569, P.M. January 1905.
- 1321 **Hall**, George W. 1131 *Arch Street, Philadelphia.* 121, P.M., 183. May 1891.
- 1322 **Hall**, James J. 47 *Adolphus Road, Finsbury Park, N., London.* 1278, P.M. November, 1892.
- 1323 **Hall**, John Basil, M.A., B. Ch. 31 *Manningham Lane, Bradford.* 974, P.M. January 1906.
- 1324 **Hall**, John William. *The Precincts, Peterborough.* 2533. October 1905.
- 1325 **Hall**, Musgrave Robert. *Junior United Service Club, St. James', S.W., London.* 2094. June 1905.
- 1326 **Hall**, Thomas J. 5 *Vicarage Road, Tottenham, Middlesex.* 1766. June 1904.
- 1327 **Hall**, William. *Claremont, Royton, near Oldham, Lancashire.* 2279, P.M. March 1904.
- 1328 **Hallas**, Arthur Edward. 2 *Henrietta Street, Spalding.* 1008. March 1905.
- 1329 **Hallett**, Frederick Charles. 23 *Brunswick Street, Teignmouth, Devon.* P.Pr.G.D., P.Pr.G.S.B. (R.A.) March 1890.
- 1330 **Hallett**, Dr. T. L. *St. John's, Newfoundland.* 776, P.M. Dis.G.Treasurer. March 1906.
- 1331 **Halliwell**, Dr. T. 115 *Brockley Road, Forest Hill, S.E., London.* 2948, P.M. January 1904.

- 1332 **Hallock, James.** Postmaster, *King William's Town, Cape Colony.* P.Dis.Gr.St.B., E. Div. S. Africa. June 1902.
- 1333 **Hamburg, Alexander Louis.** Box 703, *Pretoria, Transvaal.* 770, (S.C.) March 1906.
- 1334 **Hamel, Fergus Edward.** 73, *Hillfield Avenue, Hornsey, N., London.* 2408. June 1897.
- 1335 **Hamilton, Alfred George.** 46, *Hatfield Street, Southwark, S.E., London.* 2455, 1466. Jan. 1904.
- 1336 **Hamilton, George M. E.** 43 *St. Mary's Aze, E.C., London.* Asst. Grand Pursuivant, P.Z. October 1900.
- 1337 **Hamilton, Capt. W. G.** c/o *Grindlay & Co., 54, Parliament Street, S.W., London.* 2546. June, 1906.
- 1338 **Hamilton, William Munroe.** *Frisk Building, Pittsburg, Penna, U.S.A.* D.D.G.M. 193, P.H.P. March 1905.
- 1339 **Hamlyn, John D.** 221 *St. George's Street East, E., London.* 1695. October 1903.
- 1340 **Hamm, Johannes M.** 57 *Lordship Park, Stoke Newington, N., London.* 238, P.M. March 1891.
- 1341 **Hammerich, Sophus Johannes August.** *Durban, Natal.* 1747 (E.C.), 175 (S.C.), P.Z. June 1896.
- 1342 **Hammett, B. W.** 2 *Barking Road, East Ham, E., London.* 860. March 1899.
- 1343 **Hammond, Joseph Samuel.** *Hill House, Romford, Essex.* 1437, P.M., 1437, P.Z. January 1904.
- 1344 **Hammond, R. Gardner.** 16, *Essex Street, Strand, W.C., London.* 2455. October 1904.
- 1345 **Hammond, William.** *Bolingbroke Lodge, Wandsworth Common, S.W., London.* 209. Oct. 1899.
- 1346 **Hammond, Dr. William.** *Stuart House, Liskeard, Cornwall.* P.P.S.G.W., Pr.G.S.E. March 1888.
- 1347 **Hamsher, William.** 1 *Park Road, Beckenham, Kent.* 1139. P.M. January 1898.
- 1348 **Ham-Smith, J.W.** 71 *The High Street, South Norwood, S.E., London.* 2096. May 1899.
- 1349 **Hanckel, Robert Stuart.** *Casilla 362, San José, Costa Rica.* **Duputy Grand Master.** Representative Grand Lodge of Utah. November 1901.
- 1350 **Hancock, F. W.** 6 *Newstead Road, Lse, S.E., London.* P.Pr.G.J.D., Surrey, March 1898.
- 1351 **Hancock, Walter, M.I.E.E.** 10 *Upper Chadwell Street, E.C., London.* 2191, P.M., 91, P.Z. May 1898.
- 1352 **Hand, J. Denyer.** 5 *Whitefriars Street, E.C., London.* 1928, 1597, W.M. October 1906.
- 1353 **Hands, Joshua.** 57 *Portsdown Road, Maida Vale, W., London.* 188. May 1899.
- 1354 **Hankin, Herbert Ingle.** *The Firs, St. Ives, Hunts,* P.Pr.G.W. January 1900.
- 1355 **Hanks, Walter Samuel.** *Glenside, Erith Road, Erith, Kent.* 2466. March 1893.
- 1356 **Hann, Herbert Frederik.** 48 *Wood Vale, Forest Hill, S.E., London.* 1297. May 1905.
- 1357 **Hansard, George Albert** *The School House, Otakcn, Dunedin, New Zealand.* 696 (S.C.) P.M., 7. May 1906.
- 1358 **Hansen, Johan Henrik.** *Oxbøl Mejeri pr. Varde, Denmark.* June 1901.
- 1359 **Hanson, John Currie.** 5 *Hong Kong Road, Shanghai.* 570, 570. March 1898.
- 1360 **Hantke, Theodore John Charles.** 82 *Rundle Street, Adelaide, South Australia.* **Deputy Grand Master, Grand Haggai, South Australia.** November 1889.
- 1361 **Harben, Henry Andrade.** 107 *Westbourne Terrace, W., London.* 2408. May 1899.
- 1362 **Harcke, Carl F.** 20 *Fenchurch Street, E.C., London.* 238. June 1904.
- 1363 **Hardiman, John Percy.** *Pegu Club, Rangoon, Burma.* 542. May 1901.
- 1364 **Harding, James Cooper, M.I.Mech.E.** *Cherryhurst, Knock, Belfast.* 2462, P.M., 764. Nov. 1898.
- 1365 **Harding, Laurence.** 15 *Campden Hill Court, Kensington, W., London.* 2127. January 1906.
- 1366 **Harding, Thomas James.** *West Street, West Durban, Natal.* 738, P.M. March 1902.
- 1367 **Hardy, Andrew Allen.** 7 *St. John's Terrace, Southall, Middlesex.* 2163, P.M., 1549. May 1899.
- 1368 **Hardy, Charles Albert Creery.** *Rakaia, Canterbury, New Zealand.* **Deputy Grand Master.** June 1900.
- 1369 **Hardyment, Archibald Frost.** 7 *Mortlake Road, Kew, Surrey.* 2698, P.M. January 1901.
- 1370 **Hargreaves, J. E.** *Printing Works, Euston Street, Blackpool.* October 1903.
- 1371 **Hare, Sholto Henry, F.R.Hist.S.** 7 *Litfield Place, Clifton, Bristol.* P.Pr.G.D., Cornwall. Jan. 1892.
- 1372 **Harmer, R. Rev. John Reginald, D.D., Bishop of Rochester.** *Lollards Tower, Lambeth, S.E. London.* P.Gr.Chap., South Australia. October 1905.
- 1373 **Harrer, Dr. C.** 34, *City Road, E.C., London,* 238, P.M. January 1898.
- 1374 **Harris, Charles Danderdale.** 10 *Delacourt Road, Blackheath, S.E., London.* 140. October 1904
- 1375 **Harris, Edward Bernard.** 1 *Holy Innocent's Road, Hornsey, N., London.* 2580. June 1900.
- 1376 **Harris, Ernest Edmund.** Box 340, *Durban, Natal.* 1937, 1937. October 1899.
- 1377 **Harris, Henry, J.P.** 2 *Bancroft Road, E., London.* 1349. March 1894.
- 1378 **Harris, James.** *Boundary Street, Charters Towers, Queensland.* 655 (S.C.), 206 (S.C.). Nov. 1901.



- 1379 **Harris, Richard.** *Aliwal North, Cape Colony.* P.Dis.G. Stew., E. Div., South Africa. May 1891.
- 1380 **Harris, Thomas.** *Claremont, Dee Banks, Chester.* 425. October 1905.
- 1381 **Harris, William Henry.** *Pietermaritzburg, Natal.* P.D.G.D., P.Z., June 1891.
- 1382 **Harris, William Henry.** 95 *Elspeth Grove, Clapham Common, S.W., London.* 2795. 3144, 1329. June 1906.
- 1383 **Harrison, Frederick Drake.** *Henley Beach Road, West Adelaide, South Australia.* 22 (S.A.C.), P.M., 363 (I.C.). January 1902,
- 1384 **Harrison, G. A.** *Westfield Grove, Wakefield.* 85. October 1902.
- 1385 **Harrison, J.** 192 *Kennington Park Road, S E., London.* P.G.Stwd., Pr.G.J., Sarrey. Oct. 1905.
- 1386 **Harrison, Peroy, I.C.S.** *Moradabad, India.* P.Dis.G.R., Bengal. March 1897.
- 1387 **Harrison, Richard John.** 26 *Little Earl Street, Soho, W.C., London.* 65. March 1906.
- 1398 **Hart, Charles Sumner.** 226 *Elm Street, Concord Junction, Massachusetts.* **District Deputy Grand Master.** Walden Chapter. May 1898.
- 1389 **Hart, George.** *Port Elizabeth, South Africa.* 863, P.M. June 1898.
- 1390 **Harte, Albert Edward, J.P.** *Brisbane, Queensland.* P.D.G.W., P.D.3rd. G.P. (R.A.) January 1894.
- 1391 **Harty, John.** P.O. No. 11, *East London Division, Cape Colony.* D.G.W., E. Div. October 1892.
- 1392 **Harvest, Lieut. Col. William Sidney Smith, R.M.** *R.M. Barracks, Plymouth.* 2721, P.M., 1269. January 1901.
- 1393 **Harvey, Ernest James.** *Calle Mitre 509, Quilmes, Buenos Aires.* 2459. May 1904.
- 1394 **Harvey, William James.** *Holly Lodge, Gunnersbury, W., London.* 2191, P.M., 1319, H. Jan. 1906.
- 1395 **Harwood, Charles William.** 13 *Hill Crest Road, Sydenham, S.E., London.* 2744. March 1903.
- 1396 **Hascall, Lee Clafin.** 36 *Bromfield Street, Boston, Massachusetts.* Mt. Hermon Lodge. Jan. 1891.
- 1397 **Haselden, Horace.** *Maesinela, Rhyl, North Wales.* 1674. May 1904.
- 1398 **Haslam, Professor Francis William Chapman.** *Canterbury College University, Christchurch, New Zealand.* P.Dis.G.W. January 1897.
- 1399 **Haslop, Charles Edwin.** *Colombo, Ceylon.* 2170. October 1904.
- 1400 **Hatherley, William Firmer.** *Palmerston House, Elm Grove, South Hayling.* 1341. Oct. 1888.
- 1401 **Haviland, John, M.A.** *Shorefield, Bognor.* **Past Grand Deacon.** November 1904.
- 1402 **Hawkins, Arthur Alexander.** 3 *Shaw Place, Greenock, N.B.* 233. October 1905.
- 1403 **Hawkins, Edward Lovell.** *Barham House, London Road, St. Leonard's-on-Sea.* 1842, W.M., 357, P.M. P.Pr.G.W., P.Pr.G.Sec., Oxon. January 1906.
- 1404 **Hawkins, Ernest Albert.** 42 *Judd Street, W.C., London.* 1257, P.M. March 1906.
- 1405 **Hawkins, William Charles.** *Ford Street, Albion, Brisbane, Queensland.* 898 (S.C.), P.M. March 1902.
- 1406 **Hawkins, William Isaac.** *Bank House, Brentwood, Essex.* 31. March 1898.
- 1407 **\*Haworth, Wallace Ellwood, M.B., C.M., B.Sc.** *Penhalonga, Rhodesia.* 2678, P.M., 2678, P.Z. Local Secretary for Mashonaland. June 1899.
- 1408 **Hawthorne, Sydney Charles James.** *Kimberley, South Africa.* November 1903.
- 1409 **Hawtrey, Wilfred R. J.** *Assistant Superintendent Police, Penang.* 1555. June 1902.
- 1410 **Hayes, George S.** 111 *Fifth Avenue, New York City, U.S.A.* 454. May 1902.
- 1411 **Hazel, H. J.** *Gloucester Lodge, Carleton Road, Tufnell Park, N., London.* 1693, P.M., P.Z. Oct. 1901.
- 1412 **Hazzledine, F. A.** *Church House, Westminster, S.W., London.* 2098, P.M., 141, P.Z. March 1899.
- 1413 **Headlam, John Emmerson Wharton, Col. R.H.A., D.S.O.** *Rawal Pindi, India.* 1789. October 1897.
- 1414 **Heap, John Henry.** *High Bank, Blackburn Street, Radcliffe, near Manchester.* P.P.G.Tr. March 1903.
- 1415 **\*Heap, Herbert Ryder.** 8 *Bedford Road, Rock Ferry, Birkenhead.* P.P.G.D., N. Wales. Mar. 1895.
- 1416 **Heard, Henry Charles.** *Thatcham, Newbury, Berks.* P.Pr.G.D., Herts. May 1890.
- 1417 **Heath, Fred B.** 10 *Dahomey Street, Streatham, S.W., London.* 1107. May 1906.
- 1418 **Heath, Meyrick William.** *Mortimer House, Clifton, Bristol.* Pr.G.D.C., Bristol. May 1893.
- 1419 **Heath, Rev. William Mortimer.** *Lychett Matravers, Poole, Dorset.* **Past Grand Chaplain.** November 1887.
- 1420 **Hehner, Otto.** 11 *Billiter Square, E.C., London.* 238, P.M. February 1887.
- 1421 **Heimann, C. A.** 10 *Sussex Gardens, W., London.* P.D.G.Tr., Japan. March 1898.
- 1422 **Heitzman, Charles C.** *Heathfield, East Drive, Queen's Park, Brighton.* 2395. January 1898.
- 1423 **Hellmuth, Carl August.** *Ladybrand, Orange River Colony.* 2522, P.M. March 1899.
- 1424 **Hemann, John Christian Theodore.** *Banco Anglo, San José, Costa Rica.* 3 (C.R.C.). Oct. 1903.

- 1425 **Hemming**, Alfred O. *St. Agnes, Pinner, Middlesex.* 1503, 1503. March 1902.
- 1426 **Hemmings**, Frank. *Box 415, Buluwayo, Rhodesia.* 2792. June 1906.
- 1427 **Henderson**, Herbert Arthur. *9 Withington Road, Whalley Range, Manchester.* 2447, P.M. June 1906.
- 1429 **Henderson**, Isaac Vickers. *101 Clayton Street, Newcastle-on-Tyne.* 1342, 2557. June 1904.
- 1429 **Henderson**, John Robson. *34 St. Alban's Terrace, Gateshead.* 2520. October 1899.
- 1430 **Henderson**, William. *13 Wilton Drive, Glasgow.* 510, W.M., 296. January 1906.
- 1431 **Hendry**, Major John Burke. *7 New Square, Lincoln's Inn, W.C., London.* 396 (N.Y.C.), 173 (N.Y.C.). June 1889.
- 1432 **Henley**, John Francis. *The Cottage, Cholsey, near Wallingford, Berks.* 2647, P.M., 2416. Jan. 1897.
- 1433 **Henning**, Albert. *Kilsby Craig, Sylvan Road, Snarebrook, Essex.* 2769, P.M., P.P.G.D.C., Surrey. January 1898.
- 1434 **Hennings**, Richard J. *13 Upstall Street, Myatts Fields, Camberwell, S.E., London.* 1706, P.M., P.Pr.G.D., Essex. March 1904.
- 1435 **Henry**, George. *3 Trewsbury Road, Sydenham, S.E., London.* 1139, P.M., 180. January 1898.
- 1436 **Henry**, Joseph Carruthers. *1895 Iglehart Street, St. Paul, Minnesota, U.S.A.* 190, P.M., 55, P.H.P. January 1899.
- 1437 **\*Henshall**, Louis. *Runnymede, Stockton Heath, Warrington.* 2651. March 1904.
- 1438 **Herman**, Henry Edward. *2 Verulam Buildings, Gray's Inn, W.C., London.* 2501, P.M. Oct. 1894.
- 1439 **Hermann**, Henry William. *Resident Magistrate's Office, Graaf Reinet, Cape Colony.* 3086, S.W., 2538. May 1906.
- 1440 **Hermann**, Rudolph. *59 Mark Lane, E.C., London.* 96. May 1904.
- 1441 **Hertslet**, Godfrey Edward Procter, F.R.G.S. *35 Grove Park Gardens, Chiswick, W., London.* October 1899.
- 1442 **Hesketh**, John. *Postmaster General's Dept. (Central Office), Melbourne, Victoria.* 2286, P.M. January 1904.
- 1443 **Hett**, Frank Crowder. *St. Helen's, Brigg, Lincolnshire.* 1282, P.M., P.P.G.J.W. June 1904.
- 1444 **Hewett**, Graham. *Cunnamulla, Queensland.* 835 (S.C.), 248 (S.C.). October 1901.
- 1445 **Hewitt**, David Lythall. *2 Hough Green, Chester.* 721, P.M., 721, H. March 1905.
- 1446 **Hewlett**, Ernest Frederick John Holcombe. *One Gable, Mansfield, Notts.* 1852, 1852. June 1904.
- 1447 **Hextall**, W. B. *2 Garden Court, Temple, E.C., London.* 2123, P.M., P.P.G.W., Derby. Jan. 1904.
- 1448 **Hibberdine**, William. *24 Gordon Mansions, Gower Street, W.C., London.* Pr.S.G.D., P.P.G.D.C. (R.A.), Middlesex. June 1905.
- 1449 **Hick**, Dr. Herbert E. *Volksrust, Transvaal.* 2479. May 1902.
- 1450 **Hide**, George John. *682 Bartolomé Mitre, Buenos Aires.* 617. June 1901.
- 1451 **Higgins**, Henry. *182 Stockwell Road, S.W., London.* May 1905.
- 1452 **Higgs**, Charles James. *c/o Higginbotham & Co., Mount Road, Madras.* P.Dis.S.G.W., P.Dis.G.Sc.E. October 1893.
- 1453 **Higgs**, William. *Basing Road, Basingstoke.* 694, S.D. March 1906.
- 1454 **Hildesheim**, Paul. *27 Clement's Lane, E.C., London.* 34. March 1901.
- 1455 **Hildesley**, Rev. Walter S. *12 Stanley Street, Ormskirk, Lancs.* Pr.G.Ch., W. Lancs. Local Sec. for W. Lancs. October 1904.
- 1456 **Hill**, Arthur Robert. *Guest Road, Mill Road, Cambridge.* 88, P.M. March 1904.
- 1457 **Hill**, Elliott. *Moulmein, Burma.* Dis.G.D., Dis.G.A.So. June 1895.
- 1458 **Hill**, Ernest William. *Molescroft, Avenue Crescent, Mill Hill Park, W., London.* 2394. March 1905.
- 1459 **Hill**, George H. *4 Limerton Street, Chelsea, S.W., London.* 1977. May 1905.
- 1460 **Hill**, George Henry. *7 Chamber of Commerce, Portland, Oregon, U.S.A.* 2, 3. March 1904.
- 1461 **Hillman**, W. *George Hotel, Solihull, Warwickshire.* P.P.G.P., P.P.G.J. November 1894.
- 1462 **Hills**, David. *Rosetta, Brackley Road, Beckenham, Kent.* 185, P.M. May 1899.
- 1463 **Hills**, Gordon Pettigrew Graham, A.R.I.B.A. *7 New Court, Carey Street, Lincoln's Inn, W.C., London.* 2416, P.M. May 1897.
- 1464 **Hinds**, John. *30 Lee Park, Blackheath, S.E., London.* 1671, P.M., 1671, Sc.N. May 1906.
- 1465 **Hinds**, Tom. *10 Stonecutter Street, E.C., London.* 1671, P.M. November 1905.
- 1466 **Hinds**, Thomas Walter. *The Institution, Starcross, Exeter.* 1443, S.W., 303. November 1905.
- 1467 **Hinxman**, Ernest. *Kitnocks, St. Thomas' Street, Winchester, Hunts.* 76, P.M., P.Pr.G.Sup.W. October 1895.
- 1468 **Hiskens**, Joseph John. *Dee Street, Invercargill, New Zealand.* 9 (N.Z.C.), P.M., 3 (N.Z.C.), Z. October 1903.
- 1469 **Hitchcock**, John Franklin. *339 Broadway, New York.* 197, P.M., 160. May 1893.

- 1470 **Hoare**, George. 105 *Mount View Road, Stroud Green, N., London.* 1950. March 1901.
- 1471 **Hobbs**, Hugh Marcus. *Lloyd's, E.C., London.* P.Pr.G.W., P.Pr.G.J., Surrey. January 1890.
- 1472 **Hobbs**, Thomas H. 59 *Grosvenor Road, S.W., London.* P.P.G.D., P.P.G.D.C. (R.A.), Bucks. May 1899.
- 1473 \***Hobbs**, W. Cooper. *Kingswood, Gipsy Lane, Barnes, Surrey.* 901. November 1899.
- 1474 **Hobbs**, W. G. *Capital & Counties Bank, Northampton.* 1911, P.M. June 1904.
- 1475 **Hoblyn**, Edward Robert. 97 *Union Street, Plymouth.* 39, 247. May 1899.
- 1476 **Hobson**, Frederick George. *Villa Delta, Beverley, Yorks.* 294, P.M., 294, H. March 1906.
- 1477 **Hodge**, William John. 785 *Rivadavia, Buenos Aires.* **Past District Grand Warden. Past District Grand Principal.** June 1901.
- 1478 **Hodgkinson**, Rev. William Eccles. *Parque Duque de Casias, Capella Inglesa, Bahia, Brazil.* January 1897.
- 1479 **Hodson**, James. *Mill House, Robertsbridge, Sussex.* 1184, P.M. May 1892.
- 1480 **Hoffman**, Gert Joel. P.O.B. 86, *Capetown.* Lodge Oranje. P.M., 103, P.Z. January 1899.
- 1481 **Hogan**, Francis. *Carbonic, Bombay.* 493, P.M., S.G.W. (S.C.). May 1906.
- 1482 **Hogg**, James C. 55 *Barnard Street, Chester Road, Sunderland.* 58 (S.C.), P.M. January 1894.
- 1483 **Hokanson**, Carl Gustav. 34 *Hans Road, Hans Place, S.W., London.* 1513. May 1894.
- 1484 **Hole**, Hugh Marshall, J.P. *Bulawayo, Rhodesia.* 2479, P.M., 2566, P.Z. January 1898.
- 1485 **Holland**, Job. *Eclipse Ganister Works, Attercliffe Road, Sheffield.* P.P.G.D.D. of C. May 1898.
- 1486 **Hollander**, Felix Charles. Box 228, *Durban, Natal.* Dis.Gr.Sec. (S.C.). May 1903.
- 1487 **Hollway**, John Majendie. *Herberton, Queensland.* 1978, P.M., 206, (S.C.). November 1896.
- 1488 \***Holme**, Henry Edward. *Jhansi, U.P., India.* 391, 398. October 1896.
- 1489 **Holme**, Richard Hopper. 6 *Chester Street, Newcastle-on-Tyne.* 1676, 49. Local Secretary for Northumberland. October 1890.
- 1490 **Holmes**, Andrew. 71 *London Street, Greenwich, S.E., London.* 548, P.M., P.Z. March 1895.
- 1491 **Holmes**, John Richard, District Judge Papho. *Cyprus.* 387. June 1888.
- 1492 **Holmes**, W. J. 99 *Barcombe Avenue, Streatham Hill, S.W., London.* 1981, P.M. January 1903.
- 1493 **Holmes**, William Josiah Hartley. *Caslo, British Columbia.* 25, P.M., 120. October 1906.
- 1494 **Holt**, John. *Yarm-on-Tees, Durham.* P.P.G.D., P.P.G.H. June 1900.
- 1495 **Holt**, William Henry. 11 *Ashville Road, Birkenhead.* P.P.G.W. November 1894.
- 1496 **Hood**, Capt. Charles Ernest. *Harbour Master, Plymouth, New Zealand.* 48 (N.Z.C.). May 1906.
- 1497 **Hood**, Harry John, M.A. 115 *St. George's Road, S.W., London.* P.P.G.D.C., Oxon. June 1899.
- 1498 **Hood**, James. *Mary Street, Gympie, Queensland.* 329 (I.C.), P.M., 260 (S.C.). May 1898.
- 1499 **Hood**, W. H. 8 *Oxford Road, Gunnersbury, W., London.* 1671. November 1902.
- 1500 **Hooper**, C. F. *c/o Messrs. Thacker, Spink & Co., Calcutta.* 232. May 1906.
- 1501 **Hope**, Andrew. 38 *Prospect Park, Eseter.* P.Pr.G.D., P.Pr.A.So. November 1889.
- 1502 **Hope**, H. Curling. *Portland House, Guildford, Surrey.* 1395, W.M. January 1903.
- 1503 **Hopkins**, A. Bassett. 1 *Pump Court, Temple, E.C., London.* 2108, P.M. May 1901.
- 1504 **Hopkins**, B. B. 17 *Kellett Road, Brixton, S.W., London.* 1381, P.M. October 1905.
- 1505 **Hopley**, J. H. 6 *Northgate Street, Chester.* 425, 425. Local Secretary for Chester. Oct. 1904.
- 1506 **Hoppenstedt**, Frederick Louis. Box 335, *San José, Costa Rica.* 3. October 1904.
- 1507 **Horley**, Percy H. *Griqualand, Woodside, South Norwood, S.E., London.* 1139, P.M. Jan. 1898.
- 1508 **Horn**, Albert Frederick. *Messrs. Whitehead, Morris & Co., Box 978, Cairo, Egypt.* 71 (E.C.). March 1906.
- 1509 **Hornblower**, George. *Strathaven, Hendon, N.W., London.* 2416. June 1906.
- 1510 **Hornsby**, Thomas Nightingale. 3493 *Echeverria, Belgrano, Buenos Aires.* 617, J.W. Oct. 1900.
- 1511 **Horst**, Christian. *Fairmount, Church Hill, Walthamstow.* 1471. March 1898.
- 1512 **Horth**, F. L. *Free School, Penang.* 1555. May 1904.
- 1513 **Horton**, Edward. *Stanley Street, Rockhampton, Queensland.* 932. January 1892.
- 1514 **Horwill**, Hughes. *Shawford, Winchester.* 694, 694, Sc.E. January 1898.
- 1515 **Hosker**, J. R. *Argus Printing Company, Tudor Street, E.C., London.* 2528. June 1901.
- 1516 **Houndle**, Henry Charles Herman Hawker. 3 *Paper Buildings, Temple, E.C., London.* P.Pr.G.W., Surrey. January 1890.
- 1517 **Houghton**, Henry Charles. 79 *Hooles Road, Chester.* 721, 721. October 1905.
- 1518 **Houghton**, R. V. S. *Ivy Cottage, Helmsshore, Manchester.* 283, P.M., Pr.G.P., E.Lanca. May 1905.
- 1519 **Hovell**, Oriel Hilton Morden. *Secunderabad, Madras.* 434. January 1906.
- 1520 **Howard-Flanders**, William. *Tyle Hall, Latchingdon, Essex.* 1024, P.M., P.Pr.G.St.B., 1024, J. October 1906.

- 1521 **Howarth**, James Henry, J.P. *Somerley, Halifax, Yorks.* 974. October 1904.
- 1522 **Howe**, George Allaire. *Keystone Building, Pittsburgh, Pennsylvania, U.S.A.* 221, P.M., 268, P.H.P. October 1904.
- 1523 **Howell**, Alexander Nathaniel Yatman. *24 Albany Road, Southsea.* P.Pr.G.D., P.Pr.G.O. (R.A.) Hants. March 1888.
- 1524 **Howell-Jones**, David. *Loanla, Howard Road, Westbury Park, Bristol.* 103, P.M., P.P.G.Sup.W., Bristol. January 1903.
- 1525 **Howlett**, Arthur G. *29 Bracondale, Norwich.* 93, P.M. October 1902.
- 1526 **Hubbard**, Frederick Joseph. *Halton, Tring, Herts.* P.Pr.G.D., West Lancs., P.Pr.G.Tr., Bucks. March 1899.
- 1527 **Hudson**, Robert James. *Rathfriland, Ireland.* 80, P.M., 80, P.K. October 1899.
- 1528 **Hughes**, Frank. *Lea Bridge House, Handsworth.* 482 P.M., P.Pr.G.Reg., Staffs. Local Secretary for Staffordshire. March 1898.
- 1529 **Hughes**, George W. *52 Island Road, Garston, near Liverpool.* 220 P.M., 220, P.Z. March 1901.
- 1530 **Hughes**, Robert Percy, *The Old House, East Finchley, N., London.* 99 P.M. June 1906.
- 1531 **Hughes**, Vincent. *The Lindens, Raglan Road, Smethwick, Birmingham.* 2582. June 1905.
- 1532 **Hughes**, William. *66, High Street, Sandgate, Kent.* P.Dis.G.W., P.Dis.G.J., Malta. May 1892.
- 1533 **Hughes-Hallett**, Colonel Henry Thomas. *Headquarters Office, Valletta, Malta.* **District Grand Master, Malta.** 407. January 1902.
- 1534 **Hughes-Hunter**, Colonel Charles, F.R.S. Edin., F.S.A. Scot. *Plas Coch, Anglesey.* **Past Grand Warden, Greece, Past Grand Deacon, England.** March 1893.
- 1535 **Hullett**, Alfred Charles. *Christchurch, New Zealand.* **Grand Janitor.** May 1899.
- 1536 **Hully**, Francis. *2a Piazza Miratore, Floriana, Malta.* 2755, P.M., 407 P.Z. January 1902.
- 1537 **Humphreys**, Alfred W. *46 Clerkenwell Road, E.C., London.* 1677. June 1892.
- 1538 **Humphries**, William Andrew Sims. *91 Farleigh Road, Stoke Newington, N., London.* 45, P.M. June 1906.
- 1539 **Hunt**, A. H. *Clovelly House, Marine Terrace, Lowestoft.* 71, P.M., P.Z. June 1898.
- 1540 **Hunt**, Charles John. *State School, Nudgee, Queensland.* 803 (S.C.). June 1899.
- 1541 **Hunt**, Frank. *c/o J. Kirschbaum & Co., Salisbury, Rhodesia.* 2479. October 1901.
- 1542 **Hunt**, Rev. Jasper Benjamin. *Casilla Correo, 26, Rosario de Santa Fé, Argentine Republic.* D.Gr.Chap., 1553. May 1901.
- 1543 **Hunt**, J. H. *St. George's Terrace, Perth, West Australia.* District Grand Inner Guard. June 1900.
- 1544 **Hunter**, William Sutherland. *Kildonan, Maxwell Drive, Pollokshields, Glasgow.* **Past Grand Standard Bearer (R.A.), Scotland.** March 1890.
- 1545 **Hurst**, Walter, B.Sc. *731 Greene Street, Augusta, Georgia, U.S.A.* 2255. June 1903.
- 1546 **Husbands**, Joseph. *7 Little Britain, E.C., London.* 23, P.M. October 1902.
- 1547 **Hutchins**, Clinton James. *Box 369, Honolulu, Sandwich Islands.* 822 (S.C.). November 1905.
- 1548 **Huxtable**, William Charles. *110 Goldhurst Terrace, South Hampstead, N.W., London.* 617. June 1903.
- 1549 **Hyam**, David. *Box 1347, Pretoria, Transvaal.* 952 (S.C.). January 1906.
- 1550 **Hyde**, Henry. *67 Mornington Road, Leytonstone, Essex.* 1227, P.M., 1227, J. November 1904.
- 1551 **Hes**, Major Henry Wilson, R.A. *D.A.A.G. Burma Division, Maymyo, Burma.* 2924, P.M., 1268. P.Z. June 1905.
- 1552 **Inches**, Robert Kirk. *2 Strathearn Road, Edinburgh.* **Past Grand Jeweller.** June 1900.
- 1553 **Inghram**, John T. *236 N. Fifth Street, Quincy, Illinois, U.S.A.* 159 (Mich. C.) 5, P.H.P. March 1899.
- 1554 **Inglis**, Joseph W. S. *110 George Street, Edinburgh.* 757, 56, J. June 1899.
- 1555 **Inglis**, William. *186 Broudhurst Gardens, N.W., London.* 2492. March 1904.
- 1556 **Inskipp**, Frederick. *2 Paternoster Square, E.C. London.* 1997, P.M., 141, P.Z. October 1904.
- 1557 **Inskipp**, George, F.R.I.B.A. *5, Bedford Row, W.C., London.* 1997, P.M. March 1897.
- 1558 **Iredale**, Charles Winsloe. *Mill Valley, California.* 166, 5. October 1906.
- 1559 **Irvine**, Thomas William. *East London, Cape.* 1800. May 1899.
- 1560 **Irving**, David Halliday. *Morning Herald Office, Freemantle, West Australia.* 35 (W.A.C.). June 1900.
- 1561 **Irving**, William. *Cintra Villa, Lover's Walk, Dumfries, N.B.* 63, 174. November 1896.
- 1562 **Irwin**, Thomas. *Shaftoe Leazes, Hexham, Northumberland.* 1626. October 1905.
- 1563 **Isebree-Moens**, Joost. *Villa Bloois, Rotterdam, Holland.* L. Frederick Royal, W.M. **Grand Secretary, Grand Lodge of the Netherlands.** October 1890.

- 1564 **Isherwood**, John Vernon. *West View, Ravensthorpe, Dewsbury, Yorks.* 827. January 1899.
- 1565 **Isler**, C. *Speranza, Victoria Drive, Bognor.* 1471. October 1897.
- 1566 **Jack**, Evan M., Capt. R.E. 20 *Brunswick Place, Southampton.* 488. January 1903.
- 1567 **Jackman**, Joseph. 4 *Kenwood Park Road, Sharrow, Sheffield.* P.Pr.G.D. June 1891.
- 1568 **Jackson**, A. H. 109 *Enyfield Road, Canonbury, N., London.* 1931. June 1904.
- 1569 **Jackson**, Charles Napier. 1 *Cleveland Villas, The Green, South Tottenham, Middlesex.* 1579, P.M. May 1901.
- 1570 **Jackson**, George John. 41 *Park Row, New York City, U.S.A.* 454. P.M., 8. May 1905.
- 1571 **Jackson**, Harry George Lees Giffard. 94, *Grove Park, Camberwell, S.E., London.* 1297. Jan. 1902.
- 1572 \***Jackson**, Herbert W. 75 *Gainsboro St., Huntingdon Ave, Boston, Massachusetts, U.S.A.* March 1905.
- 1573 **Jackson**, Richard Oswald. 43 *Turner Street, Manchester.* 1458. March 1906.
- 1574 **Jackson**, Robert. 16 *Dixon Avenue, Crosshill, Glasgow.* 313, P.M. **Third Grand Sojourner.** January 1895.
- 1575 **Jackson**, Thomas Clepham. *Caiza 115, Rio de Janeiro.* 3. January 1897.
- 1576 \***Jackson-Jones**, W. 222 *Chepstow Road, Maindee, Newport, Monmouth.* March 1894.
- 1577 **Jacob**, William Henry. *Magdala Villas, Winchester.* P.Pr.G.Sup.W., P.Pr.G.So. March 1888.
- 1578 **Jacobs**, Benjamin Septimus. 2 *Westbourne Avenue, Hull.* 1010, P.M., P.P.G.Sup.W. March 1905.
- 1579 **Jacobs**, L. L. 23 *Belsize Park Gardens, South Hampstead, N.W., London.* October 1904.
- 1580 **Jacobsen**, W. 9 *Bury Court, St. Mary's Axe, E.C., London.* 238, P.M. March 1902.
- 1581 **Jahrmann**, Fritz. *Olsen, Jahrmann & Co., Christiania.* Lodge St. Olave til den hvide Leopold. October 1906.
- 1582 **James**, Henry J. *Ahaura, Grey Valley, West Coast, New Zealand.* 40 (N.Z.C.). October 1900.
- 1583 **James**, Henry Nelson. 124 *Balfour Road, Ilford, Essex.* 1716. March 1906.
- 1584 **James**, Herbert Thomas. *Central Buildings, West Hartlepool, Durham.* 764, W.M., 764. June 1906.
- 1585 **James**, Hugh. 125 *Nightingale Lane, Wandsworth Common, S.W., London.* 1441, P.M., P.G.Reg. (B.A.) Middlesex. June 1898.
- 1586 **James**, R. Denley. Box 61, *Harrismith, Orange River Colony.* 1778, 1778. October 1904.
- 1587 **Jarvis**, Matthew Jervoise. *Hawthorns, Twyford, R.S.O., Berks.* 12, P.M. May 1895.
- 1588 **Jauncey**, John. 2 *Bridgewater Street, E.C., London.* 1471. March 1898.
- 1589 **Jefferis**, Arthur Henry. 4 *St. Peter's Square, Manchester.* P.Pr.G.W., P.Pr.G.J. September 1887.
- 1590 **Jeffrey**, John. *De Beers Con. Mines, Ltd., Kimberley, South Africa.* 1832, W.M. March 1905.
- 1591 **Jenkin**, John. 101 *Thorntlaw Road, West Norwood, S.E., London.* 890. 1601. May 1905.
- 1592 **Jenkins**, Henry. 5 *Henry Road, Finsbury Park, N. London.* 860, P.M., 860 P.Z. June 1894.
- 1593 **Jenkins**, J. C. *St. Petersburg, Florida, U.S.A.* 139. June 1904.
- 1594 **Jenkins**, Sir Lawrence, K.C.I.E. *Nepean Sea Road, Bombay.* **District Grand Master.** March 1905.
- 1595 **Jenks**, Maurice. 39 *West Park, Eltham, S.E., London.* 2108. March 1902.
- 1596 **Jennings**, Major W. E. *c/o King King & Co., Bombay.* Grand Master Depute of Scotch Masons in India. March 1903.
- 1597 **Jobberns**, Rev. Joseph Brewer. *The Rectory, Carnoustie, N.B.* 679. November 1905.
- 1598 \***John**, Reginald Marshall. *Colombo, Ceylon.* 2170. October 1904.
- 1599 **Johns**, Frederick. *South Australian Register Office, Adelaide.* **Past Grand Standard Bearer, South Australia.** Local Secretary for South Australia. November 1891.
- 1600 **Johnson**, H. T. C. 346 *Little Collins Street, Melbourne, Victoria.* 110. May 1898.
- 1601 **Johnson**, Joseph. 47 *Mark Lane, E.C., London.* 2191. May 1906.
- 1602 **Johnson**, Tom Mayo. 10 *Lorne Street, Chester.* 2609, P.M. May 1905.
- 1603 **Johnston**, Charles John Kent. *Featherston, Wairarapa, New Zealand.* 19, P.M., 10, P.Z. March 1904.
- 1604 **Johnston**, Professor Swift Paine, M.A. 6 *Trinity College, Dublin.* 357, P.M. June 1898.
- 1605 **Johnstone**, Guy Vyvyau Gordon. *Lautoka, Fiji.* 562 (S.C.). January 1903.
- 1606 **Johnstone**, Henry Thomas. *Lightburne, Malakoff Street, Caulfield, Victoria.* 126. October 1904.
- 1607 **Johnstone**, Dr. James. 26 *Sheen Road, Richmond, Surrey.* 2032, P.M., 2190, P.Z. May 1906.
- 1608 **Johnstone**, John Thomas. *St. Andrew's, Gillingham, Dorset.* 2689. October 1906.
- 1609 **Jolley**, Philip Henry. *Waipukurau, Hawkes Bay, New Zealand.* **Past Assistant Grand Sword Bearer, New Zealand.** May 1894.
- 1610 **Jonas**, David. 78 *Adderley Street, Cape Town.* 2691, P.M., P.D.G.Sw.B. June 1903.
- 1611 **Jones**, A. Cadbury. 22-24 *Glasshouse Street, W., London.* 2948, 1507, P.Z. January 1904.

- 1612 **Jones, Ben.** *Grove Street, Wilmslow, Cheshire.* 2961. March 1906.
- 1613 **Jones, Charles Geo.** 109 *Ewart Road, Forest Hill, S.E., London.* 2948, W.M. January 1904.
- 1614 **Jones, Ernest Harold.** 67 *Wheeley's Road, Edgbaston, Birmingham.* 2897. March 1906.
- 1615 **Jones, Lieut.-Col. Frederick William C., R.A.M.C.** *Nasirabad, Rajputana, India.* 2307, W.M. May 1906.
- 1616 **Jones, Herbert Edwin.** *Ewias Harold, Hereford.* 120. May 1903.
- 1617 **Jones, Dr. H. J., M.R.C.S.** 30 *Lillie Road, West Brompton, W., London.* 2512. May 1903.
- 1618 **Jones, John Allen.** *Llaney Clodwel Vicarage, Oswestry, Salop.* 1124. May 1906.
- 1619 **Jones, John Archyll, B.Sc., F.C.S.** *Reethville Park Road, West Hartlepool.* 1848, P.M., 602. Nov. 1895.
- 1620 **Jones, Thomas.** 41 *Prospect Hill, Walthamstow, Essex.* 1607, P.M. January 1890.
- 1621 **Jordan, Andrew Jackson.** *Clarkson Street, Sheffield.* 296, W.M. March 1905.
- 1622 **Joseph, Dr. Hugh Percival.** *Port Surgeon's Office, Colombo, Ceylon.* 611 (S.C.), J.D. March 1906.
- 1623 **Joseph, J.** *Jansenville, Cape Colony.* October 1906.
- 1624 **Joy, Frederick George.** 7 *Glencoe Avenue, Seven Kings, Essex.* 1426, P.M. March 1905.
- 1625 **Joy, J. T.** *Beaconsfield House, The Avenue, Linthorpe, Middlesborough, Yorks.* 2391. January 1901.
- 1626 **Joyce, Alfred.** *c/o Messrs. Grindlay & Co., Parliament Street, S.W., London.* 2356, P.M. Oct. 1900.
- 1627 **Junius, Gustav Edward.** 37 *Rue de Bretagne, Paris-Asnières.* 538. June 1901.
- 1628 **Justice, Lieut.-Col. Charles le Gendre.** 48th *Pioneers, Bureilly, India.* 1843, W.M., 552. Oct. 1902.
- 1629 **Kalker, E.** 141 *Much Park Street, Coventry.* 2811, S.W. March 1906.
- 1630 **Kalish, Abner.** 92 *Market Street, Newark, New Jersey, U.S.A.* 51, P.M. 9. March 1906.
- 1631 **Keating, Edward William.** *Beaconsfield, South Africa.* 1574, W.M. March 1905.
- 1632 **Keble, Harman, J.P.** *Albyfield, Cliftonville, Margate.* 183. March 1894.
- 1633 **Keeson, Charles Albert Cuthbert.** *St. Cuthbert's, Crediton Road, West Hampstead, N.W., London.* 822, 29. November 1895.
- 1634 **\*Keighley, Lieut.-Col. C.M., C.B., D.S.O.** *The Elms, North Curry, Somerset.* **Past Grand Deacon.** January 1897.
- 1635 **Keith, John Meiggs.** *San José, Costa Rica.* **Past Grand Master.** Representative Grand Lodge, New York. November 1901.
- 1636 **Kellett, Arthur Chadwick.** *Malvern House, Trafalgar Road, Moseley, Birmingham.* P.P.G.D.C., Pr.G.P.So. January 1905.
- 1637 **Kellevink, H. J. D.** 44 *Vossius Straat, Amsterdam.* La Paix. June 1905.
- 1638 **Kelley, John Goshorn.** 306 *E. Mission Street, Santa Barbara, California, U.S.A.* 368, 250. May 1897.
- 1639 **Kelly, John Robert.** *Mount Morgan, Queensland.* 2820. May 1901.
- 1640 **Kelly, W. Redfern.** *Dalriada, Malone Park, Belfast.* P.P.S.G.W., G. Sup. (R.A.), Antfim. March 1904.
- 1641 **Kemball, Henry Vero Rooke.** *Byculla Club, Bombay.* 549, 549. January 1904.
- 1642 **Kemmis, Edward Bernhard.** *The Rectory, Conington, Cambridge.* 1184. June 1905.
- 1643 **Kemmis, Henry William Shore.** *Cowley P.O., Alberta, Canada.* 45, P.M. March 1901.
- 1644 **Kemp, H. 7 Thavies Inn, Holborn Circus, E.C., London.** 862, P.M., 862, P.Z. May 1901.
- 1645 **Kemp, William David.** 32 *Academy Street, Inverness.* 339, 115. May 1894.
- 1646 **Kendall, Edward Austin, I.C.S.** *Messrs. Grindlay, Groom & Co., Bombay.* P.Dis.G.J.D., Bengal. January 1899.
- 1647 **Kendrick, George W., jun.** 8 *South Broad Street, Philadelphia, U.S.A.* 59, 52. **Grand Master.** P.H.P. March 1906.
- 1648 **Kennan, Henry Laurens.** *Spokane, Washington, U.S.A.* **Past Grand Master.** Jan. 1900.
- 1649 **Kennedy, Alfred C.** *Omaha, Nebraska, U.S.A.* 3. June 1902.
- 1650 **Kennedy, J.** *Kookynie, West Australia.* 932 (S.C.). November 1904.
- 1651 **Kennedy, James Edward.** *Ba River, Fiji.* 1391. May 1902.
- 1652 **Kenning, Frank Reginald.** *Little Britain, Aldersgate Street, E.C., London.* 192, 192. March 1894.
- 1653 **Kenworthy, Robert Judson.** 41 *Park Row, New York.* P.Dis.D.G.M. January 1898.
- 1654 **Kenyon, George Henry, A.M., M.D.** 606 *Lapham Buildings, Providence, Rhode Island, U.S.A.* **Past Grand Master, Past Grand High Priest, Rhode Island. Representative Grand Lodges of Ireland, Canada and Florida; and Grand Chapters of Massachusetts and Georgia.** October 1890.
- 1655 **Kenyon, William John Charles.** *South Omaha, Nebraska, U.S.A.* 25 (Neb. C.), 45. Jan. 1893.
- 1656 **Keown, Thomas H.** 23 *Donegall Place, Belfast.* 180, P.M., Capt. Blue Veil (R.A.), Ireland. March 1905.
- 1657 **Kerbey, F. W.** 4 *Bloomfield Road, Burdett Road, Bow, E., London.* 11. June 1902.
- 1658 **Kerr, Robert England, M.B., M.A.** Box 2909, *Johannesburg, Transvaal.* 339. June 1895.

- 1659 **Kerr**, Rev. William John Bewglass. *Irchester Vicarage, Wellingborough, Northampton.* 3039, W.M., P.P.G.Ch., Notts. October 1904.
- 1660 **Kettlewell**, Dr. George Douglas. *Capstone Lodge, Ilfracombe.* 1266. October 1903.
- 1661 **Kersey**, Harry Augustus. 39 *Grosvenor Place, Newcastle-on-Tyne.* 24. May 1903.
- 1662 **Kessler**, Fred William. 46 *Nether Street, North Finchley, N., London.* 1897, P.M. P.Pr.G.D.C. Middlesex. May 1906.
- 1663 **Key**, Thomas E. *Kent House, Aldeburgh, Suffolk.* 936, 376. May 1899.
- 1664 **Keys**, W. Hall. *Lyndon House, West Bromwich, Staffords.* 2784, P.M., Pr.G.Reg. October 1901.
- 1665 **Keyser**, Charles Edward. *Aldermaston Court, Reading.* **Past Grand Deacon, Past Grand Sword Bearer (R.A.).** January 1893.
- 1666 **Khambatta**, Dorabji D. *Bank of Bombay, Poona, India.* 343 (S.C.), P.M. 68 (S.C.), P.K. G.Treas. May 1906.
- 1667 **Khory**, Edalji Jamsedji. 8 *Raffles Place, Singapore.* P.Dis.G.W., Eastern Archipelago. Local Secretary for Singapore. October 1890.
- 1668 **Kiallmark**, Henry Walter. 5 *Pembridge Gardens, W., London.* **Past Grand Deacon, Past Grand Standard Bearer (R.A.)** October 1895.
- 1669 **Kidd**, John Alfred. *Morley, Alberta, Canada.* 60. June 1905.
- 1670 **Kielland**, Dr. K. *Trondhjem, Norway.* St. Olaf t.d.g. Tempel. January 1904.
- 1671 **Kiesow**, Robert. 25 *Fore Street Avenue, E.C., London.* 2020. June 1903.
- 1672 **Kilham**, John. *Toowoomba, Queensland.* 1315, P.M., 194 (S.C.), P.Z. May 1891.
- 1673 **Kindness**, William. *Te Kowai, Mackay, Queensland.* 737 (S.C.). May 1902.
- 1674 **King**, Andrew. 62 *Market Place, Hull.* P.P.G.D., P.P.G.Sc.N. March 1902.
- 1675 **King**, Arthur William. *Aysgarth, R.S.O., Yorks.* 345, P.M., 345. January 1896.
- 1676 **King**, Frank. *The Laurels, Little Park Gardens, Enfield, Middlesex.* 1607. January 1890.
- 1677 **King**, George Seymour. 12 *Fors Street, E.C., London.* 765. November 1898.
- 1678 **King**, Henry. 29 *The Avenue, Ealing, W., London.* 1329, W.M., 1339. May 1902.
- 1679 **King**, Herbert. *Upper Bangor, North Wales.* 384. March 1901.
- 1680 **King**, Horatio Alfred. 38 *Exchange Street, Norwich.* 93, P.M., 807. March 1904.
- 1681 \***King**, Olenthus William. *1st Duke of Cornwall's Light Infantry, Wynberg, Cape Colony.* 552, P.M., 552, P.H. October 1904.
- 1682 **King**, Stephen. 489 *Smith Street, Durban, Natal.* 747 (S.C.). October 1896.
- 1683 **King**, Major Thomas Fraser. 23 *Brookfield Road, Bedford Park, W., London.* 1068. January 1903.
- 1684 **Kingdon**, Harold Harris. *Essex Road, Basingstoke.* 694. January 1904.
- 1685 **Kipps**, William. 93 *Lewisham High Road, S.E., London.* **Deputy Grand Organist, Past Assistant Grand Director of Ceremonies (R.A.).** June 1894.
- 1686 **Kiralfy**, Imre. *Tower House, Cromwell Road, S.W., London.* **Past Assistant Grand Director of Ceremonies.** June 1906.
- 1687 **Kirchoffer**, Samuel G., M.A., F.G.S., F.R.G.S. *Yately Grange, Blackwater, Hants.* **Past Dep. Grand Director of Ceremonies, Past Grand Standard Bearer (R.A.).** Nov 1887.
- 1688 **Kirk**, J., C.M., M.D. 3 *Raffles Place, Singapore.* 2933, W.M. March 1904.
- 1689 **Kirkpatrick**, Samuel. *Nelson, New Zealand.* P.Dis.G.So. May 1897.
- 1690 **Kitchin**, Llewellyn. *c/o Messrs. Gilder & Kitchin, Logate, Hull.* 57. January 1906.
- 1691 **Klee**, Adolph. 249 *West 99th Street, New York City, U.S.A.* 154, P.M., P.Dep.Dis.G.M. March 1906.
- 1692 **Klein**, Dr. Valdemar. *Oster Sögade 32, Copenhagen.* June 1901.
- 1693 **Knifton**, Ernest F. 66 *Lansdowne Road, Tottenham, N., London.* 1278. October 1906.
- 1694 **Knight**, Arthur. *Singapore.* P.D.D.G.M., Eastern Archipelago. May 1896.
- 1695 **Knight**, Charles Neil. 36 *Kensington Park Road, W., London.* 1036. May 1895.
- 1696 **Knight**, Herbert Manning. *Melbourne, Victoria.* **Past Deputy Grand Master.** June 1892.
- 1697 **Knight**, W. J. M. 12 *King's Bench Walk, Temple, E.C., London.* 2694. May 1904.
- 1698 **Knobel**, Alfred. *Mackay, Queensland.* 1554. October 1897.
- 1699 **Knopp**, George Leonard. 1 *Chapel Street, Colchester.* 697. June 1905.
- 1700 **Knox**, Herbert. *Secunderabad, Madras.* 434. January 1906.
- 1701 **Knuth**, C. H. 33 *Fann Street, Golden Lane, E.C., London.* 1839, P.M. March 1906.
- 1702 **Koester**, Carl. 22 *Kuesbeck Strasse, Charlottenberg, Berlin.* Friedrich Wilhelm zur Morgenröthe. June 1903.
- 1703 **Kotze**, Gysbert Willem. *Malmesbury, Cape Colony.* Lodge San Jan, P.M. May 1898.
- 1704 **Koop**, E. C. *Stalhiem, Finchley Lane, Hendon.* 238. January 1903.
- 1705 **Krall**, C. 40 *Park Hill Road, Hampstead, N.W., London.* 238. June 1903.

- 1706 **Krasa, Ferdinand.** 9 *Garlinge Road, West Hampstead, N.W., London.* 1504. January 1899.
- 1707 **Krauss, A. E.** 30 *Langham Road, West Green, N., London.* 92, S.D. October 1905.
- 1708 **Krauss, Henry.** *Chichester House, Chester.* **Past District Grand Master.** P.Dis.G.Sup., Burma. May 1906.
- 1709 **Krueger, Albert J.** 45 *Leopold de Wael Street, Antwerp.* **Grand Director of Ceremonies.** November 1899.
- 1710 **Kuehn, M.** *West Heath Lodge, Branch Hill, Hampstead Heath, N.W., London.* 238. March 1902.
- 1711 **Kundig, Henry.** 23 *Boulevard Montparnasse, Paris, 6<sup>e</sup>.* Union des Coeurs. March 1900.
- 1712 **\*Kyle, James, sen.** 152 (I.C.), P.M., 198 (I.C.). March 1895.
- 1713 **Lake, William.** *Kenwyn, Queen's Road, Beckenham.* **Assistant Grand Secretary.** May 1887.
- 1714 **Lakin, Ernest A. N.** 42 *High Street, Launceston, Tasmania.* 10. March 1904.
- 1715 **Laking, Cook.** *Eastbourne Road, Hornsea, near Hull.* 1511, P.Pr.G.P., N. & E. Yorks. March 1906.
- 1716 **Lambert, Charles Alexander.** *Warwick, Queensland.* 818 (S.C.), P.M., 200 (S.C.), P.Z. June 1896.
- 1717 **Lambert, C. W.** 51 *King Street, Manchester.* 1345. May 1906.
- 1718 **Lambert, Richard.** Room 21, *Masonic Temple, New Orleans, U.S.A.* **Grand Secretary, Past Grand High Priest, Louisiana.** Local Secretary for Louisiana. May 1857.
- 1719 **Lambert, Thomas.** *Bank of New South Wales, Melbourne, Victoria.* **Past Deputy Grand Master, Past Grand Zerubbabel.** October 1899.
- 1720 **Lamberton, James McCormick.** 216 *Market St., Harrisburg, Pennsylvania.* 21, P.M., 21. Jan. 1897.
- 1721 **Lambton, John William.** 5 *Front Street, Preston, North Shields.* P.Pr.G.St.B. January 1897.
- 1722 **Lamonby, William Farquharson.** *Bullarat, Kitto Road, St. Catherine's Park, S.E., London.* **Past Assistant Grand Director of Ceremonies, England; Past Grand Standard Bearer (R.A.); Past Deputy Grand Master, Victoria.** November 1899.
- 1723 **Lancaster, George Felton.** *St. John's Cottage, Forton, Gosport.* **Past Grand Pursuivant, Past Assistant Grand Director of Ceremonies (R.A.).** May 1887.
- 1724 **Lander, R. E. F.** 8 *Sergeant's Inn, Fleet Street, E.C., London.* 2545, P.M. November 1905.
- 1725 **Lang, Christian Suhr.** *Brolaeggerstraede 2, Copenhagen.* Lodge Christian. October 1906.
- 1726 **Lange, Albert Jacob.** *Eidsvold Voerk, Norway.* 39 (S.C.). October 1899.
- 1727 **Lange, Paul.** *Senekal, Orange River Colony.* Lodge Unity (D.C.). May 1893.
- 1728 **Langemann, Max.** 233 *Salisbury House, Finsbury Circus, E.C., London.* 1409. March 1902.
- 1729 **Langford, Frederick.** *Ladbroke Hall, North Kensington, W., London.* 1571, P.M. March 1903.
- 1730 **Langton, John Gordon.** *Sunderland Lodge, Westbourne Gardens, Bayswater, W., London.* **Past Deputy Grand Director of Ceremonies, Craft and R.A.** October 1898.
- 1731 **Lansdell, Edwin.** 452 *West Street, Durban, Natal.* 799 (S.C.). March 1895.
- 1732 **\*Lapham, Thomas Uriah.** P.O. *Livingston, North-West Rhodesia.* 2479. May 1902.
- 1733 **Lapping, James Edward.** Box 2989, *Johannesburg, Transvaal.* 2678. June 1903.
- 1734 **Lapsley, James M.** *Fire Brigade Station, Perth, West Australia.* Dis.G.W. (S.C.). Nov. 1898.
- 1735 **Lardner, Henry Joseph.** 27 *Clement's Lane, E.C., London.* **Past Grand Standard Bearer, Past Assistant Grand Director of Ceremonies (R.A.).** May 1840.
- 1736 **Larsen, August.** 117 *Holborn, E.C., London.* 2105, P.M., 720, P.Z. May 1898.
- 1737 **Larsen, A. E.** *Esbjerg.* Lodge Mary in Odense. October 1906.
- 1738 **Last, J. T., F.R.G.S.** *Zanzibar.* 3007, P.M. January 1900.
- 1739 **Latta, Samuel Whitehill.** 233 *South Fourth Street Annex, Philadelphia, U.S.A.* 631, P.M., P.H.P. March 1905.
- 1740 **Laurie, Henry William.** *Lulworth, Carew Road, Wallington, Surrey.* 90, W.M. January 1906.
- 1741 **Laver, John.** 375 *Flinders Lane, Melbourne, Victoria.* 41, P.M. October 1904.
- 1742 **Lavery, Hugh.** *Survey House, Bendigo, Victoria.* 64, P.M. **Past Grand Scribe N.** Oct. 1892.
- 1743 **Lawler, George.** *Tacoma, Wash., U.S.A.* 22, W.M. June 1906.
- 1744 **\*Lawrance, Walter, F.S.I.** 13 *Hart Street, Bloomsbury, W.C., London.* **Asst. Grand Sup. Wks., Asst. Grand D.C. (R.A.).** October 1899.
- 1745 **Lawrence, George Thomas.** *Finsbury Lodge, Hatherley Road, Sidcup, Kent.* 2741, 1446. March 1904.
- 1746 **\*Lawrence, General Samuel Crocker.** 28 *Lancaster Street, Boston, Massachusetts, U.S.A.* **Past Grand Master of Grand Lodge of Massachusetts.** March 1888.
- 1747 **Lawson, J. W.** *Newtown, Peterborough.* 2996, 442. March 1905.
- 1748 **Lawton, William Arthur.** 1 *Upper Montague Street, Russell Square, W.C., London.* 1928. June 1905.
- 1749 **Lax, George.** *Allerton Park, Chapel-Allerton, Leeds.* 2922. January 1905.
- 1750 **Lazenby, Francis.** *Fairholme, Basingstoke.* P.Pr.G.D., Hants and I.W., 694, P.Z. May 1901.



- 1751 **Lazenby**, Joseph. *Cromwell Road, Peterborough.* 2966, 442. March 1905.
- 1752 **Lea**, Edwin, J.P. *Wilderley, Heathfield Road, Gloucester.* P.P.J.G.W. October 1900.
- 1753 **Leah**, William. *Fern Bank, Hoole Road, Chester.* 721. June 1905.
- 1754 **Lee**, Andrew Ronald. *40 Brockley Road, S.E., London.* 1339, P.M. March 1903.
- 1755 **Lee**, Thomas Sterling. *The Vale, Chelsea, S.W., London.* 2233, P.M. January 1906.
- 1756 **Leete**, Thomas. *9 Church Street, Kensington, W., London.* 901, P.M. January 1904.
- 1757 **Le Feuvre**, Major John Emilius, J.P. *19 Carlton Street, Southampton.* **Past Grand Deacon, Past Grand Sword Bearer** (R.A.). September 1897.
- 1758 **Le Feuvre**, Dr. William Phillip. *Box 150, Bulawayo, Rhodesia.* 1603. January 1899.
- 1759 **Lehmann**, Ludwig. *63 Basinghall Street, E.C., London.* 2705. June 1903.
- 1760 **Lehmann**, Viggo. *Pilestroede 70b, Christiania, Norway.* Lodge Oscar til den flamende Stjerne. October 1897.
- 1761 **Leigh**, George. *52 George Street, Hull.* P.Pr.G.St.B., North and East Yorks. May 1897.
- 1762 **Leighton**, Albert. *West Harding Street, Fetter Lane, E.C., London.* 263, P.M., 1326, P.Z. May 1897.
- 1763 **Leighton**, Alexander Robert. *183 Calle Florida, Buenos Aires.* P.Pres.D.B.G.P. October 1898.
- 1764 **Leins**, Dr. H. *177 Stapleton Hall Road, Stroud Green, N., London.* 238. June 1903.
- 1765 **Leipold**, John. *State Battery, Niagara, West Australia.* November 1905.
- 1766 **Lemon**, Frank E. *Hill Crest, Redhill, Surrey.* 2033, P.M. October 1905.
- 1767 **Lemon**, Rev. Thomas William, D.D., Oxon. *Vicarage, Poughill, nr. Bude, North Cornwall.* P.P.G.W., P.Pr.G.J., Devonshire. September 1887.
- 1768 **Lennard**, George Hamilton. *P.O. Box 3082, Johannesburg, Transvaal.* 265 (I.C.). October 1902.
- 1769 **Letts**, Alfred Woodley. *2 St. Wilfred's Road, New Barnet, Herts.* 2509. October 1898.
- 1770 **Levander**, Frederick William, F.R.A.S., Pres.Brit.Astron.Assoc. *30 North Villas, Camden Square, N.W., London.* P.Pr.G.D., P.Pr.G.Treas. (R.A.), Middlesex. Local Secretary for Middlesex and North London. January 1890.
- 1771 **Leversedge**, Robert Coram. *Evercreech, Bath.* P.Pr.G.D., P.Pr.A.G.S., Middlesex. June 1900.
- 1772 **\*Leveson**, Edward John. *3 Southwick Crescent, Hyde Park, W., London.* 26, P.M. January 1901.
- 1773 **Levin**, Emile. *Box 87, Potchefstroom, Transvaal.* 766 (S.C.), W.M. March 1906.
- 1774 **Levoy**, Louis G. *Webster, South Dakota, U.S.A.* **Past Grand Master, Past Grand High Priest, South Dakota.** Local Secretary for South Dakota. October 1893.
- 1775 **Levy**, George, F.R.C.I. *Box 240, Bloemfontein, Orange River Colony.* 1022. January 1903.
- 1776 **Levy**, Jenö. *2 Podmaniczky utca, Budapest.* Lodge Madach. Dep.W.M. June 1906.
- 1777 **Lewis**, Arthur G. P., M.A. *Trenewydd, Llandaff, Cardiff.* **Past Grand Deacon.** 36, P.Z. May 1904.
- 1778 **Lewis**, Rayner Blount. *37 Anerley Park, S.E., London.* P.Pr.G.D., Hereford. November 1897.
- 1779 **Liebheim**, Dr. E. *Poetenweg 8, Liepsig-Gohlis, Saxony.* Akazie am Saalestrande. Nov. 1903.
- 1780 **Lidgely**, William. *Devoran, Truro, Cornwall.* 589, P.M., 1006, P.Z. October 1889.
- 1781 **Lightfoot**, Bruce. *Station Master, Shoreham, Kent.* 1915, P.M., 131. March 1889.
- 1782 **Lightfoot**, Richard Henry. *Herberton, Queensland.* 737 (S.C.), P.M. May 1894.
- 1783 **Liisberg**, H. C. Bering. *Oster Voldgade 10-3, Copenhagen.* Lodge Christian. October 1906.
- 1784 **Lincoln**, W. S. *2 Holles Street, Cavendish Square, W., London.* 2191, P.M., 1201. October 1905.
- 1785 **Lindesay**, Crawford. *Salisbury, Rhodesia.* 1976, P.M., 738, P.H. May 1902.
- 1786 **Lindsay**, Thomas. *7 Lauderdale Avenue, Earls Park, Newlands, Glasgow.* **Grand Marshall, Dep.Z.** October 1897.
- 1787 **\*Lindsay**, Thomas A. *Carnoustie, N.B.* P.Pr.G.H., Angus and Mearns. May 1894.
- 1788 **Lininger**, George W. *224 North 18th Street, Omaha, Nebraska, U.S.A.* **Past Grand Master, Past Grand High Priest.** June 1902.
- 1789 **Linsell**, William Goode. *Little Waltham, Essex.* 1543. October 1900.
- 1790 **Lipscomb**, William Gull, M.A. *Hopefield, Chorley New Road, Bolton, Lancs.* 1479. March 1901.
- 1791 **Lister**, Colville William. *Monkland, Queensland.* 755 (S.C.), 194 (S.C.). May 1893.
- 1792 **Littleton**, Joseph. *28 Archfield Road, Cutham, Bristol.* P.Pr.G.St.B. March 1901.
- 1793 **Livingston**, Donald McKenzie. *B. & M. Railway, Beira, Portuguese East Africa.* 2678. May 1902.
- 1794 **Llewellyn**, W. Melville. *57 Barker Road, Nether Edge, Sheffield.* 2647. May 1902.
- 1795 **Lloyd**, F. *Hillingdon, Botanic Garden Road, Durban, Natal.* 2426. October 1902.
- 1796 **Lloyd**, Francis William. *85 Gracechurch Street, E.C., London.* 2650. January 1905.
- 1797 **Lloyd**, James John. *Rodepoort, Transvaal.* 2486. January 1897.
- 1798 **Lloyd**, Dr. Samuel. *60 Bloomsbury Street, W.C., London.* 1201, P.M., June 1898.
- 1799 **Lloyd**, William Thomas. *Rodepoort, Transvaal.* 2539, P.M. October 1894.

- 1800 **Lobingier**, Charles Sumner. *Manila, Philippine Islands*. 25. Local Sec. for Philippine Islands. May 1900.
- 1801 **Locke**, Ernest William. *The Institute, Starcross, Exeter*. 444, P.M., 444, P.Z. P.Pr.G.S.D., P.R.A.G.S. October 1906.
- 1802 **Lockwood**, William. 12 *Sherwood Street, W. London*. 795. May 1903.
- 1803 **Lodge**, Alexander John. *Hartshill Cottage, Stoke-on-Trent*. 2149, 418. May 1902.
- 1804 **Loesch**, Frederick Ogden. *Goldfinch, Heathfield, Sussex*. 1184. October 1903.
- 1805 **Loewy**, Benno. 206 *Broadway, New York, U.S.A.* 209, W.M., 220, P.H.P. Local Secretary for New York. May 1894.
- 1806 **Lofthouse**, George William. 3 *Island Road, Garston, Liverpool*. 220, P.M. 220, P.Z. January 1906.
- 1807 **Logan**, William Charles. *Hendre, Penrhyndraeth, North Wales*. P.P.G.W., P.P.G.J. June 1895.
- 1808 **Lombard**, Rev. Bousfield S., M.A. *All Hallow's Vicarage, Courthope Road, N.W. London*. 889. June 1904.
- 1809 **Lombard**, Major Graves Chamney Swan. *Homewood, Worcester Park, Surrey*. 889. Oct. 1905.
- 1810 \***Long**, Geoffrey Rogers. *Moulmein, Burma*. 542, 542. November 1896.
- 1811 **Long**, Sadler. 67 *Maryon Road, Charlton, S.E., London*. 913. October 1905.
- 1812 **Longman**, Henry. *Laurel Bank, Lancaster*. P.Pr.G.Sup.W., P.Pr.G.S. January 1896.
- 1813 **Lonnon**, William, R.N. 93 *London Road, Portsmouth*. 349. May 1903.
- 1814 **Lopez**, Manly Thomas. *Chapelton, Jamaica*. 1933. March 1905.
- 1815 **Lord**, David Arthur. 2 *Balfour Road, Ilford, Essex*. 1687. May 1904.
- 1816 **Lord**, Paul Francis. 25 *Ramshill Road, Scarborough*. 1248. October 1902.
- 1817 **Lovegrove**, Henry, F.S.I., A.R.I.B.A. 18 *Foxgrove Road, Beckenham, Kent*. **Past Grand Sword Bearer**. November 1887.
- 1818 **Lovell**, Arthur. 94 *Park Street, Grosvenor Square, W. London*, 1425. October 1898.
- 1819 **Lowder**, E. Gordon. *Pendennis, York Road, Woking*. 1912, 570. May 1903.
- 1820 **Lowe**, F. J. *The Mount House, Shrewsbury*. 117. March 1898.
- 1821 **Lowe**, William Wallace. 16 *Pine Avenue, Long Beach, California, U.S.A.* 327, P.M. June 1903.
- 1822 **Lucas**, Claude Davis. Box 45, *Ermelo, Transvaal*. 2685. March 1906.
- 1823 **Luetchford**, George Harry. 16 *Beaumont Road, Hornsey Rise, N., London*. 1677. January 1903.
- 1824 **Luke**, S. A. 59 *Rideau Street, Ottawa, Canada*. **Past Deputy District Grand Master**. May 1905.
- 1825 **Lyell**, J. C. 11 *Baskerville Road, Wandsworth Common, S.W., London*. 2508. March 1902.
- 1826 **Lyons-Montgomery**, Foster Kynasfer Walter. P.O. Box 2, *Cambridge, New Zealand*. 1331. Jan. 1898.
- 1827 **MacAlister**, Robert. *Pietermaritzburg, Natal*. 701 (S.C.), P.M. October 1895.
- 1828 **Macan**, F. W. 8 *Laurence Pountney Hill, E.C., London*. 26, 773, P.M. June 1906.
- 1829 \***McCartney**, Samuel Robert. *Lynton House, Gravesend*. **Past Assistant Grand Director of Ceremonies (Craft and R.A.)**. June 1902.
- 1830 **Macaulay**, John James. c/o *Denham Bros., Rockhampton, Queensland*. 344 (I.C.). October 1902.
- 1831 **MacBride**, Andrew Somerville. 12 *Crompton Avenue, Cathcart, Glasgow*. D.P.G.M., Dumbarton. May 1893.
- 1832 **MacCullough**, William. *Thames, New Zealand*. Pr.G.M., Dep.G.Sup.(R.A.) North Island. March 1891.
- 1833 **MacDonald**, Alexander. *Thornwood, Ardrishaig, Scotland*. 753, P.M., 69. January 1893.
- 1834 **MacDonald**, John. *Longreach, Queensland*. 1175, P.M., 127 (S.C.), P.Z. November 1895.
- 1835 **MacDonald**, John Christopher. 21 *Nixon Street, Newcastle-on-Tyne*. 541. March 1898.
- 1836 **MacDonald**, Robert. 37 *Marquis Street, Glasgow*. P.P.G.D.C. June 1891.
- 1837 **Macdonald**, Andrew. 264 *San Martin, Buenos Aires*. Dis.G.St.B., Dis.A.G.S.E. March 1905.
- 1838 **Macdonald**, George, M.D. *Calgary, Alberta, Canada*. **Grand Master**, 106, P.Z. Local Secretary for Alberta. May 1904.
- 1839 **MacDonnell**, Adam John Pettigrew, B.A. *Cairns, North Queensland*. 2139. May 1901.
- 1840 **MacDowall**, Andrew. *Beaconsfield, Kircudbright, N.B.* Dep.Pr.G.M. Wigtown and Kircudbright, P.P.G.Sc.N., Berks and Bucks. March 1893.
- 1841 **Mace**, Albert E. *Chipping Norton, Oxfordshire*. 1036. March 1894.
- 1842 \***Macfarlane**, Duncan Arrol. *Moreno 351, Buenos Aires*. 617, 617. October 1905.
- 1843 **Macfarlane**, John, 313 *Campbell Street, Rockhampton, Queensland*. 677 (S.C.). January 1902.
- 1844 **MacGee**, Robert. 34 *South Castle Street, Liverpool*. 1675, P.M. May 1892.
- 1845 **Machin**, Harry. *Fircroft, Walton-on-Thames*. 231, P.M., 2489, P.Z. March 1901.

- 1846 **Machin**, Stanley. *Cleves, Oaklands, Weybridge, Surrey.* 231, P.M., 2489, P.Z. January 1906.
- 1847 **Mackay**, Daniel. P.O. Box 1101, *Johannesburg, Transvaal.* 712 (S.C.), 175, (S.C.), D.G.St.B. November 1904.
- 1848 **Mackay**, Wallace. 36 *High Street, Exeter.* 1254. June 1899.
- 1849 **Mackenzie**, Alexander F. 15 *Union Street, Inverness.* 339, P.M., 115, Z. Local Secretary for Inverness. November 1893.
- 1850 **Mackenzie**, Arthur Colin, M.D. *Inverness House, Mount Morgan, Queensland.* 763 (S.C.), P.M., 227 (S.C.). October 1900.
- 1851 **Mackenzie**, Major A. F. *Wanowrie, Poona, India.* 30 (S.C.). June 1905.
- 1852 **Mackenzie**, D. *Allahabad Bank, Lucknow, India.* 483, P.M. June 1905.
- 1853 **Mackway**, Sydney Frederick. *Bottling Stores, Linsey Street & St. James' Road, S.E., London.* 2310, P.M., 1216, P.Z. May 1901.
- 1854 **MacLeod**, George. 5 *George Terrace, Camelon, Falkirk, N.B.* P.Pr.G.W., 115, H. January 1895.
- 1855 **MacLeod**, James Morrison. 19-21 *Great Queen Street, W.C., London.* Secretary R.M.I.B. **Past Grand Sword Bearer.** November 1890.
- 1856 \***MacMillan**, Major Frederick Douglas. Box 3004, *Johannesburg, Transvaal.* **Past District Grand Master.** P.Z. November 1890.
- 1857 **MacNeill**, Percy Russell. 5 *Crossman Road, Kimberley, South Africa.* 1417. October 1894.
- 1858 **Macpherson-Grant**, John. *Milton Cottage, Kingussie, N.B.* Pr.Gr.Master, Inverness. **Senior Grand Warden, Scotland.** May 1894.
- 1859 **Maier**, S. 940 *St. James Street, City Road, E.C., London.* 2432. June 1906.
- 1860 **Main**, Alexander M. 6 *Kelvinside Gardens East, Glasgow.* 510 (S.C.), 296. November 1905.
- 1861 **Mair**, George John. 11 *Salthouse Road, Millom, Cumberland.* 1390, P.M. November 1904.
- 1862 **Mair**, John Bagrie. *Chief Constable's Office, Elgin, N.B.* 45, P.M., 263, Z. October 1905.
- 1863 **Makeham**, Henry William Payne, M.R.C.S., L.R.C.P., L.S.A. 330 *New Cross Road, S.E., London.* 1559, P.M., 1275, P.Z. October 1896.
- 1864 **Malcolm**, Alexander George. 16 *Crompton Avenue, Glasgow.* 754. November 1896.
- 1865 **Manfield**, Harry. *Moulton Grange, Northampton.* **Past Grand Treasurer.** May 1889.
- 1866 **Mangles**, William Waring. *Constitutional Club, Northumberland Avenue, W.C., London.* 811. June 1897.
- 1867 **Mann**, Edgar Montague. 7 *Clifton Hill, Exeter.* 39, 112. March 1892.
- 1868 **Manning**, William Clarence. *Hendon Asylum, Colindale Avenue, Hendon, N.W., London.* 2353. May 1904.
- 1869 **Mansbridge**, Josiah. 32 *Birchington Road, West Hampstead, N.W., London.* October 1901.
- 1870 **Mansell**, Edward Anson. 21 *Warrior Square, St. Leonard's-on-Sea.* 1842, S.W. October 1906.
- 1871 **Mansfield**, W. W. *Belle Vue House, Dean's Brook Lane, Edgware, Middlesex.* 1549, P.M., 1702, P.Z. May 1898.
- 1872 **Manton**, James Odom. *Dis. Superintendent, Midland Railway, 12 Oxford Street, Manchester.* P.Pr.J.G.W., P.Pr.G.Sc.N. March 1892.
- 1873 **Manuel**, Robert. 5 *Essex Court, Temple, E.C., London.* 1196, P.M., 1196, P.Z. October 1893.
- 1874 **Mapleton**, Cuthbert Walter. 29 *Schubert Road, Putney, S.W., London.* 256. June 1890.
- 1875 **March**, Arthur N. *West Bank, Oakwood Avenue, Shortlands, Kent.* 1321. May 1898.
- 1876 **Mardis**, Benjamin Allen, M.D. 713 *Market Street, San Francisco, U.S.A.* 87, P.M., 37. Nov. 1905.
- 1877 **Margerison**, James Bell. 47 *Shear Brow, Blackburn, Lancashire.* 345, P.M., Pr.G.A.D.C. May 1897.
- 1878 **Markham**, Christopher A., F.S.A. *The Garth, Dallington Avenue, Northampton.* P.P.G.W. May 1892.
- 1879 **Marks**, Morris. 39 *Holly Avenue, West Jesmond, Newcastle-on-Tyne.* 2557, P.M., 991, H. June 1903.
- 1880 **Marlow**, C. F. *Borrowell Cottage, Kenilworth.* 1551. A.Pr.G.P. May 1901.
- 1881 **Marples**, Robert Moffatt. 153 *Farringdon Road, E.C., London.* 754. June 1900.
- 1882 **Marr**, Robert. 29 *Corn Exchange Chambers, E.C., London.* 238. June 1896.
- 1883 **Marrian**, Charles J. 8 *Heathfield Park, Willesden Green, N.W., London.* 2489, P.M., 2489, P.Z. June 1895.
- 1884 **Marrison**, Oswald S. *Patterson Street, Launceston, Tasmania.* **Past Gr. Warden.** Jan. 1899.
- 1885 **Marriott**, Horace Bruce, Surg. R.N. *H.M.S. "Kent," Chinu Station.* 349. October 1903.
- 1886 **Marriott**, H. P. FitzGerald, F.R.G.S. c/o *H. S. King & Co., Pall Mall, S.W., London.* 5 (S.C.) 259 (S.C.). January 1897.
- 1887 **Marrs**, Henry John. *Casilla 148, G.P.O., Buenos Aires.* Dis.G.St.B., 2329. June 1901.
- 1888 **Marrs**, John H. 28 *Highland Street, Concord Junction, Massachusetts.* *Corinthian Lodge, P.M., Walden Chapter, P.H.P.* October 1898.
- 1889 **Marsh**, Joseph William. *Wallingford & Neville Streets, Pittsburgh, Pa., U.S.A.* 576, 257. January 1906.

- 1890 **Marshall**, Albert. *Griffiths Gold Mine, Coolgardie, West Australia.* 900 (S.C.). November 1903.
- 1891 **Marshall**, James. *24 Charing Cross, S.W., London.* 4, P.M., 50. March 1892.
- 1892 **Marshall**, Kenneth McLean. *Farrar's Buildings, Temple, E.C., London.* 1610. June 1906.
- 1893 **Marshallsay**, Henry George. *120 Victoria Road, Aldershot.* 723, P.M. March 1902.
- 1894 **Marsland**, Spencer. *Cooig, 10 Telford Avenue, Streatham Hill, London, S.W.* 19. October 1904.
- 1895 **Marson**, James Thomas. *Sandon Road, Stafford.* P.Pr.G., 726, P.P.G.N. November 1898.
- 1896 **Martin**, George. *19 Eltham Road, Lee, Kent.* 829, P.M., 2099, P.Z. October 1896.
- 1897 **Martin**, John. *Mornington Road, Woodford, Essex.* 1058. May 1899.
- 1898 **Martin**, Josiah. *Queen Street, Auckland, New Zealand.* 1338, P.M., P.Z., D.G.Reg. October 1904.
- 1899 **Martin**, Sir Richard Biddulph, M.A., M.P. *10 Hill Street, W., London.* **Senior Grand Deacon.** March 1902.
- 1900 **Martin**, William Thomas. *Station Villa, Comberton Road, Kidderminster.* 377, P.M., P.Pr.G.St.B. Worcester. June 1906.
- 1901 \***Marty**, Francis Charles. *Casilla Correo 32, Rosario de Santa Fé, Argentine Republic.* Pres.Dis.B.G.P., P.Dis.G.S.E. May 1898.
- 1902 **Mason**, Charles Letch. *40 Womersley Road, Crouch Hill, N., London.* P.Pr.G.W., P.Pr.G.H., W. Yorks. June 1887.
- 1903 **Massey**, Louis Conrad. *Orlando, Florida, U.S.A.* S.G.W., P.G.H.P. March 1898.
- 1904 **Masson**, Sir David Parkes, K.C.I.E. *Lahore, Punjab, E.I.* P.Dis.G.Treas., Punjab. June 1888.
- 1905 **Mathison**, James. *Box 5, Cleveland, Transvaal.* 570 (S.C.). March 1895.
- 1906 **Mathison**, Robert. *Westport Coal Co., Ltd., Wanganui, New Zealand.* 79 (N.Z.C.), W.M. June 1906.
- 1907 **Matier**, Charles Fitzgerald. *Mark Masons' Hall, Great Queen Street, W.C., London.* **Past Deputy Grand Director of Ceremonies.** P.G.S.W., Greece. June 1888.
- 1908 **Matthew**, John. *Box 92 Pretoria, Transvaal.* October 1896.
- 1909 **Matthews**, H. J. *2 Cumberland Terrace, Regent's Park, N.W., London.* 2509, P.M. Jan. 1899.
- 1910 **Matthews**, James Woodrow. *55, Bishopegate Street Within, E.C., London.* 23, P.M. June 1899.
- 1911 **Matthews**, T. *Gwynfa, Fishguard, Pembrokeshire.* 364. November 1905.
- 1912 **Matveieff**, Basil. *36 Victoria Road, Upper Norwood, S.E., London.* 176, P.M. May 1905.
- 1913 **Matzinger**, Captain Theodore. *21 Edith Road, West Kensington, S.W., London.* 174. May 1894.
- 1914 **Maughan**, T. *Eyan Street, Kalgoorlie, West Australia.* Dep.Dis.G.M., 279, Z. October 1902.
- 1915 **Maunsell**, Lieut.-Col. G. W. *1st Royal West Kent Regiment, Malta.* P.D.G.D., Bengal. Nov. 1897.
- 1916 **Maurice**, William. *Hucknall Torkard Notts.* 2583. January 1905.
- 1917 \***Maxwell**, John M. *1432 Gaylord Street, Denver, Colorado, U.S.A.* **Past Grand Master, Colorado.** May 1890.
- 1918 **May**, Dr. Charles Montague Neale. *Dutoitspan Road, Kimberley, South Africa.* 1574. March 1905.
- 1919 **Maye**, William Bennett. *Abham, Buckfastleigh, Devon.* P.Pr.G.D.C., P.Pr.G.Std.B. (R.A.), Jan. 1889.
- 1920 **Mayell**, Alfred Young. *76 Westbourne Grove, W. London.* 2416. January 1904.
- 1921 **Mayell**, Herbert Young. *37-38 Gutter Lane, E.C., London.* 227. January 1904.
- 1922 **Mayers**, John. *Bold Square, Chester.* P.Pr.G.Sup.W., P.P.G.St.B. March 1905.
- 1923 **Mayers**, William Henry Johnson. *Cairns, North Queensland.* P.D.G.D., D.G.So. January 1904.
- 1924 **Mayhall**, John. *Wood Lea, Horsforth, Leeds.* 304. October 1905.
- 1925 **Maylor**, William, jun., A.M.I.C.E. *The Grange, Hanley Castle, Worcesters.* 1125, P.M., P.D.G.D.C., Madras. June 1904.
- 1926 **Maynard**, John M. *8 Empress Avenue, Cranbrook Park, Ilford, Essex.* 2795, W.M. May 1903.
- 1927 **McAllaster**, Ralph Clapp. *113-117 Third Avenue South, Seattle, Washington, U.S.A.* **Junior Grand Warden.** 19. June 1904.
- 1928 **McCaw**, J. Dysart, M.D., F.R.C.S. *St. Levan, Wallington, Surrey.* 211 (I.C.). May 1897.
- 1929 **McCullagh**, John Charles. *Abbey House, Waterford.* 935, 935. May 1904.
- 1930 **McDowall**, Alexander. *Umtali, Rhodesia.* 2878. October 1901.
- 1931 **McDowall**, G. A. *Jesmond, Plaistow, Essex.* 2291. January 1892.
- 1932 **McGrath**, Edward Henry, M.A. *170 St. James' Road, Croydon, Surrey.* 2769. November 1904.
- 1933 **McGregor**, Austen H. *850 Broad Street, Newark, New Jersey, U.S.A.* 51, P.M. **Senior Grand Warden.** March 1906.
- 1934 \***McIntyre**, Alexander Gordon. *Kokstad, East Griqualand.* 2299. October 1903.
- 1935 **McLaren**, Joseph Henry. *Box 1178, Johannesburg, Transvaal.* 31 (W.A.C.). May 1901.
- 1936 **McLean**, William. *Ardgour Church Street, Middle Brighton, Victoria.* 57, P.M., 17. **Past President Board of General Purposes.** May 1901.
- 1937 **McLees**, J. P. *Box 114, Middleburg, Transvaal.* 573 (S.C.). January 1905.

- 1938 **McMahon**, Colonel Arthur Henry, C.S.I., C.I.E. *Quetta, Baluchistan*. May 1902.
- 1939 **McMiken**, Samuel Douglas. *Komata, Upper Thames, New Zealand*. 107, S.W. 17, So.N. January 1906.
- 1940 **McMillan**, Ernest Alexander. *Sladen's Gardens, Chetput, Madras*. 1198, 1198. March 1906.
- 1941 **McMurray**, Frederick Thomas. *Glencairn, Willis Road, Cambridge*. 2727, 88. March 1901.
- 1942 **McNeill**, Bedford. 29 *North Villas, Camden Square, N.W., London*. 2127. October 1903.
- 1943 **Mead**, Arthur Charles. 9 *Cheyne Gardens, Chelsea, S.W., London*. 1420, P.M. March 1900.
- 1944 **Mead**, William Rayment. 33 *Wellington Square, Chelsea, S.W., London*. 1420, 1694. March 1902.
- 1945 **Meade**, Francis Marshall. *Hill Side, Langport, Somerset*. 2038, 329. March 1902.
- 1946 **Meek**, J. M. 6 *Nelson Terrace, Coatham, Redcar, Yorks*. P.Pr.G.B., Durham. October 1898.
- 1947 \***Mehta**, Roostumjee Dhunjeebhoy, J.P., C.I.E. 55 *Canning Street, Calcutta*. P.Dis.G.D. June 1891.
- 1948 \***Melke**, John. *Umtali, Rhodesia*. 2678, P.M., 2566. November 1900.
- 1949 **Mella**, Frederick. 36 *Aynhoe Road, Brook Green, W., London*. Lodge Zam Stillen Temple. October 1902.
- 1950 **Mendelssohn**, Max. 244 *Camden Road, N.W., London*. 212, 1839. January 1889.
- 1951 **Mendelssohn**, Sidney. 21 *Kensington Court Gardens, W., London*. 1409, P.M. January 1889.
- 1952 **Menerey**, Samuel John. *East State School, Toowoomba, Queensland*. 901 (S.C.). June 1903.
- 1953 **Mercer**, Harry. 13 *Hartington Road, Ealing, W., London*. 382, P.M. November 1902.
- 1954 **Mercer**, Harry West. Box 6, *Barberton, Transvaal*. 747 (S.C.), P.M. October 1898.
- 1955 **Mercer**, William Hill. *Victoria Street, Auckland, New Zealand*. 87. January 1904.
- 1956 **Meredith**, Sir James Creed, LL.D. *Clonevin, Pembroke Road, Dublin*. **Deputy Grand Master, Ireland**. March 1898.
- 1957 **Merrick**, Rev. George Purnell, M.A., M.B. 110 *Belgrave Road, S.W., London*. P.Pr.G.Chap., Surrey. June 1891.
- 1958 **Merrick**, Robert Warren, M.D. *The Cliddesden Road, Basingstoke*. 694. March 1906.
- 1959 **Mertens**, Constant. *Glenelg, Enfield, N., London*. 2686. May 1904.
- 1960 **Metcalfe**, William. *Mount Pleasant, Cheshunt, Herts*. **Past Grand Standard Bearer, Past Assistant Grand Director of Ceremonies (R.A.)**. Nov. 1900.
- 1961 **Meyer**, Robert. 13 *University Square, Belfast*. 243, P.M. 36. March 1906.
- 1962 **Meymott**, Sydney. *L. & S. W. Bank, Broadway, Ealing, W., London*. 847. November 1901.
- 1963 **Michael**, Dr. Gustave. 188 *Commercial Road, E., London*. 185. March 1901.
- 1964 **Michell**, Theo. *Windsor Lodge, Taunton, Somerset*. 260, P.M., P.D.O.S.Wks. November 1903.
- 1965 **Milburn**, Robert. 84 *Brae Side Street, Glasgow*. 87 (S.C.), P.M., 87. March 1900.
- 1966 **Mildren**, W. L. *Bleak House, Dalton-in-Furness*. 1398, P.M. May 1905.
- 1967 **Miles**, Charles George. *Grahamstown, Cape of Good Hope*. 711. Local Secretary for South Africa, E.Div. March 1888.
- 1968 **Millar**, George W. 64 *Duane Street, New York*. 271, P.M., 241. May 1897.
- 1969 **Miller**, Harry Risch. 9 *Great St. Helen's, E.C., London*. 58. June 1899.
- 1970 \***Miller**, James Cram. Box 109, *Cape Town*. 654 (S.C.), 291 (S.C.). January 1904.
- 1971 **Miller**, John. *Quinta San Juan, Quilmes, Buenos Aires*. P.D.G.B., D.A.G.So. January 1901.
- 1972 **Miller**, T. L. *Eyre Cottage, Jews' Walk, Sydenham, S.E., London*. 2105. January 1897.
- 1973 **Miller**, William. 54 *Cottage Grove, Portsmouth*. P.P.D.G.D.C., P.P.A.G.D.C., Hants. March 1904.
- 1974 **Millington**, James. *Station Road, Horsforth, near Leeds*. P.P.G.D.C. (Craft and R.A.), W.Yorks. May 1893.
- 1975 **Mills**, Tom. *Union Hall, Chester*. 721. October 1905.
- 1976 **Millward**, Alfred A. 6 *St. George's Terrace, Primrose Hill, N.W., London*. 2168. May 1903.
- 1977 **Milne**, John Taylor. *Bridge Inn, Tarvin Road, Chester*. 667, W.M., 721. May 1905.
- 1978 **Milton**, John Harold, 9 *Staple Inn, W.C., London*. 5511, P.M., 174. May 1897.
- 1979 **Minhurst**, William. 20 *Percival Street, Goswell Road, E.C., London*. 2589. January 1906.
- 1980 **Mitchell**, Albert George. *Public School, Corrimal, New South Wales*. 204, P.M. June 1900.
- 1981 **Mitchell**, Frederick William. *Glenroy, Purley, Surrey*. 1013. January 1896.
- 1982 **Mitchell**, William Taylor. *Armenian Street, Georgetown, Madras*. Pres.B.G.P. October 1894.
- 1983 **Mitchell**, Wilmot Wadsworth. *Medfield, Norfolk Co., Mass., U.S.A*. Meridian L., P.M., Putman C. March 1900.
- 1984 **Moar**, John Ingram, 6 *Moor Street, W., London*. 813, P.M. March 1898.
- 1985 **Mogren**, Adolf Joseph Wilhelm Mauritz. 88 *Thornhill Road, Handsworth, Staffords*. 2878, 482. January 1905.
- 1986 **Mold**, Charles John. 69 *Carter Street, Walworth, S.E., London*. 1381, P.M. October 1906.

- 1987 **Mold**, Charles Trevor. 760 *Calle Cuyo*, Buenos Aires. **District Grand Master, Past Grand Scribe, N., England, Grand Superintendent.** Local Secretary for Argentine Republic. June 1894.
- 1988 **Mold**, Reginald. 682 *Bartolomé Mitre*, Buenos Aires. **Past District Senior Grand Warden, District Grand Principal.** June 1901.
- 1989 **Molesworth**, Rev. Hugh Thomas. *Allora*, Queensland. P.Pr.G.W. (I.C.). October 1899.
- 1990 **Moll**, Clare D. *St. Peter*, Minnesota, U.S.A. 54. May 1906.
- 1991 **Molloy**, Eustace Harper. *District Supt. of Police, Kyankpyn, Burma.* 1095, P.M. May 1903.
- 1992 **Molloy**, Harry J. *Chickmaghir, India.* P.D.G.Sup.W., Madras. May 1898.
- 1993 **Moncrieff**, James jun. *Carterton, Wairarapa, New Zealand.* **Grand Director of Ceremonies, 10, Z.** November 1903.
- 1994 **Monk**, Albert. 21 *Church Street, Lower Edmonton, N., London.* 1237, P.M. June 1906.
- 1995 **Montague**, John Henry. 101 *New Bond Street, W., London.* 2030, P.M. October 1896.
- 1996 **Monteith**, H. Campin. *Ipswich, Suffolk.* P.Pr.G.W. June 1898.
- 1997 **Monteith**, John. *Low Hall, Horsforth, Leeds.* 1311. January 1905.
- 1998 **Monteith**, Robert. *State School, St. George, Queensland.* 775 (S.C.). October 1894.
- 1999 **Montesole**, E. W. *c/o King, King & Co., Bombay.* 2735, 64 (S.C.). June 1903.
- 2000 **Montesole**, Max. *Authors' Club, 3 Whitehall Court, S.W., London.* 1766. June 1901.
- 2001 **Montgomery**, Thomas. *St. Paul, Minnesota, U.S.A.* **Grand Secretary.** May 1893.
- 2002 **Moers**, Edwin. *Kingston, Ontario, Canada.* 70, 20. March 1896.
- 2003 **Moon**, Sir Francis S. Graham. *Junior United Service Club, St. James', S.W., London.* 2094, P.M. June 1905.
- 2004 **Moor**, John Charlton. 28 *Asalea Terrace, Sunderland.* **Past Grand Standard Bearer, Pr.G.Sec., Durham. Past Grand Assistant Director of Ceremonies (R.A.)** November 1904.
- 2005 **Moore**, Lieut.-Colonel Sir George Montgomery John, R.A., C.I.E. *Madras.* **District Grand Master, District Grand Superintendent, Madras.** May 1893.
- 2006 **Moorhouse**, Benjamin Michael, M.D. *Christchurch, New Zealand.* 2627, P.M. June 1900.
- 2007 **Moors**, Henry. 498 *Punt Hill, South Yarra, Victoria.* **Past Grand Deacon. 1, P.Z.** Oct. 1892.
- 2008 **Morant**, W. 165 *Fentiman Road, Clapham, S.W., London.* 1624. March 1902.
- 2009 **Mordaunt**, Francis George. 1a *St. Helen's Place, E.C., London.* 190, W.M. May 1905.
- 2010 **Moreno**, Alberto Arturo. Box 508, *San José, Costa Rica.* 3. October 1904.
- 2011 **Morgan**, Charles Thomas. 43 *Cannon Street, E.C., London.* 1818. January 1906.
- 2012 **Morgan**, John. 112 *High Street, Merthyr Tydfil, South Wales.* 110, P.M., 110, P.Z., P.Pr.S.G.D. June 1906.
- 2013 **Morgan**, Rollin M. 38 *Park Row, New York City, U.S.A.* 454, P.M., 8, P.H.P. **Past Grand High Priest. Past Grand Steward. Grand Representative Grand Lodge of Scotland.** March 1906.
- 2014 **Morgan**, T. Westlake. *Bangor, North Wales.* **Past Grand Organist (Craft and R.A.)** March 1901.
- 2015 **Morison**, Douglas Stuart. *c/o Messrs. Cubar, Palmer & Co., Madras.* 150, J.W., 150, P.S. January 1906.
- 2016 **Morland**, Charles Henry Duncan, M.B., F.R.C.S. *Swatow, China.* 945. January 1902.
- 2017 **Morland**, John Thornhill. *Bath Street, Abingdon, Berks.* **Provincial Grand Master.** June 1896.
- 2018 **Morren**, Peter McL. Box 507 *Pretoria, Transvaal.* 231. January 1906.
- 2019 **Morris**, John Jones. 24 *Lombard Street, Portmadoc, North Wales.* P.Pr.G.Reg. May 1894.
- 2020 **Morris**, Spencer William. 48 *Christchurch Road, Streatham, S.W., London.* **Past Assistant Grand Director of Ceremonies, Past Grand Standard Bearer.** Jan. 1894.
- 2021 **Morrish**, Samuel William Furze, M.I.N.A. 6 *The Terrace, Keyham, Devonport.* 1593, W.M. March 1898.
- 2022 **Morsbach**, Walter. *Calle Libertad 730, Rosario de Santa Fé, Argentine Republic.* 1553, 1553, H. January 1903.
- 2023 **Mortimer**, Cyril Hugh, Lieut., R.G.A. *Dover.* 2195. January 1905.
- 2024 **Morton**, Francis William Watson. 39 *Brunswick Street, Fitzroy, Victoria.* **Past Grand Warden.** June 1896.
- 2025 **Mosely**, Edward Lewin. P.O. Box 1774, *Johannesburg, Transvaal.* 2748, 2313. October 1903.
- 2026 **Moss**, Bernard. Box 55, *Krugersdorp, Transvaal.* 74 (D.C.). June 1905.
- 2027 **Moss**, William Edward. 7 *Rumford Street, Liverpool.* 357. March 1899.

- 2028 **Mouider**, Victor J., F.R.Hist.S. 7 *Lower Downs Road, Wimbledon, S.W., London.* 2694. March 1900.
- 2029 **Moulder**, Warwick James. 143 *Allison Road, Harringay, N., London.* 1866. January 1901.
- 2030 **Moutray**, Rev. John Maxwell, LL.D. *Richmount Glebe, Ballygawley, Tyrone.* P.G.Ch. March 1895.
- 2031 **Moyle**, J. Copley. *Moulmein, Burma.* **District Grand Master, Grand Superintendent.** March 1893.
- 2032 **Mudie**, David Robertson. *Mossel Bay, Cape Colony.* 1938, P.M. October 1903.
- 2033 **Mugford**, Sidney Arthur, M.R.C.S., L.R.C.P. 135 *Kennington Park Road, S.E., London.* 276, P.M., J. January 1901.
- 2034 **Muggeridge**, Richard William. *The Brewery, Park Street, Southwark, S.E., London.* 1704, P.M. P.Z. March 1894.
- 2035 **Muir**, Robert Home. 1 *Lovaine Crescent, Newcastle-on-Tyne.* 9 (S.C.), 53. October 1906.
- 2036 **Mulchahey**, Edward Irving. 108 *Narragausett Avenue, Providence, Rhode Island, U.S.A.* **Grand Lecturer.** 21, P.M., 1. November 1902.
- 2037 **Muller**, Arthur. *Pizham Mill House, Dorking.* 2347. October 1905.
- 2038 **Müller**, R. 121 *Oxford Street, W., London.* 238. March 1902.
- 2039 **Mulliner**, A. F. *Dallington, Northampton.* 2380, P.M. November 1904.
- 2040 **Mullins**, Arthur Ernest. 48 *Peckham Road, S.E., London.* 1446, P.M., 720, P.Z. March 1893.
- 2041 **Munro**, John. 12 *Newton Terrace, Hebburn-on-Tyne, Durham.* P.P.G.D., 1119, P.Z. Oct. 1905.
- 2042 **Murison**, John. 6 *Wartlersville Road, Crouch Hill, N., London.* 2168. March 1906.
- 2043 **Murphy**, Major J. J. 32 *Bartholomew Road, Kentish Town, London, N.W.* 913, P.M. June 1900.
- 2044 **Murphy**, J. Keogh, M.D., F.R.C.S. 16 *Pembridges Crescent, W., London.* 2885, W.M. Jan. 1904.
- 2045 **Murray**, Alfred Alexander, LL.B., W.S., F.R.S.E. 20 *Warriston Crescent, Edinburgh.* 2, P.M. **First Grand Depute Principal, Representative Grand Lodge of Norway.** March 1898.
- 2046 **Murray**, Donald. P.O. Box 4, *Boulder City, West Australia.* 902 (S.C.). January 1902.
- 2047 **Murray**, Dr. J. *Spean House, Abbey Road, Barrow-in-Furness.* 1021, P.M., P.P.G.D. May 1905.
- 2048 **Murray**, James. 246 *Whitehill Street, Denistoun, Glasgow.* 437, P.M., 50, P.Z., Pr.G.Treas., Glasgow. March 1894.
- 2049 **Murray**, James Darling. *Mount Morgan, Queensland.* 763 (S.C.), 227 (S.C.). Local Secretary for Mount Morgan. October 1900.
- 2050 **Murray**, John. *Doric Lodge, Wickford Road, Westcliff-on-Sea.* 2589. January 1906.
- 2051 **Murray**, Joseph. *Colombo Road, South Christchurch, New Zealand,* 4 (N.Z.C.). January 1903.
- 2052 **Murrow**, Baron. *Highbury House, St. Leonards.* 2189. March 1889.
- 2053 **Myers**, Gabriel. *Ficksburg, Orange River Colony.* Lodge Star of the Border (D.C.). Oct. 1895.
- 2054 **Nadel**, Naley. *Mount Road, Madras.* P.D.A.G.Sec., 1198. March 1897.
- 2055 **Nagel**, Sigmund. *Operngasse 6, Vienna I.* January 1902.
- 2056 \***Nairne**, Perceval Alleyn. 3 *Crosby Square, E.C., London.* **Past Grand Deacon.** March 1898.
- 2057 **Nalder**, Francis Henry. 104 *Gleneldon Road, Streatham, S.W., London.* 1556, 96. January 1906.
- 2058 **Naoroji**, Dadabhai. 22 *Kennington Road, North Lambeth, S.E., London.* 1159, P.M. January 1895.
- 2059 **Napper**, Sidney. 9 *Fenchurch Street, E.C., London.* 1471, P.M. March 1898.
- 2060 **Nead**, Daniel Wunderlich, M.D. 3222 *Spencer Terrace, Philadelphia, U.S.A.* 631, P.M., P.H.P. May 1905.
- 2061 **Neighbour**, George. 102 *Evington Road, Leicester.* 523, P.M., P.P.S.G.W. October 1903.
- 2062 **Nellis**, Luther McAfee. 314 *West Fifth Street, Topeka, Kansas, U.S.A.* 17, P.M., 5. Jan. 1904.
- 2063 **Nelthorpe**, Alfred Edwin. 20 *Holborn, E.C., London.* 2589. January 1906.
- 2064 **Nelthorpe**, Herbert Charles. 20 *Holborn, E.C., London.* 1549, 65. January 1905.
- 2065 **Neser**, Cecil Vintcent. Box 15 *Middleburg, Transvaal.* 794 (S.C.), J.D. October 1906.
- 2066 **Nethersole**, Major Alfred Ralph, I.S.C. *Bangalore, Madras.* 150, 150. March 1897.
- 2067 **Neuburger**, Frederick William. *The Elms, Halton, Feltham, Middlesex.* 1425. January 1906.
- 2068 **Newby**, Timothy. *Horsforth, Leeds.* 1042, P.M. January 1906.
- 2069 **Newby**, William George. *Bean Street, Kimberley, South Africa.* 1409. October 1905.
- 2070 **Newland**, Henry. 44 *Great Sutton Street, E.C., London.* 2925, W.M. October 1905.
- 2071 **Newlands**, C. W. *Law Court Chambers, W. Keppel Street, South Shields.* 1643, P.M., 1119, P.Z. October 1905.
- 2072 **Newman**, Alfred. Box 23, *Pretoria, Transvaal.* 770 (S.C.), P.M., 231, (S.C.), P.Z. October 1896.
- 2073 \***Newman**, Henry Field. 2 *Bedford Street, Basford, Stoke-on-Trent, Staffs.* 117. October 1888.

- 2074 **Newman**, Rev. W. J. Hermann. *East Dean Vicarage, Chichester*. 175. March 1902.
- 2075 **Newport**, Howard Oliver. *Kamerunga, Cairns, North Queensland*. 2139, P.M., 2139, H. Oct. 1904.
- 2076 **Newstead**, Robert. *Grosvenor Museum, Chester*. 721. March 1905.
- 2077 **Newstead**, W. J. 117 *Fawnbrake Avenue, Herne Hill, S.E., London*. 1973, P.M. Nov. 1899.
- 2078 **Newton**, James. 23 *Silverwell Street, Bolton, Lancashire*. P.G.Sec., P.G.Sc.E., East Lancashire.  
**Past Grand Sword Bearer**. February 1887.
- 2079 **Newton**, John. *Wolstanton, Staffords*. 451, P.M. May 1902.
- 2080 **Newton**, William John. *Brightside, Heswall, Cheshire*. 1289, 537. June 1898.
- 2081 **Nicholl**, Allan Hume. *St. Hilda's, Laurie Park, Sydenham, S.E., London*. 2744, P.M. June 1900.
- 2082 **Nicholls**, George H. 41 *Stanley Street, Southsea*. 2068, P.M. October 1904.
- 2083 **Nicholls**, Harry. *Rupert Cottage, Bedford Park, W., London*. **Past Grand Standard Bearer, Past Deputy Grand Director of Ceremonies (R.A.)**. November 1903.
- 2084 **Nichols**, H. Bertram. 51 *Palace Road, Streatham Hill, S.W., London*. 1180, P.M., 1016, P.Z. May 1898.
- 2085 **Nicholson**, Alexander Charles. 12 *Salop Road, Oswestry, Salop*. 1432, P.M., P.P.G.Sup.W. October 1905.
- 2086 **Nicholson**, Harry. 12 *Church Lane, Charlton*. 700. October 1906.
- 2087 **Nickel**, Dr. August Ferdinand Alexander. *Perleberg, Germany*. Loge zur Perle. October 1895.
- 2088 **Nicklin**, John Bailey. *Chattanooga, Tennessee, U.S.A.* P.M. March 1892.
- 2089 **Nickolls**, J. B. *Royal Societies Club, St. James' Street, S.W., London*, 168, P.M. October 1901.
- 2090 **Nicol**, John Coulson. *Elmdon Lodge, Acocks Green, Birmingham*. 74, P.M. June 1899.
- 2091 **Nieuwoudt**, Gerrit, M.B., M.R.C.S. *Darling, Malmesbury, Cape Colony*. St.Jan.(D.C.), 56 (S.C.) October 1901.
- 2092 **Nixon**, Dr. Edward John. Box 57, *Heidelberg, Transvaal*. 2354, P.M. May 1898.
- 2093 **Nixon**, John Clarke. *West Riding Asylum, Menston, Leeds*. 1522. October 1899.
- 2094 **Noakes**, H. W. *Beechwood, Jarvis Brook, Crowborough, Sussex*. 108, P.M., 749, P.Z. May 1892.
- 2095 **Noakes**, J. Norman. *The Brewery, Bermondsey, S.E., London*. 92, P.M., 92, P.Z. March 1901.
- 2096 **Noakes**, Wickham. *Selsdon Park, Croydon, Surrey*. 92, P.M., 92, P.Z. March 1902.
- 2097 **Nock**, George Arthur. *National Provincial Bank of England, Hull*. 1896. January 1889.
- 2098 **Nock**, Guy Henry. *Ashdown, Wellington, Salop*. 395. May 1901.
- 2099 **Noehmer**, C. W. 3 *Havelock Road, Croydon, Surrey*. 186, P.M. January 1895.
- 2100 **Noel**, A. 100 *Highbury Hill, N., London*. 1839. June 1906.
- 2101 **Norfolk**, Thomas. 77 *Athol Road, Bradford*. 600. January 1906.
- 2102 **Norman**, Edwin Arthur. 2 *Fieldsway House, Highbury, N., London*. 1767. January 1906.
- 2103 **Norman**, George. 12 *Brock Street, Bath*. 41, P.M., 41, P.J.G.W., Somerset. November 1895.
- 2104 **Northall-Laurie**, Dudley. 15 *Ladbroke Gardens, W., London*. 1159, 3156. October 1906.
- 2105 **Northcroft**, Henry. *Swansfield Lodge, Stone, Kent*. 46, P.M., 1305, H. May 1904.
- 2106 **Northwood**, William. 56 *Rideau Street, Ottawa, Canada*. P.M. May 1905.
- 2107 **\*Norton**, Eardley. *Dunmore, Teynampet, Madras*. 1189, P.M. November 1895.
- 2108 **Norton**, James Stephen. 8 *Broad Street, Hereford*. P.Pr.G.D. March 1900.
- 2109 **Notcutt**, Ernest Toller Mursell. Box 552, *Cape Town*. P.D.D.G.M., S.Africa, W.Div. June 1903.
- 2110 **Nunn**, Richard Joseph, M.D. 5 *York Street, Savannah, Georgia, U.S.A.* 15, P.M., 3, P.K. Nov. 1889.
- 2111 **Nuttall**, John Robert. 13 *Thornfield, Lancaster*. 1051, P.M., P.Z. Local Secretary for North Lancashire. May 1899.
- 2112 **Odell**, J. W. *Grove Farm, Stanmore, Middlesex*. 1549. March 1902.
- 2113 **O'Donnell**, Francis. 2728 *Hillegass Avenue, Berkeley, California, U.S.A.* P.M., P.H.P. Oct. 1900.
- 2114 **O'Duffy**, John. 54 *Rutland Square, Dublin*. 249, P.M., 93, K. January 1899.
- 2115 **Oehley**, Oliver Charles. *Somerset East, Cape Colony*. 1585. October 1897.
- 2116 **Oetzmann**, Charles H. *Brighton Road, Surbiton, Surrey*. 2146. March 1898.
- 2117 **O'Halloran**, George Michael. *Northam, West Australia*. 10 (W.A.C.). October 1902.
- 2118 **O'Hara**, James. 18 *Cope Street, Dublin*. LIII., XI. May 1904.
- 2119 **Ohlsson**, P. c/o A. W. Ware, *Kookynie, West Australia*. 932 (S.C.), P.M., 284 (S.C.), P.Z. November 1904.
- 2120 **Öien**, Bertram. *Trondhjem, Norway*. June 1902.
- 2121 **Oldroyd**, Henry J. 51 *Louis Street, Hull*. 57, P.M., Pr.G.S.D. March 1906.
- 2122 **Oliver**, Andrew. 5 *Queen's Gardens, Lancaster Gate, W., London*. 263, 2416. May 1900.
- 2123 **Oliver**, Rev. Henry Francis. *Leslie Lodge, Worthing*. 2086, P.M., P.P.G.Chap. May 1903.



- 2124 **Oliver**, H. St. John. *Junior Carlton Club, Pall Mall, S.W., London.* 143, P.M. October 1906.
- 2125 **Olsen**, Bernhard. *Olsen, Jahrmann & Co., Christiania.* Lodge St. Olave til den hvide Leopold. October 1906.
- 2126 **Oram**, William Adams. *Hong Kong & Shanghai Bank, Bombay.* P.Dis.G.D., Japan. May 1897.
- 2127 **Orlady**, George Boal. *Huntingdon, Pennsylvania, U.S.A.* **Junior Grand Warden.** 201, P.H.P. October 1905.
- 2128 **Ormsbee**, James Jackson. *c/o El Paso Smelting Works, El Paso, Texas, U.S.A.* 505, P.M., 157. October 1906.
- 2129 **O'Rorke**, William Joseph. *22 Lister Gate, Nottingham.* P.Pr.A.G.D.C. Local Secretary for Nottingham. January 1898.
- 2130 **Orttewell**, Richard. *Malden, Essex.* 1024, P.M., 1224. November 1894.
- 2131 **Osborne**, Edmund Arthur. *San José, Costa Rica.* **Grand Secretary, Representative Grand Lodge, Montana.** November 1901.
- 2132 **Osler**, Thomas Andrew. *Salisbury, Rhodesia.* 2479. May 1905.
- 2133 **Osman**, Constant Edward. *132 Commercial Road, E., London.* 2469, P.M. November 1898.
- 2134 **Overbeck**, H. E. *London.* 216, P.M. May 1898.
- 2135 **Overton**, Frank. *12 Rectory Road, Beckenham, Kent.* 1556. January 1906.
- 2136 **Owen**, F. W. *168 High Street, Stoke Newington, N., London.* 1981. March 1904.
- 2137 **Owen**, S. Walshe, L.R.C.P. *10 Shepherd's Bush Road, W., London.* 901, 201. October 1898.
- 2138 **Owen**, Walter Thomas, A.C.A., F.R.G.S. *95 Colmore Row, Birmingham.* 925, 1016. Jan. 1903.
- 2139 **Oxford**, Matthew Fletcher. *6 Darlaston Road, Wimbledon, S.W., London.* 1820, W.M. January 1906.
- 2140 **Oxland**, Rev. John Oxley. *Hill Crests, Gillets, Pine Town, Natal.* **District Grand Chaplain.** May 1888.
- 2141 **Packer**, Henry John. *Asylum, Toowoomba, Queensland.* 775 (S.C.), P.M., 194 (S.C.), P.Z. October 1894.
- 2142 **Page**, Alfred. *19 & 21 Fowler Street, South Shields.* 2520, P.M., 240, Sc.N. May 1895.
- 2143 **Page**, Alfred. *25 King Street, Cheapside, E.C., London.* 79, P.M. March 1899.
- 2144 **Page**, W. S. *Roding House, Woodford Bridge, Essex.* 186, P.M., P.P.G.Sup.W. October 1894.
- 2145 **Page**, W. T. *Lynthorpe, Bromyard Road, Worcester.* **Past Assistant Grand Director of Ceremonies, Past Grand Standard Bearer.** Dep.Pr.G.M. October 1896.
- 2146 **Paine**, Charles C. *Hillfield, Haverstock Hill, N.W., London.* 2242, P.M. January 1900.
- 2147 **Painter**, Edwin Richard. *St. Stephen's Chambers, Telegraph Street, E.C., London.* 766. May 1898.
- 2148 **Pakes**, John James. *2 Cedar Road, Teddington.* 871, P.M., 140, P.Z. January 1890.
- 2149 **Palmer**, Frank T. *12 Montpellier Avenue, Cheltenham.* 246, P.M. January 1901.
- 2150 **Palmer**, Henry. *Manor House, Medomsley, Co. Durham.* P.Pr.G.D., P.Pr.A.So. June 1899.
- 2151 **Palmer**, Rev. James Nelson. *Bembridge, near Ryde, Isle of Wight.* **Past Grand Chaplain and Past Grand Sojourner, England.** November 1888.
- 2152 \***Palmer-Thomas**, R. *5 Horbury Crescent, Notting Hill Gate, W., London.* 1929, P.M., P.Z. June 1891.
- 2153 **Papenfus**, Herbert B. *Box 1032, Johannesburg, Transvaal.* Star of the Rand Lodge. Oct. 1891.
- 2154 **Papworth**, Oliver. *9 St. Andrew's Hill, Cambridge.* P.Pr.G.Sec., P.Pr.G.H. June 1894.
- 2155 **Paramore**, David Lewis. *Snohomish, Washington, U.S.A.* **Past Grand High Priest.** October 1893.
- 2156 **Park**, Henry J. *Northgate, Darlington.* 111. June 1905.
- 2157 **Parker**, Frederick H., Judge, M.A., B.L., F.R.G.S. *Nikosia, Cyprus.* 2277, P.M., 2402, P.Z. Local Secretary for Cyprus. November 1902.
- 2158 **Parker**, George Philip. *3 Ormonde Terrace, N.W., London.* **Assistant Grand Director of Ceremonies.** June 1898.
- 2159 **Parker**, Gerald Longley. *The Paddocks, Eccleston, Cheshire.* 6 (W.A.C.), P.M., 2566. March 1899.
- 2160 **Parkinson**, Thomas James. *Argus Printing Co., Tudor Street, E.C., London.* 2528. May 1901.
- 2161 **Parolini**, Antonio. *66 St. John's Street, E.C., London.* 2687. June 1902.
- 2162 \***Parry**, Edward Hallmark. *Castle Lodge, Duffield, Derby.* 482, 482. January 1905.
- 2163 **Parry**, Edwin. *Maycroft, Russell Road, Kidderminster.* 377, P.Pr.G.Reg., Worcestershire. June 1906.
- 2164 **Parson**, Charles H. *Golden, British Columbia, Canada.* 11. May 1904.
- 2165 **Parsons**, James. *346 South Lambeth Road, S.E., London.* 1446, 720. January 1905.
- 2166 **Partridge**, Samuel Steads. *91 De Montfort Square, Leicester.* **Past Assistant Grand Director of Ceremonies, Past Grand Sword Bearer (R.A.).** January 1889.

- 2167 **Pastfield**, John Robinson. *Princes Street South, St. Thomas, Ezeter.* 2659, W.M. March 1897.
- 2168 **Paton**, Peter. Box 126, *Cape Town.* 398 (S.C.), W.M. June 1905.
- 2169 \***Pattani**, Prabhshankar Dalpatram. *Dewan, Bhavnagar, India.* 2787. October 1904.
- 2170 **Patterson**, Dr. John N. *Lismore House, Earlestown, Lancashire.* P.Pr.D.G.D.C. March 1901
- 2171 **Patterson**, J. W. 14 *Mitchell Street, West Hartlepool.* 2462. January 1903.
- 2172 **Pavitt**, G. W. 14 *Barking Road, Canning Town, E., London.* 860. May 1898.
- 2173 **Pavone**, J. C. 265 *Regent Street, W., London.* 2687, S.W. May 1906.
- 2174 **Pawsey**, W. J. *Northwoods, Bridgemary, near Fareham, Hants.* 2153, P.M. May 1900.
- 2175 **Payne**, Garrett. 6 *Homefield Road, Chiswick.* 871. October 1904.
- 2176 \***Paynter**, Henry Harold. *Coolgardie, Western Australia.* 900 (S.C.), P.M., 287 (S.C.), P.Z. Nov. 1902.
- 2177 **Pearce**, Christopher. 73 *Commercial Road, Bournemouth.* P.P.G.A.D.C., Hants. and Isle of Wight (C. & R.A.). Local Secretary for Bournemouth. March 1901.
- 2178 **Pearce**, Gilbert P. *The Beeches, Hayle, Cornwall,* P.Pr.G.W., Cornwall. Librarian of Coombe Masonic Library, Hayle. March 1887.
- 2179 **Pearce**, Herbert George. *Penhalonga, Umtali, Rhodesia* 2678. November 1900.
- 2180 **Pearce**, John. 58 *Hardman Street, Manchester.* 1458. October 1905.
- 2181 **Pearce**, Percy J. Trevarthian. 3 *Thornville Villas, Mannamead, Plymouth.* 2727, J.W. May 1906.
- 2182 **Pearson**, Ernest A. *Eton, Mackay, Queensland.* 2624, P.M. November 1896.
- 2183 **Pearson**, Thomas. *Adderstone, Mains, Belford, Northumberland.* 424. October 1903.
- 2184 **Pearson**, Rev. Thomas. *The Rectory, Blackrock, Co. Dublin.* 357, P.M. January 1905.
- 2185 **Peart**, Thomas W. 83 *Cazenove Road, Stoke Newington, N., London.* 11, P.M. June 1902.
- 2186 **Peck**, Andrew. 1345 *Bedford Avenue, Brooklyn, New York.* 719, 209. October 1891.
- 2187 **Peck**, Michael Charles. *Park Villa, The Valley, Scarborough.* **Past Grand Standard Bearer, Past Grand Assistant Director of Ceremonies (R.A.)** March 1892.
- 2188 \***Peek**, Rev. R. *St. Magnus the Martyr, Lower Thames Street, E.C., London.* **Past Grand Chaplain.** May 1888.
- 2189 **Pegge**, William Thomas. *St. Ermin's Hotel, Westminster, S.W., London.* 757, 215 (S.C.), P.Z. June 1906.
- 2190 **Pellon**, José F. *Cienfuegos, Cuba.* **Grand Master.** May 1893.
- 2191 **Penley**, W. S. *Gt. Queen Street Theatre, W.C., London.* **Past Grand Treasurer.** Mar. 1904.
- 2192 **Penn**, Alex Streathern. *Masonic Club, Singapore.* 1555. October 1902.
- 2193 **Penny**, Major J., I.M.S. *Messrs. Grindlay & Co., Parliament Street, S.W., London.* 542 Mar. 1901.
- 2194 **Pentz**, Henry Home Ley. *Athens Villa, Mouille Point, Cape Town.* L. De Goede Hoop. Jan. 1899.
- 2195 **Pepper**, Josiah Francis. *Shirle Hill, Handswoorth, Staffords.* **Past Deputy Grand Director of Ceremonies (C. & R.A.)** March 1898.
- 2196 **Perceval**, John James. 41 *Waterloo Road, Dublin.* Dep.Pr.G.M. May 1899.
- 2197 **Percival**, Michael Passawer. *Turf Club, Cairo.* 357. Local Secretary for Egypt and the Soudan. January 1903.
- 2198 **Perkins**, Edward Payson. *Chester Hill, Woodchester, Gloucestershire.* 2709. March 1903.
- 2199 **Perkins**, G. J. *High Street, Staines, Middlesex.* 2536, P.M., 2536, P.Z. March 1905.
- 2200 **Perrin**, William James. 28, *Heron Road, Herne Hill, S.E., London.* 1658. June 1905.
- 2201 **Perrott**, Robert Rees. *c/o Harbour Board, Port Elizabeth, South Africa.* 711, P.M. May 1902.
- 2202 **Peschek**, Julius. 44 *Wellington Road, Charlton, S.E., London.* 1681. January 1904.
- 2203 **Petch**, Henry. *Parkgate, Darlington.* 111, P.M. June 1905.
- 2204 **Peters**, Frederick William. Box 747, *Johannesburg, Transvaal.* January 1889.
- 2205 **Peters**, Herbert William. *West End, Kimberley, South Africa.* D.G.Sec., C.S. Africa. June 1888.
- 2206 **Petherbridge**, Robert. 13 *Belsize Park Gardens, N.W., London.* 183. May 1901.
- 2207 **Pettigrew**, George Atwood. *Sioux Falls, South Dakota, U.S.A.* **Grand Secretary.** Oct. 1894.
- 2208 **Pettman**, Rev. C. *Albert Road, King William's Town, South Africa.* Dis.G.Ch., South Africa, E.Div. March 1906.
- 2209 **Pfeifer**, Arthur Otto Bruno. 14 *Trinity Road, Wimbledon, S.W., London.* 1425. May 1906.
- 2210 **Pflug**, B. 128 *Broadfield Road, Hither Green, S.E., London.* 238. March 1906.
- 2211 **Phelp**, Joseph. *Messrs. Bary & Co., 17 Farringdon Street, E.C., London.* January 1906.
- 2212 **Phelps**, W. E. *The Cross Ways, Chevening, Sevenoaks.* 1670, P.M., 2395. January 1898.
- 2213 **Phillipson**, Ferdinand. *Tordenskjoldsgade 24, Copenhagen.* L. Ferdinande Caroline, Hamburg. May 1893.
- 2214 **Phillips**, Ebenezer S. 1120 *Kossuth Street, Bridgeport, Connecticut, U.S.A.* 3, 13. March 1894.

- 2215 **Phillips, Fred.** *Nantcock, Newport, Monmouth.* Dep.Pr.G.M., Monmouth. May 1906.
- 2216 **Phillips, George Thorne.** *Wokingham, Berks.* 2437. June 1896.
- 2217 **Phillips, Joseph.** *St. George's Studio, Altrincham, Cheshire.* 339. June 1902.
- 2218 **Phillips, Thomas.** 89 *Poplar Road, Edgbaston, Birmingham.* 1163. March 1906.
- 2219 **Phillips, W. Herbert.** *Adelaide, South Australia.* 38. May 1898.
- 2220 **Pickance, Col. William John.** *North Foleys, Aldershot.* 1971. P.Pr.G.W., Hants and I.W. November 1905.
- 2221 **Pickering, George Alfred.** *Guildhall, E.C., London.* 29, P.M., P.G.Stew. March 1892.
- 2222 **Pickersgill, Charles Phillips.** 3 *Marlborough Terrace, Devesbury, Yorke.* P.Pr.G.D., P.Pr.G.R. (R.A.). October 1898.
- 2223 **Pickett, Jacob, M.D.** 49 *Queen Victoria Street, E.C., London.* 766, P.M. January 1895.
- 2224 **Pickett, John.** *Stratford, Taranaki, New Zealand.* 30, P.M. May 1893.
- 2225 **Pickford, Alfred.** *Liffitt's House, Delph, near Oldham.* P.P.G.Treas., P.P.A.G.Sc.E., West Lancashire. June 1898.
- 2226 \***Pierce, W. Frank.** *Crocker Building, San Francisco, California.* **Deputy Grand High Priest, California.** January 1897.
- 2227 **Pike, E. H.** *Fire Engine Station, Mile End Road, E, London.* 2374. March 1903.
- 2228 **Pike, Herbert Watson, I.C.S.** *Sitapur, India.* P.Dis.G.S.W., Madras, 391, P.H. October 1896.
- 2229 **Pilkington, Rev. J. Holme.** *The Rectory, Framlingham, Suffolk.* **Past Grand Chaplain.** June 1903.
- 2230 **Pillow, Edward.** *Le Grange, Thorpe Hamlet, Norwich.* 1500. October 1902.
- 2231 **Pinckard, George Josiah.** P.O.B. 1759, *New Orleans, U.S.A.* **Past Grand High Priest, Representative of Grand Lodge of England at Grand Lodge, Louisiana.** May 1887.
- 2232 **Pinwill, William Richard.** *The King's Regiment, Nasirabad, India.* 1268, 1268. June 1897.
- 2233 **Piper, Arthur W.** *Covra Chambers, Grenfell Street, Adelaide, South Australia.* 38. January 1904.
- 2234 **Pirie-Gordon, Harry.** *Gwernvale, Crickhowel, South Wales.* 357. October 1906.
- 2235 **Pitcher, Alfred Holman.** *Hlaitikulu, Swazieland, South Africa.* 2538, 2538. May 1906.
- 2236 **Pittman, J. J.** 59 *Dingwall Road, Croydon, Surrey.* 538, P.M. March 1897.
- 2237 **Pitts, Alvah Grenelle.** 111 *Woodward Avenue, Detroit, Michigan, U.S.A.* 357, 133. Local Secretary for Michigan. March 1899.
- 2238 **Platt, Col. Henry, C.B.** *Gorddinog, Llanfairfechan, North Wales.* **Past Grand Deacon,** Pr.G.M., North Wales. May 1905.
- 2239 **Plews, William John.** *Heath Bank, Colwyn Bay, North Wales.* 2610, P.M., 111. November 1901.
- 2240 **Pleydell-Bouverie, The Hon. Stuart.** *High Barn, Godalming, Surrey.* 1591. June 1904.
- 2241 **Plimley, Fred.** *Bodvean, Belle Vue Gardens, Shrewsbury.* 117. October 1906.
- 2242 **Pluck, Frederick.** *The Rookery, Bocking, Essex.* 1312, J.W. January 1906.
- 3243 **Plumbe, Rowland, F.R.I.B.A.** 13 *Fitzroy Square, W., London.* **Past Grand Superintendent of Works.** June 1896.
- 2244 **Plummer, H. B. W., M.D.** *West Bromwich, Staffords.* 2724, Sec. March 1903.
- 2245 **Pocklington, W. H.** 5 *Arthur Road, Holloway, N., London.* 1288, P.M. May 1898.
- 2246 **Pocknell, John Edmund.** 67 *Valkyrie Road, Westcliff-on-Sea, Essex.* 183. March 1906.
- 2247 **Pocock, F. Ernest, M.D.** *The Limes, St. Mark's Road, North Kensington, W., London.* **Past Deputy Grand Director of Ceremonies.** June 1904.
- 2248 **Pocock, James Charles.** c/o J. R. Pocock, *The Nurseries, Bromley, Kent.* 224, P.M., D.G.Sup.W., Eastern Archipelago. March 1893.
- 2249 **Pocock, Percy Vivian.** *Receiver of Revenue, Zeerust, Transvaal.* 1747. May 1906.
- 2250 **Pollard, G. E. F.** *Richmond Club, Richmond.* 2956, P.M. October 1906.
- 2251 **Pollard, Joseph.** 51 *Queen Anne St., Cavendish Sq., W., London.* P.P.G.W., Surrey. Oct. 1899.
- 2252 **Pontifex, Reginald Dudley.** *F. C. de Antofugasta á Bolivia, Antofagasta, Chile.* 901. May 1904.
- 2253 **Ponton, William Nisbet.** *Belleville, Canada.* 123, 11, Dis.Dep.G.M. October 1906.
- 2254 **Pool, Arthur G.** *North Parade, Penzance, Cornwall.* 121. January 1903.
- 2255 **Poole, Clement Vaughan.** 32 *Grove Road, Norwich.* 93, P.M. October 1902.
- 2256 **Poole, William George.** *Leighland, Grange Road, Sutton, Surrey.* 860, P.M., 860, P.Z. Jan. 1894.
- 2257 **Poole, William Richard.** 80 *Copeland Road, Peckham, S.E., London.* 65. March 1906.
- 2258 **Pooley, Reginald FitzJames.** *Oldner House, Chipping Norton, Oxon.* 1036, P.M., 1036. May 1905.
- 2259 **Pope, Alexander Winthrop.** *Newton, Massachusetts, U.S.A.* Rabboni, Boston. March 1905.
- 2260 \***Pope, Edward Barfoot George.** 4 *Rua da Estrella, Lisbon, Portugal.* 617, 617. May 1892.

- 2261 **Pope, Seth L.** Box 256, *Portland, Oregon, U.S.A.* **Past Grand High Priest.** Jan. 1899.
- 2262 **Postlewaite, William H.** 1233 South 15th Street, *Denver, Colorado, U.S.A.* 84. January 1900.
- 2263 **Potter, Frederick William.** 36 *Mayfield Avenue, Chiswick, W., London.* 720. January 1906.
- 2264 **Potter, Robert.** 9 *Crossley Street, Halifax.* 275, P.M., 61, P.Z. June 1900.
- 2265 **Pound, Roscoe.** 1969 *A Street, Lincoln, Nebraska, U.S.A.* 54. June 1902.
- 2266 **Pounder, Festus Kelly.** *St. John's Terrace, Enniscorthy, Co. Wexford.* 270, P.M., 935, P.K., Pr.G.I.G., Wic. & Wex. May 1904.
- 2267 **Powell, Arthur Cecil.** *The Hermitage, Weston-super-Mare.* P.P.G.S.Wks., Bristol, 187, P.Z. November 1902.
- 2268 **Powell, F. A., J.P., F.R.I.B.A.** 344 *Kennington Road, S.E., London.* **Past Grand Standard Bearer, Past Deputy Grand Director of Ceremonies (R.A.).** November 1887.
- 2269 **Powell, J. W.** 12 *Priory Court Mansions, Mazonod Avenue, West Hampstead, N.W., London.* 2098. January 1904.
- 2270 **Powell, James William.** *c/o Messrs. Hammond & Co., Osborne Street, Hull.* 250. January 1906.
- 2271 **Powell, Stanley Langhorne.** *Stockwell Green, S.W., London.* 2741, 720. June 1906.
- 2272 **Powis, George Triganee.** 78 *Loop Street, Cape Town.* De Goede Hoop Lodge. May 1899.
- 2273 **Powley, George Henry.** *Norfolk House, Hamilton Road, Ponsonby, Auckland, New Zealand.* **Past Deputy Grand Master, Past Grand Zerrubbabel, New Zealand.** Local Secretary for Auckland. October 1891.
- 2274 **Pownall, Wright D.** 400 *Broadway, New York City, U.S.A.* **Past Grand Master.** May 1900.
- 2275 **Pragnell, George.** 134 *Church Road, Upper Norwood, S.E., London.* 3016. January 1906.
- 2276 **Pratt, J. H.** *G.N. & L.N.W. Rly., Refreshment Room, Melton Mowbray.* 1130. March 1906.
- 2277 **Preston, Donald William.** *Penryn, Knyveton Road, Bournemouth.* P.Pr.G.D., P.Pr.G.So. Mar. 1899.
- 2278 **Pretty, Edward.** *St. George's Terrace, Perth, West Australia.* P.D.G.S.W. (W.A.C.). June 1900.
- 2279 **Prewett, Walter Stevens.** *Cairns, North Queensland.* P.D.G.D.C. May 1902.
- 2280 **Price, Alfred Bryant.** 53 *West Nintieth Street, New York, U.S.A.* 35, P.M., 2, P.H.P. P.Dis.Dep.G.M. **Past Junior Grand Deacon, New York.** June 1906.
- 2281 **Pride, Edwin Dawson.** 323 *Goldhawk Road, Hammersmith, W., London.* 1037. November 1902.
- 2282 **Prillewitz, Johannes Marius.** *Broad Street House, E.C., London.* St. Jan. (D.C.). January 1904.
- 2283 **Prim, Henry George.** 239 *Shaftesbury Avenue, W.C., London.* 2362. June 1906.
- 2284 \***Prime, William C.** *Yonkers, New York, U.S.A.* 736, P.M., Dep.Dis.G.M. 12th Masonic District, New York. October 1906.
- 2285 **Prior, Ephraim.** 133 *Clarkehouse Road, Sheffield.* 1794. January 1898.
- 2286 **Probyn, Lieut.-Col. Clifford.** 55 *Grosvenor Street, W., London.* **Past Grand Treasurer.** May 1897.
- 2287 **Probyn-Williams, R. J.** 13 *Welbeck Street, W., London.* 2000. November 1903.
- 2288 **Procter, Alfred.** 28 *Gillygate, York.* 236, P.M., 236. January 1897.
- 2289 **Proctor, Frederick Stephen.** *Qu'Appelle, Assa., Canada.* **Past District Deputy Grand Master, Manitoba.** October 1896.
- 2290 **Proctor, John James Beauchamp.** *Boys' High School, George, Cape Colony.* P.D.G.W. May 1899.
- 2291 **Proudfoot, William James Crumpton Dallas.** Box 11, *St. Vincent, West Indies.* **Past District Grand Assistant Secretary and Registrar, Barbados.** June 1901.
- 2292 **Pruden, Frederick.** 162 *St. Paul's Road, Canonbury, N., London.* 1549, S.D. January 1906.
- 2293 **Prynn, Fred.** *New Union Street, Moor Lane, E.C., London.* 334. June 1898.
- 2294 \***Pryce, Thomas Lawrence.** P.O.B. 247, *Johannesburg, Transvaal.* 823, 2313. Local Secretary for Johannesburg. May 1890.
- 2295 **Pudsey, Colonel Henry Fawcett.** *The Hall, Sutton-on-Hull, E. Yorks.* P.G.S.W., P.G.H. June 1889.
- 2296 **Pullen, John.** 73 *Friern Road, East Dulwich, S.E., London.* 1539. March 1904.
- 2297 **Pulvermann, Martin.** 26 *Minories, E.C., London.* 19. October 1895.
- 2298 **Purey-Cust, the Very Rev. Arthur Perceval, Dean of York.** *The Deanery, York.* **Past Grand Chaplain.** January 1888.
- 2299 **Purton, John Frederick.** *Tenby House, Palace Road, Hornsey, N., London.* 1541, P.M., 1269. March 1901.
- 2300 **Purvis, Rev. Edward A.** 1 *De Vaux Place, Salisbury.* 379, P.M., Pr.G.Chap. March 1897.
- 2301 **Puxty, Charles Ivor.** Box 575, *Cape Town.* 334, 334. June 1903.
- 2302 **Pyle, William.** 46 *Denmark Hill, S.E., London.* 1475, S.W. May 1904.
- 2303 **Pyrah, John.** *Woodside, Huddersfield.* Pr.G.St.B., W. Yorks. January 1906.
- 2304 **Quayle, Mark.** P.O.B. 919, *New Orleans, U.S.A.* 1, P.M. October 1889.

- 2305 **Rable**, Johannes Jacobus. P.O.B. 51, *Middleburg, Transvaal*. 794 (S.C.). October 1906.
- 2306 **Raby**, Frederick. 27 *Elderslie Road, Eltham, S.E., London*. 1973. January 1903.
- 2307 **Rae**, Robert. Box 203, *Salisbury, Rhodesia*. 2479. May 1905.
- 2308 **Rahman**, the Hon. Abdul Dato Sri Amar d'Baja, C.M.G. *Johore Bahru, Johore, Straits Settlements*. 1152. November 1893.
- 2309 **Rainey**, James Jarvis. *Spilsby, Lincolnshire*. 426, 721. March 1890.
- 2310 **Ralling**, Thomas John. *Winnock Lodge, Colchester, Essex*. **Past Assistant Grand Director of Ceremonies, Past Grand Sword Bearer**. January 1890.
- 2311 **Ramsay**, William Boswell. Box 258, *Bulawayo, Rhodesia*. 851 (S.C.), P.M. October 1899.
- 2312 **Ramsden**, Ernest Western. *Burrundie, v/ Port Darwin, South Australia*. 294. October 1903.
- 2313 **Rasmussen**, J. *Niel Juelsgarde 7, Copenhagen*. Lodge Christian. June 1906.
- 2314 **Ratcliffe**, Charles. 13 *Rufford Road, Elm Park, Fairfield, Liverpool*. 216, P.M., P.Z. May 1892.
- 2315 **Rau**, Rangarao Vasudeva, B.A. *The Hermitage, Hyderabad, Deccan, India*. 569 (S.C.). June 1906.
- 2316 **Rawlings**, Justly. 59 *Rosedale Road, West Dulwich, S.E., London*. 1671, S.W., 1671. May 1906.
- 2317 **Raymond**, Henry Francis. *Garryowen, Victoria Park, Dorchester*. P.Pr.G.D. March 1888.
- 2318 **Raymond**, Percy Miles. *California, U.S.A.* 51. January 1896.
- 2319 **Rayner**, Felix Reuben. *East London, South Africa*. 1790. November 1906.
- 2320 **Read**, R. S. *Beaumont, St. Ives, Cornwall*. 1272, P.M. January 1895.
- 2321 **Read**, Richard Charles. 10 *Finsbury Square, E.C., London*. P.P.G.D., Middlesex. June 1902.
- 2322 **Rebman**, Francis Joseph. 1123, *Broadway, New York, U.S.A.* 1768, P.M., 2000. January 1897.
- 2323 **Reddish**, John Thomas. 96 *Tarvin Road, Chester*. 2609, 721. March 1905.
- 2324 **Redfearn**, Thomas Butler. 20 *Scale Lane, Hull*. P.P.G.W., A.P.G.Sec., A.P.G.Sc.E. Jan. 1895.
- 2325 **Reed**, W. H. *Dauleigh, Aylesbury Road, Boscombe, Hants*. 382, P.P.G.Treas., Middlesex. Jan. 1893.
- 2326 **Reep**, John Robertson. *Franklin House, South Norwood, S.E., London*. **Past Grand Standard Bearer** (Craft & R.A.). June 1890.
- 2327 **Reepmaker**, M. 37 *Westersingel, Rotterdam*. Frédéric Royal. June 1905.
- 2328 **Rees**, S. P. 25 *Bartholomew Road, N.W., London*. 1446, 2416. November 1903.
- 2329 **Rees**, Thomas Ernest. *Eastleigh, C.S.A.R., Transvaal*. 1366. March 1898.
- 2330 **Rees**, W. Burt. 317 *North Soto Street, Los Angeles, California, U.S.A.* January 1903.
- 2331 **Reeve**, William. 65½ *York Street, Westminster, S.W., London*. 901. May 1900.
- 2332 **Reeves**, John G. *Lancaster, Fairfield, Ohio, U.S.A.* 57, 11. November 1905.
- 2333 **Reid**, Arthur Heury, F.R.I.B.A. Box 120, *Cape Town*. P.Dis.G.Sup. of W., Transvaal and Eastern Division, South Africa. October 1889.
- 2334 **Reid**, Lieut. George S. B. *Cape Mounted Police, Belmore, P.O., Mosheshs Ford, Barkly East, Cape Colony*. 2252, 2252. May 1902.
- 2335 **Reid**, Herbert Cartwright, M.I.C.E. *Admiralty, H.M. Dockyard, Malta*. 2913, P.M. March 1903.
- 2336 **Reid**, John. Box 1760, *Johannesburg, Transvaal*. 1022. January 1899.
- 2337 **Reid**, Robert Raymond. *Amite City, Louisiana, U.S.A.* **Past Grand Master. Grand Scribe**. November 1904.
- 2338 **Reid**, William James Beavis. 5 *Sunninghill Road, Lewisham, S.E., London*. 871, P.M. May 1906.
- 2339 **Reinthal**, Jonas E., M.D. 802 *81st Street, New York, U.S.A.* 279, P.M. June 1904.
- 2340 **Reizenstein**, Henry. c/o L. Lehmann, 68 *Basinghall Street, E.C., London*. 2075. June 1903.
- 2341 **Rendell**, Arthur Paige. 1 *Lindum Terrace, Bradford*. 974, 974. March 1893.
- 2342 **Rendle**, Rev. Alfred James, M.A. *Nutford House, Wantage, Berks*. P.Dis.G.Ch., South Africa, W.Div. March 1899.
- 2343 **Rennie**, John. *Spey Street, Invercargill, New Zealand*. 9 (N.Z.C.). October 1903.
- 2344 **Retallack-Moloney**, Joseph Henry. 199 *Romford Road, E., London*. P.P.G.Sup.W., 933, P.Z. November 1894.
- 2345 **Reuter**, Rudolph Johannes. *Normannia, Weybridge, Surrey*. March 1906.
- 2346 **Reynolds**, Alfred L. 2 *Cophall Buildings, E.C., London*. **Past Grand Deacon**. June 1906.
- 2347 **Ricardo**, Col. G. Craven. *Donnington, Newbury, Berks*. 574, P.M., 574. **Senior Grand Deacon**. May 1903.
- 2348 **Rice**, Obadiah Handford. 67 *Pitt Street, Norwich*. 213. October 1902.
- 2349 **Rich**, Harry Nelson. *Ladner, British Columbia, Canada*. 9, P.M. January 1896.
- 2350 **Richards**, Charles. 78 *Bull Street, Birmingham*. 2897, W.M. January 1906.
- 2351 **Richards**, George. 3 *Kensington Palace Gardens, W., London*. **Past District Grand Master, Transvaal**. October 1888.
- 2352 **Richards**, James Albert. 18 *Mattock Lane, Ealing, W., London*. 2030. November 1904.

- 2353 **Richards**, Thomas George. *c/o Griffiths & Co., Contractors, Ltd., Lobito Bay, Portuguese S.W. Africa.* 2459. October 1902.
- 2354 **Richards**, Thomas Newman. 17 *Watergats Road, Chester.* 721, 721. January 1906.
- 2355 **Richardson**, Arthur Connor. *Granville House, Jesmond, Newcastle-on-Tyne.* 1626, 1664. March 1898.
- 2356 **Richardson**, Bertie William. *The Exchange, Harrogate.* 2069. October 1905.
- 2357 **Richardson**, Charles Willerton. *c/o Asquith & Lord, Ltd., Bombay.* P.Dis.G.Sw.B. May 1905.
- 2358 **Richardson**, Frederick. *The Glen, Queen's Park, Chester.* 721, 721. October 1905.
- 2359 **Richardson**, George Henry. 27 *Stuart Road, Acton, W., London.* 1387. March 1906.
- 2360 **Richardson**, Harry, C.E. 5 *Somerset Road, Handsworth Wood, Staffords.* P.P.G.St.B., Worcestershire, P.P.A.G.So., Staffordshire. June 1900.
- 2361 **Richardson**, Henry. 4 *Church Street, Greenwich, S.E., London.* 140, P.M. March 1892.
- 2362 **Richardson**, Valentine. P.O. Box 421, *Pretoria, Transvaal.* 952 (S.C.). October 1906.
- 2363 **Richardson**, William. *Guisborough, Yorks.* P.P.G.W., North and East Yorks. January 1898.
- 2364 **Riches**, H. J. *North Terrace, Boulder City, West Australia.* 219 (S.C.). November 1902.
- 2365 \***Richmond**, A. E. 28 *Nelson Road, Great Yarmouth.* 100. January 1903.
- 2366 **Rickard**, F. A. *Hong Kong and Shanghai Bank, Singapore.* 570, P.M., 1152, P.Z. Dis.G.Sec. March 1906.
- 2367 **Rickard**, Capt. F. M. *Ordnance Works, Coventry.* 1789. October 1905.
- 2368 **Rickon**, Frederic John Henry. Room 236, *Phelan Building, San Francisco, U.S.A.* 2 P.M., P.H.P. March 1897.
- 2369 **Rider**, Rev. W. Wilkinson. *Musgrave Road, Beara, Durban, Natal.* 711, P.M. March 1894.
- 2370 **Ridler**, James. Box 172, *St. Paul, Minnesota, U.S.A.* 165. May 1905.
- 2371 **Ridley**, Thomas Matthew. *Stanley R.S.O., Durham.* 2929. March 1906.
- 2372 **Riegel**, Julius, Ph.D. 43 *Ob. Pirkheimerstr., Nuremberg.* Lodge Albrecht Durer, W.M. May 1906.
- 2373 **Rigg**, Richard. 26 *Evelyn Mansions, Carlisle Place, S.W., London.* 2217, P.M. May 1904.
- 2374 **Riley**, Henry. *Victoria Mansions, 28 Victoria Street, S.W., London.* 2128. November 1894.
- 2375 **Rimell**, George. 7 *Bentinck Mansions, Manchester Square, W., London.* 2492. March 1899.
- 2376 **Rivington**, Edward. *Chappel, Earl's Colne, R.S.O., Essex.* P.Pr.G.Sup.W., Jersey. Oct. 1896.
- 2377 **Rix**, Owen William. 29 *Bishopsgate Street Without, E.C., London.* 65, P.M. May 1906.
- 2378 **Robbins**, Alfred Farthing. *Dunheved, Villa Road, Briston, S.W., London.* 1928, P.M., 1928, P.Z. January 1899.
- 2379 **Robbins**, Joseph, M.D. *Quincey, Illinois, U.S.A.* **Past Grand Master.** January 1893.
- 2380 **Robert**, Thomas Bullock. *Culworth, Parkstone Avenue, Parkstone, Dorset.* 55, P.M., Nov. 1902.
- 2381 **Roberts**, Edward, M.A. *Plas Maesincla, Caernarvon, North Wales.* Dep.Pr.G.Master. **Past Deputy Grand Sword Bearer.** March 1894.
- 2382 **Roberts**, Hugh Jones, Surgeon, J.P. *Gwyddfor, Penygroes, R.S.O., Caernarvon.* 606, P.M. May 1901.
- 2383 **Roberts**, John. 22 *Wesley Street, Observatory Road, Cape Town.* P.Dis.G.W., Dis.G.J., South Africa, W. Division. June 1890.
- 2384 **Roberts**, John Farquharson. 56 *Ludgate Hill, E.C., London.* 63, 76, 2650, 2693, 2712, P.M., 63, P.Z. June 1906
- 2385 **Roberts**, William Field. *Fern Bank, Gainsborough Road, Bedford Park, W., London.* 1471. March 1898.
- 2386 **Robertson**, Rev. Arthur George Lennox. 59 *Granville Park, Lewisham, S.E., London.* 2329, P.M. 617, P.Z., P.Dis.G.Chap., Argentine Republic. September 1887.
- 2387 **Robertson**, George. *Wellington, New Zealand.* **Past Grand Secretary, New Zealand. Representative of the Grand Orient of Italy.** Local Secretary for Wellington, New Zealand. May 1892.
- 2388 **Robertson**, Robert. 55 *Moodie Street, Dunfermline, N.B.* 415, P.M. June 1902.
- 2389 **Robertson**, R. M. F. 28 *Queen Victoria Street, E.C., London.* 2663, W.M. January 1906.
- 2390 **Robertson**, Walter W. *Wardie Bank, Trinity, Edinburgh.* **Past Grand Architect, Past Grand Recorder.** May 1900.
- 2391 **Robeson**, John Granville. *Carlsruhe, Dickenson Road, Crouch End, N., London.* 192, P.M. October 1896.
- 2392 **Robin**, Rev. Leonard Philip. 30 *John Street, Bedford Row, W.C., London.* 367, 1388 (N.Z.C.). October 1900.
- 2393 **Robinson**, Alfred A. 101 *Bow Road, E., London.* 2549. June 1899.
- 2394 **Robinson**, Charles. 8 *Baker Street, Portman Square, W., London.* 1641, P.M. January 1896.

- 2395 **Robinson**, Edward Arthur. *Boydell House, Avenue Road, Aston, Birmingham.* 1163, 1031. March 1901.
- 2396 **Robinson**, George Herbert. *The Cottage, Lee-on-Solent, Hants.* 2101, 777. March 1900.
- 2397 **Robinson**, H. W. *Goldsmiths' Hall, E.C., London.* 142, J.W. May 1906.
- 2398 **Robinson**, John. 33 *High Road, Darlington, Durham.* P.Pr.G.W., 111, P.Z. January 1896.
- 2399 \***Robinson**, John. *The Flow, Cattogs, Comber, Co. Down.* P.Pr.G.D., Antrim. October 1896.
- 2400 \***Robinson**, John Peter. 17 *Gower Place, W.C., London.* October 1904.
- 2401 **Robinson**, Percy. 53 *Albion Street, Leeds.* 1221. June 1901.
- 2402 **Robinson**, William Henry. 15 *Leraud Street, Berhampore, Wellington, New Zealand.* 3 (N.Z.C.), 2. May 1906.
- 2403 **Robson**, Allan. 8 *Eldon Square, Newcastle-on-Tyne.* 1626, 1664. May 1904.
- 2404 **Robson**, George. 159a *Bedford Hill, Balham, S.W., London.* 1608, 2030. March 1905.
- 2405 **Rodriguez**, Francisco de Paula. 20 *Estrella, Havana, Cuba.* **Grand Secretary General Supreme Council, 33° A.A.S.R. Chairman of Committee on Foreign Correspondence, Cuba.** May 1893.
- 2406 \***Roffey**, James Richard. 106 *Leeds Street, Liverpool.* 1937. March 1889.
- 2407 **Rogers**, Edward. "*The People*," *Milford Lane, Strand, W.C., London.* 2948. January 1904.
- 2408 **Rogers**, William. 93 *Chancery Lane, W.C., London.* 1339, P.M., 435, P.Z. March 1896.
- 2409 **Ronaldson**, Rev. W. *Dunedin, New Zealand.* **Past Grand Secretary.** Local Sec. for Otago. May 1888.
- 2410 **Rootham**, Pery W. 93 *South Crosted Road, West Dulwich, S.E., London.* 905. October 1906.
- 2411 \***Roper**, John. *Kirkby Lonsdale, Westmoreland.* 1974. March 1893.
- 2412 **Rose**, Major J. 14 *Sloane Court, S.W., London.* 2094, P.M. March 1905.
- 2413 **Rose**, Max. 66 *Kennington Road, S.E., London.* 1558. March 1904.
- 2414 **Rosedale**, Rev. Henry Gough, D.D., F.S.A. *St. Peter's Vicarage, 13 Ladbroke Gardens, W., London.* 1297, Ch. May 1906.
- 2415 **Rosedale**, Rev. William Elitto. *Willenhall, Staffs.* 526, P.M., 419, P.Pr.G.Ch. June 1906.
- 2416 **Rosenbaum**, Rev. Morris. *Synagogue House, Heygate Street, Walworth, S.E., London.* 2557. October 1903.
- 2417 **Ross-Johnson**, Dennis. *Central Station, Madras.* P.D.G.W., P.D.G.D.C. (R.A.). October 1893.
- 2418 **Roundell**, Christopher Foulis. *Guard's Club, S.W., London.* 631, P.M. May 1899.
- 2419 **Roux**, Adrian J. T. *Malmesbury, Cape Colony.* Lodge San Jan (D.C.), P.M. May 1898.
- 2420 **Rowbotham**, Thomas. *Netherton House, Kenwood Park Road, Sheffield.* 1239, P.M. Nov. 1901.
- 2421 **Rowbotham**, Thomas Lees. *Hurstville, Sydney, New South Wales.* 219, P.M. P.Dis.G Ins.Wks. 9. October 1906.
- 2422 **Rowe**, Reginald Mark. *Clarendon, Torrs Park, Ilfracombe.* 1135, PM. Pr.G.Reg., Devon. May 1906.
- 2423 **Rowell**, Benjamin W. 206 *Masonic Temple, Boston, Massachusetts.* May 1898.
- 2424 **Rowe-Rowe**, H. Box 769, *Cape Town.* 2646, P.M. June 1898.
- 2425 **Rowley**, Walter, M.I.C.E., F.S.A., F.G.S. *Alderhill, Meanwood, Leeds.* 289. March 1888.
- 2426 **Rowell**, Alfred William. *Pietermaritzburg, Natal.* P.D.G.D. October 1889.
- 2427 **Rowell**, Ebenezer William. *Glenavon, Neston Avenue, Withington, near Manchester.* 2359, P.M. March 1904.
- 2428 \***Roy**, Robert. 2 *Garden Court, Temple, E.C., London.* P.Pr.G.Pt., Cambridge. November 1888.
- 2429 **Royaards**, J. G. M. 9 *Binnen Amstel, Amsterdam.* Concordia Vincit Animos. June 1905.
- 2430 **Royston**, Joseph. 22 *Newmarket Road, Cambridge.* 441, P.M., P.Z. October 1903.
- 2431 **Royston**, Rev. Peter. *Orton Longueville, Peterborough.* P.P.G.Chap., Norths & Hunts. May 1897.
- 2432 **Rubie**, John Edwin. *The Common Room, Middle Temple, E.C., London.* 41, P.M. June 1906.
- 2433 **Rudd**, John. 172 *Palatine Road, West Didsbury, Manchester.* 2698, 1045. June 1899.
- 2434 **Rudderow**, Samuel Glover. *Front and Market Street, Camden, New Jersey, U.S.A.* 15, P.M., 19, P.H.P. March 1904.
- 2435 **Ruddle**, W. H. *Secunderabad, Deccan, India.* 434. January 1906.
- 2436 **Rumble**, Thomas William. 18 *Aldermanbury, E.C., London.* 134, 2147. June 1903.
- 2437 **Rusby**, Reginald William. *Wharfedale, Prospect Road, Moseley, Birmingham.* Pr.G Sup.W., Worcesters, 2034. January 1905.
- 2438 **Rush**, James Walker. 94 *Leadenhall Street, E.C., London.* 1531. June 1903.
- 2439 **Rush**, Lieut. John Shipman. *Coràite Factory, Aruvankad, Nilgiri Hills, India.* P.D.G.D.C., Burma, P.D.U.S.B., Madras. January 1895.
- 2440 \***Rushton**, W. H. *Eastern Jumna Canal, Saharanpur, U.P., India.* 413. June 1895.

- 2441 **Russack**, W. J. C. *Marine Hotel, St. Andrew's, N.B.* May 1899.
- 2442 **Russell**, Francis Duncombe Astley. *1st Cheshire Regiment, Lichfield.* June 1903.
- 2443 **Russell**, Joseph. *27 Milk Street, E.C., London.* **Past Grand Standard Bearer.** March 1898.
- 2444 **Rust**, George Robert Dowe. *Kingston, Jamaica.* P.D.G.Sw.B., Jamaica. Local Secretary for Jamaica. October 1900.
- 2445 \***Rustomjee**, Cursetjee, I.C.S. *Moradabad, North West Provinces, India.* 2018. October 1898.
- 2446 **Rutherford**, George. *38 Lombard Street, E.C., London.* 1531. June 1903.
- 2447 **Rutt**, Pattisson Talfourd. *Main Street, Zeehan, Tasmania.* 20, P.M. October 1904.
- 2448 **Ryan**, John Hugh McAuley. *High Court Chambers, Madras.* 150, 150. October 1896.
- 2449 **Ryley**, Robert Acherly. *Newcastle, Natal.* 2097, P.M., 276, H. March 1904.
- 2450 **Rymer**, Sir Joseph Sykes. *17 Park Place, York.* P.Pr.G.W., P.P.G.H., N. & E. Yorks. Nov. 1888.
- 2451 **Sadler**, W. Dawson, M.A., F.R.Hist.S. *107 Holly Road, Northampton.* 1911. March 1905.
- 2452 **Sakakini**, Joseph, Bey. *Alexandria, Egypt.* October 1906.
- 2453 **Salter-Whiter**, James. *Sunny Bank, Wallington, Surrey.* 1892, P.M., 1347. March 1898.
- 2454 **Samuelson**, Frederick, C.E. *Mora, Clifton Road, Rugby.* 2562. June 1898.
- 2455 **Sanders**, Rev. Canon Samuel John Woodhouse, LL.D., M.A., F.G.S. *St. Martin's Vicarage, Leicester.* **Past Grand Chaplain and Past Grand Sojourner.** January 1889.
- 2456 **Sanderson**, Charles Edward Fenwick. *Singapore, Straits Settlements,* P.Dis.G.W., 508. October 1894.
- 2457 **Sandford**, James Benjamin. *Qu'Appelle, Assa, Canada.* 32. March 1898.
- 2458 **Sandham**, Robert. *16 Littledale Road, Seacombe, Cheshire.* 2876. January 1902.
- 2459 **Sansom**, Dr. Arthur Ernest. *84 Harley Street, W., London.* **Past Grand Deacon.** June 1902.
- 2460 **Sargeant**, I. W. H. *Webb's Mines, Emmaville, New South Wales.* 119, P.M. October 1904.
- 2461 **Sarson**, Henry Logsdail. *Vinegar Works, City Road, S.E., London.* 2000. October 1896.
- 2462 **Sasso**, Isaac David. *Box 82, San José, Costa Rica.* 3. May 1905.
- 2463 **Satterthwaite**, G. W. *Tacloban, Leyte, Philippine Islands.* 242. May 1905.
- 2464 **Saulez**, Rev. Wilberforce. *Little Milton, Wallingford, Berkshire.* 1753. May 1898.
- 2465 **Saunders**, Alexander. *1 Canning Street, Birkenhead.* P.Pr.G.St.B., Pr.G.J. (R.A.). October 1896.
- 2466 **Saunders**, Alfred. *Erin Villa, Burston Road, St. John's Road, Putney, S.W., London.* 144, P.M. January 1900.
- 2467 **Saunders**, George Richard. *Heathside, Worcester Gardens, Sutton, Surrey.* 1347, 1347. June 1901.
- 2468 **Saunders**, John. *Sea Cliff House, near Cape Town, South Africa.* P.Pr.G.Supp., Cape (S.C.). October 1888.
- 2469 **Saunders**, Col. Robert J. Pratt, C.B. *Saunders Grove, Baltinglass, Ireland.* **Prov. Grand Master, Wicklow and Wexford.** March 1898.
- 2470 **Saunders**, Sibert. *Springfield House, Canterbury Road, Whitstable, Kent.* P.Pr.G.Reg., P.P.G.J. November 1887.
- 2471 **Saunton**, Henri. *129 Lower Thames Street, E.C., London.* 1423, P.M. March 1902.
- 2472 **Sawkins**, Arthur Wise. *Rondebosch, Cape Town.* 2220, 334. January 1892.
- 2473 **Sawyer**, Charles L. *1916 Columbus Avenue, Minneapolis, Minnesota, U.S.A.* 19, P.M., 9. June 1903.
- 2474 **Schartau**, Herbert William. *7 Loughborough Road, S.W., London.* 1261, P.M., P.P.G.O., M<sup>sex</sup>. October 1904.
- 2475 \***Schaufuss**, Camillo Festivus Christian. *Cölln Elbe, Saxony.* Lodge zur Akazie. November 1899.
- 2476 **Schiller**, Ferdinand P. M. *3 Hare Court, Temple, E.C., London.* 357. June 1891.
- 2477 **Schlaich**, Fred. *Johnsonville, Wellington, New Zealand.* 2, 127, P.M. (N.Z.C.). October 1906.
- 2478 **Schmerl**, Augustus. *4 Victoria Mansions, West Hampstead, N.W., London.* 188. November 1903.
- 2479 **Schmidt**, Clarence R. M. *Ootacamund, India.* 1285, 1285. P.Dis.G.D., P.Dis.G.O. (R.A.). October 1898.
- 2480 **Schneider**, Frank Louis. *17 Bath Road, Bedford Park, W., London.* 2512. June 1898.
- 2481 **Schoder**, Anthony. *Woodbridge, New Jersey, U.S.A.* **Past Grand High Priest.** June 1897.
- 2482 **Schonberger**, B. *4 Whitehall Court, S.W., London.* 2108. June 1897.
- 2483 **Schultz**, Edward T. *215 West German Street, Baltimore, Maryland, U.S.A.* **Past Grand Warden and Past Grand Deputy High Priest, Maryland.** June 1888.
- 2494 **Scott**, E. Irwin, M.D. *69 Church Road, Hove, Sussex.* P.P.G.D., 271, P.Z. May 1905.
- 2485 **Scott**, Henry. *1 Forest Road, Dalston, N.E., London.* 2557. June 1906.
- 2486 **Scott**, Hugh Jamieson. *Middleburg, Transvaal.* 2479. November 1900.



- 2487 **Scott of Gala**, John Henry Francis Kinnaird. *Gala House, Galashiels, N.B.* Pr.G.S.D. **Prov. Grand Supt. for Peebles, Roxburgh and Selkirkshire.** March 1902.
- 2488 **Scott**, Mark. *Micklegate, Selby, Yorks.* P.Pr.G.W., Pr.G.Treas. (R.A.), North and East Yorks. May 1892.
- 2489 **Scott**, Owen Stanley. *Bowes Museum, Barnard Castle, Co. Durham.* 1230. May 1897.
- 2490 **Scott**, R. J. H. 23 *Circus, Bath.* 53, P.M., 53, P.Z. January 1906.
- 2491 **Scott**, W. *Kookynie, West Australia.* 932 (S.C.) November 1904.
- 2492 **Scott**, William Henry, A.M. 357 *Westminster Street, Providence, Rhode Island, U.S.A.* **Past Grand Master, Representative Grand Lodge of Ohio.** 1, P.H.P. Local Secretary for Rhode Island. June 1889.
- 2493 **Scott-Hall**, Rev. William E., F.S.A., Scot. *Plás, Llanfaelog, Anglesey, N. Wales.* 1849, P.M., P.P.G.Ch. Local Secretary for North Wales. March 1893.
- 2494 **Scriven**, George, M.D. 33 *St. Stephen's Green, Dublin.* **Junior Grand Deacon,** November 1905.
- 2495 **Scrivener**, John Charles. *Mistleigh, Caterham Valley, Surrey.* 2920. May 1905.
- 2496 **Scurrah**, William Alfred. 12 *Rutland Street, Regent's Park, N.W., London.* **Past Grand Standard Bearer.** March 1890.
- 2497 \***Seamon**, William Henry. *Chihuahua, Mexico.* **Past Grand High Priest.** May 1890.
- 2498 **Searle**, Edward. *Port Elizabeth, South Africa.* 711. May 1896.
- 2499 **Searle**, William. *East London, South Africa.* March 1904.
- 2500 **Sears**, J. G. *St. George's Avenue, Northampton.* 2431. November 1904.
- 2501 **Seavill**, Leonard Crowley. 153 *Calle Entre Rios, Rosario de Santa Fé, Argentine Republic.* 2960. June 1905.
- 2502 **Seehoff**, J. Box 47, *Krugersdorp, Transvaal.* Lodge Libertas, P.M., 2643, P.Z. May 1898.
- 2503 **Seeligson**, L. *Colonial Mutual Chambers, St. George's Terrace, Perth, West Australia.* 859 (S.C.) P.M., 274 (S.C.) November 1903.
- 2504 **Seers**, William. *Brookside, Hoole, Chester.* 721, P.M., P.P.G.Tr. May 1905.
- 2505 **Selflow**, Max. 25, *Savage Gardens, E.C., London.* 238. January 1902.
- 2506 **Semans**, Dr. William M. *Delaware, Ohio, U.S.A.* 18. October 1899.
- 2507 **Setna**, Sorabjee Dhunjeebhoy. 6 *De Veaux Road, Hong Kong.* 1165, 618 (S.C.) May 1889.
- 2508 **Severs**, William. *Wilmslow, Cheshire.* 1565. May 1899.
- 2509 **Sexton**, Henry. *Town Close Road, Newmarket Road, Norwich.* 213. October 1902.
- 2510 **Seymore**, William Byron. *Charleston, Washington, U.S.A.* 117. March 1904.
- 2511 **Shallcrass**, G. 2 *Gilstead Road, Singapore.* 110 (V.C.) May 1898.
- 2512 **Shanks**, Frederick Hemsley, M.D. 917 *Seymour Street, Vancouver, B.C., Canada.* 105, 98 (G.R.C.) May 1901.
- 2513 **Sharp**, G. Harold. *Dashwood House, 9 New Broad Street, E.C., London.* 183. May 1902.
- 2514 **Sharp**, H. J. 60 *Main Street, Yokohama, Japan.* **Deputy District Grand Master, Japan.** June 1903.
- 2515 **Sharpe**, Wallace William Jessop. *Florence Terrace, Falmouth.* Pr.J.G.W., 75, P.Z. January 1892.
- 2516 **Sharratt**, Albert Varey. 6 *King's Drive, Heaton Moor, near Stockport.* 1375, P.M. March 1899.
- 2517 **Shaver**, George David, M.D. 920 *Yakima Avenue, Tacoma, Washington, U.S.A.* 22, P.M., 4, P.H.P. January 1894.
- 2518 **Shaver**, William Mitchell. *Topeka, Kansas, U.S.A.* **Past Grand Master, Grand Secretary** (R.A.) January 1903.
- 2519 **Shaw**, B. 65 *King William Street, E.C., London.* 1950. March 1901.
- 2520 **Shaw**, Benjamin. *Wharfedale, Carlbourne Terrace, Menston, Leeds.* 2669. October 1902.
- 2521 **Shaw**, George Arthur. *Garrison Side, Hull.* 57, P.M. October 1906.
- 2522 **Shaw**, James. *Youngwoods, Headington, near Oxford.* 1515. October 1904.
- 2523 \***Shaw**, Robert Barclay. 94 *Commerce Street, Glasgow.* 3 bis, 50. June 1895.
- 2524 **Shaw**, T. W. Box 974, *Pretoria, Transvaal.* 861 (I.C.) May 1906.
- 2525 **Sheffield**, Lieut.-Col. Frank. *Palaspai, Daleham Gardens, Hampstead, N.W., London.* 2029, P.M. June 1894.
- 2526 **Shelbourne**, Hugh John. 70 *Fenchurch Street, E.C., London.* 2652. June 1904.
- 2527 **Shephard**, George Waterman. 29 *Bishopsgate Street Without, E.C., London.* 65. June 1906.
- 2528 **Shepherd**, Edward L. *The Lindens, Abingdon, Berkshire.* P.P.G.W. November 1893.
- 2529 **Sheppard**, Richard John. *Parsonstown, Ireland.* Prov.Gr.Sec., Midland Counties. May 1899.
- 2530 **Sher**, Frederick Paul. 1216 *North 8th Street, Philadelphia, Pennsylvania, U.S.A.* 368, P.M., 91, P.H.P. October 1904.

- 2531 **Sherman, William Ross.** 4 *Westminster Street, Providence, Rhode Island, U.S.A.* **Senior Grand Steward**, 30, P.M. 1. May 1893.
- 2532 **Sherras, Frederick Alex.** 6 *Rochester Row, Westminster, S.W., London.* 1608, 2030. March 1901.
- 2533 **Sherrington, William Staunton.** 10, *New Court, Lincoln's Inn, W.C., London.* 198. June 1906.
- 2534 \***Shields, Isaac Mann.** 122 *Leadenhall Street, E.C., London.* **Past Grand Deacon, Past Deputy Grand Sword Bearer** (R.A.) May 1900.
- 2535 **Shipman, B. J.** *Pioneer Press Building, St. Paul, Minnesota, U.S.A.* 165. May 1905.
- 2536 **Shirk, George H.** *Hanover, Pennsylvania.* P.Dis.Dep.G.M., Pennsylvania. October 1891.
- 2537 **Shirrefs, Robert Archibald.** 451 *Grier Avenue, Elizabeth, New Jersey, U.S.A.* 33, P.M., 6, P.H.P. **Representative Grand Lodge of South Carolina. Local Secretary for New Jersey.** May 1895.
- 2538 **Short, William Henry.** *Nelson, New Zealand.* 40, P.M. October 1892.
- 2539 **Shread, George.** *Cambridge House, Trinity Road, Birchfield, Birmingham.* P.P.G.W. May 1893.
- 2540 **Shyock, Thomas J.** *Masonic Temple, Baltimore, Maryland, U.S.A.* **Past Grand Master of Maryland.** May 1890.
- 2541 **Shuttleworth, Thomas Ernest, B.A.** 5 *Park Avenue, Riverdale Road, Sheffield.* 2268. March 1904.
- 2542 **Sibthorpe, John.** 33 *Molesworth Street, Dublin.* 4 (I.C.), P.M. March 1900.
- 2543 **Side, Arthur Orsini.** 34 *Lorne Road, Brixton, S.W., London.* 183, P.M., 720, P.Z. May 1893.
- 2544 **Silberbauer, Conrad Christian.** P.O.B. 263, *Cape Town.* Dep.Pr.Gr.M. (D.C.) March 1889.
- 2545 **Silberbauer, Charles Frederick.** *Rondebosch, Cape Town.* 828. October 1891.
- 2546 **Silley, Alfred Charles.** *Constantinople.* 687, P.M. October 1903.
- 2547 \***Sim, Harry Alexander, I.C.S., C.I.E.** c/o *H. S. King & Co., 9 Pall Mall, S.W., London.* P.Dis.G.W. June 1896.
- 2548 **Simcox, A. H. A., I.C.S.** *Messrs. Grindlay, Groom & Co., Bombay.* D.G.W., 757, H. March 1904.
- 2549 **Simcox, Joseph Jonathan.** *Saunderton House, High Wycombe, Bucks.* Pr.G.Tr. **Past Assistant Grand Director of Ceremonies** (R.A.) January 1899.
- 2550 **Simkin, Lingard.** *Wantabadgery, Wagga Wagga, New South Wales.* 2207. October 1889.
- 2551 **Simmons, Harold S.** 4, *Elm Court, Temple, E.C., London.* 2466, W.M. November 1905.
- 2552 **Simner, Abel.** 3 *Grosvenor Court, 137 Victoria Street, S.W., London.* **Past Assistant Grand Director of Ceremonies, Past Grand Standard Bearer.** October 1902.
- 2553 **Simner, Percy Reginald Owen Abel, M.A.** 137 *Victoria Street, S.W., London.* 357. June 1905.
- 2554 **Simon, L.** 1 *Aldersgate Buildings, E.C., London.* 1693, P.M., P.Z. May 1898.
- 2555 **Simonsen, Sophus Heimann.** *St. Kiobmagergade 14, Copenhagen.* Lodge zur Bruderkette, Hamburg. **Local Secretary for Denmark.** June 1887.
- 2556 **Simpkin, Harry.** *High Bank, New Road, Whitefield, near Manchester.* 266. January 1903.
- 2557 **Simpson, George Palgrave.** 24 *Howe Street, Higher Broughton, Manchester.* 2087, P.M., 1538. June 1903.
- 2558 **Simpson, Gilbert.** *Calle Bulcarce 230, Lomas de Zamora, Buenos Aires.* 2517, W.M. 617. May 1906.
- 2559 **Simpson, H. R.** *Skagway, Alaska, U.S.A.* 133 (Wash. C.) October 1903.
- 2560 **Simpson, John.** *South Mount, Cameron, Tasmania.* 4. June 1891.
- 2561 **Sinclair, Hugh William.** 443 *Chancery Lane, Melbourne, Victoria.* **Past Grand Treasurer, Past Grand Joshua.** **Local Secretary for Melbourne.** October 1895.
- 2562 **Sinclair, Robert.** P.O., *Wellington South, New Zealand.* 816 (S.C.). March 1896.
- 2563 **Sinner, F. A.** *Rockingham, Blessington Road, Blackheath, S.E., London.* 1851. October 1904.
- 2564 **Sirr, Harry.** 50 *Twisden Road, Highgate Road, N.W., London.* 2416. May 1904.
- 2565 **Skerrett-Rogers, Charles Campbell.** *Foochow, China.* 1912, P.M. June 1903.
- 2566 **Skirving, J. B.** *Potchefstroom, Transvaal.* 2354. June 1897.
- 2567 **Slack, Arthur William.** *Beechwood, Buxton, Derbyshire.* P.Pr.G.R. January 1891.
- 2568 **Sladden, Robert.** *Townsville Street, Queenon, Charters Towers, Queensland.* 2613, P.M. **Local Secretary for Charters Towers.** June 1898.
- 2569 **Slater, Frederick.** *Evening Telegraph, Charters Towers, Queensland.* 2613. January 1905.
- 2570 **Slater, Henry William.** 192 *Osborne Road, Forest Gate, S.E., London.* 63, P.M. June 1906.
- 2571 **Slaughter, Mihill.** *Northwood, Burgess Hill, N.W., London.* **Past Assistant Grand Director of Ceremonies.** 176, P.M. March 1906.
- 2572 **Slotegraaf, Pieter George.** *Jansenville, Cape Colony.* 1590. May 1906.
- 2573 **Small, James Scott.** *Innerleithen, Scotland.* 856. May 1898.
- 2574 **Small, Henry Gordon.** *Wythburn, Heaton Moor, Stockport.* P.Pr.G.W., P.Pr.G.H. (R.A.), Cheshire. November 1897.
- 2575 **Small, James Miln.** 17 *Victoria Street, S.W., London.* 708, P.M., 1691, P.Z. May 1899.

- 576 **Smiles, James Thomas.** *Dept. of Mines, Sydney, New South Wales.* P.M. June 1897.
- 2577 **Smit, Frederick Simon.** Box 136, *Cape Town.* June 1899.
- 2578 **Smith, Alfred Edwin.** *Dee Street, Invercargill, New Zealand.* 9 (N.Z.C.), P.M. October 1903.
- 2579 **Smith, Alfred Ernest.** *4 Hungerford Street, Calcutta.* 2441, W.M., 64 (S.C.). May 1905.
- 2580 **Smith, Capt. Benjamin Edwin.** *15 Kahun Road, Poona, India.* 2532, P.M., 1198, P.Z. Oct. 1894.
- 2581 **Smith, Charles.** *65 Birdhurst Rise, South Croydon, Surrey.* 19. October 1895.
- 2582 **Smith, Charles Winlove.** *50 High Street, King's Lynn, Norfolk.* P.P.G.W., P.P.G.Sc.N. Oct. 1891.
- 2583 **Smith, Cornwell.** *57 Manor House Road, Newcastle-on-Tyne.* 481, P.M., 481. November 1903.
- 2584 **Smith D. Crawford.** *19 Queen Street, Perth, Scotland.* 3, P.M. March 1898.
- 2585 **Smith, Donald.** *St. Helena, Brisbane, Queensland.* 775 (S.C.). June 1900.
- 2586 **Smith, D. M.** *21 Terminus Road, Eastbourne.* 2676, W.M. January 1906.
- 2587 **Smith, E. J. Jervis, Lieut.** *85th Battery R.F.A., Harrismith, O.R.C.* 357. January 1903.
- 2588 **Smith, Edwin George.** *9 Dowanhill Road, Catford, S.E., London.* 176. May 1905.
- 2589 **Smith, George.** *Bouldercombe, v/- Rockhampton, Queensland.* 819 (S.C.). March 1897.
- 2590 **Smith, George Frederick.** *Seabourne, Bonham Road, Brixton Hill, S.W., London.* **Past Grand Organist.** June 1899.
- 2591 **Smith, Herbert.** *The Orchards, College Road, Cheshunt, Herts.* 2948, P.M. January 1904.
- 2592 **Smith, H. Squire.** *King William's Town, Cape.* 1800, P.M., 853. November 1898.
- 2593 **Smith, James.** *Commercial Bank House, Markinch, Fife, N.B.* P.Pr.G.Treas., Dumfries. **Grand Recorder.** Representative Grand Lodge and Grand Chapter, Missouri. October 1891.
- 2594 **Smith, James Thomas.** *333 Westminster Street, Providence, Rhode Island, U.S.A.* 37, 1. Oct. 1906.
- 2595 **Smith, John.** *21 Vernon Road, Edgbaston, Birmingham.* 1782, P.M., 587. October 1901.
- 2596 **Smith, John, B.E., M.I.C.E.** *County Surveyor, Ballinasloe, Ireland.* P.Pr.J.G.W., South Connaught, 137, P.K. March 1892.
- 2597 **Smith, General John Corson.** *65 Sibley Street, Chicago.* **Past Grand Master.** May 1889.
- 2598 **Smith, John Moore, F.S.I.** *96 Romford Road, Stratford, E., London.* 2291. October 1894.
- 2599 **Smith, Joseph Collett.** *Snow Hill Buildings, E.C., London.* 1965. May 1898.
- 2600 **Smith, Joseph Walter.** *6 Newington, Liverpool.* 1675, P.M. October 1905.
- 2601 **Smith, J. W.** *170 Dogsthorpe Road, Peterborough.* 2996, W.M. January 1906.
- 2602 **Smith, Kirkman, jun.** *75 Kitto Road, St. Catherine's Park, S.E., London.* 1982. January 1906.
- 2603 **Smith, Montague Howard.** *75 Queen Victoria Street, E.C., London.* 280, 280. March 1895.
- 2604 **Smith, Philip Henry Waddel.** *Westinghouse Building, Pittsburgh, Pa., U.S.A.* 576. Nov. 1905.
- 2605 **Smith, Robert, jun.** *Newcastle, Natal.* P.D.G.D.C. May 1898.
- 2606 **Smith, Robert George.** *Rostrevor, Newmarket Road, Norwich.* Pr.G.Sup.W. October 1902.
- 2607 **Smith, Robert Thursfield.** *21 Chester Road, Whitchurch, Salop.* 2311, J.W. March 1906.
- 2608 **Smith, Rev. Samuel George, D.D., LL.D.** *125 College Avenue, St. Paul, Minnesota, U.S.A.* 3 (Minn. C.). March 1900.
- 2609 **Smith, Sydney Frederick.** *Suva, Fiji.* 1931. June 1903.
- 2610 **Smith, Thomas William Christopher, M.A.** *Murtonroyd, Montseaton, Whitley Bay, Northumberland.* 2279. January 1905.
- 2611 **Smith, William Ferguson.** *Rhodesia Club, Bulawayo, South Africa.* 2566. May 1904.
- 2612 **Smith, William Henry, B.A.** *State School, Monkland, Gympie, Queensland.* 775 (S.C.), P.M., 194 (S.C.). Local Secretary for Gympie. May 1891.
- 2613 **Smith, William Leonard.** *189 Shrewsbury Road, East Ham, Essex.* 1638. March 1905.
- 2614 **Smith, W. Price.** *York House, Bangor, North Wales.* Pr.G.A.P. March 1901.
- 2615 **Smith, William Richard Albert.** *6 Florence Street, Islington, N., London.* 1511. May 1906.
- 2616 **Smithies, William Edward.** *Springfield, Elland, Yorkshire.* P.P.G.D., P.P.G.St.B. (R.A.). Oct. 1888.
- 2617 **Smyth, William Henry.** *Elkington Hall, Louth, Lincolnshire.* **Past Provincial Grand Master.** May 1890.
- 2618 **Smythe, J. Marner.** *Lane Lane, Wavertree, Liverpool.* P.Pr.A.G.D.C., W. Lancs. January 1906.
- 2619 **Snashall, Percy Barden.** *Umtali, Rhodesia.* 2479. October 1901.
- 2620 **Snell, Alfred Saxon.** *22 Southampton Buildings, Chancery Lane, W.C., London.* 33. Jan. 1906.
- 2621 **Snelling, William Walton.** *14 Semley Road, Brighton.* 1541, P.M., 1269, P.Z. March 1893.
- 2622 **Snowball, Fitzgerald.** *Stanwix, St. Aubyn's Avenue, Caulfield, Victoria.* 752 (E.C.). June 1892.
- 2623 **Snowball, Oswald Robinson.** *19 Queen Street, Melbourne, Victoria.* P.M. June 1892.
- 2624 **Soley, Alexis.** *Umtali, Rhodesia.* 786. June 1901.
- 2625 **Solomon, Albert Joseph.** *12 Ninian Road, Cardiff.* 960, W.M., 960. October 1906.

- 2626 **Solomons, Maurice E., J.P.** 26 *Waterloo Road, Dublin.* **Grand Inner Guard, Past Reg. R.A. Instruction.** March 1901.
- 2627 **Soltau, William Edward.** *Festing Grove, Southsea.* 257, P.M. May 1903.
- 2628 **Soole, William.** *Dunstable Lodge, Sheen Road, Richmond, Surrey.* 946. June 1903.
- 2629 **Sorrell, John Edward, R.N.R.** *St. Leonard's, Butt's Green Road, Hornchurch, Essex.* 19. May 1900.
- 2630 **Sounes, Clarence.** *Woodlawn, Vanbrugh Park Road East, Blackheath, S.E., London.* 723, 723. October 1902.
- 2631 **South, Benjamin Herbert.** *Grahamstown, Cape.* 651 (S.C.), P.M., 118 (S.C.), P.Z. March 1895.
- 2632 **Southam, John Downes.** *Linslade, Shrewsbury.* 262, P.M., 262, Z. March 1906.
- 2633 **Spafford, Frederick Angier.** *Flandreau, South Dakota, U.S.A.* 11, P.M., 19. May 1895.
- 2634 **Spalding, Edmund S.** 5 *Tremont Street, Boston, Massachusetts, U.S.A.* St. John's. March 1903.
- 2635 **Spalding, Frank Wilby.** 47 *Newmarket Terrace, Newmarket Road, Norwich.* 213, W.M. Oct. 1902.
- 2636 **Spalding, John Tricks, J.P.** 22 *Villa Road, Nottingham.* P.Pr.G.W., Pr.G.H., Notts. May 1894.
- 2637 **Sparks, Alfred.** *Bowmanville, Bromley Common, Kent.* 1987. May 1895.
- 2638 **Sparks, Harry James.** 72 *Cromwell Gardens, S.W., London.* **Past Grand Deacon.** P.D.D.G.M., Bengal. March 1893.
- 2639 **Spaul, H. B.** 10 *Broadway, Ludgate Hill, E.C., London.* 145, P.M. November 1901.
- 2640 **Spencer, Thomas.** 3 *Brookfield Terrace, Fairfield, near Manchester.* 1774, W.M. January 1900.
- 2641 **Spielman, Ferdinand J.** 56 *Westbourne Terrace, Hyde Park, W., London.* 559. March 1906.
- 2642 **Spill, W. A.** *Masonic Temple, Warren, Ohio, U.S.A.* 3, P.M. May 1905.
- 2643 **Springett, Bernard H.** 20 *Tudor Street, E.C., London.* 2430, P.M., 19. November 1903.
- 2644 **Sponneck, Count Carl Waldemar.** *Hop Exchange, London Bridge, S.E., London.* 2105. May 1901.
- 2645 **Squier, Hamilton R.** 206 *Broadway, New York, U.S.A.* 454. March 1899.
- 2646 **Squires, James William.** 8 *Frenches Road, Redhill, Surrey.* 176 (Wis.C.), P.M. January 1905.
- 2647 **Squires, William.** *The Hollies, Pannal, Leeds.* 1221. March 1901.
- 2648 **Stacey, William Arthur.** *Burlington, Kansas, U.S.A.* 66, W.M. May 1906.
- 2649 **Stacy, Jonathan Sargeant.** 164 *Shoreditch, E.C., London.* 1572, P.M. March 1904.
- 2650 **Stackard, Stephen Frank.** 36 *Duke's Avenue, Muswell Hill, N., London.* 807, P.M. January 1899.
- 2651 **Stafford, G.** *City Sawmills, Wellington, New Zealand.* 132 (N.Z.C.). May 1905.
- 2652 **Staley, George Whittle.** *High Street, Bognor, Sussex.* 1726. May 1906.
- 2653 **Stallard, Frederick.** 17 *Mildmay Park, N., London.* 1613, P.M. June 1906.
- 2654 **Starkey, John W.** *Gas Office, La Valletta, Malta.* P.Dep.G.M., D.G.H., Malta. Local Secretary for Malta. January 1888.
- 2655 **Starkey, Richard Ball.** *Ankerstead, Leicester.* 2429, P.M., P.P.G.W. October 1900.
- 2656 **Statter, William Aked.** *Warren House, Wakefield, Yorks.* 154, P.M., 154, P.Z. March 1890.
- 2657 **Stauffer, William Ferdinand.** *Barnsbury Works, Barnsbury Street, N., London.* 19. May 1893.
- 2658 **Staynes, William Henry.** *The Ferns, Belgrave, Leicester.* P.P.G.St.B. March 1902.
- 2659 **St. Clair, Ernest.** 48 *Hatton Garden, E.C., London.* **Past Assistant Grand Director of Ceremonies.** May 1895.
- 2660 **Stead, Col. J. Walter.** *Ridgecote, Headingley, Leeds.* 2608, P.M., Pr.G.Reg. May 1905.
- 2661 **\*Stevenson, Joseph, B.A.** *c/o H. S. King & Co., Pall Mall, S.W., London.* P.D.G.W., P.D.G.B. (R.A.), Madras. January 1893.
- 2662 **Stecker, Ernest.** *c/o B.T.A., Box 41, Bulawayo, Rhodesia.* 2479, P.M. November 1900.
- 2663 **Steele, Lawrence.** *Fernside, Waterloo Road, Freemantle, Southampton.* 359, P.M. Nov. 1891
- 2664 **Steele, William Frederick, M.B., B.S.** *Underleigh, Darwen, Lancashire.* 381, P.M., 381, P.Z. March 1898.
- 2665 **Steggles, William Henry.** *Westbrook, Godalming, Surrey.* P.Pr.G.D.C., 777, P.Z. June 1902.
- 2666 **Stephens, Edwin.** 36 *Bridge Street, Hereford.* 120, P.M., 120, P.Z. January 1903.
- 2667 **Stephens, Isaac Robert.** 2 *Orwell Terrace, Langer Road, Felixstowe.* 2371. March 1896.
- 2668 **Stephens, Samuel George.** *Toowoomba, Queensland.* P.D.G.S.B. October 1895.
- 2669 **Stephenson, William Henry.** *Messrs. Sargood & Co., Melbourne, Victoria.* 2530. March 1902.
- 2670 **Stevens, Albert Clark.** *Paterson, New Jersey, U.S.A.* 88, P.M., 33, P.H.P. May 1895.
- 2671 **\*Stevens, Daniel Collette,** F.R.G.S., F.R.C.I. *City Club, Cape Town.* 1409. May 1889.
- 2672 **\*Stevens, Frank, M.I.C.E.** P.D.G.S.B., Madras. March 1895.
- 2673 **Stevens, John Thomas.** 18 *Emanuel Avenue, Acton, W., London.* 2765. March 1902.
- 2674 **Stevens, John William, A.R.I.B.A., F.S.I.** 21 *New Bridge Street, E.C., London.* 2234, P.M., 720, P.Z. June 1891.

- 2675 **Stevenson**, James Dunlop. *Freemasons' Hall, Perth, West Australia.* **Grand Secretary.** October 1900.
- 2676 **Steward**, J. A. *The Fort Royal, Worcester.* 280, P.M., P.P.J.G.D. October 1904.
- 2677 **Steward**, Joseph Ellis. *Lane Ends, Maple Bridge, near Stockport.* P.Pr.G.D., P.Pr.G.H., Cheshire. January 1899.
- 2678 **Stewart**, Alan McKenzie. *Morden, Manitoba, Canada.* P.D.D.G.M. March 1900.
- 2679 **Stewart**, Charles H. *Melbourne, Florida, U.S.A.* **Past Grand Deacon.** 5. March 1899.
- 2680 **Stewart**, Rev. Charles Robert. *The Rectory, Basingstoke.* 3051. May 1906.
- 2681 **Stewart**, Robert. *13 Oxford Terrace, Gateshead, Durham.* 428, P.M., 48, P.Z. November 1895.
- 2682 **Steyermann**, Max. *56 Portsdown Road, Maida Vale, W., London.* 1180. November 1905.
- 2683 **Stillson**, Henry Leonard. *Bennington, Vermont, U.S.A.* 13, P.M., 39. March 1892.
- 2684 **Stimson**, Edward. *52 Brixton Hill, S.W., London.* 15, P.M. May 1898.
- 2685 **Stimson**, Edwin Charles, A.R.I.B.A. *22 Atherton Road, Forest Gate, E., London.* 2376. Jan. 1896.
- 2686 **Stitt**, Rev. Samuel Stewart, M.A. *Stretham Rectory, Ely.* P.Pr.G.Chap., Hants and Isle of Wight. March 1896.
- 2687 **St. John**, Louis Frederick. *33 Havelock Road, Hastings.* 1184, 40. Local Secretary for East Sussex. May 1894.
- 2688 **Stockings**, William F. *22 Newmarket Road, Norwich.* 943, P.M. October 1902.
- 2689 **Stocks**, William Henry. *Weem, Aberfeldy, N.B.* **Past Grand Organist.** March 1902.
- 2690 **Stohwasser**, Lieut.-Col. Francis Joseph. *103 Priory Road, West Hampstead, N.W., London.* 569. June 1903.
- 2691 **Stokes**, Charles. *Cecil House, Highfields, Sheffield.* 1239, P.M. October 1900.
- 2692 **Storey**, Robert. *Dean Street, Shildon, R.S.O., Co. Durham.* 2415. January 1901.
- 2693 **Story**, John Alexander. *84 Oxford Street, W., London.* 1287. March 1903.
- 2694 **Stow**, Ernest Charles Sargent. *Thornton House, Hull Road, Hessle, near Hull.* 250, P.M. January 1906.
- 2695 **Stowell**, Clarence Warner. *357 Westminster Street, Providence, Rhode Island, U.S.A.* 22. May 1906.
- 2696 **\*Strangways**, Leonard R., M.A., M.R.I.A., F.R.S.A.I. *8 Luxemburg Gardens, Brook Green, W., London.* 357, 33. March 1898.
- 2697 **Stratton**, Buchan Francis. *55 Barrowgate Road, Chiswick, S.W., London.* 49, P.M., 22, P.Z. November 1895.
- 2698 **Stratton**, William Joseph. *12 Algernon Road, Kilburn, N.W., London.* P.Pr.G.D.C., Bucks. March 1899.
- 2699 **Strochlin**, Dr. Paul Charles. *6 Rue des Puits, St. Pierre, Geneva.* Lodge Union et Travail. October 1906.
- 2700 **Stuart**, Alick Graham. *Mackay, Queensland.* 737 (S.C.). November 1900.
- 2701 **Stubbs**, Dr. Percy Belford Travers, J.P. *Wynberg, Cape Town.* 2577, P.M. March 1897.
- 2702 **Stubington**, Arthur Stuart. *15 Kinnoull Mansions, Rowhill Street, Clapton, N.E., London.* 1347. November 1898.
- 2703 **Sturrock**, Capt. G. C., R.A. *Cordite Factory, Wellington, India.* 2885. October 1903.
- 2704 **Sturton**, John Gilbert. *Broad Street, Peterborough.* 2996. May 1905.
- 2705 **Stuttaford**, William Foot. *Cleveland, Worcester Park, Surrey.* P.D.G.Tr., W.D.S.A. June 1897.
- 2706 **Subrahmanyam**, N. Barrister, Gov. Pleader. *The Luz, Madras.* Dis.G.Treas. June 1893.
- 2707 **Sudlow**, Robert Clay. *Snow Hill Buildings, E.C., London.* **Past Assistant Grand Director of Ceremonies, Past Deputy Grand Director of Ceremonies (R.A.).** October 1892.
- 2708 **Sully**, John. *46 Cannon Street, E.C., London.* 1804, P.M., 1716, J. November 1905.
- 2709 **Sumner**, Reginald Philip. *Westfield House, Gloucester.* P.P.G.W. January 1895.
- 2710 **Sundstrom**, Carl Alfred. *4444 Main Street, Manayunk, Philadelphia, U.S.A.* 444, P.M., 175, P.H.P. October 1904.
- 2711 **Sutton**, S. John. *Darabe, via Emtento, Tembuland, South Africa.* October 1894.
- 2712 **Swales**, William. *38 Blackwellgate, Darlington.* 1650, P.M., 111, P.Z. June 1905.
- 2713 **Sweatman**, J. A. *80 Bowes Road, Palmers Green, N., London.* 183. March 1901.
- 2714 **Sweet**, John Thomas. *7 Lancaster Place, Strand, W.C., London.* 2721, P.M. June 1897.
- 2715 **Swift**, Frank. *6 Queen Anne's Gate, Westminster, S.W., London.* 2024. June 1906.
- 2716 **Swinden**, Francis George. *27 Temple Street, Birmingham.* Pr.G.Sec. **Past Deputy Grand Sword Bearer, Past Assistant Grand Director of Ceremonies (R.A.).** January 1893.
- 2717 **Swinn**, Charles. *125 Upper Moss Lane, Manchester.* P.Pr.G.D., P.Pr.G.Sw.B. (R.A.). June 1894.
- 2718 **Swinstead**, Rev. John Howard. *Chalgrove, Wallingford, Berks.* 357. January 1905.
- 2719 **Sykes**, Edwin. *Union Bank Yard, New Street, Huddersfield.* 1783. January 1904.

- 2720 \*Symns, Robert Corser Montfort, I.C.S. *c/o A. Scott & Co., Rangoon, Burma.* D.G.J.W., D.G.P.J. March 1901.
- 2721 Symonds, George John. *76 Whitshall Park, N., London.* 183, P.M. June 1897.
- 2722 Symons, William Wallace. *7 Farcliffe Terrace, Bradford.* 2321, 302. January 1906.
- 2723 Taber, George H. *Frick Building, Pittsburgh, Pa., U.S.A.* 51, 91. January 1906.
- 2724 Tackley, Rev. Frederick James, M.A. *The Vestry, Parish Church, Bradford.* P.D.G.Chap., 2538. October 1898.
- 2725 Tailby, William. *89 Herbert Road, Plumstead, Kent.* 13, P.M., 13, P.Z. May 1893.
- 2726 Tallent-Bateman, Charles Tallent. *40 Brazenose Street, Manchester.* 1375. March 1900.
- 2727 Tarnay, Henri. *Zelinka Gasse, Vienna.* Schiller Lodge. October 1899.
- 2728 Tarrant, Herbert. *Colombo, Ceylon.* 2170. March 1899.
- 2729 Tarrant, W. H. *Witney, Oxon.* 1703, P.M. January 1897.
- 2730 Tate, Clement John Gifford. *Bloemfontein, Orange River Colony.* 1022, P.M. January 1899.
- 2731 Tate, John. *Bawnmore, Whitehouse, Co. Antrim.* **Past Grand Deacon.** P.Dep.Dis.Gr.Master, Bombay. October 1893.
- 2732 Tate, Leonard George. *20 Bucklersbury, E.C., London.* 1351, 19. March 1904.
- 2733 Taubman, Edward Teare. *Aberdeen, South Dakota, U.S.A.* 38, P.M., 14. May 1895.
- 2734 Taylor, Charles Clement Jennings. *Derby Villa, Derby Road, Kenilworth, Cape Town.* 1409, 153 (S.C.). March 1889.
- 2735 \*Taylor, Edward Reginald. *Medomsley, Sidcup, Kent.* 190. March 1900.
- 2736 Taylor, Francis Robert. *34 Hawarden Grove, Herts Hill, S.E., London.* 2416. January 1905.
- 2737 \*Taylor, George Frederick. *Ashmount, Shirley, Birmingham.* 2480, 2678. May 1905.
- 2738 \*Taylor, George William, A.I.N.A. *116 Cannon Street, E.C., London.* 171, 140. October 1889.
- 2739 Taylor, Henry, F.S.A. *12 Curzon Park, Chester.* 425, P.M., Pr.G.Reg. March 1901.
- 2740 Taylor, John, J.P., F.L.S., F.C.S. *15 Lucius Street, Torquay.* P.Pr.G.W., P.Pr.G.Sc.N. Jan. 1888.
- 2741 \*Taylor, John Arnold. *166 High Street, Clapham, S.W., London.* 1056. January 1905.
- 2742 Taylor, Joseph Henry. *29 Lee Terrace, Blackheath, S.E., London.* 1275. October 1905.
- 2743 Taylor, Robert William. *Skagway, Alaska, U.S.A.* 113 (Wash. C.), P.M. October 1903.
- 2744 Taylor, Roland James. *31 Northampton Street, Birmingham.* 739, 739. June 1906.
- 2745 Taylor, Thomas. *Rosendale, The Brampton, Newcastle, Staffordshire.* **Past Junior Grand Deacon, Past Deputy Grand Sword Bearer (R.A.).** May 1900.
- 2746 Taylor, William. *54 Earlesfield Road, Wandsworth Common, S.W., London.* 2455. Nov. 1903.
- 2747 Taylor, D. A. *Waimate, Canterbury, New Zealand.* 99, P.M. October 1904.
- 2748 Taylor, William Campbell. *1 Horseguard's Avenue, S.W., London.* 913, P.M., P.Z. March 1898.
- 2749 Taylor-Brown, Dr. J. Box 63, *Jeppesstown, Transvaal.* 265 (I.C.), P.M. June 1898.
- 2750 Temple, Dr. Thomas Cameron. *Shefford, R.S.O., Bedford.* 2620. May 1901.
- 5751 Tennant, David, jun. Box 232, *Cape Town.* De Goede Hoop Lodge. November 1898.
- 2752 Terry, Major-General Astley. *26 Inglis Road, Colchester.* **Past Grand Sword Bearer.** October 1897.
- 2753 Terry, Major Astley Herbert, A.S.C. *The Hermitage, Headington, Oxford.* P.Z., P.G.W., Guernsey and Alderney. March 1899.
- 2754 Terry, James. *143 Tufnell Park Road, N., London.* **Past Grand Sword Bearer.** June 1888.
- 2755 Terry, John Albert. *Melrose House, Hamlet Court Road, Westcliff-on-Sea.* 975. March 1902.
- 2756 Tharp, Henry Walter. *Merboro House, Knighton Drive, Leicester.* 49. May 1895.
- 2757 Tharp, John Alfred. *9 Norton Folgate, Bishopsgate, E.C., London.* 1228, 55. November 1895.
- 2758 Tharp, William Anthony. *86 Ladbroke Grove, W., London.* 49. May 1895.
- 2759 Thaxter, Frank William. *1224 Monroe Avenue, Kansas City, Missouri, U.S.A.* 316, P.M. Oct. 1899.
- 2760 Thibaut, John Stanley. *Donaldsonville, Louisiana, U.S.A.* 251, 2. June 1896.
- 2761 Thomas, Alfred James. *30 Regent Street, S.W., London.* 1, P.M. **Past Assistant Grand Director of Ceremonies (R.A.).** March 1900.
- 2762 Thomas, Hugh James Protheroe. *Tyggwyn, Haverfordwest.* 464. May 1906.
- 2763 Thomas, J. J. *24 Cavendish Road, Brondesbury, N.W., London.* **Past Grand Standard Bearer.** November 1894.
- 2764 Thomas, John. *10 West Terrace, North Ormesby, Middlesborough.* P.Pr.G.Sup.W., N. and E. Yorks. October 1898.
- 2765 Thomas, John Douglas. *Eton, Mackay, Queensland.* 2624, P.M. October 1895.
- 2766 Thomas, John Lloyd. *160 Bleecker Street, New York, U.S.A.* 28, P.M., 8. June 1903.

- 2767 **Thomas**, Richard Griffith, M.S.A., F.I.A.S. *Victoria Hotel, Menai Bridge, North Wales.* P.Pr.G.Sup.W., P.Pr.G.A.So., North Wales. May 1894.
- 2768 **Thomas**, Robert Anwyl. *Council Chambers, Guildford, West Australia.* **Grand Director of Ceremonies.** May 1901.
- 2769 **Thomas**, Lieut.-Col. William Frederick, M.D., I.M.S. *Madras.* 260, P.M. March 1900.
- 2770 **Thomas**, William Kingdon. *42 Triangle, Clifton, Bristol.* P.Pr.G.Sup.W., Somerset. June 1891.
- 2771 **Thompson**, A. J. *10 Drury Lane, Liverpool.* 2433, P.M., P.Z., P.Pr.G.S.B., Cheshire. March 1906.
- 2772 **Thompson**, Edward James. *Blackall, Queensland.* 2207. March 1896.
- 2773 **Thompson**, Frank J. *Fargo, North Dakota, U.S.A.* **Grand Secretary (C. & R.A.), Past Grand Master, North Dakota.** October 1894.
- 2774 **Thompson**, James Thomas. *51 Hamilton Square, Birkenhead.* P.Pr.G.R., P.Pr.G.St.B. (R.A.), Cheshire. January 1894.
- 2775 \***Thompson**, John. *Albion Brewery, Mile End, E., London.* 2242. November 1892.
- 2776 **Thompson**, John Campbell, J.P. *Perth House, Anlaby Road, Hull.* 1010, P.M. May 1906.
- 2777 **Thompson**, John William. *Newholme, Heaton, Bolton, Lancs.* P.P.G.D., E. Lancs. March 1892.
- 2778 **Thompson**, Ralph. *2 Silver Street, Berwick-on-Tweed, Northumberland.* P.Pr.G.W. March 1890.
- 2779 **Thompson**, Reginald Swire. *Box 157, Salisbury, Rhodesia.* 2792, P.M. May 1905.
- 2780 **Thompson**, William Roper. *44 Victoria Road, Alexandra Park, Wood Green, N. London.* 1507, P.M., 2397, P.Z. January 1896.
- 2781 \***Thomson**, Andrew. *Middle Crescent, Middle Brighton, Victoria.* **Past Grand Deacon, Past Grand Director of Ceremonies (R.A.), Victoria.** June 1892.
- 2782 **Thomson**, Matthew. *34 Poplar Grove, West Kensington Park, W., London.* 2795, 3144. Oct. 1906.
- 2783 **Thomson**, Octavius Leopold. *47 Lincoln's Inn Fields, W.C., London.* 1624. November 1903.
- 2784 **Thorne**, William. *Adderley Street, Cape Town.* 398 (S.C.). June 1894.
- 2785 **Thornton**, Robert S., M.B. *Deloraine, Manitoba, Canada.* **Past Grand Master.** Local Secretary for Manitoba. May 1897.
- 2786 \***Thornton**, William Eber. *Deynecourt, Frodsham, Warrington.* 2651. June 1897.
- 2787 **Thornton**, William Henry Lindsay. *Tower Hill, Aubigny, Toowoomba, Queensland.* 2338. October 1893.
- 2788 **Thwaites**, C. *22 Chancery Lane, E.C., London.* 2319. March 1899.
- 2789 **Tickle**, William John Wilson. *Seaview, Slindon, near Arundel, Sussex.* 1765. October 1903.
- 2790 **Tidman**, Charles W. *Tunstall Avenue, West Hartlepool.* 940, P.M. January 1899.
- 2791 **Tiffany**, William Henry. *P.O.B. 387, Cape Town.* Lodge de Goede Hoop. Hon. Sec. Masonic Education Fund of South Africa. Local Secretary for South Africa, West Division. May 1897.
- 2792 **Tiljou**, Charles J. B. *County Court, Bow Road, E., London.* **Past Grand Standard Bearer, Past Assistant Grand Pursuivant.** January 1898.
- 2793 **Timme**, Henry Frederick Oscar. *14 Billiter Street, E.C., London.* 238, 1615. January 1902.
- 2794 **Timms**, Thomas Martin. *22 Knatchbull Road, Camberwell, S.E., London.* 857. March 1905.
- 2795 **Tipper**, Harry. *35 The Grove, Hammersmith, W., London.* **Past Assistant Grand Pursuivant, Past Assistant Grand Director of Ceremonies (R.A.)** June 1889.
- 2796 **Tobias**, Henry A. *20 St. Catherine's Terrace, Hove, Sussex.* **Past Grand Standard Bearer.** October 1903.
- 2797 **Todd**, John J. *12 High Street, Paisley, N.B.* 129, Sub.M. March 1905.
- 2798 **Todd**, Thomas Olman. *7 Winifred Terrace, Sunderland.* P.Pr.G.St.B. (C. & R.A.) January 1898.
- 2799 **Todd**, William George. *1 French Church Terrace, Waterford.* 32, P.M., 32, P.K., P.Pr.G.S.D. March 1906.
- 2800 **Tomlinson**, Sir William Edward Murray, Bart., M.P. *3 Richmond Terrace, Whitehall, S.W., London.* **Past Grand Deacon.** March 1901.
- 2801 **Tonkin**, Alfred James. *St. Ives, Werrall Road, Clifton, Bristol.* 1755, 935. November 1892.
- 2802 **Tonkin**, Rev. Charles Douglas. *Stamford Hill, Durban, Natal.* D.G.Chap. May 1898.
- 2803 **Toomey**, Mark Antony. *283 Castlereagh Street, Sydney, New South Wales.* P.M. **Deputy Grand Secretary.** Local Secretary for New South Wales. October 1906.
- 2804 **Totton**, Joseph Harold. *102 Wymering Mansions, Elgin Avenue, W., London.* 243 (I.C.). March 1906.
- 2805 **Tovey**, Duncan. *15 Joubert's Mansions, Chelsea, S.W., London.* 2771. January 1903.
- 2806 **Townend**, Harry. *16 Cornhill, E.C., London.* 180. March 1895.
- 2807 **Townley**, Frederick M. *Sayreville, Middlesex Co., New Jersey, U.S.A.* 63, 4. March 1904.
- 2808 **Tozer**, Edward. *84, Fenchurch Street, E.C., London.* 3049, 58. June 1905.
- 2809 **Treleaven**, Philip William John. *40 Queen Street, Portsmouth.* 342, 342. January 1903.

- 2810 \***Trentham**, George. *Calthorpe Houss, Gough Road, Edgbaston, Birmingham.* 1246, 482. Oct. 1900.
- 2811 **Trevor-Smith**, James. 1 *North Parade, Parsonage, Manchester.* 1458, P.M. October 1905.
- 2812 **Trotman**, George. 52 *Station Road, Bedford Park, Chiswick, W., London.* 1329. May 1904.
- 2813 **Truslove**, William. *Sussex Villa, Bushey Heath, Watford.* 1549, 3069, P.M. 1549, P.Z. October 1906.
- 2814 **Tulloch**, Col. J. *Baluoon, Orchard Road, Eastbourne.* January 1903.
- 2815 **Turle**, John Glanville. *Abbey Mount, Torquay.* 1402, P.M., 1402. May 1899,
- 2816 **Turnbull**, Edmund J. 69 *Tierney Road, Streatham, S.W., London.* 1524, P.M., 2030. P.Z. January 1897.
- 2817 **Turner**, A. E. 125-129 *Rosebery Avenue, E.C., London.* 1839, P.M. March 1906.
- 2818 **Turner**, C. A. *Moulmein, Burma,* P.Dis.G.Sup.Wks., D.G.S. November 1896.
- 2819 **Turner**, George Edward. *Purbeck, Blandford, Dorset.* P.Pr.Sup.W. March 1892.
- 2820 **Turner**, John J. C. *Essex Hall, Colchester.* **Past Grand Standard Bearer, Past Assistant Grand Director of Ceremonies (R.A.)** June 1900.
- 2821 **Tweddill**, Samuel Milburn. *Pretoria, Transvaal.* Lodge Connaught (I.C.) P.M. January 1906.
- 2822 **Twiss**, Lt. Col. George Edward, R.A.M.C. *Netley Cliff, Netley, Hants.* 1436, P.M., 1461, Z. January 1899.
- 2823 **Tyacke**, William, jun. 142 *Market Street, Newark, New Jersey, U.S.A.* P.D.D.G.M., Grand Representative Grand Lodge of Georgia. January 1904.
- 2824 **Tyndale-Biscoe**, Major A. S., R.F.A. *Hulme Barracks, Manchester.* 988. October 1896.
- 2825 **Uhlig**, Curt Oscar. *Broad Street Place, Blomfield Street, E.C., London.* 1969. October 1897.
- 2826 **Ulstrup**, A. Norman. *Stavanger, Norway.* 5. January 1899.
- 2827 **Unwin**, Arthur Harry. *Rosario Electric Co., Rosario de Santa Fé, Argentine Republic.* 2960, J.D., 1553. January 1906.
- 2828 **Upton**, Hon. William Henry, M.A., L.L.M., F.R.S.A. *Walla Walla, Washington, U.S.A.* **Past Grand Master.** Local Secretary for Washington. March 1893.
- 2829 **Uttley**, Edwin A. P.O. Box 38, *Buluwayo, Rhodesia.* 2464, 2566. June 1906.
- 2830 **Van Der Gon**, Dr. W. H. Denier. 45 *Valerius Straat, Amsterdam.* October 1906.
- 2831 **Van Duzer**, F. C. 114 *Southampton Row, W.C., London.* **Past Assistant Grand Director of Ceremonies.** June 1906.
- 2832 **Vane-Stow**, Major Harry. 24 *Holborn, E.C., London.* **Past Deputy Grand Sword Bearer.** June 1902.
- 2833 **Van Heerde**, Gerrit. 2 *Pepper Street, Cape Town.* Lodge de Goede Hoop. November 1899.
- 2834 \***Vassar-Smith**, Richard Vassar. *Charlton Park, Cheltenham.* **Past Grand Deacon.** November 1888.
- 2835 **Vaughan**, J. C. M. *Whitecross, Hereford.* 120, P.M., 120 (S.C.), P.P.G.P. March 1900.
- 2836 **Vaughan**, Lieut.-Col. T. T., R.A. *Fort St. George, Madras.* May 1889.
- 2837 **Vaux**, T. R. *The Oaks, Ilkley, Yorkshire.* P.Pr.G.Sup.W., West Yorkshire. June 1897.
- 2838 **Veale**, Dr. Herbert Prior. *Crow Pharmacy, Pretoria, Transvaal.* 770 (S.C.), P.M., 231 (S.C.), P.Z. October 1903.
- 2839 **Venables**, Rowland George. *Oakhurst, Oswestry, Shropshire.* **Past Assistant Grand Director of Ceremonies, Past Grand Standard Bearer (R.A.), England,** January 1889.
- 2840 \***Vernon**, William. *Teanhurst, Tean, Stoke-on-Trent.* P.Pr.G.S.B. May 1899.
- 2841 **Vibert**, Arthur Lionel, I.C.S. *Madura, Madras.* P.Dis.G.D., P.Pr.G.S.B. Local Secretary for Madras, Bombay, N.W. Provinces and Oudh. January 1895.
- 2842 **Vicars**, Sir Arthur, F.S.A., Ulster King of Arms. *Dublin Castle.* XXV. January 1898.
- 2843 **Vickers**, Sydney Furze. 6 *Devonshire Square, E.C., London.* 1704, P.M. June 1903.
- 2844 **Vigo**, James George. 31 *York Terrace, Regent's Park, N.W., London.* 1671, P.M. October 1898.
- 2845 **Vine**, George Henry Meston. 85 *Aldersgate Street, E.C., London.* 3111. March 1906.
- 2846 **Vogel**, C. 53 *Leadenhall Street, E.C., London.* 238. March 1902.
- 2847 **Vogeler**, G. 17 *Philpot Lane, Fenchurch Street, E.C., London.* 238. June 1903.
- 2848 **Vreede**, Dirk E. *Port Elizabeth, Cape Colony.* 711. June 1898.
- 2849 **Wacha**, Bhicafee Eduljee. *Bruce Road, Quetta, Baluchistan.* January 1903.
- 2850 **Wade**, Henry Logan. *Legal Chambers, Auckland, New Zealand.* 689. March 1901.
- 2851 **Wade**, Samuel Duncombe. 29 *Gracechurch Street, E.C., London.* 1228, P.M. November 1893.
- 2852 **Waite**, Arthur Edward. *Sidmouth Lodge, South Ealing, W., London.* 2430. March 1902.



- 2853 **Wakeford**, George William. *Charlottetown, Prince Edward's Island, Canada. Grand Lecturer, Past Grand Secretary, Past Deputy Grand Master of Prince Edward's Island, Past Grand King, Grand Chapter of Nova Scotia.* March 1888.
- 2354 **Walden**, Robert Woolley. *Bella Vista, Upper Warlingham, Surrey.* 2882. March 1903.
- 2855 **Wale**, Percy W. *Stanmore, Weelingsborough Road, Northampton.* 2431. March 1906.
- 2856 **Waley**, Capt. John D. *23 Bryanston Square, W., London.* 2524, W.M. May 1906.
- 2857 \***Walker**, Alexander. *City Chambers, Glasgow.* 873, P.M., 122, P.Z. October 1901.
- 2758 **Walker**, Frank. *c/o British Westinghouse Co, 65 Renfield Street, Glasgow.* 2144. October 1906.
- 2859 **Walker**, Col. G. Walton. *The Firs, West Bromwich.* Dep.Prov.Gr.Master, Pr.G.Sc.E., Staffords. November 1904.
- 2860 **Walker**, John. *504 Oxford Street, W., London.* 30. May 1906.
- 2861 **Walker**, Maurice Anson. M.D. *Dillon, Montana, U.S.A.* 30, 8. January 1903.
- 2862 **Walker**, William Henry. *87 Pepys Road, New Cross, S.E., London.* 2272, P.M. January 1906.
- 2863 **Wallbach**, Quarter-Master Lieut. D. *Zunguru, West Africa.* 1065, P.M. November 1898.
- 2864 **Wallis**, John George. *31 Albion Street, Hull.* 1511, P.M., 1511, P.Z. October 1906.
- 2865 **Wallis**, R. F. *Box 139, Krugersdorp, Transvaal.* 2643, P.M., D.G.D.C. Local Secretary for Krugersdorp. May 1898.
- 2866 **Wallis**, Hamilton. *48 Wall Street, New York. Past Grand Master, New Jersey.* June 1895.
- 2867 \***Wallis**, Walter Joseph. *Oudtshoorn, Cape Colony.* 2088. May 1902.
- 2868 **Walsh**, Albert. *Box 39, Cape Town. P.Dis.G.W., Eastern Division, South Africa.* June 1897.
- 2869 **Walters**, Francis Isaac. *Parambore, Madras. P.Dis.G.D., P.Pr.G.Soj. (R.A.).* June 1896.
- 2870 **Waltho**, Peter. *The Beeches, Perry Bar, Staffordshire.* 482, 482. October 1905.
- 2871 **Wanamaker**, John. *Wyncote, Montgomery Co., Pennsylvania, U.S.A.* 400. October 1904.
- 2872 **Warburton**, Samuel. *Egerton Lodge, Bury Old Road, Manchester. P.Pr.G.St.B., P.Pr.G.S.B. (R.A.).* March 1897.
- 2873 **Ward**, Martindale C., M.D., J.P. *Saltburn, Twickenham, Middlesex.* 23, P.M. June 1898.
- 2874 **Ward**, Walter B. *161 Broadway, New York.* 33, P.M., 16, P.H.P. May 1898.
- 2875 **Wardman**, George. *10 Oakburn Road, Ilkley, Yorks.* 1042, 1042. November 1896.
- 2876 **Warliker**, Lieut.-Col. Damodar, I.M.S. *25th M.I., Mauritius.* P.M. October 1896.
- 2877 **Warne**, John Herbert. *128 Florence Road, Wimbledon, S.W., London.* 2822. January 1905.
- 2378 **Warner**, William Thomas. *15 Streathbourne Road, Upper Tooting, S.W., London.* 2272, P.M., P.Pr.G.So., Essex. May 1890.
- 2879 **Warren**, Herbert George. *13 Victoria Street, Westminster, S.W., London.* 1719. June 1904.
- 2880 **Warren**, James Syer. *Little Neston, Chester.* 979, P.M., 321, Z. January 1894.
- 2881 **Warrington**, Capt. Albert Francis Grosvenor. *S. S. Envoy, Tavoy, Lower Burma.* 542. Oct. 1901.
- 2882 **Warvelle**, George W. *115 Dearborn Street, Chicago, Illinois, U.S.A.* P.M. **Grand High Priest.** March 1894.
- 2883 **Warwick**, Henry Sidney Robert. *Battleford, North West Territory, Canada.* 2507. May 1901.
- 2884 **Washburn**, T. A., jun. *Bell Lane, Gloucester.* 839. June 1900.
- 2885 **Washington**, Thomas Lowndes. *Marsa, Malta.* P.D.G.D. March 1900.
- 2886 **Waterlow**, Paul Langborne. *Foreland, Bembridge, Isle of Wight.* 2545, P.M. May 1902.
- 2887 **Watson**, Daniel Ernest. *6 Lurline Gardens, Battersea Park, S.W., London.* 973. January 1898.
- 2888 **Watson**, Harold Bernard. *97 Hopton Road, Streatham, S.W., London.* 2096. June 1905.
- 2889 \***Watson**, James Procter, J.P. *Castle Carrock, Cumberland, and Bombay.* 944. May 1897.
- 2890 **Watson**, John R. *Westbrook, Darlington.* 1650. June 1905.
- 2891 **Watson**, Reginald Cyrus. *30 Bedford Row, W.C., London.* 2427. March 1902.
- 2892 **Watson**, W. *Box 17, Potchefstroom, Transvaal.* 2828, P.M., 307 (S.C.), P.Z. January 1903.
- 2893 **Waugh**, William James. *Seawood, Grange-over-Sands, Lancashire.* 1545, P.M., 600. March 1889.
- 2394 **Way**, the Rt. Hon. Sir Samuel James, P.C., D.C.L., LL.D., Chief Justice. *Freemasons' Hall, Flinders Street, Adelaide. Grand Master, South Australia.* January 1891.
- 2395 **Wearne**, Charles Francois R. *127 Murray Street, Perth, West Australia.* June 1900.
- 2396 **Weatherilt**, Henry Charles. *Tsao, Palapye Road Station, British Protectorate, South Africa.* 1417. October 1889.
- 2897 **Weatherby**, Arthur Andrew Henry Wynne. *Christian Street, Kimberley, South Africa.* 1574. March 1905.
- 2898 **Weaver**, S. B. *Ankle Hill, Melton Mowbray.* 1130, P.M. March 1906.
- 2899 **Webb**, J. *Clovelly, Grove Park, Camberwell, S.E., London.* 92. January 1896.
- 2900 **Webb**, J. A. *Roseneath, Elm Park, Stanmore, Middlesex.* 1549. May 1902.

- 2901 **Webb, W. Howard.** 43 *Fassett Road, Kingston-on-Thames.* 1973. June 1905.
- 2902 **Webb, William Sidney.** 24 *Elmer Road, Catford, S.E., London.* 1299. November 1901.
- 2903 **Webber, William Henry.** 7 *Great James Street, Bedford Row, W.C., London.* 2374. January 1906.
- 2904 **Webster, Alfred George, M.D.** *Ashleigh, Golcar, near Huddersfield.* 1645, 1645. March 1901.
- 2905 **Webster, George.** *Middleton, N.E. Railway, South Africa.* 1581, P.M. May 1892.
- 2906 **Webster, W. R.** *Warkworth House, Bulwer Road, Leytonstone.* 2663. January 1906.
- 2907 **Weeden, Sydney A.** *Dogmar House, Rydon Crescent, Roseberry Avenue, E.C., London.* March 1900.
- 2908 **Weeks, William Self.** Local Secretary Historical Society of Lancashire and Cheshire. *Clitheroe, East Lancashire.* P.Pr.G.Reg. (C. & R.A.), East Lancashire. March 1891.
- 2909 **Weigall, Rev. Edward Mitford.** *Frodingham Vicarage, Doncaster.* P.Pr.G.Chap., P.Pr.G.So., Lincolnshire. March 1889.
- 2910 **Weiss, Arnold.** 70 & 71 *Chiswell Street, E.C., London.* 1017, P.M. March 1903.
- 2911 **Weiss, Fred.** 49 *Culmington Road, Ealing, W., London.* 1297. May 1902.
- 2912 **Weiss, J. H.** *Portland House, Basinghall Street, E.C., London.* 238. June 1903.
- 2913 **Welch, J. B.** *Eqjington, Leighton Buzzard, Bedfordshire.* 1524. March 1897.
- 2914 **Wellcome, Henry Solomon.** *Snow Hill Buildings, E.C., London.* 3, P.M. January 1904.
- 2915 **Weller-Poley, Thomas.** *West Broyle, Chichester, Sussex.* **Past Grand Deacon.** Dep.Pr.G.M. October 1906.
- 2916 **Wells, Arthur W.** *Parkstone, Maybury, Woking, Surrey.* 2. June 1903.
- 2917 **Wells, Bryan Walter.** *Mutdapilly, Queensland.* 803 (S.C.). May 1898.
- 2918 **Wells, Dr. Charles.** *Fairfield, Cookham Dean, Berkshire.* 2323, P.M. November 1895.
- 2919 **Welsford, William Oakley.** 15 *Great Queen Street, W.C., London.* 1321, P.M., P.Z. October 1900.
- 2920 **\*Welsh, William Henry.** *Dovedale, Blockley, Worcestershire.* 2183. June 1899.
- 2921 **Wemyss, John.** *Neepawa, Manitoba, Canada.* 24, P.M. May 1901.
- 2922 **Wenborn, F. M.** 139 *Green Lane, N., London.* 2361, P.M. June 1904.
- 2923 **Werbeck, J.** *Winckelmannstrasse 2, Dresden.* Zum Goldenen Kreuz. March 1905.
- 2924 **West, Henry Hebard.** *Southern Pacific Railway, Arcade Depot, Los Angeles, California, U.S.A.* 290, 57. June 1904.
- 2925 **West, William Washington.** 16 *Erskine Road, Walthamstow, Essex.* 2664. March 1898.
- 2926 **Weston, Samuel Thomas.** 9 *Church Road, Allahabad.* 269, 391, J.D. 269, 391. June 1900.
- 2927 **Westropp, Thomas Johnson, M.A., M.R.I.A.** 115 *Strand Road, Sandymount, Dublin.* 143, P.M. November 1897.
- 2928 **Westwood, W. F. T.** *May Court, Alexandra Road, Addiscombe, Croydon, Surrey.* 1790, P.M. January 1904.
- 2929 **Wetherell, Charles.** *Keppel's Head Hotel, Portsmouth.* 3040. May 1905.
- 2930 **Whadcoat, John Henry, F.R.G.S., F.S.S., M.S.A, F.C.A., etc., J.P.** *Bodiam Manor, Bodiam, Sussex.* **Past Grand Deacon.** March 1894.
- 2931 **Wheeler, Willoughby.** Box 1025, *Pretoria, Transvaal.* 770 (S.C.). May 1906.
- 2932 **Wheelwright, John Bolland.** Box 1222, *Cape Town.* **Past Assistant Grand Director of Ceremonies, Past Grand Standard Bearer (R.A.).** October 1891.
- 2933 **Whiley, Edwin.** *Zeerust, Transvaal.* 1946, P.M. October 1893.
- 2934 **Whish, John David.** Box 39, *Capitol P.O., Albany, New York, U.S.A.* 452, P.M., 242. June 1900.
- 2935 **Whitaker, George.** 19 *Park Road, Bingley, Yorks.* 408, P.M., 408. January 1906.
- 2936 **Whitaker, W. S.** 226 *Barry Road, East Dulwich, S.E., London.* **Past Assistant Grand Pursuivant.** March 1898.
- 2937 **White, Charles.** *Royal Hotel, Rangoon, Burma.* 2735, P.M. May 1906.
- 2938 **White, Henry Pearson.** 34 *Barry Road, East Dulwich, S.E., London.* 1541, P.M., 1901. Jan. 1905.
- 2939 **White, J., jun.** 28 *Badge Row, Cannon Street, E.C., London.* 176, P.M. June 1895.
- 2940 **White, Joseph Walwyn.** *Huntley, Hunt's Cross, Liverpool.* 1908, P.M. June 1894.
- 2941 **White, Thomas Jeston.** 8 *Maldon Road, Acton, W., London.* 860, 860. May 1898.
- 2942 **White, William Alfred.** *Pullman, Whitman Co., Washington, U.S.A.* 21, P.M. January 1902.
- 2943 **White, W. H.** 1 *St. John's Wood Road, N.W., London.* 2488. March 1905.
- 2944 **Whitehead, J. Fred.** 24 *Balliol Road, Bootle, Liverpool.* 793 (S.C.), 159 (I.C.). June 1895.
- 2945 **Whitham, Sam F.** *The Drive, Roundhay, Leeds.* 380, P.M., P.Z., P.Pr.A.G.D.C. January 1906.
- 2946 **Whitley, Edward Forbes.** Mem. R.I., Cornwall. *Woodville, Truro, Cornwall.* P.Pr.G.J.W., P.P.G.J. March 1887.
- 2947 **Whittle, F. M.** *Beech Lea, Montague Road, Sale, Cheshire.* 163, P.M. May 1906.
- 2948 **Whysall, William Edward.** *Loco. Works, C.S.A.R., Pretoria, Transvaal.* 952 (S.C.). October 1906.
- 2949 **Wiebe, Carl Cornelius.** *Hagenau 5, Hamburg.* **Past Grand Master, Hamburg.** May 1895.

- 2950 **Wigginton**, Edward John Doherty. 40 *Tweedy Road, Bromley, Kent.* 1820, W.M. March 1903.
- 2951 **Wilbur**, Newell Lee. 511 *Butler Exchange, Providence, Rhode Island, U.S.A.* 36, P.M., 1.  
**Grand Musical Director, R.A.** June 1889.
- 2952 **Wilcox**, C. R. *Seattle, Washington, U.S.A.* 3, 27. November 1894.
- 2953 **Wild**, Lewis. 21 *Elms Avenue, Muswell Hill, N., London.* 813. January 1899.
- 2954 **Wiley**, P. J. 30 *Hawes Road, Bromley, Kent.* 1437. January 1902.
- 2955 **Wilke**, George. *Furstenwallstr. 18, Magdeburg, Germany.* Lodge z. goldenen Krone. Nov. 1898.
- 2956 **Wilkins**, Herbert Edward. *Education Office, Rangoon, Burma.* Dis.G.W., Dis.G.J. Local Secretary for Burma. June 1895.
- 2957 **Wilkinson**, Francis James Robert. 50-52, *Southampton Row, W.C., London.* 11, P.M., 2741, W.M., 11, H. June 1906.
- 2958 **Wilkinson**, George Edward. 25 *Gladsmore Road, Stamford Hill, N., London.* 1607, P.M. May 1899.
- 2959 **Wilkinson**, Samuel Blaze. 69 *Billing Road, Northampton.* P.Pr.G.W. Local Secretary for the Province of Northampton and Huntingdonshire. November 1888.
- 2960 **Wilkinson**, Thomas. 36 *Dyke Road, Brighton.* 271, P.M., P.P.G.R. June 1905.
- 2961 **Wilkinson**, Thomas. 22 *St. Paul's Churchyard, E.C., London.* 3016. January 1906.
- 2962 **Wilkinson**, William. *Bank Chambers, Bishop Auckland, Durham.* 1121, P.M. March 1902.
- 2963 **Wilkinson-Pimbury**, Charles James. 60 *Marmora Road, Honor Oak, S E., London.* 1997, P.M., 1260, P.Z. March 1887.
- 2964 \***Wilks**, E. T., F.R.G.S. *Ashlyns, Watford, Herts.* 18, P.M. October 1896.
- 2965 **Will**, Alexander. *Grahamstown, Cape Colony.* 339, P.M., 118 (S.C.), P.Z. January 1895.
- 2966 **Williams**, Alexander. *Lock Box 33, Carson, Louisiana, U.S.A.* 119, P.M., 33. November 1904.
- 2967 **Williams**, Charles Lewis. *Vaughan, via Castlemaine, Victoria.* 63 (W.A.C.). October 1906.
- 2968 **Williams**, David James. *Ivy Bank, Chislehurst, Kent.* 178, J.W. May 1906.
- 2969 **Williams**, Rev. Edmund Nelson Goddard. *Redlynch Vicarage, Salisbury.* 1724, P.M. Nov. 1894.
- 2970 **Williams**, Edward Lloyd. *Abboutiakoon, Tarkwar, Gold Coast Colony.* 1369. May 1904.
- 2971 **Williams**, Frederick John. 70 *Upper Tulse Hill, S.W., London.* 2899. June 1905.
- 2972 **Williams**, George Blackstone. *R.M. Office, Cape Town.* 1832. January 1892.
- 2973 **Williams**, Harry. *Langton Castle, Bootle, Liverpool.* 2463, W.M. May 1906.
- 2974 **Williams**, Henry Montague. 33 *Compton Avenue, Brighton.* 271, P.Z., P.Pr.G.R., Sussex. May 1895.
- 2975 **Williams**, James. *Emberton Lodge, Newport Pagnell, Bucks.* **Past Deputy Grand Sword Bearer.** 1501. January 1889.
- 2976 **Williams**, Jesty. *Tivoli, Stow Hill, Newport, Monmouth.* 683. May 1906.
- 2977 **Williams**, Joseph Henry. 133 *S. 12th Street, Philadelphia, U.S.A.* 53, P.M., 52, P.H.P. March 1906.
- 2978 **Williams**, Robert Jones. 29 *Eastgate Row North, Chester.* 425, P.M., 425. October 1904.
- 2979 **Williams**, Walter C. 244 *Camberwell Road, S.E., London.* 1329. May 1904.
- 2980 **Williamson**, Capt. James Morrison. *c/o T. M. Wood, 17 Water Street, Liverpool.* 611 (S.C.). March 1906.
- 2981 **Williamson**, Malcolm. *Bank of England, E.C., London.* 263, S.D. October 1905.
- 2982 **Williamson**, Walter Lehman. *Lisbon, North Dakota, U.S.A.* 12, P.M., 7, P.H.P. October 1904.
- 2983 **Willock**, Col. George Woodford. *Junior United Service Club, S.W., London.* 1466. March 1895.
- 2984 **Wilcox**, David. 49 *Burgher Street, Parkhead, Glasgow.* 123, P.M., 87. January 1892.
- 2985 **Wilcox**, William Carl. 210 *Champion Street, Bellingham, Washington, U.S.A.* 44, P.M., 12, P.H.P. October 1894.
- 2986 **Wills**, Thomas H. 2 & 4, *Market Street, Torquay.* 1402, P.M. October 1891.
- 2987 **Wilmot**, Henry. *Leeming Bar, Bedale, Yorkshire.* 2610, P.M., Pr.G.S.B. June 1904.
- 2988 **Wilson**, Alexander. *Beechwood, Rubislaw Den South, Aberdeen.* Pr.G.M., 155. November 1888.
- 2989 **Wilson**, Charles Henry. 98 *Chapeltown Road, Leeds.* 306, P.M., P.Z. January 1906.
- 2990 **Wilson**, David. *Vancouver, British Columbia.* **Past Grand Master.** October 1898.
- 2991 **Wilson**, F. S. H. 65 *Wilkinson Street, Sheffield.* P.P.G.D., West Yorks. January 1903.
- 2992 **Wilson**, James Richard. *Union Street, Plymouth.* 954, P.M. March 1900.
- 2993 **Wilson**, John. *Carleton Chambers, Ottawa, Canada.* **Past Deputy District Grand Master,** 16. January 1903.
- 2994 **Wilson**, John Macfarlane. Box 282, *Durban, Natal.* 2623. May 1901.
- 2995 **Wilson**, Reginald William, M.R.C.S. *Infirmiry, Thornton Heath, Surrey.* P.Pr.G.D., Herts. November 1899.
- 2996 **Wilson**, Richard. *Westfield House, Armley, Leeds.* **Past Grand Deacon, Past Assistant Grand Sojourner.** May 1893.

- 2997 **Wilson, Richard.** *West Bank Terrace, Skipton, Yorkshire.* 810. May 1899.
- 2998 **Wilson, Washington.** *Metuchen, New Jersey, U.S.A.* 135, 4. May 1906.
- 2999 **Wilson, William.** *Carbucky, Bogabilla, New South Wales.* 862 (S.C.), P.M. May 1906.
- 3000 **Wilson, William Mortimer, M.A.** *The Firs, Alfreton, Derbyshire.* 102<sup>a</sup>, W.M., 1324. May 1905.
- 3001 **Wilson, William Thomas.** Box 53, *Cape Town.* De Goede Hoop Lodge (D.C.). October 1898.
- 3002 **Windle, Rev. W. E., M.A.** *Uyborough Vicarage, Ivybridge, Devon.* P.Pr.G.Ch., 710, P.Z. Mar. 1898.
- 3003 **Wing, John Clifford.** *Northfield Road, Ilfracombe.* 1135. May 1906.
- 3004 **Winning, John Gray.** *Branzholme, Knowe, Hawick, Scotland.* 111, 89, P.Z. March 1898.
- 3005 **Winter, James William.** Box 198, *Barberton, Transvaal.* 2710, P.M., 220 (S.C.), P.Z. Oct. 1898.
- 3006 **Wise, E. Croft.** 9 *Bampton Road, Forest Hill, S.E., London.* 619, P.M., 862. March 1898.
- 3007 **Wisner, G. S. E.** Box 31, *Anaconda, Montana, U.S.A.* P.M. October 1901.
- 3008 **Withers, George.** *Aston Villas, Uttoxeter.* Pr.G.D.C., Pr.G.N. (R.A.). May 1905.
- 3009 **Withers, Samuel, jun.** *Sandhurst, Port Hill Road, Shrewsbury.* 117. January 1901.
- 3010 **Withey, Thomas Archer.** *Edzell, Oakwood Mount, Roundhay, Leeds.* P.P.G.D.R., West Lancs. May 1895.
- 3011 **Wolf, Lucien.** 15 *Brunswick Square, W.C., London.* 1928. May 1902.
- 3012 **Wolfskeil, William Daniel.** 225 *Broad Street, Elizabeth, New Jersey.* 49, P.M., 16, P.H.P. May 1898.
- 3013 **Wolsey, William Henry.** 12 *Albert Square, Clapham Road, S.W., London.* 1381, P.M. 1381, M.E.Z. March 1906.
- 3014 **\*Wonnacott, Ernest William Malpas, A.R.I.B.A., F.S.I.** 199 *Piccadilly, W., London.* 2416, 720. March 1904.
- 3015 **Wood, Alfred Gerald.** *Thirlmere, Park Road, Redhill, Surrey.* 1541. March 1905.
- 3016 **Wood, John William.** *Front Street, Stanley, Co. Durham.* 2929 (S.C.), 83. March 1906.
- 3017 **Wood, R. E. J.** *Cobar, New South Wales.* 97. October 1904.
- 3018 **Woodd, Walter.** 2152 *Santiago de Chile.* 168 (N.S.W.C.). June 1906.
- 3019 **Woodcock, J. T.** *Westgate, Guisborough, Yorks.* 561, P.M., 543, H. March 1902.
- 3020 **Woodhead, Thomas Mansley.** *Fairfield, Baildon, Yorks.* Pr.J.G.W., W. Yorks. 2869, 600. October 1901.
- 3021 **Woodforde, William Sidney Bidout, M.B.C.M. Edin.** *Goondiwindi, Queensland.* 862 (S.C.), P.M. October 1901.
- 3022 **Woodman, Dr. W. J.** 13 *New Road, Rochester.* 1174, P.M. March 1906.
- 3023 **Woods, Herbert.** *Moore, Warrington.* 143, 143. October 1906.
- 3024 **Woods, P. J.** 6 *Garnault Place, Risebery Avenue, E.C., London.* 1839. March 1906.
- 3025 **Woods, William Fountain.** 31 *Rosetti Mansions, Chelsea, S.W., London.* 858, P.M., 92, P.Z. October 1900.
- 3026 **Woodside, Nevin G.** 710 *Fair Oaks Avenue, Oak Park, Chicago, Illinois, U.S.A.* 318. Jan. 1899.
- 3027 **Woodthorpe, John William.** *Barrymore, Fallow Lane, North Finchley, London, N.* 1679, P.M., 4, M.E.Z. January 1895.
- 3028 **\*Woolen, T. H., M.I.M.E.** 119 *St. Mark's Road, N. Kensington, London, W.* 1431. May 1901.
- 3029 **Woolley, Victor James.** *King's College, Cambridge.* 859, 859. October 1906.
- 3030 **Woosnam, William Wesley.** 2 *Park Hill, Ealing, W., London.* 2022, P.M. March 1903.
- 3031 **Wormal, George.** *Stafford.* Pr.G.W., P.P.G.N. June 1895.
- 3032 **Wriede, Peter.** *Finhenwaerder, Hamburg.* Lodge Gudrun, Hamburg. October 1906.
- 3033 **Wright, Rev. Charles Edward Leigh, B.A.** *Heathwood Lodge, Bezley, Kent.* **Past Grand Deacon, Past Grand Standard Bearer (R.A.).** March 1889.
- 3034 **Wright, Francis William.** 4 *Rocky Hill Terrace, Maidstone, Kent.* P.Pr.G.D., P.Pr.G.J. May 1891.
- 3035 **Wright, Frederick.** 323 *Seven Sisters Road, N., London.* 1763, P.M., 55, P.Z. January 1906.
- 3036 **Wright, H. F.** *Barry House, Abbey Road, Barrow-in-Furness.* P.P.G.D. June 1905.
- 3037 **Wright, Henry John.** *The Bezches, Sproughton, Ipswich.* P.Pr.G.D.C., P.Pr.G.J. January 1896.
- 3038 **Wright, J. W. B.** 81 *Albert Road, Middlesborough, Yorkshire.* 2391. January 1901.
- 3039 **Wright, Joseph Pretty.** 283 *Burrard Street, Vancouver, B.C., Canada.* 7, 98. March 1905.
- 3040 **Wright, Olin S., M.D.** *Plant City, Florida, U.S.A.* P.M. June 1900.
- 3041 **Wright, Silas B.** *De Land, Florida, U.S.A.* **Past Grand Master, Past Grand High Priest.** March 1893.
- 3042 **Wright, William Henry Sterling.** *St. Paul, Minnesota.* 163, 44 (Wis.C.), P.H.P. Local Secretary for Minnesota. November 1892.
- 3043 **Wrightson, Arthur, F.S.I.** 26 *Budge Row, E.C., London.* 2416, P.M. January 1898.

- 3044 **Wyatt**, Oliver Newman, F.S.I. 10 *West Pallant, Chichester, Sussex.* P.P.S.G.W., P.P.G.Sc.N. January 1893.
- 3045 \***Wyatt**, Rev. Vitruvius Partridge. *St. Leonard's Clergy House, Bedford.* Past Grand Chaplain, Past Grand Principal Sojourner. May 1895.
- 3046 **Wynn-Mackenzie**, Stanley Charles William. 81 *Linnaeus Street, Hull.* 2798. March 1903.
- 3047 **Wynter**, Andrew Ellis, M.D. *The Corner House, Bromley Road, Beckenham, Kent.* 1139. Jan. 1898.
- 3048 **Yarker**, John. *Burton Road, West Didsbury, Manchester.* Past Grand Warden, Greece. May 1887.
- 3049 **Yates**, Charles. 31 *Aire Street, Leeds.* 289. November 1896.
- 3050 **Yerbury**, George S. 121 *Oraton Street, Newark, New Jersey, U.S.A.* 51, 7. January 1904.
- 3051 **York**, Francis Colin. *F.C. Pacifico, Junin, Buenos Aires.* 617. October 1890.
- 3052 **Yorke**, Rev. Harry Walter. *Laverstoke Rectory, Whitchurch, Hants.* 1373, P.P.G.Ch., Jersey. October 1904.
- 3053 **Yorston**, John C. 1336 *Cherry Street, Philadelphia, U.S.A.* University Lodge. October 1904.
- 3054 **Young**, Archibald Edward. *The Green, St. Leonard's-on-Sea, Sussex.* 1842, P.M., 40, P.Z. Jan. 1892.
- 3055 **Young**, George Lewis. *Prince's Wharf, Port Adelaide, South Australia.* 2, P.M. May 1889.
- 3056 **Young**, Henry James. 62 *Blenheim Gardens, Willesden Green, N.W., London.* 183. March 1906.
- 3057 **Young**, H. S. Schultess. 2 *Essex Court, Temple, E.C., London.* 2664. January 1905.
- 3058 **Young**, Isaac. 107 *Grandison Road, Clapham Common, S.W., London.* 2664, P.M. March 1898.
- 3059 **Young**, James. *Prince's Dock, Belfast.* P.Pr.G.W., Antrim. January 1904.
- 3060 **Young**, James Augustus. *New Westminster, B.C., Canada.* 9, P.M. October 1903.
- 3061 **Young**, Joseph G. 72 *Mark Lane, E.C., London.* 749, 1329. October 1901.
- 3062 **Youngman**, Charles H. *Messrs. Barclay & Co., Ltd., Bankers, Saffron Walden, Essex.* 305, P.M. November 1898.
- 3063 **Zacharias**, Hans Conrad Ernest. *Kwala Lumpor, Selangor, Malay States.* 2337, S.W., 2225. May 1906.
- 3064 **Zanchi**, Ventura Blayner Murray. 65 *Bedford Court Mansions, W.C., London.* 91, P.M., 176, P.Z. January 1906.
- 3065 \***Zobel**, Carl Moritz Emil. 4 *Beach Street, Penang, Straits Settlements.* 2678. November 1900.

## SUPPLEMENTARY LIST.

### *Members admitted on the 8th November, 1906.*

- 3066 **Quilmes** Lodge, No. 2459, Quilmes, Buenos Aires.
- 3067 **Lodge Union Royale**, Amsterdam.
- 3068 **Anderson**, Rufus E. *Hannibal, Missouri, U.S.A.* 188, P.M., Past Grand Master, Past Grand High Priest.
- 3069 **Aspinall**, John Squire. *Mary Street, Gympie, Queensland.* 863 (S.C.), P.M.
- 3070 **Berks**, Henry Woodside. *Champaign, Illinois, U.S.A.* 240, P.M., 50, P.H.P. Dis.Dep.G.M.
- 3071 **Bolton**, Samuel. 61 *New Road, Woolwich, S.E., London.* 2262.
- 3072 **Briggs**, John, M.A. 32 *Red Lion Square, W.C., London.* 45, P.M., 45, P.Z.
- 3073 **Chapman**, Arthur W. 11 *Gloucester Road, Regent's Park, N.W., London.* 289, P.M., P.Pr.S.G.W., Yorks., 2397, P.Z.
- 3074 **Dale**, Gerard Anselm. 1860 *Ayacucho, Buenos Aires, Argentine Republic.* 617, 617.
- 3075 **Davids**, Smith William. *Nelson, via Cairns, North Queensland.* Pyramid Lodge, W.M., 2139, P.S.
- 3076 **Day**, George. *Hough Green, Chester.* 721, P.M., 721.
- 3077 **De Neut**, Henri. *Monte Carlo Hotel, 1-2 Leicester Street, W.C., London.* 144, 3171.
- 3078 **Dickson**, James Patrick. 9 *Oak Lane, E.C., London.* 1572, P.M., 1572, P.Z.
- 3079 **Donovan**, Edward Wynne. *Hilton House, Prestwich, Lancs.* 62, P.M.
- 3080 **Dudgeon**, Patrick James. 11 *Glebe Place, Chelsea, S.W., London.* 3175, J.W.
- 3081 **Gibbs**, William Harvey. *St. Ives, King's Heath, Birmingham.* 2654, 2034.
- 3082 **Gowing**, Herbert Manley. 80 *Brixton Hill, S.W., London.* 857.
- 3083 **Grounds**, Holbrook. 29 *Tilbot Road, Tottenham, N., London.* 1707.
- 3084 **Hider**, Ernest J. W. 8 *Clifford's Inn, Temple Bar, E.C., London.* 1627.
- 3085 **Howard**, Joseph H. *The Meadows, Mount Pleasant Road, Tottenham, N., London.* 1707.
- 3086 **Hollingbury**, Charles William Paulet. *Derwent, 75 Hindes Road, Harrow.* 1139,

- 3087 **Hudson, Alan Murray.** *Casilla 18, Rosario de Santa Fe, Argentine Republic.* 2960, 1553.
- 3088 **Jacobson, Charles H.** *39 Masonic Temple, Denver, Colorado, U.S.A.* **Grand Secretary, Grand Scribe Ezra.**
- 3089 **Larkam, Edward.** *Birchfield, Alcester Road, King's Heath, Birmingham.* 2654, 2034.
- 3090 **Lean, George Gilbert.** *Palace Chambers, Westminster, S.W., London.* 9.
- 3091 **Le Neve-Foster, Ernest.** *39 Masonic Temple, Denver, Colorado, U.S.A.* 84, P.M., 29, P.H.P.
- 3092 **Lewis, Elias St. Elmo.** *131 Lothrop Avenue, Detroit, Michigan, U.S.A.* 357.
- 3093 **\*Macgregor, James.** *Invercargill, New Zealand.* 471 (S.C.), P.M., 3 (N.Z.C.), P.Z.
- 3094 **Mackay, John.** *42 Lower Kennington Lane, S.E., London.* 1658.
- 3095 **Moule, John.** *38 Snell Park, Upper Edmonton, N., London.* 1579.
- 3096 **Norton-Knight, Arthur Gerald.** *c/o Messrs. Parry & Co., Madras.* 1198, 1198.
- 3097 **Owens, Frederick Edward.** *35 Hamilton Square, Birkenhead.* 2633, P.M., 2633.
- 3098 **Palmer, John.** *17 Brand Lane, Ludlow, Salop.* 611, S.W., 267.
- 3099 **Paten, A. J.** *Carlton Lodge, Thorpe Road, Peterborough.* 2533, W.M., 442.
- 3100 **Paton, John.** *London & River Plate Bank, Rosario de Santa Fé, Argentine Republic.* 1553, P.M., 1553, P.Z.
- 3101 **Potts, James Rowland.** *14 Warwick Terrace, Plumstead, Kent.* 1472, 1472.
- 3102 **Prested, Harry.** *Elthorne Road, Holloway, N., London.* 2804.
- 3103 **Richards, Sydney Thomas.** *Trevon, Beulah Road, Thornton Heath.* 907.
- 3104 **Rowe, Thomas George.** *Fieldview, 125 Church Street, Lower Edmonton, N., London.* 2372.
- 3105 **Sach, Charles F.** *Danecroft, Lebanon Gardens, Wandsworth, S.W., London.* 1541, P.M.
- 3106 **Schmidt, Edwin Valentine.** *57 Jordan Avenue, San Francisco, Cal., U.S.A.* 166.
- 3107 **Shears, Thomas Edward.** *378 Lafayette Street, Denver, Colorado, U.S.A.* 117, P.M., 2, P.H.P.
- 3108 **Smith, Harry John.** *Manager, Windsor Diamond Mining Co., Smith's Mine, Klipdam, Cape Colony.* 2486, S.W.
- 3109 **\*Smith, H. H. Montague.** *Constitutional Club, Northumberland Avenue, W.C., London.* 3175, Treas., 1321, S.W.
- 3110 **Smith-Rose, William.** *39 Bark Place, Bayswater, W., London.* 1668, P.M., 890, Z.,
- 3111 **Stevenson, W.** *Post Office Box 33, Mafeking, South Africa.* 2534.
- 3112 **Turner, A.** *Brook House, 10-11 Walbrook, E.C., London.* 416, P.M., P.Pr.G.Reg., Surrey.
- 3113 **Vaughan, J. Evans.** *The Sycamores, Surrey Road, Bournemouth.* 2208, P.M., Pr.S.G.W., Hants., 195, J.
- 3114 **Wiberg, John Engelbert.** *9 Old Bond Street, W., London.* 1901, W.M., 1901, J.

### ACCIDENTALLY OMITTED.

- 3115 **Bainbridge, T. H.** *Wavertree, Hurst Road, Eastbourne.* 2434, W.M. January 1906
- 3116 **Williams, J. F.** *Victoria House, Cifa, Ruzhon, Derbyshire.* 1756. November 1905.





## LOCAL SECRETARIES

### GREAT BRITAIN AND IRELAND

Bournemouth	Christopher Pearce	73, Commercial Road, Bournemouth
Chester	J. H. Hopley	Northgate Street, Chester
Durham	G. W. Bain	Tunstall View, Ashbrooke Rd., Sunderland
Edinburgh	R. S. Brown	75, Queen Street, Edinburgh
Essex	W. H. Bamlet	Floradale, Argyle Road, Westcliff-on-Sea
Halifax and Vicinity	C. Greenwood	26, Akeds Road, Halifax
Inverness	A. F. Mackenzie	15, Union Street, Inverness
Lancashire, North	J. R. Nuttall	13, Thornfield, Lancaster
Lancashire, West	{ Rev. W. S. Hildesley and F. B. Goodacre	12, Stanley Street, Ormskirk Low Wood, Aughton, Ormskirk
Middlesex and North London	F. W. Levander	30, North Villas, Camben Sq., N.W., London
Northampton & Huntingdonshires	S. B. Wilkinson	69, Billing Road, Northampton
North Wales	Rev. W. E. Scott-Hall	Plás Llanfaelog, Anglesey
Northumberland	R. H. Holme	6, Chester Street, Newcastle-on-Tyne
Nottingham	W. J. O'Rorke	22, Lister Gate, Nottingham
Oxfordshire and Gloucestershire	E. Conder, jun.	The Conigree, Newent, Gloucestershire
Scotland, South	J. B. Cowan	Commercial Bank, Hawick
Sheffield and Vicinity	J. Binney	Bank Street, Sheffield
Staffordshire	Frank Hughes	Lea Bridge House, Handsworth
Sussex, East	L. F. St. John	33, Havelock Road, Hastings
Warwickshire and Worcestershire	Arthur W. Adams	Broad Road, Acock's Green, Birmingham
Yorkshire, North & East Ridings	G. L. Shackles	Wickersley, Brough, East Yorks
Yorkshire, West Riding	J. Banks Fearnley	Springwood Avenue, Huddersfield
H.M. Navy	J. S. Gibson-Sugars	H.M.S. Vernon, Portsmouth

### EUROPE

Bavaria	E. Adrianyi	Wodan Strasse 71, Nuremberg
Cyprus	F. H. Parker	Nikosia, Cyprus
Denmark	S. H. Simonsen	St. Kiobmagergade 14, Copenhagen
Holland	J. C. G. Grasé	65, Fr. v. Mierisstraat, Amsterdam
Hungary	L. de Malczovich	Belügyministerium, Budapest
Malta	J. W. Starkey	Gas Office, La Valletta, Malta

### AFRICA

Egypt and Sudan	M. P. Percival	Turf Club, Cairo
Kimberley	A. W. Adams	P.O.B. 467, Kimberley
Mashonaland	W. E. Haworth	Penhalonga, Rhodesia
Natal	T. Cook	Box 105, Durban, Natal
Orange River Colony, North	Dr. H. H. Browne	Bungalow, Bethlehem
South Africa, Western Division	W. H. Tiffany	Box 387, Cape Town
Transvaal, Johannesburg	T. L. Pryce	Box 247, Johannesburg
„ Krugersdorp	R. F. Wallis	Box 139, Krugersdorp
„ Pretoria	W. L. Green	Box 1200, Pretoria
„ Roodepoort	S. Andrews	Box 78, Roodepoort

## ASIA

Burma	H. E. Wilkins	Education Office, Rangoon, Burma
India, Madras and Bombay )	A. L. Vibert	Madura, Madras
„ N.W. Prov. and Oudh )		
India, Bengal	Rev. W. K. Firminger	Kidderpore, Calcutta
Philippine Islands	C. S. Lobingier	Manila, Philippine Islands
Shanghai	J. C. Hanson	5, Hong Kong Road, Shanghai
Singapore	E. J. Khory	8, Raffles Place, Singapore

## AMERICA

Georgia	W. F. Bowe	Augusta, Georgia
Louisiana	R. Lambert, G.Sec.	Masonic Temple, New Orleans
Michigan	A. G. Pitts	111, Woodward Ave., Detroit, Michigan
Minnesota	W. H. S. Wright	St. Paul, Minnesota
New Jersey	R. A. Shirreffs	451, Grier Avenue, Elizabeth, N.J.
New York	Benno Loewy	206, Broadway, New York
Rhode Island	W. H. Scott	357, Westminster Street, Providence, R.I.
South Dakota	L. G. Levoy, P.G.M.	Webster, South Dakota

## CANADA

Alberta	G. Macdonald, M.D.	Calgary, Alberta
Manitoba	R. S. Thornton	Deloraine, Manitoba

## CENTRAL AMERICA

Costa Rica	A. G. M. Gillott	Box 385, San José, Costa Rica
------------	------------------	-------------------------------

## WEST INDIES

Jamaica	G. R. D. Rust	Kingston, Jamaica
---------	---------------	-------------------

## SOUTH AMERICA

Argentine Republic	C. Trevor Mold, Dis.G.M.	760 Calle Cuyo, Buenos Aires
--------------------	--------------------------	------------------------------

## AUSTRALASIA

New South Wales	M. A. Toomey	Masonic Hall, Sydney
New Zealand, Auckland	G. H. Powley	Hamilton Rd., Ponsonby, Auckland
„ „ Christchurch	S. C. Bingham	202, Durham Street, Christchurch
„ „ Southland	K. A. Gerstenkorn	Esk Street, Invercargill
„ „ Wellington	G. Robertson	Wellington
„ „ Otago	Rev. W. Ronaldson	390, Castle Street, Dunedin
Queensland, Charters Towers	R. Sladden	Townville St., Queenton, Charters Towers
„ Croydon	T. Bennion	Ophir Cottage, Croydon
„ Gympie	W. H. Smith	Monkland, Gympie
„ Mount Morgan	J. D. Murray	Mount Morgan
South Australia	F. Johns	Register Office, Adelaide
Victoria	Hugh W. Sinclair	443, Chancery Lane, Melbourne



## DECEASED.

<u>Bergmann, T.</u>	<i>Late of London</i>	<u>11th March, 1906.</u>
<u>Breed, Edward Aries Thomas</u>	„ <i>Brighton</i>	<u>13th December, 1905.</u>
<u>Cole, Cristian John</u>	„ <i>Cape Town</i>	<u>5th September, 1905.</u>
<u>DeFabeck, William Frederick</u>	„ <i>Bangalore, Madras</i>	
<u>Fellows, Joseph W.</u>	„ <i>Manchester, New Hampshire</i>	<u>26th April, 1906.</u>
<u>Ferry, Charles Edwin</u>	„ <i>Isleworth</i>	<u>6th October, 1906.</u>
<u>Finnemore, Robert Isaac</u>	„ <i>Pietermaritzburg</i>	<u>22nd July, 1906.</u>
<u>Fooks, William. LL.B.</u>	„ <i>London</i>	<u>June, 1906.</u>
<u>Frazer, Rev. W. Henry</u>	„ <i>London</i>	<u>25th January, 1906.</u>
<u>Freeman, Vincent Paine</u>	„ <i>Brighton</i>	<u>17th January, 1906.</u>
<u>Gribble, James Dunning Baker</u>	„ <i>Secunderabad</i>	<u>28th August, 1906.</u>
<u>Hewer, Henry John</u>	„ <i>Blackall, Queensland</i>	<u>24th December, 1905.</u>
<u>Hicks, Edward</u>	„ <i>Sutton</i>	<u>21st May, 1905.</u>
<u>Hopkins, R. B.</u>	„ <i>London</i>	<u>8th November, 1906.</u>
<u>Howard, Sir Richard Nicholas</u>	„ <i>Weymouth</i>	<u>25th November, 1905.</u>
<u>Isitt, Sydney Frederick</u>	„ <i>Chigwell</i>	<u>8th December, 1905.</u>
<u>King, William Youill</u>	„ <i>Edinburgh</i>	
<u>Last, John Thomas</u>	„ <i>Bradford</i>	<u>February, 1906.</u>
<u>Lloyd, J. W.</u>	„ <i>Maubin, Burma</i>	
<u>Lockwood, Luke A.</u>	„ <i>New York</i>	<u>21st November, 1905.</u>
<u>Logan, William</u>	„ <i>Durham</i>	<u>19th November, 1905.</u>
<u>Long, Hiram</u>	„ <i>London</i>	<u>12th July, 1906.</u>
<u>Marsland, Octavius</u>	„ <i>London</i>	<u>28th September, 1906.</u>
<u>Moors, Henry</u>	„ <i>South Yarra, Victoria</i>	<u>19th September, 1906.</u>
<u>Officer, William</u>	„ <i>Edinburgh</i>	<u>11th April, 1906.</u>
<u>Page, Alfred</u>	„ <i>Nottingham</i>	<u>18th November, 1905.</u>
<u>Parkin, Henry</u>	„ <i>London</i>	<u>16th October, 1906.</u>
<u>Pickering, Thomas</u>	„ <i>Newcastle-on-Tyne</i>	<u>28th June, 1906.</u>
<u>Rideal, George Samuel</u>	„ <i>Johannesburg</i>	<u>June, 1906.</u>
<u>Roffey, James Richard</u>	„ <i>Liverpool</i>	<u>11th November, 1906.</u>
<u>Royston, Rev. Peter</u>	„ <i>Peterborough</i>	<u>7th August, 1906.</u>
<u>Rupp, George P.</u>	„ <i>Philadelphia</i>	<u>3rd July, 1906.</u>
<u>Smailes, Dr. Robert</u>	„ <i>Leeds</i>	<u>21st June, 1906.</u>
<u>Stoetzer, Fritz</u>	„ <i>London</i>	<u>6th May, 1906.</u>
<u>Sudworth, Samuel</u>	„ <i>West Croydon</i>	<u>25th March, 1906.</u>
<u>Todman, Frank</u>	„ <i>Hove</i>	<u>18th December, 1905.</u>
<u>Tristram, Canon Henry Baker</u>	„ <i>Durham</i>	<u>8th March, 1906.</u>
<u>Upton, The Hon. William Henry</u>	„ <i>Washington</i>	<u>3rd November, 1906.</u>
<u>Walker, Dr. Charles Rotherham</u>	„ <i>Worthing</i>	<u>28th March, 1906.</u>
<u>Warre, Charles Bampfylde</u>	„ <i>West Brighton</i>	<u>September, 1905.</u>
<u>Welch, Louis</u>	„ <i>Delaware, Ohio</i>	<u>24th June, 1906.</u>
<u>Westropp, Col. William Keilly</u>	„ <i>Folkestone</i>	<u>27th November, 1905.</u>
<u>White, Hubert</u>	„ <i>London</i>	<u>29th January, 1906.</u>
<u>Williams, Howard Douglas</u>	„ <i>Eastbourne</i>	<u>6th July, 1906.</u>
<u>Wolff, Albert</u>	„ <i>Brisbane, Queensland</i>	<u>30th July, 1906.</u>

# DIRECTORY.

## ENGLAND.

**Bedfordshire.** Amphill, 327, 1106; Bedford, 87, 688, 3045; Leighton Buzzard, 2913; Luton, 952; Shefford, 2750.

**Berkshire.** Abingdon, 2017, 2528; Cookham Dean, 2918; Newbury, 469, 914, 1416, 2347; Reading, 1865; Slough, 557; Twyford, 1587; Wallingford, 1432, 2464, 2718; Wantage, 1231, 2342; Wokingham, 2216.

**Buckinghamshire.** Amersham, 923; Aylesbury, 582; High Wycombe, 2549; Newport Pagnell, 2975; Taplow, 966.

**Cambridgeshire.** Cambridge, 107, 585, 903, 1456, 1642, 1941, 2154, 2430, 3029; Ely, 188, 317, 2686; Wisbech, 104.

**Channel Islands.** Guernsey, 281, 795; Jersey, 109, 1242.

**Cheshire.** Alderley Edge, 927; Altrincham, 590, 964, 2217; Ashton-upon-Mersey, 359; Birkenhead, 1d, 175, 574, 849, 1056, 1415, 1495, 2465, 2774, 3097; Chester, 345, 383, 423, 639, 850, 928, 936, 937, 1058, 1380, 1445, 1505, 1517, 1602, 1708, 1753, 1922, 1975, 1977, 2076, 2323, 2354, 2358, 2504, 2739, 2880, 2978, 3076; Congleton, 422; Eccleston, 2159; Heswell, 2030; Knutsford, 460; Liscard, 495; Lymm, 1038; Malpas, 511; Sale, 532, 2947; Seacombe, 2458; Wilmslow, 1612, 2508.

**Cornwall.** Cambourne, 135; Falmouth, 57, 2515; Hayle, 81, 2178; Liskeard, 85, 1346; Penzance, 60, 395, 761, 847, 2254; Poughill, 1767; St. Ives, 2320; Truro, 720, 1780, 2946.

**Cumberland.** Castle Carrock, 2889; Millom, 1861.

**Derbyshire.** Alfreton, 827, 3000; Ashbourne, 543; Buxton, 2567; Chesterfield, 982, 1037; Derby, 68; Duffield, 2162; Ripley, 128.

**Devonshire.** Beaworthy, 596; Buckfastleigh, 1919; Budleigh Salterton, 1070; Devonport, 2021; Exeter, 53, 632, 757, 811, 1257, 1466, 1501, 1801, 1848, 1867, 2167; Ilfracombe, 1660, 2422, 3003; Ivybridge, 3002; Plymouth, 473, 1241, 1392, 1475, 2181, 2992; Sidmouth, 976; Teignmouth, 1178, 1329; Torquay, 1f, 129, 2740, 2815, 2986; Great Torrington, 993.

**Dorsetshire.** Blandford, 2819; Dorchester, 440, 2317; Gillingham, 1608; Parkstone, 2380; Poole, 1419; Portland, 891.

**Durham.** Barnard Castle, 2499; Beamish, 312; Bishop Auckland, 2962; Darlington, 2156, 2203, 2398, 2712, 2890; Dnrham, 611; Ebchester, 1219; Gateshead, 54, 1169, 1429, 2681; Hebburn-on-Tyne, 2041; Medomsley, 2150; Shildon, 431, 2692; South Shields, 2071, 2142; Stanley, 2371, 3016; Sunderland, 384, 1482, 2004, 2798; West Hartlepool, 1584, 1619, 2171, 2790; Yarm-on-Tees, 1494.

**Essex.** Bocking, 2242; Brentwood, 1406; Buckhurst Hill, 1235; Colchester, 754, 1699, 2310, 2752, 2820; Earl's Colne, 2376; East Ham, 2613; Hornchurch, 321, 2629; Hockley, 296; Ilford, 568, 763, 1583, 1815, 1926; Latchingdon, 1520; Leytonstone, 1550, 2906; Little Waltham, 1789; Maldon, 2130; Plaistow, 1931; Romford, 393, 534, 1343; Saffron Walden, 3062; Seven Kings, 1624; Snarebrook, 1433; Southend-on-Sea, 1064, 1127, 1156; Walthamstow, 759, 1511, 1620, 2925; Westcliff-on-Sea, 407, 934, 1205, 2050, 2246, 2755; South Woodford, 536, 1256; Woodford Bridge, 2144; Woodford, 1697.

**Gloucestershire.** Bristol, 1371, 1418, 1524, 1792, 2770, 2801; Cheltenham, 2149, 2834; Gloucester, 529, 640, 1752, 2709, 2884; Newent, 20; Stroud, 1285; Woodchester, 2198.

**Hampshire.** Aldershot, 1893, 2221; Alresford, 1163; Basingstoke, 337, 699, 1453, 1684, 1750, 1956, 2680; Blackwater, 1687; Bournemouth, 64, 165, 274, 358, 650, 831, 2177, 2277, 3113; Boscombe, 163, 2325; Fairham, 2174; Gosport, 1248, 1723; Havant, 103; Landport, 131, 157; Lee-on-Solent, 2396; Netley, 2822; Overton, 832; Portsmouth, 1221, 1813, 1973, 2809, 2929; South Hayling, 1400; Southampton, 528, 1078, 1566, 1757, 2663; Southsea, 641, 646, 825, 1117, 1523, 2082, 2627; Whitechurch, 3052; Winchester, 939, 1467, 1514, 1577.

**Herefordshire.** Colwall, 821; Hereford, 1616, 2108, 2666, 2835.

**Hertfordshire.** Cheshunt, 1960, 2591; Harpenden, 581; New Barnet, 1769, St. Alban's, 912, 913, 959, 1039, 1299; Tring, 1626; Watford, 740, 2813, 2964.

**Huntingdonshire.** St. Ives, 1174, 1354.

**Isle of Man.** Ballesalla, 895.

**Isle of Wight.** Bembridge, 2151, 2886; Shanklin, 151; Ventnor, 90.

**Kent.** Beckenham, 403, 1347, 1462, 1713, 1817, 2135, 3047; Bexley, 3033; Broadstairs, 1314; Bromley, 805, 1206, 1266, 1294, 2248, 2637, 2950, 2954; Canterbury, 719; Charing, 686; Chislehurst, 2968; Deal, 733; Dover, 1110, 2023; Erith, 1355; Faversham, 61, 1233; Gravesend, 453, 788, 789, 1829; Ightham, 471; Lee, 859, 1896; Maidstone, 3034; Margate, 644, 1632; Plumstead, 671, 826, 2725, 3101; Ramsgate, 1a, 868; Rochester, 3022; Sandgate, 1532; Sevenoaks, 443, 2212; Shoreham, 1781; Shortlands, 1875; Sidcup, 1745, 2735; Stone, 2105; Tonbridge, 660; Tunbridge Wells, 275, 1189; Whitstable, 153, 2470.

**Lancashire, Eastern Division.** Blackburn, 73, 1877; Bolton, 546, 1790, 2078, 2777; Bury, 424, 645; Clitheroe, 2908; Darwen, 2664; Manchester, 360, 432, 445, 459, 467, 488, 603, 677, 708, 751, 829, 972, 1060, 1414, 1427, 1518, 1573, 1589, 1717, 1872, 2180, 2427, 2433, 2556, 2557, 2640, 2717, 2726, 2811, 2824, 2872, 3048; Oldham, 1327, 2225; Prestwich, 3079; Stockport, 957, 2677.

**Lancashire, Western Division.** Barrow-in-Furness, 310, 2047, 3036; Blackpool, 1370; Dalton-in-Furness, 1966; Earlistown, 2170; Grange-over-Sands, 2893; Heaton Moor, 160, 2516, 2574; Lancaster, 419, 1812, 2111; Liverpool, 474, 880, 1000, 1529, 1806, 1844, 2027, 2314, 2406, 2600, 2618, 2771, 2940, 2944, 2973, 2980; Newton-le-Willows, 162; Ormskirk, 8, 1455; Southport, 333, 525; St. Anne's-on-Sea, 889; St. Helen's, 111; Warrington, 1437, 2786, 3023; Wigan, 530, 628.

**Leicestershire.** Leicester, 27, 261, 499, 501, 1172, 2061, 2166, 2455, 2655, 2658, 2756; Melton Mowbray, 986, 2276, 2898.

**Lincolnshire.** Brigg, 1443; Gainsborough, 79; Grantham, 1082; Grimsby, 102; Lincoln, 71; Louth, 2617; Spalding, 1328; Spilsby, 2309.

**London.** 1b, 1e, 7, 9, 12, 17, 18, 21, 22, 29, 32, 33, 34, 1, 47, 51, 52, 63, 65, 67, 183, 263, 286, 289, 302, 313, 314, 320, 323, 340, 341, 342, 344, 347, 348, 353, 354, 361, 366, 370, 378, 379, 392, 392, 398, 399, 402, 409, 410, 412, 420, 428, 433, 434, 437, 449, 452, 458, 462, 476, 479, 483, 487, 492, 500, 504, 508, 509, 510, 517, 518, 522, 523, 524, 527, 533, 542, 549, 552, 554, 560, 564, 572, 573, 576, 586, 594, 595, 600, 601, 602, 604, 606, 616, 619, 620, 630, 631, 637, 648, 651, 655, 657, 661, 662, 664, 667, 668, 670, 672, 673, 674, 676, 678, 679, 684, 691, 694, 695, 696, 697, 700, 706, 707, 711, 715, 722, 724, 725, 726, 732, 735, 739, 741, 742, 744, 758, 765, 767, 773, 774, 778, 783, 791, 793, 794, 799, 801, 802, 803, 804, 806, 808, 809, 812, 813, 816, 817, 818, 822, 830, 834, 841, 843, 844, 845, 848, 857, 861, 862, 865, 867, 869, 870, 871, 873, 874, 884, 887, 888, 893, 896, 901, 916, 917, 929, 930, 942, 943, 944, 946, 948, 955, 961, 962, 963, 967, 968, 969, 970, 974, 975, 978, 987, 989, 994, 995, 999, 1001, 1002, 1003, 1005, 1009, 1011, 1013, 1015, 1016, 1017, 1021, 1022, 1025, 1027, 1029, 1030, 1033, 1042, 1043, 1044, 1045, 1048, 1049, 1051, 1054, 1057, 1065, 1077, 1081, 1085, 1089, 1092, 1093, 1097, 1100, 1104, 1111, 1118, 1120, 1123, 1124, 1135, 1137, 1143, 1146, 1154, 1157, 1159, 1162, 1168, 1175, 1176, 1177, 1179, 1180, 1186, 1188, 1190, 1193, 1195, 1197, 1198, 1202, 1204, 1210, 1222, 1223, 1225, 1227, 1229, 1234, 1237, 1238, 1243, 1245, 1246, 1249, 1250, 1260, 1262, 1265, 1275, 1279, 1283, 1289, 1290, 1292, 1298, 1301, 1302, 1303, 1305, 1303, 1312, 1315, 1316, 1318, 1319, 1320, 1322, 1325, 1326, 1331, 1334, 1335, 1336, 1337, 1339, 1340, 1342, 1344, 1345, 1348, 1350, 1351, 1352, 1353, 1356, 1361, 1362, 1365, 1372, 1373, 1374, 1375, 1377, 1382, 1385, 1387, 1394, 1395, 1404, 1411, 1412, 1417, 1420, 1421, 1431, 1434, 1435, 1438, 1440, 1441, 1447, 1448, 1451, 1454, 1458, 1459, 1463, 1464, 1465, 1471, 1472, 1475, 1483, 1490, 1492, 1497, 1499, 1503, 1504, 1507, 1509, 1515, 1516, 1530, 1537, 1538, 1546, 1548, 1555, 1556, 1557, 1568, 1569, 1571, 1579, 1580, 1585, 1588, 1591, 1592, 1595, 1601, 1611, 1613, 1617, 1628, 1633, 1644, 1652, 1657, 1662, 1668, 1671, 1677, 1678, 1683, 1685, 1686, 1693, 1695, 1697, 1701, 1705, 1706, 1707, 1710, 1722, 1724, 1728, 1729, 1730, 1735, 1736, 1744, 1748, 1754, 1755, 1756, 1759, 1762, 1764, 1770, 1772, 1778, 1784, 1796, 1798, 1802, 1808, 1811, 1818, 1823, 1825, 1828, 1853, 1855, 1859, 1863, 1866, 1868, 1869, 1873, 1874, 1881, 1882, 1883, 1886, 1891, 1892, 1894, 1899, 1902, 1907, 1909, 1910, 1912, 1913, 1920, 1921, 1942, 1943, 1944, 1949, 1950, 1951, 1953, 1957, 1959, 1962, 1963, 1969, 1972, 1976, 1978, 1979, 1984, 1986, 1994, 1995, 2000, 2003, 2008, 2009, 2011, 2020, 2028, 2029, 2033,

2034, 2038, 2040, 2042, 2043, 2044, 2056, 2057, 2058, 2059, 2063, 2064, 2070, 2077, 2081, 2083, 2084, 2086, 2089, 2095, 2100, 2102, 2104, 2122, 2124, 2133, 2134, 2136, 2137, 2139, 2143, 2146, 2147, 2152, 2158, 2160, 2161, 2165, 2172, 2173, 2175, 2185, 2188, 2189, 2191, 2193, 2200, 2202, 2206, 2209, 2210, 2211, 2221, 2223, 2227, 2243, 2245, 2247, 2251, 2257, 2263, 2268, 2269, 2271, 2275, 2281, 2282, 2283, 2286, 2287, 2292, 2293, 2296, 2297, 2299, 2302, 2306, 2316, 2321, 2326, 2328, 2331, 2338, 2340, 2344, 2346, 2351, 2352, 2359, 2361, 2373, 2374, 2375, 2377, 2378, 2384, 2385, 2386, 2389, 2391, 2392, 2393, 2394, 2397, 2400, 2404, 2407, 2408, 2410, 2412, 2413, 2414, 2416, 2418, 2428, 2432, 2436, 2438, 2443, 2446, 2459, 2461, 2466, 2471, 2474, 2476, 2478, 2480, 2482, 2485, 2496, 2505, 2513, 2519, 2525, 2526, 2527, 2532, 2533, 2534, 2543, 2547, 2551, 2552, 2553, 2554, 2563, 2564, 2570, 2571, 2575, 2588, 2590, 2598, 2599, 2602, 2603, 2615, 2620, 2630, 2638, 2639, 2641, 2643, 2644, 2649, 2650, 2653, 2657, 2659, 2661, 2673, 2674, 2682, 2684, 2685, 2690, 2693, 2696, 2697, 2698, 2702, 2707, 2708, 2713, 2714, 2715, 2721, 2732, 2736, 2738, 2741, 2742, 2746, 2748, 2754, 2757, 2758, 2761, 2763, 2775, 2780, 2782, 2783, 2788, 2792, 2793, 2794, 2795, 2800, 2804, 2805, 2806, 2808, 2812, 2816, 2817, 2825, 2831, 2832, 2843, 2844, 2845, 2846, 2847, 2851, 2852, 2856, 2860, 2862, 2877, 2878, 2879, 2887, 2888, 2891, 2899, 2902, 2903, 2907, 2910, 2911, 2912, 2914, 2919, 2922, 2936, 2938, 2939, 2941, 2943, 2953, 2957, 2958, 2961, 2963, 2971, 2979, 2981, 2983, 3006, 3011, 3013, 3014, 3024, 3025, 3027, 3028, 3030, 3035, 3043, 3056, 3057, 3058, 3061, 3064, 3071, 3072, 3073, 3077, 3078, 3080, 3082, 3083, 3084, 3085, 3090, 3094, 3095, 3102, 3104, 3105, 3109, 3110, 3112, 3114.

**Middlesex.** Alperton, 607; Edgware, 1871; Enfield, 415, 421, 1676; Feltham, 2067; Hampton Court, 130; Hampton Hill, 1148; Harrow, 1183, 3086; Hendon, 1704; Hounslow, 659; Pinner, 1425; Southall, 1367; Staines, 705, 2199; Stanmore, 1096, 2112, 2900; Teddington, 311, 605, 2148; Twickenham, 2873.

**Monmouthshire.** Newport, 1074, 1576, 2215, 2976.

**Norfolk.** Brandon, 325; Hunstanton, 24; Hemsby, 1101; Great Yarmouth, 2365; King's Lynn, 58, 2582; Norwich, 7, 427, 693, 769, 815, 878, 1080, 1525, 1680, 2230, 2255, 2348, 2509, 2606, 2635, 2688.

**Northamptonshire.** Northampton, 301, 441, 977, 998, 1083, 1474, 1865, 1878, 2039, 2451, 2500, 2855, 2959; Peterborough, 727, 728, 1324, 1747, 1751, 2431, 2601, 2704, 3099; Stamford, 83; Wellingborough, 1659.

**Northumberland.** Belford, 2183; Bedlington, 656; Berwick-on-Tweed, 77, 647, 922, 2778; Hexham, 1562; Morpeth, 418; Newcastle-on-Tyne, 265, 351, 439, 472, 635, 701, 991, 1026, 1068, 1244, 1428, 1489, 1661, 1835, 1879, 2035, 2355, 2403, 2583; North Shields, 1721; Tweedmouth, 945; Tynemouth, 745; Whitley Bay, 2610.

**Nottinghamshire.** Hucknall Torkard, 1916; Nottingham, 1059, 2129, 2636; Mansfield, 1446; Newark-on-Trent, 343, 940.

**Oxfordshire.** Burford, 446; Chipping Norton, 1841, 2258; Goring, 1217; Oxford, 11, 854, 920, 2522, 2753; Witney, 907, 1278, 2729.

**Shropshire.** Ludlow, 94, 3098; Newport, 152, 535; Oswestry, 1618, 2085, 2839; Shrewsbury, 59, 69, 477, 931, 1264, 1820, 2241, 2632, 3009; Wellington, 2098; Whitchurch, 2607.

**Somersetshire.** Axbridge, 1040; Bath, 1771, 2103, 2490; Burnham, 368; Langport, 1945; North Curry, 1634; Taunton, 1964; Weston-super-Mare, 666, 692, 2267.

**Staffordshire.** Handsworth, 306, 1528, 1985, 2162, 2195, 2360; Hanley, 78, 161, 386; Harborne, 147; Lichfield, 118, 2442; Longton, 89; New-castle-under-Lyme, 2745; Perry Bar, 2870; Rugeley, 1171; Stafford, 4, 5, 101, 186, 1895, 3031; Stoke-on-Trent, 98, 1133, 1803, 2073, 2840; Tamworth, 119; Uttoxeter, 520, 3008; Walsall, 892; Wednesbury, 99; West Bromwich, 372, 394, 681, 1664, 2244, 2859; Willenhall, 2415; Wolstanton, 2079; Wolverhampton, 149, 1216.

**Suffolk.** Aldeburgh, 1663; Bury St. Edmund's, 114; Felixstowe, 599, 2667; Framlingham, 91, 2229; Ipswich, 1996, 3037; Lowestoft, 1539; Walton, 898.

**Surrey.** Barnes, 1473; Camberley, 14; Caterham Valley, 2495; Croydon, 23, 938, 1297, 1932, 2096, 2099, 2236, 2581, 2928; Epsom, 953; Dorking, 2037; Farnham, 295; Kew, 485, 1369; Godalming, 1004, 2241, 2665; Guildford, 979, 1502; Kingsford-on-Thames, 2901; Purley, 1981; Redhill, 1766, 2646, 3015; Reigate, 16, 436; Richmond, 1607, 2250, 2628; Sanderstead Hill, 932; Surbiton, 2116; Sutton, 805, 2256, 2467; Thornton Heath, 430, 2995, 3103; Wallington, 1028, 1300, 1740, 1928, 2453; Walton-on-Thames, 1845; Weybridge, 1846, 2345; Wimbledon, 1261; Woking, 1c, 1819, 2916; Worcester Park, 1809, 2705; Upper Warlingham, 2854.

**Sussex.** Bodiam, 2930; Bognor, 288, 426, 908, 1194, 1218, 1401, 1565, 2652; Brighton, 279, 704, 1304, 1422, 2821, 2990, 2974; Chichester, 26, 925, 2074, 2915, 3044; Crowborough, 2094; Eastbourne, 352, 484, 886, 1062, 1182, 2586, 2814, 3115; Hastings, 2687; Heathfield, 1804; Hove, 357, 1010, 2484, 2796; Lewes, 610, Pulborough, 1144; Robertsbridge, 1479; Slindon, 2789; St. Leonard's, 35, 417, 1403, 1870, 2052, 3054; Ticehurst, 718; Worthing, 1199, 2123.

**North Wales.** Anglesey, 1534, 2493; Bangor, 1151, 1679, 2014, 2614; Carnarvon, 2381, 2382; Colwyn Bay, 2230; Llanfairfechan, 2238; Manai Bridge, 2767; Mold, 297; Penrhyn-deudraeth, 1807; Portmadoc, 2019; Rhyl, 1397; Ruabon, 3116.

**South Wales.** Crickhowel, 2234; Cardiff, 465, 881, 1777, 2625; Fishguard, 1911; Haverfordwest, 2762; Merthyr Tydfil, 2012.

**Warwickshire.** Atherstone, 553; Birmingham, 93, 142, 295, 318, 390, 503, 545, 598, 814, 941, 1032, 1087, 1098, 1153, 1531, 1614, 1636, 2090, 2138, 2218, 2350, 2395, 2437, 2539, 2595, 2716, 2737, 2744, 2810, 3081, 3089; Coventry, 1629, 2367; Kenilworth, 1880; Rugby, 2454; Solihull, 1461; Warwick, 665.

**Westmoreland.** Kirkby Lonsdale, 2411,

**Wiltshire.** Salisbury, 1287, 2300, 2969.

**Worcestershire.** Blockley, 2920; Hanley Castle, 1925; Kidderminster, 1900, 2163; King's Norton, 450, 1071; Stourbridge, 365; Worcester, 2145, 2676.

**Yorkshire, North and East Ridings.** Aysgarth, 1675; Bedale, 2987; Beverley, 1132, 1476; Brough, 23; Driffield, 567; Guisborough, 1141, 2363, 3019; Howden, 97; Hornsea, 1715; Hull, 55, 115, 179, 455, 502, 609, 746, 855, 1236, 1578, 1674, 1690, 1761, 2097, 2121, 2270, 2324, 2521, 2694, 2776, 2864, 3046; Middlesborough, 618, 1052, 1625, 2764, 3038; Northallerton, 1086; Redcar, 122, 1946; Scarborough, 123, 1816, 2187; Selby, 92, 755, 2488; Stokesley, 709; Sutton-on-Hull, 2295; York, 8, 66, 141, 155, 264, 2288, 2298, 2450.

**Yorkshire, West Riding.** Baildon, 1113, 3020; Bingley, 356, 2935; Bradford, 863, 1094, 1323, 2101, 2341, 2722, 2724; Brighouse, 127; Dewsbury, 1121, 1564, 2222; Doncaster, 2909; Eiland, 2616; Golcar, 2904; Gomersal, 750; Halifax, 56, 1286, 1521, 2264; Harrogate, 703, 2356; Heckmondwicke, 1228; Huddersfield, 1095, 2303, 2719; Ilkley, 2837, 2875; Leeds, 31, 6, 156, 324, 369, 381, 457, 990, 1063, 1140, 1160, 1749, 1924, 1974, 1997, 2068, 2093, 2401, 2425, 2520, 2647, 2660, 2945, 2989, 2996, 3010, 3049; Penistone, 132; Rotherham, 112; Settle, 571; Sheffield, 167, 349, 416, 442, 505, 507, 587, 771, 956, 1125, 1126, 1158, 1271, 1317, 1485, 1567, 1621, 1794, 2285, 2420, 2541, 2691, 2991; Skipton, 2997; South Milford, 734; Sowerby Bridge, 125; Tadcaster, 593; Wakefield, 1384, 2656.

## IRELAND.

**Ballymena,** 199; **Ballinasloe,** 2596; **Ballygawley,** 2030, **Baltiunglass,** 2469; **Belfast,** 195, 335, 819, 1364, 1640, 1656, 1961, 3059; **Borris O'Kane,** 1230; **Boyle,** 772; **Coleraine,** 376; **Comber,** 2399; **Cork,** 950; **Dublin,** 10, 2, 448, 464, 489, 491, 669, 685, 777, 846, 1006, 1122, 1181, 1604, 1956, 2114, 2118, 2184, 2196, 2494, 2542, 2626, 2842, 2927; **Enniskillen,** 712; **Fermoy,** 1201; **Galway,** 331; **Glanmire,** 454; **Kells,** 429; **Lurgan,** 775; **Newry,** 894; **Parsonstown,** 2529; **Rathfriland,** 1527; **Waterford,** 1929; **2799;** **Wexford,** 1050, 2260; **Whitehouse,** 2731.

## SCOTLAND.

**Aberdeen,** 1020, 2988; **Aberfeldy,** 2689; **Ardrihaig,** 1833; **Ardrossan,** 201; **Carnoustie,** 1597, 1787; **Dunfermline,** 984, 2388; **Dumfries,** 1561; **Edinburgh,** 3, 617, 762, 876, 1552, 1554, 2045, 2390; **Elgin,** 1862; **Falkirk,** 514, 1854; **Galashiels,** 2487; **Glasgow,** 13, 266, 375, 385, 515, 519, 526, 634, 690, 710, 768, 860, 960, 1088, 1239, 1430, 1544, 1574, 1786, 1831, 1836, 1860, 1864, 1965, 2048, 2523, 2857, 2858, 2984; **Greenock,** 1402; **Hawick,** 362, 851, 1307, 3004; **Innerleithen,** 405, 2573; **Inverness,** 1645, 1849; **Kelse,** 400; **Kingussie,** 1858; **Kircudbright,** 1840; **Kirkwall,** 875; **Markinch,** 2593; **Melrose,** 550; **Paisley,** 2797; **Perth,** 2584; **Rothsay,** 305; **Row,** 642; **St. Andrew's,** 2441; **Stirling,** 911; **Tweedmouth,** 945.

## AFLOAT.

1220, 1885, 2881.

## EUROPE.

- Austria.** Vienna, 2055, 2727.
- Belgium.** Antwerp, 228, 229, 1709; Brabant, 1240; Brussels, 48; Mons, 1212.
- Denmark.** Copenhagen, 1692, 1725, 1783, 2213, 2313, 2555; Espjerg, 1737; Oxbøl Mejeri pr. Varde, 1358.
- France.** Bordeaux, 1130; Paris, 1627, 1711.
- Germany.** Altenburg, 230; Berlin, 37, 231, 468, 981, 1702; Brunswick, 232; Cölln-Elbe, 2475; Dresden, 2923; Eschwege Hessen, 461; Frankfurt-on-Maine, 1255; Gera, 1114; Hamburg, 38, 39, 2949, 3032; Herford, Westphalia, 569; Ilmenau, 1007; Jena, 466; Leipsic, 236, 1779; Magdeburg, 2955; Nuremberg, 303, 2372; Perleberg, 2087.
- Holland.** Alkmaar, 226; Amsterdam, 233, 1267, 1637, 2429, 2830, 3067; Dordrecht, 225; The Hague, 40; Middleburg, 227; Rotterdam, 1563, 2327; Utrecht, 234; Zutphen, 1076.
- Hungary.** Budapest, 19, 1142, 1776.
- Italy.** Rome, 1138; Sarzana, 792.
- Norway.** Christiania, 11, 235, 1581, 1760, 2125; Eidsvold, 1726; Stavanger, 2326; Trondjem, 570, 1670, 2120.
- Portugal.** Lisbon, 2260.
- Sweden.** Stockholm, 980.
- Switzerland.** Geneva, 2699; Veytaux, 470.
- Turkey.** Constantinople, 2546.
- Mediterranean.** Cyprus, 169, 194, 1491, 2157; Gibraltar, 9, 70; Malta, 10, 531, 654, 1533, 1536, 1915, 2335, 2654, 2885

## AFRICA.

- Bechuanaland.** Mafeking, 3111; Palapye, 2896.
- Egypt.** Alexandria, 2452; Assiout, 947; Cairo, 760, 1508, 2197; Khartoum, 1014; Port Said, 1069; Samallout, 949.
- West Coast.** Sierra Leone, 1224; Zunguru, 2863.
- Gold Coast.** Tarkwar, 2970.
- Griqualand.** Beaconsfield, 1631; Kimberley, 294, 872, 902, 1274, 1310, 1408, 1590, 1857, 1918, 2069, 2205, 2897; Klipdam, 3108; Kokstad, 1934.
- Mauritius.** 2876.
- Natal.** Bellair, 1128; Durban, 563, 627, 743, 766, 828, 918, 1019, 1061, 1099, 1187, 1208, 1341, 1366, 1376, 1486, 1682, 1731, 1795, 2369, 2802, 2994; Ladysmith, 1247; Mount Ayliff, 985; Newcastle, 2449, 2605; Pietermaritzburg, 12, 143, 280, 481, 1164, 1381, 1827, 2426; Pine Town, 2140.

**Orange River Colony.** Bethlehem, 626; Bloemfontein, 116, 1226, 1309, 1775, 2730; Hicksburg, 2053; Harrismith, 1586, 2587; Ladybrand, 1423; Rouxville, 193; Senekal, 1727; Winburg, 1191.

**Portuguese East Africa.** Beira, 1793.

**Portuguese South West Africa.** Lobito Bay, 2353.

**Rhodesia.** Battlefields, 713; Buluwayo, 387, 438, 1426, 1484, 1758, 2311, 2611, 2662, 2829; Livingston, 1732; Penhalonga, 1407; Salisbury, 177, 330, 583, 1107, 1200, 1213, 1214, 1541, 1785, 2132, 2307, 2779; Umtali, 185, 315, 1067, 1108, 1930, 1948, 2179, 2619, 2624.

**South Africa, Eastern Division.** Aliwal North, 159, 1379; Barkly East, 1192, 2334; Burghersdorp, 490; Butterworth, 191; Cradock, 133, 367; Darabe, 2711; East London, 148, 1391, 1559, 2319, 2499; Engcobo, 796, 797; Graaf Reinet, 110, 547, 658, 1439; Grahamstown, 105, 203, 332, 364, 444, 1012, 1018, 1119, 1957, 2631, 2965; Jansenville, 1623, 2572; King William's Town, 1046, 1332, 2208, 2592; Maghaliën, 329; Port Elizabeth, 100, 716, 782, 1136, 1306, 1389, 2201, 2498, 2848; Somerset East, 2115.

**South Africa, Western Division.** Capetown, 20, 41, 182, 202, 218, 222, 326, 334, 480, 537, 622, 770, 921, 1079, 1103, 1139, 1145, 1480, 1610, 1970, 2109, 2168, 2194, 2272, 2301, 2333, 2383, 2424, 2468, 2472, 2544, 2545, 2577, 2671, 2701, 2734, 2751, 2784, 2791, 2833, 2868, 2932, 2972, 3001; George, 2290; Laingsburg, 498; Malmesbury, 221, 1703, 2091, 2419; Mossel Bay, 513, 909, 910, 2032; Oudtshoorn, 158, 2867; Paarl, 220; Riversdale, 223; Simon's Town, 217; Worcester, 140; Wynberg, 1681.

**Swaziland.** Hlaitikulu, 2235.

**Transvaal.** Barberton, 1954, 3005; Cleveland, 1905; Devon Station, 1131; Eastleigh, 2329; Ermelo, 1822; Heidelberg, 1209, 2092; Jeppestown, 2749; Johannesburg, 176, 178, 206, 210, 219, 287, 292, 307, 494, 756, 823, 836, 992, 1166, 1196, 1295, 1658, 1733, 1768, 1847, 1856, 1935, 2025, 2153, 2204, 2294, 2336; Klerksdorp, 516; Krugersdorp, 299, 833, 2026, 2502, 2865; Middleburg, 1937, 2065, 2305, 2486; Potchefstroom, 578, 1072, 1276, 1773, 2566, 2892; Pretoria, 209, 1023, 1280, 1333, 1549, 1908, 2018, 2072, 2362, 2524, 2821, 2838, 2931, 2948; Roodepoort, 336, 1797, 1799; Springs, 298, 1272; Volkerust, 1449; Zeerust, 172, 2249, 2933.

**Zanzibar.** Zanzibar, 1738.

## ASIA.

**Assam.** Silchar, 187.

**Baluchistan.** Quetta, 273, 1938, 2849.

**Bengal.** Calcutta, 653, 749, 1024, 1112, 1500, 1947, 2579; Cawnpore, 80, Julpaigurie, 780; Lucknow, 1832; Meerut, 683.

**Bombay.** Bombay, 291, 621, 748, 786, 1102, 1167, 1481, 1594, 1596, 1641, 1646, 1999, 2126, 2357, 2548; Bhavnagar, 2169; Dharwar, 181; Hyderabad, 2315; Karachi, 835; Kirkee, 204; Poona, 558, 1115, 1666, 1851, 2580,

**Burma.** Kyankpyn, 1991; Maymyo, 1551; Moulmein, 88, 714, 1457, 1810, 2031, 2818; Pegu, 539; Rangoon, 14, 95, 106, 397, 521, 747, 1273, 1363, 2720, 2937, 2956; Tavoy, 824.

**Ceylon.** Colombo, 1105, 1399, 1598, 1622, 2728; Kandapolla, 935.

**Central Provinces.** Kamptee, 72; Nagpur, 1259.

**China.** Hong Kong, 86, 2507; Foochow, 2565; Shanghai, 18, 276, 1359; Swatow, 2016; Tientsin, 475.

**Eastern Archipelago.** Johore, 2308; Penang, 1409, 1512, 3065; Selangor, 173, 3063; Singapore, 17, 84, 120, 192, 328, 551, 866, 965, 1036, 1090, 1268, 1667, 1688, 1694, 2192, 2366, 2456, 2511; Taiping, 166.

**Japan.** Yokohama, 2514.

**Java.** Batavia, 224.

**Madras.** Arnavkad, 2439; Bangalore, 189, 988, 1053, 2066; Bellary, 82; Calicut, 164; Chickmaghir, 1992; Georgetown, 997, 1982; Madras, 15, 62, 304, 309, 339, 463, 649, 687, 752, 900, 1008, 1075, 1452, 1940, 2003, 2015, 2054, 2417, 2448, 2706, 2769, 2836, 2869, 3096; Madura, 174, 2841; Munnar, 216; Nungumbankum, 562; Ootacamund, 126, 2479; Saidapet, 346; Secunderabad, 933, 1519, 1700, 2435; Teynampet, 2107; Trichinopoly, 731; Vepery, 121; Vizagapatam, 184; Wellington, 2703.

**North West Provinces.** Allahabad, 76, 663, 2926; Bareilly, 401, 1628; Benares, 146; Jhansi, 1498; Moradabad, 1386, 2445; Sitapur, 170, 2228.

**Philippine Islands.** Leyte, 2463; Manila, 625, 1800.

**Punjab.** Dera Ismail Khan, 8561; Kashmir, 496; Lahore, 13, 1293, 1904; Rawal Pindi, 154, 612, 1413; Sialkote, 113.

**Rajputana.** Nasirabad, 1615, 2532.

## AUSTRALASIA.

**Fiji.** Ba River, 1651; Lautoka, 377, 1165, 1605; Suva, 2609; Vanua Levu, 785.

**New South Wales.** Bogabilla, 2999; Cobar, 3017; Corrimal, 1980; Emmaville, 2460; Inverell, 899; Narromine, 1150; Sydney, 46, 316, 2421, 2576, 2803; Wagga Wagga, 2550.

**New Zealand, North Island.** Auckland, 411, 1053, 1898, 1955, 2273, 2850; Cambridge, 1826; Carterton, 1993; Featherston, 1603; Morrinsville, 781; New Plymouth, 597, 1496; Taranaki, 842, 2224; Thames, 1832, 1939; Waipukurau, 1609; Wanganui, 1906; Wellington, 43, 134, 171, 493, 1184, 2387, 2402, 2477, 2562, 2651.

**New Zealand, South Island.** Ahaura, 1582; Blenheim, 1296; Canterbury, 1368, 2747; Clyde, 256; Christchurch, 506, 698, 820, 1398, 1535, 2006, 2051; Dunedin, 251, 1357, 2409; Invercargill, 252, 1211, 1468, 2343, 2578, 3093; Nelson, 254, 1689, 2538; Oamuru, 613; Otago, 414; Palmerston, 145; Rangiora, 253; Reefton, 255; Winton, 257.

**Queensland.** Allora, 1989; Balcaldine, 144; Blackall, 9772; Brisbane, 19, 196, 680, 852, 1390, 1405, 2585; Bundaberg, 906; Cairns, 456, 1839, 1923, 2075, 2279, 3073; Charters Towers, 136, 208, 290, 1378, 2568, 2569; Croydon, 482; Cunnamulla, 212, 1444; Georgetown, 447, 1277; Goondiwindi, 3021; Gympie, 124, 211, 213, 652, 1498, 2612, 3069; Herberton, 300, 541, 1252, 1487, 1782; Inglewood, 215; Laidley, 168; Longreach, 1834; Mackay, 138, 197, 205, 207, 1673, 1698, 2182, 2700, 2765; Monkland, 1791; Mount Morgan, 200, 1639, 1850, 2049; Mutdapilly, 2917; Nudgee, 1540; Rockhampton, 380, 451, 1149, 1513, 1830, 1843, 2589; Roma, 150; Rosewood, 214; Stamford, 1203; St. George, 1998; Tambo, 190; Taringa, 636; Toowoomba, 193, 322, 1034, 1672, 1952, 2141, 2668, 2787; Townsville, 139; Warwick, 1716.

**Sandwich Islands.** Honolulu, 1547.

**South Australia.** Adelaide, 44, 247, 293, 425, 882, 924, 1360, 1383, 1599, 2219, 2233, 2894, 3055; Burrundie, 2312; Clare, 250; Gawler, 244; Naracoorte, 248; Norwood, 246; Snowtown, 249; Strathalbyn, 245.

**Tasmania.** Cameron, 2560; Launceston, 1714, 1884; Zeehan, 258, 579, 2447.

**Victoria.** Bendigo, 1742; Caulfield, 1606, 2622; Fitzroy, 2024; Melbourne, 45, 435, 497, 951, 1251, 1442, 1600, 1696, 1719, 1741, 2561, 2623, 2669; Middle Brighton, 1936, 2781; Port Fairy, 1073; Vaughan, 2967; Yarra, 2007.

**Western Australia.** Boulder City, 608, 2046, 2364; Coolgardie, 1890, 2176; Dongarra, 675; Fimiston, 548; Freemantle, 1560; Guildford, 2768; Kalgoorlie, 1914; Kookynie, 1650, 2119, 2491; Niagara, 1765; Northam, 2117; Perth, 486, 723, 1129, 1170, 1311, 1543, 1734, 2278, 2503, 2675, 2895.

## SOUTH AND CENTRAL AMERICA.

**Antofagasta,** Chili, 2252; **Bahia,** Brazil, 1478; **Buenos Aires,** 16, 96, 117, 180, 408, 551, 580, 623, 738, 839, 919, 1155, 1270, 1291, 1393, 1450, 1477, 1510, 1763, 1837, 1842, 1887, 1971, 1987, 1988, 2558, 3051, 3066, 3074; **Chihuahua,** Mexico, 2497; **Monte Video,** 108; **Pernambuco,** Brazil, 588; **Port Limon,** Costa Rica, 260; **Rio de Janeiro,** 1575; **Rosario de Santa Fé,** Arg. Rep., 137, 396, 858, 1215, 1281, 1542, 1901, 2022, 2501, 2827, 3087, 3100; **San José,** Costa Rica, 42, 259, 389, 729, 1232, 1349, 1424, 1506, 1635, 2010, 2131, 2462; **Santiago,** Chili, 3018; **Vilela,** Arg. Rep., 897; **Talcahuano,** Chili, 807; **Valparaiso,** Chili, 800.

## WEST INDIES.

**Anchovy,** Jamaica, 864; **Chapelton,** Jamaica, 1814; **Cienfuegos,** Cuba, 2190; **Havana,** Cuba, 2405; **Kingston,** Jamaica, 74, 1047, 2444; **St. Vincent,** 2291.

## CANADA.

**Battleford,** N.W.T., 239, 2883; **Belleville,** Ontario, 2253; **Calgary,** Alberta, 238, 1084, 1838; **Caslo,** B.C., 1493; **Charlottetown,** Prince Edward Island, 2853; **Cowley,** Alberta, 1643; **Deloraine,** Manitoba, 2785; **Edmonton,** N.W.T., 565; **Golden,** B.C., 2164; **Hamilton,** Ontario, 36, 50;

Indian Head, Assa., 692; Kingston, Ontario, 2002; Ladner, B.C., 2349; Medicine Hat, Assa., 237; Melita, Manitoba, 689, 879; Montreal, 75; Morden, Manitoba, 2678; Morley, Alberta, 1669; Neepawa, Manitoba, 2921; New Westminster, B.C., 973, 3060; Nicola Lake, B.C., 589; Ottawa, 277, 1824, 2106, 2993; Qu'Appelle, Assa., 2289, 2457; Rapid City, Manitoba, 890; St. John's, Newfoundland, 1035, 1330; Toronto, 30; Vancouver, B.C., 2512, 2990, 3039; Victoria, B.C., 35; Waweig, New Brunswick, 559; Winnipeg, Manitoba, 27.

## UNITED STATES OF AMERICA.

**Alabama.** Montgomery, 21; Wylam, 1041.

**Alaska.** Skagway, 2559, 2743.

**California.** Berkeley, 283, 2113; Los Angeles, 271, 2330, 2924; Long Beach, 1821; Mill Valley, 1558; San Francisco, 784, 1207, 1876, 2226, 2368, 3106; Santa Barbara, 1638.

**Colorado.** Denver, 404, 666, 1234, 1917, 2262, 3088, 3091, 3107; Glenwood Springs, 954.

**Connecticut.** Bridgeport, 2214; New Haven, 971; Portland, 338.

**District of Columbia.** Washington, 22, 49, 262;

**Florida.** De Land, 3041; Jacksonville, 33; Melbourne, 2679; Orlando, 1903; Ormond, 702; Plant City, 3040; St. Petersburg, 1593.

**Georgia.** Atlanta, 615, 1282; Augusta, 556, 1545; Savannah, 2110.

**Illinois.** Champaign, 3070; Chicago, 2597, 2882, 3026; Quincy, 1553, 2379.

**Indiana.** La Porte, 915.

**Iowa.** Cedar Rapids, 23; Des Moines, 282, 996, 1288.

**Kansas.** Burlington, 629, 2648; Osawatomie, 512; Topeka, 24, 2062, 2518; Wichita, 1066.

**Kentucky.** Louisville, 24.

**Louisiana.** Amite City, 2337; Carson, 2966; Donaldsonville, 2760; New Orleans, 577, 1718, 2231, 2304.

**Maine.** Portland, 26, 267.

**Maryland.** Baltimore, 2483, 2540; Cumberland, 1134.

**Massachusetts.** Boston, 28, 926, 1396, 1572, 1746, 2423, 2634; Concord, 633, 1388, 1888; Newton, 2259; Medfield, 1983.

**Michigan.** Ann Arbor, 278; Detroit, 240, 272, 2237, 3092; Port Huron, 721.

**Minnesota.** Duluth, 268; Mankato, 241; Minneapolis, 2473; St. Paul, 736, 764, 1116, 1436, 2001, 2370, 2535, 2608, 3042; St. Peter, 1990.

**Missouri.** Hannibal, 3068; Kansas City, 2759.

**Montana.** Anaconda, 3007; Dillon, 2861; Helena, 29; Missoula, 717.

**Nebraska.** Omaha, 1649, 1655, 1788; Lincoln, 2265.

**New Jersey.** Arlington, 1263; Bound Brook, 853; Camden, 2434; East Orange, 540, 1147; Elizabeth, 682, 2537, 3012; Flemington, 958; Metuchen, 2998; Monclair, 561; Newark, 1630, 1933, 2823, 3050; Paterson, 2670; Sayreville, 2807; Trenton, 406; Woodbridge, 2481.

**New York.** Albany, 391, 2934; Brooklyn, 319, 374, 591, 730, 2186; Lima, 363; New York, 15, 30, 539, 737, 798, 877, 983, 1173, 1410, 1469, 1570, 1653, 1691, 1805, 1968, 2013, 2274, 2280, 2284, 2322, 2339, 2645, 2766, 2866, 2874.

**North Carolina.** Brevard, 638.

**North Dakota.** Fargo, 2773; Lisbon, 2982.

**Ohio.** Akron, 787; Cincinnati, 840; Corning, 544; Delaware, 2506; Fairfield, 2332; Newark, 904; Warren, 2642.

**Oregon.** Portland, 1269, 1460, 2261.

**Pennsylvania.** Hanover, 2536; Harrisburg, 1109, 1253, 1720; Huntingdon, 2127; Philadelphia, 31, 284, 885, 1161, 1321, 1647, 1739, 2060, 2530, 2710, 2977, 3053; Pittsburgh, 614, 643, 810, 838, 1313, 1338, 1522, 1889, 2604, 2723; Robertsdale, 373; Sunbury, 776; Steelton, 308; Warren, 1031; Wyncote, 2871.

**Rhode Island.** Pawtucket, 753; Providence, 350, 584, 1654, 2036, 2492, 2531, 2594, 2695, 2951.

**South Carolina.** Camden, 837.

**South Dakota.** Aberdeen, 2733; Deadwood, 371; Flandreau, 2633; Sionx Falls, 2207; Webster, 1774.

**Tennessee.** Chattanooga, 2088; Memphis, 413; Nashville, 1152

**Texas.** Dallas, 790; El Paso, 2128; Galveston, 624.

**Vermont.** Bennington, 2683; Middlebury, 575.

**Virginia.** Richmond, 32.

**Washington.** Anacortes, 242; Bellingham, 2985; Bremerton, 478; Charleston, 2510; Enumclaw, 243; Pullman, 2942; Seattle, 285, 1254, 1927, 2952; Snohomish, 2155; Spokane, 1648; Tacoma, 269, 1258, 1743, 2517; Walla Walla, 270, 2828.

**West Virginia.** Wheeling, 388.

**Wisconsin.** Milwaukee, 34.

**STATED MEETINGS OF THE LODGE IN 1907.**

Friday 4th (11th) January.

Friday, 1st March.

Friday, 3rd May.

Monday, 24th June.

Friday, 4th October.

Friday, 8th November.



# ABBREVIATIONS.

## MASONIC.

A.	Arch, Assistant	K.	King ( <i>American &amp; Irish R.A.</i> )
A.G.	Assistant Grand	L.	Lodge
B.	Bearer	M.	Master, Most
C.	Ceremonies, Constitution	Mem.	Member
Ch.	Chaplain.	M.E.	Most Excellent
Chap.	Chapter	M.W.	Most Worshipful
Com.	Committee	N.	Nehemiah
D.	Director, Deacon, Dutch	O.	Organist
D.C.	Director of Ceremonies	Or.	Orator
(D.C.)	Dutch Constitution	P.	Past, Principal, Priest ( <i>Am. &amp; I.R.A.</i> )
D.M.	Director of Music	P.Dep.	Past Deputy
Dep.	Deputy, Depute ( <i>Scotch</i> )	P.Dep.Dis.	Past Deputy District
Dep.Dis.	Deputy District	P.Dep.Pr.	Past Deputy Provincial
Dep.Pr.	Deputy Provincial	P.Dis.	Past District
Dis.	District	P.Dis.G.	Past District Grand
Dis.A.G.	District Assistant Grand	P.G.	Past Grand
Dis.G.	District Grand	P.H.	Past Haggai
Div.	Division	P.H.P.	Past High Priest ( <i>Amer. &amp; Irish R.A.</i> )
E.	Ezra, English, Excellent	P.J.	Past Joshua
(E.C.)	English Constitution	P.K.	Past King ( <i>American and Irish R.A.</i> )
G.	Grand, Guard	P.M.	Past Master
G.Ch.	Grand Chaplain	P.Pr.	Past Provincial
G.Chap.	Grand Chapter	P.Pr.G.	Past Provincial Grand
G.D.	Grand Deacon	Pr.	Provincial
G.D.C.	Grand Director of Ceremonies	Pr.G.	Provincial Grand
G.H.	Grand Haggai	Pt.	Pursuivant
G.H.P.	Grand High Priest ( <i>Am. &amp; Irish R.A.</i> )	P.Z.	Past Zerubbabel
G.J.	Grand Joshua	R.	Registrar, Right
G.L.	Grand Lodge	R.A.	Royal Arch
G.M.	Grand Master	R.W.	Right Worshipful
G.O.	Grand Organist	S.	Senior, Scottish, Sword
G.P.	Grand Principal (R.A.)	S.B.	Sword Bearer
G.Pt.	Grand Pursuivant	(S.C.)	Scottish Constitution
G.R.	Grand Registrar	Sc.	Scribe
G.S.B.	Grand Sword Bearer	Sc.E.	Scribe Ezra
G.Sc.E.	Grand Scribe Ezra	Sc.N.	Scribe Nehemiah
G.Sec.	Grand Secretary	S.D.	Senior Deacon
G.St.B.	Grand Standard Bearer	Sec.	Secretary
G.Stew.	Grand Steward	So.	Sojourner
G.So.	Grand Sojourner	Stew.	Steward
G.Sup.	Grand Superintendent (R.A.)	St.	Standard
G.Sup.W.	Grand Superintendent of Works	Sub.	Substitute ( <i>Scottish</i> )
G.Treas.	Grand Treasurer	Sup.	Superintendent
G.W.	Grand Warden	Sup.W.	Superintendent of Works
G.Z.	Grand Zerubbabel	S.W.	Senior Warden
H.	Haggai	Treas.	Treasurer
H.P.	High Priest ( <i>American &amp; Irish R.A.</i> )	V.	Very
I.	Irish, Inner	V.W.	Very Worshipful
(I.C.)	Irish Constitution	W.	Warden, Worshipful, Works
I.G.	Inner Guard	W.M.	Worshipful Master
J.	Joshua, Junior	Z.	Zerubbabel
J.D.	Junior Deacon		
J.W.	Junior Warden		

## SOCIAL AND MILITARY.

A.D.C.	Aide de Camp	I.C.S.	Indian Civil Service
A.S.C.	Army Service Corps	I.M.	Indian Marine
Bart.	Baronet	I.M.S.	Indian Medical Service
B.C.S.	Bombay or Bengal Civil Service	I.S.C.	Indian Staff Corps
		I.S.O.	Imperial Service Order
C.B.	Companion of Order of the Bath	J.P.	Justice of the Peace
C.I.E.	Companion of Order of the Indian Empire	Kt.	Knight
C.M.G.	Companion of Order of SS. Michael and George	M.L.C.	Member of Legislative Council
C.S.I.	Companion of Order of the Star of India	M.P.	Member of Parliament
	(N.B.—K. or G. prefixed to the above signifies Knight Commander, or Knight Grand Cross, or Knight Grand Commander of the Order concerned.)	R.A.M.C.	Royal Army Medical Corps
D.L.	Deputy Lieutenant	R.E.	Royal Engineers
D.S.O.	Distinguished Service Order	R.F.A.	Royal Field Artillery
Hon.	Honourable	R.G.A.	Royal Garrison Artillery
		R.H.A.	Royal Horse Artillery
		R.M.A.	Royal Marine Artillery
		R.N.	Royal Navy

## PROFESSIONAL

A.M.	Master of Arts	L.S.	Linnæan Society
A.K.C.	Associate of King's College	M.A.	Master of Arts
B.A.	Bachelor of Arts	M.B.	Bachelor of Medicine
B.C.L.	" of Civil Law	M.D.	Doctor of Medicine
B.Ch.	" of Surgery	Mus.Doc.	" of Music
B.Sc.	" of Science	P.	President
C.A.	Chartered Accountant	Ph.D.	Doctor of Philosophy
C.E.	Civil Engineer	Prof.	Professor
C.I.S.	Chartered Institute of Secretaries	P.W.D.	Public Works Department
C.S.	Chemical Society	R.A.	Royal Academy
C.M.	Master in Surgery	R.A.S.	" Asiatic Society ( <i>Members</i> )
Dr.	Doctor	R.A.S.	" Astronomical Society ( <i>Fellows</i> )
D.C.L.	" of Civil Laws	R.C.I.	" Colonial Institute
D.D.	" of Divinity	R.C.P.	" College of Physicians
D.Lit.	" of Literature	R.C.S.	" " of Surgeons
D.Sc.	" of Science	R.C.V.S.	" " of Veterinary Surgeons
G.S.	Geological Society	R.G.S.	" Geographical Society
I.C.	Institute of Chemists	R.H.S.	" Historical Society ( <i>Fellows</i> )
I.C.E.	" of Civil Engineers	R.H.S.	" Horticultural Society ( <i>Members</i> )
I.E.E.	" of Electrical Engineers	R.I.	" Institute of Painters in Water Colours
I.M.E.	" of Mining Engineers	R.I.A.	" Irish Academy
I.Mech.E.	" of Mechanical Engineers	R.I.B.A.	" Institute of British Architects
I.N.A.	" of Naval Architects	R.S.	" Society
I.I.	Imperial Institute	R.S.E.	" " Edinburgh
K.C.	King's Counsel	S.A.	Society of Arts ( <i>Members</i> )
L.D.S.	Licentiate in Dental Surgery	S.A.	" of Antiquaries ( <i>Fellows</i> )
LL.B.	Bachelor of Laws	S.C.L.	Student of Civil Law
LL.D.	Doctor of "	S.I.	Institute of Surveyors
LL.M.	Master of "	S.S.	Statistical Society
Lic.Mus.	Licentiate of Music	V.P.	Vice President
		Z.S.	Zoological Society

NOTE.—A. M. or F. prefixed to letters indicating an Institute or Society stands for Associate, Member or Fellow of the Society in question.









3 9015 02313 5901

Filed by Preservation NEH 1992

