

# THE PSIONIC GRIMOIRE

by

**Charles W. Cosimano**

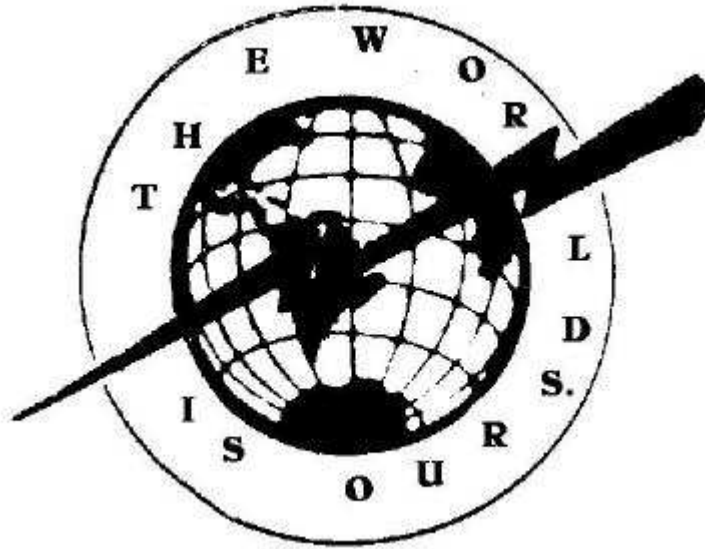

Being a study of the magickal art of planets and spirits and how they may be used most effectively for the benefit of the magician and those whom he wish to benefit along with him as well as causing destruction and wreck to those whom the magician does not like, copiously illustrated with divers colors and drawings.

## BY WAY OF INTRODUCTION

I began as a magician. I studied the Kabbala before Madonna was even heard of. I summoned demons to my service and aid while still a boy. I created talismans and used words of power unheard of before or since. And I did this for years before I hit upon psionics.

But I came to psionics by way of magick and thus never fell into the trap of thinking it a hard science, for such was the error of its founders. Even now there are those who tape pictures printed from a digital camera to a computer screen with a moving gif and think that they are somehow doing science. Well, let them. We know better.

Psionics is magick and magick is not a science, it is an art. It is the way of making things happen that would not happen any other way. It is the way of wonders and miracles and things that go boom in the night. It is the power that speaks to truth and truth gives way before it. It is the creation of reality.

And it is a power that all can wield if they are willing to take the time and trouble.

Fortunately, with psionics, that time and trouble can be minimized.

But this work is a grimoire, which means it is concerned with two aspects of magick, the evoking of spirits and the powers thereof, and the use of talismans to contain and direct those powers to serve the ends of the magician. It makes no pretense of spiritual advancement. It is purely concerned with earthly ends and human ends. You will not become enlightened from this but you will be as God, beyond the need of knowing good and evil.

With this book I return again to my magickal roots. It will be a fusion of the hermetic traditional and the psionic anti-traditional, bringing out the best of the old world to redress the balance of the new. In it I will go beyond the general techniques of Psionic Magick and the small section on sigils in Psionic Power. And in it all I will not forget the words of Marlowe's Faustus, "A sound magician is a mighty god."

## THE EQUIPMENT OF THE MAGICIAN

Magick used to be very expensive and for that reason in the good old days Magicians were from the best class of society. It cost a lot of money to get the tools and the robes and the books and the place to work undisturbed, something that the worthless peasantry (Yuck!) could not afford and it would not do them any good because even if they could afford it they could not read the books. A country witch could be illiterate. A magician needed education!

So, the first thing you need is books, lots of books, preferably books with Psionic in the title written by me! OK, so I have to have some fun with this and a little commercial now and then does not hurt. My old Key of Solomon was published by L. W. DeLaurence and he put ads for everything in that book, including an absolutely hilarious one for paper that went, "Gold is gold, diamonds are diamonds and extra virgin parchment paper is extra virgin parchment paper!" (What parchment has to do with olive oil eludes me.) It is that sort of thing that actually makes magick fun because you never know when you are going to burst out laughing. But the system worked and the pentacles in it work even better, which is why I have made a point of including them in this work.

Tradition stated that a Magician had to first get himself a knife to cut a branch with to make his wand. Well, tradition can be mold on the bathroom wall and this is one of those times. Your wand will be a flashlight.

This used to drive my friends nuts. But it is one of those ideas that was born of necessity that actually works and predates my interest in psionics.

When I was a young magician full of youthful enthusiasm and impatience I had a problem. All the instructions on using a magick wand insisted that you visualize a light coming out of the end of it. This created a problem for me in that I could not visualize for shit! But despair is not a word normally in my vocabulary (depression is, but it passes) and I figured out a perfect work-around. I picked up a flashlight and pointed it, turning it on at the same time. Then I made the sigil in the air with the beam of the flashlight! It worked perfectly and strange noises came from a corner of the room to the great consternation of the cat who had been watching me wondering if her favorite human had taken leave of his few senses.

I learned about banishing real fast that night.

So go out to the hardware store and purchase, without haggling, a new flashlight.

Bring it home. Put batteries into it.

Now you have your wand. Just be sure to put it somewhere where you will not grab it to look under the sink. Try to only use it for magick if possible.

The next thing you will need is your radionic box.

This is the schematic layout of the basic radionic box. To build it you will need:

Two foil circles about 3 inches in diameter each.

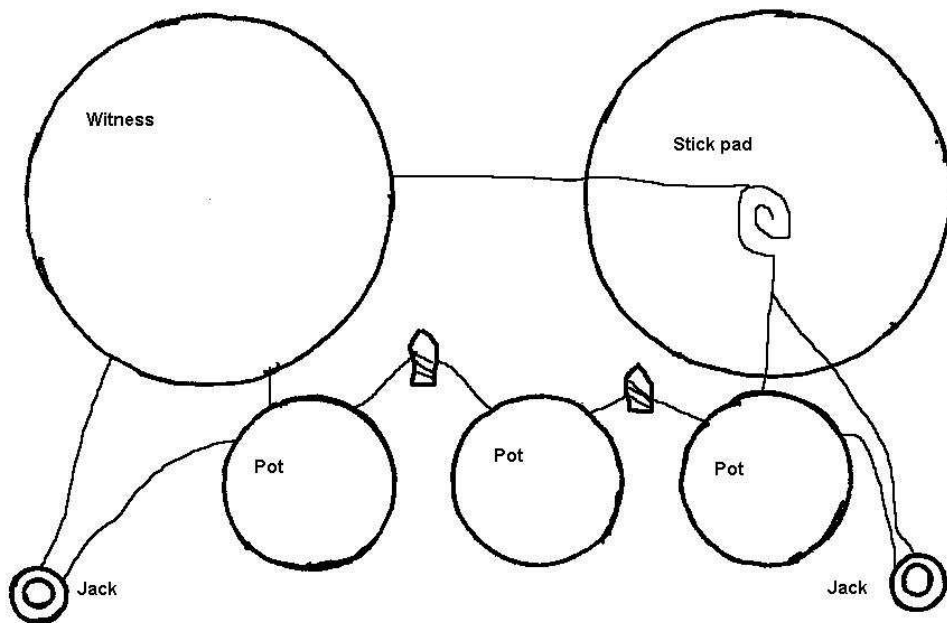

Three potentiometers (value unimportant) and knobs

2 crystals

2 small jacks

Some connecting wire

Some unshielded (magnet) wire.

A box to put it in.

Begin by laying out the pattern of the instrument on the box. You will want the two circles and the knobs for the potentiometers outside the box as well as the openings for the two jacks.

Punch the holes in the box as appropriate to the layout.

Now assemble the parts. Make two small coils of magnet wire to place under the foil plates and wire them to the potentiometers as shown. Wire the jacks to the potentiometers as shown.

Wire the potentiometers together with the crystals between them as shown.

Put it all together in the box. Put the knobs on the potentiometer stems.

Simple wasn't it.

Ok, put the box aside and make yourself a stick pad. This is even easier.

You will need:

1 length of speaker wire.

1 plug, the same size as the jacks you used on the box.

A plastic coffee can lid

A short length of unshielded wire.

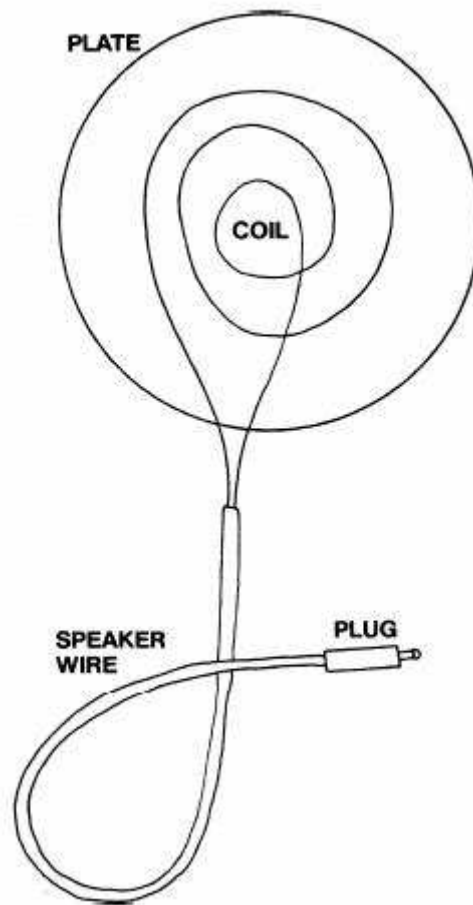

As you can see, the unshielded wire is coiled under the lid and glued in place and then wired to the speaker wire which is then attached to the plug.

Ok, next thing--the pendulum.

For this you can use any object that terminates in a point and can be attached to a convenient length of string. The illustration is of a child's wooden top, but you can use an old key as well.

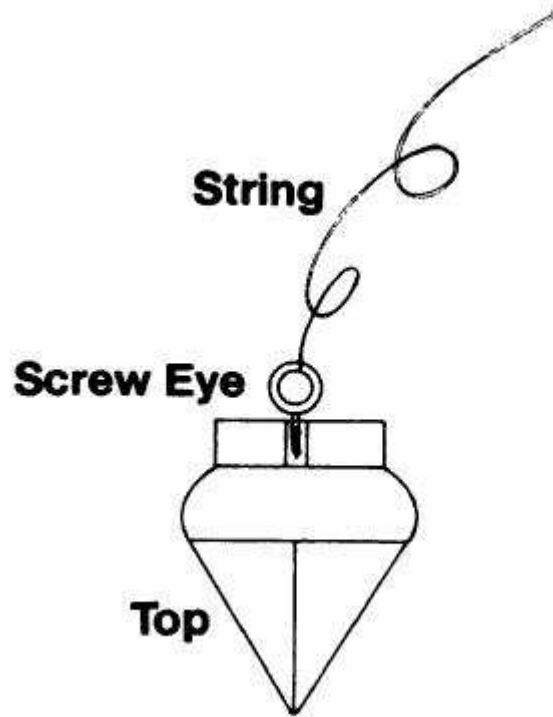

Now for two easy ones. All you need do is print them up.

The first is a simple yes-no chart.

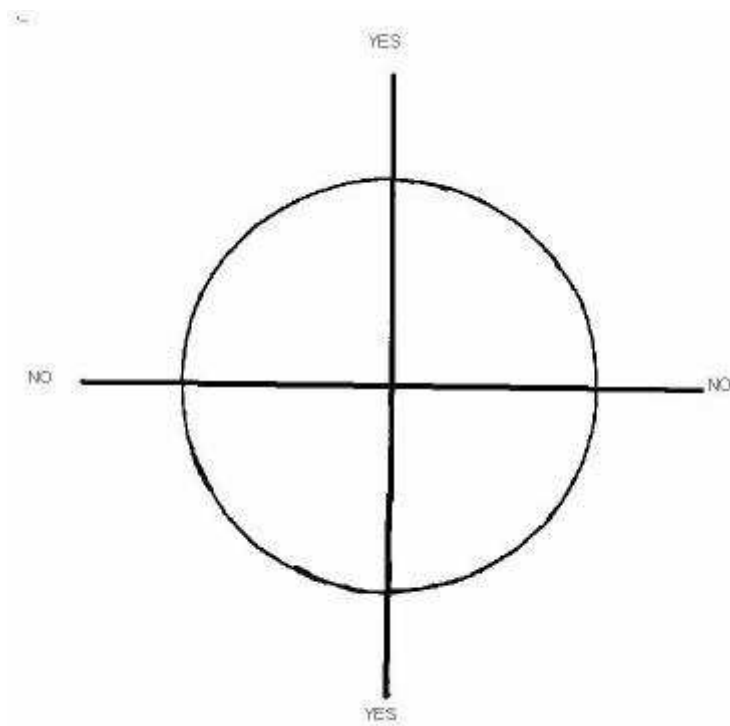

The second is a chart with letters, numbers and punctuation.

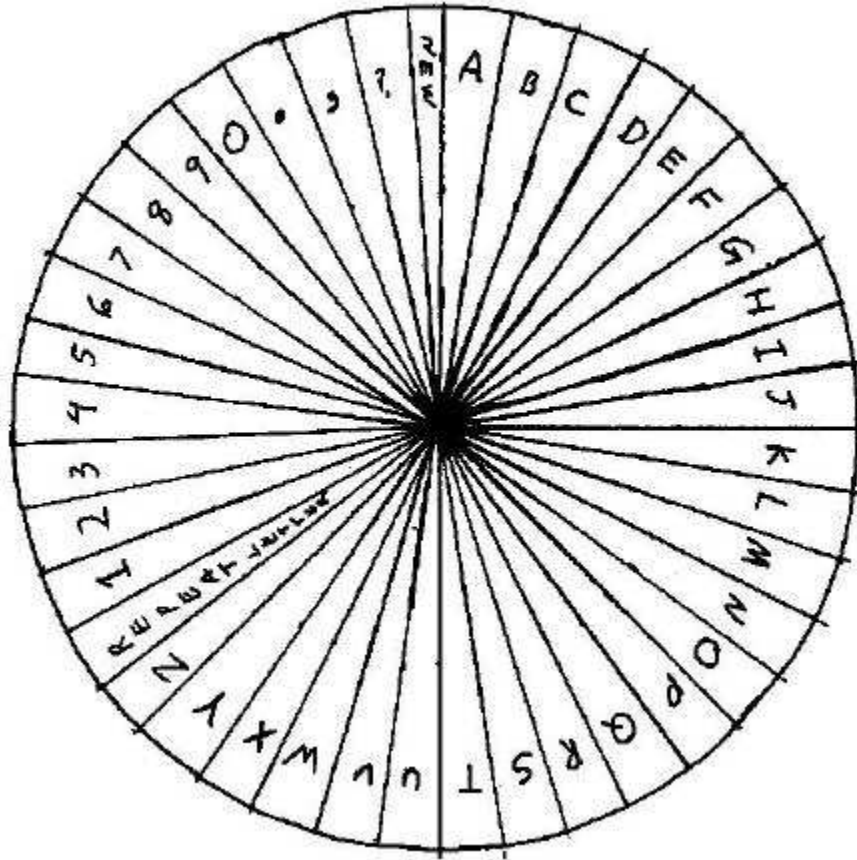

These are the charts that you will use with your pendulum to get answers from the spirits. It is a lot less trouble to do it this way than it is to listen to them talking in your head because they like to talk and sometimes the voices get very annoying and you have to kill people to make them stop and....**CHUCK!!!**

Ok I'm having fun.

This next instrument is going to be the most complicated one you will need to make right now. It is the psionic amplifying helmet and to make it you will need:

1 hard hat with removable liner

3 potentiometers

1 jack



1 foil circle

8 1 inch pieces of magnet strip with adhesive back (craft stores have it in rolls and you cut the pieces to length)

Something to make the crest out of. I used to say cut Styrofoam but it can also be made out of cardboard cut to the shape.

Finally, some wire.

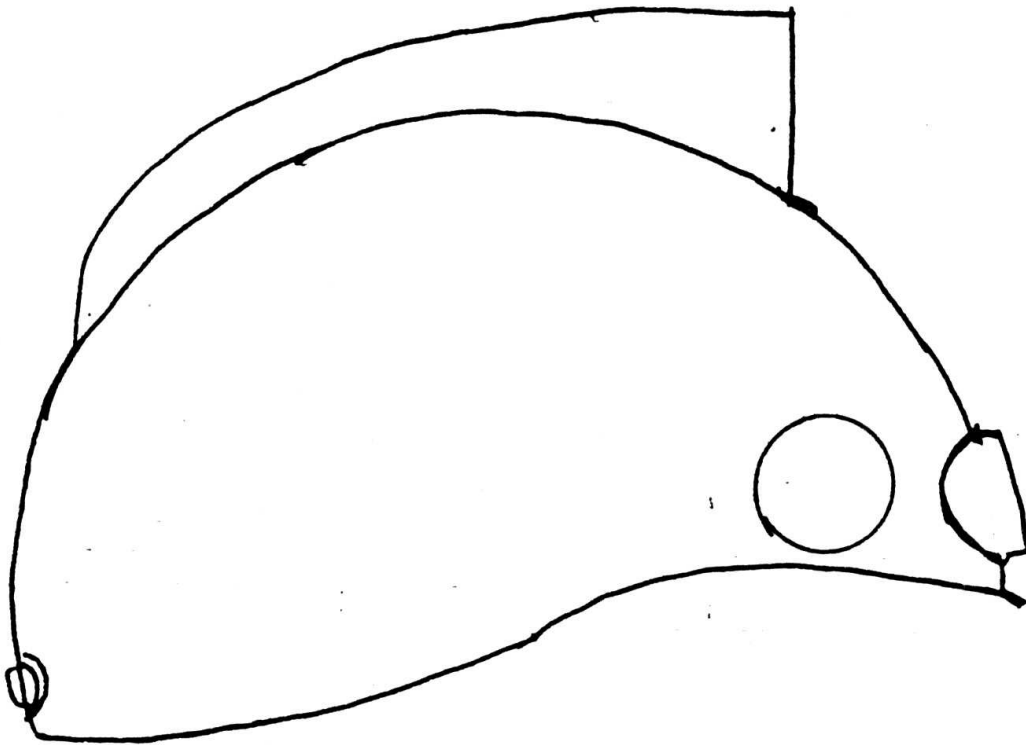

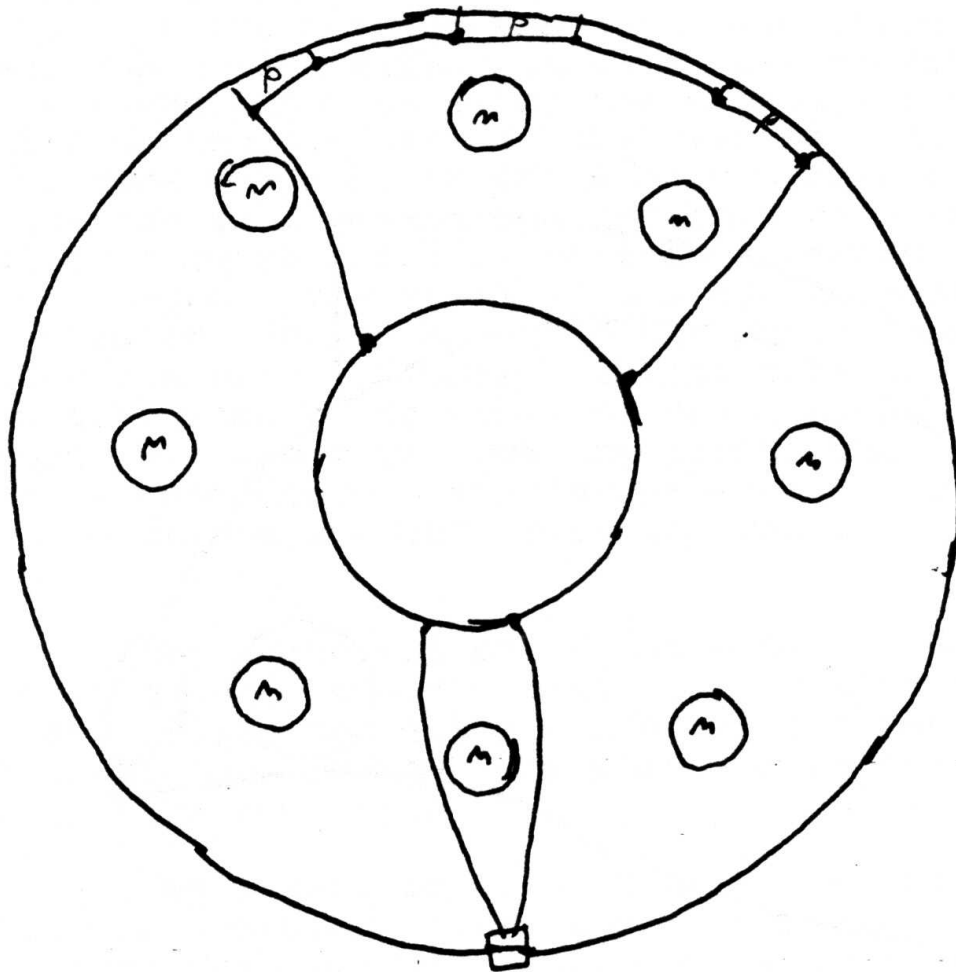

This is the layout of the helmet.

Of all the instruments you will need, this is the most intimidating to make until you actually get started. Then it becomes very simple.

The first thing you need to do is take the liner out of the hard hat. This should be pretty easy, they are usually made to be removed by pushing a few things out some slots. Once you do that, put the hat on the table on its side and, using a piece of paper, trace the curve of its top from a little in front of the center to the back. This is the template for cutting the bottom curve of the crest.

Finish the template by drawing the crest on the piece of paper. Cut it out.

Lay the template on one of the pieces of cardboard and trace around it. Then cut that out of the cardboard. Set the hardhat upright and hold the cardboard crest to it to see if you have the bottom curve matching the hard hat surface. If you do, repeat the process with the second piece of cardboard and set them aside for a bit.

Now you will need a drill and the correct size bit. You will want a bit just a little bigger than the screw part of the potentiometers (usually a 3/8 to 1/2 inch bit will work fine) so that after you drill the hole you can slip the pot into place and then bolt it down with the nut that comes with it.

Make three holes in the front of the helmet spaced so that the tuning knobs will not run into each other.

Now, with a smaller bit, make the hole for the jack on the same principle as the holes for the pots and a hole at the very top of the helmet.

Take a piece of wire and coil it flat with a length coming out one end. Put this coil on one of the pieces of cardboard and tape it in place so that the end wire runs out the bottom of the crest-piece. Now smear the cardboard with glue and place the other piece on top of it to make a sandwich. Clamp it together and let the glue set.

While that is going on, cut the magnet strip into eight pieces and stick them around the inside of the helmet, alternating the polarities. This is done by placing them vertically and horizontally so that one has the long side pointing to the top, the next has it pointing along the side.

Now fix the foil circle to the spot on the liner that sits on the top of your head when you put it on. This part of the liner tends to be fabric, so put some tape on the back of the circle, not covering it entirely, and then staple it to the fabric with the folding side of the staples AWAY from your head. The tape will allow the foil to hold without tearing.

Now wire the pots together and put a length of wire at each end of the circle, make sure this wire is long enough that when it is attached to the foil circle there will be enough room for your head. Put the pots into the holes you have drilled for them, bolt them down and attach the knobs.

Wire the jack and put it into the hole provided for it.

Attach the wire from the crest antenna to the foil circle.

Put the liner back into the hard hat.

Attach the wires from the pots and the jack to the circle.

And that's it for the basic tools. There is one more but we will get to that after explaining how the box and helmet are used.

Now, for those of you who have read my other books, you will notice that I do not require a calibration for the knobs. There is a reason for this. In the operations in this book all the rates are contact rates and they change all the time, so calibration is a waste of time and work.

The key to using the box and helmet is the relationship that they establish between the operator and the subject of the operation. Setting the dials on the box and helmet locks in that relationship and frees the mind of the operator to do other tasks. There is nothing electronic about it, which is why these devices make no sense electronically. When you use a sigil to contact a spirit, the instruments do the heavy lifting and all you have to do is communicate.

How is the rate, which is what the settings on the dials are called, taken? It is actually very simple.

To get a rate on the box, plug in the stick pad on the right-hand side jack of the instrument. Put the witness, which can be anything representing what you want to contact, on the witness plate on your left side and, while stroking the pad with your right thumb, slowly turn the dial to the farthest left. Do this until your thumb just sort of stops. This is the "stick" and it really cannot be described, but you will know it when it happens.

Repeat this procedure with each dial. The settings are now locked in. Now it is time to add the helmet.

Using a patch cable, plug the jack of the helmet into the left-hand jack of the box. Now repeat the tuning procedure with the helmet. Once that is done, you can put the helmet on and be in instant contact with whatever or whomever you have in the machine. It's kind of like a psychic telephone. And it is very easy to use. The equipment does all the work, you just have to sit back and let your brain have fun.

Play around with this, get used to working with it. Send messages to people in their sleep, spy on the neighbors. And once you get the hang of radionics, it is time to build your last instrument, which I take from my Psionic Magick, the Ritual Board.

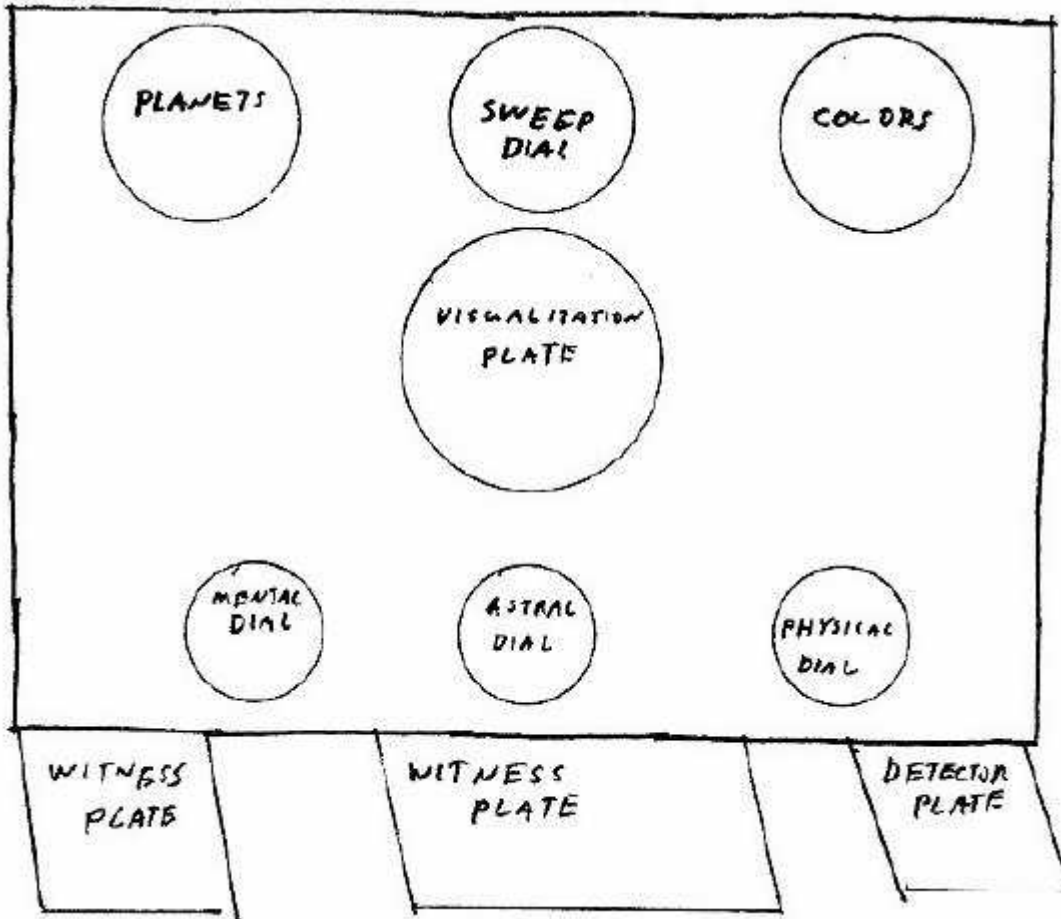

In Psionic Magick this device is made out a sheet of cardboard with dials cut out of poster board and foil sheets for the plates. And it works very well that way because all you are doing is setting up relationships in your consciousness with what you are working with.

Of course if you want you can make a more conventional box in this pattern. To do that, you will need:

4 potentiometers

6 knobs

2 short 1-2" 1/4 inch diameter rods (the excess from Radio Shack pot stems cut to fit works fine)

wire

foil for the witness plates, detector plate and visualization plate.

Three pieces of poster-board cut as pointers about 5/8 inch wide and two inches long cut to a point on one end for the color dial, the planet dial and the sweep dial.

two small pieces of magnet strip

And this is how it is wired.

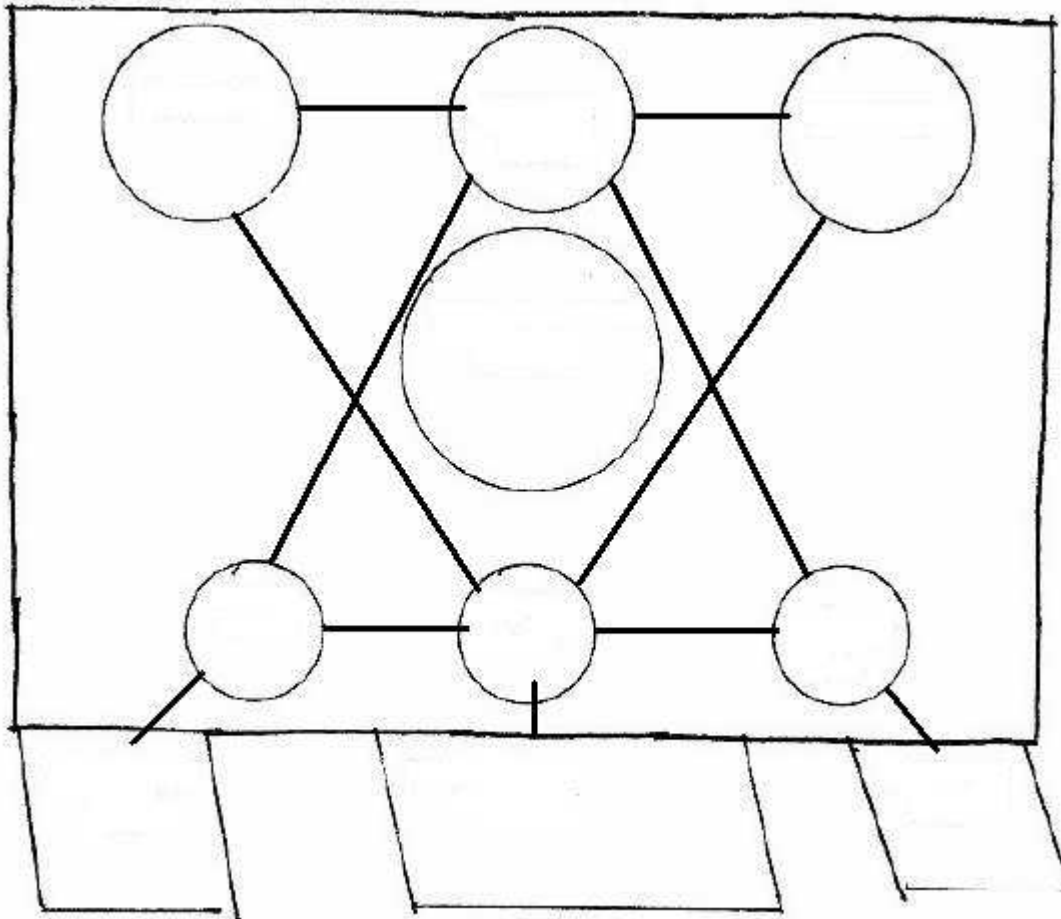

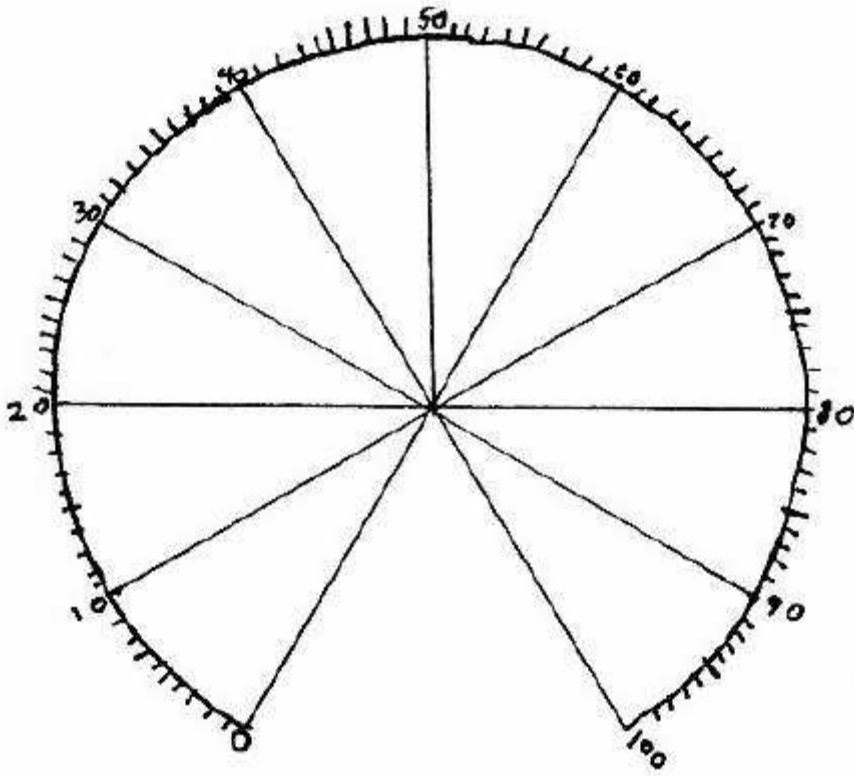

This is the sweep dial.

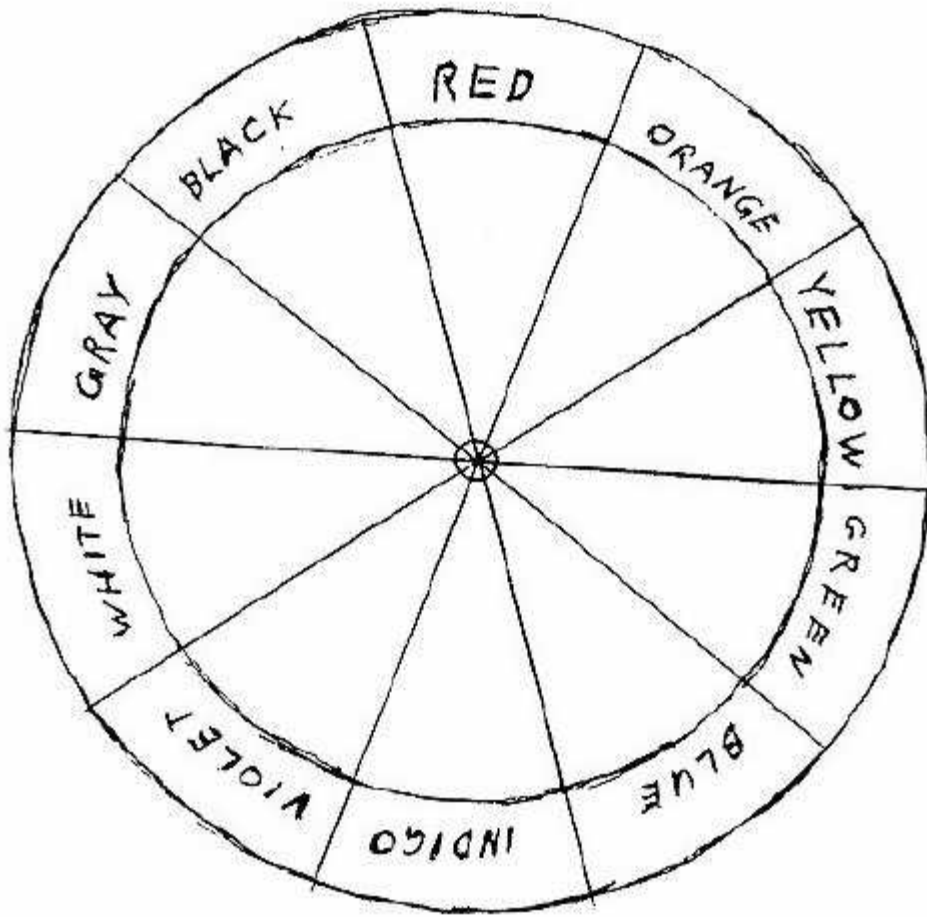

This is the color dial.



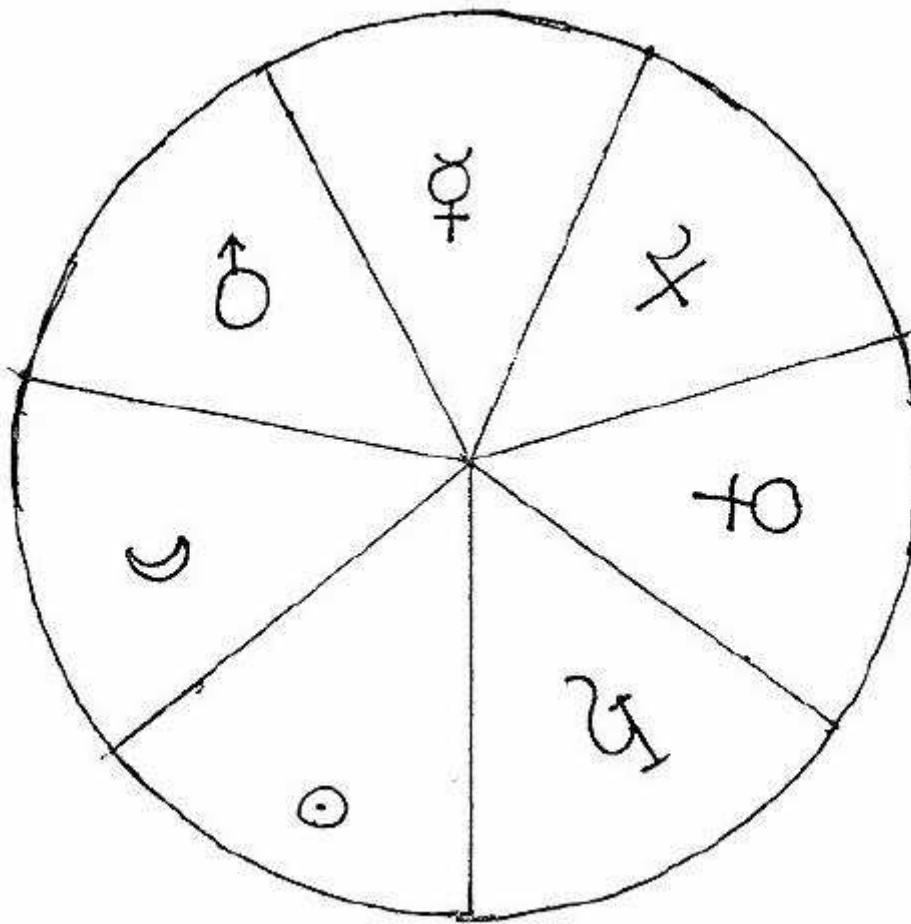

This is the planet dial.

You create this by first cutting the short pieces of metal with a hacksaw and making sure that they fit in the knobs with about an inch left over. Once you have done that, glue the poster board pointers over the base of the knobs so that when you turn the knob you turn the pointer as well. Put a piece of magnet strip on two of the dials which you will use for the planet and color dials. Punch a hole in each so that the stems will fit into the knobs, tighten the little screws in the two for the color and planet dials that hold them and then set them aside.

Make two circles of wire for the color and planet dials and set them aside. When these dials are set, the magnet strip will interact with the wire to establish the rate.

Now set up the wiring for the box. On the inside of the box, lay out where each dial will be with the visualization plate in the center as well as the witness and detector plate hook-ups. Punch holes as required and then tape the wire circles in place where the color and planet dials will be. Make certain that the holes in the planet and color circles are tight enough so that the stems will fit snugly.

Wire the pots as indicated on the drawing. Wire the circles to the pots as indicated. This should give you a hexagram pattern with the visualization circle in the center. This device needs a little explaining. It is designed to assist in manifesting the power of a spirit in any of the three worlds that they operate in and that we are able to work in ourselves, the mental, the astral and the physical. When working with it, you take the sigil of the spirit, whom you have already established a relationship with and place it on one of the witness plates. You then set the planet dial for the planet whose influence you are invoking for this, the color dial, which will correspond to the planet and then the three dials at the bottom are set as in any other radionic operation, by stroking the detector plate and turning each dial until you get a stick.

The sweep dial at the top is set last and that is the rate that sort of puts it all together.

The visualization plate is set at the center of the energy pattern created by the instrument and by means of it you can scry the results of the operation or communicate with the spirit.

## **CLOTHING, VESTMENTS AND OTHER SUCH STUFF**

In the olden times it was considered de rigeur for the magician to have a set of special clothes that he would use when doing his work. This is still not a bad idea but you do not have to go to the trouble and expense of having something made for each particular day of the week! The best thing to do is to get thee to the local costume shoppe and purchase, without haggling, something that you feel suits you and your magickal personality best. It does not even have to look very magickal.

A lot is sometimes made of the choice of clothing, but the fact is that it really does not matter very much what you wear. The key is that what you wear must fit into helping your mind set. So, for example, a lab coat may be more appropriate for a contemporary magician than a priest's cassock. Do not worry about overmuch symbolism. Your belt is to keep your pants up, not to symbolize your position in the cosmos, unless you want it to. So feel free to have fun with this. If you want to look like some barbarian warrior or science-fiction character, go for it.

The same is true for the ritual chamber. It is nice if you have a house that is big enough that you can dedicate a room to magick, your temple as it were, but it is certainly not necessary. If it were, a lot of us would be in trouble. All you need is a space to set up your equipment and when you are done you can put the equipment away and have dinner. If you have the space and you want to, decorate with things that put you in the magickal frame of mind, a few paintings, a plasma globe to symbolize the power of the universe, a skull of a former girlfriend, whatever works. What you do need is a computer because there are some things you will want to run on the screen while you are working, such as images of planets, that sort of thing.

## **SPEAKING OF PLANETS...**

One of the things you will run into if you do any study of magick is the notion that certain operations have to be done under the influence of a specific planet. This is, of course, nonsense, but enough people have believed it over the centuries that each planet has acquired a powerful thoughtform which can be tapped into. What this means is that while you are not locked into a specific day and time, you can still take advantage of the thoughtforms to boost your work.

There are a number of ways to use the planets other than following the time and day. You can take a picture of the planet and place it in the radionic box and transmit its energy to you, as well as setting up the planet on the ritual board, or you can put the picture in a projector and shine it on the wall of the ritual chamber. But the easiest is to just bring up the picture on your computer screen and let that emit in the ritual chamber while you work.

Now, in most books on magick, there are a whole bunch of things to remember when working with the planets, such as perfumes, flowers, weeds, types of clothes to wear, all that stuff. You do not need to bother with any of that. All those things are memnonics, things to help you remember that you are working with the energies of a given planet. With psionics, you engage in direct contact with the planetary energy and thus memory is unimportant which at my age is a very good thing because I tend to forget things a lot, like my name, where I live...CHUCK!! STOP THAT!

Anyway, here is what the planets are set up for.

## SATURN

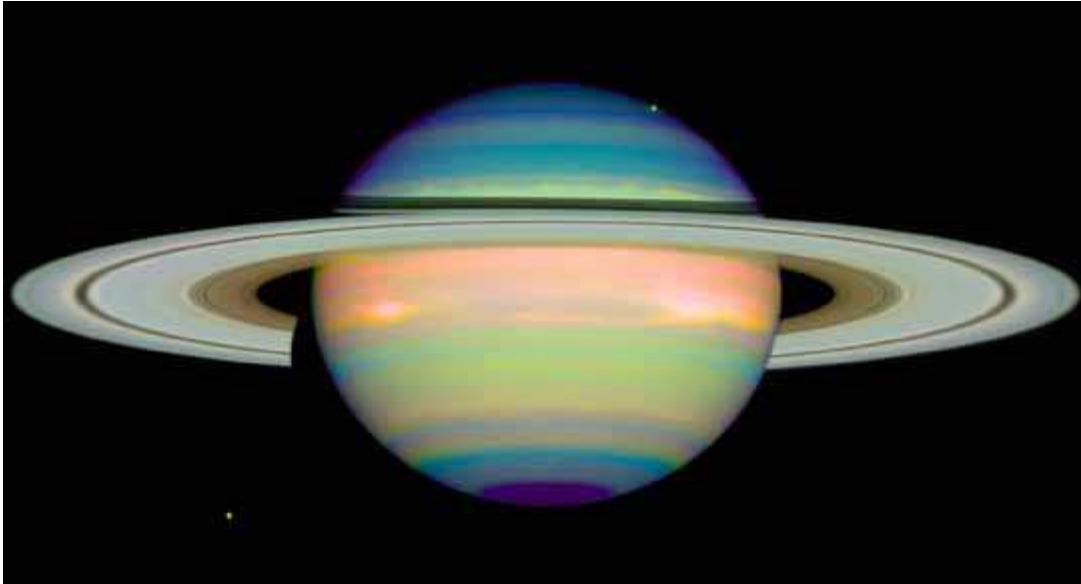

Saturn is good for summoning the souls of the dead, which means it is a good planet to do necromancy with. Get out your Ouija board next Saturday and see if your sainted Aunt Lydia will give you her pickle recipe. In fact Saturn is good for anything having to do with death, so it is probably a good planet to use to help kill off your rich Uncle George or anyone else you think has lived too long.

You can also use Saturn to work with anything involving buildings, be it the architect, the construction crew or the fault line running beneath it; call spirits to serve you as familiars (which can be a problem for, as we all know, familiarity breeds contempt); helping your business and hurting your competitors'; and anything involving possessions, worldly goods and the seed for your plants; and, of course, anything to do with causing discord and destruction, hatred and death, the good stuff.

The color associated with Saturn is black.

This is the seal associated with Saturn and Saturday and should be kept handy when working with the energy of this planet.



## JUPITER



Jupiter is good for all things that benefit you, be it to acquire honor, riches, friendship, promotion, good health and all manner of happiness. You do not use the energy of Jupiter to kill your in-laws.

The color associated with Jupiter is blue.

Here is the seal you use with Jupiter and Thursday, the day traditionally assigned to Jupiter.





## MARS

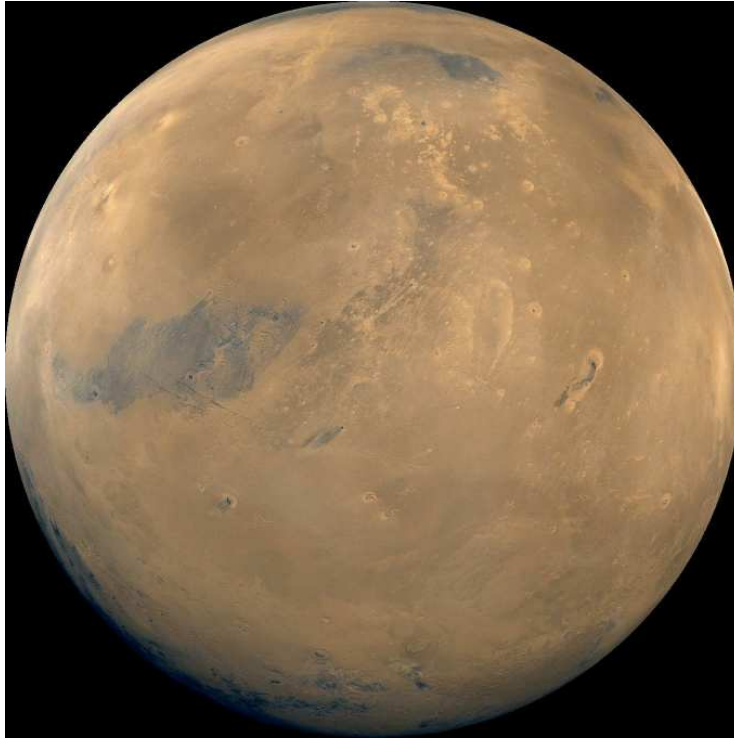

Mars is the planet of war and all that pertains to conflict, struggle, courage, victory, defeat and devastation of enemies and relatives. Using it you can cause ruin, slaughter, cruelty, discord, wounds and death. My kind of planet! It is also perfect for works of protection from all of the above because being the good sadist that I am, I would never want people to be able to do to me what I enjoy doing to them.

The color associated with Mars is red, as if that would be a surprise.

This is the seal for Mars and Tuesday.

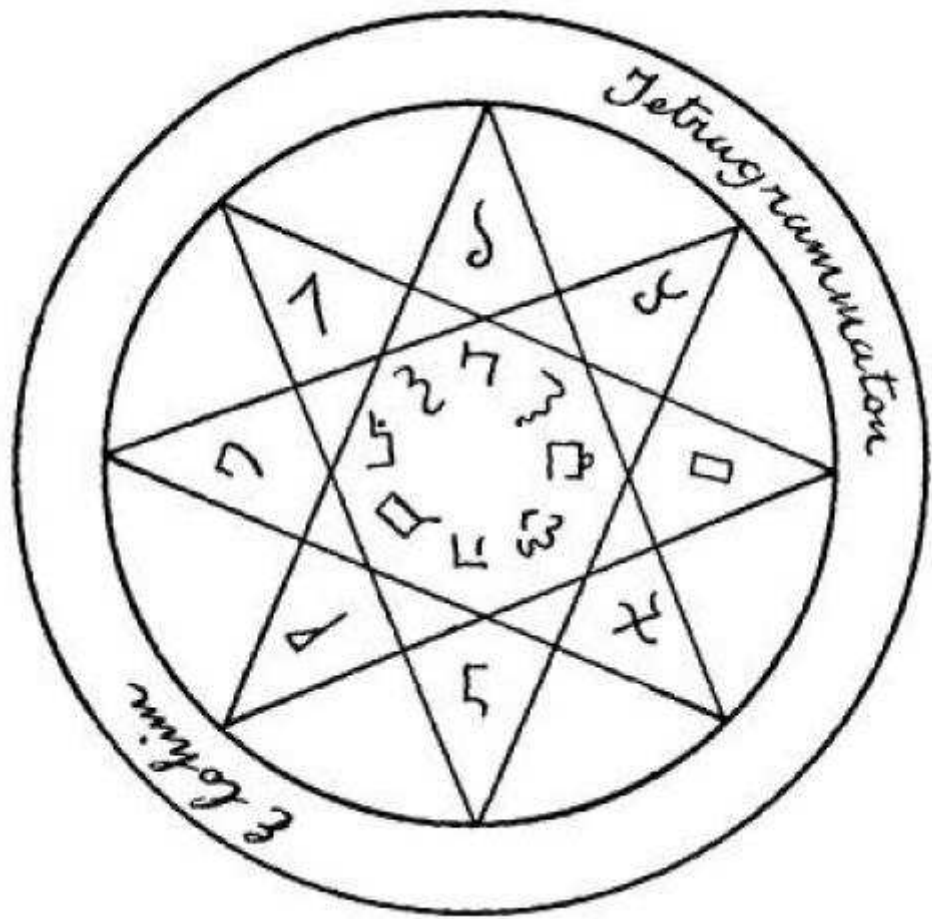

## The Sun

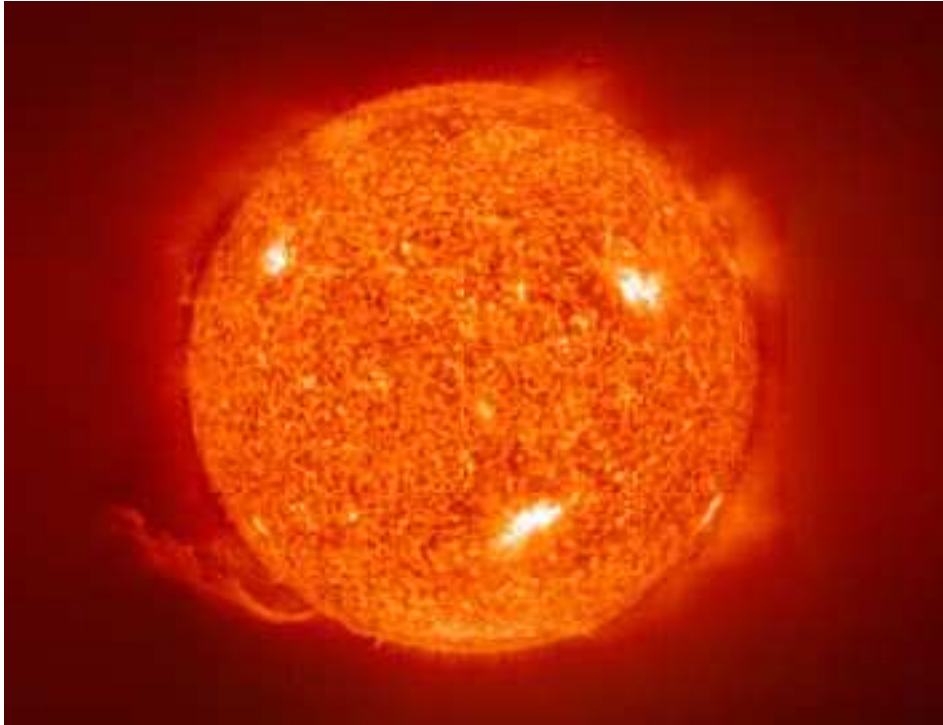

The Sun is Jupiter on steroids! You use its energy for everything good you can imagine, be it wealth, health, gain of all types, good fortune, divination, the favor of people who are important, dissolve hostile feelings in case your Mars workings run amok, and to make friends, especially generous friends with money.

The color of the Sun is yellow.

The Sun is usually associated with Sunday, for some bizarre reason, and here is the seal for it and the day.

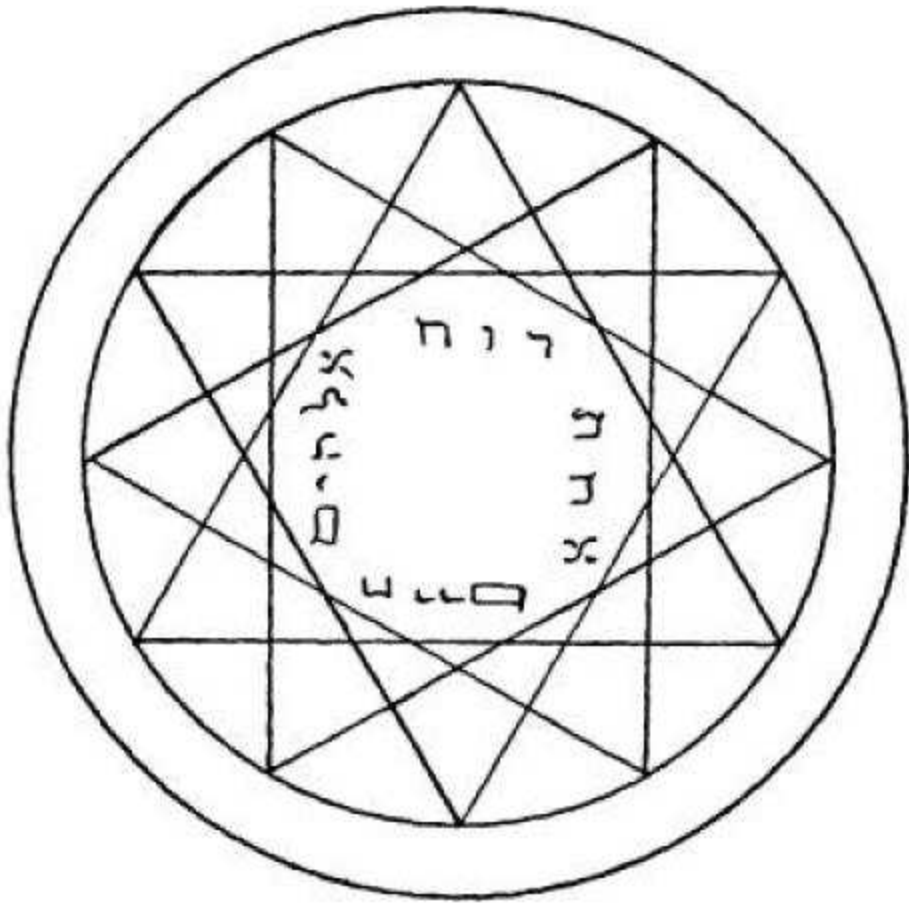

## VENUS



Venus is perfect for getting laid, anything involving love, sex, finding someone to use the new whip on, and safe travel, particularly traveling for love, sex and using the new whip.

The color associated with Venus is green.

Friday is the day of Venus and here is the seal you use with them.

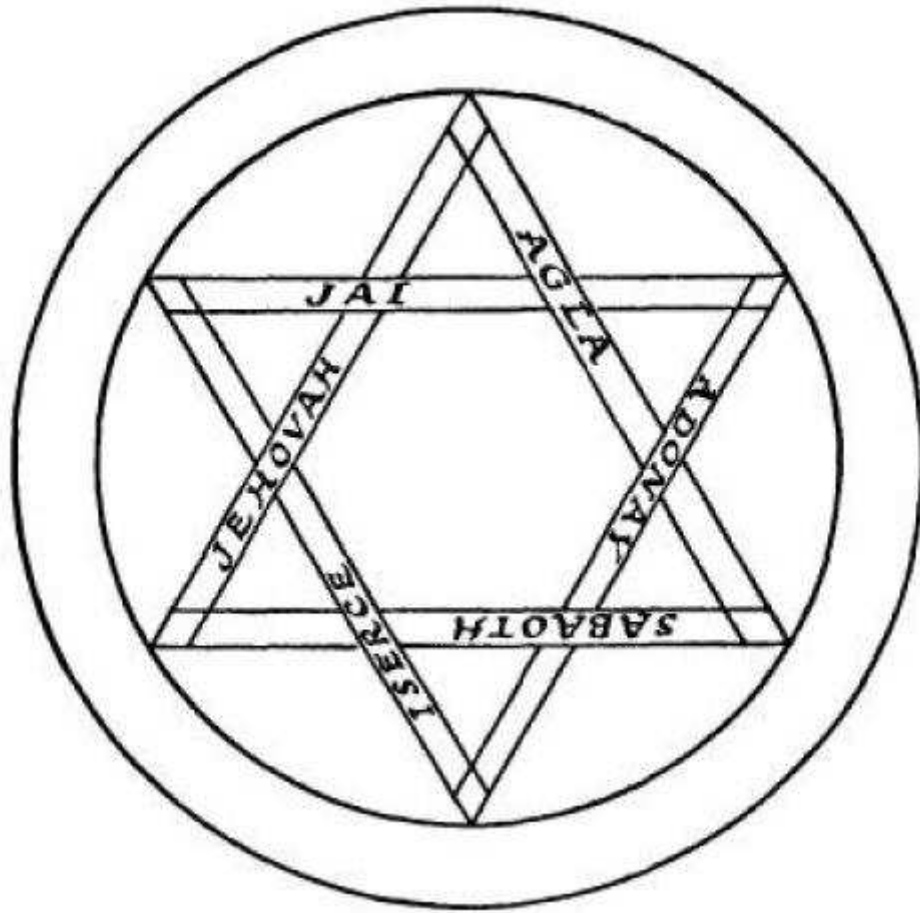

## MERCURY

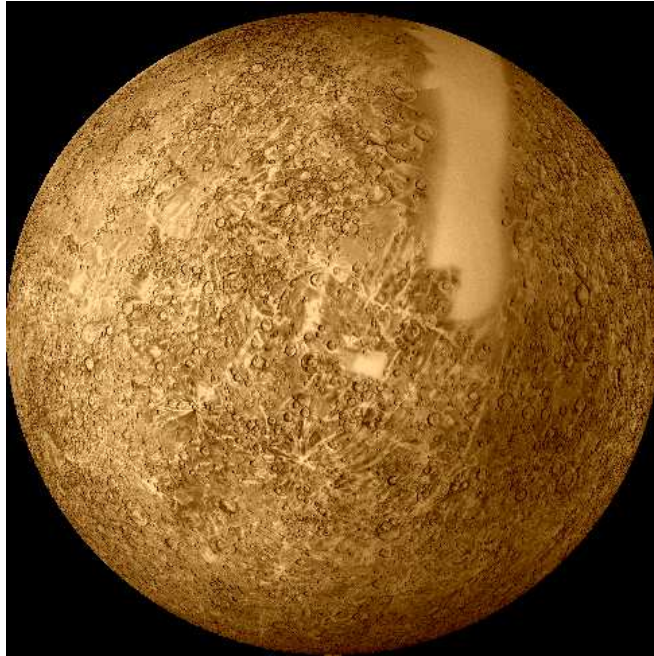

Mercury is good for anything involving intelligence, which means no Packers' fans or rappers need apply; business, science, divination, causing miracles and things to just sort of appear (like illusions of the Virgin Mary to drive your Catholic neighbors nuts), writing, as well as those mercurial arts of theft and deceit. It is best to do your taxes while under the influence of Mercury.

The color associated with Mercury is orange.

You were supposed to invoke Mercury on Wednesday with this seal.

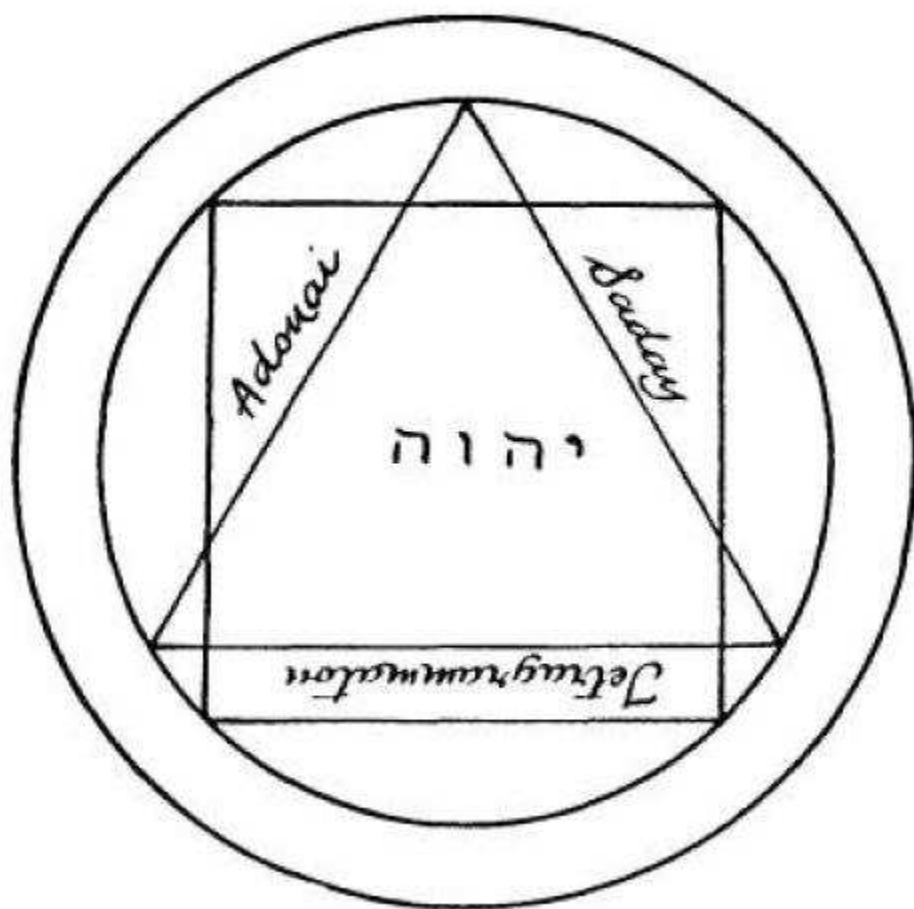



## The MOON



The moon is good for anything involving communication, like mercury, travel by water, cruises, etc., love, sex, gravity, anything shipped by water. You can use an image of a waning moon to cause shipwreck and storms at sea, like hurricanes. Remember that the next time your mother-in-law decides to go to Florida.

The color associated with the moon is silver or white.

And the day of the Moon is Monday with this seal.



These are the seven major planets. The others, Uranus, Neptune, Pluto and Mickey (or whatever they are calling the latest one) have various influences assigned to them but as they are so recent they have not had the chance to build up the thoughtforms that the other planets have and thus I have not put them in.

## **THE PLANETARY SEALS OR PENTACLES OF SOLOMON**

Assigned to each planet are a number of seals, or pentacles which we find in the Greater Key of Solomon. Each of these is useful for various magickal operations and in the old days it was necessary to make them on the day and hour of the planet in question in ink of the color associated with the planet. For our purposes, this is not going to be necessary. All you need do is print up the seal you intend to use, charge it with the energy of the planet and set it to work.

Each seal has been used many times by many people, all for the same purposes. This means that each one has attached to it a very powerful thoughtform and when you put a seal to work, you are tapping into the power of that thoughtform so it really is not important to worry about what angels are named in them or all that other stuff. This is why it is not necessary to go to all the trouble that our magickal forebears, and some of us who worked with them before we got into psionics (now who could that have been?) had to. All you need do is bring the image of the planet whose seal you are charging up onto the computer screen and hold the seal up to it. That will charge the seal with the energy of the planet. If you wish a more potent charge, put the image of the planet into your radionic box, set the rate, put the seal onto the receiver plate and let it go for a couple hours under a desk lamp.

## PENTACLES OF SATURN

### The First Pentacle of Saturn

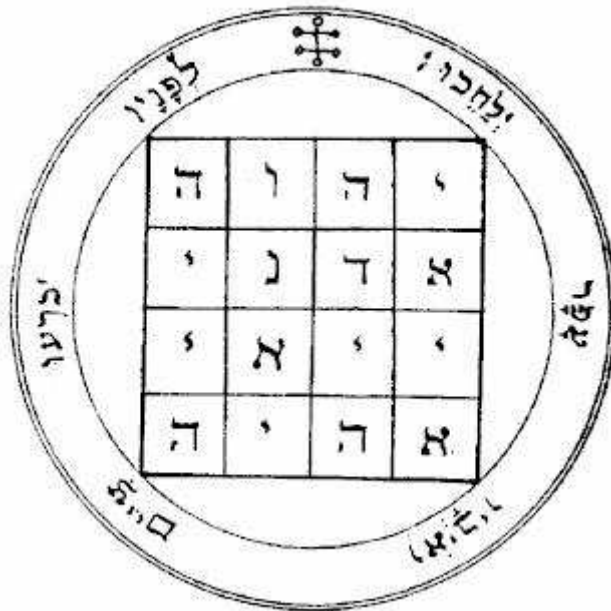

This pentacle was designed to strike terror into spirits. That was considered very important in the Yahwehist system of magick because the spirits were considered to be hostile. As we do not view them that way, striking terror into them is counterproductive, but if you have an angry spirit for some reason, such as a mad ghost, this pentacle can be useful. All that is necessary is for the spirit to see it and it will calm down, thus making it perfect for dealing with that annoying poltergeist.

### The Second Pentacle of Saturn

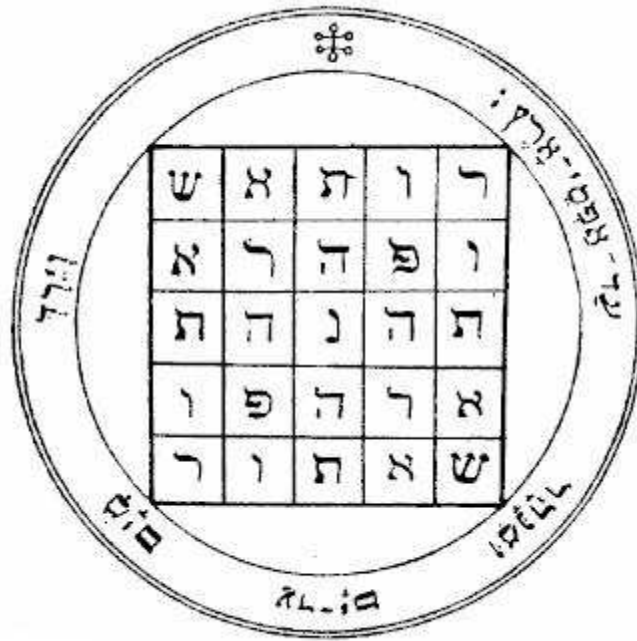

This pentacle was said to be perfect for repressing the pride of the spirits, but again, we do not want to repress their pride. We want that pride to help us! It is, however, also of great use against adversaries of all kinds.

### The Third Pentacle of Saturn



This pentacle is for use at night when evoking spirits of the nature of Saturn.

## The Fourth Pentacle of Saturn



Now we get to the good stuff! The fourth pentacle of Saturn is used for causing ruin, destruction and death. Just the thing to have when you think of your in-laws. It also can be used to summon spirits that bring news if you face south when you use it.

### The Fifth Pentacle of Saturn

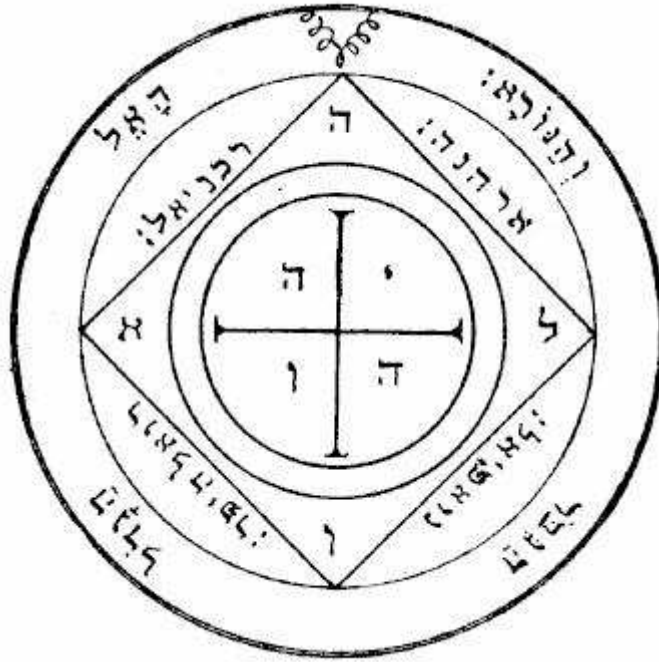

Another pentacle to guard the magician against the spirits he is invoking if the invoking is done at night. It also chases away spirits who guard treasures. Of course how many treasures are there that have spirits guarding them? However, this might be useful for archaeologists, just in case.



## The Sixth Pentacle of Saturn

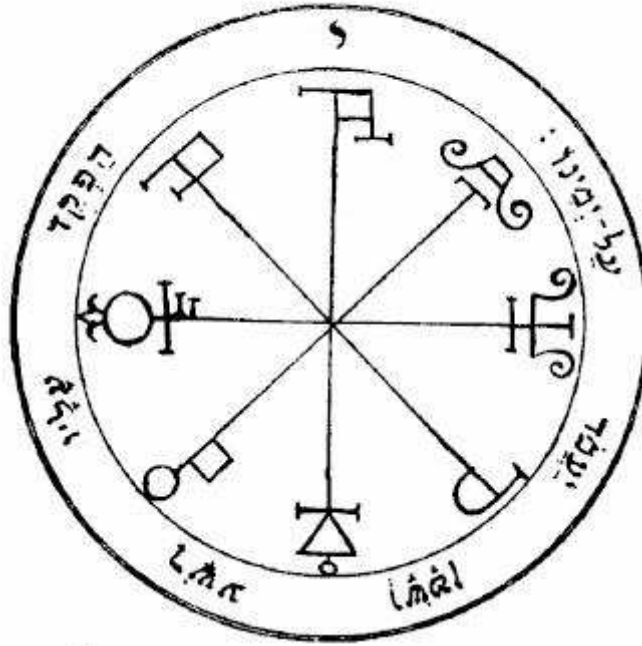

This is the pentacle that you use for performing incorcisms, which is to say, casting demons into a person. You aim the pentacle (or use a radionic device to project it) at the target and say the bible verse inscribed around it, "Set thou a wicked one to be ruler over him, and let Satan stand at his right hand."

## The Seventh Pentacle of Saturn



This pentacle is made for causing earthquakes, which means that you put it on the transmitting end of the radionic device and the satellite picture of the target region on the receiving end. It works really well on places that are prone to such things, like Iran.

## THE PENTACLES OF JUPITER

### The First Pentacle of Jupiter

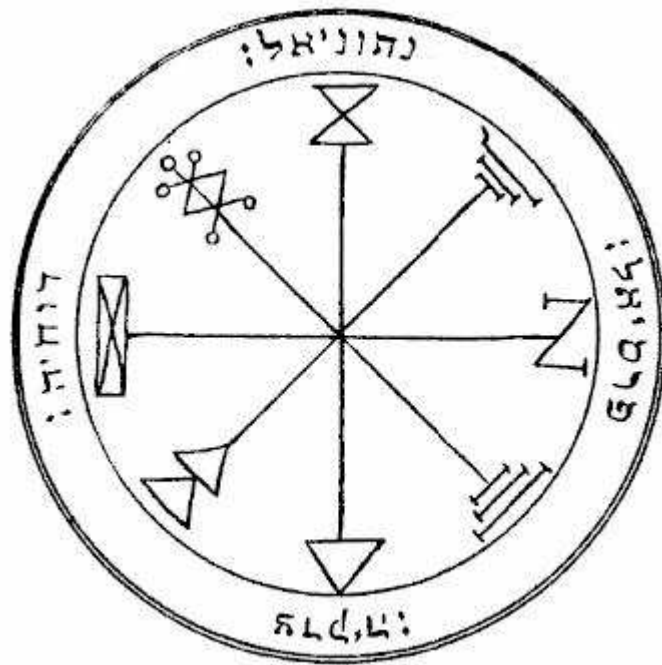

This pentacle is used in evoking the spirits of Jupiter and is especially good for taking possession of places where treasures are supposedly hidden. In modern terms, this means making good stock trades and business acquisitions.

## The Second Pentacle of Jupiter

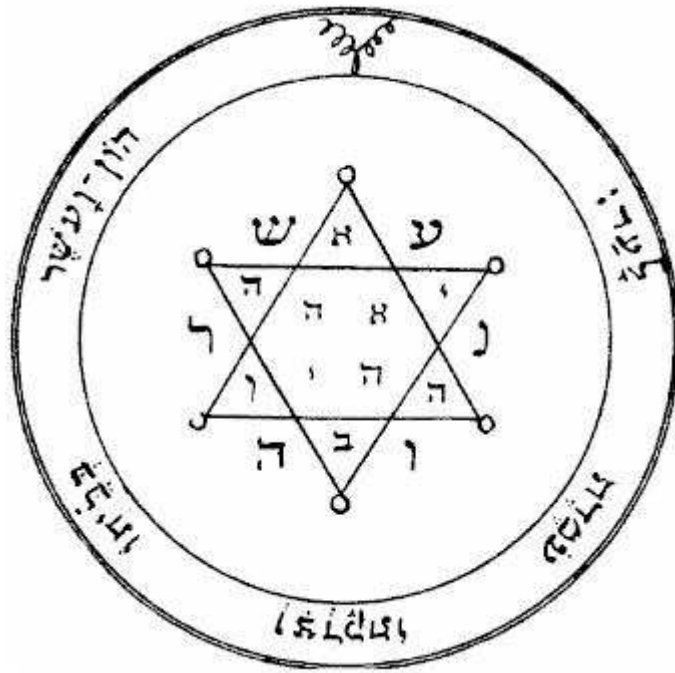

This is one of the really useful ones. It is designed for acquiring honors, glory, dignity, riches, and all manner of goodies, combined with the tranquility of mind that only comes from having lots of money. It is also useful for business acquisitions (finding treasure in the olden days) and chasing away spirits who are guarding them, which means that Lord Carnarvon could have used this when he found King Tut.

### The Third Pentacle of Jupiter

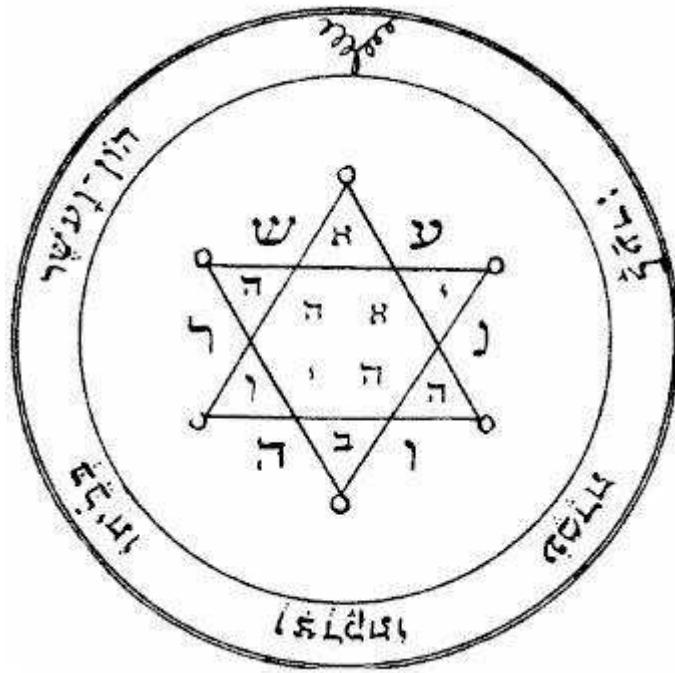

This was designed to protect the magician from grumpy spirits when they were evoked to full visibility. It is useful for dealing with the occasional annoying spirit but as we do not evoke in the old way its usefulness is limited. It is one of those things to keep handy but do not expect to need it very often.

## The Fourth Pentacle of Jupiter

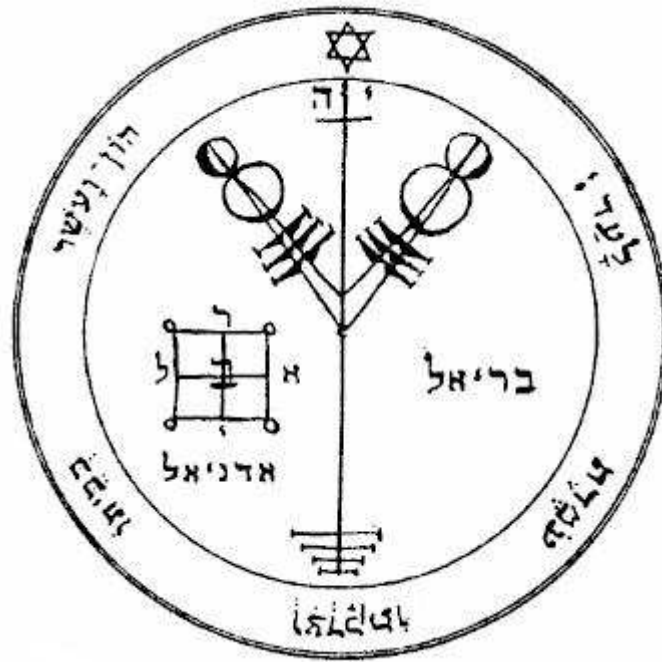

This is one of the most useful ones. It serves to acquire riches and honor and to gather much wealth. It is used by gazing at it and repeating the verse written around it, "Wealth and riches are in this house and his righteousness endures forever."

## The Fifth Pentacle of Jupiter

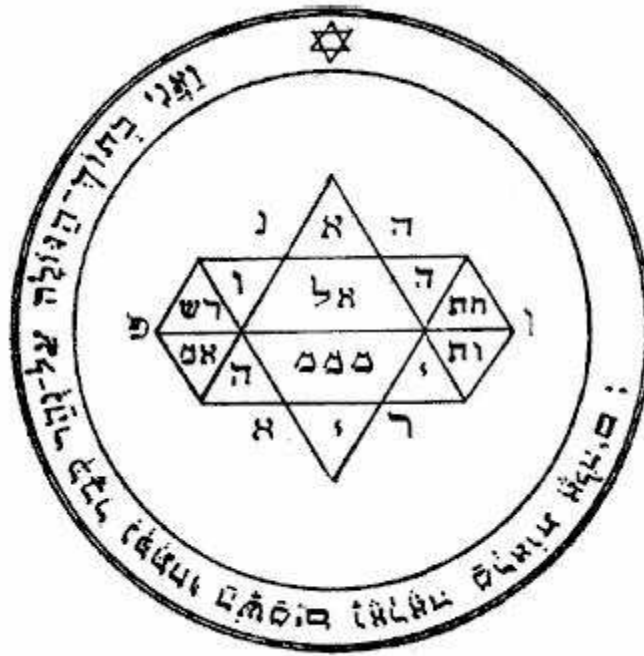

You use this pentacle for seeing visions. What manner of visions you see are not specified and you should be really careful about taking anything you get too seriously. The Astral Plane is full of pranksters.

## The Sixth Pentacle of Jupiter



This is a very powerful pentacle of protection from the dangers of daily living. You look on it every day when you get up in the morning and repeat the verse surrounding it which says, "You shall never perish."



### The Seventh Pentacle of Jupiter



This pentacle protects against the greatest danger a human can face--poverty. You look upon it each day and repeat the verse, "He lifts the poor up out of the dirt and raises the needy from the dunghill, that he may set him princes, yea even the princes of his people."

## THE PENTACLES OF MARS

### The First Pentacle of Mars

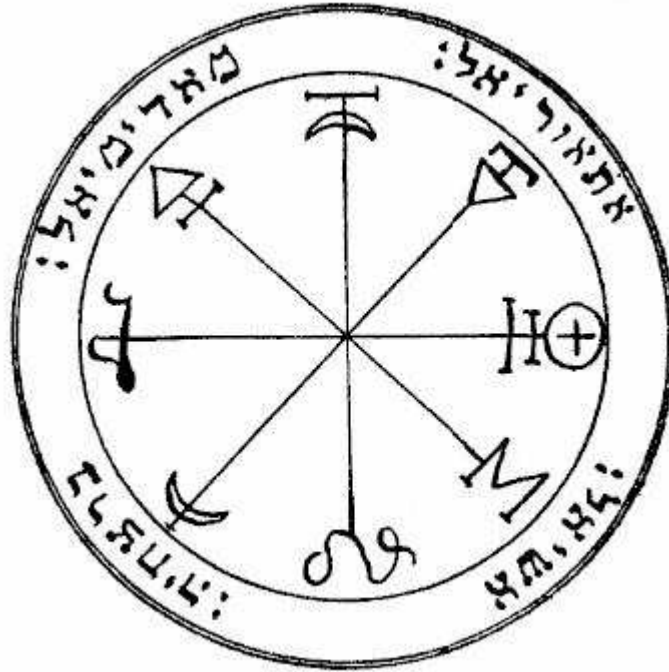

This pentacle is used in evoking the spirits of Mars in general. In other words, if you do not know which particular spirit you wish to evoke, but just one that comes under the influence of Mars, you would use this pentacle to bring one to you.

## The Second Pentacle of Mars

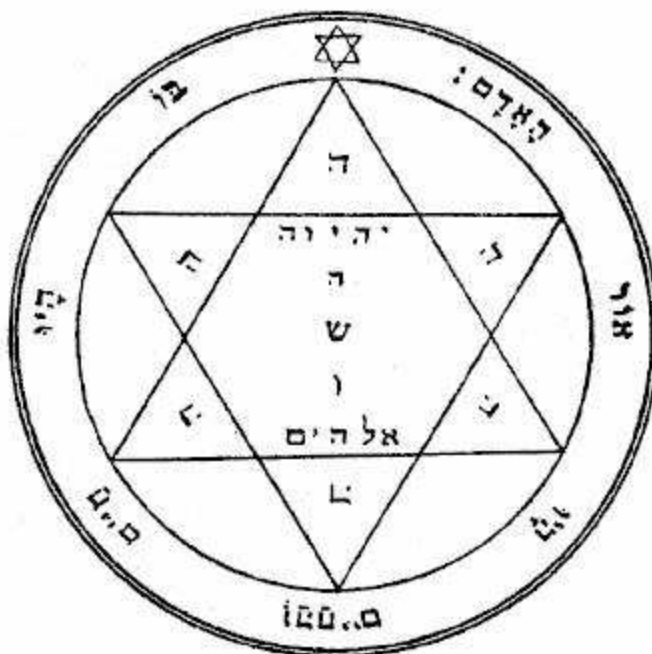

This pentacle has a feature that one would not expect to come under the heading of Mars. It is used for--gasp--healing. You lay it on the afflicted part of the body and do not tell the doctor because he will become very upset at you.

### The Third Pentacle of Mars

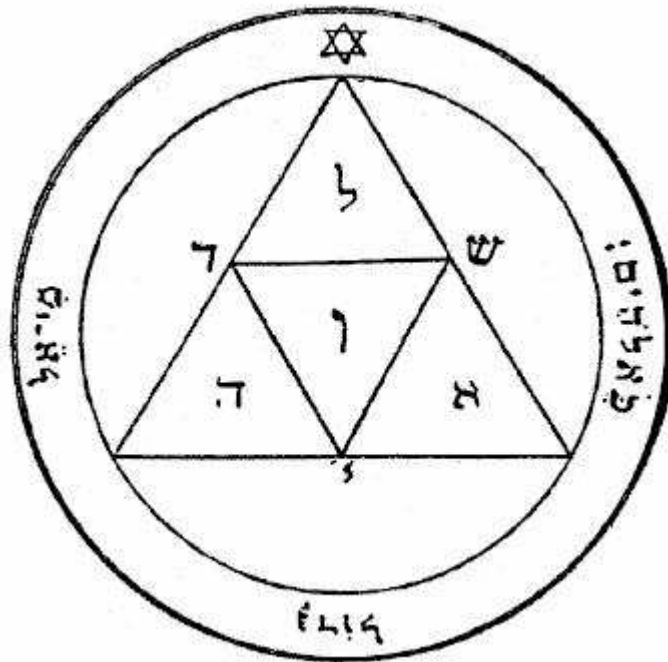

Now we have a pentacle that does what you expect a Martian pentacle to do. (NO! It does not summon little green men with two heads no matter what my deranged ex-girlfriend thinks!) This pentacle is of great and wondrous value for exciting war, wrath, discord, and hostility, as well as for resisting enemies and striking terror into grumpy spirits. Carry this one with you whenever you visit your in-laws.

### The Fourth Pentacle of Mars

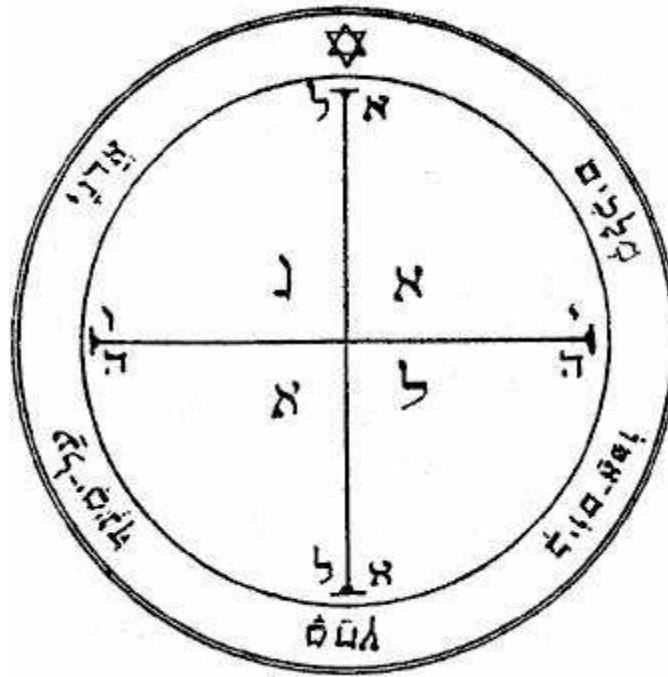

This is one that you should always have handy when you go online. It is of great virtue and power in war and brings victory. So when you get into a flame war, have this next to your computer.

## The Fifth Pentacle of Mars

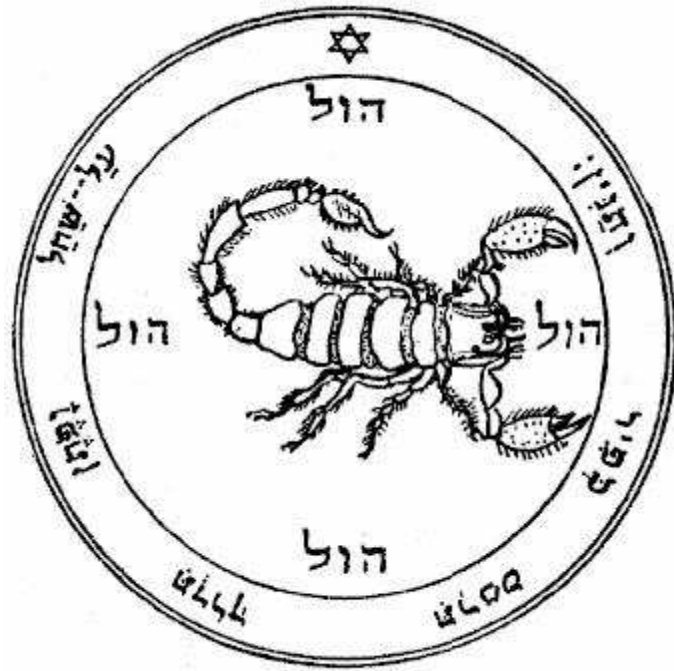

It is a pity that you will probably not get much use for this pentacle because it is very pretty. It is used to terrify demons, but we do not want to terrify them, we want to put them to work. Of course if you have to do an exorcism, this is the pentacle to have along with the first pentacle of the Sun.

## The Sixth Pentacle of Mars

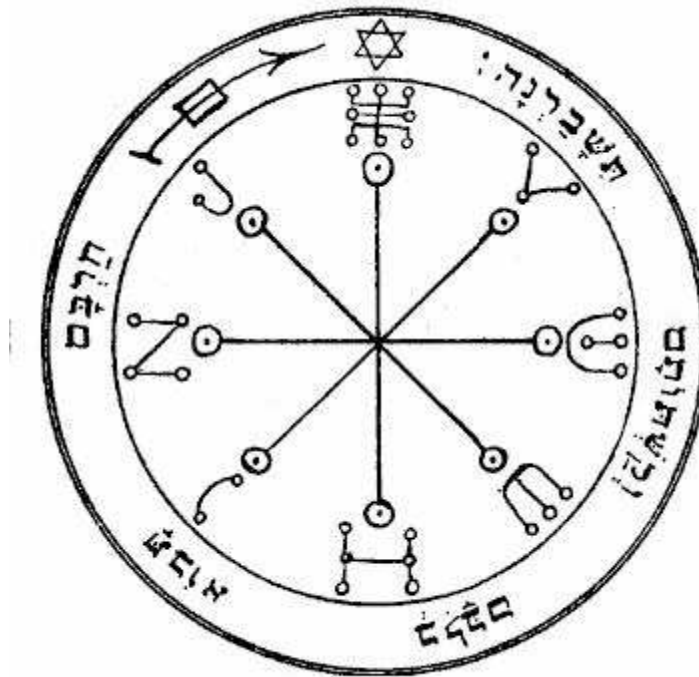

This is a good pentacle to carry with you when you walk down a dark alley. If you are attacked, your attacker will be destroyed by his own weapons. It is also useful to have in your car as it works marvelously to cause traffic cops to have serious accidents before you reach their speed trap.

## The Seventh Pentacle of Mars



After you have charged this pentacle, use it as a transmission witness and the target area will be beset with major thunderstorms and hail. With luck and the favor of the Gods you may even hit it with a tornado. If you should get a traffic ticket, aim this at the offending town. They will have expenses they never dreamt of.



## PENTACLES OF THE SUN

### First Pentacle of the Sun



This is a pentacle that gives general power over spirits and everything else. You use it when you need a blast of power, particularly if you are dealing with an angry spirit, which fortunately does not happen very often.

## The Second Pentacle of the Sun

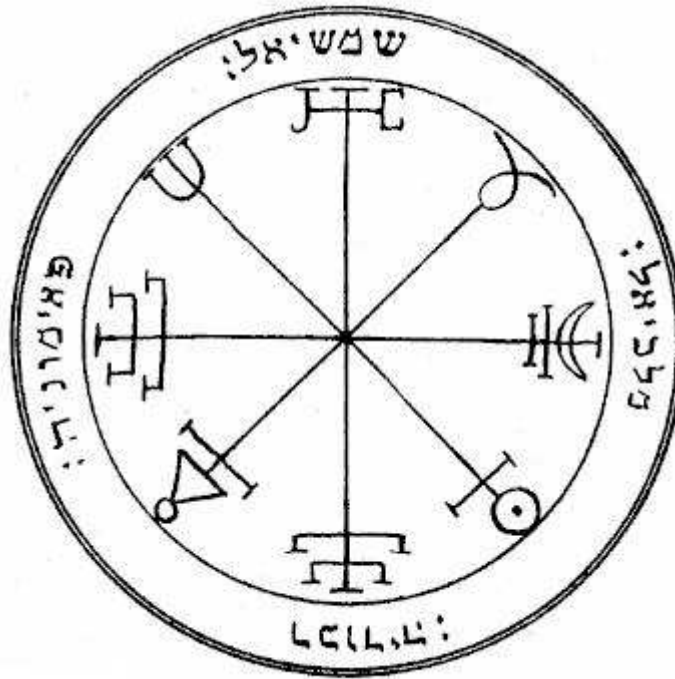

This is another pentacle designed to control unruly spirits. Now, you must understand that when this stuff was created the magicians did not see spirits as friends, but rather as possible enemies to be feared, so protection was important to them. We do not need it so much, but like a handgun near the bed, it is something you had better have if you do need it.

### The Third Pentacle of the Sun



This is a pentacle that is of much greater practical value than the two preceding it. It aids the magician in acquiring power, empire, kingdoms (or, in our world, political clout) to inflict loss on enemies, in-laws and deranged ex-girlfriends, and getting renown and glory. Every magician needs this one.

## The Fourth Pentacle of the Sun



At first glance, this may seem another pentacle of dubious modern value, particularly when psionics is involved. It enables the magician to see spirits that are invisible, which is, of course, the natural state of spirits. It can, however, be useful in dealing with hauntings.

## The Fifth Pentacle of the Sun

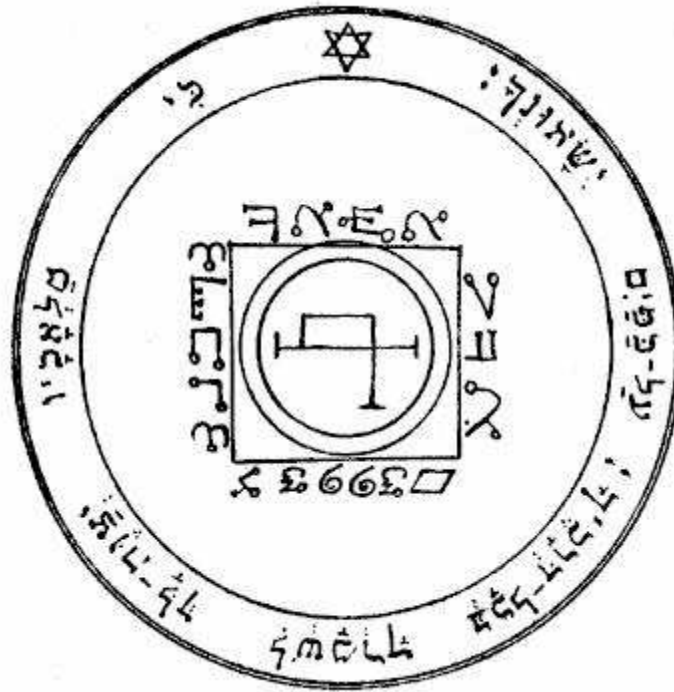

This pentacle is a good one to keep in your car, or on your person whenever you travel. It is used to evoke spirits who can aid in your journey, keep you safe and on schedule, a thing far more important thing now than when these were created.

## The Sixth Pentacle of the Sun



This is one that can be useful, or dangerous. It makes you invisible. Now, understand that you will still reflect light so you actually can be seen as by a camera, it is just that people will, for some reason, not see you in their minds. This can be a good thing if you are trying to avoid someone, or play a prank, but it can be a damned nuisance if you are trying to get through a crowd. People will keep running into you and you will have to kick small children out of your path.

## The Seventh Pentacle of the Sun



This is one that I have never had need of use. It is to help one escape physical bondage, like being in the hoosegow. Of course if you do your magick right, that should never happen because your spirits can make evidence disappear, witnesses lose their memory or die, prosecutors become epileptic at embarrassing moments, cops get run over by trucks, etc.. So think of this as a sort of back-up that you never really should have to bother with.

## THE PENTACLES OF VENUS

The First Pentacle of Venus



This pentacle is made to control the spirits of Venus. You should not have to use it, but keep it handy just in case.



## The Second Pentacle of Venus

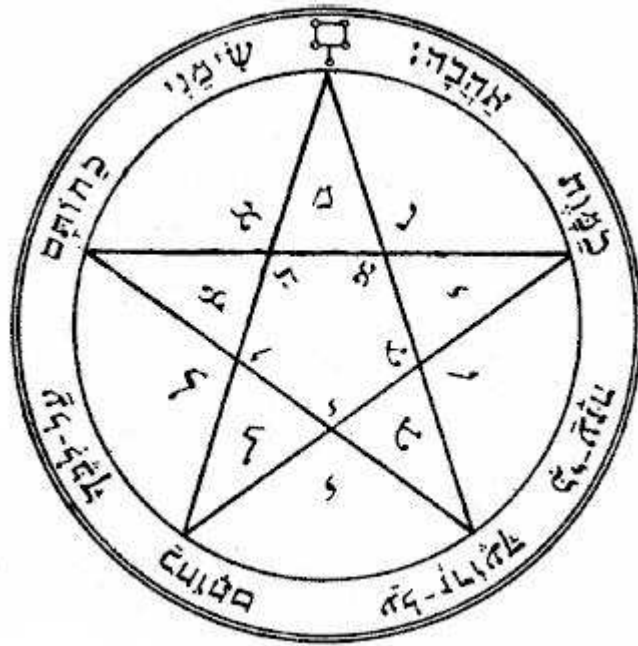

This a good one! Using this pentacle can give you grace and honor and all things which pertain to Venus.

### The Third Pentacle of Venus



If this pentacle is just shown to a person, that person will become sexually attracted to you. The trick is to get the person to look at it. The best way is to use your radionics to broadcast it to the person in her sleep. She will see it in her dreams and cannot resist it.

### The Fourth Pentacle of Venus



This pentacle puts the spirits of Venus to work and when transmitted to a person will cause the person to come to you.

The Fifth (and last, you are not being cheated) Pentacle of Venus



This is another one you transmit to the target in her sleep to make her horny as hell at the mere thought of you.

## THE PENTACLES OF MERCURY

### The First Pentacle of Mercury



This is supposed to invoke the "spirits who are under the firmament." Now, I have no idea what in hell that is supposed to mean in practical terms so experiment with it and see who shows up.

## The Second Pentacle of Mercury

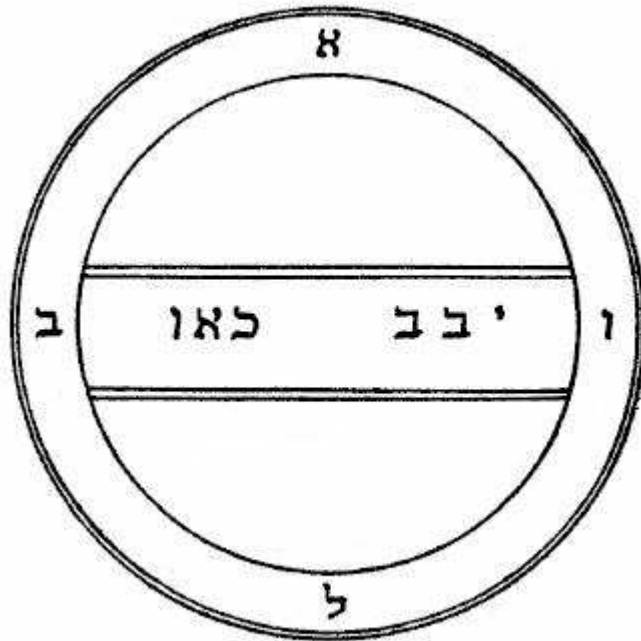

This is to bring spirits who do not fit any other category and can do things which are supposed to be contrary to the order of nature. In other words, it is for miscellaneous spirits who work miracles.

### The Third Pentacle of Mercury

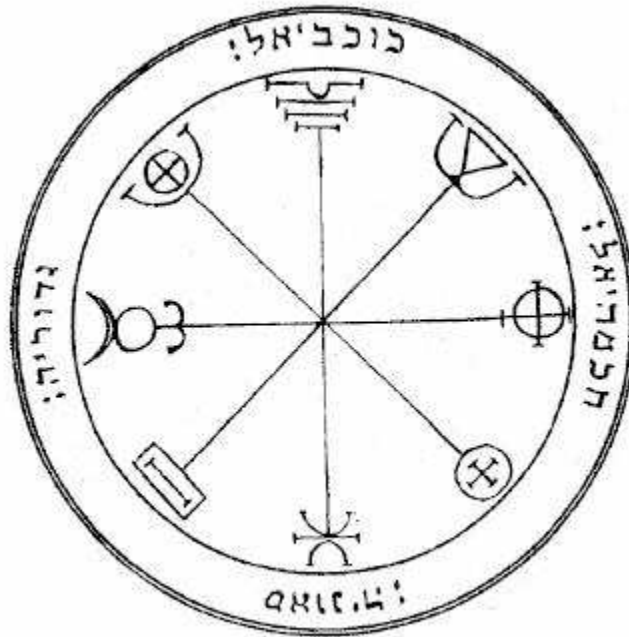

This is for invoking spirits of Mercury and thus will be useful for all the operations associated with Mercury.

## The Fourth Pentacle of Mercury

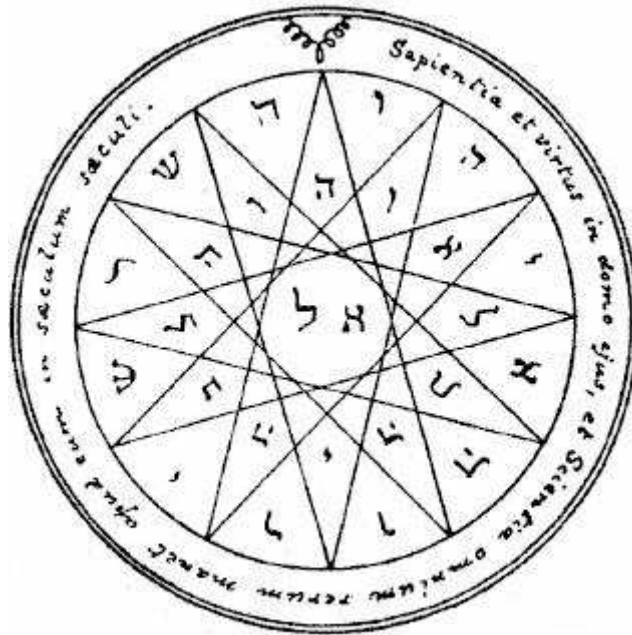

This is a good one if you are puzzled by a mystery of any kind. It helps to bring knowledge and understanding, especially of hidden things.



## The Fifth Pentacle of Mercury



If you accidentally lock yourself out of your car, this pentacle might help. It is supposed to open locked doors. I'm not sure if it works but you can play with it and see what it can do.

## THE PENTACLES OF THE MOON

### The First Pentacle of the Moon

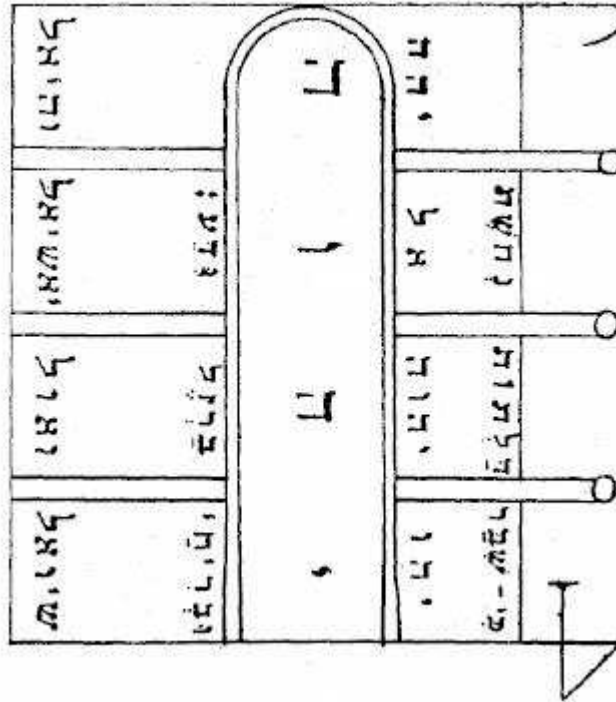

Do you get the impression that the author of the Key of Solomon had a hard time keeping track of where he left his keys? This is another pentacle that opens doors! It also serves to invoke lunar spirits.

## The Second Pentacle of the Moon



This is to keep the magician safe from the perils of water, particularly storms. If you are in Tornado Alley, it might be a good idea to paint this on your house.

### The Third Pentacle of the Moon



Carry this one with you when you travel, particularly if you are going to a dangerous place by boat. It protects the magician from danger when on journeys, especially if by water.

## The Fourth Pentacle of the Moon



This protects the magician from everything evil, be it from in-laws, bankers, lawyers, bill collectors, politicians, bureaucrats, traffic cops, wiccans, deranged ex-girlfriends or even other magicians. It also helps the magician to work with herbs and stones.

## The Fifth Pentacle of the Moon



This is a very useful pentacle. It helps you to get answers in your sleep, causes your enemies to have loss and destruction, protects against phantoms that come in the night and even helps to call up the dead, provided you have their area code.

## The Sixth and LAST Pentacle of the Moon

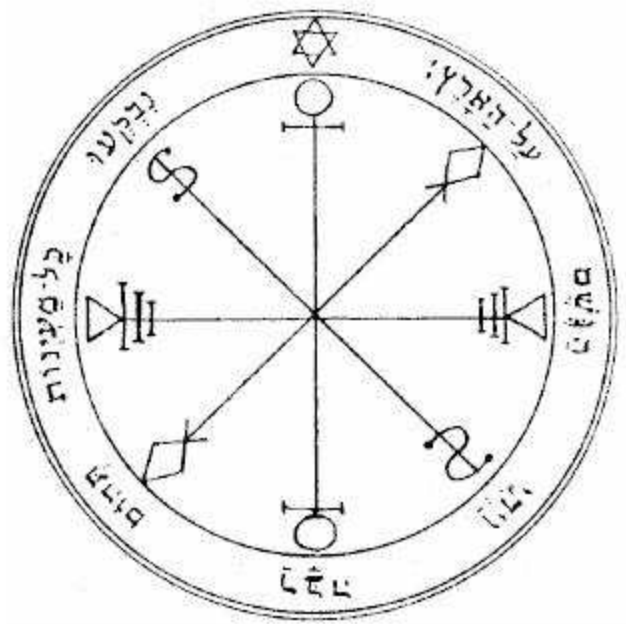

This is a fun one. It causes there to be heavy rains on the target area. Put it in the transmittal side of the radionic box and a satellite photo of the target region in the receiving side and watch the fun as people head for the hills. It is a wonderful tool to have during hurricane season.

Whew!! Am I glad that's done! Now onto the spirit world.

## "WHEN UNTO SPIRITS SPIRITS SPEAK"

The evocation of spirits is one of the areas of magick that everyone has to do at some time and the older writers would really get their robes in a knot over it. To do it the old-fashioned way, you need a circle, a wand, a sword, a whole bunch of extraneous items and a triangle for the spirit to pop up out of, or appear in the mirror set in the triangle. All of this was to protect the magician from the wrath of the disturbed shade and keep him from being torn limb from limb.

Well, if you look at those old conjurations, you can see why this stuff was necessary. Let us be honest, if someone got you out of the shower by calling you "most unclean and foul spirit," and then threatening you with eternal hellfire you would be really annoyed at that person. And, of course, the spirits obliged. They would pick the most unpleasant forms to manifest in, with all manner of noise and stuff, all intended to make the magician nervous. This is why you get the instructions to do homage to the spirit, wear a hat, do not wear a hat, do not do homage to the spirit, and do not forget that the spirit has all kinds of titles and ranks which somehow correspond to the social structure of the Renaissance.

Do you get the feeling that some folks were being had?

Spirits are, basically, friends of the magician. Oh, some of them can get grumpy at times, and downright unfriendly on rare occasions, but usually they are co-operative and helpful. I think it is because they rather enjoy the attention.

Now, there are two aspects to spirits. The first is the personality of the spirit. This is the spirit as being, an individual with a functioning consciousness that has volition, can act at will. When you evoke, or in our case, contact, this is what you are dealing with. You will see something. And it is important to remember that what you see is not the only image the spirit can project. They can change that at will to suit the prejudices of whomever they are in touch with, so someone who thinks of them as terrifying will see a terrifying image. Someone who is not frightened by such things will see something more pleasing and they also change genders, which is why one magician will see a spirit as male, another will see the same spirit as female. They have no physical bodies to be limited by.

You contact a spirit using psionics in the same way as you would call a friend on the phone. It is a conversation, not a peremptory summons. As long as you remember that, you will be fine.

The system for contacting the spirits is very very simple. You place the sigil of the spirit in question on the transmittal side of the radionic box and take a rate. Then you plug in the helmet and take a rate on it. This is the equivalent of dialing the spirit's phone number. You put on the helmet, relax and then, when you see the spirit in your mind, start talking to it. And don't jump out of your skin when it answers!



Now, there are going to be times when you want something a bit more concrete than images in your head, and this is where your pendulum and the charts come in. You contact the spirit and, holding the pendulum over the chart that is appropriate, ask the spirit what you need to know. The pendulum will point out the answer. This method is particularly useful in contacting the spirits of the dead.

Using the energy from the spirits is pretty much something I covered in Psionic Power. You simply choose the spirit whose energy you need for an operation, put the sigil of that spirit in the radionic box, take the rate and put the witness for the subject of the operation on the receiver plate. If you wish, and sometimes it may be a good idea, contact the spirit and ask to use his sigil and energy.

This is a very simple procedure and often the hardest part is deciding which spirit to deal with and what is the best way to approach the problem you wish to solve. For example, recently a person on a mailing list wanted to use a spirit to pass a college course. Well, he was thinking in terms of making the professor like him and overlook any mistakes he may make on the test. I pointed out to him that the better course would be to work on himself so that he would remember everything he needed to know when he took the test and have sufficient skill at writing the answer that he would have no trouble getting the grade he wanted.

Sometimes this is not obvious. The descriptions written for the offices of the spirits are very old and not really that useful in our world. For example, there are relatively few people who bury treasure any more. Now they put it in banks so a spirit whose function is stated as finding buried treasure is not going to be much use if that is all he can do. But, of course, that is never all a spirit can do. They may have had a particular specialty that applied to the person writing the book, but you can be certain he can do more than that. And of course if a spirit can find buried treasure, he can probably also help you to find lots of things so do not let yourself be limited by the descriptions of what spirits can do. Use those as starting points and see from there what you can accomplish.

Often you will have an operation that will come under the stated expertise of several spirits and you will want to know which spirit is best for the particular working. You could, of course, ask them, but like people they will all say that they are the best one for the job. Spirits have egos, just like we do. This is where your pendulum will come in handy.

Take the sigils of the spirits you are considering and lay them in a row on a table in front of you. Now, hold your pendulum a little below the row at its center and ask the pendulum to point to the spirit that is best for what you wish to accomplish. It will pick one out and that is the one you should go with.

One thing you need never have to worry about. You will never get a message on your pendulum chart that says, "Thank you for your conjuration, however your working does not meet our needs at the present time. Best of luck with another spirit."

## **PLANETARY SPIRITS**

There are a number of spirits who are assigned to specific planets. At least that is what they want us to think and there is little point in arguing the matter. Planetary spirits are generalists, within the purview of the planetary energy that they are attached to. They are able to perform all the tasks that are appropriate to the planet they are assigned to.

Now, there are actually quite a few of them and Franz Bardon did a very good job of cataloging them but for our purposes you really only need to know about the seven big ones. Once you have contacted them, you can go to work on dealing with the others if you want to.

To work with these spirits, have on hand the first pentacle of the planet you are dealing with and the sigil of the spirit in question. Have the pentacle handy and set your radionic box and helmet for the spirit and then communicate. You should have no problems, but if the spirit should become tempermental, you will have the pentacle to help you. And with that, here are the spirits.

Saturn

Aratron

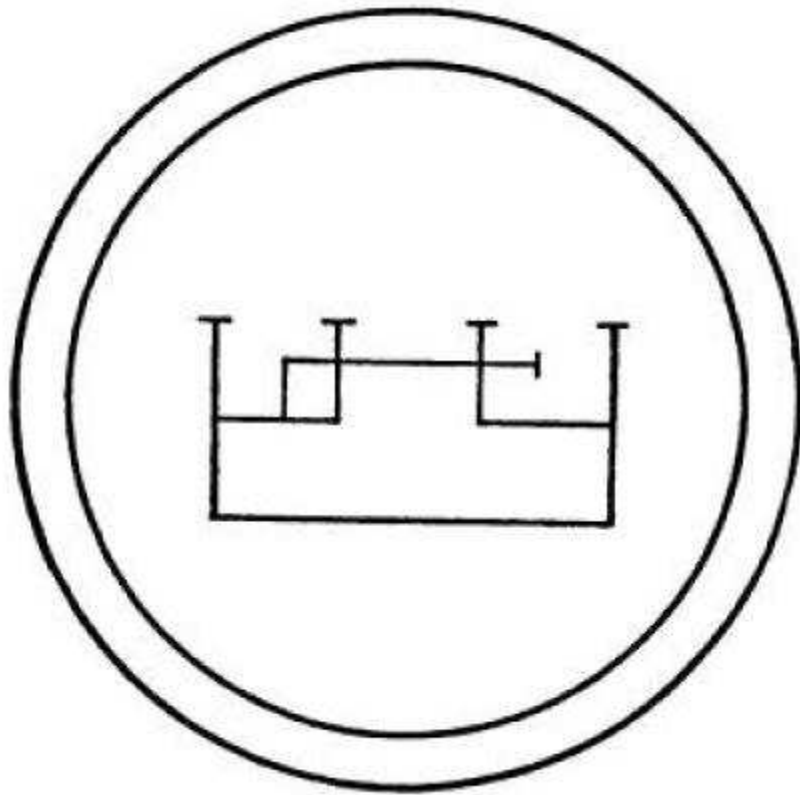

JUPITER

Bethor

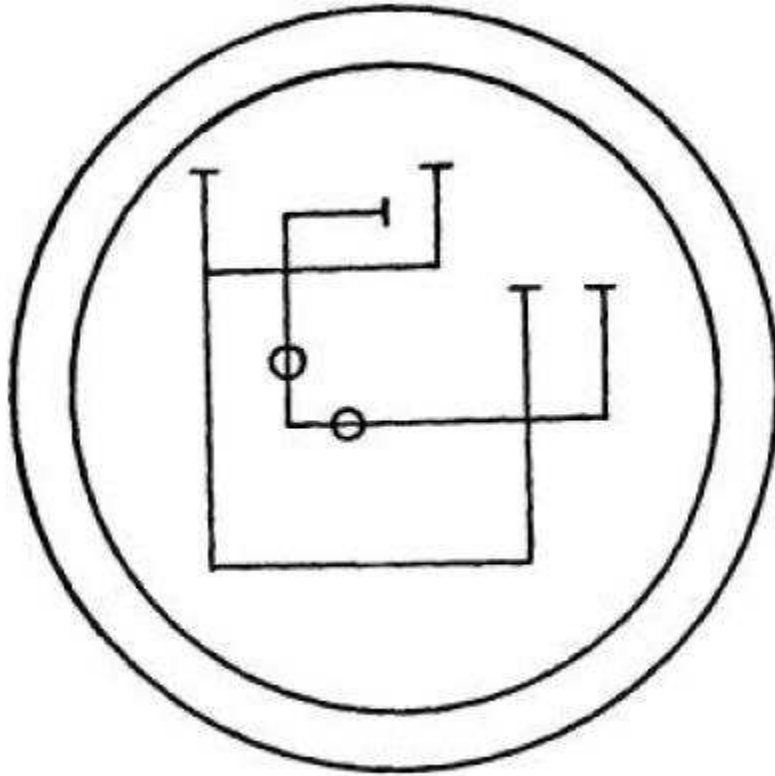

MARS

Phaleg

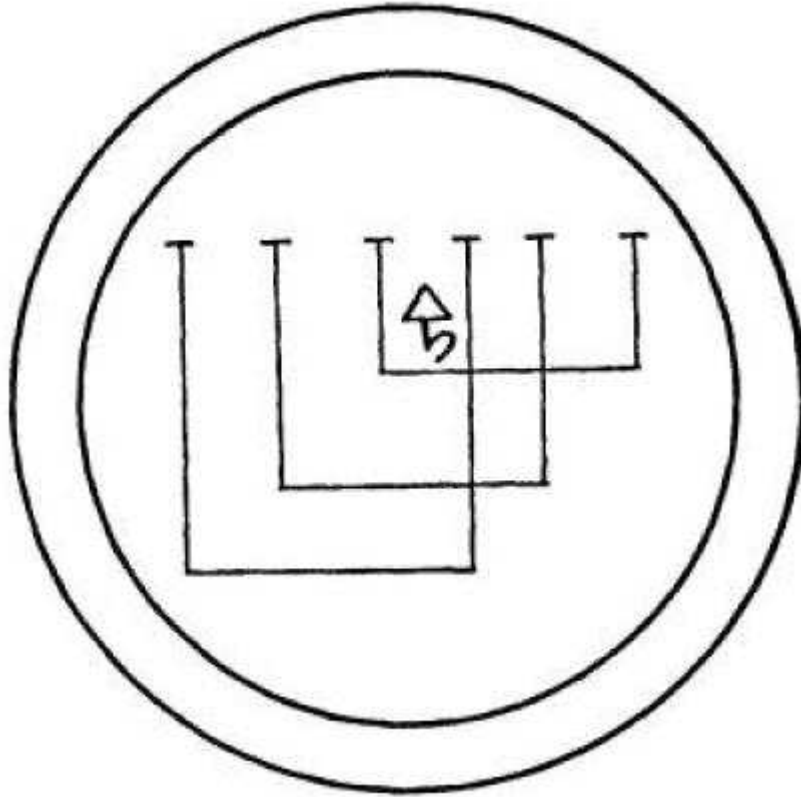

THE SUN

Och

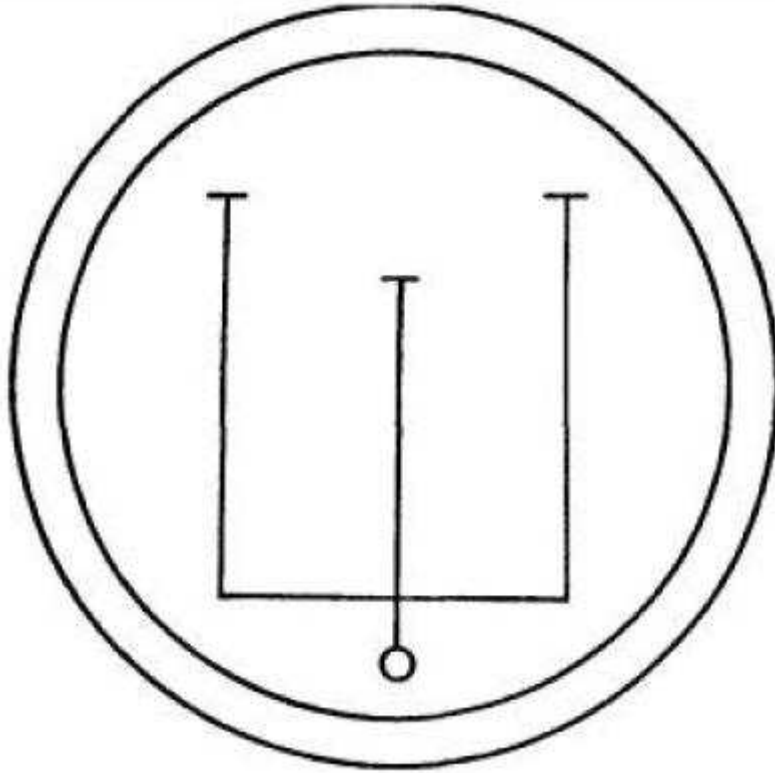

**VENUS**

**Hagith**

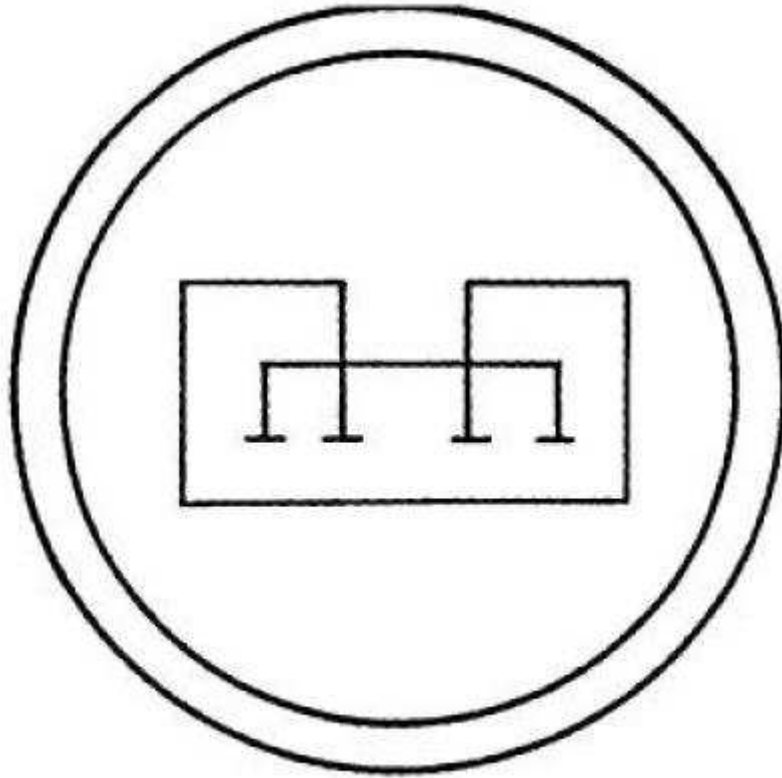

**MERCURY**

**Ophiel**

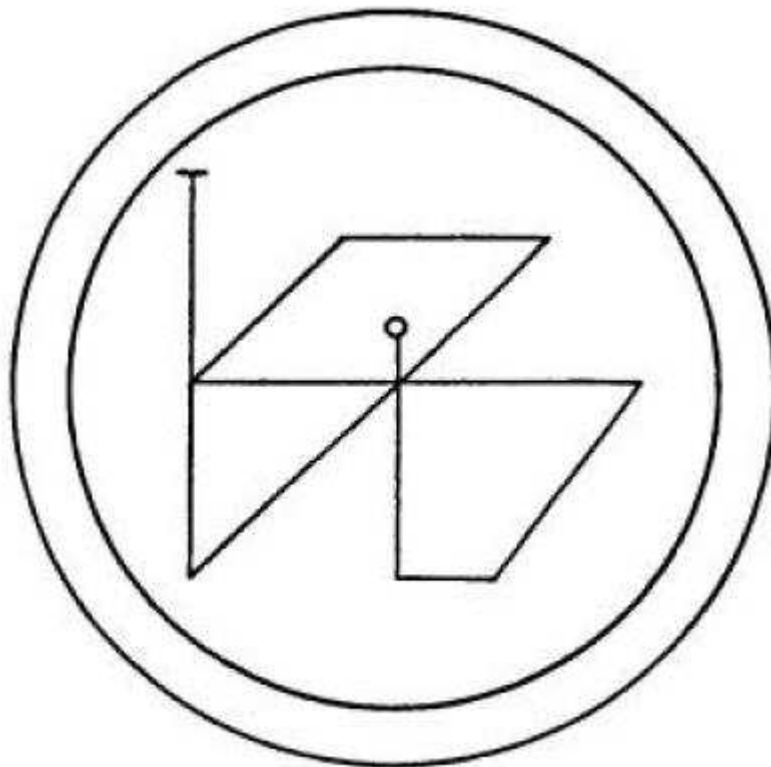



## THE MOON

### Phul

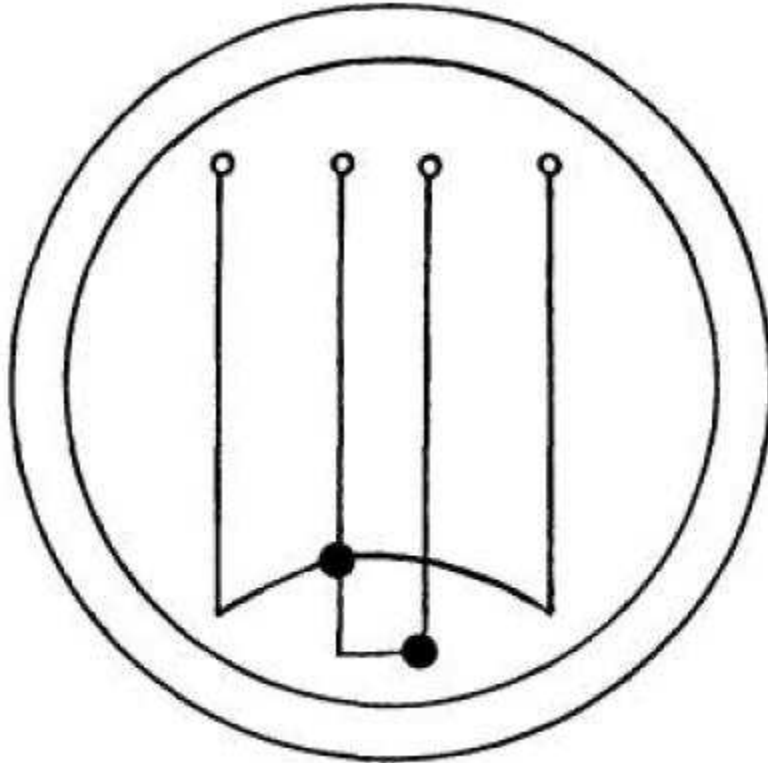

It is a good idea to contact all of these spirits and get to know them. They are generally quite friendly and helpful and will assist you in gaining the knowledge and friendship of other planetary spirits as well as those spirits that sort of just float around and have no assigned place in the firmament, whatever in hell the firmament is supposed to be.

Now, there comes a little problem with this help in that you will ultimately need sigils for the spirits you contact in order to maintain contact with them. In the case of planetary spirits, sigils are pretty easy to create. You use the kamea, or magic squares.

When you contact the main planetary spirit with the intention of getting the name of a sub-spirit who can help you with a specific project, use the pendulum and alphanumeric chart to spell out the name of the spirit. Now, let us say you have contacted Aratron of Saturn to get help and he gives you the name of a spirit who is called Sorath (to the best of my knowledge, there is no such spirit, I just made the name up to use as an example). Using the numerology chart you get the numbers that correspond to the letters in the name and then take a copy of the square of Saturn and use it to plot the sigil.

1	2	3	4	5	6	7	8	9
A	B	C	D	E	F	G	H	I
J	K	L	M	N	O	P	Q	R
S	T	U	V	W	X	Y	Z	

The numbers are 1, 6, 9, 1, 2, 8. You plot them as follows.

First, 1 to 6.

4	9	2
3	5	7
8	1	6

Second, 6 to 9.

4	9	2
3	5	7
8	1	6

Third, 9 to 1.

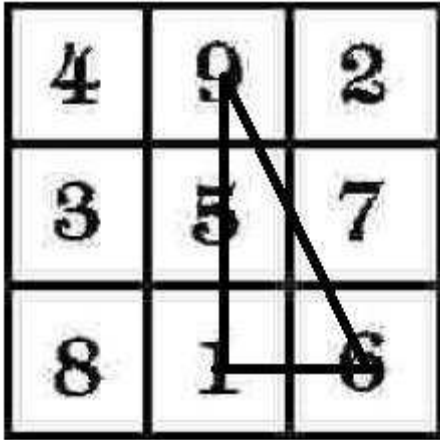

Fourth, 1 to 2.

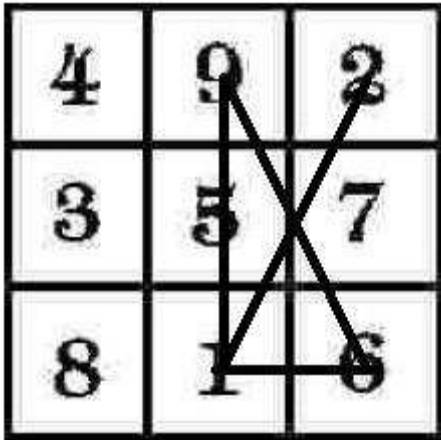

And finally, 2 to 8.

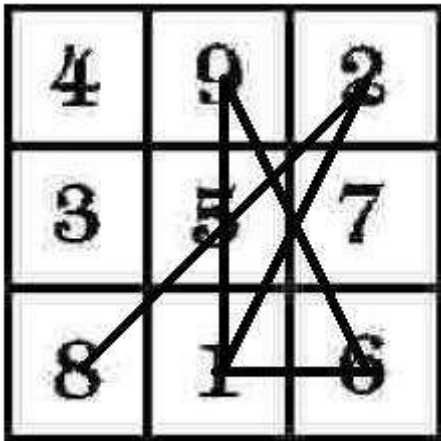

The final plot is the sigil of the spirit Sorath. You copy that sigil to a piece of paper and then put in the radionic box to make the initial contact. Anyway, here are the kamea.

Saturn

<b>4</b>	<b>9</b>	<b>2</b>
<b>3</b>	<b>5</b>	<b>7</b>
<b>8</b>	<b>1</b>	<b>6</b>

Jupiter

<b>4</b>	<b>14</b>	<b>15</b>	<b>1</b>
<b>9</b>	<b>7</b>	<b>6</b>	<b>12</b>
<b>5</b>	<b>11</b>	<b>10</b>	<b>8</b>
<b>16</b>	<b>2</b>	<b>3</b>	<b>13</b>

Mars

<b>11</b>	<b>24</b>	<b>7</b>	<b>20</b>	<b>3</b>
<b>4</b>	<b>12</b>	<b>25</b>	<b>8</b>	<b>16</b>
<b>17</b>	<b>5</b>	<b>18</b>	<b>21</b>	<b>9</b>
<b>10</b>	<b>18</b>	<b>1</b>	<b>14</b>	<b>22</b>
<b>23</b>	<b>6</b>	<b>19</b>	<b>2</b>	<b>15</b>

Sun

6	32	3	34	35	1
7	11	27	28	8	30
19	14	16	15	38	24
18	20	22	21	17	13
35	29	10	9	26	12
36	5	33	4	2	31

Venus

32	47	16	41	10	35	4
5	28	48	17	42	11	29
30	6	24	49	18	36	12
18	31	7	25	43	19	37
38	14	32	1	26	44	20
21	39	8	33	2	27	45
46	15	40	9	34	3	28

Mercury

8	58	59	5	4	62	63	1
49	18	14	52	53	11	10	50
41	38	33	44	48	19	16	45
82	84	86	29	25	85	89	28
40	26	27	27	26	30	31	33
17	47	46	30	21	43	42	34
9	55	54	12	13	51	50	18
64	2	3	61	60	6	7	57

## Moon

37	78	29	70	21	62	13	54	5
6	38	79	30	71	22	63	14	46
47	7	39	80	31	72	23	55	15
16	48	8	40	81	32	64	24	56
57	17	49	9	41	73	33	65	25
26	58	18	50	1	42	74	34	66
67	27	59	10	51	2	43	75	35
36	68	19	60	11	52	3	44	76
77	28	69	20	61	12	53	4	45

There are a number of listings of spirits out there, the most famous being those of the Lesser Key of Solomon and those are the ones I cover in my Psionic Power. But there are others and they are readily available so there is no need to copy them here. It takes very little research to find them.

When you deal with spirits the best attitude to take would probably be termed, "business casual." You want to be friendly but not too chummy, respectful without being reverential. Remember, these are the employees. You want to keep them happy so they can make you happy. Of course sometimes things get a little hairy and on those very rare occasions you have to resort to stronger means to get your way. That is where the main planetary spirits and some of the pentacles come in handy. The pentacles are linked to some pretty powerful thoughtforms and when you bring one out you are tapping into that energy. And that is also when you use the flashlight.

## EXORCISM AND INORCISM

Exorcism is something that happens when things really really really go wrong. It does not happen often, in spite of some the peculiar notion of certain Pentecostal preachers and televangelists, but when it does you will know it. Things tend to get unpleasant.

The first thing you have to understand is that usually you can do an exorcism by simple power of personality. Often just yelling at the spirit will work wonders but not always. Sometimes they get mad back at you. That is when you have to bring out the heavy artillery.

You need your pentacles, the help of the planetary spirit, the first pentacle of the Sun works really well and you have that, and your flashlight. Why the flashlight? Because it directs your will to the particular location of the spirit. Wands have always worked better in exorcism than swords and knives because usually it meant driving the spirit out of somebody and stabbing the person was seriously counter-productive, to say nothing of messy.

Using your pendulum and chart, find out the name of the spirit. This makes yelling at him a lot easier because spirits, even grumpy ones, respond better to their names than a just, "Hey! You! Spirit!" Once you know that, hold the pentacle in your left hand and point the flashlight in its general direction with your right. Now, speak in a firm, commanding voice:

"X! I command you to leave this place. I order you to leave. Get out! Get out NOW!"

Say this while shining the flashlight and mean it! It may take a few shots, but it will work.

Now, sometimes the spirit keeps coming so if that happens, get a bottle and fill it with salt. Draw the six-pointed Star of David on it (the center of the hexagram has a peculiar energy to it, pendulums hold still over it and it blocks energy from escaping). Command the spirit into the bottle and seal it. You now have a bottle of spirit and you can use this spirit if you have to make life interesting for someone you do not like. I'll leave that to your imagination.

This sort of general exorcism technique works far better than the drawn-out methods of the religious folk for a very simple reason. Some spirits do not respond to religious exorcism and just get madder. A Roman Catholic priest trying to exorcize the spirit of a Baptist is going to have some unexpected difficulties.

Now about inorcism.

Inorcism is the process of casting demons INTO people. it can be great fun and works wonders on ex-girlfriends (Oh, do I have story about that one I should write someday!). To accomplish this you need the Sixth Pentacle of Saturn, the cooperation of a friendly

spirit who shares your sense of humor and personal malevolence and an unwilling victim.

Using the ritual board, make contact with the spirit who is going to aid in this and have the Pentacle of Saturn on your person. Set the machine to the rate for the spirit, his planet and the color of the planet and then lay the pentacle on the middle witness plate.

Visualize as clearly as possible the spirit in the visualization plate in the center of the instrument. Do not be surprised if you hear his voice in your head or even audibly. It happens sometimes. Once you have the image, tell him of your plan and ask him to help by possessing the person who intend to send him to. When he agrees, and he probably will, ask him to enter the pentacle.

Now, take the pentacle with the spirit in it and place it in the radionic box. Set the rate and then place the witness of the victim on the receiver side. Command the spirit to go from the pentacle to the target. Hold the pendulum over the pentacle and see if it swings. If it does not, just sort of makes little jerky movements which it always will from the muscles of your hand, then you know the spirit is on its way and you can sit back and watch the fun. (Do not be surprised if you get a letter from the victim accusing you of being in league with the Reptilians.)



## MAKING AND USING TALISMANS

A talisman is an energy emitting object and any object can function in this way. That being said, a talisman is usually something that is specifically made for a magickal purpose, to make life easier for the magician and it can either be carried, left in a safe place, or used as a transmittal witness to bring about the effect that the magician desires. And making them is extremely easy and not at all time consuming.

This was not always the case. In the olden days it was required that talismans be made of specific materials, often metals that were either expensive or difficult if not impossible to obtain (such as solid Mercury). That was modified with time and experience to be a requirement that they be drawn on parchment (extra virgin parchment paper was considered best according to L. W. DeLaurence who sold the stuff). By the time I started, paper worked just fine but if you really wanted it to work good you soaked the paper lightly in salt water first and then hung it up to dry before drawing on it.

You do not even have to do that, ordinary paper will work quite nicely.

You begin by deciding what the talisman is supposed to do and then you write that out on a piece of paper. Once you have done that, take your number chart and find the number of each letter in what you have written. Add down the numbers of each word until you get a single number for each word, in other words if the numbers of the letters of a word are 2, 3, 6, 4, you would add  $2+3+6+4$  which would give you 15. You add  $1+5$  to get 6, which is the number of the word.

Decide which planet your talisman will work under and then using the magic square for that planet, plot the lines between the numbers as I explained in the directions for creating the sigil for a spirit.

Copy the resulting design onto a piece of paper and then draw a circle around it using a compass (it is good to have a true circle, it looks nicer). (If you have the software, you can do this on your computer as well, but I'm old fashioned and like to do things by hand.) That is all there is to it. Now you have the talisman and it only needs to be charged.

You do this by either bringing up the image of the planet whose energy you are using onto your computer monitor screen and holding the talisman to it, willing the energy of the planet into the talisman, or you set up your radionic box with the picture of the planet in the transmittal side and the talisman on the receiving end. Take a rate for the planet and let the machine run under a desk lamp for a couple hours.

And that is all there is to it. The talisman will automatically be personalized by the process of making it, there is no need to do anything else and charged by the energy of the planet. Now all you have to do is work with it as appropriate and that is determined by the nature of the desire placed in the talisman.

There you have it, magick made easy.

As you go along with this stuff, you will find that you get inspirations of your own and often they will conflict with things you have read or learned. When that happens, go with your inspiration. No one, especially authors, knows everything and if something better pops into your head the fact that it may disagree with someone is no reason not to use it. That way we all make progress.

The bane of magick is that for centuries it was locked into rote and rule and no one had the nerve to make any changes for fear of being devoured by devils or worse. Well, the time came when people broke from that and started to truly experiment and the result is that magick now is a vibrant, living thing, not the dead words from centuries past.

Unfortunately there are those now who would do the same thing, try to create rules to impose on the rest of us. Resist them, ignore them, they have no place in your life and your work. Your only judge is yourself and your only criteria are results. Remember that and you will do just fine.

And with that this work is finished.

Done in Hell, in the presence of the Devils (I've always wanted to write that)

I am

Uncle Chuckie