

By the same author

A Narghile of Poems

The Search for Abraxas (with Nevill Drury)

Techniques of High Magic (with Francis King)

The Oracle of Geomancy

Enochian Magic

Edited

Aleister Crowley's Astrology

Aleister Crowley's Tao Teh King

In Pursuit of Gold

The Magical Diaries of Aleister Crowley

The Complete Enochian Dictionary

Terrestrial Astrology

DIVINATION BY
GEOMANCY

Stephen Skinner



ROUTLEDGE & KEGAN PAUL

LONDON, BOSTON AND HENLEY

Contents

	Acknowledgments	· xii
	Author's note	· xiii
	Introduction	· 1
Part one	HISTORY	
1	The roots of geomancy	· 11
2	<i>Raml</i> and Islamic origins	· 30
3	<i>Fa, ifa</i> and voodoo	· 53
4	The <i>sikidy</i> of Madagascar	· 71
5	European geomancy in the middle ages	· 88
6	The Renaissance: the apogee of geomancy	· 120
7	The great astrological revival	· 140
8	Geomancy in the twentieth century	· 156
Part two	PRACTICE	
9	Method and manipulation	· 167
10	Generation of the Judge	· 176
11	The sixteen figures in detail	· 184
12	Practical divination	· 198
13	Astrogeomancy	· 204
14	Summary of technique and interpretation	· 215
15	Astrogeomantic examples	· 225

Part three APPENDICES

- I *Zodiacal attributions of the geomantic figures* · 233
 - II *Element attributions of the geomantic figures* · 235
 - III *Allocation of the geomantic figures to the Houses* · 237
 - IV *Times of planetary days and hours* · 240
 - V *Names of the sixteen geomantic figures in Arabic, Greek, Provençal, Hebrew, Berber, Malagasy, and various west African dialects* · 242
- Notes · 250
 Bibliography · 257
 Index · 287

Illustrations

FIGURES

- 1 Origins and lines of transmission of geomancy · 7
- 2 Arabic manuscript attributed to Tum-Tum, showing a geomantic talisman for finding water (MS Arabe 2697, fol. 16, Bibliothèque Nationale) · 21
- 3 The expansion of Islam and spread of *raml* AD 635–760 · 25
- 4 Geomantic talisman against diseases of various parts of the body, from an eighteenth-century Arab manuscript attributed to Idris (MS Arabe 2631, fol. 64v, Bibliothèque Nationale) · 43
- 5 Geomantic talisman to uncover hidden treasure showing attribution of geomantic figures to compass points (MS Arabe 2631, fol. 65r, Bibliothèque Nationale) · 45
- 6 Medieval geomantic manuscript of *Geomantia Nova* by Hugh of Santalla (Florence, Laurentian MS Plut. 30.29 (cod. 25 v.) · 93
- 7 The geomancy of Richard II 1391 (British Museum, MS Royal 12. c. v) · 113
- 8 Tabulae Humfridi Ducis Glowcestriae (British Museum, MS Arundel 66) · 115
- 9 The geomantic figures as portrayed in Henry Cornelius Agrippa's 'Of Geomancy' in *Fourth Book of Occult Philosophy*, London 1655 · 124
- 10 Geomantic consultation by Simon Forman, 1597 (Bodleian MS) · 130

- 11 Section title page from Robert Fludd's *Utriusque Cosmi*, 1618, showing geomancy as one of the seven microcosmic arts · 133
 - 12 Two cards from *The Astro-Mythological Game* by Mlle Lenormand showing geomantic squeezer marks · 153
 - 13 The pattern of generation of the figures · 182
 - 14 Planetary groupings of the sixteen geomantic figures · 187
 - 15 Complete table of geomantic figures and attributions · 196-7
 - 16 Plan of a sample geomantic divination · 201
 - 17 Houses of Heaven · 206
 - 18 Angular, Succedent and Cadent Houses · 209
 - 19 The geomantic figures distributed amongst the Twelve Houses of Heaven. House numbers are in Arabic numerals, geomantic figures designated by Roman numerals · 211
 - 20 Zodiacal attributions using Appendix I (col. 2) · 213
 - 21 The complete astrogeomantic figure including planetary equivalents · 214
 - 22 A traditional geomantic chart · 217
 - 23 Geomantic chart: Will the proposed business partnership be a success for me? · 226
 - 24 Astrogeomantic chart: Will the proposed business partnership be a success for me? · 227
- 3 Two divining chains (*opelẹ*). Left figure made of *opelẹ* pods and brass chain with cowries at each end. Right figure cast in white metal with coins at each end. The left chain shows the geomantic figure Qşş-Ofun; the right chain shows the geomantic figure Ofun-Qşş
 - 4 Wooden Yoruba divination plate for responses from the oracle of Ifa
 - 5 The figure *adabara* (Fortuna Major) obtained by *sikidy* and used as a charm to protect a village in Madagascar

PLATES

between pages 66-7

- 1 Two divining trays with the face of Eshu at the top, the lower tray with a set of sixteen palm nuts
- 2 The divining tray being used to mark a figure. The sixteen palm nuts are in the left hand of the diviner and the tray is covered with wood dust

Acknowledgments

Acknowledgments to Helene Hodge who had the idea of writing an up-to-date manual on geomancy, to Beverley Lawton and Christine Galea who undertook the task of typing it, and to the staff of the British Library, Museum of Mankind, Warburg Institute and the School of Oriental and African Studies, for helping in so many ways. My thanks especially to Dr Nicholas Tereshchenko, Dr Donald Laycock and to Abdurahman ben Yahya who assisted respectively with translations from French and Arabic. Lastly my thanks to Eileen Castle for bibliographic assistance.

The author and publishers are grateful to the following for permission to reproduce illustrations: Éditions Bordas, Dunod, Gauthier-Villars, Paris, for Figures 2, 4 and 5 (from manuscripts in the Bibliothèque Nationale); Biblioteca Medicea-Laurenziana, Florence, for Figure 6; the British Library, London, for Figures 7, 8 and 11; Askin Publishers, London, for Figure 9; the Bodleian Library, Oxford, for Figure 10; B.P. Grimaud, Paris, for Figure 12, the Lowie Museum of Anthropology, University of California, Berkeley, for Plates 1-3, from William Bascom, *Ifa Divination* (Indiana University Press, 1969); the Frobenius-Institut, Frankfurt-am-Main, for Plate 4; Presses Universitaires de France for Plate 5, from André Caquot and Marcel Leibovici, *La Divination* (1968).

Author's note

The word 'geomancy' covers two completely distinct areas. The original use of the word, *divinatory geomancy*, was a technique which used sixteen figures composed of dots to foretell the future.

Telluric geomancy is a comparatively recent use of the word to designate both the beliefs of *feng-shui* (concerning the interrelation of man, his buildings and tombs with the life force, or *ch'i*, which flows through his environment) and its recently evolved western counterpart concerned with the study of megalithic alignments and ley lines.

This work is concerned solely with *divinatory geomancy*. However, a second volume on *feng-shui* and *telluric geomancy* is currently in preparation.

Introduction

This book is about divination by earth: it is a book of the art of geo-mancy. The *New English Dictionary* defines geomancy as 'divination by means of lines, figures or dots on the earth or on paper, or by particles of earth cast on the ground'. The word is derived from two Greek words, γαῖα or γῆ (*gaia* or *gé*) meaning the earth, and μαντεία (*manteia*) meaning divination.

The techniques of geomancy are many and varied. They include inspecting the configurations made by scattered pebbles, the manipulation of handfuls of palm nuts or seeds (themselves born of the earth), or the making of marks haphazardly in the ground with a stick. Divination by marking the earth or casting things on the ground also developed into the interpretation of lines or dots made more or less haphazardly on paper with a pen or pencil.

Divinatory geomancy has its roots in Arabic sand divination, which appears also in various guises as African divinatory systems on the West Coast (*ifa* and *fa*) and Madagascar (*sikidy*). The first chapter considers their history in outline, while the subsequent chapters consider the varying techniques of interpretation in each area in detail.

Geomancy has come to be one of the three or four great European methods of divination, like the tarot or astrology. It is also the most easily apprehended of the four elemental modes of divination: pyromancy (divination

by fire), hydromancy (by water), aeromancy (by air) and geomancy (by earth).

Geomancy could be defined as the art of obtaining insight into the present or future by observing the combinations of patterns made in the earth or on paper by a diviner allowing his intuition, or 'the spirits of the earth', to control the movement of his wand or pencil. To become familiar with the basic practice of geomancy let us try a very simple geomantic divination, using paper and pencil.

First formulate a question and write it at the top of the paper. Place the paper at arm's length. Then, with eyes half closed and thinking only of the question, make four lines of random dots, making as many dots as you feel inclined in each line. Repeat this procedure four times, so that you generate four lines of dots.

Next, mark off the dots you have made in each line, a pair at a time. Take each line in turn and you will be left with either:

- if there is an odd number of dots
- ○ if there is an even number of dots.

Starting with the first line, transcribe the one or two dots remaining. Below this, mark the one or two remaining dots of the second line. Do the same with the third and fourth lines. You have now created a geomantic figure.

Somewhere in the sixteen possible combinations in the table below will be the geomantic figure you have generated. Look it up and read off the answer to your question.

The geomantic figures and their basic meanings

<i>Fortuna Major</i> — great	<i>Fortuna Minor</i> — lesser
○ ○ fortune	○ fortune
○ ○	○
○	○ ○
○	○ ○

Via — the way

○
○
○
○

Acquisitio — acquisition

○ ○
○
○ ○
○

Puella — girl

○
○ ○
○
○

Conjunctio — conjunction

○ ○
○
○
○ ○

Puer — boy

○
○
○ ○
○

Carcer — prison

○
○ ○
○ ○
○

Populus — people

○ ○
○ ○
○ ○
○ ○

Laetitia — joy

○
○ ○
○ ○
○ ○

Amissio — loss

○
○ ○
○
○ ○

Albus — white

○ ○
○ ○
○
○ ○

Rubeus — red

○ ○
○
○ ○
○ ○

Tristitia — sorrow

○ ○
○ ○
○ ○
○

<i>Caput Draconis</i> — head of	<i>Cauda Draconis</i> — tail of
○ ○ the	○ the
○ Dragon	○ Dragon
○	○
○	○ ○

This simple operation may be extended by producing four such figures which are referred to as Mother figures. From these, by a form of addition, are produced a further dozen figures. The final or Judge figure derived from them by mechanical means, gives the answer. In Part Two this practical technique is explained in detail, together with its astrological associations. Here it is sufficient to grasp the basic technique so that the historical chapters that follow make sense.

The performance of casting the figures may well remind the reader of the yarrow stalk system of establishing the hexagram for *I Ching* divination. The mechanics are less complicated, but the system is the same. The binary mathematics which govern both the 2⁶ hexagrams of the *I Ching* and the 2⁴ figures of geomancy are the basis of the physical work of both divinatory systems. In this century when computers now make many of man's economic, political and commercial forecasts, it is easy to forget that these machines work on the same principle of binary mathematics as the infinitely more ancient machines of the *I Ching* and geomancy.

It is interesting to note that Leibniz (1646-1716) who is the father of modern binary mathematics and the algebra of classes, drew much of his inspiration from the Jesuit translations of the *I Ching* which were just beginning to reach Europe in his lifetime, and was quite probably familiar with Flacourt's work on *sikidy*, the geomancy of Madagascar, which was published in Paris in 1661.

It might seem as if geomancy provides a very simple set of meanings with which to discover the answer to *any*

question, but these are just the beginning, useful for getting quick answers to simple questions. The *modus operandi* described above is a very simplified version of geomantic practice, but adequate to introduce geomancy and its figures.

Having outlined *divinatory* geomancy in its original form, it is worthwhile to consider briefly the more recent applications of the word to *telluric* geomancy. When the Chinese science of divining the presence of the subtle currents in the earth and their effect on man was first investigated by Europeans, the Chinese term *feng-shui* was translated 'geomancy'. Certainly *feng-shui* was concerned with the earth, but the appropriation of a word which applied to a divinatory technique to describe this practice was rather confusing. Around 1870 writers on the strange art of *feng-shui* began to call it 'geomancy' for want of a better name, falsely connecting it with the system of divination which is completely different from its Chinese sibling. 'Topomancy' or even 'geoscopy' might have been a much better translation of *feng-shui*, the art of discovering 'dragon veins', the subtle telluric currents of *ch'i* which the Chinese supposed affected the propitiousness of any particular site for building or burying. Stephan Feuchtwang, who has written the most comprehensive work to date of *feng-shui* in English, says (p. 224): 'I draw attention to the fact that Chinese geomancy would be defined more accurately as topomancy. It is not divination by means of an earth or sand tray, which is the most common type of divination to be described as geomancy.' However, as we have now been stuck with the name for just over a century, 'geomancy' has come to describe both dot-divination and *feng-shui*.

Once *feng-shui* began to be known more popularly in the West, the hardworked term 'geomancy' was applied to yet another study. Exponents of the ley-line theory, noticing superficial similarities between ley-lines and

dragon lines, christened their own work 'geomancy'. There is however a world of difference between Alfred Watkin's old 'straight tracks' connecting sites in England apparently on the same ley-line, and the sinuous coils of the dragon veins of *feng-shui*. Nevertheless 'geomancy' acquired yet another meaning.

Finally there is a mention in Agrippa of divination by earth movements: 'The first, therefore, is Geomancy, which foreshows future things by the motions of the earth, as also the noise, the swelling, the trembling, the chops, the pits, and exhalation, and other impressions thereof, the art of which Almadel, the Arabian, sets forth.'¹ Polydore Virgil ascribes this type of geomancy to the Persian Magi.² Livy also wrote at length about the meaning of earthquakes and their effect on the destiny of Rome, referring their cause to the goddesses Ceres and Libera, and the god Liber. This fourth use of the word, despite the observations of Diodorus Siculus or 'Almadel the Arabian', partakes more of seismography than geomancy.

'Geomancy' has come therefore to have several meanings. We have (i) a system derived from Arabic sand divination, which developed into African systems of divination by earth, nuts and beads, and into medieval divination by binary mathematics north of the Arab world; (ii) an independent Chinese method for determining the location of dragon veins in the earth; and (iii) ley-line theories coupled with the interpretation of the siting of Megalithic monuments; not to mention (iv) seismography. In this book we will treat only of the various systems of *divinatory geomancy*.

The geographical dispersion of belief in both *divinatory* and *telluric* geomancy is shown in Figure 1 to clarify the different origins, provenance and extent of these two subjects.³ This map will also serve to elucidate the next chapter.

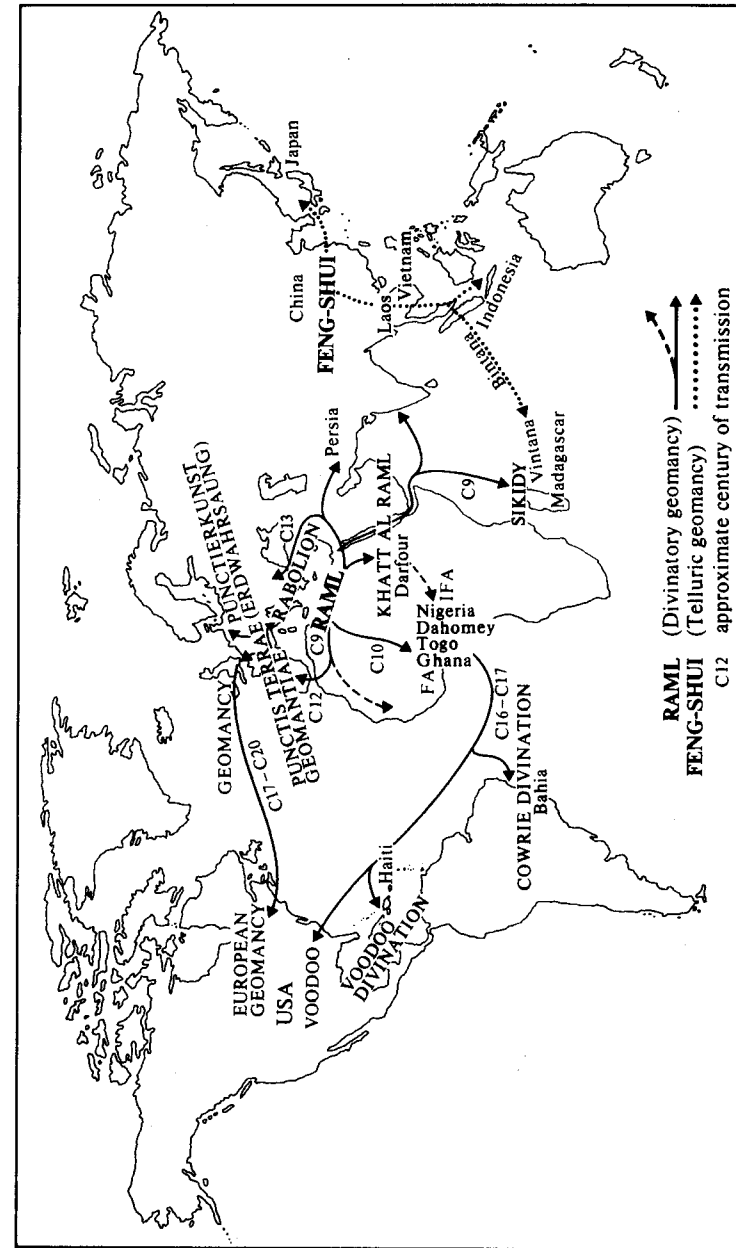

Figure 1 Origins and lines of transmission of geomancy

PART ONE · **History**

I · The roots of geomancy

One of the difficulties of writing even a short history of geomancy is that to date studies of its emergence in one culture have tended to disregard manifestations of the *same* divinatory technique in other cultures. Even within Africa there are few studies (with one or two exceptions, notably René Trautmann, Bernard Maupoil and J.C. Hébert) which even appear to realize that *ifa* and *fa* on the west coast of Africa are exactly parallel with *sikidy* in Madagascar, and that both stem from *raml*, a common Arab origin.

The position gets worse when the question of comparison between African and European manifestations of geomancy arises. A classic example of such lack of cross-cultural information occurs in Lars Dahle's study of *sikidy*, one of the more comprehensive works in English to date.¹ When Dahle comes to assessing the work of Flacourt on geomancy, he fails to follow up the references of his predecessor to 'the authors of Europe'. Flacourt, who was much wider read than Dahle, described the sixteen figures of the *sikidy* by giving each its equivalent Latin name, rather than by drawing the figures in full. Instead of looking up the many works on European geomancy, Dahle criticizes Flacourt for 'merely translating' the Malagasy into Latin, and proceeds to *guess* (wrongly) what figure each Malagasy term applied to. Dahle then satirizes Flacourt:

He adds that 'all these figures have the same meaning and power as are attributed to them by the authors of Europe'. As it would almost amount to an insult to my readers to suppose that any of them are ignorant of what 'the authors of Europe' teach with regard to geomancy, I shall of course abstain from commenting upon this very conclusive information!

He abstains from commenting because he has no idea which authors Flacourt refers to, or even that there was a flourishing European interest in geomancy contemporary with Flacourt's study of its appearance in Madagascar!

There is nothing new in 'authorities' ignoring each other's work, except that in the case of geomancy, many European field-workers have not realized that geomancy was just as much a part of the undergrowth of *European* magical beliefs as it is of the North African Arabs, Malagasy of Madagascar, tribes of Benin (Dahomey), or of the voodoo cult in the Americas. Furthermore, such a lack of historical identification has also led to some false identifications, based on semantic confusion rather than a thorough study of the system concerned, such as that of Chinese *feng-shui*.

Because so many geomantic works are anonymous, and because it has become fashionable among scholars to doubt geomancies attributed to famous men (sometimes on no better grounds than 'so-and-so would not have written a geomancy'), in examining the written sources of this art I have for the most part attributed works according to the title pages of their first printed version, or manuscript incipit and catalogue entry. In doing so, some will be falsely ascribed works, but this is a preferable course of action to listing unlimited anonymous texts of uncertain date. Besides, in many cases of disputed authorship, the critics can suggest no more likely an author than the one they dispute.

Finally, geomancy was *not* looked upon during the middle ages as the poor relation of the divinatory sciences,

as it has come to be, an attitude which has biased many scholars to the point where they look upon the subject, which was important in its own time, as below the notice of the great men of the period under study – a situation rather similar to doubting that Newton was interested in alchemy, when in terms of written output it far exceeded his interest in physics.

THEORIES OF ORIGIN

Classical references

The earliest mention of the word is made in Archimedes (278–212 BC), in which he reputedly drew geomantic figures in the sand during the siege of Syracuse to determine the outcome of the situation, but the nature of these signs cannot satisfactorily be established.

Roman divination by augury has sometimes been pointed to as a possible origin for geomancy, but this too is a red herring, for the rules of augury have been carefully preserved for us by writers such as Cicero and bear no resemblance to geomancy.

The method of augury consisted chiefly in the augur using a crooked staff (*lituus*) which is free of knots (like a magic wand), to frame an area of sky or land within whose bounds an omen was to appear. He then settled down to watch and wait for a sign. The *lituus*, according to Livy, 'marked off the heavens by a line from east to west, designating as "right" [*dextrae partes*] the regions to the south, as "left" [*laevae partes*] those to the north, and fixing in his mind an [easterly] landmark opposite to him and as far away as the eye could reach'. The augur 'next shifting the crook to his left hand and, laying his right hand' on the head of the person for whom the augury was performed, uttered a prayer to Jupiter. Within

the bounds of this *templum* any natural phenomena now would be interpreted by the augur as a message from the gods. This interpretation of the signs was extremely complex and, although some of the detailed rules have now been lost to us, it is known that the meaning of the appearance of specific varieties of birds in particular quarters and in particular numbers was clearly defined. Factors taken into account included the height and manner of flight, perch, tone of call, and the direction from which the bird came. Obviously this description is not of the sixteen figures of geomancy, and so it is that when Marcus Terentius Varro (116–28 BC) speaks of *geomantia* he also does not refer to the present method of divination.²

Greece

Normally one would examine the etymology of a word to derive data on its origin. However in the case of geomancy the classical Greek and Roman uses of the word had only a general meaning which persisted throughout the early middle ages to mean simply divination by observing patterns or cracks in the earth, just as the three other elementary methods of divination, pyromancy, hydromancy and aeromancy were basically techniques of *divination by inspection* rather than systematized mathematically based practices with specific rules, figures and formulations.

As Paul Tannery, the well-known French historian of science, has pointed out:³

the Greek words which now refer to this form of divination had in antiquity only a general meaning. In the middle-ages in the West this name was given to an Arabic practice by the translator Hugh of Santalla, who lived in Aragon in the first half of the 12th century. The later Byzantine Greeks did not use the word geomancy in this context, but called the practice by a different name which had been derived from the Arabic *raml* (meaning sand).

A translation of Paul Tannery's letter dated 15 June 1897 confirms this:⁴

Their exist in Greek treatises of geomancy, which are said to be translations from the Persian with the title 'ράμπλιον *rhampliōn* or alternatively 'ραβόλιον *rabolion* which seems to indicate a Semitic route from 𐤓𐤁𐤍 as in Byzantine Greek, the letters *μπ* are equivalent in sound to *b*. On the other hand this word seems to be translated into Greek under the form *λαξευτήριον*, *laxeuterion*, which is a Greek word meaning 'the stone cutter's chisel'. The metaphor is perhaps justifiable by the shape of the geomantic lines which will be a point of departure for further combinations. But I have vainly tried to find the Arabic or Persian word transcribed as *rhampliōn* or *rabolion* and translated by the word 'chisel'. Nor have I seen either that geomancy has been designated in Arabic by a similar word, but this has relatively little importance.

To sum up, in such Byzantine Greek manuscripts as that of Georges Mideates (1462), *rabolion* is a Greek transliteration of the Arabic *raml* which means sand, while the word *laxeuterion* probably refers to the *method* of divination, involving the poking of holes, which is an act which has been compared with chiselling a stone. As *laxeuterion* is simply a figurative word for the divinatory procedure, Tannery instead used the word *rabolion* when speaking about geomancy.

With the exception of two anonymous manuscripts, the word *geomantia* does not appear in any Greek manuscripts on the subject, the word *rabolion* being much more common. Thus the etymological incorrectness of the word 'geomancy' is sufficiently established.

The fact that portions of the practice of geomancy first appear in Greek manuscript, translated *from* the Arabic,⁵ and not in any classical sources, indicate quite definitely that the practice was of Arab origin rather than Greek. This is contrary to the usual line of cultural transmission (in which many of the Greek sciences passed into Arabic), but nevertheless supported by a number of facts which we will consider later in this chapter, and again in chapter 5.

Persia

Other origins have been posited for the practice of geomancy, often motivated by the 'romance of the East' rather than historical fact. One such study is the historical appendix written by Dr Alexander Rouhier in Eugène Caslant's *Traité Élémentaire De Géomancie*. Rouhier supposes that geomancy was established in Persia at least as early as the eighth or ninth centuries, during that epoch of Iranian culture which flourished at the universities of Gondé-Shapour and Baghdad which attracted the intellectual élite of many countries. However, he does not educe any proof in support of this theory, merely asserting that the Arab and Jewish scholars who attended these universities, and brought various sciences back to their homelands with them, also carried the science of geomancy to the University of Damas[cus], Alexandria, and eventually to Cairo.

The attribution of the origins of geomancy to Persia is shown to be completely false because all of the words connected with geomancy have come originally from Arabic rather than the Greek or Persian. The reason for this is that from the thirteenth century the Greeks were no longer in direct communication with the Arabs, and it is to Persia that they looked, on the other side of the Turkish hordes, for the centre of the civilization and the science of Islam. For the same reason the great authority on geomancy, az-Zanati is often called a Persian, although he is in fact a north African Arab of the twelfth to thirteenth century. This false nationality lent colour to the hypothesis that Persia was the home of geomancy.

India

India as a possible origin is however harder to dispose of. The basis for attributing the roots of geomancy to India

probably lies in the reputed authority on geomancy called Tum-Tum el-Hindi.⁶ The epithet has been thought by many commentators to indicate India as his birthplace, however '*el-Hindi*' was applied to a number of other writers including Apollonius of Persia (who certainly was not an Indian) which in his case at least evidently meant 'the ingenious'. In addition, the word *bindasi* meant a geometer, and *bindi* is more likely to have been an indication of the occupation of the person so designated, rather than his country of origin.

The other half of the name, 'Tum-Tum', has sometimes been construed by French savants as a corruption of Ptolemy. Whilst this is not proven, it would at least tie in with the tradition concerning the Islamic derivation of geomancy through Idris, Tum-Tum and Hermes Trismegistus. This last mentioned line of adepts will be examined at greater length in chapter 2. Suffice it to say that India is less likely as an origin for geomancy, when the only basis for this ascription rests on the epithet *el-hindi*.

Medieval geomancies often claim a connection with India. One condemned at Paris in 1277 began, 'The Indians have believed . . .', and several geomancies have been called *Indeana* indicating their supposed origin. Another manuscript in the British Library⁷ begins, 'This is the Indyana [i.e. geomancy] of Gremmgi which is called the daughter of astronomy and which one of the sages of India wrote . . .' However it was almost as common practice to attribute a work of this nature to a fabulous country of origin as to a fabulous author, and although it is *possible*, it seems unlikely that India was the fountainhead of geomancy.

Hebraic origins

Daniel, the Biblical prophet, was in great vogue in the middle ages as the reputed author of various books of

prediction and dream interpretation. Amongst writing allegedly by Daniel is a manuscript on geomancy written in Turkish now in the British Library.⁸ Although Daniel remained a popular author-designate for Latin manuscripts from the tenth to the fifteenth century, this particular geomancy is an exception to this rule. The fact that it is written in Turkish puts it in a class of its own, and Seyyed Hossein Nasr, in a letter to the author in 1977, suggests that 'the traditional account that [geomancy] was founded by Prophet Daniel who received it as an inspiration from heaven accords very well with the historical evidence as far as its semitic origin is concerned'. He goes on to say, 'of course historical sources cannot either prove or invalidate the traditional doctrine concerning the inspired origin of this discipline. But they have borne out the fact that this [is] closely related to old semitic practices of divination'. Here we have a suggestion of a semitic origin for geomancy, a birthplace not as far east as Rouhier suggested. A number of authors also parallel geomancy with ancient divinatory practices, such as Sassanian divination techniques; but direct evidence of the existence of specifically *geomantic* techniques in early texts of this period is missing, so we are still on rather shaky ground.

The *Jewish Encyclopedia* places the origins of geomancy in North Africa about the ninth century from where, it maintains, the practice penetrated into Jewish literature. Here we are on much firmer ground for the *one* fact we can be sure of is that the practice was well established in North Africa about the ninth century AD. At this time, geomancy was referred to in Arabic as *raml*, whilst in Hebrew it was called by a number of names, including גורל החול *Goral Ha-hol*, literally 'the lot by sand' or *Hokmah Ha-nekuddot*, the 'science of points'. Aran ben Joseph refers to diviners who use geomancy as *Yidde 'Oni*, or 'he who casts by means of points', in his commentary on *Deuteronomy* (18:11).

The best known Hebrew writers who refer specifically to geomancy include Maimonides (1135–1204) of Cordova in Spain who travelled across most of the Arab world to die finally in Cairo, and Nachmanides who mentioned geomancy in his commentary on the Pentateuch. Maimonides, most famous for his work *Guide for the Perplexed*, refers to geomancy in his commentaries on the *Mishnah*.⁹ However these were all Hebrew writers living in a Muslim world, pointing strongly to an Arab origin as the real genesis of the practice. Following these authoritative writers, came a host of lesser Hebrew commentators.¹⁰ An undergrowth of literature subsequently grew up, mostly anonymous works on geomancy, many of them called *Sepher ha-Goralot*, of which numerous examples will be found in any extensive library of Hebrew literature.¹¹ The Hebrew literature however was a cul-de-sac of the history of geomancy, and not a major influence on either the development of geomancy in Europe, or the spread of geomancy to the south, in Africa. Rather it was the Arab *raml* which was most widely disseminated and which had the most influence on the later development of geomancy. It would seem for this reason fairly safe to attribute the actual origin of the technique to the Muslim area of North Africa.

Islamic origins

Islam, with its strict doctrine of predestination, offered fertile ground for the proliferation of all systems of divination: geomancy or to give it its full name, '*ilm al-raml*, literally the 'science of the sand', was to survive longer than most.

Ahmad ben 'Ali Zunbul, who lived circa 1550, outlined the traditional Arab pedigree of geomancy, according to which the angel Gabriel first appeared before Idris (the Arabic name for Hermes Trismegistus) and taught him

the art of geomancy. In the usual Hermetic texts, a revelation is bestowed on Hermes who in turn passes it on to his son Tat or to Asklepios (in the case of more medically inclined Hermetica). Such texts form part of a vast corpus of 'Hermetic literature', of which the *Poemanders* is perhaps the best known in the west.

Zunbul describes the meeting of Idris with the angel Gabriel in the following terms:

Idris, on the instruction of a spiritual being had travelled extensively. During one of these journeys, Gabriel appeared to him in the shape of a man, drew lines in the sand and said to him: 'You are a prophet; but you hide your gift of prophecy out of fear of your fellow men.' And Idris answered: 'Yes out of love and reverence for you.' Idris was surprised at the [geomantic] knowledge that Gabriel possessed and said to him: 'Dear Brother, I will become your companion and you shall teach me that which is known to you.' And Gabriel answered: 'Out of love and respect for you will I do this.' Thus Idris met Gabriel every day until he had mastered this science. Then Gabriel said unto him: ... 'Go to the Indian Tum-Tum and his people and teach them this science.'

So from Idris/Hermes Trismegistus the chain of tradition passes to the elusive 'Tum-Tum'. Tum-Tum appears to belong to legend rather than history, although as we have seen his name may be a corruption of an actual personage, perhaps Ptolemy, and he may not necessarily come from India. For Islam, India had the same aura of mystery as Egypt has had for Europe in more recent years: consequently if it was necessary to give a subject greater authority, an Indian source was invoked by Islamic writers: Tum-Tum also occurs as an authority in other occult writings in Arabic. Zunbul even claims that Tum-Tum's geomancy was written 'in the language of the inhabitants of India'. Moreover, Muslim travellers often made a pilgrimage to India, and 'to be an Indian, wise in the interpretation of secrets' was a common phrase, and one of the ideals of the Brethren of Purity.

Halaf al-Barbari was next in the Arabic chain of



Figure 2 Arabic manuscript attributed to Tum-Tum, showing a geomantic talisman for finding water (MS Arabe 2697, fol. 16, Bibliothèque Nationale)

traditional descent. He travelled to India to study geomancy, where he copied Tum-Tum's text into Arabic. Abu 'Abdallah Muhammad az-Zanati drew on al-Barbari's work in turn to produce one of the more complete

geomancies of his time. Although az-Zanati's dates are not known, it is suspected that he lived during the twelfth or thirteenth centuries, as he is quoted by Ibn Khaldoun in the following century. Az-Zanati's works have often been reprinted in Arabic from the thirteenth century to the present day, and he stands as one of the greatest Arabic authorities on geomancy. In turn Ahmad ben 'Ali Zunbul drew his material from az-Zanati in the sixteenth century (when geomancy in Europe and *raml* in Islam simultaneously reached their peaks), establishing *raml* as an integral part of the world of Islam. Its special features are examined in the next chapter.

To return to tracing the expansion of geomancy from the Muslim world. It would seem to have occurred in three directions: firstly, Africa southwards across the Sahara to the Gulf of Guinea; secondly, via the Red Sea and the Indian Ocean to Madagascar; and thirdly, north through Muslim Spain to the rest of Europe. Geomancy migrated finally from both Europe *and* the Gulf of Guinea (in the sixteenth and seventeenth centuries) to the New World of the Americas, by which time it had lost many of its essentially Muslim features.

The migration of nomadic Arabs and the consequent spread of Islam south through the Sahara along the trade routes into the rich Equatorial Africa or present-day Nigeria, Dahomey (Benin), Togo and Ghana, is the first line of migration we shall consider.

Islam first stirred Africa out of its lethargy in the eighth century. The Berbers, who were already masters of the Sahara when the Arabs arrived, accepted Islam, and in about AD 800 drove the Tukulors and the Oulofs as far south as Senegal. In the later part of this century, almost all the black dynasties seem to have been replaced by others of northern origin, Berbers perhaps, so that in about 850 the Dya-Ogo of Diara (south of Senegal) spread from the Gambia to Aoudaghost; while the Songhai of

Dahomey later occupied Gao, and in 990, made it their capital. Likewise the Hausa of the lower Niger, whose king (circa 890) rejoiced in the Arab name, Abu Yazid. The only kingdom which escaped northern domination was the empire of Ghana, whose creation seems to have dated from much earlier. At the beginning of the ninth century, this empire of the Sahel stretched from Timbuktu to Kayes, and from the upper Niger to Hodh, and at the end of the tenth the Sarakolle occupied Mauritania, where Muslims were also numerous.

Although Islam was not formally introduced into these regions before the eleventh century, trade was active, and Arab civilization had penetrated deeply. Caravans escorted by Berbers maintained commercial links across the Sahara, and cultural contact was established between black Africa and the Mediterranean, the Arabs taking with them the habit of 'sand-cutting' or *raml*. The introduction of the camel greatly assisted this contact between the seventh and tenth centuries, and clothing, food, customs and textiles spread to lower Senegal. The Sahara traffic directed towards Egypt or Tunisia used the regular tracks from Khumbi, Timbuktu, and Gao in the south, and Tripoli, Tahert and Marrakesh in the north. The salt of the Sahara, the gold of the upper Niger, the copper of Agades and the slaves of Guinea were traded for dates, coral and textiles. Later, Saladin's relations with the Muslim rulers of Bornu and Gao brought the reopening of the caravan routes from Egypt to Lake Chad and the Niger.

Communications with Madagascar via the Red Sea explain how the practice of *raml* made its way down the east coast of Africa to Madagascar, where it was easily adopted by the indigenous Malagasy population, between the ninth and fourteenth centuries, when Arab colonies were set up in the north-west corner of that island.

The history of geomancy at this point closely parallels the history of the expansion of Islam, which made great

progress in Negro Africa in the eleventh and twelfth centuries. In the Sudan the three great empires were all Muslim. The empire of Mellé on either side of the upper Senegal and the upper Niger was formed from the old kingdom of Ghana. Its ruler from 1255 to 1270 even went on a pilgrimage to Mecca; and its architecture, in cobwork and fired brick, was influenced by the style of the Maghrib. From Egypt and Morocco also came a large number of merchants. The Mellistine empire stretched from Senegal to the south Algerian oases, and the River Niger. This was the great period of Timbuktu, a flourishing intellectual centre from which the customs of Islam spread southwards. This empire reached its highest point at the end of the fifteenth century.

At the same time several Hausa states had come into existence in the central Sudan, between the Niger and Lake Chad, the most important of them being the one centred on Kano. One of its rulers, Yeji (1349-85), was visited by Muslims from Mellé and converted to Islam.

Islam thus penetrated to the heart of Africa, so far in fact that even the Maghrib scholars of the fifteenth century did not hesitate to go to Timbuktu to consult with African scholars. It must be added, however, that only the sovereigns and upper social levels adhered to Islam; the masses remained loyal to the beliefs of their ancestors, adapting the Islamic practice of *raml* to their own style of worship.

In its simplest form, *raml* was called 'sand-cutting', which consisted in making a random number of marks in the sand or dust, cancelling them off two by two until only one or two marks are left, and from this drawing a single or double line. Repeated four times, this procedure yields one of the basic sixteen geomantic figures of *raml*. Sand-cutting was and is a widespread form of geomancy practised by many Islamic groups in both west and north Africa: its similarities to the Dahomean divinatory system

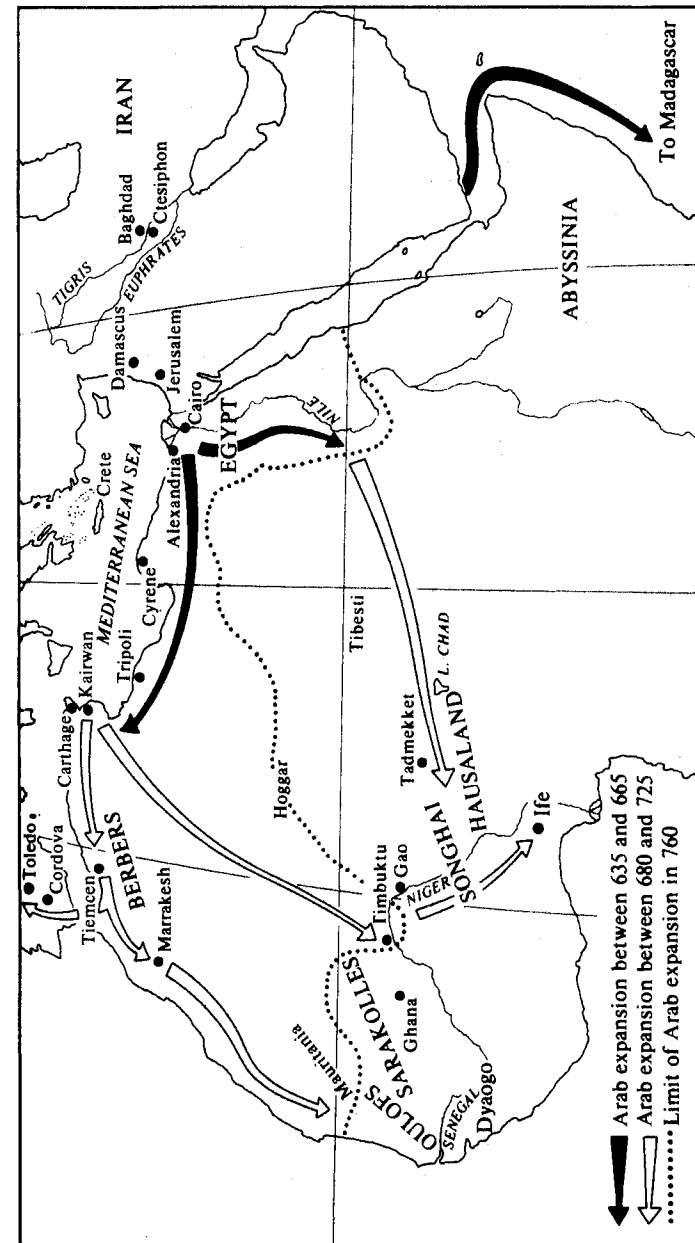

Figure 3 The expansion of Islam and spread of *raml* AD 635-760

of *fa*, and the Yoruba *ifa*, were first noted by Fischer in 1929, and later elaborated on by Monteil, Trautmann, Schilde, and most importantly, Bernard Maupoil in 1943, who also drew attention to the similarities with Madagascan *sikidy* divination.

However, as early as 1864, the well-travelled Sir Richard Burton noted similarities between the Dahomean *fa* and the 'geomancy of the Greeks, much cultivated by the Arabs under the name of *al-raml*.' Here he erred in attributing the ultimate origin to the Greeks, but he was in some ways even better read than his successors, because he drew yet a further parallel with Napoleon's *Book of Fate* which he described as 'a notable specimen of European and modern [geomantic] vulgarisation',¹² thus leaping centuries of the development of divination to this forgoing of the 1820s (see p. 141).

A chapter of *Voyage au Darfour* (Paris, 1845) written by Sheikh Muhammad ibn Omar al Tounsi and translated by Dr Perron, contains a study of geomancy as it was practised in Darfour (a country annexed by Egypt in 1874), with the Arab names and meanings of the figures, description of the operations of *khatt al-raml* (literally calligraphy traced in the sand) and of *dharb* (or *derb*) *al-raml* (the art of marking the sand) by the sand diviners. These are obviously a 'halfway house' between *raml* and west-coast African divinatory systems.

Further suggestive evidence of the direct connexion between *raml* and the divinatory systems of the Yoruba comes from the presence among the Yoruba of a form of sand-cutting, called by them *iyarin tite*, which is practised by Muslim diviners known as *alufa* who often referred to the technique as *hati ramli* (or *atimi* for short). The names of the sixteen basic figures (Al Káuseji, Aláhika, Utúba dahila, etc.) clearly differ from those of *ifa* but correspond to those given by az-Zanati. The order in which these figures were recently given by an *alufa*, a

native of Zaria, is identical with that in which they are listed by az-Zanati. Although this system of the *alufa* may be a recent introduction of Islamic geomancy, the local parallels in practice between it and *ifa* help to confirm the Muslim origin of the latter.

The practitioners of *ifa* divination rely upon extensive verses which are memorized and recited in response to the generation of a particular geomantic figure: traces of such verses exist in Islamic *raml*, but not the propitiatory sacrifices which are of such central importance to *ifa*. On the positive side, sand-cutting is sometimes used rather than the throwing of seeds to generate a figure in both *ifa* and *raml*, and the whole mathematics of addition of odds and evens, the shapes of the figures, and some meanings are identical.

Burton and Maupoil¹³ both came to the conclusion that *ifa*, *fa* divination and *sikidy* (in Madagascar) are all derived from Islamic geomancy. Considering the trade routes and general expansion of Islam, together with the incredible internal similarity, this thesis seems to be inescapable. A final piece of evidence is produced by Ellis (1894) who says of the divination board used by the *ifa* diviners that it is 'exactly similar to those used by children in Muslim schools in lieu of slates, about two feet long and eight or nine inches broad . . .', thus reinforcing the evidence for the Islamic origin of *ifa*.¹⁴ It could even be conjectured that Muslim practitioners demonstrated *raml* on school boards whilst teaching the Yoruba other subjects. The Yoruba then might easily have assumed that the board was a necessary part of the impedimenta of divination rather than merely a convenient writing surface. Farrow also refers to the divining board as 'an engraved circular board, or a rectangular one, with a handle, similar to a Mohammedan writing tablet . . .'.¹⁵ Although the reference to the use of a Muslim type of slate as a divining tray may possibly stem from a misinterpretation of

Burton's account of 1893, it seems a fairly likely cultural transition. Accordingly, in chapter 3 we investigate the techniques used by the Yoruba for their Ifa related divination, and by their neighbouring Dahomean Fa diviners.

With the introduction of slavery in the sixteenth century, many of the slaves taken to the New World took with them the religion of their ancestors, the cults of Şango, Eshu, Fa and Ifa, together with the divination techniques associated with these gods. Consequently, to this day the islands in the Caribbean, particularly Haiti, have inherited these ancestral divination systems which still bear an uncanny resemblance to Arabic *raml*. Slaves sent to Bahia, who integrated much of their religion with Christianity, have also preserved an elaborate ritual divination based on the sixteen figures of Ifa, derived from *raml*, which are generated by the manipulation of cowrie shells, a traditional form of African currency from the Gulf of Guinea. In Recife and Bahia the shell is so altered that there is an artificial opening opposite the natural opening. When the shells are thrown on a flat surface, either the artificial opening or the natural opening remains uppermost, and it is the different proportions of open to closed which provide the odd and even components of the figures. The traditional deities associated with the verses and divinatory meaning are still part of the technique of divination. Unfortunately, in the last couple of decades, specialists in these techniques of divination in these areas seem to have mostly disappeared.

Returning to the world of Islam in North Africa, we can trace the trade routes down the Red Sea round the Horn of Arabia past the Yemen and along the coast of Africa down to Madagascar where the tradition of *sikidy*, which is examined in detail in chapter 4, has been brought almost intact, with its original Arabic names for the various figures. The arrival of Arab traders bearing with them this technique of divination is well documented, and it has

blended successfully with the traditional beliefs of the native Malagasy. In fact it held such a sway over the imagination of the population before the coming of Christianity, that the missionaries responsible for the latter found it harder to conquer than the ritual religious practices of a non-divinatory kind!

In chapter 5 we move north from the world of the Prophet to the great school of translators at Toledo in Spain, who were responsible for transmitting so much of the best of Arab civilization and science into the comparatively backward Europe of the Dark Ages.

2 · Raml and Islamic origins

Divination in the world of Islam took many forms. The best summary of these in a European language is Toufic Fahd's *La Divination Arabe*. The main forms of divination include *kibana*, *djafr*, *fa'l*, *ihhtiladj*, *ta'bir* (oneiromancy), and of course *raml*, more precisely *al-khatt bi-raml*, the original name for Arab geomancy. Of course, *ta'bir* has always been the most popular, followed by *raml*.

Raml, literally 'sand', is variously spoken of as *derb-al-raml*, *derb-al-ful*, *'ilm al-raml* (the science of sand), *hati ramli* (colloquially) and *khatt al-raml*.¹ In the Islamic era, the term, *raml* (or *'ilm al-raml*) was dominant, but with the growing influence of astrology on the occult sciences, the term *shakl* (plural *ashkal*), 'figure' came into prominence. From *shakl* may be derived the expression to 'squill' or practise divination by sand, and perhaps *sikily* or *sikidy*, the terms used in Madagascar to denote geomancy.

Khatt in Arabic originally meant a straight furrow or line drawn in the sand by a stick or with the finger. In time the word came to mean a line drawn on parchment or paper, or a line of writing, and finally, the art of calligraphy. For our purpose, the earlier meaning is the most interesting because it especially applied to the lines which a diviner (*hazi*) drew in the sand to prognosticate the happy or unlucky outcome of an undertaking or event about which he was consulted.

At first sight, *khatt* is the line which the geomancer

traces on the sand when, strictly speaking, he is practising psammomancy. This is also the meaning of *raml*. Finally the development from *khatt* to *raml* began with the juxtaposition of the two terms. Indeed, *khatt al-raml* is the term most frequently used to denote geomancy.²

For the purpose of divining by *khatt al-raml*, the diviner, accompanied by an assistant or acolyte, drew with the utmost haste a quantity of lines or ripples in the sand, allowing himself to be carried away, so that he did not know how many lines he had drawn. Then he slowly wiped out groups of two ripples at a time, whilst his assistant often recited an incantation in Arabic, such as the words: 'Ye two sons of 'Iyan hasten with the explanation!'

The marks they made were joined by other marks (*khutut*) in order to complete a figure (*shakl*). When these figures became stylized, a board was used, which was covered with sand or even flour, and the finger was drawn over it at random; the shapes formed in this way were then examined. If in the end two lines were left (i.e. there was an *even* number of lines drawn) then this foretold success. If however only one line remained (an *odd* number of lines drawn) then disappointment was certain. Here can be seen the germ of the later and more complex practice, where each line is reduced to odd (only one left) or even (two remaining). In this, the simple form of *khatt al-raml*, only *one* set of marks were made, leading straight to a lucky/unlucky prediction.

A more modern Arab version of this technique involves the making of lines in the sand. On to these lines, corns of barley or date-stones (or even cubes resembling dice with combinations of one or two marks on each face) are thrown. The resultant patterns provide a more complex prognostication. Where dice are used, the four possible markings on their six faces are:

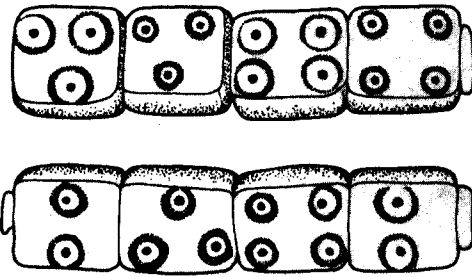

Examples of such dice are to be found in the Ni'matollahi Khanaqah Library in Tehran.

We have already examined the almost mythical roots of geomancy deriving the doctrine from the Archangel Gabriel through Idris to the possibly mythical Tum-Tum. From here we are on firmer ground with the copying of Tum-Tum's work into Arabic by Halaf al-Barbari. Unfortunately it is difficult to determine from what language it may have been copied into Arabic, and whether this throws doubt upon Arabic being the ultimate origin of the practice, or whether it is merely a distancing device designed to give the practice more authority.

AZ-ZANATI

Much more is known about al-Barbari's successor Abu 'Abdallah Muhammad az-Zanati who lived in the twelfth or thirteenth century, and who founded a school of geomancy: his followers are to this day called al-Zanatiyya. Not only has his work been reprinted many times from the thirteenth century to the present day, but a number of manuscripts are still extant purporting to be from his pen.

The work which is attributed to him bears different titles, the printed versions of which were issued in Cairo in 1863 under the title *Kitab al-Fasl fi usul 'ilm al-raml*, and again in 1908 under the title *al-Akwal al-mardiyya*

fi'l-abkam al-ramliyya.

Az-Zanati was also responsible for some of the earliest transmissions of geomancy into Greek, because his classic work was translated from Persian into Greek verse by the monk Arsenius in 1266.

IBN MAHFUF

Next in order of fame comes 'Abd Allah ibn Mahfuf al-Munadjjim, known as the 'Astrologer' (i.e. the geomancer) who died before 1265 leaving a work entitled *Muthallathat Ibn Mahfuf fi'l-raml*³ (and sometimes called *Risalat raml*).⁴ A manuscript of this work bearing Berber glosses has found its way to the Berlin Library,⁵ and it is from this manuscript that the Berber equivalent of each of the geomantic figures has been derived for the present Appendix V. Connected with the treatise by 'Abd Allah ibn Mahfuf may be the Latin translation *Astrologia Terrestris* attributed to Ali ben 'Umar which was translated from Arabic into Italian and German.⁶

THE ASSASSINS

The Assassins of Alamut were a group of Persian Isma'ilis founded by Hasan ibn-al-Sabbah (also known as the Old Man of the Mountain). His followers were given hashish as a reward to induce absolute obedience and disregard of their own safety; hence the name Assassin, 'one who takes hashish'. Later, in the twelfth century, the Assassins spread to Syria where the Crusaders first came into contact with them. The tales which the Crusaders spread to Europe of the exploits of the Assassins were coloured with not a little envy; envy of the Assassins' ruthless murder of their opponents, their sense of

brotherhood imitated by later chivalric orders such as the Templars, their belief in Muhammad and his daughter Fatima (faintly reflected in the later obedience supposed to have been given by the Templars to Baphomet). Lastly, their 'paradise' to which were escorted the flower of their guerrilla force, to spend a few days in the arms of both *bouris* and hashish before leaving Alamut on their missions.

It seems likely that one of the recensions of *az-Zanati's* work, or possibly that of *ibn Mahfuf* may have made its way into the library of the Assassins, who had a mystical and cultural impact on their period wider than the merely political ramifications of their religious zeal. From Alamut they carried out raids on adjoining areas not only assassinating political opponents, but sometimes kidnapping scholars and others whom they thought might be of use to them.

AL-TUSI

One of the greatest mathematicians and scientists of the thirteenth century, *Nasir Al-Din Al-Tusi* (1201-74), was one such victim. Persian by birth, Al-Tusi was also a philosopher, astronomer and physician, who wrote in both Arabic and his native language. His devotion to systematic scientific inquiry led to him being dubbed 'al-Muhaqqiq', the investigator. Born in Savah, or in Tus, Khurasan, he was kidnapped at an early age by the Isma'ili governor of Quhistan, and sent to Alamut, where he remained, if not a prisoner at least an unwilling guest, until its capture by the Mongols in 1256. It may have been here that Al-Tusi first became interested in geomancy, for the Isma'ili doctrines contained much of an esoteric nature.

Al-Tusi was however responsible for the destruction of this community, for it was on his advice that the then Grand Master of the Assassins, *Rukn al-din Khurshah*, gave

himself up peaceably to the besieging Mongol horde who had surrounded Alamut, thereby ending the reign of the Assassins. This apparently extremely subtle betrayal of his captors has never been adequately explained, for when the Assassins quietly handed over their stronghold, Al-Tusi entered the service of the grateful Mongol chief, taking with him much of the library and knowledge of the Assassins. He remained in Mongol service, becoming a *wazir* and obtaining increasing influence over the Mongol chief *Hulagu Khan* by his astrological knowledge. Soon *Hulagu* did not dare to undertake anything without his astrologer's advice, and Al-Tusi was finally appointed administrator of the property revenues which he may have used to help build and endow the observatory and library of Maragha, where he resided from 1259 until almost the end of his life in 1274.

A large number of writings (at least fifty-six) on many subjects are ascribed to him. These mainly included astrological and astronomical works concerned directly with such questions as the trajectory, size and distance from earth of specific planets, as well as their more arcane influence on people and politics. His knowledge was largely derived from Greek sources of which he had made a deep study, probably in the library of the Assassins. He knew the main Greek mathematicians through Arabic translations and commentaries, wrote commentaries on *al-Kindi*, *Qusta ibn Luqa*, and other famous Arab astrologers and astronomers, and compiled works on the calendar. Amongst all this activity, both political and scholarly, he found time to write his *Kitab al-wafi fi 'ilm al-raml* (or 'The perfect treatise on the science of sand', i.e., geomancy), also entitled *Al-risala al-sultaniya fi khatt al-raml* ('The Sultanian epistle on the sand figure'), which figured as a classic of geomancy for many centuries.

IBN KHALDOUN

During the fourteenth century, the celebrated Ibn Khaldoun (who died in Cairo in 1406) devoted a chapter of his *Prolegomena*, or *Muqaddimah*, to the art of geomancy.⁷ Ibn Khaldoun assumed that geomancy was developed by the sand diviners 'because they found it difficult to establish the attitude of the stars by means of instruments, and to find the adjusted [position of the] stars by means of calculations. Therefore, they invented their combinations of figures.'

After a description of the sixteen geomantic figures, each named and classified into favourable and unfavourable, Ibn Khaldoun explains this classification in terms of the astral influences which are brought to bear by each of them. The sixteen figures are then set under the domination of the Twelve Signs of the Zodiac and of the Four Cardinal Points.

Geomancers are called by him *munadjjdimun* or 'astrologers', thereby connecting the derived meanings of the geomantic figures with astrological speculations. There is, however, never any doubt that Ibn Khaldoun is talking about geomancy and not astrology.

Ibn Khaldoun objected to geomancers because they used 'artificial' geomantic figures rather than observing the real and natural astrological phenomena of the various stars in the sky. Here the rationalist Arab philosopher makes the error of confusing geomancy, which works by the chance formation of patterns, with the precise calculations of man's location in time and space which gives his relationship with the universe, as expressed in astrology. Geomancy is however not a debased form of astrology as Ibn Khaldoun would have us believe, but a valid divination system in its own right.

Even more aberrant, Ibn Khaldoun thinks, is the pretension of certain geomancers to succeed in perceiving

the unknown by applying their minds to the geomantic figures, then abstracting a complete understanding of the human sphere and the spiritual realm. He parallels this with the manner of the soothsayers and particularly those who practised omoplatoscopy, hydromancy and lecanomancy. Ibn Khaldoun concludes: 'the truth that you must present to the mind is that the supernatural cannot be revealed by any technique; it cannot be perceived by an élite class of men naturally predisposed to pass from the conscious world into the spiritual.' Ibn Khaldoun did however concede that the better types of geomancers 'attempt to remove [the veil of sense perception] by occupying their senses with the study of combinations of figures' by which they 'may attain intuitive supernatural revelation (*kashf*) through complete freedom from sense perception', thereby exchanging bodily perceptions for spiritual ones. For Ibn Khaldoun, the ability to 'soothsay' was god-given, and it did not matter at all if the soothsayer used bones, sand, pebbles, water or anything else as an aid to stimulate his ability. However, anyone who used sand divining, without this natural ability was, according to Ibn Khaldoun, 'merely trying to spread the falsehoods to which they are committed'.

The *modus operandi* outlined in the *Muqaddimah* is much as it occurs in medieval European works on geomancy, having sixteen figures which are produced by rows of dots made on paper, sand or flour, which are made at random whilst asking the question. Each row is then marked off, a pair of dots at a time, until only one or two dots are left. These are transcribed and form the first four figures. From these (Mother figures) the remaining twelve figures are generated by juxtaposition and addition, the details of which are set out later in this book. In applying these geomantic figures to the Houses of Heaven the Arab geomancers, according to Ibn Khaldoun, limited themselves to using only the sextile (60°) aspect

rather than the whole range of possible astrological aspects from conjunction (0°) to opposition (180°).⁸

Arab diviners assumed the existence of sixteen Houses in all: twelve corresponding to the Signs of the Zodiac (the ordinary Houses) and four to the *cardines*. The practitioners of *khatt-al-raml* thus invented 'a discipline which runs parallel to astrology and the system of astrological judgements'.

Ibn Khaldoun thought that horary questions put to astrology,⁹

do not come within the influence of the stars or the positions of the spheres, nor do (the stars and the positions of the spheres) give any indications with regard to them. This branch of [horary] questions has indeed been accepted in astrology as a way of making deductions [concerning a particular query] from the stars and positions of the spheres. However, it is used where it is not natural for it to be used.

How much less legitimate then is geomancy in Ibn Khaldoun's view, as geomantic figures 'are based upon arbitrary conventions and wishing thinking. Nothing about them is proven.'

In accord with the tradition, Ibn Khaldoun ascribes the origin of the art of geomancy to the prophets of old, frequently to the Biblical Daniel or the Koranic Idris.

AHMAD BEN 'ALI ZUNBUL

Ibn Khaldoun, together with az-Zanati's classic work on geomancy, provided the basis for the later works of Ahmad ben 'Ali Zunbul. Zunbul's dates are not certain, but as he mentions the Sultan Sulaiman the First (1520-66), and also that one of his sons died in 1553, it can be assumed that Zunbul flourished circa 1550. Between the time of Ibn Khaldoun in the fourteenth century and Zunbul in the sixteenth century there is little

mention of *raml*. Zunbul's key works were the *Kitab lamm as-saml fi 'ilm al-raml*, and the more important *Kitab al-maqalat fi hall al-muskilat* (or Treatise on the Solution of Problems) by Ahmad ben 'Ali Zunbul al-Mahalli al-Munaggim, which occurs in manuscript versions in the library of the Greek Patriarchate in Jerusalem, in Cairo, and in Istanbul. However, the Jerusalem manuscript is not contemporary with its author, and dates from the year 1721.

Apart from az-Zanati, Zunbul's sources probably number amongst them works by the literary circle of the Isma'iliyya, such as the *Rasa'il ikhwan as-safa'* or *Epistles of the Brethren of Purity* (written in the second half of the tenth century, but an Arabic edition of which was last published in Cairo in 1928). Other sources cited by Zunbul include at-Tarabulusi, Muhammad al-Kantawi, Ahmad al-Kurdi, al-Hamdani, at-Ta'labi and Abu-l-Hasan 'Ali ben Yunus al-Misri (author of an astronomical table), Ptolemy's *Tetrabiblos*, and 'Antiquus' who is often cited in the *Astrology of the ubiquitous Masa'allah*, and perhaps some of these will provide fruitful avenues of exploration.

Zunbul's longest work, the *Kitab al-maqalat fi hall al-muskilat*, is designed to be a very practical manual of geomancy. It is the largest of Zunbul's books and is divided into thirty-one chapters. After outlining the history of geomancy in his preface, Zunbul (in the guise of Hermes Trismegistus or Idris) explains that the sixteen figures of geomancy (*ashkal*) are allocated to the sixteen Houses or Mansions (*buyut*). Zunbul then outlines the sixteen different figures explaining that the primary figure is *Via*, or in Arabic *Tariq* (the path or way). This is the primary figure because it contains one dot on each of its four layers: these layers corresponding with the four Elements, so that reading downwards we have:

- Fire (*Nar*)
- Air (*Hawa'*)
- Water (*Ma'*)
- Earth (*Turab*)

From this basic figure of *Via (Tariq)*, Zunbul states that all the other figures are derived, and are less perfect than this prime figure. Here geomancy, like alchemy, utilized a method of mixing the Elements, to form the various figures. Thus if the bottom dot (corresponding to Earth) is removed, and replaced instead by two dots (or by a line, in the manuscript) we get the figure *el 'ataba el kbarga*:

⋮
⋮

which is *Cauda Draconis*. *Cauda Draconis* therefore symbolically consists of Fire, Air, Water, but not Earth. Likewise for *nusra el-kbarga* or *Fortuna Minor*:

⋮
⋮

which consists of Fire and Air but not Water or Earth. The other figures listed by Zunbul are tabulated in Appendix V.

The first four geomantic figures are cast in the usual manner and the remainder worked out by addition till you have a series of sixteen figures to place in the Houses or Mansions. This configuration, or *taskin*, is then interpreted on the basis of the astrological relationships between figures, and with reference to their Elemental constitution. This division of individual geomantic figures into Elements is almost unique to the Arab tradition as expressed in Zunbul's manuscript, and does not seem to have been carried through into later European developments of geomancy, although of course *whole* individual figures have always had specific Elemental attributions.

In interpretation the most powerful figure is again *Tariq*, or *Via*, because it includes all of the four Elements. This is quite the reverse of later geomantic interpretations when *Via* was attributed to the fluctuating moon, and became one of the less powerful figures. Perhaps the nomadic element in Arab life has contributed to the importance of *Tariq*.

Further qualities are denoted by the position of the dots of the figure, so that, from the geomancy of the 'Indian' *Tum-Tum*, the first dot equates with minerals, the second with living creatures, the third with plants, and the fourth with inorganic bodies. Time sequences can also be determined from figures by attributing certain numbers of years, months, weeks or days to each figure, so that the length of a life, of a journey, of a dynasty, or of an appointment can be determined by geomantic manipulation.

So much for Zunbul's preface. The first chapter explains in detail the sixteen Houses: the twelve usually known to astrology, and the further four which are derived from them by addition. Some of the Houses or Mansions are considered to be fortunate (numbers 1, 2, 3, 7, 9, 11, 13, 15), whilst some are less favourable (4, 10). The most unfortunate Mansions are the 6th, 8th, 12th, 14th and 16th. This division of Mansions into fortunate and unfortunate assists in the later interpretation by examining the figures which fall into one or other category of House or Mansion.

The second chapter considers the result of discovering any one of the sixteen geomantic figures in any one of the sixteen Houses. Thus some figures are more propitious in some Houses than in others, giving flesh to the skeletal interpretation. This theory of combination falls under sixteen times sixteen (or 256) different headings.

The third chapter considers specific questions, such

as the fate of a ship (*taskin al-markab*), in which case examination of each Mansion in turn determines events happening at every stage of the voyage. Other special combinations of figures reveal whether the travellers are Muslims, Christians or Jews, what their business is, and whether it will be profitable or not.

Further specialized configurations or *taskins* are outlined together with mnemonics for remembering their order. Gematria, or the art of interpreting words in terms of the total of the numerical equivalents of each of their letters, is introduced at this point. Using the mnemonic of a particular *taskin* such as *Bzdb*, Zunbul explains that the letters represent the four Elements, in descending order of grossness. Each letter also represents a number in Arabic, thus:

- b - 2 - Fire
- z - 7 - Air
- d - 4 - Water
- h - 8 - Earth

This mnemonic therefore indicates House number 2 for Fire, House number 7 (Air), House number 4 (Water), and House number 8 (Earth). For each of the Houses indicated in this *taskin*, we see that the second is most compatible with Fire, the seventh with Air, and so on. Therefore, if the geomantic figure *Laetitia* (or in Arabic *Hayyan*), which is solely Fire, occurs in the second House, this would be an extremely favourable omen. Likewise, the occurrence of *Rubeus* (or *Humra*), which is solely Air, in the seventh House would also be extremely auspicious. Further chapters are devoted to even more complicated combinations of the basic figures, and to labyrinthine rules for everything from marriage to medicine. Diagnosis by *raml* even became a lay rival of the latter, and tables were educed of the relationship between specific parts of the body and the geomantic figures.

امراض البلغم بافهم وتدبر وفس على هذا الفياس وهذه
صورة بني ادم لاحل ما تصددي على اللمري اي عضو هو

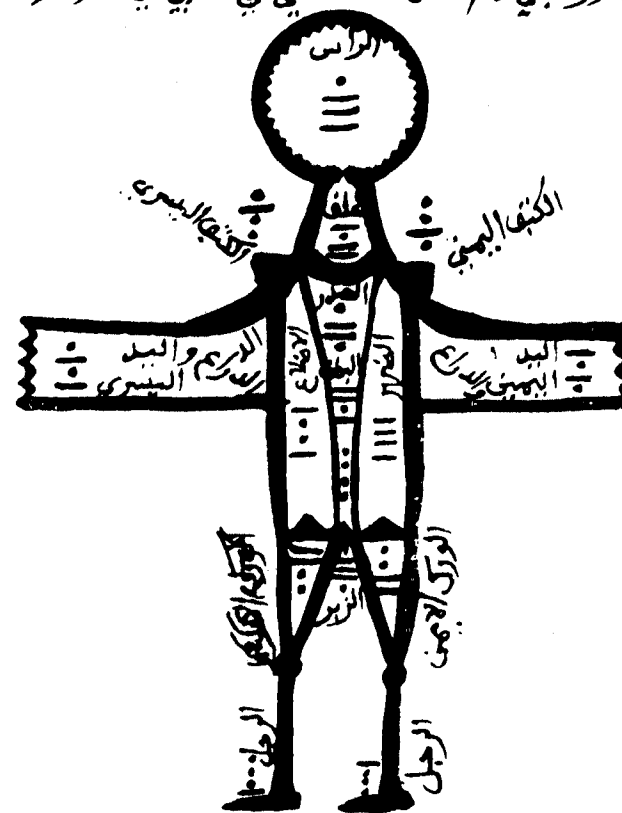

وصل في معرفة الحبايا والكنوز والدجاين فاذا اردت
معرفة

Figure 4 Geomantic talisman against diseases of various parts of the body, from an eighteenth-century Arab manuscript attributed to Idris (MS Arabe 2631, fol. 64v, Bibliothèque Nationale)

For example, a particularly beautiful Arabic manuscript of the eighteenth century¹⁰ attributed to the prophet Idris deals with the medical application of geomantic theory. It contains diagrams correlating the various parts of the body and diseases with the sixteen geomantic figures including the stylized figure of a man drawn in red and black ink with the following attributions:

Head	Laetitia
Throat	Rubeus
Right Shoulder	Puella
Left Shoulder	Puer
Chest (heart?)	Cancer
Right Side of ribcage	Conjunctio
Left Side of ribcage	Populus
Solar Plexus	Albus
Stomach	Via
Right Hand	Amissio
Left Hand	Acquisitio
Right Thigh	Fortuna Major
Left Thigh	Fortuna Minor
Genitals	Tristitia (Laetitia?)
Right Foot	Cauda Draconis
Left Foot	Caput Draconis

The figure faces outwards from the page, so left and right have been designated in Figure 4 from the point of view of the figure rather than the manuscript page. The same manuscript continues with a series of talismans using the geomantic figures for the usual gamut of magical reasons, such as uncovering hidden treasure. It could be, however, that the square into which the sixteen geomantic figures are subdivided is much more than just a talisman, for techniques have persisted until the seventeenth century for determining direction by use of geomancy, an obvious start when trying to locate hidden treasure!

معرفة ذلك باضرب الرمل على تلك النية وانضري البيت
الرابع فإن وجدت فيه أحد هذه الاشكال الثلاثة وهم
هؤلاء  واعلم ان الموضع فيه شيء من الابدان
وان اردت الحف من الكذب كالباعث والمليان باضرب
شكل البيت الرابع مع الشكل السادس فان تولد منهم
شكلا داخلين في ذلك الموضع دفين والباقي فلاب وان
كان الشكل منقبلا سعيدا فيكون الدفين شيء يسير فاذا
علمت في ذلك الموضع شيء فافهم الموضع على هذه الصورة

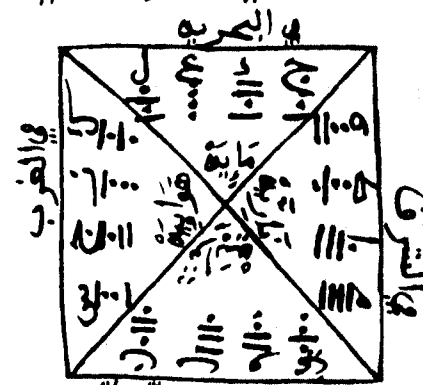

ثم انضرم ما يظهر في البيت الرابع في اي ناحية حركتم

Figure 5 Geomantic talisman to uncover hidden treasure showing attribution of geomantic figures to compass points (MS Arabe 2631, fol. 65r, Bibliothèque Nationale)

With the advent of Zunbul's book came a deluge of lesser treatises and a general upsurge of interest in *raml* in the Muslim world. Indeed geomancy was second only to oneiromancy in the prestige it enjoyed in the lands under Muslim domination. The practice of geomancy was also supported by Sura XLVI, 4 of the Koran which has been interpreted by some as alluding to geomancy.¹¹ However, its most formal claim to fame lies in the saying attributed to Muhammad: 'among the prophets there was one who practised *kbatt*; whoever succeeds in doing it according to his example will know what that prophet knew.'¹² As a result of this, some licence was given to the art of geomancy and it was allowed to experience an amazing expansion across the Islamic world.¹³ Like that other popular form of Arab divination, oneiromancy, *raml* or Arab geomancy has extended beyond the frontiers of the Muslim empire both to the coast of India, the coasts of Byzantium (as explored in chapters 1 and 5), south through black Africa (chapter 3), Madagascar (chapter 4) and finally to the Latin west (chapters 5-8).

In modern times such usage has continued, with a decline in scholarly interest in *raml*, but a wide dissemination of material pitched at popular level. Although the rules as outlined by Zunbul still hold sway throughout the Muslim world, there are many regional variations in the system of interpretation of the basic figures. Davies, in *Sudan Notes*,¹⁴ describes in some detail a system of sand divination which was practised early this century by Mahamid and Ta'aisha Arabs, but which was common in northern and central Kordofan and the northern Sudan. Locally it retained its traditional name of *kbatt al-raml*. It is interesting to examine the technique in some detail as it is representative of *raml* as it is practised today in village communities.

A smooth patch of sand is prepared by the practitioner or *kbattat* at a specific hour of the day, according to

the nature of the question. The querent places the tip of the middle finger of his right hand on the sand whilst at the same time concentrating on his question, which he usually does not tell the *kbattat*. At the same time the *kbattat* makes in the sand four lines or jabs of random length with his fingers. These are then marked off, a pair at a time, until either one or two are left over. This process is repeated four times, generating a geomantic figure made up of four levels containing either one or two marks in the sand. A further three figures are made in the same way. These four figures are the 'Mother' figures and, placed in order from right to left, they breed the rest of the *kbatt*, or geomantic spread.

The technique for deriving the remaining eleven figures is detailed in the chapters on practice towards the end of this volume. However, briefly it is as follows: figure V is the figure formed by taking in order the top components or heads of figures I, II, III and IV. The four components next below these (or necks) give figure VI; those components next below (or bodies) give figure VII; those at the bottom (or feet) give figure VIII.

Figure IX is bred from figures I and II by a different process. The top two components are combined to form the new top component, which is a single mark if the combined components amount to an odd number of marks, and a double mark when they amount to an even number. Similarly the remaining components of figure IX are derived by combining in pairs the remaining components of I and II. In exactly the same way, figures III and IV breed X; V and VI breed XI; VII and VIII breed XII; IX and X breed XIII; XI and XII breed XIV; XIII and XIV breed XV, the Judge.

The fifteen figures now look like this:

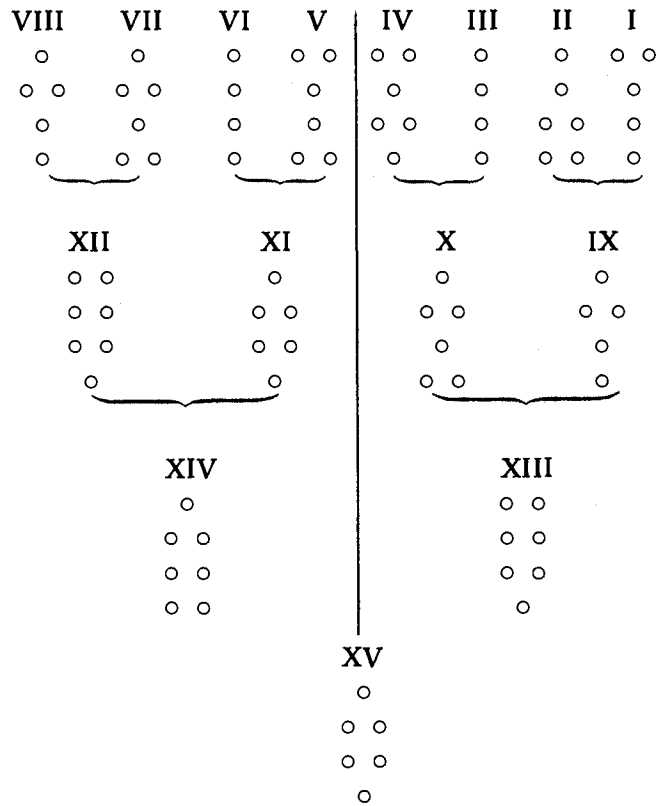

The fifteenth figure is the Judge and final determinant of the entire *khatt*. These fifteen figures formed by the above process are now interpreted according to the position in which they fall.

The Houses on the right of the central line are relevant to the querent, together with the Seventh House, whilst those on the left are concerned with his enemies, or the object of his question. Additionally the Eighth House is 'double-faced', and rather mercurially neutral. If the same figure as that occurring in House 8 also occurs in Houses 1-4, the figure in House 8 allies itself with the Houses of the querent.

The fifteen positions or Houses into which any one of the figures may fall are designated as follows:

House number (Position in <i>Khatt</i>)	House name	Interpretation of figure falling in that House
1	<i>Beit al niya</i>	the House of the object of the quest
2	<i>Teni al beit</i>	the repetition of 1
3 & 4	<i>Buyut al jiran</i>	the neighbour's Houses
5	<i>El beit al muqabila</i>	the House opposite
6	<i>Beit al zulm</i>	the House of wrong
7	<i>Sabi' al buyut</i>	the seventh House
8	<i>Al sbatteir</i>	the double-faced
9, 10, 11 & 12	<i>Watid</i>	a 'peg'
13 & 14	<i>Farash</i>	a bed
15	<i>Al kbatima</i> or <i>Majma' al kbatt</i>	the seal or sum total of the <i>khatt</i>

At this point a wide range of very specific interpretative rules come into play, some of which are still contained in European geomancy, and some of which are purely unique to the Arab system. Basically they indicate the effects of a specific geomantic figure in a specific House position. For example, a *Rasn* (Fortuna Major) in House 1 would indicate a journey on the part of the querent. If it were combined with a *Jebbar* (Fortuna Minor) in House 9, the inference would be that the journey would be delayed by some powerful person, because *Jebbar* represents a powerful sheikh or notable.

Before the specific rules are applied, the *khattat*, or diviner, would generally examine the fifteenth or 'Judge' figure which was the 'sum total of the *khatt*' and which would indicate the general trend of the answer. If, for example, the fifteenth figure was a *Qabid* (Acquisitio) then the diviner would be absolutely sure that the querent was going to get what he was seeking. One *khattat* made his name by 'throwing' the *khatt* for some police who came at night to his village looking for an escaped prisoner.

Seeing a *Qabid* as the 'seal' of the *khatt*, he prophesied immediate success to a search of the village, and the prisoner was duly caught in one of the houses. Conversely, a *Qabid* in House 5 or 6 would have indicated that the thief was most unlikely to be caught. Conversely, a *Kharij* (Amissio) in the same position would be the worst possible omen, unless of course the querent was trying to sell or rid himself of something.

The *khattat* then proceeds to examine each of the Houses in turn so that, for example, if identical figures are found in both the First and Second Houses, the *khatt* is infallibly interpreted as a bad omen. If the question concerned the fate of a sick man, the appearance of a *Jibin* (Laetitia) in both of these positions would indicate almost certain death. If the question concerned a business venture, then its outcome looks very bleak indeed. However, as a precaution against a complete dashing of hopes, the querent has the right to try the *khatt* three times, if a preliminary inspection of the first two tries should show the omens to be unfavourable. However, two figures of the same kind in the first *four* Houses would 'bring over' a third figure of the same kind from the left or 'enemy side', to the aid of the searcher. Obviously, in this context, the interpretation is very strongly connected with tribal and family life, so that under these circumstances, it would appear that an enemy is to be considerably handicapped, perhaps by losing an ally to the querent's cause or party.

Obviously the combinations are almost unlimited, and the *khattat* needed a prodigious memory. This was however aided by a series of rhymes which indicated the auspicious or inauspicious combinations of figure and House, learned by each diviner during his apprenticeship, but largely lost to the printed literature of the subject. Oddly enough, although Zunbul considered the figure *Tariq* (Via) to be the most powerful of the figures

(being the sum total of all four Elements together, and thus the only 'complete' figure of the sixteen), modern Arabs consider it to be the most insignificant of all the figures.

The order of the figures outside of the *khatt* is significant in as much as they are grouped by the Arabs of the Kordofan in complementary pairs¹⁵ so that the first and second figures have, if compared at each level, one dot where the other has two, and vice versa. Likewise the third and fourth figures are complementary, the fifth and sixth figures, and so on. This of course is only one way of arranging these figures in order, but interpreted by the Arabs to mean that certain family relationships occur between the different figures. For example:

Jibin (Tristitia) and *Rakiza* (Cauda Draconis) are man and wife

Hurr (Laetitia) and *Raiya* (Caput Draconis) are man and wife

Beyyad (Albus) and *Jodala* (Puer) are man and wife
Mubzum (Puella) and *Humra'* (Rubeus) are man and wife

Damir (Conjunctio) and *Surra* (Carcer) are also man and wife

Jebbar (Fortuna Minor) and *Rasn* (Fortuna Major) are brothers

Qabid (Acquisitio) and *Kharij* (Amissio) are also brothers

Tariq (Via) and *Tiql* (Populus) bear no relationship to each other.

Figures which contain a total number of even points are said to be *Helu*, sweet or a good omen, whilst those which contain odd numbers of total points *Murr*, bitter, or ill-omened.

Further details of the modern practice of *raml* can be found in *Magie et Religion dans L'Afrique du Nord* by Edmond Doutté, while a more romantic and living

description is given by Dr J. C. Mardrus in *Sucre d'Amour*, where the atmosphere and magic accompanying a *raml* consultation are perfectly evoked.

3 · *Fa, ifa* and voodoo

On the great trade routes from the Maghrib, across the western end of the Sahara through what is now Algeria and Mali, to the fabulous city of Timbuktu, and along the banks of the Niger River, came the camel trains, the merchants, the missionaries of the Prophet, the slavers and the traders of Islam, to the rich tropical areas south of the Niger, into which territory they thrust at different times both peacefully and with violence.

Travelling down the Niger and across country to the sacred city of Ife and to Benin, they brought with them the *raml* of the desert dweller. Hamilton described the system of divination he observed in the Sahara, which was called *derb al-raml* or *derb al-ful*, according to the medium used to 'project' the initial figures: for the desert dweller it was sand, but in the tropical area beans were used. The latter method is the simplest, but both are in principle the same. Hamilton relates the relatively simplified *modus operandi*:¹

beans are held in the palm of the left hand, which is struck with a smart blow with the right half-closed fist, so that some of the beans jump into the right hand – if an odd number, one is marked; if even, two . . . This being repeated four times gives the first figure, and the operation is performed until there are obtained four [geomantic] figures, which are placed side by side in a square.

The square defines the various geomantic Houses into which any of the sixteen figures may fall, and the

technique of *derb al-raml* goes on to add the four geomantic figures together in the usual way to obtain fresh combinations and interpretations. In its use of four rather than two basic Mother figures *derb al-ful* is a half-way house between Islamic sand-cutting or *raml* in the traditional sense, and the use of beans to produce two Mother figures by the diviners of Ifa to the south of the Sahara.

Thus as the practice is carried across the Sahara and into the tropical areas of Dahomey (Benin), Togo and Nigeria, the sand which was previously used to generate the figures becomes the powder on the diviner's board (see p. 68), whilst the figures themselves are generated by manipulations of beans or palm nuts. Together with this adaptation, the unique verbal heritage of the Yoruba contributed material to the complex set of verses designed as a mnemonic to aid the practitioner to memorize the interpretations of the various combinations of geomantic figures passed on to them by the Arab traders.

In trying to ascertain an exact point of contact between Islamic *raml* and the divination system of *ifa*, we can do no better than accept the traditions of the Fõn and the Ewe tribes who acknowledge the Yoruba city of Ife as the centre from which the practice of *ifa* divination has spread. The Yoruba traditions themselves consistently refer back to the early kings of Ife and their diviners from whom the system was said to be derived. It seems therefore that this was the reception and subsequent diffusion point of the Islamic heritage of *raml*.

Ifa is the best known and most respected form of divination used by the Yoruba people of Nigeria, their African neighbours and their descendants in the Americas. *Ifa* is both the method and the deity of divination. The diviners that work the *ifa*, known in the Yoruba language as *babalawo* (literally 'father that has secrets'), are devotees of the god Ifa.

The divination technique is based on the sixteen figures or *odu*, and their 256 (i.e. 16 x 16) derivatives. These are formed by either the throwing down of a divining chain (*opelẹ*) which has eight half seed shells strung on it, or by the manipulation of sixteen palm nuts (*ikin*).

The divining chain is quicker than the sixteen palm nuts, but the latter are considered more reliable, perhaps because they were more traditional, while the chain is a more recent 'short-cut method'.

Ifa, the oracle god, is supposed to have been the god who directed creation. Ifa took the materials of the universe from a snail shell in a 'bag' suspended between the thighs of an older god, and used them to form the universe, scattering 'soil' to form the earth. Ifa later descended to earth in human form to help with child-bearing, teach medicine and give information on secret and hidden matters. Like the Roman Mercury, or the Greek Hermes, Ifa brings messages from the gods and is patron of divination and medicine. Also like Mercury, he is multi-lingual, and the god of language. Rather than attributing *ifa* divination to the Arab traders, the Yoruba people say that Ifa taught his method of divination to them whilst he was on earth.

A similar system of divination is practised in near-by Dahomey, and dedicated to the god Fa, who was said to have presented the tribes with some special palm nuts brought down from heaven. The diviner in both systems is supposed to throw the nuts from one hand to another, and, depending on whether the remaining nuts were odd or even, mark down either one or two marks on the powder scattered on a divining board. It is this pattern traced on the board which provides the data for the interpretation of the oracle.

It is obvious, with but little examination, that these two systems of divination, which have remarkably similar names, have a common source. Although we will concentrate on

the *ifa* divination of the Yoruba, it is useful first to survey briefly the myths connected with *fa* divination.

Fa was said to have sixteen eyes, made of the sixteen nuts of divination which enabled him to see everything in the world: a parable suggesting that the sixteen figures of geomantic divination enable the diviner to discover everything going on in the world. Fa lived on a palm tree in the sky, from where he could see the world; it was also said that the mischievous god Legba had the duty every morning of opening Fa's eyes. Legba, who lived on the earth had to climb the palm tree to open Fa's eyes. As Fa did not wish to speak to Legba unless he was uttering an oracle, he put palm nuts into Legba's hands to indicate how many eyes he wanted opened. However, as Legba was such a mischievous god, and delighted in doing exactly the opposite of that which the other gods wanted him to do, Fa used to put one palm nut in Legba's hand if he wanted two eyes opened, but two nuts if he wanted only one eye opened. To this day, one palm nut thrown by the diviner means two marks on the divining board, whilst two nuts means one mark, because of the deceitfulness of Legba.

Each of the sixteen possible 'figures' that may arise are associated with sacred verses, and as many myths, which can then be applied in various combinations to the question in hand; the *babalawo*, or diviner, using the elements of the verses to build up a story-like reading.

The *babalawo* is both a focal point in the traditional Yoruba religion, arbitrating in the matter of sacrifices and ritual acts, as well as a professional diviner who is consulted by the worshippers of many of the Yoruba deities and also by Muslim and Christian converts. Rather like the practitioners of *sikidy* (chapter 4), he is involved in prescribing means of avoiding the fates which he predicts, as well as the more straightforward prescription of medicines. The many thousands of verses which he has to

commit to memory to perform his function as a diviner even resulted in the establishment of a church in Lagos in 1934 which takes these verses as its 'Bible'. However, it seems to have always been meritorious amongst the worshippers of Ifa, to know his verses by heart.

Apart from a prodigious memory, the *babalawo* must naturally have or acquire during his three initiations a reasonable degree of clairvoyance, as it is standard practice for the querent to whisper his question to the palm nuts, rather than asking the *babalawo* directly. It is even commonly said that it is wrong for the diviner to know the nature of the problem, because this would tempt him to lie to satisfy the client, either by faking a verse or manipulating the figures accordingly.

Because of the similarity between the divinatory systems associated with Ifa and Fa, and their obvious historical connexion, we will simply consider the *ifa* system in detail, drawing occasional parallels with that of *fa* where necessary. Considering for the moment the distribution of *ifa* divination, we find that in recent literature there is no mention of it west of Togo or east of Nigeria, but early references have mentioned it as far west as the Ivory Coast (at Assinie) and in coastal Ghana, north of the River Niger (the Nupe people) and almost as far east as the Cameroons.

The principal tribes practising *ifa* divination are the Yoruba and Benin Edo of Nigeria. In Dahomey the Fõn practice *fa*, and the Ewe of Togo call it *afa*. The Gbari or Gwari of Niger province practise the Islamic form of sand-cutting *as well as* using the palm nuts which would be accounted for by their northerly position, and geographical proximity to the strongly Islamic influenced town of Kano.

What may be the earliest report of *ifa* divination comes from the coast of what is now Ghana in a description given by Bosman, who served as factor for the Dutch at

Elmina and Axim. Bosman, who was in Ghana by 1690 says, 'the second way of consulting their Idols, is by a sort of wild Nuts, which they pretend to take up by guess and let fall again: after which they tell them, and form their Predictions from the number falling even or odd'.²

Another early account comes from Assinie in the south-eastern corner of the Ivory Coast, still farther to the west. Loyer in about 1700 describes a method in which palm nuts are taken from a wooden or copper cup, and marks are made with the finger in wood dust on a board (a foot long and half a foot wide) as a result of this operation.³

Allowing for occasional misinterpretations by early travellers and missionaries, the system of divination has not changed much since the late seventeenth century, and has been passed down from *babalawo* to *babalawo* for the last three hundred years. If we ignore, for the moment, the persistence of some forms of sand-cutting in this area, we find that the initial figures are generated either by palm nuts or by the (possibly more modern) use of a 'divining chain'.

THE AWAKENING OF IFA

In divining with either the palm nuts or the divining chain, the diviner is first seated on a mat, with a carved wooden divining tray placed in front of him.

A description by Irving of the significance of the god Ifa in the divining process, portrays well the dependence upon the indwelling god to assure the accuracy of the divination, a far cry from the attitude of Islamic diviners to their art:⁴

Ifá, the god of palm-nuts, or the god of divination, is said to be superior to all the rest. He is consulted on every undertaking - on going on a journey, entering into a speculation, going to war, or on a kidnapping expedition, in sickness, and, in short, wherever there

is a doubt of the future. To him are dedicated palm-nuts, as by these the oracle is consulted. Various acts of adoration and prostration, touching the nuts with forehead &c., initiate the performance.

After the preliminaries, the *babalawo* spreads wood dust on the tray, and places the divining cup in the centre of it. An assortment of miscellaneous objects is placed on the right side of the tray and two bags of cowrie shells (one containing eighteen palm nuts) in front of the tray. The diviner first takes the palm nuts out of the bag, separating two nuts from the rest, which are then sometimes returned to the bag.

PRELIMINARY INVOCATION

Before the first divination of the day, and while the apparatus is being arranged, invocations are made to both Ifa and Eshu. Blowing spit on the palm nut, the *babalawo* says: 'Ifa awake, oh Orunmila [a synonym for Ifa]. If you are going to the farm, you should come home, oh. If you are going to the river, you should come home, oh. If you are going to hunt, you should come home, oh.'

He then places the divining cup on the ground to the left of the divining tray, saying: 'I take your foot and press the ground thus. I take your foot and press the top of the mat thus. I carry you to sit on the mat, so you can carry me to sit on the mat forever.'

He replaces the cup on the divining tray: 'I carry you to sit on Ifa's tray, so that you can carry me to sit on Ifa's tray forever.'

Prayers for longevity, fertility, children and money follow, as he draws a line clockwise in the wood dust around the base of the divining cup: 'I build a house around you, so you can build a house around me: so you

can let children surround me, so you can let money surround me.'

The line is wiped out with his cow-tail switch and taking some of the wood dust from the tray he places it on the ground, paying homage to the earth. He sets the divining cup aside again and marks a line away from him in the divining powder at the centre of the tray, saying, 'I open a straight road for you, so you can open a straight road for me.' After a nod in the direction of various other gods including Eshu (the messenger of Ifa), Oṣun, Ṣango and Orunmila, the *babalawo* removes the palm nuts from the cup and handles them according to the prescribed form, whilst reciting protective formulae.

Having established the preliminaries, the *babalawo* now generates the two geomantic figures from which the meanings of the oracle are derived. There are two pieces of equipment designed for this purpose: either the sixteen palm nuts already referred to or a divining chain. As the divining chain is probably a modern short cut, we will consider the method of the sixteen palm nuts first.

GENERATING THE FIGURES WITH PALM NUTS

The sixteen nuts, or *ikin*, are picked up with the right hand. As sixteen nuts form a large handful (and as they are heavily polished through use) some usually remain in the diviner's left hand. If one or two nuts remain in the left hand then corresponding marks are drawn on a divining tray: if two nuts remain, a single mark, but if one nut remains, a double mark. This apparently arbitrary reversal is justified in Dahomey in terms of the deceitfulness of the god Legba in conveying the oracle to the diviner (see p. 56). If no nuts, or more than two nuts, are left in the left hand the operation is repeated until the desired

binary number of nuts is left.

The operation is repeated a total of eight times, giving two geomantic figures (each line of which will either have one or two marks). These are drawn in the dust of the divining board side by side. An example of such a set of marks forming *Irẹtẹ*, the geomantic figure, or Puer (on the left) and *Ọkanran* or Tristitia (on the right) is shown below: this figure is called *Ọkanran Irẹtẹ*.

```

|   | | |
|   | |
| |  | |
|   |

```

Unlike the more northerly variations of geomancy, where four Mother figures are necessary, Ifa makes do with two figures. These are stylized as below, so that consecutive single marks or consecutive double marks will be drawn in a stylized manner in the dust with the fingers like continuous lines; the same figures now become:

```

|   ||
| |  ||
|   |

```

However we will not concern ourselves with the actual stylized marking down of the figures. Instead we will use the first version in which the figures are recognizably like the familiar geomantic figures, which we have already encountered.

Obviously each one of the pair of figures could be any one of the sixteen basic geomantic figures. Hence as a combination, there are a total of sixteen multiplied by

sixteen possibilities, or 256 derivative figures. In forming these pair of figures, the marking order is slightly eccentric passing from one figure to another and back again rather than concentrating on generating one figure first, then the other, as shown in the scheme below:

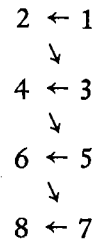

Like the yarrow stalks of the *I Ching*, where one extra stalk is removed from the bundle before divining with the rest, so it is with *ifa*. Only sixteen palm nuts are manipulated in divining, but in Ife the diviner has a seventeenth or eighteenth nut that he places opposite him beyond the divining tray, on a ring of cowries known as 'the money of Ifa'. The nuts themselves are from the oil palm, *Elaeis guineensis*, and are about an inch long, ovoid with hard, black shells marked with lengthwise grooves. Inside are white kernels from which the Yoruba extract palm kernel oil for soap-making and for export. Alternatively one of the 256 *odu* of Ifa can be obtained by a single cast of the divining chain, which is a considerably faster method for generating the *odu* than the eight passes made with the nuts.

THE DIVINING CHAIN

The most common divining chain is made from the seed pod known as *opelẹ*, from which the chain takes its name. It comes from the *opelẹ* tree, *Schrebera golungensis*. This seed pod has a distinctive pear shape and naturally

splits open at the base, with the two halves splaying out from the top, where they are joined. On the concave inner surface of each half is a marked ridge.

Other items which have at one time or another been used to make divining chains include: (1) Seed shells from the oro tree, the African mango (*Irvingia gabonensis* or *Irvingia barteri*), egbere shells (widely used in Nigeria and often found in elephant dung), seeds of *Mangifera gabonensis*, *Mangifera indica* (the mango) and seeds of the apuraga fruit; (2) Metal markers in the shape of *opelẹ* pods or seeds decorated with simple geometric patterns and cast in brass, copper and a light white metal (perhaps aluminium), and less usually in silver, lead and iron (although the last three metals are used for the chain in preference to the markers); (3) It is probable that cowrie shells were used in the past in place of seed shells; (4) Pieces of calabash strung together with cord are popular amongst apprentice *babalawos* in Ife; (5) Animal-derived markers, including the scales of the pangolin or scaly anteater and the crocodile, head bones of fish (the *abori*), and sea-turtle shell pieces; (6) Wood or ivory. Altogether a wide range of items, with the common denominator being a concave and a convex side, capable of being interpreted as a double or single mark.

The divining chain, which is called *opelẹ Ifa* by the Yoruba, is about three to four feet long and usually consists of eight halves of seed shells or pods joined by sections of chain three to four inches long. The chain is held in the middle so that there are four shells or seeds hanging on the right and four hanging on the left. The chain is thrown with the right hand, and tossed in such a way that the two lines of shells fall parallel with each other. Each of the eight seeds or shells can then fall with either the concave inner surface or the convex outer surface facing upwards. The ends of the chain have various items attached to them so that the diviner can establish

which is the left and which is the right geomantic figure (it being essential to know which is the first and which is the second column, to prevent the reverse figure being read by erroneous juxtaposition of the columns). Half a seed shell falling with the concave surface facing upward is equivalent to a single line on the tray, while a fall in the 'closed' position with the convex outer surface up, is the equivalent of a double mark.

Divination with the chain of seeds, though regarded as inferior, is more rapid, but otherwise the two systems are identical. They employ the same set of figures with the same names and rank order, and the same verses. Bascom explains:⁵

the divining chain is said to 'talk more' than the palm nuts, but it is regarded as an inferior instrument, less reliable than palm nuts for deciding important questions. It is also spoken of as Ifa's servant . . . a number of Ifẹ diviners employ only the chain, because they dislike using the palm nuts . . . the divining chain arrives at the same interpretation through the same set of figures and verses more rapidly, and answers more questions than are usually asked when the slower method with palm nuts is employed.

It is interesting to note that other tribes use different variations of this chain, including divination with four strings of four markers each, which is used in the Yoruba system of divination called *agbigba*. Some tribes, for example the Igbira, produce a quadruple figure which instantly generates the four Mother figures familiar to European geomancy. Among the Fɔn of Dahomey the chain is called the *agummago*, but is used in much the same way as the *opẹlẹ*.

The diviners see the fall of the seeds not as a matter of chance but as by an act controlled by Ifa, the deity of divination. Any interference with the free fall of the chain by the diviner garbles the message which Ifa wishes the client to receive: hence the ritual of throwing the chain is governed by very precise rules.

THE SIXTEEN FIGURES OF IFA

Whichever method is used, the palm nuts or the *opẹlẹ*, two of the sixteen basic figures of Ifa are generated and marked down on the divining tray. Bearing in mind that the concave side of the shell on the divining chain is equivalent to a single mark, and the convex equivalent to a double mark, the sixteen basic figures of Ifa are listed below in the order recognized by the south-western Yoruba, which is the most widespread arrangement in Africa:

1	2	3	4	5	6	7	8
Ogbe	Ọyẹku	Iwori	Edi	Irosun	Ọwọnrin	Ọbara	Ọkanran
○	○ ○	○ ○	○	○	○ ○	○	○ ○
○	○ ○	○	○ ○	○	○ ○	○ ○	○ ○
○	○ ○	○	○ ○	○ ○	○	○ ○	○ ○
○	○ ○	○ ○	○	○ ○	○	○ ○	○
9	10	11	12	13	14	15	16
Ogunda	Ọsa	Ika	Oturupọn	Otura	Ireṭe	Ọṣe	Ofun
○	○ ○	○ ○	○ ○	○	○	○	○ ○
○	○	○	○ ○	○ ○	○	○ ○	○
○	○	○ ○	○	○	○ ○	○	○ ○
○ ○	○	○ ○	○ ○	○	○	○ ○	○

The order of the sixteen basic figures of *ifa* is not standardized throughout the areas where *ifa* is practised. However, with some modifications in pronunciation and spelling, there is a consensus between the Fɔn of Dahomey, the Ewe of Togo and Ghana, and their descendants in Cuba and Brazil. This ranking of the figures, which is important for answering questions asked in terms of specific alternatives, is said to be based on the seniority of the figures, that is, the order in which 'they were born and came into the world'. Although it is easy to recognize

the sixteen geomantic figures of *Via* through to *Acquisitio* in the above list, the order of the figures is uniquely African.

The meanings of the names of the geomantic figures of *ifa* are unknown. Various 'authorities' suggest similar words in Yoruba, such as the cock's comb (*ogbe*), camwood (*irosun*), lagoon (*osa*), wickedness and finger (*ika*), soap (*oshe*) and loss (*ofun*); but according to Bascom,⁶ all of these have distinctly different pronunciations. Puns on some of these similar words occur in the verses, but these are not serious etymologies, and one draws a similar blank comparing the Yoruba names of the figures with the corresponding Arabic. This is in direct opposition to the very obvious Arabic derivations of the terminology of Madagascan geomancy which we will consider in the next chapter.

THE DOUBLE FIGURES OF IFA: THE ODU

From the sixteen basic figures are manufactured 256 double figures or *odu* by taking each figure in turn and combining it with each of the others, giving sixteen times sixteen possible *odu*. These *odu* are also spoken of as the 'roads of Ifa', and each figure is named and interpreted in terms of its two halves, of which the right is regarded as male and more powerful than the left (female). For this reason the name of the right half precedes that of the left.

The *odu* in our example is *Okanran Irete*, taking the right geomantic figure first, then the left. The two components of the *odu* are spoken of as feet, sides, arms or hands. The fact that the figures are read right to left was taken by Burton as yet another proof of the Islamic/Arabic origins of the system.

When considering the 256 double *odu*, remember that each half of the figure can be *any* one of the sixteen basic

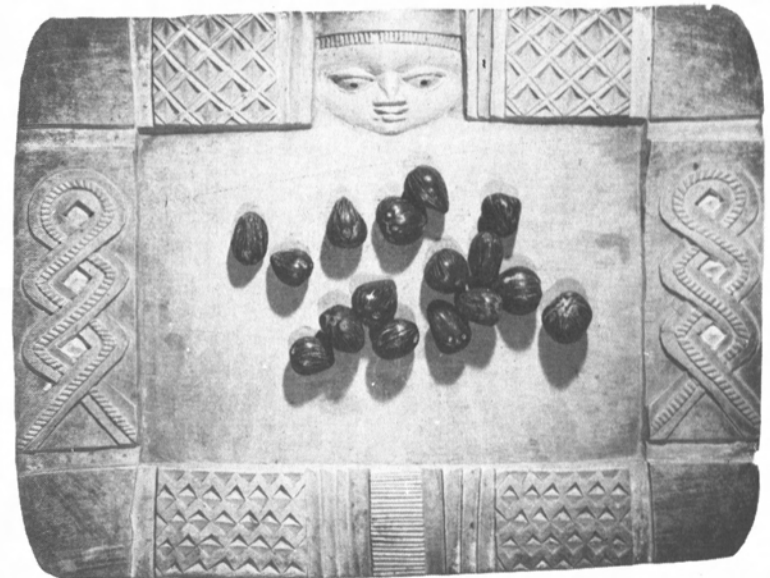

1 Two divining trays with the face of Eshu at the top, the lower tray with a set of sixteen palm nuts



2 The divining tray being used to mark a figure. The sixteen palm nuts are in the left hand of the diviner and the tray is covered with wood dust



3 Two divining chains (*opelq*). Left figure made of *opelq* pods and brass chain with cowries at each end. Right figure cast in white metal with coins at each end. The left chain shows geomantic figure Qşş-Ofun; the right chain shows the geomantic figure Ofun-Qşş

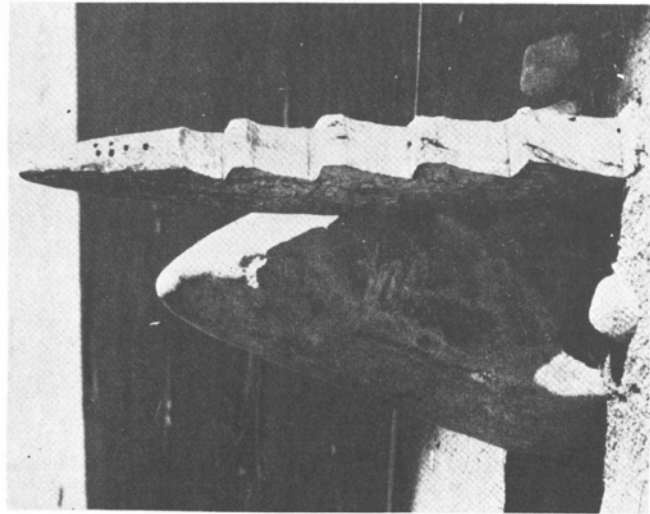

5 The figure *adabara* (Fortuna Major) obtained by *sikidy* and used as a charm to protect a village in Madagascar



4 Wooden Yoruba divination plate for responses from the oracle of Ifa

forms shown in the table of the figures of *Ifa*. Although any basic figure can make up the two halves of the *odu*, it sometimes happens that the same basic figure appears twice. This creates a double or *meji odu*, for example:



is *Irètẹ̀*, while two *Irètẹ̀* together form an *Irètẹ̀ Meji*:



Therefore in sixteen of the 256 *odu* the two component figures must be identical, so that one finds *Ogbe Ogbe*, *Oyẹ̀ku Oyẹ̀ku*, *Iwori Iwori*, and so on. These paired figures are known as *Two Ogbe* (or *Ogbe Meji*), *Two Oyẹ̀ku* (or *Oyẹ̀ku Meji*). All the double or *meji* figures are very important in divination, and each were thought to generate the fifteen other possible combinations of that figure with all the others, thus for example *Ogbe Meji* was the father of *Ogbe Oyẹ̀ku*, *Ogbe Iwori*, and all the other combinations beginning with *Ogbe*.

THE ORDER OF THE 256 ODU

The paired figures rank in power from *Ogbe Meji*, which is the strongest, to *Oṣẹ̀ Meji*. *Oṣẹ̀ Meji*, the last of the paired figures, is an exception. It has some of the strongest magic associated with it, and when it is generated, it is immediately turned over so as to make a different figure. Although listed sixteenth, *Oṣẹ̀ Meji* is equal in rank with *Owọ̀nrin Meji* in the eighth position. This is explained

conventionally in terms of the story of a fight between *Ogunda Meji* and *Ofun Meji*, when the figures were historic persons who spent time on earth.

It is interesting that *Ogbe* is considered the most powerful of all the figures and *Ogbe Meji* is spoken of as 'father of all the figures', as *Ogbe* corresponds to the Arabic figure *Tariq*, thought by the Arabs to be the prime figure from which all the others have been generated. In terms of the order of the figures, this points to a closer link between Arab *raml* and *ifa* than between Arab and European geomancy, where the supreme importance of *Tariq* (Via) has been lost.

To summarize, the rank order descends from the double or *meji* pairs which are the most powerful, and so occupy the first sixteen places. After them come the fifteen other variations of *Ogbe*, then the fifteen variations of *Oyęku*, and so on down to the variations of *Ofun*, completing the 256 paired *odu*.

To return to the *modus operandi*, one of these *odu* will be generated by either the nuts or the chain and then drawn on the divining tray.

THE DIVINING TRAY (QPQN IFA) AND POWDER (IYĘROSUN)

This tray is flat and usually circular, or sometimes rectangular, ranging from about six to eighteen inches in width. The outer edge is carved in a variety of geometric designs or representations of human and animal forms in low relief, and often numbering four or sixteen (obvious key numbers in *ifa* divination). The raised edged of the tray must have at least one stylized face representing Eshu (the equivalent of Legba in the Fa divination of Dahomey), which is placed opposite to, and facing the diviner, so that he can address his questions to Eshu, who conveys

Ifa's answers. Virtually all trays are made of wood, with the occasional quartz or brass tray being made for special occasions. The figures of Ifa are marked on the tray in a powder (*iyęrosun*) which is scattered on its surface. This probably comes from *Baphia nitida*, the camwood or *irosun* tree, and is actually the dust made from the wood termites. When some is needed, the diviner takes a termite-infested piece of *irosun* wood, pounds it to knock out the dust, panning it on the divining tray so that larger bits of wood can be removed. Although *iyęrosun* is preferred, the kind of wood does not matter as much as the fact that the dust is made by termites.

Wyndham and Price⁷ refer to the use of sand on the divining tray in Ifę instead of termite powder, paralleling closely the sand which is basic to Islamic *raml*. Whatever substance is used, it is not merely considered as a convenient marking device, but part of the magic of Ifa, an assurance of a correct answer. In fact, 'dust' in Arabic, *afar*, is probably the origin of the name of the god Ifa.

THE 256 VERSES OF IFA

The real core of *ifa* interpretation lies in the thousands of memorized verses associated with the 256 *odu* of Ifa. The verses form a corpus of myth, folk-tale, incantation, song, proverb and riddle: to the Yoruba their aesthetic merit is secondary to their religious significance. A *babalarwo* is expected to know a large number of these verses, as an accepted authority on Yoruba religion. When the *odu* has been produced, the correct verse bearing on the client's problem must be selected from those which the diviner has memorized for this figure. This verse may prescribe a sacrifice to be offered, to modify the outcome of the matter. It is then necessary for the client to offer this sacrifice in the prescribed manner in order to avert the

consequences that have been foretold, or to ensure the benefits described. Such offerings may be: (1) a calabash of cold water; (2) two dried fish and two dried rats; (3) food and drink (stew and yam loaves); (4) dry meat, i.e. game caught by the querent; (5) a live animal killed at home. To the selected offering is added a specific sacrifice to indicate to which god it is made. For Oriṣa, two snails; for Ifa, kola is added to the cold water; or maize beer is added to the stew and yam loaves, and so on.

Further play is made with the various contents of the *babalawo's* divining bag, a feature which may have caused some confusion with a completely different form of African divination, *Ndembu* divination, which is mentioned by Feuchtwang whilst making a point about the anthropological background of divination. *Ndembu* divination actually owes nothing of its theory or mechanics to the *raml* derived divinatory techniques of geomancy and *ifa* divination.

When slavery took root in the Gulf of Guinea early in the sixteenth century, many of the Dahomean and Yoruba slaves took their traditions with them, and their descendants practise divination, sometimes in the name of Ifa, in the USA, Cuba, Brazil, Bahia and Haiti to this day, while remnants of *ifa* divination survive quite strongly in Recife in Brazil. René Ribeiro⁸ relates that he was once actually asked by a priestess of a Yoruba-derived Afro-Brazilian cult to 'look Ifa' for her, when he showed her the cards for a Rorschach psychological test!

But let us return to Africa to examine another derivative of *raml*.

4 · The *sikidy* of Madagascar

In Madagascar, a system of geomancy has grown up partly derived from Arab influence and partly from local tradition and practice. This system of geomancy which is locally called *sikidy* is particularly interesting because it demonstrates that, despite geographical remoteness, it has a close connection with its European cousin, at least in the mechanical manipulation of the geomantic figures.

When Lars Dahle asked a Malagasy practitioner, 'what is *sikidy*?', the answer was, 'the Bible of our ancestors', indicating how central the practice was to the beliefs of the pre-Christian Malagasy people. Accordingly, practitioners of *sikidy* were called either *mpisikidy* (one who understands the *sikidy*) or *ny māsina* (the holy or powerful ones) or in the southwest, *ambiāsa* (derived from *ambia*, the Arabic for 'prophet').

The origin of the word '*sikidy*' is not known for sure but it has been conjectured that *sikidy* is derived from arabic *sichr*, 'incantation' or 'charm'; or from *chikel* meaning 'figure'. However, it is universally believed by the Malagasy people that this divinatory art was supernaturally communicated to their ancestors. They have a tradition that God gave it to Ranakandriana, who passed it on to a line of diviners terminating with one who gave it to the people, declaring:

Behold, I give you the *sikidy*, of which you may inquire what offerings you should present in order to obtain blessings; and what

expiation you should make so as to avert evils, when any are ill or under apprehension of some future calamity.

Fortunately, the practical details of *sikidy* have been thoroughly documented by various missionaries and colonial governors from the mid-seventeenth century (notably Flacourt) to the late nineteenth century (notably Lars Dahle and William Ellis), and in this century by a number of French anthropologists.

The consciousness of time/space appropriateness which is strongly rooted in Chinese belief also manifests itself in Madagascar, and with it comes the use of common directional terminology. It is called *vintana* but owes its origin to the Malay word *bintana* and the migration of Malay ideas and people to Madagascar, as opposed to the Arab imported *sikidy*. The consequent confusion of these practices with the *divinatory* geomancy of *sikidy* is a conspicuously false trail which is immediately highlighted by conversation with practitioners of either art. Of course, the belief systems of any self-contained culture deserve to be treated as a whole, but to associate aspects of belief merely because they were mistakenly given the same English name, and attempt thereby to draw conclusions is bravely stepping on very shifting ground.

Let us examine *sikidy* in some detail, taking its mechanics step by step.

THE AWAKENING OF THE SIKIDY

Like many systems of divination the practice of *sikidy* was often prefaced by an invocation to the gods or earth spirits, designed to ensure an accurate response. One such formula quoted by Dahle reads:¹

Awake, O God, to awaken the sun! Awake, O sun, to awaken the cock!

Awake, O cock, to awaken mankind! Awake, O mankind, to awaken

the *sikidy*, not to tell lies, not to deceive, not to play tricks, not to talk nonsense, not to agree to everything indiscriminately; but to search into the secret; to look into what is beyond the hills and on the other side of the forest, to see what no human eye can see.

Wake up, for thou art from the long-haired Mohammedans from the high mountains, from [Anakandriananàhitra, the almost mythical founder of the art in Madagascar, whose name is followed by those authorities who passed the art on to the people and their present diviners, thereby establishing an historical line of legitimacy] . . .

Awake! for we have not got thee for nothing, for thou art dear and expensive. We have hired thee in exchange for a fat cow with a large hump, and for money on which there was no dust [i.e. good value]. Awake! for thou art the trust of the sovereign [the ruling house of pre-colonial Madagascar used court diviners literally dozens of times a day to decide the advisability of even the most everyday actions, from matters of state to the timing of matters of personal hygiene] and the judgement of the people. If thou art a *sikidy* that can tell, a *sikidy* that can see, and does not [only] speak about the noise of the people, the hen killed by its owner, the cattle killed in the market, the dust clinging to the feet [i.e. uninteresting commonplaces], awake here on the mat!

But if thou art a *sikidy* that does not see, a *sikidy* that agrees to everything indiscriminately, and makes [false statements, as if] the dead [were] living, and the living dead, then do not arise here on the mat.

Of course the invocation varied from practitioner to practitioner, but the message was the same: to constrain the earth spirits/gods to tell the truth. The emphasis is upon the trickiness of the communicating entities, who misled if they could.

Anthropologists certainly rationalize this tendency by explaining it in terms of the psychology of the 'primitive' mind, which has a supposedly infinite capacity for belief, despite any number of disappointments; each time avidly rationalizing the cause of the fault rather than discarding the belief. Those with practical experience of the system worked by a competent practitioner will be more inclined towards the native explanation that there really *is* a perversity in the agency of divination, be it external spirit

in turn, fills the figures of Harèna, Fàhatelo and Vòhitra columns, in that order. For example:

Vòhitra	Fàhatelo (= hàvany)	Harèna	Talè	
•	•	•	••	Zatòvo
•	•	••	•	Marina
•	•	•	••	Vehivavy
•	••	••	•	Faha- valo

The four basic geomantic figures thus created now become the Mothers of all the rest. The remaining eight figures are generated from them without further recourse to the above technique.

(c) To do this, two figures are taken at a time, for example:

○	and	○ ○	first line
○ ○		○ ○	second line
○		○	third line
○ ○		○	fourth line

These are examined at each level and added together according to the formula:

○ + ○ ○	gives	○	}	i.e. an odd number of beans
○ ○ + ○	gives	○		
○ ○ + ○ ○	gives	○ ○	}	i.e. an even number of beans
○ + ○	gives	○ ○		

Thus in our example above:

the first line yields ○
 the second line yields ○ ○
 the third line yields ○ ○
 and the fourth line yields ○

Thus the two geomantic figures add together to spawn a third.

By combination of the four Mothers, eight more boxes are filled with figures. These boxes are laid out:

Tsinin' ny velona								Zatovo an-trano hafa
Alika								Marina an-trano hafa
Olon-dratsy								Vehivavy an-trano hafa
Korozy								Firiariavana an-trano hafa
	Fahasivvy (= rano)	Masina (= mpisikidy)	Nia (= harina)	Andriamanitra	Asorotany (= andriana = razana)	Mpanontany	Lalana	Trano

Completed, the whole *toetry* or grid with the four Mother figures and the eight newly generated figures looks like:

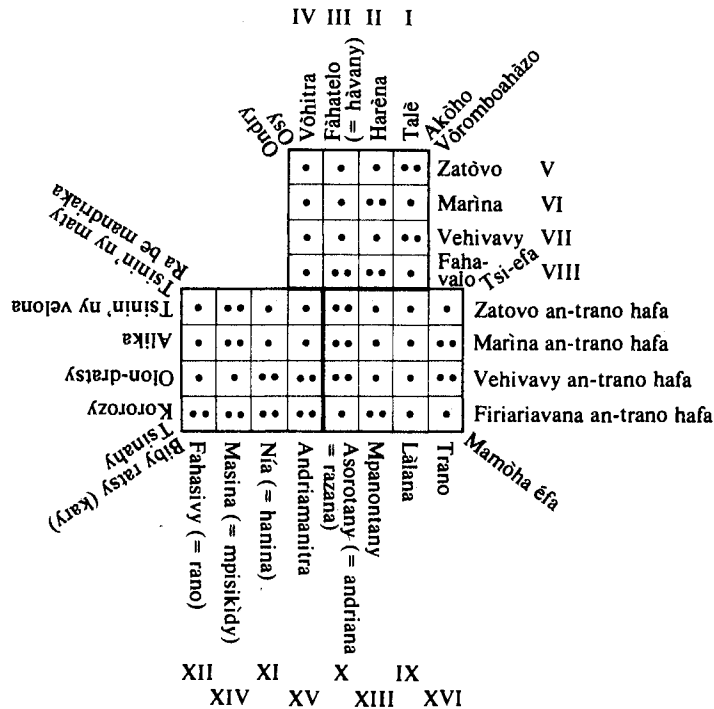

(d) The generation of the lower eight figures from the four Mother figures takes place as follows:

- (i) For convenience, the four vertical Mother figures are numbers I to IV.
- (ii) The fifth figure is the horizontal row comprising the tops of columns I to IV. The sixth to eighth figures are manifested in the same way.
- (iii) The ninth figure (Làlana) is formed by the addition together line by line of figures I and II (i.e. Talè and Harèna). Thus:

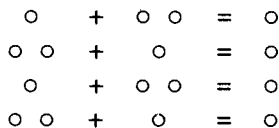

- (iv) Likewise the tenth figure (Asorotany) is formed by the addition of figures III and IV (Fàhatelo and Vòhitra).
- (v) The eleventh figure (Nía) from figures V and VI (Zatòvo and Marìna).
- (vi) The twelfth figure (Fahasivy) from figures VII and VIII (Vehivavy and Fahavalo).
- (vii) The thirteenth figure (Mpanontany) from figures IX and X (Làlana and Asorotany).
- (viii) The fourteenth figure (Masina) from figures XI and XII (Nía and Fahasivy).
- (ix) The fifteenth figure (Andriamanitra) from figures XIII and XIV (Mpanontany and Masina). This being the figure for God it stands as a sort of Judge for the whole question, determining amongst other things, the divination's right to survive or be wiped out without interpretation. It is also the central column of the bottom figures *so far formed* with three columns flanking it on either side.
- (x) Finally the last and sixteenth figure (Trano) is formed from the first (Talè) and fifteenth (Andriamanitra) figure, thus uniting God and the querent in a last figure which stands to the right of all the others.

Generation could be summarized as follows:

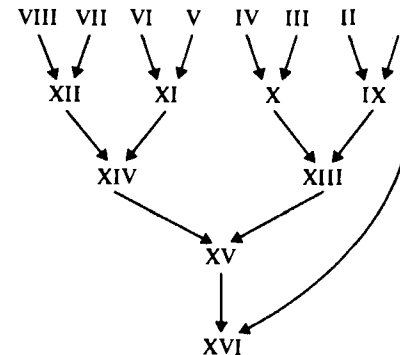

This matches closely the pattern of generation in European geomancy as outlined in Part Two.

INTERPRETATION OF THE SIKIDY

The *toetry* is now filled, and sixteen figures established. From the system of generation it is easy to see that especial importance is laid on the fifteenth (God) figure, the first (querent) figure, and their resolution, or the attitude of the Gods to the fate of the individual, which is given in the sixteenth (Trano) figure.

Hence the first figure to be examined in any interpretation, is the fifteenth (Andriamanitra) figure which refers to God. In European geomancy the figure which falls into the First House is checked to see if it is the dreaded Dragon's Tail. If it is, the whole figure is immediately destroyed, and divination proceeds no further. The Malagasy equivalent is the finding of a Slave figure in the column of Andriamanitra, which likewise results in the instant destruction of the figure for fear that it may provoke an evil event. In fact, it is mathematically impossible to generate any of the following in the sixteenth column, a fact overlooked by earlier commentators who saw in this rule (designed to check errors in manipulation) just another superstition.

The slave figures are Alàhizàny, Votsíra (Vontsira), Sàka, Alikísy, Kìzo, Adikasájjy, Alaimòra and Adibijàdy. The remaining figures were 'noble' figures or 'Kings of *sikidy*' and were allowed to appear in the Andriamanitra column.

Assuming that the figure is not destroyed owing to inaccurate manipulation, the interpretation proceeds by examining the four upper columns. From these one must be chosen to represent the nature of the question asked. To appreciate the significance of each column, it is necessary to investigate the structure of the divination

grid more closely.

The *toetry* has room for twelve vertical geomantic figures in all. These twelve positions correspond to the twelve Houses of astrology, inasmuch as they designate various categories of life into which a specific geomantic figure may fall. Each row has a specific Malagasy name thus associating each with a particular topic or everyday thing about which an answer may be sought:

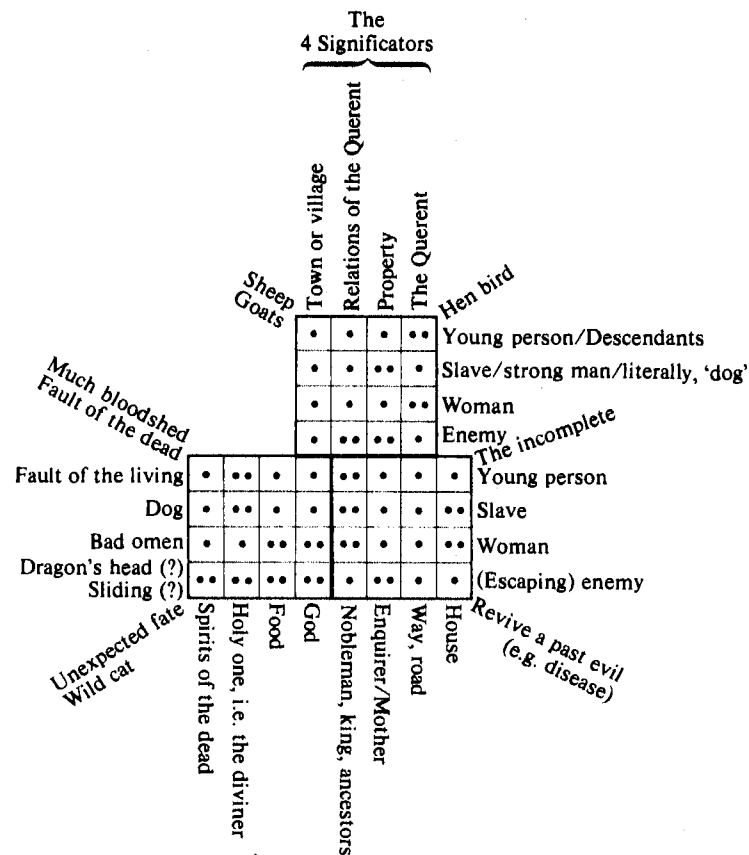

The interpretation of the *toetry*

To complicate things a little, further figures can be discovered by reading sideways or even diagonally as well as vertically so that:

(a) The top 4 columns (Talè to Vòhitra) are read downwards. In this example they are (using the European names) respectively *Acquisitio*, *Amissio*, *Cauda Draconis* and *Via*.

(b) The bottom 8 columns (Trano to Fahasivy) are similarly read downwards.

(c) The right-hand 8 rows (Zatòvo to Firiariavana an-trano hafa) are read from right to left.

(d) The left-hand 4 rows (Kororozy to Tsinin'ny velona) are read from left to right.

(e) While all corner names are read accordingly:

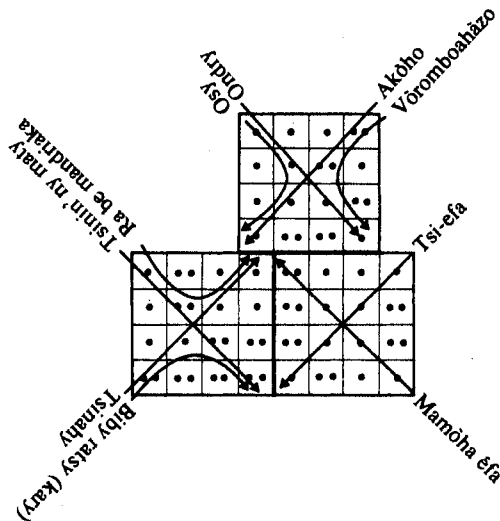

THE WORKING OF THE SIKIDY

To return to the actual divinatory operation, having selected one of the four Mother figures to represent

the category of question asked, the geomantic figure in that column is examined. In our example, we have selected the *Talè* column as signifier of the inquirer and we find the figure in it is *Molahidy* (i.e. *Acquisitio*) figure (see Appendix V).

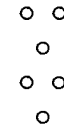

Now as the *Molahidy* figure is in the column concerned with the question, the next job is to see if it also appears anywhere also in the figure (with the exception of the other three Mother figures). Looking through the grid on page 78, you will find that *Molahidy* is not lurking in any other position in the grid. Had it been, the subject associated with that column might have provided a clue to the nature of the problem to be resolved.

Lars Dahle explains this point more practically:²

If I expect a ship and am going to enquire about its coming by means of the *sikidy*, the rubric [i.e. column] *Harena* (property) is of course to represent it. If in this rubric [column] I find, for instance, the figure *Jamà* [Populus], and on further examination find the same figure in the rubric *Andro* [? = *Trano*, house] this gives me no answer, as there is no natural connection between the two conceptions. If, on the contrary, I find the same figure in the rubric [column] marked *Làlana* [way or road], then of course I know that the ship is at any rate already *on the way*. I have then got an answer to the chief question; but there may still be good reason for a sharp look-out, for there may be difficulties in its way. Suppose that I also find the same figure in the rubric [column] marked *Fabavalo* (enemy), my mind will immediately be filled with gloomy apprehensions of *pirates*. Not a bit more cheerful will be my prospects, if I find the same figure under *Ra be mandriaka* (much bloodshed). But what a consolation, on the other hand, if the same figure reappears under the rubric [column] *Nia* (food); for then I must certainly be a blockhead if I do not understand that, although the ship may have a long voyage, there is no fear

of scarcity of food on board; and so on. It is easy enough to see that a man with much practice and a good deal of imagination could produce much 'information' in this manner; and I suppose that in a good many cases the *mpisikidy* were able to find an answer already in this first act of their proceedings, even if the means of finding it might seem scanty enough to ordinary mortals.

Dahle appears to have consulted the *sikidy* often enough for his own benefit, despite his rather patronizing attitude towards it when he says, 'I do not intend the reader to practise the *sikidy* (this secret I shall keep for my own use)': a rather incredible statement for a staid Christian missionary of the turn of the century!

It is an interesting point that the process of divination was a two-way operation, and not merely a passive questioning of an accepted 'kismet-type' fate. It was felt that not only the events and train of circumstances of the present shaped the outcome of the divination, but also that manipulation of the divination could alter the outcome of events.

The divination did not just stop at being simply a divination, but was used as a diagnostic tool, and finally became part of the prognosis. The *mpisikidy* actually uses it to manipulate, ease, or avert the evils which have been diagnosed or predicted by it. Hence *sikidy* becomes a doctor's aid, and a magical tool in its own right.

Following this identification of the key figure in its other possible locations on the *toetry* there comes a complex system of pairing and grouping, which although we will not detail here, because of the many variations in interpretation from *mpisikidy* to *mpisikidy*, leads none the less to a quite detailed analysis of the circumstances surrounding the main events, and the first hints of actions to circumvent some of them.

Having considered the various combinations of *sikidy* and the significance of those which fall in more than one position, it is now necessary to turn to the *sikidy tokana*,

or the figures which stand alone. In our original example (p. 78) the figure in the Talè or first column is such a *sikidy tokana* for it occurs nowhere else in the grid, it is unique. Special attention is again devoted to the Andriamanitra (fifteenth) column and the Talè (first) column.

Sikidy tokana in the first or Talè column as in our example, have a very direct effect on the querent. It will be seen that Mòlahidy (Acquisitio) is the *sikidy tokana* in the first column, and as this figure means gain in possessions, the outcome of the divination seems to imply a fairly speedy arrival of material possessions for the querent.

Similarly, a *sikidy tokana* in the fifteenth or Andriamanitra column has a very strong effect, and if this effect is malevolent, then the necessary *fadriftras* will have to be paid the closest of attention, for here the querent is dealing with the god's attitude towards him and his question. Obviously none of the Slave figures can appear in the Andriamanitra column as that would have resulted in the instant destruction of the whole divination.

This limits the possibilities to eight figures. For example, if Asòravàvy (Fortuna Major) turned up, the execution of a *faditra*, in the form of a cooking pot of rice hurled by the querent, opens up the possibility of the acquisition of a lesser fortune in the immediate future.

Sometimes the four to eight beans actually making up the auspicious figure can constitute a talisman in their own right, for having fallen as a *sikidy tokana* into the incredibly powerful column of Andriamanitra they are charged with the necessary force. Thus the beans making up a *sikidy tokana* figure of Alokòla (Carcer) in the Andriamanitra column constitute a protection against gunshot if put into a bullock's horn and worn on the person. Similarly the beans of a *sikidy tokana* in the form of Mòlahidy (Acquisitio) if found in the Andriamanitra column and mixed with the herb *tambinoana* are supposed

to be an excellent specific against illness if licked six times and then placed on the head! Likewise various parts of the divinatory layout are sometimes combined with other parts apparently at the whim of the diviner to derive or inspire further recipes for magical treatment or correction of the prevailing trends. These ideas actually generated very elaborate rules specifically designed to 'rig' a particular divination in order to obtain the desired auspicious result and thereby claim the beans necessary for the charm!

The directions derived from the *sikidy* are of two kinds – the *sorora* which are intended to obtain favours and the *faditra* designed to avert predicted ills. The latter is analogous to the scapegoat ceremony of ancient Judaism and takes the form of ashes, cut money, a sheep, a pumpkin or almost anything else the *sikidy* might prescribe. If the *faditra* is ashes, then they are allowed to blow away, if a coin then it is thrown into the deepest water, if a pumpkin then it is dashed to the ground with mock fury, and if a sheep it is carried on the shoulders of a man as far as he can run: this then should discharge the evil.

The *sorora* on the other hand is either cooked and eaten or worn as a charm, the latter being a string of beads or pieces of silver, whilst the former can be a bullock, fowl, rice, milk, honey or any other foodstuff.

RAMIFICATIONS OF THE SIKIDY

From the table of meanings attributed to each section of the *toetry* we can see that the system is as complicated as the horary astrology of seventeenth century Europe. Like the *ifa* system of divination, which we have already considered, *sikidy* reaches much deeper into the lives of the people of Madagascar than would be expected. Not only will the divination prescribe remedies for the adverse

fates, but a system of 'rigged divination' can be used to provide favourable patterns of nuts or sand, which when collected form a charm in their own right. This is a facet of sympathetic magic superimposed on the classically elegant lines of the Arab *khatt al-raml*, so that the social impact of the *mpisikidy* is far more significant than merely that of a diviner.

Various other belief systems, including that of *vintana* have been associated with *sikidy*, but the former derives from the Malay origins of the Malagasy people, where possibly some elements of Chinese *feng-shui* had penetrated. In practice the only connection between *sikidy* and *vintana* is that *sikidy* is sometimes consulted to determine the best *vintana*, or location for house or burial plot, just as it might be used for any other purpose.

While some of the early missionaries in Madagascar, including a one-time Governor, wrote their reminiscences and descriptions of *sikidy* in European memoirs, to follow the development of geomancy in Europe³ we have to go back to the middle ages.

5 · European geomancy in the middle ages

Having traced the southward migration of geomancy through Africa, let us turn to the northward movement, from the world of Islam via the translators of part-Muslim Spain into Europe.

Isidore of Seville AD 560–636 lists geomancy along with other divinatory methods such as necromancy, hydromancy, aeromancy and pyromancy, without giving much detail about their *modus operandi*. It is tempting to deduce that the art had reached Spain by the seventh century, but it is certain that the geomancy mentioned by Isidore was the general type of ‘divination by inspection of the element’, and not the elaborate type of divinatory art explored in this book. Isidore refers to divination by cracks in the earth, by observation of chance patterns, rather than the complete logical system of geomancy derived from *raml*. As we shall see later in this chapter, the word ‘geomancy’ did not take on its present meaning till the translation by Hugh of Santalla of an Arabic treatise on *raml*.

The next major mention of geomancy in Europe occurs in the twelfth century when it is included in a breakdown and condemnation of the magical arts. Hugh of St Victor (1096–1141) divided magic rather pedantically into five main divisions, each then further sub-divided:

1 *Mantike*

- (a) necromancy

- (b) geomancy
- (c) hydromancy
- (d) aerimancy [*sic*]
- (e) pyromancy

2 *Mathematica*

- (a) aruspicina horae – which consists of the observation of hours
- (b) aruspicina hara – which consists of the observation of entrails
- (c) augury – which consists of the observation of birds [as in Classical times]
- (d) horoscopia – which consists of the observation of nativities

3 *Sortilegia* or divination by lots

4 *Maleficia* – defined by St Victor as ‘the performance of evil deeds by incantations to demons, or by ligatures or any other accursed kind of remedies with the co-operation and instruction of demons’.

5 *Praestigia* – in which ‘by phantastic illusions concerning the transformation of objects, the human senses are deceived by demoniacal art’.

This early definition of the field of action of magic is very interesting for a number of reasons. First, *mantike* or divination grouped together the four elemental methods, of which geomancy came first, preceded only by necromancy which perhaps better belonged among the incantatory arts of *maleficia*.

Mathematica, far from being the abstract science of today, covered the practical interpretive arts which relied upon observation of natural phenomena, from birds and the intestines of sacrificed animals, to the movements of the stars (*horoscopia* or astrology) which partook of more actual calculation than the three other subdivisions of *mathematica*. Here one can clearly see the gulf between formal geomancy and augury, which relies upon the chance movement of birds or animals across

certain quarters of the sky or land.

The third main category, *sortilegia*, was also sometimes confused with geomancy, because occasionally a geomantic figure was generated to indicate the page or column of a book, which would just as easily be determined by lot or dice, hence artificially introducing geomancy into *sortilegia*. This has led to *libri delle sorti* or lot-books being dubbed 'geomancies', a frequent source of confusion.¹

Maleficia and praestigia are those categories which have now come to be seen primarily as magic, the first operating through the actions of demons, the second being illusory and deceptive. *Maleficia* has always been 'black magic', whilst *praestigia* has wavered between the contrived illusions of prestidigitators or legerdemain, and the more subtle magic of deceptions which may have been demoniacally inspired, or may have been natural. At various times sundry subjects, now become 'sciences', have been the province of *praestigia*. *Maleficia* has always held its own, but has perhaps widened its field of action to elementals, genies, spirits, and more morally neutral inhabitants of the netherworld than medieval theology ever wished to concede it.

The arrival of the practice of *raml* in Europe had however to await the period of feverish translating activity which began in Spain. It was in the brilliant universities of Cordoba, Toledo and Seville that the Italians of the twelfth century translated the great Arab works, such as the *Canon* of Avicenna and Ptolemy's *Almagest*, which introduced science and Muslim civilization to the Europe of the middle ages. Along with the natural sciences, many of them the relics of Greek civilization which had been translated into Arabic during the period of Haroun al-Raschid (AD 763-809), came the peculiarly Islamic contributions to astrology and the divinatory arts.

HUGH OF SANTALLA

The first geomancy translated into Latin from Arabic was Hugh of Santalla's *Ars Geomantiae*. Hugh of Santalla (or Hugo Sanctelliensis) was an astrologer, alchemist and translator of the first half of the twelfth century born in Santalla in northwest Spain. He appears to have worked under the patronage of Michael the bishop of Tarazona, from 1119 to 1157. Although he to some extent translated the same works as his contemporaries, for instance the *Centiloquium* ascribed to Ptolemy (Latin versions of which have also been credited to Plato of Tivoli and John of Seville), he appears to have worked independently of the Toledo translators. Hugh's translations are undated but at least some of them, including his *Ars Geomantiae*, antedated the work of his more famous contemporaries. Hugh's seven known translations are concerned with works of astronomy, astrology and divination. Those on astrology include Albumasar's *Book of Rains*, Messahala on nativities, a book by pseudo-Aristotle, 'from 255 volumes of the Indians', and *De spatula*, a treatise on divination from the shoulder-blades of animals. In the preface to the geomancy he promises to write next on hydromancy but says that he has failed to find any books on aeromancy or pyromancy. This is understandable as it seems that the two last forms of divination were simply void categories carried over as labels from classical writers to satisfy the medieval craving for symmetry of classification. Finally, the *Emerald Tablet*, that archetypal alchemical text attributed to Hermes Trismegistus, was made available from the Arabic in the first Latin translation by Hugh.

There are *two* basic treatises on geomancy translated by Hugh of Santalla, the *Ars Geomantiae*² and the *Geomantia Nova*:³ they are quite distinct texts.⁴ In them Hugh mentions the art of spatulomancy which was taken

made all the translations ascribed to him: he was tremendously active but we may assume that many other translations were made under his direction and that he was in fact the head of a school of translators. Later translations may have been ascribed to him because he was considered the translator par excellence of the period. Finally, some ascriptions to him are confusions with the work of the Italian astrologer Gerard of Sabbioneta who flourished in the second half of the thirteenth century.

GERARD OF SABBIONETA

Gerard of Sabbioneta composed or translated one treatise on geomancy, the *Geomantiae Astronomiae Libellus* (probably in 1294) and a summary of Ptolemaic astronomy as explained by al-Farghani and al-Battani, thus very closely paralleling the work of Gerard of Cremona himself.

The *Geomantiae Astronomiae Libellus* was first printed with the *Fourth Book of Occult Philosophy* of Cornelius Agrippa,⁷ and was the subject of a rather clumsy translation published first in Italian, then again in French in many editions (Paris 1615, 1664, 1687 to name a few) as *Géomancie astronomique de Gérard de Cremone* [sic] *pour savoir les choses passées les présentes et les futures* by the Sieur de Salerne, an Italian refugee in Paris. It can be immediately said that this book of astrological geomancy attributed to Gerard of Cremona and printed in *The Fourth Book of Occult Philosophy* is definitely by Gerard of Sabbioneta and not by Cremona, a fact firmly established by Prince Boncompagni.⁸ Moreover the technique outlined by Gerard of Sabbioneta is a *special* practice which does not use the same technique as the geomancy of Gerard of Cremona.⁹

The Arab work translated by the real Gerard of Cremona at Toledo, about 1160, is to be found in a Latin Bodleian manuscript entitled *Liber geomantiae de artibus divinatoriis qui incipit estimaverunt Indi*.¹⁰ It is possible that the *Libellus geomantie juxta arabum semitas ex arabico in hispanum et ex hispano idiomate in latinum translatus* of the Bibliothèque Nationale is also a copy of the original work.

PLATO OF TIVOLI

Parallel with the intense translating activity in Toledo, which was preparing the ground for the breakthrough of scientific thought in Europe, translators also stirred in Barcelona. Plato of Tivoli was one such translator who sojourned in Barcelona from 1134 to 1145. Most of Plato's Arabic translations were astrological. He was assisted by a Jew, Abraham bar Hiyya (or to use his Latin name, Savasorda). Included amongst his better known works is a divinatory geomancy entitled: *Alfakini arabici filii quaestiones geomantiae*, which was later published in the collection called *Fasciculus Geomanticus* along with Robert Fludd's work on geomancy. This collection later became the standard printed Latin source for the rules of geomantic practice, and Plato's contribution one of the earliest contained in it.

ROBERT OF CHESTER

In a British Museum manuscript, one of Plato of Tivoli's translations is preceded by a translation of the *Judgements* of the astrologer Alkindi by one Robert of Chester.¹¹ Little is known of Robert except that he was an English mathematician, astronomer, alchemist and translator

from Arabic into Latin. He lived in Spain about 1141–7 where he was archdeacon of Pamplona, before removing to London in 1150, so he could easily have come into contact with Plato.

Robert of Chester was also responsible in 1144 for translating perhaps the first work on alchemy into Latin. In *The Book of Morienus* Robert states that the Latin world does not yet know of the strange science of alchemy. However it took very little time for both these arts to 'catch on' in Europe.

MICHAEL SCOT

Geomancy, according to Lynn Thorndike 'seems to have been nearly as popular in the medieval period as the ouija board is now', and so it is no surprise to find that Michael Scot (c. 1175–c. 1235), a leading intellectual in Europe during the early thirteenth century also embraced the practice of geomancy. Scot has appeared as a shadowy and intriguing character to later generations, an alchemist, physician, astrologer and divine. His insistence on experience and experiment influenced the methods of such figures as Robert Grosseteste and Roger Bacon. On the other hand, Scot was also a man of his period and delighted 'in the adulterine arts such as the interpretation of dreams, auguries and lots'. He was born in Scotland and is thought to have studied at Oxford, and like Roger Bacon, taught and studied at the University of Paris. The earliest certain date in his cosmopolitan academic career is 1217 when he translated the work of al-Bitrugi, a twelfth century astronomer. He also introduced the works of Avicenna and Averroes to the Christian West. He was working in Toledo when he made his first translation, and later in Bologna, after which he probably served at the Court of Frederick II, at whose request many of his works

were written.

Scot was often cited by many of the great scholars that followed him, including names which are also associated with the history of geomancy, such as Peter of Abano and Abraham ibn Ezra. His most popular works were *Liber Introductorius*, a general introduction to astrology, and *Liber Particularis*, a more popular version of the former, containing a series of questions and answers on astrology and allied natural sciences.

Although his main activities were as translator and experimental philosopher, Scot was especially famous in the following generations as an astrologer and magician. Many legends crystallized around his memory and he thus became in the popular mind one of the foremost magicians of the middle ages. Dante put him in Hell (Canto XX, 116), characterizing him as knowing magic rather than performing it:

Michele Scoto fù, che veramente
Delle magiche frode seppe il giuoco.

Dante also speaks of geomancy in the first lines of Canto XIX of the *Purgatorio*:

In the hour when the day's heat overcome by the earth and sometimes by Saturn, can no longer temper the cold of the moon, when the geomancers see their *Fortuna Major* rise in the east before dawn by a path which does not long stay dark for it, there came to me in dream a woman, stammering, cross-eyed, and crooked on her feet, with maimed hands and of sallow hue.

The reference of course would be understood by Dante's contemporaries: the path or *Via* is of course attributed to the moon (night) while *Fortuna Major* is in the domain of the sun (day).

But to return to Michael Scot, we find him defining magic as, 'not found nor received in philosophy, because it is the mistress of all iniquity and evil, often deceiving and seducing the souls of its practitioners and injuring their bodies'. This identified the invocation of demons rather

than the experimental natural magic which was the medieval parallel of today's science. On the other hand, it was the demons who form 'various figures in the clouds, destroy bridges, uproot trees, and sometimes remove the roofs of houses'. Scot's attitude to magic parallels that of Hugh of St Victor (see p. 88). Scot however extended the subdivisions of divination to a total of twenty-eight categories, of course including the four familiar elemental types of divination.

In his *Liber Introductorius* Scot neither condemned geomancy nor asserted its claim to an astrological basis, reminding his readers that geomancers were 'apt to offend against the rule that once a question has been asked and answered, it should not be repeated'. However, as Scot was not anti-geomancy, and interested in the art, he probably tried his hand at writing a geomancy. In fact, a manuscript which closely resembles his style of writing occurs in a (sixteenth century) collection of geomantic treatises at Munich.¹² The text enumerates the sixteen geomantic figures, and Scot traditionally associated the sixteen geomantic figures with the twelve Signs of the Zodiac, giving two each to Taurus, Gemini, Virgo and Libra. Each geomantic Sign is also associated with one of the planets, a day, month, colour, odour, taste, stone, tree, metal and human type. Scot's geomancy goes into immense detail over the significance of each geomantic figure: in fact, more so than any other contemporary geomancy. Just to take one example,¹³ Scot says of *Acquisitio* that it is

of the planet Jupiter and the sign Aries. It is *optima*, fortunate, earthly [not in the elemental sense], fixed, masculine, oriental, airy, hot and wet like blood. Of colours it signifies white mixed with yellow declining to red; of tastes, sweet; of odours, fragrant; of stones, the hyacinth; of metals, gold and brass; of trees, fruit trees; of days, Thursday; of months, March; of time, years.

Scot continues with an extensive description of a typical

Acquisitio man:

of mediocre stature, handsome, rather tall, with pleasing eyes, a thin nose, beautiful forehead, thin chin, long neck, hairy, and having two large upper teeth; extravagant, greedy of gain, desirous of some degree of honour and lordship, benign, faithful, and giving many goods to others for their service and friendship.

Acquisitio further 'signifies bodily health, pecuniary gain, male offspring, a hot illness and quick escape, reversion, the fugitive life of an absentee, a man of good condition who loves easily and faithfully . . . '.

Although George Sarton¹⁴ felt that the geomancy of Michael Scot was a doubtful ascription, the work itself is still a significant milestone in geomancy, dealing as it does with such a wide spectrum of attributions for each of the geomantic figures.

ALBERTUS MAGNUS

From Scot we move on to a more illustrious contemporary, Albertus Magnus (1193–1280), Bishop of Ratisbon and intellectual luminary of the Church. Ironically Albertus Magnus took almost 700 years to live down his reputation as a magician and sorcerer, finally being canonized by the Church in 1935. Since then, what is reputed to be his bones have been moved to a crypt chapel in Cologne. Although his memory has been cleared of the charge of sorcery, a number of books on the subject still circulate under his name. However in his genuine works Albertus refers to magic and geomancy (*punctis terrae*) whilst defending the Magi against any suspicion of unwholesome magic. He shows an intimate grasp of the subject when he states: 'in the science of geomancy the figures traced from the points are of no value unless they can be made to conform with astronomical images.'¹⁵

Albertus appears to approve of the art of geomancy,

the only qualification being that it was illicit and superstitious to utter prayers over the pen and ink employed in jotting down the lines of points, or to seek to divine only on a favourable day, or when the weather was settled (a frequent and favourite injunction of geomantic books). If these preliminaries were *not* observed then Albertus conceded that geomancy was no more superstitious than astrology, which on the whole he approved of in his writing.

THOMAS AQUINAS

His pupil, Thomas Aquinas (c. 1226–74) was more careful and circumspect in his comments about the various magical arts. He admitted chiromancy to the category of ‘natural’, and therefore acceptable, divination but he excluded geomancy, on the grounds that the original figures are based on either the outcome of chance or of voluntary human action. Geomancy is therefore regarded by him as a superstition, rather than as a divinatory art with a natural basis not influenced by the reason and will, like augury.

Aquinas cautions against casting of lots, a process which is similar in technique to geomancy, unless there is a ‘real necessity, or without due reverence and devotion’ or for purely human and worldly purposes, excepting of course ecclesiastical elections. As Aquinas’s censures are based on the theory that God is often supposed to influence the casting of lots, it follows that geomancy, which depends on voluntary human action, does not come under the heading of ‘natural’ divination.

WILLIAM OF MOERBEKE

One of St Thomas Aquinas’s friends was William of

Moerbeke (c. 1215–86), a Flemish Dominican translator from Greek into Latin. Many of his translations were made specifically at the request of Aquinas, and included the first translation of Aristotle’s *Politics*, which had hitherto been unknown both to the Christian West and to the world of Islam. Whilst Thomas Aquinas urged him to translate various books of a neo-Platonic persuasion, Moerbeke worked on a treatise on geomancy called *De Arte et Scientia Geomantiae*, making it quite likely that he and St Thomas both tried their hand at this divinatory art.

Not only were the clergy of this period obliged to fulminate against the divinatory arts, but they were also the most likely candidates to be practising them, especially given the limited literacy of the non-ecclesiastical population. It was not only Bishops (Albertus Magnus), Saints (Thomas Aquinas), or Dominican monks (William of Moerbeke), but also missionaries and martyrs such as Ramon Lull (1235–1315) who were involved in using and writing about the art of geomancy.

RAMON LULL

Ramon Lull was one of the most energetic and versatile characters of the thirteenth and early fourteenth centuries, as well as one of the most enigmatic. He was born in Palma on the island of Majorca, and remains the patron saint of that city. Having spent his youth as a libertine and pleasure-loving courtier composing the long love poems in Catalan which make him a prominent figure in the history of Spanish literature, he like Saint Francis, underwent a conversion at about the age of thirty and thenceforth devoted himself to learning and religion.

The two driving forces in his life after this conversion were the method of his ‘Art’ (*ars nova*) and his urge to convert the Muslim world to Christianity and secure

Jerusalem for Christendom. In pursuit of the latter objective he persuaded the King of Aragon to establish a school for the study of Arabic in Majorca, and the Pope himself to authorize chairs in Greek, Hebrew, Chaldean and Arabic at Rome, Paris, Oxford, Bologna and Salamanca. This considerably accelerated the translation of valuable Greek and Arabic works into Latin. Further, in the pursuit of his aim to convert the whole Muslim world, he travelled extensively through Cyprus, Armenia and three times in north Africa. On his last trip to north Africa he achieved martyrdom by being stoned to death.

It was however for his 'Lullian Art' that the medieval world remembered him. This art is something which recurs again and again throughout the following centuries, as a theme or technique referred to by a number of different writers. Thorndike has explained it as 'the invention of a logical machine which would constitute the same sort of labour-saving device in a scholastic disputation or medieval university as an adding machine in a modern bank or business office'.¹⁶ In fact it was an elaborate system of logic which could be applied mechanically by properly arranging concepts in categories, subjects and predicates in such a way that 'computer-like', by the intermeshing of geared wheels upon which the categories were written, the answers of theological arguments would be derived. Lull even thought that such a machine might be able to convince a sceptical Muslim of the 'mechanical truth' of Christianity in a way that no missionary could. The Art was applied to every art and science Lull could lay his hands on, theology, medicine, logic, philosophy... even astrology and, of course, geomancy. The possibilities of combining Lullian wheels with geomancy might in fact prove a fruitful field for speculation, especially as twentieth-century French writers on geomancy have used such circles to explain the complementary and opposing relationships between the

different geomantic figures.

Lull's treatment of astrology is typical of his desire to encompass all arts and sciences within his own scheme or *ars nova*. As Sarton says: 'It is clear that he had no real grasp of either mathematics or astronomy; he treated these subjects with the habitual conceit of a philosopher who believes he can dominate them without detailed and intimate knowledge.'¹⁷

Despite the fact that many of Ramon Lull's wheels and 'logic machines' look like geomantic wheels, often being divided into sixteen chambers, he talks slightly of the art of geomancy and its practitioners. His wheels, however, are of interest to the geomancer. They are made of a number of card or wooden discs stuck with the same central pin, rotating independently but sometimes linked to other wheels by cogs. Each is marked with different categories or:¹⁸

sixteen 'chambers' representing kindness, grandeur, eternity, power, wisdom, will, virtue, truth, glory, perfection, justice, beneficence, pity, humility, dominion and patience. One hundred and twenty more 'chambers' were formed by combining pairs of the foregoing. Another circle shows the rational soul in the center represented by four squares and has its circumference divided into sixteen compartments representing appropriate qualities. A third circle, devoted to principles and meanings, enclosed five triangles in a circumference of fifteen compartments; while a fourth circle divided fourteen compartments of its circumference between the seven virtues and seven vices respectively rendered in blue and red. Other 'figures' dealt with predestination, fate, and free-will, truth and falsity. The following is a specific instance of the way in which these were combined. When the rational soul is troubled and uncertain in the circle of predestination, because the chambers of ignorance and merit, science and fault, mingle together, it forms a third figure representing doubt.

A similar arrangement can be used by a geomancer with the sixteen figures marked on four discs of different sizes. When any combination of four Mother figures come into line a Judge is revealed without the necessity of

drawing up a full geomantic figure. Similarly, 'machines' for judging the figures generated in a horoscope have been used. The present writer has reconstructed several such 'Lullian geomantic machines'.

BARTHOLOMEW OF PARMA

Despite Ramon Lull's elaborate methodological treatises, probably the most elaborate treatise on geomancy written in the thirteenth century was the *Summa Breuiloquium*, of Bartholomew of Parma. It was written at Bologna in 1288 at the express request of Theodosius de Flisco, bishop-elect of Reggio in northern Italy. Bartholomew also appears to have written summaries of this weighty work in 1294 and 1295 for other friends who wanted a slightly more concise text! Unfortunately Bartholomew's works were never printed, although a large number of the manuscripts are extant (see manuscript bibliography). It is interesting that the bishop-elect of Reggio should have given his patronage and shown interest in the work, thereby indicating that such divinatory arts were at least not consistently condemned by the clergy of this period.

Bartholomew's work is quite detailed and begins by asserting quite emphatically that the art of geomancy originated from God and was taught to the sons of Noah by an angel who conveniently took on human form before the time of the flood. According to Bartholomew, the inventors of geomancy derived the sixteen figures 'with great ingenuity and subtlety' from observation of the configuration of the constellations, an often repeated claim to legitimize the connection between geomancy and astrology. As the figures are comparatively simple and do not appear to follow any obvious visual pattern in their astrological correspondences, this origin seems to be fallacious, but indicative of the connection between

astrology and its terrestrial counterpart which as we have seen dates back to Arab usage.

Bartholomew elaborates on the simple zodiacal and planetary correspondence to include with each figure's attributions a day, month, colour, taste, stone, tree, metal and human type. Finally Bartholomew divides the figures into two basic groups:

<i>Favourable</i>	<i>Unfavourable</i>
∴ Acquisitio	∴ Amissio
∴ Albus	∴ Rubeus
∴ Puella	∴ Puer
∴ Laetitia	∴ Tristitia
∴ Caput Draconis	∴ Cauda Draconis
∴ Populus	∴ Via
∴ Coniunctio	∴ Carcer
∴ Fortuna Major	∴ Fortuna Minor

Such a table is of course an over-simplification of the elaborate rules and categorizations supplied by Bartholomew of Parma. Bartholomew's *Summa* has perhaps been copied more times than any other geomantic manuscript of this or any period, and was consequently responsible for spreading the practice of geomancy far and wide.

THE INQUISITION AND PETER OF ABANO

By the fourteenth century however the Inquisition had

begun to busy itself with divination as well as magic and heresy. Nicholas Eymeric (1320–99), a Dominican professor of theology and inquisitor general of Aragon, seems to have been a stout opponent of any heresy, divination, magic or alchemy. Oddly, he describes ‘geomancy’¹⁹ as making use of a circle and a mirror; while the method of divining by chance markings of dots or scattering sand which is usually called geomancy, is called by Eymeric ‘geometrimancy’.

The Inquisition also affected Peter of Abano (1250–1317). He studied medicine in Paris before returning to Padua to practise as a physician. Towards the end of his life, he was actually accused of practising sorcery by the Inquisition and was imprisoned. He was later acquitted but then re-arrested, and died in prison in 1317 whilst again awaiting trial.

A geomancy exists in several printed editions and manuscripts which is usually attributed to Peter of Abano: as Gabriel Naudé (1600–53), the French librarian, stated that Peter left treatises on ‘physiognomy, geomancy, and chiromancy’, there seems to be no need to dispute the accuracy of this ascription. In his *Conciliator* (Diff. 156) Peter asserted that the future, and that which is absent, could be predicted by means of characters ‘as geomancy teaches’. In his other great work, the *Lucidator*, he describes in some detail the method of geomancy, stating that its figures were produced under the influence of the constellations, and that not infrequently its judgments were verified. However, he regarded geomancy as a very difficult science, one requiring long experience and practice (although many of his contemporaries tried it simply because it looked so easy!). As he had a well-paid practice as a physician, and a place in society to keep up, it is conceivable that the treatise remained in manuscript form till some time after his death, especially as he was in some trouble with the Inquisition.

Of the books of magic attributed to Peter of Abano, the *Heptameron* is the best known, but Naudé states that two other books of his were banned after his death, the *Elucidarium Necromanticum* and *Liber Experimentorum Mirabilium de Annulis Secundum 28 Mansiones Lunae*, or ‘Book of marvellous experiments with rings according to the 28 Mansions of the moon’. Amongst the less salubrious works from his pen was a work on poisons, commissioned by the then incumbent pope, possibly Honorius IV: ironical in view of Peter’s treatment at the hands of the Pope’s agents, the Inquisition.

Shortly after Peter’s death, geomancy was immortalized in a Provençal didactic poem written in 1332 and running to 3,700 lines. This labour of love rather than art rhymes its way through all the possible combinations of the figures in the Houses of Heaven: one wonders whether the poet sought immortality in art or in didactic verbosity. Nevertheless this exhaustive treatment escaped the flames to provide useful clues about the earlier writers on geomancy.

JOHN DE MORYS AND NICHOLAS ORESME

Jean de Murs (often Latinized Iohannes de Muris or Anglicized as John de Morys) was a prominent Parisian astronomer and arithmetician of the first half of the fourteenth century. One of John’s several claims to fame is the construction of a fifteen foot radius *Kardaja* for astronomical observation. By way of comparison, Tycho Brahe employed one of only six foot and nine inch radius, although Dr John Dee (two centuries later) was reputed to have had a sextant of some forty feet radius. John de Morys combined the study of astronomy with that of its terrestrial sibling, geomancy. Amongst manuscripts possibly attributable to John is one in which the sixteen geomantic figures are related in detail to the planets and

signs.²⁰ John goes on to give the usual Christian mythical history of geomancy, stating that the art had its origins at the time of Noah. The relation of the geomantic figures to the twelve Houses of Heaven is considered, but much of the work is taken up with the interpretation of specific House/figure combinations, closely relating the concepts of astrology to geomancy. Amongst the traditionally geomantic material are details on related astrological topics such as the 'Egyptian' or inauspicious days upon which it is not wise to cast geomantic figures, or in fact do much else!

Despite such works, the fourteenth century sported numerous sceptics such as Nicolas Oresme, philosopher and mathematician, who in his *Des Divinations* spoke disparagingly of geomancy as 'nothing but the distinction between odd and even'. He calls it 'the game of philosophers' but concedes suggestively that certain problems in arithmetic can be worked out by using it. As he finds no reference to geomancy in classical writers, he rightly concludes that it is a medieval invention, although he doesn't spot its Arab origins. On the whole he spoke out against geomancy and similar divinatory practices.

LITERARY REFERENCES TO GEOMANCY

Such perception however went unheeded in popular circles. In *The Vision of Piers Ploughman* (c. 1362), William Langland describes a series of moralistic visions in which geomancy is associated with guile and sorcery:

But astronomy is a hard thing and evil to know;
Geometry and geomancy are guileful of speech;
Who so works at these two must stay awake late,
For sorcery is the sovereign book of that science.
There are mechanical devices²¹ of many men's wits,

Experiments in alchemy of Albert's²² making,
Nigromancy and pyromancy which raise up ghosts.
If you follow Dowel, deal with these never.
All these sciences I myself in sooth
Have found among the first to deceive folk.²³

Other poets spoke of geomancy, and Chaucer²⁴ in 1386 in the *Parson's Tale* opined that:

What say we of them that believe in divinations, as by flight or by noise of birds, or of beasts, or by sort [lot], by *geomancy*, by dreams, by chirking of doors, or cracking of houses, by gnawing of rats, and such manner of wretchedness? Certes, all this is defended [forbidden] by God and by all Holy Church.

ROYAL INTEREST IN GEOMANCY

Not only the popular tradition, but also royalty were interested in the intricacies of geomancy, for when Charles IV of Bohemia founded Prague University in 1348 it is likely that geomancy featured amongst his scholarly interests. Charles died in 1378 leaving his son Wenceslaus IV to succeed him.

Wenceslaus or Wenzel, the Holy Roman Emperor from 1378-1400, and king of Bohemia until 1419, was devoted to astrology and geomancy. This is amply testified by the existence in the National Library of Vienna of a superbly illuminated manuscript dated 1392/3 and marked with his initial. Illustrations include pictures of tubs and bathing girls which characterizes manuscripts associated with Wenceslaus, commemorating his imprisonment and supposed liberation by the bathkeeper Susanna. (There is an uncanny similarity to the infamous Voynich manuscript, whose provenance might well eventually be traced back to the same source.) The manuscript is made up of a treatise upon constellations, the Alfonsine Tables (the standard Ephemeris of the period), and a beautifully illuminated geomancy, followed by a list of fixed stars

and some details of aspects.

When Henry IV's daughter (Wenceslaus' sister), Anne of Bohemia, married Richard II of England in 1382 she found Richard more than sympathetic to geomancy. In fact an extremely elaborate astrological geomancy²⁵ was compiled for Richard II in 1391, just one year before the execution of Wenceslaus's manuscript in 1392/3.

ENGLISH GEOMANCERS

These two 'royal' geomantic manuscripts are amongst the most visually striking in existence. The interest of kings reflected an upsurge of interest by commoners, and under Richard's successor, Henry IV, a practitioner of medicine in Suffolk kept a notebook²⁶ record of details of methods for obtaining: 'oracular answers prepared beforehand by this great Doctor for those of both Sexes who shall come to consult him', which included the 'names of the 12 signs with such marks as shew that this John Crophill was a dabbler in Geomancy'.

Crophill was not alone amongst a wide range of professional men and clerics who consulted geomancy. In a manuscript²⁷ of this period is a detailed description of the technique of 'astrological geomancy' broken down very conveniently into 125 chapters by [Walter] Cato who probably translated the work direct from Arabic, as it shows strong signs of Arabic influence and is less likely to have been a recension of an earlier Latin work. The preceding treatise bound with it is also a manuscript on geomancy.

Other contemporaneous matter included references to the art in the *Apology for Lollard Doctrines* (1400) from which it appears that a number of Lollard sympathizers were also village 'cunning men' and practitioners of geomancy. In fact interest in England was so rife

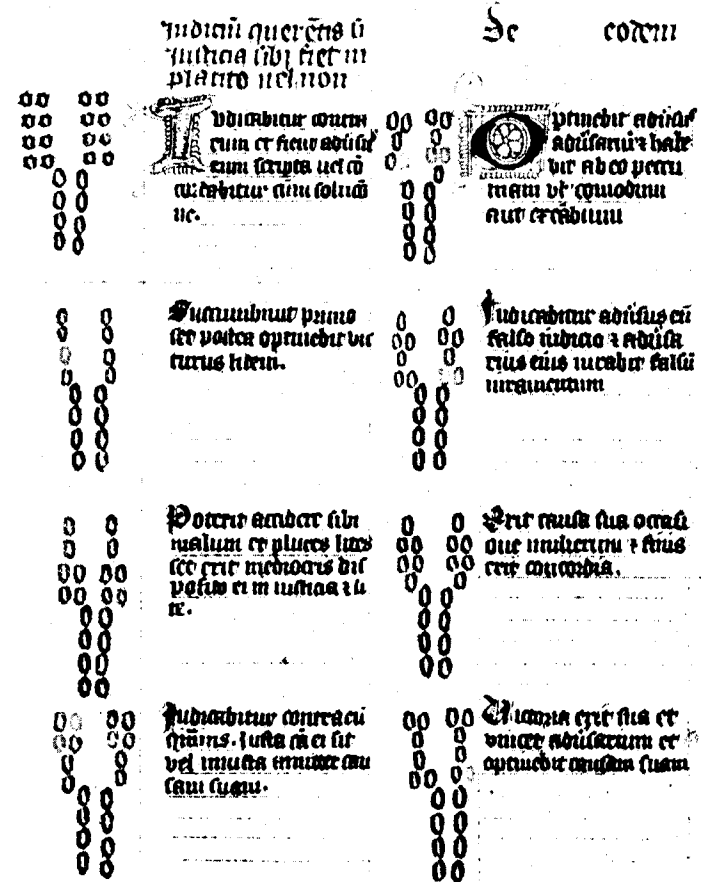

Figure 7 The geomancy of Richard II 1391 (British Museum MS Royal 12. C.V.)

at this period that those who could afford it, such as the Dukes of Bedford and Gloucester, cultivated and employed such geomancers as they could find, sometimes even luring them away from overseas posts.

Ducal Geomancies

Roland Scriptoris of Lisbon graduated in medicine from Paris University in 1424. After serving as a master and dean of the faculty for the next fifteen years, he became physician to John, Duke of Bedford. Whilst so employed he wrote one of the clearest early manuscript geomancies now in the British Museum.²⁸ It is neatly written in a large hand with illuminated initials, and was probably executed some time in the 1430s. The treatise begins with details of the sixteen geomantic figures and their relationship with the seven planets and twelve signs. The rules for deriving the figures are then laid out before the tables of reference and sample answers, to various questions, categorized under the twelve Houses of Heaven, each House covering from six to forty different categories of question. Apparently Roland was attempting a fairly complete coverage of the divinatory arts, as he also wrote treatises on physiognomy, chiromancy and astrology for the Duke.

Not only Bedford, but also Humphrey Duke of Gloucester had a geomancy drawn up for his use. It now resides in the British Library as part of one of the Arundel manuscripts,²⁹ and is entitled *Tabulae Humfridi Ducis Glowcestriae in iudiciis artis geomansie* being bound with another geomancy, *Liber scientie arientalis [?] de iudiciis geomansie ab Alpharino filio Abrabe Judeo editus*, a translation from the Arabic of Alpharinas.* Humphrey, who

* Critical notes on this manuscript may be found in Tanner *Bibl. Brit. Hib.* and the *Monthly Notes of the Royal Astronomical Society*, 80 (1920).



Figure 8 *Tabulae Humfridi Ducis Glowcestriae* (British Museum, MS Arundel 660)

was very interested in the magic arts generally, bequeathed his library as the basis of what is now the Bodleian collection at Oxford, a notable repository of many magical and geomantic manuscripts. Less fortunately, in 1441 his wife Eleanor Cobham was accused, along with other members of the Duke's entourage, of attempting to kill Henry VI by sorcery and witchcraft. In the event, she was banished to perpetual imprisonment on the Isle of Man, while her husband survived the scandal to endow 'Duke Humphrey's library' with other examples of early geomantiae.

COCLES

Meanwhile in Italy the art was alive and flourishing under the ministrations of a retired barber. Bartolommeo della Rocca, called Cocles, was born in 1467 near Bologna. Cocles made a speciality of forecasting doom. As the preface to his work on physiognomy and chiromancy puts it:³⁰

Cocles left his country home (Tuguriolum) and came to Imola, to whose princes he predicted the loss of their dominion. He then went to Faenza, where Hieronymus de Manfredis was cousin of the prince, and foretold an ill fate for Astorgius of Faenza, who died soon after. As for Cocles, he proceeded to Cesena and Pesaro and visited Guido Ubaldi. To Julius Varanus of Camerino he forecast an evil fate for himself and his sons.

Needless to say, this kind of prediction acquired for Cocles a lot of enemies, so much so that his prediction of his own death came true when in 1504 he was murdered by order of the son of his patron, Giovanni Bentivoglio, to whom he had dedicated several of his works. According to one writer, Cocles even knew how he would be murdered, and foreseeing that he would be knocked over the head, he took to wearing a metal plate in his hat. Unfortunately for him, his assassin, disguised as a vendor

of kindling wood, belaboured Cocles with the wood when he came to his front door, unprotected by his hat. As for the rest of his predictions it was said that of a list of forty-five men who would die a violent death, all but two had reached their predicted sticky ends by the time that Jerome Cardan (1501-76) inspected the list, long after Cocles's own death.

Aside from his rather saturnian predictions, Cocles made a practice of resurrecting antiquated methods of divination, which presumably he wielded with some dexterity. Of these, he is best known for his extensive and learned work on chiromancy and physiognomy, although according to writers such as Cardan, Cocles started life as a mendicant barber, 'ignorant of letters'.

For his work on geomancy he drew on Hali, Gerard of Cremona, Bartholomew of Parma, and the unidentifiable but ubiquitous 'Tundinus'. Apart from mentions of geomancy in his work on the arts of chiromancy and physiognomy, *Chryomantie ac Physionomie Anastasis*, Bologna 1504, there is a whole book on this subject, entitled *La Geomantia* (1550), which is ascribed to him. In the former book he lists exhaustively the different types of divination:³¹

several different modes of procedure . . . presented under pyromancy, hydromancy and necromancy. Long accounts are given of augury and interpretation of dreams. Spatulomancy is not defined as usual, as divination from the shoulder blades of sheep, but rather from the bone of a goat recently killed. Other less familiar varieties of divination are litteramancy and nomancy from letters and names respectively, solmancy from the rays of the sun, venamancy and umbilicomancy which are both connected with childbirth.

In the same work, Cocles defended Peter of Abano who also had a popularly attributed geomancy to his name. In fact Peter's geomancy was first published in 1542. Patricio Tricasso da Cerasari was later to re-publish both Cocles's work and Peter's geomancy. While Cocles

defended geomancers and astrologers, he attacked other professions such as the clergy and lawyers whom he derisively classified with 'rustics . . . mechanics, humanists, grammarians and women!' The clergy were of course prime targets because they opposed his art; of them he said:³²

we have at Bologna certain hypocrites in hoods who are supremely ignorant, whose names I pass over in silence, who under a certain appearance of sanctity are really fathers of deception. They daily deceive our citizens, especially idle women and most of all widows and insane old crones and some little men.

Cocles seems to have made a point of looking for trouble, and his death seems to have been more of a foregone conclusion than a fulfilled prophecy!

Jerome Cardan did not limit his study of geomancy to Cocles's prodigious predictions, but also examined other arguments for and against the subject in *De verum Varietate* where he conceded (XIV, 58, p. 270) that geomancy was a genuine form of divination, on the grounds that its figures stimulate the mind to 'intent inquiry and truth telling', a faint echo of Ibn Khaldoun's limited praise of the art.

Other contemporaries of Cardan such as Paracelsus (1493-1541) spoke favourably of the art. Gerhard Dorn, one of Paracelsus' disciples (who in fact edited in Latin translation his master's works) used geomancy to illustrate his points concerning the microcosm and anatomy of man in his *Clavis*. On the other hand, Erastus criticized Paracelsus' attitude to divination in general, seeing astrology as the foundation of all other magic arts, and geomancy as not much better.

Despite such clerical censure, the election of popes came within the province of geomancy, with not a few successes credited to its practitioners. The election of Giovanni de Medici (the son of Lorenzo the Magnificent) as pope was predicted by a geomancer of Bologna in 1513 to the sceptical philosopher Pietro Pomponazzi

(1462-1525). The incident is reported in Pomponazzi's book *De Naturalium effectuum cousis sive de incantationibus*,³³ where he relates that on four successive days the geomantic figures gave the same answer, and in due course Giovanni was elected to the papacy as Leo X. A probably apocryphal story says that after his election, Leo offered the geomancer fifty gold pieces or a green hat of office to show his appreciation: the geomancer sensibly took the former.

6 · The Renaissance: the apogee of geomancy

AGRIPPA

Henry Cornelius Agrippa (1468–1535), born just prior to the Renaissance, was in many ways an all round Renaissance man, being a writer, soldier and physician. However, his main influence on history, a claim to an important place in the development of the thought of the period is as a commentator on magic. As Agrippa himself says:¹

some that are perverse . . . may take the name of Magic in the worse sense and, though scarce having seen the title, cry out that I teach forbidden Arts, sow the seed of heresies, offend the pious, and scandalize excellent wits; that I am a sorcerer, and superstitious and devilish, who indeed am a Magician: to whom I answer, that a Magician doth not, amongst learned men, signify a sorcerer or one that is superstitious or devilish; but a wise man, a priest, a prophet.

He was born in 1486 in Nettesheim, a small town south west of Cologne, of a family of scholars who ensured that he acquired the fundamentals of a good education, specifically Latin, together with the writings of the ascetics, scholastics and canonists. As printing was still a very new invention the dissemination of rarer texts depended very much on the scholar gaining access to patronage and private manuscript collections. Because Agrippa's accomplishments included foreign languages, he was taken from his studies in 1501 to serve the Holy

Roman Emperor, Maximilian I of Germany, first as a secretary and then afterwards for seven years as a soldier. Towards the close of this period he travelled to Paris University, ostensibly as a scholar, but in fact as an observer of political developments there for Maximilian (a combination of activities which later occupied one of Agrippa's admirers, Dr John Dee, who undertook similar missions for Elizabeth I).

In 1509 Agrippa prepared a lecture on Reuchlin's *De Virbo Mirifico*, which he delivered at Dole. The University conferred a doctorate of divinity upon him, he was received by the archbishop of Besançon, and he attracted the attention and patronage of Margaret of Austria, the daughter of Maximilian I, to whom he had dedicated his lectures. He had chosen his theme well, for Reuchlin was not only a seminal influence, but was also well known in his own time, his book being eagerly devoured by Pope Leo X, Cardinal de Medici and other princes of the Church and State.

In pursuance of the patronage of Princess Margaret, Agrippa wrote his most frequently reproduced treatise on the *Nobility and Pre-excellence of the Female Sex*, a most ingeniously argued tract which was designed to ingratiate him with his patron. Having thus established himself, he married and settled down to work on his *De Occulta Philosophia*, which occupied him for the next two years (1509–10) but was not published until much later. Before the publication of this work Agrippa prospered, being elected regent by the University of Dole, held in high esteem by many learned men, and blessed with a clever and beautiful wife.

Fearing that *De Occulta Philosophia* might be misconstrued by the public he sent it to the Abbot John of Trittenheim, called Trithemius, with whom he had in the past conferred about 'divers things concerning Chemistry, Magic, and the Cabala'. Trithemius replied with

enthusiasm: 'your work, which learned men can sufficiently commend, I approve of', but he warned Agrippa that he should 'communicate vulgar secrets to vulgar friends, but higher and secret to higher and secret friends only . . . lest you be trod under the oxen's feet', implying that persecution would follow the publication of this book, as indeed it did. For that volume contained a summary and popularization of all the basic doctrines of magic, the qabalah and divination known at that time. His book was practically the only starting point of qabalistic knowledge amongst Latin-reading scholars in Europe: it consequently enjoyed an immense repute, and for this reason was especially feared by the Church. Strangely, most of the information in the book came rather from the mythology and philosophy of Greece and Rome than the later Hebraic qabalah. In his third book, which he devoted to 'theology', there is much about angels, demons and the souls of men, linked by an extremely competent system of correspondence, based wherever possible on the numbers one to twelve, and tied in extensively with classical mythology.

Agrippa divided his famous work on occult philosophy into three volumes, followed posthumously by a fourth volume, which contains his main treatise on geomancy with other works on magic and geomancy such as the *Magical Elements* of Peter de Abano. The first volume treats of Natural magic, the second of Celestial magic, and the third of Ceremonial magic, following the traditional division of philosophy into Natural (being concerned in large part with those subjects nowadays grouped under the physical sciences), Mathematical (including astrology, astronomy, geometry and akin subjects) and Theological or Metaphysical philosophy (concerned with speculations on Cosmology, Cosmogony and more religious issues). The fourth volume contains the practice, especially that of geomancy.

In his great rebuttal of all arts and sciences, *De*

Incentitudine, Agrippa lists earlier geomancies by Hali, Gerard of Cremona, Bartholomew of Parma, and an unidentifiable Tundinus, and adds:² 'I too have written a geomancy quite different from the rest but no less superstitious and fallacious or, if you wish, I will even say "mendacious".' This work is presumably the treatise published in Agrippa's *Fourth Book of Occult Philosophy*.³ Despite numerous references to its 'spuriousness' it is genuinely a collection of six treatises by various authors; only two of which actually purport to be by Agrippa. Of these the *On Geomancy* at least is probably genuine. This treatise is possibly the one he sent to Metz for in 1526. At the same time he requested a copy of Trithemius' *Steganographia*, a work simultaneously devoted to cryptography and angel magic. Perhaps, to Agrippa, there was an obscure connection between this work by his old master and the art we are considering.

In this treatise we have to thank Agrippa for one of the most concise definitions of geomancy ever penned:⁴

Geomancy is an Art of Divination, whereby the judgement may be rendered by lot or destiny, to every question of everything whatsoever, but the Art hereof consisteth especially in certain points whereof certain figures are deducted according to the reason or rule of equality or inequality, likeness or unlikeness; which Figures are also reduced to the Coelestiall Figures [astrological Signs and Houses], assuming their natures and properties, according to the course and forms of the Signs and Planets . . . the points of this Art to be made with signs in the Earth, wherefore this Art is appropriated to this Element of Earth . . . the hand of the Projector or Worker [the geomancer] to be most powerfully moved, and directed to the terrestrial spirits; and therefore they first used certain holy incantations and deprecations, with other rites and observations, provoking and alluring spirits of this nature . . .

Agrippa's attitude to geomancy wavered between opposite extremes for, whilst doubting the complete efficacy of astrology and geomancy, he nevertheless both practised and wrote about them in some detail, and in his own

practice he tended to rely upon the geomantic tables drawn up by Cornelius Schepper circa 1524.

of Geomancy.

<i>The greater Fortune.</i> * * * * *	<i>The lesser Fortune.</i> * * * * * *	<i>Solis.</i> ○
<i>Via.</i> * * * *	<i>Populus.</i> * * * * * * * *	<i>Luna.</i> ☾
<i>Acquisitio.</i> * * * * * * * * *	<i>Lætitia.</i> * * * * * * *	<i>Jovis.</i> ♃
<i>Puella.</i> * * * * * * *	<i>Amissio.</i> * * * * * * * *	<i>Veneris.</i> ♀
<i>Conjunctio.</i> * * * * * * *	<i>Albus.</i> * * * * * * * *	<i>Mercurii.</i> ♁
<i>Puer.</i> * * * * * *	<i>Rubeus.</i> * * * * * * * *	<i>Martis.</i> ♂
<i>Carcer.</i> * * * * * *	<i>Tristitia.</i> * * * * *	<i>Saturni.</i> ♄
<i>Ω Dragons head.</i> * * * * *	<i>∪ Dragons taile.</i> * * * * *	

B 2

Figure 9 The geomantic figures as portrayed in Henry Cornelius Agrippa's 'Of Geomancy' in *Fourth Book of Occult Philosophy*, London 1655

THE CHURCH AND OTHER PRACTITIONERS

Contemporary with Agrippa was the astrologer and master of geomancy, Luca Gaurico (c. 1531), who passed on his art to Gian Luigi de' Rossi. Another, but anonymous German practitioner of the art, published his magnum opus in Mayence in 1534, entitled *Künstlicher und rechtschaffner gebrauch der alten Kleynen Geomancey*. Such works however came under the condemnation of the Church.

The Catholic Indices of prohibited books did not begin to list works on occult subjects till the middle of the sixteenth century, till then contenting themselves with heresy and the works of religious reformers. The Indices of Venice and Milan of 1554 are amongst the first to condemn works of geomancy along with her sister arts of hydromancy, pyromancy, nigromancy, necromancy and the notary art. Agrippa and Bartholomew Cocles were amongst the writers on geomancy so condemned.

In the Index of Paul IV issued at Rome in 1559, works of geomancy are again listed together with the above mentioned 'mancies' plus chiromancy, physiognomy, aeromancy, hydromancy, onomancy, pyromancy, sortilege, venefica, auguries, aruspicina, incantations and certain branches of judicial astrology. Interestingly enough alchemy is not mentioned in this Index. Of geomantic authors, Cocles and Agrippa are again singled out, together with Peter de Abano.

In 1580 the Congregation of Cardinals, perhaps fearing that divination was becoming too prominent an issue, wrote to the Inquisitor at Bologna, directing him not to interfere in cases of geomancy, but to leave them to the Ordinary. Additionally, if any person was charged both with using the divinatory arts and heresy, the latter charge was to be given precedence. Similar decrees highlight the fact that the Inquisition was primarily charged with

the rooting out of heresy rather than magic, and prosecution for the latter was often based on the premise that those who professed magical beliefs were heretics.

Gaspar Peucer in his book *Les Devins* (Antwerp 1584), a commentary on the principal types of divination, fulminates against geomancy: 'gens curiux [*sic*] et profanes, aux ridicules subtilitez'. He gives several chapters to a refutation of its principles and attempts to demonstrate that the devil is its author!

The Indices were followed up in 1586 by the famous Bull of Sixtus V which was proclaimed generally against most forms of divination and magic. Ironically later ages were to accuse this Pope, who built the Vatican Library and published new editions of the *Septuagint* and *Vulgate* with being himself a magician!

Further internal decrees were issued, such as that of 1591 issued to the Friars Minor of the Observance preventing them from having any writings or books on geomancy, chiromancy and similar subjects. Penalties ranged up to ten years in the galleys for those found flagrantly guilty. A year later all permits to read prohibited books which had been issued for bishops and local inquisitors were recalled, and even the official Jesuit censors themselves were instructed not to keep or use the books which they themselves had been responsible for expurgating or withdrawing from circulation. Hard times indeed for any scholar of the magic arts, be he lay or clerical!

Various defences of divination, particularly of astrology, were penned by such writers as Campanella who argued that astrology and hence its dependants, such as geomancy, are sciences, and that the suppression of astrology thereby brings all science and philosophy into disrepute. By an odd twist of fate Campanella met Urban VIII, the next pope to issue a comprehensive Bull against astrology and divination. Now, although Urban wished to suppress astrology, he was in fact a firm believer in it. He had

horoscopes drawn up for all his cardinals resident in Rome and was in the habit of openly predicting the dates of their deaths from these horoscopes. By way of retaliation between 1626 and 1628 his own imminent death was astrologically predicted. This activity was probably the main cause behind his anti-astrology Bull of 1631, especially as the main target of the Bull was predictions of the deaths of princes (especially popes) and their families: the crime was however more one of *lèse-majesté* than heresy or sorcery!

But to return to Campanella, whose interest in astrology more than matched that of the Pope. As 1628 drew to a close, Urban VIII became increasingly worried about the astrological and geomantic predictions of his death. He not only consulted Campanella a number of times, but actually engaged in ritual magic to circumvent the influences of the stars, taking measures against the 'disease bearing eclipse and evil influences of Mars and Saturn'. In his book *De Fato Siderali Vitando* (in *Astrologicorum Libri VI*, 1629) Campanella relates the events:⁵

First they sealed the room against the outside air, sprinkled it with rose-vinegar and other aromatic substances, and burnt laurel, myrtle, rosemary and cypress. They hung the room with white silken cloths and decorated it with branches. Then two candles and five torches were lit, representing the seven planets; since the heavens, owing to the eclipse, were defective . . . The other persons present had horoscopes immune to the evil eclipse. There was Jovial and Venereal music, which was to disperse the pernicious qualities of the eclipse-infected air and, by symbolising good planets, to expel the influences of bad ones. For the same purpose they used stones, plants, colours and odours, belonging to good planets (that is, Jupiter and Venus). They drank astrologically distilled liquors.

Obviously the magic was successful, as Campanella lived to be thrown into prison for publishing the details of the ritual (he was later pardoned), and the Pope lived to pass the Bull of 1631 against astrologers and other diviners. This however did little to check the spread of geomancy.

CHRISTOPHER CATTAN

In France from the end of the sixteenth to the end of the seventeenth century studies of geomancy multiplied, and many editions of the better known texts were published. The best known were those of the Italian Christopher Cattan (1558), the French translation of Cornelius Agrippa, and the indigenous works of De la Taille (1574) and De la Tayssonnière (1574).⁶ Of these, only *The Geomancie of Maister Christopher Cattan* was translated out of French 'into our English tongue' by Francis Sperry in 1591, immediately becoming a best-seller which necessitated its reprinting in 1608. Its popularity is also attested by the number of contemporary manuscript copies held in the British Library⁷ which owe their origins to this work. The book is dedicated by Sperry to 'Lord Nicat, Lord of Bosnay, and of Chesney, one of the Kinges Counsaile, and Maister of the Requests of the Housholde'. Cattan himself was the soldier and servant of Lord Thais.

Cattan proposes in his preface to write in the future a Physiognomie and a Chiromancie, reinforcing the association between these three arts, which had grown since the time of Cocles: this he failed to do however. Following tradition, Cattan says 'the Iudians [Indians], Chaldeans, Hebrews, Arabians, Greekes, Egiptians and Latines' have written on geomancy. He selected three of these works as important, (a) the manuscript beginning 'Estimaverunt Indi . . . written by the Indians'; (b) the manuscript beginning 'Ha veenestre . . . written by the Hebrewes'; (c) the Latin work of Bartholomew de Pine [Parma]. An interesting choice of reference sources.

Cattan's work is divided into three books, being, (i) A treatise of the art; (ii) On the twelve Houses of Heaven; and (iii) Judgment with examples. The author is careful at the outset to explain that geomancy is not wrought 'by diabolicke invocation, but a part of Natural Magicke,

and daughter of Astrology . . . and S. Thomas of Aquine [Aquinas] himself, a Doctor of the church of no small estimation, saith in his *Quolibet*, that it [geomancy] may bee admitted, because it doth participate with Astrologie, and is called her daughter'.

In his first chapter, Cattan defines geomancy:

Geomancie is a Science and art which consisteth of points, prickes, and lines, made in steade of the foure Elements, and of the starres and Planets of Heaven, called the Science of the Earth, because in times past it was made on it as we will hereafter declare. And thus everie pricke signifieth a Starre, and everie line an Element, and everie figure the faure quarters of the world, that is to say, the East, West, South, and North. Wherefore it is easie to know that Geomancie is none other thing but Astrologie, and a third meane, that is to say, participating of two, which is *Alquemy* [Alchemy].

Geomancy is called *Gy* a Greek word, which signifieth earth: and *Mancie*, which is to say knowledge. Or defining it more properly, it is derived of *Gyos* and *Magos*, which signifieth knowledge of earthly things, by the power of ye superior bodies, of the foure Elements, the seaven planets, and of the twelve signes of heaven. And this Arte may be made upon the Earth, or in white Paper, or uppon any other thing, whereon it may commodiouslie bee done, so that the prickes and lines may be knowne.

In chapter 3, Cattan explains what equipment is needed and recommends pen, ink and paper, explaining that the use of 'beanes or other grains' to produce a geomantic figure is in 'the manner of the curtizances of *Bolognia*'. It is interesting that Cattan has come across a *modus operandi* similar to the palm nut and bean manipulation of African geomancy, perhaps found in the *Summa* of Bartholomew of Parma which was composed in Bologna.

After a fairly traditional explanation of the generation of the figures, Cattan supplies extensive tables for use by the intending geomancer. Cattan's book being widely distributed would have been known to Simon Forman (1552-1611), the Elizabethan contemporary of John Dee who practised geomancy for clients, and as a diagnostic tool. Richard Napier, rector of Great Linford in

became a supporter of the Rosicrucian cause and wrote several works supporting this almost mythical brotherhood of sages which had first come to the notice of the scholars in Europe in the early seventeenth century. As he was an influential writer in his own time, much of what has later come to be considered as Rosicrucian was in fact based on Fludd's treatises rather than any directly Rosicrucian material.

He was also important in other fields of endeavour and became a close correspondent of the astronomer Kepler. Fludd's contribution to astronomy was more in the nature of cosmological speculations, but because of the logic of the time, Kepler felt that amongst Fludd's cosmological speculation were principles which he could possibly apply to deducing the physical nature of the universe. It was not unusual in the seventeenth century for thinkers to subscribe to the 'as above so below' theory, and use the conclusions of one science to answer questions in another.

Kepler was so fascinated with Fludd's theories explained in the *Utriusque Cosmi* that when he wrote his own treatise on the solar system he included an appendix specifically addressed to Fludd. However, where Fludd saw the universe animated by a living soul and ruled by spiritual essences, angelic powers and the whole machinery of planetary intelligences, Kepler took a more modern view and described the system in terms of mathematics. In some ways Fludd and Kepler represent the division between ancient and modern approaches to cosmology: on Fludd's side is the platonic theory of the world soul integrated with the Christian ideas of his period, on the other side Kepler adheres rigorously to those things which he can prove by figures.

Fludd's speculation on Creation and natural history mixed theories of thunderbolts with addresses on anatomy, military manoeuvres, theological theories, religious rationalizations and qabalistic conjectures. For



Figure 11 Section title page from Robert Fludd's *Utriusque Cosmi*, 1618, showing geomancy as one of the seven microcosmic arts

Fludd, there was no dividing line between science and religion.

As Fludd saw geometry and its attendant science, mathematics, at the root of the whole cosmos, it is not unusual that he felt that the binary mathematics of geomancy were a reliable means for probing the future.

Fludd describes one of his experiences with geomancy in the section on 'the internal principle of terrestrial astrology or geomancy' in his *Historia Macrocosmi*, the translation of which is based on the work of C.H. Josten.⁹

In [1601-2] . . . I was compelled to spend the whole winter in the city of Avignon . . . With many other young men of good background, and of sound education (former pupils of the Jesuits) I received board and lodging at the house of a certain captain.

One evening, while we were drinking at table, I discussed philosophical subjects with the others and observed their various opinions on geomantic astrology. Some of them denied its usefulness altogether; others, with whom I sided, stoutly defended the truth of that art. I set out many arguments in which I proved myself fairly well versed in geomancy.

The meal being over, I had no sooner returned to my bedroom, when one of my companions followed me and asked me to try my skill [in geomancy] (which, he said, he had seen was considerable) in the resolution of a problem of some importance which greatly troubled him. Having made many excuses, I was at last prevailed upon by his entreaties. So, instantly I marked down geomantic dots for the question he had proposed. This question was: whether a girl with whom he had vehemently fallen in love returned his love with equal fervour with her entire mind and body, and whether she loved him more than anyone else.

Having drawn up the [geomantic] chart, I assured him that I could describe the nature and appearance of his beloved and, having duly described to him the stature and shape of the girl's body, I indicated also a particular and rather noticeable mark, a kind of wart on her left eye-lid, which he agreed was there. I said also that the girl loved vineyards, and this detail, too, was confirmed by him with pleasure. He said that her mother had for that very reason built her house among the vineyards. Finally I gave the following answer to the question: that his beloved was unfaithful and by no means steady in her love of him, and that she loved somebody

else more than him. Whereupon he said that he had always very much suspected that this was the case and that he was [now] seeing it with open eyes.

He left my room in haste and then related to his companions with some admiration the truth and virtue of my art. Yet some of them, who knew the girl well, denied altogether that she had any such mark on her eye-lid as I had described, until they talked to her the following day and saw the correctness of that detail which I had foretold by the art of geomancy, and which even they had never previously noticed.

This interesting episode however could have led to serious trouble for Fludd as the papal town of Avignon contained a number of clergy who considered such practices unlawful and harmful, if not exactly demoniac. Fludd continues:

Thus I became better known than I desired, so much so that rumours of this matter reached the ears of the Jesuits. Two of them went secretly to the Palace and, impelled by envy, reported to the Vice-Legate [Carlo Conti di Poli] that there was a certain foreigner, an Englishman, who had made predictions of future events by the science of geomancy, which science was not approved of by the Catholic Church. The following morning this was related to me by a captain of the Palace, named John.

John put Fludd's fears to rest for he had heard the Vice-Legate's reply:

Truly this is not so serious an offence as you are trying to make out. Is there indeed a single Cardinal in Italy who does not possess an interpretation of his nativity after the astrological or the geomantic method?

A few days later di Poli invited Fludd to have a meal with him, and discuss geomancy. Just to be on the safe side, and to have a witness, in case his words should later be twisted in a court, Fludd took his old friend, Monsieur Malceau, the well-known papal apothecary. After the usual formalities the Vice-Legate broached the reason for his invitation and asked Fludd for his real opinion of geomancy. The Vice-Legate also wanted to know how a

scientific method of divination could be based on an apparently random and accidental jotting. By this time Fludd saw that there was no trap concealed in the conversation, and that his questioner really wanted to know the inner mechanics and rationale of geomancy. Accordingly, Fludd replied:

the principle and origin of those dots made by the human hand was inward and very essential, since the movement [of the hand] emanated from the soul. I added that the errors of geomancy are not caused by the soul but by the unrefined nature of the body distorting the intention of the soul. For that reason it is a general rule in this art that the soul [of the geomancer] must be in a peaceful condition, and a condition in which the body is obedient to the soul; also that there must be no disturbance of body or soul, nor any bias concerning the question; that the [geomancer's] soul must be like a just and impartial judge . . . Likewise it is necessary for the practitioner to think intensely of the question that had been proposed so that he might not be seduced by any extraneous thoughts.

According to Fludd, geomancy was a 'science of the intellectual soul in which intellectual rays emanated from the mind to mundane affairs and then returned to their centre with tidings of the future', a typically Fluddian rationalization attempting to make the occult sciences intellectually respectable. A state of almost prophetic rapture is, according to Fludd, needed as a prerequisite of divining by geomancy. It is interesting to note that it is on record that despite Fludd's rationalization of the reasons for geomancy's success, he preferred to use a wheel with sixteen projections which was spun, rather like a roulette wheel or a Lullian wheel to obtain the necessary geomantic figures. As with any art though, it is necessary to master completely all its details before any of its short-cuts can successfully be used.

POPULARIZERS AND THE DECLINE OF GEOMANCY

Richard Sanders (or Saunders), a fellow countryman of

Fludd, was primarily a popularizer in the field of physiognomy and chiromancy, but found time to insert casual references to geomancy in his *Physiognomie and Chiromancie* which was published in London in 1653. In it he included such odd pieces of information as 'how to discover the physiognomy of anyone, or know the dreams of princes', both supposedly by geomancy!¹⁰

Sanders dedicated his book to Elias Ashmole, the antiquarian and member of the Royal Society who combined these pursuits with a passionate love of magic and astrology. As mentioned earlier Ashmole was given Richard Napier's papers, along with Simon Forman's, and less directly John Dee's, most of which finished up in the Bodleian library. It was in fact Ashmole who was largely responsible for rescuing the magical diaries of Dr John Dee, from the flames, and from oblivion. Sanders referred to his dedicatee as 'a real mercurial encyclopaedian'.

Another popularizer like Sanders was the self-avowed, and not a little pompous, John Heydon who between 1662 and 1664 brought out three tomes entitled *Theomagia, or the Temple of Wisdom*, based primarily upon geomancy and the production of talismans or 'telesmes'. Not only is the book a hotch-potch of previous works, but it was only a small part of Heydon's voluminous output designed to promote alchemy, geomancy and a dubious brand of Rosicrucianism. Frances Yates, describes him as:¹¹ 'that strange character, John Heydon, who abandoned all precedent by loudly claiming that he was a Rosicrucian, published a series of works in which the Rosicrucian tendency to fanciful utopianism reached unprecedented heights.'

Heydon not only had an impact on his own time, but also (probably because of his reputed Rosicrucian connections) impressed MacGregor Mathers who used *Theomagia* as his prime source when drawing up the papers on geomancy for the Hermetic Order of the Golden Dawn

in the late nineteenth century. As a result the various spirits which Heydon spoke about, like Kedemel, Sorath and Barzabel, were woven into those instructions on geomancy which later became the fountainhead of information for most of the magical groups of the twentieth century, despite the fact that these spirits have no part to play in traditional geomancy and were borrowed by Heydon from other magical disciplines outlined in Agrippa.

The same popularization occurred in continental Europe, where in 1657, and again in 1663, a work called *La chiromance, la physionomie et la géomance . . .* by de Peruchio, explained in some detail the art of astrological geomancy, together with 'astrological chiromancy' and physiognomy which had increasingly become its sister sciences since the days of Cocles. The medieval grouping of geomancy, pyromancy, hydromancy and aeromancy had given way to the above trilogy mainly because of the dearth of information on these elusive and partly fanciful arts. Peruchio supplements his geomancy with dice divination and the 'Wheel of Pythagoras', a circular numerological arrangement falsely attributed to the Greek philosopher, but common in works of divination of the period.

Henry de Pisis, whose work on geomancy was first printed in 1638, appears reprinted in the *Fasciculus Geomanticus* (Verona, 1687) with the important treatise by Fludd already mentioned. De Pisis divides geomancy into three books: theory, practice, and examples of questions taken from previous authors.

Instead of generating the geomantic figures by marking sixteen rows of dots at random, de Pisis uses a disc with the sixteen geomantic figures marked on it as a wheel to be spun four times to determine the four initial figures, reminiscent of Ramon Lull. This is a much faster way of generating the Mother figures, but far estranged from the sand-cutting of its forebear, *raml*. De Pisis relies

heavily on authorities like the Arabic writers Geber and Aomar, medieval Latins like Gerard of Cremona and Peter de Abano, popularizers like Cocles, and recent contemporaries like Fludd.

Very late in 1704 the *Fasciculus Geomanticus*, followed by an additional *Tabulae Geomanticae*, was reprinted in Frankfurt: a handbook and compendium not since rivalled for clarity and completeness. Indeed the hour was very late for geomancy itself, since it was the eighteenth century with its growing rationalism which delivered the *coup de grâce* to geomancy. It was just a short step from the Jesuit father Francois Ménétrier, who considered in his *Philosophie des images énigmatiques* in 1694 that all the operations of geomancy were diabolical, to the so-called age of reason when geomancies were relegated to the status of drawing-room diversions or bibliophile's curios. No original studies appeared in this century, and despite a flourishing trade in anonymous geomancies in German, they were, without exception, purely devised to delight, or while away the hours. These '*Punctierkunsts*' or '*Punctier-Buchs*' were the first of a long line of thin anonymous or pseudonymous volumes often published with misleading imprints and unreliable dates. This tendency to popularize geomancy is part of the roots from which the English astrological revival of the early nineteenth century sprang.

7 · The great astrological revival

Robert Cross Smith was born on 19 March 1795. The year was a vintage one for astrologers, as it also saw the birth of 'Dixon' and Richard James Morrison who later used the pseudonym 'Zadkiel' in his astrological books and pamphlets.

Very few new astrological books had been printed in the eighteenth century and the three men born in 1795 were to instigate a new flood of astrological writing and interest beginning in the 1820s. Smith is of greatest interest from our point of view as he also attempted to revive geomancy, another almost forgotten art, but now dressed up in a variety of new guises. Not content with geomancy by itself, Smith contrived to give the technique all sorts of fantastic pedigrees whilst omitting to mention that the subject of his text was in fact geomancy, which has as old a *genuine* pedigree as most forms of divination.

When Smith came to London circa 1820 he found employment as a clerk in Upper Thames Street. Before long he was being supported by G. W. Graham, the balloonist, who also encouraged him to take up astrology. In 1822 they collaborated in writing and publishing *The Philosophical Merlin* which was their first venture. The pamphlet outlined a method of geomantic fortune-telling with a simple *modus operandi*.

Ellic Howe says of Smith that he 'was in the habit of "discovering" pseudo-Napoleonic manuscripts, and was as

assiduous in attributing occult interest to Napoleon as a later generation was in connection with Adolf Hitler'.¹ *The Philosophical Merlin . . . a Valuable Manuscript Formerly in the Possession of Napoleon Buonaparte . . . Fate: by the Rules of the Ancient Geomancy* is a curious little tract first published in London in 1822 by Smith and Graham. It uses the sixteen geomantic figures to outline disposition, auspicious colours, favourable hours and days, and inherent qualities, much like astrological Sign descriptions. It was described as being 'the translation of a valuable manuscript, formerly in the possession of Napoleon Buonaparte' [sic], and started a craze for such supposititious Napoleonic works. Graham and Smith certainly made up in publicity what they lacked in honesty concerning the origins of this work, and it became an instant success.

In the prologue 'to the ingenious reader' the authors built up their tale, making careful provision for future money-spinning publications should the demand warrant them:

At the decisive and to him [Napoleon], fatal, battle of Leipsic, nearly the whole of his curious, and valuable manuscripts fell into the hands of some Prussian officers; several of which have been already published; in different forms; [perhaps a reference to Kirchenhoffer's *Book of Fate* which will be examined later in this chapter] but none, so curious, or interesting as the present; which if patronized, by a discerning Public, will be only the prelude, to others, which when made known, cannot fail to excite the most intense interest, some of which are already nearly ready for the press, but awaiting the *fiat* of public opinion [later geomantic works by Smith with faked pedigrees]. The Editor does not pretend to establish the *fact* that Napoleon actually gained all his victorious laurels, by his knowledge of futurity; that point must be left to the candid attention of the impartial Reader. It is however a singular, but no less certain, fact, that after the above fatal battle, he never was victorious! So that the loss of his manuscripts, and victorious fame went hand in hand!

The Philosophical Merlin was much less sophisticated in its divination techniques than those already outlined in

this book. One arrives at the necessary divinatory figure by making only eight lines of random dots: the instructions suggest that each random line should have at least twelve dots in it. These lines of dots generated two figures in the usual manner (each odd line gave one dot, each even line, two dots). These two figures are joined together by adding each line (odd and even in the usual fashion) till you are left with your final figure. Then you look up the chapter relevant to the geomantic figure and see if the answer appears to coincide with your fate and fortune. If it does, well and good – the rest of the text gives you all the details you need. If it doesn't, then the experiment should be repeated up to three times in all, with a delay of at least an hour between each try. The manuscript goes on to explain:

It is necessary for the Reader to observe that, if on trial, the answer does not correspond with the *known* part of his fate, (and particularly the disposition and bodily marks;) he may be sure that some mistake has been made by him in the process . . . This being the case, (*which sometimes will necessarily happen*), let him, if during the Summer Season, wait during the full *space of an hour and a half*, and if during the Winter Season, *one hour*, before he *again* makes his divining point. The Editor has also discovered from repeated trials, among his Friends, that it would be better for each person to make *three* trials, (after the proper time has intervened), and if *two*, out of the *three* trials, produce similar *figures*, let him choose *that particular* figure, which comes *twice* the same, for his Horoscope [in 1822 this word did not *only* mean an astrological chart]. But if all *three* are different, let him choose that which corresponds with his own ideas, and bodily marks or moles, as described in the Work.

The text occasionally refers to people 'being born under one symbol' or another, thus betraying the fact that this material was obviously 'borrowed' from an earlier work of astrogeomancy rather than from Napoleon's bedside. Nevertheless the interpretations of each geomantic figure are quite unique, even if the *modus operandi* is somewhat oversimplified.

When one particular geomantic figure is finally settled upon, the relevant chapter gives details of your most favourable astrological influences, qualities of mind and body, particular fads, fantasies or phobias, favourite colour, financial fortune, crucial ages, and fortunate times and hours. As an indication of the rather unique interpretation given to the figures by Smith, I quote here the text for Amissio:²

They who have this *figure* of Geomancy, arising, are under the spirits of the watery regions, and chiefly under the Moon and Venus. They will be of a studious, melancholic, patient, firm, and laborious disposition, rather inclined to obstinacy, and very amorous, votaries of Venus. – Part of their life, will be much fatigued, with getting riches; which they shall obtain; but often lose again, and that suddenly, without great caution is used. – However, as they sink into the vale of years, fortune shall again smile on them; and they shall again re-gain, even more than they lost; seeing their most bitter enemies utterly subjected, and cast down, while they shall descend to the silent tomb, surrounded by happiness.

They shall have moles on the neck, throat, arms, and breast; are subject to scorbutic and hereditary diseases, heartburn, liver complaints, and hypochondria; but generally enjoying good health.

In the south angle of their horoscope, they will have the sorrowful figure Tristitia, of the airy Triplicite, chiefly governed by the cold and rigid Saturn; which will make them remarkable for having dreams of dead things, sepulchers, church-yards, ghosts, and terrific, yet unnatural appearances: and of lofty places, troubled and muddy waters, and destruction. Their dreams shall indeed, for the most part, be ominous, and troublesome. Let them beware of disappointments, when they dream of money – and of deceit, after having dreamed of flattering notice.

They, shall be fortunate in finding hidden, and lost things, and shall at some period of their life, discover a treasure. In their gait, they shall generally appear stooping, and looking, as if towards the earth. They shall arrive to great honor, and dignity, and experience great favor, and friendship, from rich and noble persons, bearing rule in public affairs or offices, and fortunate in the science of hydraulics, and in liquids and fluids in general. – They will be successful in houses, lands, gardens, and earthly things, and should reside in low, crowded and dark places, where they are much frequented.

They will be in danger from an ox, and from other beasts, chiefly those who ruminates, to violent blows and falls, they will be much subject, especially at the ages of *five* and *eight* years. They must be careful of water, at the ages of *nine* and *thirty-six*.

In the west angle, will be found the deceitful and violent figure *Rubeus*, which will cause them at times to be very enviously accused, in some measure through their own seeking, as they shall at times, court hostility, but though not very courageous shall overcome their adversaries. This figure also gives many false friends, with danger of law suits, or public contentions, and will cause them during some period of their life to appear before a Court of Justice, either on the offensive or defensive.

At *ten*, *fifteen*, *twenty-one*, *thirty*, and *forty-six* years of age, they will meet with changes and good fortune, removals, or journeys. At *two*, *four*, *five*, *seven*, *eleven*, *sixteen*, *twenty-eight*, *thirty-five*, and *forty-two* years of age, they will meet with sickness and trouble; at *eighteen* or *twenty-eight* take a long voyage, or go to reside near the water. They shall marry well, but to persons of hasty temper, occasionally devoted to Bacchus, but rigidly careful. At *nineteen*, if a woman, she shall be in love, and marry previous to *twenty-four* years of age. They shall have more than one marriage, and bury their first child.

In the north angle they will have *Fortuna Major*, belonging to the region of the fire, foreshowing a legacy, or some considerable property - trifling gain by the lottery, or games of chance, - they shall be fortunate in *white*, *purple*, *red*, and *citron* colors, - and in bay horses.

They shall have much trouble through their relations, and survive the greatest part of their kindred, - they will be liable to stings from insects, and especially bees or wasps, - they will generally however, die an easy death.

If they travel, let it be by land, and not on horseback, but in some conveyance, let them also beware of fair women, on their travels.

Friday, is their fortunate day, and chiefly about sun-setting, they will prevail. Let them also chose the Moon in *Taurus*, if they would overcome any obstacle, and going to the *full*.

If born in the night time, they will be more fortunate, and successful, than those who are born between sun-rising and sun-setting.

The name of this Angel, or Tutelary Spirit is *Anael*.

Because of the uniqueness of this text, the attributions of all of the figures have been given in tabular form on pp. 146-7.

It is interesting to note from the table on p. 147, and the text for *Conjunctio*, that if one is born at midnight, with a new Moon in conjunction with the Sun, *Conjunctio* for Ascendant and *Albus* for mid-heaven, 'the dead in their graves shall scarcely rest for them, such will be their desire for mysterious intercourse, magic and necromancy.' The text then asserts that 'the manuscript [sic] here relates that Edward Kelly, Chiancungi, and Agrippa, were born under this horoscope, with similar configurations, one of which, the second, was crushed to atoms by infernal spirits.' An odd reference, but interesting inasmuch as the mention of Agrippa points to the possible source of the geomantic borrowings. Where Kelly fits in is not so obvious, except for his well-known interest in necromancy (which incidentally was not embraced by his mentor John Dee). It is probably not coincidence that the infamous engraving depicting Kelly and Paul Waring raising spirits in a churchyard, which is often erroneously captioned as 'John Dee and Edward Kelly raising spirits' first appeared in an astrological magazine edited by Smith (see p. 150).

The Emperor Napoleon himself is reputed by the text to have been born with *Puella* in his ascendant with *Puer* in the Seventh House, but in a later chapter is said to have had *Cancer* in ascendant, demonstrating a rather careless insertion of the Emperor's name into an already existent text, for the purposes of confirming the book's false pedigree.

Finally the last four figures, *Via*, *Fortuna Minor*, *Cauda* and *Caput Draconis* are considerably abridged, having no attributions for their South, West or North points, almost as if upon running short of space towards the end, the chapters on these four figures were confined to a page apiece. Altogether a rather singular variation on the theme of geomancy.

*Table of the attributions of the geomantic figures culled from
The Philosophical Merlin*

Geomantic figure of the Ascendant	Elemental region	Planets ruling	Figure of the South Angle or Mid-heaven	Figure of the West Angle or Seventh House	Figure of the North Angle or Fourth House	Fortunate day	Favourable lunar configuration	Angel or tutelary spirit
<i>Amissio</i>	water	Moon Venus	Tristitia	Rubeus	Fortuna Major	Friday	Moon in Taurus	Anael
<i>Puer</i>	fire	Mars	Carcer	Puella	Populus	Tuesday	Moon in Capricorn and in her first quarter	Samael
<i>Populus</i>	water	Sun Moon Jupiter (or Moon only if born during the day)	Puer	Carcer	Amissio	Monday & Thursday night	Moon waxing in Cancer or Pisces in good aspect to Jupiter	Gabriel
<i>Albus</i>	air	Saturn Mercury	Letitia [sic]	Acquisitio	Conjunctio	Wednesday & Saturday	Moon in Scorpio or Aquarius	Raphael
<i>Fortuna Major</i>	fire	Sun Jupiter (or Sun only if born during the day)	Amissio	Tristitia	Rubeus	Sunday	Moon in Aries or Sagittarius and in her first Sextile	Michael
<i>Conjunctio</i>	earth	Mercury Venus (or Moon and Mercury if born at night)	Albus	Letitia [sic]	Acquisitio	Wednesday & Saturday night	Moon waxing in Cancer by day, and Virgo by night & in Trine to the Sun	Raphael
<i>Puella</i>	air	Venus	Via & Populus	Puer	Carcer	Friday & Monday night	Moon in Cancer or Capricorn at night) approaching conjunction with Venus and Trine with the Sun	Anael
<i>Acquisitio</i>	fire	Jupiter (in Sagittarius)	Conjunctio	Albus	Letitia [sic]	Thursday	Moon in Pisces in Trine to Jupiter or the Sun, but not the new Moon	Zadkiel
<i>Rubeus</i>	water	Mars	Fortuna Minor	Amissio	Tristitia	Tuesday & Friday night	Moon in Cancer approaching full Moon	Samael
<i>Tristitia</i>	air	Saturn Mercury	Rubeus	Fortuna Major	Amissio	Saturday	Moon in Capricorn and sextile to the Sun	Cassiel
<i>Carcer</i>	earth	Mars	Puella	Via	Puer	Saturday & Wednesday night	Moon in Aries, and Trine to Jupiter. Avoid Moon in Cauda Draconis	Samael
<i>Letitia [sic]</i>	water	Saturn Jupiter & Venus (if born at night)	Acquisitio	Conjunctio	Albus	Thursday & Sunday	Moon in Libra, and Sextile to the Sun, also Trine Saturn	Zadkiel & Anael
<i>Via</i>	water	Moon	[not listed]			Monday night	Moon in Capricorn or Virgo. Avoid the new Moon	Gabriel
<i>Fortuna Minor</i>	?	Sun (at night)	[not listed]			Saturday night & noon Thursday	Moon waxing in Leo or Pisces	Michael
<i>Cauda Draconis</i>	fire	South Node of Moon	[not listed]			Tuesday	New Moon, or Eclipse only	Barzabel
<i>Caput Draconis</i>	earth	Jupiter Venus	[not listed]				Moon waxing in Gemini	Raphael & Uriel

NAPOLEON'S OTHER BOOK OF FATE

In the same year as *The Philosophical Merlin* came out, another book appeared, edited by Herman Kirchenhoffer, also purporting to have belonged to Napoleon: it was called *Napoleon's Book of Fate*. Both books make use of geomantic figures, but both are quite different in structure and style.

The Book of Fate by Kirchenhoffer claims an Egyptian origin and was allegedly discovered by Napoleon in a royal tomb near Thebes during his Egyptian campaign in 1798. It was then supposed to have been translated out of the hieroglyphics into French by a Copt (about a thousand years after the knowledge of the meaning of the hieroglyphs had died out amongst the indigenous Coptic population, and almost a quarter of a century before Champollion rediscovered their meaning). The manuscript was then translated into German (for safety!) and in this form found its way into Kirchenhoffer's hands. Unfortunately the book is simply an extension of geomancy, with a simplified system for generating one Mother figure, and is almost certainly a translation from one of the many earlier German books on geomancy. It consists of a series of questions to which a long list of possible answers are appended, appropriately glamorized by the addition of Napoleon and Egyptology, both of which were fashionable at the time.

As Richard Deacon says of it:³

The Book of Fate became a talking point at fashionable London dinner parties, for the moment that Napoleon died a fickle British public turned him from an ogre through which they threatened recalcitrant children into a romantic legend of chivalry and genius. They became eager to learn every possible scrap of gossip about the man who so very nearly became Master of the World. The book itself was sometimes used, as *The Fashion Gazette* had suggested, for party games and refined but shy young ladies surreptitiously consulted it in the privacy of their bedrooms to find out what

kind of husbands they could expect. There were plenty who scoffed, of course, but they were outnumbered by those who actually consulted the book.

Both *The Book of Fate* and *The Philosophical Merlin* claim that the manuscript belonged to the French Emperor and was lost by him at the battle of Leipzig, after which (of course) he was never again completely victorious. It is however rather difficult to see how he won battles using the technique described in either book, for *The Book of Fate* specializes in questions like:⁴

Inform me of any or all particulars relating to the woman I shall marry.
 Shall I live to an old age?
 Shall I have to travel far by sea or land, or reside in foreign territories?
 Shall I make or lose my fortune by gambling?
 Will the patient recover from illness?
 Does the person whom I love, love and esteem me?
 Have I any, or many enemies?
 Will my name be immortalised and will posterity applaud it?
 Will my beloved prove true in my absence?
 Shall I ever recover from my present misfortunes?

Although *The Philosophical Merlin* is not constructed in the same manner, consisting as we have seen of an interpretation of the sixteen traditional geomantic figures, it seems however equally useless for determining military strategy!

Such were some of the manifestations of geomancy in the nineteenth century: masquerading as Napoleon's bedside book, or as the secrets of an ancient Egyptian papyrus. As we have already seen, Europe knew the secrets of geomancy long before either Robert Cross Smith, or Napoleon.

A similar system appeared as recently as 1962 disguised as *The Ladies Oracle* erroneously ascribed to 'Cornelius Agrippa, being an infallible prophet of the male sex'; enough to make the original Agrippa turn in his grave!

While Kirchenhoffer's volume remained a 'one off' effort, Smith and Graham contrived to work at popularizing astrology and geomancy.

Graham combined ballooning with astrology (no doubt consulting his chart before going aloft) and a touch of alchemy, all of which he found quite practical arts. Smith, under the pseudonym of Raphael, meanwhile became the editor of a periodical, the *Stragglng Astrologer of the Nineteenth Century*. Immediately Smith's genius for 'invoking' the names of the famous came to the fore and he apparently enlisted as contributors Her Royal Highness the Princess of Cumberland, the celebrated clairvoyant Mademoiselle Lenormand, not to mention the 'Members of the Mercurii... and other celebrated astrologers'. Her Royal Highness was none other than Mrs Olivia Serres, an eccentric lady who claimed to be the daughter of the Duke of Cumberland; Mademoiselle Lenormand was probably not even aware of the magazine; and the 'Members of the Mercurii' were Smith's friends who formed a little astrological society, of which Lieutenant R.J. Morrison, R.N. ('Zadkiel') was a member, and Smith probably the founder. Nevertheless circulation was greatly boosted!

An interesting example of the application of geomancy to political prognostication is to be found in *The Stragglng Astrologer*, in an article entitled a 'Singular Fulfilment of Predictions respecting the Spitalfields Silk-weavers'. The geomantic figure was cast on the earth in Kensington Gardens on 20 March 1824, to ascertain the result of the Bill pending in Parliament that year concerned with the regulation of the Spitalfields silk-weavers.⁵

Another of Smith's ideas was a column, the 'Weekly Astrological Calendar: founded on Celestial influence' carried by the *Stragglng Astrologer* which became the forerunner of the modern daily newspaper astrology column. After the decease of the *Stragglng Astrologer*,

Smith wrote for yet another magazine produced by the same publisher in 1824-5, and called *Urania*; or, *The Astrologer's Chronicle and Mystical Magazine*, edited by 'Merlinus Anglicus, Junior', yet another of Smith's pseudonyms.

By 1827, Smith was short of funds and so agreed to write an annual publication called the *Prophetic Messenger*, which found numerous purchasers when it finally made its appearance. The instant success of this meant that a number of publishers now rushed to commission new books from him, a number of which are listed in the bibliography. Amongst them was *Raphael's Witch, or the Oracle of the Future*, 1831, which provided a geomantic form of oracle and was delightfully advertised by its publisher as the archetypal coffee-table book of the 1820s, 'adapted to lay about in *drawing rooms* - to be read in *gardens* and *groves* - to ornament the *boudoir* - to be consulted *in* every mood of mind and temper... it removes *ennui* and low spirits, by cheering the heart - brightening the ideas, and alluring to virtue, happiness and bliss.' The original formulators of geomancy could never have foreseen this application!

Many of Smith's friends however were averse to his interest in geomancy, for shortly after his death in 1832 Dixon wrote, 'In professing the science of *geomancy* and *magic* Raphael made many enemies among his astrological friends.' Despite this, the *Prophetic Messenger* became so well known that when Smith died there was great competition to succeed him as its editor. Indeed so well known was his pseudonym that not only are a number of astrological and geomantic publications still in print today under that name, but also no less than five other writers adopted it as their own. They included John Palmer (1807-37), Medhurst who took over the editorship of the *Prophetic Messenger* from 1838-1847, Edwin Wakeley who called himself 'Edwin Raphael', Sparkes (1820-75) and Robert T. Cross (1850-1923) who wrote a number of

books on astrology and issued a cyclostyled manuscript on *The Art of Talismanic Magic* which extracted much material from earlier writers, and has been reprinted a number of times since. He also acquired the copyrights of the well-known *Raphael's Ephemeris* which persists to this day and is published every year in September.

A post-script to the story of Robert Cross Smith is provided by an item in the 1899 *Notes and Queries*⁶ which relates the existence of a geomantic manuscript which was transcribed from an original by 'R.C.S.', quite possibly our Raphael, and which belonged at one time to the painter and astrologer John Varley, the original having been sold with the library of the second Earl of Essex. It would be interesting if this turned out to be the original inspiration for Napoleon's bedside prognosticator.

Mlle Lenormand again features in the history of geomancy, albeit without her knowledge, for B.P. Grimaud issued a pack of cards rejoicing in the name *The Secret and Astro-Mythological Practices* by Mademoiselle Lenormand, dated (incorrectly) 1845. Each card bears either the picture of a figure or a compartmentalized design which includes a mythological/historical scene, flowers, an ordinary playing card design, two lesser scenes, a star constellation, and a letter occasionally accompanied by a geomantic figure. The latter are not explained in the accompanying rather frivolous explanation booklet.

BULWER LYTTON

While geomancy was being thus popularized, its more serious students were carefully studying earlier works on the subject in an attempt to build geomancy into an overall philosophical and magical system. One such student was the novelist Bulwer Lytton (1803-73). He was best known as the author of a number of historical romances

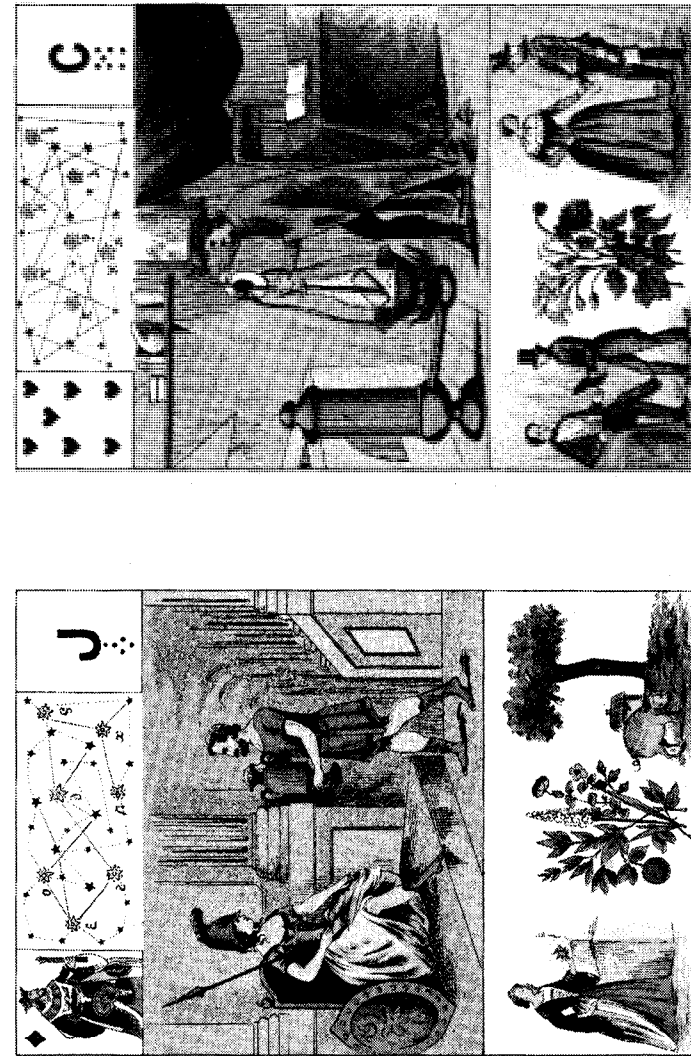

Figure 12 Two cards from *The Astro-Mythological Game* by Mlle Lenormand showing geomantic squeezezer marks

and occult novels, a successful playwright and a politician who rose to be Secretary for the Colonies. During his life, his novels dealing with the supernatural were dismissed as aberrations that would soon be forgotten. Today his occult works such as *Zanoni*, *A Strange Story* and *Zicci* are as well known, if not better known than his other works.

Bulwer first became interested in mesmerism at Cambridge where he met the mesmerist Chauncey Hare Townshend. His marriage in 1827 against his mother's wishes resulted in the withdrawal of his allowance and the subsequent need to write to support himself and his wife. In 1838, two years after separation from his wife, he was created a baronet. Greater financial freedom gave him time to study the medieval and Renaissance writers on divination and magic. His novels increasingly reflected his interest in these subjects.

His favourite method of divination was geomancy, combining this method with astrology. He wrote a long prediction of the career of Disraeli which proved to be amazingly accurate, and drew up horoscopes for various personal friends.

Amongst the books of his library was a well-thumbed copy of *The Geomancie of Master Christopher Cattan* published by John Wolfe in 1591, together with John Heydon's *Theomagia* which also contained much geomancy. From a letter he sent to Hargrave Jennings, author of a two-volume work on the Rosicrucians, it appears that Lytton belonged to at least one Rosicrucian organization. He is also reputed to have organized a club for the practice and investigation of ceremonial magic, to which he recruited the occultist Eliphas Lévi among others. Members are said to have attempted to evoke elemental spirits on the roof of a building in Oxford Street in London, in 1853.

His reputation for being interested in magic grew and he was invited to take part in the Society for Psychical

Research's investigation of the amazing medium D.D. Home. However, when the Societas Rosicruciana in Anglia appointed him as their Honorary Patron he refused the honour (not surprisingly considering that the Society decided on the appointment without consulting him, only actually notifying him of the appointment, on a letterhead on which his patronage was already printed!). The Society however spawned one of the best known magical fraternities, the Hermetic Order of the Golden Dawn.

8 · Geomancy in the twentieth century

The Golden Dawn was the brainchild of S.L. MacGregor Mathers and two of his Masonically inclined associates, Dr Wynn Westcott and Dr Woodman. The history of the formation of this Order, based on alleged German Rosicrucian manuscripts, is too well known to bear repeating here: suffice it to say that Mathers was the synthesizing genius who amassed an encyclopaedic knowledge of magic, from the manuscripts and printed books of the British Museum Library. He combined this avid scholarship with a Celtic turn of mind, an ascetic life-style, and an enthusiasm for all matters military. Not only was Mathers's breadth and depth of knowledge about magic and the other medieval sciences of divination, invocation and evocation, essential to the founding of the Golden Dawn, but also his ability to synthesize previously disparate views and apparently unconnected ideas, into a monolithic schema, would have done credit to the most intricate of the Renaissance memory systems.

Mathers resorted to the rather quaint distortions of Arab magic that had filtered through to Europe via Spain in the eleventh and twelfth centuries, the fragments of classic tradition which had become part of magic, the Jewish Qabalah (for which he had a very special passion), the intricate symbolism of alchemists, and the fantasies of the Rosicrucians, and welded them together into a coherent and living whole which used as its framework the

Tree of Life, or Otz Chiim (*Etz 'Hayyim*), and the complex pantheon of Egyptian gods. For Mathers, the magical dictum 'as above so below' was as strong an article of faith as his belief in the reality of the earth beneath his feet. As a result of this view of the world, Mathers was able to draw the most complicated parallels between previously diverse systems, using the numerical classification of the thirty-two Paths and Spheres of the Tree of Life which brought together systems based on the Triad, the Heptad, the Dodecad, the twenty-two Tarot Trumps, or letters of the Hebrew alphabet, the sixteen figures of geomancy, twenty-five elements and sub-elements, pantheons both European and Oriental, and the bewildering maze of spirits, Dukes, Earls and other Lords of Hell in the Grimoires.

From John Heydon's *Theomagia*, Christopher Cattán's *Geomancy*, and various manuscript geomancies in the British Museum, Bibliothèque d'Arsehal and Bibliothèque Nationale in Paris, he drew together a concise document on geomancy. This has had a number of recensions with Israel Regardie's and Aleister Crowley's printed works relying on it for geomantic source material, but it was basically in the form of a 'knowledge lecture' circulated amongst the members of the Hermetic Order of the Golden Dawn that Mathers's work served its primary purpose.

One of the early associates of the Golden Dawn was Franz Hartmann whose *Principles of Astrological Geomancy* (1913) includes a rather Theosophically flavoured astrological introduction, with material from Agrippa, and a large appendix 'containing two thousand and forty-eight answers to questions translated from the German of the sixteenth century', in reality a Judge/Witness table providing answers to sixteen basic questions.

Israel Regardie, a member of the Stella Matutina, a later offshoot of The Golden Dawn, published a version of this geomancy 'knowledge lecture' in the fourth volume of his

The Golden Dawn. This has been until recently the best modern source of information on geomancy succinctly packed into twenty-four pages, and has been reworked by Regardie into a short booklet.

In 1909 Crowley began publishing his series of bi-yearly magazines called the *Equinox*, which resembled in its bulk a book rather than a magazine. In the second number, published in that year there was a short sketch called *A Handbook of Geomancy* which relied for most of its information on the Golden Dawn 'knowledge lecture' given to Crowley at his initiation. In the course of transcribing this material Crowley abridged most of the instructions, and according to his own admission, omitted a number of pertinent points. To quote his introduction to the Handbook:

This MS. is now first printed from the private copies of certain adepts, after careful examination and collation. It is printed for the information of scholars and the instruction of seekers. By the order of the A ∴ A ∴ [Crowley's magical Order] certain formulae have been introduced into it, and omissions made, to baffle any one who may seek to prostitute it to idle curiosity or to fraud. Its practical use and the method of avoiding these pitfalls will be shown to approved students by special authority from V.V.V.V.V. [Crowley] or his delegates.

It is strange that Crowley chose this particular 'instruction' to obfuscate, as he published much of the Golden Dawn material of a much more recondite nature elsewhere in the *Equinox*. Obviously his note was also designed to attract students to his order, the A ∴ A ∴.

The work was also prefaced by a quote from the *Oracles of Zoroaster*, a square from the *Sacred Magic of Abra-Melin the Mage*, and a sketch by Austin Osman Spare; none of these having much, if anything, to do with geomancy. The quote from Zoroaster is actually a diatribe *against* divination, for it says:

Direct not thy mind to the vast surfaces of the earth; for the Plant of Truth grows not upon the ground. Nor measure the motions of the Sun, collecting rules, for he is carried by the Eternal Will of the Father, and not for your sake alone. Dismiss from your mind the impetuous course of the Moon, for she moveth always by the power of Necessity. The progression of the Stars was not generated for your sake. The wide aerial flight of birds gives no true knowledge, nor the dissection of the entrails of victims; they are all mere toys, the basis of mercenary fraud . . .

Presumably, had Zoroaster been familiar with geomancy, he would have also decried its use as a technique of divination.

The use of an Abra-Melin square is even more odd, for this particular square is drawn from the tenth chapter of the third book of Abra-Melin, and is a square designed 'to hinder Sorcerors from operating'; presumably a safeguard against the mis-use of geomancy! The sketch by Spare is the so called 'Death Posture' from Spare's work *The Book of Pleasure (Self-love): The Psychology of Ecstasy* which was published in 1913 *after* the *Equinox* article. At the time of the *Equinox* article Spare was one of Crowley's A ∴ A ∴ pupils, a fact confirmed by Crowley's manuscript comments on the copy of this work held by the Mitchell Library in Sydney.

The main text of Crowley's *Equinox* commences with a table of zodiacal Sign, and Element, with the corresponding geomantic figure, its sex, name and meaning, presiding Genius, ruler and planet; quite conventional in itself. The second chapter rapidly outlines the method of generating the geomantic figures from the four Mothers to the Judge, with the exception that Crowley introduces the Golden Dawn inspired prescription to 'place appropriate Pentagram (either with or without a circumscribed circle) invoking. If a circle, draw this first. Sigil of ruler to which nature of question most refers should be placed in the Pentagram.' This stipulation has been repeated by other writers of the Golden Dawn tradition, including Israel Regardie, but there appears to be no precedent for this

particular operation before the synthesizing genius of S.L. MacGregor Mathers put together the Golden Dawn, drawing upon Heydon for most of his geomantic information.

Crowley then quickly summarizes the determination of the Part of Fortune and the Reconciler before moving onto his third chapter, where he attributes the first twelve geomantic figures to the twelve Houses of heaven. His method of attribution is traditional Golden Dawn attribution and summarized in Appendix III (pp. 238–9).

Then comes the part of the handbook which Crowley might well have 'designed to baffle anyone who may seek to prostitute it', for it consists of sets of interpretative tables whose main claim to fame is that they are an incomplete summary of an earlier text. The tables of Witnesses and Judge are set out in such a way that you can derive answers to ten different categories of questions which are, 'Life, Money, Rank, Property, Wife, Sex of Child, Sickness, Prison, Journey, Thing Lost'. These ten categories of question, rather oddly assorted in themselves, are actually a bastardized version of the twelve categories of the astrological Houses into which any particular geomantic figure could fall. Additionally one would have hoped that anyone slightly versed in geomancy should have been able to combine the basic meanings of two Witness and one Judge figure and use their own intuition to derive a much more specific answer than the extremely bare 'mod', 'good', 'bad', 'evil', etc. Even this scheme breaks down and occasionally a number appears in the column indicating that the judgment should be determined, 'by the figure in that House of Heaven': as the text was in its original form designed to be a table of Houses, this is a fair indication of the degree of debasement which has occurred to the text. Regardie in *The Golden Dawn* says of these tables: 'I have found them most untrustworthy, giving answers in utter contradiction to the proper divination worked out by the readings.'

In Chapter V Crowley gives tables of the meanings of the sixteen figures when they fall in each of the twelve Houses. These are basically accurate but extremely abridged.¹

The last five pages of Crowley's *Handbook of Geomancy* cover extremely rapidly the astrological interpretation of the figures, aspects, essential dignities, friendship and enmity of the planets and figures, and other matters: an extremely sketchy treatment culminating in yet another sketch by A.O. Spare. Nevertheless this text on geomancy was one of the few available this century, and has therefore been quite influential, appearing again by itself at a later date in a card-covered edition.

Crowley's interest in geomancy was also reflected in his great work of Qabalistic correspondences *Liber 777*, and in *Magick in Theory and Practice*, where he praises geomancy as being 'rigorously mathematical'. He goes on to explain:²

The objection to its use lies in the limited number of the symbols. To represent the Universe by no more than 16 combinations throws too much work upon them. There is also a great restriction arising from the fact that although 15 symbols appear in the final figure, there are, in reality, but 4, the remaining 11 being drawn by an ineluctable process from the 'Mothers' . . . Some Adepts, however, appear to find this system admirable, and obtain great satisfaction from its use. Once more, the personal equation must be allowed full weight.

Crowley claims to have used geomancy extensively, but never felt wholly at ease with it, finding interpretation very difficult, which is not to be wondered at if he used his own tables! He conceded that the tables given in his *Handbook* 'are exceedingly vague on the one hand, and insufficiently comprehensive on the other', but justified his inability to get on with geomancy in terms of the low order of the geomantic intelligences involved, who were far from sympathetic to his work.

If Crowley lacked success in his practice of geomancy, then one of his pupils, Thomas Windram (or Frater Semper

Paratus), did not. To quote Crowley's *Confessions*:³

this brother possessed the most remarkable magical faculties, within a certain limited scope. It was natural for him to bring into action those forces which impinge directly upon the material world. For instance, his ability to perform divination by means of geomancy (which presumes the action of intelligences of a gross type) has no parallel in my experience . . .

By profession Frater Semper Paratus was a chartered accountant. He would be called in to audit the finances of some firm. He would find himself confronted by an overwhelming mass of documents. 'It means three weeks' work', he would say to himself, 'to discover the location of the error . . .' Instead of exploring the mass of material at random, he would set up a series of geomantic figures and, after less than an hour's work, would take up the volume geomantically indicated and put his finger at once upon the origin of the confusion.

Formerly one might not have associated the 'geomantic intelligences' with accountancy, their nature being more associated with the earth, consequently it comes as no surprise that:

On another occasion, he bethought himself that, living as he did in Johannesburg, surrounded by gold and diamonds, he might as well use geomancy to discover a deposit for his own benefit. Indifferent as to whether he found gold or diamonds, he thought to include both by framing his question to cover 'mineral wealth'. He was directed [by the geomantic intelligences] to ride out from the city by a given compass bearing. He did so. He found no indication of what he sought. He had given up hope and determined to return when he saw a range of low hills before him. He decided to push on and see if anything was visible from their summit. No, the plain stretched away without promise, a marshy flat with pools of stagnant water dotted about it. At this moment of complete disappointment, he noticed that his pony was thirsty. He therefore rode down to the nearest pool to let him drink. The animal refused the water, so he dismounted to find out the reason. The taste told him at once that he had discovered an immensely rich deposit of alkali. His geomancy had not misled him; he had found mineral wealth. He proceeded to exploit his discovery.

However, as is often the case with such magically acquired information, his practical exploitation of this find was,

according to Crowley, balked by Brunner, Mond and Company, who presumably were also interested in these deposits. A similar experiment undertaken with a combination of geomantic intelligence and pendulum, coupled with a map, to determine the location of gold deposits, resulted ironically enough in a perfect fix being obtained on a point on the map which subsequently turned out to be the vaults of a rather large bank!

While English adepts applied geomancy to magical ends, their French counterparts were reaping the harvest of their anthropologists' labours in Madagascar, in what was then French West Africa, and Northern Africa. Because of this, the French literature on geomancy has long been aware of the history of the subject, stretching as it does from the Arab culture of North Africa, south to sub-Saharan regions and Madagascar. It is interesting that ex-colonial settlement patterns still have an influence on cultural orientation, although studies of *ifa* and *fa* in English do not seem to have ever been correlated with European geomancy except as a footnote or passing remark by writers such as Burton, who was not blinkered by a particular 'discipline'.

Some two years after Caslant produced his study of geomancy,⁴ drawn from the work of Christopher Cattan, we find a hefty two-volume tome published by Dom Néroman, an 'ingénieur civil des mines' called *Grande Encyclopédie Illustrée Des Sciences Occultes*. Oddly enough this volume is one of the few 'occult' books which are actually shelved in the British Library's open reference section, and although it is very much a reflection of its period, and of French occultism generally, the Library has seen fit to have this as almost sole reference work over and above many similar English compilations. Nevertheless the work contains a large chapter on geomancy whose main claim to an original contribution is a systematization of the generation of the figures of geomancy which was later taken up and carried to its logical conclusion by Robert

Jaulin in his work *La Géomancie: Analyse-Formelle* in 1966, the best so far on the logical relationships between the figures. Apart from this, Néroman contributes some interesting circular drawings of the sixteen geomantic figures opposing each other in various relationships such as must have been part of a Lullian disc. He includes a large table which links up the geomantic figures with more than the usual planets and elements, by including metals, colours, months of the year, days, lengths of time and typical occupations associated with each figure.

PART TWO • Practice

9 · Method and manipulation

CONDITIONS FOR PRACTICE

Before divining you should make sure that external circumstances are favourable. Agrippa suggests that you should not divine on a 'cloudy or rainy day, or when the weather is stormy, nor while the mind is disturbed by anger or oppressed with cares'.

Gerard of Cremona likewise explains:¹

you must always take heed, that you do not make a question in a rainy, cloudy, or a very windy season, or when thou art angry, or the minde busied with many affairs; nor for tempters or deriders, neither that you may renew and reiterate the same Question again under the same figure or forme; for that is error.

More specifically, a fourteenth-century work on geomancy by Nicholas Oresme suggests that if a man who is about to put a question to the oracle walks about in the quiet of the night and thinks the matter over thoroughly with all the reasons pro and con, and then suddenly casts his points without noting their number, the 'motion of the sky' will lead him to the right number and hence the right answer.

It is easy to see why the diviner should be in a calm state of mind, for obviously the intuition is going to function better if the person is not depressed, thinking of other things, or acting in an offhand manner. For the same reasons, geomancy or any form of divination should not be

attempted lightheartedly at a party, for gratifying idle curiosity or mere amusement. All of these circumstances will tend to destroy any feeling or faculty you have for divination. Similarly, do not keep asking the same question, hoping that a 'better answer' will be produced. If the first answer is not easy to understand, then the second will not be any easier; besides repeated asking of the oracle is as impolite as continually demanding the same thing from a person, who may be answering you, but whom you cannot hear. If an answer is genuinely perplexing, try asking a different corroborative question rather than using the same form.

The first half of Agrippa's stipulations are however harder to understand: not only is the diviner to be in a peaceful mood, but also the weather! This specification is the same as that made for evocation in many of the grimoires, so it seems that disturbed weather makes it difficult to attract and get answers from the earth elementals necessary for the divination. Aleister Crowley suggests that the diviner²

must banish all thoughts which concern himself, those of apprehension no less than those of ardour . . . So long as his mind is stirred, however slightly, by one single aspect of the subject, he is not fit to begin to form the figure . . . he must await the impulse to trace the marks on the sand; and, as soon as it comes let it race to the finish. Here arises another technical difficulty. One has to make 16 rows of dots; and, especially for the beginner, the mind has to grapple with the apprehension lest the hand fail to execute the required number. It is also troubled by fearing to exceed; but excess does not matter. Extra lines are simply null and void, so that the best plan is to banish that thought and make sure only of not stopping too soon!

THE EQUIPMENT

Having established the right conditions for practice, it is

necessary to consider the equipment of divination. In its original form, geomancy used the earth itself, or a sand tray in which to make the initial marks.

A. If you want to be this authentic you should obtain a shallow square box, several inches deep and up to a couple of feet square, filled with dry sand obtained from an inland site.

B. Traditional sub-Saharan *raml* equipment is a chalk and slate (both products of the earth) which are even easier to use for marking rows of dots.

C. The *ifa* board covered with flour or termite dust is another possible instrument, to be used in conjunction with palm nuts.

D. For European practice one can do no better than quote Christopher Cattan's *Geomancie*: 'The instrument of this Arte is a Penne, Incke, and Paper, or a board wel shaven, and a little bodkin or punchin, or else upon the ground in dust, or sand well purged and made cleane, with a little sticke, which is the verie manner which was used in the olde time . . . But now the best way for to practice the same is, with Penne, Incke, and Paper . . .

'Beanes or other grains is the manner of the curtizances [citizens] of Bolognia, when they would know newes of their friends absent, and as yet it is used throughout all Italie.' The latter is a practice strangely reminiscent of the techniques used for consulting *ifa*!

E. Two other methods for producing the initial geomantic figures have been suggested by Israel Regardie. The first consists of using a bowl full of large pebbles. From it are drawn a handful of pebbles at a time for each line. If the number of pebbles drawn is uneven, then one dot is written down, if even then two dots. Sixteen draws are needed to complete the initial geomantic figures as will be explained later in this chapter.

F. His second suggestion was simply to use two dice to produce odd or even number combinations, with the same

result in terms of dots.

Both *E* and *F* are considerably simpler than the traditional methods, but the pebbles have more of the quality of earth about them than the dice.

G. Throughout the rest of this book, however, the more simple equipment of pencil and paper will be used to make the initial sixteen lines of points.

Whichever method selected from those given above, according to which appeals most to your temperament, stick to it and don't flit from one method to another.

Having assembled your equipment, you may now like to consecrate it to the service of the Earth elementals, thereby establishing a point of contact between them and the equipment. A simplified form of consecration could consist of anointing them with olive oil or sprinkling salt over them whilst reading an Invocation to the Gnomes of your own devising.³ When your equipment is 'charged', it should be kept wrapped or covered and out of sight, unless in use.

Before going any further you should acquire a book in which to keep your geomantic exercises, in which the questions, charts and interpretations should be fully and truthfully recorded. There is no good in deceiving yourself about your correct predictions, if you forget your less accurate answers. Keep a fair score as to the correctness or otherwise of each of your divinations. This will give you a clear indication if you need to refine your technique, or conversely will demonstrate beyond doubt the emergence of your intuitive faculty. As you improve this ability your score should rise to at least 80 per cent accuracy, or even better.

THE QUESTION

Among the questions which geomancy undertakes to answer are:⁴

how long will one live, whether one will better one's present position, whether one should enter the clergy or remain a layman, whether a journey will be dangerous, whether a rumour is true or false, whether you buy or not, whether the year will be a fertile one, and concerning gain and loss, hidden treasure, the condition of a city or castle, and which side is stronger in a war. Whether a child will be born or not, of what sex it will be, and whether it is legitimate or a bastard. Which of two magistrates is superior in wisdom, whether a scholar can by study become an honour to the convent or not, whether the soul of some dead person is in paradise or before the doors of paradise or in purgatory or in hell.

Of course these questions rather quaintly reflect the hopes and the desires of several centuries ago and the oracle could equally well be asked for news of possible promotion, success of a business venture, trustworthiness of a partner, employees or a spouse, the development of a love affair, marriage, the whereabouts of a thief or of stolen goods and so on: the range of possible questions is limitless.

Let us assume that you are provided with the necessary equipment, be it pencil and paper, sandtray, chalk and slate, pebbles, or dice. Now you must formulate your question. It is no good just trying out geomancy for fun. If you want a reliable device to give you serious answers to your serious questions and serve you well, then you must treat it as such. Imagine that your tools of divination in fact are a person whose advice you respect. Immediately it is obvious that you should not ask it fatuous questions or invent questions whose answers you already know, just to try it out. If you have no faith in its abilities to reveal the unknown to you, it will treat your flippant questions to a dose of nonsense or flippant answers.

So, when selecting your question, think seriously, write down the question in your book of geomantic exercises so that there is no possible ambiguity in it or room for evasive answers, then check to see which of the following categories it falls into:

Questions of Mars

Concerned with war, struggle, fighting, victory, weapons, dissension, energy, haste, anger, destruction, danger, accidents, surgery and vitality.

Questions of Jupiter

Concerned with good fortune, general happiness, church matters, or holding office in an organization concerned with spiritual matters, abundance, plenty, growth, expansion, generosity and some forms of spirituality.

Questions of Saturn

Concerned with gardening, farming, crops, sorrow, bereavement, death, legacies, long-standing problems, older people and old plans; debts and their repayment, real estate, wills, stability, inertia, time and patience.

Questions of Mercury

Concerned with science, learning, trickery, theft, knowledge, gambling, business matters, writing, contracts, judgment, short travels, buying, selling, bargaining, neighbours, giving and obtaining information, literary capabilities and intellectual friends, libraries, books, papers, communications, publications.

Questions of Venus

Concerned with love, music, pleasure or luxury, social affairs, affections and emotions, women, younger people, the arts, music, beauty, extravagance and self-indulgence.

Questions of the Moon

Concerned with travelling, fishing, childbirth, reproduction or tidal change, the general public, women, short journeys and removals, changes, fluctuations, the personality, visions and dreams.

Questions of the Sun

Concerned with music, feasting, success, power and rulership, employers, executives, power and success, life, money, growth of all kinds, illumination, imagination, mental power, creativity and health.

If you wish to take great pains with your divination, then you might choose to perform it at certain times, which are more propitious for some types of question than others. The time is dependent on the planetary category into which the question falls. Why the time should make a difference is hard to say, but magicians and diviners have been using certain days or hours for certain types of question or operation for many centuries now. Perhaps the constant usage has 'worn into' the time, the associated qualities. Details of such times may be found in Appendix IV for those who care to use them.

THE ACTION

The physical process of geomantic divination is similar to the trial-run simple divination outlined in the Introduction, except that instead of drawing only four lines to generate one figure, we use sixteen lines to generate four figures. Greater complexity generates greater accuracy.

Having decided on the planet relevant to your question, take a clean piece of paper and write out your question as specifically as possible.⁵ Then make a row of random dots

or points, at the same time thinking clearly of the question. In all a total of sixteen rows of dots should be made. The pen is to be held firmly in the hand, which should not rest on the paper, while making the dots quickly and mechanically, from right to left, without counting. The right-left direction is obviously a carry-over from geomancy's Arabic origins. It is best to avoid the temptation of anticipating or counting them, which can result in unconscious manipulation of the divination. If you are working with the sand tray you may have to note the number of digs (points made in the sand) every four lines or so, and after transferring the numbers to your paper, rub them out and proceed to the next four lines. However, if you are working solely with a pencil and paper you can go ahead until you have done at least sixteen lines of dots. A few more won't matter as you just discount any lines after the sixteenth. It is however, advisable to have at least something in the vicinity of a dozen dots per line. Next cancel the points in each line, a pair at a time, until only one or two points are left. (Alternatively you can count the total number of points in the line. If the total is odd, mark one point as the remainder; if even, mark two points as the remainder.) Observing the operation from right to left we get:

	<i>Figures generated</i>	<i>Points</i>	<i>Row</i>
Fire (South)	Fire	○	○ ○ ○ ○ ○ ○ ○ 1
	Air	○	○ ○ ○ ○ ○ ○ ○ ○ 2
	Water	○ ○	○ ○ ○ ○ ○ ○ ○ ○ ○ ○ 3
	Earth	○ ○	○ ○ ○ ○ ○ ○ ○ ○ ○ ○ 4
Air (East)	Fire	○ ○	○ ○ ○ ○ ○ ○ ○ ○ ○ ○ 5
	Air	○ ○	○ ○ ○ ○ ○ ○ ○ ○ ○ ○ 6
	Water	○	○ ○ ○ ○ ○ ○ ○ ○ ○ ○ 7
	Earth	○ ○	○ ○ ○ ○ ○ ○ ○ ○ ○ ○ 8

Water (North)	Fire	○	○ ○ ○ ○ ○ ○ ○ ○ 9
	Air	○	○ ○ ○ ○ ○ ○ ○ ○ ○ ○ 10
	Water	○	○ ○ ○ ○ ○ ○ ○ ○ ○ ○ 11
	Earth	○ ○	○ ○ ○ ○ ○ ○ ○ ○ ○ ○ 12
Earth (West)	Fire	○ ○	○ ○ ○ ○ ○ ○ ○ ○ ○ ○ 13
	Air	○ ○	○ ○ ○ ○ ○ ○ ○ ○ ○ ○ 14
	Water	○	○ ○ ○ ○ ○ ○ ○ ○ ○ ○ 15
	Earth	○	○ ○ ○ ○ ○ ○ ○ ○ ○ ○ 16

Here ends the physical work of the divination. From here on, the figures formed from the above dots are manipulated to give an answer to the question, so you can lay aside your sand tray, slate, pebbles or dice and work solely on paper.

In order to understand the details on the left-hand side of the page it is useful to quote Christopher Cattani: 'everie pricke [point] signifieth a Starre, and everie line an Element, and everie figure the foure quarters of the world', so that a system of symbolism may be imposed upon the lines of points. Thus, the first line is attributed to Fire, the second to Air, the third to Water, and the fourth to Earth. The same sequence repeats for the fifth to eighth line, the ninth to twelfth line, and also the last four lines. Similarly, each group of four lines which is to become a geomantic figure in its own right is attributed to an element: the first figure of four lines to Fire, the second to Air, and so on. A further level of meaning can be added to the figures by giving cardinal directions to the lines and figures, south to Fire lines and figure, east to Air, north to Water and west to Earth.

10 · Generation of the Judge

MOTHERS (MATRES)

The four geomantic figures so formed are called the four Mothers and are the basis for the whole geomantic chart. From here on the geomantic figures and calculations are generated solely out of these four figures. Put them *side by side* from right to left and examine them carefully:

	Earth	Water	Air	Fire
	IV	III	II	I
head	○ ○	○	○ ○	○
neck	○ ○	○	○ ○	○
body	○	○	○	○ ○
feet	○	○ ○	○ ○	○ ○
	West	North	East	South

Look at each Mother: you will see that each line containing either one or two dots is labelled according to the parts of the body. From these four figures the rest of the chart is formed, and although the operations which follow look complex, in fact they only take about three minutes once you have got the hang of them. Read the instructions through first, then come back to this point and using a pencil and paper, construct each of the figures given in this example as outlined in the instructions.

DAUGHTERS (FILIAE)

The Mothers 'give birth' to the first Daughter, which is generated by taking all the heads from Mothers I to IV and placing them one on top of the other.

First Daughter - figure V

- from the head of I
- ○ from the head of II
- from the head of III
- ○ from the head of IV

Then take all the necks from Mothers I to IV and place them on top of each other to produce the second Daughter.

Second Daughter - figure VI

- from the neck of I
- ○ from the neck of II
- from the neck of III
- ○ from the neck of IV

Similarly, the Third Daughter - figure VII

- ○ from the body of I
- from the body of II
- from the body of III
- from the body of IV

And the Fourth Daughter - figure VIII

- ○ from the feet of I
- ○ from the feet of II
- ○ from the feet of III
- from the feet of IV

The Daughters assume the same element and directional qualities as the Mothers:

Daughters				Mothers			
VIII	VII	VI	V	IV	III	II	I
○ ○	○ ○	○	○	○ ○	○	○ ○	○
○ ○	○	○ ○	○ ○	○ ○	○	○ ○	○
○ ○	○	○	○	○	○	○	○ ○
○	○	○ ○	○ ○	○	○ ○	○ ○	○ ○
Earth	Water	Air	Fire	Earth	Water	Air	Fire
West	North	East	South	West	North	East	South

NEPHEWS (NEPOTES)

Next comes the generation of the Nephews, which are produced in a different manner. Look at the eight figures laid out above, take them two at a time and 'add' them together thus:

Mother I	plus	Mother II	=	Nephew IX
head ○	+	○ ○ = odd	=	○
neck ○	+	○ ○ = odd	=	○
body ○ ○	+	○ = odd	=	○
feet ○ ○	+	○ ○ = even	=	○ ○

In this example, the heads together make up three dots (*odd*), so mark down one dot. Taking the necks of these Mothers, we again have an *odd* number, so again mark down one dot. Likewise the bodies make one dot (*odd*). But the feet together make up four dots (*even*) so mark down two dots. The figure of the first Nephew is now:

Nephew IX	○
	○
	○
	○ ○

For the next Nephew repeat the same process but with Mothers III and IV.

Mother III	plus	Mother IV	=	Nephew X
○	+	○ ○ = odd	=	○
○	+	○ ○ = odd	=	○
○	+	○ = even	=	○ ○
○ ○	+	○ = odd	=	○

For the next two Nephews, repeat the same process but with the Daughters.

Daughter V	plus	Daughter VI	=	Nephew XI
○	+	○ = even	=	○ ○
○ ○	+	○ ○ = even	=	○ ○
○	+	○ = even	=	○ ○
○ ○	+	○ ○ = even	=	○ ○

And

Daughter VII	plus	Daughter VIII	=	Nephew XII
○ ○	+	○ ○ = even	=	○ ○
○	+	○ ○ = odd	=	○
○	+	○ ○ = odd	=	○
○	+	○ = even	=	○ ○

So far we have got:

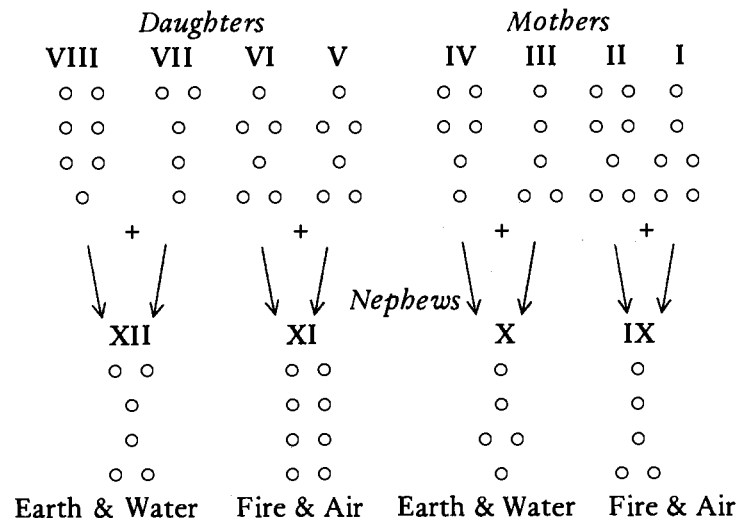

WITNESSES (TESTES)

From the four Nephews are constructed the two Witnesses (Coadjutrices or Testes) in the same manner, that is the first Witness from IX and X, and the second from XI and XII.

<i>Nephew IX</i>	plus	<i>Nephew X</i>		<i>Witness XIII</i>
○	+	○ = even	=	○ ○
○	+	○ = even	=	○ ○
○	+	○ ○ = odd	=	○
○ ○	+	○ = odd	=	○

and then:

<i>Nephew XI</i>	plus	<i>Nephew XII</i>		<i>Witness XIV</i>
○ ○	+	○ ○ = even	=	○ ○
○ ○	+	○ = odd	=	○
○ ○	+	○ = odd	=	○
○ ○	+	○ ○ = even	=	○ ○

The two Witnesses look like this, and are attributed to all four Elements which make up their nature:

<i>Witness XIV</i>		<i>Witness XIII</i>
○ ○		○ ○
○	and	○ ○
○		○
○ ○		○

JUDGE (JUDEX)

Finally, from the Witnesses is formed the Judge, again by addition.

<i>Witness XIV</i>	plus	<i>Witness XIII</i>		<i>Judge XV</i>
○ ○	+	○ ○ = even	=	○ ○
○	+	○ ○ = odd	=	○
○	+	○ = even	=	○ ○
○ ○	+	○ = odd	=	○

Thus are formed the figures required for judging the outcome of the geomantic divination, the Four Mothers, Four Daughters, Four Nephews, the Right Witness, Left Witness and the Judge.

The Judge gives a general answer to the question as to whether the matter will come to a good or bad end. If the Judge's figure is compatible with the first Mother, and the other figures generally on the right hand side of the chart, then one can expect a good outcome with benefit to the querent. If however the Judge agrees in nature with the Daughters and those figures to be found generally on the left-hand side of the geomantic chart then matters are likely to go against the querent and in favour of his enemies as signified by the left Witness. In short:

- 1 A good Judge made of two good Witnesses is good.
- 2 A bad Judge made of two bad Witnesses is bad.
- 3 A good Judge made of one good Witness and one bad Witness means success, but delay and vexation.
- 4 If the two Witnesses are good and the Judge bad, the result will be obtained; but it will turn out unfortunately in the end.
- 5 If the first Witness is good and the second bad, the success will be very doubtful.
- 6 If the first Witness is bad and the second one good, the unfortunate beginning will take a good turn.

Sometimes if the divination still provides conflicting answers, it is possible to construct a Reconciler (or Supreme Judge) which is constructed by adding together the first Mother (I) and the Judge (XV). Only consult the Reconciler if there is no clear answer. Never consult it just because you do not like the answer you have.

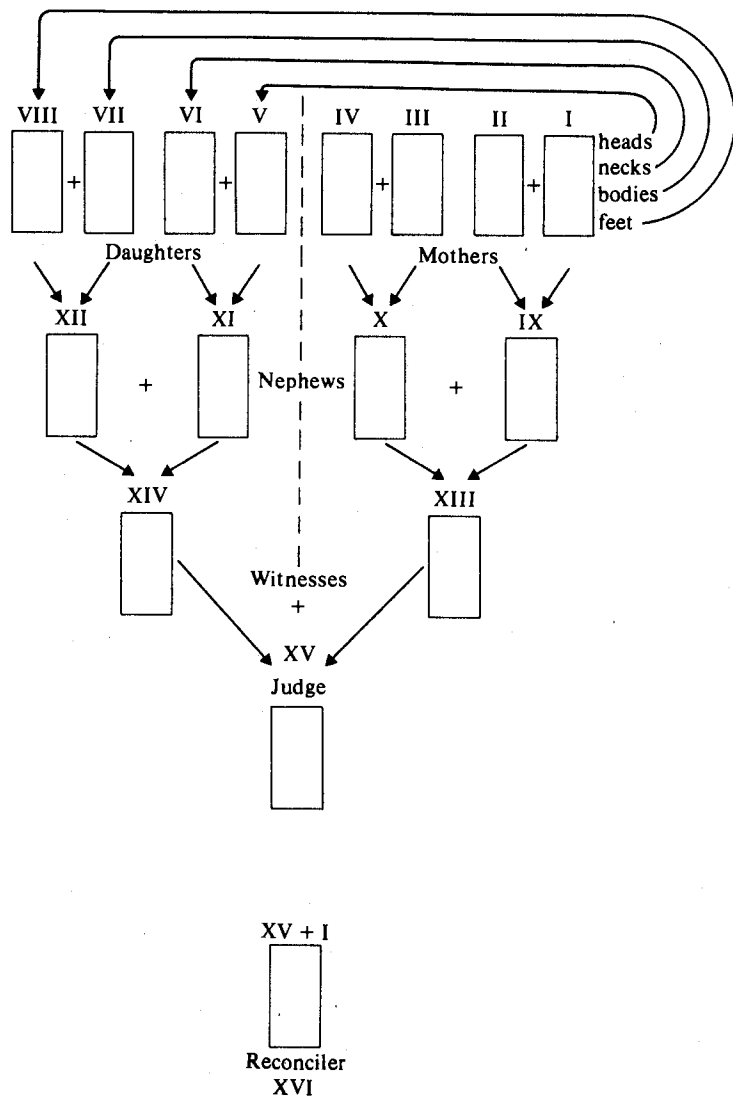

<i>Judge XV</i>	plus	<i>Mother I</i>	=	<i>Reconciler XVI</i>
o o	+	o	=	o
o	+	o	=	o o
o o	+	o o	=	o o
o	+	o o	=	o

All this sounds complex but it isn't; it just takes a long time to explain. If we set out the evolution of the figures in a graphic form, the simplicity of the whole operation becomes apparent (see Figure 13).

Because of the manner in which the Judge is formed, being composed of various parts of all the other figures, it can only come out as one of eight possible figures, *Acquisitio*, *Amissio*, *Fortuna Major*, *Fortuna Minor*, *Populus*, *Via*, *Conjunctio* or *Carcer* - in fact only those whose *total* number of dots add to either 4, 6 or 8. This provides a rough but handy check, for if a Judge with an odd number of points turns up, you should check your calculations. Because of the binary mathematics involved it is certain that a mistake has been made if any other figure is generated as a Judge.

Figure 13 The pattern of generation of the figures

II · The sixteen figures in detail

The most basic attribution is that of the four Elements to the sixteen figures of geomancy, not the circumstantial attribution which we examined in the previous chapter (which changes from divination to divination) but the permanent attribution of Element to figure according to the significance and nature of that figure. (Variant arrangements may be found in Appendix II.) The following are the four figures of

Fire in the South

Fortuna Minor
Amissio
Rubeus
Cauda Draconis

Air in the East

Conjunctio
Puer
Laetitia
Acquisitio

Water in the North

Puella
Populus
Via
Albus

Earth in the West

Caput Draconis
Fortuna Major
Cancer
Tristitia

So far we have the techniques for creating the four Mothers using sand tray, slate, paper, pebbles or dice. Then we have the analysis and manipulation which forms the four Daughters, four Nephews, two Witnesses, Judge, and possibly the Reconciler. We must now be able to read the hieroglyphs so created.

If you look back to the Introduction, you can recognize the rough meanings of each of the sixteen possible figures which may turn up in any geomantic divination. To these basic meanings can be added a host of traditional attributions, which help to explain the meaning of specific figures found in the various parts of the geomantic chart drawn up for a particular question.

Each of the seven classical planets has two of the geomantic figures allocated to it:

The greater and lesser Fortunes are ascribed to the Sun; Fortuna Major when the Sun is above the horizon and astrologically dignified, Fortuna Minor during the night when the sun is below the horizon or placed in lesser dignities.

The Moon rules Via (street or way) and Populus (people or crowds) during her waxing and her waning respectively.

The Jupiterian figures of Acquisitio (gain and profit) and Laetitia (joy) are both bountiful figures respectively of material success and happiness; the former when the planet has direct motion, the latter when moving retrograde.

Puella (girl) and Amissio (loss) are respectively the fortunate and retrograde (or less fortunate) aspects of Venus.

Similarly, Conjunctio (union) and Albus (white) are the

two sides of Mercury, both good figures, but the first more propitious than the second.

The good and evil aspects of Mars are represented by the Puer (boy) and Rubeus (red) figures respectively.

Saturn's two figures are by the very nature of the planet, both evil. They are Carcer (prison) and Tristitia (sorrow); the first being the more evil of the two.

The remaining figures, Caput Draconis and Cauda Draconis are represented in the heavens by the nodes of the Moon, the point where the Moon crosses the Ecliptic. These last two are strange concepts inasmuch as they are not heavenly bodies but mathematical points in the sky. They are not used much in modern astrology but their old meanings are still very necessary parts of a divination.

The reason for the introduction of astrological terms at this point is twofold. First, they will be of great help later when applying the geomantic figures to the Houses of Heaven. Second, and most importantly, they help to bring alive the rather stilted geometric shapes of the geomantic figures.

Now look at Figure 14 and notice the pairs of figures which are brought together by their association with a particular planet.

Take the geomantic figures one at a time, and add in their divinatory meaning and further attributes. In the case of zodiacal ascriptions, the various authorities do not agree. Consequently the ascriptions of the Hermetic Order of the Golden Dawn have been used here, and a table of alternate ascriptions has been provided in Appendix I, for those who want to pursue them further.

The traditional ascriptions are based on the rulership of the zodiacal Sign by the planet ascribed to that geomantic figure. Thus, in each case, the planet, Sign and Element should be in perfect agreement.

As the zodiacal Signs have traditional dominion over the parts of the body, trees, plants, geographical regions

and similar categories, the answer to a question obtained in the form of a geomantic figure can in turn refer to any of these other categories of things, thereby extending the possibilities for a precise answer from a geomantic divination. It is for this reason that the following information about each figure is tabulated.









Direct or dignified	Planet	Retrograde or adverse
Fortuna Major	Sun	Fortuna Minor
::		:
:		::
Via	Moon	Populus
:		::
:		::
Acquisitio	Jupiter	Laetitia
::		:
:		::
Puella	Venus	Amissio
::		:
:		::
Conjunctio	Mercury	Albus
::		:
:		::
Puer	Mars	Rubeus
:		:
:		::
Carcer	Saturn	Tristitia
::		:
:		::
Caput Draconis	Dragon's Head and Tail	Cauda Draconis
::		:
:		::

Figure 14 Planetary groupings of the sixteen geomantic figures

In each case, the geomantic figure is given first with its Latin name, planet, Element and astrological Sign. Following these are the various divinatory meanings which

will 'decode' the answer given each time. The simplest form of decoding is simply to locate the Judge amongst these sixteen possible forms and read off the meaning of the figure, ignoring for the moment the associated astrological material. If more information is required, read off the meaning of each of the Witnesses which contributed to the judgment of the Judge.

One can either use geomancy to form a snap judgment from the Judge and two Witnesses, or at greater length to encourage your intuitive abilities by combining the more detailed meanings of these three figures from the following explanations of each figure, for a richer and more detailed answer.

I

Puer	Mars	Fire	Aries
⋮	♂	△	♈

Puer means 'boy' in Latin. The figure also means yellow, beardless, rash and inconsiderate. The nature of the figure depends upon its position in the geomantic spread. The figure is basically neutral, but is rather bad than good. The traditional description of Puer is 'evil in most demands, excepting those relating to war or love'. Puer is the malevolent and destructive side of Mars. Associated ideas include son, servant, slave, page and bachelor. More detailed meanings for this and the following figures, as found in various cultures, may be consulted in Appendix V.

II

Amissio	Venus	Earth	Taurus
⋮	♀	▽	♉

Amissio means 'lost', comprehended without, and that which is taken away: it is a bad figure. Although Venus is astrologically a benefic, the geomantic figure Amissio means quite the opposite. Traditionally it is 'good for loss of substance and sometimes for love, but very bad for gain'. Regardie gives a telling example of the action of Amissio: 'if a woman were seeking counsel as to whether she should divorce her husband, Amissio in the appropriate house would indicate a positive answer. On the other hand, so far as the possibility of alimony is concerned the figure would be negative.' This is also a warning to the inquirer to phrase his questions carefully. Amissio is the less fortunate side of Venus, or as it used to be put, it is 'retrograde or combust'. Associated ideas include that of loss through death.

III

Albus	Mercury	Air	Gemini
⋮	♿	△	♊

The Latin literally means 'white, dead white'. Its divinatory meanings include 'white head', fair, wisdom, sagacity, clear thought, all Mercurial concepts. As the traditional explanation has it, 'good for profit and for entering into a place or undertaking'. Associated ideas include pale, bright (as in Lucifer's brightness), white paint, and egg whites.

IV

Populus	Moon	Water	Cancer
⋮	☾	▽	♋

The Latin means 'the people', forming a community or

state, a congregation or crowd. It is essentially a neutral figure and reflects its surroundings (or the adjoining geomantic figures), as does a crowd or gathering. The element water and the Moon which are attributed to this figure demonstrate its reflective properties. Populus is 'sometimes good and sometimes bad; good with good, and evil with evil'. It rules the waning part of the Moon's cycle, and is therefore less auspicious than Via who rules the Moon with it. Associated meanings include: a host, a multitude, a free state, the people as opposed to their rulers.

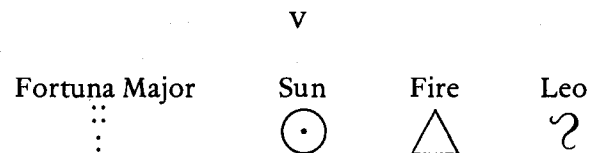

Fortuna means 'chance, luck, lot, fate, or fortune'. Fortuna Major means the greater fortune: it is attributed to the Sun which is the source of light and life, and is a very good figure. Fortuna Major also means safeguard, entering, success, and interior aid and protection. This figure is ascribed to the Sun during its daylight hours when it is 'posited in his dignities'. Associated ideas include: property, possessions and a good position in life.

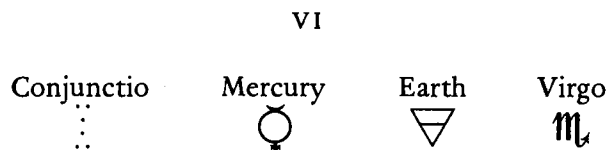

Conjunctio means assembling, 'uniting or joining together'. It is rather good than bad, and its old definition was 'good with good or evil with evil, recovery of things lost'. Conjunctio is more fortunate than Albus which is the

second geomantic figure of Mercury. Ideas associated with Conjunctio include marriage, allies and relationships.

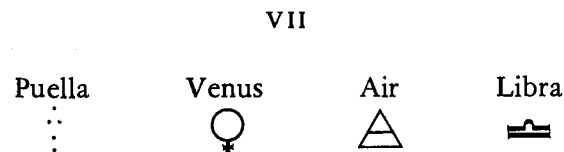

Puella means 'a girl or a maiden'. Its divinatory meanings include a pretty face, pleasant, a daughter, or a young wife. It is not very fortunate, and the mere possession of beauty does not promise underlying beneficence. Puella is the better side of Venus and used to be considered 'good in all demands, especially in those relating to women'.

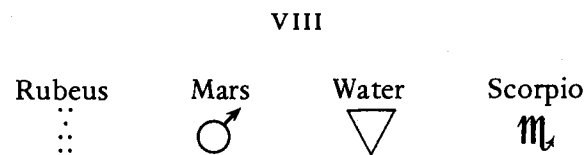

Rubeus means red or reddish and has the divinatory meaning of redhead, passion, vice and fiery temper: it is a bad figure, and covers the traditionally evil associations of Scorpio. The violently sexual aspects of Scorpio are also implied.

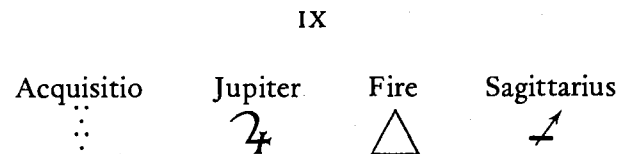

Acquisitio means 'acquisitions or additions to existing possessions, or money'. Its divinatory meanings include

success, comprehending within, obtaining, absorbing, receiving, gain and good fortune, all attributes of Jupiter: it is a very good figure. The old meaning was 'generally good for profit and gain'. If it appears as the significator in a geomantic figure, or as the Judge then great success is indicated. *Acquisitio* is the better half of the two figures which are ruled by Jupiter. In a sense the gain or acquisition occurs as a direct result of inquiry or supplication.

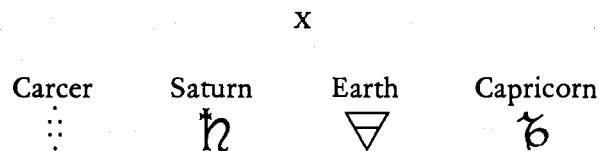

Cancer means 'a prison, jail or cell'. Its divinatory meanings include: being bound or confined, and it is good or bad according to the nature of the question. Traditionally, if Cancer occurs in the first House of the geomantic map then the divination is to be immediately discontinued and the details destroyed. No further attempt to ask the question should be made for some hours. The old meaning was 'generally evil, delay, binding, bars, and restriction'. Cancer has the distinction of being the more malevolent of the two Saturnian figures.

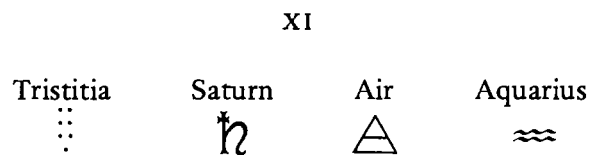

Tristitia means in Latin sadness, sorrow and melancholy. Its divinatory meanings also include: damned, cross, perversion and condemnation, with the old meaning 'evil in all things' except usefully Saturnian qualities like

fortification, earthworks, retrenchment, or strangely enough, debauchery. Additionally it can apply to moroseness, ill-humour, severity and sternness.

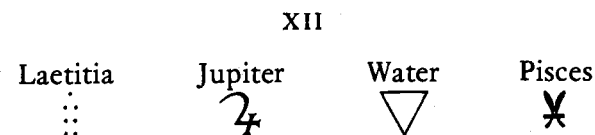

Laetitia literally means joy, expressed and unrestrained gladness or delight. It implies health and laughter, bearded, and is a very fortunate figure, 'good for joy, present, or to come'. Additional meanings include: a pleasing appearance, beauty and grace.

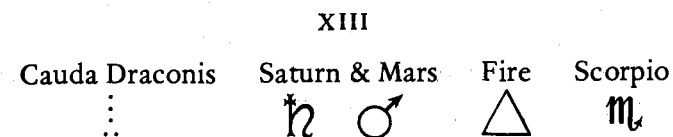

Cauda Draconis, the Dragon's Tail, has as its divinatory meanings the exit, lower kingdom or outer or lower threshold. It is 'good for evil, and for terminating affairs of any kind'. It represents the harbinger of disaster and is thoroughly evil. If this symbol occurs in the first House, the divination should be abandoned and the forms destroyed. Again, the planetary ascription is convenient, the two so-called 'malefics' being the strongest kind of planetary attribution applicable, but nowhere near as strong as the meaning of the Dragon's Tail.

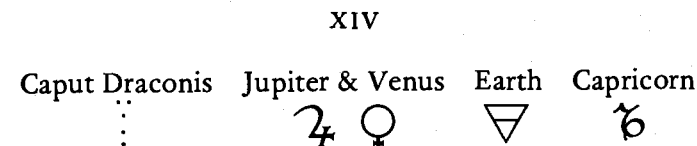

Caput Draconis is the Dragon's Head, and is named after the constellation Draco. It refers to the Moon's northern node, which is the point at which the Moon's orbit intersects the plane of the ecliptic. Its divinatory meanings include: the entrance, upper threshold or upper kingdom. The planetary ascription is tentative and mainly for the sake of tidiness: in effect the Head and Tail of the Dragon are points in the sky in their own right.

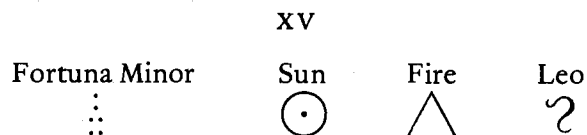

Fortuna Minor means the lesser fortune, safeguard going out, external aid and protection, and is not nearly as good a figure as Fortuna Major. Like the latter, it is also attributed to the Sun, but the Sun at night, 'or placed in lesse dignities'. Sometimes Fortuna Minor has Air attributed to it, which balances the attribution of geomantic figures to elements better by providing four figures per element, rather than a surplus of figures for Fire.

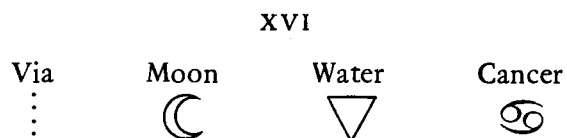

The Latin means 'street or way', literally the way along which one goes, and hence its divinatory meaning also includes journey. Again it is essentially neutral, being reflective like the Moon. Via is 'injurious to the goodness of other figures generally, but good for jounies and voyages'. Via governs the waxing half of the Moon's cycle. Associated meanings include: a highway, a way through, a wind-pipe, a march and a method.

For easy reference these details and meanings have been tabulated together with the name of the ruler of each figure; in accordance with Golden Dawn attributions as listed in Appendices I and II.

The logical grouping of some of the figures in pairs is obvious from the figures themselves, but is made more evident if the original Arabic names for the figures (see Appendix V) are considered in detail. Here it becomes immediately apparent that three figures (Caput Draconis, Acquisitio and Fortuna Major) all have the word *dakil* in their title which carries the meaning of interior, whilst the figures formed by inverting these figures (Cauda Draconis, Amissio and Fortuna Minor) all contain the word *kbarga* with the meaning of exterior. The Latin names for these figures do not so obviously display this polarity. Other pairs, however, are obvious such as Populus and Via, being the figures with the most and least points respectively; Albus and Puella, being the two 'colour' figures; the boy and girl combination of Puer and Puella; leaving the last two pairs of Tristitia and Laetitia (obvious in the Latin but not in the Arabic), Carcer and Conjunctio. It is interesting to compare the interaction of meaning between such pairs.

Geomantic figure	Name	Meaning
⋮	Puer	Boy, yellow, beardless, rash and inconsiderate, is rather good than bad
⋮	Amissio	Loss, comprehended without, that which is taken away, a bad figure
⋮	Albus	White, fair, wisdom, sagacity, clear thought, is a good figure
⋮	Populus	People, congregation, an indifferent figure
⋮	Fortuna Major	Greater fortune, greater aid, safeguard entering, success, interior aid and protection, a very good sign
⋮	Conjunctio	Conjunction, assembling, union or coming together, rather good than bad
⋮	Puella	A girl, beautiful, pretty face, pleasant, but not very fortunate
⋮	Rubeus	Red, reddish, redhead, passion, vice, fiery temper, a bad figure
⋮	Acquisitio	Obtaining, comprehending within, success, acquisition, absorbing, receiving, a good figure
⋮	Carcer	A prison, bound, is good or bad according to the nature of the question
⋮	Tristitia	Sadness, damned, cross, sorrow, grief, perversion, condemnation, is a bad figure
⋮	Laetitia	Joy, laughing, healthy, bearded, is a good figure
⋮	Cauda Draconis	The threshold lower, or going out, dragon's tail, exit, lower kingdom, is a bad figure
⋮	Caput Draconis	The head, the threshold entering, the upper threshold, dragon's head, entrance, upper kingdom, is a good figure
⋮	Fortuna Minor	Lesser fortune, lesser aid, safeguard going out, external aid and protection, is not a very good figure
⋮	Via	Way, street, journey, neither good nor bad

Sign	Element	Ruler	Planet
♈	△	Bartzabel	♂
♉	▽	Kedemel	♀
♊	△	Taphthartharath	♀
♋	▽	Chashmodai	☾
♌	△	Sorath	☉
♍	▽	Taphthartharath	♀
♎	△	Kedemel	♀
♏	▽	Bartzabel	♂
♐	△	Hismael	♁
♑	▽	Zazel	♁
♒	△	Zazel	♁
♓	▽	Hismael	♁
♈	△	Zazel & Bartzabel	♁ ♂
♉	▽	Hismael & Kedemel	♁ ♀
♊	△	Sorath	☉
♋	▽	Chashmodai	☾

Figure 15 Complete table of geomantic figures and attributions

12 · Practical divination

To make the operation of the oracle clearer, and to explain its interpretation in detail, let us take a sample divination: in this case, to determine if the querent should marry a specific person. Suppose that the lines of dots were traced and the figures generated, as in the first seven steps of the divining process (see p. 215 for a summary). This gives us the four Mothers which must be written from right to left. We can commence our example at *Step 8*:

Mothers

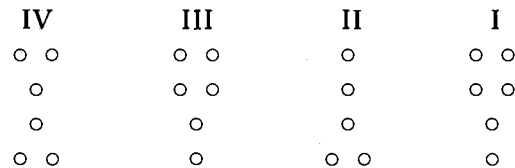

STEP 9

Now you will remember that the Daughters are formed from the Mothers by taking:
 all the heads of the Mothers for the first Daughter
 all the necks of the Mothers for the second Daughter
 all the bodies of the Mothers for the third Daughter
 all the feet of the Mothers for the fourth Daughter

Write them also from right to left:

Daughters

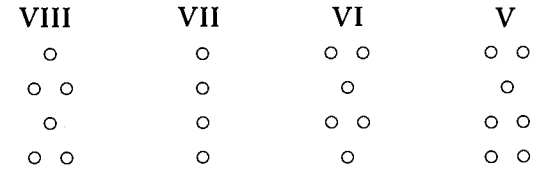

STEP 10

Now for the Nephews, which are formed using the 'addition formula':

Mother I + Mother II = Nephew IX
 Mother III + Mother IV = Nephew X
 Daughter V + Daughter VI = Nephew XI
 Daughter VII + Daughter VIII = Nephew XII
 These are also written right to left:

Nephews

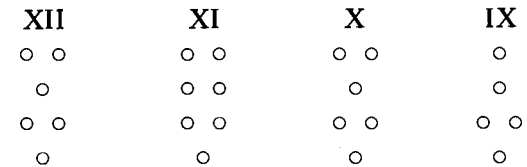

STEP 11

Likewise Witnesses are formed by addition.
 Nephew IX + Nephew X = Witness XIII
 Nephew XI + Nephew XII = Witness XIV

Witnesses



STEP 12

These two are then added to form the Judge.
 Witness XIII + Witness XIV = Judge XV

Judge

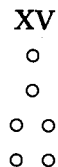

Lay out the full fifteen figures as shown in Figure 16.

Interpretation

Having gone through the mechanical generation of the fifteen figures of the geomantic spread, now comes the work of interpretation. Before we can determine the meaning of the chart we have to identify the name of each of the fifteen figures. On the chart each figure has been given its name. Observe particularly the figures that are in the Witnesses and Judge.

The Judge is Fortuna Minor which is grouped amongst the unfavourable figures by Bartholomew of Parma (chapter 5) as a general indication of its nature. In detail it means

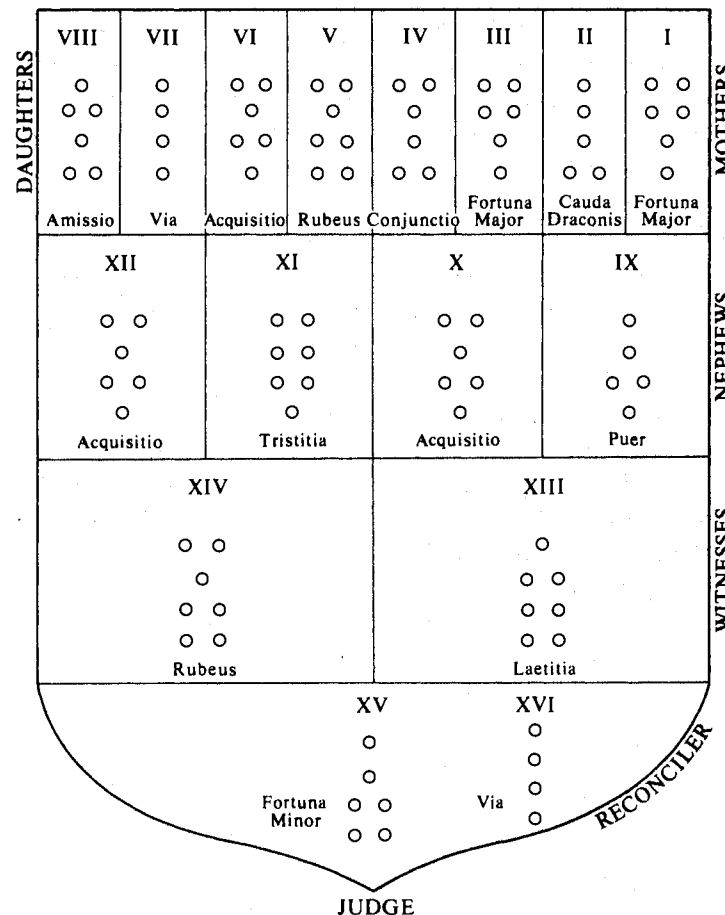

Figure 16 Plan of a sample geomantic divination

‘the lesser fortune, safeguard going out, external aid and protection’, and is attributed to the Sun at night, that is the cold, hidden or vanquished Sun. This does not sound very promising for a marriage, so let us examine the Witnesses which contributed to the production of this Judge.

Left Witness This is Rubeus, which means ‘red, reddish, redhead, passion, vice and fiery temper; it is a bad figure,

and covers the traditionally evil associations of Scorpio. The violently sexual aspects of Scorpio are also implied.' Here we have considerable light thrown on the question. The nature of attraction is strong sexual desire of a violent kind rather than love.

Right Witness This is Laetitia which literally means 'joy, expressed and unrestrained' and its additional meanings include 'a pleasing appearance, beauty and grace'. Although it is a good figure it confirms beautifully what we now know, that it is basically sexual attraction at the root of the proposed marriage with no depth of feeling or long-lasting good fortune implied. This also explains how Fortuna Minor can be listed as a partly favourable figure, for here the sexual attraction and pleasure is pleasant, but does not bode well for the success of the marriage, which after all is what the question is about.

STEP 13

Who could ask for greater clarity? If the answer were ambiguous, don't forget that you could always resort to that back-stop, the Reconciler (figure XVI), which is formed by 'adding' together figures I and XV, that is, the first Mother and the Judge. However don't form a Reconciler if you have already got a satisfactory answer, as this is rude persistence in the face of a perfectly adequate reply by the oracle!

If more detail is required, refer back to the first Mother (figure I) for the beginning of the matter. This figure is Fortuna Major, indicating that the relationship commenced with a good figure which means 'the greater fortune' and is attributed also to Leo and the Sun, but the Sun during the day. Thus both this figure and the Judge are attributed to the Sun and Leo, but the relationship moves from the Sun

during the day to the Sun at night, in short the relationship cools off and dies. Fortuna Major also includes among its divinatory meanings 'safeguard, entering success, and interior aid and protection', indicating the beginning of the relationship, which perhaps commenced with some elements of a desire on the part of one partner to protect or look after the other.

The termination or end of the relationship is indicated by figure IV which is Conjunctio or 'uniting or joining together', more good than bad, but 'good with good or evil with evil'. Associated ideas include marriage.

This is interesting because it indicates clearly that although the Judge warns against the marriage as being the lesser fortune, the likely upshot of the matter is that the marriage will take place nevertheless. As Conjunctio is 'good with good or evil with evil', the mixture of Rubeus and Laetitia (violent sexual attraction and good looks) will draw the two into a marriage which will nevertheless wane in quality as the Sun at day (figure I, Fortuna Major) reverts to the Sun at night (figure XV, Fortuna Minor).

Crowley neatly sums up the operation of judgment, emphasizing the need of a meditative frame of mind untouched by bias in assessing the correct interpretation of the information supplied by the geomantic chart:¹

In the judgment, the diviner stands once more in need of his inmost and utmost attainments. He should exhaust the intellectual sources of information at his disposal, and form from them his judgment. But having done this, he should detach his mind from what it has just formulated, and proceed to concentrate it on the figure as a whole, almost as if it were the object of his meditation. One need hardly repeat that in both these operations, detachment from one's personal partialities is as necessary as it was in the first part of the work.

13 · Astrogeomancy

When skill has been achieved in the manipulation of ordinary geomantic divination, it will become increasingly obvious that the Judge and Witness figures are really not much more than artificially derived summaries of the primary figures, the Mothers, and consequently a shade mechanical.

It is traditional to flesh out the interpretation of a geomantic spread by referring it to the Houses of judicial astrology. Robert Fludd actually called geomancy, 'terrestrial astrology', and therefore a knowledge of astrology outside of that contained in this chapter is helpful, and some background reading would be useful. There is however no need for complex calculations, for that part of astrology is not utilized in geomantic interpretation. As far as geomancy is concerned, astrology is an interpretive tool and it is therefore not necessary to go into it in depth.

If we ignore the relative positions of the solar system in which the planets revolve around the Sun, and think instead of the universe from the point of view of a man standing on the earth and gazing up at the dome of the sky we will get a clearer picture of astrology. It does not matter what the complex orbital systems are which result in planets and stars being in certain parts of the sky at certain times; what does matter is the angles they make with each other and their relationship with the spot on the

earth where we are standing.

If we had to devise a system of astrology for people born on the surface of the Sun, then the present scientific model of the (heliocentric) solar system would be a perfect start. However, we are dealing with the relationship of the planets and stars *with the earth*, so it is irrelevant to talk about their orbital relationship with the Sun.

Having disposed of this unnecessary complication, let us imagine that we are standing at night with feet firmly planted on the earth, some time before Copernicus, looking up into the blue-black dome of the night. The stars gradually move across the sky, each star keeping the same position relative to the other stars. Those who watched this phenomenon did not think in terms of the rotation of the earth but, taking the earth as their reference point, chose to examine particular groups of stars fixed, as they thought, into the crystal sphere of the stars which ceaselessly turned around the earth. These groups of stars they called constellations.

SIGNS OF THE ZODIAC

Obviously as the dome of the sky moved it was necessary to find a fixed point of reference for measuring the movement of the Sun, Moon and planets. Twelve particularly outstanding constellations in a rough band about 16° wide round the earth were chosen as 'markers' in the sky by which to plot the movement of the planets, Sun and Moon. These twelve constellations are the twelve signs of the Zodiac.

HOUSES OF HEAVEN

Astronomers also needed another system of measurement,

for although we have the Signs of the Zodiac, they are moving as part of the sphere of stars and are therefore not a fixed system of measurement. For this purpose astrologers have devised the 'House' system. These Houses form an imaginary but fixed grid centred on the earth and orientated according to the spot of ground on which you are standing. The twelve fixed House divisions are projected out into the sky forming the ribs of the system:

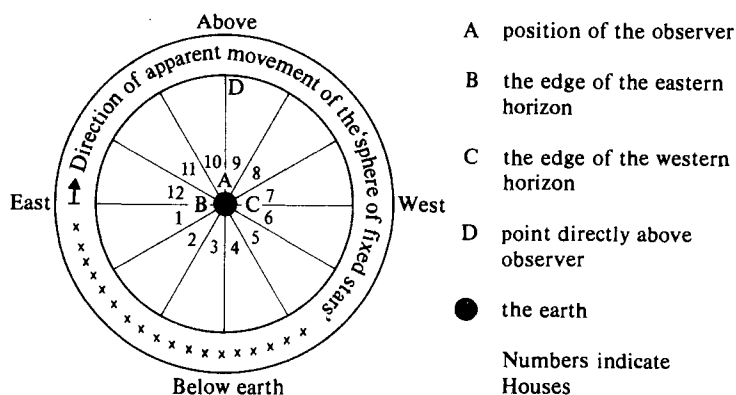

Figure 17 Houses of Heaven

The First House is always located just under the eastern horizon (left-hand side of chart) with the rest numbered in order around the earth till House 12 is just *above* the eastern horizon. This is fixed, for the Houses are a man-made fixed grid, whilst the Zodiac is based on the natural phenomena of the moving Zodiacal Signs. These then provide two systems of reference for plotting the position of the planets; as a planet's position in the sky may be indicated by both its House and its Zodiacal Sign location.

Each of the Houses is given a meaning, so that each sector of the sky both above the earth and under the earth is associated with a particular type of question or function:

The meanings of each House

First House The person himself, his life, health, behaviour, habits, disposition, personal characteristics and apparent personality.

Second House Money, property, personal wealth, financial profit and loss, income and expenditure, and associated ideas of theft, loss or negligence.

Third House Brothers, sisters, blood relatives, news, letters, communication, short journeys, languages, writing, publicity, agencies, and similar mercurial pursuits.

Fourth House Home environment, fathers and grandfathers, inheritances, possessions, especially buildings, land and hidden treasure. It also gives details about thefts and thieves. Retirement, the grave. The *conclusion* of any matter is also included in the significations of this house.

Fifth House Women, luxury, eating, drinking. Creation, recreation, procreation; love affairs, courtship; pregnancy and childbirth; children and the young in general, creative artistic work; amusements and pleasures, sexual compatibility, gambling or speculation.

Sixth House Servants and employees; sickness and recovery; which parts of the body are most likely to suffer in illness or injury, aunts and uncles, and domestic animals.

Seventh House Wedlock, whoredom and fornication, love, marriage, partnerships and associations. Public enemies, law suits, company business, war, conflict, opponents and controversies. Thieves, robbers, dishonour.

Eighth House Deaths and financial matters connected with death, such as wills, legacies, the estate of the deceased, or business connected with death such as undertakers, executors or spirit mediums. Poverty.

Ninth House Long journeys, voyages, relations with foreigners. Science, philosophy, the Church, religion,

art, visions, dreams and divinations.

Tenth House Fame or notoriety, reputation, rank, honour, trade or profession, authority, employment, and worldly position generally. Also signifies the querent's mother.

Eleventh House Friends, acquaintances and social contacts, hopes and wishes. Also patronage by the rich or well placed. Philanthropic or altruistic organizations.

Twelfth House Sorrows, fears, punishments, imprisonment, intrigue, enemies in secret, servants, prostitutes, institutions, asylums, orphanages, hospitals, prisons, secret societies, unseen dangers, restrictions, and misfortune generally (for details refer to the Sixth and Eighth Houses).

It is also necessary to understand the terms Angular, Succedent and Cadent. They refer to the three types of Houses. Those on the Angles, that is the horizon in the east and west and the Houses at the midheaven and directly below the earth, are the strongest Angular Houses and are the First, Fourth, Seventh and Tenth. Those Houses following or succeeding the Angular Houses are called Succedent Houses and are the Second, Fifth, Eighth and Eleventh Houses. Finally those furthest away from the first mentioned Angular Houses are called Cadent, and are the Third, Sixth, Ninth and Twelfth Houses (see Figure 18).

When interpreting the meaning of the geomantic figures in the twelve Houses it is useful to remember that if the figure falls in an Angular House, then its action will be strong and 'profitable for the question propounded', in the Succedent House it is less effective, and if the figure falls into a Cadent House its action is positively retarded.

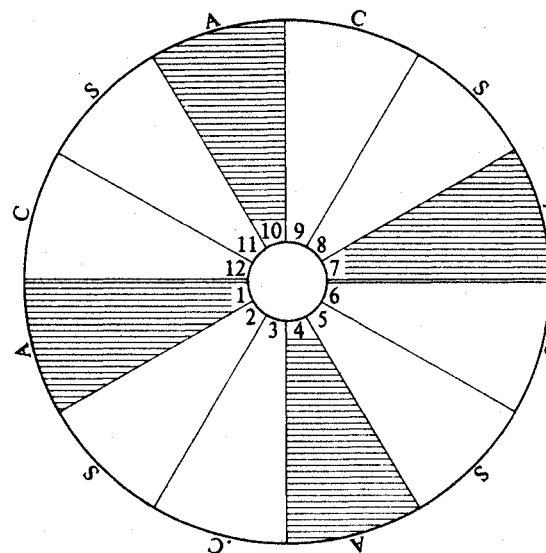

Figure 18 Angular, Succedent and Cadent Houses

Having considered the framework of astrology, the time has come to apply the figures derived in ordinary geomantic divination to this framework to derive a more detailed interpretation.

In almost every case a greater clarification is necessary than can be obtained merely by reading off the meaning of the Judge and Witnesses. One such method of clarification is to allocate the first twelve geomantic figures to the twelve Houses of Heaven on an astrological chart.

As already explained, the only fixed framework which marks out the sky in astrology is the House system, through which revolves the Zodiac, and against which the planets move with complex motions. The Houses traditionally represent the departments of everyday life, and it is the Houses which contain the answers to the mundane questions with which geomancy deals: questions such as the number and sex of children, the outcome of a business deal, the success of a journey, and so on.

Therefore, the geomantic figures which have been derived by divination are to be put into this House grid system, and the figure which is allocated to the House most relevant to the question asked, becomes the major signifier. With the addition of the seven planets and twelve Signs of the Zodiac to the House system, more information can be derived concerning the question.

The seven planets are the *forces* that act on human beings, the twelve Signs show *how* they act, whilst the Houses show *where* they act, and in what department of life their action will be felt. In this manner the static answer of the plain geomantic divination is fleshed out with background information and associated causes and conditions.

Now, there are several systems for allocating the geomantic figures derived in an ordinary divination to the twelve Houses of astrology. It has often been said that the correct method of allocation is the real secret of geomancy which has never been published. Even Aleister Crowley, who was in the habit of 'telling everything like it is', admitted that a major key had been left out of his explanation of the technical side of astro-geomancy. That key was the House allocation system. Amongst the systems outlined in this book is the major key which was omitted. For the present we will simply use the House allocation system prescribed by the Golden Dawn. In Appendix III you will find the alternative systems. You may find, with practice, that one of those systems gives you more consistently accurate results. It is up to you to choose one system and stick with it.

Using the Golden Dawn system (Appendix III) and the example used in chapter 12, place the first Mother, Fortuna Major, into the Tenth House. Then mark in the second Mother, Cauda Draconis, in the First House. Follow through anti-clockwise with the two other Mothers in the Angular Houses. Then draw in the Daughters (in

the Succedent Houses) and Nephews (in the Cadent Houses).

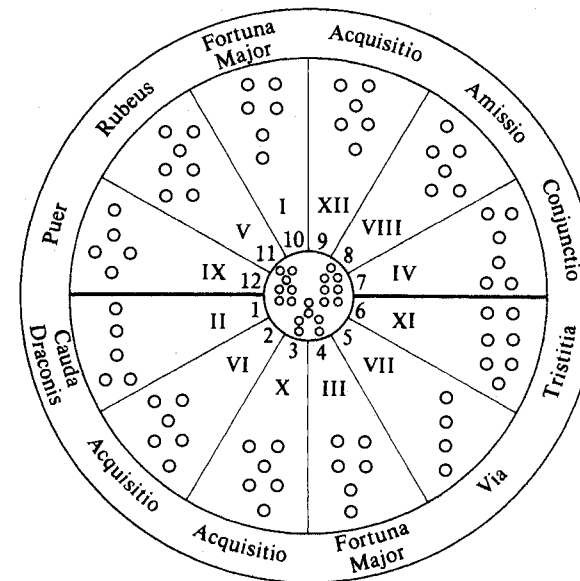

Figure 19 The geomantic figures distributed amongst the Twelve Houses of Heaven. House numbers are in Arabic numerals, geomantic figures designated by Roman numerals

One word of warning here, whichever House system you decide to use, remember always that if Rubens or Cauda Draconis fall in the first House or Ascendant, the chart is *not fit for judgment* and it should be destroyed without any further calculation or consideration. You should not attempt divination again concerning this question for at least a couple of hours and preferably not for a day or so. Presumably the question is important for such a result to have happened, and therefore you should think about it very seriously before re-attempting the divination.

Why such an extreme reaction? Well, Cauda Draconis in the First House means a short life and bad fortune, in fact

impending death for the person asking the question. Rubeus in the First House means the same, and it became the practice to destroy these two answers which occasionally crop up, on the principle that with these two particularly nasty outcomes, it is as well not to tempt fate by examining them in detail.

You will notice that only the first twelve figures are used in astrological geomancy, that is the Mothers, Daughters and Nephews. You may if you like, place the two Witnesses and the Judge in the central circular space to remind you of the general interpretation of the geomantic layout.

Having inserted the geomantic figures into the House framework it is now necessary to translate them into astrological terms of reference.

ZODIACAL SIGNS

To add in the astrological data, first find which geomantic figure has been allocated to House I (the Ascendant). Look in the Table of Zodiacal Correspondences in Appendix I and (using the column you have already elected to use as your own standard attribution) find the Zodiacal Sign attributed to this figure. Write this Sign in the First House. Then following the Houses round in order of number (i.e. anti-clockwise) write in the Zodiacal Signs in order. For example, if the Sign attributed to the First House was Pisces, then the Second House would receive Aries, the Third Taurus, the Fourth Gemini and so on round the Zodiac.

Returning to our example, look in the First House and you will see that it contains Cauda Draconis. Now although a chart with Cauda Draconis in the First House should not be used, let us continue for the moment with this just to illustrate the method. Look up Cauda Draconis in Appendix I (col. 2) and we find that Cauda Draconis =

Scorpio. Therefore place Scorpio in the First House. Now take the Signs in order, placing Sagittarius in the Second House, Capricorn in the Third House, and so on till we have filled in the whole chart.

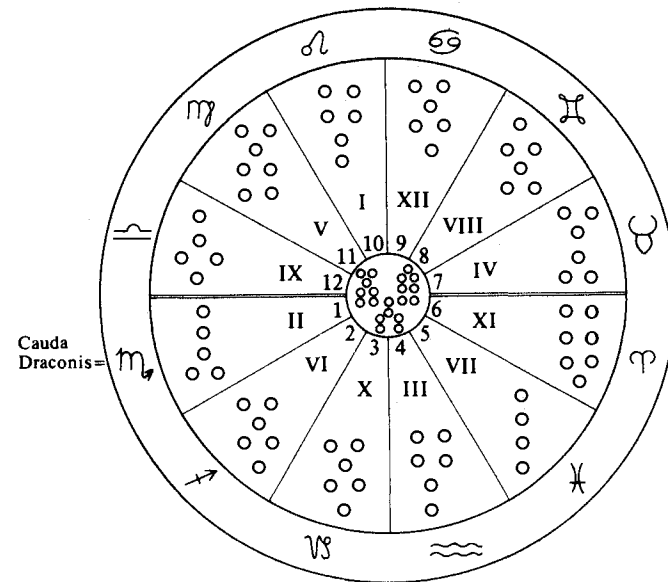

Figure 20 Zodiacal attributions using Appendix I (col. 2)

PLANETS

The translation of the geomantic figures into their planetary equivalents is quite straightforward. Merely refer back to chapter 11, or Appendix I, and write down the planet corresponding to the geomantic figure. In our example, it is resolved as shown in Figure 21.

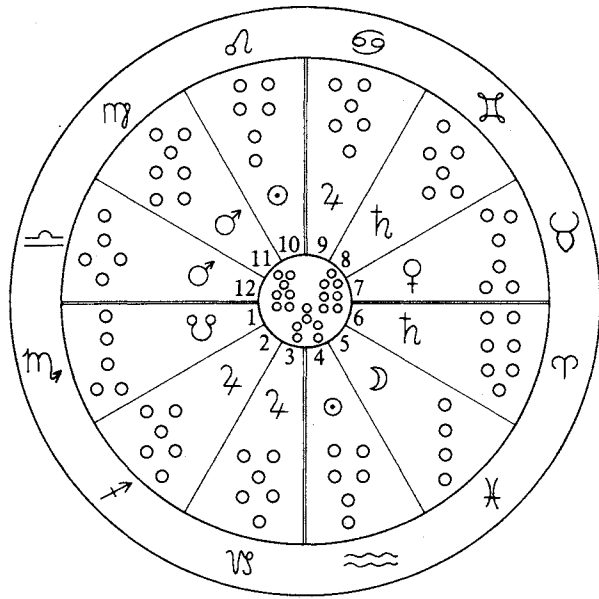

Figure 21 The complete astrogeomantic figure including planetary equivalents

14 · Summary of technique and interpretation

First, to recap on the technique:

1. Choose the time, hour and day in which to carry out the divination (see Appendix IV).
2. If it is decided to go ahead immediately, lay out your equipment, paper and pencil.
3. Formulate the question precisely and write it down at the top of the page. Decide which House and planet the question belongs to: write this down also.
4. Inscribe pentagram and appropriate sigil, if so desired.
5. Make 16 rows of random dots with eyes half closed and mind concentrating on the question.
6. Divide the 16 rows into 4 groups of 4 lines.
7. Count each line and mark down two points for an even number and one point for an odd number.
8. Write the 4 figures so formed on the paper from right to left, side by side. These are the 4 Mothers. It is useful to make copies of the chart in this chapter and fill in the figures in the appropriate boxes, as they are worked out.
9. Form the Daughters. The first Daughter is formed from the heads of each Mother written down one above another, the second Daughter from the necks of the Mothers, the third Daughter from their bodies, and the last

Daughter from their feet.

10. Form the Nephews. The first Nephew is created by 'adding together' Mothers I and II, the second from adding together Mothers III and IV. The third Nephew is formed from adding together the first and second Daughters (figures V and VI). The fourth Nephew is formed from adding together the third and fourth Daughter (figures VII and VIII).

11. Form the two Witnesses. The Right Witness is formed by adding together the first and the second Nephews (figures IX and X). The Left Witness is formed by adding together the third and the fourth Nephew (figures XI and XII).

12. Form the Judge by adding together the two Witnesses.

13. If the answer is not clear at this point, form a Reconciler by adding together the first Mother (figure I) and the Judge (figure XV).

14. Using the chosen House system (see Appendix III) place the geomantic figures in the Houses, check to see if Rubeus or Cauda Draconis are in the First House (in which case the figure should be destroyed).

15. Determine the corresponding Zodiacal Sign of the geomantic figure in the First House (using Appendix I), and write in the rest of the Zodiac sequentially in an anti-clockwise direction.

16. Translate each geomantic figure into its planetary equivalent (Appendix I).

Although the above method looks fairly complex at first glance, you will find as soon as you have done two or three divinations that the manipulation becomes almost automatic. It is simply a matter of getting the sequence right.

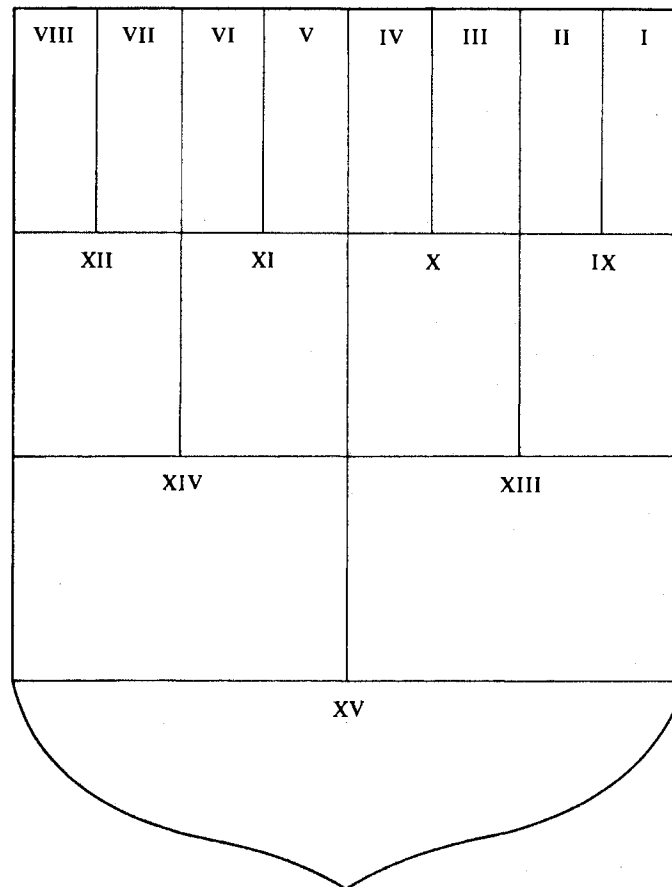

Figure 22 A traditional geomantic chart

INTERPRETATION

Having completely drawn up the astrogeomantic chart, and entered the geomantic figures, Zodiacal Signs and Planets in the correct Houses, then:

1. Check the Witnesses and Judge to see if the latter is favourable or otherwise.¹ Note that the Right Witness signifies the querent whilst the Left Witness symbolizes the thing asked about. It is said by some writers that if Populus appears as a Judge then the figure should be judged solely on its interaction with the Houses, and the significance of Populus as a Judge *per se* should be ignored, but this is not a universally accepted rule.

2. If more detail is required, refer back to the Mothers (figures I-IV) for details of the commencement (figure I) and termination of the matter (figure IV).

3. Note which geomantic figure falls in the House relating to the question (the Significator) and write it down along with its accompanying Sign and Planet.

4. If it is a question of money the Part of Fortune should be consulted. This is done by calculating the total number of points in the twelve geomantic figures in the Houses, and then dividing this total by twelve. The number remaining after this division indicates the House in which the Part of Fortune will be found: the geomantic figure in this House is the Index for questions of money.

5. If Index figure appears elsewhere on the chart, that is 'passes' or 'springs' into another House, then the significance of that House is to be taken into account when interpreting the figure. Cattani and several other writers give elaborate tables for the passing of each and every figure from one House to the next, but careful consideration of the meaning of the figure in relation to that of the relevant House should suffice for an accurate interpretation. For example, in a question concerning stolen money, if the figure in the Second House (money and movable possessions) is also found in the Sixth House (servants and employees) it might indicate that the thief was a servant or employee.

6. Check the figure falling in the Ascendant or First House for information about the querent.

7. Look in a Table of Geomantic figures in the Houses² to see the significance of the geomantic figure which falls into the House of the question under consideration. Write this down in full.

8. Check the Table of Essential Dignities (p. 221) to determine the strength of the figure in that House. This will tell you how much weight to give any factor in the final analysis.

9. Check to see if the same geomantic figure as figure XV, the Judge (which has not been placed in a House but in the centre of the chart) actually turns up anywhere else. If it does, then the House it appears in is highly significant.

10. The planets interact with the Houses so that if a figure of Mercury falls in the First House, it is a particularly good omen. Likewise if the Moon falls in the Third; Venus in the Fifth; Mars in the Sixth; the Sun in the Ninth; Jupiter in the Eleventh; or Saturn in the Twelfth.

11. Determine the aspects made between figures and note the Houses in which they fall.

12. It is possible, if the divination is still not clear at this point, to form a new Reconciler figure by adding together the points of the Judge and the Significator figure in the House of the question.

RELATIVE STRENGTH OF FIGURES IN HOUSES

Sometimes the interpretation of the meaning of an answer given by an astrogeomantic chart is difficult because a number of competing pieces of information can be extracted, but it is difficult to see the overall picture because of apparently conflicting items in the chart.

To give a simple example, you may find *Acquisitio* in the Second House, boding very well for gain of money or property. However, the same figure, *Acquisitio*, may also

turn up in another House, for example House 6, illness and employees. In principle you know that *Acquisitio* is 'acquisition as a result of your own effort' and that employees are unlikely to be part of the work indicated, while illness could even be a strong factor preventing you exercising this effort. However, this still leaves you with an uncertainty as to whether that effort is going to be strongly baulked by the effects of House 6 or only mildly retarded. To assess this, provided there is not a clear indication elsewhere in the chart, it is necessary to have some measure of the relative strength of one influence versus another. This measure of strength is given in the Table on p. 221 which relies on the 'essential dignity' of the planets and their associated geomantic figures. From the table, *Acquisitio* is *strong* in the Second House but at its *weakest* in the Sixth, therefore fortunately the influence of the Second House will prevail.

The essential dignity of a figure in a particular House is a measure of its strength, the degree to which it will influence the judgment. It could in fact be invoked as a 'tie-breaker'.

Essential dignity means the strength of a figure when found in a particular House. A figure is therefore strongest when in its own House; very strong when in its Exaltation; strong in its Triplicity; very weak in its Fall; weakest of all in its Detriment. A figure is in its Fall when in a House opposite to that of its Exaltation, and in its Detriment when opposite to its own House. These terms are only given by way of explanation to those who like to know the underlying astrological reasons. It is sufficient for the moment merely to use the table to determine which of two apparently conflicting situations shown in a chart is the stronger and therefore the more likely to overcome the other. The numbers refer to the House in which the geomantic figure is strong or weak.

Table* of essential dignities

Geomantic figure	For reference: corresponding planet	Strongest: ruler of own House	Very strong: exaltation	Strong: triplicity	Very weak: fall	Weakest: detriment
Puer	Mars	1, 8	10	5	4	2, 7
Amissio	Venus	2, 7	12	9, 11	6	1, 8
Albus	Mercury	3, 6	6	4, 10	12	9, 12
Populus	Moon	4	2	12	8	10
Fortuna Major	Sun	5	1	8	7	11
Conjunctio	Mercury	3, 6	6	4, 10	12	9, 12
Puella	Venus	2, 7	12	9, 11	6	1, 8
Rubeus	Mars	1, 8	10	5	4	2, 7
Acquisitio	Jupiter	9, 12	4	1, 2, 7	10	3, 6
Carcer	Saturn	10, 11	7	3, 6	1	4, 5
Tristitia	Saturn	10, 11	7	3, 6	1	4, 5
Lactitia	Jupiter	9, 12	4	1, 2, 7	10	3, 6
Cauda Draconis	—	—	9	—	3	—
Caput Draconis	—	—	3	—	9	—
Fortuna Minor	Sun	5	1	8	7	11
Via	Moon	4	2	12	8	10

*To arrive at this table, the twelve Houses are considered as answering to the twelve Signs of the Zodiac, the First House to Aries, Second to Taurus and so on.

The table thus has five categories of essential dignity, ranging from the strongest to the weakest. The planets appear only as a guide, and the main use of the table is to settle judgments made complicated by several factors. Thus if Puer was in the First House and the Fourth House, from the first line of the above table, it is obvious that Puer has a much stronger significance in the First House (in connection with the nature and characteristics of the person himself) than in the Fourth House (where it shows the outcome of the matter or the nature of the home environment or property owned by the querent).

Compatibilities

Further aid to interpretation can be derived from the relationships between the planets.

with	♄	♃	♂	☉	♀	♁	☾
Saturn ♄		F	E	E	E	F	F
Jupiter ♃			E	F	F	F	F
Mars ♂				E	F	E	E
Sun ☉					F	E	F
Venus ♀						F	F
Mercury ♁							F
Moon ☾							

E = enemy

F = friend

Planetary compatibilities according to Francis Sperry (1608)

QUESTIONS OF MONEY

As money is such an important factor in life and perhaps the most subject to vicissitudes, astrologers have in the

past devised a special calculation and symbol for ready money, or easily available cash belonging to the person asking the question. This is called the Part of Fortune and symbolized by a circle with a cross dividing it into quarters.

For geomantic purposes, it is not necessary to perform the astrological calculations to find the Part of Fortune. It is just necessary to add together all the points of the first twelve geomantic figures, that is the total points of the four Mothers, four Daughters and four Nephews.

Divide your total by twelve and note down the remainder. The number of the remainder will give you the number of the House in which the Part of Fortune is to be found. If there is no remainder, it goes in the Twelfth House. The nature of the House it falls in tells you the direction from which ready cash might come, or be obtained. The geomantic figure, the sign and the planet in the House, give you details of the likelihood of the ready cash turning up (geomantic figure) and the sequence of events involved in its appearance (the planet).

THE ASPECTS OF THE HOUSES

It is traditional, but not very productive, to examine the aspects formed between the Ascendant and the other Houses, and sometimes also those formed in relation to the Significator found in the House of the question. Obviously the aspects are not the exact ones of conventional astrology, but whole Houses are considered in their aspect to each other. This means that if you consider the First House, it will be aspected by the Eleventh (as sextile), Tenth (as square) and Ninth (as trine) in a Dexter (i.e. clockwise) direction. It is also similarly aspected to the Third (sextile), Fourth (square) and Fifth (trine) in a Sinister (or anti-clockwise) direction. Additionally it is

aspected by the Seventh House in opposition and the Second House in a sort of 'conjunction' which in geomancy is always considered in an anti-clockwise direction in House pairs (First and Second, Third and Fourth, and so on).

This leaves exactly *three* Houses unaspected by the First House. It is for this reason that judging aspects geomantically is not exactly rewarding, but the details are given below nevertheless:

1. *Trine* (\triangle) aspect is formed by the fifth House from and including the Significator in both directions (clockwise and anti-clockwise), thereby forming two trines. The dexter trine is stronger in effect than the sinister trine. The trine is a favourable aspect.

2. The *Square* (\square) aspect is formed by the fourth House from and including the Significator in both directions. Usually it is a bad aspect, representing a challenge of some sort, an obstacle that may or may not be overcome successfully, depending on the geomantic figures found in those Houses.

3. *Sextile* (\times) aspect is to be found three Houses from and including the Significator in both directions. The sextile is a mildly beneficent aspect.

4. *Opposition* (\circ) is of course directly opposite to the Significator, 180° away, and indicates the nature of the chief difficulties to be expected by the querent.

5. *Conjunction* (\circ) is a mutually supportive arrangement, only taking place between the pairs of Houses already specified, and not for example, the Second and Third, or Fourth and Fifth Houses.

15 · Astrogeomantic examples

Let us take an example and try to judge it thoroughly by using the steps outlined in the last chapter. Suppose we were to ask: 'Will the proposed business partnership be a success for me?' As before, we generate the four basic Mother figures from the sixteen lines of dots, going on to generate the Daughters, Nephews, Witnesses and Judge (see Figure 23).

These in turn can be translated to the astrological chart form placing the figures I-XII in the twelve Houses, with the Witnesses and Judge in the centre. Using the Golden Dawn system of figure to House allocation (Appendix III), the figure in the First House is Fortuna Major, which is Leo. Therefore the zodiacal signs may be inserted from the First House as Leo, in their proper order, through the Second House as Virgo, Third House as Libra and so on to the Twelfth House as Cancer. The planets, of course, are simply the translation of each figure into its appropriate planet (Appendix I). The resulting astrogeomantic chart can be seen in Figure 24.

Now we can begin the judgment, taking our interpretation step by step.

1. First, neither Rubeus nor Cauda Draconis are in the First House, so the figure is safe to proceed with.

2. Noting planets in Signs we have:
Sun in Leo, Capricorn and Taurus
Venus in Virgo

4. Now let us look in the Houses relevant to the question. These are:

House 2: money, property, personal wealth, financial profit and loss, income and expenditure.

House 7: partnerships, amongst other things.

House 11: friends, acquaintances and social contacts, hopes and wishes, and patronage.

Interestingly we find the same two Houses that sprang to our attention when we examined the planet and Sign combination (point 2). This is a typical example of the way in which a successful geomantic divination begins unmistakably to 'fall into place'. Again and again the same elements come to our attention confirming and strengthening our verdict.

But to continue, as we have identified the three relevant Houses, to interpret the meaning of the geomantic figures found in these three Houses.

Puella in House 2: (Venus in Virgo) No increase of riches nor greater poverty.

Caput Draconis in House 7: (in Aquarius) There are many adversaries and lawsuits.

Laetitia in House 11: (Jupiter in Gemini) Many friends among the high, protection. This might be interpreted that either your partnership is with someone well placed or that you may escape the worst results of such a partnership by appealing to friends in high places.

Again the picture is one of warning against the partnership: it will not be profitable and may involve you in costly lawsuits.

5. Of the three geomantic figures in the three relevant Houses, only Caput Draconis appears elsewhere or 'springs into' another House. Puella and Laetitia only occur once each in the whole figure.

Caput Draconis 'springs into' House 8 where its meaning is: 'death is certain; legacies and inheritances; prospects of a wealthy wife'. Those parts relevant to financial matters

indicate that legacies (inheritance due to someone's death) or a financially advantageous marriage are more likely to be of profit than the proposed business partnership. This may indicate that the venture is better financed from family money rather than that of the partner, although this possibility would involve a second complete reading in itself.

6. To determine the Index (or as it is a money question, the Part of Fortune), add up the total number of dots used in forming the first twelve figures. In this example, the total comes to 151 dots. Dividing by 12 gives an answer of 12 with a remainder of 7. The remainder is significant because it places the Part of Fortune in the Seventh House. Again we have the Seventh House (of the twelve possible Houses) cropping up to reinforce the reading of Caput Draconis in the Seventh House, which was, 'There are many adversaries and lawsuits.' Again our answer is confirmed: don't enter the partnership.

7. As the interpretation so far has been in complete accord with itself there is no need to use the 'tie-breaker' table of Essential Dignities, but just for practice look up:

Puella in the Second House

Caput Draconis in the Seventh House

Laetitia in the Eleventh House.

The first two are listed as the strongest possible combinations, whilst Laetitia in the Eleventh House is neither strong nor weak. This confirms the inadvisability of the partnership without offering much hope of it being salvaged by high-placed friends. Here it is useful to have an assessment of the weight to place on each piece of the interpretation, and the message of Puella and Caput Draconis is unequivocal.

8. The outcome, which is the Fourth House, shows Acquisitio. In the tables it reads 'a large inheritance . . . a hidden treasure shall be found, a rich, but covetous father'. This harks back to the earlier remarks that in this case

inheritance is a more likely source of wealth than the business partnership, and in fact confirms that this will be the eventual outcome.

9. Although the occurrence of the Judge (Figure XV) elsewhere in the figure is a very minor indication, here we will follow it up, just to be complete. Figure XV, Fortuna Minor, does in fact appear in House 10. This suggests the death of the parents (the idea of inheritance again) and lawsuits and contentions (outcome of the partnership if undertaken).

10. A Reconciler is not necessary as we already have a wealth of confirmation.

11. The answer is clear: such a partnership would result in no profit, but lawsuits and contention. It is better not to enter into it and money will come from an inheritance instead.

PART THREE · Appendices

APPENDIX I

Zodiacal attributions of the geomantic figures

Geomantic figure	Planet	1 Golden Dawn	2 Agrippa by Ruler	3 Agrippa Esoteric Book II	4 Agrippa Book II	5 Gerard of Cremona	6 Christopher Cattan
Populus	☾	☉	☉	☿	♄	♄	♃
Via	☾	☉	☉	♄	♃	♃	☉
Conjunctio	♀	♄	♄	♁	♄	♄	♄
Carcer	♃	♄	♄	♃	♃	♃	☿
Fortuna Major	☉	♃	♃	♃	☿	☿	♃
Fortuna Minor	☉	♃	♃	♃	♃	♃	♁
Acquisitio	♃	♁	♃	♁	♁	♁	♃
Amissio	♀	♃	♁	♁	♁	♁	♄
Tristitia	♃	☿	☿	♁	♁	♁	♄
Lactitia	♃	♃	♁	♁	♃	♃	♁
Rubeus	♁	♁	♁	☉	♁	♁	♁
Albus	♀	♁	♁	♃	☉	☉	♃
Puella	♀	♁	♃	☉	♁	♁	♁
Puer	♁	♁	♁	♁	♁	♁	♁
Caput Draconis	♁	♁	♄	♁	♄	♄	♁
Cauda Draconis	♁	♁	♁	♄	♁	♁	☿

1. Golden Dawn ascriptions derived from the rulership of the planets as follows:

☉	rules	?
☾	rules	☿
♀	rules	♁ and ♀
♁	rules	♂ and ♀
♂	rules	♁ and ♀
♃	rules	♁ and ♀
♄	rules	♁ and ♀

2. Agrippa's attribution in the *Fourth Book of Occult Philosophy* also drawn from the above rulership of the planets but with some differences in the case of joint rulership. There is a misprint in the English edition of Agrippa, as Puer is omitted from the series so the only remaining sign, Aries has been inserted here.

3. A second attribution of Agrippa's given as traditional but 'vulgarly used', in other words, these attributions though common in books on geomancy, are not the 'initiated' version.



















































4. This system is derived from Agrippa Book II, and was used by Franz Hartmann (with Aquarius mistakenly attributed to Tristitia). It is also the system of attribution proposed by Christopher Cattan (with the reversal of Fortuna Minor and Major) and subsequently utilized by Eugène Caslant.

5. Was used by Gerard of Cremona (i.e. Sabbioneta) in his system of astrological geomancy, by Peter de Abano (with Puer and Puella interchanged), and by Robert Fludd in his *Tractatus de Geomantia*.

6. Christopher Cattan's (1608) version of the rules of 'Gerard of Cremona'.

APPENDIX II

Element attributions of the geomantic figures

Element	Arrangement			
	1 Golden Dawn (according to Sign) derived from John Heydon	2 Agrippa (according to Sign)	3 Agrippa (according to Planet and Figure)	4 Agrippa 'Esoteric Arrangement'
Fire 	Puer 	Puer 	Puer 	Fortuna Minor
	Fortuna Major 	Fortuna Major 	Fortuna Major 	Amissio
	Acquisitio 	Laetitia 	Amissio 	Rubeus
	Cauda Draconis 	Fortuna Minor 	Rubeus 	Cauda Draconis
Air 	Albus 	Albus 	Conjunctio 	Conjunctio
	Puella 	Amissio 	Puella 	Acquisitio
	Tristitia 	Tristitia 	Laetitia 	Laetitia
	Fortuna Minor 		Fortuna Minor 	Puer
Water 	Populus 	Populus 	Populus 	Populus
	Rubeus 	Rubeus 	Acquisitio 	Albus
	Laetitia 	Acquisitio 	Via 	Puella
	Via 	Via 	Cauda Draconis 	Via
Earth 	Amissio 	Puella 	Albus 	Fortuna Major
	Conjunctio 	Conjunctio 	Tristitia 	Tristitia
	Carcer 	Carcer 	Carcer 	Carcer
	Caput Draconis 	Caput Draconis 	Caput Draconis 	Caput Draconis

- 4 Mothers in the 4 Angular Houses
- 4 Daughters in the 4 Succedent Houses
- 4 Nephews in the 4 Cadent Houses

Laid out in full the twelve Houses contain these figures.

<i>Figure</i>	<i>Houses</i>
Angular I Mother	1
Succedent V Daughter	2
Cadent IX Nephew	3
Angular II Mother	4
Succedent VIII Daughter	5
Cadent XII Nephew	6
Angular III Mother	7
Succedent VII Daughter	8
Cadent XI Nephew	9
Angular IV Mother	10
Succedent VI Daughter	11
Cadent X Nephew	12

The system relies on the Mothers, the primary geomantic figures, being placed at the most powerful points on the chart, the four so-called Angular Houses (the Houses at the East and Mid-heaven and their opposite points, i.e. Houses 10, 1, 4 and 7). The secondary figures, the Daughters, are given to the Succedent Houses, that is the next House round in an anti-clockwise direction from each of the Angular Houses (Houses 11, 2, 5 and 8). Finally the four remaining or Cadent Houses are allocated the four Nephews (Houses 12, 3, 6 and 9).

THE GOLDEN DAWN SYSTEM OF HOUSE ALLOCATION

This is as follows:

Mothers:	I	House 10	} Angular Houses
	II	House 1	
	III	House 4	
	IV	House 7	
Daughters:	V	House 11	} Succedent Houses
	VI	House 2	
	VII	House 5	
	VIII	House 8	
Nephews:	IX	House 12	} Cadent Houses
	X	House 3	
	XI	House 6	
	XII	House 9	

APPENDIX IV

Times of planetary days and hours

An important consideration for geomancers which would have been obvious in the middle ages is underlined by Peruchio when he explains that geomancers, like magicians, must reckon the hours of the day from dawn to dawn rather than midnight to midnight. Thus the first hour of the day is under the planetary influence of that day, with each successive hour changing its allegiance to the planets in the usual order of Saturn, Jupiter, Mars, Sol, Venus, Mercury, Luna. The questions of geomancy should if possible be put in the planetary hour most appropriate to the question, for example, literary questions in the hour of Mercury, those of agriculture in the hour of Saturn and so on.

The planetary days are as follows: Monday - questions of the Moon; Tuesday - Mars; Wednesday - Mercury; Thursday - Jupiter; Friday - Venus; Saturday - Saturn; Sunday - the Sun.

To determine planetary hours find out the time of sunrise and sunset from an ephemeris or the daily newspaper and calculate the number of minutes in the day between those two times. Divide the number of daylight minutes by twelve to give you the exact length of a planetary 'hour', which will be less than sixty minutes in winter but more than sixty minutes during the summer. On two days of the year (on the Equinox), the length of a planetary daylight 'hour' will be exactly sixty minutes.

Counting off each planetary 'hour' (calculating according to the number of minutes in the planetary hour), you find that the first and the eighth 'hour' of each day is dedicated to the planetary ruler of that day. For example, the first and eighth hour of Monday is sacred to the Moon,

whilst the first and eighth hour of Friday is dedicated to Venus.

If you wish to choose an appropriate night hour, again count the number of minutes of darkness from sunset to sunrise. Divide this by twelve to get the length of a planetary night 'hour'. Then counting off these 'hours', take the third and the tenth 'hours' of the night. Thus the third and tenth 'hours' of Monday night are dedicated to the Moon, whilst the third and tenth night hours of Friday are dedicated to Venus, and so on.

APPENDIX V

Names of the sixteen geomantic figures in Arabic, Greek, Provençal, Latin, Hebrew, Berber, Malagasy and various west African dialects

Figure	ARABIC	
	Traditional	
<i>populus</i>	jamā'a	group of people, band, party, gang
<i>via</i>	ṭarīq	way, road, highway, trail
<i>conjunctio</i>	ijtimā'	meeting, get together, gathering, social life, conjunction
<i>carcer</i>	'uqla	prison, arrest, bond, tie
<i>fortuna major</i>	el nuṣra el-dākila	interior, inside, inmost, hidden help or assistance (interior personal victory)
<i>fortuna minor</i>	el nuṣra el-khārga	external, outer, outside, foreign, exterior, help, aid or assistance (exterior victory)
<i>acquisitio</i>	qabḍ el-dākil	interior, grasping, taking possession, receiving, receipt (taken forcibly)
<i>amissio</i>	qabḍ el-kharge	'giving outside', to take outside, or give away
<i>tristitia</i>	(mankūs el-khārga, ankūs) [rakiza khārga] ³	change, turn, upside-down, to fall, inverted, reversed, relapsing or suffering a relapse
<i>laetitia</i>	[el-dakila] (lihya? janūbi fariha?)	joy, southern happiness (happiness in the south?) rejoicing, gladness/bearded
<i>rubeus</i>	ḥumra	redness, red implying a bad omen, danger
<i>albus</i>	el-bayād	whiteness, or writing paper, or blank space in a manuscript, barren, desolate, wasteland
<i>puella</i>	naqīy el-kadd	clear cheek (complexion), pure, clean, immaculate, unstained, free of dirt or impurity (young girl)
<i>puer</i>	(jūd lahu') kausaj	literally 'generosity is for him', open-handedness, liberality/ <i>kausaj</i> is a swordfish/beardless
<i>caput draconis</i>	el 'ataba el-dākila	the interior threshold (the step to go inside)
<i>cauda draconis</i>	el 'ataba el-khārga	the exterior threshold (the step to go out)

Numbers indicate order of figures in original source.

1 According to M. Steinschneider, 'Die Skidy' in *Z.D.M.G.*, vol. 31, Leipzig 1877.

2 From R. Davies, 'A System of Sand Divination' in *The Moslem World*, vol. XVII, New York 1927, pp. 123-9.

3 According to the tradition of Ahmad ben 'Ali Zunbul.

	Name in the Kordofan ²	Kordofan Divinatory Interpretation ²
جماعة ¹	2 tiql	an ape, a man of empty talk
طريق	1 tariq	a road, indicating a journey
اجتماع	15 dāmīr	a hungry man on a journey
عقلة	16 ṣurra	a woman of good omen
النصرة الداخلة	5 rasn	a head-rop, indicating a journey
الخارجة —	6 jebbār	a powerful sheikh or notable
قبض الداخل	9 qābid	indicating a successful seizure of an animal, etc.
الخارج —	10 khārij	an indication of a journey, or selling, or loss of a stolen animal, etc.
(منكوس — انكيس)	3 jihīn or abu heila	a fikih, red in colour
(? لحيان = ? جنوبي فرج)	7 ḥurr	a tall yellow man with a fire-mark or pock-mark in mid-forehead
حمرة	14 humra'	a red woman, with face-markings, an indication of blood, a successful hunt
البياض	11 beyyād	a poor unimportant man
نقى الخد	13 mahzūm	a stouthearted man, the thief (if found in the enemy's houses), but weaker than jebbār
(الجود له) كوسج	12 jōdala	a woman of no importance
العتبة الداخلة	8 rāiya	a tall woman, like a flag, full of words
الخارجة —	4 rakiza	a woman who brings news

Figure	GREEK BN Greek MS 2424 ¹	MS 2419 ²	PROVENÇAL BN Latin MS 7420 A ³
<i>populus</i>	(ν)τζαμάτ τζμαάτης		poble
<i>via</i>	ταρίχ		via
<i>conjunctio</i>	ιστιμά(ς) (η)		conjunctio
<i>carcer</i>	ούχλᾶς ἰουχλᾶ	φυλαχή	carcer
<i>fortuna major</i>	(ταρχάνα) νουςρατουλταχήλ	ἔξοδος τῆς δόξης	aventura major
<i>fortuna minor</i>	(σάμψαν) νουςρατουλχάριζ	εἴσοδος τῆς δόξης	aventura minor
<i>acquisitio</i>	β χαπδουλταχήλ	εἴσοδος τῶν χρημάτων	aquisicio
<i>amissio</i>	β χαπδουλχάριζ	εξοδος τῶν χρημάτων	perda
<i>tristitia</i>	ἀγγῆς (ἀγκίς) (ἀγκῆς)	χατωφερές	tristetia
<i>laetitia</i>	λαχιδμ λαχιδν	ἀνωφερές	alegria
<i>rubeus</i>	χουμπᾶ(ς)	ἐρυθροτής ἡγουν ὁ πόλεμος	ros
<i>albus</i>	παγιᾶδ (θ)	λευχότης	blancor
<i>puella</i>	ναχιουλχάτ	ἄνηδος ἡγουν ὁ ἀρσενιχός	donzel
<i>puer</i>	φαρά(ρ)χ(ης) φαράχη φαράχ	σπανός, ἡγουν ὁ θηλυχός	donzela
<i>caput draconis</i>	χαιτ(σ)μᾶς	εἰσερχόμενον ἀνώφλιον	portal alzat
<i>cauda draconis</i>	(δαμοσάπητα) θ επιτά(ς)	ἐξερχόμενον ἀνώφλιον	portal reversat

Numbers indicate order of figures in original source

¹ Written by Pierre de Montdore, 1552–67 } transliterations from the Arabic

² Written by Georges Midiates, 1462

³ Edited by Paul Meyer, *Romania*, tome XXVI

LATIN Hugh of Santalla ⁴	Other Latin ⁵	Meaning
14 congregatio	aggregatio	an assembling together, union, society
15 via	(iter)	way, street (journey)
12 coadunatio vel conjunctio	collectio	to add together, uniting, collecting
13 constrictus carcer		fetter, confine, bind together, prison, jail
3 auxilium intus	tutela intrans	interior aid or assistance, interior guard or protection
4 auxilium foris	tutela exiens	exterior aid or assistance, exterior guard or protection
1 comprehensum intus		interior comprehension, interior seizing or amassing (of wealth)
2 comprehensum foris	comprehensum extra	exterior comprehension, seizing (of one's goods) extrinsically
6 transversus, diminutus	(damnatus)	crossed, thwarted (transverse), diminished (blamed)
5 barbatus, ridens	(sanus)	bearded, laughter, joy, healthy, sane
8 rubeus	(ruffus)	red, ruddy
9 candidus, albus		shining white, dazzling beauty, dead white
7 mundus facie		pretty, pure of form figure or face
16 imberbis (inberbis)	gladius erigendus (flavus)	beardless, erect sword (i.e. phallus), golden-yellow
10 limen interius	limen intrans/intus (limen superius)	interior threshold (upper threshold)
11 limen exterius	limen exiens/foris (limen inferius)	exterior threshold (lower threshold)

⁴ BN MS 7354, *Ars Geomantiae* by Hugh of Santalla

⁵ Including Hugh of Santalla's *Geomantie Nova*, and other sources

Figure	HEBREW		BERBER (in Hebrew characters)	
<i>populus</i>	kehila	congregation*	קהלה	
<i>via</i>	derech	way	דרך	(? אבירר) אכריר
<i>conjunctio</i>	chiburt	collection (collective)	חבור (קבוץ)	חראולין
<i>carcer</i>	beit hasohar	prison	בית הסהר	הכרובי
<i>fortuna major</i>	kavod nichnas	honour or fortune enters (incoming)	כבוד נכנס	אתודי
<i>fortuna minor</i>	kavod yotze	honour or fortune exits (goes out)	כבוד יוצא	אסכריאל
<i>acquisitio</i>	mamun nichnas	monetary fortune enters (incoming)	ממון נכנס	אמק
<i>amissio</i>	mamun yotze	monetary fortune exits (goes out)	ממון יוצא (— נראה)	
<i>tristitia</i>	shefel rosh	main humiliation (poverty)	שפל ראש	אלחייני אנזילא
<i>laetitia</i>	nisho rosh	main joy (wife)	נשוא —	
<i>rubeus</i>	(ha) adom	the red one	(ה) אדום	אמסרוס אוקיע
<i>albus</i>	ha laban	the white one	הלבן	
<i>puella</i>	bar halechi	the one with the (clear) cheek	בר הלחי	כאריע (והוא כאדום)
<i>puer</i>	nilcham	the fighter	נלחם	אמרו
<i>caput draconis</i>	sof nichnas	enters threshold	סוף נכנס	תארה לה
<i>cauda draconis</i>	sof yotze	exits threshold	סוף יוצא	נאר סל(אל?) תקע

†kibbutz *From the same root in Bible, kohelet = Ecclesiastes

Figure	MALAGASY		
	<i>Hova</i> Interior dialect (From Dahle)	<i>Antanosy & Sakalava</i> West coast dialect (From Dahle)	<i>Fort Dauphin region</i> (From Flacourt)
<i>populus</i>	jamà (or zomà)	asombòla	assomboulo
<i>via</i>	taraiky	taraiky	tareche
<i>conjunctio</i>	aditsimà (aditsimay)	alatsimay	alissima
<i>carcer</i>	alokòla	alikhòla	alocola
<i>fortuna major</i>	asòravàvy	adabàra	adabara
<i>fortuna minor</i>	asóralàhy	asóralahy	alazadi
<i>acquisitio</i>	vànda miòndrika (= mòlahidy)	alahòtsy	alohotsi
<i>amissio</i>	vànda mitsàngana (= mikarija)	adàlo	adalou
<i>tristitia</i>	alikhisy	alikhisy	alinchissa
<i>laetitia</i>	alàhizàny	alizàha	alihiza
<i>rubeus</i>	alaimòra	alihimòra	alohomoré
<i>albus</i>	adibijàdy	alabiàvo	alibiauou
<i>puella</i>	kizo	alakaràbo	alacarabo
<i>puer</i>	adikasàjy	bètsivóngo	alicozaza (alimiza)
<i>caput draconis</i>	sàka	alakaosy	alacossi
<i>cauda draconis</i>	votsira (= vontsira)	karija	cariza

Figure	WEST AFRICAN TRIBAL			
	<i>Sara Madjingaye</i> (South Chad)	<i>Sara Deme</i> (South Chad)	<i>Dakbel</i> (North East Chad)	<i>Gula & Yalnas</i> (East Chad)
<i>populus</i>	jama'a — dead ancestors	tigil — shadow of a village tree	tigil — the crowd	tegil — indicates direction
<i>via</i>	tarik — little children	terek — all the men of the village	terik — exit, door, path, passage	tarik — to be ready to leave
<i>conjunctio</i>	danhur — meat	danhur — drink of bilibili (food)	dam'r — famine, lean person, empty stomach	damir — to have a lot to do
<i>carcer</i>	sura — chiefs	sura — plenty of food	sura — small pregnant woman	sura — full stomach, food
<i>fortuna major</i>	arshan — highways	rashan — all the young men of the village	rashan — wealth, assets, cattle	rashan — horse bit (harness)
<i>fortuna minor</i>	djobar — byways	djobar — weapons of the village	djabur — light colour and short hair (= enemy/infidel)	djobar — indicates who is the head or chief
<i>acquisitio</i>	gab — objects of iron	gab = qabdah — highway	gab — strong and intelligent man, conqueror	gab — to be caught, told off
<i>amissio</i>	harija — men of other villages	harija — war	harija — chiefs, men with authority and prestige	kharik — misfortune
<i>tristitia</i>	djhiliti — death, foreign	djuhiliti — village hut	djuhiliti — a sign of bad omen, misfortune, lack of courage	djillit — black and limping man (misfortune)
<i>laetitia</i>	lahica — interior of huts, joys and possessions	pure — recovery from sickness	hurr — health	hurr — liberty, non-condemnation
<i>rubeus</i>	homra — red	homra — people sleeping in huts	homra — red, blood, injury	homra — red, blood
<i>albus</i>	bahiti — world in the village, whiteness, death	bayada — injury	bayada — white, chance, joy, happiness	bayad — happiness
<i>puella</i>	métason — high place on the earth	madjum — anger of the village men, but not about hunger	mazum — ill men and women, suffering	mahazum — duty to be proud
<i>puer</i>	kosaje — shadow of a village tree	djoalla — thinking of something	djoalla — welcome during travel	djodala — arriving at a place without incident, welcome
<i>caput draconis</i>	raya — men in the village	raya — the bush or scrub outside the village	raya — beautiful man or woman	raya — women, all women
<i>cauda draconis</i>	arkis — women of the tribe	rakis = kharija — men (servants?) of the village	rakis — woman with large buttocks, delay, expectation, deception	rakisa — steatopygous woman

Figure	WEST AFRICAN TRIBAL		
	DAHOMEY Name and meaning ¹	BAMBARA (Mali) Corresponding Patriarch	Meaning ²
<i>populus</i>	yeku — west, night	Moussa — Moses	kingdom
<i>via</i>	gbe — life, east, day	Abachim	argument, dispute
<i>conjunctio</i>	woli — ferocious animals, south	Ali	strength
<i>carcer</i>	di — woman, copulation, north	Sulaymann — Solomon	power, authority, relationship with chief
<i>fortuna major</i>	wele — illnesses	Nouhoun — Noah	offspring, prosperity
<i>fortuna minor</i>	loso — a hole, accident, misfortune	Kalantala — Muhammad	tranquillity, abortion, peace, prosperity
<i>acquisitio</i>	fu — white, maternal principle	Ousmane	misfortune
<i>amissio</i>	ce — breakable, bad smell	Issa — Jesus	complaint, stomach-pains, news
<i>tristitia</i>	akla — twins	Yacouba — Jacob	household dispute
<i>laetitia</i>	abla — rope, duration, possessions	Adana — Adam	origin, genealogy, assembly, tribe, counsel
<i>rubeus</i>	ka — snake, filial piety, filial love	Amara — Amar	fidelity, friendship
<i>albus</i>	turukpe — pregnancy, anything protruding	Idrissa — Idris	paternal house, expanse of water
<i>puella</i>	tula — speech, mouths	Ladari(?)	death of the sick person, profit when travelling
<i>puer</i>	lete — earth, death	Jonas	vicissitude, soul
<i>caput draconis</i>	sa — black magic (ill-omen), feminine fire	Madi — the messenger	house, mother's family, happiness
<i>cauda draconis</i>	guda — sword, testicle, erection	Lassima al Houssein	certainty, bite of the serpent

¹ After Bernard Maupoil² After Labouret & Travélé

Notes

Introduction

- 1 *De Occulta Philosophia*, Book I, chapter LVII.
- 2 *De invent. rer.*, Book I, chapter XXIII.
- 3 Chinese *feng-shui* is the subject of a forthcoming book by the present author.

Chapter 1 *The roots of geomancy*

- 1 'Sikidy and Vintana', in *The Antananarivo Annual and Madagascar Magazine*, Antananarivo, 1886–8, pp. 222–4.
- 2 This is further confirmed in the etymological work of Isidore of Seville (VIII, 9, 13) in which he defines Varro's use of the word.
- 3 *Mémoires Scientifiques*, vol. IV, Paris and Toulouse, 1920.
- 4 Quoted by Baron Carra de Vaux in his introduction 'La Géomancie chez les Arabes' to vol. IV of Tannery's posthumous *Mémoires Scientifiques*, Paris and Toulouse, 1920.
- 5 The Greek text very obviously betrays its Arabic origin, and may be consulted in the printed version in Tannery, *Mémoires Scientifiques*, vol. IV, 1920, pp. 359–71.
- 6 Sometimes rendered Tomtom.
- 7 Sloane MS 314.
- 8 Additional MS 9702.
- 9 'Ab. Zarab, iv.
- 10 Including Nissim ben Moses, who wrote on the subject in *He Haluz* (chapter VII, 124), Aran ben Joseph and Joseph Albo who wrote extensively about geomancy in his *Ikkirim* (chapter IV, 4) in which he not only defined it, but referred specifically to the upper and lower points, establishing the existence of a Hebrew

geomantic vocabulary.

- 11 To name but a few authors of this title: Ahithophel ha-Giloni, Abraham ibn Ezra (whose work enjoyed numerous translations into Latin and other European languages), and a further *Sepher ha-Goralot* by the qabalist Saadia Gaon.
- 12 R.F. Burton, *A Mission to Gelele, King of Dahome*, London, 1864, pp. 334–5.
- 13 Ibid. See also Bernard Maupoil, *La Géomancie à l'ancienne Côte des Esclaves*, Paris, 1943.
- 14 Burton, op. cit.
- 15 Stephen Farrow, *Faith, Fancies and Fetish or Yoruba Paganism*, London, 1926, pp. 38–9.

Chapter 2 *Raml and Islamic origins*

- 1 According to Fahd in his article on *Khatt* in *Encyclopedia of Islam* (new edn): 'Instead of *khatt*, *darb* began to be used especially in dialect; *darb* is in fact the modern substitute for *tark*, which was used originally to denote lithomancy (or the casting of pebbles on the sand)'. Thus a certain confusion has resulted in *khatt* = *tark* = *darb* as Arabic terms for geomancy. We will here use the more correct term, *khatt*.
- 2 Fahd adds that 'raml and *khatt* also mean the black or white lines on the hooves of wild cattle or on the flanks and the backs of stags', a linguistic point which though quite suggestive really does not add to our comprehension of geomancy.
- 3 Rağip Paşa MS 964, copy made by Ahmad 'Isā.
- 4 Esat Ef. MS 1988, copy made by Ahmad 'Iyād at al-madrasa al-Zāhiriyya.
- 5 Berlin MS 4200 (2), ff. 12–67, according to Fahd.
- 6 Steinschneider, *Europ. Übersetz.* II, 1, No. 125. Bernard Silvester translated a geomancy involving the twenty-eight Mansions of the Moon under the title *Experimentarius oder liber fortunae* and many manuscripts of this survive. An *Astrologia terrestris* attributed to one 'Ali ben 'Umar has been translated from Arabic into Italian and German concerned with the treatise of Ibn Mahfuf.
- 7 Ibn Khaldun, *The Muqaddimah*, London, 1958, vol. 1, pp. 226 ff., vol. 2, p. 201.
- 8 Modern geomantic practice also takes cognizance of the square and opposition.
- 9 *The Muqaddimah*, vol. 1, p. 204.

- 10 Bibliothèque Nationale, MS 2631, f. 64v.
- 11 See Tabari, *Tafsir*, xxvi, 3, 1. 3 ff.
- 12 Wensinck *et al.*, *Concordance*, i, 40. Noted by 'Atā' ben Yasār.
- 13 This expansion has led to a great number of manuals and treatises, examples of which can be found in almost all the Arab collections in the East and the West, and details of which may be found in the *Encyclopedia of Islam* (new edn).
- 14 R. Davies, 'System of Sand Divination', in *Moslem World*, vol. XVII, New York, 1927, pp. 123–9.
- 15 See Arabic section of Appendix V for the local order of the figures.

Chapter 3 Fa, ifa and voodoo

- 1 Cited in A. Ellis, *The Yoruba-speaking people . . .*, London, 1894, p. 63.
- 2 W. Bosman, *A New and Accurate Description of the Coast of Guinea . . .*, London, 1705, p. 152.
- 3 G. Loyer, *Relation du voyage . . . en Afrique*, Paris, 1714, pp. 248–9.
- 4 Dr Irving, 'The Yoruba Mission', in *Church Missionary Intelligencer*, vol. IV, p. 233.
- 5 *Ifa Divination*, London, 1969, p. 29.
- 6 *Ibid.*, p. 43.
- 7 J. Wyndham, 'The Divination of Ifa (A Fragment)', in *Man*, vol. XIX, 1919, pp. 151–3. W. Price, *Dark Subjects*, London, 1939, p. 134.
- 8 R. Ribeiro, 'Projective Mechanisms and the Structuralization of Perception in Afro-brazilian Divination', *Revue Internationale d'Ethnopsychologie Normale et Pathologique*, vol. I (No. 2), 1956, pp. 18–19.

Chapter 4 The sikidy of Madagascar

- 1 Lars Dahle, 'Sikidy and vintana', in *The Antananarivo Annual and Madagascar Magazine*, Antananarivo, 1886–8, p. 121.
- 2 *Ibid.*, p. 231.
- 3 European geomancy occurs in an interesting connection in Richard Deacon's *The Book of Fate*, London, 1976. In chapter 8, he gives the history of a probably bogus early nineteenth-century

character called 'Princess Caraboo'. *Alakaràbo* is the word for *puella*, or girl, in the Sakalava (or West Coast dialect) of Malagasy. It is conceivable that Caraboo derived her pseudonym from this Malagasy word for *puella*. In the Malagasy listings in Appendix V, the word is given as *alakaràbo*, but of course *al* is the definite article in Arabic, leaving *karabo*.

Chapter 5 European geomancy in the middle ages

- 1 The study by Skeat, 'An Early Mediaeval "Book of Fate"', in *Medieval and Renaissance Studies*, vol. III, London, 1954, helps to iron out this confusion, whilst Richard Deacon's *Book of Fate* only confuses the issue.
- 2 Bibliothèque Nationale, MS 7354. Copies also exist at Cambridge University, Magdalene MS 27 (late fourteenth century) and Vienna MS 5508 (fourteenth century).
- 3 Laurentian MS Plut. 30, cod. 29 (Vienna MS 5327 contains a fragment of Hugh's geomancy in a fifteenth-century hand). See MS bibliography for details of incipits.
- 4 Both were edited and partly published by the French scholar and historian of mathematics, Paul Tannery, in his posthumous *Mémoires Scientifiques*, vol. IV, Paris and Toulouse, 1920.
- 5 G. Contini, 'Un Poemetto provenzale di argomento geomantico', *Collectanea Friburgensia*, 1940. See also T. Ebnetter, *Poème sur les signes géomantiques en ancien provençale*, 1955.
- 6 *Mémoires Scientifiques*, vol. IV, 1920, pp. 324–6.
- 7 Reprinted by Askin Publishers, London, 1978.
- 8 In *Atti dell' Accademia dei Nuovi Lincei IV*, 1851, p. 100 et seq.
- 9 Details of which will be found in my *Oracle of Geomancy*, chapter 13.
- 10 Ashmole MS 4.
- 11 Cotton Appendix VI.
- 12 CLM 489, f. 174–216v, *Incipit liber Geomantiae Michaelis Scoti. Geomantia dicitur ars judicandi per terram*.
- 13 Quoted by L. Thorndike, *Michael Scot*, London, 1965, p. 109.
- 14 *Introduction to the History of Science*, 1927–47, vol. II, p. 580.
- 15 *Treatise on Minerals*, Book II, iii, 3.
- 16 L. Thorndike, *A History of Magic and Experimental Science*, vol. II, p. 865.
- 17 *Introduction to the History of Science*, vol. II, p. 909.
- 18 L. Thorndike, *A History of Magic and Experimental Science*, vol. I, p. 865.

- 19 Bibliothèque Nationale, MS 3171, fol. 90v–95r.
- 20 Venice, S. Marco VIII, 44.
- 21 Ramon Lull's machines.
- 22 Albertus Magnus.
- 23 *Piers Ploughman*, A.XI.153.
- 24 For further details see Mahmoud Manzalaoui, 'Chaucer and Science', in *Geoffrey Chaucer*, ed. Derek Brewer, London, 1974.
- 25 Richard II's geomancy is still preserved in the British Museum library as Royal MS 12. C.v.
- 26 Harleian MS 1735, ff. 29–44v.
- 27 All Souls College 96, ff. 16–41.
- 28 Sloane MS 3487.
- 29 Arundel MS 66.
- 30 From a letter from Horatius Bichardus of Fano to Alessandro Bentivoglio, dated from Bologna on 15 December 1503, which is prefixed to Bartholomaeus Cocles, *Chryomantie ac physionomie Anastasis cum approbatione magistri Alexandri de Achillinis. Bononiae, ex arte Ioannis Antonii de Benedictis*, 1504.
- 31 L. Thorndike, *A History of Magic and Experimental Science*, vol. V, p. 58.
- 32 *Ibid.*, p. 63.
- 33 Basle, 1556, pp. 191–2.

Chapter 6 *The Renaissance: the apogee of geomancy*

- 1 Cornelius Agrippa's address to the reader, in *Three Books of Occult Philosophy*, vol. 1, reprinted New York 1897.
- 2 *De Incertitudine et vanitate scientiarum et artium*, Antwerp, 1531, chapter 13.
- 3 Reprinted Askin Publishers, London, 1978.
- 4 Agrippa, 'Of Geomancy' in *Fourth Book of Occult Philosophy*, London, 1655, reprinted London, 1978, pp. 1–2.
- 5 Quoted in D.P. Walker, *Spiritual and Demonic Magic from Ficino to Campanella*, London, 1958, p. 207.
- 6 These were partly based on manuscripts of the sixteenth century (probably copies of earlier manuscripts) including *Introduction à la Géomancie* and *La Géomancie plaine et parfaite*, translated by (Brother) Gilles de Morbeta, both now in the Bibliothèque Nationale. The Bibliothèque Mazarine also possesses amongst other texts on geomancy, a German manuscript of the sixteenth century, *Von der Geomancie*, together with a French work

- printed in Strasbourg in 1609: *Géomancie ou l'art de connaître les choses secrètes par points faits en terre*. The extraordinary *Manuscrit de Géomancie* of the Bibliothèque Arsenal dates from the early seventeenth century and has innumerable marginal signs, which give it the appearance of an antiphonal.
- 7 Such as Sloane MS 2186.
 - 8 Analysed in their historical context in A.L. Rowse, *Simon Forman*, London, 1974.
 - 9 *Journal of the Warburg and Courtauld Institutes*, vol. XXVII, London, 1964, pp. 332–4.
 - 10 Similar instructions for determining someone's physiognomy or general complexion by geomancy can be found in Jean Belot's *Instruction familière et tres facile pour apprendre les sciences de chiromancie et phisiognomie . . .*, Paris, 1819.
 - 11 *The Rosicrucian Enlightenment*, London, 1972, p. 189.

Chapter 7 *The great astrological revival*

- 1 In *Raphael, or the Royal Merlin*, London, 1964.
- 2 The full text for each geomantic figure is reprinted in the appendices of my *Oracle of Geomancy*, Warner Destiny, New York, 1977.
- 3 In *The Book of Fate: its Origins and Uses*, London, 1976, p. 19.
- 4 *Ibid.*, pp. 115–16.
- 5 Full details of the interpretation and conclusion of the matter may be found in my *Oracle of Geomancy*, pp. 301–5.
- 6 *Notes and Queries*, Ninth Series, vol. IV, pp. 328–9.

Chapter 8 *Geomancy in the twentieth century*

- 1 The full version occurs in Agrippa's *Fourth Book of Occult Philosophy* and is reproduced in my *Oracle of Geomancy*, pp. 272–93.
- 2 Paris, 1929, pp. 158–9.
- 3 Routledge & Kegan Paul edn, 1979, p. 693.
- 4 Eugène Caslant, *Traité élémentaire de géomancie*, Paris, 1935.

Chapter 9 *Method and manipulation*

- 1 Gerard of Cremona (i.e. Sabbioneta) 'Astronomical (sic)

- Geomancy' in Agrippa's *Fourth Book of Occult Philosophy*, London, 1655, reprinted 1978, p. 157.
- 2 *Magick in Theory and Practice*, Paris, 1929, pp. 165-6.
- 3 Tolkien's *Lord of the Rings* or Eliphaz Lévi's *Doctrine and Ritual*, part II, chapter 4 offer inspiration along these lines.
- 4 L. Thorndike, *History of Magic and Experimental Science*, vol. II, p. 838.
- 5 Golden Dawn sources suggest that a planetary sigil with invoking encircled pentagram be inscribed at this point, but this is not a traditional essential of the process, being derived from John Heydon's *Theomagia*, 1662-4.

Chapter 12 *Practical divination*

- 1 *Magick in Theory and Practice*, Paris, 1929, p. 166.

Chapter 14 *Summary of technique and interpretation*

- 1 Or refer to Judge/Witness tables such as those printed in my *Oracle of Geomancy*, chapter 8, or Hartmann's *Geomancy*, appendix.
- 2 Such as appears in Agrippa's *Fourth Book of Occult Philosophy* (1655, reprinted 1978), pp. 157-75 or my *Oracle of Geomancy*, pp. 272-93.

Bibliography

It is very difficult to draw up a complete bibliography of works on geomancy, as it would include magical, historical, anthropological and sociological works in a number of different languages covering Africa, the Middle East and Europe. Likewise it is undesirable simply to list such works alphabetically. They are here divided into the basic cultural areas, in much the same way that chapters 1-5 are broken down according to cultural region. In each case the most relevant and fruitful texts are marked with an asterisk, and where any of these have extensive bibliographies this is also noted, so that the student of geomancy can pursue his researches in greater detail.

For a general historical background to divination the reader should consult Bouché-Leclercq, *Histoire de la divination dans l'antiquité* (4 volumes) Paris, 1880-2.

For Hebraic sources the reader should consult the bibliographic references in the geomancy article in the *Encyclopaedia Judaica*. Likewise for extensive bibliographic references (especially to Arabic manuscripts) the reader should consult *Encyclopaedia of Islam* (new edition: the article on Khatt by Toufic Fahd).

Paul Tannery's *Mémoires scientifiques* is the best introduction to the early history of geomancy in Europe and the connection between Arab sources and their Greek and Latin derivatives.

For extrapolations, worked examples and tables connected with practical European geomancy see my own *Oracle of Geomancy*, Warner/Destiny, New York, 1977, and my forthcoming work on *Feng-shui* for details of the unrelated system of Chinese geomancy.

The works of George Sarton and Lynn Thorndike are of course invaluable historical frames of reference.

Raml and Islamic origins (chapter 2)

The most important source works are in Arabic, being those of az-Zanati and Ahmad ben 'Ali Zunbul, with the works of Tannery, Toufic Fahd and Carra de Vaux being the most useful of the French critical works on *raml*. Unfortunately there is little material in English on *raml*, and the few magazine articles that have appeared range from sketchy to downright misleading.

- ABOU BAKR BEN CHOAIB. 'La bonne aventure chez les musulmans' in *R.A.*, 1906, pp. 62-70.
- * ABU 'ABDALLAH MUHAMMAD (BEN 'UTHMAN?) AZ-ZANATI. *Kitab al-Fasl fi usul 'ilm ar-raml*, Cairo, 1863-4.
- * ABU 'ABDALLAH MUHAMMAD (BEN 'UTHMAN?) AZ-ZANATI. *al-Aqwal al-mardiyyah fi l-ahkam ar-ramliyyah*, Cairo, 1908-9.
- * AHMAD BEN 'ALI ZUNBUL AL-MAHALLI AL-MUNAGGIM. (1) *Kitab al-maqalat fi hall al-muskilat*. (2) *Kitab ad-dahab al-ibriz al-muharrar*. (3) *Kitab lamm as-saml fi 'ilm ar-raml*. (4) *Kitab ad-durr al-mubdi fi zubur al-Mahdi*.
- ARDANT DU PICQ, J.J.J. *L'influence islamique sur une population malayopolynésienne de Madagascar*, Charles-Lavauzelle, Paris, 1933.
- BARAKAT, ROBERT A. *Tawula: A Study in Arabic Folklore*, Tiedeakatemia, Helsinki, 1974 (F.F. Communications, No. 214).
- BROCKELMANN, C. *Geschichte der arabischen Litteratur*, vol. II, Leiden, 1949, pp. 298, 326 ff.
- * CARRA DE VAUX, BERNARD. 'La Géomancie chez les Arabes', see P. Tannery, *Mémoires Scientifiques*.
- CRUZET, V. 'Du "khet-er-Raml" ou art de lire l'avenir sur le sable' in *R.T.*, 1920, pp. 267-76.
- DAVIES, R. 'A System of Sand Divination', in *Sudan Notes and Records*, vol. III, 1920, pp. 157-62 and in *Moslem World*, vol. XVII, Missionary Review Publishing Co., New York, 1927, pp. 123-9.
- DECOURDEMANCHE, J.A. 'Sur quelques pratiques de divination chez les Arabes', *Revue des traditions populaires*, 1906, vol. 21, pp. 66-73.
- DOUTTÉ, EDMOND. *Magie et religion dans l'Afrique du Nord*. Algiers, 1909, pp. 377 ff.
- ELISSEÉFF, N. *Thèmes et motifs des Mille et Une Nuits. Essai de classification*, Beirut, 1959, pp. 127-8.
- * FAHD, TOUFIC. *La Divination Arabe*, Brill, Leiden, 1966, pp. 195-204.
- * FAHD, TOUFIC. 'Khatt' in *Encyclopedia of Islam* (new edition), pp. 1128-30.
- * FERRAND, GABRIEL. *Les Musulmans à Madagascar et aux îles Comores*, Algiers, 1891, pp. 73-100. Paris, 1902, Appendix, pp. 141-50.
- FERRAND, GABRIEL. 'Un chapitre d'astrologie Arabico-Malgache', *Journal asiatique*, Paris, 10th series, vol. vi, Sept-Oct. 1905, pp. 193-273.
- FERRAND, GABRIEL. 'Madagascar', *Encyclopedia of Islam* (old edition), vol. 3, pp. 70-4.
- HADJDI, KHALIFA. *Encyclopedia of Islam* (new edn) vol. III, pp. 478 f.
- * IBN KHALDUN (ABD AL-RAHMAN IBN MUHAMMAD). *The Muqaddimah* (ed. Franz Rosenthal), 3 vols, Routledge & Kegan Paul, London, 1958, vol. 1, pp. 226 ff, vol. 2, p. 201.
- * KHAMBALLAH, HADJI. *La Géomancie traditionnelle . . . Traité pratique d'enseignement et dictionnaire d'interprétation géomantique*, Editions Vêga, Paris, 1947.
- KLEIN-FRANKE, FELIX. 'The Geomancy of Ahmad ben 'Ali Zunbul. A Study of the Arabic Corpus Hermeticum', *Ambix*, London, vol. 20, 1973.
- LELUBRE, M. 'La Géomancie chez les Touareg'. *Bulletin de Liaison saharienne*, Paris, 1952, no. 10.
- LEROUX, H. 'Animisme et Islam dans la subdivision de Maradi (Niger)', *Bulletin de l'Institut Français d'Afrique Noire*, vol. X, Paris, 1948, pp. 652-6.
- LEWICKI, T. 'Prophètes, divins et magiciens chez les Berbères médiévaux', *Folia orientalia*, 1966, vol. 8, pp. 3-27.
- MADRUS, J.-C. *Sucre d'Amour*.
- MARGOLIOUTH, D.S. 'Divination (Muslim)' in *Encyclopaedia of Religion and Ethics*, ed. J. Hastings et al., 1908, vol. 4. pp. 816-18.
- * MAUPOIL, BERNARD. 'Contribution à l'étude de l'origine musulmane de la géomancie dans le Bas-Dahomey', *Journal de la Société des Africainistes*, vol. XIII, Paris, 1943, pp. 1-94.
- MAXWELL, J. *La Divination*, Paris, 1927, pp. 135-7.
- MERCADIER, CAPTAIN. 'Un Procédé de divination par le sable, en usage chez les peuplades sahariennes', *Bulletin de Liaison saharienne*, no. 10, Paris, 1952.

- MUHAMMAD AL SUDI. *A Treatise on Astrology and Divination*.
 MUHAMMAD IBN OMAR AL TOUNSI. *See* Perron.
 NASR, SEYYED HOSSEIN and CHITTICK, WILLIAM. *An Annotated Bibliography of Islamic Science* (Section XF & XG – The Occult Sciences), Imperial Iranian Academy of Philosophy, forthcoming.
- OSMAN, BEN ALI (supposed author). *Grosses Punktir-Buch des weisen Arabers Osman Ben Ali oder Blicke in die Zukunft*, Landsberg, n.d.
- PERRON, DR. *Voyage au Darfour*, Paris, 1845.
- RESCHER, O. *Der Islam*, vol. IX, 1919, p. 37.
- ROSENTHAL, FRANZ, *see* Ibn Khaldun.
- RUSKA, J. *Arabische Alchemisten*, vol. II, Heidelberg, 1924.
- SARTON, GEORGE. *Introduction To The History of Science*, vols. 1-3, Williams & Wilkins, Baltimore, 1927-47 (Carnegie Inst. Pub. no. 376).
- * STEINSCHNEIDER, MORITZ. 'Die S[i]kidy oder geomantischen Figuren', *Zeitschrift der Deutschen Morgenländischen Gesellschaft*, vol. 31, Leipzig, 1877, pp. 762-5.
- * STEINSCHNEIDER, MORITZ. *Europäische Übersetzungen* (35-37), 1904.
- * TANNERY, PAUL. *Mémoires Scientifiques*, vol. IV, Sciences Exactes chez Les Byzantins. Mémoire No. 14 – 'Le Rabolion (Traité de Géomancie arabes, grecs, et latins)', pp. 295-411 (includes 'La géomancie chez les arabes' by Baron Carra de Vaux, p. 299) Heiberg & Zeuthen, Toulouse and Paris, 1920.
- TRANCART, ANDRÉ. 'Sur un procédé de divination de l'Adrar mauritanien, le gzân', *Bull. du Comité d'études historiques et scientifiques de l'Afrique occidentale française*, vol. XXI, no. 104, Paris, Oct.-Dec. 1938, pp. 489-98.

Fa, ifa and voodoo (chapter 3)

The outstanding work in this section is that by Bernard Maupoil, followed by the comparative work of J.C. Hébert, Ardant du Picq and René Trautmann. In English the most comprehensive text on *ifa* divination is that by William Bascom (1969), who is also the most extensive periodical writer on the subject. Extensive bibliographies will be found in all the above texts. Herskovits (1938) is of course the classic writer on Dahomey, and Dennett (1910) and Spieth are also well worth consulting. Finally there are several

texts listed which are written by Yoruba writers, of which the two most notable are those of Bishop Johnson (1899) and J. Abayomi Cole. Unfortunately the latter, although quoted in a number of places, is virtually unobtainable, having disappeared from most of the large public library collections where it has been catalogued.

- ALAPINI JULIEN. *Les Noix Sacrées. Etude complète de Fa-Abidégoun. Génie de la Sagesse et la Divination au Dahomey*, Regain, Monte-Carlo, 1950, p. 126.
- * ARDANT DU PICQ, J.J.J. 'Etude comparative sur la divination en Afrique et à Madagascar', *Bull. du Comité d'études historiques et scientifiques de l'Afrique occidentale française*, vol. XIII, no. 1, Paris, Jan.-Mar. 1930, pp. 9-25.
- BASCOM, WILLIAM. 'Ifa Divination: Comments on the Paper by J.D. Clarke', *Man*, vol. XLII (21), 1942, pp. 41-3.
- BASCOM, WILLIAM. 'The Sanctions of Ifa Divination', in *Journal of the Royal Anthropological Institute*, London, vol. LXXI, 1941, pp. 43-54.
- BASCOM, WILLIAM. 'The Relationship of Yoruba Folklore to Divining', in *Journal of American Folklore*, vol. LVI, 1943, pp. 127-31.
- BASCOM, WILLIAM. 'Two Forms of Afro-Cuban Divination', in *Acculturation in the Americas*, Sol Tax (ed). *Proceedings and Selected Papers of the XXIXth International Congress of Americanists*, vol. I, 63-9, University of Chicago Press, 1952.
- BASCOM, WILLIAM. 'Odu Ifa: The Order of the Figures of Ifa', in *Bulletin de l'Institut Français d'Afrique Noire*, Paris, vol. XXIII, 1961, pp. 676-82.
- BASCOM, WILLIAM. 'Odu Ifa: The Names of the Signs', *Africa*, London, vol. XXXVI, 1966, pp. 408-21.
- * BASCOM, WILLIAM. *Ifa Divination: Communication between Gods and Men in West Africa*, Indiana University Press, Bloomington and London, 1969. Extensive bibliography.
- BERTHO, JACQUES. 'La Science du destin au Dahomey', *Africa*, London, vol. IX, no. 3, July 1936, pp. 359-78.
- BERTHO, JACQUES. 'La Science du Destin chez les Noirs du Dahomey', in *Écho des Miss. Afric de Lyon*, Lyon, no. 10, Dec. 1936, pp. 162-4; no. 1, Jan. 1937, pp. 9-10.
- BOEHMER, J. *Religions - Urkunden Der Völker*, Section 4, Book 2, 1909; *see also* Spieth, J.
- BURTON, RICHARD FRANCIS. *A Mission to Gelele, King of Dahomey. With notices of the so called 'Amazons', the grand*

- Customs, the Yearly Customs, the Human Sacrifices, the Present State of the Slave Trade, and the Negro's place in Nature*, Tinsley Brothers, London, 1864; Routledge & Kegan Paul, London, 1966 (2 vols); vol. I, pp. 161, 330-7.
- CLARK, J.D. 'Ifa Divination', in *Journal of the Royal Anthropological Institute*, London, vol. LXIX, part 2, plate XIII, 1939, pp. 235-56.
- * COLE, J. ABAYOMI. *Astronomical Geomancy in Africa*, 1898, untraceable but cited in Dennett (1906), Ellis (1894) and Baudin (1885).
- DENNETT, R.E. *At the Back of the Black Man's Mind, or Notes on the Kingly Office in West Africa*, Macmillan, London, 1906, Appendix.
- * DENNETT, R.E. *Nigerian Studies, or the Religious and Political System of the Yoruba*, Macmillan, London, 1910.
- DIETERLEN, GERMAINE. *Textes sacrés d'Afrique Noire*, Gallimard, Paris, 1965.
- ELLIS, ALFRED BURTON. *The Ewe-speaking Peoples of the Slave Coast of West Africa, their Religion, Manners, Customs, Laws, Languages*, Chapman & Hall, London, 1890.
- ELLIS, ALFRED BURTON. 'How the Yoruba count and the Universal Order in Creation', *Journal of the African Society*, London, vol. XVII, 1917-18.
- * ELLIS, ALFRED BURTON. *The Yoruba-speaking Peoples of the Slave Coast of West Africa, their Religion, Manners, Customs, Laws, Languages, etc . . . with an Appendix containing a comparison of the Tshi, Ge, Ewe and Yoruba languages*, Chapman & Hall, London, 1894.
- EPEGA, D. ONADELE. *The Mystery of Yoruba Gods*, Hope Rising Press, Lagos, 1931.
- EPEGA, D. ONADELE. *Ifa-amqna 'awqn Baba wa*. Imqlẹ Oluwa Institute, Ode Remo, Nigeria, Hope Rising Press, Lagos, 1931.
- EPEGA, M. LAJUWON. 'Ifa - The light of my Fathers', in *The Nigerian Teacher*, vol. I, no. 5, 1935, pp. 11-14.
- FAGG, WILLIAM and WILLETT, FRANK. 'Ancient Ife. An Ethnographical Summary', *Odu*, no. 8, 1960, pp. 21-35.
- FARROW, STEPHEN SEPTIMUS. *Faith, Fancies and Fetish or Yoruba Paganism*, Macmillan, London, 1926.
- FROBENIUS, LEO. *Auf den Trümmern des klassischen Atlantis*, Berlin, 1912, pp. 254-91.
- FROBENIUS, LEO. *Das Unbekannte Afrika. Aufhellung der Schicksale eines Erdteils*, Oskar Beack, Munich, 1923, table, 185-92.
- FROBENIUS, LEO. *Kulturgeschichte Africas*, Phaidon-Verlag, Zurich, 1933, pp. 169-73. Pl. 88, 113, 123, 128.
- FROBENIUS, LEO. *Histoire de la Civilisation Africaine* (trans. H. Back and D. Ermont), Gallimard, Paris, 1936.
- F.S. 'Ifa', in *Nigerian Chronicle*, Lagos, 12 March 1909.
- GAILLARD, DR. 'Étude sur les Lacustres du Bas-Dahomey', *L'Anthropologie*, Paris, vol. XVIII, 1907, pp. 99-125.
- GORER, GEOFFREY EDGAR SOLOMAN. *Africa Dances*, Faber & Faber, London, 1935.
- HAZOUÉMÉ, PAUL. 'Annales Dahoméennes. La conquête du royaume houéda par les Dahoméens au XVII^e siècle', *Bulletin de l'enseignement de l'Afrique Occidentale Française*, Gorée, no. 45. January 1921, p. 43.
- HAZOUÉMÉ, PAUL. 'Le Calendrier Dahoméen', in *La Reconnaissance Africaine*, Cotonou, no. 43, 1 October 1927, pp. 2-3, no. 44; 1 November 1927, pp. 3-5.
- HAZOUÉMÉ, PAUL. 'La Mentalité du Dahoméen. La Consultation du Fa', *Conférence*, Cotonou, 25 December 1941 and 1 January 1942.
- HAZOUÉMÉ, PAUL. *Le Pacte de Sang au Dahomey*, Institut d'Ethnologie, Paris, 1937.
- HAZOUÉMÉ, PAUL. 'La Mentalité du Dahoméen, Bokano, le Prêtre du Fa (Divinité des Oracles)', *Conférence*, Cotonou, 11 December 1941.
- HAZOUÉMÉ, PAUL. 'La Mentalité du Dahoméen. Le Fa, la Divinité des Oracles', *Conférence*, Cotonou, 18 December 1941.
- * HÉBERT, J.C. 'Analyse structurale des géomancies comoriennes, malgaches, et africaines', in *Journal de la Société des Africainistes*, vol. XXXI, fasc. II, 1961, pp. 115-208. Extensive bibliography.
- * LE HÉRISSE, A. *L'Ancien Royaume du Dahomey. Moeurs, Religion, Histoire*, Larose, Paris, 1911.
- HERSKOVITS, MELVILLE J. and HERSKOVITS, FRANCES. 'An Outline of Dahomean Religious Belief', *Memoirs of the American Anthropological Association*, Menasha, vol. III, no. 41, 1933.
- HERSKOVITS, MELVILLE J. and HERSKOVITS, FRANCES. 'The Art of Dahomey I', the *American Magazine of Arts*, Washington, vol. XXVII, no. 2, Feb. 1934, pp. 67-76.
- HERSKOVITS, MELVILLE J. 'The Art of Dahomey II', the *American Magazine of Arts*, Washington, vol. XXVII, no. 3, March 1934, pp. 124-31.
- HERSKOVITS, MELVILLE J. 'African Gods and Catholic Saints

- in New World Negro Belief', *American Anthropologist*, Menasha, new series, vol. XXXIX, no. 4, Oct.-Dec. 1937, pp. 635-43.
- HERSKOVITS, MELVILLE J. *Life in a Haitian Valley*, Knopf, New York and London, 1937, p. 30.
- * HERSKOVITS, MELVILLE J. *Dahomey: An ancient West African Kingdom*, Augustin, New York, 1938, 2 vols; vol. II, chapters XXX & XXXI, and passim.
- JOHNSON, JAMES. *Yoruba Heathenism*, James Townsend, London, 1899.
- * LABOURET, HENRI and TRAVÉLÉ, MOUSSA. 'Quelques aspects de la magie africaine: Amulettes et Talismans au Soudan Français', *Bull. du Comité d'études historiques et scientifiques de l'Afrique Occidentale Française*, Paris, vol. X, nos. 3-4, July-Dec. 1927, pp. 480-545.
- McCLELLAND, E.M. 'The Significance of Number in the Odu of Ifa', *Africa*, vol. XXXVI (4), 1966, pp. 421-30.
- MARCELIN, EMILE. 'Les Grands dieux du vodou haïtien', *Journal de la Société des Africainistes*, Paris, 1947 (?), pp. 51-135.
- MAUPOIL, BERNARD. 'L'Ethnographie dahoméenne et la Probité scientifique', *L'Afrique Française*, Paris, no. 7, July 1937, pp. 358-60.
- MAUPOIL, BERNARD. 'Le Culte du vaudou', *M.J. Herskovits et l'Ethnographie afro-américaine*, Outre-Mer, Paris, 3rd quarter, 1937, p. 2.
- * MAUPOIL, BERNARD. *La Géomancie à l'ancienne Côte des Esclaves*, Institut d'Ethnologie, Paris, 1943, Travaux et Mémoires de l'Institut d'Ethnologie, vol. 42. Extensive bibliography.
- * MAUPOIL, BERNARD. 'Contribution à l'étude de l'origine musulmane de la géomancie dans le Bas-Dahomey', *Journal de la Société des Africainistes*, vol. XIII, Paris, 1943-6, pp. 1-94.
- MEEK, C.K. *A Sudanese Kingdom. An Ethnographical Study of the Jukun-speaking Peoples of Nigeria*, Kegan Paul, London, 1931.
- MERCIER, PAUL. 'Procédé de divination observé à Boutilimit-Mauritanie', *Notes africaines*, Paris, 1947, no. 33, pp. 12-13.
- MÉTRAUX, ALFRED. *Voodoo in Haiti*, Deutsch, London, 1959, p. 29.
- MONTEIL, CHARLES. 'La Divination chez les Noirs de l'Afrique occidentale française', *Bull. du Comité d'études historiques et scientifiques de l'Afrique occidentale française*, Paris, vol. XIV nos. 1-2, Jan.-June 1931. pp. 72 et seq., esp. pp. 82-95, 108.
- MONTEIL, CHARLES. *La Divination chez les Noirs de l'Afrique occidentale française*, Larose, Paris, 1932.
- PRÉVAUDEAU, MARIE-MADELEINE. *Abomey la Mystique. Préf. de Pierre Mille*, Albert, Paris, 1936.
- QUÉNUM, MAXIMILIEN POSSY-BERRY. 'Au pays des Fons', *Bull. du Comité d'Études historiques et scientifiques de l'Afrique Occidentale Française*, Paris, vol. XVIII, nos. 2-3, April-Sept. 1935 (reprinted Larose, Paris, 1938).
- PRINCE, RAYMOND. *Ifa. Yoruba Divination and Sacrifice*, Ibadan University Press, Ibadan, 1963, p. 18.
- RIBEIRO, RENÉ. 'Projective Mechanisms and the Structuralization of Perception in Afro-brazilian Divination', *Revue Internationale d'Ethnopsychologie Normale et Pathologique*, vol. I (2), 1956, pp. 3-23.
- SISSOKO, FILLY DABO. 'La Géomancie', *Bull. de recherches soudanaises*, Paris, nos. 5-6, 1936, pp. 248-68.
- SKERTCHLY, J.A. *Dahomey as it is . . .*, Chapman & Hall, London, 1875, pp. 474-7, et seq.
- SOLICHON. 'Croyances et superstitions dans le Bas-Dahomey', *Bull. du Com. d'Études historiques et scientifiques de l'Afrique Occidentale Française*, Paris, vol. IV, no. 4, Oct.-Dec. 1921, pp. 667-71, 674.
- ŞOWANDE, FĒLA. *Ifa*, Forward Press, Yaba [c. 1964], p. 74.
- ŞOWANDE, FĒLA. *Ifa. Odu Mimọ*, Ancient Religious Societies of African Descendants Association, Lagos, 1965, pp. viii, 70.
- SPIETH, JAKOB. *Die Religion der Eweer in Süd-Togo*, Vandenhoeck & Ruprecht, Gottingen, 1911. See also Boehmer, J.
- * STEINSCHNEIDER, MORITZ. 'Die S[i]kidy oder geomantischen Figuren', *Zeitschrift der Deutschen Morgenländischen Gesellschaft* 31, Leipzig, 1877, pp. 762-5.
- TALBOT, PERCY AMAURY. *The Peoples of Southern Nigeria*, Oxford University Press, London, 1926, 3 vols, vol. II, p. 33-4, 185-8, 357 and passim; vol. III, pp. 431-3.
- TEGNOEUS, HARRY. *Le Héros civilisateur. Contribution à l'étude ethnologique de la religion et de la sociologie africaine*, Stockholm, 1950, pp. 65-81.
- THOMPSON, FREDERICK WILLIAM. *West African Secret Societies. Their organisation, officials and teaching*, Witherby, London 1929.
- TRANCART, ANDRÉ. 'Sur un procédé de divination de l'Adrar mauritanien, le gzân', *Bull. du Comité d'études historiques et scientifiques de l'Afrique Occidentale Française*, Paris, vol. XXI, no. 104, Oct.-Dec. 1938, pp. 489-98.
- TRAUTMANN, RENÉ. 'La Divination à la Côte des Esclaves et à

Madagascar. Le Vôdoû – le Fa – le Sikidy', *Mémoires de l'Institut Français d'Afrique Noire*, no. 1, Larose, Paris, 1939.

TRAVÉLÉ, MOUSSA. See Labouret.

VERGER, PIERRE. 'Notes sur le culte des orisa et vodun à Bahia, la baie de tous les saints, au Brésil, et à l'ancienne Côte des Esclaves en Afrique', *Mémoires de l'Institut Français d'Afrique Noire*, no. 51, Dakar, 1957.

VERGER, PIERRE. *Dieux d'Afrique Culte des orishas et vodouns à l'ancienne Côte des Esclaves en Afrique et à Bahia, la baie de Tous les Saints au Brésil* . . . Paris, 1954.

VIGNÉ D'OCTON, PAUL. *Terre de Mort (Soudan et Dabomey)*, Lemerre, Paris, 1892.

VINCENT, JEANNE FRANÇOISE. 'Divination et possession chez les Mofu, montagnards du Nord – Cameroun', in *Journal de la Société des Africainistes*, vol. LVI, Paris, 1971, pp. 71–132.

WYNDHAM, JOHN. 'The Divination of Ifa (A Fragment)', *Man*, vol. XIX (80), 1919, pp. 151–3.

Sikidy (chapter 4)

With the exception of the work of a few writers like Lars Dahle, William Ellis and James Sibree, the most relevant works on *sikidy* are all in French, due no doubt to the colonial history of the island. Of these, Caquot has some of the few extant photographs of diviners practising *sikidy*, and Ferrand and Hébert are the most comprehensive. Flacourt is interesting particularly because of his position of Governor of Madagascar, and the fact that writing in the mid-seventeenth century he was able to recognize the presence of a similar divinatory mode in Europe.

- * ARDANT DU PICQ, J.J.J. 'Etude comparative sur la divination en Afrique et à Madagascar', *Bull. du Comité d'études historiques et scientifiques de l'Afrique Occidentale Française*, Paris, vol. XIII, no. 1. Jan.–March 1930, pp. 9–25.
- ARDANT DU PICQ, J.J.J. *L'influence islamique sur une population malayapolynésienne de Madagascar*, Charles-Lavauzelle, Paris, 1933.
- BERTHIER, HUGHES. 'Notes sur les destins des quatre éléments', *Bull. de l'Académie malgache*, vol. X, Paris, 1913, pp. 185–6.
- * BERTHIER, HUGHES. *Notes et impressions sur les moeurs et coutumes du peuple malgache*, Tananarive, 1933.
- * CAQUOT, ANDRÉ and LEIBOVICI, MARCEL. *La divination*,

Presses Universitaires de France, Paris, 1968, pp. 331–427, 473–551.

- * DAHLE, LARS. 'Sikidy and Vintana: Half-Hours with Malagasy Diviners', in *The Antananarivo Annual* (ed. Rev. J. Sibree and Rev. R. Baron), nos. X–XII, LMS Press, Antananarivo, pp. 219–34 (1886), 315–24 (1887) and 457–67 (1888).
- DANDOUAU, ANDRÉ. 'My famboazan'ny Sikidy (région d'Analava)', in *Bull. de l'Académie malgache*, vol. V, Paris, 1908, pp. 61–72.
- DANDOUAU, ANDRÉ. 'Le Sikidy sakalava', *Anthropos*, vol. IX, nos. 3 & 6, Paris, 1914, pp. 546–68 & 833–72.
- DECARY, RAYMOND. *Moeurs et coutumes des Malgaches*, Payot, Paris, 1951.
- DECARY, RAYMOND. *La Divination malgache par le sikidy*, Geuthner, Paris, 1970 (Ser. 6. vol. 9, Pub. du Centre Universitaire des langues orientales vivantes).
- DEVÈZE, P. LA. 'Scènes de divination à Madagascar – Les Mpisikidy', *Le mois littéraire*, Paris, March 1913, pp. 244–50.
- DOULIOT, H. *Journal du voyage fait sur la côte ouest de Madagascar, 1891–1892*, Paris, 1895.
- * ELLIS, WILLIAM. *History of Madagascar*, 2 vols, Fisher, London, 1838.
- FAUBLÉE, JACQUES. 'Techniques divinatoires et magiques chez les Bara de Madagascar', *Journal de la Société des Africainistes*, Paris, 1952, vol. XXI, pp. 127–38.
- * FERRAND, GABRIEL. *Les Musulmans à Madagascar et aux îles Comores*, vol. 9, Algiers and Paris, 1892–1902, pp. 73–101.
- * FERRAND, GABRIEL. 'Un chapitre d'astrologie arabo-malgache', *Journal asiatique*, Paris, Sept.–Oct. 1905, pp. 193–273.
- FERRAND, GABRIEL. 'Les Destins des quatre éléments dans la magie malgache', *Revue des études ethnographiques et sociologiques*, Paris, 1908, pp. 277–8.
- FERRAND, GABRIEL. 'Madagascar', *Encyclopedia of Islam* (old edn), vol. 3, pp. 70–4.
- * FLACOURT, ÉTIENNE DE. *Histoire de la grande isle Madagascar* . . . , Paris, 1661, pp. 171–8.
- * GRANDIDIER, ALFRED and GUILLAUME. 'Ethnographie de Madagascar', in *l'Histoire physique, nationale et politique de Madagascar*, vols. III, IV, Paris, 1917, pp. 458–507.
- * HÉBERT, J.C. 'Analyse structurale des géomancies comoriennes, malgaches, et africaines', in *Journal de la Société des Africainistes*, vol. XXXI, (II), 1961, pp. 115–208. Extensive bibliography.

- LEIBOVICI, MARCEL. *See* CAQUOT, A.
- PENNICK, NIGEL. *Madagascar Divination*, Fenris-Wolf, Cambridge, 1976 (?).
- RUSSILLON, HENRI. 'Le Sikidy malgache', *Bull. de l'Académie malgache*, vol. VI, Paris, 1909, pp. 115-62.
- SIBREE, JAMES. *Madagascar before the Conquest*, Fisher Unwin, London, 1896 (copied almost verbatim from Dahle).
- * STEINSCHNEIDER, MORITZ. 'Die s[i] kidy oder geomantischen Figuren', *Zeitschrift der Deutschen Morgenländischen Gesellschaft*, vol. 31, pp. 762-5, Leipzig, 1877.
- * TRAUTMANN, RENÉ. 'La Divination à la Côte des Esclaves et à Madagascar. La Vôdoû - le Fa - le Sikidy', in *Mémoires de l'Institut Français d'Afrique Noire*, no. 1, Larose, Paris, 1939.

European geomancy (chapters 5-8)

Texts here are too numerous to mention, but the seminal ones are those of Henry Cornelius Agrippa, Christopher Cattan, Bartholomew of Parma, Cocles, Robert Fludd, Gerard of Cremona (or Sabbioneta) and Peter de Abano.

In French the work of Tannery, Caslant (taken from Cattan) and Delatte are important for the historical details and bibliographies. The work of John Heydon is mainly derivative, as are most twentieth-century works, with writers like Deacon contributing towards the general confusion between geomantic books and *libri delle sorti*, rather than clarifying the issue.

Lynn Thorndike's monumental work remains the most reliable background work on the history of European geomancy.

- * ABU-HALI-BEN-OMAR (pseud.). *Vollkommene Geomantia, deren erster Theil die aufs neue revidirte . . . Punctier-Kunst in sich begreift . . . Der ander theil aber des . . . Arabers Abu-Hali-ben-Omar neimabls vorhin gedruckte astrologia terrestris oder Indische Stern-Kunde . . .* Leipzig, 1735.
- AGRIPPA, HENRY CORNELIUS. *Three Books of Occult Philosophy*, London, 1651, vol. I, book 1, chapter 57; book II, chapters 48, 51.
- * AGRIPPA, HENRY CORNELIUS. 'On Geomancy', *Fourth Book of*

Occult Philosophy, London, 1655; reprinted Askin Publishers, London, 1978.

- * AGRIPPA, HENRY CORNELIUS. *Opera* (ed. Richard H. Popkin), Hildesheim, 1970, vol. I, pp. 500-26.
- AGRIPPA, HENRY CORNELIUS. *Of The Vanitie and Uncertainty of Artes and Sciences*, California State University, Berkeley, 1974, pp. 60, 109, 408.
- AGRIPPA, HENRY CORNELIUS (pseud.). *The Ladies Oracle*, Evelyn, London, 1962.
- AGRIPPA, CORNELIUS (pseud.). *Oracle du Destin: or Ancient and Modern Ladies Oracle*, Evans, London [1857].
- ALADIN BEN ABDUL WAHHÂB (pseud.). *Neuestes grosses arabisches Punctierbuch. Nach den untrüglichenst orientalischen Quellen des Aladin ben Abdul Wabbâb ins Deutsche Übertragen*, Reutlingen, n.d.
- ALFAKINUS. *See* Fasciculus Geomanticus.
- * AMBELAIN, ROBERT. *La Géomancie magique*, Niclaus, Paris, 1940, pp. 198-9.
- ANON. *Ausfürliches Punctierbuch. In neuer und gründlicher Weise ausgearbeitet und vervollständigt nach den Aufzeichnungen des weisen Arabers Harun al Raschid und der weltberühmten franz-ösischen Wahrsagerin Lenormand*, Reutlingen, 1920.
- ANON. *Beliebtes Punctier-Buch mit einem belustigenden Frage und Antwoortspeil . . .* Leipzig, n.d.
- ANON. *Curieuse und ganz neue Art zu Punctiren. Aus dem Arabischen ins Deutsche übersetzt von einem Leibhaber dieser Kunst*, Darmstadt [c. 1970]. (Facsimile reprint of ed. published Weimar, S.H. Hoffman 1768).
- ANON. *Géomancie où l'art de connaître les choses secrètes par points faits en terre*, Strasbourg, 1609.
- ANON. *Geomantia*, Jordan, Meintz, 1532.
- ANON. *El Gran libro de los oraculos, arte de adivinar la suerte presente y futura de las personas, por el metodo ejipto y por el de los astros. Manuscrito ballado en las catacumbas de Ejipto cuando la expedicion de los Franceses, y cuya propiedad fue esclusiva des Emperador, Napoleon . . . Contiene además la historia de los antiguos oraculos, la zodialogia ó sea la ciencia de pronosticar los tempos por medio de lost planetas*, Madrid, 1841.
- ANON. *Geomantia. Künstlicher und rechtschaffner Gebrauch der alten kleynen Geomancey . . .*, Mainz, 1534.
- ANON. *Geomantia metrica seu ars punctandi nova*, 1775.
- ANON. *Neuestes Punctierbüchlein nebst Planeten für beide*

- Geschlechter* . . . , Berlin, n.d.
- ANON. *Punktierbuechlein nebst Blumen* . . . , Mulheim, n.d.
- ANON. *Vollkommene Geomantia oder so genante Punctier-Kunst*, Freystadt, Jena, 1702.
- ANON. *Vollkommene Punktierkunst oder* . . . , Vienna, n.d.
- AXON, W.E. 'Divination by Books', in *Manchester Quarterly*, vol. 26, Manchester, 1907.
- BELOT, JEAN. *Les Œuvres de M. Jean Belot, curé de Mil Monts, Professeur aux Sciences Divines et Célestes. Contenant la Chiromence, Physionomie, l'Art de Memoyre de Raymond Lulle, Traicté des Divinations, Augures et Songes*, etc. . . , Rouen, 1640 & Lyon, 1654.
- BERNARDUS SILVESTRIS. See Savorelli, M.B.
- BOLTE, JOHANNES. 'Zur geschichte de lasbücher', appendix to *Georg Wickram's Worke*, Tübingen, 1903, vol. IV, pp. 276-348 (especially 288-9).
- BOLTE, JOHANNES. 'Zur geschichte der Punktier und Losbücher', in *Jahrbuch für Historische Volkskunde*, ed. W. Franger, I, *Die Volkskunde und ihre Grenzgebiete*, Berlin, 1925.
- BONCOMPAGNI, PRINCE. *Atti dell' Accademia dei Nuovi Lincei*, vol. IV, Rome, 1851, pp. 100 et seq.
- [BRETEAU]. *Grand jeu de société. Pratiques secrètes de Mlle. Lenormand. Explication et application des cartes astro-mytho-hermétiques, avec . . . la manière de faire les talismans; suivi de la géomancie et d'un double dictionnaire des fleurs emblématiques*, 1st part, pp. XIV + 309, Chez l'Editeur, Paris, 1845.
- BRETT, YVONNE MARGARET. 'Astronomical and Astrological Illustrations in printed books of the later Renaissance, with special reference to Libri delle Sorti', M. Phil. Thesis, University of London, 1975, pp. 57-72.
- BREWER, DEREK. [ed.]. *Geoffrey Chaucer*, Bell, London, 1974.
- BRINI. See Savorelli, M.B.
- CARRERAS Y CANDI, FRANCISCO. 'Un libro de geomancia popular del segle XIII', in *Miscelánea histórica catalana*, Ser. 1, Barcelona, 1905, pp. 161-74.
- * CASLANT, EUGÈNE. *Traité Élémentaire de géomancie* [with bibliography by Dr Rouhier], Editions Véga, Paris, 1935.
- * CATTAN, CHRISTOPHE DE. *The Geomancie of Maister Christopher Cattan Gentleman* . . . Translated out of French into our English tongue [by Francis Sparry], J. Wolfe, London, 1591 & 1608.
- * CATTAN, CHRISTOPHE DE. *La Géomance du Seigneur Christofe de Cattan, gentil-homme Genevois, livre non moins plaisant et récréatif, que d'ingénieuse invention, pour sçavoir toutes choses présentes, passées et advenir, avec la Roüe de Pythagoras. Le tout corrigé, augmenté, & mis en lumiere par Gabriel du Preau* . . . Gilles, Paris, 1558, pp. 178 ff.
- CHATTERJEE, RUSHICK MOHUN. *Extracts from works on astrology . . . containing genethliology, horary, mundane, atmospherical and medical astrology, to which are added extracts from geomancy, chiromancy, physiognomy and Napoleon Buonaparte's 'Book of Fate': with tables for calculating nativities*, 2 vols, Jyotish Prokash, Calcutta, 1880-3.
- * COCLES, BARTHOLOMEO. *La Geomantia di Bartholomeo Cocle filosofo integerrimo; nuovissimamente tradotta e ancho datta in luce*, Venice, 1550.
- COLONNA. *Le nouveau miroir de la Fortune, ou abrégé de la Géomance, pour la récréation des personnes curieuses de cette science*, Paris, 1726.
- * CONTINI, GIANFRANCO (ed.). *Maestre, 'Un Poemetto provenzale di argomento geomantico'*, *Collectanea Friburgensia*, fascicule 27, Fribourg, 1940.
- CRAVEN, J.B. *Doctor Robert Fludd . . . Life and Writings*, London, 1902.
- CROWLEY, ALEISTER. *Magick in Theory and Practice*, Lecram, Paris, 1929 (chapter XVIII); available in *Magick* (edited, annotated and introduced by John Symonds and Kenneth Grant), Routledge & Kegan Paul, London, 1973.
- * CROWLEY, ALEISTER. *Equinox*, vol. I, no. 2, Simpkin, Marshall, London, 1909.
- CURTZE, MAX. 'Der Liber embadorum des Savasorda in der Übersetzung des Plato von Tivoli', in *Abhdl. zur Geschichte der Mathematik*, vol. 12, Leipzig, 1902, pp. 3-183.
- DEACON, RICHARD. *The Book of Fate*, Muller, London, 1976.
- * DELATTE, ARMAND and LOUIS. 'Un Traité byzantin de géomancie - codex Parisinus 2419', *Mélanges Franz Cumont, Annuaire de l'Institut de philologie et d'histoire orientales et slaves* [Université Libre de Bruxelles], Brussels 1936, vol. 4, pp. 574-658 (Bibliography of European Geomancy).
- EBNETER, THEODOR. *Poème sur les signes géomantiques en ancien provençale*, Urs Graf-Verlag, Olten and Lausanne, 1955.
- * ———. *Fasciculus Geomanticus: in quo varia variorum opera Geomantica continentur*, Verona, 1687 & 1704. Containing: (1)

- Robert Fludd 'De animae intellectualis scientiae . . . seu geomantia' (pp. 3-18). (2) Roberti Flud[d] 'Tractatus de Geomantia in Quatuor Libros Divisus' (pp. 19-160). (3) Robert Fludd 'De Geomantia Morborum' (pp. 161-70). (4) H[enri] de Pisis 'Opus Geomantiae Completum in Libros Tres divisum Quorum' [reprinted Lyon, 1638 & 1625] (pp. 171-523). (5) 'Quaestiones Geomantiae Alfakini arabici filii a Platone. In latinus translatae ex Antiquo Manuscripto de Anno 1525. Nunc prima vice typis datae' [Translated originally from Arabic by Plato of Tivoli c. 1134-45] (pp. 525-644). (6) [bound with 'Tabulae geomanticae seu liber singularis de tribus ultimis' 1693-1704.]
- FLUDD, ROBERT. 'Tractatus secundi, Pars XI. De Geomantia in quatuor libros divisa', in *Utriusque Cosmi Maioris scilicet et Minoris Metaphysica, Physica atque Technica Historia*, vol. I, part 2 (pp. 715-83), Oppenheim, Frankfurt 1617-18. [Reprinted Verona 1687 and 1704 under the title: Roberti Flud 'Tractatus de Geomantia in Quatuor Libros Divisus', in *Fasciculus Geomanticus* (q.v.)]
- FLUDD, ROBERT. 'Tractatus Primi. Sectionis II. Portio II. De Animae intellectualis scientia seu Geomantia hominibus appropriata, quorum radii intellectuales extrinsecus, hoc est, circa negotia mundana versantes, & à centro dissipati in centrum recolliguntur', *Utriusque Cosmi . . . Historia*, vol. II, part 2 (pp. 37-46), Oppenheim, 1619 [Chapters I to VI of this text reprinted with slight modifications in *Fasciculus Geomanticus* (q.v.)]
- FLUDD, ROBERT. 'De Divinatore Iatromathematica' in *Katholikon Medicorum Katoptron*, 1631.
- FRÄNGER, W. See Bolte, J.
- G, MAESTRE. See Contini, G.
- Geomantia Künstlicher und rechtschaffner gebrauch der alten kleynen Geomancey mit welcher durch hilff der Rechnung und des menschen Tauffnamens sampt der Planeten wirckung in iren stunden allen Adams kindern Künsstiger zufall des gütten bösen glücks eröffnet wirt . . .* Jordan, Mainz, 1534.
- * GERARD OF CREMONA. 'Of Astronomical Geomancy', in *Fourth Book of Occult Philosophy*, London, 1655; reprinted Askini Publishers, London, 1978.
- GERARDUS CREMONENSIS. *Géomancie astronomique . . .* traduite par le Sieur de Salerne, Salerne, Paris, 1669 & d'Hourg, Paris, 1697.
- GEBER, GIO[V] ANNI. *De la Geomantia dell' eccel. filosofo Gioanni Geber*, Venice, 1552.
- GODWIN JOSCELYN. *Robert Fludd*, Thames & Hudson, London, 1979.
- * HARTMANN, FRANZ. *The Principles of Astrological Geomancy*, Rider, London, 1913.
- * HEYDON, JOHN. *Theomagia, or the Temple of Wisdom*, 3 vols, London, 1662-4.
- HEYDON, JOHN. *El Havareuna or the English Physitians Tutor in the Astrobolismes of Mettals Rosie Crucian . . . All Harmoniously united and operated by Astromancy and Geomancy . . .* London, 1665.
- HOFMANN, ALBERT [DR BERTHOF]. *Wie stelle ich ein Horoskop? Kurzer Schlüssel zur Geomantie (Punktierkunst) auf astrologischer Grundlage nach Agrippa von Nettesheim und Gerhard von Cremona*, Berlin, 1919.
- HOWE, ELLIC. *Raphael, or the Royal Merlin*, Aborfield, London, 1964.
- * JAULIN, ROBERT. *La Géomancie. Analyse formelle with Notes Mathématiques* by Françoise Dejean and Robert Ferry, La Haye, Paris, 1966 (Cahiers de l'Homme, N.S. IV.).
- * JOSTEN, CONRAD HERMANN. 'Robert Fludd's Theory of Geomancy and His Experiences at Avignon in the Winter of 1601 to 1602' in *Journal of the Courtauld and Warburg Institutes*, vol. XXVII, London, 1964.
- * KHAMBALLAH, HADJI. *La Géomancie traditionnelle . . . Traité pratique d'enseignement et dictionnaire d'interprétation géomantique*, Editions Véga, Paris, 1947.
- KING, FRANCIS and SKINNER STEPHEN. *Techniques of High Magic*, C.W. Daniel, London, and Warner Destiny, New York, 1976.
- KING, FRANCIS. *Astral Projection*, Neville Spearman, London, 1971.
- KIRCHENHOFFER, HERMAN. *The Book of Fate*, London, 1826.
- LEMAY, RICHARD. See Pomponazzi, P.
- LENORMAND, Mlle. *The Secret and Astro-Mythological Practices [sic]* (Card pack with geomantic symbols in the upper left corner), nineteenth century.
- LYNDOE, EDWARD. *Everybody's Book of Fate and Fortune*, Odhams, London, 1935.
- MAXWELL, J. *La Divination*, Paris, 1927, pp. 135-7.
- MÉNÉSTRIER, CL. FRANÇOISE. *La Philosophie des Images*, 2 vols, Paris, 1682-3 and Lyon 1694.
- MEYER, PAUL. *La Géomance du Seigneur Christofe de Cattan . . .*, 1567.

- MORBECA, GUGLIELMO DELLA. *Libro della geomantia fatto da frate*.
- MORBETA, GILLES DE (trans.). *Introduction à la Géomancie*.
- MORBETA, GILLES DE (trans.). *La Géomancie Plaine et Parfaicte*.
- NÉROMAN, DOM. *Grande encyclopédie illustrée des sciences occultes*. 2 vols, Strasbourg, 1937.
- NÉROMAN, DOM. *See also* Rougie, Maurice.
- Neuermehrtes, und mit einer mercklichen Anzahl wohl auszesonener ungemainer Staatsfragen verneueretes Oraculum, in Welchem allerhand verborgene Sachen menschlicher Zufälle künstiger Begebenheiten aus dem Grunde der bekandten Geomantie calculirt und artig entworffen . . . von Einem den die Unbekandten nicht Kennen*, Förster, Frankfurt, 1717.
- OSMAN, BEN ALI (pseud.). *Grosses Punktir-Buch des weisen Arabers Osman Ben Ali oder Blicke in die Zukunft*, Landsberg, n.d.
- PEMBROCK, GRAF and GRÄFINN VON [pseud. for HENRY and SIDNEY HERBERT]. *Sämliche Werke der Punctirkunst nach welcher ein jeder sich selbst die Nativität stellen und wissen kan, ab er in die Welt glücklich oder unglücklich seyn, und ob er jung oder alt sterben werde*, Lebrecht, Frankfurt and Leipzig, 1781.
- PEMBROCKE, LADY EMMY (pseud.). *Neues Punktierbüchlein oder die Kunst von dem Schicksal . . .*, Reutlingen, n.d.
- PERUCHIO, LE SIEUR DE. *La Chiromance, la Physionomie et la Géomance, avec la signification des Nombres & l'Usage de la Roüe de Pytagore*, Paris, 1657 and 1663.
- * PETRUS DE ABANO. *Geomantia de Pietro d'Abano nuovamente tradotta di Latino in volgare per il Tricasso Mantuano*, Venice, 1542.
- PETRUS DE ABANO. [Geomantia] *Novamente dall' excell. M.S. Musio da Capoa ricorsa*, 2 parts, Venice, 1546-50.
- PETRUS DE ABANO. *Della Geomantia di Pietro D'Abano di Latino nella volgar lingua tradotta per il Tricasso Mantuano*, Venice, 1550.
- PETRUS DE ABANO. *Comincia la Geomantia di Pietro d'Abano* (in 2 parts), Venice, 1556, 1552.
- PETRUS DE ABANO. *Œuvres Magiques . . . avec des secrètes occultes*, Liège, 1788.
- PEUCER, GASPAR. *Les Devins ou Commentaires des principales sortes de devinations*, Anvers, 1584.
- PIOBB, PIERRE, V. *Traité de Géomancie: étude du macrocosme*, Paris, 1947 [Translation of Robert Fludd's *De Geomantia*, q.v.].
- * PISIS, HENRI DE. *Opus geomantiae completum in libros III divisum*, Lyons, 1638 (reprinted in *Fasciculus Geomanticus* (q.v.)).
- PLACIDUS, JANUS. *Jani Placidi a Ponte Albo med. cult. vanitas geomantiae detecta oder Bedencken über die vorjetzt so hochberühmte Punctir-Kunst*, Jena, 1703.
- POINSOT, M.C. *The Book of Fate and Fortune*, Grant Richards, London, 1932.
- POMPONAZZI, PIETRO. *Libri V de fato, de libero arbitrio et de praedestinatione* (ed. Richard Lemay), Lucano, 1957.
- POPKIN, RICHARD, H. *See* Agrippa, H.C. *Opera*.
- PRÉAU, GABRIEL DU. *See* Cattan, C.
- RAPHAEL [ROBERT CROSS SMITH]. *The Book of Fate . . .*, London, n.d.
- RAPHAEL [ROBERT CROSS SMITH]. *The Familiar Astrologer*, London, 1831.
- RAPHAEL [ROBERT CROSS SMITH]. *Urania; or, The Astrologers Chronicle*, London, 1825.
- RAPHAEL [ROBERT CROSS SMITH]. *The Stragglng Astrologer, or The Astrologer of the Nineteenth Century or Compendium of Astrology, Geomancy and Occult Philosophy* (edited for the Society of the Mercurii), London, 1825.
- RAPHAEL [ROBERT CROSS SMITH]. *The Philosophical Merlin*, London, 1822.
- RAPHAEL [ROBERT CROSS SMITH]. *The Prophetic Messenger*, London, 1927.
- RAPHAEL [ROBERT CROSS SMITH]. *The Royal Book of Fate*, London, 1828.
- RAPHAEL [ROBERT CROSS SMITH]. *Raphael's Witch*, London, 1831.
- RAPHAEL [ROBERT CROSS SMITH]. *The Pythoness of the East*, London, 1894.
- RAPHAEL [ROBERT CROSS SMITH]. *The Royal Book of Dreams*, London, 1830.
- REGARDIE, DR FRANCIS ISRAEL. *The Golden Dawn*, vol. 4, Llewellyn, St Paul, 1970.
- * REGARDIE, DR FRANCIS ISRAEL. *A Practical Guide to Geomantic Divination*, Aquarian, London, 1972.
- ROUGIE, MAURICE. *La géomancie Retrouvée*, Paris, 1948. *See also* Néroman, Dom.
- ROUHIER, DR. *See* Caslant, E.
- ROWSE, A.L. *Simon Forman*, Weidenfeld & Nicolson, London, 1974.
- SARTON, GEORGE. *Introduction to the History of Science*, vols. 1-3, Williams & Wilkins, Baltimore, 1927-47 (Carnegie Institution Pub. No. 376).

- SA[U]NDERS, RICHARD. *Physiognomie . . . divinative, steganographical and Lullian sciences*, London, 1653.
- SA[U]NDERS, RICHARD. *Physiognomie, and Chiromancie, Metoposcopie, The Symmetrical Proportions and Signal Moles of the Body, Fully and accurately explained . . .*, London, 1671.
- SAVORELLI, MIRELLA BRINI [ed.]. 'Un manuale di geomanzia presentato da Bernardo Silvestre da Tours: (XII secolo): "l'Experimentarius"', in *Rivista critica di storia della filosofia*, fascicule III, Florence, 1959, pp. 283-342.
- SKEAT, THEODORE CRESSY. 'An early Mediaeval "Book of Fate": the Sortes XII patriarchum with a note on "Books of Fate" in general', in *Medieval and Renaissance Studies*, vol. III, London, 1954.
- * SKINNER, STEPHEN. *The Oracle of Geomancy*, Warner Destiny, New York, 1977. See also King, F.
- SMITH, ROBERT CROSS. See Raphael.
- SYLVESTER, BERNARD. See Savorelli, M.B.
- * TAILLE, JEAN DE LA. *La Géomance abrégée de Jean de la Taille de Bondaroy, gentil-homme de Beauce, pour sçavoir les choses passées, présentes et futures . . .*, Breyer, Paris, 1574.
- * TANNERY, PAUL. See p. 260.
- TANNERY, PAUL. 'Geomantia nova. Notice sur des fragments d'onomatancie arthmétique', in *Notices et Extraits de mss. de la Bibliothèque Nationale*, vol. XXXI, Paris, 1885, pp. 231-60.
- TANNERY, PAUL. 'Practica Geometriae', in *Bull. des sciences mathématiques*, vol. 23, pp. 140-5, 1899 (earliest latin geomantic text).
- * TAYSSONNIÈRE, SEIGNEUR DE CHANEIUS, GUILLAUME LA. *La Géomance, par laquelle on peut prévoir, deviner et prédire de toutes choses douteuses et incertaines. Science repurgée des superfluités qui l'offusquoient, séparée de l'Astrologie et réduite à sa pure simplicité et vraye pureté ancienne, pour les gens d'esprit, par tables briefves et familières*, Lyon, 1575.
- * THORNDIKE, LYNN. *A History of Magic and Experimental Science*, vols. I-VIII, Columbia University Press, 1923-58.
- THORNDIKE, LYNN. *Michael Scot*, Nelson, London, 1965.
- TRESWELL, RALPH. See Cattan, Christopher.
- WEISEN, MEISTER. *Geomancj. Die viertzeben Weisen Mayster in der Geomancj*, Strasbourg [c. 1550].
- WIETFELDT, ANNA. *Neues Punktierbüchlein oder: Das Orakel in der Rocktasche . . .*, Muhlhausen, 1907.
- YATES, FRANCES. *The Rosicrucian Enlightenment*, Routledge &

Kegan Paul, London, 1972.

- * ZIEGLER, ALOYSIUS K. *Histoire de la Géomancie latine du milieu de XII^e siècle au milieu de XVII^e siècle* (Ecole Nationale des Chartes, Positions des Thèses soutenues par les élèves de la promotion de 1934), pp. 159 et seq.

Manuscripts

Manuscripts are designated by the title of their place or collection and grouped geographically into London, Oxford, Cambridge, and then continental European manuscripts. I have tried to err on the side of completeness rather than risking the omission of a relevant manuscript, consequently some *libri delle sorti* and manuscripts of only peripheral interest to geomancy have crept into this list. Details are given for the most important manuscripts only. Manuscript Arabic works are only touched upon here, but the *Encyclopaedia of Islam* (new edition article on *khatt*) should be consulted for further reference, while Paul Tannery provides more extensive listing of relevant Greek manuscripts. However this list contains almost every relevant manuscript mentioned by Sarton, Thorndike and Steinschneider, and is therefore fairly extensive in terms of manuscripts in European languages. There are additional interesting notes about Hebrew and Arabic manuscripts held in the Bibliothèque Nationale in Caslant (1935) although some of Caslant's and Rouhier's historical interpretations should be taken with a grain of salt.

LONDON

Additional 2472

Bernard Sylvester. *Experimentarius* (fifteenth century).

Additional 8790

La Geomantia del S. Christoforo Cattaneo, Genovese, l'inventore di detti Almadel Arabico.

Additional 9702

Bian Al Raml Turcice (Turkish geomancy ascribed to Daniel the prophet).

Additional 10362

Bartholomaei de Parma, *Flores quaestionum et judiciorum Veritatis Geomanciae* (fourteenth century).

Additional 15236

ff. 95–108. *Prenosticon Socratis, Basilei* (Fortune telling by lots).
ff. 130–52r *Libellus Alchandiandi de astrologia judiciali* (geomancy, late thirteenth early fourteenth century).

Additional 21173

f. 97b Latin geomancy (twelfth-fourteenth century).

Additional 25881

f. 238b. Daniel, Prophet, *Oraculum et visio* (sixteenth century).

Additional 33788

Le Dodechef/d/ron de Maistre Jean Meung, qui est le livre des sorts et la fortune des nombres (sixteenth century libro delle sorti printed in Paris 1556 and later in London 1618, translated by Sir W.B. Knight).

Additional 33955

Lorenzo Spirito *Libro della Ventura* (sixteenth or seventeenth century Italian libro delle sorti, consulted by the cast of 3 dice).

Additional 40093

Libro de Goraloth (eighteenth–nineteenth century Ladino. A book of lots in Hebrew characters containing incantations).

Arundel 66

ff. 269–277b ‘Incipit Liber scientie ar[z]ienalis de iudiciis geomansie ab Alfarino filio Abrahe Judeo editus et a Platone [Plato of Tivoli] de Hebreico sermone in Latinum translatus sequitur nomina fisurariny [?] cum fisuris geomansie’ (Illuminated vellum MS of fourteenth–fifteenth century).
ff. 277b–287b ‘Tabulae Humfridi Ducis Glowcestriae in Iudiciis artis geomansie’ (fifteenth century).

Arundel 268

f. 75. Jacob Ben Isaac Alkhindi *de iudiciis liber* (Latin, fourteenth century).

Cotton Appendix VI

f. 109. Alkhindi iudicia [*Judgements*] translated by Roberti de Ketene [Robert of Chester].

Harleian 671

ff. 2–168b. Tracts on Geomancy, Sections 3–22 (ranging from illuminated black letter on old vellum to sixteenth-century paper: one of the best collections of MSS on geomancy covering such a range of centuries).

Harleian 2404

Codex . . . in quo continentur Tractatus insequentis Geomantici ff. 1–19. *Indices Geomancie Indëane*, ‘Haec est Geomancia Indëana, que vocatur Filia Astronomie; quam fecit unus Sapientum Indie; et est facta per 7 Planetas’.
ff. 19–33. *Geomancia Indëana*.

Harleian 3814

art. 6. *Liber sortilegus, ad solvendas certas quaestiones accommodatus, cum tabulis, et responsis, versibus Leonis conceptis*. (A libro delle sorti, fourteenth century.)

Harleian 4166

art. 1. *Artis Geomanticae & Astrologicae Tractatus quinque* (fifteenth century).

Harleian 6482

A quarto, containing the Characters of the sixteen figures of Geomancy, expressed in the great & lesser Squares of Tabula sancta; together with an explication of the seven Tables of Enoch, which are charged with Spirits or Genii, both good and bad of several Orders & Hierarchies, which the wise King Solomon made use of. Collected from Dr Rudd’s Papers by P. Smart, M.A. It contains remarks on Sylphs, Salamanders, Gnomes, &c.

Royal 12.C. v

Presentum geomancie libellum. ‘Prime omnium bonorum cause soli deo . . .’ (An elaborate astrological geomancy, compiled for Richard II in 1391). See also CLM 1697.

Royal 12.C. xii

f. 94. Book of Sortes grouped under birds’ names.
f. 98b. Book of Sortes grouped under planets’ names.
f. 108. Bernard Silvester, *Liber Experimentarius* (fourteenth century: 3 libri delle sorti) (See Savorelli, M.B.).

Royal 12.C. xvi

Roland Scriptoris. (Physician to the Duke of Bedford.)
‘Compilatorium sive aggregatorium tocius artis geomanciae’ (mid-fifteenth century).

Royal 12.C. xviii

f. 26. Abraham Ben Meir Aben Ezra, Spanish Rabbi and astrologer (d. 1174). *Electiones Abraham*, Latin (fourteenth century). Not the same translation as that by Peter de Abano printed Venice 1507.

Royal 12.E. iv

Bernardus Silvester, *Liber Experimentarius* (fourteenth century). (See also Royal 12. C. xii, Harleian 3892 f. 43, and Sloane 2472.)

Royal 12.G. viii

Liber Novem Judicum – Jacobus Alkindus (fourteenth-century Latin). (Printed with the omission of the first part at Venice 1509. See also Sloane 268 and Oxford Digby 149.)

Sloane 268

Ars iudicatoria secundum novem iudices (seventeenth century). (Libri delle sorti.)

Sloane 309

Excerpta geomantica (fifteenth century).

Sloane 310

ff. 66 Gerardi Carmonensis *Geomantia*. Praefigitur haec rubrica, 'In nomine illius, qui major est, incipit liber Geomancie magistri Girardi Crimonensis ab auditoribus via astronomica composita' (fifteenth century).

Sloane 312

ff. 252–255b, 215. Abraham ben Meir Aben Ezra, 'Perfectus est liber electionum laudabilium horarum ab Hali filio Hamethembram, translatus de Arabico in Latinum in civitate Barchinona [Barcelona] ab Abraam Judeo existente interprete, qui dicitur Salva Corda [Savasorda?]: perfecta est translatio (fifteenth century).

Sloane 314

ff. 2–65. Et est Gremmgi Indyana, que vocatur filia astronomie quam fecit unus sapientum Indie. ['This is the Indyana (i.e. "geomancy") of Gremmgi which is called the daughter of astronomy and which one of the sages of India wrote'] (fifteenth century).

Sloane 887

ff. 3–59b. *Liber Geomantie* (sixteenth century Italian).
ff. 68b–80. Observationes quaedam astrologicae et geomanticae; cum figuris (sixteenth century).

Sloane 2186

ff. 1–97. Treatise on Geomancy (Probably a transcript from the Geomancy of Christopher Cattan) (seventeenth century).

Sloane 2472

Bernardi Sylvestris. *Experimentarius* (twelfth-century libro delle sorti – a copy of Bodleian MS. Ashmole 304).

Sloane 3487

ff. 1–233 Ro[landus] Scriptorici (physician to John Duke of Bedford). 'Compilerium sive aggregatorum totius Artis Geomanciae'. 'Explicit aggregatorum sive compilerum geomanciae editum per Ro[landus] Scriptoris . . . quantum possibile est ad astronomiam redacta. Et est scriptum per Martinum Carum auctoritatibus Apostolica et Imperiali notarum' (fifteenth century). (See also Royal 12.G. xii.)

Sloane 3554

Amalricus Physicus (Geomancy by wheel: fifteenth century).

Sloane 3810

ff. 1–78. Treatise of Geomancy by Nicholas Monnel (sixteenth century, French).

Sloane 3857

ff. 164–195b. Bernardini Sylvestris. *Experimentarius*.
ff. 196–206. *Consideratio Socratica* (a book of lots in Latin).
ff. 207–221. *Consideratio Pythagorae* (a book of lots in Latin).

Warburg FMH 2770

Morath, Johan Mathaeus von Creussen. MS containing astrological and geomantic tables, 1646.

OXFORD

All Souls 96

ff. 1–15. Geomancy.
ff. 16–41. [Walter] Cato, Astrological geomancy in 125 chapters, c. 1400. (Probably a translation from Arabic.)

Ashmole 4

ff. 5–6. 'De 16 figuris Geomantiae, cum diversum notarum explicatione'.
ff. 7–11. 'Hic incipiunt Flores quaestionem et iudiciorum veritatis artis Geomantiae'.
ff. 44–47. 'Gerardus Crimenensis (sic) . . . variae quaestiones ex eo auctore deceptae'.
ff. 47b–48b. 'Observationes ex libro Geomantiae compilato per magistrum Martinum Hispanum Abbatem de Cernatis in ecclesia Burgen'.
ff. 49–70. Various short geomantic questions (c. 1600. Includes a late recension of 'Estimaverunt Indi . . .').

Ashmole 5

Art. 5: 16 figuris (of geomancy) (fourteenth century).

Ashmole 304

f. 2. 'Experimentarius Bernardini Silvestris . . .' (thirteenth century, bound with other libri delle sorti).

Ashmole 354

ff. 5-170. 'S[imon] Forman de Arte Geomantica' 1589.

f. 198. 'Tabula . . . Geomantica'.

Ashmole 392

ff. 46-254. 'Geomantiae liber per [Simon] Forman' (a large practical treatise).

Ashmole 393

Art. 8. Geomantic tables (of the sixteenth century translated in Ashmole MS 417, art 33 (2)).

Ashmole 398

ff. 1-118b. 'Ci comence la grand et la parfit overaigne de Geomancie . . .' (fourteenth century).

Ashmole 417

f. 124. 'How to know ye places . . .' (geomancy).

ff. 126-141b. A treatise on geomancy.

ff. 169-176b. 'An introduction unto Geomancy. Nomyelkin Zyobrim'.

ff. 181-3b. 'They that are desirous to give true judgement accordinge to . . . Geomancie'.

Ashmole 434

ff. 114-41. 'Magna pars cujusdam tractatus, sive Summerum, de Geomantia . . .'. 'The [arte?] of geomancye by the worthe doctoure Parysiences in hys booke . . .'.

Ashmole 1478

ff. 120-1. 'To know ye intent of the querent' [by geomancy].

Ashmole 1488

II, f. 138-140. Questions resolved by geomancy, by Napier.

Digby 46

ff. 1-92. Experimentarius . . . Bernardini Silvestris (two toothed divining wheels inset in cover).

ff. 93-106. Ars geomantiae.

ff. 109b-110. De geomantia Quaedom (fourteenth century?).

Digby 74

ff. 1-52. Gerardi Cremonensis, sive Carmonensis, Tractatus in Artem Geomantiae (sixteenth century).

Digby 134

Bartholomew of Parma - *Summa* (complete version of 1288), 128 fols. in an Italian hand, 'Ars Geomantie que docet hominem solvere omnes questiones de quibus vult certificari divina virtute per istam artem . . . Compositus quidem est iste presens liber a magistro Bartholomeo de Parma in Bononia [?] ad preces domini Tedesii de Flisco, qui erat tunc electus in episcopum civitatis Regii, curentibus annis Domini MCCLXXXVIII' (fifteenth century).

CAMBRIDGE

Emmanuel 70

Bartholomew of Parma - *Summa* (complete version) (fifteenth century), f. 80 gives the date as 1286 instead of 1288; 'Incipit breviliquium mag. bartholomei nacione parensis bononie compilatum et confirmatum per prudentes viros de fructis tocius astronomie ad preces domini Thedesii de fusco anno 1286.'

Magdalene 27

ff. 1-66. 'Ludus philosophorum qui apellatur filius [?] filia] Astronomie. Rerum opifex deus qui sine exemplo nova condidit universa . . . Ego sanctelliensis geomantie interpretationem ingredior et tibi mi domine tirasonensis antistes . . .' Hugh of Santalla's *Ars Geomantiae* (late fourteenth century).

ff. 72-88. 'Hec est geomentia Indiana que vocatur filia Ast . . . quam fecit unius [sic] sapientum Indie . . .'.

Magdalene Pepys 911

Trinity 1404 (II)

FLORENCE

Laurentian, Plu. 30 cod. 29.

Hugh of Santalla's *Geomantia Nova* 'Incipit liber geomantie nove magistri Ugonis Satiliensis, editus ab Alatrabuluci translatione . . . Estimaverunt indi . . . (thirteenth century?).

Magliabech XX, 13

ff. 1-60. Bartholomew of Parma - *Summa* (abbreviated version of 1294). 'Incomincia il libro dell' arte della geomancia nuovamente

compilato da maestro Bartholomeo da Parma a contemplatione de' suoi scholari da Bologna anno Domini MCCLXXXIII' (fifteenth century). Many other geomancies.

MUNICH

CLM 192

f. 3-. Bartholomew of Parma – *Summa* (abbreviated version of 1294 and 1295). This copy 1544 AD.

CLM 196

ff. 1–10. Bartholomew of Parma – *Summa* (abbreviated version of 1294) (fifteenth-sixteenth century).

CLM 240

Bartholomew of Parma – *Summa* (abbreviated version of 1294 and 1295) (fifteenth century).

CLM 276

ff. 69–75. *Geomantia mag. Gerardi Cremonensis* (fourteenth century).

CLM 392

f. 80. Petrus de Abano *Geomantia* (fifteenth century).

CLM 398

f. 1. Bartholomew of Parma – *Summa* (abbreviated versions of 1294 and 1295).

CLM 436

f. 46. Bartholomew of Parma – *Summa* (complete version of 1288) (sixteenth century).

CLM 489

(1) f. 1. Bartholomew of Parma – *Summa* 'Incipit Prologus Libri Geomantiae editi a mgro Bartholomeo Parmensi Astrologo. Erba collecta de libro magno Geomantiae quae introducunt novum discipulum ut sciat sufficienter principia eiusdem artis per quae poterit cognoscere tot et tanta de arte Geomantia quod per se sciat universales regulas artis doctrinae ac questiones quaerentium generales iudicare absque errore si Deus voluerit. Hoc quidem opus est Bartholomaei astrologi Natione Parmensis Compilatum Anno Domini MCCLXXXV Mense, Novembris Sole existente in primo gradu Sagittarii.'

(2) f. 61. Bartholomew of Parma – *Summa* (abbreviated version of 1294) 'Incipit breviliquium artis Geomantiae noviter compilatae a

mgro Bartholomeo de Parma, quod breviliquium extraxit de summa eius artis quam compilavit anno 1288 ad partes (preces) nobilis viri Theoderici de flisco. Et sic complevisse fatetur utrumque opus fideliter et verius quam scivit utilia scribens et superflua relinquens in hoc opusculo ad preces duorum suorum amicorum et discipulorum Johannes et Paulus Theutonicorum sub Anno Domini 1494 (1294) de mense Octobris in Bononia' (sixteenth-century copy).

(3) Michael Scot's *Geomantia*. 'Incipit liber Geomantiae Michaelis Scoti. Geomantia dicitur ars iudicandi per terram' (sixteenth century).

(4) Alkindi's geomancy (sixteenth century).

(5) Peter of Abano's *Geomantia* (sixteenth century).

CLM 1697

f. 246. An elaborate astrological geomancy compiled for Richard II in 1391. (See also Royal 12. C. v.)

PARIS

Bibliothèque Arsenal MS *Remarques sur la Géomance*

BN Hebrew MS *Diverses règles relatives à la géomancie* (c. 1320).

BN Latin MS *Libellus geomantie juxta arabum semitas ex arabico in hispanum et ex hispano idiomate in latinum translatus*.

BN 8 (Arabico-Malgache collection).

BN 2406; BN 2419; BN 2424 (Greek geomancies); BN 2631, 2632, 2697, 2699, 2716, 2725, 2727, 2730, 2731, 2732, 2734, 2758 (Arabic geomancies).

BN 7354 *Ars Geomantiae* of Hugh of Santalla (similar incipit to Cambridge Magdalene 27).

BN 7486 'Incipit liber alkardiani phylosophi. Cum omne quod experitur sit experiendum propter se vel propter aliud . . . ' (fourteenth century). Alkardiani's geomancy.

BN 14778 *Dictionnaire de Géomance et des Rosecroix*, 1778.

VENICE

S. Marco VIII, 44

ff. 64r–99r. Geomancy of Iohannis de Muris (fourteenth century), 'Compilatio magistri Iohannis de Muris in arte geome're (*sic*)

. . . Sicut dicit Boetius in arimetica sua, omnia que a primeva rerum origine processerunt ratione numerorum formata sunt . . . '.

VIENNA

Vienna 2352

ff. 83–96. Wenceslaus' geomancy dated 1392/3.

Vienna 5327

ff. 59r–60v. Operis de geomantia ad Tirasconensem anstitem prologus et caput primum (fifteenth century). Hugh of Santalla's geomancy – prologue and first chapter only.

Vienna 5508

ff. 182–200. Hugh Sacelliensis sive Saxaliensis, Geomantia, 'Rerum opifex deus . . . / . . . sive mundus facie' (fourteenth century).

Hugh of Santalla's *Ars Geomantiae* (similar incipit to Cambridge Magdalene 27).

Vienna 5523

Bartholomew of Parma – *Summa* (complete version of 1288) (fifteenth-sixteenth century).

Index

- Abachim, 249
 Abano, *see* Peter of Abano
 'Abd Allah Ibn Mahfuf al-Munadjjim, *see* Ibn Mahfuf
 Abraham Bar Hiyya, 97
 Abraham Ibn Ezra, *see* Ibn Ezra
 Abra-Melin, 158–9
 Abu 'Abdallah Muhammad az-Zanati, 16, 21–2, 26–7, 32–4, 38–9
 Abu-l-Hasan 'Ali Ben Yunus al-Misri, 39
 Abu Yazid, 23
 Adam, 249
 Adana, *see* Adam
 Aeromancy, 2, 14, 88–9, 91, 94, 125, 138
 Afa, 57
 Agbigba, 64
 Agrippa, Henry Cornelius, 6, 96, 120–5, 128, 145, 149, 157, 167–8, 233–6, 254–6
 Agummago, 64
 Ahithophel Ha-Giloni, 251
 Ahmad al-Kurdi, 39
 Ahmad Ben 'Ali Zunbul, 19–22, 38–51, 242–3
 Ahmad 'Isa, 251
 Ahmad 'Iyad, 251
 Albertus Magnus, 101–3, 111, 254
 Albo, Joseph, 250
 Albumasar, 91
 Ali, 249
 Ali Ben 'Umar, 33, 251
 Alkindi, *see* Kindi
 Almadel, 6
 Alpharinus, 114
 AlRaml, *see* Raml
 Alufa, 26–7
 Amar, 249
 Amara, *see* Amar
 Ambiasa, 71
 Anael, 144, 147
 Anakandriananahitra, 73
 Anbia, 71
 Anne of Bohemia, 112
 'Antiquus', 39
 Aomar, 139
 Apollonius, 95
 Apollonius of Persia, 17
 Aquinas, Thomas, 102–3, 129
 Aran Ben Joseph, 18, 250
 Archimedes, 13, 95
 Aristotle, 95, 103
 Arsenius, 33
 Ars Nova, 103–6
 Ars Punctatoria, 94
 Aruspicina, 89, 125
 Ashkal, *see* Shaki
 Ashmole, Elias, 131, 137
 Asklepios, 20
 Assassins, 33–5
 Astorgius of Faenza, 116
 'Atā' Ben Yasār, 252
 Atimi, 26; *see also* Raml
 Augury, 13–14, 89–90, 117, 125
 Averroes, 98
 Avicenna, 90, 98
 Babalawo, 54, 56–63, 69–70
 Bacchus, 144
 Bacon, Roger, 98
 Bambara (Mali), 249
 Baphia nitida, 69
 Baphomet, 34

- Barbari, al-, 20-1, 32
 Batholomew of Parma, 92, 106-7, 117, 123, 128-9, 201
 Bartolomeo della Rocca, *see* Cocles
 Bartzabel, 197; *see also* Barzabel
 Barzabel, 147; *see also* Bartzabel
 Battani, al-, 96
 Belot, Jean, 255
 Bentivoglio, Alessandro, 254
 Bentivoglio, Giovanni, 116
 Berbers, 22-5, 33, 246
 Bichardus, Horatius, 254
 Bintana, 7, 72; *see also* Vintana
 Bitruigi, al-, 98
 Boncompagni, Prince, 96
 Bosman, W., 57-8, 252
 Brahe, Tycho, 109
 Brethren of Purity, *see* Isma'ilis
 Brewer, Derek, 254
 Bulwer-Lytton, *see* Lytton
 Burton, Sir Richard F., 26-8, 66, 251
 Buyut, 39
- Campanella, T., 126-7
 Camwood, 69
 Caraboo, Princess, 253
 Cardan, Jerome, 117-18
 Carra de Vaux, Baron, 250
 Caslant, Eugène, 16, 163, 234, 255
 Cassiel, 147
 Cato, Walter, 112
 Cattan, Christopher, 128-9, 154-5, 157, 163, 169, 175, 233-4, 236
 Cerasari, Patricio Tricasso da, 117
 Ceres, 6
 Chain, diving, 55, 60, 62-5
 Charles IV of Bohemia, 111
 Chashmodai, 197
 Chaucer, Geoffrey, 111
 Ch'i, 5
 Chiancungi, 145
 Chikel, 71
 Chiromancy, 102, 108, 114-17, 125-6, 128, 137-8, 255
 Cicero, 13
 Coadjutrices, 180
 Cobham, Eleanor, 116
 Cocles, Bartholomew, 116-18, 125, 138, 254
 Conti di Poli, *see* Poli
- Contini, G., 253
 Cowrie divination, 7, 59, 62-3
 Craven, J., 131
 Crophill, John, 112
 Cross, Robert T., 151
 Crowley, Aleister, 157-63, 168, 203, 210
 Crusaders, 33-4
 Cumberland, Duke of, 150
 Cumberland, 'Princess' of, 150
- Dahle, Lars, 11, 71-4, 83-4, 247, 252
 Dahomean geomantic terms, 249
 Dakhel, 248
 Daniel, the Prophet, 17-18, 38
 Dante, 99
Darb, 251; *see also* *Derb*
 Davies, R., 46, 242-3, 252
 Deacon, Richard, 148, 252-3
 Dee, Dr John, 109, 121, 137, 145, 219
 De Peruchio, *see* Peruchio
 De Pisis, *see* Pisis
Derb al-Ful, 30, 53, 54; *see also* *Raml*
Derb al-Raml, 26, 30, 53, 54; *see also* *Raml*
 Deuteronomy, 18
Dharb, *see* *Derb*
 Dice, 31-2
 Diodorus Siculus, 6
 Disraeli, Benjamin, 154
 Dixon, 140, 151
Djafr, 30
 Dorn, Gerhard, 118
 Doutté, Edmond, 51
 Dya-Ogo, 22
- Ebnetter, T., 253
 Edo, Benin, 57
 Elaeis Guineensis, 62
 El-Hindi, 17; *see also* Tum-Tum
 Elizabeth I, 121, 131
 Ellis, A., 27, 252
 Ellis, William, 72
 Erastus, Thomas, 118
 Erdwahrtaung, 7
 Eshu, 28, 59-60, 68
 Essex, Second Earl of, 152
 Euclid, 95
 Ewe, 54, 57, 65
- Eymeric, Nicholas, 108
- Fa*, 1, 7, 11, 26-8, 55-7, 68, 163, 252
 Faditra, 85-6
 Fahd, Toufic, 30, 125
Fa'l, 30
 Fano, 74
 Farghani, al-, 96
 Farrow, Stephen, 27, 251
 Fatima, 34
Feng-shui, 5-7, 12, 87, 250
 Feuchtwang, Stephan, 5
 Filiae, 177-8
 Fischer, 26
 Flacourt, E., 4, 11-12, 72, 74, 247
 Flisco, Theodosius de, 106
 Fludd, Robert, 97, 131-7, 139, 204, 234, 236
 Fqn, 54, 57, 64-5
 Forman, Simon, 129-31, 137
 Francis, St, 103
- Gabriel, Archangel, 19-20, 32, 147
 Galen, 95
 Gaon, Saadia, 251
 Gaurico, Luca, 125
 Gbari, 57
 Geber, 139
 Gematria, 42
 Geoscopy, 5
 Gerard of Cremona, 94-7, 117, 123, 139, 167, 233-4, 255
 Gerard of Sabbioneta, 96-7, 234, 255
 Ghana, Kingdom of, 23-4
 Giloni, *see* Ahithophel Ha-Giloni
 Golden Dawn, Hermetic Order of, 155-8, 186, 210, 233-6, 238, 256
 Goral Ha-Hol, 18, 246
 Graham, G.W., 140-1, 150
 Gremmgi, 17
 Grimaud, B.P., 152
 Grosseteste, Robert, 98
 Gula, 248
 Gwari, 57
- Halaf al-Barbari, *see* Barbari
 Hali, 123
 Hamdani, al-, 39
 Hamilton, 53
 Haroun al-Raschid, 90
- Hartmann, Franz, 157, 234, 236, 256
 Hasan, Ibn-al-Sabbah, 33
Hati raml, 26, 30; *see also* *Raml*
 Hausa, 23-5
 Hazi, 30
 Hébert, J.C., 11
 Henry IV, 112
 Henry VI, 116
 Hermes, 55
 Hermes Trismegistus, 17, 19-20, 39, 91
 Hermetica, 20
 Hermetic Order of the Golden Dawn, *see* Golden Dawn
 Heydon, John, 137-8, 154, 157, 235-6, 256
Hindasi, 17
 Hismael, 197
 Hitler, Adolf, 141
 Hiyya, *see* Abraham Bar Hiyya
 Hokmah Ha-Nekuddot, 18, 246
 Home, D.D., 155
 Horoscopia, 89
 Howe, Ellic, 140
 Hugh of Santalla, 14, 91-5, 245
 Hugh of St Victor, 88-9
 Hulagu Khan, 35
 Humphrey, Duke of Gloucester, 114-16
 Hydromancy, 2, 14, 37, 88-9, 91, 94, 117, 125, 138
- Ibn Ezra, Abraham, 99, 251
 Ibn Khaldoun, 22, 36-8, 251
 Ibn Mahfuf, 33-4, 251
 Ibn Sina, 95
I Ching, 4, 62
 Idris, 17, 19, 20, 32, 38-9, 43-4, 249
 Idrissa, *see* Idris
Ifa, 1, 7, 11, 26-8, 53-70, 87, 163, 169, 252
 Ife, city of, 53-4, 62-4, 69
 Igbira, 64
Ihhtiladj, 30
Ikin, 55-62
'Ilm al-Raml, 18, 30; *see also* *Raml*
Indeana, 17
Indyana, *see* *Indeana*
 Inquisition, 107-9, 125-8
 Iohannes de Muris, 109-10
 Irosun wood, 69
 Irving, P.R., 58, 252

- Irvingia barteri*, 63
Irvingia gabonensis, 63
 Isidore of Seville, 88–90, 94, 250
 Isma'ilis, 20, 33–4, 39
 Issa, *see* Jesus
 'Iyan, 31
Iyanrin titq, 26
Iyerosun, 68–9
- Jacob, 249
 Jaulin, Robert, 163–4
 Jean de Murs, 109–10
 Jennings, Hargrave, 154
 Jesus, 249
 Johannes de Muris, *see* Jean de Murs
 John de Morys, *see* Jean de Murs
 John, Duke of Bedford, 114
 John of Seville, 91
 John of Tritenheim, *see* Trithemius
 Jonas, 249
 Judex, 180–3
- Kalantala, 249
 Kantawi, Muhammad, al-, 39
Kasbf, 37
 Kedemel, 197
 Kelly, Edward, 145
 Kepler, J., 132
 Khaldoun, Ibn, *see* Ibn Khaldoun
Khatt, 30–1, 46–51, 251
Khatt al-raml, 7, 26, 30–1, 38, 46–51, 87, 251; *see also* *Raml*
Khattat, 46–50
Khatt bi-raml, 30; *see also* *Raml*
Kbutut, 31
Kibana, 30
 Kindi, al-, 35, 97
 Kirchenhoffer, Herman, 148–50
 Kordofan, 46–51, 243
- Labouret, H., 249
 Ladari, 249
 Langland, William, 110
 Lassima al Houssein, 249
 Laxeuterion, 15, 244
 Lecanomancy, 37
 Legba, 56, 60, 68
 Leibniz, G.W. von, 4
 Lenormand, Mlle, 150, 152–3
 Leo X, Pope, 121
 Lévi, Eliphaz, 154, 256
 Ley-line, 5–6
- Liber, 6
 Libera, 6
 Libri delle sorti, 90, 277; *see also* Sortilege
 Lithomancy, 251
 Litteramancy, 117
Lituus, 13
 Livy, 6, 13
 Lollard, 112
 Lot-books, 90; *see also* Sortilege
 Loyer, G., 252
 Lull, Ramon, 103–6, 164, 254
 Lytton, Bulwer, 152–5
- Mahamid Arabs, 46
 Mahfuf, *see* Ibn Mahfuf
 Maimonides, Moses, 19
 Malceau, 135
 Maleficia, 89–90
 Manfredis, Hieronymus de, 116
Mangifera gabonensis, 63
Mangifera indica, 63
 Mantike, 88–9
 Manzalaoui, Mahmoud, 254
 Mardrus, Dr J.C., 52
 Margaret of Austria, 121
 Masa'allah, 39; *see also* Messahala
 Mathematica, 89–90
 Mathers, S.L. Macgregor, 156–60
 Matres, 177
 Maupoil, Bernard, 11, 26–7, 249, 251
 Maximillian I, 121
 Maximillian II, 121
 Medhurst, 151
 Medici, Cardinal de, 121
 Medici, Giovanni de, 118
 Medici, Lorenzo de, 118
Meji odu, 67; *see also* *Odu*
 Mellé, Kingdom of, 24
 Mercurii, 150
 Merlinus Anglicus, Junior, 151; *see also* Smith, R.C.
 Messahala, 91; *see also* Masa'allah
 Meyer, Paul, 244
 Michael, angel, 147
 Michael, Bishop of Tarazona, 91
 Midiates, Georges, 15, 244
 Moerbeke, *see* William of Moerbeke
 Mongols, 34–5
 Montdoré, Pierre de, 244
 Monteil, C., 26
- Morbeta, Gilles de, 254
 Morrison, Lieutenant R.J., 140, 150
 Moses, 249
 Moussa, *see* Moses
Mpisikidy, 71–85
 Muhammad, the Prophet, 29, 34, 46, 249
 Muhammad al-Kantawi, 39
 Muhammad Ibn Omar al Tounsi, 26
 Munadjjimun, 33, 36
- Nachmanides, 19
 Napier, Richard, 129–31, 137
 Napoleon, Bonaparte, 26, 140–5, 148–9
 Nasir al-Din al-Tusi, 34–5
 Nasr, Seyyed Hossein, 18
 Naudé, Gabriel, 108–9
 Necromancy, 88, 117, 125
 Nepotes, 178–9
 Néroman, Dom, 163
 Newton, Sir Isaac, 13
 Nicat, Lord of Bosnay and Chesney, 128
 Nigromancy, 125
 Nissim Ben Moses, 250
 Noah, 106–10, 249
 Nomancy, 117
 Notary Art, 125
 Nouhoun, *see* Noah
 Nupe, 57
 Ny Mäsina, 71
- Odu*, 55, 65–9
 Omoplatoscopy, 37
 Oneiromancy, 30, 46
 Onomancy, 125
Opelè Ifa, 55, 60, 62–5
Opön Ifa, 68–9, and plates 1–5
 Oresme, Nicholas, 109–10, 167
 Orişa, 70
 Qrunmila, 59–60; *see also* Ifa
 Qsun, 60
 Oulofs, 22, 25
 Ousmane, 249
- Palmer, John, 151
 Palm nuts, 55–63
 Paracelsus, 118, 131
 Perron, Dr, 26
 Peruchio, de, 138, 240
- Peter of Abano, 99, 107–9, 117, 122, 125, 139, 234
 Peucer, Gaspar, 126
 Physiognomy, 108, 114–17, 125, 128, 137–8, 255
 Pisis, Henry de, 138
 Plato of Tivoli, 91, 97
 Poli, Carlo Conti di, 135
 Polydore, Virgil, 6
 Pomponazzi, Pietro, 118–19
 Powder, divining, 68–9
 Praestigia, 89–90
 Price, W., 69, 252
 Psammomancy, 31
 Pseudo-Aristotle, 91
 Ptolemy, 17, 39, 90–1, 95
 Punctierkunst, 7, 94, 139
 Punctis Terrae, 7, 101
 Pyromancy, 1, 14, 88–9, 91, 94, 111, 117, 125, 138
- Qusta Ibn Luqa, 35
- Rabolion*, 7, 15, 244
Raml, 7, 11, 14–15, 18–54, 68–70, 87–8, 90, 94, 138, 169, 242–3, 251–2
 Ranakandriana, 71
 Raphael, angel, 147
 'Raphael', *see* Smith, R.C.
 'Raphael, Edwin', *see* Wakeley, Edwin
 Raschid, *see* Haroun al-Raschid
 Regardie, Israel, 157–60, 169, 189
 Reuchlin, Johannes, 121
Rhampliön, 15, 244
 Ribeiro, René, 70, 252
 Richard II, 112–13, 254
 Robert of Chester, 97–8
 Roland Scriptoris, 114
 Rosicrucians, 132, 137, 156
 Rossi, Gian Luigi de', 125
 Rouhier, Dr Alexander, 16, 18
 Rowse, A.L., 255
 Rukn al-Din Khurshah, 34–5
 Ruler, Geomantic, *see* Tutelary Spirit
- Saadia Gaon, *see* Gaon
 Sahel, 23
 Saladin, 23
 Salerne, Sieur de, 96

- Samael, 147
 Sanctelliensis, Hugo, *see* Hugh of Santalla
 Sanders, Richard, 136-7
 Şango, 28, 60
 Sara Deme, 248
 Sarakolle, 23, 25
 Sara Madjingaye, 248
 Sarton, George, 101, 105
 Saunders, *see* Sanders
 Savasorda, *see* Abraham Bar Hiyya
 Schepper, Cornelius, 124
 Schilde, 26
 Scot, Michael, 98-101
 Seismography, 6
 Semper Paratus, Frater, 161-3
 Serres, Olivia, 150
Shakl, 30-1
Sicbr, 71
Sikidy, 1, 4, 7, 11, 26-30, 56, 71-87, 247, 250, 252-3
Sikidy tokana, 85-6
Sikily, *see* *Sikidy*
 Silvester, Bernard, 251
 Sixtus V, Pope, 126
 Skeat, T., 253
 Smith, Robert Cross, 140-52
 Societas Rosicruciana in Anglia, 155
 Solmancy 117
 Solomon, 249
 Songhai, 22-3, 25
 Sorath, 197
 Sorora, 86-7
 Sortes, *see* Sortilege
 Sortilege, 89-90, 125
 Sortilegia, *see* Sortilege
 Spare, Austin Osman, 158-9, 161
 Sparkes, 151
 Sparry, Francis, 128
 Spatulomancy, 91-2, 117
 Spirit, *see* Tutelary spirit
 Steinschneider, M., 242-3, 251
 Stella Matutina, 157; *see also* Golden Dawn
 Sulaymann, *see* Solomon
 Susanna the Bath-keeper, 111
 Sylvester, *see* Silvester

 Ta'aisha arabs, 46
 Tabari, 252
 Ta'bir, 30
 Tafsir, 252

 Taille, Jean de la, 128
 Ta'labi, 39
Tambinoana, 86
 Tanner, 114
 Tannery, Paul, 14-15, 94, 250, 253
 Taphthartharath, 197
 Tarabulusi, 39
Tark, 251; *see also* *Khatt*
 Tarot, 1, 157
 Taskin, 40-2
 Tat, 20
 Tayssonnière, de la, 128
 Templars, 34
 Testes, 180
 Thais, Lord, 128
 Theodosius de Flisco, *see* Flisco
 Thorndike, Lynn, 98, 104, 253-4, 256
Toetry, 74-85
 Tolkien, J.R.R., 256
 Tomtom, *see* Tum-Tum el-Hindi
 Tondinus, 117; *see also* Tundinus
 Topomancy, 5
 Tounsi, *see* Muhammad Ibn Omar al Tounsi
 Townshend, Chauncey Hare, 154
 Trautmann, René, 11, 26
 Travélé, M., 249
 Tray, divining, 68-9 and plates 1, 2, 4, 5
 Tree of Life, 157
 Trithemius, 121, 123
 Tukulors, 22
 Tum-Tum el-Hindi, 17, 20-1, 32, 41, 250
 Tundinus, 123; *see also* Tondinus
 Tusi, *see* Nasir al-Din al-Tusi
 Tutelary spirit, 144, 147, 197

 Ubaldi, Guido, 116
 'Umar, *see* Ali Ben 'Umar
 Umbilicomancy, 117
 Urban VIII, Pope, 126-7
 Uriel, 147

 Varanus, Julius, 116
 Varley, John, 152
 Varro, Marcus Terentius, 14, 250
 Venamancy, 117
 Venefica, 125
Vintana, 7, 72, 87, 250, 252
 Virgil, *see* Polydore Virgil

 Voodoo, 7, 70, 252
 Voynich manuscript, 111

 Wakeley, Edwin, 151
 Walker, D.P., 254
 Waring, Paul, 145
 Watkins, Alfred, 6
 Wenceslaus IV of Bohemia, 111-12
 Wensinck, 252
 Wenzel, *see* Wenceslaus IV
 Westcott, Dr Wynn, 156
 William of Moerbeke, 102-3
 Windram, Thomas, 161-3
 Wolfe, John, 154
 Woodman, Dr W., 156
 Wyndham, J., 69, 252

 Yacouba, *see* Jacob
 Yalnas, 248
 Yates, Frances, 137
 Yeji, 24
Yidde 'Oni, 18
 Yoruba, 26-8, 54-7, 62-70

 Zadkiel, angel, 147
 'Zadkiel', *see* Morrison, R.J.
 Zanati, *see* Abu 'Abdallah Muhammad az-Zanati
 Zanatiyya, 32
 Zazael, 197
 Zoroaster, 158
 Zunbul, *see* Ahmad Ben 'Ali Zunbul