

*The Booke
of Solomon's
Magick*



*by Carroll "Poke" Runyon, M.A.
Archimage -- Ordo Templi Astartes*

About the Author:

Carroll “Poke” Runyon describes himself as “A *Gentleman of The Old School*” which he defines as, “One who recites classical poetry to heartless beauties while wrestling alligators.” He has lived out his Neo-Romantic philosophy as a Captain in the Green Berets, a student of Ninjutsu, a blue-water sailor, a scuba-diver, an internationally published novelist and author of adventure stories in the legendary *ARGOSY* magazine. For more than thirty years he has been a leading figure in the revival of ceremonial magick as Western civilization’s spiritual counterpart to Eastern mysticism and native American shamanism.

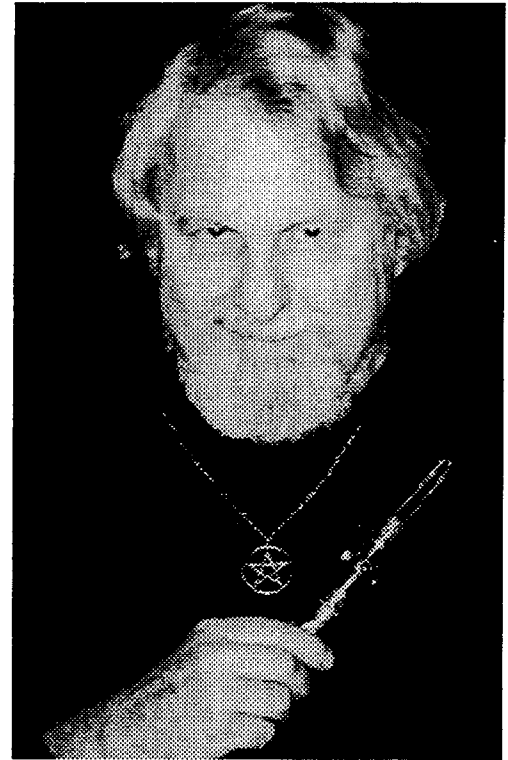

His background in occult study and practice is extensive: in 1970 he became the founder-magister of the *Ordo Templi Astartes*, which is now America’s oldest continually operating ritual magick lodge. In 1980 Runyon received his Master’s Degree in cultural anthropology from California State University at Northridge, specializing in magick. After graduate school he took all the degrees of Freemasonry in both the *Scottish* and *York Rites*.

He then undertook an intense series of Tibetan tantric initiations and training sessions under the direction of H.E. Luding Khen Rinpoche of the *Sakya Order*, mastering the *Vajra Yogini* (Goddess of the Sorcerers) system. Runyon later received the *Kalachakra* initiation from H.H. The Dalai Lama.

His articles on Magick and the Western Tradition have appeared in *Gnostica* magazine and his Church’s journal, *The Seventh Ray*. Runyon’s most noted contribution to the post W.W. II occult revival has been his rediscovery and subsequent development of the **facial reflection/distortion dark mirror skrying method** for magical evocation. In 1974 he appeared as a guest on the *Tom Snyder t.v. show*, narrating film footage of O.T.A. magical operations. Through his Church (*The Church of the Hermetic Sciences, Inc.*), Runyon has written, produced and narrated a video entitled: *The Magick of Solomon* that dramatically demonstrates the unique and powerful spiritual development system described in *The Book of Solomon’s Magick*. Most recently he has produced a video documentary of an actual Goetic magical operation, *Dark Mirror of Magick*, with remarkable prophetic results in our troubled times.

The Book of Solomon's Magick

*How to Invoke Angels into the Crystal
and Evoke Spirits to Visible Appearance
in the Dark Mirror*

by

Carroll "Poke" Runyon, M.A.

C.H.S., Inc.
Silverado, California

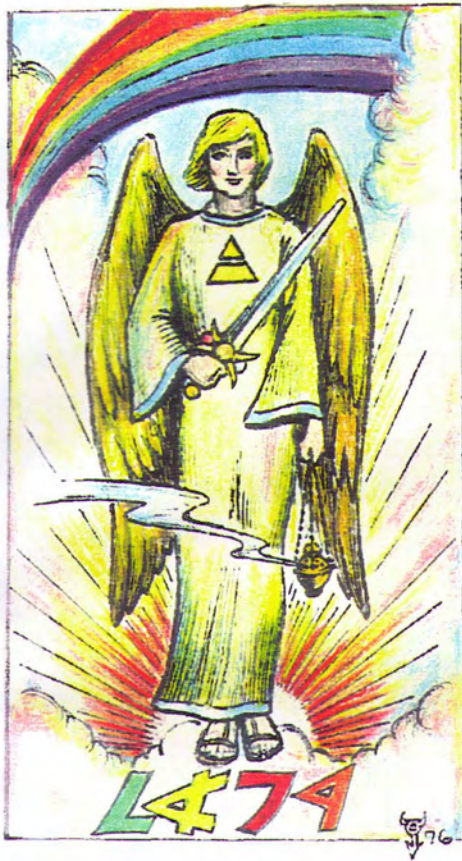

© 1985 C.H.F., Inc.



© 1975, C.H.S., Inc.



© Copyright C.H.S., Inc., 1976

Table of Contents

Pronouncement.....	1.
Introduction.....	2.
 <i>Part One: The History and Theory of Solomon's Magick</i>	
Chapter One: Hypnosis and Yoga	10.
Chapter Two: The Secret of the Dark Mirror.....	24.
Chapter Three: Fallen Angels/Pagan Gods.....	39.
Chapter Four: The Secret of the Holy Table.....	47.
Chapter Five: The Kabbalah of Wizardry.....	56.
Chapter Six: The Architecture of Our Magical System.....	69.
Chapter Seven: The Ba'al -- Astarte Mythos.....	80.
Chapter Eight: Arabian Origins of Magick and Witchcraft.....	87.
Chapter Nine: The Hermetic Caduceus.....	93.
Chapter Ten: Solomon's Sex Magick.....	100.
 <i>Part Two: The Practice of Solomon's Magick</i>	
Chapter Eleven: Pentagram and Septagram Rituals.....	107.
Chapter Twelve: Invocation and Evocation Rituals.....	116.
Chapter Thirteen: The Evocation of Nithael.....	127.
 <i>The Goetia of Solomon the King.....</i>	 136.
<i>The Seventy-Two Spirits of the Brass Vessel.....</i>	<i>144.</i>
<i>Goetia Rulers of the Quarters.....</i>	<i>181.</i>
<i>Angels of the Schemhamephorash.....</i>	<i>183.</i>
 <i>Appendix 1. Goetia Spirits Rectified.....</i>	 <i>192.</i>
<i>Appendix 2. Quick Reference Chart and Magical Alphabet.....</i>	<i>193.</i>
<i>Appendix 3. Magical Temple Furniture and Equipment.....</i>	<i>195.</i>
<i>Appendix 4. Documentary Exhibits -- Almadel text, Schemhamephorash</i> <i>MS. facsimile, Research Paper:</i> <i>Kabbalah and Medieval Magick</i>	<i>204.</i>
<i>Appendix 5. Study Guide and Bibliography.....</i>	<i>222.</i>
 <i>Color Plates: The Four Archangels.....</i>	 <i>preceding page 0.</i>
<i>The Master Mandala.....</i>	<i>following page 232.</i>

Pronouncement

IN THE YEAR 1969 I went through a near-death experience that brought on an altered state of consciousness during which I rediscovered a lost secret of Western Ritual Magick. I learned how to summon the seventy-two spirits of King Solomon's legendary Brass Vessel to visible appearance in the Dark Mirror on the Triangle of Art. This book, and our accompanying video, **THE MAGICK OF SOLOMON**, demonstrate and properly teach this secret method for the first time.

Inspired by the rediscovery of this GOETIC method of practice, I was further enabled to recover the technique of Angelic Crystal Invocation from the ancient book ALMADEL. I was then led to rectify this essential LEMEGETON sub-system with the seventy-two Angels of the SHEMHAMEPHORASH and link them to their seventy-two demonic counterparts in the GOETIA. This produced a spiritually balanced, theoretically elegant and astrologically coordinated scheme of practice that was compatible with modern theories of Jungian psychology.

Students who have struggled for years to visualize these entities and to make sense of the confused and even contradictory instructions in the LEMEGETON will be delighted to finally discover operative methods *that really work* within a theoretical framework that emulates the impeccable celestial models of the Renaissance magi. Newcomers, starting with our system, may very well wonder what was so difficult about all of this in the first place ?

If this is so, then I have succeeded in my task. . .

And So Mote it Be!

Magister Thabion

*Was not Solomon called a wise and even Wizard King?
Who did confine two-and-seventy rebellious spirits
In the Vessel of Brass; metal of the Sphere Mercurial
With mastery of Brazen Shield and Sword of Iron –
Did he not call them to appear in the Triangle of his Art?
Led by the first of their number, Lord-Cloud-Rider,
Whereafter Solomon did build a Temple to Ba'al's Consort,
The Fair Astarte. . .*

from Cult of the Sangreal by Thabion

Introduction:

THIS IS A THEORETICAL AND PRACTICAL handbook of Ceremonial Magick that is different from any you've ever read. The magick this book teaches was reconstructed and rectified from authentic ancient sources, re-interpreted in modern psychological terms and brought to life by powerful hypnotic techniques. This system was developed by and for imaginative people who are *not natural psychics*. I have written *The Book of Solomon's Magick* for those special individuals in the broader *Neo-Romantic Community* who seek the ultimate spiritual-intellectual adventure. If you have ever yearned to be a wizard or an enchantress in the grand old medieval/Renaissance tradition, but were put-off by the bric-a-brac of "Victorian Occultism" while finding yourself underwhelmed by the

current Neo-Pagan and New Age alternatives, then this is the book for you. ¹

This book — and our accompanying video, *The Magick of Solomon* — will show you how to invoke Holy Angels and then summon ancient Goddesses, Gods, Fallen Angels and even hell-bound demons to visible appearance. You will be in direct communication with these mighty beings. The methods I will teach you *are absolutely authentic and remarkably effective*.

Before we go any further I want to make two things very clear: first, I am not going to insult your intelligence by providing you with an over-simplified “cook book” filled with nothing but training exercises, skrying techniques and warmed-over rituals culled from 19th century sources. Certainly the training exercises for our special invocation & evocation methods, the rituals, the practical information and the references you will need are all here — but I am also giving you *the history, the philosophy and the theory* behind this powerful system.

There are some forms of shamanism where the practitioner is permitted to be, *or even expected to be, illiterate*. Our tradition is *quite the opposite*. A Western magus or, if this term seems too masculine for female readers, an enchantress, is expected to be *a person of knowledge* (to paraphrase Carlos Castaneda), at least in his or her own field. Remember that our mythological avatar, King Solomon, was noted for his wisdom.

With that in mind I sincerely hope that you will find the background material I’ve presented on Carl Jung’s theories, Hermetic philosophy, Kabbalah, hypnosis and yoga to be too condensed and obviously introductory. You are expected to consult the works I have recommended in the study guide. Don’t let anyone tell you that you don’t need this knowledge to be a Western magician. *You do!*

You may also contact me directly. In fact if you are going to seriously pursue this system, I *definitely* want to hear from you.

Now that we are clear on that there is one other thing I must warn you about before you begin. If you successfully complete this program *you will not be the same person you were when you started*. Once you have experienced these wonders you may return to the mediocrity of everyday life but your mind and soul will range in realms beyond. You will be transformed forever into one of *The Far-seeing People*.² You may never be able to share what you know with those you love *and you may not even wish to*. Solomon's Magick opens a door into the starry gulfs of eternity. Once you have passed through that door, and it closes behind you, there is no going back. We might say that the ordinary person knows only the short span from birth to death while the Magus understands that this life adds one more skull to a necklace that must eventually be valued like a jeweler would appraise a string of pearls.

There are very few people who would be willing to pay the price I paid to learn these ancient, secret methods. In 1969 I nearly lost my life and my sanity discovering and perfecting these techniques. I am one of a handful of practicing and teaching magicians in the Western world. Certainly there are those in our select fraternity who are more erudite than I am, more qualified in kabbalistic, astrological and alchemical studies — but the power to summon the spirits to visible appearance is the mark of the *Thaumaturgist*. That is the portion of the Sacred Art which Divine Providence has assigned me to expound and no one can teach you more about that aspect of Solomon's Magick than I can.

In recent years this mission has taken on a special urgency because the ancient secret of conjuration to visible appearance in Goetic evocation that I rediscovered in 1969 (the Dark Mirror facial-reflection-distortion phenomenon) has since been pirated, over-simplified, mass-marketed and finally popularized to the level of a OuiJa[®] board session. As with the OuiJa board (which was also based on the rediscovery of an ancient magical secret) commercialization can lead to frivolous misuse. Without proper training and a knowledge of what

you are doing, the use of the powerful Dark Mirror facial reflection-distortion technique to summon spirits can seem as capricious and apparently trivial as Mr. Fuld's talking board. OuiJa has been called "The Most Dangerous Game" but that may have to be corrected; likening the perils of the Talking Board to those of the Dark Mirror is like comparing a trip to the zoo with a hunting safari in Africa — or fire crackers with dynamite.

Besides the obvious psychological dangers in popularizing Goetia there is a deeper spiritual peril involved which the mass marketers have totally overlooked. Granted, all Goetia spirits are not bad — some are even good natured — *but there are a certain number who qualify as genuine hell-raking demons and one who is considered to be the very Devil Himself.*

In the Middle Ages and in the Renaissance magicians never used the Goetia without the strongest spiritual safeguards. They depended on their faith in God and His Holy Names to protect them when dealing with the rebellious spirits. Today we don't have that vital reservoir of faith to draw from so we must re-establish our link with the divine and re-empower our Spiritual Guardians in order to give us a truly balanced magical system. *This is why the Angelic Almadel must be worked in direct conjunction with the Goetia. For this reason I have gone to considerable lengths to rectify and unify these two basically complimentary Lemegeton systems.*

When you combine the secret of The Dark Mirror with The Lost Art of Angelic invocation into The Crystal Shewstone, you have empowered the Magick of Solomon to yield the full measure of its ancient promise.

Even if you are steeped in the lore of Western occultism and still have not attained your goal of becoming a magus or enchantress (because you were not born clairvoyant) this is the book that will make those dreams come true. Certainly you'll have to work and study, but if this is the right path for you, the work will be rewarding and the study will be nourishment for your mind and your soul.

I assure you is that there are no drugs, drastic fasting regimens or dangerous yoga practices involved in this system. Providing you are in good mental and physical health, are at least eighteen years of age, and able to understand the concepts and the instructions, you should have nothing to fear from this program other than the profound transformation of which you have already been warned.

You will need to master self-hypnosis and develop the ability of fixed concentration (the yoga of *tratakam*). Once you have properly trained yourself, you will be able to perform one of these Grand Operations of Solomon's Magick in less than an hour's time by yourself or with friends who have undergone the same training. You will be able to instruct others and start your own Lodge of Magicians — or remain a solitary master or mistress of this ancient art. You might even wish to affiliate with our brothers and sisters of the *Ordo Templi Astartes* — America's oldest continually operating ritual magick lodge — and learn what lies beyond Solomon's Art of Kings. The choice is entirely yours because I have provided everything you need to start you off in this book and in our documentary video, *The Magick of Solomon*.

But before we begin, let's make sure that we agree on what High Magick (or *Art Magick*, to use Max Theon's term) really is and what sort of people wizards and sorceresses are — or should want to be. This is very important. First let us state what Magick is not (or should not) be:--

High Magick does not (or should not) grant the power to dominate and/or exploit others. In spite of its Arabian Nights' glamour we cannot claim that it will help you win lotteries, sweepstakes or make big money in the commodities market. Magick should not be thought of as a push-button technology that directs impersonal energies, neither should it be used as a personal empowerment system to help one climb a corporate ladder and dazzle the opposite sex. If conscientiously pursued, the Art should actually achieve the opposite effect by lead-

ing you to *what you really need* rather than giving you *what you think you want*.

So what is Solomon's Magick?

The magician Dion Fortune gave us a concise definition of magick as "*The art of causing changes in consciousness to occur in accordance with the will.*" This presupposes that you understand the meaning of the term "art" — because High Magick is first, last and always *an Art!*

Magick is an artform. If we need to get technical about it we could call it a composite artform similar to grand opera. Consider the artistic elements in a Magical operation: we have the stage set; our temple (or our outdoor henge). We have the costuming: our robes, lamens, etc. There are the props: the circle, altar, crystal ball, triangle, dark mirror, swords, wands and pentacles. We create a theatrical atmosphere; candle light flickers through tendrils of exotic incense, a gong reverberates, bells chime, drums throb while the slow-motion dream dance around the circle is accompanied by a droning chant. . . followed by conjurations in Shakespearean style delivered in hypnotic tones.

Of course Solomon's Magick is more than just good theater — but good theater is its starting point. It uses that sense of fascinated detachment you experience at a well staged theatrical production or at an impressive church service as a gateway into an altered state of consciousness in which your waking mind and your deep mind are in communication. This is our unique Western shamanic experience. If you think about it this way, these theatrical aspects of magical operations will seem quite appropriate. Remember, the so-called primitive shamans use all the musical-dramatic-artistic elements of their own native cultures, so why shouldn't we?

If you are not comfortable with this Romantic-Shamanic aspect of Solomon's Magick then it is obviously not Your Path. When I say "Romantic" I mean it in the philosophical-artistic sense of the term.

Magicians are the ultimate romantics. To us the human spirit is divine and unbounded in its potential. Aleister Crowley — a modern magician and a romantic in his own fashion — held that the greatest sin was restriction, but to my mind an even greater sin is mediocrity. My favorite Romantic maxim is the credo of *Quo Vadis's* Nero: “*Let it be wonderful or let it be terrible so long as it is uncommon!*”

Which brings us to another important point: Solomon’s Magick is not a get-rich-quick scheme but it will jump-start and supercharge your creative processes. If you are willing to seriously study the books I’ve recommended, in a few years you will have acquired an education comparable to a liberal arts degree from a university. You may be inspired to undertake formal studies in psychology, anthropology, physics, genetics or biochemistry. You may excel in any of the creative arts . . . or become a spiritual leader. Magick will open these doors for you and show you the way. This is the real power and promise of King Solomon’s Art — for Solomon, as you recall, was mainly noted for his wisdom. Although this type of Magick is a Royal Art it is not restricted to the elite; *Solomon’s Magick creates the elite!*

The magical vision is primarily an ecstatic and transformative experience that may be enhanced by a group performance but is essentially *subjective* in its effect. In other words, this method of magick produces a controllable dreamstate wherein the practitioner summons the spirits to visible appearance and communicates with them. No other system of magick, not the Golden Dawn, Tibetan Tantra, Voodoo or Wicca offers such an authentic, spontaneous experience. Only Solomon’s Magick fulfills the whispered promise of the old grimoires. The Master or Mistress of this Art shares power with the Archangels, commands the demons and walks with the Gods.

If this is your desire read on and enter the Treasure Cave of the Arabian Nights where the mighty Jinn of Old King Solomon are at your command. The first challenge on your quest will be to roll a huge

stone away from the entrance to your own Magical Cavern. That stone has been built up over a lifetime out of thousands of verbalized encrustations such as, “*It’s just your imagination!*”

Introduction/Notes:

1. I am very much aware of the tremendous debt we owe to Dr W. Wynn Westcott, MacGregor Mathers and their compatriots. They gave us the most complete and useful synthesis of Western esoteric lore since Heinrich Cornelius Agrippa in 1531 c. e. It is safe to say that there would be no modern revival of Western Magick without their efforts and virtually all of today’s magicians, including this author, use their correspondences. They were, however, restricted by the mindset of their era and the lack of practical techniques that would not emerge from the Orient, and re-emerge from the history of our own tradition, until the 20th century. Modern Golden Dawn adepts are now revitalizing their tradition with methods very similar to those described in this book. I like to think that our O.T.A. rediscoveries have made some contribution in this regard.
2. In Chapter Nine of his recent book *Angel Magic* (Llewellyn, 1995) my friend and colleague, Geoffrey James presents a somewhat fictionalized account of an O.T.A. magical operation conducted here in our *Montsalvat Temple*. He describes his host (your author) as “The Angel Magus” who was “. . . friendly but reserved with a certain distance in his eyes that seemed to say, *I have seen strange things . . .*”

Part One:

*The History and Theory
of Solomon's Magick*

*Memory through the Ages spans
To Olden Kings with bloody hands
And yet with birth the vision flies. . .
Beyond The Veil — but never dies
The portal cracks a hair in dreams
The whistling Wind of Zuvran screams:
How far would you dare to ride. . .
If the Secret Door were opened wide ?*

from The Teachings of Kha Khiabo by Thabion

Chapter One: Hypnosis and Yoga

After familiarizing myself with the operation of the Chevreul Pendulum I began to ask my subconscious mind questions of a very personal nature. It did not always give me the answers I wanted or even expected, lending an air of credibility to the process. When I was totally convinced of the validity of the technique, I asked the ultimate question : “Do you remember past lives?”

The answer was strong and unmistakable. “Yes!” it told me.

From the author’s Magical Record of 1969

ONE OF THE GREATEST DISCOVERIES I made in the course of my illness was a realization of the awesome depth and range of knowledge available to the subconscious mind. Even though I count myself an imaginative, articulate writer, mere words cannot describe the experience of such a revelation. When I say you are going to become one of “The Far-Seeing People” I mean more by that than you can possibly grasp before you begin your training.

Because of the crucial importance of a “Long Track”, multi-life-time perspective in your dedication to Magick, you must begin your program with these consciousness expanding and knowledge extending exercises. Although your religious and folkloric heritage is important, Magick will teach you that your beliefs are actually tools and weapons. *You are at the center of your reflection of the Universe.* You can believe anything you choose and the Universe will give it to you. Let me give you an example:

A secret ritual, transmitted to me orally by my Tibetan guru, permitted me entrance to a sensual astral paradise populated by voluptuous, insatiable *dakinis*. After an orgy that seemed to last for days, during which I realized every sexual fantasy I’d ever entertained, I finally descended, like the ancient Romans, into decadence and ultimately into satiated voyeurism. The *dakinis* were very accommodating, doing whatever I could think of to entertain me. . . Finally I’d had enough. I tried to escape from them but they were everywhere, smiling, giggling, flirting, posing and purring like kittens.

At last I wormed my way through the wiggling hoard of naked, velvet-skinned, perfumed houris to a lake in the center of The City of the Damsels. In the middle of this pond floated a small boat. In the boat sat a long bearded man holding a fishing pole. I dived into the water and swam out to him. Fortunately the *dakinis* couldn’t (or wouldn’t) swim, so I was free of them at last. I clambered into the boat and introduced myself. “How long have you been here?” I asked him.

“I lost count after the first thousand years,” he said.

“Are there any fish in this lake?”

“I’ve never had a bite,” he said with a faint smile.

“Then why do you fish?”

“It passes the time,” he whispered.

Fortunately for me, I was only visiting The City. I had not chosen it as my Heaven or perhaps my Bodhisavatta vows had come to my rescue — at least in this astral adventure. And yet Vajrayogini was not so easily dismissed. She then physically manifested Herself in beauti-

ful human form (disembodied spirits have a penchant for doing this). I took her with me on an expedition to the ruins of lost Lemuria (Nan Modal) — and upon that hangs another tale. . .

Ibn Saba, The Old Man of the Mountain, who had promised his followers a similar sensual paradise, once said: “*Nothing is true. Everything is permitted.*” This is essentially correct but what Saba, Grand Master of the Assassins, did not mention was *the price*.¹

Another medieval Arabian sage placed the age of our human race at forty-four thousand years. Only in the past century did science confirm this. Considering the age of us all and the special effort you have made to obtain this book I will wager that you have walked this path before. If so, you will understand the essence of the teachings revealed in the next paragraph.

During magical operations a camera will not record Angels flying down through shimmering clouds or demons crawling up through smoking cracks in the earth — but these Mighty Beings are nonetheless real and very powerful. They exist beyond the limits of your personal imagination and yet they are seen through your prism in the multi-faceted lens of *The Great Universal Mind*. They can be super-human, sub-human or non-human. They rise up from the vast, dark depths of *The Collective Unconscious* and swim into the shallow lagoons of our individual subconscious minds. According to our *Neo-Romantic Philosophy*, this *Universal Ocean of the Deep Mind* extends beyond the furthest limits of *Interstellar Space*, penetrates the smallest sub-atomic particles and is connected with the *Primordial Imprint of DNA*. *It is mirrored in the Anti-Matter Universe that exists side-by-side with our mundane dimension. We think, therefore we are — and are not!* The “*Idea*” of a thing and the energy that flows into its creation are greater realities than the static physical result. We can imagine nothing as great or greater than God’s conceptions, therefore our God-given ideas of soul transmigration, reincarnation and magick must exist for those of us who believe in such concepts because if such were not true it would mean that humankind had conceived a master

plan of spiritual evolution beyond God's power to grant. Given the awesome age, size, cohesion, symmetry, synchronicity and ultimate mystery of the Universe this would seem to be the one and only true impossibility. These precepts are the foundation of our modern *Magical Field Theory.* Beyond these conceptions lies the inevitable truth that ALL sentient beings are merely differing reflections of yourself. If you understand and embrace these principles you will soon grasp the importance of self-hypnosis and Raja Yoga as basic access techniques and prerequisite skills to mastering *The Magical Art.*

In 1969, as mentioned in the introduction, I discovered, or more properly, rediscovered, the essential secret key to Solomonic magical evocation. I found out how to summon spirits to visible appearance and converse with them without depending on special psychic talent — but first I had to learn self-hypnosis, *and so will you.* Granted you can get the facial reflection-distortion method to work without learning hypnosis and yoga. Children have been scaring themselves with the phenomenon for as long there have been mirrors — but then you can't control it any more than they can. Unlike children, you are not going to scream and run --*even though it might be better if you did!* Without the perception of one who understands and controls his own trance you are operating in an unfamiliar state of mind and dabbling with something beyond your conscious comprehension.

Because self-hypnosis was so important in my development, let me tell you briefly how I got into it and how it led me to discovering the secret of the mirror-in-the-triangle and its full significance.

You've already read my biographic sketch so you know my qualifications but they do not tell the real story. In truth, I had learned the methods and the philosophy I'm now sharing before I ever attained the credentials cited in my resume. The remarkable discovery of Solomon's hypnotic secrets actually propelled me through seven years of anthropology, thirty-nine degrees of Freemasonry and a year of intensive Tibetan Tantric training under the finest magicians to come out of that mysterious land. Now I want to share these original

concepts and techniques so that they may open similar gateways for others who choose this path.

In 1969 I was a former Green Beret and an avid scuba-diver eking out a living as a pulp-fiction writer. I had two paperback novels and a series of underwater adventure stories in ARGOSY magazine to my credit. Any impression I might have had at that time about ancient sorcery would have come from the fantasies of H. P. Lovecraft or Robert E. Howard. I liked science fiction and I had a good imagination — but, before my illness set in, I never dreamed that reviving the lost art of Solomon's Magick would become the major creative effort of my life.

Like so many writers in those days I was a chain-smoker and a perpetual coffee drinker. I assumed that these bad habits were responsible for my frequent bouts with indigestion. This condition became chronic and finally unbearable. I went to a doctor and was diagnosed as having an ulcer. At that time stomach ulcers were thought to be entirely psychosomatic. A 'sissy' disease for a macho type. I wasn't about to give up beer, coffee, cigarettes and steak dinners to go on a milktoast diet. I reasoned that if ulcers were caused by anxiety, I'd conquer my inner fears through self-hypnosis and heal myself in the process.

In desperation I learned the theory and mastered the techniques quickly. My text was Leslie M. LeCron's, *Self Hypnotism, The Technique and Use in Daily Living*. (This book has since gone through several editions and is now considered a classic.) I was soon able to suppress the pain . . . but then it would always return, often worse than before. I must have taken myself as deep into trance as anyone has ever managed through self-induction, but I could not cure the ulcer because — as the doctors eventually discovered when I was almost dead — I was carrying within me a gallbladder that had turned into *a mass of solid rock!*

In the later stage of my illness I was in an altered state of mind that I now realize was a toxic psychosis. Subconsciously I must have

known that I was dying. This morbid condition drove me to stranger and more esoteric experiments in self-hypnosis. I began my occult studies with Tantric yoga — but, when I discovered our own culture's magical counterpart to that Eastern system, something clicked. *I knew with absolute certainty that Western Ceremonial Magick was my path and I would discover its lost secret.*

From my studies and my first experiments I had learned that a hypnotic effect could be achieved through *a fixed gaze on a reflective surface* such as a crystal ball, or a dark mirror — and I knew that these devices had often been used by the old magicians — but were they the actual *spiritus locii*, the place where angels and spirits could be conjured to visible appearance? I could put myself into a hypnoidal state staring at them but I did not see a face appear or sense a genuine presence — and yet I was convinced that hypnosis was necessary and that some sort of window into the other dimension, like the crystal or the dark mirror, had to be employed.

But, if this was true, then why did Golden Dawn magician Aleister Crowley, and his mentor, Alan Bennett, waste so much time and effort unsuccessfully trying to evoke a Goetia spirit out of the smoke from an incense burner? Why did the Golden Dawn oath-bind its members not to undergo hypnosis — and why did they virtually eschew those traditional conjuration devices of medieval and Renaissance magicians?

On one level we can answer these questions by recalling that in their time the hypnotic trance was equated with spiritualism and magnetizing quackery. In parlor room seances crystal balls were as common as OuiJa boards and even dark mirrors were sometimes used. Skrying on these devices was assumed to be humbug because of its widespread popularity. The burlesque image of the Gypsy fortune teller with her crystal ball is a cultural icon left over from that era.

But, at a deeper level a more subtle and insidious mental attitude had infected the intelligentsia at the end of the Renaissance and would cheat later generations of Western magicians out of their heritage.

The philosopher (1595-1650) René Descartes — the father of Rational Philosophy — had been inadvertently responsible for what the military calls “collateral damage” to spiritual development in the Western World. In the service of fledgling science he had declared that *there was a total separation between mind and matter; between mental conception and its physical manifestation.*

Although this is an over simplified statement of his theory it is a deadly accurate assessment of its effect. Although his construct allowed for advances in engineering, the divinely inspired human imagination — the greatest creative force in the universe — had been relegated to the importance of childhood day-dreaming!

Once you grasp the significance of this outrage against your personal divinity you are just starting to move that giant Stone away from the entrance to your Treasure Cavern. When you return to Plato and realize that *the original idea of something* is more dynamically *real* than its eventual static, physical manifestation, you can hear and feel that huge boulder start to move. It makes *a skreeking sound* of protest because you have recovered one of the great suppressed secrets of magick: *the creative power of the human mind.* But simply recognizing this power will not unleash its potential.

Along with *The Stone* we have another enemy within ourselves: *The Chattering Monkey* of the conscious mind. As we heave against the rock, the Monkey dances around us distracting our attention and belittling our efforts. Finally we become so frustrated and discouraged that we give up and return to “reality” — and immediately our nasty little Monkey disappears.

Unfortunately he will return whenever we try to quiet our minds and resume our spiritual work — *so we have to get rid of the Monkey.* Then we have to train ourselves to use this mental power in much the same way that an athlete trains to perfect his or her sporting skills. If you don't think this is necessary, if you don't believe that you need to master self-hypnosis and the *tratakam yoga* technique to practice Solomon's Magick, I'll challenge you to test yourself.

Take a few deep breaths and then stare at your wrist watch with a fixed, unmoving gaze for *three minutes*. During that time you may breathe normally *but you must not blink, you must not think of anything and you must not change your visual focus*. If you perform this test correctly you will find yourself in an Alpha (hypnoidal) state when the exercise is completed.

Why do I say, *you must not blink*?

Because the unblinking stare (tratakam) is totally committed to its object — and it is the hallmark of the true magician.

However, if you pass this test you will still want to study this chapter carefully to understand the unique hypnotic characteristics of the magical trance state. You will also need to go through the exercises so that you can teach them to others.

Do not assume that because you've gone through a Golden Dawn style program that you can skip this part of your training. Remember, the Golden Dawn avoided any form of hypnosis and was not preparing its members to use Solomonic magical equipment. Relying on the Golden Dawn's indirect mental conditioning procedures as preparation for Solomonic work would be analogous to substituting basic (soft) Tai Chi training for the rigorous preparation necessary to compete in a full-contact Karate match. Granted a Tai Chi master (or in our case, a Golden Dawn adept) could certainly hold his own, *but only after years of training*.

Solomon's magick is the Art of evoking spirits to visible appearance and invoking knowledge of, and conversation with, Holy Angels — whereas much of Golden Dawn magick is of the "*Do-the-ritual-to-imprint-the-astral-and-then-see-what-happens-later*" variety.² Be sure you realize the difference.

There is also a shade of difference between most yoga trances and the hypnotic state as we know it here in the West. This is best illustrated by another anecdote from my Tibetan training: early in the program I was trying to master a ritual in which I was to assume the form of Vajrayogini and perform various symbolic actions in Her persona.

Knowing that mudras (hand and finger positions) are sometimes done while visualizing, I asked Lama Luding Khen Rimpoche if I was to emulate any of the actual gestures of the deity as pictured in Her tanka (icon). After a good natured chuckle at my expense he patiently explained that this was all done in the mind while sitting inert and physically anesthetized in the lotus asana — somewhat like a Western pathworking.

Most Tibetan magick is done from the inert, seated asana position whereas much of Solomon's magick is performed standing up and even moving. Our hypnotic trance allows us a unique mobility and a remarkable capacity to *operate in the subconscious and conscious mind simultaneously*. This enables the operator to ask the receiver, "Do you have a presence?" or "Would you like it stronger?" without disrupting the trance state. In a solo working the operator can question his own spirit manifestation directly, going back and forth between his own rational mind and the manifestation from his subconscious as normally as he would carry on a conversation with another person. The reason for this is implicit in the dialog nature of hypnotic induction — *and especially the self-directed dialog developed in self-hypnosis training*.³

Although the *tratakam* (fixed gaze) yoga technique is an Eastern derivation, it is the most directly hypnotic of the yoga practices and integrates perfectly with other aspects of Western style hypnotic induction. As a pre-requisite to *tratakam* and hypnosis generally, *pranayama* (controlled breathing) training is also necessary. The magical student does not need to carry this any further than an 8-8-8 count but he or she should be comfortable with at least a 6-6-6 cycle (no pun intended).

It is not my intention to write complete treatises on self-hypnosis and Raja Yoga in this book. You are expected to consult the practical manuals we recommend on these subjects and follow their instructions. I was fortunate enough to discover two of the finest training guides on each of these fields back when I started my practice of mag-

ick twenty-five years ago. These two books have remained constantly in print ever since. For self-hypnosis, see Leslie M. LeCron's *Self-Hypnotism, The Technique and Use in Daily Living*, and for Raja Yoga, Dr Rammutri Mishra's *Fundamentals of Yoga*.

Many people have already experienced hypnosis induced by someone else but the magician must master the technique of self-induction. The reason for this is that magick operates through *the will of the operator* and yet the operator *must be in trance* when he or she operates. This sounds like a paradox. Isn't the hypnotic trance a passive state? Not necessarily. The hypnotic state is really a condition of *total, one-pointed concentration*. It can be passive or active — but, if it is to be active, then the operator needs to get himself into it or participate in a preliminary meditation wherein the whole circle becomes entranced. In the Orient, hypnotists always put themselves into trance before they attempt to hypnotize others.

Even if you have been subjected to the hypnotic state by someone else, you are going to find self-hypnosis a remarkable experience. Perfecting this technique can be one of the major transforming elements in your life. *For the very first time, you are in total control of you!* And, as discussed at the beginning of this chapter, you can then access your memories back to the dawn of our race. When a true adept says that one should not practice magick *without initiation*, this is the experience he is referring to, not to some pageant performed in a lodge room.

Once you have crossed this threshold in your development you have empowered yourself to practice Solomon's magick. The hypnotic state is total concentration and total involvement of *both levels of your mind*. If you operate only from a conscious level you are intoning words and going through motions while wearing an astral blindfold and ear muffs. As we have noted, this is a form of magick but it is not the Thaumaturgic Art of Solomon.

Although you will be combining elements of tratakam yoga and hypnosis, you need to know the subtle difference between the two sys-

tems: Tratakam yoga (empty-minded, undistracted fixed gaze on an inert object) will induce the hypnodial states called *yoganindra* (physical anesthesia) and then *samadhi* (space-time suspension) as side effects but it is not a true hypnotic induction because there is no direction involved beyond strict maintenance of a passive mental attitude. Tratakam is more properly a form of meditation. It is *essential training for our Solomonic mirror and crystal skrying* because it conditions us to see something without “looking at it”, to contemplate our reflection in a dark mirror, or the angelic aura surrounding a crystal ball, without analyzing the optical phenomena as they occur. It is easily mastered with regular daily practice. If you get discouraged just remember that John Dee and Cagliostro would have given their fortunes and have devoted years to practice and to master these techniques if they had only known they were available.

Practical Exercises:

There are a number of ways to practice tratakam. Dr. Mishra lists nasal and frontal gaze exercises which are uncomfortable and alien to Western practitioners. We recommend an easily constructed variation of one of his techniques involving a blue light bulb behind a 12” dia. round cardboard shield with a 1½” dia. filtered hole cut in the center. In the center of the frosted filter, place a ½” dia. black dot. This device is suspended from the ceiling. We call it a “*Samadhi Lamp.*”

To use the samadhi lamp, do your stretching exercises, take your asana, do a few minutes pranayama and then lie flat on your back and fix your gaze on the illuminated hole, with its central black dot, for ten to fifteen minutes. Do not explore the lamp with your eyes, just look at its glowing center. Try not to think about the optical phenomenon as they occur. Try not to think about the relaxation and numbness coming over you or the hypnotic state you are drifting into. . . *Try not to think at all . . .*

Along with your tratakam training you will be regularly improving your skills in self-hypnosis. The first key to mastering self-hypnosis is physical/mental relaxation. You'll notice I've joined the two words together because they go together.

Physical relaxation is best achieved by first stretching the muscles of the body and then compressing them. For stretching do the classic yoga "Sun Salute", then for compression, point out and stiffen each leg in turn, curling your toes. Hold the leg rigid for ten seconds. Thrust each arm out straight and make a hard fist. Hold it for ten seconds. Relax. Roll your head in a circle. Open your mouth and work your jaw muscles. Tighten the muscles of your face. Take several long, deep breaths through your nose. Hold the air in your chest at least as long as it took you to inspire it — then blow it out through your mouth.

Having achieved relaxation you must learn to empty your mind.

To empty the mind and to develop the ability to shift the center of consciousness to other parts of the body take a comfortable asana position with your back straight. Close your eyes and focus them upward without strain. While maintaining this position and gaze perform at least four cycles of simple pranayama (without hand manipulations) on a four count inhale, four count hold, four count exhale, four count hold-on-the-void. With your breathing finished keep your closed eyes focused upwards while you quietly imagine that your body *is growing larger and larger until it is nearly fifty feet tall*. Your skull is a great, dim-lit hollow vault half filled with deep, dark, still water. You (your consciousness point) are in the form of a small pearl floating half-submerged in the water. The water is comfortable, safe and protective. Above you are the random thoughts that flit across your mind. You see them in the form of luminous fireflies darting back and forth to no purpose. They buzz and chitter without meaning.

You allow yourself to sink just below the surface. Now you can neither hear nor see those distracting thoughts. You are at peace with-

in yourself. You sink down to the level of your throat . . . and then down into your chest. . .

After three minutes you may re-surface, realizing that you are now the master of your mind. These unwanted thoughts that have plagued you for so long are no more bothersome than gnats on summer day.

Now you are ready to hypnotize yourself or, if you have been leading a group in these exercises, you are all ready to enter the hypnotic state.

Here follows one of our ritual hypnotic inductions you may modify and practice with. . . This one is adapted from our advanced pathworking system but it gives the general idea. (The Soul Door referred to is a floor-to-ceiling dark mirror set in an ancient Egyptian style door frame. You can see it veiled in the video.) Note that we make the inert, seated physical body huge and keep the enlivened spiritual body within — into which we project our consciousness — very small. Once you have perfected your basic hypnotic and yoga techniques, you may use this secret Tibetan method of Inner Plane projection with full effectiveness. . .

As we stare at the planetary symbol of _____, our physical eyelids are becoming very heavy. Our bodies are totally inert. We sit like great stone statues surrounding our double cube altar — which has become a huge, tall building . . . Our Spirit bodies within us are now as small as a finger on the hand of our huge sleeping physical forms. These tiny Spiritual Bodies are now the radiant centers of our consciousness. We are filled with living energy and eager to be off on our journey. We look to Westward and see the distant star of our destination, the Sephira of _____, as it beckons to us far away in the night sky beyond the great pylons of The Soul Door Gate.

Now we allow our physical eyelids to finally close. We project our Spiritual Bodies out the Third Eye Chakra toward the Soul Door

Gate and through the great pylons into the vast night sky of the endless universe! Ahead of us gleams the star of _____, leading us onward. We are passing over the dimly lighted landscape a thousand feet below . . . (here you will insert the description of the Otz Chiim Path over which you are flying.)

This is also the method of choice for projecting into and through *Enochian* pyramids. It is likewise a vital skill necessary for exploring the powerful psychic centers or chakras within your body. With self-hypnosis and Raja Yoga training you can master even advanced techniques such as this in months instead of years.

It is said that a picture is worth a thousand words. I hope that the mental imagery evoked by the above passage will serve to convince you of the importance of hypnosis and yoga as basic foundation skills for this Art.

Do not neglect your mental training.

Chapter One/Notes:

-
1. To understand the mystery of the false paradise, students of Solomon's Magick should read Burton's original version of *The City of Brass* in *Alf Layah wa Layah*, THE ARABIAN NIGHTS.
 2. This statement may disturb some of my senior G. D. colleagues who have become genuine shamanic wizards *in spite* of the Golden Dawn's non-hypnotic methods. This is not to say that the creative visualizations in the Pentagram and Middle Pillar rituals are not very valuable and even essential in their own right —*but they are projected onto the astral, not received from it.* The G.D.'s Tattwa skrying exercises were taken directly from an Eastern source.
 3. Those who have popularized our evocation technique have stated that solo operations are quite difficult, possibly dangerous, and should be avoided. This demonstrates their lack of understanding of the importance of self-hypnotic training in Solomonic magick. A solo operation (for an entity of the same sex as the operator) is usually less difficult due to the reduction of the personal variables involved.

*Know that the Jinn which mighty Solomon
Did conjure in the Triangle of Art
Were formed in the reflection of his face
For they were aspects of his soul
Each agreeing unto a Quadrant,
A Planet and a metal thereof
Which when burnished did reflect
Even as a Mirror*

*And when thou holdest the lighted tapers
In thine own hands
And thou dost gaze deep into thine own eyes
Know that thou dost perform The Art
In the very manner in which it was truly done*

from The Book of Astarte by Frater Aleyin (Thabion)

Chapter Two: The Secret of The Dark Mirror

MY ILLNESS AND MY QUIXOTIC attempt to cure it through hypnosis, had driven me into the shamanic tradition of my ancestors — and, as the saying goes, “*When the student is ready, the teacher appears*”. In this case the teacher came in the form of a book. My first introduction to Western Magick still stands as the best survey work written on the practical aspects of the subject: *The Black Arts* by Richard Cavendish, published in 1968. Using Cavendish’s excellent bibliography, I quickly acquired Waite’s *The Book of Black Magic and of Pacts* along with the Mathers-Crowley *Goetia*, Mathers’ *The Key of Solomon the King*, and Francis Barrett’s *The Magus*.

The medieval *Key of Solomon* provided an authentic handbook for making magical regalia, implements and talismans but it was the more notorious *Goetia of the Lemegeton*, the so-called *Lesser Key of Solomon*, that was the real wizard's *Liber Spiritum*. The *Goetia* (pronounced, *Go-ey'-sha*) catalogued and described 72 rebellious spirits that, according to a Talmudic legend, old King Solomon had imprisoned in an enchanted Brass Vessel submerged in a lake in Babylon. This read like a fabulous tale from the Arabian Nights but in my irrational state I was convinced that there was a hidden truth behind the fantastic story. Like Aladdin's wonderful lamp or Ali Baba's "Open Sesame" there was a Secret Key to calling up those mighty Princes of the Jinn that Solomon had imprisoned so long ago — and I was determined to find it.

Years later, when I was doing graduate studies in cultural anthropology I realized that back in 1969 I had crossed over into a realm of divine madness that few Anglo-Americans had ever experienced. I had gone through the true shamanic initiation, that mortal illness and vision quest that brings the shaman in touch with his gods and gives him the power to practice his craft. . . .

It was during that season of my madness, when agony alternated with ecstasy, that I had discovered, or more properly, re-discovered, the lost secret of the Magical Art and I wrote *The Book of Astarte* from which the key passage that heads this chapter is drawn. ¹

I had studied the writings of the ancient and modern magicians. They had filled their books with the most detailed instructions on how to build, inscribe and decorate all the necessary equipment, all the signatures of the spirits and even the hours during which to summon them — but the most important element, that method by which one could make the spirit physically appear, was always missing in the old grimoires and not explained in the recent texts.

I knew that over a dozen ancient and modern writers on Magick could not be involved in one big, long-standing conspiracy to suppress this final secret, so it seemed obvious that at some time after the 17th

century and before the middle of the 19th century the practical keys to the Magical evocation and invocation processes had been lost.

This turned out to be true. The ancient writers had hidden the secrets in plain sight — as you will see when we examine the old texts — but the Victorian age magicians of the Golden Dawn school, with their phobia against hypnosis and their commendable distrust of passive spiritualist mediumship, had de-emphasized the actual methods of Renaissance evocation and invocation in favor of a Westernized Tantra in which images were carefully built up in the imagination and then allowed to provide psychic feed-back. Instead of the traditional crystals and dark mirrors for visionary work, they preferred to use abstract colored symbols to stimulate the imagination. These methods are different in conception and technique from the shamanic calling down or summoning up of spontaneous visions from that great storehouse of images Renaissance magicians knew as the “World Soul” and we now refer to as “The Collective Unconscious.”

If I hadn't been touched with divine madness at the time I probably would have accepted the Victorian reconstruction of Magick and put aside my yearning to actually conjure spirits to visible appearance in Solomon's Triangle of Art. I would have agreed with critics like Professor Eliza Butler that those who had practiced out of the old grimoires were credulous and self-deluded. However Arthur Edward Waite, who was also a ruthless critic of the Art Magical, had conceded that they achieved results. In the introduction to his 1898 *Book of Black Magic and of Pacts* he wrote: —

“It would, however, be unsafe to affirm that all persons making use of the ceremonies in the rituals would fail to obtain results. Perhaps in the majority of cases most of such experiments made in the past were attended with results of a kind. To enter the path of hallucination is likely to insure hallucination, and in the presence of *hypnotic* and clairvoyant facts it

would be absurd to suppose that the seering processes of ancient magic — which were many — did not produce seership, or that *the auto-hypnotic state* which much magical ritual would obviously tend to occasion in predisposed persons did not frequently induce it, *and not always only in the predisposed*. To this extent some of the processes are practical, and to this extent they are dangerous.” (emphases mine)

This paragraph was one of the clues that set me on the trail to discovering the secret of Solomon’s Triangle. It should be noted that I had first read all of the available 16th and 17th century material before I got into Regardie and the *Golden Dawn*. Therefore my original perspective was, and still remains, that of a Renaissance magician rather than a Victorian occultist (even though I will be the first to concede our tremendous debt to the Golden Dawn). I think it is important to mention this because there is a natural tendency for people to be heavily influenced by their first impressions in any field of endeavor.

This was especially true in my case given my near-terminal illness and altered state of consciousness. I literally devoured the books listed above with the obsession of a religious fanatic. But, even in the grip of a toxic psychosis, I hadn’t lost my intellect. Madness is known to stimulate genius. I was on the verge of discovering, or re-discovering, an extraordinary secret hidden in these quaint, and apparently whimsical, books of forgotten lore.

I knew there had to be a way to make Solomon’s traditional operations actually work without resorting to drugs, fasting or endless conjurations to produce hallucinations through hysteria and exhaustion.

A century ago Aleister Crowley had tried to conjure one of the Lemegeton’s Goetia demons out of incense smoke. He had very little success after a great deal of effort. As a self-taught hypnotist this did

not surprise me. Trying to form an image, or commanding a spirit to produce an image, out of curling, twisting smoke was more of an experiment in telekinesis than a skrying process. Crowley obviously did not know the technique but he certainly understood the philosophy. He stated it clearly in his 1904 edition of the *Goetia*: —

“But can any of the effects described in this our book *Goetia* be obtained, and if so, can you give a rational explanation of the circumstances ? Say you so?

I can, and will.

The spirits of the *Goetia* are portions of the human brain. Their seals therefore represent (Mr. Spencer’s projected cube) methods of stimulating or regulating those particular spots (through the eye).

The names of God are vibrations calculated to establish:

- (a) General control of the brain. (Establishment of functions relative to the subtle world.)
- (b) Control over the brain in detail. (Rank or type of the Spirit.)
- (c) Control of one special portion. (Name of the Spirit.)

The perfumes aid this through smell. Usually the perfume will only tend to control a large area; but there is an attribution of perfumes to letters of the alphabet enabling one, by a Qabalistic formula, to spell out the Spirit’s name.

I need not enter into more particular discussion of these points; the intelligent reader can easily fill in what is lacking. If, then, I say, with Solomon: “The Spirit Cimieries teaches logic,” what I mean is:” Those portions of my brain which subserve the logical faculty may be stimulated and developed by following out the processes called “The Invocation of Cimieries.”

I have quoted the above passage at some length because it made such a strong impression on me when I first read it. It is certainly not romantic or artistic; in fact it is downright analytical — like wiring a ballet dancer with electronic sensors so we can get a scientific read-out on *Swan Lake* — but it serves an absolutely necessary purpose. Crowley's statement places Solomon's Magick squarely within the parameters of a psychological system.

“Solomon's Spirits are portions of the human brain.”

— But the human brain is only the hardware for the greatest computer system ever designed: *The Human Mind*. A modern hacker-magus would say we run our Solomonic Magick program on an operating system designed by Carl Jung using a language called “Agrippa 777.”

For those of you who are not yet magical cybernauts that needs some explaining: Crowley's conceptions of Magick pre-dated Carl Jung's *Archetypes in the Collective Unconscious* theory. Crowley knew that magical manifestations involved altered states of consciousness and could produce psychosomatic effects but he may not have been aware that entire pantheons of ancient Gods and Goddesses, choirs of Angels and hordes of demons might exist in the deepest reaches of everyone's mind.

Actually this theory was not very modern. Around 200 A.D. Hermes Trismegistus, the mysterious founder of Hermetic Philosophy, had written in his *Asclepius* that: “The Gods of the Zodiac are eternal but man himself creates his own lesser gods.” The implications of this statement were awesome. If we create gods, then we control them! And if we can control them, are we not Gods ourselves? (*In Your Temple You are One with the Gods!*) This is why the late Warburg Institute scholar Francis Yates called the *Asclepius* “The charge of dynamite behind Renaissance Neoplatonism.”

Echoes of that explosion reverberate in the words of Heinrich Cornelius Agrippa written in 1527: “. . . *Such things are delivered and writ by great and grave philosophers, whose traditions who dare say*

are false? Nay, it were impious to think them lies: only there is another meaning than what is writ with the bare letters. We must not look for the principle of these grand operations without ourselves; it is that internal spirit within us which can very well perform whatsoever the monstrous Mathematicians, the prodigious Magicians, the wonderful Alchemists and the bewitching Necromancers can effect."

In the 1920's Jung declared that beneath and beyond the personal subconscious mind there flowed a vast deep sea of dream images and forgotten lore he referred to as "*The Collective Unconscious*". This mysterious psychic ocean was not the exclusive property of any individual human being. It was a dimension shared by us all! Here one might discover the great *Archetypes* of mythology: the heroes, the beautiful courtesans, the martyred saints and monstrous villains of our past. Here were the mysterious man-created gods which Hermes Trismegistus had written about so long ago. Here was the World Soul of the Renaissance magicians. Here were the demons of Solomon's Brass Vessel.

When Jung discussed his theory with his famous colleague, Sigmund Freud, Freud was horrified. "*Carl!*" he whispered. "*If you reveal this to the public you will release a black flood of occultism!*"

However it would take more than just a theory to release the flood of occultism Freud feared. Theories by themselves do not produce results. For results the magician still depends today as he did thousands of years ago on methods and techniques.

Since time immemorial magicians have placed themselves and others into states of trance during which visions and oracles were received. We now know that this process was hypnotic and that all the phenomena we have come to associate with modern hypnosis were in fact known and practiced by ancient sorcerers under the guise of 'fascination', 'spell-casting' and 'enchantment' . . .

The powerful hypnotic effect achieved through *a fixed gaze on a reflective surface* is the reason why the crystal ball, or *shewstone*,

and the dark mirror, or *speculum*, were used by the wizards of olden times as their *spiritus locii*, the actual place where angels and spirits could be conjured to visible appearance. This was and still is a *hypnotic process*. . . . However *the final secret of how to use these magical aides was always missing*. With all the philosophy, the atmosphere, the paraphernalia, the powerful conjurations and the hypnotic techniques, such spontaneous visions in a crystal or in a dark mirror, still depended upon some *special psychic talent*. To make it really work *one had to be a natural medium* — so, with all my hypnotic experiments and my toxic fever dreams, I had certainly become a mystic . . . *but not a clairvoyant*.

This is a very important point. Mediums, psychics and clairvoyants have dominated the mystic arts for centuries because most of us have assumed that they are the only ones gifted with the abilities to see and hear the spirits. This situation was so pervasive that even great magicians like Abramelin the Mage, Dr. John Dee,² Count Cagliostro and the later Frederick Hockley thought they had to employ specially talented skryers or gifted children to do the actual receiving for them. If I had been in a fully rational state at the time I probably would have accepted this historically established handicap — but obsessed genius knows no bounds.

I was convinced there had to be a way, a method by which *anyone* with the desire and the determination could summon spirits to visible appearance and converse with them. This was what Solomon had promised and — like the indefatigable amateur archaeologist, Heinrich Schlieman who had actually discovered ancient Troy right where Homer said it was — I was sure that the medieval ‘Solomon’ was telling the truth.

I could place a crystal ball into the triangle but then if I stood back inside the magick circle, as the operator was supposed to do according to the ancient texts, even a 60mm crystal ball would appear the size of a door knob -- but I knew *something* had to be placed in that triangle: something fascinating, something hypnotic and something large

enough to provide a viewing surface. . . Obviously the speculum: *the Dark Mirror* . . . And what better entrance into that realm the mystic poet Coleridge had called, "*Caverns measureless to man.*"

It had to be the dark mirror! — but how to use it? *How to make it actually work*, I asked myself — then something I had read the year before jogged my memory — something I had read somewhere about the use of dark mirrors in the Far East. . . ?

That final all-important clue had been sitting right there on my book shelf! The secret was in a work called *Tantra, the Yoga of Sex* by Omar Garrison published in 1964. In this book the author explained an ancient Oriental method for conjuring up images of previous incarnations from the reflection of *one's own face . . . in a dark mirror . . . flanked by candles!*

As I re-read this passage in Garrison's book I felt a shiver of excitement. I was experiencing the same tingling exhilaration that an archaeologist must feel when he brushes the sand away and looks down at the unbroken seal of an ancient royal tomb! I tried Garrison's experiment and found that *it worked with remarkable effectiveness*. If a person in a darkened room stares for several minutes into a mirror flanked by candles, a strange phenomenon will almost always happen: The familiar reflection will fade out and disappear. The mirror will go black and, when the image returns, it will be the face of *someone or something else!*

This experience is usually accompanied by *a profound sense of an other-worldly presence*. . . It was obvious that this phenomenon must have been discovered a long time before any concept of reincarnation. It probably went back as far as the paleolithic when stone-age people stared fascinated at their reflections in dark, still pools of water, seeing the strange transformation occur — and being convinced *they were in the presence of their Gods!*

I suspected that in a ritual setting, using traditional conjurations and symbols, specific spirits and even ancient Gods and Goddesses might be summoned from the 'Other Side' . . . This might well be the

ancient secret behind that strange passage in the Bible that reads: “*God fashioned Man in His own image*”

It was certainly the reason why Solomon has us command the spirit, often described as a monstrous hybrid, to “*Appear in fair and human form and speak unto us in a clear, intelligible voice in our mother tongue.*”

After this discovery the use of the magick mirror in an elevated triangle seemed obvious. Our 17th Century Lemegeton manuscript, Sloane 2731 clearly shows a *large black-filled circle* in the center of Solomon’s Triangle. (See figure 1.)

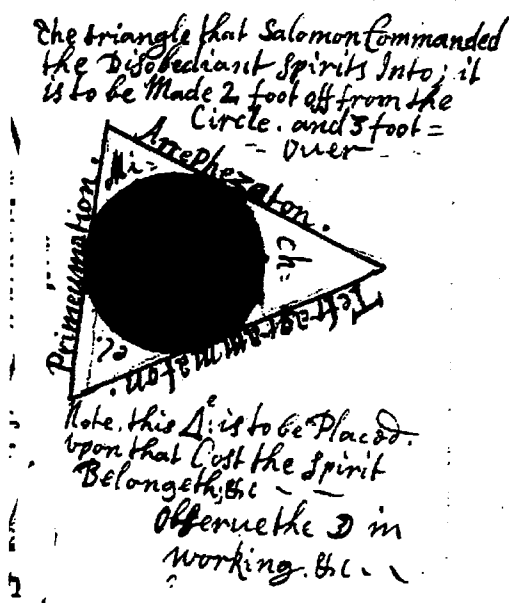

Figure 1.-- Detail from British Library Sloane MS. 2731 showing and describing the Triangle to be used in Goetia workings.

Note that the instructions written around the triangle say: “Two foot off from the Circle and three foot over.” — not “Three foot across,” as the published version has it. The triangle was intended *to be raised up to eye-level. . .*

This is clearly shown in a drawing from a 17th Century Manuscript by the mysterious “Dr. Thomas Rudd”, which depicts a mirror on a stand with *Solomon’s Secret Seal from the Goetia of the Lemegeton* clearly rendered on the reverse side. . . (See figure 2.)

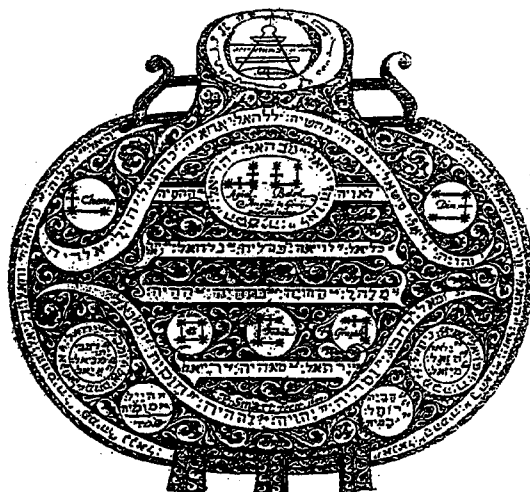

Figure 2. -- The back of a Magick Mirror showing the Secret Seal of Solomon from the Goetia, drawn by Peter Smart 1699.

We know that polished obsidian mirrors were used in the neolithic Middle-Eastern city of *Katal Hyuck* as far back as nine thousand years ago — before The Great Flood. And later, in the time of Solomon, the Egyptians and the Canaanites made mirrors of polished copper and of silver, metals attributed to the planet Venus and the Moon . . .

. . . Let your mind travel back to those ancient times and imagine what might have happened when a Priestess sitting before her mirror, putting on her make-up in the dim light, saw her face change and *become The Goddess!* Perhaps she would call the High Priest to witness the transformation. They would both be familiar with possessions and trance states and would be quick to see the possibilities. . .

Now I am certain that some of my magical colleagues will cluck in their beards and say: “Well Runyon developed an effective system

— *but it's modern.*” They will cite the fact, already mentioned, that Cagliostro, Dee, Hockley and others had to employ skryers to do their visioning. If those worthies didn't know the reflection secret, then who had known?

My answer is that the medieval Arabian magicians probably knew it as these quotes from C.J.S. Thompson indicate: “*According to Arab tradition, magic or 'sihr', which means 'to produce illusion before the eyes' was revealed by two angels in Babel, named Harut and Marut, who instructed mankind in this art . . . When a miracle was deemed a 'sihr' it was regarded as an optical illusion or due to an illicit dealing with demons . . . The use of the magic mirror — which was made of metal or glass with a polished surface — for seeing spirits, was known to the Arabs at an early period. The image was said to appear in a cloud or vapor floating between the medium used and the gazer's eye. . .*”

Ceco d' Ascoli, Dr. Thomas Rudd and others may very well have known but kept it secret. The method was so simple that there was no need to write it down. It could have been passed from mouth-to-ear (and yet the hints in the Sloane 2731 Goetia are almost too obvious). We should recall that the Goetia was not a system magicians felt comfortable writing about back in the days of the Inquisition.

And they did not need Carl Jung's subjective psychological theories to justify using their own reflection as a focal point. There was a haunting Orphic myth about Dionisus being entranced *by his reflection in a mirror*, caught by the Titans and torn to pieces, his parts rescued by Zeus and given to Apollo to plant in the earth — from which he rose reconstituted and revived.

Here we have the modern psychological concepts of fragmentation, reintegration and individuation of the personality, we also have our seventy-two all-encompassing spirits let out and then put back into The Brass Vessel. The ancients did not create such fables for idle amusement.

But my most telling argument sits in every grammar school class in the country. Along with playing hopscotch on The Tree of Life, children have a game called “Bloody Mary” (Clive Barker’s “Candyman”) which they have been scaring each other with as long as there have been mirrors to look into. Any modern magician who thinks his predecessors didn’t discover this same phenomenon ages ago and make use of it doesn’t hold them in very high regard — but to those who still insist that this method of magical evocation is modern, I will be most happy to accept credit for it. ²

In the week following my remarkable discovery (or re-discovery) my illness overcame me to such a degree that my doctor was compelled to conduct a more thorough examination. At that point he discovered the truth and advised me that only an operation could save my life — but that I was too debilitated and inflamed to undergo the surgery. I asked the Archangel Raphael to heal me and Prince Ba’al to give me strength — then (because the Gods help those who help themselves) I went out and found another doctor. When I recovered from my surgical operation, health and sanity quickly returned — but I remembered what I had learned during my sabbatical in Tartarus and, to my surprise, I discovered that *Solomon’s Magick was still as effective* — and even more so when contrasted with my otherwise rational state of mind.

To my even greater surprise, I found that this ancient system would work for any sincere person who could concentrate on a fixed point long enough to achieve a light hypnotic trance.

I extended my experiments to include others and I soon discovered that the process was just as effective if I — as the magician — stood behind a passive ‘receiver’ who would only need to hold the candlesticks and concentrate on the mirror.

At that time I was a bachelor in my thirties, living in a beachside Southern California apartment and riding a motorcycle. This put me in a position to recruit young women willing to transform into the

Goddess Astarte. These experiments, harmless as they were, made me notorious.

According to a published account one of my Astartes disappeared off the face of the Earth — and yet I saw her socially in the week following the operation.

It did appear that women made the best, or perhaps the most enthusiastic, receivers but for the most part my female volunteers were not clairvoyant. Those few who were natural psychics would receive their vision “off-face” after the mirror blacked out. Non-psychic receivers (most of us) will see a different face replace our familiar reflection. However, it is important to note that this transformation process for non-psychics is, if anything, a more intense and consciousness altering experience than the more familiar visioning process the psychic undergoes.

So I had the secret. Like Dr. Frankenstein, I had learned *how to do it* — but, even though I may have been just as obsessed as the fictional Victor Frankenstein, *I didn't want to make his mistake.* Before I opened the *Brass Vessel* and released these spirits into the world again, I wanted to understand the philosophy and the spiritual significance behind a process that been kept such a closely guarded secret for thousands of years. I had to ask myself, was it possible there were slumbering demons from our past that — as the late Howard Phillips Lovecraft had suggested — *might better be left unawakened?* How and why had the beautiful Goddess Astarte and her handsome consort, Prince Ba'al, the Thunder God, *become demons in the forbidden books of medieval black magick?* . . . I found some of the answers to these questions in the long-lost Biblical *Book of Enoch.* . .

Chapter Two Notes on following page. . .

Chapter Two/Notes:

1. This passage may be familiar to some occult students outside of the O.T.A. *The Book of Astarte* has been pirated and circulated in the occult underground since 1979 even though it was copyrighted under my pseudonym by a major university in 1976.
2. In actual fact, since its rediscovery in 1969, the method has become so popular that one of my former students privately claimed credit for it and started three mini-lodges of his own. Another O.T.A. defector offered a typescript exposé of the mirror-reflection Goetia technique in 1979 — Then, in 1988 a popularizer of magick admittedly drew on that earlier exposé for a chapter on Goetia evocation in a book issued by a major publisher. He and his publisher followed this up with a simplistic, mass-marketed pamphlet on the Goetia Dark Mirror method in 1994. This finally prompted us to go into production on *The Magick of Solomon* video and *The Book of Solomon's Magick* to present the real story behind modern Goetia/Almadel Magick and teach the proper methods of practice.

*Concerning these Jinn of Wise Kinge Solomon
Thou shouldst know a great truth
And so approach thy work with prudence
Yea even reverence
For they be not all mean and evil
As the uninitiated scribes have recorded
Some are the very Gods of Khem
Of Phoenicia and Chaldea
The Queen of Heaven and the Bull of the Sun
Are among their number
For all may be called through The Dark Window
Into thy soul*

from The Book of Astarte by Frater Aleyin (Thabion)

Chapter Three: Fallen Angels/Pagan Gods

THE ANCIENT AND MODERN HISTORY of the *Book of Enoch* unfolds like an Indiana Jones adventure. It is a truly ancient Biblical book that belonged in the *Pentateuch* between Genesis and Exodus. It disappeared, along with the Ark of the Covenant, sometime after Solomon's death. A copy was known to be in the possession of the Pagan star-magicians of *Harran* in Syria and another was rumored to be hidden in a remote, secret monastery in Ethiopia. In 1773 the Scottish explorer, James Bruce, risked his life to smuggle two Ethiopian copies out of that ancient, legendary kingdom of "Prester John".

The importance of the *Book of Enoch* to Western Magick cannot be overstated.¹ In the time of the Arabian Nights' Caliph, *Harun Al-Raschid*, the medieval Sabian wizards of Harran, when compelled by the Muslims to present their Holy Books, had brought forth the *Book of Enoch* and the *Hermetic corpus*. Magicians have venerated these works ever since.

In mythical, prehistoric times before The Great Flood, the *Book of Enoch* tells of a War in Heaven in which God and his loyal host of angels, led by the Archangel Michael, were arrayed against a horde of rebellious angels who had lusted after the daughters of men and had descended to earth, where they were breeding a race of giants and were teaching humans the forbidden secrets of sorcery and magick. The Arabian legend of the fallen angels *Harut* and *Marut*, quoted earlier, is only one of many mythological offshoots of this original theme.

The *Book of Enoch* goes on to relate that the four Great Archangels, *Michael*, *Raphael*, *Gabriel* and *Auriel (Phaniel)* came down and imprisoned these Fallen Angels at the Four Corners of the Earth where they became known as "*The Watchers*."

Jewish, Christian and Islamic theologies retained the traditional, loyal Angels of Heaven — especially those four Great Beings who rule the Quarters of the Universe, Raphael, Michael, Gabriel and Auriel — but they had no place for the Gods and Goddesses of the ancient Pagan religions they had conquered. The Rabbis, Priests and Imams practiced a slight-of-hand trick and reclassified the homeless, but not forgotten, Pagan deities as those same "Fallen Angels" who were already chained in deep pits at the ends of the earth.

The 17th century English Christian poet John Milton summarized this militant transformation process in his *Paradise Lost*:

“First Moloch, horrid king besmeared with blood
Of Human sacrifice and parent's tears . . .
. . . Of Solomon he led by fraud to build
His temple right against the temple of God . . .

. . . To do him wanton rites, which cost them woe. . .
Till good Josiah drove them thence to hell.
With these came they, who from the bord'ring flood
Of old Euphrates to the brook that parts
Egypt from Syria ground, had general names
Of Baalim and Ashtaroth, those male,
These feminine. For Spirits when they please
Can either sex assume. . . “ 2.

Thus their greatest rival, the Canaanite thunder god, *Prince Ba'al* became *the demon Bael*, first among the ranks of the fallen, who was said to appear as a cat, a toad or a man — or all three at once — and to grant the power of invisibility (See figure 3.)



*Figure 3. The Spirit Bael from Collin de Plancy's DICTIONNAIRE
INFERNAL.*

Prince Ba'al's beautiful consort, *the Goddess Astarte*, Queen of Heaven and mistress of the Temple of Love was transformed into *the demon Astaroth*, described as a hurtful angel with bad breath but who,

when summoned, would reveal *the true history* of the Fallen Angels.
. . . *As indeed She has!*

Although John Milton may have been wrong about “Moloch”, which could be a scribe’s misinterpretation of “Malak = King”, he was otherwise quite correct. Among those Fallen Angels, transformed from the God and Goddess of ancient Canaan, you will also find the ancient Egyptian Gods, Amon-Ra (Amon) and Horus (Flauros) along with some very real demons (Belial and Asmodeus). You may dare to contact Osé, the mysterious titular spirit of shape-shifters, werewolves and leopardmen. (See *The Evocation of Nithael* .)

This myth of The Fallen Angels laid the foundation for a Middle Eastern legend (recounted in the Talmud) about the Biblical King Solomon, who was said to have been the greatest magician of ancient times. According to our legend, Solomon, *armed with the power of God’s Holy Angels*, bound and sealed those 72 rebellious spirits, or Genii, into the “Brass Vessel” — from which he called them forth to do his bidding, even to assist him in building the Great and Holy Temple at Jerusalem. . .

Whether or not you take these ancient myths and stories literally or you consider them to be symbolic, the legend of “The Fallen Angels” — who became the horde of Genii in Solomon’s brass bottle — forms the secret tradition and the wellspring of power behind the fabulous wizardry of the Arabian Nights and even the medieval sorcery of Dr. Faustus.

But can our fantastic legend have any truth behind it? Are we really seeing these ancient Gods and Goddesses, who became “Fallen Angels”, in the dark mirror on our magic triangle? Do the strange voices that speak through our lips during the magical channeling process actually come from these deities and demons of the dim past? Have we really opened “That lost Portal Between Worlds” — and, if so, can these powerful Genii now be commanded to reveal secret knowledge and accomplish wonderful things?

The final proof is in the doing! I invite you to follow in my footsteps and find out for yourself! — but, I warn you, unless you take Solomon’s Magick very seriously, you should have nothing to do with these experiments! This ancient art is not a party game or a Halloween prank. There is no place for the dabbler or the thrill-seeker in the Magick Circle. All aspects of this system, from the spiritual to the psychological, must be thoroughly understood before any experimentation takes place.

Like the knights of olden times, the magician must be trained, armed and armored before he or she goes forth to do battle. . . First you should understand that The Magick Circle is the philosophical fortress that protects you when you open the gate between the worlds (see *Appendix 3.*). It represents the perfect circle of the vast universe and the unbroken boundary and spiritual integrity of your own being — which are *one-in-the-same* when you practice Solomon’s Art. *As above, so below; as within, so without.*

Let me share my personal Magick Circle formula with you. This was derived from an Archangelic invocation of Gabriel. She said that “*The Four Archangels are positioned at the Four Compass Quarters because they represent the structure of the Universe. They are four of the Mighty and Eternal Seven*”. In later meditation I learned that the other three of The Seven, in our personal microcosm, are *Metatron* Above, *Sandalphon* Below and the Spirit of God within us (our *Holy Guardian Angel*) in our Heart Center. Using this visualization as a circle-casting formula provides complete protection because you are projecting an impregnable sphere all around you linked to and empowering a Heavenly force within you.

This is why we invoke (draw down) Angels and higher spirits into the Magick Circle and evoke (call up) lesser spirits into a *locus spiritus* outside the Circle. ³

You should know that even back in ancient times the Triangle represented the philosophical *first plane of manifestation*. It acts as a cage, containing and restraining the spirits you evoke. As a hypotheti-

cal example let us imagine that we are participating in the original Act of Creation, back at the Dawn of Time and out in the vast reaches of cosmic space.

First we will create just *one point*. . . Next we (or God) will establish a *second point* and connect it to the first so that we have a *line* — then, when we plot our *third point* we have our triangle; the first, flat surface. . . Now, when we create *Point Four*, we have the *first solid*. We have created a thing. . . and, as long as we refrain from establishing *point five*, setting our thing in motion, we will constrain our creation to remain in its position. *We will keep our spirit within the Triangle.*

From a Kabbalistic standpoint we can say that the Triangle represents the Tetragrammaton in the Process of Creation: Air (Aleph), Water (Mem), Fire (Shin) combining to create Earth (Omega). ⁴ *You should understand this symbolic geometry thoroughly before you open Solomon's Brass Vessel and release the genii . Visualize the process several times in your mind until you have made it yours. Repeat the Tetragrammaton formula as you visualize (Ah Mah Sha Oh or Sha Mah Ah Tah.)* ⁴.

Traditionally the Name of the Archangel Michael, the Angel of Power, was separated into three syllables; *Mi- Cha - el* and written in the corners of the Triangle to add a visual emphases to the symbolic geometry that bound the spirit (see *Appendix 3*).

Michael is the Archangel of Power but the other three; Raphael, Gabriel and Auriel are equally important — for what good is Power without Truth, Love and Beauty?

So how do we invoke these great Archangels?

Notes of following page. . .

Chapter Three/Notes:

1. Beginning students should be advised that Dr Dee and Edward Kelley's 16th Century "Enochian" system, and its subsequent *Golden Dawn* variation, is not based on the original Biblical *Book of Enoch*. There is no corollary between the Fallen Angels listed in Biblical Enoch and the entities that Dee and Kelley had converse with. We should also mention that Kelley employed a dark mirror for his skrying -- but he was a natural clairvoyant and did not use his own facial reflection as a focal point.
2. This selection from Milton's epic has been edited and condensed to get the point across without interrupting the flow of our chapter. I apologize to students of English literature and I encourage readers to read the original.
3. Once you *evoke* an ancient Goddess or God, who was transformed into a 'demon' in the Goetia, you may then *invoke* them, whenever appropriate, and/or continue to use the evocation process with emphasis on the Apology.
4. These are Hermetic Tetragrammaton formulas we derived from the *Sepher Yetzirah*. See Note 3., in Chapter Five for a description. Later you may wish to visualize these Phoenician letters of creation in their Atziluthic (King Scale) colors —(see Phoenician Alphabet Appendix).

וזו אחר שותפים מפורדים אחד במעלה ואחד בדפוס ואחד במזרח ואחד
 וזו קיינו כפי כח קצות יפוע קצות על כפינו וישנו קשבע קיום קדמ
 אשר בו קשעבע יעשע מול קשורת יחז' יום וישכיע זיכס קריח פ
 קצותיו קשעעלים באזור קיום אשר ער ישעש קשעעש בקשעעש קשעעלר לוס
 קשעעלר בכל לבס קשעעו קשעעעו לקשעעלר וישעו קשעעעו בכל עש קשעעק
 לקשעעו לק עולו קשעעע קשעעעו קשעעו קשעעעו קשעעו לק עולו קשעעע קשעעו
 קשעעו קשעעו קשעעו קשעעו קשעעו קשעעו קשעעו קשעעו קשעעו קשעעו קשעעו

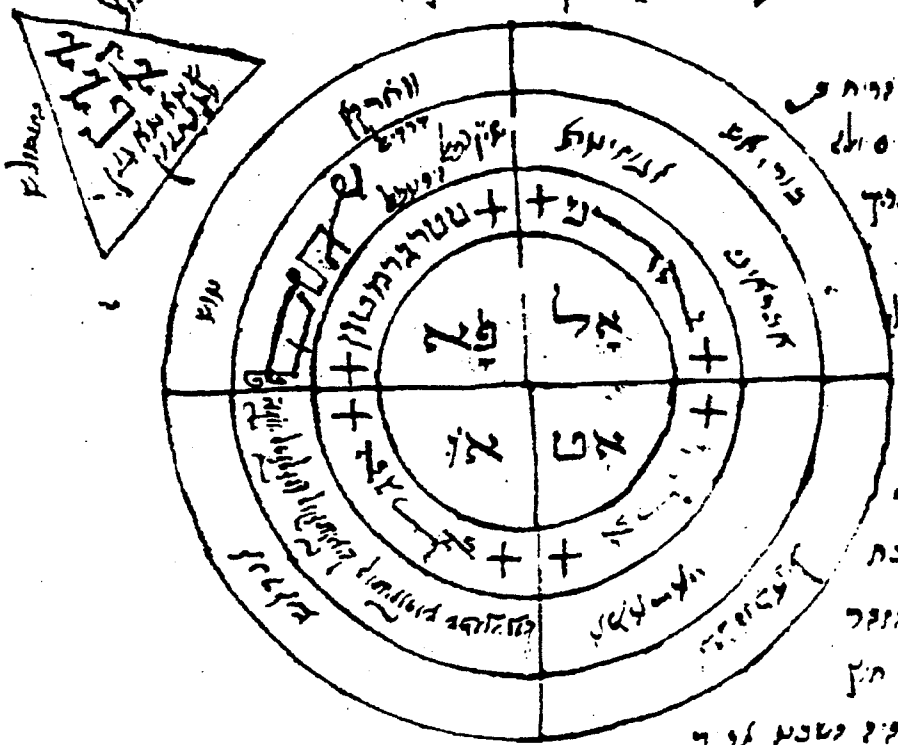

וישנו קשעעו קשעעו קשעעו קשעעו קשעעו קשעעו קשעעו קשעעו קשעעו קשעעו
 קשעעו קשעעו קשעעו קשעעו קשעעו קשעעו קשעעו קשעעו קשעעו קשעעו
 קשעעו קשעעו קשעעו קשעעו קשעעו קשעעו קשעעו קשעעו קשעעו קשעעו

Facsimile of a page from an ancient Hebrew *Greater Key of Solomon* showing a magick circle divided into quadrants, with Solomon's Triangle of Art tangent to the sigil of one of the four Great Archangels of the quarters (Michael according to Peter de Abano or Raphael according to Tycho Brahe). -- From *The Sepher Maphteah Shelomo* courtesy of G.H. Frater Sabazius X^o.

*And yet King David sang the mystery of Wand and Cup
And Hiram Priest-King of Pagan Tyre
Did he not rejoice in the building of the Temple of Solomon ?
In the lusty embrace of the Cherubim
Sun Gold symbol of Mighty Emanations
Begetting Prince and Princess upon
The Mother of the Sea
Lords of Fire and Water — Air and Earth
The very Tetragrammaton*

from Cult of the Sangreal by Thabion

Chapter Four: The Secret of the Holy Table

IT MATTERS NOT WHETHER YOU ARE a Christian, a Jew, a Muslim or a Pagan. *The Four Great Archangels are very much a part of our Western Tradition.* They represent *the positive forces that drive the engine of the universe and the love that holds it all together.* From a practical point of view, they are The Tetragrammaton. They represent the Four Philosophical Elements of Creation. In *the Order of the Temple of Astarte* we conceive and visualize them as complimentary male and female beings, in keeping with the nature of their functions — for Angels can appear *in any form they wish*, or any suitable form that your imagination can provide for them.

You are free to enlarge and use the icons I have created for the O.T.A. in your personal temple (See Color Plate) or you may wish to develop your own original designs.

The Archangels activate your Magick Circle of protection. Casting your circle with a traditional Pentagram Ritual before each operation is certainly important but that alone is not enough. *The Great Archangels must live in your mind and in your heart — You must have them inside as well as outside.* ready to help you control the rebellious spirits — otherwise opening the “Brass Vessel” would be like opening *Pandora’s Box*, which, according to the ancient Greek myth, released evil into the world and could not then be re-closed.

Therefore we must first master the art of *Angelic Invocation* before we proceed to its darker counterpart: the evocation of Solomon’s 72 spirits.

Along with the secret of the mirror-in-the-triangle, the other crucially important element missing from the *Goetia* is the fact that the 72 spirits of the Brass Vessel have *72 direct counterparts in the Holy Angels of the Shemhamphorash*. These derived, or “suffix” angels are not as personified as the Four Archangels of the Quarters or the Seven Archangels of the Planetary Spheres, but *they do act as specific and very effective channels of power through which those Great Archangels control each and every rebellious spirit*.

If this concept is not fully understood and integrated into your Goetic evocation operations, you are on spiritually dangerous ground. The careful operator should use both Goetia and Shemhamphorash sigils and conjurations in evocational operations.

Like the *Goetia* spirits these *Shemhamphorash* angels have their own special signatures and there is a short traditional invocation for each one of them. We credit these invocations to the 17th century magus, Dr Thomas Rudd. The sigils themselves come from MacGregor and Moina Mathers of the Golden Dawn who claimed to have found them in an old French magical MS. Even if this story was a veil of glamour to enhance their creation, they were certainly master magicians and their sigils are effective. ¹.

Before anyone in *The Order of the Temple of Astarte* is allowed to participate in Goetic operations, we insist that they experience a

series of *four Archangelic invocations* — so that the *Great Archangels of the Quarters*, those personifications of the *Tetragrammaton*, which bound the original Fallen Angels, will thereafter in-dwell and empower the student so he or she may then open the Brass Vessel and contemplate the dark mirror from a psychic center point of spiritual balance and strength.

Now that you understand the general theory, let's get down to practical methods. How do we go about this Angelic invocation process?

There is another book in the Lemegeton compendium that probably should have been published with the *Goetia*. It is called *The Almadel of Solomon* and gives us a very effective method for *invoking* — and by that I mean: calling down — the angels. (See Figure 4.)

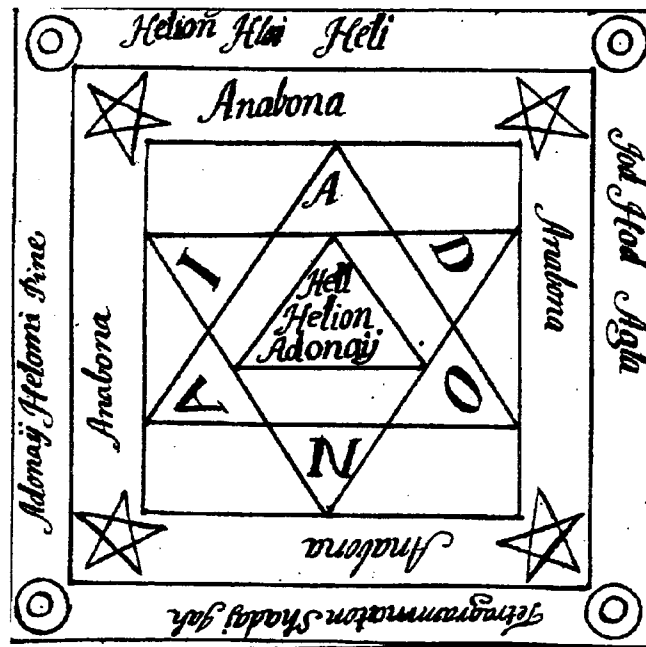

Figure 4. -- Diagram of the waxen Almadel from British Library Sloane MS 2731, THE LEMEGETON.

The original Almadel was a table-top device made entirely of wax. This was an ingenious design. The square slab of wax had holes at each corner through which the four candles were inserted, leaving

enough length below to raise the little platform high enough so that a small incense burner could be placed beneath it . . . from where the incense fumes could rise, through another set of holes, to envelop the crystal shewstone in mysterious tendrils of fragrant smoke — thus adding to the hypnotic effect. ².

As with the Goetia, the secrets of the Almadel were not clearly explained in the Lemegeton. I had to use equal measures of scholarship and inspiration to reconstruct and fine-tune the system. . . but the effort was certainly worth the trouble *because the Almadel Angels control the Goetia spirits!*

I know that statement may be surprising to some magical scholars who never look beyond (to quote Cornelius Agrippa again) “*what is writ in the bare letters.*” The Almadel’s Angels are not arranged in an ascending hierarchy, they are attributed to the Four Quarters and the twelve signs of the zodiac, with each of the four Quarters governing the three astrological signs particular to its nature — in other words, *the Cardinal Signs of Air, Fire, Water and Earth, which we know are governed by the Four Great Archangels of the Quarters, Raphael, Michael, Gabriel and Auriel.*

Realizing this we can simply disregard the late 17th century hodgepodge of garbled angelic names the Lemegeton’s scribe ³. has attributed to these “altitudes” *and thus restore the Almadel system to its full power and purpose as delineated in our Master Mandala* (see Color Plate).

Each of the four Great Archangels of the Quarters empower three sets of six Shemhamephorash Angels, who in turn control three sets of six counterpart Goetia Spirits — which are distributed, two to each of the 36 dekans, or ten degree divisions of an astrological Sign. This occurs in similar order all around the zodiac (see the Master Mandala).

Correcting these errors and rectifying the system intellectually was certainly necessary but of equal importance was the secret of *the*

actual technique. Once again I had encountered *the phenomenon of a missing key*.

Even during the excitement of my Dark Mirror discovery, I still realized that these Great Beings of Light had to be invoked first to stabilize the evocation process — otherwise the legendary symbolism of the Brass Vessel would be lost. I was convinced *the Almadel* was the proper Invocation System simply because it, like *the Goetia*, was one of the five books that made up *the Lemegeton*.

I constructed several different versions of the Almadel device, using the crystal, the candles and the incense burner, until I finally discovered the way to maximize the effect — and share it with others.

The skryers sit, totally isolated, on low stools in semi-darkness looking up at the crystal, placed on a high table and surrounded by shielded candles (an excellent theatrical lighting effect) while spectrally illuminated smoke curls upward. With this set-up the practitioners are more than halfway into dreamtime before the invocation starts.

When I first developed this technique we found the effect was so powerful and the experience so profound, we soon realized — even before my research confirmed it — that we had opened the Gates of Heaven. We had called down those glorious Beings of Light whose sweet voices then whispered in our minds as we sat in reverent awe about The Holy Table of Art.

But, wait a minute! Have I said anything about anybody *actually seeing anything* in the crystal ball? No, I have not — and for a very good reason. Unless you are clairvoyant you will probably not see anything specific. However, if you have mastered self-hypnosis and the yoga of *tratakam* (see Chapter 1), you will witness an electric blue astral aura shot through with rays of golden light, the crystal will radiate with power and you will sense a profound change in the space-time-continuum. You will *know* that you are “On Holy Ground” and that the Angel has arrived. This is very similar to “The Burning Bush” experience described in the Bible. If you think of the Biblical Burning Bush as an ordinary shrub seen silhouetted on the crest of a dark ridge-

line just as the sun rises behind it, you will understand the mechanics of a miracle. . .

Is this a modern, subjective approach?

For the answer to that question let us go back three hundred and fifty years and consult the venerable Dr Thomas Rudd on the subject:

“If good Angels or Elemental powers of light or otherwise dignified Spirits of benevolent or symbolizing nature with celestial powers, and allied to the welfare and preservation of mankind, are moved and called forth to visible appearance in a Crystal Stone or Glass Receiver, as one usual way or customary form is among the learned Magicians, then the sign of their appearance most seemeth like a veil or curtain or some beautiful color hanging in and about the stone or glass as a bright cloud or other pretty kind of Hieroglyphical show, both strange and very delightful to behold.”

So once again we were following in the footsteps of our Ancient Masters. Unlike the dark mirror, it is not necessary to see anything *specific* in the shewstone. You can have a tremendously powerful contact and even become a channel through which the Angel may deliver an oracle. Further on in your magical development you might undergo a life-transforming experience with this method— such as “Knowledge and Conversation with your Holy Guardian Angel” — and *never at any time* ‘see’ anything like a face or a recognizable symbol in the crystal. ⁴

If you are wondering why Angels are less visible than Spirits and Pagan God-Goddess forms, the answer is not far to seek; Angels are agents and messengers of the Supreme Power whereas Spirits and Godforms are personifications of Nature. God is a Crystal and Nature is a Mirror; God radiates and Nature reflects.

Like the secret of your reflection in the Dark Mirror for evocation, this knowledge frees you from dependence on psychics and clairvoyants in your Angelic invocations. You have gone beyond the limi-

tations that handicapped John Dee, Count Cagliostro and Frederick Hockley. You are in direct communication while they could only act as scribes.

Our modern O.T.A. Alamadel is combined with the traditional double-cube altar (see Equipment Appendix). We have shielded candles at the four 'horned' corners and an incense chamber below, with slots cut around the central compass rose to allow the rising smoke to surround our crystal shewstone — which is placed on *our Master Mandala that unifies the Goetia and Almadel systems in one all-encompassing design.*

This modern innovation of mine turned out to be just as effective, in its own way, as the ancient Almadel, *with the important advantage of being ideal for group workings.* We place low stools around the foot of the altar so that four or more people may sit and gaze up at the smoke-shrouded crystal, haloed in spectral light, *with nothing else in their field of vision.*

The operator sits in the East and serves incense through a hinged round door which replicates the Alchemical Spirit symbol. The other participants gaze at the illuminated, smoke-shrouded crystal from a low angle that automatically induces a hypnotic alpha state. Beginning in the East and passing deosil, these invocations (to be found in practical section of this book) are articulated by each person in turn while the rest continue to softly chant the Archangel's name in unison. This 'round-robin' continues until all have invoked. After this the chanting is intensified until the operator in the East sees a "Glory on the Altar" and senses a presence. He or she then welcomes the Archangel and the oracular phase of the operation proceeds.

Remember, you are *invoking* these angels, not *evoking* them. *Invoking is similar to praying.* You're calling them down and inviting them to visit you. You are asking them to help you — so you should not order them around in commanding tones and you certainly should not banish them when the operation is over. You thank them, you ask them to come again, and then you bid them "Hail and Farewell."

Now that you have been introduced to the Evocation of spirits and the Invocation of angels, the time has come to explore the geography and study the architecture of their realm.

Chapter Four/Notes:

1. These sigils were copied by Mathers from French *Arsenal MS. 2495* attributed to the magician Blaise Vignaire. We are indebted to Pat Zalewski for providing us with direct reproductions of the Mathers' originals. These sigils resemble those in Mathers' version of *The Grimoire of Armadel*.
2. The ancient Almadel was probably placed on a waist high table at which a single operator sat during the entire invocation. The candle-illuminated wax has a subtle, translucent quality that enhances the crystal. This effect is difficult to describe and cannot be fully replicated on video tape. Actually making an Almadel and experimenting with it would be very worthwhile, especially for the solitary practitioner. See the complete transcript of *The Art Almadel of Solomon* included in this book.
3. This slap-dash, cook-book style of transcription was typical according to Professor Eliza Butler in her book, *Ritual Magic*. She pointed out that the burgeoning market for hand-copied magical manuscripts in the 17th and 18th centuries encouraged scores of inept and even fictitious renderings. We should also remember that the great magicians of the Renaissance were philosophers whereas those who venerated them were sometimes (to use Rabbi Kramer's expression) "eductated beyond their intelligence".

Notes continued next page:

Chapter Four Notes continued:

- 4, Do not confuse this with the projection technique we use in exploring *Enochian Ayres*. In that method we stare at the crystal (or black obsidian ball) and chant until “The Gate Opens”. Then we *close our eyes* and project onto the Inner Planes. This is very similar to the Pathworking process.

*In the Beginning there was Whirling Darkness
The Mother of Night and The Dragon of Chaos
And The Dragon embraced The Mother of Night
Who gave birth to Two Sons: The Light,
Who shone forth to Ensoil The Worlds,
And Time Who gave Meaning to Eternity.*

from The Teachings of Kha Khiabo by Thabion

Chapter Five: The Kabbalah of Wizardry

REMEMBER, AS ABOVE, SO BELOW — As Within, So Without. At this point you might be wondering how can we, as mere mortals, presume to Invoke Archangels and Evoke ancient Gods, Goddesses and Demon Kings. Even though we have the essential operative secrets: hypnosis, the mirror reflection phenomenon and the aura producing crystal, where do we get the special knowledge, the philosophy and the empowerment to use these methods in magical operations?

The philosophy behind Solomon's Magick is Kabbalah. In Magick the Kabbalistic mind-set is as important as the hypnotic operating technique. If hypnosis is the tactic of the wizard then Kabbalah is his strategy. About this there is comforting news and challenging news:

The challenging news is you that you cannot escape learning the basics of kabbalah. The comforting news is that you don't need to read Hebrew any better than some Tibetan lamas can read Sanskrit (and they are still excellent magicians). Please understand I don't propose to teach you kabbalah in this book. This short chapter merely sets forth the special characteristics of *our version of kabbalah*. You can familiarize yourself with the grand old system in the works I've recommended in the study guide.

With this in mind let's look briefly at what I call "The Kabbalah of Wizardry." It was developed in the late middle ages and early renaissance by nominally Christian magicians and is usually referred to as "The Hermetic Kabbalah". How does it differ from Rabbinical Kabbalah and just how "Pagan", how "Gnostic" or how "Judeo-Christian" is it?

These questions may not seem important at this point but they will loom large as you begin a serious study of the subject, so I will do my best to answer them as briefly and as simply as I can right at the outset of your training.

Let us begin by attempting a one sentence definition of Kabbalah.

Kabbalah is a philosophical-mathematical-geometric system that describes the creation and operation of the universe through four dimensions by employing a schematic design containing ten spheres of descending emanation connected by twenty-two paths attributed to letters of the alphabet and their numerical equivalents.

This is a starting point but not much better than giving weight, height and color as the definition for an elephant. Essential to understanding kabbalah is the concept of *Ain Soph*, "The Limitless Nothing" that contracts into itself and produces the *Ain Soph Aur*, "The Limitless Light", which then expands to produce The Universe and continues to enliven and to ensoul it. This conception predates modern physics' "Big Bang Theory" by a thousand years. It also puts Kabbalistic philosophy in a very controversial position in relation to orthodox Jewish

and Christian religion. At the highest level the kabbalist can conceive, God is not judgmental or in any way dissatisfied with His Creation. He simply *Is* and continues to *Be*. A contemporary popular analogy would be “The Force” in the Lucas STAR WARS films.

The Universe is therefore operated by lesser, more differentiated personifications such as Angels, Gods, Goddesses and Elemental Spirits. This idea was originally Neoplatonic (the philosophical high water mark of Classical Paganism) and can be explored further in the writings of the philosopher Plotinus and his followers.

We attribute all these lesser powers to the various Spheres and Paths of the Tree of Life structure described in our one sentence definition. We can then access them for knowledge or for help.

Thinking of it in a more subjective way, we might say that kabbalah is a spiritual-magical computer program for your mind. It interfaces the left and right hemispheres of the brain (a modern physiological reality originally theorized by the kabbalist, Issac Luria in the 16th century) and allows you to go on-line with “The Great Mainframe”. In other words, the *Microcosm* (you) accesses the *Macrocosm* (God).

Since its emergence in medieval southern France and Spain to the present era, kabbalah (especially magical kabbalah) has been studied and practiced by as many Gentiles as Jews.

In fifteenth century Europe a philosophical marriage took place that established the lineage of The Western Esoteric Tradition. Hebrew Kabbalah was united with Classical Paganism (Hermeticism). Hermetic philosophy had arisen in the second century of the Christian era as an attempt to preserve the ancient wisdom from the anti-intellectual onslaught of Christian zealots. It combined elements of Neoplatonic, Gnostic and Orphic teachings. When the Hermetic writings were rediscovered by Renaissance Europeans, magick was literally reborn. Hebrew Kabbalah, which shared many of the same original roots, was soon integrated into the Hermetic scheme to give it a necessary structure.

Humanist “Hermetic” philosophers enriched their magical art by including the Pagan Orphic Hymns to the Gods and drawing on the exotic *Arabian-Sabian*¹ planetary magical system (having origins in ancient Canaan and Babylon) to create an elegant synthesis. The Earth was declared a Goddess (the *Anima Mundi*). The deified Sun, Moon and planets were evoked both in the human body and in the heavens beyond. This obviously Pagan, capricious and amoral pantheon was balanced and regulated by Angelic counterparts retained from the Biblical system. However, in the Hermetic Kabbalah these Angels were thought of as the sentient messengers or special power-givers not of a “Biblical Jehovah” but of an omnipresent, omnipotent and non-judgmental “Force” that flowed throughout the universe. The famous Renaissance philosopher magician, Giordano Bruno, who was supposedly burned at the stake for supporting Copernicus’s heliocentric theory, was actually executed by the Inquisition not because he publicly declared that “Yes, the earth does revolve around the Sun” — but because he then insisted that “*the Sun is a God!*”

Kabbalah, in its earliest form, was probably derived from a synthesis of Pythagorean mathematical/geometric philosophy and Simonian (Samaritan) Gnosticism in first century Palestine and Alexandria. Its Palestinian roots are shrouded in myth but we can make an argument for a Pagan Samaritan origin.²

In its later Hermetic form the practical (magical) kabbalah is similar to *Tibetan Tantric Buddhism* in that elaborate visualizations of frankly Pagan godforms, angels and elemental spirits are encouraged. Judaic and Muslim religious tradition forbids this imagery, thus severely handicapping their forms of kabbalah.³ There is, however, one major difference between our Hermetic system and that of the tantrics: they contend that everything is *ultimately illusion* whereas we say that everything is *ultimately reality*. For this reason we place great emphasis on developing and balancing the four philosophical “Elements”: *Fire, Air, Water* and *Earth* (animated by “The Force” which we call “*Spirit*”).

In Hermetic-kabbalistic terms, these Four Elements are the manifestation of *The Tetragrammaton*, the four-fold Name of God. They are further personified by the Four Archangels of the Quarters with which you are already familiar.

The importance of these Four Magical Elements (which are also the Grail Hallows and the Tarot suits) cannot be overemphasized. I need not press my argument further than to refer the student to one of our major beginning texts, *Initiation into Hermetics* by Franz Bardon. This entire work is devoted to the mastery of these four principles.

Hermetic kabbalah also employs Angelic balancing forces as invoking and evoking formulas to call down and summon up its otherwise Pagan entities. There should be no disrespect or irreverence toward ancient deities in this process. It is the traditional source of the magician's power. The Arts of Theurgy and Thaumaturgy⁴ allow you to explore vast dream realms and discover lost treasures of spirit. One might say that the worshiping mystic waits on the whim of his god while the magician sets out to climb Mount Olympus. If you are a spiritual adventurer the respectful manipulation of these forces will be the appropriate method for you.

You now have a beginning idea of what Hermetic kabbalah is about but you may still wonder how it differs from traditional Jewish kabbalah.

It differs in three ways. First: Jewish kabbalah is primarily concerned with decoding the first five books of the Bible via the process of *Gematria* (each Hebrew letter has a number value; hence any other word adding up to the same value has a mystic relation or could be a coded substitution). Second: Jewish kabbalah (of the most esoteric *Lurianic* school) does postulate a non-judgmental god-force at the highest level but becomes highly moralistic in descending levels — and, Third: Jewish Kabbalah has nothing to do with the Tarot or any Pagan godforms on The Tree of Life.

By the eighteenth century the Jewish intellectual establishment had generally abandoned kabbalah as a “baleful influence” on their

culture — although, in recent years there has been a revival of interest in the subject in the Jewish community (especially in the in the nineteen sixties and seventies when the rabbis discovered that some of their brightest young people were attracted to esoteric Buddhism). This historical background is mentioned so that the reader will be aware that there are distinctly different conceptions and philosophies of kabbalah. There is no “Official Kabbalah”, there is only the kabbalah that is right for you.

We should also mention that our particular O.T.A. version of the Hermetic kabbalah uses *Phoenician Letters* instead of Hebrew (see *Figure 5.* and Phoenician Alphabet Appendix) and that we use a non-Judaic Tetragrammaton in lieu of YHVH. ⁵

Where does Jesus fit into all of this? Was there ever any such thing as a “Christian Kabbalah”?

There were some attempts at this during Renaissance but Christianity’s Doctrine of Faith is fundamentally opposed to the kabbalah’s Doctrine of Knowledge (Gnosis) and Christianity’s triune structure will not fit into the ten spheres of the *Otz Chiim* (Tree of Life) . If you are eclectic you can place Jesus in *Tiphareth* (along with Ba’al and Osiris) but you should be aware that this is not an elegant assignment because there are no other deities in any “Christian pantheon” whom you can then place in the other *Sephiroth*. The Apostles won’t fit and the Saints aren’t appropriate.

(Conversely, ancient Semitic Pagan deities fit so perfectly on The Tree that one might think that the kabbalah was secretly designed for their eventual return! Modern archaeological research by Prof. Simo Parpola, presented in his article *The Assyrian Tree of Life* from *The Journal of Near Eastern Studies* (1994), supports this view, establishing that the original ten sphere “Tree” was attributed to the Gods and Goddesses of ancient Mesopotamia -- which were nearly cognate with our Canaanite pantheon -- and which were imported into ancient Israel after the Assyrian conquest with the forced resettlement of the Samaritans. See *Note 2.* and see *Figure 5* on the following page. . .)

*The Phoenician Kabbalah
of the
Ordo Templi Astartes*

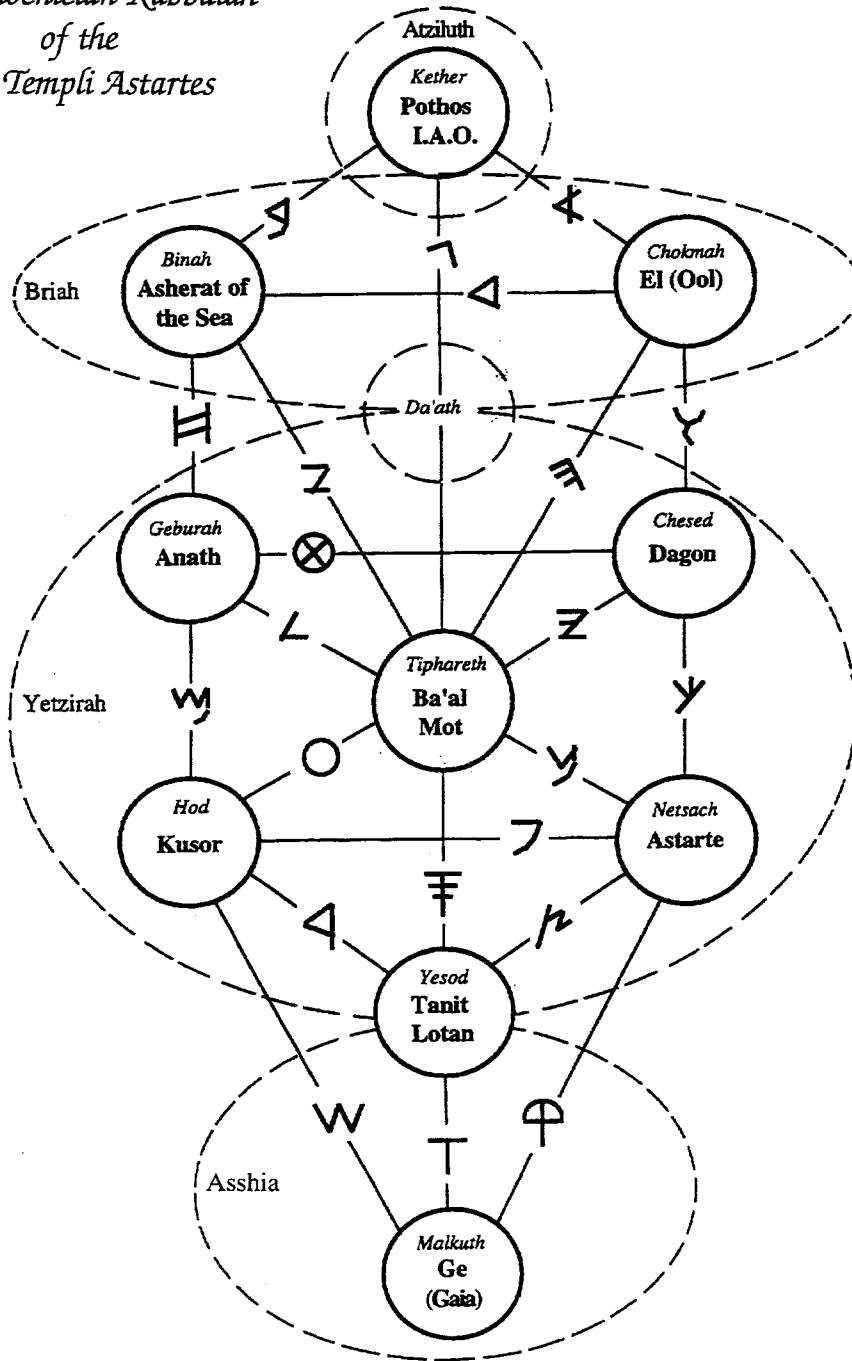

Figure 5. -- The Otz Chiim (Tree of Life) with the Phoenician alphabet and Godforms attributed to Paths and Spheres.

I feel that a person's relationship with Jesus should be a personal and private matter. We do not invoke Christ in our rituals because He does not fit into the Hermetic system. He would not be comfortable having to share importance with our ancient Gods and Goddesses or even the Angels that empower the Four Elements. If you consider Jesus to have been the chosen representative of God among Men, you should let Him stand alone.

At this juncture we need to explain how the kabbalah relates to our Goetia and Almadel systems. The best way to understand these relationships is to study the Tree of Life diagram (Figure 5.) and try to visualize the conceptions.

The Tree of Life (*Otz Chiim*) is a philosophical schematic of the universe as it was created and as it continues to function. The Tree has ten Spheres because we have ten fingers and our mathematics is based on the number ten. We separate The Tree into four descending *Olam*s or dimensions. (In an over-simplified way these dimensions can be thought of as levels of vibration or frequency, like UHF, VHF, etc.) At the top we have *Atziluth*, the World of Origins, which creates and contains the single *Sephera* of *Kether*. At this exalted level God is neither male or female and certainly not judgmental. This is "The Force" which empowers the mighty two-stroke engine of the next dimension, *Olam Briah*, the World of Archetypes and Archangels, where the Yin-Yang (the *Sephiroth* of *Chockmah* and *Binah*, male/positive-female/negative) revolves with impersonal, cyclical detachment, generating the myriad pre-forms of the *Olam Yetzirah*, the *Olam of Formation*, the so-called "Astral Plane". (This derives from Plato, who originated the idea of "The Original Idea"; the concept that there has to be an "ideal archetype" preceding every physical manifestation. The Neoplatonists then made these ideal forms dynamic through the theory of emanations.) These "pre-forms" become physically manifested in the final *Olam*, *Asshia*, which contains the single *Sephera* of *Malkuth*.

The Yetziratic dimension, wherein the magician does most of his or her work, comprises the *Sephiroth* from *Chesed* down to *Yesod*. Here we find the anthropomorphic and zoomorphic images of mythology. This is the Realm of the Gods that Carl Jung called “The Collective Unconscious” and here we will find the Genii of King Solomon’s Brass Vessel. . .

. . . Well, not exactly. . . The truth is that all of King Solomon’s Spirits are found in *the lowest Sephera of the Astral, the lunar sphere of Yesod*. This is the case even though they are attributed to all the planets from Mercury (Hod) on up to Saturn (Binah).

We have what appears to be a paradox as a result of trying to explain Kabbalah in one short chapter. The Tree of Life design serves different functions. In the description above (and on Fig. 5) we use the Four Olam Division on one single Tree to show the process of creation. Be aware, however, that *each of the Four Dimensions operate throughout the whole Tree and each Sephera contains its own complete Tree*. We find all of Solomon’s Genii in the various planetary spheres of Yesod because Yesod is gateway to the Astral, the sphere of memory and the sphere of The Dark Mirror.

If this sounds confusing, try to visualize it this way: The Moon is the planetary sphere closest to the Earth (in kabbalistic terms, Yesod is the sephira closest to Malkuth). The outer planets and the sun are reflected down through it. Coming up from below, it is our port of entry into the subconscious emotional Astral Plane (Olam Yetzirah). Thus the lunar ‘mirror and memory aspects’ of Yesod are very appropriate because the Goetia spirits are, in a psychological sense, *all reflections of different aspects of yourself* extended out in a flat circle on this primal, emotional level.

“*Observe the Moon in all thy workings*” the Lemegeton declares.

Given the above, your next question should be which Archangels control these Goetia Spirits? Obviously Gabriel rules Yesod and should be invoked in a Greater (lunar-planetary)

Septagram Ritual preceding every Goetic operation. Remember, the 72 Spirits of the Brass Vessel are *not an ascending hierarchy* and neither are the four Archangels of the Quarters and the 72 Angels of the *Shemhamphorash* ⁶ who control the 72 Goetic spirits. They are all in a flat circular pattern following the signs of the zodiac (see the Master Mandala).

You may note another apparent paradox with the four Archangels of the Quarters and the Elements also doubling as four of the seven planetary Archangels. Kabbalistic hair-splitters will tell you they are actually different beings with the same names. You may find it necessary, at a certain stage of your development, to go along with this. Eventually you will internalize the Archangels as principles (e. g., Raphael personifies the illuminating Sun in the Eastern Quadrant and the life-giving properties of the Air). Recall my *Metatron-H.G.A.-Sandalphon* angelic Totem Pole. These angels are not attributed to the planets in any context.

Once you have raised such ancient deities as Ba'al, Astarte, Amon-Ra or Horus through their Goetia forms via the Lunar Gate, you may certainly seek them in their higher spheres under their original titles in proper planetary operations. (The *Picatrix* provides an excellent resource for such advanced workings.) Remember, the ancient Gods and Goddesses are capricious, like the forces of nature they represent. Balance your work carefully.

Considering the above the thoughtful student might ask if Hermetic-kabbalistic magick is an amoral system?

It is not possible to give a quick and simple "No" answer to this question. One reason is that there is nothing quick and simple about kabbalah. Another reason is that without certain philosophical principles such as reincarnation, the Law of Karma and the belief that spiritual evolvment requires one to transcend personal ego and find compassion for all humankind, Hermetic kabbalah could be seriously misused.

For this reason we follow the example of Hermes Trismegistus and keep the teachings as a prize to be won by seekers after wisdom, not a gospel to be preached to multitudes. (So, if you find this chapter a little difficult to understand, without parallel reading, you should realize that we are following that principle — and you will be encouraged to study the recommended texts.)

If this brief theoretical explanation raises as many questions as it answers, we are at least off to a good start. . . Now let's take a quick look at the practical kabbalistic aspects of a Goetic operation: —

After opening the Lunar Gate (Yesod) with a *Planetary Septagram Ritual*, during which you will internally expand *The Tree of Life in Yesod* (located in the genital chakra) to displace and overlay the other psychic centers in your body (see Chapter Nine, Figure 7.), you will then circumambulate your magick circle deosil as many turns as the number of the Sephira you are working (e. g., seven times for the Sphere of Netzach). Likewise, in a Yesod-Netsach operation you would use green candles and burn sandalwood incense. The Names of Power that you plug into your standard conjuration are drawn from The Master Mandala and the 777 references to the Sphere of your working. You will also use the proper planetary metal (or an affordable facsimile) for the spirit's lamens worn by the receiver.

As you can see, there is psycho-technical structure to Solomon's Magick that is definitely kabbalistic. This does not mean that you have to master all the theoretical principles and practical methods of this venerable philosophy before you venture into wizardry. The fact is you will *never* master it all. One of the more important things you will learn from the study of kabbalah and the practice of magick is the vast extent of what *you really do not know*. The more you study and practice the greater, deeper and further this unknowing extends. Remember this when someone tries to tell you how much they 'know' or how much 'you do not know' about kabbalah. ⁷.

Chapter Five/Notes:

1. This little-known Pagan Sabian connection is vitally important in the history of Western Magick. The Harranian scheme of planetary correspondences reached the European magi through the medieval Arabic grimoire, *Picatrix*, which has not yet been completely translated in English. In the O.T.A. we use a private translation of the Sabian Planetary Prayers made by the Master of our East Coast Temple, Frater Sabezius, who has specialized in this ancient Pagan school of magick.
2. The possibility of a Samaritan origin for the Kabbalah has been carefully side-stepped by Jewish writers. The Samaritans were Babylonian Pagans who were resettled in Israel by the Assyrians after their conquest of Palestine in 721 B.C. From that time on through to the Christian era they practiced a mixture of Pagan and Jewish religious traditions that was more magical than orthodox Judaism. They may have originated the concept of Gematria (see Wallis Budge's *AMULETS AND TALISMANS*). One of the great progenitors of our Hermetic tradition, the Gnostic magician Simon Magus, was a Samaritan. The Samaritan 22 letter alphabet is directly analogous to Hebrew and, like the earlier Phoenician characters, is a good choice for Hermetic Pagan magicians who prefer not to use Hebrew.
3. Muslim kabbalah is called *Abjad* after the first five letters of the Arabic alphabet.
4. As Issac Bonewitz pointed out during our 1974 presentation on NBC's *Tom Snyder Show*, *Theurgy* means "Divine Working" whereas *Thaumaturgy* translates as "Miracle Working". From this we can deduce that the expression "Goetic Theurgy" is actually a contradiction in terms.
5. YHVH means "I Am What I Am". It is an anagram for some thing unknown like U.F.O. or V.I.P. Regardless of this ambiguous symbolism it has very strong religious connotations. If you are Jewish or an Old Testament oriented Christian, you should probably continue to use it. Modern Hermetic Pagans may find AMShO — derived from the Three Mother Letters of the *Sepher Yetzirah*, plus Omega — less "Biblical" in the negative sense (even Hebrew kabbalists conceded that their alphabet needed another letter). However, if you don't want to add another letter to the Phoenician or Samaritan alphabet for the Earth Element, you might also consider my ShMAT

Notes continued on next page. . .

Chapter Five/Notes continued:

(*Sha Mah Ah Tah*) formula. Shin (Fire/Atziluth) Mem (Water/Briah) Aleph (Yetzirah/Air) Tau (Saturn-Earth-Malkuth). These three Tetragrammaton arrangements should be studied in relation to the *Sepher Yetzirah* in any case. Even if you do not agree with the new Hermetic forms you are sure to profit from a serious study in preparation to challenge them.

6. The *Shemhamphorash* (extended name of God) that is used in our Master Mandalla is the version derived from the 72 word verses in Exodus, not from the permutation of YHVH via the Tetrakis referred to in my kabbalah research paper included in Appendix 4.
7. A venerable kabbalist once said that: "God is ineffable and everything else is man's cleverness". Another equally venerable sage commented that: "Women have babies and men have kabbalah!"

*The number is Ten — for the fingers
Of Adam Kadmon. . .
Only because the First Man counted thus
And made it so!
It reduces to nothing — and expands
To infinity
Without thy calculations.*

from The Book of Astarte by Thabion

Chapter Six: The Architecture of our Magical System

I OFFER AN APOLOGY for some of the complexities we must deal with in this chapter. Please bear with me and look closely as we lift the veil to examine the inner workings of our magical system. It is important that you understand these concepts because I have made some radical innovations to rectify and improve traditional forms. You need to understand these modifications and the reasons for them because our system differs from several others that you may become familiar with as you learn more about magick.

In line with the above, one of the major shortcomings in modern occultism is a remarkable lack of original thinking on any intellectual level above a practical understanding of the mechanics of 16th to 19th century rituals — which are endlessly re-hashed until, in some

cases, an actual degenerative process sets in. An example in point is the present large-scale misuse of Regardie's Watchtower Opening. For many years Francis Regardie had let it be known that he had developed a ritual to open the four Enochian Elemental Tablets and the Tablet of Union for Temple working. He finally got a chance to publish the rite in 1980 but the publisher suggested that, for marketing purposes, the book should be presented as introductory. Of course it was anything but introductory.

In order to make the procedure accessible to beginning students, Regardie suggested they might use the sigils on the tops of the Tablets rather than put off performing the rite until they had a full set of boards constructed — even though they were certainly expected to visualize The Tablets as being “in place.” After Regardie's death his simplified substitution was inappropriately reduced to the use of generic elemental symbols (e.g., Δ = Fire) at the quarters. We ended up with an exclusively Enochian procedure to open Enochian Watchtowers which were neither present nor even understood to be activated on the astral. This ritual is now being offered by its proponents as a “Basic Temple Opening” for all Hermetic operations. This is acceptable only under the agreed upon condition that the ultimate architecture of the Spiritual Universe is Enochian. *Of course it can be if the student chooses to accept it* but he or she deserves the opportunity to make that choice at a point in the curriculum where the philosophical implications are understood. This is especially true for practitioners who are not Thelemites (followers of Aleister Crowley) or advanced students of the Golden Dawn. As the French have learned, it is not prudent to serve wine to children.¹

I have dealt with this Enochian issue at some length above in order to make a point: the Almadel/Goetia system is *not* Enochian. Granted that Thomas Rudd, and later Aleister Crowley, both made attempts to integrate the two systems — but they did not succeed. I would strongly advise students not to mix Almadel/Goetia with Enochian until you feel you are ready to pick up where Rudd and

Crowley left off, realizing that you would be undertaking a project that daunted two of the most brilliant magical scholars of the last 300 years.

With the Enochian question thus temporarily put by, let us proceed to the basic architecture of the Almadel and Goetia systems as they have come down to us and as they have been interpreted in modern times. First, the Almadel: —

The Almadel Angels are not arranged in a descending hierarchy but rather attributed to *the four elemental signs of the zodiac* — which represent the true quarters (or Watchtowers if you will) of The Universe. The original Almadel attributes five Angels to each “Altitude” (i.e., three signs of the same element). The number five in this case is either erroneous, arbitrary or based on Agrippa’s numerology, and the names of the Angels are hopelessly garbled. One literally has to dismantle and reconstruct the system to make it work the way I believe it was originally intended to function.

Instead of five Angels per “Altitude”, we fall back on the Traditional Directional/Elemental Guardians of the Four Quarters: *Raphael, Michael, Gabriel* and *Auriel*. Each of these Great Heads then direct three sets of six Shemhamephorash Angels — the 72 direct counterparts of the Goetia Spirits who are, appropriately enough, governed by Four Kings attributed to the same Four Quarters. The final proof of the system’s validity is in its elegance. If the Almadel was not originally conceived this way, *it certainly should have been*.

Now to the Goetia: — The first thing we have to deal with in considering where and how to arrange our 72 Spirits is the Art/Science of Astrology. Here we basically have two choices, Tropical or Sidereal. We can start our series off at 0° Aries (as we and most others have done with the Goetia ²·) and forget any precise celestial positioning, or we can anchor our circle of Spirits at 0° Leo, following the Golden Dawn system, forever fixing them in the heavens. This is what the Golden Dawn did with its version of the Shemhamephorash Angels.

Either system is valid. You can also *have it both ways* if you feel, as one of my respected colleagues does, that adherence to Golden Dawn and Thelemic traditions demand the astrological compromise — just so long as you understand what that compromise involves. . .³

If your Spirits start at 0° Aries and your Shemhamephorash Angels start at 0° Leo, they simply will not match up. The Angels are fixed and the Spirits are sliding backwards. The reason why the Golden Dawn left us with this unresolved problem was simply that they considered the Shemhamephorash Angels as part of their official (Sidereal) system but consigned the Goetia Spirits to an unofficial sub-system which they did not incorporate. This is why the Goetia Demons are left in their Tropical sequence. It is also the reason why the G.D., and later Crowley, never corrected the cumbersome and poorly justified “Day and Night Demon” arrangement listed in 777. This scheme treats each 10° Decan as a 24 hour period (?) in an attempt to untangle the ponderous and garbled instructions in the Goetia. These directions seem to derive from Planetary Hours, the Mansions of the Moon and Agrippa’s numerological superstitions about “good and bad numbers”. If the logic behind all this escapes you, you are not alone. Nobody else has been able to figure it out. ⁴ Just remember this: because all Goetia Spirits are “Fallen Angels”, they reside *in the lower astral or Lunar Sphere* (Yesod). They are one ring of an onion with the Shemhamephorash in another ring beyond them. It is best to summon them during a waxing moon because of the moon’s influence on emotions (remember the astral plane is also the emotional plane), otherwise you can contact *any one them any time you wish*.

In line with the above I have taken the liberty to start our Shemhamephorash Angels off at 0° Aries, *linking them directly with our Goetia Spirits* — But we also use MacGregor Mathers’ sigils which the G.D. employed in their Sidereal sequence. How do we justify this? Very easily: Mathers claimed that he got the sigils from “The Great Magician, Blaise Vignaire.” Now if anybody could prove that

Blaise Viginair started his Shemhamphorash off at 0° Leo we might have a problem — but, like the traditional Goetia, the chances are overwhelming that they were originally fixed on 0° Aries.

We have made one switch in the Sloane 2731 Goetia Spirit number sequence. Astaroth # 29 (Astarte) has changed places with Stolas # 36. This has been done for symbolic and philosophical reasons which should become apparent when looking at our Master Mandala. You will note that this assignment puts *The Queen of Heaven* (Astarte) at *The Autumn Equinox Point* directly opposite *The Prince of Earth* (Ba'al) at *Vernal Equinox* and places Her under the aegis of Auriel, in the Sign of Virgo, The Harvest Maiden (Zodiacal Icon of The Goddess) and also locates Her in the Decan of ♀ (Venus).

Along with this you may also note that Ba'al (Bael) heads the list at 0° ♈ (Aries), a fire sign under King Göap, whereas the Goetia calls him “a King ruling in The East”, thus placing him under Amaymon. In the video I conjured him under Amaymon because the sequence was a re-creation of my first operation. Actually he comes through stronger in the Southern Quarter under Michael and Göap in the Decan of ♂ (Mars).

At this point a perceptive Golden Dawn student will realize that our main reason for keeping the system in its tropical form rather than rectifying in the sidereal mode is this frankly religious seasonal equinox factor mentioned above. If you understand everything we have discussed in this chapter and you feel you would rather have a mandala with all spirits and angels anchored on 0° ♌ (Leo), please be encouraged to construct one — as one of my G.D. colleagues is already in the process of doing at this writing.

From a philosophical point of view the preceding technical dissertation serves mainly to prove the implicit converse of the Hermetic axiom, *As Above, So Below*. It is true that the Western magician — who considers everything, imagined or envisioned to be real — needs a fully integrated magical universe that extends infinitely in all direc-

tions (the Tree of Life and the Cube of Space), whereas my Tibetan teachers, who considered everything to be illusion, could handle several technically contradictory systems so long as they were philosophically harmonious.

So, am I imposing an Eastern perspective onto Western magick with the unique synthesis of the Master Mandala?

In one sense I am and in another I am not. When faced with the problem of standing an egg on end, the anecdotal Columbus did not declare the egg to be an illusion that could be imagined in any position desired, he just picked the egg up and *cracked the end* so it would stand up by itself. This is basically what I have done with the Goetia/Almadel and some other barnacle encrusted aspects of our Western Tradition.

To present another example, wouldn't it be nice if we had a real Western psychic center (chakra) system? *Straighten out the Lightning Flash (Flaming Sword) on the Tree of Life and you have one!* (See *The Hermetic Caduceus* and our *Septagram Ritual* in this book and also my demonstration in the video.)

Tibetans and the Rosicrucians are both right! Everything is real and nothing is true — and every combination of this sentence is valid and not valid. E.g., Nothing is real and everything is true or everything is true and nothing is real. The only real (or true) difference between Tibetans and Western magicians is that we play our game on a much bigger chess board and often find ourselves checkmated behind our own pieces before we ever reach the end-game stage. This handicap is most often caused by our superstitious reluctance to sweep out the errors and contradictions accumulated over the centuries and reprogram our universal sending and receiving apparatus according to basic Hermetic philosophical principles.

Therefore, if we need to be formal about it, let us call The Master Mandala an example of a *Subjective Radial Spiritus Theory* based on the following argument: The human mind inherits a variety of internal regulating systems subject to external influences, e.g., the

biological clock, the lunar menstrual cycle and the innate structure for language grammar.

Exterior operative systems may also be imposed upon it much like the computer programming process, e.g., musical, linguistic, artistic, athletic and mathematical disciplines. Such new systems are acceptable to the mind because they are themselves mental constructs that can be understood and implemented by other minds. There is and must always be a structuralism involved in this process. The mind generates structures and systems, such as hierarchies, emanations, progressions and permutations because it (the mind) emulates the greater universe which it continually observes *and even creates*.

Chaos is inevitable *but the mind and the universe will always revert to structure, seeking out the simplest, most efficient and elegant operative procedure for perception and cognition even if such constructs are arbitrarily perceived and imposed*. A bumble bee cannot fly and the internal combustion engine should not work as well as it does — but both function excellently because the Greater Universe and the Human Mind desire that they do.

You are at the Center of your Magical Universe. Envision The Master Mandala as a compass card floating in the binnacle of your skull (The Brass Vessel!). Remember, the spirits of the Lunar Sphere (Yesod) surround your personal horizon. You are the Navigator of the Inner Planes.

Before René Decarte's separation of subjective and objective perceptions became dogma Hermetic magi artfully constructed new spiritual models of the cosmos that could be accepted and operated through the mental structuring process described above. Given the "As Above, So Below" maxim, such constructs, if philosophically consistent, were entirely functional. An example of such an operative magical universe would be the Enochian system of Dr Dee and Edward Kelley. Enochian magick, like Athena, sprang full-armed from the brow of Zeus, whereas the older, and to this day more widely used,

Goetia system was recopied by inept scribes, bowdlerized and distorted until it became a hodgepodge of contradictory instructions and arbitrary assignments.

But I could not help thinking that the Goetia was once as elegantly and philosophically constructed as Dee and Kelley's system. With that in mind, and my awareness of the sadly disorganized entourage that has come down to us, I did what any Renaissance magus worth his salt would have done: I consulted the Demon Kings of the Quadrants themselves -- King Göap, of the Southern Fire Quadrant, cut the Gordian knot straight away: ". . . *A magician should rearrange the order of his spirits so that those with the same or similar elemental characteristics come under the rulership of the signs appropriate to their nature.*"

Well, what could be simpler than that?

He went on to explain that this was what was actually meant by sealing the rebellious spirits in the Vessel of Brass.

This operation opened a floodgate of understanding. I went quickly to Bardon's INITIATION INTO HERMETICS and reviewed the classical characteristics of Hermetic Elements, and then I returned to THE GOETIA armed with a clear vision of what was needed. In a surprisingly short time I had all 72 sorted out into four sets of 18 spirits, each attributed to one of the four primal elements, astrological triplicities and directional quadrants. I continued the process and assigned each spirit to a specific astrological sign. Taking the final step, I then matched, and in some cases changed, the planetary ranks (Marquis = ☉) to agree with the planets ruling the decans. Following the planetary attributes of the decans, this produced a balanced system of six solar spirits, six lunar spirits and twelve spirits for each of the five planets, all corresponding exactly to traditional astrology.

What has re-emerged here is the system as I believe it was originally constructed. However, because this was an intensely personal process and because it required so many radical changes in what has

become a traditional order, I have listed my rectified arrangement only to the extent of the four elemental attributes (see Appendix 1.).

You may wish to go through this rectification process and develop your own special order. Göap and I both believe that this should be the work of each individual Goetia/Almadel magician. Thus we are leaving the Master Mandala in its first stage of rectification but be aware that as such it is a “rough ashlar” that obviously needs perfecting. When you have taken your Mandala to the third stage of rectification, you may call yourself a Goetia/Almadel Master. So now you have your work cut out for you. Good Magick!

In the spirit of Renaissance Hermeticism we have thus rectified the Goetia, integrated it with an equally rectified Almadel and Shemhamphorash, to produce a complete and balanced system of practice. As long as you understand that the Angels and the Spirits communicate with you *through your mind*, you will have no difficulty making contact with them, and they will find it easier to get through to you, using this system.

Chapter Six/Notes:

-
1. Before accepting the Enochian system as the architecture of one's personal magical universe I would suggest reading and thoughtfully meditating upon Don Tyson's article, THE ENOCHIAN APOCALYPSE in the Summer 1996 issue of GNOSIS. I do not agree with Tyson that working Enochian could in any way precipitate *The Apocalypse* on a macrocosmic scale but an obsession with Enochian might be likened to the opening of *Pinhead's Puzzle Box* in your own microcosmic universe.
 2. In their 1975 book *The Sword and the Serpent*, Melita Denning and Osborne Phillips published four pages of hand written notes purporting to be a Goetia arrangement. This sequence starts in the first odd numbered quinance (5^o division or one half of a decan) of Leo (as per the Golden Dawn Sideral system) and continues through the Spirit list in odd numbered slots, then starts over again with the even numbered sequence *but in Aries rather than Leo!* If you find this confusing you are in good company. However, in examining the *Arum*

Notes continued on next page. . .

Chapter Six/Notes continued . . .

Solis tables one gets the impression that this was an attempt to develop something that never quite came off and should have remained unpublished.

3. In this case I'm referring to THE TAROT OF CEREMONIAL MAGIC by Lon & Constance DuQuette (from U.S. Games) along with its accompanying book by Lon DuQuette (from Samuel Weiser). This is a very valuable package and highly recommended as the authoritative (Thelemic & G.D.) traditional alternative to my radical innovations. The DuQuettes do not use our optical mirror/facial distortion method in Goetia operations but they have considerable respect for it. If you are going to be a Goetia/Almadel magician you should certainly study their work along with Frater Hymenaeus Beta's excellent 2nd edition of Crowley's 1904 GOETIA (also from Weiser).
3. Ours is not the first published rectification of the Goetia on a straight quinance sequence. In 1988 Llewellyn offered a Goetia "divination" card deck, and accompanying book, both created by Priscilla Schwei. In spite of its obvious attempt to trivialize and commercialize a ceremonial system the Schwei book and card set represents a genuine effort to reconstruct the Goetia along astrological lines. She properly rejected the 777 day and night demon arrangement in favor of a straight progression and then correctly divided the 72 Spirits into astrological quaternaries. However, she did not attribute her Quarter divisions to the traditional Kings and Archangels but rather to the Heavenly Orders from which some of the spirits claimed to have fallen. Only four out of the 15 citing such a heavenly origin matched up in her arrangement. This idea was philosophically flawed in any case and resulted in a moral discrepancy. Because of the heavenly origin of all these "Fallen Angels" (whom she had earlier stated were of ancient Egyptian origin), they were supposed to be able to police themselves and would not permit the operator to engage in black magick. If Schwei had published the traditional descriptions of the spirits (especially those who cause running sores crawling with worms) I doubt that anyone could have taken this idea seriously.
4. Trying to find some logical order in the descriptions of the Goetia spirits from MS 2731 can be an exhaustive and exasperating task. No matter how one arranges the existing sequence, the ones who are supposed to appear in Sagittarius do not and one who is supposed to be under Amaymon cannot be shifted to that quarter without displacing two of his minions who are

Notes continued on next page . . .

Chapter Six/ Notes continued:

already there. The spirits cannot be aligned by the planetary attributes of the decans because different planetary ranks (e.g., Dukes = ♀) are not equally distributed among them. And yet there is a definite intimation of an original order — based (as Göap and I theorized and then reconstructed) on the planetary attributes of the astrological signs, i.e. all Dukes (Venusian spirits) would be attributed to Earth and Air Signs. There is plenty of room for more research and rectification. Those who wish to dig into this further might also get in touch with “Artemidorus” and request his interesting paper on the subject. — P.O. Box 14941, Long Beach, CA 90814

*By the Alchemy of Calcination,
Darkness, Fear and Woe Begone !
We Light this Fire of Purification
In the Mystic Name of Sol-Om-On !*

*from 'The Ordo Templi Astartes'
Summer Solstice Ritual by Thabion*

*This Chapter is an edited version of an editorial from
The Seventh Ray, Vol. II, Number 4, (Whole number 8)
Winter Solstice, 1973.*

Chapter Seven: The Ba'al-Astarte Mythos

WHETHER OR NOT KING SOLOMON ever studied and practiced the Art of Ceremonial Magick is not a crucial question. Of greater importance are the philosophical-psychological principles behind the legend of the Monarch-Magus who bound the "Two-and-Seventy Rebellious Spirits" in the Vessel of Brass. The multi-level implications of this Arabian folk-tale (with its Biblical origins) — which was a major operative cosmology behind medieval ceremonial magick before the rise (or descent) of the perverted 'Faustian School' — should be fascinating to Jungian and even Freudian psychologists. From a kabbalistic standpoint, the *seventy-two* spirits of the traditional Goetia are a significant corollary to the *seventy-two* letters of the extended Name of God, the SHEMHAMEPHORASH, from which the names of *seventy-two* Angels can be derived, implying an inseparable duality of 'good' and 'evil' throughout the entire celestial-infernal pantheon.

Considering this in light of the micro-macrocosm dogma, we are presented with the concept of seventy-two greater and lesser bipolar archetypes functioning in the collective and personal unconscious. The Brass Vessel — aside from its obvious ‘yoni’ symbolism— then represents the receptacle of the controlled and organized psyche. The rebellious spirits are summoned to appear by the power of Tetragrammaton ¹. (the ultimate cathexis), required to render service in accordance with their particular capabilities and then consigned to bondage in the ‘Brass Vessel’ where they can cause no harm and from whence they can be readily called upon when needed. The psychotherapeutic analogy in the above is inescapable. (We will discuss the philosophical symbolism of the Triangle of Art wherein such entities are commanded to appear in *The Documentary Appendix* .)

This then is the crux of the Solomonic system of magick: pride, passion, greed and hatred cannot be divorced from their intrinsic counterparts, humility, purity, charity and love. They can only be organized and controlled as essential factors of the balanced personality — a sophisticated internalized concept that seems paradoxical with the popular image of the robed and hooded demonologist intoning his “infernal conjurations”.

But why did the Arab Doctors attribute this system to Solomon and why do we, the foremost modern practitioners of it, call ourselves the *Order of the Temple Astarte* ? The answer to both questions can be found in the Bible. In *1st Kings, Chapter 11*, we read that Solomon followed *Ashtoreth* (the Goddess Astarte), “the abomination of the Sidonians.”

If we put the Biblical account in a broader perspective, we realize that the patriarchal Levite sect of Yahweh was in constant, bitter conflict with the Ba’al-Astarte cult of Canaan. Now it should be understood that the Religion of Moses was a sect derived from the same mythos as its rival.

Abraham, a Babylonian of Ur, had been blessed by Melchizedek the Canaanite King of Jerusalem and a priest of EL, “The Most High God (*Genesis, Chapter 14*) This same EL was the father of Ba’al and

Astarte. In Babylon EL was called ANU and was the father of Ishtar. Space does not permit us speculation on all the factors that aided the growth of the austere Religion of Yahweh but the hard, nomadic, ethnocentric life of the Hebrews was certainly one of the foremost. When this wandering branch of the *Amorite* people returned 'home' to Canaan they began the transition from pastoral tribesmen to agriculturalists and urbanites. Before the time of Saul and David, the religious battle lines were drawn. Joshua's attempted genocide of the Canaanites had not been successful and they still "abounded in the land".

The new farmers were naturally attracted to the nature-oriented intensification rituals of Ba'al, and their newly urbanized brethren were fascinated with the sensual glamour of Astarte's saturnalian rites. It was probably at this point that the first puritanical "blue laws" of orthodox Judaism appeared.

During the Empire of Solomon, the socioeconomic transition was complete but the religious conflict had not resulted in a synthesis. Instead we look back on two spiritually unbalanced cults fighting for supremacy. The transvestite priest of Astarte finding final exaltation in publicly castrating himself is hardly more odious than the Levite priest demanding a young woman be stoned to death for adultery or exacting a ruinous judgment from a poor farmer struggling to save his precious harvest by working on the Sabbath.

Was Solomon attempting, by his catholic example, to bring about a mellow fusion of these separate cults of EL's progeny into a pansemitic polymorphous monotheism similar to the Hindu religion of India? He may well have built the magnificent Temple at Jerusalem not only for the Levite Yahweh but for the universal overgod of all the Semites.² Why else would Hiram of Tyre, a Pagan Phoenician (as had been Melchizedek), "rejoice" and say "Blessed be the Lord" before assisting Solomon so readily? (*1st Kings, Chap. 5.*) Why is Solomon's greatest literary work, *The Song of Solomon* so pregnant with the symbols of The Goddess — and why did he construct conspicuous Temples to Her? Even the Levites conceded to the 'Wisdom of Solomon' but if the above conjecture is true, they hardly understood

how wise he really was. . . For in the Celestial Marriage of Ba'al and Astarte, ritually enacted by priest and priestess, we see a direct analogy to the Shiva-Shakti congress of the Tantric adepts, a Magical formula of considerable power even in this faithless modern age (see *Chapter Ten*). How much more awesome it must have been in times when the sanctified celebrants and their congregation believed utterly in the truth of Divine Possession?

One need only compare the *Great Rite* in its full ancient significance to the Transformation Miracle of the Paulian Mass (an indirect and passive assumption of god-form) to realize why the Art of Magick has been feared and suppressed for so many centuries in the West. A solar cult that castrates its god and transforms his bride into a "Virgin Mother" cannot compete magically with a virile and fertile Sol-Terra mythos. Even though the Paulians adapted Pagan festivals, embraced anthropomorphism and deified a vast pantheon of saints, their system has no direct, creative link with the deepest and most basic forces that energize Humans and Nature. Like the Levities, theirs is a religion of "Thou shalt not"— and high on the list of 'Thou shalt nots' is the practice of Magick.



We should perhaps digress to caution the casual reader against assuming from the above that the *Ordo Templi Astartes* is anti-Christian. We have the deepest respect for the teachings of the Master Jesus and we are only critical of Paul's interpretation of them. The *knowledgeable* may choose to renounce Jesus as a creation of Paul but the *wise* do not. Not only would such a renunciation be injurious to the personal egragore, it is historically unjustified; Jesus never claimed he was God and should not be blamed for the acts of those who posthumously deify him. A study of elementary Kabbalah will quickly resolve any difficulties in understanding this Rosicrucian view and lead the student to a full grasp of the significance of what the Master did say: "I am the son of Man." Further study and meditation may even lead to a revelation of the link between Jesus and Melchizedek— But to return to our subject . . . A convincing argument for the actual existence of a Solomonic proto Magical tradition such as we have described above, can be found in The Song of Solomon itself, wherein the mysterious "Shulamite" thrice declares: "I charge you, oh daughters of Jerusalem, stir not up nor awake my love, until he please." This Psalm may well be a hymn to the Queen of Heaven.

Perhaps it is the culture-memory of that *Magical Religion* Solomon tried to create that comes down to us in the ancient systems of thaumatergy and theurgy the Arabians attributed to him? The essential polymorphism of Magick with its rich pantheon of Phoenician, Babylonian and Egyptian entities as personalized male and female aspects of the Tetragrammaton — an all-pervading, transsexual life-force, moral only in its impersonal harmony — is a far more 'EL' ish conception than the paternal and patriarchal God of Moses.

It might be considered a cosmic joke that the great EL survived only as one of the many names attributed to His nomadic step-son and that His daughter, The Fair Astarte, was transformed into *Astaroth*, a male demon with bad breath! In the words of Khayyam (out of context) "Many a cup of this forbidden wine will drown the memory of that insolence."— and Solomon's Magick is indeed a forbidden wine. The Judeao-Paulian equation Sex = Evil = Sex was inculcated in

scripture not from the dread of a distant hell (the Hebrews did not even have a concept of hell) but from fear of the Cult of Astarte and the lure of its courtesans. As Wilhelm Reich theorized and the later Soviet social experiments proved, the power of authoritarianism depends largely on its ability to channel the sexual drives of its subjects. The ancient Pagan establishment maintained such control by sanctifying the sex act with its official priestesses, while the Hebrews, later the Paulians and finally the Communists decided to make a 'sin' out of it. Needless to say, both extremes are insults to freedom and dignity.

As a corollary to this sexual negation, the Hebrew (and later Muslim) prohibition against graven images, especially anthropomorphic ones, was not imposed from any desire to promote a concept of pure monotheism — as is usually supposed — but rather to restrict the practice of Magick which depends on such visual links to function effectively. As a pragmatic compromise, the Paulians dangled the anthropomorphic carrots of angelic and saintly icons before their Pagan converts. For this dubious reason, the so-called Christian Kabbalah was more Magical than its non—visual Hebrew antecedent — explaining its evolution into the 'Neo-Solomonic' system we practice today.

Romantically, we may speculate that this ancient religion of Solomon's may well have evolved in a manner that the sage old monarch intended. If he was the first Magus, he may have envisioned a secret tradition, sought only by the wise, which would perpetuate the truth he had discovered: that the spirit of Divine Providence within us has many faces: good and evil, male and female — all reflected in the multifaceted Jewel of the Microcosm, while in the Macrocosm they are ALL ONE. Perhaps he even understood the Arcanum of the Celestial Marriage with its ultimate formula: *In Your Temple You are One with The Gods!*

Chapter Seven, Notes next page . . .

1. We have adopted a more intrinsic universal Tetragrammaton, *Ah Mah Sha Oh* (Ω ש ה ז = 1141), which derives from the three Mother Letters of the ancient Semitic alphabet with Omega as the final 'Earth' character. Hebrew kabbalists were always aware that there was a "missing letter" in their alphabet (see Gershom Scholem's *ON THE KABBALAH & ITS SYMBOLISM*). This formula and its more conventional 22 letter alternative, *ShMAT* (שמאח = 741) (see *Sepher Sephiroth* in *The Equinox*. Crowley lists the formula but not in the most elegant arrangement) are discussed elsewhere in this volume.
2. The Bible history of this period was written by the Levites to favor Yahweh as *The One and Only True God*. Actually he was their *one-and-only tribal god*, whom they, like all bedouin tribes of that era, had carried with them in a sacred box. Idris Shah recounts that there were 360 of these "tribal gods" set up in a great circle inside *The Kabba* at Mecca in the days before Mohammed chucked them all out and dedicated the Temple to *Allah* (EL = Aleph Lamed, a prototype of Allah). We should also note that the ancient Semitic nobility dedicated themselves to higher divinities than the common people, thus Hiram of Tyre and Solomon could both have been devotees of EL — leading to cooperation in building a great central Temple that would have spiritually united their peoples. In line with this we should also recall that the ten northern ("Lost") tribes of Israel preferred "EL" over YHVH as their Most High God even after the conquest of Canaan. In this custom they were following the tradition of Melchizedek in the times before Moses. Christians should ponder the Bible passage in Hebrews: Ch. 6, v. 20 and ask themselves whose "God" they are worshiping?

*Is it not true that Theurgic Masters
From far Harran
Heirs of those who had passed the Golem Secret
To venerable Father Abram,
Those who yet worshipped
The Seven Wanderers of the Starry Vault;
Sabian Wizard-Lords of Zodiac and Magick!
Who were Sages to the Caliphs of Islam,
Did honor Hermes Trismegistus as Prophet
And preserve His teachings with their own Arcanum
At the Courts of Moorish Spain
In the years of the Holy Kabbalah
By the word of She who Blackens. . .*

from Cult of the Sangreal by Thabion

This Chapter is an edited version of an editorial that appeared in The Seventh Ray, Vol. VI, Number 2, (Whole number 19) Winter Solstice, 1977

Chapter Eight: Arabian Origins of Magick and Witchcraft

ALEISTER CROWLEY BEGAN his preface to Mathers' translation of *The Goetia* with a tantalizing reference to *The Arabian Nights*, setting it on a par with *The Bible* as a source of esoteric lore, but he offered no explanation for the comparison. In a subliminal sense we accept the Arabian Magician as the archetypal paragon of our Occult Tradition but if we were asked to name one historical example, few of us could. If asked to cite even one Arabian magical text, most of us, except the credulous believers in the fictitious "Necronomicon", would have to beg off. And yet the vision of the

Arabian Mage commanding the Jinn enslaved by King Solomon, persists undimmed in our mind's eye.

The historical reality behind this romantic image is an example of suppressed truth reasserting itself in legend and folklore. The fact is that much of European magick and witchcraft was developed from Arabian sources emanating from Moorish Spain before 1492 c.e. For a millennium clouds of smoke have been stirred up to obscure this essential truth by rabbis who did not want the origins of medieval kabbalah too closely examined, by imams and even Sufis who did not want the medieval Pagan cults of *Harran* and Morocco revived. A mixed bag of Christians, Theosophists and self-styled authorities on Nazi occultism continue to insist that Western magick is essentially a survival of Manichaeism.

A fresh wind of genuine scholarship, emanating from the University of London, has recently blown away this long-standing smoke screen. Frances Yates' (1964) inquiry into the origins of Renaissance Neoplatonism has pointed to the Hispano-Moorish *Picatrix* as a major source for the astrological Magick of the 15th century Magus, Marsilio Ficino. This revelation, along with J.B. Segal's (1963) study on the Sabian Planetary Cult of Harran, directed our attention back to Lynn Thorndike's (1923) monumental, *History of Magic and Experimental Science* wherein we discovered a wealth of information on Arabian Magical lore.

In the Terminal Essay following his translation of *Alf Layah Wa Laylah*, Burton describes 9th century Baghdad as the richest and noblest city in the world. Cinematic Sinbad fantasies hardly exaggerate its luxury and power. These were the times of the Great Caliphs and their fabulous Court Magicians. Mightiest of the Wizards of Old Baghdad was *Thebit ibn Korat*, the Sabian from Harran.

The Sabians were a mysterious race of celestial magicians who had lived in their ancestral city of Harran since before the time of Abraham. There they had perpetuated the astro-magical rituals of ancient *Sumer* and *Akkad*. To this arcanum they had added the *Book of Enoch* and the writings of Hermes Trismegistus. In the *Koran*, the Prophet had cited them as exempt from forced conversion to Islam and

so they were allowed to profess their Pagan philosophy while serving the Sultans as court astrologers and wizards. This is why the magick described in the Arabian Nights has such an obviously Pagan character.

The practice of attributing specific metals, perfumes, colors, jewels and geometric forms to the planets in magical rituals can be traced back to the Sabians. Although there was some interest among medieval Jews in astrology, the astrological planetary aspects of magick (and of the Practical Kabbalah) are Sabian.

Besides the great Sabian influence we should also consider the writings of the 9th century Islamic sage, *Alkindi* who authored a treatise called, *The Theory of Magick Art or Stellar Rays* which was the precursor of Ficino's "*Spiritus*" concept. The idea of man acting in synchronicity with the celestial pulse of a living universe goes back to Alkindi. The works of *Albumasar*, *Costa ben Luca* and *Rasis* should also be cited as major sources from which European magicians drew their inspirations.

In the area of sexual magick we should consider the *Beni Udhra* cult of sexual arousal without consummation: intended to raise enthusiasm which would be redirected into poetic inspiration. This practice spread from Baghdad to Spain and influenced the medieval European "Courts of Love" according to Walker (1970).

In the Kabbalistic perspective there is the question of language itself. Hebrew Kabbalistic gematria is based on a number-letter analog



which certainly triggers subconscious associations but Arabic Kabbalah (*Abjad*) is based on root word analogs which are more direct in their deep structure associations. As an example, Shah cites the consonantal root, *KHLD* in the Arabic word for “mole” as synonymous with six other words of philosophical significance. This is an intrinsic, unilateral system whereas Hebrew¹ depends on a bilateral relationship with mathematics (his math analog is profoundly important in its own right but the mathematical relationship also obtains in Arabic as well; e.g., the “Barbarous Names” of the grimoires are of Arabic or Gnostic origin and are actually number formulas in letter form).

Semitic Paganism manifesting in Moorish Spain also seems to have been a major source of what became European Witchcraft: a theory that Gerald Gardner himself lent support to in his novel, *High Magic's Aid* (1949). Idries Shah (1964) suggests that Witchcraft grew out of the cult and totem of the *Aniza* tribe, the word for goat (*Anz*) being cognate with Aniza. He also cites the use of an “Al-dhame” knife, meaning “blood-letter”. The Witches’ cross-quarterly festivals are noted as being identical with those in the Arabian calendar. The use of a datura-



based flying ointment — also cited by Michael Harner (1973) as central to European Witch-cult practice — is corroborated by Shah’s linguistic reconstructions. Arkon Daraul (1962) likewise attributes a Moorish-Spanish origin to European Witchcraft but he links it to a Moroccan Cult of the Double-Horned” (Which might be an outgrowth of the Aniza cult cited by Shah). Daraul also mentions an “Al-dhame” knife for self-sacrifice. Most importantly he credits the Horned Cult with a concept of reincarnation back into the same coven which is strikingly similar to Gardnerian eschatology. Widdershins circumambulation is shown to be originally Muslim and the worship of

“*El Aswad*”, the Black Man, is traced to the Moorish Horned Cult. Our space is too brief to permit a full exegesis of this material. Readers who find this Witchcraft theory disturbing are urged to read the sources before forming an opinion.



Finally, we should remember that the *Goetia* of the *Lemegeton* calls forth the Jinn from the Brass Vessel of King Solomon in accord with Arabian legends of magick.² Solomon’s Secret Seal, with which he stoppered the Jinn inside the vessel according to the *Goetia*, was the ancient Carthaginian *Tanitrum*, the Double-Horned Glyph of the North African Moon Goddess. This symbol surmounted by the *Sabian Planetary Septagram* is the Insignia of the *Ordo Templi Astartes* and should serve as a

continual reminder of our rich legacy from the Wizards of Old Baghdad and the Sorcerers of Morocco.

Chapter Eight/Notes:

1. The Hebrew of today, although derived from ancient roots, was reconstructed in medieval Spain on an Arabic grammar. Arabic was itself a reconstructed form of ancient *Aramaic* with six new letters added to match the Mansions of the Moon. Of the three major Western kabbalistic systems, Hebrew, Arabic and Greek, the latter is probably the oldest.

Notes continued on next page. . .

Chapter Eight/Notes continued. . .

2. The version of the Brass Vessel legend recounted in the *Lemegeton* comes from the *Talmud*, however the Talmudic source is quite possibly Arabian as this fascinating quote from Burton suggests: “. . . *“Baktanu’s” is the lord of three Moslem troops of the wandering Jinns which number a total of twelve bands and extend from Sind to Europe. The Jinns, Divs, Peris (“faries”) and other pre-Adamite creatures were governed by seventy-two Sultans all know as Sulayman . . .When he refused to bow before Adam he and his chiefs were eternally imprisoned.”* (Burton, Vol. III, p. 225 f.n.) Elsewhere in the Arabian Nights there are many references to Solomon sealing the Jinn in “brass bottles” with his “magick ring” and then casting them into the sea.

*... Conjunction is the Sublime Culmination of
The Yearly Alchemical Cycle
The further Operations of Alchemy —
From Coagulation to Projection
Are to be Perfected in the Microcosm
Of the Magician himself.*

*from the Pastophoris Initiation
of Crata Repoa by Thabion*

Chapter Nine: The Hermetic Caduceus

The original version of this monograph was published in THE SEVENTH RAY issue number 19, Winter Solstice, 1977. It has been revised and expanded for inclusion in THE BOOK OF SOLOMON'S MAGICK. This paper is an outline of a system that is more advanced than the Almadel/Goetia material but it is an integral part of ALL our operations and should therefore be introduced to beginning students. If you have trouble understanding it, consult Motoyama's THEORIES OF THE CHAKRAS and Ponce's KABBALAH.

ON THE SECOND OF DECEMBER, 1975 I had the kind of experience a Gnostic might have described as a revelation from "Higher Powers", although I prefer to think that my subconscious had tapped into that 'Intellect' of the Collective Unconscious which we call the *Sephira* of *Hod*. After months of speculative meditation on how to form the True Body of Light, I suddenly realized that the building of the Microcosmic Tree within the body was

more than a mere philosophical analogy. The inspiration came literally 'in a flash', the symbolic "Lightning Flash" that descends through the sephiroth of The Tree in numerical sequence from Kether down to *Malkuth*. (See *Figure 8*.)

With a mystical certainty I knew that the *Sephira* of *Tiphareth* was identical with the Chakra of *Anahata* in the Raja Yoga system. This was the key to bringing the Eastern and Western microcosmic mandalas together.

Even though I was the catalyst, I must credit Sor. Psyche (Lady Mara) with opening my chakras via the SS technique during Sor. Artemis' and my initiation into The Order of 1734 on the 4th of October, 1975. Fra. Dejuiti (Joe Wilson) deserves subsequent credit for rectifying the Names of Power of the classic Goetia conjuration in line with the Caduceus sequence (see the Planetary Septegram Ritual) — and we should not forget the historical precedent: the 17th century Hermetic philosopher, Johann Gitchel, who produced a mysterious drawing (see *Figure 6*.) showing the planets roughly in line with the chakra positions in kabbalistic order (Hall, 1916:1xxv).

Here again, as with our Goetia method, we may be experiencing a recovery as well as a new development. But the ultimate proof of the validity of the Hermetic Caduceus has been its successful use in-Lodge for twenty years. It may be a more profound contribution to the Western Occult Revival than our notable reconstruction of Goetia evocation. It was necessary to keep the secret only until the system proved itself — now it may be shared with other builders of The Temple Within.

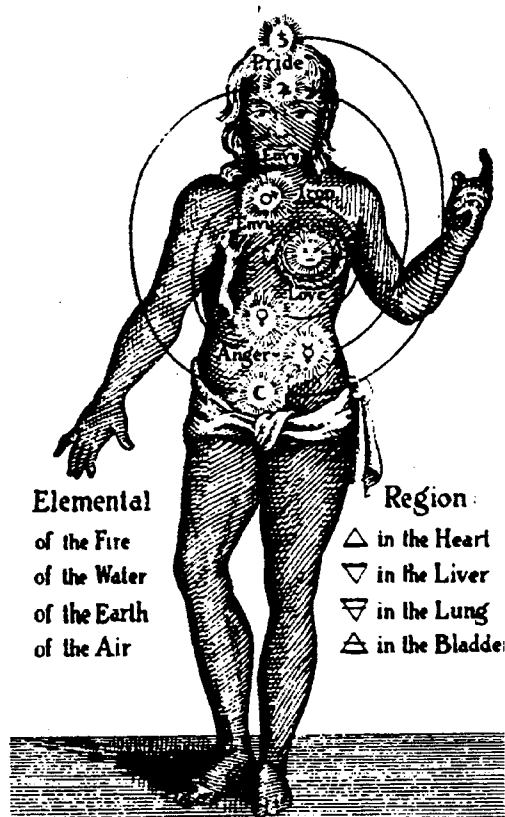

Figure 6.-- The Planets Within.

It has been suggested that Yoga was originated in the West by Pythagoras and then imported into India by Alexander (Iskandar) several hundred years before Patanjali wrote down the precepts in Sanskrit. The ancient Hermetic Caduceus represents the snake-like primary *Nadis* of the *Ida* and the *Pingala*, intertwined about the central channel of the *Sushumna* and crowned by the winged essence of liberated consciousness at *Sahasraram*. This striking similarity has been noted and pondered upon as long as Yoga has been known in the West (Woodroffe, 1919:21) .

There have been numerous attempts to align the sepheroth of the *Otz Chiim* (Tree of Life) with the *chakras* of the Yoga system. These efforts have always failed because their authors refused to consider the problem from a logical perspective, preferring instead to base their interpretations on literal readings of the Hindu and kabbalistic texts. In the traditional relation of the *Otz Chiim* to the *Adam Kadmon* (spiritual body) the sepheroth are arranged on three pillars instead of one, as on the *Sushumna* of the *chakras*. In medieval and renaissance iconography this led to the placement of the sepheroth on the shoulders, hips, etc. Occultists, respecting “tradition” above all else, have tended to perpetuate this naive conception even though all but the most credulous among them are aware that the *Otz Chiim* is not a structural diagram but rather a philosophical schematic.

Combining the three Pillars of The Tree into one central “*Sushumna*” was too simple and drastic for them to consider — even with The Lightning Flash or Sword of Wisdom staring them right in the face. In fairness to those G. D. adepts (mainly Regardie) who conceived “The Middle Pillar” exercise, no raising of the *Kundalini* was ever intended. Theirs was not an attempt to develop a Tantric Yoga of the West but rather a meditation on the Tree of Life in relation to the human body. It seems the 13th century kabbalist, Abraham Abulafia actually went further in our direction, combining breathing exercises, the chanting of Holy Names, the musical scale and color visualizations in his meditation practice (Scholem, 1974:180)

In developing — or if one prefers, recovering — the Psychic Centers of the West, certain priorities had to be met: first, the physical

points employed in the Raja system had to be matched along the spinal cord as a logical concession to centuries of successful practice in the East. In this respect the physiological control relationships as stated by Dr Mishra (1959:73-80) would be retained intact.

Second, the Heart Chakra, *Anahata*, had to correspond to *Tiphareth*, the strongest link between the two systems. And finally, most important of all, the Western system had to be philosophically consistent with the Holy Kabbalah. This was a tall order but the solution — as mentioned above — came ‘In a flash’; in point of fact, the “Lightning Flash” diagram that the G.D. used to show the descent of the Spirit down through each *Sephira*. The natural numerical sequence of The Tree solved the problem.

If *Tiphareth* (number 6) is anchored at *Anahata* in the chest, then *Geburah* (number 5) is at *Vishudda* in the throat, *Chesed* (number 4) is then at *Anja*, behind the Third Eye, and this places Da’ath, the boundary of the *Yetzirah* Astral dimension and gateway to the Abyss, in the center of the skull vault with *Binah*, the Supernal Mother connoting “Understanding”, (number 3) in the right cerebral hemisphere and *Chockmah*, the Supernal Father connoting “Wisdom”, (number 2) in the left half of the cerebellum where kabbalists had located them hundreds years before modern medical science confirmed their vision.

The ineffable originating source of Light and Power is *Kether* (number 1). *Kether* sends its Light down through the Tibetan-Tantric “Aperture of Brahman” (Evans-Wentz, 1935-267) depression in the top of the skull where the soul leaves the body. (One can easily locate this spot with the fingers.) Above this natural gateway lies *Kether* in the highest essentially Macrocosmic dimension of *Atziluth*, which may be compared to the thousand petalled lotus of *Sahasraram* in the Hindu system.

In descending order, *Netsach* (number 7) is at *Manipura* in the solar-plexus, *Hod* (number 8) is at *Svadhastana* below the navel, and *Yesod* (number 9) in the genitalia. Here we have another gateway between the *Olams* (dimensions), with the physical world of *Asshia* with its one *Sephira*, *Malkuth*, being linked to *Yesod* in the *Yetzirah* by the contact proximity of the asana position. Together, these two

sepheroth form a highly qualified analog to the Hindu conception of *Muladahara*. In this case kabbalistic philosophy must be served and the solution might even be considered elegant. (See Figure 7.)

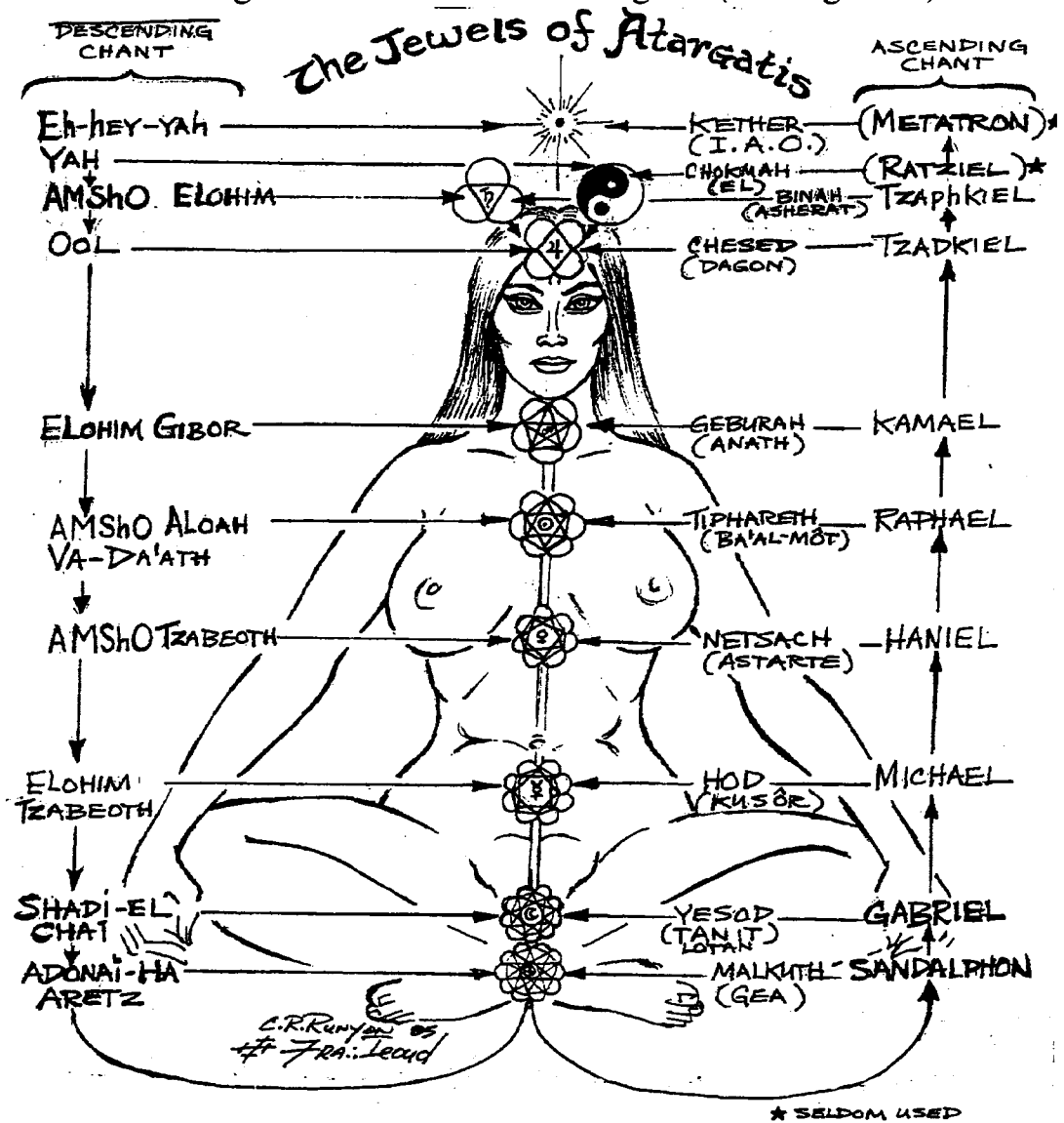

Figure 7. -- Author's rendering of The Ordo Templi Astartes' kabbalistic Psychic Center System .

Considering the above arrangement, it will be immediately obvious to the advanced student of kabbalah and yoga that certain correspondences of the Hindu chakras with the kabbalistic sepheroth, such as colors and elemental attributes are not always going to

match—and to this we say, '*vive La difference*' ! This is a Western System. These are Psychic Centers, not Chakras. They are to be envisioned as Jewels within the Mystic Rose rather than the Lotus and they are opened by our traditional God Names in *Atziluth* on the seven-note scale rather than by Sanskrit mantras. We frankly admit to a considerable degree of syncretism with Raja and Tantric Yoga; in fact we use their techniques whenever possible — but the determining symbolism and philosophy of the system is Western.

The Ida , the Pingala and the Sushumna are ours via the snakes and staff of Hermes' Caduceus, but what of the twenty-two paths connecting the sepheroth ? Should they be considered the secondary Nadis ? The answer to that must be no. It should be realized that the Paths of the Tree are subjective and arbitrary as to their placement in any pre-existing etheric sense. In the construction of the Body of Light Within they should be considered tasks to be accomplished, or astral initiations, via our preliminary pathworking system rather than increments of a completed system to be established inside the body.

Two other questions must be answered before we accept this system for practice. First, are the kabbalistic attributes of the sephiroth compatible with the characteristics of the Hindu chakras and does it matter if they are not? And, second, is the kabbalistic color scheme applicable to them? To answer the former we must say that the kabbalistic centers are remarkably similar but not identical. If this is a problem then consider that there are different chakra systems for every Tibetan deity and the Dervish orders, according to Idries Shah, consider the actual physical location of the *Lataif* (Sufic psychic centers) to be "theoretical" (Shah, 1964:332).

Secondly, Hindu symbolic colors applied to the chakras do not always match the colors skryed on the etheric plane by adepts. Of course our kabbalistic colors do not match either but this is to be expected. We are practicing magick, not passively observing psychic phenomenon. *Symbolic color is what we apply to the center to activate our effect*, not the actual color the center itself. If this is understood there should be no problem in working the system and reaping the tremendous benefits it affords. Now all the powerful subjective tantric

and even taoist techniques are open to us within the symbolic framework of our own system.

This building of the Body of Light, once perfected, will grant the third and crowning Power of the Magician: that of Soul Travel, both within and beyond the microcosm, and ultimately, consciousness survival on the Taoist principle of building a vehicle for the Soul. It is the true beginning of The Great Work.



Figure 8. -- The Lightning Flash or "Flaming Sword" that comes down through the *Sephiroth* of the *Tree of Life* (and through the Psychic Centers of the Hermetic Caduceus). The Archangels are *Sandalphon* and *Metatron*. From an *Isis-Osiris* Golden Dawn Temple Scroll rendered by the author.

*Ba'al: With this Golden Gift I wed Thee,
With this draught I plant my spark!
Nurture deep the Dew of Sunfire. . .
In Thy Vast and Vital Dark!*

*Astarte: With this Silver Cup of Mystery
From beyond the Veil of Night
Come I to take the Rainbow
In my Shrine of Hidden Light!*

Nuptiae, Vernal Equinox Rite by Thabion

Chapter Ten: Solomon's Sex Magick

A NUDE WOMAN LIES IN THE CENTER of the magick circle. The dim candle light casts a soft, glistening glow over her oiled body. Her head rests in the center of Solomon's Triangle while she stares upward into the depths of a great, dark mirror suspended from the ceiling. Her eyes are wide open and unblinking. She is in deep trance. Sitting close around her on both sides are darkly robed and hooded figures. Only their hands can be seen, the fingertips moving slowly up and down her body as they hum a droning overtone chant.

At her shoulder sits the Magus. While the others continue their rhythmic massage, in sync with the rising and falling hum of their voices, he delivers the conjuration: ". . . *We call Thee in the Name of All-Father Ool and in the Name of Thy Supernal Mother, Asherat-of-*

the-Sea and in the Name of Thy Royal Consort, Prince Ba'al the Thunderer — Come: be with us in this fair and human form. Come, oh Great Goddess Astarte ! “

The woman arches her naked body and languorously stretches like a waking cat. The blank stare in her eyes is replaced by an expression of dawning awareness which quickly becomes a look of omnipotent intelligence. She laughs and then speaks in voice not her own: “*I am here, my children. Why have you called me?*”

The operation I have just described is an advanced technique which we call Assumption of Goddess-form. It is actually more of a sensual magick operation than one of sex magick — but our *Hieros Gamos*

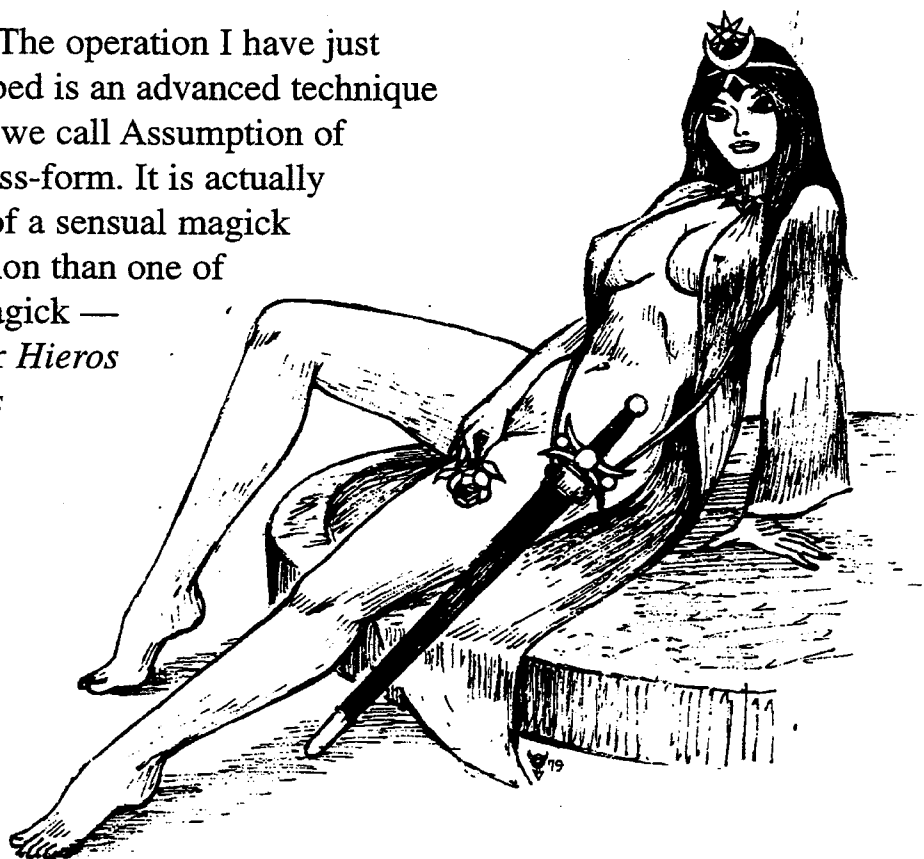

(Divine Congrex) uses this same tactile, Mesmeristic ¹. technique as a starting point so we will begin at the beginning.

First you should be aware that straight Assumption of Goddess (or God) form operations do not, or should not, involve direct sexual stimulation. The technique is more Mesmeristic than hypnotic and depends on directing energy flows up and down the body. If one of the massagers lets his or her fingers stray onto (or into) the receiver's erogenous zones, you will short-circuit the current. I vividly recall

having a grim, hand-clenching battle with a former student during an assumption operation to keep him from taking liberties with one of our lodge sisters who was deep in trance. Make certain that you all agree on the rules of conduct before you undertake this type of operation.

It is *absolutely essential* for your receiver to have successfully evoked the entity in a previous Goetia Contact Operation. The operator and the receiver should establish a comfortable rapport with the entity and request its safe cooperation before performing an assumption operation. Needless to say, certain entities should be *absolutely avoided* in this regard.

I can only recommend Astarte and Ba'al for this sort of work and even with these friendly beings I urge caution. (No one under eighteen years of age should be allowed to engage in any Goetia type operations, especially assumptions.)

You can use your Earth Pantacle mirror as an overhead speculum if you put three or four rings around the rim to hang it from. If you have a full sized temple, I would suggest a larger mirror. (We use a convex 21" diameter dark mirror mounted on a circular wooden frame which also works well for pathworkings and astral time travel.) Place the spirit's sigil on the mirror as you would in a regular Goetia operation. Be sure to have the receiver wear the spirit's lamen. Place three candles at the corners of the Triangle, acquire a bottle of scented massage oil (warm it to blood temperature) and you are ready to operate.

In other respects, straight assumption operations are similar to Goetia contacts. You must alter the conjuration to say: "Within this Circle and upon this Triangle. . . Speak to us through our receiver; bless her and harm her not!"

The receiver should not allow herself or himself to become fully possessed. When receiving in this type of working take an observer's seat somewhere in your mind and monitor the entity you are channeling. For the receiver an assumption should be the spiritual equivalent of a "method" actor's performance. Invite the entity in and allow yourself to "play the role" but always remember that this is Magick, not Voodoo. You are not a horse for the gods to ride, you are a host entertaining an honored guest. *Don't let it go further than that.* A competent magister will make sure that such operations are carefully planned

and properly performed with consenting, emotionally stable adults who know exactly what they are doing.

As we stated above, straight assumption operations are sensual but not sexual — and yet they are the starting point for the Hieros Gamos or what our Wiccan friends refer to as “The Great Rite”.

The Hieros Gamos is a Sacred Marriage, not an orgy. It is a very private and Holy Rite. It involves, or should involve, one man and one woman who have already established a deeply meaningful sexual relationship. Here again, do not use these methods for seduction because they are too complex, intense and subjective for people who don't already know and respect each other in the most intimate sense.

Before we get into operational details a brief review of western sex magick theory might be in order: — You remember Plato's idea of the original idea? Plotinus took it out of the abstract and hooked up an energy flow (the Star Wars “Force”) to “the idea”, giving us what is known in occult terminology as “an astral pre-form”. In other words all physical forms and events must be preceded by a pre-form in the Yetzirah (astral) dimension.

The entire active aspect of Magick involves creating and programming these astral pre-forms. There are several methods for doing this: creative visualization, ritual, talisman creation, etc. — but one of the most dynamic and effective techniques is to sexually create a *magical child* and program it to accomplish your desire. This method works on the old kabbalistic doctrine that every sex act, even masturbation, creates some sort of pre-form entity on the astral. Congrex between a man and a woman will therefore result in a magical offspring if no physical conception is accomplished. (This very ancient belief is one of the reasons behind the religious prohibition against having sex for fun. God creates *and so do you* — and the clergy doesn't want you to know it!) Therefore, if you and your partner decide you want to create a magical child, you first make a talisman to represent it and the purpose it's going to accomplish, then you have sex and impregnate the talisman with your combined effluvium. Nine days later you go through the same procedure again and re-impregnate the talisman. You then seal it up, forget it and let it perform its task.

I can relate from personal experience that this is one of the most powerful techniques in magick. It virtually has to work, even if you don't believe in it!

As described it is a simple, mechanical technique that will succeed to some degree no matter how basically you perform it — back before W.W. I, male German O.T.O. members often carried out the rite without their wives even being aware of it -- however, if you want to get the most out of the method, you will want to ritualize it the way the ancients did. In other words, you will enact the Hieros Gamos, or Sacred Marriage.

This Great Rite was usually performed by a high priest and high priestess or a king and queen at the beginning of the year to ensure prosperity for the land and the people. We symbolize it in our *Nuptiae* pageant at Vernal Equinox. The lines of poetry heading this chapter are from that rite and may be used as the only spoken words the manifested God and Goddess need recite to each other when coming together for their congress. The sacramental mead is poured from Ba'al's Golden Flagon into Astarte's Silver Goblet and then shared as a symbolic gesture of the physical consummation about to take place. However, you may wish to add the following statement of purpose: —

Astarte: What task shall the Child of our Union
 perform, oh my Lord?

Ba'al: Verily He shall (here state the task)
 In Good Time and Full Measure!

In ancient Babylon the Hieros Gamos was enacted on top of a ziggurat whereas in Canaan it was performed on a hilltop or in the inner "Holy of Holies" chamber of the Temple. Here again the procedure is straight forward and simple. The priestess invokes the God into the priest and then the God invokes His Goddess consort into the priestess. In modern practice you may carry out the invocations under the suspended mirror, in the same manner as in an Assumption operation, or you may enact the procedure standing up while facing a full

length mirror (we use the Lunar Soul-Door in the Western Quadrant — see the Egyptian arch shown veiled in our video).

Appropriate makeup, costuming and jewelry will aid in the transformation and a cot mattress covered with black cloth should be placed in the Magick Circle. Sandlewood incense, roses and soft background music on an exotic theme would help to create a proper atmosphere. When both have assumed their godforms, the Great Rite is formally consummated and the mighty talisman of the working is charged (see *Figure 1.* below).

Aside from its tremendous magical potency this is a profoundly beautiful experience that can deeply enrich and re-empower a monogamous relationship. If you and your partner are beginning to find your sexual relations getting just a little boring, invite Ba'al and Astarte into your lives and let them rekindle the fires of romantic love.

In closing let me again caution you against any frivolous, irresponsible use of these powerful techniques or any degenerate perversion of their worthwhile purposes. Honor and respect these methods and they will serve you well. Show reverence to The Goddess and to Her Prince Consort and you will surely prosper.

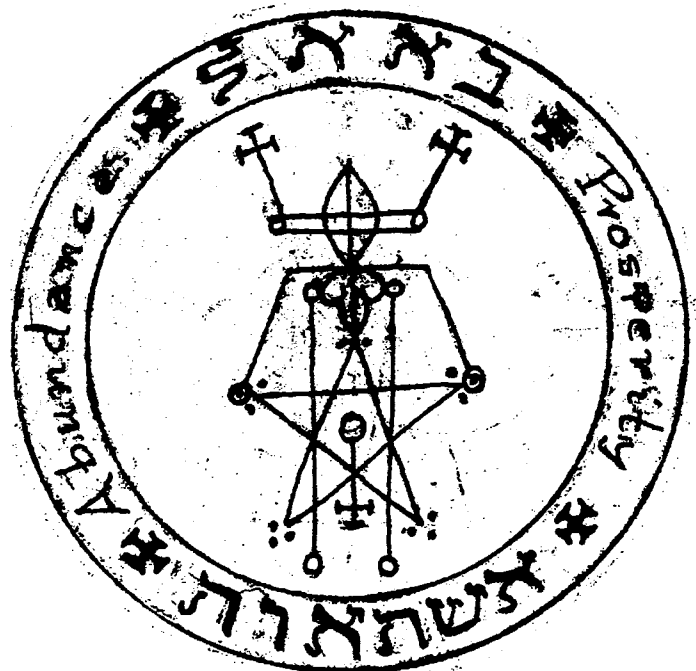

Figure 1. Reverse side should show symbolism specific to the Magical Child and its intended purpose.

Chapter Ten Notes on following page. . .

Chapter Ten/Notes:

1. Mesmerism, the first popular form of trance induction to be introduced to the western world, was developed by Dr Franz Anton Mesmer in the late 18th century. The technique depended more on an influx or exchange of magnetic energy, directed by the Mesmerist, than on the hypnotic induction routines we are familiar with today. A Mesmerist would not say: "You are very relaxed, you are feeling sleepy, etc.," he'd simply put a hand on your shoulder, look into your eyes and command you to "Sleep!" . . . *and you would*. In spite of many attempts to discredit the old system, it still works. Mesmerism is not hypnosis but the two methods overlap. Whenever hypnosis is combined with physical contact or eye contact, Mesmerism comes into play. The famous American hypnotist, Milton Erickson, was said to have "a hypnotic touch". Even his friends were reluctant to shake hands with him. This was pure Mesmerism. . . For a broader discussion of hypnosis, Mesmerism and magick see the author's *Magick and Hypnosis* from C.H.S., Inc.

Part Two:

*The Practice of
Solomon's Magick*

*Man, even as God, writes with the Wand
And emblazons with the Sword;
Letters and Symbols in a Spectrum of Fire.
Woman, like unto Goddess, nurtures the Glyphs In Her Cup. . .
Giving them substance from Her Pentacle: --
The Ineffible Vowels. . .
And yet there is that in Man which is Womanly,
And that in Woman which is Manly --
Hence all tools of The Word should be thine. . .
In tasks of The Art.*

Cult of The Sangreal by Thabion

Chapter Eleven: Pentagram and Septagram Rituals

THIS CHAPTER DEALS WITH TWO vitally important rituals that you will use throughout your entire magical career. The Pentagram ritual casts your Magick Circle of protection and establishes your Guardians at the Four Quarters of the Universe. The Planetary Septagram Rite draws down The God Power, activates your inner psychic centers, selects the Sphere of your working and Opens the Gateway between the Worlds. You should practice these rites daily and make your visualizations more and more vivid. Study the Archangel icons we have provided. If you are artistic, draw and color your own versions. . . Explore your own inner dimensions. Our Magick will work with a minimum of effort -- but no magician should ever be satisfied with anything less than perfection! Work!

The Pentagram Ritual

THIS RITUAL, WITH ITS VARIATIONS, is one of the most important rites you will commit to memory in your magical career. You should employ it every day for inspiration, protection and personal centering. You can perform it without a sword or gestures as an internal projection of your imagination at any time you need protection. In its full dress, formal application it is the required “circle casting” or “quarters rite” preceding every ritual in nearly all Western magical traditions and variations of it are even used by Wiccans. The Golden Dawn used it primarily in the banishing form to cleanse a temple before working. We use it in the invoking form to consecrate our magick circle and set “The Wards of Power” at the compass quarters. These Wards are traditionally the four Archangels of the Tetragrammaton. We employ the banishing form at the end of the rite to close and seal the circle of our working.

Background: — The Pentagram Ritual is a legacy from **The Order of the Golden Dawn**. The invoking and banishing Pentagram forms were found in the original *Cypher Manuscript* but the concept of the ritual itself must be credited to W. Wynn Westcott. Before this elegant rite was conceived each magician had his or her own way of casting a circle, often involving the actual tracing of the circle on the floor or ground.

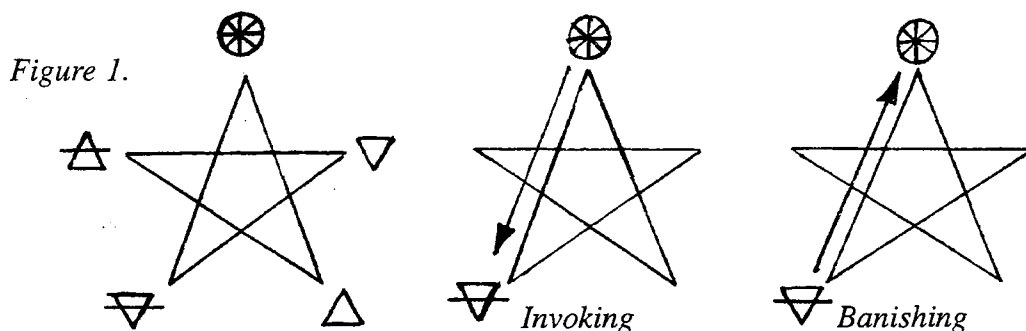

Structure: — The Pentagram Ritual is still referred to as “*The Lesser Pentagram Ritual*” in The Golden Dawn papers because it utilized only the final form attributed to the Earth Element. The term “Lesser

Pentagram Ritual” is used because the so-called “Greater Pentagram Ritual” used to open Enochian Tablets was later incorporated into the Enochian “*Watchtower Opening.*”

In our video we use only the *Earth Element Pentagram form* as a minimum opening and closing requirement -- but the experienced operator can certainly use the other elemental forms as an additional Quadrant opening similar to the Enochian Watchtower concept. (If this confuses you at this point, don't worry about it. Our mandatory *Planetary Septagram Rite* will cover the Quadrants as well.)

In activating these Pentagram forms on the astral you invoke toward the point of the Element and banish from that point. Earth is on the lower left point, hence we are invoking Spirit into and banishing it from the Element of Earth. This is an appropriate opening and closing for all magical operations because it brings Spirit into and then releases it from the physical plane or material basis of the work (*for a more detailed discussion of this concept see The Lesser Ritual of the Pentagram by Fra. Perseus and Sor. Kalla in T-7R no. 7*).

Because these are Earth Pentagrams they must be visualized in *bright, neon green!* ¹. The words and Names of Power must be vibrated and projected.

Here follows a step-by-step description of the rite with variations:-

Lesser Pentagram for Temple Opening & Closing

Face East. Touch right hand (with sword) to forehead and say: “Ateh” (aa-tah). Touch sword pommel to chest and say: “Malkuth” (Mal-koot). Touch right shoulder and say: “Veh-Geburah”, then left shoulder and say: “Veh-Gedulah.” Extend sword outward with both hands and say: “Le-Olam!” Bring the sword back to the chest saying: “AUM.” (This is the Kabbalistic Cross. Translated it means: “Thine is the Kingdom, The Power and the Glory Forever, Amen!”)

Trace the first Earth Pentagram in the East with the point of your sword (invoking to begin the rite; banishing to close). Thrust the point through the center vibrating: “AMShO” (Ah Mah Sha Oh) or the 22

letter Alphabet form, “ShMAT” (Sha Mah Ah Tah). ². Keeping the sword point extended do a right facing movement and trace another Pentagram in the South. Thrust through the center while vibrating: “ADONAI!” (Ah-doh-nye). Swing the point to the West and trace another Pentagram, thrusting through with: “EHEIEH!” (Ah-hey-yah). Complete the circle in the North with the final Pentagram saying: “AGLA!” (Ah-gay-lah — or, if you prefer, *Ateh Gibor Le-Olam Adonai!* Thine is the Power forever my Lord!)

Again face East and extend your arms in the form of a cross, saying: “Before me, Raphael!” (Ra-phy-el). Visualize the Archangel towering above the clouds at sunrise with his sword and censer. Still fac-

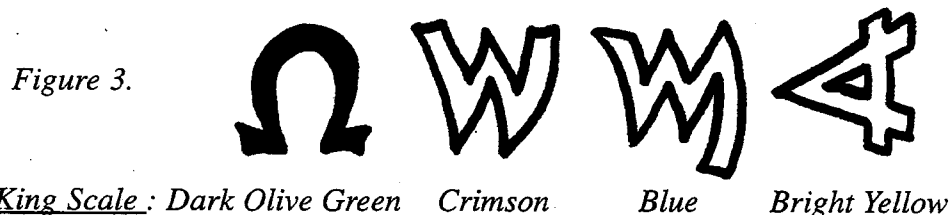

ing East, vibrate: “Behind me, Gabriel!” (Gab-ree-el). Behind your back visualize the Archangel holding Her silver chalice with the Moon and the ocean behind her. Then say: “At my right hand Michael!” (Mee-ky-el). In the south (to your right) visualize the Archangel in armor towering above a fiery volcano with his flaming lance. Next say: “At my left hand, Auriel!” (Au-ree-el). To your left visualize the Archangel, with the green hills behind Her, holding a Pantacle heaped high with the fruits of the Earth.

Then say: “Around me flame the Pentagrams!” Again visualize the green pentagrams at each quarter (East, South, West and North). Next vibrate: “Above me shines the Six-Rayed Star!” Visualize above your head a unicursal hexagram in bright yellow gold.

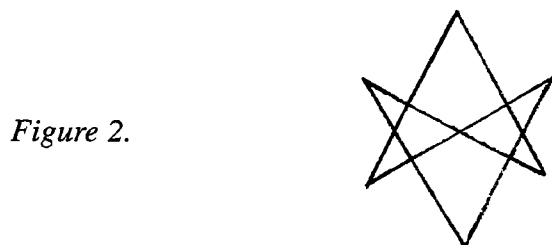

Again perform the Kabbalistic Cross to complete the rite.

Extensions and Variations of the Pentagram Ritual

The first variation is the daily personal empowerment version (which is always done in invoking mode). It is the same as above except that when the Archangels are called and visualized, the following petitions are added: “Raphael grant me perfect health and wisdom... Michael grant me creative force and energy ... Gabriel grant me unlimited love and sensitivity... Auriel grant me boundless wealth and prosperity”Then we add the visualization of the Tetragrammaton overhead in colored Phoenician letters starting from right to left, Ah Mah Sha Oh, (or Sha Ma Ah Ta) while saying: “Great Lord of the Universe, grant me freedom and spiritual enlightenment.”

The second variation is the protection version. It is usually done in the invoking mode but can be done as a banishing in conjunction with other rites. It is the same as the basic form except that the Archangels are visualized as facing outward in a shielding mode. The following petitions are made: “*Raphael, protect me (us) from the perils of wind and plague . . . Michael, protect me (us) from the dangers of fire and fury. . . Gabriel, protect me (us) from the threat of flood and storm. . . Auriel, protect me (us) and what is mine (ours) from theft, injury, accident or destruction.*” Again visualize AMShO (ShMAT) above and say: “*Ah Mah Sha Oh*” *protect me (us) from above and below and within and without.*”

This last petition is the most important — especially if you are defending against magical attack. Black magick uses your own weakness against you.

There is another variation to be mentioned. This is really not a regular Pentagram ritual but it is a four-quarters rite. It is more of a New Age NeoPagan form suited for an outdoor setting. It is especially good to use with non-initiates present.

This rite is an invocation and extension of Universal Love to unite yourself with Nature and Humankind. It should be done in conjunction with the practice of the O.T.A.’s Personal Transformation Mantra: —

Through me flows a river of unlimited love!

Facing East and say: "Above me Sun-Father, beneath me, Earth Mother; empowered by one, I serve the other. Air-Earth-Fire-Water-Father-Mother-Son-Daughter - AUM!"

Raising your hands in the receiving mode (palms up) repeat the Transformation Mantra twenty-two times, then look off as far to the East as you can see and vibrate: "I project Love to the limits of the East . . .and receive in return a vision of beauty!"

Wait to absorb the vision, then face South and repeat the formula. The same to the other quarters in a deosil round. Close with the opening salutation.

The basic Pentagram ritual should be thoroughly memorized before any of the variations are attempted. The Transformation Mantra can be used at any time. It is the subject of a separate paper and is only mentioned here in conjunction with the last Pentagram variation. The Phoenician Tetragrammatons, Aleph Mem Shin Omega (AMShΩ) and Shin Mem Aleph Tau (ShMAT) are discussed in *Note 1., Chapter Seven.*

Pentagram Ritual/Notes:

1. This is bound to confuse and upset some "authorities" and their students who insist that Earth Pentagrams should be visualized in an astral electric blue color. If you have already established this visualization then I don't insist that you abandon it -- but, if you have not set it in concrete, you should conform to the basic principle of magical color projection. The G.D. color scales are NOT what we see on the astral, *they are what we project and impose in order to accomplish our purpose.* You are creating an Earth Pentagram, not skrying one that's already there -- so, don't make 'blue' water Pentagrams for the Earth Quadrant. Make 'um *green.*
2. Readers who are either Jewish or Old Testament oriented Christians should use YHVH (Yod He Vau He) as their Tetragrammaton. Pagans should certainly respect YHVH -- but they don't have to use it.

Planetary Septagram Ritual

THIS RITUAL FOLLOWS THE Pentagram rite. Whereas the Pentagram “Casts the Circle” and establishes the Guardians at the Quarters, the Septagram Ritual then “Opens the Gate” specific to the working. The Planetary Septagram graphic shown below is an ancient traditional design used by virtually all orders in the Western Tradition. (As in the Pentagram, we invoke toward the point of our working and banish with a reverse motion.) Although the Planetary Septagram design is traditional, our method of drawing down, internalizing and localizing the Spirit in the Sphere of the working is original with the O.T.A. — Remember, in Goetia all operations take place in the Sphere of Yesod. Therefore when this rite is performed to open a Goetia operation, only the Yesod form is used. The Planetary Sphere within Yesod will then be evoked by the Magus during the conjuration.

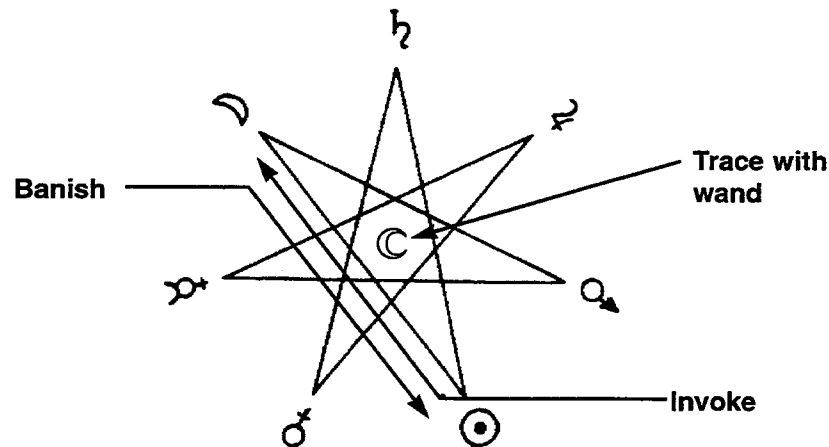

The Planetary Septagram for Yesod

Face West, holding the Wand in the right hand before your chest (point upwards). Tilt your head back, look up overhead, close your eyes and take a moment to imagine yourself as a fifty foot tall giant, then visualize a distant, brilliant flash of LIGHT (*Kether*) high above you. Vibrate the Name: EHEHE! Bring the LIGHT down through the

Aperture of Brahman in the top of your skull (Tibetan *Hoc Phut* spot) and illuminate the left side of your brain (*Chocmah*) as you vibrate: YAH ! Visualize this as a swirling, luminous *gray cloud*. Let the LIGHT flow over to the right hemisphere and vibrate: AHMASHAO ELOHIM ! Visualize a *black triangle* (*Binah*) . Move the LIGHT to a point just above and between your eyes. Vibrate: OOL! (EL) and visualize a bright *blue square* (point upward like a diamond) (*Chesed*).

Still looking up with your eyes closed, now imagine your giant form extending above you, thus enabling you to lower your consciousness point into your body as the LIGHT descends. Bring the LIGHT down into your throat and vibrate: ELOHIM GIBOR while visualizing a *red pentagram* (*Geburah*). Drawn the LIGHT down into your chest, vibrating: AHMASHAO ALOAH VA DA'ATH while visualizing a golden *unicursal hexagram* (*Tipareth*). Descend to the solar plexus and vibrate: AHMASHAO TZABEOTH and create an *emerald septagram* (*Netsach*). Move the LIGHT below your navel and vibrate: ELOHIM TZABEOTH. Imagine a bright *orange octagon* (one square superimposed over another)(*Hod*). Drop to the genital region and vibrate: SHADDAI EL CHAI, visualizing an *amethystine enneagram* (three superimposed triangles) (*Yesod*). Finally drop to the perineum and vibrate: ADONAI HA ARETZ. Create the *crystalline decagram* (by superimposing two pentagrams) (*Malkuth*). You have now opened all your psychic centers in the highest (*Atziluthic*) dimension.

You will now start up from the bottom using the *Briatic* scale of formulas. Holding the *decagram* visualization, vibrate: SANDALPHON. Move back up to the *enneagram*, See it now as a pale yellow design traced on a violet background and vibrate: GABRIEL.

Open your eyes and look Westward. Trace a Lunar invoking planetary septagram with your wand. Trace a lunar crescent in its center and vibrate: ARARITA SHADDAI EL CHAI. Repeat this at each quarter, moving deosil, until you return to the West — then hold your arms out in the form of a cross and say: “In the Name of the Archangel GABRIEL I declare the Gateway to the *Sphere of Yesod* Hermetically unsealed and the Portal Between Worlds hereby opened.”¹. Bring the wand back to your chest, holding it with both hands, and complete the rite by intoning: AUM !

To close the Yesod Gate at the conclusion of the operation (before the final banishing Pentagram), you merely repeat the rite, again starting in the West, using the same intonations but tracing the Septagram in banishing mode. You do not need to do any internal visualizations. Conclude back in the West by declaring the Yesod Gate to be “Hermetically sealed and the portal between Worlds hereby closed— AUM!” (*Note: — For non-Goetic planetary operations you should begin your Septagram rite in the appropriate Quadrant, e.g., Venus in the North.*)

Note on Septagram Rite:

1. I cannot overemphasize the importance of this “Opening and Closing of the Gates” declaration. It should be used in all magical operations, most especially evocations and pathworkings. Your subconscious mind needs to be told that “The door is now open” because it understands other dimensions in the most literal form, as “**other dimensions**”. If it is not informed that the way is now open it may struggle blindly through the whole operation against a barrier you could have removed with a few words in the beginning.

*Who stands before the Lunar Gate?
What Power dost thou wield?
What Lord did send thee hither. . .
And what payment wilt thou yield?*

*Behold Ashtart of Armageddon!
Shaddai El Chai shall clear the way.
I am on My Father's service. . .
And the Veil of Dreams shall I pay.*

*from The Festival of Seven Gates
by Thabion*

Chapter Twelve: Invocation and Evocation Rituals

AN ANGELIC INVOCATION of one of the four Great Archangels should begin with an Invoking Pentagram, followed by a Planetary Septagram (the internal visualizations accompanying each rite are to be practiced by all attending). We locate Raphael in Tiphareth, Michael in Hod, Gabriel in Yesod and Auriel in Malkuth (along with Sandalphon). The opening and closing Septagram rites should be arranged accordingly (see previous chapter). We then enter the Circle and stand close around the double-cube altar, upon which have been placed the *Master Mandala* and the crystal orb.

The Operator then lights the incense burner, serves appropriate incense (*Tiphareth*: frankincense, *Hod*: storax, *Yesod*: jasmine and *Malkuth*: Dittany of Crete), elevates it and salutes *The Lord of The*

Universe. He then removes the silken cloth covering the crystal and rings the bell over it to symbolize the descent of the Holy Spirit. Following this he places the incense burner into its chamber and all take seats on the low stools around the altar.

The Magus recites the Invocation and then the recitation passes around deosil as the others begin a soft overtone chant of the Archangel's name. After everyone has invoked in turn, the chant continues to grow in power and intensity until the Glory comes upon the altar and the Magus makes the sign of adoration and welcomes the Archangel. He may then make a petition or channel an oracle; following this he will ask the person on his left: "Does the Angel speak through you?" If the answer is "Not at this time," the Magus will ask the question of the next person on his left and so on until all have had a chance to vocalize the "knowings" which have entered their enchanted minds. . . Finally the Magus will stand (cueing all to rise) and thank the Archangel for coming, bidding Him or Her "To remain ever stronger in our hearts and to return to us when reverently called by the rites of Holy Magick. Hail and Farewell!" He then covers the ball with silk. The Planetary and Elemental banishing rites are then performed to conclude the operation. (Note: even though we ran these invocations together in the video, only *one* Archangel should be invoked per operational session.)

*Archangelic Invocations*¹.

We call Thee, Great Archangel **RAPHAEL** in the name of Tetragrammaton — *Ah Mah Sha Oh!* Come to us, oh Guardian of the Eastern Quadrant, Master teacher, Loving healer, Wielder of the Sword of Truth and Lord of the Ariel Realm! Come, we beseech thy presence here upon this Holy Table . . . Shine forth from this pellucid crystal. . . Grant us a glimpse of thy glory and a whisper of thy wisdom. . . (overtone chant by all in unison) . . .

Ra-pha-el! Ra-pha-el! Ra-pha-el!

We call Thee Great Archangel, **MICHAEL**, in the name of Tetragrammaton, *Ah Mah Sha Oh!* Come to us, oh Guardian of the Southern Quadrant, Master of the Sacred Lance, Warrior and Defender! Lord of the Realm of Fire! Come, grant us a measure of Thy Power and a warning of any dangers that might lie before us. . . *Mi-cha-el! Mi-cha-el! Mi-cha-el!*

We call Thee, Great Archangel **GABRIEL**, in the Name of Tetragrammaton: *Ah Mah Sha Oh!* Come to us, oh Guardian of the Western Quadrant, Lady of the Waters and Mistress of the Holy Grail! Quicken within us the faculties of sympathy and of intuition. Grant us a glimpse of thy mystic Grace and an oracle from thy vast, dark ocean of Understanding. . . *Gab-ri-el! Gab-ri-el! Gab-ri-el!*

We call Thee, Great Archangel **AURIEL**, in the Name of Tetragrammaton, *Ah Mah Sha Oh!* Guardian of the Northern Quadrant, Lady of the Earth and Mistress of the Holy Pantacle of Art! Bring us in Harmony with nature's cycle and make fertile all our just desires! Bestow upon us thy Love and lead us unto thy treasures—in the Name of **Adonai ha-Aretz** . . . *Au-ri-el! Au-ri-el! Au-ri-el!*

Remember: you must complete all four Archangelic Invocations before you proceed to the Evocation of Spirits. These Archangelic operations consecrate and empower your Master Mandala.

Goetic Evocation Operations:

When I first began my Goetia experiments in 1969 I used all three conjurations and The Curse of Chains (I still have the metal box with which I tormented the spirits by heating their sigils over the thurible) but after the first year of O.T.A. group workings, using our hypnotic dark mirror method, I realized that for our purposes the complete medieval armamentarium was unnecessary. The first conjuration

(especially the rectified version below) has all the Names of Power and correspondences you need to bring up a manifestation. Whether it is wise to intimidate elements of the subconscious mind is a debatable point in any method of evocation, but I think it should be especially avoided when keying off your own, or your receiver's, reflection. You may need to repeat the first conjuration two or even three times in a stronger tone of voice to bring the spirit in — but any more than this should not be necessary. ².

CIRCUMAMBULATION

With a full complement (Operator, Receiver, Server and Acolyte) this can be a very impressive phase of the ritual. It is always marched deosil (clockwise) with the East as a starting point. The Operator beats the drum and leads the sonorous overtone vowel chant (Ah — Aae — Eee — Oh — Ooo) , the receiver wears the lamen of the spirit and has no task except to spiral into the vortex by concentrating on, and pivoting around, the pentacle of the sphere (within Yesod) placed in the center of the circle. The server gently swings the lighted censer, burning the appropriate incense. The Acolyte rings the bell each time he passes the East, marking the circumambulations. As the circumambulation proceeds, the pace, the chant and the drumbeat gradually increase in speed, volume and intensity. After the last ring and final drumbeat, the Magus and receiver enter the circle while the others quickly and carefully move the equipment into position. This stage business is covered by the . . .

PRELIMINARY INVOCATION

This is an edited version of The ancient “Bornless Ritual”. It should be read by one of the operator's assistants, or recited from memory by the Magus, to cover the setting-up phase directly after the circumambulation has been completed. This recitation maintains the magical mood while the Triangle is moved into position, the work table is brought into the Circle, the receiver is given the candle sticks to hold , the incense server takes his position, the Magus puts on his

ring and lights the skryer's candles. . .

Thee I invoke, The Bornless One!
Thee that didst create the earth and the heavens!
Thee that didst create the darkness and the light!
Thou art Osiris-onofris, Osiris the Beautiful . . .
Whom no one hath seen at any time!
Thou hast distinguished between the just and
The unjust!
Thou didst make the female and the male
Thou didst produce the seed and the fruit
Thou didst form us to love one another and to hate
One another!
Thou didst produce the moist and the dry and that
Which nourisheth all created life!

I invoke Thee, the Terrible and Invisible God who
Dwelleth in the Void Place of the Spirit!

I am He! The Bornless Spirit! Having sight in the feet:
Strong, and the Immortal Fire!
I am He! The Truth!
I am He who hates that evil should be wrought
In the World!
I am He that brings the lightning and the thunder!
I am He who showereth life upon the earth!
I am He whose mouth ever flameth!
I am He, the begetter and manifester unto the Light!
I am He, the Grace of the World:
The Heart Girt with the Serpent is My Name!

Come Thou forth, and follow me and make all spirits
Subject unto me so that every spirit of the firmament
And of the aether, upon the earth and under the earth;

On dry land or in the water; of whirling air or of rushing fire
— And every spell and scourge of God may be
Obedient unto me!

Note: — Just before beginning the actual conjuration, be sure to invoke the particular angel of the SHEMHAMEPHORASH which corresponds to the spirit being evoked. (See ANGELS OF THE SHEMHAMEPHORASH.) The Magus should open the Brass Vessel, take out the sigil of the spirit, show it to the receiver and then turn it to show the reverse side, with the sigil of the Angel, while he recites the Latin versicle — e.g., *Domini dilexi decorum domus tuae et locem habitationes gloriae tuae: Mon - ah - del !* (for Astaroth-Astarte).

This done, the Operator raises his or her wand and begins the conjuration. During the recitation of the Names of Power he or she will trace the “Jewels of Artargatis” down the receiver’s spine while projecting a visualization of the psychic centers through the receiver’s back. (See THE HERMETIC CADUCEUS.)

EVOCATION OF GOETIA SPIRITS

THE CONJURATION

I evoke and conjure thee, Spirit _____, strengthened by Almighty God and I command thee by: BARALAMENSIS, BALDACHIENSIS, PAUMACHIA, APOLOROSEDES, and by the princes GENIO and LIACHADI, ministers of the Seat of Tartarus and Chief Princes of the Throne of Apologia in the Ninth Region!

I command thee by Him who spake it and it was done! By the Holy and glorious Names: EHEHE, YAH, AMASHAO³, ELOHIM, OOL, ELOHIM GIBOR, AMASHAO ALOAH VA-DA’ATH, AMASHAO ZABEAOTH, ELOHIM ZABEAOTH, SHADAI EL CHAI, ADONAI HA ARETZ . . . Sandalphon, Gabriel, Michael, Haniel, Raphael, Kamael, Tzadkhiel.⁴

Come! Appear before this Circle, within that Triangle, in fair and human form without horror or deformity and without delay. Come to us from whatever part of the world thou art and answer our questions. Come presently, come visibly, come affably and manifest that which we desire; being commanded by the eternal and living God, HELIORUM !

I command thee also in the name of the particular King to whom thou owest thine obedience, the Mighty _____, and by the Holy Name of the Great Archangel _____, who rules the _____ Quadrant.

I conjure thee by the Ineffable Name to which all creatures are obedient; the Mighty Tetragrammaton: AH-MAH-SHA-OH ! by which the elements are overthrown: the air is sundered, the fire is generated, the sea rolls back, the earth moves, and all the host of things celestial, of things terrestrial, of things infernal do tremble and are confounded together!

Come! Appear before us visibly, and speak unto us affably in a clear, intelligible voice in our mother tongue, free from ambiguity and guile. Come in the Name of the Archangel _____. Come, why dost thou tarry? ADONAI SHADDAI, King of Kings, commands thee!

WELCOME TO THE SPIRIT

We welcome thee, most noble (Rank)_____. We thank thee for heeding our summons. We give thee sweet incense and good entertainment and, by the Power of God, we charge thee to remain affably and visibly here before our Circle, within our Triangle, giving us true answers and faithful service until we shall license thee to depart.

LICENSE TO DEPART

Spirit _____, because thou hast diligently heeded the rites of Magick and complied with our demands, we do hereby license thee to depart without giving injury to any person, beast or thing. Depart I say but be ever ready to return when duly summoned by the sacred rites of Magick. Withdraw quickly and quietly and may the peace of God continue between us and thee. Depart, depart, depart I say, and be gone!

(Having said this the operator should ask the receiver if the spirit is really gone. If so, the Magus snuffs out the receiver's candles, turns the lamens, to display the pentagram on the reverse side, and then covers the mirror with the green silk cloth. If not, then the lamens should be turned over, the candles left lighted and the license to depart repeated again in a stronger tone. In *a very rare instance* where the above procedure is not sufficient, the classic exorcism can be used:

EXORCISM

The operator turns the receiver around to face him or her, looks the receiver directly in the eyes and firmly declares: "Behold in me the person of the exorcist who is known as OCTINOMOS, armed by God and fearless in the midst of the exorcism! Behold the Pentacle of Solomon which I bring into your presence to your confusion!" (Direct the receiver's attention to the hem of your robe. You may also call attention to the Pentagram on the reverse side of the lamens). "I command thee, in the Name of the Archangel _____, to withdraw from this place quickly and quietly giving no harm to any person or thing! Depart, depart, depart I say and BE GONE!"

EVOCATION OF THE KINGS OF THE QUARTERS ⁵.

I evoke and conjure Thee, Mighty King Amaymon, Lord of the Eastern Quadrant and Master of the Spirits of the Air and of all their

Legions! I command Thee in the name of the Holy Archangel, Raphael, Guardian of the Gate of Sunrise (South=Noontide, West=Sunset, North=Eventide) and Bearer of the First (Second, Third, Fourth) Letter of the Holy Name — Tetragrammaton: AH MAH SHA OH! (trace and visualize letters in color with wand) By which the Air is sundered, the Sea rolls back, the Fire is generated, the Earth moves and all things Celestial, Terrestrial and Infernal are confounded together! I command Thee by the Holy and Glorious Name that rules the Sphere of Yesod: SHADDAI EL CHAI and by the Name that rules Thy Sphere within this realm: AHMASHAOH ALOAH VA-DA'ATH. Come, appear before this circle, within this Triangle in fair and human form without horror or deformity and without delay. Come, speak unto us in our mother tongue in a fair and human voice, free from ambiguity and guile. Come; why dost Thou tarry? ADONAI SHADDAI, King of Kings commands Thee!

(The welcome and license to depart are the same as they would be for any Goetia entity with the sensible addition of “Great and Mighty King” as an honorary prefix. A flaming libation of liquor would be an appropriate sacrifice — but, if you use 151% rum straight from the bottle into the thurible you could blow yourself up. Always decant any dangerous flammables into *very small bottles* before you operate.)

EVOCATION OF CANAANITE GOD FORMS

THE CONJURATION

I evoke and conjure thee, Spirit _____, I supplicate Thee great (Rank) _____, strengthened by almighty God, and I command Thee by Him who spake it and it was done! By the Holy and glorious Names: EHEHE, YAH, AHMASHAOH ELOHIM, OOL, ELOHIM GIBOR, AHMASHAOH ALOAH VA-DA'ATH, AHMASHAOH ZABEAOTH, ELOHIM ZABEAOTH, SHADAI EL CHAI, ADONAI HA ARETZ . . . Sandalphon, Gabriel, Michael, Haniel, Raphael, Kamael, Tzadkhiel.

Come! Appear before this Circle, within that Triangle, in fair and human form without horror or deformity and without delay. Come to us from whatever part of the world thou art and answer our questions. Come presently, come visibly, come affably and manifest that which we desire; being commanded by the eternal and living God, HELIORUM !

I summon Thee also in the Name of Father EL (Ool) and Mother ASHERAT OF THE SEA and by the particular King of the Quarter to whom thou owest thine obedience, the Mighty _____ , and by the Holy Name of the Great Archangel _____, who rules the _____ Quadrant.

I conjure thee by the Ineffable Name, to which all creatures are obedient; the Mighty Tetragrammaton: AH-MAH-SHA-OH ! by which the elements are overthrown; the air is Sundered, the fire is generated, the sea rolls back, the earth moves, and all the host of things celestial, of things terrestrial, of things infernal do tremble and are confounded together!

Come! Appear before us visibly, and speak unto us affably in a clear, intelligible voice in our mother tongue, free from ambiguity and guile. Come in the Name of the Archangel _____. Come, why dost thou tarry? ADONAI SHADDAI, King of Kings, commands thee!

APOLOGY TO THE GODDESS OR GOD ⁶.

We welcome Thee, great (God/Goddess) _____ ! We apologize for summoning Thee with such strong incantations, but we hasten to declare that we command only that aspect of thee that dwells within ourselves; Thy higher presence and universal essence we hold in true reverence and serve in all humility.

LICENSE TO DEPART

Great (Rank) _____ , we thank Thee for attending our rites and for granting our requests. We hope that your inspiration will remain and grow ever stronger within us even as your Greater Presence departs from our Circle. Return now to your wondrous realm but be ever ready to appear again when called by the Sacred Rites of Magick. Hail and Farewell!

Notes: Chapter Twelve

1. These Archangelic Invocations are the original creations of the author and protected by his Copyright. They may be used in private ceremonies by individuals or groups but may not be reproduced for publication or used for public performance in any medium.
2. During the circumambulation the receiver should be wearing the Spirit's Lamén. The metal (or finish) of the lamén is determined by the spirit's rank (e.g. Dukes, ♀ = copper) and has Solomon's banishing pentagram on the reverse side. The spirit's sigil appears three times: on the lamén, on parchment in the Brass Vessel, and on the skrying mirror traced with a *black* china marker (note: we used a *yellow* marker in the video only for better camera visibility). Usually the receiver stands before the mirror. Fra. Ake Phalos (Jim Nobles) prefers to seat his receivers so that they can be more relaxed. (In this case a stool is recommended because a chair might interfere with psychic center energies and also has a *séance* connotation.)
3. This is our Pagan Tetragrammaton, which we have explained earlier. Operators who are Jewish or Old Testament oriented Christians should substitute *Yod He Vau He* for *Ah Mah Sha Oh*.
4. You should bring the Light/Power all the way down and ground it in the Malkuth center. This is the Atziluthic descending empowerment. Then bring it up, via the Briah dimension, to the Sphere of the working (remembering that this is all within Yesod) e.g., Ashtaroth = Venus = Netsach = "Haniel".
5. For the unique O.T.A. sigils of the Goetia Rulers and the sigils of the Four Great Archangels who directly control them, see THE 72 SPIRITS OF THE BRASS VESSEL.
6. This very important element was originally suggested and first written into our ritual by Soror Ariel (Ms Jo Carson) in 1970.

*. . . And Thou! Beneath its influence born --
Thou worm! whom I obey with scorn --
Forced by a Power (which is not thine,
And lent thee but to make thee mine)
For this brief moment to descend,
Where these weak Spirits round thee bend
And parley with a thing like thee --
What would'st thou, Child of Clay! with me?*

from Manfred by Lord Byron

Chapter Thirteen: The Evocation of Nithael

*The popular writers on magical evocation will tell you that there is nothing dangerous about this practice while experienced Magicians fill their books with precise instructions giving the impression that everything is always under control . . . But what happens when the Dark Side comes through unexpectedly and with overwhelming power? **What do you do then?***

IT WAS THE LAST NIGHT OF THE FULL MOON in September at the secluded, tree-shrouded Montsalvat Hermitage-Temple in Pasadena. Frater Prometheus, an actor and aspiring screen writer, suggested we perform another Bardonian evocation. It would be our third this month. Prometheus had just discovered Franz Bardon's second volume and was fascinated by its multitude of empowering spirits. I sympathized. I had had a similar romance with the same book

many years ago when I was beginning my study and practice of magick. Even then I had thought Bardon somewhat mad. However, Bardon's was a Holy Madness, not unlike my own in those days, to which I felt a strong kinship . . . Yes, we would do another operation from Bardon. Magical enthusiasm should be ridden hard while it lasts — like heavy surf following a storm. And, if we needed a rationale, it was in line with our Second Degree training.

I had been supervising Prometheus and his lady, Soror Rhiannon, in the summoning of Goetia spirits during the waxing moon periods for the last several months. I always start off new Second Degree people with Astarte (Ashteroth) and Ba'al (Bael) from the traditional *Goetia of the Lemegeton* to introduce them to the patron Goddess and God of our Temple — and then to such benign lesser entities as Vassago to train them in the hypnotic conjuration-to-visible-appearance technique that has been the *Ordo Templi Astartes'* mainstay for the past twenty-six years.

Franz Bardon's *Magical Evocation* is closely related to this system ¹ but does require a zodiacal circle. Our nine-foot Solomonic hard circle is elemental on one side and celestial on the reverse, so any one of Bardon's carefully calibrated entourage of spirits can be easily located and the pentagram pointed precisely in his/her direction. Our standing triangle, dark speculum, planetary lamens, evocation candles and other standard Goetia equipment can then serve without modification.

As it turned out Soror Rhiannon wanted to operate and I was asked to receive. As Magister I don't often get the chance to be the receiver in evocation operations. Full moon time is at a premium and the new people need the experience. However, this was not a regular meeting and Prometheus had just received the Bardonian spirit, *Pigios* (15^o ♀) the night before. Both initiates had been staying with me at the Hermitage during that time.

I should have been looking forward to the operation but I was not. From a mundane perspective it had been a hectic week. I was tired and would rather have gone to bed with a novel or even watched t.v.

I took a nap after dinner when I should have been researching for the operation. At eight p.m. I awoke, heaved up off the couch, fumbled for Bardon's second volume and grunted: "Okay, I'll find something Mercurial that's good for writers. Maybe it'll help us both come up with something saleable."

I had just mixed up a batch a very pungent storax incense the night before so Mercury (*Hod*) seemed a good idea. I found the Mercurial spirits in Bardon — all seventy-two of them but the significance of that venerable number did not register with me at the time. I selected *Nithael* (number 54 at 26-30^o ↗). He was described as "... a great friend of all artists, writers and orators, & etc." — Everything positive, up-beat, constructive; one of 'the good guys'. I even instructed Soror Rhiannon to drop the Goetia "Barbarous Names" from the conjuration so we wouldn't contaminate the transcendentalism of Bardon with anything demonic. What could go wrong?

I liked the sigil too; it wasn't Bardon's typical automatic writing in his *Liber Spiritum*. This one had captions in a strange language and a wavy symmetry in its design.

I copied it onto the dark mirror with a black grease pencil and then duplicated it on a blank brass lamen I would wear around my neck. I was ready . . .

We sat down around a small, low table on which a single candle burned. We would preform a preliminary meditation in the darkened common room before processing through the veil into the Temple.² Before beginning pranayama I assigned tasks: Rhiannon would ring the quarters in circumambulation, Prometheus would handle the censer and serve incense. He would also read *The Bornless Invocation* while we were setting up to operate. With assignments made we settled down in asanas, did our breathing exercises and then closed our eyes. I brought down power through the Chakras with the aid of an electronic synthesizer to play the descending scale. We opened our eyes to the candle flame. Prometheus directed us in breathing in the rays and charging the psychic center of Hod. We took hands,

synchronized power and carried it with us, intoning an overtone chant, into the Temple.

After the traditional lighting of the lodge, invocation to The Goddess and the Invoking Pentagram Ritual we proceeded to the operation itself. After declaring that we would succeed in summoning the spirit “Because we will it!”, the circumambulation commenced.

With our eyes locked on the pentacle of Mercury placed in the pentagram, we slowly paced the circle eight times deosil. With the muffled drumbeat, the smoking censer swinging, the vibrant chanting and the bell ringing the quarters this traditional circumambulation was a journey into dreamtime. It has always been one of the most dramatic elements of the Magical Art. As the receiver, I emptied my mind so that I could spiral backward through the distant Ages and outward through the dark reaches of the Universe as we revolved around the twelve spoked wheel of space and time.

With the last ring of the bell we positioned the Triangle and entered the Circle. Prometheus intoned The Bornless Invocation while I took my position facing the mirror with a candlestick in each hand. His trained actor’s voice was thick and rich with power:

“Thee I invoke, The Bornless One! Thee that didst create the earth and the heavens. Thee that didst create the night and the day — the darkness and the light! Thou hast distinguished between the just and the unjust!”

I wondered if there was any of our alchemical fluid condenser still active behind the mirror but quickly put this thought out of my mind. The only thing I needed to do now was to get the lighting right on my hooded face and then commence the passive, unblinking stare at my reflection that brings on the blackout. . .

“I summon thee, Spirit Nithael, strengthened by Almighty God ! And I command thee by the Holy and glorious Names. . . “ From behind me Rhiannon intoned the descending God Names in *Atziluth*, ending with *Elohim Tzabaoth* commanding the Sephiroth of *Hod*. . . *“I command thee by Him who spake it and it was done! By the mighty Tetragrammaton . . . “*

I wasn't experiencing any sense of distortion yet . . . but my face was fading out . . .

“ . . . By which the air is Sundered, the sea rolls back, the fire is generated , the earth moves and all the host of things celestial, of things terrestrial, of things infernal do tremble and are confounded together!”

Blackout! . . . Something coming from far away . . . Only two points of flame in a cloud of darkness . . . The candles . . . Something is closer now. . .

“ . . . Appear before this Circle, within that Triangle in fair and human form without horror or deformity and without delay!”

I was looking into the glowing eyes of a black panther!

'No', I told myself, 'It's just the two candles . . . ' But then the panther's head became visible and the voice came out of my mouth in a soft, deep-purring whisper:

“I am a cat; a black cat”, it said. *“ . . . And I am a spirit of the dark side.”*

Rhiannon welcomed the spirit, somewhat hesitantly, and asked for an oracle. . .

“I am not an evil spirit,” the entity purred, *“ — But I am a spirit of evil!”*

At this point the part of me that was still 'Me' was entrenching itself into a defensive position where reason and sanity could prevail. We had *a very strong contact going here*; one of the strongest I had ever experienced!

For me it was more independently visual than any evocation I could remember from twenty-seven years of practice. I usually receive “on-face” — that is after black-out my own reflection reappears as someone else along with that undeniable sense of alien presence that confirms the contact — but this was *different*.

What I was seeing and experiencing was not some dimly remembered archetype from Jung's Collective Unconscious but rather a transpersonal, un-human presence that seemed to come from the far reaches of outer space. One might say it was almost 'Lovecraftian'.

As I continued to stare deep into the dark mirror the panther metamorphosed into a deformed, fungoid face that glowed in fluorescent mauve. *“I can teach you things that would shock even your jaded minds,”* his voice intoned seductively through my lips, *“ — But I warn you that you should balance my teachings with the bright side of Mercury.”*

The power and intensity of the contact was actually increasing. My emotional psyche was fascinated, intrigued, seduced — but the rational part of my mind was becoming increasingly critical. This wasn't what Franz Bardon had described. This was *not* what we had set out to summon. This is *not* the way the system was supposed to work. . . .

But wasn't Magick supposed to be an adventure into the unknown?

“Look — I will open a dark portal for you and take you on a far journey. . .” the spirit whispered and his monster face melted into a swirling vortex, pulling at my astral form to suck me into a black hole far out in the universe. . . *I knew I could go through it! I wanted to go through it!*

“Banish this thing!” I muttered to Rhiannon who stood close behind me.

She sounded relieved as she recited the banishing: *“Because you have diligently answered our demands, I do license thee to depart, giving harm to no living creature. . . and may the peace of God continue between me and thee! Depart and begone. . . but be ever-ready to return when summoned by the sacred rites of Magick!”*

The mirror clouded and cleared. The presence was gone. I suppressed a shudder as Rhiannon turned the lamens on my chest, and snuffed out the candles.

I did a banishing pentagram ritual and we closed the Temple.

Back inside the Hermitage the usual after-operation critique session and log entry was conducted. We always do this directly after the operation because magical visions are very much like dreams. If you

don't write them down immediately you'll forget important details. As receiver I was first to transcribe my impressions in the log book.

Frater Prometheus had been seated in the server's position, feeding incense into the thurible during the summoning. He had wanted to ask questions but it was all over too soon. Soror Rhiannon, who was not an experienced operator, was surprised that the manifestation came so quickly and was so powerful. Also, ". . . It could not give us the blessings needed," she wrote.

Neither faulted me for bailing out when I did. We all knew something had gone wrong. In his book Bardon clearly stated that he had excluded demons from his list and, to make matters even stranger, "Nithael" was actually one of the seventy-two angels of the Shemhamephorash; the extended Name of God! These celestial angels are supposed to be the direct and benign counterparts of the Goetia's seventy-two demons.

I went to my library and came back to the conference table with an arm load of books. Davidson's *Dictionary of Angels* gave Nithael Shemhamephorash status citing Barrett's *Magus* but also listed an obscure French reference that claimed he was "A fallen angel " who resides in Hell , ". . . And governs emperors, kings and civil and ecclesiastical personages of the highest rank." Knowing Barrett to be a lift from Agrippa I checked the with venerable Henry Cornelius himself and he concurred on the Heavenly status of Nithael. Bardon had put him in slot 54 at 26^o-30^o ♂ — right where Agrippa had him if you start from 0^o ♀ (However, Golden Dawners should remember that Mathers started his Shemhamephorash off at 0^o ♁).

At this point Frater Prometheus remembered that he had opened the operation with a banishing rather than an invoking pentagram ritual. In our method of working we use an *invoking* pentagram ritual to call down the Guardian Angels of the Quarters and a banishing to clear out the Temple after completion. We had had no Quarter Guards. . .

I was beginning to understand what had happened.

I went to the *Goetia* and checked number 54. In Crowley's version (B.M. MS. Sloane 2731) the position was occupied by Murmur, a

Duke (Venusian spirit) who appears as “A warrior on a gryphon”, teaches philosophy and assists in necromancy. I dimly remembered summoning Murrur years ago. He didn’t seem to have been the entity we had contacted. Then, on impulse, I picked up Dr. Rudd’s *Treatise on Angel Magic* (circa 1699). We use his short invocations to the Shemhamphorash Angels as a preliminary counter-balancing safety factor in Goetia operations.

Nithael was there in position 54 — but Rudd had also included his own list of Goetia and other spirits. As I recalled, they were not in the same order as in Sloane Ms. 2731 which had been Mathers and Crowley’s source.

I turned to Rudd’s list, counted out to 54 and felt the hairs rise on the back of my neck rise as I read: “*Osé is a great President (Mercurial spirit) and cometh forth like a leopard and counterfeiting to be a man.* I checked this with the oldest list of Goetia spirits we have, Reginald Scot’s 1584 *Discovery of Witchcraft*, and found Osé in slot 55 with an almost identical description . . . except that Scot had added a warning: “. . . (H)e (Osé) transformeth a man’s shape, and bringeth a man to that madness, that he thinketh himself to be that which he is not . . .”

I then recalled that Mercury is the only planet in the solar system that does not revolve. Its dark side is always dark. Perhaps this is why the Faustian shadow of Prometheus remains so demonic even as humankind progresses?

With the next full moon we might have answers to that and other questions -- but we would be better prepared and take proper precautions. ³.

Notes on The Evocation of Nithael:

1. Bardon’s system is based on the medieval “onion ring” concept of the celestial spheres. His hierarchy starts with 360 Spirits of the Earth Sphere as the nearest ring. Above these are the 28 Spirits of

Notes continued on next page . . .

Evocation of Nithrael, Notes continued:

the Lunar Mansions and above them are the 72 Spirits of Mercury (the Shemhamephorash). When we consider that our Goetia Spirits are all circled around the lowest level of the Lunar Sphere (Fallen Angels controlled by the Moon), we see that Bardon's arrangement actually places the Shemhamephorash in an immediately superior position not unlike The Master Mandala.

2. A preliminary meditation period in an outer chamber (we call it "the common room") before entering the Temple is a very sound practice. It gets everyone into a mild trance state so that the Temple remains a sacred precinct. In *The Book of Solomon's Magick*, I have not emphasized this because it largely depends on the individual skill of the operator and a deep knowledge of our psychic center system. We sit in asanas around circular table upon which is placed one candle. We do pranayama on a four-four-four count, staring at the candle flame, until everyone is relaxed -- then the leader has the group close their eyes and visualize *The Drawing Down of The Light* as in the *Septagram Ritual*. (I use an electronic synthesizer on a descending harmonic scale.) The psychic center of the working is thus activated. We all join hands and energy is transmitted deosil around the circle. We slowly raise our joined hands until they are extended overhead, then we break the circle, seal the energy and process into the Temple humming an overtone chant in unison.
3. Next month we carried out a direct evocation of Osé with another receiver who agreed to undertake the operation without reading my previous log entry. This action was monitored and reported by a prominent academic authority on the occult, not a member of the O.T.A. Our receiver confirmed the "Red cat's eyes", said that Osé was "A hunting God" and represented "Fiery aspects of the Tree". "Osé is the Spirit of Maya -- the images of this world. Reflections of the divine." When asked if he (Osé) had been summoned in the correct position, he replied: "More or less, but I am fluid, like Mercury." Soror Astrea, a clairvoyant, saw a great swishing cat's tail behind our receiver. Our academic observer agreed that this was something beyond a Jungian Archetype.

The Goetia

*being the First Book
of the Lemegeton
of Solomon the King*

THESE BE THE 72 MIGHTY Kings and Princes which King Solomon Commanded into a Vessel of Brass, together with their Legions. Of whom BELIAL, BILETH, ASMODAY, and GÄAP, were Chief. And it is to be noted that Solomon did this because of their pride, for he never declared other reason why he thus bound them. And when he had thus bound them up and sealed the Vessel, he by Divine Power did chase them all into a deep Lake or Hole in Babylon. And they of Babylon, wondering to see such a thing, they did then go wholly into the Lake, to break the Vessel open, expecting to find great store of Treasure therein. But when they had broken it open, out flew the Chief Spirits immediately, with their Legions following them; and they were all restored to their former places except BELIAL, who entered into a certain Image, and thence gave answers unto those who did offer Sacrifices unto him, and did worship the Image as their God, etc.

OBSERVATIONS

FIRST, thou shalt know and observe the Moon's Age for thy working. The best days be when the Moon Luna is 2, 4, 6, 8, 10, 12, or 14 days old, as Solomon saith; and no other days be profitable. The Seals of the 72 Kings are to be made in Metals. The Chief Kings' in Sol (Gold); Marquises' in Luna (Silver); Dukes' in Venus (Copper); Prelacies' in Jupiter (Tin); Knights' in Saturn (Lead); Presidents' in Mercury (Mercury); Earls' in Venus (Copper), and Luna (Silver), alike equal, etc.

THESE 72 Kings be under the Power of AMAYMON, CORSON, ZIMIMAY or ZIMINIAR, and GÖAP, who are the Four Great Kings ruling in the Four Quarters, or Cardinal Points, viz.: East, West, North, and South, and are not to be called forth except it be upon Great Occasions; but are to be Invocated and Commanded to send such or such a Spirit that is under their Power and Rule, as is shown in the following Invocations and Conjurations. And the Chief Kings may be bound from 9 till 12 o'clock at Noon, and from 3 till sunset; Marquises may be bound from 3 in the afternoon till 9 at Night, and from 9 at Night

till Sunrise; Dukes may be bound from Sunrise till Noonday in Clear Weather; Prelates may be bound any hour of the Day; Knights may from Dawning of Day till Sunrise, or from 4 o'clock till Sunset; Presidents may be bound at any time, excepting Twilight, at Night, unless the King whom they are under be Invocated; and Counties or Earls any hour of the Day, so it be in Woods, or in any other places whither men resort not, or where no noise is, etc. ¹.

LIST OF THE 72 CHIEF SPIRITS OF
THE GOETIA, ACCORDING TO RESPECTIVE RANK. ².

(Seal in Gold.) **KINGS:** (1.) Bael; (9.) Paimon; (13.) Beleth; (20.) Purson; (32.) Asmoday; (45.) Vine; (51.) Balam; (61.) Zagan; (68.) Belial.

(Seal in Copper.) **DUKES.**—(2.) Agares; (6.) Valefor; (8.) Barbatos; (11.) Gusion; (15.) Eligos; (16.) Zepar; (18.) Bathin; (19.) Sallos; (23.) Aim; (26.) Buné; (28.) Berith; (29.) Astaroth; (41.) Focalor; (42.) Vepar; (47.) Vual; (49.) Crocell; (52.) Alloces; (54.) Murmur; (56.) Gremory; (60.) Vapula; (64.) Haures; (67.) Amdusias; (71.) Dantalion.

(Seal in Tin) **PRINCES and PRELATES.**—(3.) Vassago; (12.) Sitri; (22.) Ipos; (33.) Gäap; (36.) Stolas; (55.) Orobas; (70.) Seere.

(Seal in Silver.) **MARQUISES.**—(4.) Samigina; (7.) Amon; (14.) Lerajé; (24.) Naberius; (27.) Ronové; (30.) Forneus; (35.) Marchosias; (37.) Phenex; (43.) Sabnock; (44.) Shax; (59.) Orias; (63.) Andras; (65.) Andrealphus; (66) Cimeies; (69.) Decarabia. (Seal in Mercury.)

PRESIDENTS.—(5.) Marbas; (10.) Buer; (17.) Botis; (21.) Marax; (25.) Glasya-Labolas; (31.) Foras; (33.) Gäap; (39.) Malphas; (48.) Häagenti; (53.) Caim; (57.) Osé; (58.) Amy; (61.) Zagan; (62.) Valac.

(Seal in Copper and Silver alike equal.) **EARLS, or COUNTS.**—(17.) Botis; (21.) Marax; (25.) Glasya-Labolas; (27.) Renové; (34.) Furfur; (38.) Halphas; (40.) Raum; (45.) Vine; (46.) Bifrons; (72.) Andromalius.

(Seal in Lead.) **KNIGHTS.**—(50.) Fucas.

THE MAGICAL CIRCLE*

A figure of the Circle of Solomon that he made to preserve himself from the malice of those Evil Spirits, & etc.

This Circle is to be made 9 foot over & these names round it in

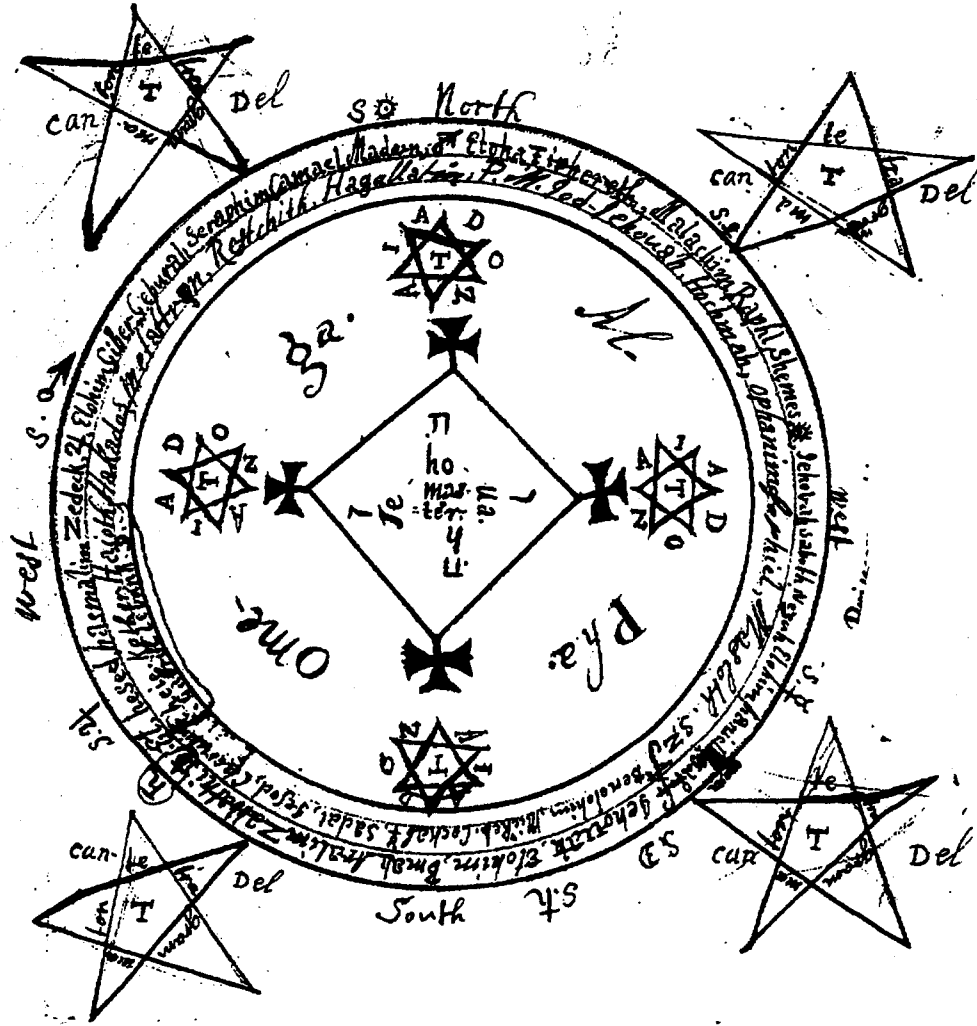

one line beginning at EHEIE (inner circle) & so on to this "F" marke, then come in at (outer circle) Jehovah Elohim, & from there to hod: & Benelohim (sic) & then to Levanah: & C & etc.

* The circle shown here is from the Sloane 2731 manuscript. Crowley shows a different version in his Goetia. Also see the O.T.A.'s Rectified Goetia/Almadel Magick Circle in Appendix 3. -- Thabion

THE HEXAGRAM OF SOLOMON

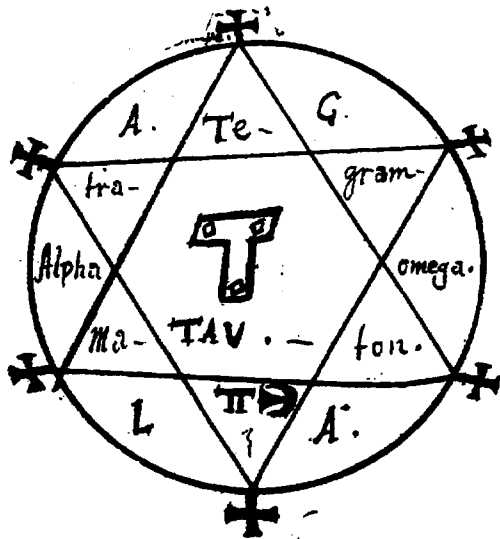

THIS is the form of the Hexagram of Solomon, the figure whereof is to be made on parchment of a calf's skin, and worn at the skirt of thy white vestment, and covered with a cloth of fine linen white and pure, the which is to be shown unto the Spirits when they do appear, so that they will be compelled to take human shape upon them and be obedient.

THE PENTAGRAM OF SOLOMON

THIS is the Form of the Pentagram of Solomon, the figure whereof is to be made in Sol or Luna (Gold or Silver*) and worn upon thy breast; having the Seal of the Spirit required upon the other side thereof. It is to preserve thee from danger, and also to command the Spirits by.

* More correctly upon the metal appropriate to the Spirit's Rank. The Pentagram may be then be drawn on parchment and glued to the back of the Spirit's lamen -- Thabion

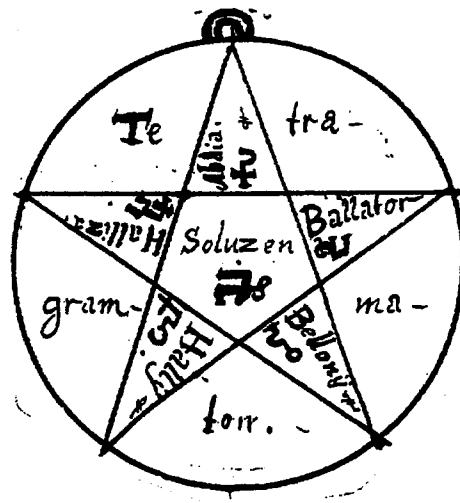

SOLOMON'S MAGICALL RING

This is the Form of the Magic Ring of Solomon, to be made in ☉ (silver) or ☼ (gold). It is to be held before the face of the exorcist to preserve him from the stinking sulphurous fumes and flaming breath of the Evil Spirits.*

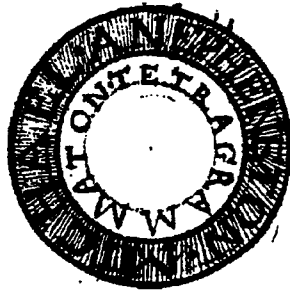

- * Outer ring reads: "MICHAEL • ANEPHENETON • "
Silver is more appropriate than gold. We also place an amethyst in the center (see The Magick of Solomon video). -- Thabion

THE SECRET SEAL OF SOLOMON.³

This is the Form of the Secret Seal of Solomon, wherewith he did bind and seal up the aforesaid Spirits with their legions in the Vessel of Brass. This seal is to be made by one that is clean both inwardly and outwardly, and that hath not defiled himself by any woman ** in the space of a month, but hath in prayer and fasting desired of God to forgive him all his sins, etc. It is to be made on the day of Mars or Saturn (Tuesday or Saturday) at

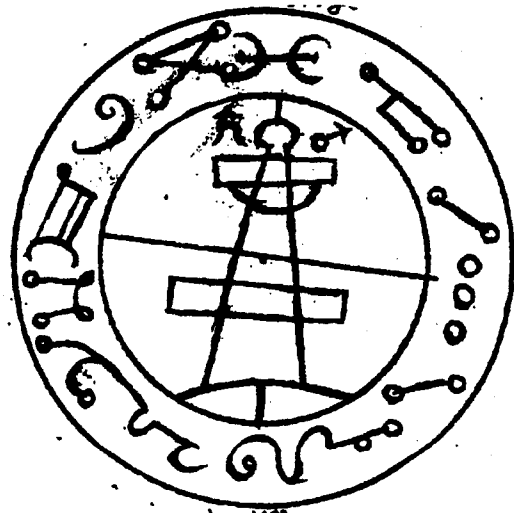

** Nowadays we would be more apt to do the exact opposite and consecrate it with the effluvium. -- Thabion

night at 12 o'clock, and written upon virgin parchment with the blood of a black cock that never trode hen. Note that on this night the moon must be increasing in light (i.e. going from new to full) and in the Zodiacal Sign of Virgo. And when the seal is so made thou shalt perfume it with alum, raisins dried in the sun, dates, cedar, and lignum aloes.

Also by this seal King Solomon did command all the aforesaid Spirits into the Vessel of Brass, and did seal it up with this same seal. He by it gained the love of all manner of persons, and overcame in battle, for neither weapons, nor fire, nor water could hurt him. And this privy seal was made to cover the vessel at the top withal, etc.

THE VESSEL OF BRASS.⁴

The Form of the Brazen Vessel that Solomon shut up the Spirits in. The Spirit's Seals (sic) Aforesaid was made in brass; to cover this vessel with at top & etc.

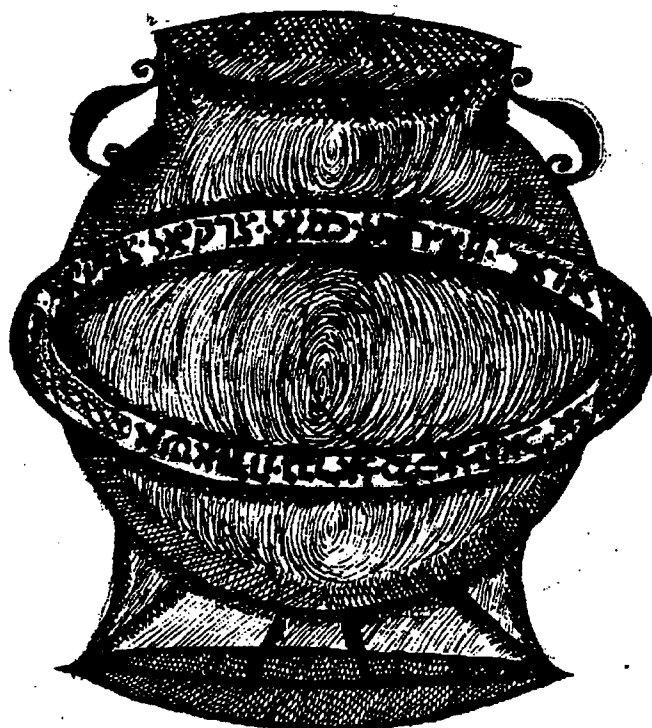

THE OTHER MAGICAL REQUISITES

The other magical requisites are: a sceptre, a sword, a mitre, a cap, a long white robe of linen, * and other garments for the purpose; also a girdle of lion's skin three inches broad, with all the names written about it which be round the outmost part of the Magical Circle. Also perfumes, and a chafing-dish of charcoal kindled to put the fumes on, to smoke or perfume the place appointed for action; also anointing oil to anoint thy temples and thine eyes with; and fair water to wash thyself in. And in so doing, thou shalt say as David said:

THE ADORATION AT THE BATH.

“Thou shalt purge me with hyssop, O Lord! and I shall be clean: Thou shalt wash me, and I shall be whiter than snow.”
And at the putting on of thy garments thou shalt say:

THE ADORATION AT THE INDUING OF THE VESTMENTS.

“By the figurative mystery of these holy vestures (or of this holy vestment) I will clothe me with the armour of salvation in the strength of the Most High, ANCOR; AMACOR; AMIDES; THEODONIAS; ANITOR; that my desired end may be effected through Thy strength, O ADONAI ! unto Whom the praise and glory will for ever and ever belong ! Amen !”

After thou hast so done, make prayers unto God according unto thy work, as Solomon hath commanded.

* A black or midnight blue robe with a matching hood is better for group work because it does not reflect light. -- Thabion.

Additional Notes on following page . . .

Notes on Goetia Instructions:

1. The instructions in the preceding paragraph are unnecessary and are not even heeded by modern magicians who follow the day-and-night progression. Remember, the moon should be waxing or full. This is the only really important time constraint. -- Thabion.
2. Crowley's note:— "It will be remarked that several among the above Spirits possess two titles of different ranks: e.g. (45.) Vine is both King and Earl; (25.) Glasya-Labolas is both President and Earl, etc. "Prince" and "Prelate" are apparently used as interchangeable terms. Probably the Seals of Earls should be made in Iron, and those of Presidents in mixture either of Copper and Silver, or of Silver and Mercury; as otherwise the Metal of one Planet, Mars, is excluded from the List; the Metals attributed to the Seven Planets being: to Saturn, Lead; to Jupiter, Tin; to Mars, Iron; to the Sun, Gold; to Venus, Copper; to Mercury, Mercury and mixtures of Metals, and to Luna, Silver." -- A.C.
- 2a. To the preceding we should add that these "Ranks" and lamen metals are what determine the kabbalistic sphere (within Yesod) wherein the Spirit resides. In a fully rectified Goetia where the Spirits are directly attributed to the Planetary rulers of the Decans (see *Documentary Appendix*) there would be six solar spirits, six lunar spirits and twelve spirits for each planet. I believe this was what was originally intended when the system was first conceived; but after a thousand years of bootleg copying and re-copying, what has come down to us is a hodge-podge. -- Thabion.
3. This is the Magick Circle from the original Sloane MS. See Crowley's GOETIA for the "Coiled Serpent" version and our *Appendix 3* for the O.T. A. version. -- Thabion.
4. The Vessel of Brass, in various forms, was sometimes used as a conjuration device. There are a number of ways this could have been done: it could have been highly polished as a form of speculum; it could be opened to form a polished or painted skrying bowl, perhaps filled with water or ink. It might even have been used as a smudge pot. In hypnotic dark mirror Goetia, we use it to contain 72 parchment sigils of the spirits with the Secret Seal facing downward under the lid (see video). The Hebrew (More correctly Phoenician) letters surrounding our rectified Vessel are (reading from right to left):--

שלמה * אל שמאה רפאל מיכאל גבריאל אוריאל
(= Solomon * [Biblical spelling] AL Tetragrammaton Raphael Michael Gabriel Auriel.) Before inscribing your Brass Vessel, convert the Hebrew letters to Phoenician. In this case all letters can be either red, black or engraved.

The Seventy-two Spirits of the Brass Vessel

(1.) BAEI.—The First Principal Spirit is a King ruling in the East, called Bael. He maketh thee to go Invisible. He ruleth over 66 Legions of Infernal Spirits. He appeareth in divers shapes, sometimes like a Cat, sometimes like a Toad, and sometimes like a Man, and sometimes all these forms at once. He speaketh hoarsely. This is his character which is used to be worn as a Lamen before him who calleth him forth, or else he will not do thee homage.

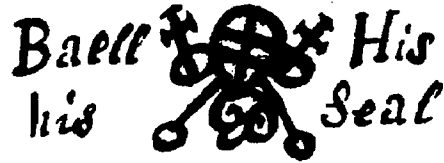

Sign: Υ , 0° - 4° , Mar 21 - 25. Decan: Υ ♂ . Rank: King = \odot , Ruler: Goap, Shem: Vehuiah, Arch: Michael, Orig: — *Ba'al* (Canaanite) Thunder God, Consort of # 36 Astaroth/Astarte. In this position Ba'al presides over the Vernal Equinox *Nuptiae* Rites of the ancient Canaanite/Phoenician *Hieros Gamos* (Sacred marriage) to His Consort, the Goddess Astarte.

(2.) AGARES. — The Second Spirit is a Duke called Agreas, or Agares. He is under the Power of the East, and cometh up in the form of an old fair Man, riding upon a Crocodile, carrying a Goshawk upon his fist, and yet mild in appearance. He maketh them to run that stand still, and bringeth back runaways. He teaches all Languages or Tongues presently. He hath power also to destroy Dignities both Spiritual and Temporal, and causeth Earthquakes. He was of the Order of Virtues. He hath under

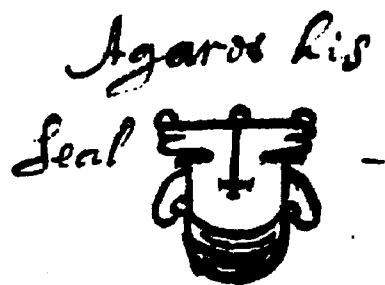

his government 31 Legions of Spirits. And this is his Seal or Character which thou shalt wear as a Lamén before thee.

Sign: Υ , 5^o- 9^o, Mar 25 - 29. Decan: $\Upsilon\text{♂}$. Rank: Duke = ♀, Ruler: Goap, Shem: Ieliel, Arch: Michael, Orig: Fallen Angel; Order of Virtues.

(3.) VASSAGO.—The Third Spirit is a Mighty being of the same nature as Agares. He is called Vassago. This Spirit is of a Good Nature, and his office is to declare things Past and to Come, and to discover all things Hid or Lost. And he governeth 26 Legions of Spirits, and this is his Seal.



Sign: Υ , 10^o- 14^o, Mar 30 - Apl 3. Decan: $\Omega \odot$. Rank: Prince = ♃, Ruler: Goap, Shem: Sitael, Arch: Michael, Orig: Probably same as Agares.

(4.) SAMIGINA, or GAMIGIN.—The Fourth Spirit is Samigina, a Great Marquis. He appeareth in the form of a little Horse or Ass, and then into Human shape doth he change himself at the request of the Master. He speaketh with a hoarse voice. He ruleth over 30 Legions of Inferiors. He teaches all Liberal Sciences, and giveth account of Dead Souls that died in sin. And his Seal is this, which is to be worn before the Magician when he is Invocator, etc.



Sign: Υ , 15^o- 19^o, Apl 4 - 8. Decan: $\Omega \odot$. Rank: Marquis = ♄, Ruler: Goap, Shem: Elemiah, Arch: Michael, Orig: ?

(5.) MARBAS.—The fifth Spirit is Marbas. He is a Great President, and appeareth at first in the form of a Great Lion, but afterwards, at the request of the Master, he putteth on Human Shape. He answereth truly of things Hidden or Secret. He causeth Diseases and cureth them. Again, he giveth great Wisdom and Knowledge in Mechanical Arts; and can change men into other shapes. He governeth 36 Legions of Spirits. And his Seal is this, which is to be worn as aforesaid.



Sign: ♄, 20°- 24°, Apl 9 - 14. Decan: ♄ ♄. Rank: President = ♀,
 Ruler: Goap, Shem: Mehasiah, Arch: Michael, Orig: — *Kusor wa-Hasis* (Canaanite), Tubal Cain (Biblical), Vulcan (Classical).
 Mercurial Blacksmith-Craftsman God.

(6.) VALEFOR.—The Sixth Spirit is Valefor. He is a mighty Duke, and appeareth in the shape of a Lion with an Ass's Head, bellowing. He is a good Familiar, but tempteth them he is a familiar of to steal. He governeth 10 Legions of Spirits. His Seal is this, which is to be worn, whether thou wilt have him for a Familiar, or not.



Sign: ♄, 25°- 29°, Apl 15 - 19. Decan: ♄ ♄. Rank: Duke = ♀,
 Ruler: Goap, Shem: Lelahel, Arch: Michael, Orig: ?

(7.) AMON.—The Seventh Spirit is Amon. He is a Marquis great in power, and most stern. He appeareth like a Wolf with a

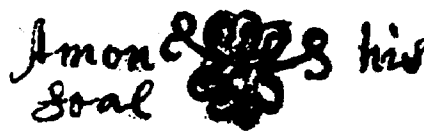

Serpent's tail; vomiting out of his mouth flames of fire; but at the command of the Magician he putteth on the shape of a Man with

Dog's teeth beset in a head like a Raven; or else like a Man with a Raven 's head (simply). He telleth all things Past and to Come. He procureth feuds and reconcileth controversies between friends. He governeth 40 Legions of Spirits. His Seal is this which is to be worn as aforesaid, etc.

Sign: ☿, 0°- 4°, Apl 20 - 24. Decan: ☿ ♀. Rank: Marquis = ☉,
 Ruler: Ziminiar, Shem: Akaiah, Arch: Auriel, Orig:— *Amon*
 (Egyptian) "The Hidden God", later combined with Ra to become
Amon-Ra.

(8.) BARBATOS.—The Eighth Spirit is Barbatos. He is a Great Duke, and appeareth when the Sun is in Sagittary, with four noble Kings and their companies of great troops. He giveth understanding of the Singing of Birds, and of the Voices of other creatures, such as the barking of Dogs. He breaketh the Hidden Treasures open that have been laid by the Enchantments of Magicians. He is of the Order of Virtues, of which some part he retaineth still; and he knoweth all things Past, and to come, and conciliateth Friends and those that be in Power. He ruleth over 30 Legions of Spirits. His Seal of Obedience is this, the which wear before thee as aforesaid.

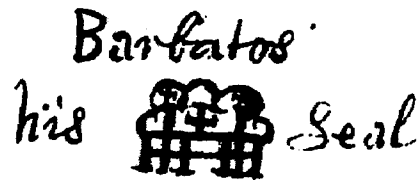

Sign: ☿, 5°- 9°, Apl 25 - 29. Decan: ☿ ♀. Rank: Duke = ♀,
 Ruler: Ziminiar, Shem: Cahethel, Arch: Auriel, Orig: Fallen
 Angel; Order of Virtues. A good spirit.

(9) PAIMON.—The Ninth Spirit in this Order is Paimon, a Great King, and very obedient unto LUCIFER. He appeareth in the form of a Man sitting upon a Dromedary with a Crown most glorious upon his head.

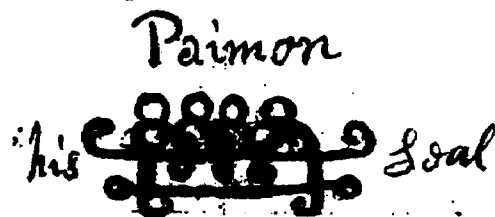

There goeth before him also an Host of Spirits, like Men with Trumpets and well sounding Cymbals, and all other sorts of Musical Instruments. He hath a great Voice, and roareth at his first coming, and his speech is such that the Magician cannot well understand unless he can compel him. This Spirit can teach all Arts and Sciences, and other secret things. He can discover unto thee what the Earth is, and what holdeth it up in the Waters; and what Mind is, and where it is; or any other thing thou mayest desire to know. He giveth Dignity, and confirmeth the same. He bindeth or maketh any man subject unto the Magician if he so desire it. He giveth good Familiars, and such as can teach all Arts. He is to be observed towards the West. He is of the Order of Dominations. He hath under him 200 Legions of Spirits, and part of them are (were) of the Order of Angels, and the other part of Potentates. Now if thou callest this Spirit Paimon alone, thou must make him some offering; and there will attend him two Kings, called LABAL and ABALIM, and also other Spirits who be of the Order of Potentates in his Host, and 25 Legions. And those Spirits which be subject unto them are not always with them unless the Magician do compel them. His Character is this which must be worn as a Lamén before thee, etc.

Sign: ☿, 10° - 14°, Apl 30 - May 4. Decan: ☿, Rank: King (Queen) = ☉, Ruler: Ziminiar, Shem: Haziél, Arch: Auriel, Orig: Fallen Angel of the Order of Dominions but probably a Middle Eastern Pagan Goddess. Paimon (pron. "Paymon") means a "tinkling sound", as made by the sistrum of *Isis*. Some accounts show the Spirit appearing as a young woman riding a camel.

(10.) BUER.—The Tenth Spirit is Buer, a Great President. He appeareth in Sagittary, and that is his shape when the Sun is there. He teaches Philosophy, both Moral and Natural, and the Logic

Art, and also the Virtues of all Herbs and Plants. He healeth all distempers in man, and giveth good Familiars. He governeth 50

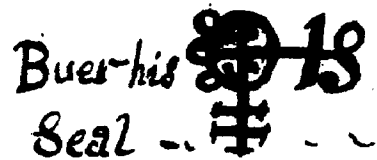

Legions of Spirits, and his Character of obedience is this, which thou must wear when thou callest him forth unto appearance.

Sign: ☿, 15° - 19°, May 5 - 9, Decan: ☿, Rank: President = ☿,
Ruler: Ziminiar, Shem: Aladiah, Arch: Auriel, Orig: ?

(11.) GUSION.—The Eleventh Spirit in order is a great and strong Duke, called Gusion. He appeareth like a Xenophilus. He telleth all things, Past, Present, and to Come, and showeth the meanings and resolution of all questions thou mayest ask. He conciliateth and reconcileth friendships, and giveth Honour and Dignity unto any. He ruleth over 40 Legions of Spirits. His Seal is this, the which wear thou as aforesaid.

Gusion his ¹¹
Seal 

Sign: ☿, 20° - 24°, May 10 - 14, Decan: ☿, Rank: Duke = ☿,
Ruler: Ziminiar, Shem: Lauiah, Arch: Auriel, Orig: ?

(12.) SITRI.—The Twelfth Spirit is Sitri. He is a Great Prince and appeareth at first with a Leopard's head and the Wings of a Gryphon, but after the command of the Master of the Exorcism he putteth on Human shape, and that very beautiful. He enflameth men with Women's love, and Women with Men's love; and causeth them also to show themselves naked if it be desired. He governeth 60 Legions of Spirits. His Seal is this, to beworn as a Lamén before thee, etc.

Sitri his ¹²
Seal 

Sign: ☿, 25° - 29°, May 15 - 19, Decan: ☿, Rank: Prince = ☿,
Ruler: Ziminiar, Shem: Hahaiah, Arch: Auriel, Orig: ?

(13.) BELETH.—The Thirteenth Spirit is called Beleth (or Bileth, or Bilet). He is a mighty King and terrible. He rideth on a pale horse with trumpets and other kinds of musical instruments playing before him. He is very furious at his first appearance, that is, while the Exorcist layeth his courage; for to do this he must hold a Hazel Wand in his hand, striking it out towards the South and East Quarters, make a triangle, Δ , without the Circle, and then command him into it by the Bonds and Charges of Spirits as hereafter followeth. And if he doth not enter into the triangle, Δ , at your threats, rehearse the Bonds and Charms before him, and then he will yield Obedience and come into it, and do what he is commanded by the Exorcist. Yet he must receive him courteously because he is a Great King, and do homage unto him, as the Kings and Princes do that attend upon him. And thou must have always a Silver Ring on the middle finger of the left hand held against thy face, as they do yet before AMAYMON. This Great King Beleth causeth all the love that may be, both of Men and of Women, until the Master Exorcist hath had his desire fulfilled. He is of the Order of Powers, and he governeth 85 Legions of Spirits. His Noble Seal is this, which is to be worn before thee at working.



Sign: II , 0° - 4° , May 21 - 25, Decan: II ♃ , Rank: King = ☉ ,
 Ruler: Amaymon, Shem: Ieazel, Arch: Raphael, Orig: Fallen
 Angel; Order of Powers but probably derived from *Beltiya*,
 "My Lady", generic term for Babylonian Goddesses — also
 possibly the later Roman Bellona who was a Goddess of war.

(14.) LERAJE', or LERAIKHA.—The Fourteenth Spirit is called Lerajé (or Leraie). He is a Marquis Great in Power, showing himself in the likeness of an Archer clad in green, and carrying

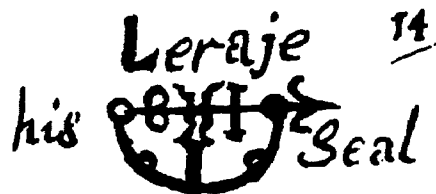

a Bow and Quiver. He causeth all great Battles and Contests; and maketh wounds to putrefy that are made with Arrows by Archers. This belongeth unto Sagittary. He governeth 30 Legions of Spirits, and this is his Seal, etc.

Sign: ♀, 5° - 9°, May 26 - 31, Decan: ♀, Rank: Marquis = Ⓞ,
Ruler: Amaymon, Shem: Mebahel, Arch: Raphael, Orig: ?

(15.) ELIGOS.—The Fifteenth Spirit in Order is Eligos (or Eligor), a Great Duke, and appeareth in the form of a goodly Knight, carrying a Lance, an Ensign, and a Serpent. He discovereth hidden things, and knoweth things to come; and of Wars, and how the Soldiers will or shall meet. He causeth the Love of Lords and Great Persons. He governeth 60 Legions of Spirits. His Seal is this, etc.

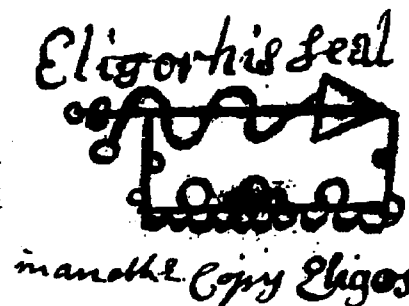

Sign: ♀, 10° - 14°, June 1 - 5, Decan: ♀, Rank: Duke = ♀,
Ruler: Amaymon, Shem: Hariel, Arch: Raphael, Orig: ?

(16.) ZEPAR.—The Sixteenth Spirit is Zepar. He is Great Duke, and appeareth in Red Apparel and Armour, like a Soldier. His office is to cause Women to love Men, and to bring them together in love. He also maketh them barren. He governeth 26 Legions of Inferior Spirits, and his Seal is this, which he obeyeth when he seeth it.

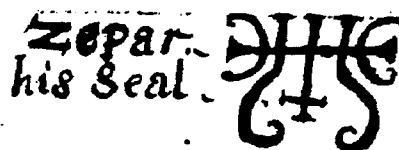

Sign: ♀, 15° - 19°, June 6 - 10, Decan: ♀, Rank: Duke = ♀,
Ruler: Amaymon, Shem: Hakamiah, Arch: Raphael, Orig: ?

(17.) BOTIS.—The Seventeenth Spirit is Botis, a Great President, and an Earl. He appeareth at the first show in the form of an ugly Viper, then at the command of the Magician he putteth on a Human shape with Great Teeth, and two Horns, carrying a bright and sharp Sword in his hand. He telleth all things Past, and to Come, and reconcileth Friends and Foes. He ruleth over 60 Legions of Spirits, and this is his Seal, etc.

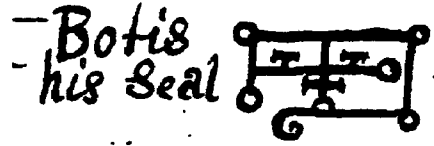

Sign: ♀, 20°- 24°, June 11 - 15, Decan: ♁ ♃, Rank: President & Earl = ☉♁, Ruler: Amaymon, Shem: Leviah, Arch: Raphael, Orig: ?

(18.) BATHIN.—The Eighteenth Spirit is Bathin. He is a Mighty and Strong Duke, and appeareth like a Strong Man with the tail of a Serpent, sitting Upon a Pale-Coloured Horse. He knoweth the Virtues of Herbs and Precious Stones, and can transport men suddenly from one country to another. He ruleth over 30 Legions of Spirits. His Seal is this which is to be worn as aforesaid.

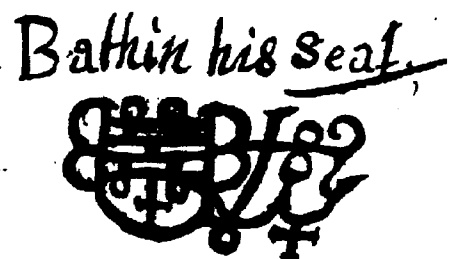

Sign: ♀, 25°- 29°, June 16-21, Decan: ♁ ♃, Rank: Duke = ♁, Ruler: Amaymon, Shem: Caliel, Arch: Raphael, Orig: ? Excellent for long range consciousness projection.

(19.) SALLOS.—The Nineteenth Spirit is Sallos (or Saleos). He is a Great and Mighty Duke, and appeareth in the form of a gallant Soldier riding on a Crocodile, with a Ducal Crown on his head,

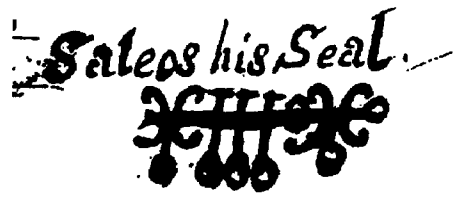

but peaceably. He causeth the Love of Women to Men, and of Men to Women; and governeth 30 Legions of Spirits. His Seal is this, etc.

Sign: ☉, 0°- 4°, June 22 - 26, Decan: ☉ ☾, Rank: Duke = ♀,
Ruler: Corson, Shem: Leuuiah, Arch: Gabriel, Orig: ?

(20.) PURSON.—The Twentieth Spirit is Purson, a Great King. His appearance is comely, like a Man with a Lion's face, carrying a cruel Viper in his hand, and riding upon a Bear. Going before him are many Trumpets sounding. He knoweth



all things hidden, and can discover Treasure, and tell all things Past, Present, and to Come. He can take a Body either Human or Aerial, and answereth truly of all Earthly things both Secret and Divine, and of the Creation of the World. He bringeth forth good Familiars, and under his Government there be 22 Legions of Spirits, partly of the Order of Virtues and partly of the Order of Thrones. His Mark, Seal, or Character is this, unto the which he oweth obedience, and which thou shalt wear in time of action, etc.

Sign: ☉, 5°- 9°, June 27 - July 1, Decan: ☉ ☾, Rank: King = ☉,
Ruler: Corson, Shem: Pahaliah, Arch: Gabriel, Orig: Fallen
Angel; Virtues (5) and Thrones (3) (Heavenly Levels according
to Pseudo-Dionysius).

(21.) MARAX. — The Twenty-first Spirit is Marax. He is a Great Earl and President. He appeareth like a great Bull with a Man's face. His office is to make

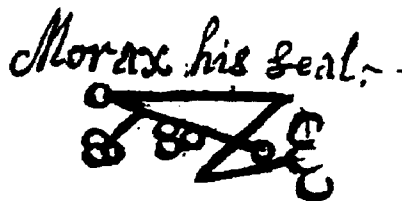

Men very knowing in Astronomy, and all other Liberal Sciences; also he can give good Familiars, and wise, knowing the virtues of Herbs and Stones which be precious. He

governeth 30 Legions of Spirits, and his Seal is this, which must be made and worn as aforesaid, etc.

Sign: ☉, 10°- 14°, July 2 - 7, Decan: ♃, ♂, Rank: Earl & President = ♂ ♀, Ruler: Corson, Shem: Nelkael, Arch: Gabriel, Orig: ?

(22.) IPOS.—The Twenty-second Spirit is Ipos. He is an Earl, and a Mighty Prince, and appeareth in the form of an Angel with a Lion's Head, and a Goose's Foot, and Hares Tail. He knoweth all things Past, Present, and to Come. He maketh men witty and bold. He governeth 36 Legions of Spirits. His Seal is this, which thou shalt wear, etc.



Sign: ☉, 15°- 19°, July 8 - 12, Decan: ♃, ♂, Rank: Prince & Earl = ♃ ♂, Ruler: Corson, Shem: Ieiai, Arch: Gabriel, Orig: ?

(23.) AIM.—The Twenty-third Spirit is Aim. He is a Great Strong Duke. He appeareth in the form of a very handsome Man in body, but with three Heads; the first, like a Serpent, the second like a Man having two Stars on his Forehead, the third like a Calf. He rideth on a Viper, carrying a Firebrand in his Hand, wherewith he setteth cities, castles, and great Places, on fire. He maketh thee witty in all manner of ways, and giveth true answers unto private matters. He governeth 26 Legions of Inferior Spirits; and his Seal is this, which wear thou as aforesaid, etc.

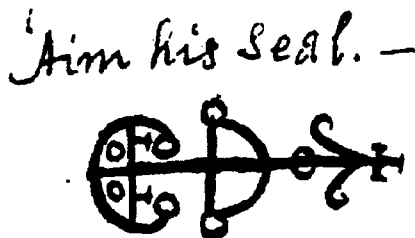

Sign: ☉, 20°- 24°, July 13 - 17, Decan: ♃, ♀, Rank: Duke = ♀, Ruler: Corson, Shem: Melahael, Arch: Gabriel, Orig: ?

(24.) NABERIUS.—The Twenty-fourth Spirit is Naberius. He is a most valiant Marquis, and showeth in the form of a Black Crane, fluttering about the Circle, and when he speaketh it is with a hoarse voice. He maketh men cunning in all Arts and Sciences, but especially in the Art of Rhetoric. He restoreth lost Dignities and Honours. He governeth 19 Legions of Spirits. His Seal is this, which is to be worn, etc.

Naberius his seal, 24



Sign: ☉, 25°- 29°, July 18 - 22, Decan: ☾ ☿, Rank: Marquis = ☉.
Ruler: Corson, Shem: Chahuiiah, Arch: Gabriel, Orig: ?

(25.) GLASYA-LABOLAS —The Twenty-fifth Spirit is Glasya-Labolas. He is a Mighty President and Earl, and showeth himself in the form of a Dog with Wings like a Gryphon. He teacheth all Arts and Sciences in an instant, and is an Author of Bloodshed and Manslaughter. He teacheth all things Past, and to Come. If desired he causeth the love both of Friends and of Foes. He can make a Man to go Invisible. And he hath under his command 36 Legions of Spirits. His Seal is this, to be, etc.

Glasya Labolas his seal.

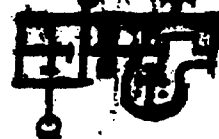

Sign: ♀, 0°- 4°, July 23 - 27, Decan: ♀ ☉, Rank: President & Earl = ♀ ♂,
Ruler: Goap, Shem: Nithaiah, Arch: Michael, Orig: ?

(26.) BUNÉ, or BIMÉ.—The Twenty-sixth Spirit is Buné (or Bimé). He is a Strong, Great and Mighty Duke. He appeareth in the form of a Dragon with three heads, one like a Dog, one like a Gryphon, and one like a Man. He speaketh with a high and comely Voice. He changeth the Place of the Dead, and causeth the Spirits which be under him to gather together upon your Sepulchres. He giveth Riches unto a Man, and maketh him Wise and Eloquent. He giveth true Answers unto Demands. And he governeth 30 Legions of Spirits. His Seal is this, unto the which he oweth Obedience. He hath another Seal but the first is the best.

Bune his seal.

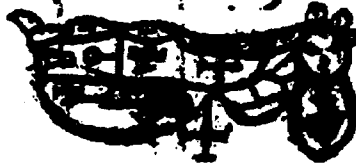

or this



Sign: Ω , 5° - 9° , July 28 - Aug 1, Decan: Ω \odot , Rank: Duke= ♀ .
 Ruler: Goap, Shem: Haaiah, Arch: Michael, Orig: Unknown but might be related to the ancient Egyptian Goddess *Buto*. (This entity always delivers on money requests but not in the most pleasant manner.)

(27.) RONOVE—The Twenty-seventh Spirit is Ronové. He appeareth in the Form of a Monster. He teacheth the Art of Rhetoric very well and giveth Good Servants, Knowledge of Tongues, and Favours with Friends or Foes. He is a Marquis and Great Earl; and there be under his command 19 Legions of Spirits. His Seal is this, etc.

Ronobe his seal. 27

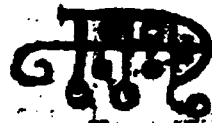

Sign: Ω , 10° - 14° , Aug 2 - 7, Decan: ♁ ♃ , Rank: Marquis & Earl = ♁ ♂ , Ruler: Goap, Shem: Ierathel, Arch: Michael, Orig: ?

(28.) BERITH —The Twenty-eighth Spirit in Order, as Solomon bound them, is named Berith. He is a Mighty, Great, and Terrible Duke. He hath two other Names given unto him by men of later times, viz.: BEALE or BEAL, and BOFRY

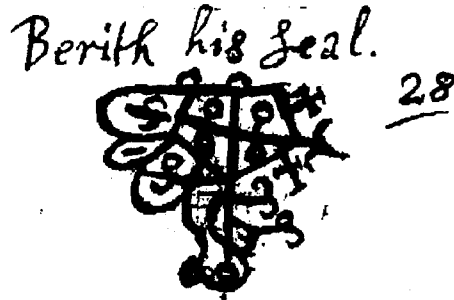

or BOLFRY. He appeareth in the Form of a Soldier with Red Clothing, riding upon a Red Horse, and having a Crown of Gold upon his head. He giveth true answers, Past, Present, and to Come. Thou must make use of a Ring in calling him forth, as is before spoken of regarding Beleth. He can turn all metals into Gold. He can give Dignities, and can confirm them unto Man. He speaketh with a very clear and subtle Voice. He governeth 26 Legions of Spirits. His Seal is this, etc.

Sign: Ω , 15^o- 19^o, Aug 8 - 12, Decan: \nearrow \mathcal{L} , Rank: Duke = ♀,
Ruler: Goap, Shem: Seehiah, Arch: Michael, Orig: ?

(29.³⁶.) * STOLAS, or STOLOS.—The Twenty-ninth (36th) Spirit is Stolas, or Stolos. He is a Great and Powerful Prince, appearing in the Shape of a Mighty Raven at first before the Exorcist; but after he taketh the image of a Man. He teacheth

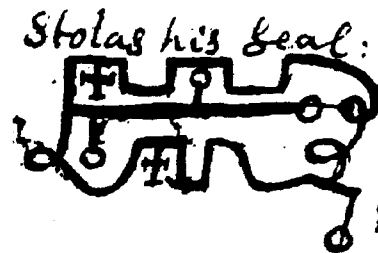

the Art of Astronomy, and the Virtues of Herbs and Precious Stones. He governeth 26 Legions of Spirits; and his Seal is this, which is, etc.

Sign: Ω , 20^o- 24^o, Aug 13 - 17, Decan: ∇ \mathcal{O} , Rank: Prince = \mathcal{L} ,
Ruler: Goap, Shem: Reiel, Arch: Michael, Orig: ?

* In our system Stolas (#36) has changed places with Astaroth (#29).

(30.) FORNEUS.—The Thirtieth Spirit is Forneus. He is a Mighty and Great Marquis, and appeareth in the Form of a Great Sea-Monster. He teacheth, and maketh men wonderfully knowing in the Art of Rhetoric.

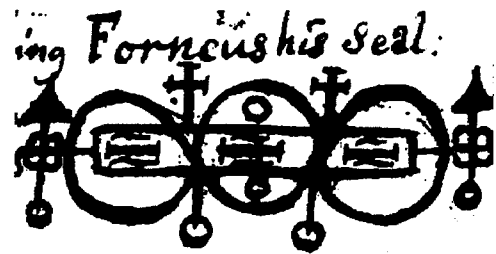

He causeth men to have a Good Name, and to have the knowledge and understanding of Tongues. He maketh one to be beloved of his Foes as well as of his Friends. He governeth 29 Legions of Spirits, partly of the Order of Thrones, and partly of that of Angels. His Seal is this, which wear thou, etc.

Sign: ♁, 25°- 29°, Aug 18 - 22, Decan: √♁♂, Rank: Marquis = Ⓢ,
Ruler: Goap, Shem: Omael, Arch: Michael, Orig: Fallen Angel;
of Thrones (3) and Angels (9) (Heavenly Levels according to
Psuedo-Dionysius).

(31.) FORAS or FORCAS —The Thirty-first Spirit is Foras. He is a Mighty President, and appeareth in the Form of a Strong Man in Human Shape. He can give the understanding to Men how they may know the Virtues of all Herbs and Precious Stones. He teacheth the Arts of



Logic and Ethics in all their parts. If desired he maketh men invisible, (could be “invincible”. See Crowley’s note in his 1904 edition) and to live long, and to be eloquent. He can discover Treasures and recover things Lost. He ruleth over 29 Legions of Spirits, and his Seal is this, which wear thou, etc.

Sign: ♃, 0°- 4°, Aug 23 - 27, Decan: ♃♁♂, Rank: President = Ⓢ,
Ruler: Ziminiar, Shem: Lecabel, Arch: Auriel, Orig: A Fallen Angel
of unknown rank.

(32.) ASMODAY.—The Thirty-second Spirit is Asmoday, or Asmodai (Asmodeus). He is a Great King, Strong, and Powerful. He appeareth with Three Heads, whereof the first is like a Bull, the second like a Man, and the third like a Ram; he hath also the tail of a Serpent, and from his mouth issue Flames of Fire.

Asmoday's Seal:



His Feet are webbed like those of a Goose. He sitteth upon an Infernal Dragon, and beareth in his hand a Lance with a Banner. He is first and choicest under the Power of AMAYMON, he goeth before all other. When the Exorcist hath a mind to call him, let it be abroad, and let him stand on his feet all the time of action, with his Cap or Headdress off; for if it be on, AMAYMON will deceive him and call all his actions to be bewrayed. But as soon as the Exorcist seeth Asmoday in the shape aforesaid, he shall call him by his Name, saying: "Art thou Asmoday?" and he will not deny it, and by-and-by he will bow down unto the ground. He giveth the Ring of Virtues; he teacheth the Arts of Arithmetic, Astronomy, Geometry, and all handicrafts absolutely. He giveth true and full answers unto thy demands. He maketh one Invincible. He showeth the place where Treasures lie, and guardeth it. He, amongst the Legions of AMAYMON, governeth 72 Legions of Spirits Inferior. His Seal is this which thou must wear as a Lamén upon thy breast, etc.

Sign: M , 5° - 9° , Aug 28 - Sept 1, Decan: M ☿, Rank: King = ☉,
 Ruler: Ziminiar, Shem: Vasariah, Arch: Auriel, Orig: Ancient Persian demon adopted by the Hebrews. Said to be the incestuous offspring of *Tubal-Cain* and his sister, *Naamah*. Several of the legends of King Solomon's magick involve Asmodeus. . . Because of his math skills I once evoked him to help me in a statistics course. I got an 'A' on the mid-term but flunked the final. (Asmoday is also "the demon of confusion. . .") Our first High Priestess wanted me to evoke him for her but he refused to appear in the mirror. It was one of my first operations and I did not banish as well as I should have. Four hours later she woke up with a start, seeing him on the ceiling over her bed. A hasty exorcism solved the problem and we learned a valuable lesson: Don't ever assume a spirit hasn't arrived just because you can't see it.

(33.) GÄAP.—The Thirty-third Spirit is Gäap. He is a Great President and a Mighty Prince. He appeareth when the Sun is in some of the Southern Signs, in a Human Shape, going before Four Great and Mighty Kings, as if he were a Guide to conduct them along on their way. His office is to make men

Insensible or Ignorant; as also in Philosophy to make them Knowing, and in all the Liberal Sciences. He can cause Love or Hatred, also he can teach thee to consecrate those things that belong to the Dominion of AMAYMON his King. He can deliver Familiars out of the Custody of other Magicians, and answereth truly and perfectly of things Past, Present, and to Come. He can carry and re-carry men very speedily from one Kingdom to another, at the Will and Pleasure of the Exorcist. He ruleth over 66 Legions of Spirits, and he was of the Order of Potentates. His Seal is this to be made and to be worn as aforesaid, etc.

Gäap; his Seal,

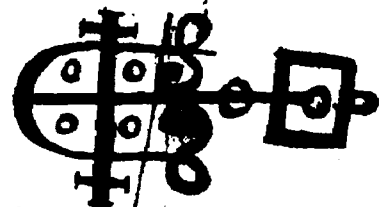

Sign: III , 10° - 14° , Sept 2 - 7, Decan: Z h , Rank: President & Prince = Z h , Ruler: Ziminiar, Shem: Iechuiah, Arch: Auriel, Orig: Fallen Angel, Order of Potentates (Powers). Heavenly Level 6.

(34.) FURFUR.—The Thirty-fourth Spirit is Furfur. He is a Great and Mighty Earl, appearing in the Form of an Hart with a Fiery Tail. He never speaketh truth unless he be compelled, or brought up within a triangle, Δ .

Being therein, he will take upon himself the Form of an Angel. Being bidden, he speaketh with a hoarse voice. Also he will wittingly urge Love between Man and Woman. He can raise Lightnings and

Furfur his Seal



Thunders, Blasts, and Great Tempestuous Storms. And he giveth True Answers both of Things Secret and Divine, if commanded. He ruleth over 26 Legions of Spirits. And his Seal is this, etc.

Sign: ☉, 15°- 19°, Sept 8 - 12, Decan: ⚡, Rank: Earl = ♂, Ruler: Ziminiar, Shem: Lehachiah, Arch: Auriel, Orig: ?

(35.) MARCHOSIAS.— The Thirty-fifth Spirit is Marchosias. He is a Great and Mighty Marquis, appearing at first in the Form of a Wolf having Gryphon's Wings, and a Serpent 's Tail, and Vomiting Fire out of his mouth. But after a time, at the command of the Exorcist, he putteth on the Shape of a Man. And he is a strong fighter. He was of the Order of Dominations. He governeth 30 Legions of Spirits. He told his Chief, who was Solomon, that after 1, 200 years he had hopes to return unto the Seventh Throne. And his Seal, is this, to be made and worn as a Lamén, etc.

Marchosias his Seal;

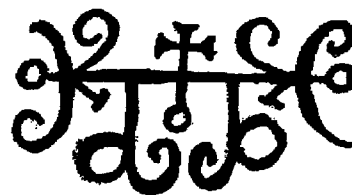

(Restored from the original)

Sign: ☉, 20°- 24°, Sept 13 - 17, Decan: ♂♀, Rank: Marquis = ♂, Ruler: Ziminiar, Shem: Kavakiah, Arch: Auriel, Orig: Fallen Angel, from Order of Dominations. (This spirit may have been counting Heavenly Thrones up from the bottom, in which case, according to St. Ambrose's hierarchy, Dominations (3) would be the Seventh Level.)

(36.) ASTAROTH.*—The Thirty-sixth Spirit is Astaroth. He is a Mighty, Strong Duke, and appeareth in the Form of an hurtful Angel riding on an Infernal Beast like a Dragon, and carrying in his right hand a Viper. Thou must in no wise let him approach too near unto thee, lest he do thee damage by his Noisome Breath. Wherefore the Magician must hold the Magical Ring

near his face, and that will defend him. He giveth true answers of things Past, Present, and to Come, and can discover all Secrets. He will declare wittingly how the Spirits fell, if desired, and the reason of His own fall. He can make men wonderfully knowing in all Liberal Sciences. He ruleth 40 Legions of Spirits. His Seal is this, which wear thou as a Lamén before thee, or else he will not appear nor yet obey thee, etc.

Astaroth's Seal:

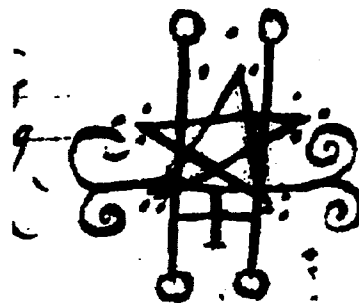

Sign: ♀, 25°- 29°, Sept 18 - 22, Decan: ♀ ♀, Rank: Duke = ♀, Ruler: Ziminiar, Shem: Monadel, Arch: Auriel, Orig: Canaanite and Phoenician Goddess *Astarte*, consort of *Ba'al* (Bael # 1.). She is placed in slot #36 presiding over the Autumnal Equinox in the sign of Virgo, Harvest Goddess of the Earth. In ancient times *Astarte* descended from Heaven down to the Underworld to resurrect the dead Prince *Ba'al* at Autumn Equinox in *The Festival of Seven Gates*. This was the original "Dance of the Seven Veils" later attributed to Princess *Salome* in the Bible.

(37.) PHENEX.—The Thirty-Seventh Spirit is Phenex (or Pheynix). He is a great Marquis, and appeareth like the Bird Phoenix, having the Voice of a Child. He singeth many sweet notes before the Exorcist, which he must not regard, but by-and-by he must bid him put on Human Shape. Then he will speak marvelously of all wonderful Sciences if required. He is a Poet, good and excellent. And he will be willing to perform thy requests. He hath hopes also to return to the Seventh Throne after 1, 200 years more, as he said unto Solomon. He governeth 20 Legions of Spirits. And his Seal is this, which wear thou, etc.

Phoenix's Seal:

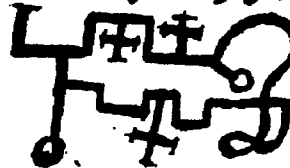

Sign: ♄, 0°- 4°, Sept 23 - 27, Decan: ♄ ♀, Rank: Marquis = ♄, Ruler: Amaymon, Shem: Aniel, Arch: Raphael, Orig: Ancient Egyptian *Benu* bird (Phoenix). Also a Fallen Angel, probably from the Order of Dominations as was *Marchosias*.

(38.) HALPHAS, or MALTHUS.—The Thirty-eighth Spirit is Halphas, or Malthous (or Malthas). He is a Great Earl, and appeareth in the form of a Stock-Dove. He speaketh with a hoarse Voice. His Office is to build up Towers, and to furnish them with Ammunition and Weapons, and to send Men-of-War to places appointed. He ruleth over 26 Legions of Spirits, and his Seal is this, etc.

Halphas his seal:

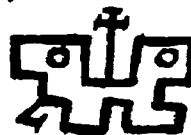

Sign: ♃, 5^o- 9^o, Sept 28 - Oct 2, Decan: ♃ ♀, Rank: Earl = ♂,
Ruler: Amaymon, Shem: Chaamiah, Arch: Raphael, Orig: ?

(39.) MALPHAS.—The Thirty-ninth Spirit is Malphas. He appeareth at first like a Crow, but after he will put on Human Shape at the request of the Exorcist, and speak with a hoarse Voice. He is a Mighty President and Powerful. He can build Houses and High Towers, and can bring to thy Knowledge Enemies' Desires and Thoughts, and that which they have done. He giveth Good Familiars. If thou makest a Sacrifice unto him he will receive it kindly and willingly, but he will deceive him that doth it. He governeth 40 Legions of Spirits, and his Seal is this, etc.

Malphas his seal:

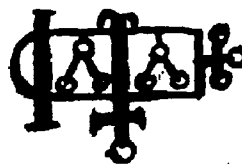

Sign: ♃, 10^o- 14^o, Oct 3 - 7, Decan: ♃ ♀, Rank: President = ♀,
Ruler: Amaymon, Shem: Rehael, Arch: Raphael, Orig: ?

(40.) RAUM.—The Fortieth Spirit is Raum. He is a Great Earl; and appeareth at first in the Form of a Crow, but after the Command of the Exorcist he putteth on Human Shape. His office is to steal

Raum his seal.



Treasures out of King's Houses, and to carry it whither he is commanded, and to destroy Cities and Dignities of Men, and to tell all things, Past, and What Is, and what Will Be; and to cause Love between Friends and Foes. He was of the Order of Thrones. He governeth 30 Legions of Spirits; and his Seal is this, which wear thou as aforesaid.

Sign: ♁, 15°- 19°, Oct 8 - 12, Decan: ♁ ♃, Rank: Earl = ♂,
 Ruler: Amaymon, Shem: Ihiazel, Arch: Raphael, Orig: Fallen Angel;
 Order of Thrones.

(41.) FOCALOR.—The Forty-first Spirit is Focalor, or Forcalor, or Furcalor. He is a Mighty Duke and Strong. He appeareth in the Form of a Man with Gryphon's Wings. His office is to slay Men, and to drown them in the Waters, and to overthrow Ships of War, for he hath Power over both Winds and Seas; but he will not hurt any man or thing if he be commanded to the contrary by the Exorcist. He also hath hopes to return to the Seventh Throne after 1,000 years. He governeth 30 Legions of Spirits, and his Seal is this, etc.

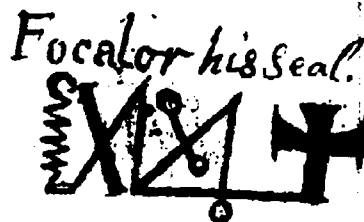

Sign: ♁, 20°- 24°, Oct 13 - 17, Decan: ♁ ♃, Rank: Duke = ♀,
 Ruler: Amaymon, Shem: Hahahel, Arch: Raphael, Orig:
 Fallen Angel; Order of Thrones.

(42) VEPAR.—The Forty-second Spirit is Vepar, or Vephar. He is a Duke Great and Strong and appeareth like a Mermaid. His office is to govern the Waters, and to guide Ships laden with Arms, Armour, and Ammuni-

tion, etc., thereon. And at the request of the Exorcist he can cause the seas to be right stormy and to appear full of ships. Also he maketh men to die in Three Days by Putrefying Wounds or Sores, and causing Worms to breed in them. He governeth 29 Legions of Spirits, and his Seal is this, etc.

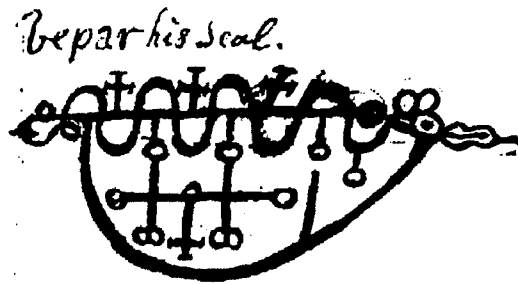

(Partially restored from original)

Sign: ☾, 25° - 29°, Oct 18 - 22, Decan: ☾ ♀, Rank: Duke = ♀, Ruler: Amaymon, Shem: Mikael, Arch: Raphael, Orig: ?

(43.) SABNOCK.—The Forty-third Spirit, as King Solomon commanded them into the Vessel of Brass, is called Sabnock, or Savnok.

He is a Marquis, Mighty, Great and Strong, appearing in the Form of an Armed Soldier with a Lion's Head, riding on a pale-coloured

Sabnack his Seal.

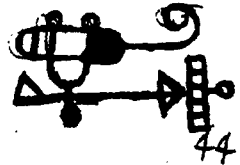

horse. His office is to build high Towers, Castles and Cities, and to furnish them with Armour, etc. Also he can afflict Men for many days with Wounds and with Sores rotten and full of Worms. He giveth Good Familiars at the request of the Exorcist. He commandeth 50 Legions of Spirits; and his Seal is this, etc.

Sign: ♀, 0° - 4°, Oct 24 - 27, Decan: ♀ ♂ Rank: Marquis = ♂, Ruler: Corson, Shem: Vevaliah, Arch: Gabriel, Orig: May derive from the "Reporbated Angel Saboac", one of Seven High Angels desanctified by the Roman Church in 745 A.D. (along with Uriel or Auriel, our traditional guardian of the Northern Quadrant).

(44.) SHAX.—The Forty-fourth Spirit is Shax, or Shaz (or Shass). He is a Great Marquis and appeareth in the Form of a Stock-Dove, speaking with a voice hoarse, but yet subtle. His Office is to

Shax his Seal.



take away the Sight,

Hearing,

or Understanding of any

Man or Woman at the command of the Exorcist; and to steal money out of the houses of Kings, and to carry it again in 1,200 years. If commanded he will fetch Horses at the request of the Exorcist, or any other thing.

But he must first be commanded into a Triangle, Δ, or else he will deceive him, and tell him many Lies. He can discover all things that are Hidden, and not kept by Wicked Spirits. He giveth good Familiars, sometimes. He governeth 30 Legions of Spirits, and his Seal is this, etc.

Sign: ♁, 5^o - 9^o, Oct 28 - Nov 1, Decan: ♁, ♂, Rank: Marquis = ☉,
Ruler: Corson, Shem: Ielahiah, Arch: Gabriel, Orig: ?

(45.) VINÉ—The Forty-fifth Spirit is Viné or Vinea. He is a Great King, and an Earl; and appeareth in the Form of a Lion, riding upon a Black Horse, and bearing a Viper in his hand. His Office

*Vine his Seal.*⁴⁵



is to discover Things Hidden, Witches, Wizards, and Things Present, Past, and to Come. He, at the command of the Exorcist will build Towers, overthrow Great Stone Walls, and make the Waters rough with Storms. He governeth 36 Legions of Spirits. And his Seal is this, which wear thou, as aforesaid, etc.

Sign: ♁, 10^o - 14^o, Nov 2 - 6, Decan: ♁, ♃, Rank: King = ☉,
Ruler: Corson, Shem: Sealiah, Arch: Gabriel, Orig: ?

(46.) BIFRONS.—The Forty-sixth Spirit is called Bifrons, or Bifröus, or Bifrovs. He is an Earl, and appeareth in the Form of a Monster; but after a while, at the Command of the Exorcist, he putteth on the shape of a Man. His Office is to make one knowing in Astrology, Geometry, and other Arts and Sciences. He teacheth the Virtues of Precious Stones and Woods. He changeth Dead Bodies, and putteth them in another place; also he lighteth seeming Candles upon the Graves of the Dead. He hath under his Command 6(0) Legions of Spirits. His Seal is this, which he will own and submit unto, etc.

Bifrons his seal. 46



Sign: ♁, 15° - 19°, Nov 7 - 12, Decan: ♁, ♃, Rank: Earl = ♂,
Ruler: Corson, Shem: Ariel, Arch: Gabriel, Orig: ?

(47.) UVALL, VUAL, or VOVAL.—The Forty-seventh Spirit Uvall, or Vual, or Voval. He is a Duke, Great, Mighty, and Strong; and appeareth in the Form of a Mighty Dromedary at the first, but after a while at the Command of the Exorcist he putteth on Human Shape, and speaketh the Egyptian Tongue, but not perfectly. His Office is to procure the Love of Woman, and to tell Things Past, Present, and to Come. He also procureth Friendship between Friends and Foes. He was of the Order of Potestates or Powers. He governeth 37 Legions of Spirits, and his Seal is this, to be made and worn before thee, etc.

vual his seal 47

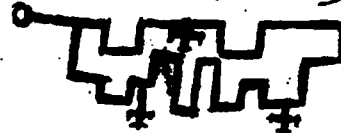

Sign: ♁, 20° - 24°, Nov 13 - 17, Decan: ♁, ☾, Rank: Duke = ♀,
Ruler: Corson, Shem: Asaliah, Arch: Gabriel, Orig: Fallen Angel,
Order of Powers. (Crowley reported that Uvall conversed in Coptic.)

(48.) HAAGENTI.—The Forty-eighth Spirit is Haagenti. He is a President, appearing in the Form of a Mighty Bull with Gryphon's Wings.

This is at first, but after, at the Command of the Exorcist he putteth on Human Shape. His Office is to make Men wise,

and to instruct them in divers things; also to Transmute all Metals into Gold; and to change Wine into Water, and Water into Wine. He governeth 33 Legions of Spirits, and his Seal is this, etc.



Sign: ♄, 25° - 29°, Nov 18 - 22, Decan: ♄, ☉, Rank: President = ♀,
Ruler: Corson, Shem: Mihael, Arch: Gabriel, Orig: ?

(49.) CROCELL.—The Forty-ninth Spirit is Crocell, or Crockel. (PROCEL in Sloane 2731.) He appeareth in the Form of an Angel. He is a Duke Great and Strong, speaking something Mystically of Hidden Things.

He teacheth the Art of Geometry and the Liberal Sciences. He, at the

Command of the Exorcist, will produce Great Noises like the Rushings of many Waters, although there be none. He warmeth Waters, and discovereth Baths. He was of the Order of Potestates, or Powers, before his fall, as he declared unto the King Solomon. He governeth 48 Legions of Spirits. His Seal is this, the which wear thou as aforesaid.



Sign: ♄, 0° - 4°, Nov 24 - 27, Decan: ♄, ♃, Rank: Duke = ♀,
Ruler: Göap, Shem: Vehuel, Arch: Michael, Orig: Fallen Angel;
Order of Powers.

(50.) FURCAS.—The Fiftieth Spirit is Furcas. He is a Knight, and appeareth in the Form of a Cruel Old Man with a long Beard and a hoary Head, riding upon a pale-coloured Horse, with a Sharp Weapon in his hand. His Office is to teach the Arts of Philosophy, Astrology, Rhetoric, Logic, Cheiromancy, and Pyromancy, in all their parts, and perfectly. He hath under his Power 20 Legions of Spirits. His Seal, or Mark, is thus made, etc.

Furcas his Seal.



Sign: ♄, 5° - 9°, Nov 28 - Dec 2, Decan: ♄ ♃, Rank: Knight = ♄, Ruler: Goap, Shem: Daniel, Arch: Michael, Orig: The only Saturnian Spirit in the Brass Vessel. Furcas has attributes of the Greek and Phoenician God, Kronos. (In the fully rectified Goetia there would be 12 Saturnian attributions.)

(51.) BALAM. — The Fifty-first Spirit is Balam or Balaam. He is a Terrible, Great, and Powerful King.

He appeareth with three Heads:

the first is like that of a Bull; the second is like that of a Man; the third is like that of a Ram. He hath the Tail of a Serpent, and Flaming Eyes.

Balam his Seal.



He rideth upon a furious Bear, and carrieth a Boshawk upon his Fist. He speaketh in a hoarse Voice, Giving True Answers of Things Past, Present and to Come. He maketh men to go invisible, and also to be Witty. He governeth 40 Legions of Spirits. His Seal is this, etc.

Sign: ♄, 10° - 14°, Dec 3 - 7, Decan: ♄ ♂, Rank: King = ☉, Ruler: Goap, Shem: Hachasiah, Arch: Michael, Orig: Biblical. Canaanite sorcerer from the Old Testament.

(52.) ALLOCES.—The Fifty-second Spirit is Alloces, Alocas or Allocer. He is a Duke, Great, Mighty, and Strong, appearing in the Form of a Soldier riding upon a Great Horse. His Face is like that of a Lion, very Red, and having Flaming Eyes. He speaketh in a very big, hoarse voice. His Office is to teach the Art of Astronomy, and all the Liberal Sciences. He bringeth unto thee Good Familiars; also he ruleth over 36 Legions of Spirits. His Seal is this, which, etc.

Alloces his Seal.

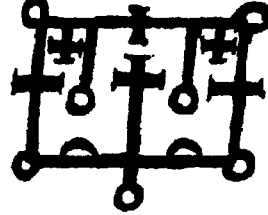

Sign: ♄, 15° - 19°, Dec 8 - 11, Decan: ♄ ♂, Rank: Duke = ♀, Ruler : Göap, Shem: Imamah, Arch: Michael, Orig: ?

(53.) CAMIO or CAIM.—The Fifty-third Spirit is Camio, or Caim. He is a Great President, and appeareth in the Form of the Bird called a Thrush at first, but afterwards he putteth on the Shape of a Man carrying in his Hand a Sharp Sword. He seemeth to answer in Burning Ashes, or in Coals of Fire. He is a Good Disputer. His Office is to give unto Men the Understanding of all Birds, Lowing of Bullocks, Barking of Dogs, and other Creatures; and also of the Voice of the Waters. He giveth True Answers of Things to Come. He was of the Order of Angels, but now ruleth over 30 Legions of Spirits Infernal. His Seal is this, which wear thou, etc.

Caim his Seal.

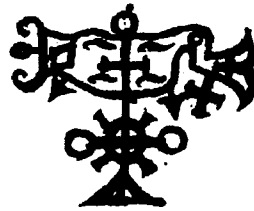

Sign : ♄, 20° - 24°, Dec 12 - 16, Decan: ♄ ☉, Rank: President = ♀, Ruler : Göap, Shem: Nanael, Arch: Michael, Orig: Fallen Angel; Order of Angels (9 = Yesod).

(54.) MURMUR, or MURMUS.—The Fifty-fourth Spirit is called Murmur, or Murmus, or Murmux. He is a Great Duke, and an Earl; and appeareth in the Form of a Warrior riding upon a Gryphon, with a Ducal Crown upon his Head. There do go before him those his Ministers with great Trumpets sounding. His Office is to teach Philosophy perfectly, and to constrain Souls Deceased to come before the Exorcist to answer those questions which he may wish to put to them, if desired. He was partly of the Order of Thrones, and partly of that of Angels. He now ruleth 30 Legions of Spirits. And his Seal is this, etc.

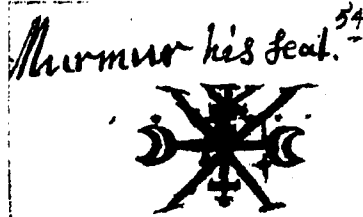

Sign: ♃, 25° - 29°, Dec 17 - 21, Decan: ♃ ☉, Rank: Duke = ♀, Ruler: Goap, Shem: Nithael, Arch: Michael, Orig: Fallen Angel; partly of Thrones (3 = Chesed) and Angels (9 = Yesod). The Patron Demon of Necromancers.

(55.) OROBAS.—The Fifty-fifth Spirit is Orobas. He is a great and Mighty Prince, appearing at first like a Horse; but after the command of the Exorcist he putteth on the Image of a Man. His Office is to discover all things Past, Present, and to Come; also to give Dignities, and Prelacies, and the Favour of Friends and of Foes. He giveth True Answers of Divinity, and of the Creation of the World. He is very faithful unto the Exorcist, and will not suffer him to be tempted of any Spirit. He governeth 20 Legions of Spirits. His Seal is this, etc.

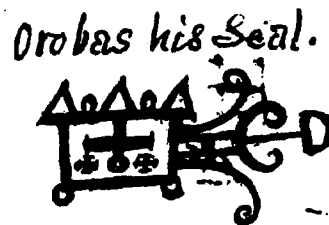

Sign: ♃, 0° - 4°, Dec 22 - 26, Decan: ♃ ♃, Rank : Prince = ♃, Ruler: Ziminiar, Shem: Mebahiah, Arch: Auriel, Orig: ?

(56.) GEMORY, or GAMORI.—The Fifty-sixth Spirit is Gremory, or Gamori. He is a Duke Strong and Powerful, and appeareth in the Form of a Beautiful Woman, with a Duchess's Crown tied about her waist, and riding on a Great Camel. His Office is to tell of all Things Past, Present, and to Come; and of Treasures Hid, and what they lie in; and to procure the Love of Women both Young and Old. He governeth 26 Legions of Spirits, and his Seal is this, etc.



Sign: ♃, 5° - 9°, Dec 27 - 31, Decan: ♃ ♎, Rank: Duke = ♀, Ruler: Ziminiar, Shem: Poiel, Arch: Auriel, Orig: unknown but obviously of a female nature.

(57.) OSÉ, or VOSO.—The Fifty-seventh Spirit is Oso, Osé, or Voso. He is a Great President, and appeareth like a Leopard at the first, but after a little time he putteth on the Shape of a Man. His Office is to make one cunning in the Liberal Sciences, and to give True Answers of Divine and Secret Things; also to change a Man into any Shape that the Exorcist pleaseth, so that he that is so changed will not think any other thing than that he is in verity that Creature or Thing he is changed into. He governeth 30 Legions of Spirits, and this is his Seal, etc.



Sign: ♃, 10° - 14°, Jan 1 - 5, Decan: ♃ ♉, Rank: President = ♀, Ruler: Ziminiar, Shem: Nemamiah, Arch: Auriel, Orig: unknown. The Patron Demon of shape-shifters, werewolves and leopard men. An older Goetia codex (Scot's *The Discoverie of Witchcraft*) warns that Osé brings on madness in the form of delusions of grandure. During an operation

where I acted as receiver, Osé told me that he was "Not an evil spirit but rather a spirit of evil." (See *The Evocation of Nithael.*) In our fully rectified arrangement Ose would be a Mercurial Air Sign. (In this case the 777 assignment falls in the correct triplicity whereas the straight progression does not -- but then exceptions prove the rule.) No matter what slot you put Osé in this entity should not be contacted by inexperienced operators and receivers.

(58.) AMY, or AVNAS.—The Fifty-eighth Spirit is Amy, or Avnas. He is a Great President, and appeareth at first in the Form of a Flaming Fire; but after a while he putteth on the Shape of a Man. His office is to make one Wonderful(ly) Knowing in Astrology and all the Liberal Sciences. He giveth Good Familiars, and can betray (as per Sl. 2731) Treasure that is kept by Spirits. He is partly of the Order of Angels and partly of Potentates (Powers). He hopes to return to the Seventh Throne in 1200 years. He governeth 36 Legions of Spirits, and his Seal is this, etc.

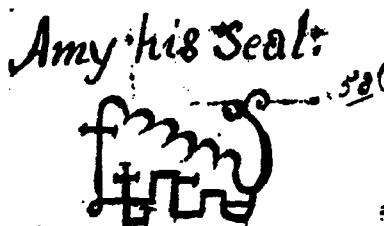

Sign: ♄, 15° - 19°, Jan 6 - 10, Decan: ♄ ♀, Rank: President = ☽, Ruler: Ziminiar, Shem: Ieialel, Arch: Auriel, Orig: Fallen Angel; Order of Angels and of Powers.

(59.) ORIAX, or ORIAS.—The Fifty-ninth Spirit is Oriax, or Orias. He is a Great Marquis, and appeareth in the Form of a Lion, riding upon a Horse Mighty and Strong, with a Serpent's Tail; and he holdeth in his Right Hand two Great Serpents hissing. His Office is to teach the Virtues of the Stars, and to know the Mansions of the Planets, and how



to understand their Virtues. He also transformeth Men, and he giveth Dignities, Prelacies, and Confirmation thereof; also Favour with Friends and with Foes. He doth govern 30 Legions of Spirits; and his Seal is this, etc.

Sign: ♁ , 20^o- 24^o, Jan 11 - 15, Decan: $\text{♁} \text{♁}$, Rank: Marquis = ♁ ,
 Ruler: Ziminiar, Shem: Harachel, Arch: Auriel, Orig: unknown.
 Has a relation to Mitriatic symbolism. Might also be one of the
 Phoenician Seven Spirits of Creation.

(60.) VAPULA, or NAPHULA.—The Sixtieth Spirit is Vapula, or Naphula. He is a Duke Great, Mighty, and Strong; appearing in the Form of a Lion with Gryphon's Wings. His Office is to make Men Knowing in all Hand-crafts and Professions, also in Philosophy, and other Sciences. He governeth 36 Legions of Spirits, and his Seal or Character is thus made, and thou shalt wear it as aforesaid, etc.



Sign: ♁ , 25^o- 29^o, Jan 16 - 19, Decan: $\text{♁} \text{♁}$, Rank: Duke = ♁ ,
 Ruler: Ziminiar, Shem: Mizrael, Arch: Auriel, Orig: ?

(61.) ZAGAN.—The Sixty-first Spirit is Zagan. He is a Great King and President, appearing at first in the Form of a Bull with Gryphon's Wings; but after a while he putteth on Human Shape. He maketh Men Witty. He can turn Wine into Water, and Blood into Wine, also Water into Wine. He can turn all Metals into Coin

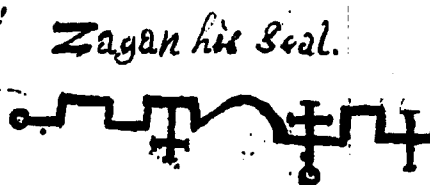

of the Dominion that Metal is of. He can even make Fools wise. He governeth 33 Legions of Spirits, and his Seal is this, etc.

Sign: ♁, 0° - 4°, Jan 20 - 24, Decan: ♁ ℞, Rank: King = ☉,
Ruler: Amaymon, Shem: Umabel, Arch: Raphael, Orig: ?

(62.) VOLAC, or VALAK, or VALAU, or UALAC.—The Sixty-second Spirit is Volac, or Valak, or Valu. He is a President Mighty and Great, and appeareth like a Child with Angel's Wings, riding on a Two-headed Dragon. His Office is to give True Answers of Hidden Treasures, and to tell where Serpents may be seen. The which he will bring unto the Exorciser without any Force or Strength being by him employed. He governeth 38 Legions of Spirits, and his Seal is thus.

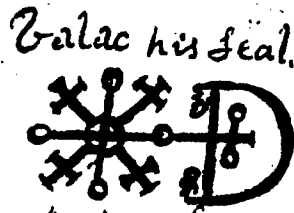

Sign: ♁, 5° - 9°, Jan 25 - 29, Decan: ♁ ℞, Rank: President = ♀,
Ruler: Amaymon, Shem: Iahhel, Arch: Raphael, Orig: ?

(63.) ANDRAS.—The Sixty-third Spirit is Andras. He is a Great Marquis, appearing in the Form of an Angel with a Head like a Black Night Raven, riding upon a strong Black Wolf, and having a Sharp and Bright Sword flourished aloft in his hand. His Office is to sow Discords. If the Exorcist have not a care, he will slay both him and his fellows. He governeth 30 Legions of Spirits, and this is his Seal, etc.



Sign: ♁, 10° - 14°, Jan 30 - Feb 3, Decan: ♁ ♀, Rank: Marquis: ☾,
Ruler: Amaymon, Shem: Annauel, Arch: Raphael, Orig: ?

(64.) HAURES, or HAURAS, or HAVRES or FLAUROS.—
 The Sixty-fourth Spirit is Haures, or Hauras, or Havres,
 or Flauros. He is a Great
 Duke, and appeareth at
 first like a Leopard,
 Mighty, Terrible, and
 Strong, but after while,
 at the Command of the
 Exorcist, he putteth on
 Human Shape with Eyes
 Flaming and Fiery, and a
 most Terrible Countenance. He giveth True Answers
 of all things, Present, Past, and to Come. But if he be
 not commanded into a Triangle, Δ , he will Lie in all
 these Things, and deceive and beguile the Exorcist in
 these things, or in such and such business. He will,
 lastly, talk of the Creation of the World, and of Divinity,
 and of how he and other Spirits fell. He destroyeth
 and burneth up those who be the Enemies of the Exor-
 cist should he so desire it; also he will not suffer him
 to be tempted by any other Spirit or otherwise. He
 governeth 36 Legions of Spirits, and His Seal is this,
 to be worn as a Lamén, etc.



Sign: \approx , 15° - 19° , Feb 4 - 8, Decan: \approx ♀, Rank: Duke = ♀,
 Ruler: Amaymon, Shem: Mecheiel, Arch: Raphael, Orig:
 a Fallen Angel who will not reveal his former rank. He might
 be related to the Egyptian God, HOROS not so much from the
 discription but rather the similarity of his name and the bird
 like nature of his sigil.

(65.) ANDREALPHIS.—The Sixty-fifth Spirit is Andre-
 alphus. He is a Mighty Marquis, appearing at first in
 the form of a Peacock, with great Noises. But after a
 time he putteth on Human shape. He can teach

Geometry perfectly. He maketh Men very subtle therein; and in all Things pertaining unto Mensuration or Astronomy. He can transform a Man into the Likeness of a Bird. He governeth 30 Legions of Infernal Spirits, and his Seal is this, etc.

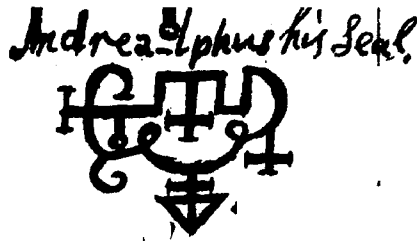

Sign: ♁, 20° - 24°, Feb 9 - 13, Decan: ♁ ♀, Rank: Marquis = Ⓢ, Ruler: Amaymon, Shem: Damabiah, Arch: Raphael, Orig: ?

(66.) CIMEJES, or CIMEIES, or KIMARIS.—The Sixty-sixth Spirit is Cimejes, or Cimeies, or Kimaris. He is a Marquis, Mighty, Great, Strong and Powerful, appearing like a Valiant Warrior riding upon a goodly Black Horse. He

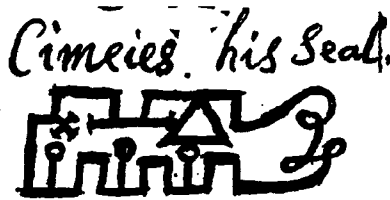

ruleth over all Spirits in the parts of Africa. His Office is to teach perfectly Grammar, Logic, Rhetoric, and to discover things Lost or Hidden, and Treasures. He governeth 20 Legions of Infernals; and his Seal is this, etc.

Sign: ♁, 25° - 29°, Feb 14 - 18, Decan: ♁ ♀, Rank: Marquis = Ⓢ, Ruler: Amaymon, Shem: Menkiel, Arch: Raphael, Orig: unknown but probably from Morocco.

(67.) AMDUSIAS, or AMDUKIAS.—The Sixty-seventh Spirit is Amdusias, or Amdukias (Anduscias in Sloane 2731). He is a Duke Great and Strong, appearing at first like a Unicorn, but at the request of the Exorcist he standeth before him in Human Shape,

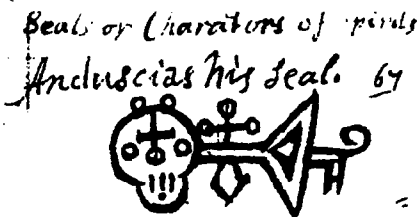

causing Trumpets, and all manner of Musical Instruments to be heard, but not soon or immediately. Also he can cause Trees to bend and incline according to the Exorcist's Will. He giveth Excellent Familiars. He governeth 29 Legions of Spirits. And his Seal is this, etc.

Sign: ♃, 0° - 4°, Feb 19 - 23, Decan: ♃ ♃, Rank: Duke = ♀,
Ruler: Corson, Shem: Eiael, Arch: Gabriel, Orig: ?

(68.) BELIAL.—The Sixty-eighth Spirit is Belial. He is a Mighty and a Powerful King, and was created next after LUCIFER. He appeareth in the Form of Two Beautiful Angels sitting in a Chariot of Fire. He speaketh with a Comely Voice, and declareth that he fell first from among the worthier sort, that were before Michael, and other Heavenly Angels. His Office is to distribute Presentations and Senatorships, etc.; and to cause favour of Friends and of Foes. He giveth excellent Familiars, and governeth 50 Legions of Spirits. Note well that this King Belial must have Offerings, Sacrifices and Gifts presented unto him by the Exorcist, or else he will not give True Answers unto his Demands. But then he tarrieth not one hour in the Truth, unless he be constrained by Divine Power. And his Seal is this, which is to be worn as aforesaid, etc.

Belial his Seal. —



Sign: ♃, 5° - 9°, Feb 24 -29, Decan: ♃ ♃, Rank: King = ☉, Ruler: Corson, Shem: Chabuiah, Arch: Gabriel, Orig: a Fallen Angel formerly of high rank. Order of Virtues (5 = Geburah). Considered synonymous with Satan in the DEAD SEA SCROLLS. Possibly the most dangerous spirit in the Goetia. Sacrifices and offerings are required. If you must experiment with this entity use powdered bull's blood (blood meal fertilizer) and a flaming libation of brandy (as the late Vincent Price suggested: "Good brandy, please.").

(69.) DECARABIA.—The Sixty-ninth Spirit is Decarabia. He appeareth in the Form of a Star in a Pentacle at first; but after, at the command of the Exorcist, he putteth on the image of a Man. His Office is to discover the Virtues of Birds and Precious Stones, and to make the Similitude of all kinds of Birds to fly before the Exorcist, singing and drinking as natural Birds do. He governeth 30 Legions of Spirits, being himself a Great Marquis. And this is his Seal, which is to be worn, etc.

Decarabia his Seal.



Sign:)(, 10^o - 14^o, Mar 1 - 5, Decan:)(☉, Rank: Marquis = ☉,
Ruler: Corson, Shem: Raehel, Arch: Gabriel, Orig: ?

(70.) SEERE, SEAR, or SEIR.—The Seventieth Spirit is Seere, Sear, or Seir. He is a Mighty Prince, and Powerful, under AMAYMON, King of the East. He appeareth in the Form of a Beautiful Man, riding upon a

Seere his Seal.



Winged Horse. His Office is to go and come; and to bring abundance of things to pass on a sudden, and to carry or re-carry anything whither thou wouldest have it to go, or whence thou wouldest have it from. He can pass over the whole Earth in the twinkling of an Eye. He giveth a True relation of all sorts of Theft, and of Treasure hid, and of many other things. He is of an indifferent Good Nature, and is willing to do anything which the Exorcist desireth. He governeth 26 Legions of Spirits. And this his Seal is to be worn, etc

Sign:)(, 15^o - 19^o, Mar 6 - 10, Decan:)(☉, Rank: Prince = ♃,
Ruler: Corson, Shem: Iibamah, Arch: Gabriel, Orig: possibly Persian.
Excellent for long range consciousness projection.

(71.) DANTALION.—The Seventy-first Spirit is Dantalion. He is a Duke Great and Mighty, appearing in the Form of a Man with many Countenances, all Men's and Women's Faces; and he hath a Book in his right hand. His Office is to teach all Arts and Sciences unto any; and to declare the Secret Counsel of any one; for he knoweth the Thoughts of all Men and Women, and can change them at his Will. He can cause Love, and show the Similitude of any person, and show the same by a Vision, let them be in what part of the World they Will. He governeth 36 Legions of Spirits; and this is his Seal, which wear thou, etc.

Dantalion his Seal. 71



Sign: ♃, 20° - 24°, Mar 11 - 15, Decan: ♃ ♂, Rank: Duke = ♀, Ruler: Corson, Shem: Haiaiel, Arch: Gabriel, Orig: ?

(72.) ANDROMALIUS — The Seventy-second Spirit in Order is named Andromalius. He is an Earl, Great and Mighty, appearing in the Form of a Man holding a Great Serpent in his Hand. His Office is to bring back both a Thief, and the Goods which be stolen; and to discover all Wickedness, and Underhand Dealing; and to punish all Thieves and other Wicked People and also to discover Treasures that be Hid. He ruleth over 36 Legions of Spirits. His Seal is this, the which wear thou as aforesaid, etc.

Andromalius his Seal. 72

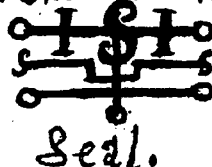

Sign: ♃, 25° - 29°, March 16 - 20, Decan: ♃ ♂, Rank: Earl = ♂, Ruler: Corson, Shem: Mumiah, Arch: Gabriel, Orig: ?

GOETIA RULERS OF THE QUARTERS

This is the first time that the sigils of the Goetia Rulers of the Quadrants have ever been seen outside of the inner sanctum. These signatures were obtained from the Rulers themselves during evocations undertaken by the author. You are free to use them in your private workings but they may not be republished without our written permission. I refer to them not as “Kings” but as “Rulers” because Corson, Ruler of the West had a definite female aspect while Amaymon, Göap and Ziminiar were definitely masculine in nature.

Amaymon rules the ariel spirits of the arts and sciences in the East, Göap controls the fiery spirits of wrath and domination in the South, Corson oversees the spirits of prophecy and divination in the West, while Ziminiar commands the forces that ensure prosperity and material accomplishment.

Considering that our rectified Goetia is to be reorganized in accordance with the four philosophical elements, I wanted to know the difference between these Rulers and the traditional Elemental Kings and Queens. Ziminiar answered: “Ghob, (the Gnome King) is ruler of the Spirits of the Rocks, whereas I am the ruler of the Spirits of the Inner Earth.”

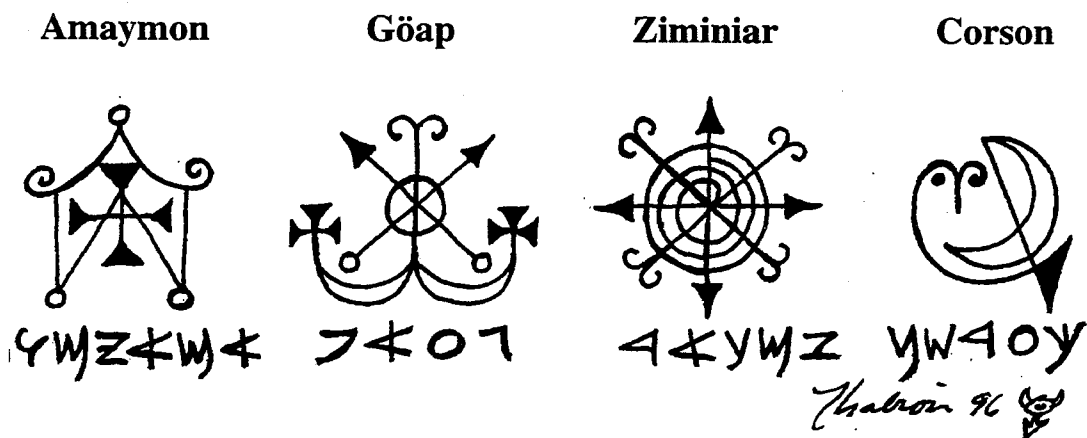

Every serious practitioner of this system should evoke these great rulers at the outset of the cycle of working. Remember that they are directly controlled by the Four Great Archangels of the Quarters.

The sigils of the great Archangles of the Quarters should therefore be drawn on the reverse of the sigils of the Goetia Quadrant Rulers. The signatures of Michael, Raphael and Gabriel were traditional but there was no sigil for Auriel. To create one I used the method described by Geoffrey James in his book ANGEL MAGIC (the 9th Chapter of which recounts an O.T.A. invocation operation) of translating the Phoenician letters in Her name into an Arabic magical alphabet and then running them together to form a continuous design.

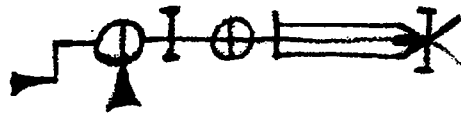

Raphael -- Traditional



Michael -- Traditional

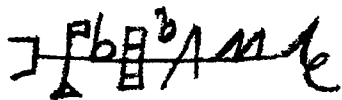

Gabriel -- Traditional



Auriel -- O. T. A.

The Schemhamephorash

THE SCHEMHAMEPHORASH are seventy two Angels that form the extended Name of God. This formula actually preceded the the use of Tetragrammaton in historical Kabbalah. The names of the angels are derived from three verses in the book of Exodus (*vs. 19-21, Exodus xiv.*) and are not permutations of YHVH, although such a scheme was used to create a later version of the 72 Holy Names. The Angelic Names we use are taken from Agrippa. The sequence and spelling does not always agree with Mathers' version of Blaise Viginare's sigils or with the angelic names accompanying Thomas Rudd's Latin versicles -- so we were required to create a composite of these three lists ¹. making sure that the sigil matches the name regardless of position.

Golden Dawn magicians will point out that these sigils start at 0° ♌ (Leo) in their system but I would be very surprised if "The Great Magician, Blaise Viginare" intended to use them in a sidereal progression. (See *Documentary Appendix.*)

These sigils and verses are to be drawn and written on the back of the parchment sigil of your Goetia spirit. Before beginning the conjuration, the sigil should be taken from the Brass Vessel, both sides should be shown to the receiver and then the Latin verse is read by the Magus to invoke the power of the Angel. (See video.)

1. Tu Domine susceptor meus es
gloria mea et exaltans Caput
meum: — **Vehuiah**



2. Et tu Domine ne elongaveris
auxilium tuum a me, ad
defensionem meam conspice:
— **Ieliel**

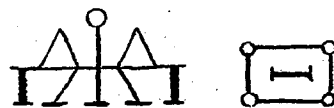

3. Dicam Domino susceptor meus
es tu, et refugium meum Deus
meus sperabo in sum: — **Sitael**

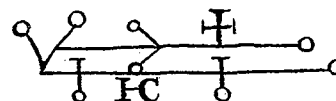

4. Convertere Domino, et eripe animam meam, salvum me fac propter misericordiam tuam :
— **Elemiah**

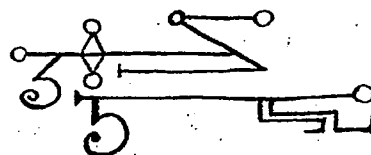

5. Ex qui sive Dominum et exaudivit me, et ex omnibus tribulationibus eripuit me:
— **Mahasiah**

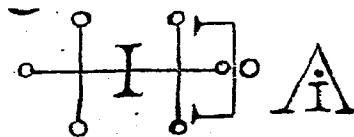

6. Psalite Domino qui habitat in Sion annunciate inter gentes studia eius: — **Lelahel**



7. Miserator et misericors Dominus, longanimus et multum misericors:
— **Akaiah**

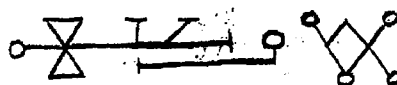

8. Venite, adoremus, et procidamus ante Dominum qui ferit nos:
— **Cahethel**



9. Reminiscere miserationum tuarum Domine et miserationum tuarum quae a saeculo sunt: — **Haziel**

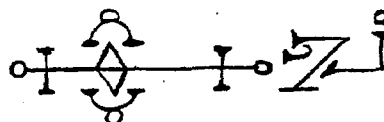

10. Fiat misericordia tua super nos, quernadmodu speravimus in te:
— **Aladiah**

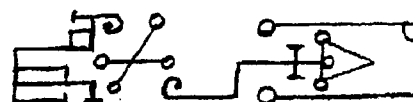

11. Vivit Dominus et benedictus Deus meus et exaltetur Deus salutis meae:
— **Lauiah**







12. Ut quid Domine recessisti longe despiris in opportunitatibus in tribulatione :— **Hahaiah**

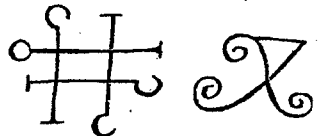
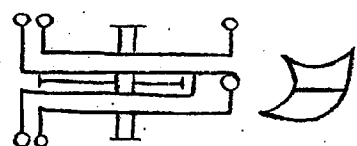

13. Jubilate Domino omnis Terra, Cantate, et exultate, et Psallite:
— **Ieazel**

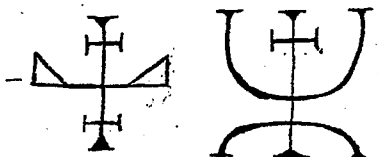
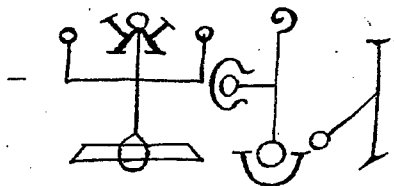
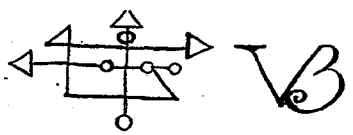

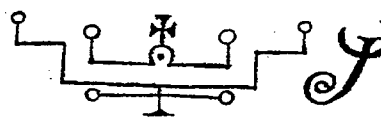
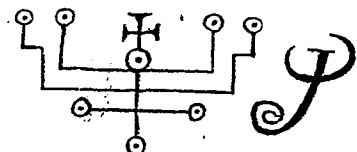
14. Et factus est Dominus refugium,
et Deus meus in adjutorium spei meae:
— **Mebahel** 
15. Et factus est mihi Dominus in refugium
et Deus meus in adjutorium spei meae:
— **Hariel** 
16. Domine Deus salutis meae in
die clamavi et nocte coram te:
— **Hakamiah** 
17. Domine Dominus noster quam
admirabile est nomen tuum in
universa terra: — **Leviah** 
18. Iudica me Domine secundum
misericordiam et iustitiam tuam
Domine Deus meus et non
supergaudeant mihi: — **Caliel** 
19. Expectans expectavi Dominum
et intendit mihi: — **Luviah** 
20. Et nomen Domini invocabo O Domine
libera animam meam: — **Pahaliah** 
21. Xeo autem in te speravi Domine dixi
Deus meus es tu: — **Nelkael** 
22. Dominus custodit te, Dominus protectio
tua super manum dextram tuam:
— **Iaiaiel** 
23. Dominus custodit introitum tuum et
exitum tuum ex nunc et usque in
saeculum :— **Melahel** 

24. Beneplacitum est Domino super
 timentes eum, et in iis qui sperant
 super misericordiam eius:
 — **Chahuiah**

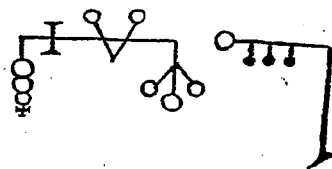

25. Confitebor tibi Domine in lote corde
 meo narrabo omnia mirabilia tua:
 — **Nithhaiah**



26. Clamavi in toto corde meo, exaudi
 me Domine, iustificationes meas
 requiram: — **Haaiah**

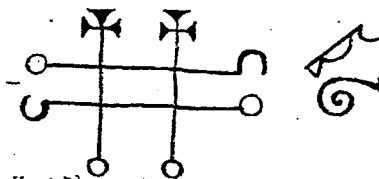

27. Eripe me Domine ab homine malo
 a viro iniquo eripe me: — **Ierathel**

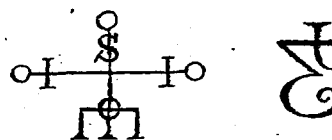

28. Deus ne elongeris a me Deus meus in
 auxilium meum respice: — **Seehiah**

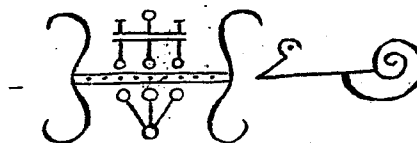

29. Ecce Deus adiuvat me et Dominus
 susceptor est animae meae:— **Reiel**



30. Quoniam tu es potentia mea Domine.
 Domine spes mea a iuventute mea:
 — **Omael**

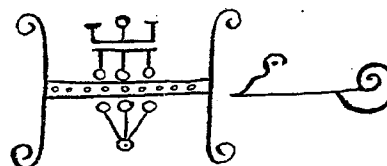

31. Introibo in potentia Domini, Deus
 meus memorabor iustitiae tuae solius:
 — **Lecabel**

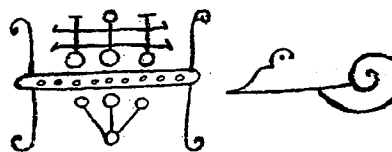

32. Quia rectum est verbum Domini et
 omnia opera eius in fide:— **Vasariah**



33. Dominus scit cogitationes hominum
 quoniam vana sunt: — **Iechuiah**

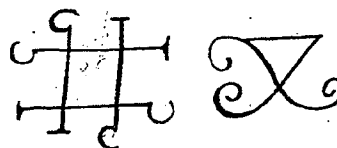

34. Speret Israel in Domino ex hoc nunc
et usque in saeculum: — **Lehachiah**

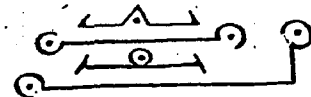

35. Dilexi quoniam exaudi Dominus
vocem orationis meae : — **Kavakiah**

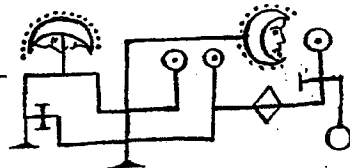

36. Domini dilexi decorum domus tuae
et locem habitationis gloriae tuae:
— **Monadel** (see video)

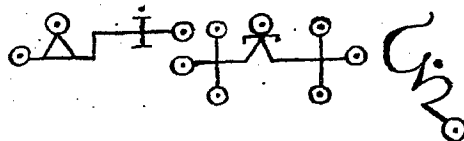

37. Domine Deus virtutum converte nos
et ostende faciem tuam et salvi erimus:
— **Aniel**

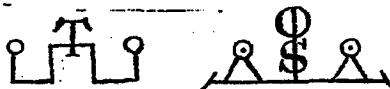

38. Quoniam tu es Domine spes mea
altissimum profuisti refugium tuum:
— **Chaamiah**

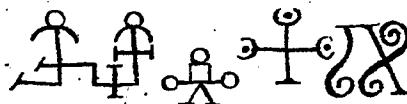

39. Audivit Dominus et misertus est mihi
Dominus factus est adiutor meus:
— **Rehael**

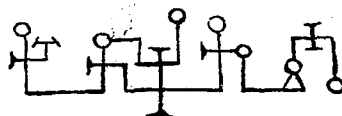

40. Ut quid Domine repellis
animam meam, avertis faciem
tuam a me: — **Ihiazel**

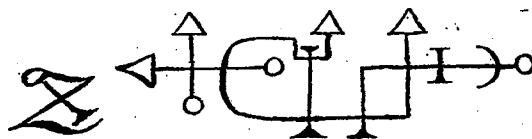

41. Domine libera animam meam a
labiis iniquis et a lingua dolosa:
— **Hahahel**

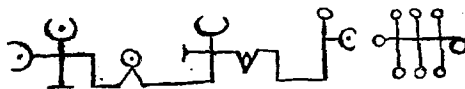





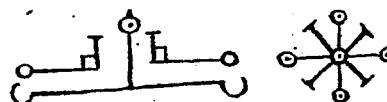

42. Domine custodit te ab omni malo et
custodiet animam tuam: — **Mikael**

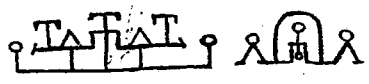
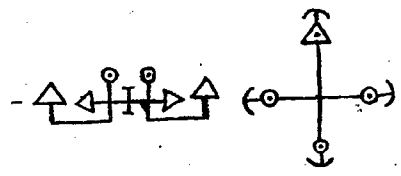
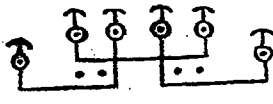
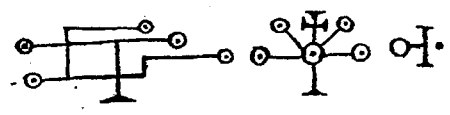
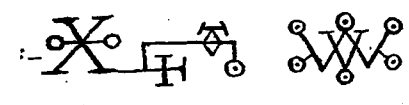
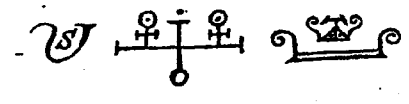
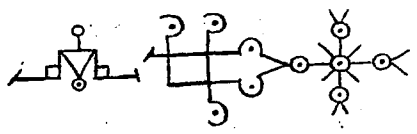
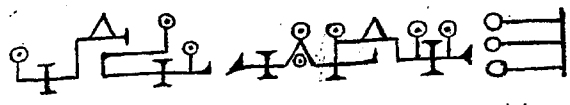
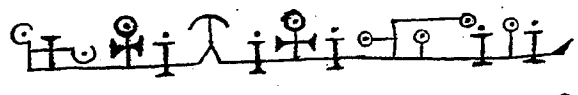
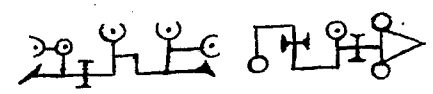

43. Et Ego ad te Domine clamavit, et mane
oratio meae praeveniet te: — **Vevaliah**

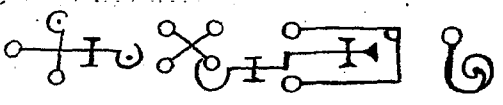
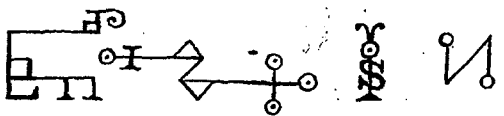
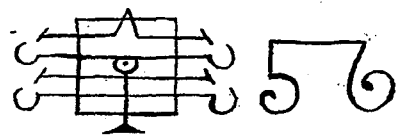
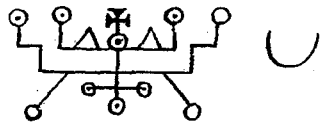
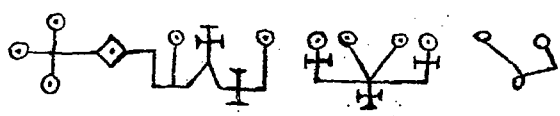
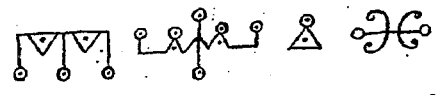

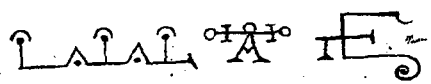
44. Voluntaria eris mei beneplacita
fac Domine et Judicia tua doce:
— **Ielahiah** 
45. Si dicebam motus est pes meus
misericordia tua Domine, adiuvabit
me: — **Sealiah** 
46. Suavis Dominus universis et
miserationes super omnia opera
eius: — **Ariel** 
47. Quam magnificata sunt opera tua
Domine, nimis profundae factae
sunt cogitationes tuae: — **Asaliah** 
48. Notum fecit Dominus salutare tuum
in conspectu gentium, revelabit
justitiam suam: — **Mihael** 
49. Magnus Dominus et laudabilis et
magnitudinis eius non est finis:
— **Vehuel** 
50. Miserator et misericors Dominus,
patiens et multum misericors:
— **Daniel** 
51. Sit gloria Dominus in
saeculul laetabitur Dominus
in operibus suis :
— **Hachasiah** 
52. Confitebor Domino
sacundum justitiam eius
et Psallam nomini Domini
altissimi: — **Imamiah** 
53. Cognovi Domine quia aequitas
judicia tua et in veritate tua
humiliasti me: — **Nanael** 

54. Dominus in Caelo paravit sedem suam et Regnum suum omnibus dominabitur: — **Nithael** 
55. Tu autem Domine in aeternum permanes et memoriale tuum in generationem et generationem: — **Mebahiah** 
56. Allevat Dominus omnes qui corruunt, et erigit omnes elisos: — **Poliel** 
57. Qui timent Dominum speraverunt in Domino, adiutor eorum et protector eorum est :— **Nemamiah** 
58. Et anima mea turbata est valde sed tu Domine usque quo: --**Ieiaiel** 
59. Ab ortu Solis usque ad occasum laudabile nomen Domini: — **Harachel** 
60. Iustus Dominus in omnibus viis suis et sanctus in omnibus operibus eius: — **Mizrael** 
61. Sit nomen Domini benedictum ex hoc nunc et usque in saeculum:— **Umabel** 
62. Vide quoniam mandata tua Domine dilexi secundum misericordiam vivificam: — **Iahhel** 
63. Servite Domino in Laetitia, introite in conspectu eius in exultatione: — **Annauel** 

64. Ecce oculi Domini super metuentes eum et in eis qui sperant super misericordiam eius : — **Mecheiel**

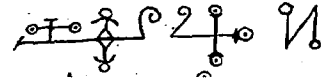

65. Convertere Domine usque quo et deprecabilis esto super servos eius: — **Damabiah**

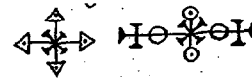

66. Ne derelinquas me Domine Deus meus ne discesseris a me: — **Menkiel**

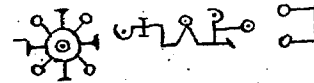

67. Delectare in Domino et dabit tibi petitiones cordis tui :— **Eiael**

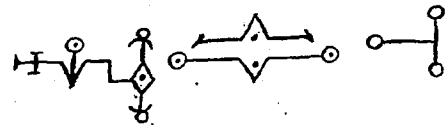

68. Confitemini Domino quoniam bonus, quoniam in aeternam misericordia eius: — **Chabuiah**

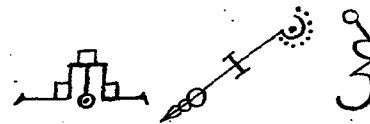

69. Dominus pars haereditatis meae et calicis meae tu es qui restitues haereditatem meam mihi: — **Raehel**

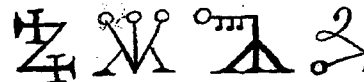

70. In principio creavit Deus Caelum et Terram: — **Iibamiah**

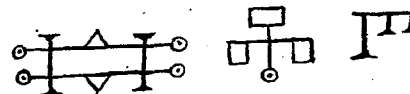

71. Confitebor Domino nimis in ore meo, et in medio multorum laudabo eum: — **Haiaiel**

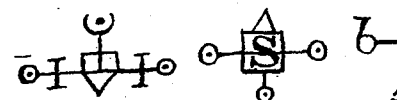

72. Convertere anima mea in requiem tuam quoniam Dominus benefaciet tibi: — **Mumiah**

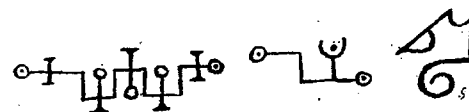

Here Ends The Schemhamephorash

Notes on Following Page. . .

Notes on Schemhamphorash: --

1. The sigil designs used in this section are scanned directly from a photo copy of MacGregor Mathers' copy of *Arsenal MS. 2495 "Characters or Seals of the 72 Schemahamphorasch (sic)"* courtesy of Pat Zalewski. Those interested in the Golden Dawn version of this sequence should consult Zalewski's *The Kabbalah of the Golden Dawn*, 1993. (See *Documentary Appendix* for an exhibit of the title folio of the Mathers' MS.)
2. The Latin verses used to invoke these Angels are taken from *British Library Harley MS. 6482* as published by Adam McLean in *A Treatise on Angel Magic*, 1982. We have changed Dr. Rudd's spelling of the Angelic names to agree with those on our Master Mandala which is derived from Agrippa. The translations of these scriptural verses into English that McLean includes are possibly proprietary, therefore the interested reader should consult the McLean edition directly. The work would make an excellent addition to any magician's library and is now available in an inexpensive paperback edition.

Additional Note: -- I am again including the sigils of the Four Great Archangels for easy reference. In our system they are directly related to the Angels of the Shemehamphorash.

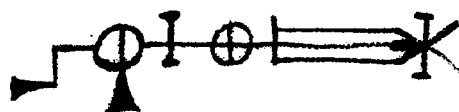

Raphael, Traditional



Michael, Traditional

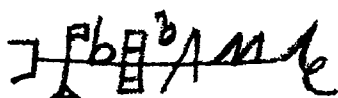

Gabriel, Traditional



Auriel, O.T.A. form
(derived from ancient
Arabic magical alphabet.
See James' *Angel Magic*.)

Appendix 1.

Goetia Spirits Rectified to the Four Hermetic Elements and Quadrants

This listing rearranges the 72 Spirits into four Elemental groupings by their characteristics and certain clues in their descriptions (e.g., “Appears in Sagittarius”, etc.). Their order of placement in these divisions has no significance beyond their sequential occurrence in the original Sloane 2731 list.

Ariel Spirits Under Amaymon	Fiery Spirits Under Göap	Watery Spirits Under Corson	Earthy Spirits Under Ziminiar
5. Marbas	1. Bael	3. Vassago	2. Agares
24. Naberius	8. Barbatos	4. Samigina	6. Valefor
27. Ronové	10. Buer	7. Amon	12. Sitri
32. Asmoday	14. Leraje	9. Paimon	13. Beleth
33. Gäap	23. Aim	11. Gusion	16. Zepar
36. Stolas (#29. in our sequence)	25. Glasya- Labolas	15. Eligos	18. Bathin
37. Phenex	28. Berith	17. Botis	19. Sallos
39. Malphas	34. Fufur	22. Ipos	20. Purson
44. Shax	35. Marcho- sias	30. Forneus	21. Marax
50. Furcas	38. Halphas	41. Focalor	26. Bune
53. Camio	40. Räum	42. Vepar	29. Astaroth (#36 in our sequence)
57. Osé	43. Sabnock	45. Viné	31. Foras
59. Oriax	52. Alloces	47. Uvall	46. Biforns
60. Vapula	58. Amy	49. Crocell	48. Haagenti
65. Andre- alphus	63. Andras	54. Murmur	51. Balam
67. Amdusias	64. Haures	55. Orbas	61. Zagan
69. Decar- abia	68. Belial	56. Gremory	62. Volac
70. Seere	72. Andro- malius	71. Dantallion	66. Cimejes

Appendix 2.

Quick Reference Chart for Goetia/Almadel Operations:

Sephiroth	Color (King Scale)	Planet	Incense
1. Kether	White	Infinity	Ambergris
2. Chokmah	Grey	Zodiac	Musk
3. Binah	Black	Saturn	Myrh
4. Chesed	Blue	Jupiter	Cedar
5. Geburah	Red	Mars	Dragon's Blood
6. Tiphareth	Yellow	Sun	Frankincense
7. Netsach	Green	Venus	Sandalwood
8. Hod	Orange	Mercury	Storax
9. Yesod	Violet	Moon	Jasmine
10. Malkuth	Citrine, olive, russett & Black	Earth	Dittany of Crete

Goetia Spirits (By Rank)	Descending Formula (Atziluth)	Ascending Formula (Briah)*
1.	Eh heh yah	Metatron
2.	Yah	Ratziel
3. Knights	AhMahShaOh Elohim	Tzaphkiel
4. Princes	El (Ool)	Tzadkiel
5. Earls	Elohim Gibor	Kamael
6. Kings	AhMahShaOh Aloah Va-Da'ath	Raphael
7. Dukes	AhMahShaOh Tzabaoth	Haniel
8. Presidents	Elohim Tzabaoth	Michael
9. Marquises	Shaddi El Chai	Gabriel
10.	Adonai Ha Aretz	Sandalphon

* Note: The ascending formula is also the list of Archangels attributed to the Tree of Life and the planetary spheres.

The Magical Alphabet

Phoenician (Canaanite) characters with Hebrew equivalents for reference. To be visualized in King Scale colors.

CAPH	YOD	TETH	CETH	ZAIN	VAU	HE	DALETH	GIMEL	BETH	ALEPH	NAME
											HEBREW LETTER
20 K	10 Y	9 T	8 C	7 Z	6 V	5 H	4 D	3 G	2 B	1 A	NUMERICAL VALUE
											PHOENICIAN
21 Q	20 M	19 S	18 G	17 H	16 B	15 P	14 Q	13 C	12 K	11 A	OTZ CHIM PATH
WHEEL OF FORTUNE	HERMIT	STRENGTH	CHARIOT	LOVERS	HIEROPHANT	EMPEROR	EMPRESS	PRIESTESS	MAGUS	FOOL	TAROT TRUMP
VIOLET	YELLOWISH GREEN	GREENISH YELLOW	AMBER	ORANGE	RED-ORANGE	SCARLET	EMERALD GREEN	BLUE	ORANGE YELLOW	PALE YELLOW	KING SCALE
KAFF	YODH	TATH	KA-ATH	ZAH-YEEN	WON	HAY	DAH-LATH	GE-MEL	BAY-TH	AH-LEFF	PHONETIC

THAN	SHIN	RESH	KOPH	IZADDI	PHE	AYIN	SAMEKH	NUN	MEM	LAMED	NAME
											HEBREW LETTER
400 T	300 S	200 R	100 Q	90 I	80 P	70 O	60 S	50 N	40 M	30 L	NUMERICAL VALUE
											PHOENICIAN
32 T	31 S	30 R	29 Q	28 I	27 P	26 O	25 S	24 N	23 M	22 L	OTZ CHIM PATH
WORLD	JUDGEMENT	SUN	MOON	STAR	TOWER	DEVIL	TEMPERANCE	DEATH	HANGED MAN	JUSTICE	TAROT TRUMP
INDIGO	SCARLET ORANGE	ORANGE	ULTRA-VIOLET CRIMSON	VIOLET	SCARLET	INDIGO	BLUE	GREEN-BLUE	DEEP BLUE	EMERALD GREENS	KING SCALE
TAH'OO	SHEEN	RASH	QUOF	TRAND-DEE	PAY	AH-YEEN	SAM-EKH	NOON	MAM	LAHM ED	PHONETIC

Appendix 3.

Magical Temple Furniture & Equipment

HERE IS WHERE WE COME to one of the most satisfying -- and for some people perhaps the most frustrating -- aspects of the art magical: building your temple equipment. Right at the outset let me explain that I have not provided fully scaled and dimensioned three view plans because some of you may not want to operate in a full size (18' x 18') temple setting. Our double cube altar is 42" high and just manages to go through a standard door frame. The outside diameter of our Circle is, according to Solomon, nine feet -- which means that, along with pillars in the north and south and room to circumambulate, the 18' x 18' floor space is a minimum. Most spare bedrooms aren't that big. You'll need a two car garage and then you'll have to panel and insulate it or freeze in the winter time. Hypnotic magick doesn't work very well when people's teeth are chattering, so you may have a lot of remodeling to do just to make the temple comfortable-- and don't forget ventilation; you can't burn charcoal and incense in a completely sealed area. All considered, it might be better to scale down and settle for the spare bedroom when you are first getting started.

Even so you may want to paint and carpet the area. Avoid black for two reasons: first it will *not* give you the deep, endless darkness that midnight blue will provide (black actually reflects light whereas blue totally absorbs it as any camera buff will tell you) -- and, second-

ly, if any profane invades your magical inner sanctum (and sooner or later this is certain to happen) black will convince him that you are a satanist. . . Real midnight blue paint has to be specially mixed at a paint store, but it should last a lifetime and is worth the trouble. Next get a dark blue indoor-outdoor carpet so that you have a completely blue chamber (see video). You may accent with burgundy drapes, violet veils, etc., but the basic color should always be dark blue.

Now let's move to the first item you'll need to construct: the Magick Circle. The Circle can be made out of cloth or plywood. We've never used cloth so I can't give any experienced advice on that. I opted for plywood backed with fiberboard (but I must confess that I spent a year designing and building props for Ringling Brother's Circus, so I tend to build things that can be stepped on by elephants!).

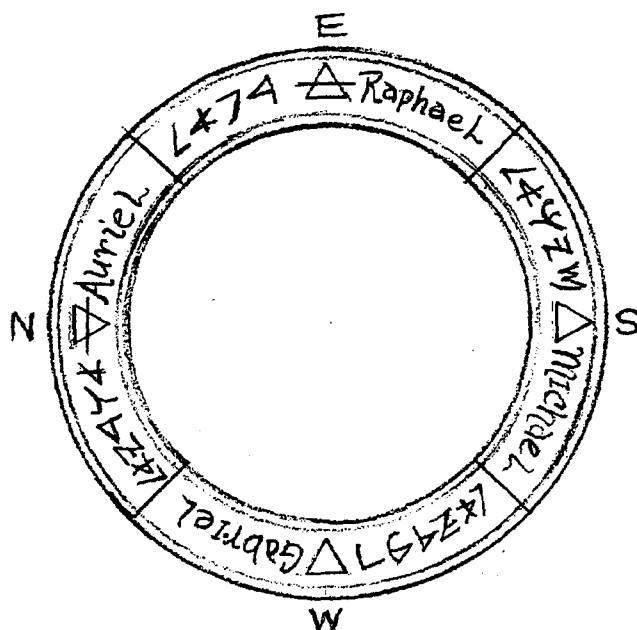

If you decide to use a fiberboard backing to keep the plywood from warping, then be sure to use plenty of carpenter's wood glue and finishing brads. If you are wondering how to cut this monster out, this is the trick: drive a rod into the ground and tie a 4¹/₂' cord to it. Put your pencil through a loop on the far end and score an arc on the plywood. Drop back 14" and score an inside arc. Use a carpenter's square to bring your beam compass line out at right angles to mark off the radius at each end of your circle section. Cut this section out and use

it as a pattern for the next three sections. What could be simpler than that? For a lighter weight circle you might try laminating a top layer of masonite rather than fiberboard. It's also a better painting surface.

After you've cut out the four sections, sand them, prime coat them and paint them black with a one inch white border along the outside and inside edge. Now you are ready to decorate. Even if you are not intending to use u.v. sensitive fluorescent paint ¹. you will still have to undercoat all your decorations with white. All lettering and symbols in the East are in bright yellow, in the South, flaming scarlet, in the West, bright blue and in the North, bright green. (See the Phoenician/Hebrew alphabet.) You may also add the signs of the zodiac and their ruling planets around each of the elemental symbols.

Now to the Double-cube altar which will be placed in the center of the Circle for Angelic invocations and other transcendental operations.

The double cube should be exactly that; a double cube. The bottom half is painted black and the top half, white. Ours is made out of 1/4" plywood on a 2" x 2" frame with a top lid frame made from 1" x 10" lumber. Our altar is so heavy we need a handtruck to move it back and forth from the temple to our outdoor henge. If you don't have to do four offsite ceremonies a year I believe masonite for the four side panels and 1/4" plywood for the top lid frame would be a better choice. Stay with the 2" x 2" frame, however, and make sure the top and incense chamber floor are both 1/4" plywood.

You'll notice in the video that we have four alchemical symbols in bas-relief around the sides of the upper cube. The Spirit Wheel symbol in the East swings out on a hinge as the door to the incense chamber. The other symbols are ♁ sulphur in the South, ☿ mercury in the West and ☾ salt in the North. You can jig them out of plywood with a scroll saw, then glue and tack them on.

The altar top is also an area that can lend itself to further decoration. Look carefully at the video and see how we have painted the four quadrant colors (no fluorescents here) on the altar top and then applied a jugged-out, gold leafed compass rose with the Tetragrammaton letters at each directional point. Unless you apply several coats of clear liquid plastic varnish over the altar top it will quickly become

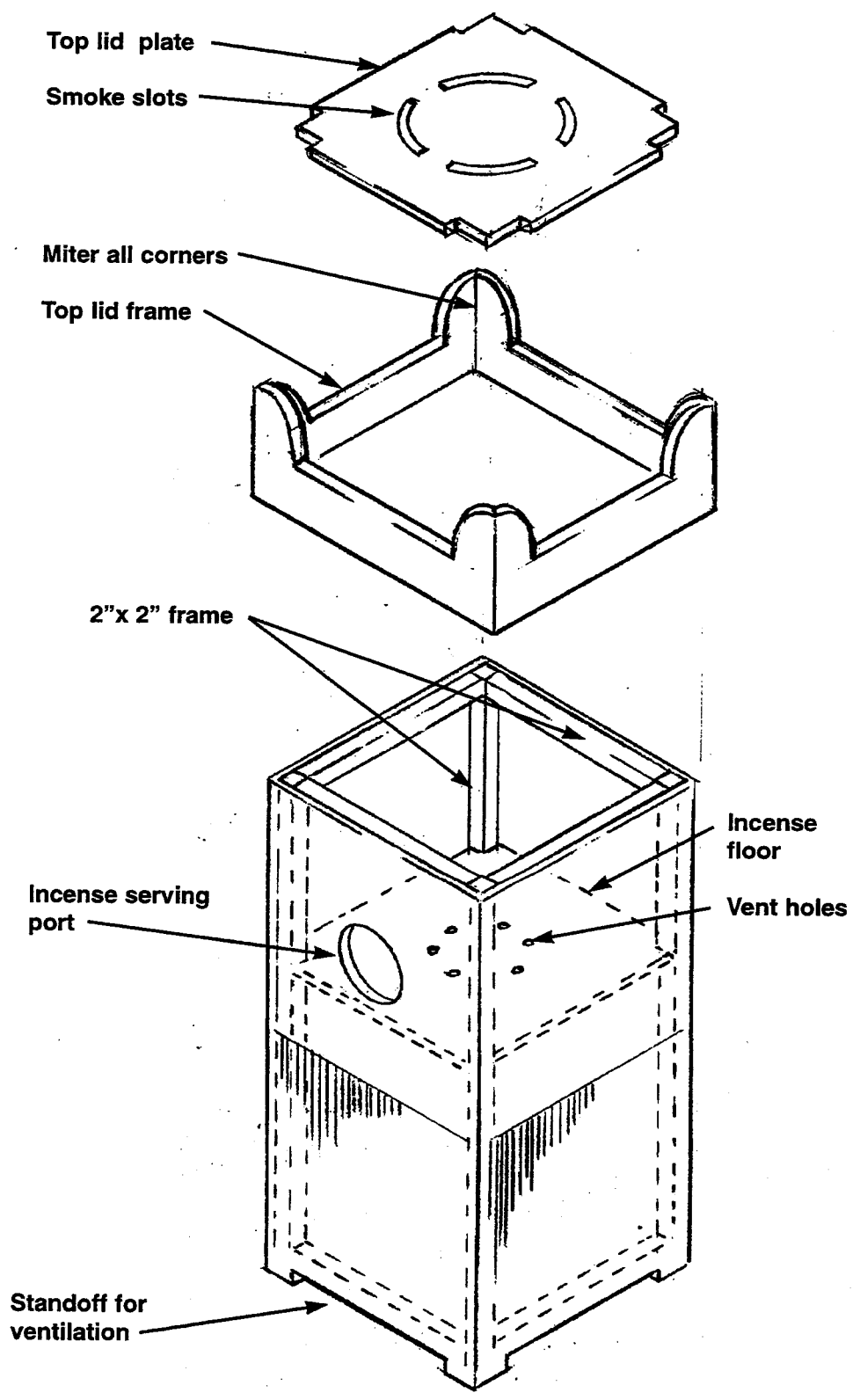

marred, stained and chipped with all the charcoal, oils, incenses and candle drippings you are going to use on it. Build your altar to last.

Solomon's Triangle has no standard dimensions but the white inner triangle *must be equilateral*. You may have noticed that our outer triangle (the black border surrounding the white inner surface) is two inches higher at the peak. This adds an aspect of dynamic distortion to an otherwise static design. It gives the Triangle an element mystery it deserves as a portal between the worlds.

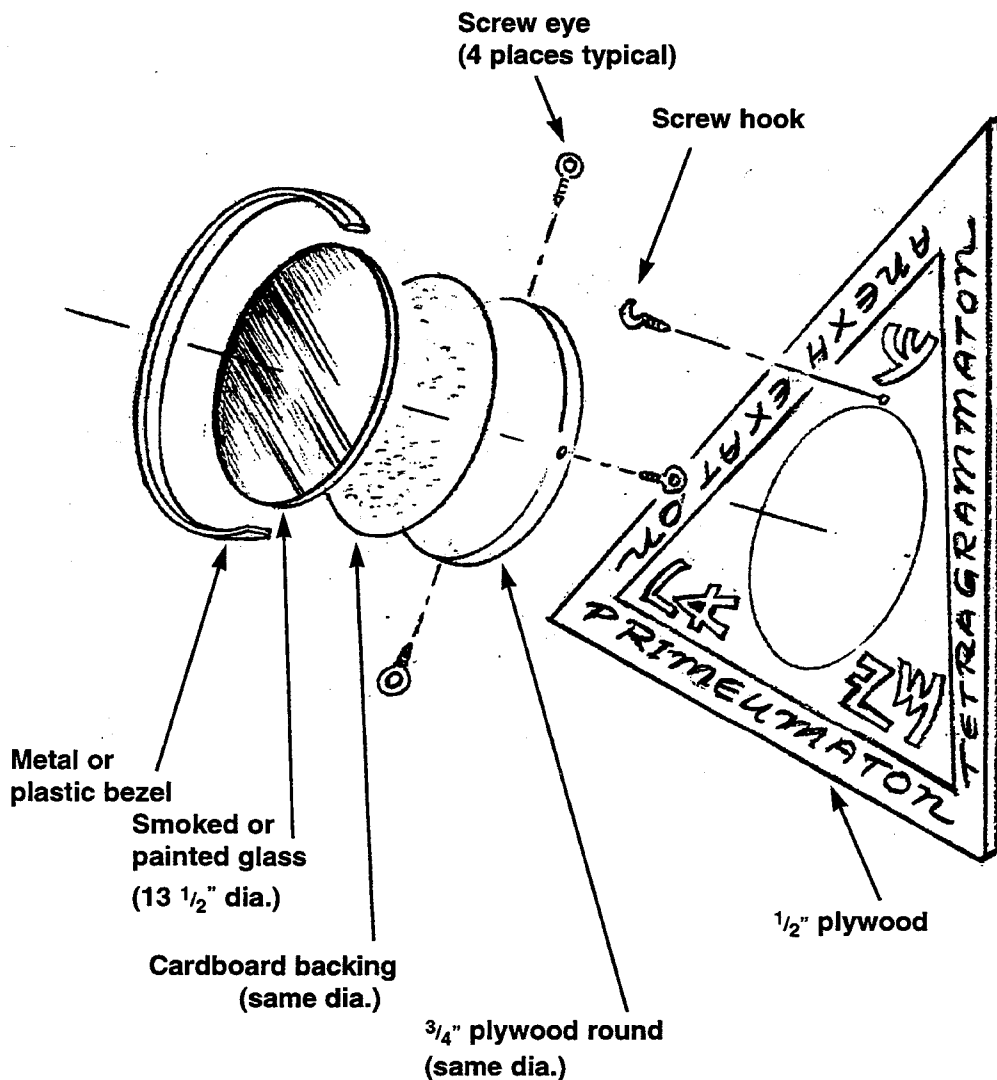

Triangle outer dim.= bottom: $37\frac{1}{2}$ " , sides: 42" ea. Inner dim.= $31\frac{1}{2}$ " all sides. Baseline 3" up from bottom edge. Inner Circle =13" dia. Colors = outer border: black, outer lettering: scarlet, inner triangle: white, inner circle: forest green. Phoenician letters (see Alphabet).

As for constructing your mirror, you have a number of choices: you might be able to find an antiqued smoked glass panel, of the type used by interior decorators, that appeals to you. I know this sounds like a mundane option but some of these designs are frankly more evocative than what you might be able to create -- in any case you *must* have your glass professionally cut for you at a glass shop. This is not expensive. It will save you frustration and possibly serious injury. Also ask the glass shop to grind off the sharp edges for you so you won't cut yourself handling the plate.

Buy three cans of spray lacquer; one silver (luna), one copper (venus) and one gloss black. Clean your glass with alcohol or carbon tetrachloride, then mist the inner surface with the metallic spray paints. I use an inward spiraling circular pattern evocative of a vortex far out in the depths of outer space. Make sure you keep this pattern *subtle and delicate*. After your metallic mist effect has completely dried, *place the glass plate over a piece of black poster board* to see how it will look when you seal it over with the black paint. If you like the effect of the metallic mist on the black background, then spray it with three layers of black, letting each layer dry fully before applying the next coat. However, if you don't like the effect (sometimes it is difficult to get it right the first time) just wipe off all the metallic paints with thinner and start over again. Don't settle for anything less than the best you can achieve.

The place for your alchemical "fluid condenser", if you choose to employ one, is on your cardboard backing.² I suggest that you leave it off your first mirror or at least delay applying it until after you have successfully performed operations without it. The reason is this: your subconscious mind is more superstitious than your rational mind is and it will believe that the condenser is an essential part of the process if you start off using it at the beginning of your operations. It is much better to prove to yourself that you can make the magick happen through the power of your mind than to depend on a rabbit's foot or a mojo bag. If you want to add the condenser later, then do so. We have even experimented by charging our rock crystal Almadel ball with a 250,000 volt Vandergraff lightning machine -- but this was only after we knew we didn't need to.

Your mirror should be anchored to the corrugated cardboard backing with several swatches of industrial grade double-sticky tape. (We have found double-sticky tape to be an essential item for practical magick.) The cardboard backing is glued to the plywood round. Finally a plastic or metal bezel band is wrapped, glued and screwed in around the edge, holding everything together. (Be sure to drill start holes through the band and into the plywood. No hammering!) Four brass screw eyes must also be attached around the edge (you only need one if you don't intend to suspend your mirror from overhead).

The reason why you don't want to permanently mount your mirror in your Triangle is that your mirror *is also your Pentacle of Art*. It is the fourth traditional implement of the Magus, the platter or shield of the Grail Hallows. You will use it for other magical functions besides Goetia skrying. For the reverse side (the plywood back) you might use the traditional Golden Dawn Earth Pentacle design -- or, if you are more of a Pagan, we suggest the ten-pointed double pentagram for the Sphere of Malkuth as shown and described below: --



O.T.A. Magick Mirror -- Reverse side. Earth Pentacle. Colors = Border band: gold, upright pentagram: gold, downward pentagram: silver. Quadrants colors: citrine, olive, russet and black.

You will notice that our pentacle differs from the Golden Dawn version only in the selection of the central design. We use the double pentagram to form a ten-pointed "Malkuth-Asshia" decagram appropriate to the element, the sphere and the dimension. You should also acquire a 3' x 3' square of green silk to wrap up the mirror-pentacle when not in use, or to cover it, as with a veil, before an operation. You may also hang the mirror on the Triangle with the pentacle side outward when the equipment is not in use -- but this should only be a temporary expedient.

The Circle, Altar, Mirror and Triangle are the major items of equipment you will need to construct in order to practice the O.T.A.'s Goetia/Almadel system. However, you should not neglect the four Archangels of the Quarters. I suggest that you have the color plates of the Angels enlarged and then mounted on icon frames -- such as the ones shown in the video -- with shelves for candles. (They don't have to be as elaborate as ours. Just a board with a shelf at the bottom will do quite well.) Hang them on the four walls of your temple. You can then ceremonially light the Four Quarters as a form of temple opening.

If you want to add full size pillars to your temple you will need to find a salvage yard and then spend several days patching, caulking and sanding your forlorn acquisitions -- but eventually *Jochin* and *Boaz* will emerge (with the help of black and white enamel, gold and silver leaf and coats of plastic varnish.) Smaller pillars can be created from p.v.c. pipe or even heavy cardboard tubes.

The early O.T.A. had its own distinctive magick wand that was derived from a design by Eliphaz Levi. We constructed it out of a two foot long decorative wooden spindle of the type used for railings. One half was painted white and the other black. Each end of the spindle was fitted with a cast iron quatrefoil point of the type used to cap wrought iron fences and gates. The white end was pointed forward for invoking and the black end forward for banishing. This allowed the operator to do some artful wand twirling. The iron points could be wire wrapped with cotton waste, which when soaked with naphtha and ignited, provided a spectacular display -- especially when the operator was able to clench the flaming point with his bare hand to extinguish the fire. (We

will *not* be responsible for any injuries incurred by anyone attempting to replicate this feat!)

Many old time O.T.A. members and numerous students of the various irregular O.T.A. groups still use this style of wand. As an operator I came to find it cumbersome in working the psychic center system from directly behind the receiver. We now use this original two foot wooden version only for seasonal ceremonies in its capacity as a “fire wand”.

Notes on Furniture and Equipment:

1. We started using u.v. lighting in our temple back in 1970. We use it only for the Holy Names around the Magick Circle and on our planetary septagram design. For this limited purpose it is very effective because it keeps the wards of power and the correspondences of the working always visually charged and constantly seen even out of the corner of the eye. The ultraviolet light also lends an otherworldly atmosphere to the temple. It is, in fact, very much like the electric blue of the astral plane. Of course we have been criticized by magicians with far less operative experience who believe that only olive oil lamps and candle light are acceptable to their spirits -- but our spirits seem to enjoy the higher frequencies. We have also experimented with a Vandegraff static generator to charge our Almadel rock crystal ball. “The Orb” absorbs energy at such a rate that it actually doubles the usual spark gap, creating two foot long lightning bolts. (Such experiments are more common in European lodges than in America.)
2. Fluid condensers are alchemical compounds (either liquid or dry) that attract astral “fluids” and hence are used by magicians of the Franz Bardon school to charge their magic(k) mirrors. However, Bardon does not emphasize optical mirrors. He prefers a non-reflective black surface for tantric style visualization. With these non-optic mirrors the condenser is sprinkled directly on the viewing surface. With O.T.A. style optic mirrors the fluid condenser is sometimes placed behind the mirror as an added reinforcement. I can’t say that it does any particular good in our case, but, as long as you don’t depend on it, it can be considered an alchemical enhancement (See *Initiation into Hermetics* by F. Bardon.)

Appendix 4
Documentary Exhibits

1. *The Art Almadel of Solomon*
(Direct transcription from B.L. MS. 2731 with facsimile of "Armarel" drawing from Sepher Maphteah Shelomo, courtesy of G.H. Frater Sabazius X^o.)

2. *The Characters or Seals of the 72 Schemahamphorasch*
(Facsimile of first page of Arsenal MS. 2495 copied by S. L. MacGregor Mathers, courtesy of Pat Zalewski.)

3. *Pythagorean Influence on the Sepher Yetzirah and its Subsequent Application in Medieval Magick*
(Academic paper in *Jewish Mysticism*, California State University, Northridge, 1975 – with up-dated footnotes.)

The Almadel

*being the Fourth Book
of the Lemegeton
of Solomon the King*

IN THIS FIRST SECTION of the Documentary Appendix we are presenting a complete, literal transcription of *The Art Almadel of Solomon* from *Sloane 2731, The Lemegeton*. We are also showing a drawing of an earlier Almadel type device called “The Armarel” or “Almarel” from one of the oldest surviving Key of Solomon manuscripts, *The Sepher Maphteah Shelemo*, (Hermann Gollancz, 1914 edition) courtesy of Fra. Sabazius X^o. (See page 49 for MS. 2731 Almadel facsimile.)

Readers may wish to recreate their own waxen Almadel. (See our reconstruction and demonstration in the video). You may even decide to experiment with the original system. Please be encouraged to do so. Because the Almadel from the Lemegeton does not match up with the Goetia Spirits (thus prompting our radical rectification), this does not mean that the old Almadel (or Almarel) system itself is essentially flawed. Although somewhat garbled in its Angelic nomenclature, it works well in its own right and the visual effects are spectacular. One pinch of incense lasts for the entire operation -- (When making your Almadel, dish out a concave depression in the bottom side of the wax plate to channel the smoke up through the holes, and then be sure to keep your incense burner well below the wax when you are operating.)

The Art Almadel of Solomon

Here beginneth the Fourth Part of this Book (Lemegeton) which is called the Art Almadel of Solomon. By this art Solomon attained great wisdom from the chief angels that govern the four Altitudes of the World: for you must observe that there are four Altitudes which represent the four Altitudes of the West, East, North and South: the which is divided into 12 parts; that is, every part 3. And the Angels of every (one) of these parts hath their particular virtues and powers, as shall be showed in the following matter:—

Make this (Eastern) Almadel of pure white wax; but the others must be coloured suitable to the Altitudes. It is to be 4 inches square, and 6 inches over every way, and in every corner a hole, and write

betwixt and every hole with a new pen those words and names of God following. But this is to be done in the day and hour of Sol (the Sun). Write upon the first part towards the East, ADONAIJ, HELOMI, PINE. And upon the second towards the South part HELION, HELOI, HELI. And upon the West part JOD, HOD, AGLA. And (on) the Fourth part which is North write TETRAGRAMMATON, SHADAI, JAH.

And betwixt the first and the other parts make the pentacle of Solomon thus:  and betwixt the first quarter write this word ANABONA, and in the middle of the Almadel make a Sexangle figure, and in the middle of it a triangle, wherein must be written these names of God HELL, HELION, ADONAIJ, and this last have round about the six-angled figure, as here it is made for an example (see Lemegeton Almadel MS. facsimile folio page 49.)

And of the same wax there must be made four candles. And they must be of the same colour as the Almadel is of. Divide your wax into three parts: one to make the Almadel of, and the other two parts to make the candles of. And let there come forth from every one of them a foot made of the same wax to support the Almadel. (See facsimile folio of the "Almarel" from *Sepher Maphteah Shelomo*.)

This being done, in the next place you are to make a seal of pure gold or silver (but gold is best) whereon must be engraved those three names HELION, HELLUION, ADONAIJ.

And note that the First Altitude is called Chora Orientis, or the East Altitude. And to make an experiment in this Chora it is to be done in the day and hour of the Sun. And the power and office of those angels is to make all things fruitful, and increase both animals and vegetables in creation and generation, advancing the birth of children, and making barren women fruitful.

And their names are these, viz: ALIMIEL, GABRIEL, BARACHIEL, LEBES, HELISON.

And note you must not pray for any angel but those that belong to the Altitude you have a desire to call forth.

And when you operate set the four candles upon four candlesticks, but be careful you do not light them before you begin to operate. Then lay the Almadel between the four candles upon a waxen foot

that comes from the candles, and lay the golden seal upon the Almadel, and having the invocation ready written upon virgin parchment, light the candles and read the invocation.

And when he appeareth, he appeareth in the form of an angel-carrying in his hand a banner or flag having the picture of a white cross upon it, his body being wrapped round with a fair cloud, and his face very fair and bright, and a crown of rose flowers upon his head.

He ascends first upon the superscription on the Almadel, as it were a mist or fog.

Then must the exorcist have ready a vessel or earth of the same colour as the Almadel is of, and the other of his furniture, it being in the form of a basin, and put thereinto a few hot ashes or coals, but not too much lest it should melt the wax of the Almadel.

And put therein three little grains of mastick in powder so that it may fume and the smell go upwards through the holes of the Almadel when it is under it.

And as soon as the Angel smelleth it he beginneth to speak with a low voice, asking what your desire is, and what you have called the princes and governors of this Altitude for.

Then you must answer him, saying:

“I desire that all my requests may be granted and what I pray for may be accomplished: for your office maketh it appear and declareth that such is to be fulfilled by you, if it please God.”—

Adding further the particulars of your request, praying with humility for what is lawful and just: and that thou shall obtain from him. But if he do not appear presently, then you must obtain the golden seal, and make with it three or four marks upon the candles, by which means the Angel will presently appear as aforesaid.

And when the Angel departeth he will fill the whole place with a sweet and pleasant smell, which will be smelled for a long time.

And note the golden seal will serve and is used in all the operations of all four Altitudes.

The colour of the Altitude belonging to the first Altitude, or Chora, is lily-white; the second Chora a perfect red rose colour; the

third Chora is to be a green mixed with a white silver colour; the fourth Chora is to be black mixed with a little green or a sad colour.

Of the Second Chora or Altitude

Note that the other three Altitudes, with their Signs and Princes (have) power over goods and riches, and can make any man rich or poor.

And as the first Chora gives increase and maketh fruitful, so these give decrease and barrenness. And if any have a desire to operate in any of these three following Choras or Altitudes, they must do it in die Solis (Sunday) in the manner above showed.

But do not pray for anything that is against God and His laws, but what God giveth according to the custom or course of nature: that you may desire and obtain. . .

All the furniture to be used is to be of the same colour the Almadel is of. . .

And the princes of the second Chora are named, viz: APHIRIZA, GENON, GERON, ARMON, GEREIMON.

And when you operate kneel before the Almadel, with clothes of the same colour, in a closet hung with the same colours also; for the holy apparition will be of the same colours.

And when he appeareth, put an earthen vessel under the Almadel, with fire or hot ashes and three grains of mastick to perfume as afore-said. And when the Angel smelleth it he turneth his face towards you, asking the exorcist with a low voice why he hath called the princes of this Chora or Altitude. Then you must answer as before:

“I desire that my requests may be granted, and the contents thereof may be accomplished: for your office maketh appear and declareth that such is to be done by you, if it please God.”

And you must not be fearful, but speak humbly, saying:

“I recommend myself wholly to your office, and I pray unto you, Prince of this alltitude, that I may enjoy and obtain all things according to my wishes and desires.”

And you may further express your mind in all particulars in your prayer, and do the like in the two other Choras following.

The Angels(sic) of the second Altitude appeareth in the form of a young child with clothes of a satin, and of a red rose colour, having a crown of red gilly flowers upon his head. His face looketh upwards to heaven and is of a red colour, and is compassed round about with a bright splendour as the beams of the sun. Before he departeth he speaketh unto the exorcist saying, "I am your friend and brother."

And illuminateth the air round about with his splendour, and leaveth a pleasant smell which will last a long time upon their heads.

Of the Third Chora or Altitude

In this Chora you must do in all things as you was before directed in the other two. The angels in this Altitude are named, viz: ELIPHANIASAI, GELOMIROS, GEDOBONAI, TARANAVA & ELOMINA.

They appear in the form of little children or little women dressed in green and silver colours very delightful to behold, and a crown of baye leaf with white and colours upon their heads. And they seem to look a little downwards with their faces. And they speak as the others do to the exorcist, and leave a mighty sweet perfume behind them.

Of the Fourth Chora or Altitude

In this Chora you must do as before in the others, and the Angels in this Chora are called BARCAHIEL, GEDIEL, DELIEL and CAPI-TIEL. They appear in the form of little men or boys, with clothes of a black colour mixed with a dark green; and in their hands they hold a bird which is naked; and their heads compassed round about with a bright shining of divers colours.

They leave a sweet smell behind them, but differ from the others something.

Note that there is (sic) twelve Princes, beside those in the four Altitudes: and they distribute their offices amongst themselves, every one ruling thirty days every year.

Now it will be in vain to call any of the Angels unless it be those that govern them. For every Chora or altitude hath its limited time, according to the twelve signs of the Zodiac; and in that Sign the Sun is in that or those Angels that belong to that Sign hath the government. As, for example: suppose that I would call the 2 first or the 5 that belong to the first Chora.

Then choose the first Sunday in March, after the Sun hath entered Aries: and then I make an experiment. And so do the like, if you will, the next Sunday after again.

And if you will call the two second that belong to the first Chora, that Sunday after the Sun enters Taurus in April. But if you will call the last of the 5, then you must take those Sundays that are in May after the Sun has entered Gemini, to make your experiment in.

Do the like in the other Altitudes, for they have all one way of working. But the Altitudes have names formed severally in the substance of the heavens, even a character. For when the Angels hear the names of God that is attributed to them, they hear it by virtue of that character.

Therefore it is in vain to call any angel or spirit unless he knows what name to call him by. Therefore observe the form of this conjuration or invocation following:

The Invocation

“O thou great, blessed and glorious Angel of God (N), who rulest and is the chief governing Angel in the first (2nd, 3rd or 4th) Chora or Altitude. I am the servant of the Highest, the same your God Adonaij, Helomi, and Pine, whom you do obey, and is your distributor and disposer of all things both in heaven earth and hell, do invoke, conjure and entreat you (N) that thou forthwith appear in the virtue and power of the same God, Adonaij, Helomi and Pine; and I do command thee by him whom ye do obey, and is set over you as King in the divine

power of God, that you forthwith descend from thy orders or place of abode to come unto me, and show thyself visibly here before me in this crystal stone, in thy own proper shape and glory, speaking with a voice intelligible to my understanding.

O thou mighty and powerful Angel (N), who art by the power of God ordained to govern all animals, vegetables and minerals, and to cause them and all creatures of God to spring increase and bring forth according to their kinds and natures: I, the servant of the Most High God whom you obey, do entreat and humbly beseech thee to come from your celestial mansion, and shew unto me all things I shall desire of you, so far as in office you may or can or is capable to perform, if God permit to the same.

“O thou servant of mercy (N), I do humbly entreat and beseech thee by these holy and blessed names of your God ADONAIJ, HELLOMI, PINE;

“And I do also constrain you in and by this powerful name ANABONA, that you forthwith appear visibly and plainly in your own proper shape and glory in and through this crystal stone, that I may visibly see you, and audibly hear you speak unto me, and that I may have thy blessed and glorious angelic assistance, familiar friendship and constant society, community and instruction, both now and at all times, to inform and rightly instruct me in my ignorance and depraved intellect, judgement and understanding, and to assist me both herein and in all other truths also, through the Almighty Adonajj, King of Kings, the giver of all good gifts that his bountiful and fatherly mercy be graciously pleased to bestow upon me.

“Therefore, O thou blessed Angel (N), be friendly unto me, so far as God shall give you power and presence, to appear, that I may sing with his holy Angels.

“O Mappa Laman, Hallelujah. Amen.” #

When he appears, give him or them kind entertainment; and then ask what is just and lawful, and that which is proper and suitable to his office. And you shall obtain it.

*So Endeth the 4th Book (of The Lemegeton)
called the Almadel of Solomon The King*

The "Arml" (Armarel or Almarel) of Solomon from *The Sepher Maphteah Shelomo* partially translated and published in facsimile by Herman Gollancz, M.A., D. Lit., Oxford Univ. Press, 1914 -- Courtesy of G.H. Frater Sabazius X^o.

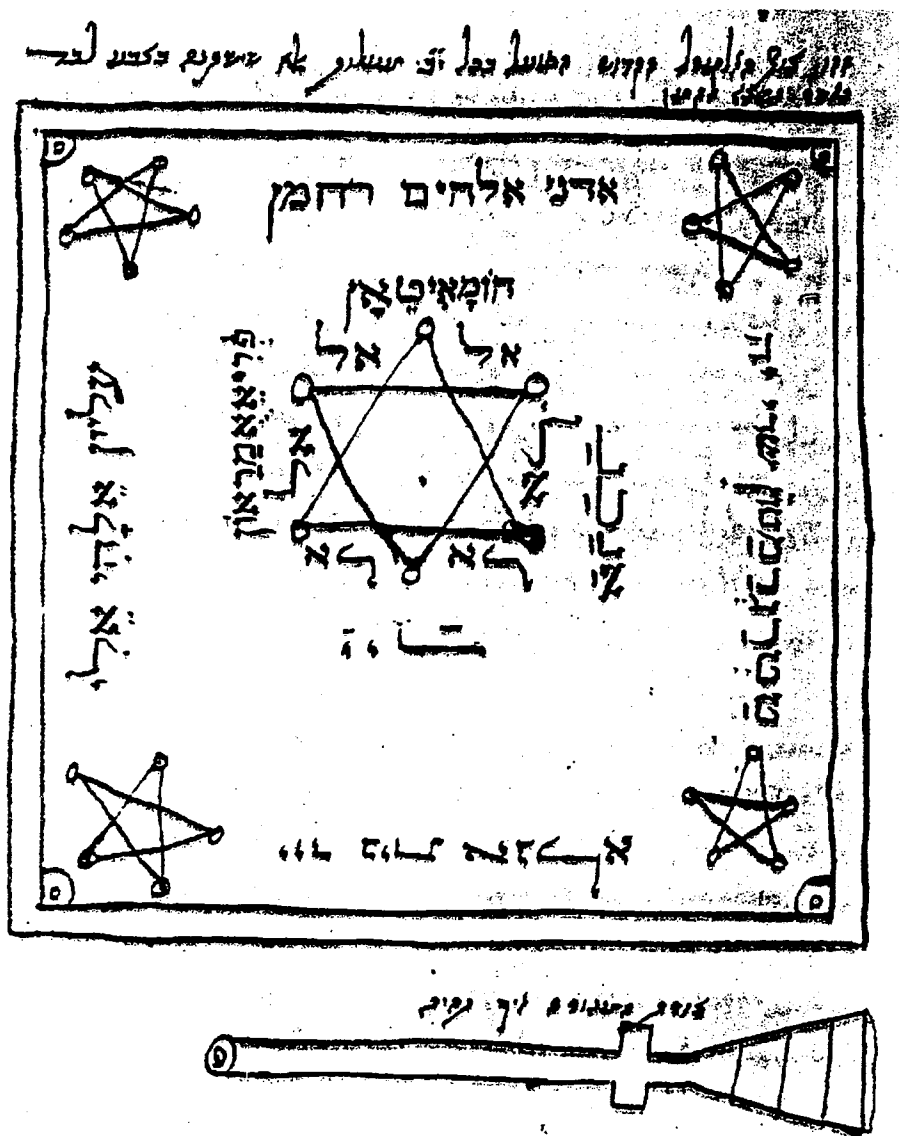

Note:-- This early version of *The Greater Key of Solomon* also contains a Magick Circle diagram that shows a Triangle of Art positioned just outside of its perimeter.

Facsimile of the first page of *The Characters or Seals of the 72 Schemahamphorasch* as copied from Paris Arsenal MS. 2495 by Samuel Liddell MacGregor Mathers courtesy of Pat Zalewski.

*The Characters or Seals
of the
72 Schemahamphorasch.*

(from

Ar. 2495.)

(By the Great Magician "Blaise Viginair)

(1) *Vehriah*: — 

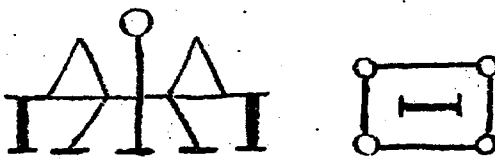
(2) *Ietiel*: — 

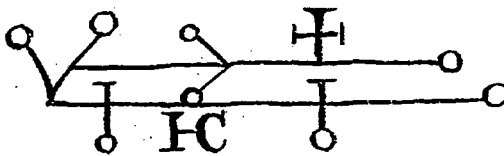
(3) *Sitael*: — 

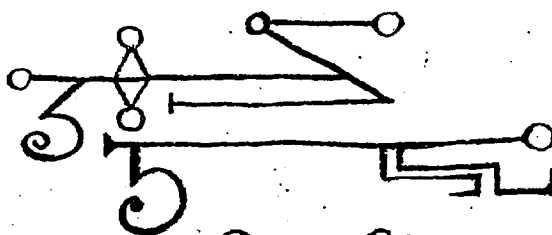
(4) *Etemiah*: — 

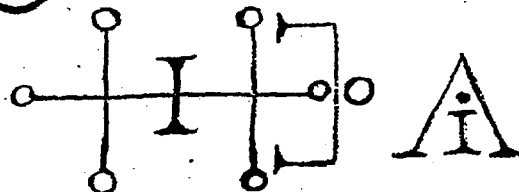
(5) *Makasiak*: — 

Carroll R. Runyon
RS 480 Jewish Mysticism
Rabbi W. Kramer
California State University
at Northridge

2,268 words

First draft, 20 March, 1975
Revised and expanded, 8 April, 1975

Author's 1996 Note:

I have decided to present this paper in its original form and reserve my current editing for the footnotes. This serves three purposes: first, it documents my research and experimentation in Goetia up to the time of submission, secondly, it presents the system in a more traditional kabbalistic context and last (and by ALL means least) it shows that I learned the rules before I broke them.

*Pythagorean Influence on the Sepher Yetzirah and its
Subsequent Application in Medieval Magic*

PROPOSING THE TETRACTYS of the Pythagoreans as a philosophical inspiration for the concept of “the Three Mother Letters” (A, M, Sh) in the *Sepher Yetzirah* is neither a very original nor controversial thesis, especially in light of Gershom Scholem’s cursory comment, “We can only be sure that it (the *Sepher Yetzirah*) was written by a Jewish Neo-Pythagorean some time between the third and the sixth century.”¹ In his English translation of the work, Rabbi Kalisch writes, in a commentary footnote to Chapter One,

Section Three, “Like Pythagoras, who taught that the digits inclusive number ten (*sic*) which are typified in Tetractys, namely: 1 plus 2 plus 3 plus 4 equal 10, and which comprise the whole arithmetic system of nature, etc.”²

Although a case can also be made for the *Tetractys* relating to the *Tetragrammaton*, e.g. Y, YH, YHV, YHVH, and this when extended produces the *Shemhamphorash* or 72 letter Name.³ This seems to be independent of the *Sepher Yetzirah* which does not deal with the *Tetragrammaton* concept. Whether this is a later derivation from the same source (the *Tetractys*) or a ‘deep structure’ synchronism, might be debated but direct Pythagorean influence on the *Yetzirah* seems fairly obvious.⁴

However comfortable it might be to concede that the *Aleph*, *Mem* and *Shin* generative trilogy in the *Sepher Yetzirah* derived from the Pythagorean-Platonic ‘Point’ (1.) ‘Line’ (2.) ‘Triangular Plane’ (3.) ‘Primordial solid’(4.) (tetrahedron) creation concept,⁵ when we carry this into the realm of the “Practical Kabbalah” we find ourselves faced with what may well be a disturbing reassessment. It appears that we have uncovered one of the secrets of “Solomon’s Triangle of Art” as delineated in the *Goetia* of the *Lemegeton*.⁶ — and if so, we might have to concede that some medieval ceremonial magicians were not such ignorant louts and bumpkins as Arthur Edward Waite would have us believe.⁷

What I am suggesting is that the medieval “Triangle of Art” was a philosophical-mystical *spiritus locus par excellence*, not simply in its triangular configuration but in its entire design. Before considering the ramifications, let us reflect on the compelling elegance of the tetrahedron in relation to Ceremonial Magic. *Aleph*, *Mem* and *Shin* (the triangular plane) generate a hypothetical fourth point, which transforms the triangle into a solid (this single point in the *Sepher Yetzirah* alphabet system would translate directly to the Seven Double Letters as they relate to the six dimensions plus the center point of space.) What better model could we possibly construct to symbolize the creative process (from *Atziluth* to *Briah*), leaving the manipulation of *Yetzirah* forms to the magician ?

On studying Solomon's triangle further, we note that the focal disc in the center is "green" (an Earth attribute) and that the English or Latin letters *Mi*, *Ch*, *Ael* (Michael) surround it at the three angles. Michael, greatest of the Archangels, forerunner of the *Shekinah* and the Angel of the Burning Bush certainly relates to *Shin*, which, with its three serifs, was used as a code glyph to represent the Supernal Triad of the *Otz Chiim* in later *Zoharic* notation.¹⁰ This transmutation of symbols is certainly allowable by the 17th Century but it is my contention that if we could uncover the original Spanish-Hebrew *Lemegeton* that Weirus and later scholars date to the 13th Century, we would probably discover the Letters *Aleph* (yellow), *Mem* (blue) and *Shin* (red) surrounding and 'generating' the green disc in the center.¹¹

In further considering the significance of the 'green disc', we should not avoid a reconstruction of how the *Triangle Of Art* must have been employed in actual practice — but because the prevailing opinion of medieval magicians is so universally low, no scholar has bothered to consider it beyond a general assumption that it was an area over which hallucinations were supposed to occur (induced by fasting, hysterical conjurations, toxic fumes, etc.)

It is interesting to note that in Crowley's published version of the *Goetia*, the Triangle is described or 'quoted' as being positioned, "Two feet distant from the Magical Circle and it is three feet across."¹² A. E. Waite's version, however, is almost correct: "Two feet outside this circle and three feet over it."¹³ The actual quotation from *Sloane MS. 2731* reads: "Two foot off from the Circle and three foot over,"

Neither Waite nor Crowley seem to have been aware of what to do with the Triangle even though Waite's rendering was correct. (It should be noted, however, that Mathers, and later Crowley, were working from a Latin MS. in the British Museum and not the English *Sloane 2731* as was Waite.) In Waite's case, he apparently did not care and in Crowley's case he obviously did not know.¹⁴

I make bold to suggest that the medieval magicians who developed and practiced this system were perhaps more mature and sophisticated in their approach to the actual method than Crowley was even

though his psychological forward to his version of the *Goetia* is the very antithesis of credulity, Crowley's operational methods are totally romantic — but this is perhaps consistent on some abstract level of Simonian Gnostic (Thelemic) paradox that we benighted 'monists' are not privileged to understand. ¹⁵.

Rejecting the 'smoke' method and taking a more pragmatic approach to the problem, we will erect our triangle "Two feet out and three feet over", as specified, and then place one of "the seven planetary metal mirrors" cited by E. Wallis Budge, ¹⁶ on our 'green disc' and then, holding a pair of, candles, *we stare at our own reflection* in the manner Tantric adepts employ to evoke visions of previous incarnations, ¹⁷ while our Magus stands behind us, intoning the conjuration, *and we have a method that works.* ¹⁸.

Before we declare this method a modern synthetic (which is the opinion of Francis Regardie ¹⁹.) we should perhaps consider that *if* our medieval magicians were philosophical enough to adopt the Pythagorean-Yetziratic Triangle symbolism, *if* they believed in the microcosm-macrocosm analogy, *if* they held that God created man in His own image, *and if* their Triangle was elevated rather than flat, it would seem probable that something like my suggested method was employed. The Seventy-two Spirits of the Brass Vessel might then have constituted a microcosmic (internalized) counterpoint to the Seventy-two Angels of the *Shemhameforash*. Considering the Gnostic influence on the *Sepher Yetzirah* and on the later Kabbalah, we should perhaps consider the following Mandaean passage cited by Hans Jonas: --

"Abathur (one of the Uthras plotting the creation of the world) goes into that world (of darkness). . . He sees his face in the black water." This son is Ptahil-Uthra, the actual demiurge of this world. This example from an area so far removed from the intellectual environment in which Plotinus met his Gnostics shows how persistently the act of mirroring is conceived in Gnostic literature as the production of an alter ego, and at the same time how closely this is connected with cosmogony.— Hans Jonas. *The Gnostic Religion*, 1958.

And for a broader perspective we may turn to Frazer's *Golden Bough* where we read, "As some peoples believe a man's soul to be in his shadow, so other (or the same) peoples believe it to be in water or in a mirror." ²⁰ Carrying this theme into the realm of Jewish folklore, we find the following in Trachtenberg; "If a woman at the commencement of her period stares fixedly into a bright metal mirror she will behold in it a drop of blood, for the demon that is in her glance creates an evil influence in the air which adheres to the mirror. . ." ²¹.

We should note that our 'green disc' and the Magick Mirror we place upon it — which is the *Pantacle of Art*, attributed to Earth — represents a direct theoretical parallel to the original visionary *Golem* operation. This may be our best argument for a Jewish over an Arabian origin of the *Lemegeton*. ²².

Whether or not the system I have described was used in medieval and renaissance ceremonial magick is of little consequence to its modern effectiveness, which, from a Jungian psychological viewpoint, is startling.

I and my associates have not thought it wise to broadly exploit this method due to the danger that might be incurred through its misuse by the immature and the impressionable — especially in conjunction with psychoactive drugs (which we do not employ in our operations). I have presented the above for your private consideration in your professional capacity and I trust that these matters will remain in confidence. ²³.

Notes on Kabbalah Appendix:

1. Gershom Scholem, *The Kabbalah and its Symbolism* (New York: Schocken Books, 1965) p. 167.
2. Isidor Kalish, *Sepher Yetzirah* (Hollywood, CA: Signs & Symbols, 1973, reprint of orig. edit., 1877) p. 11, n.7.

Notes continued on next page. . .

Kabbalah Notes continued. . .

3. Charles Ponce, *Kabbalah* (San Francisco: Straight Arrow Books, 1973) p.175.
4. The triangular *Tetractys* generating the 72 letter *Shemhameforash* does have a very interesting relation to the *Lemegeton*, which uses a triangle in which 72 spirits are conjured. (1995 note: — OTA uses the version of the *Shemhameforash* derived from the *Book of Exodus*, not the YHVH permutation.)
5. Walter Burkert, *Lore and Science in Ancient Pythagoreanism* (Cambridge & Harvard Univ. Press, 1972) p. 72; See also, H. P.D. Lee, Plato; *Timeaus and Critias* (Baltimore, Md., Penguin Books, 1965) Chap. 22.
6. British Museum, London, *Sloane MS 2731*.
7. A.E. Waite is only the most vehement of those who hold this view. Having been a practicing occultist, his lofty contempt for Magick is rather suspect. A more accomplished recent proponent is Frances A. Yates, *Giordano Bruno and the Hermetic Tradition*, 1964, who holds that medieval magic had been forced by the Church “. . . into dark holes and corners.” But she is not referring to Moorish Spain where the *Lemegeton* probably originated.
8. Isidor Kalish, *Sepher Yetzirah*, Chap. 4, Sec. 4.
9. Gustav Davidson, *A Dictionary of Angels* (New York: The Free Press, 1967) p. 193.
10. Charles Ponce, *Kabbalah*, p. 111.
11. I realize that these four colors are Alchemistic rather than Kabbalistic and may indicate a Hermetic influence, perhaps via *Picatrix* if a 13th Century Moorish-Spanish origin is correct — but the important element here is that there is a color scale relating to a central focal point, i.e. the green disc.
12. Aleister Crowley, the *Goetia* (Chicago, DeLaurence Scott & Co., 1916) p. 49.
13. Arthur Edward Waite, *The Book of Ceremonial Magic* (New York, Citadel, 1970 ; original edit., 1898) p. 222.

14. This is confirmed by Crowley's description of a primitive and ponderous attempt, that he and an associate made to work the system conjuring in smoke from a censer placed on a flat triangle outside the Circle. After several hours they had only a faint suggestion of success; Aleister Crowley, *Magick Without Tears* (St. Paul, MN: LJewellyn, 1973, p. 359.)
15. In all due respect to Gershom Scholem, there was more to Crowley than "colorful humbug". Perhaps if Scholem had considered Crowley as a Simonian Gnostic rather than a pseudo-Jew, he might have seen "The Great Beast" in a more academic, dispassionate perspective. Scholem also wrote that Crowley had "an infinitesimal knowledge of kabbalah" -- but, conversely, Scholem had an infinitesimal knowledge of Crowley! (1995 note: Since this writing I have done more research on Simon Magus. Crowley certainly was a libertine Gnostic and he did borrow the Scarlet Woman motif from Simon, but we cannot properly term Crowley a neo-Simonian because Simon Magus truly venerated and exalted the Divine Feminine according to G.R.S. Mead in his monograph, *Simon Magus, The Gnostic Magician*, pp. 40, 41.)
16. E. A. Wallis Budge, *Amulets and Talismans* (New York: University Books, 1968) p. 490. Unfortunately Budge does not give his source on this.
17. Omar V. Garrison, *Tantra, The Yoga of Sex* (New York, Julian Press, 1964) p. 201.
18. Hans Holzer, *The New Pagans* (New York: Doubleday, 1972) p. 141.
19. (1995 note: When I first told Regardie about my rediscovery of this method in 1970 he barked back at me: "They didn't do it that way, *they did it in smoke!*" Based on his authoritative assertion I had harbored a nagging doubt about the antiquity of the mirror method until 1985 (the year Regardie died) when I found Adam MacLean's 1982 published version of *B.M. Harley MS 6482, A Treatise on Angel Magic*, showing a drawing of a magic mirror on a stand with *Solomon's Secret Seal* from the *Goetia* of the Lemegeton on the back (see *Fig. 2.*, p. 34).
20. James G. Frazer, *The Golden Bough* (New York: MacMillan, 1942) p. 192.

Kabbalah notes continued . . .

21. Joshua Trachtenberg, *Jewish Magic and Superstition* (New York Behrman's Jewish Book House, 1939) p. 185.
22. (1995 note:) the *Lemegeton* is actually a later, possibly 17th century, compendium of five books on magick. The *Goetia* and the *Almadel* are probably the oldest and could date back to the 13th century. Both systems as we have them are probably of Spanish origin but, in the case of the *Goetia*, the Arabian influence is very strong (see C.J.S. Thompson's *The Mysteries and Secrets of Magic* p. 89) and there is early Christian influence in the references to former angelic orders such as "Dominions", "Thrones", "Virtues", etc. which were accepted by the Hermetic Kabbalists according to Frances Yates. (see *Giordano Bruno and the Hermetic Tradition*, Chap. VI.)
23. In 1974 on NBC's *Tomorrow Show*, hosted by Tom Snyder, we showed a film clip of a Goetia operation in progress. The upright triangle, supporting the dark mirror, was briefly displayed. The receiver, holding the evocation candles, was visible with myself, as operator, standing behind her. The method would have been obvious to any one with a knowledge of magick but not to the general public. We were neither exploiting the dark mirror technique, nor making a secret of it.

The bibliography for this paper ran to 19 items. It is included in the general bibliography for this book.

Appendix 5

Study Guide & Bibliography

AS STATED IN THE INTRODUCTION, ours is a literate tradition (sometimes it seems too literate!) and no one can teach you all about Solomon's magick in one book. However, what I can and will do is provide you with a list of the best books for practical exercises, study and reference. I will also suggest what to avoid in order to keep you ON THE PATH. First I'm going to lay out a short "crash course" for those who want to get started quickly:

Read my *Magick and Hypnosis* and *Negative vs. Positive Gnosis* then go directly to the practical manuals: for self-hypnosis, Leslie M. LeCron's *Self Hypnotism: The Technique and its Use in Daily Living*. For Raja Yoga (pranayama, tratakam, etc.) Dr Rammutri Mishra's *Fundamentals of Yoga*. These books are modern classics and usually in print or otherwise available. If you can't locate them, a professional book search service will quickly find them for you.

For a concise practical survey of Western Magick *The Black Arts* by Richard Cavendish is still the best. It has been through several editions and is back in print at this writing.

As for Grimoires, the only three you really need at the outset are the Mathers/Crowley *Goetia* (the new 2nd edition from Samuel Weiser is recommended) and the Mathers' *Key of Solomon the King* (also from Weiser). The latter is essential for talismans and equipment

decoration, etc., and Francis Barrett's *The Magus*. This book has a bad reputation among scholars because the author lifted so much material from earlier sources but it is still the best compendium of arcane lore for the beginning magician. (Later you may want to collect separate editions of Barrett's source works such as Agrippa's *Three Books of Occult Philosophy*, etc.)

For Kabbalah there are two books that I consider essential. Fortunately they are both short, concise and as clearly written as possible considering the complexity of the subject: *Kabbalah* by Charles Poncé and *A Garden of Pomegranates* by Francis Israel Regardie.

For an operational reference handbook you will need some version of Crowley's 777. (Contrary to popular myth, the main correspondences have not been Thelemized. It is still basically the Golden Dawn system.)

The above listed monographs and books form the "bare-bones basic library" to back up the Solomonic system taught in this book. Of course you are going to be interested in further reading and research. Let me caution you about two major traps you may encounter: the first is the "Eastern Masters" or "Great White Brotherhood" theme. Back in the 1880's Helena Blavatsky promoted her unique version of Sikh Sant and Buddhist religion under the guise of a super-ancient Tibetan system (she was apparently protecting her Sikh sponsors in Kashmir. In the late 1800's the British and the Russians were fighting a "Cold War" on the Indian frontier.) If you become glamorized by this modern myth you will be seduced away from a straight course toward Western adeptship.

The extensive influence of Theosophy in occultism also presents a continuous veracity problem for the Western magical student who needs to explore and understand both Eastern and Western magical systems. Several of the books we recommend are actually published by the Theosophical Society (Quest Books). The best rule is too understand the principles of your own tradition and those of the Eastern systems from the purest source material you can find -- then you, yourself, can decide where they differ and where they agree.

The second pitfall you should avoid is a headlong rush into the Enochian system. Because Enochian is presently so popular, and

because both the Golden Dawn and the Thelemic (O.T.O.) systems use it, there is a tendency to include Enochian conjurations, Watchtower Opening procedures, etc. in beginning texts on magick without any qualification as to the special nature of the Enochian system. Donald Michael Kraig's *Modern Magick* is an example of this trend but he is not alone. Avoid a commitment to Enochian until you have a good idea of what Western Magick is all about — then decide whether or not you want to experiment with it. (I have studied and practiced Enochian magick for many years. I made my own set of Watchtower Tablets and have even channeled some original Enochian material. The O.T.A. operation that Geoffrey James recounts in Chapter Nine of his *Angel Magic* was Enochian — but I am very much aware that Enochian is not the only Western system. It is not necessarily 'bad' or especially dangerous but when beginning students ask me about it, I usually tell them that "There are no warm fuzzies in Enochian". Enochian entities don't love you. In many case they don't even like you. Therefore beginning students should not be maneuvered or tricked into practicing the system before they are ready to make their own knowledgeable commitments.)

The same rule applies in some respects to the Golden Dawn system itself. Westcott and Mathers gave us the greatest synthesis of Western esoteric lore since Agrippa in the mid-1500s. We use their correspondences and color scales in the O.T.A. but this does not mean that we, or anyone for that matter, has to be bound by the Victorian-age restrictions that hobbled their magick. (We should mention that several modern Golden Dawn adepts are very much aware of these Victorian handicaps and now support a return to Renaissance methods. The Ciceros use dark mirrors and Pat Zalewski employs an obsidian orb in his Enochian operations.) You should certainly get Regardie's *The Golden Dawn* (the 6th edition has an index) and use it as a reference tool at the very least. Going through the grades of the Golden Dawn is not unlike earning a degree from a university. Dedicated magicians should certainly consider the advantages.

No serious discussion of the art magical would be complete without considering the contributions and the impact of Aleister Crowley. On the good side he brought magick into the twentieth cen-

tury as a vital artistic and intellectual force rather than a quaint anachronism. He was a freedom loving romantic out to liberate the long-repressed Faustian-Promethean shadow underlying the Western psyche. Unlike Westcott, Mathers and even Blavatsky, he did not hide behind smoke screens of ancient mythology. He boldly created his own religion, declared himself its prophet and set out to conquer the world with a declaration that discovering and pursuing one's "True Will" should be the most important single factor in human life. This philosophy is especially attractive to magicians and the word "Magick" (using the Renaissance spelling) became almost synonymous with Crowley himself.

On the down-side, he was extravagantly amoral and suffered from multiple substance addiction. In the 1970's, cult-worship of Crowley, especially the glorification of his faults and weaknesses over his virtues, continued to distort the true purpose of his teachings. For a quarter of a century following his 1947 demise, Crowley's lurid public image tainted his legacy. However, by the time of this writing his *Ordo Templi Orientis* has matured into the elite and respected magical sodality it was originally intended to be. Crowley's *Book of The Law* may now be accepted as a subjective declaration of personal freedom rather than a manifesto for social anarchy. No student of modern Magick should consider his or her education complete without at least reading Crowley's *Magick in Theory and Practice*.

Finally we come to the Bardonian system. You were introduced to it in *The Evocation of Nithael*. Franz Bardon was a European magus who flourished in the years directly before and after WW II. He was a professional stage hypnotist, a devotee of Rudolph Steiner and a practitioner of both Raja and Tantric yoga. Like Julius Evola, he forged links between the Hermetic and Eastern systems. Bardon's books suffer from stilted translation. One of my late colleagues would read passages from Bardon aloud in a thick German accent for a humorous effect — but regardless of Bardon's quaint style and dogmatically superstitious approach, he had a profound practical and theoretical knowledge of magick and his is still the best training program for the solitary practitioner who wishes to devote his or her life to the magical art. Bardon demands a major long-term commitment in which the

student, through a series of intense concentration exercises, will literally transform himself into a magical adept as powerful and (hopefully) as enlightened as any Tibetan Lama.

Franz Bardon's road is not an easy one. He tells the student exactly what must be accomplished in mastering each of his steps but often he does not explain how to do it. Bardon's first book, *Initiation into Hermetics*, is actually more of an outline for a course of study than a complete program. It requires the additional mastery of self-hypnosis along with Raja and Tantric Yoga. The O.T.A. Solomonic program is an excellent prerequisite to Bardon, providing one realizes that Bardon demands evocation from a non-reflective "mirror". When you get to this stage you can no longer fall back on the optical phenomenon of facial reflection/distortion in the mirror or the auric halo around the crystal that make our O.T.A. operations so easy in the beginning. Bardon's magick is for the advanced student who, having completed our Goetia/Almadel program, is ready to accept a long term regime of personal magical development.

Bardon's first and second volumes are excellent. However, his *Key to the True Quabbalah* (3) and *Frabato* (4) are perhaps too divergent from the British-American magical point of view. Look to Bardon for method and technique but for system architecture and magical philosophy you might be better advised to explore Classical and Renaissance Hermetism and Neoplatonism, starting with the works of the late Frances Yates, such as *Giordano Bruno and the Hermetic Tradition*.

For the most concise and accessible selection of Carl Jung's own work I suggest *Modern Man in Search of a Soul* and for a true perspective on ancient Middle-Eastern Paganism underlying the kabbalah I recommend *The Hebrew Goddess* by Raphael Patai.

Bibliography:

Note: Those books we consider important for you to read, study and/or have available for reference are listed in **bold typeface**. The rest are cited for purposes of documentation.

1. **Agrippa,
Henry Cornelius** *Three Books of Occult Philosophy* (1651)
Trans. by James Freake. 1993 edition
edited by Don Tyson. Llewellyn Publications,
St. Paul, MN

2. **Bardon, Franz** *Initiation into Hermetics*
Osiris-Verlag. Kettig Uber Koblenz, 1962
W. Germany

3. *The Practice of Magical Evocation*
Rudolf Pravica, Graz-Puntigam,
Austria, 1967

4. **Barrett, Francis** *The Magus* (1801)
University Books, New Hyde Park, N.Y. 1967

5. Budge, E.A. Wallis, *Amulets and Talismans,*
University Books, New Hyde Park, N.Y., 1968.

6. Burkert, Walter, *Lore and Science in Ancient*
Pythagoreanism, translated by
Edwin L. Minar Jr., Harvard
University Press, Cambridge, Mass., 1972.

7. Burton, Richard *Alf Lahyah wa Lahyah* (1885)
(The Arabian Nights) 16 Volumes
Reprint by The Burton Club, n.d.

8. Butler, Eliza *Ritual Magic*
Cambridge Univ. Press, 1949

9. **Cavendish, Richard** *The Black Arts*
G. P. Putnam's Sons, N.Y. 1967

10. Crowley, Aleister *The Goetia, The Lesser Key of Solomon the King* (1904) -- 2nd Edition. Samuel Weiser, York Beach, ME, 1995

11. *777 and Other Qabalistic Writings of Aleister Crowley*, Samuel Weiser, N.Y. 1973

12. *Magick* (new expanded version of *Magick in Theory and Practice*. Edited by Hymenaeus Beta, Samuel Weiser, York Beach, ME, 1995 (Includes *777* and *Liber Al*)

13. Daraul, Arkon *A History of Secret Societies*
Citadel Press, N.Y., 1962

14. Davidson, Gustav, *Dictionary of Angels*,
The Free Press, New York, N.Y., 1967.

15. DuQuette, Lon Milo *The Tarot of Ceremonial Magick*
Samuel Weiser, York Beach, ME 1995

16. Evans -Wentz, W.Y. *Tibetan Yoga and Secret Doctrines*
Oxford Univ. Press, 1935

17. Frazer, James G. *The Golden Bough*, (1890)
Gramercy, Avenel, N.J., 1981

18. Garrison, Omar V. *Tantra, The Yoga of Sex* ,
Julian Press, New York, N.Y., 1964.

19. Gardner, Gerald *High Magic's Aid*
Michael Houghton, London, 1949

20. Hall, Manly P. *The Secret Teachings of All Ages* (1916)
Philosophical Research Society, Los Angeles, 1962

21. Holzer, Hans, *The New Pagans* , Doubleday & Co.,
Garden City, N.Y., 1972.

22. James, Geoffrey *Angel Magic*,
Llewellyn Publications, St. Paul, MN 1995

23. Jonas, Hans, *The Gnostic Religion* , Beacon Press, Boston, MA, 1963.
24. Jung, Carl Gustav *Modern Man in Search of a Soul* (1933) Harvest Books, New York, n.d.
25. Kalisch, Isidor, *Sepher Yetzirah* (1877) Symbols & Signs, North Hollywood, CA., 1973
26. Laurence, Richard (translator) *The Book of Enoch* (Ethiopian Enoch) (1883) Wizard's Bookshelf, Minneapolis, 1976
27. Lee, H.P.D. *Plato, Timaeus and Critias* , Penguin Books, Baltimore, Md., 1965.
28. Mathers, S. L. MacGregor *The Key of Solomon the King* (1888) Routledge & Kegan Paul, London, 1972 (also available from Samuel Weiser)
29. McLean, Adam *A Treatise on Angel Magic*, Magnum Opus Hermetic Source Works, Edinburgh, U.K., 1982
30. Mead, G. R. S. *Simon Magus, The Gnostic Magician*, (1992 reprint) The Alexandrian Press, WA
31. Mishra, Rammurti *Fundamentals of Yoga* The Julian Press, New York, 1959
32. Motoyama, Hiroshi *Theories of the Chakras* Quest Books, Wheaton, IL 1981
33. Patai, Raphael *The Hebrew Goddess* KTAV Publishing House, Inc., New York, 1967
34. Poncé, Charles *Kabbalah* Quest Books, Wheaton IL, 1973
35. Regardie, Francis Israel *A Garden of Pomegranates* Llewellyn Publications, St. Paul, MN 1970

36. *The Golden Dawn* (6th edition)
Llewellyn Publications, St. Paul, MN 1989
37. Runyon, Carroll R. *Negative vs. Positive Gnosis*
Gnostica, vol. 5, no. 4, whole no. 40,
Llewellyn Publications, 1976 (Reprint
by C.H.S., Inc., 1996.)
38. *Magick and Hypnosis*
Gnostica, vol. 5, no. 9, whole no. 45,
Llewellyn Publications, 1978
(Reprint by C.H.S., Inc., 1996.)
39. Scot, Reginald *The Discoverie of Witchcraft* (1584-1930)
Dover Publications, New York, 1972
40. Segal, J. B. *The Sabian Mysteries*
from: Vanished Civilizations, McGraw-Hill,
New York, 1963
41. Shah, Idries *The Sufis*
Doubleday, New York, 1964
42. Scholem, Gershom *Kabbalah*
Meridian Books, New York, 1978
43. *On the Kabbalah and its Symbolism*
Schocken Books, New York 1969
44. Thompson, C.J.S. *The Mysteries and Secrets of Magic* (1927)
Barnes & Noble, New York, 1993
45. Thorndike, Lynn *A History of Magic and Experimental Science*,
8 vols. Columbia Univ. Press, N.Y. 1923
46. Trachtenberg, Joshua *Jewish Magic and Superstition*,
Behrman's Jewish Book House,
New York, N.Y., 1939.

47. Waite, Arthur Edward *The Book of Ceremonial Magic* (originally titled
The Book of Black Magic and of Pacts)
The Citadel Press, New York, N.Y., 1970.
48. Walker, Benjamin *Sex and the Supernatural*
Harrow Books, New York, 1970
49. Woodroffe, John
 (Arthur Avalon) *The Serpent Power*
Dover Publications, New York, 1974
50. Yates, Frances *Giordano Bruno and the Hermetic Tradition*
University of Chicago Press, Chicago 1991
51. Zalewski, Pat *The Kabbalah of the Golden Dawn*
Llewellyn Publications, St. Paul, MN, 1993

Manuscripts:

- British Library, *The Lemegeton, Sloane MS 2731,*
London, 1683.
- Private Collection, *The Characters and Seals of the*
Schemahamphorasch from Ar. MS 2495
-- copy by S.L. MacGregor Mathers --
courtesy of Pat Zalewski.
- Private Collection, *The Sepher Maphteah Shelomo,* Herman
Gollancz, M.A., D. Lit., Oxford Univ. Press,
1914 -- courtesy of G.H. Fra. Sabazius X°

Other Media:

***The Magick of Solomon,* Carroll "Poke"
Runyon, M.A., VHS videotape documentary,
(ISBN 0-9654881-0-1) from C.H.S., Inc.,
Silverado, CA, 1996**

-- 0 --

*The Master
Mandala*

The Master Mandala

©1996 by C. R. Runyon

This is the Key to the integration of the Lemegeton Invocation and Evocation systems. It provides a spiritually controlled and psychologically balanced method of practice. It also represents the psychic structure of the Magical Universe in the lower Yetzirah or astral plane.

The sequence of both the 72 Goetia Spirits of the Brass Vessel and the higher 72 Angels of the Schemhamphorash both start in the first quinance (five degree segment) of the first decan of Aires. The two linked sets (Angels and Spirits) continue their matched progression together through the signs in harmony with the general scheme of tropical astrology. The dates when each particular Spirit is exalted are listed in the notes following the Spirit's description in the text.

For Almadel Invocation operations, the Master Mandala should be mounted in the center of the top of the double-cube incense altar. The first Spirit, Bael (Ba'al), should be facing due East, with Astaroth (Astarte) due West. (This can also be "magical" East and West if your temple is not so aligned.)

A crystal orb on an openwork stand is placed in the center of the Mandala as the visual focal point for the operation. The crystal is to be covered with a white silken cloth when not in use.

The proper incense for each summoning is determined by the fourth ring from the center of the Mandala, the planetary attributes of the Spirits. This symbol also determines the Spirit's kabbalistic sephira (within Yesod), e.g. Bael (Ba'al) a "King" = Sun (☉) = frankincense. This attribute likewise determines the number of circumambulations. In our example: "Six turns deosil in the Sphere of Tiphareth of Yesod."

The Master Mandala is not used directly in Goetia Evocation operations but the corpondances are followed, e.g. Michael, Vehuiah, Göap, Bael (Ba'al). In this sequence the Triangle is placed outside the Southern Quadrant.

The Master Mandala

©1996 by C. R. Runyon

