

HOW TO USE THE POWERS OF DARKNESS

A BOOK OF SHADOWS



GARY BRODSKY

MASTER PRACTITIONER
OF THE BLACK ARTS



How To Use THE POWERS OF DARKNESS

A BOOK OF SHADOWS

GARY BRODSKY

GaryBrodsky.com

ISBN 1-55601-025-7

Copyright © 2009 GaryBrotsky.com

All rights reserved.

No part of this book may be reproduced
without the permission of the publisher.

GaryBrotsky.com

INTRODUCTION

You are about to enter a world of unbelievable power. The staggering potential possible to you through the use of the information to be found within this book is not to be taken lightly. To do so would be more than foolhardy, it would be dangerous in ways some people can barely understand.

Understand that this is not some parlor game. The magicks contained here are not something for bored teenagers to play with when their Ouija boards and Tarot cards no longer amuse. This is a guide to power unimaginable. Take a moment to understand those words.

Power.

Unimaginable.

The drawings you now possess are signposts to all worldly desires. They are the basis for a system of sorcery which both created and destroyed the greatest empires of the ancient world. The drawings contained within this volume date back to 3,000 B.C. They are amongst the oldest written human records, cursed and praised things the exact origin of which nobody knows.

All that is known is as follows: they were created, used and maintained down through the millennia by the Yoruba Africans. The deities in them are used to invoke the power of the ancient, but still active Yoruban deities. The proper term for these gods is "orishas," which translates as "force of light (or power)." The orishas do not correlate to any of the belief systems which followed them. In some aspects they resemble the Egyptian, Greek and Roman gods, in some, the Catholic saints and even the ideas behind the cabalistic Tree of Life. It is a religion which predates all others, and from which these others may have freely borrowed over the centuries.

Understand that the drawing spells you are about to work with are as simple and effective as they were at the dawn of human recorded history. They predate books, scrolls and even alphabets. Their simplicity makes them deceptively dangerous. Do not

be fooled by the ease involved here. The ancients worked on belief. If you believe-truly believe-these drawings will give you power without limit. If you don't think you can handle something, it is certain you can't. Be careful. Be certain. Do nothing out of frivolity. The price of arrogance is destruction.

Always.

The symbolic drawings, or signatures as they are called in their native lands, represent the powers of nature. More exactly, they are the Orishas, the spirit forces that manipulate the powers of nature to their own ends. On their own they can sometimes be malicious. Sometimes they will be helpful. They are willful, powerful entities, and must be treated with the proper respect.

The powers of the Orishas overlap only in the smallest details. They are jealous spirits and must be invoked carefully. Some are more powerful than others. Some can influence only certain segments of nature, some can influence them all. One must not concern themselves overly with who the Orisha are, or try to know them in any kind of personal sense.

These forces are known by the following names. But remember, these names are given for you that you might show the proper respect, not try to give orders. These forces are like unto gods. If they notice you and accept your request, it is because you have pleased or amused them. Never think that you are a master giving commands.

OBATALA: Keeper of the peace. A provider of health. Reservoir of all that is pure.

ELLEGUA: Opener of opportunities. Messenger of all the other Orishas. A dangerous spirit, it is the closest of the Orishas to what the Western mind would call the Devil.

OSHUN: Guardian of seduction. Lover of money. That which watches over marriage and all the joys of life.

YEMAYA: Mother of all. The main provider of health, but also of protection. The healer that uses pure love as a shield. Strongly connected with the seas.

CHANGO: Bestower of virility. Keeper of honor. The righteous defender that uses fire and lightning as its terrible weapons.

OGGUN: Lord of the attack. The killer. Patron of all laborers as well as the blacksmith of the Orishas.

OCHOSI: The divine hunter. Protector of the loner. The one who watches over jails and prisons.

Now, try to remember, as the wise old saying goes, "familiarity breeds contempt." Keep your distance from these forces. Draw your signatures as instructed. Do as the instructions say. Do not deviate from the formulas as given. Do not try to understand the beings upon whom you are calling. They are all-powerful. They are unknowable. Call on them for favors, and plead your case carefully.

Do not make demands. Be wise in your asking. Remember, greed, like the love of comfort, is a kind of fear. All of nature abhors fear, and instinctively will attack it. Do not make your callings out of fear or anger. Calm your heart. Ask for what you truly desire. If you allow your passions to control your askings, they you will ask for too much.

When this happens, you will no longer be controlled by your passions. You will be the toy of the Orishas. Remember the old saying, "be careful what you wish for, you just might get it."

NOTE: Almost all of the drawings revealed here must be made on either a wooden surface or a piece of paper. There is a single instance where red cloth can be used (and wood is still preferred). Either should be as unprocessed as possible. The less ink, varnish, paint, chemicals, et cetera, that make up your magical canvas, the more effective your spell will be.

ALSO: ALL of your drawings should be made with either chalk, crayon or pencil. The only colors used should be white or green. Note that when the word "chalk" is used in a ritual, what is really being called for is crushed egg shell. All signatures that call for chalk should really be made with the powder of crushed egg shells. Since this is an ingredient that is very hard for most Westerners to obtain (or even to make for themselves), chalk can be substituted here. The casting will not be as effective, and the ritual will have to be invoked for a longer period of time, but it will eventually work.

ALSO: Once any ritual has been completed, before your canvas can be used again, it must be washed clean with rum. ONLY rum will do. Note: Whenever rum is called for in a signature, it must only be used for cleaning. If no cleaning is required, it must be sacrificed. DO NOT DRINK the rum used in any ritual.

Also: Remember that any rum, cigars, honey or anything else used in a ritual must be of the finest quality. Do not think of insulting the gods with anything but the best.

Also, remember that this is a judgment call-if, for instance, you honestly believe that you have acquired the best cigar in town, even if there is a much better cigar available right next door, the gods invoked will know your intentions. As long as you honestly believe you have done your best, they will be satisfied.

ALSO: Some rituals will call for the use of an "Elegua." This is a special magical tool which takes literally decades of preparation. It is unknown in the West and, due to some of its ingredients, can not even be imported into Western countries.

However, a personal stone can be used in its place. Not a piece of concrete or a brick, a stone. Pick one as your own. Clean it in rum and keep it for all your rituals. It will not generate the power of an Ogun, but it will function in its place.

ALSO: Do not substitute any color candle for those colors prescribed. If you can not get the candle called for, **DO NOT ATTEMPT THE RITUAL**. Your candles do not have to be large, scented or expensive. They merely must be the correct color.

ALSO: Light all candles with wooden matches. Paper matches are second best. A lighter can be used, but metal can be harmful to signature rituals.

1. PROTECTION FROM ENEMIES

This is the signature of the three warriors. It is used for personal protection against illness and enemies.

After completing your drawing, light three white candles at the top of the upper arrows as shown in the diagram. Next, light one red candle which should be positioned over the "X" formed by the two diagonal arrows.

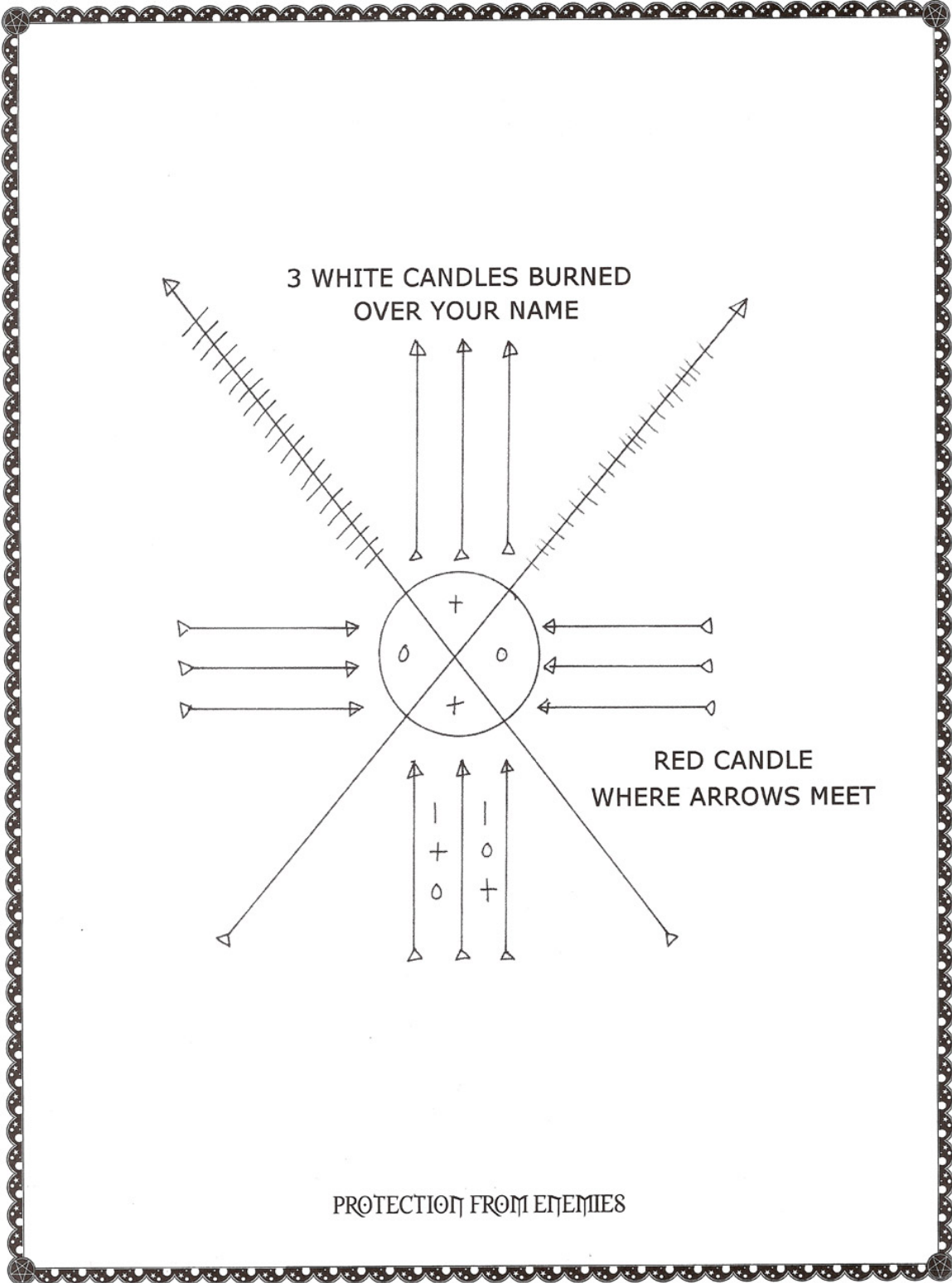

2. ESCAPE AND FREEDOM

This is Ochosi. This drawing is to be used to gift prisoners with freedom. It can be used in simple cases such as freeing people from jail, or in more complicated situations such as releasing people (or oneself) from destructive relationships or even addictions.

The name or names of those for whom you desire freedom are to be written in front of the two sheathed arrows (the arrows actually within their bows). Red and white candles must be placed as shown in the diagram.

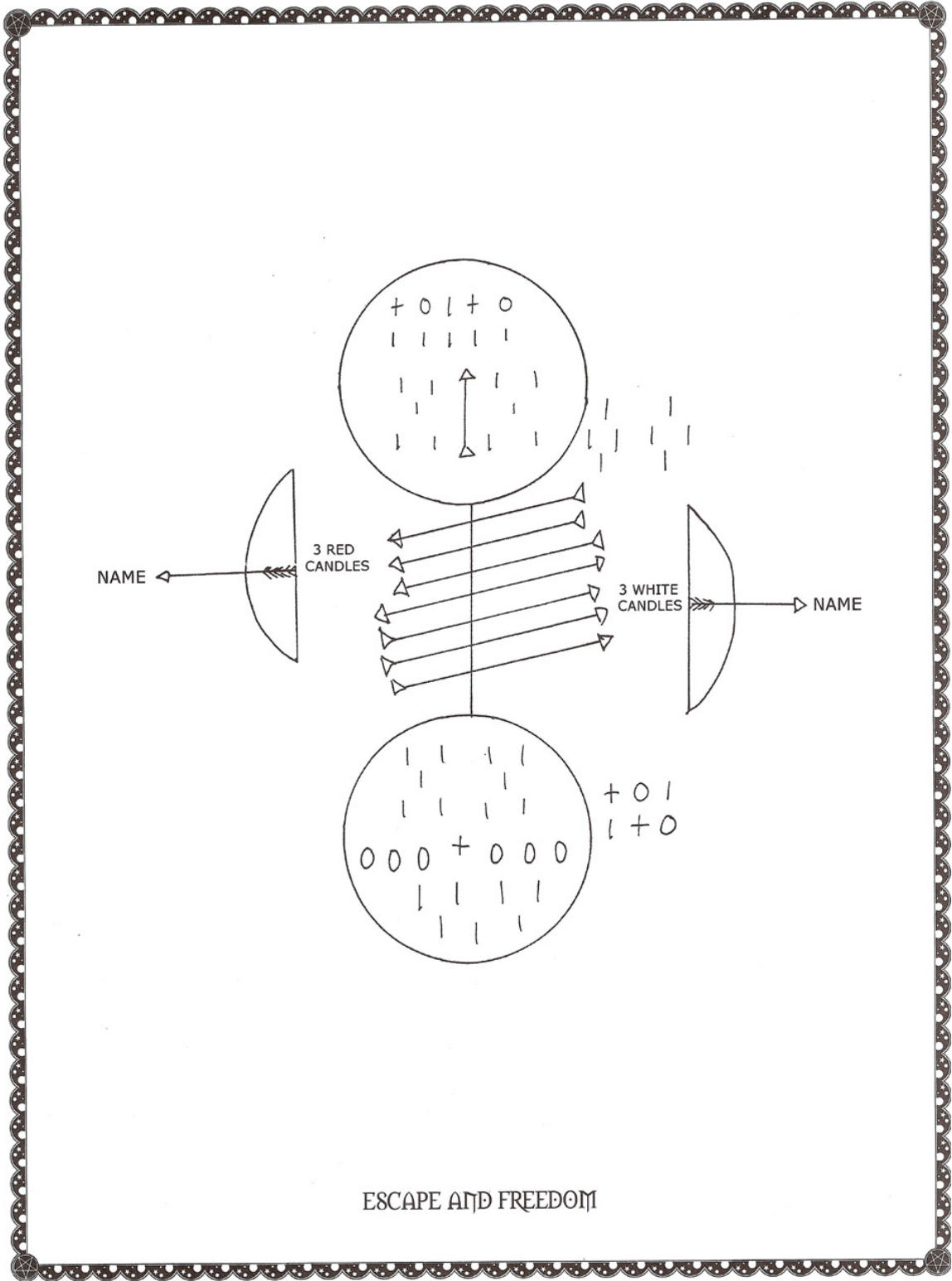

3. GOOD HEALTH

This is one of the most powerful invocations to be found within this belief system. It must be drawn in white on wood-ONLY. It would be best to make the drawing with egg shells. If egg shells are not used, only white chalk can be substituted.

This spell is used in the pursuit of both great wealth and good health. Two white, one green, and one black candle are needed. Light and position them as shown. Write your name about the central arrow as shown.

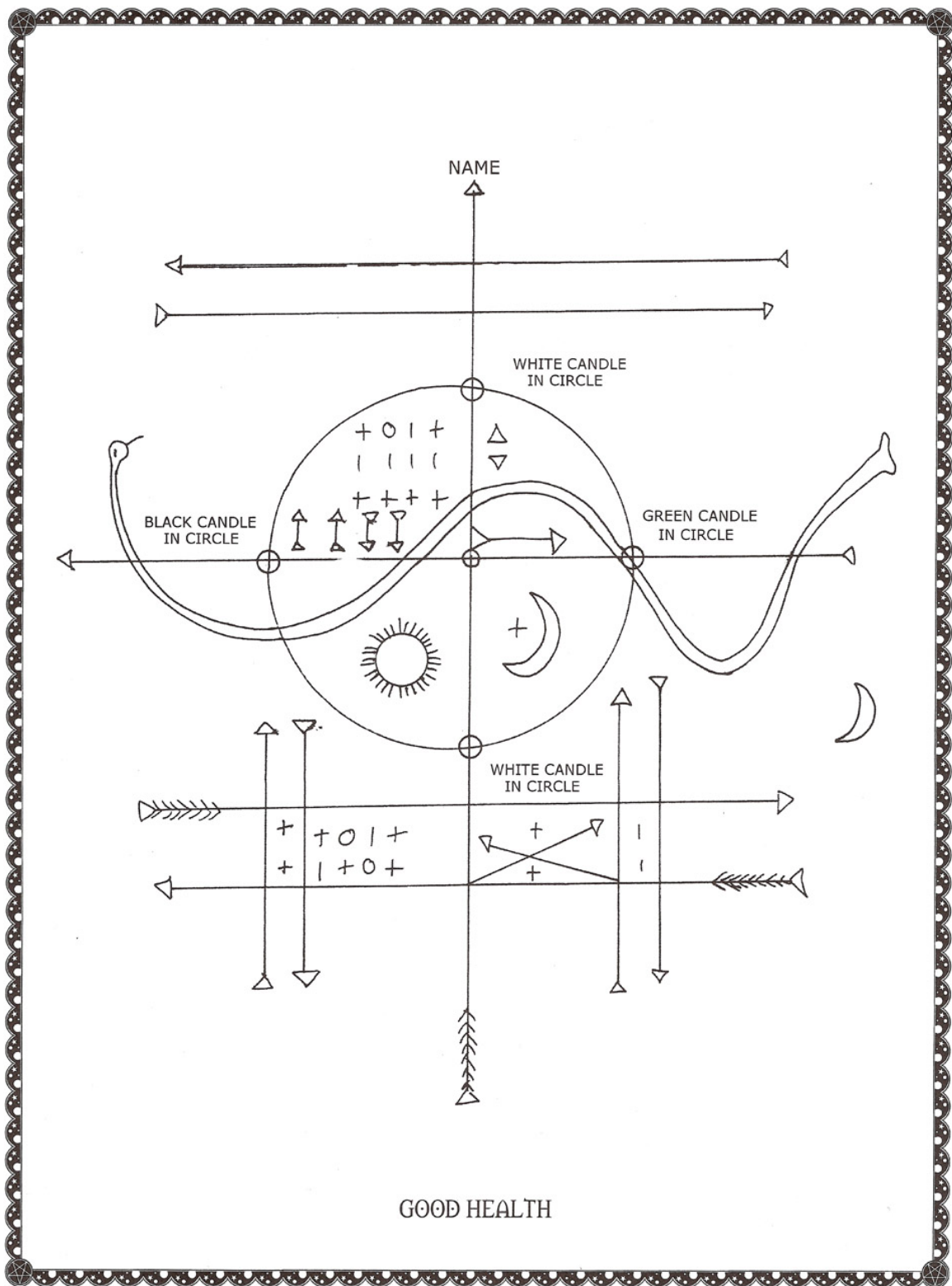

4. PEACE, JOY AND HARMONY

This is one of the simpler rituals. It invokes kind and gentle powers, entreating them to bring you the good things in life.

Once drawn (on either paper or wood), it should be hidden beneath a rug, or better yet, the floor, for best results. This ritual should not be washed away as its effect for you will only be felt as long as it remains cleanly drawn and hidden from sight.

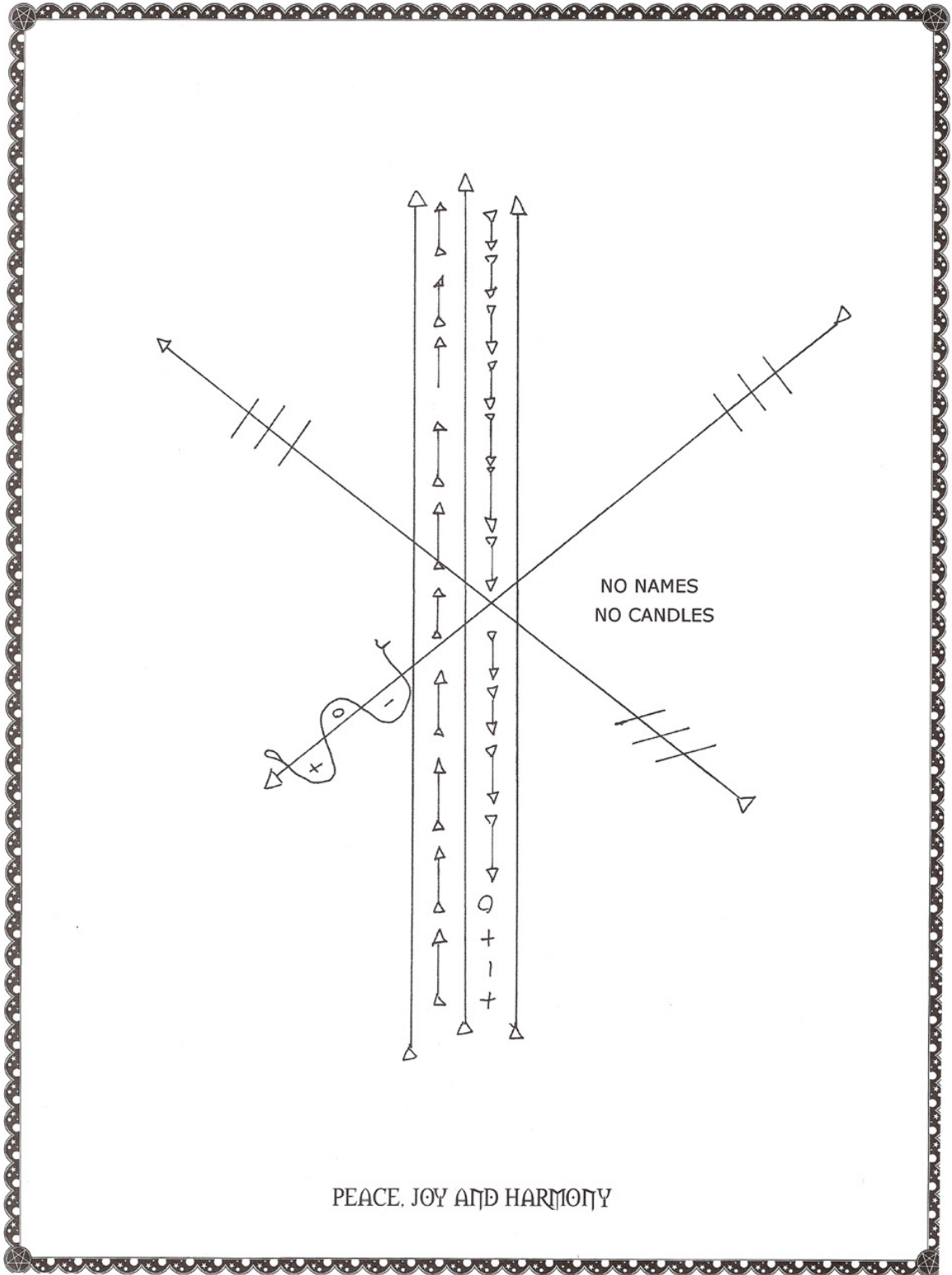

NO NAMES
NO CANDLES

PEACE, JOY AND HARMONY

5. THE DOMINATOR

This ritual drawing invokes the power of the "Dominator" or "Controller." It is an all-purpose spell, one to be used to control, or dominate, friends, lovers or enemies. The nature of your relationships is unimportant to the powers being called upon here.

Three red candles are to be placed on the three central "Xs" located between the vertical arrows (see diagram). The name of the person you wish to control is to be written in chalk or pencil above the candles as shown in the diagram. Better still to be used here is a personal item of the person to be dominated.

This ritual is for the calling of good fortune. It summons unto the user a combination of all available powers. It will make all good things in your life better than they are. It will not, however, eliminate bad influences.

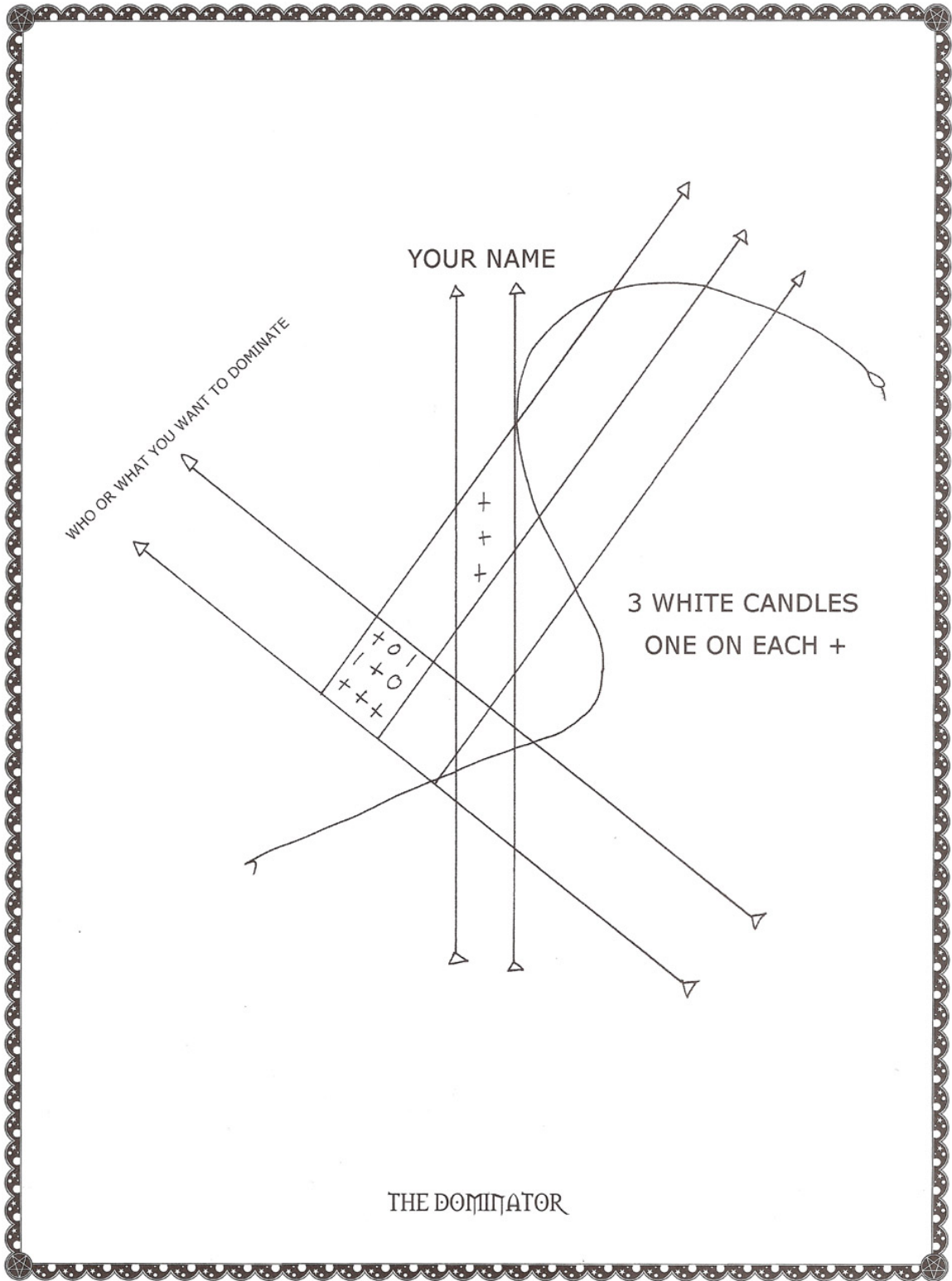

6. WHEEL OF LUCK AND FORTUNE

This ritual must be drawn on wood. To be effective it must be written in white chalk. Your signature must go at the point of the solitary arrow (see diagram). A white candle must be lit and placed at the apex where the serpent and the snake cross (see diagram).

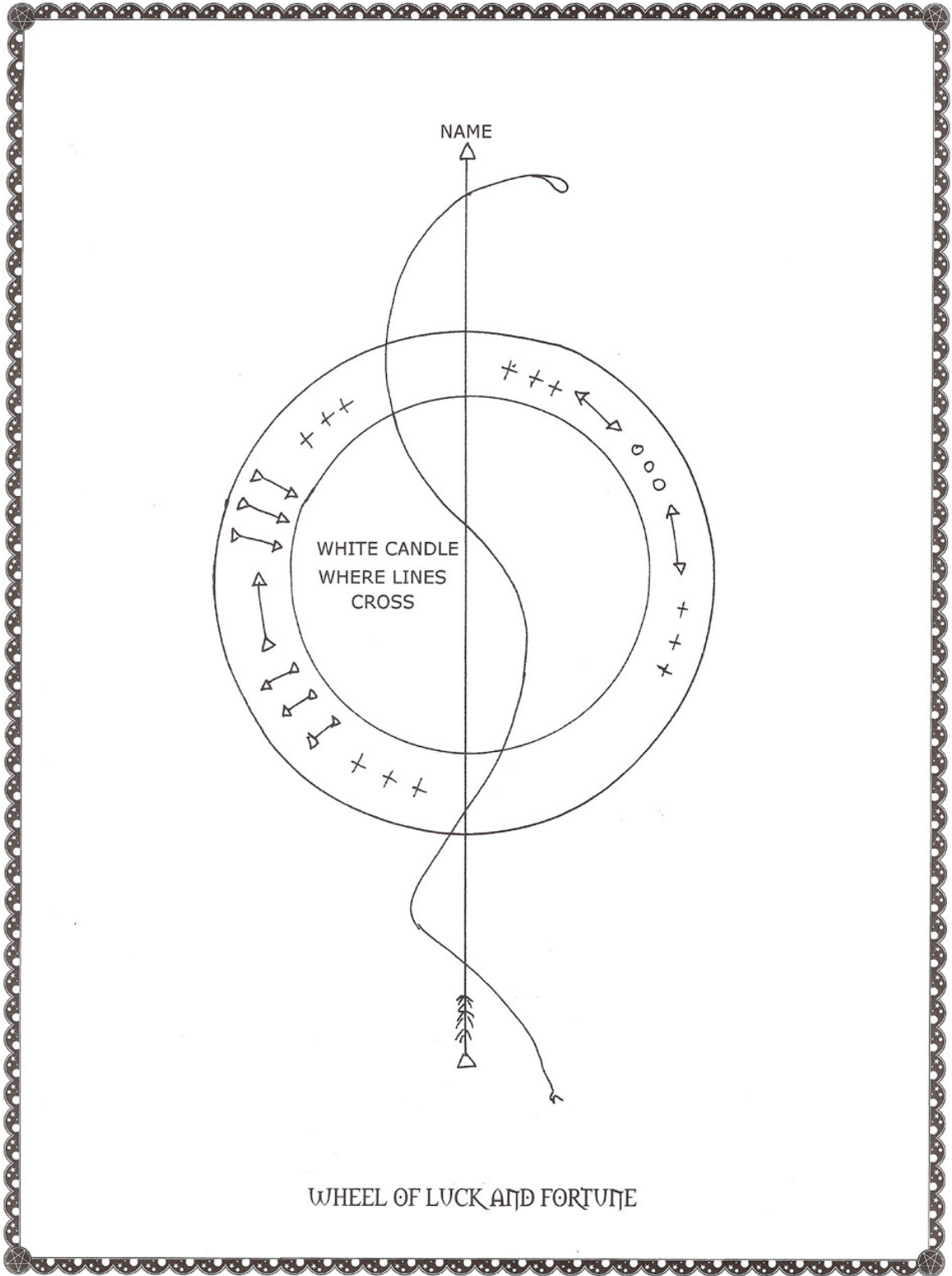

WHEEL OF LUCK AND FORTUNE

7. GOOD LUCK AND GOOD FORTUNE

This ritual also evokes all available powers. It is to be used for wish fulfillment.

It should only be drawn on wood and only with white chalk. Your signature should be placed at the top of the central arrow as shown in the diagram. Your desires should be written at the point of the diagonal arrow as shown. Understand that while there is no limit to the amount of wishes you can make at one time with this spell, the more wishes made at one time, the more watered down the ritual will become.

After completion, this drawing should be left within your main personal dwelling place. It is vitally important that the central arrow point be aimed facing toward a doorway, especially one that leads to the outside. Also: duplicating the spell on a piece of paper and keeping it with you at all times will greatly enhance its power.

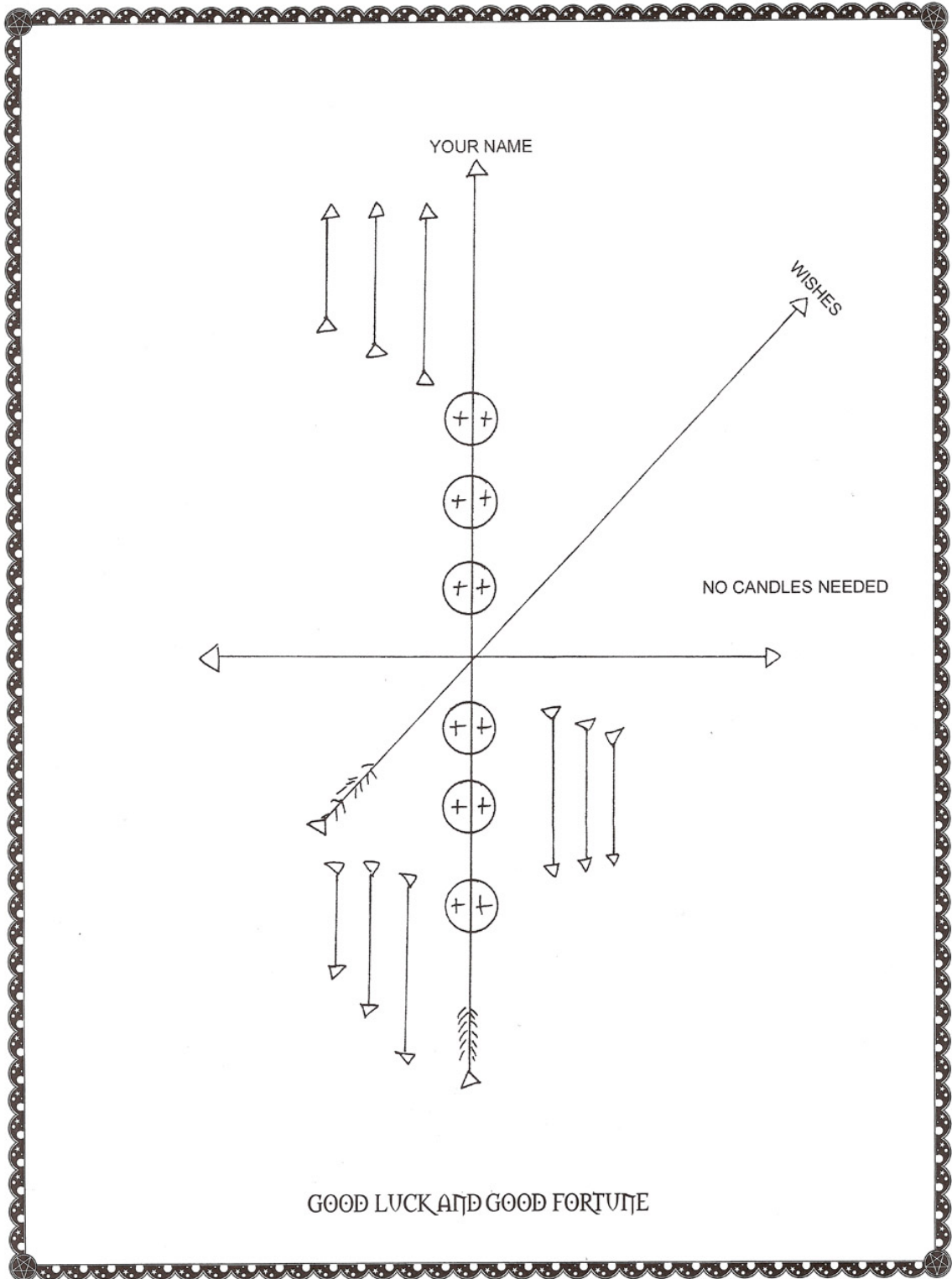

8. GREAT FREEDOM

This signature is for obtaining freedom, whether it be for someone else or for one's self. If that freedom is sought from prison, from a marriage, or any other type of physical or spiritual imprisonment, this is the ritual which must be invoked.

This drawing should be made on wood with white chalk. The name of the person to be freed should be written above the arrow tips as shown. The name of that which is imprisoning the prisoner should be written below the base of the shafts as shown. A white candle must be burned at the exact center of the drawing as shown.

ALSO: A small glass with honey in it should be placed near the white candle. The exact position is not important. The honey should be tasted before the glass is positioned, but after the candle has been lit.

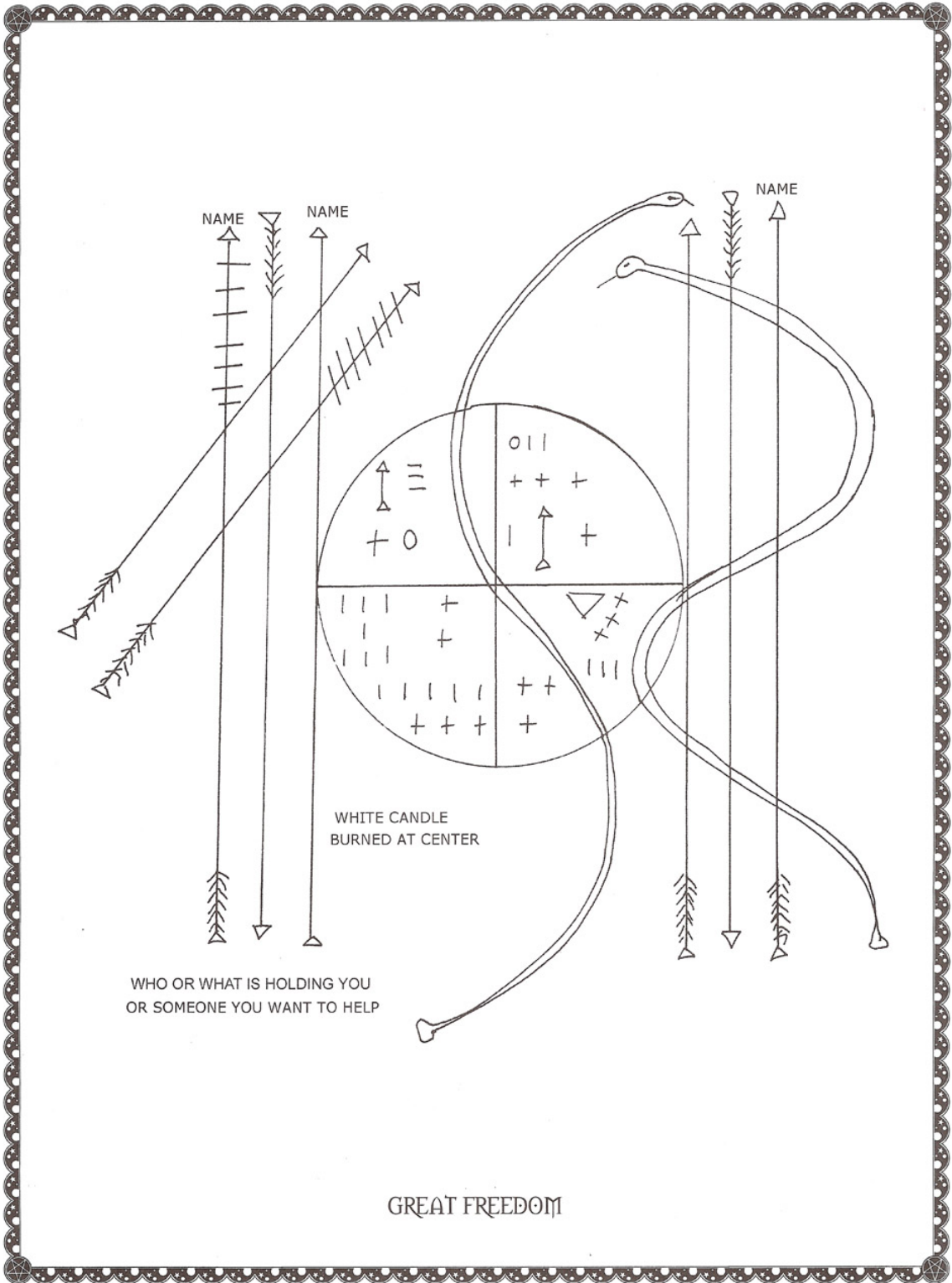

9. ALL PURPOSE

This signature is to be drawn on a red surface (either paper or wood) with white chalk. The name of the person to be affected is to be written at the tip of the vertical arrow. An Ogun must be placed over their name. A white candle and a yellow candle must both be burned. Place as shown.

This ritual is for the ensuring of continued health. It is not a healer. It may also be used for minor wishes.

10. GREAT POWER

This ritual is for the generating of wishes. It can be drawn on either paper or wood. Any of the writing materials may be used.

The name of the person whom the wishes will affect is to be written at the tip of the single vertical arrow. The wishes are to be written at the tips of the three arrows running diagonally to the right, and then again at the tips of the three arrows running diagonally to the left.

All three wishes must center around the person who is named.

When finished, this ritual can be hidden anywhere. It is, however, highly effective when drawn on the front door of one's dwelling place.

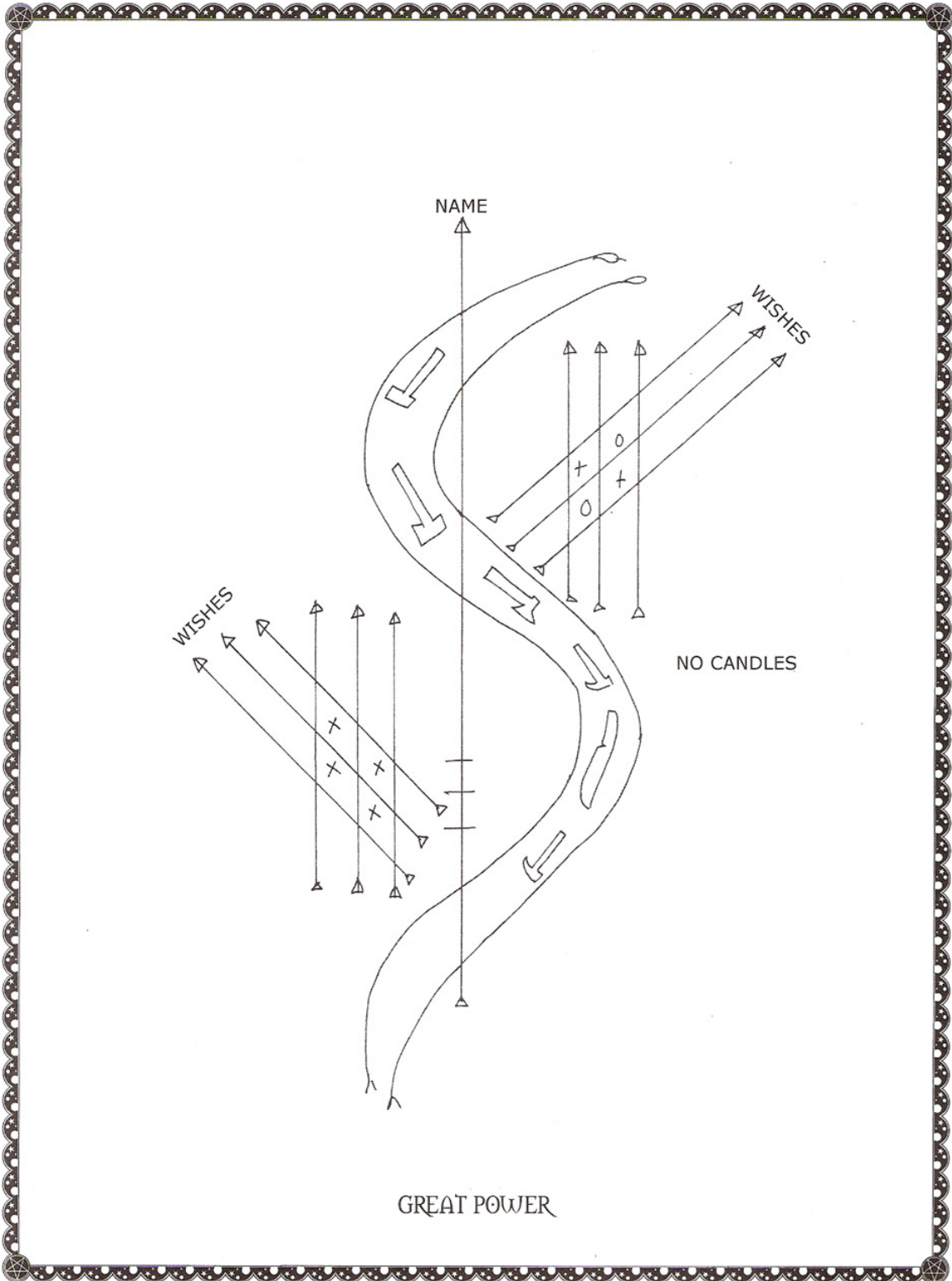

11. GOOD LUCK ALL AROUND YOU

This signature invokes the powers of Elegua. It is used to attract general good fortune to one's self, home and family. One must have a specific idea of the fortune one is looking for (i.e., general good health for the family, luck in business for one's self, happiness for a daughter, et cetera). This ritual only ensures general good fortune; it will not respond to specific requests.

This signature is to be drawn on a red surface (either paper or wood) with white chalk. The name of the person (or persons) to be affected is to be written at the tip of the central arrow. An Ogun must be placed over their name. A white, green and yellow candle must be burned within the triangles as shown.

Note that the lines creating the snakes must be OPEN. This is not a single thick line, but two thin lines creating a form.

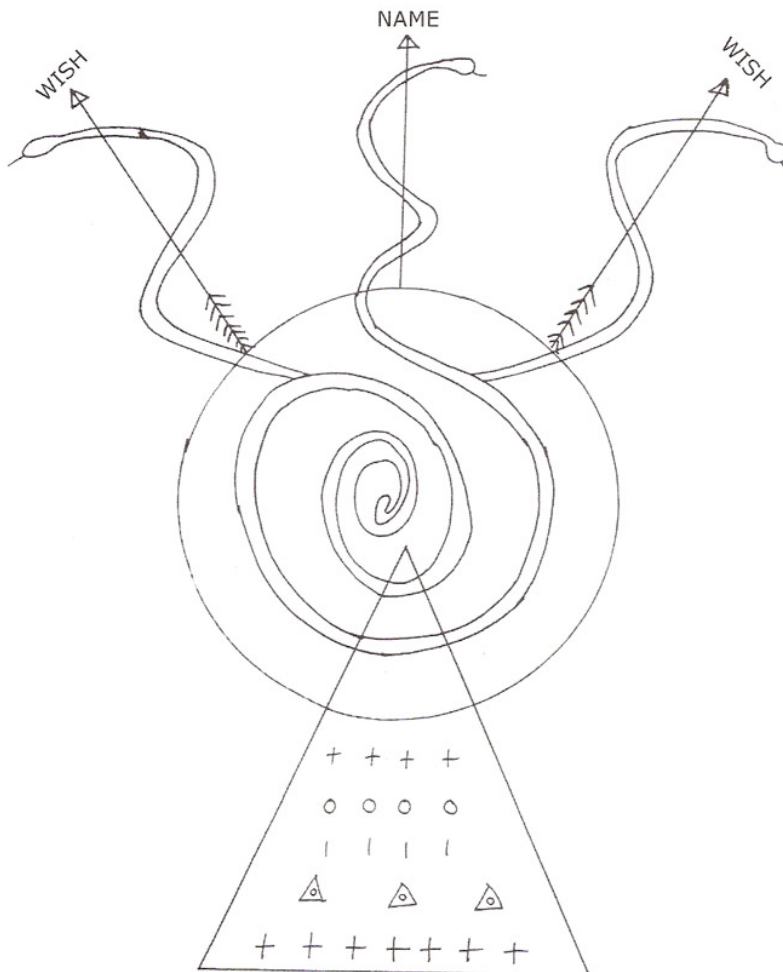

1 WHITE, 1 GREEN, 1 RED CANDLE
IN THE 3 SMALL CIRCLES

GOOD LUCK ALL AROUND YOU

12. THE LADDER OF POWER

This signature is for climbing the ladder of success. This means more than just reaching for success in the world of commerce. It is equally effective in any human endeavor where perseverance is needed, i.e., the world of sports, the arena of romance, et cetera. It is to be used to give a general boost to any segment of your life, rising it up to what is generally known as "the good life."

The paper is then to be carried with you at all times. It need not be on your person, it can be in a pocketbook or brief case, et cetera. But, it must be nearby. Also: you may not draw one for home, one for the car, one for the office, and so on. You can draw only one (at a time) and that one must be kept with you.

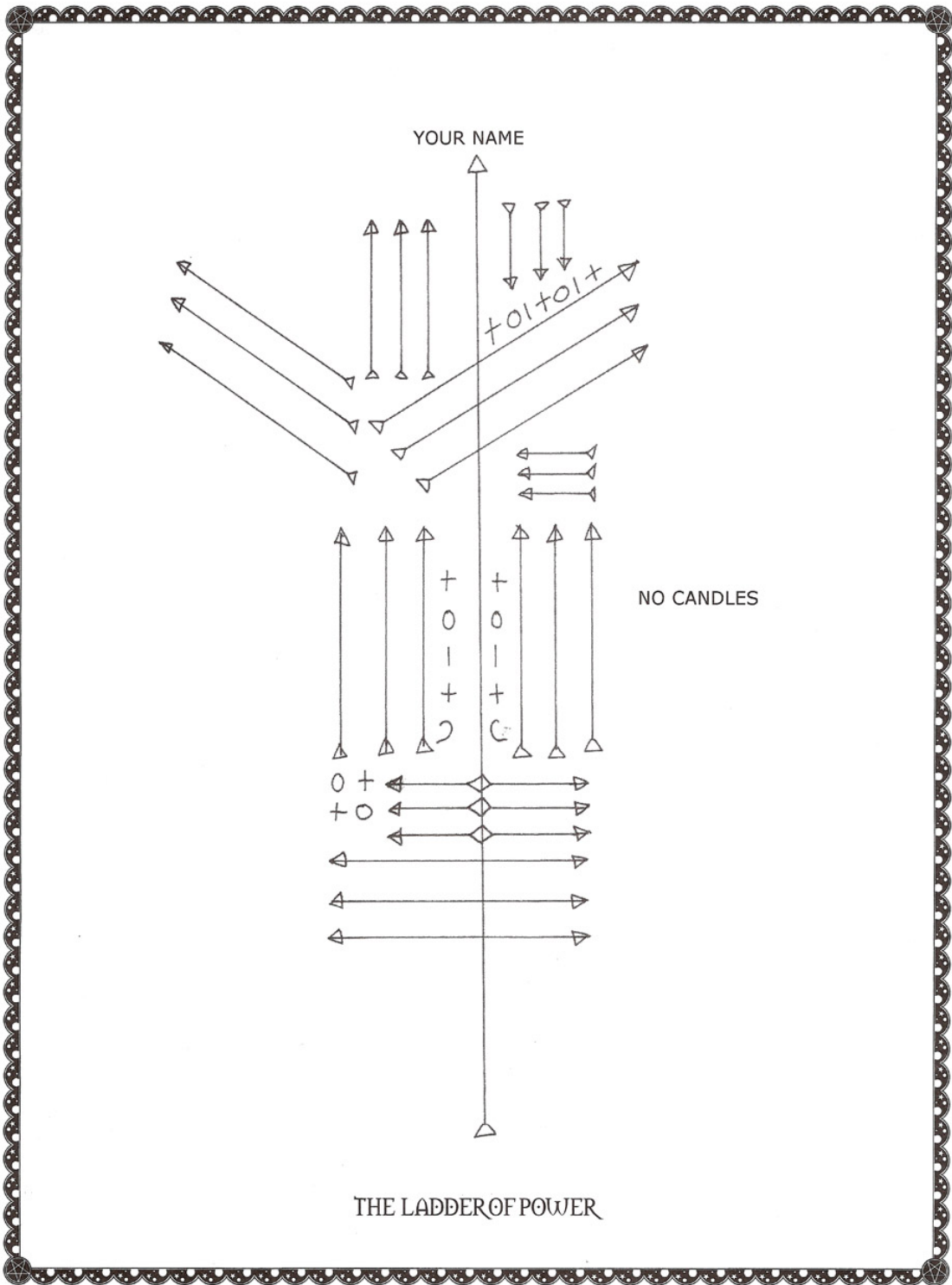

13. GOOD FORTUNE

This signature calls upon the powers of Oshun. It is to be used to bring to oneself good fortune. This is not great, multi-millionaire kinds of fortune. This is a more modest ritual, used for bringing a condition more akin to "comfort." It can be used for creating this condition within any aspect of life.

Simply draw the ritual out of a piece of wood or paper with any of the preferred mediums. Once completed, it should be concealed in one of three places:

1. Under a rug
2. Under a mattress
3. At the bottom of a drawer

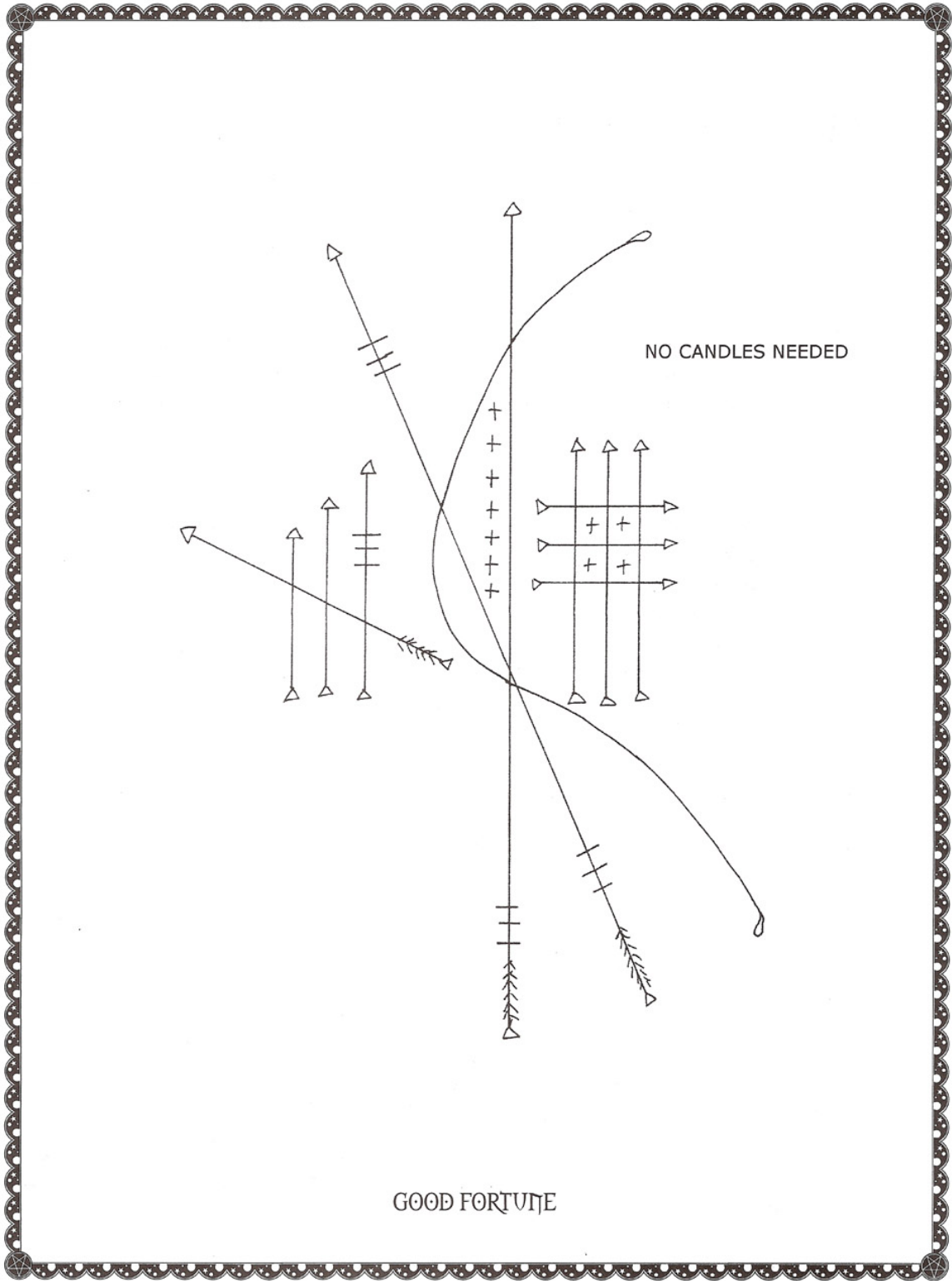

NO CANDLES NEEDED

GOOD FORTUNE

14. GREATEST POWER

This signature calls upon Ellegua, the Devil. This is a very powerful ritual and must be done with extreme caution. It beseeches Ellegua to override Ochosi and effect the release of a person from prison.

This signature is to be drawn on wood, with white chalk. The name of the person to be released (oneself or another) is to be written at the tip of the central vertical arrow. The name of the institution where the imprisoned one is being held must be written at the top of the central descending, diagonal arrow (see diagram for position).

A white candle is to be lit near the drawing. A small glass of rum, or a cigar, must be placed near the candle while it is burning.

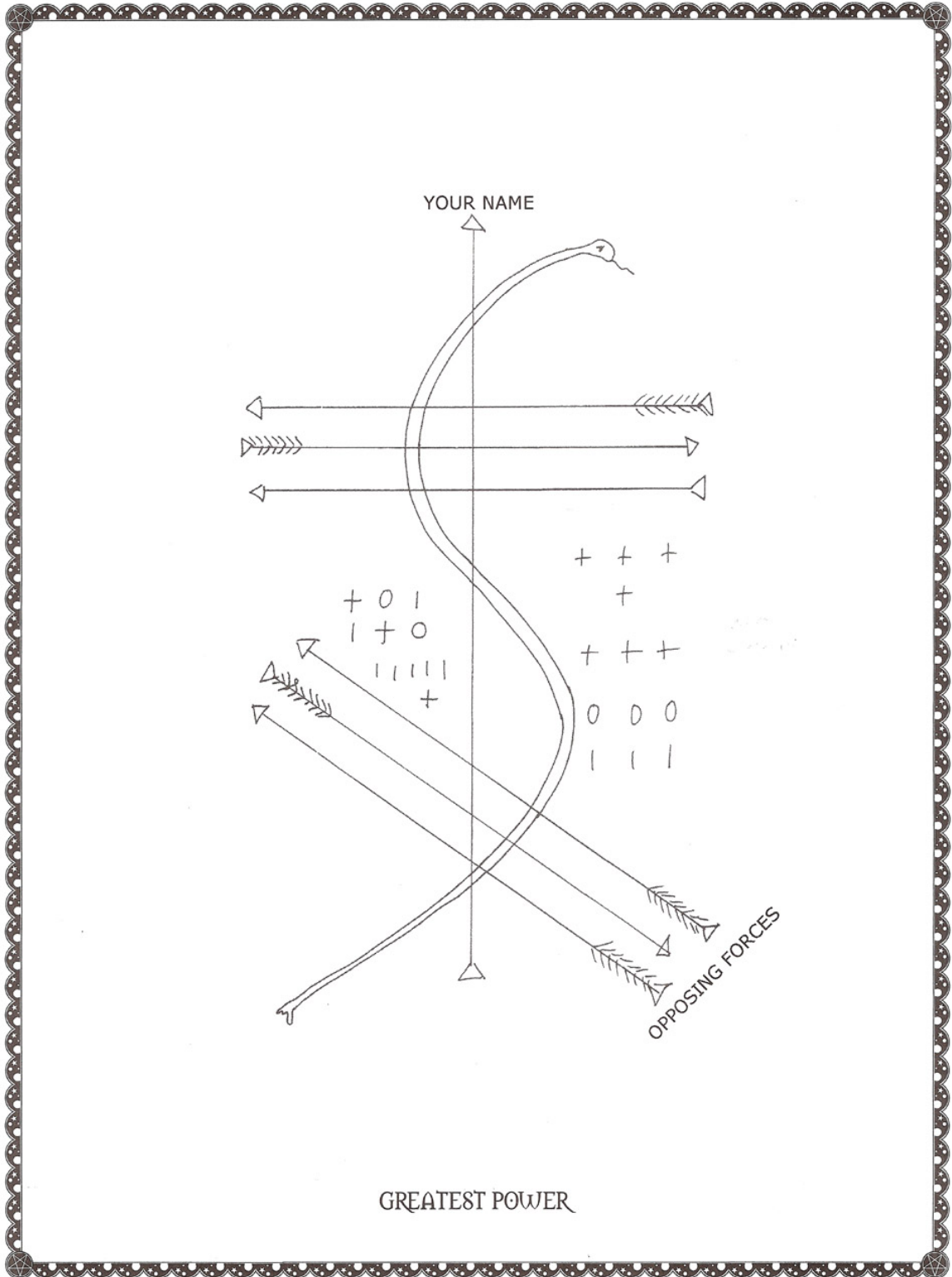

15. ROMANCE FOR LONG TERM RELATIONSHIP OR MARRIAGE

This signature is for finding the right person for you. Ms. Right, Prince Charming, whatever. It can be used in either or two ways: to help make a choice between two or more potential lovers, or to simply help bring an unknown, but perfect mate to you.

It can be drawn on wood with white chalk or paper with pencil. Place your name at the tip of the left-leaning arrow (see diagram). Place the "title" of the person you are seeking-husband, girl friend, lover, soulmate, et cetera-at the tip of the central, vertical arrow.

After the drawing has been completed, a pink candle must be burned at the center of the uppermost circle (see diagram for position).

Note: this is a more difficult drawing than many of the others, and it often does not work the first time. Patience can be required with this signature.

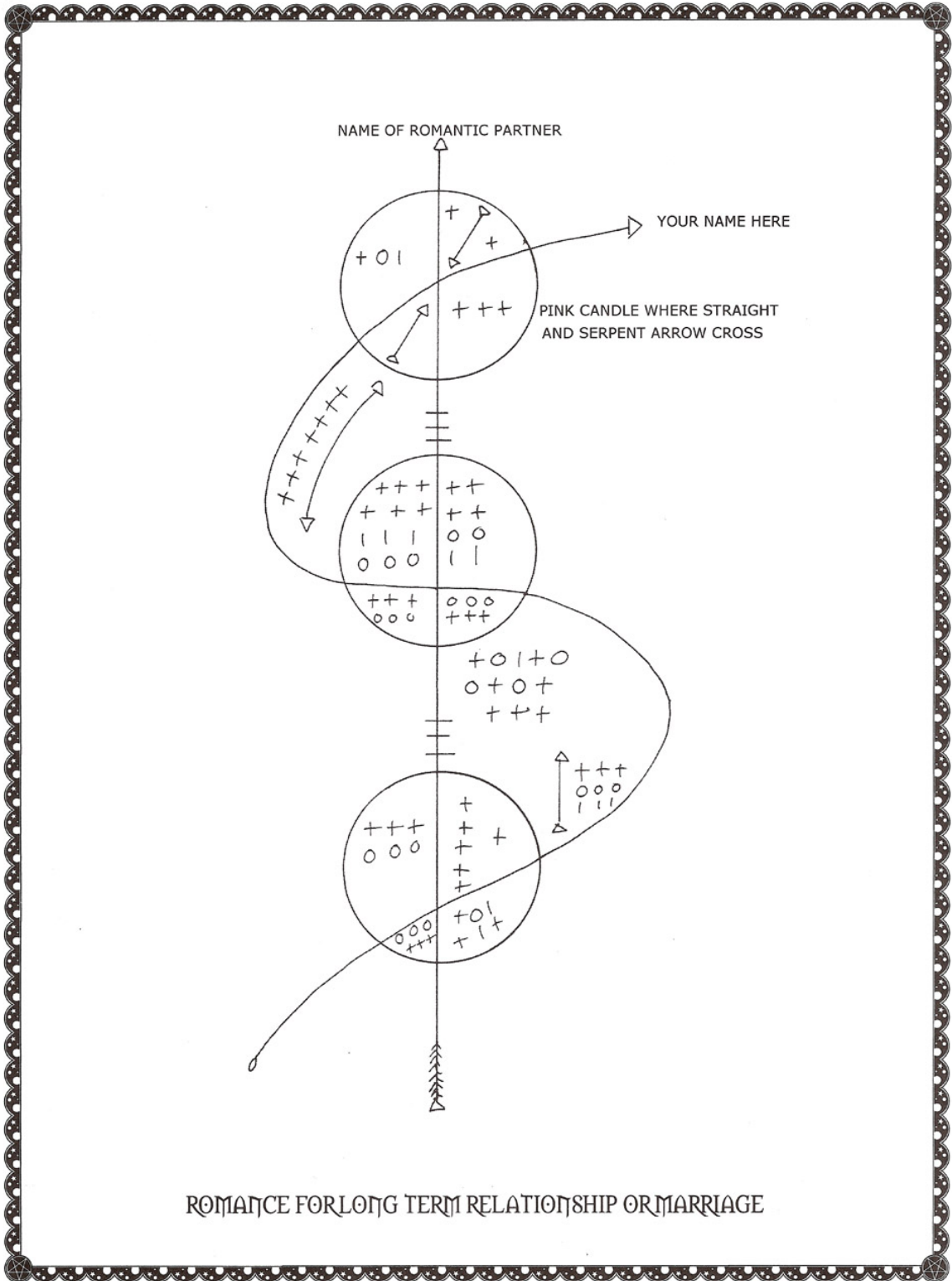

16. FOR HEALTH AND STRENGTH

Yemaya is in charge of pleas coming from the use of this ritual. It is a signature for the invocation of good health. Note that this is not for sustaining current good health, but for the displacement of illness. Note also that it is to be used for ANY illness from the common cold to cancer, as well as in those cases where one simply "isn't feeling right." It is also to be used in the case of mental as well as physical illnesses.

Make this drawing on a wooden surface with white chalk. After the drawing has been completed, three white candles are to be burned simultaneously.

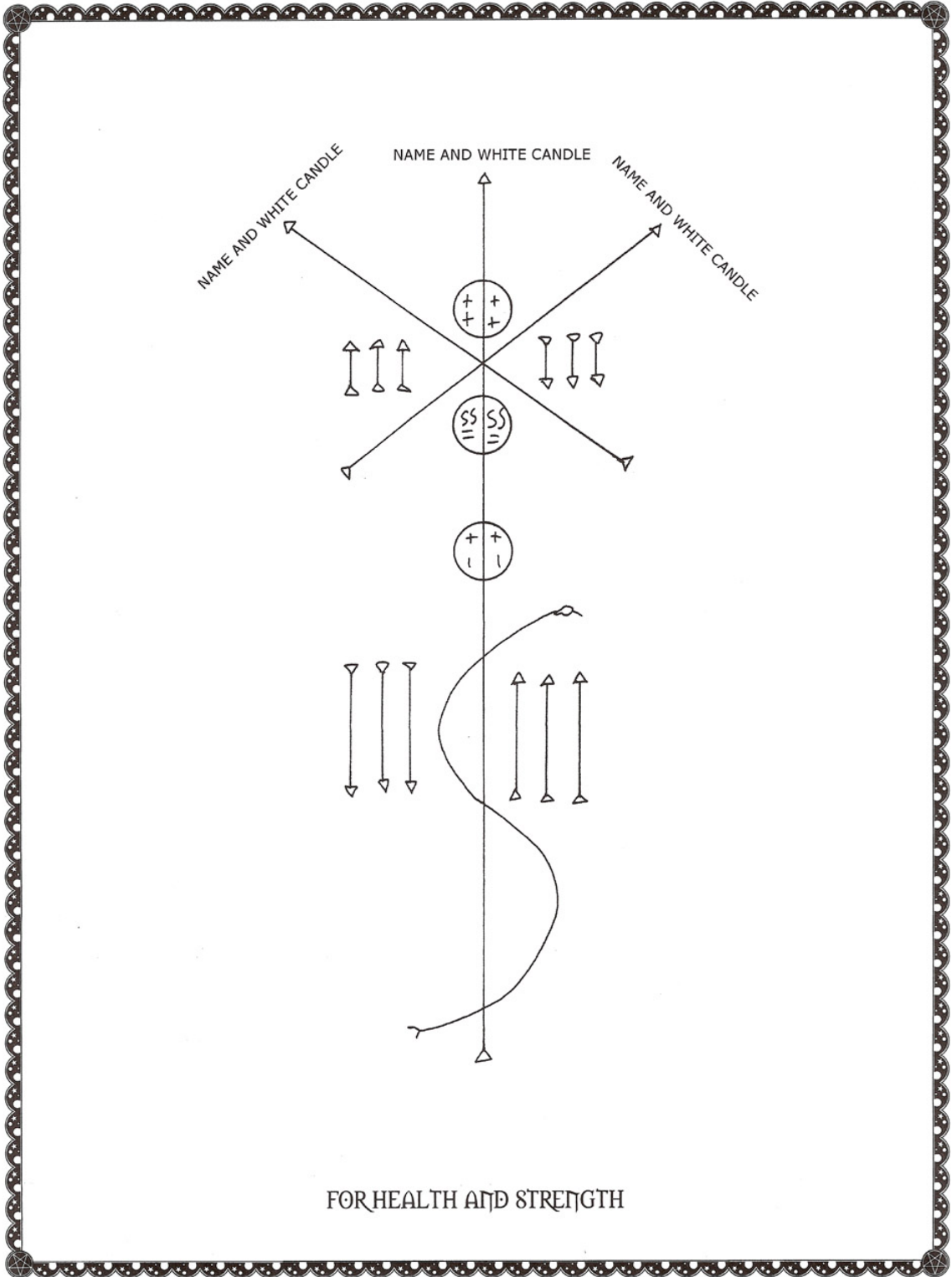

17. FOR BUSINESS WHEN THERE IS A DRY PERIOD

This signature calls on all of the Orishas except, fortunately, for Ellegua. It is to be used for increasing or expanding a business venture. It works only on ventures already established. It is NOT for the creation of a new venture.

Make the drawing on a wooden surface with white chalk, pencil or crayon. Green candles are to be burned at the tips of the vertical arrows (see diagram for placement). A white candle is to be burned at the same time. It should be placed at the center of the central circle as shown in the diagram.

Your name should be placed at the tips of both of the diagonal arrows. Your wishes (i.e., how you wish your business to be expanded) should be written at both ends of the three horizontal arrows. Again, see the diagram for the proper positioning.

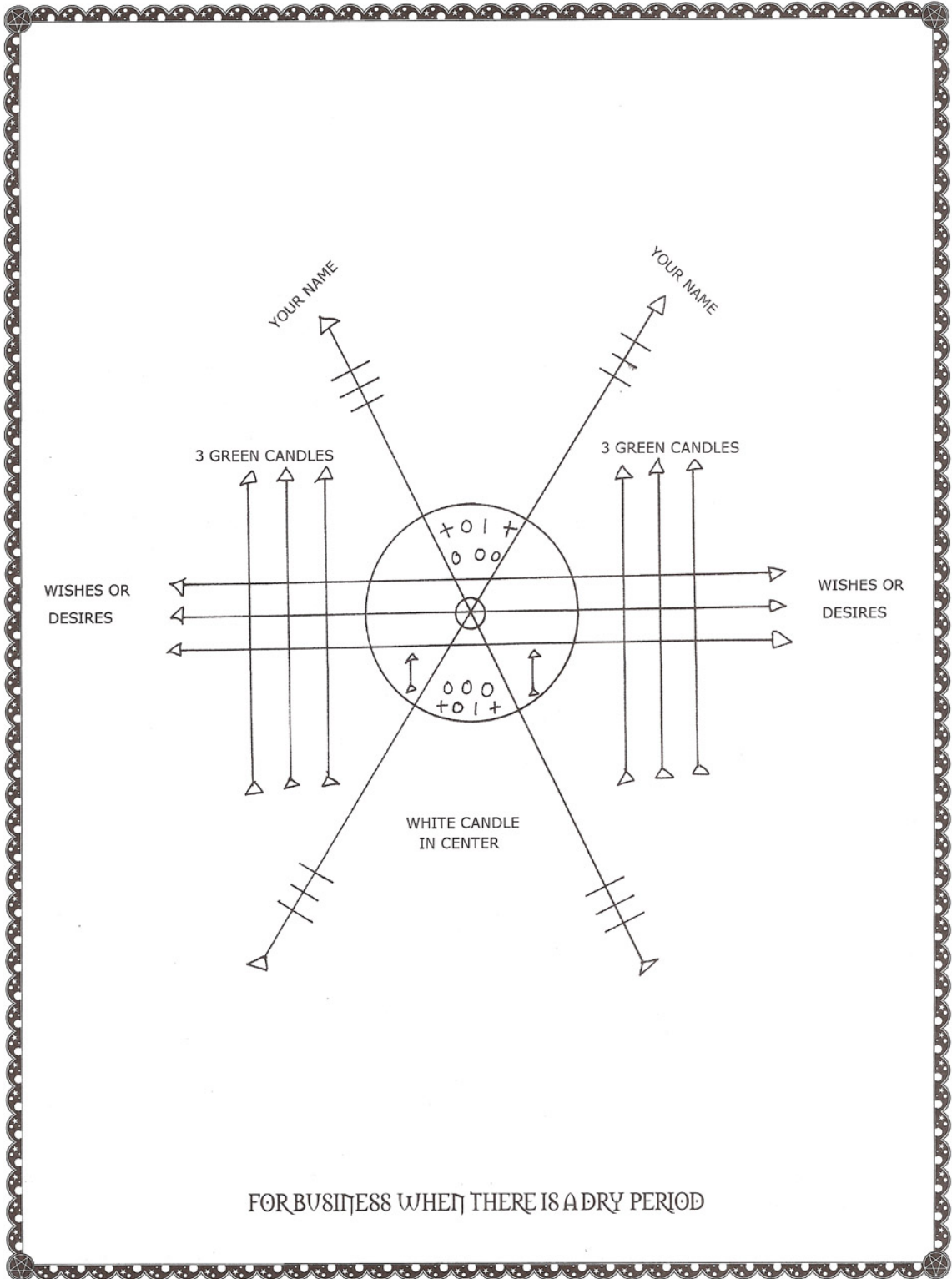

18. INVOKE POWER FOR FREEDOM

This signature calls on Ellegua, which means one must be precise and careful in all motions. It is used to bring blessings on one who is in trouble with the authorities. While it can be used to obtain someone's release from prison, it is a more "all purpose" casting. This should be used to aid those (or oneself, if necessary) being hunted by the law, facing a trial, awaiting sentencing, et cetera.

This signature is to be drawn on wood, only, with white chalk. Three red candles must be burned at the tips of the downward extending, diagonal arrow. After they have been burned, one white candle must be burned at the tip of the upward extending, right-leaning diagonal arrow.

Your name must be written at the tip of the upward extending, left-leaning diagonal arrow. Your name must also be written at the tip of the central, vertical arrow. An Ogun must cover your name wherever it appears in the signature. See the diagram for all positionings.

Also: after the ritual has been completed, the chalk (or egg shell powder) used must be scraped together and taken to a place of authority which symbolizes the trouble you seek to avoid. If, for instance, one is seeking to avoid capture by the police, the chalk must be taken to a police station. Then, in front of the building, you must take a pinch of the powder in your fingers, bring it close to your lips, then blow it away.

19. POWERFUL DESTROYER OF ENEMIES

Here is a simple signature. It is used for removing jinxes, negative influences, or any other obstacles you perceive as being in your path.

No candles or stones, et cetera, are needed here. Simply draw it on a piece of paper in any medium. It will remove all evil or negative influences from your life. Keep it in your pocket, hide it anywhere.

Once created it will work for life, although it is advised that one should recreate this signature at a regular interval merely to show gratitude to the gods. One does not want the Orishas to think they are being taken for granted.

YOUR NAME

NO CANDLES

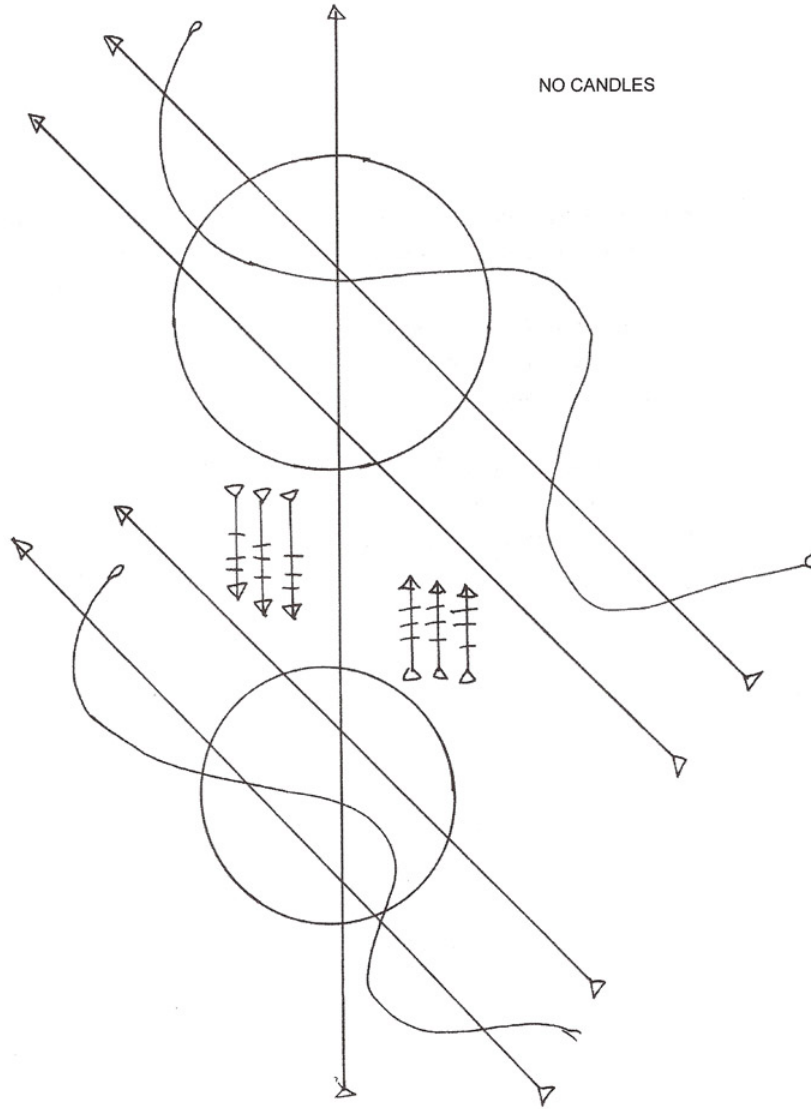

POWERFUL DESTROYER OF ENEMIES

20. EXTREME GOOD HEALTH

This signature is to be used to help the extremely ill. In those cases where the patient is hospitalized, it may be impossible to use due to the extent of the candle burning which must be done.

The drawing may be made on wood or paper in any medium. The signature must then be placed under the patient's mattress. It must remain there undisturbed for twenty-one days.

Also: a white candle must be burning when the ritual is placed under the patient's mattress. This candle, or a series of candles, must burn continually for the next twenty-one days. Or, for twenty-one, twenty-four hour, cycles. This is absolutely critical.

NO CANDLES

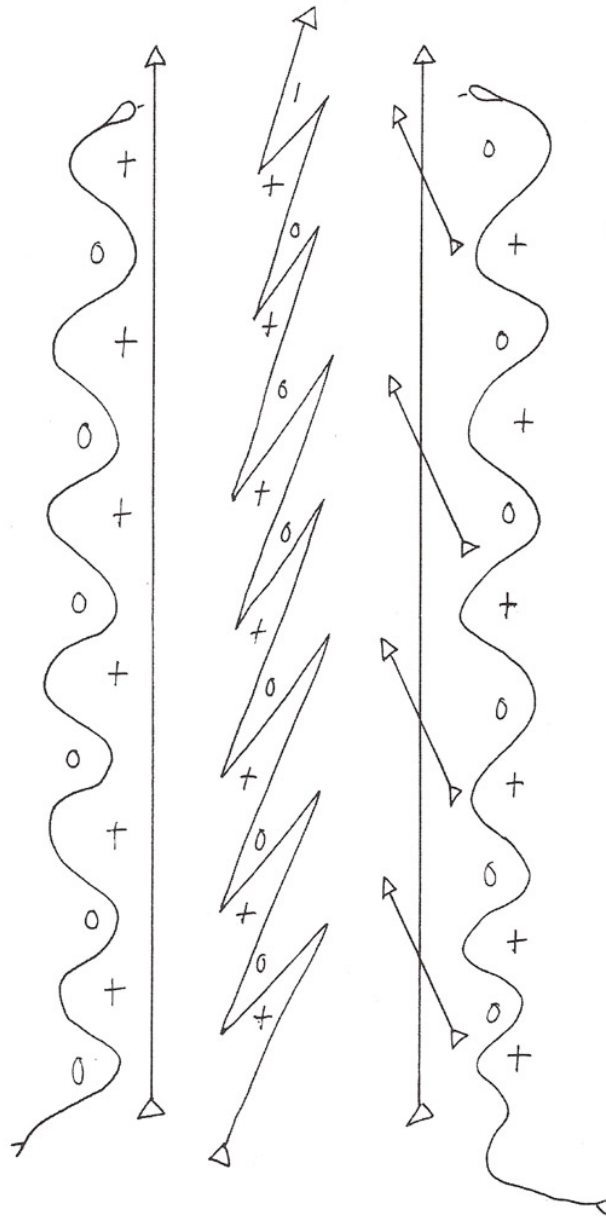

EXTREME GOOD HEALTH

21. THE HIDING SPIRIT

This signature is to be used when one has enemies. Using this one keeps one's enemies from conspiring against you, from finding you, or even from thinking about you. It works against specific enemies that you know about, and against those unknown to you, as well. This does not just mean those who wish you harm, but also forces such as the I.R.S., creditors, et cetera.

This ritual must be drawn on wood, with either chalk or crayon. Once finished, it must be pointed out from the front door of your dwelling.

Then, your name must be written at both ends of each of the diagonal arrows at the top of the signature. Four white candles must then be placed over each writing of your name and burned. Also, the name of your enemy must be written at the top of the central, vertical arrow. A red candle is to be placed on your enemy's name and burned at the same time the white candles are burned.

Note: if you do not know your enemy's name, a group name can be substituted (i.e., POLICE, MEDIA, et cetera). If you are simply seeking to protect oneself from possible unknown enemies, simply write "DEATH UNTO MY ENEMIES" in the same space.

WHO YOU WANT TO HIDE FROM
THEIR NAME UNDER WHITE CANDLE

YOUR NAME & WHITE CANDLE
YOUR NAME & WHITE CANDLE

YOUR NAME & WHITE CANDLE

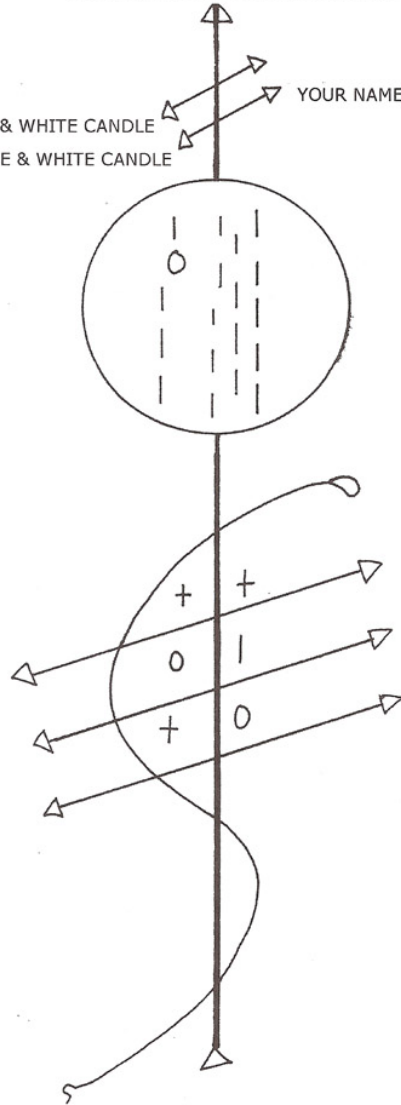

THE HIDING SPIRIT

22. LOVE SPELL: STRENGTH IN AN EXISTING RELATIONSHIP

This signature is a love spell. It is not for bringing an unknown person into your life. This ritual only works on one who is known to you. You do not have to know them well. They do not have to actually know you. But, you must have someone specific in mind.

This one is to be drawn with white chalk. It can be drawn on wood or paper. After the ritual is drawn, write your name alone at the tip of the central vertical arrow. Then, write your name, and the other person's name, one on top of the other, at the tips of the other two arrows (see diagram). Write your name first (or, on the bottom), then write the other name over (or, on top of) your name.

Note: you do not need to know the person's name exactly. You can write a representational name, such as: girl in science class, man at the bank, et cetera.

Eight candles are to be burned in this ritual. Position as shown in the diagram and born. Candles should be pink if you are seeking a deep and spiritual romance. Red candles should be burned if you are looking for a quick, wild fling. A mix of the two should be used if you are looking for a long-lasting relationship that is not necessarily deep, but is wild and steamy.

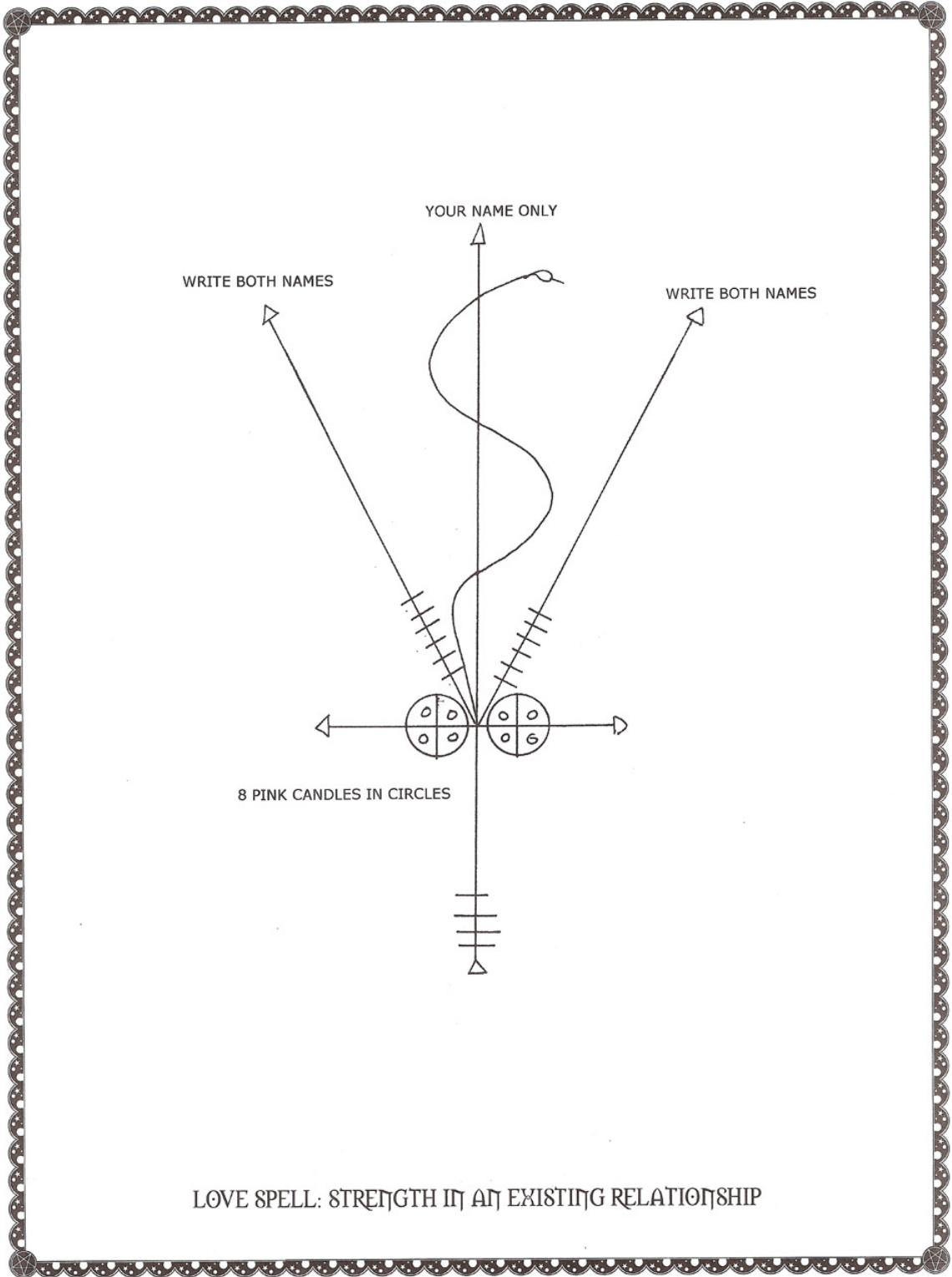

23. AMAZING PERSONAL POWER

This signature is to be used when seeking the creation of strong, personal power. The type of power one is looking for is irrelevant. Do you want to become irresistible to the opposite sex? A lion in the business world? Is it your dream to be the center of attention, a person of such personal magnetism that you make friends and charm everywhere wherever you go? This is the signature you want to use.

This one must be drawn on wood with chalk. Period. Although it is unwise to make substitutions in any signature, this is perhaps the one that would have the most long-reaching negative effects if the formula were not followed. Wood and chalk-only!

Write your name at the tip of the central arrow. A white candle must be placed over your name, and at the tips of the other two upward thrusting, vertical arrows as well (see diagram). All three candles must be burned simultaneously. The wax of the central candle must completely cover your name when it burns or the ritual will be nullified.

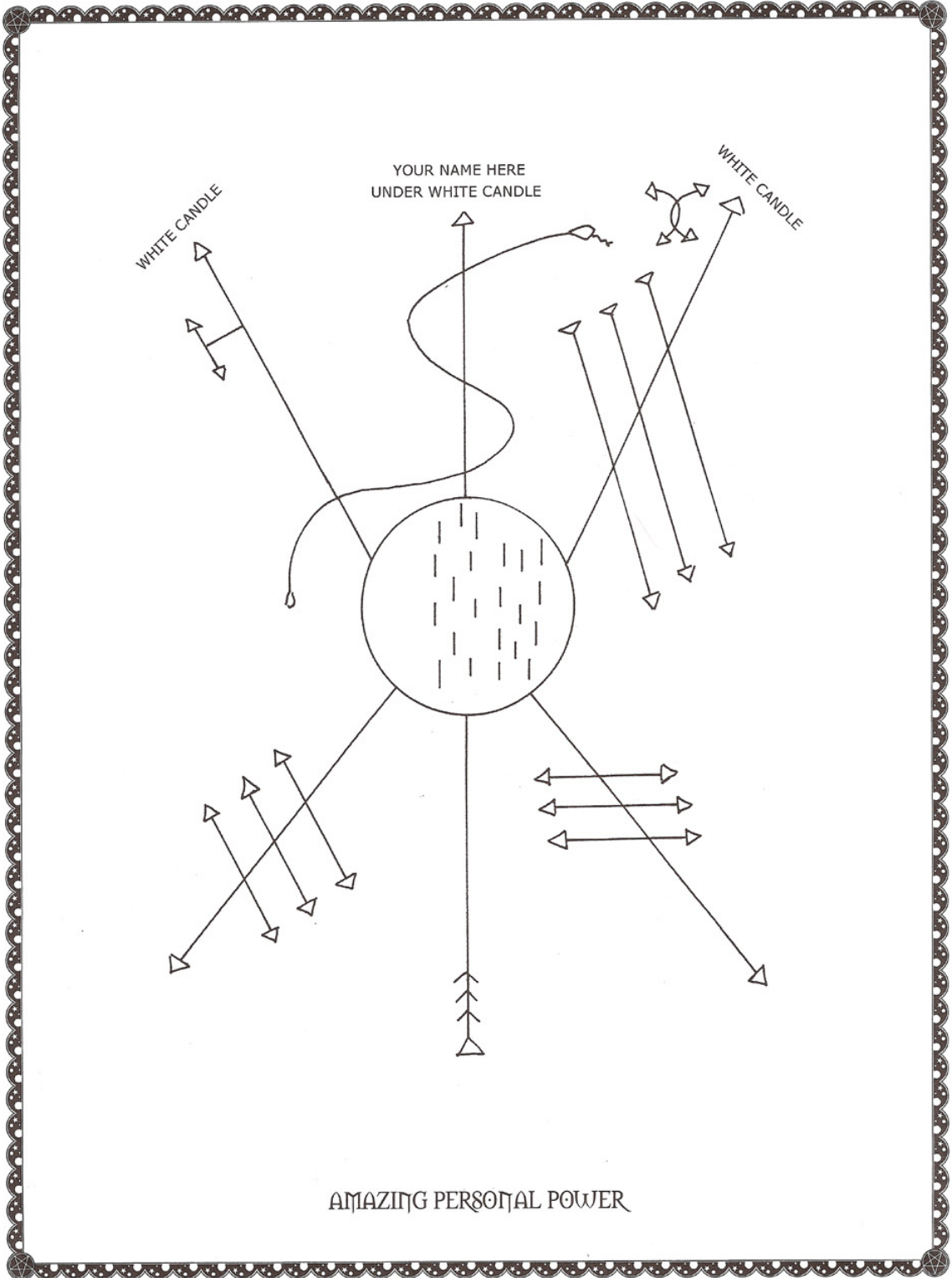

24. TO BRING BACK POWER, FIGHT OFF OBSTACLES

This signature invokes the power of Oshun. Oshun is the Orisha of love, marriage and money. When romance, marriage or a business venture begin to show signs of strain or turmoil, that is the time to perform this ritual in the hopes of eliminating the coming roadblocks, finding ways around setbacks, et cetera.

This ritual must be drawn on wood. It can be drawn with either white or yellow chalk. Four candles are to be used. Three green ones, and one white one. See the diagram for positioning. All four candles must be burned at the same time. The green ones must be lit first. Then the white one.

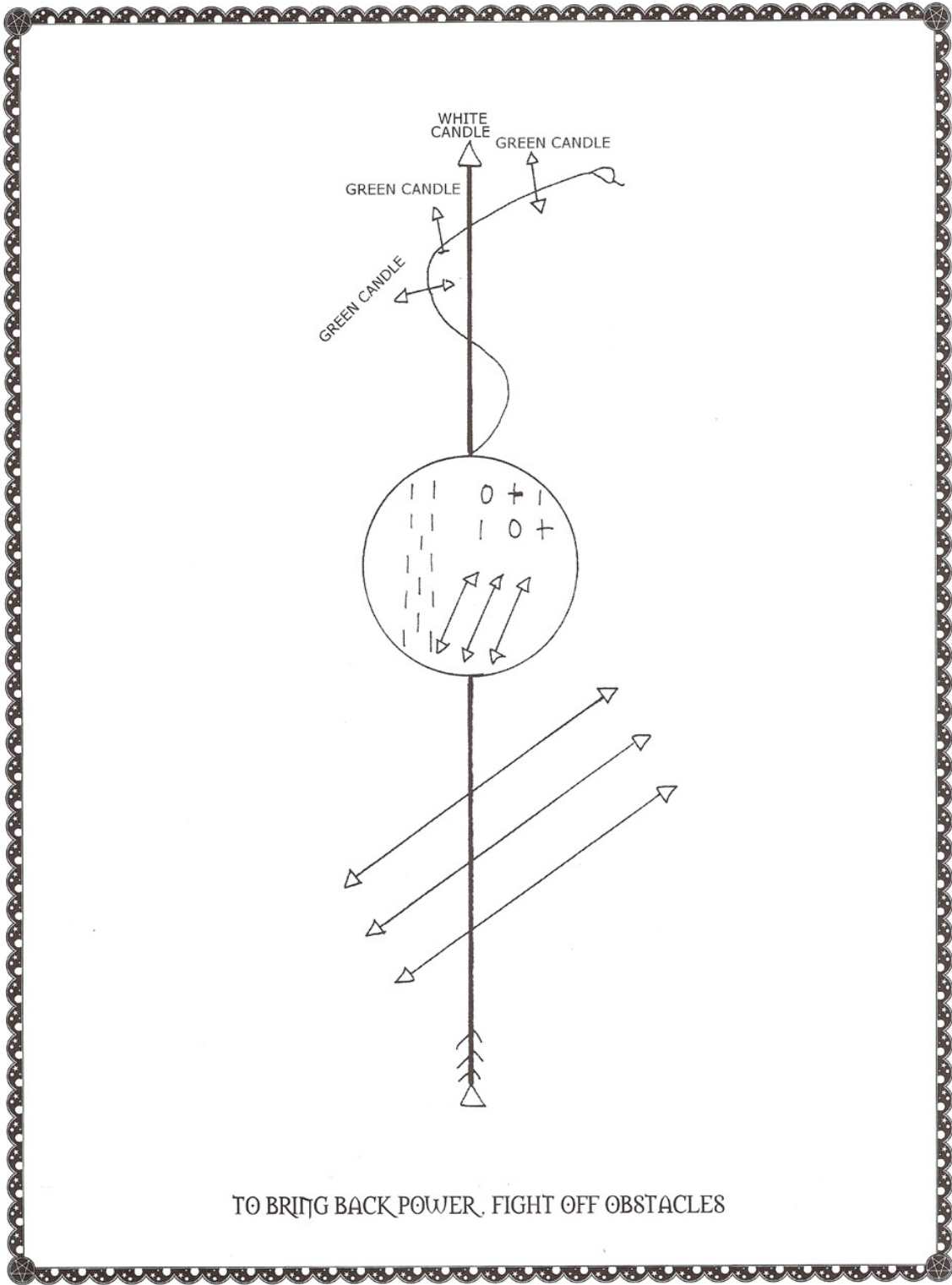

TO BRING BACK POWER, FIGHT OFF OBSTACLES

25. FOR FEMALE CHASING MALE

This signature is for the ladies only, and then it's only for those chasing after a particular lover (and, sorry to say to you untraditional gals, this is for females seeking a particular male). You must know the person you want to enthrall, you must know their actual name, and you must be a female chasing a male. Any variation will still cause the two of you to come together, but it will be a vile, spiteful relationship that will bring mental torment and torture to both parties, but mainly to you, the spell caster.

This signature must be drawn on wood, but it can be drawn in any medium. Five candles are used-one red, one yellow, one white, one green and one pink. See the diagram for positioning.

Also: you must write the name of the man being chased at the tip of the left, upward-thrusting arrow. Your name, the name of the female doing the chasing, must be written at the tip of the right, upward-thrusting arrow. Again, see the diagram for positioning.

Note: the positioning of both the names and the candles is of extreme importance. Everything must be exactly where it belongs or you will be in for a truly sour and horrendous relationship.

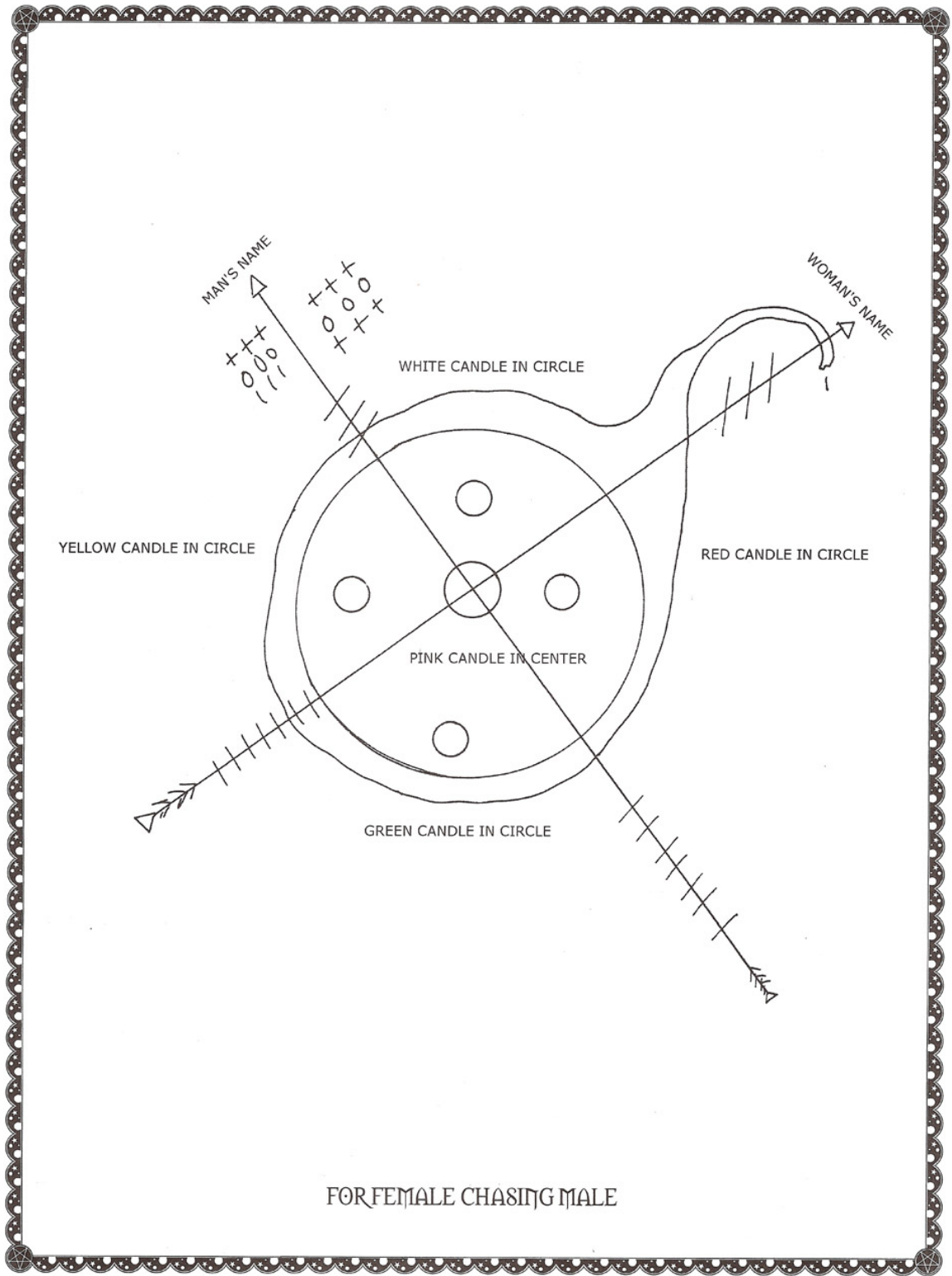

26. LUSTFUL WILD ROMANCE AND SEX

This signature is for sex. It is for everyone to be used on anyone (or anything, for that matter). Men or women, whomever it is you want to attract, this is the spell for you. Understand, however, this is not a LOVE spell. It is a SEX spell.

Also: using this spell on a person to get yourself a wild fling can possibly stand in your way if later on you decide you want to draw this person to you once more for romance. In other words, know what you want before you chose-you may only be able to get the one.

To be drawn on wood with white chalk. Nine red candles are to be positioned along the central vertical arrow as shown in the diagram.

Note: this ritual can also be used to cure male sexual performance problems. Do everything exactly the same as indicated above, then add the writing of your name at the tip of the central vertical arrow.

NAME OR GENDER WRITTEN ON TOP OF THE ARROW OF WHO YOU WANT
EXAMPLE: PERSON'S NAME OR GENDER MAN OR WOMAN

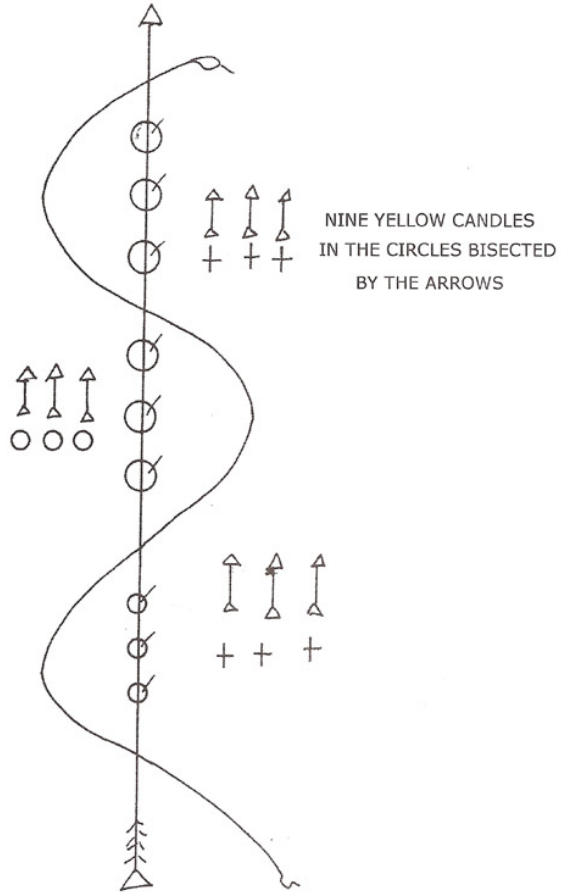

LUSTFUL WILD ROMANCE AND SEX

27. THE LOVE BOMB

This signature is another love spell. It is totally captivating, but be warned, it is not long-lasting. Although it will bring the person to you that you desire, the enthrallment will last for only a few months-a year, at the best. Once the bewitched begins to come out from under your influence, there is no putting things back the way they were. Be prepared to get out of this relationship when the cracks begin to appear-quickly!

This ritual is to be drawn on wood with chalk. At the tip of the central, vertical arrow, write the name of the person to be entranced. A picture of this person works better.

Note: If you were to write a description of the person (their moods, feelings, personality, et cetera) as well as their name, or on the back of their picture, the spell will work even better.

Your name must go at the tops of the crossed, diagonal arrows. Also: Two white candles must be burned. Three days after the white candles burn out, three pink candles must be burned. As always, see the diagram for positioning.

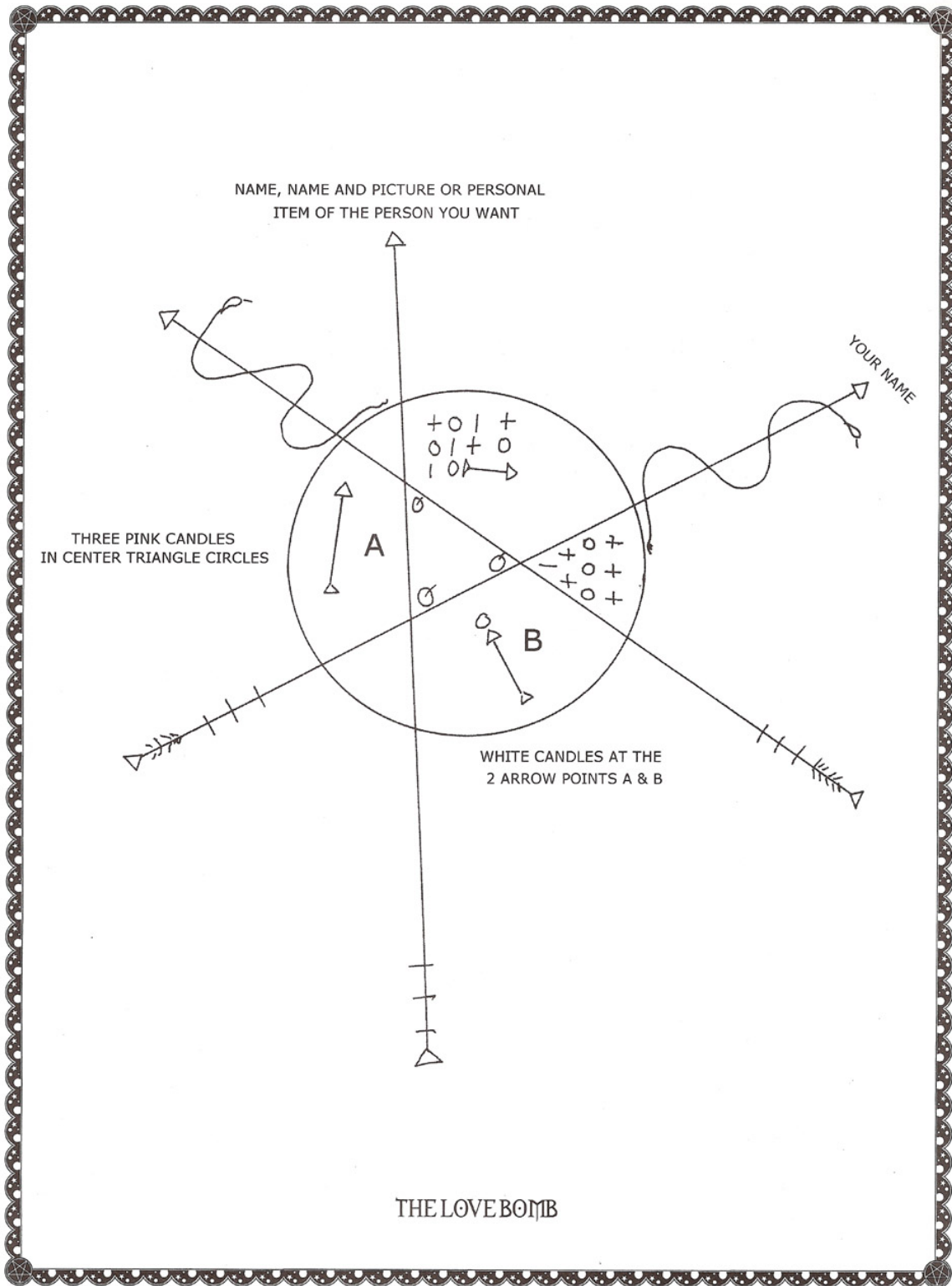

28. ATTACK AND CONFUSE ENEMY

This signature is to be used to blanket your enemies with suffering and confusion. This ritual has many uses. It has been employed to break up conspiracies, to dispel rumors, to confound brutal and imposing foes or simply to get annoying people off one's back.

It must be drawn on wood with chalk. Your name must go at the tip of the left-leaning, diagonal arrow. The name or names of those to be confounded must go at the tip of the spiralling arrow at the center of the drawing.

You must light the white candle first. Then, immediately, light the black candle second with the same flame with which the white candle was lit. This order must be maintained. The candles must both be lit with the same match. If a lighter is used, the flame must remain constant. You can not light the lighter twice, once for each candle. Besides, lighters should not be used, anyway. For all lighting of candles, wooden matches are best.

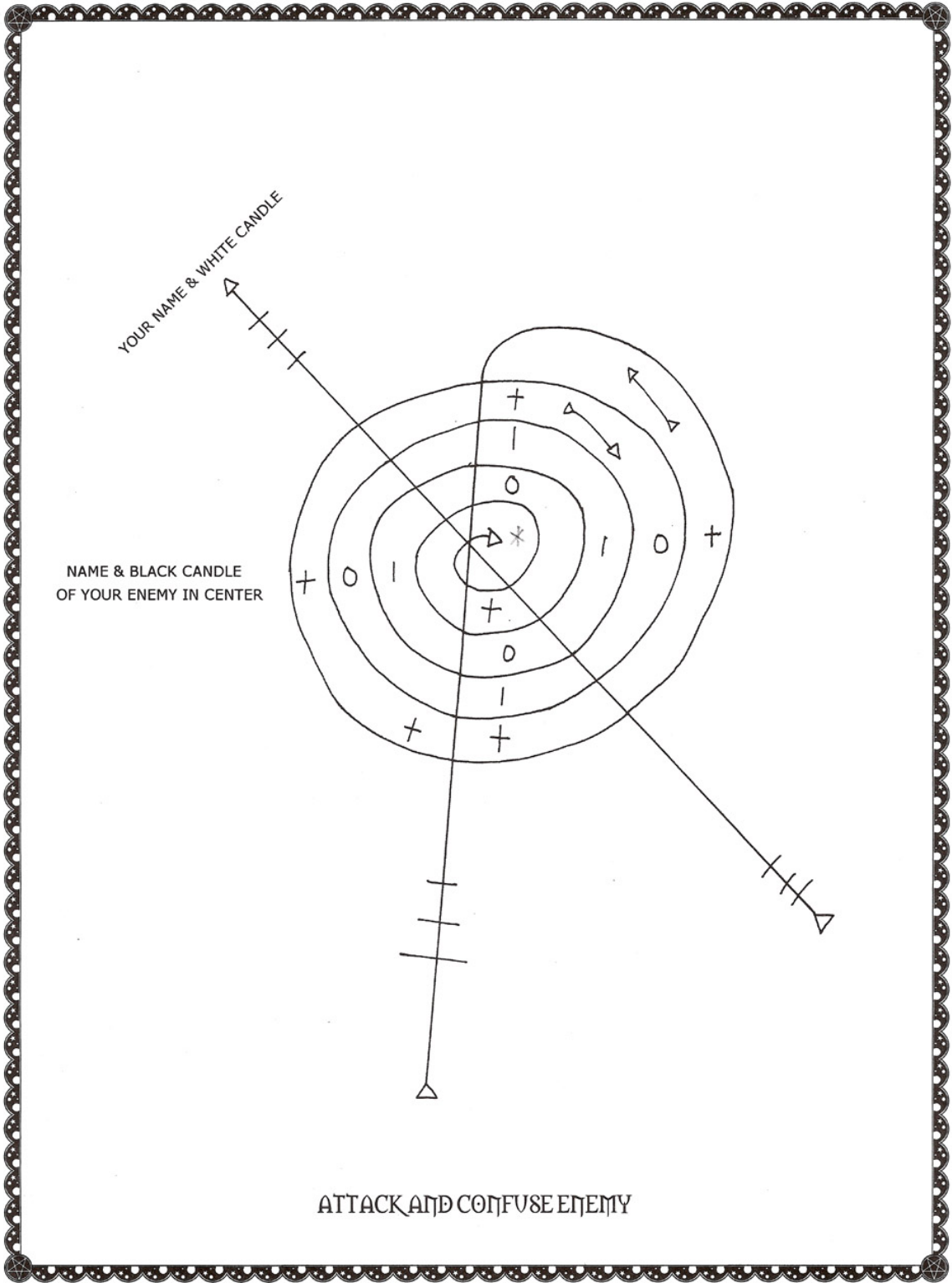

29. START FROM BOTTOM

This signature is used when you are trying to find your path. Looking for the correct business to start? Want to start an acting career? Thinking of the convent? This ritual will help clear your mind and not only direct you to your proper pathway, but open doors that might bar your immediate entry to your best future.

To be drawn on wood with white or purple chalk. Your name must appear three times: at the tips of the short, left and right-extending diagonal arrows and below the tip of the single, central, descending arrow. What it is that you desire (what kind of career you are looking for [note: the more exact information you provide the ritual, the better]) must be written at the tips of the long, left and right-extending diagonal arrows. See diagram for the exact positions.

One white candle is to be burned. It is to be placed in the exact center of the signature. Again, consult the diagram for the correct position.

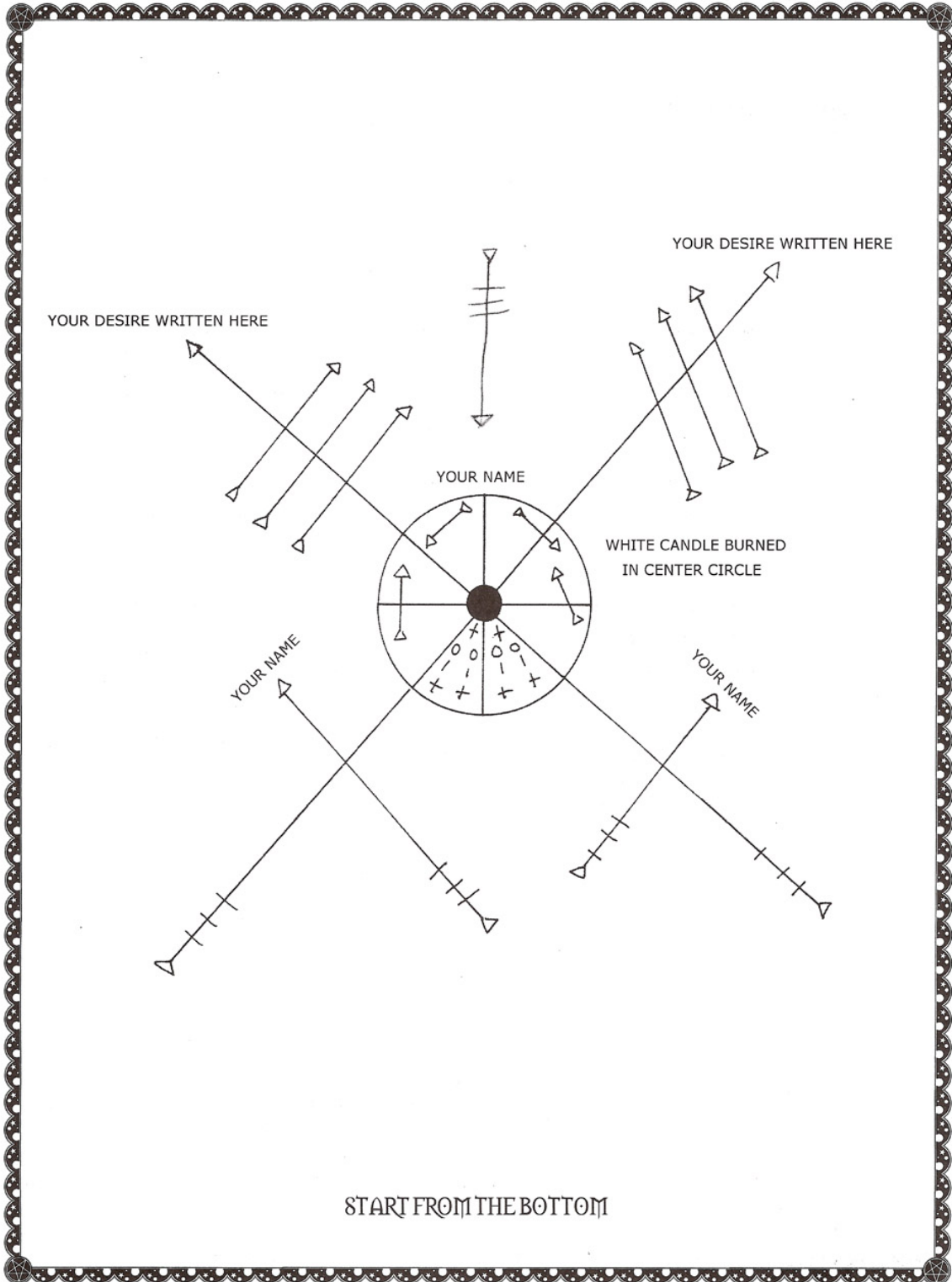

30. TO INCREASE

This signature is a simple plea for an increase in business, or even just to increase one's cash flow.

As with so many, this ritual must be drawn on a wooden surface with chalk. At the tip of the central, vertical arrow, you must write your name. Not the name of your business or your problems or anything else. Just your name.

Six green candles are to be burned. They are to be positioned within the angles of the two large triangles. One white candle is to be burned within the center of the single small triangle. As always, see the diagram for the positioning of the candles.

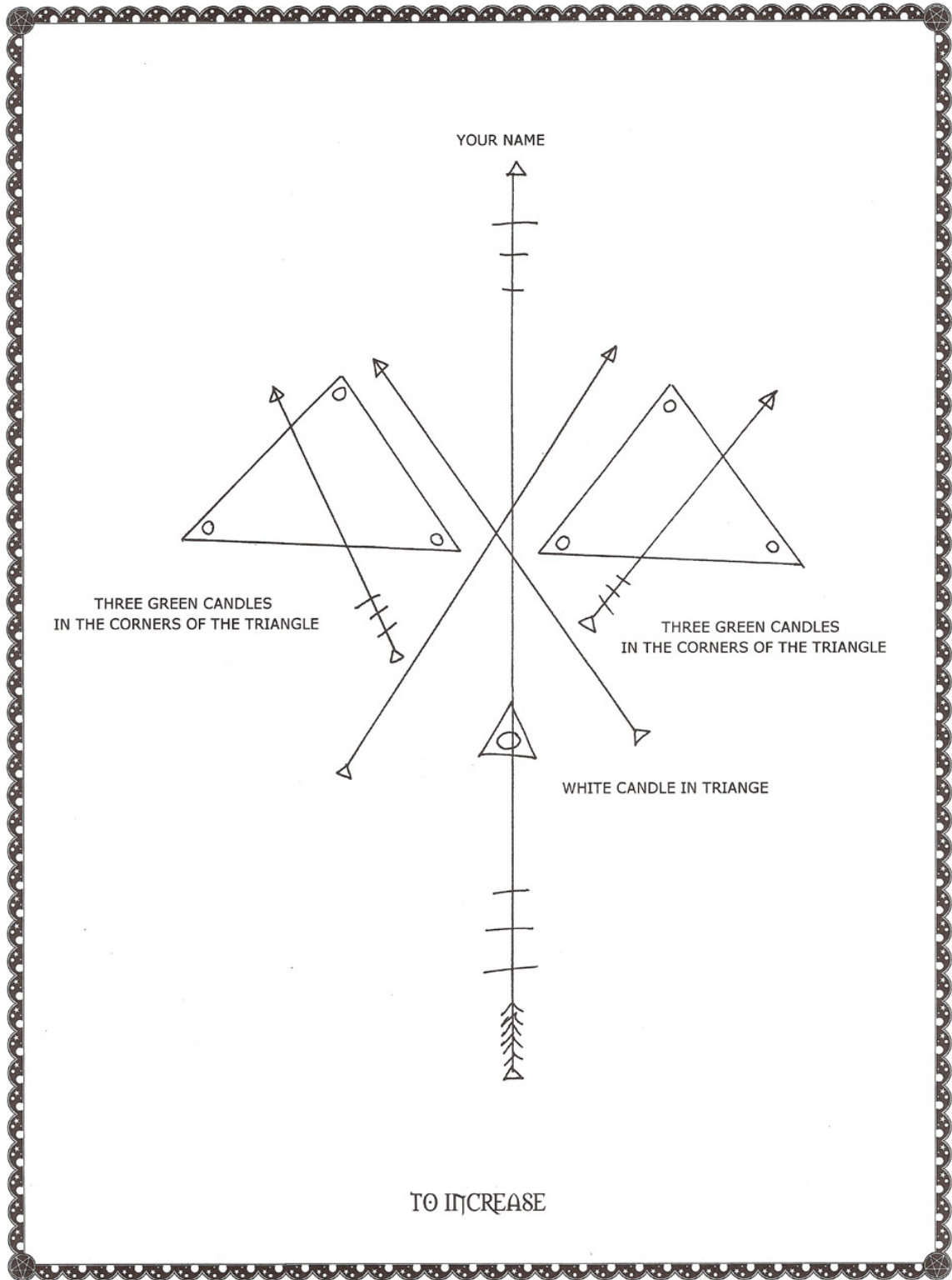

31. SALVATION FROM DEATH OR ENEMIES

This signature is to be used to cheat death. As one might imagine, when toying with such primal forces, one must beseech Ellegua. This always means that there is danger involved, so be certain everything you do is by the book. This ritual can be used to save the life of a friend or loved one, or it can be used personally.

This must be drawn on wood which has been previous cleaned with rum. Chalk must be used to make the drawing. The name of the person to be saved from death must be written in the middle of the center-most circle of the ritual.

Five candles in all must be used: one each of white, black, red, blue and green. Position the candles as shown in the diagram, with black at the "noon/midnight" position. The candles must then be lit in a clockwise (right-to-left) manner.

Each candle must be lit with a separate flame. One match per candle. Do not use a lighter. Do not have any metal present on your person when performing this ritual (remember, zippers, buttons, chains, nails in one's shoes, hairpins, belt buckles, et cetera. THINK!).

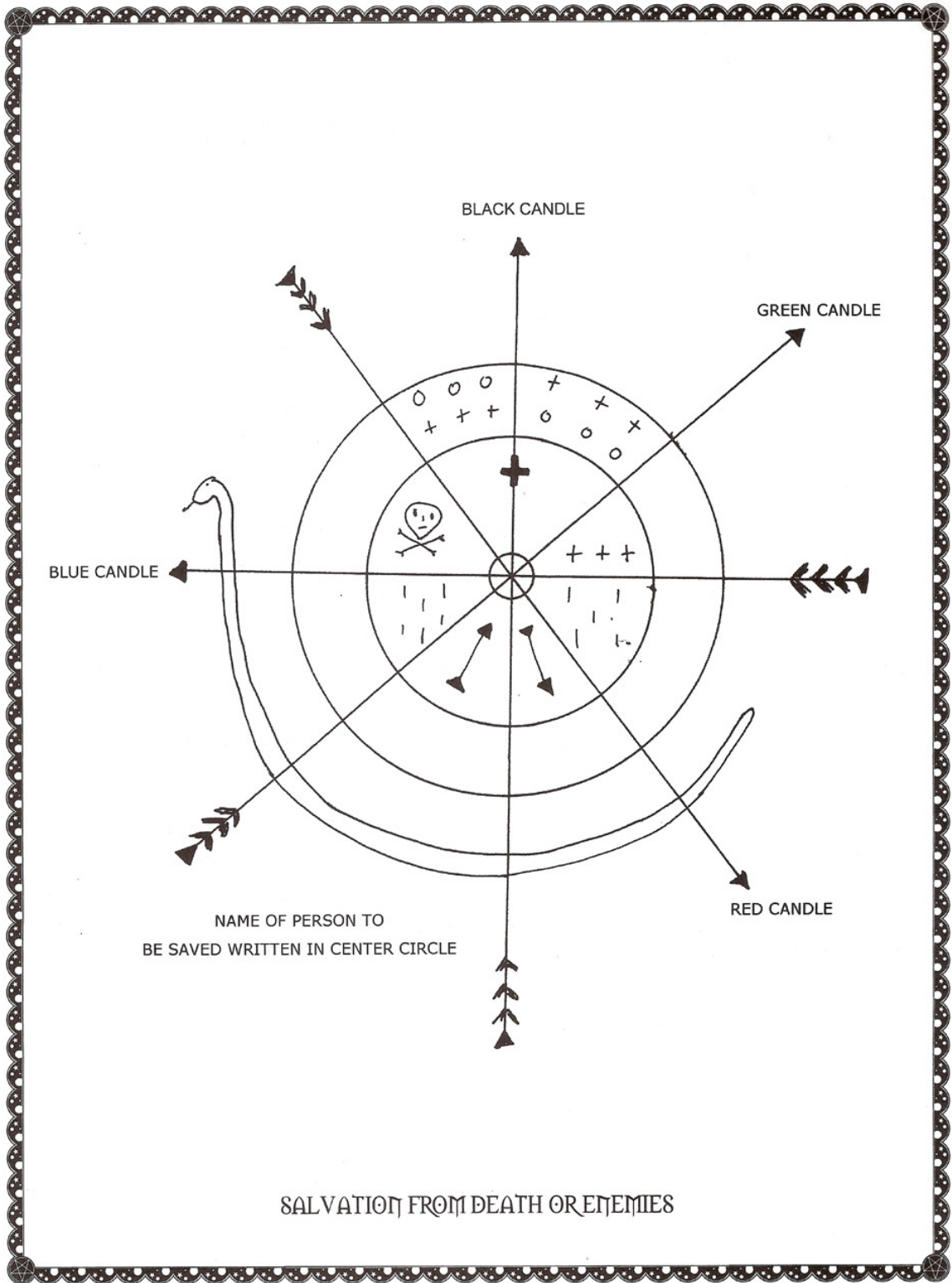

32. FOR CONQUEST

This signature is for the taking of something from someone else. As with many rituals, this can be translated loosely. You might desire to take away a rival's clients. Or take away his entire business. You might wish to steal another's mate to be your own. You might want to get your hands on another's apartment.

This ritual can be drawn on either wood or paper in any medium. When the drawing is completed, you must write your name three times, once each at the tips of the three, leftward-pointing arrows. Then, you must write the name of that which you desire three times, once each at the tips of the three, rightward-pointing arrows. Then, you must place three white candles over the three places where you have written your name. Afterward, you must place three black candles over the three places where you have named that which you desire.

The three white candles must be lit by a single match. The three black candles must be lit by a single match. The white candles must be lit first. The black candles must be lit second.

YOUR NAME WRITTEN 3X
 IN FRONT OF THE 3 ARROW POINTS
 UNDER 3 WHITE CANDLES

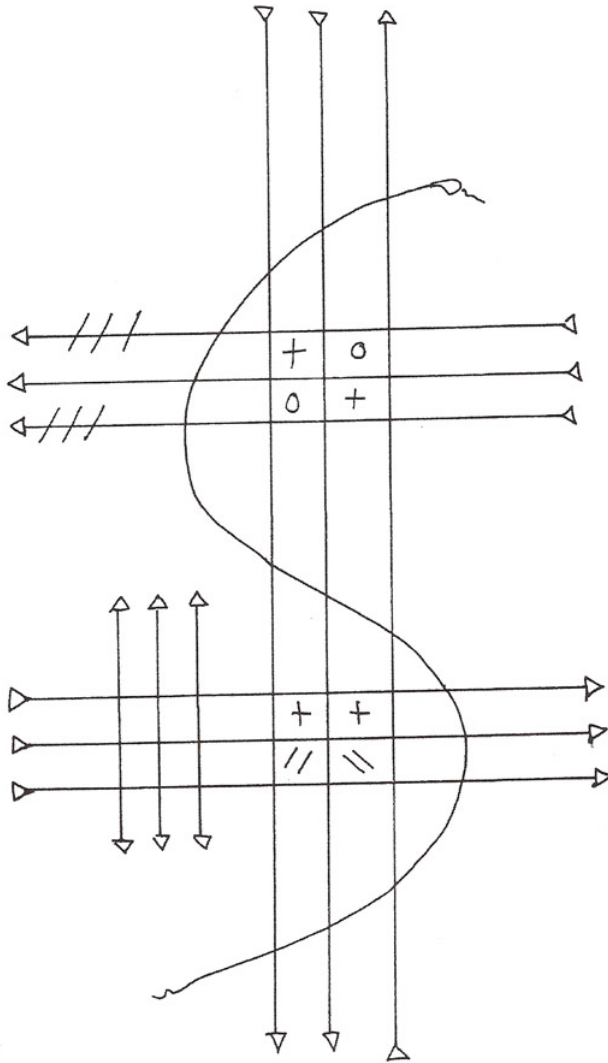

3 BLACK CANDLES, 1 AT EACH POINT
 OF THE ARROW, AND WRITTEN WHO
 OR WHAT YOU WANT TO CONQUER

FOR CONQUEST

33. FOR ESCAPE

This signature can be used in either of two ways-to get rid of creditors, or for calling down good health on oneself-with very few changes.

To relieve the pressures of debt: draw the ritual on wood or paper in chalk, ink or crayon. Then, your name must be written once, wide, across the tips of the three, leftward-leaning diagonal arrows and once, wide, across the tips of the three, rightward-leaning diagonal arrows.

Afterward, three white candles must be placed over both places where you have written your name (in other words, three white candles on the left, three on the right [again: consult the diagram for proper positioning]). Then, you must write the name of your creditor at the tip of the central, vertical arrow. A yellow candle must be burned atop this name.

To ensure good health: The only change is to write nothing at the tip of the central, vertical arrow.

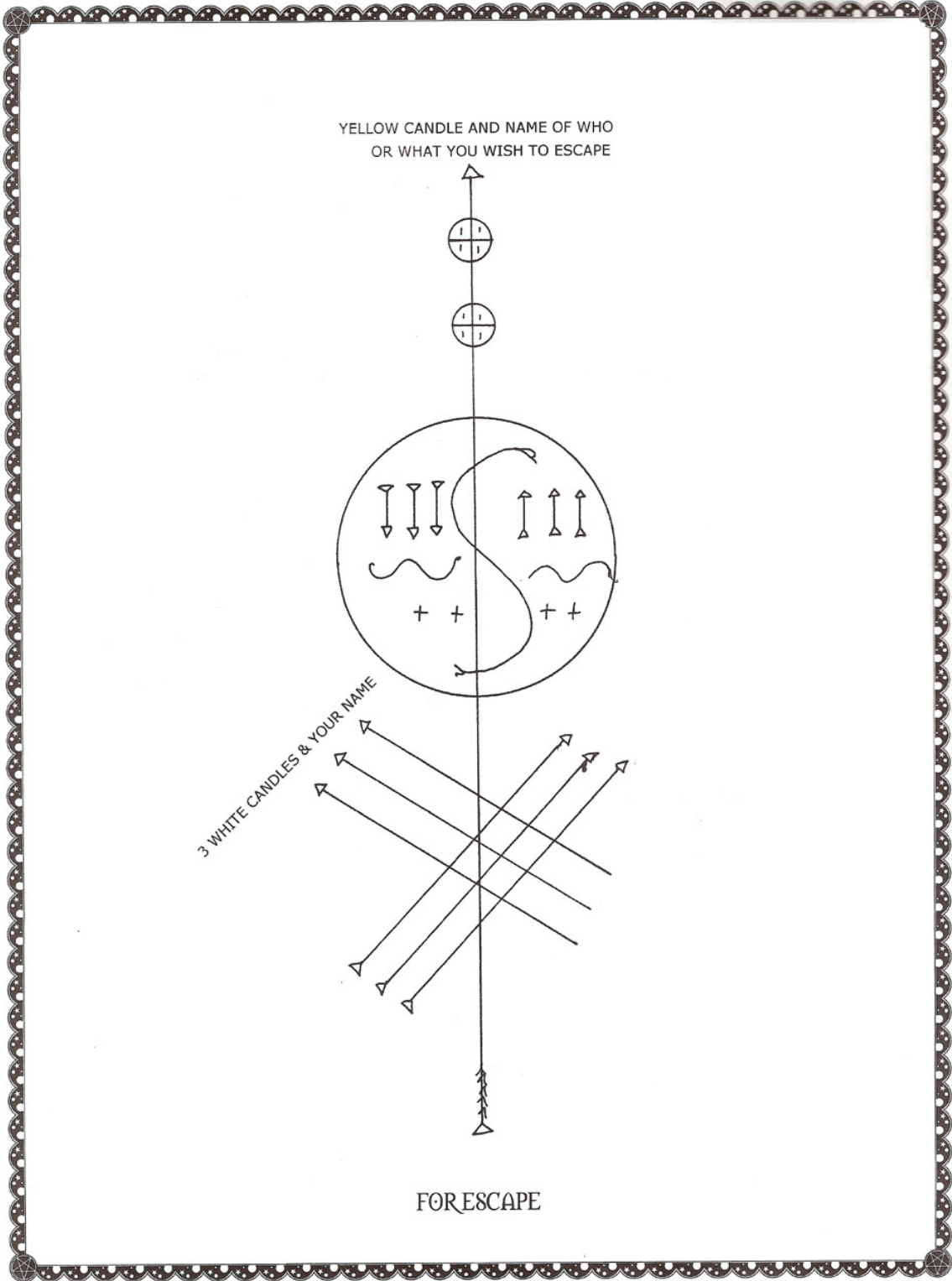

34. CHEATING ON YOUR WIFE OR GIRLFRIEND

This signature is for use by men only. It is known as "the blanket of joy," and it ensures that a cheating husband or boyfriend will be able to get away with his shenanigans and never get caught. Not just by his wife or girlfriend, but by anyone.

To be drawn on wood with purple chalk. Once this is done, your name must be written at both the tips of the single, horizontal arrow. After this, a red candle must be burned over both places where your name has been written.

Then, the name of your girlfriend or mate must be written at the tip of the rightward-leaning, diagonal arrow. Next, a yellow candle must be burned over this name.

Next, the name of the woman with whom you wish to cheat on your girlfriend or mate must be written at the tip of the leftward-leaning, diagonal arrow. Next, a yellow candle must be burned over this name as well.

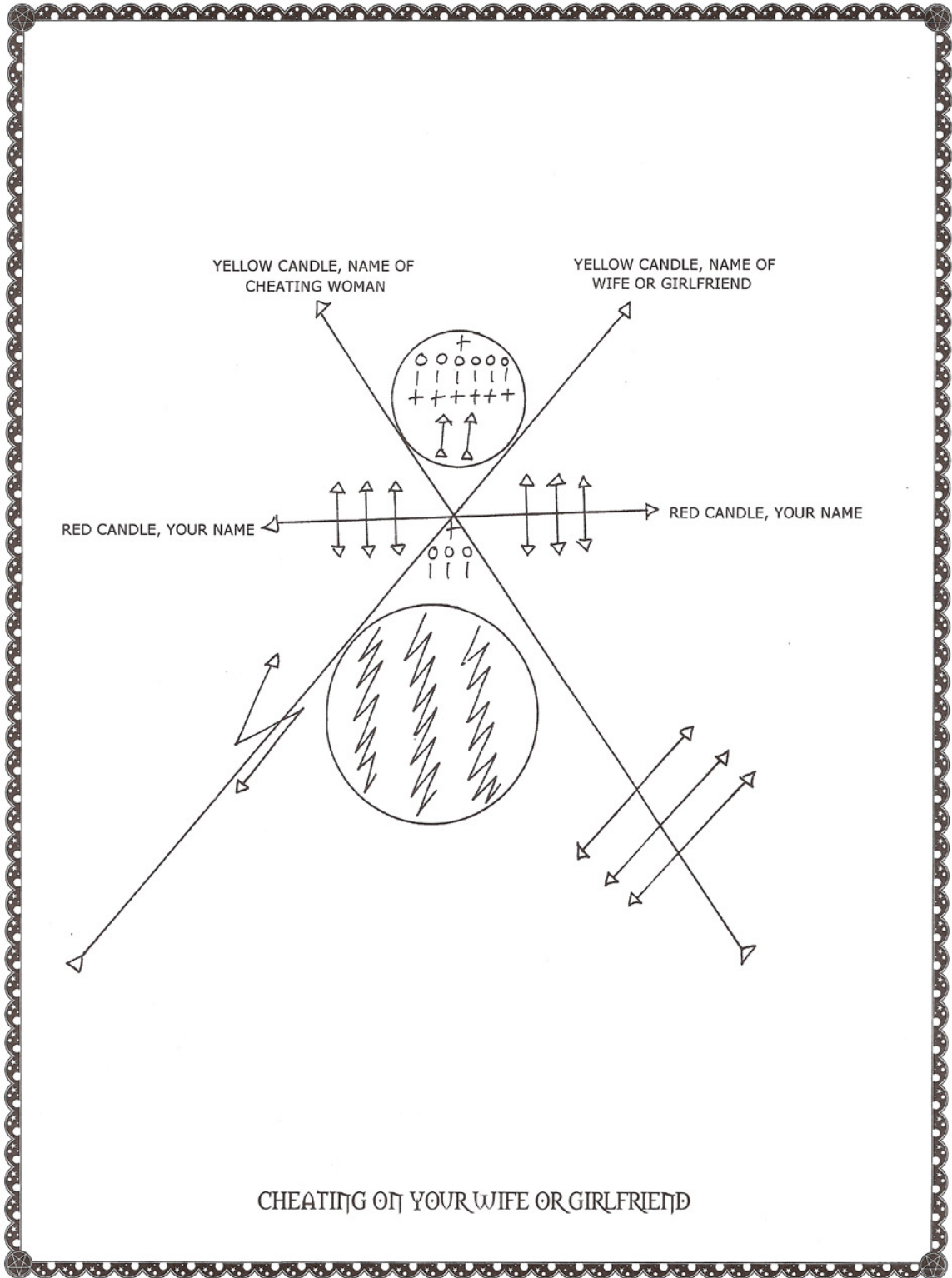

35. TO DESTROY OR KILL YOUR ENEMIES

This is a dangerous signature. Follow the instructions carefully to ensure it does not backfire on you. This ritual is used to hunt and either harm, or kill, your enemies. It is not to be used lightly.

The drawing can be made on either wood or paper, in either chalk, ink or crayon. Once the drawing is completed, write your name at the tip of the central, vertical arrow. Afterward, place a red candle over your name and burn it.

Then, carve the name of the person to be harmed or killed into a black candle with either a pin, knife or pencil. Afterward, place the candle in the center of the drawing as shown in the diagram and burn it.

Note: if you merely wish harm to your enemy, perform the ritual as given above. If death is your goal, here is the one variation that must be made. Before using the black candle, you must turn it upside down and carve it to where you have exposed the wick. Then, place the candle where it goes as per the diagram and light it. In effect you are burning the candle "upside down." This variation changes the ritual from harmful to deadly.

Of course, be sure to carve the name of your enemy into the candle in either case.

RED CANDLE LIT OVER YOUR NAME

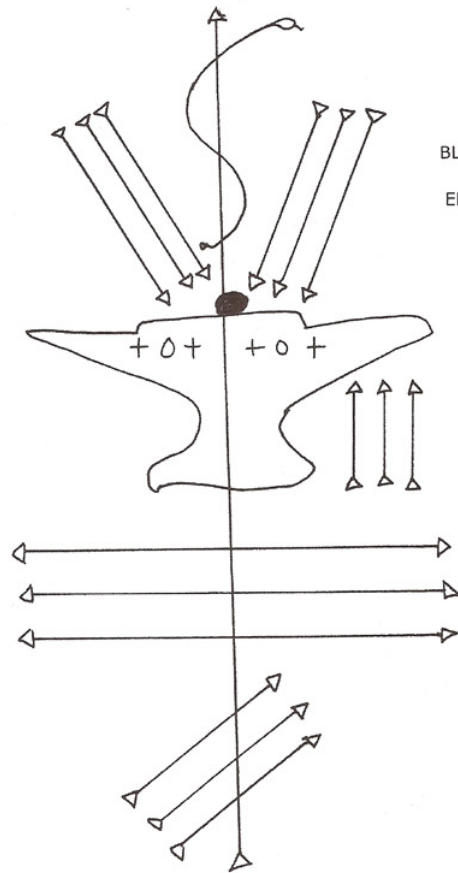

BLACK CANDLE WITH NAME OF
ENEMY IN SOLID CIRCLE ON ANVIL

TO DESTROY OR KILL YOUR ENEMIES

36. THE NEVERENDING CONQUEROR

This signature is the mark of the conqueror. It is used to allow one to conquer a situation. Again, you must think "outside the box," as they say. Do you want to conquer a lover? A business rival? Do you want to conquer all challengers at a sporting event? Your bookie? Or, perhaps you have a fear of something you want to conquer? In any of these cases, this is the ritual you want.

To be drawn on wood or paper in chalk, ink or crayon. After the drawing has been completed, the name of that which is to be conquered (person, fear, goal, et cetera) must be written at the tip of the central, vertical arrow.

Then, a single red candle is to be placed in the center of the circles as shown in the diagram and burned.

NAME, PERSON OR SITUATION YOU WANT TO CONQUER

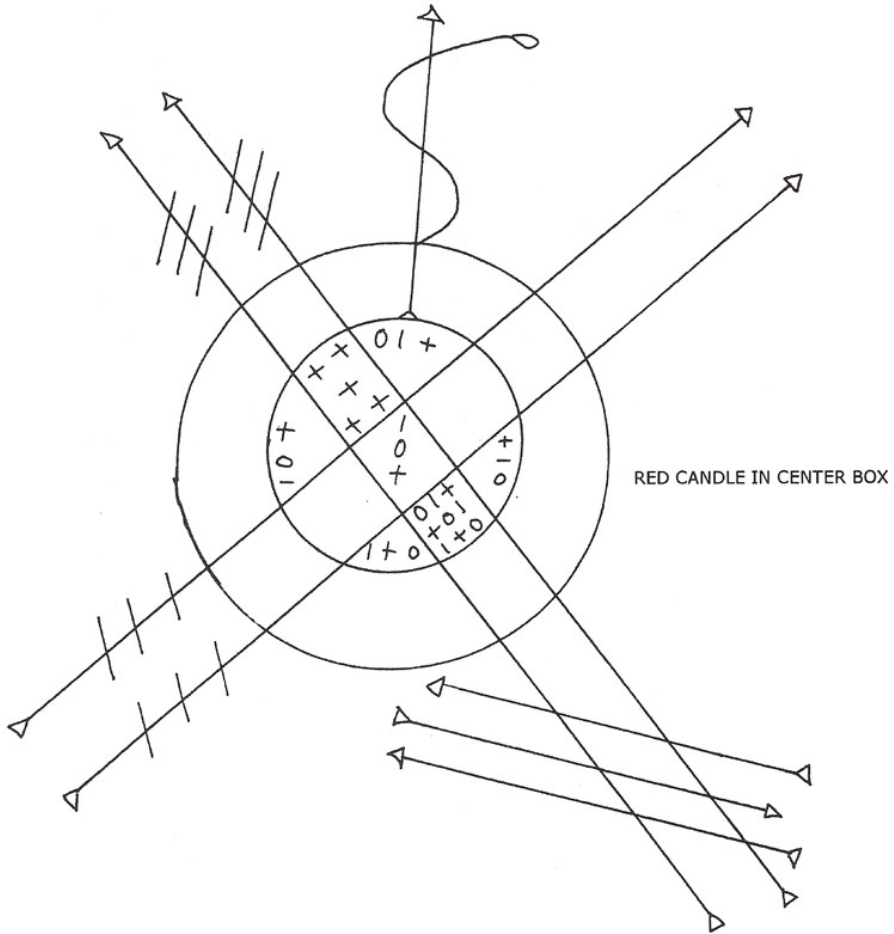

THE NEVERENDING CONQUEROR

37. DESTROYING GROUPS OF ENEMIES

A highly specific signature, this ritual is to be used to destroy enemies that work in GROUPS. Think law firms, the I.R.S., the police or media, et cetera.

The drawing is to be made on wood with chalk. It is to be pointed out of the front entrance to your dwelling. Your name is to be written at the tip of the two vertical arrows. The name of the organization that is your enemy must be written at the uppermost point of the triangle that rests between these two arrows.

Your name must be covered in both places with a white candle. The name of your foes must be covered by a black candle. The two white candles must be lit with a single flame. The black candle must be lit after the white candles. A separate flame must be used for the black candle.

ALSO: this is extremely important! You must be present when the candles (or at least, the last candle) finish burning. Immediately after the last candle (black or white does not matter) extinguishes itself, the wax must be scraped from the wood. The wood must be washed clean in rum. The wax must be buried outside, in the dark, away from moonlight.

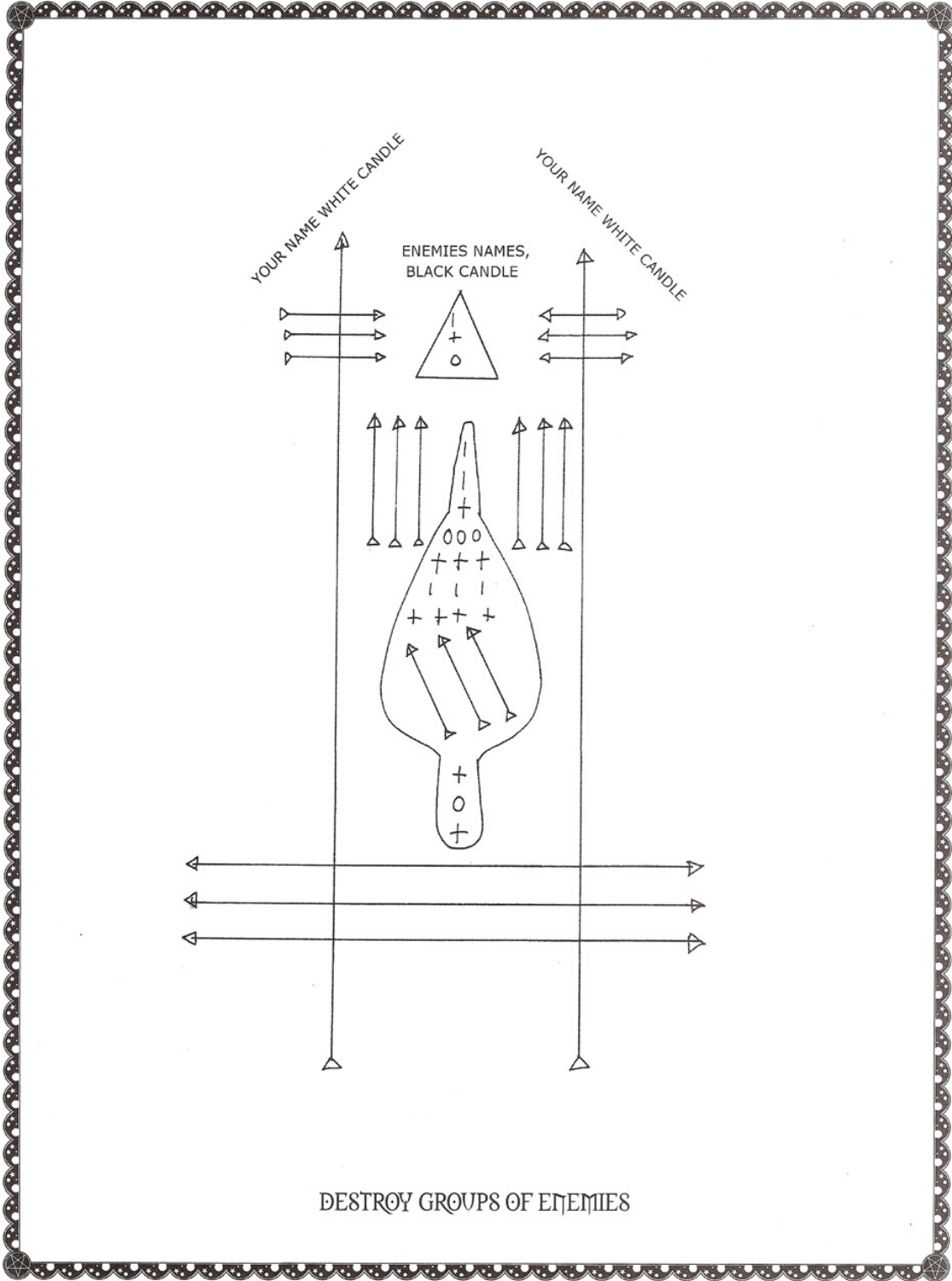

DESTROY GROUPS OF ENEMIES

38. FREEDOM FROM EMERGENCY

This is an odd, all-purpose signature that calls upon Chango. It can be used to ask for defense, help in matters of seduction, or to cheat death. It is not as effective as some others with the same results, but it is far safer to use, especially in the case of trying to avoid the Grim Reaper.

This ritual is to be drawn on paper in ink, chalk or crayon. The name of the person to be affected (yourself or another) must be written at the tip of the central, vertical arrow. The name of that which is being asked for is to be written at the tip of the leftward-leaning, diagonal arrow.

Two white candles are then to be placed at the tips of the wavy, horizontal arrow at the bottom of the signature as shown in the diagram. Burn the candles, then, burn the signature itself. The ashes and wax are to be thrown into open water of a natural design (the ocean, a stream, lake, et cetera). In other words, do not throw the remains into a swimming pool, a reservoir, et cetera.

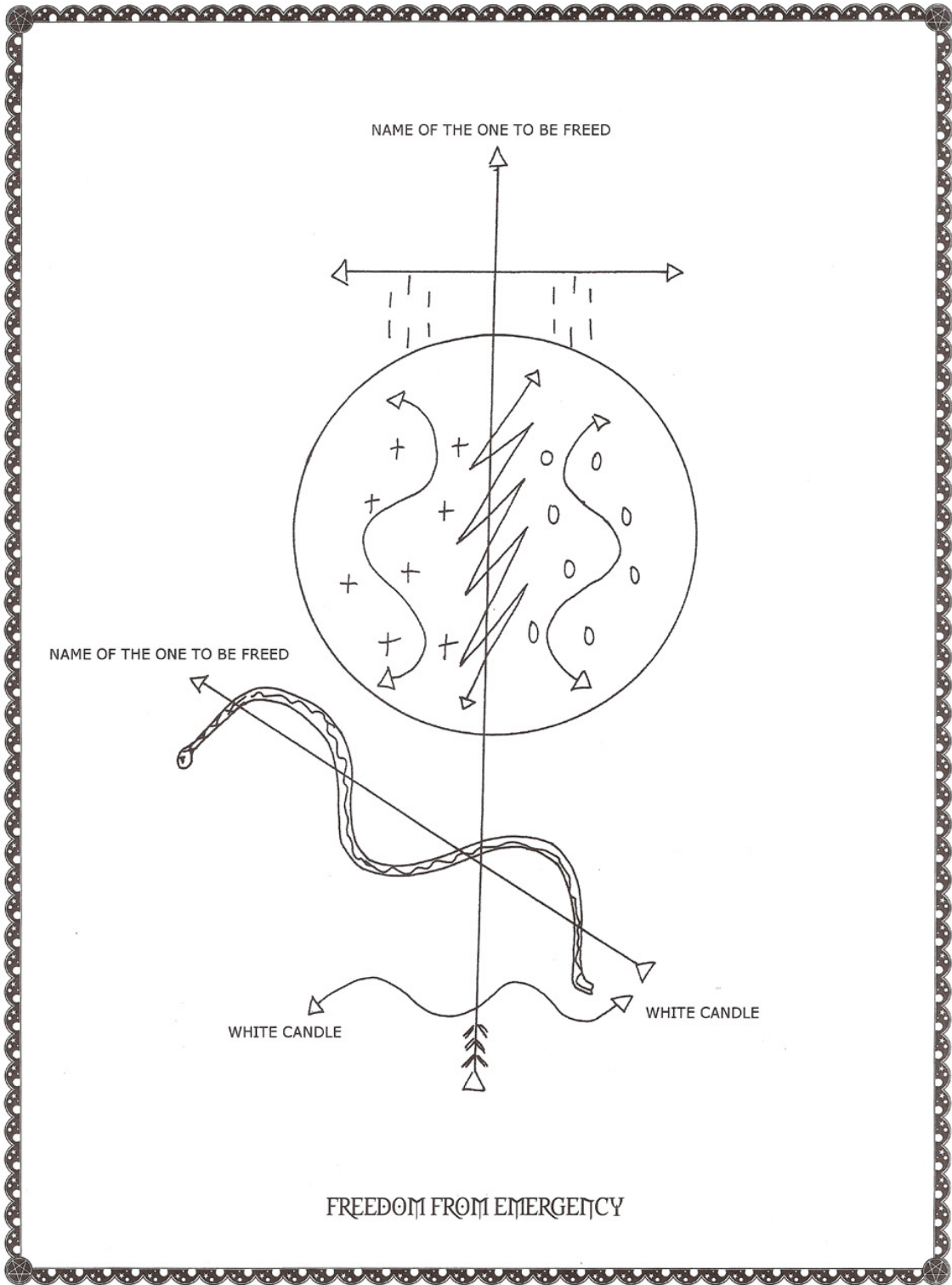

39. FOR CHARISMA IN ROMANCE OR BUSINESS

This ritual is for the enhancing of sexual charisma. If you are looking to be perceived as more macho or more feminine, this is the signature you should begin working on immediately.

Interestingly, this is one of the few signatures that can be used in either or two ways.

A) It can simply be drawn and carried at all times (no candles necessary). If this is desired, it should be drawn on paper, with ink, crayon or chalk. Your name should appear at tip of the central, vertical arrow.

B) If you don't want to carry the ritual everywhere you go, draw it on wood with chalk. Write your name at the tip of the central, vertical arrow. Then, a green candle must be placed over your name and burned.

Once this ritual is completed, you can dispose of the signature, or you can slide it under your bed or mattress. The more times one sleeps on this ritual, the greater its effect (equal to carrying a paper version everywhere one goes).

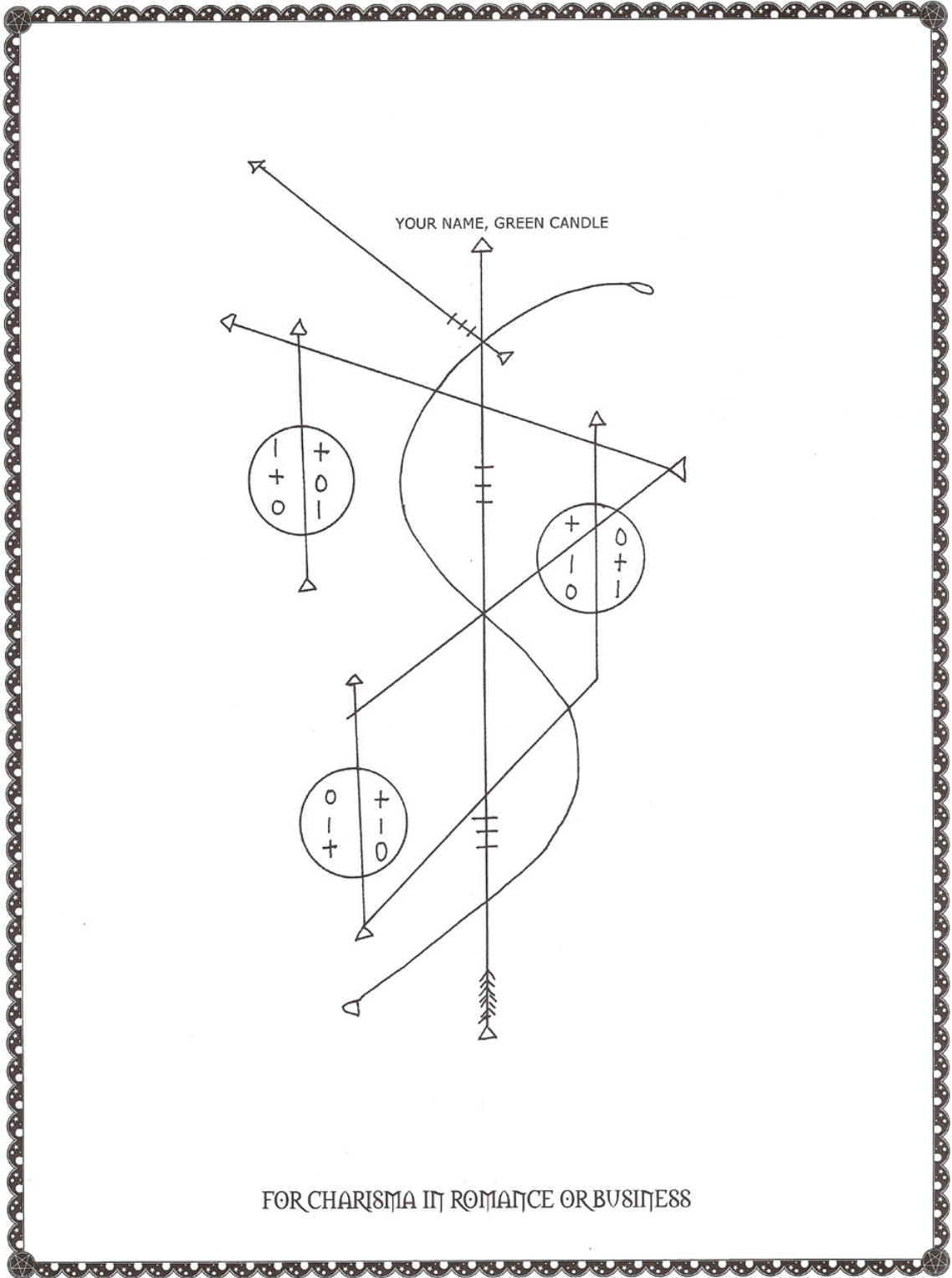

40. FOR PEACE IN THE HOME

This signature is an appeal to Chango for peace in the home. Creating this ritual in your home is a way to quell all disagreements with one's mate. It brings the user obedient, quiet children. It also blesses one's home with an aura that makes every guest glad to be invited (and craving those invitations).

Note: this is a permanent fixture. Once you draw it, it must remain in the home forever.

One draws this in chalk or (for a stronger effect) paints it with white paint. It must be made on wood which can be kept anywhere in the home. The front door is the best place for it to be displayed. Its powers are strongest when displayed here. But, for the timid, it can be kept anywhere in the home. Remember, however, the more it is hidden, the less faith and respect one is showing Chango. The harder a god has to work for one, the less inclined they are to do it.

NO NAMES OR CANDLES NEEDED

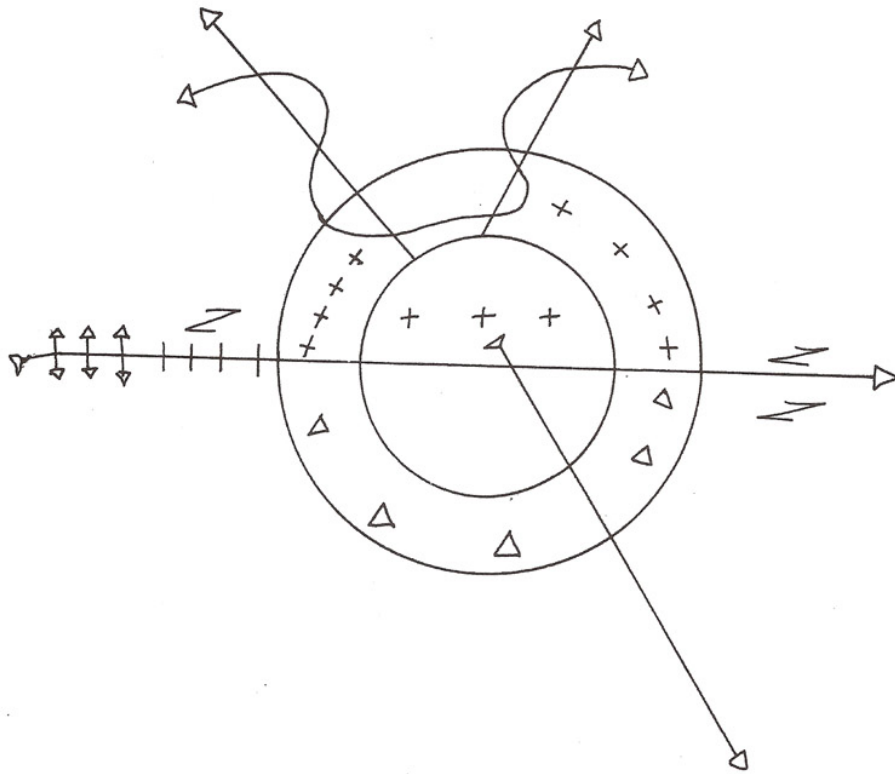

FOR PEACE IN THE HOME

41. POWERFUL LOVE SPELL FOR MEN ONLY

This is a love spell only to be used by men. Ladies, use the signatures designed for you. This one has severe consequences in store for women who dare to try and invoke its powers.

Specifically, it is to be used by men who want to initiate a romance. Also, note that this is not to be used simply to grab some quick sex. It is for beginning a relationship.

This one can be drawn on wood or paper. It can be drawn in crayon or chalk. It can be drawn in red, white or green. Once completed, the man's name must be written at the tip of both the leftward-leaning, upward-pointed diagonal arrow, and the rightward-leaning, downward-pointed diagonal arrow. Then, the name of the woman being chased must appear at the tip of the leftward-leaning, downward-pointed diagonal arrow.

On top of the woman's name, some personal item of hers should be deposited. This can be a hair, a napkin they have used, change obtained from them ("can you change a dollar?"), et cetera.

Once the signature is complete, three pink candles must be burned. See the diagram for proper positioning.

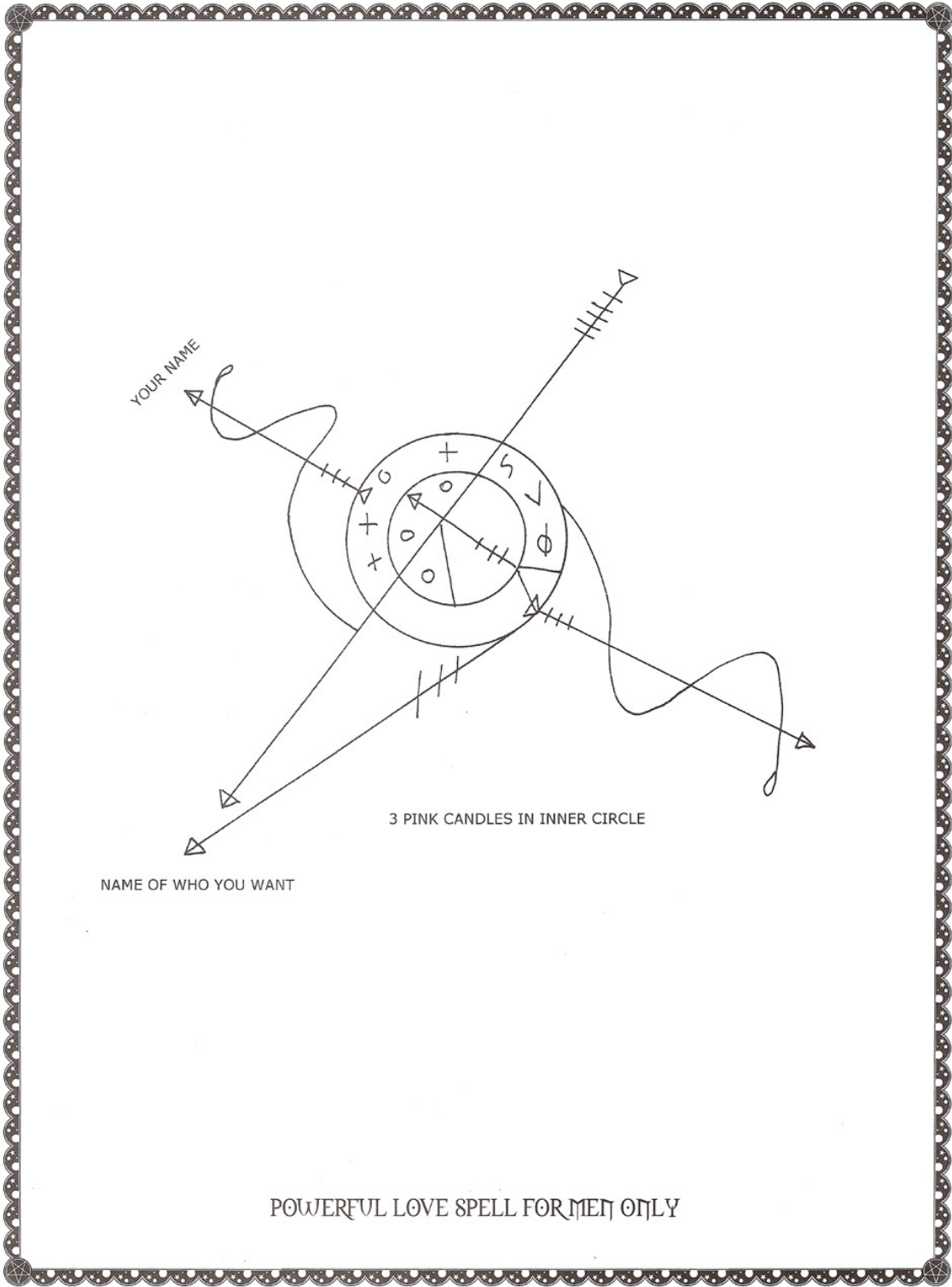

42. RUINING AND RIDDING OF ENEMIES

This signature is to be used to harm or rid oneself of enemies. It does this through causing your enemies to harm themselves.

This ritual is to be drawn on a piece of wood in white chalk. Once completed, it must be faced out the front entrance of your home.

Your name must be written three times, once each over the tips of the three small arrows at the base of the signature. Once your name is written, each writing must be covered by a red candle. After this, the name of your enemy must be written at the tip of the arrow extending from the circle at the top of the signature. Once their name is written, it must be covered by a black candle. The candles should be lit, red first, black second. Each should be lit with a separate flame.

NOTE: Unlike most of the signatures collected here, the wood this ritual is completed on must not be used again. It must not even remain in your home. After washing in rum, it must be thrown out immediately. Also: you should not put it in your own trash. You should place it in someone else's garbage. They should not even live in the same place as you. Driving a few blocks, or even a few miles away is better.

Understand that this ritual must be taken away. You cannot bury it. You will know where it is and thus it will still be in your possession. You cannot throw it in a river. It will, essentially, be in the river, you will know it is in the river, and thus it will still be in your possession.

You must have it taken away by a stranger. Since you will not know who the sanitation engineer is who collects the garbage on some far away street, you will not know where they are taking it and the ritual will be complete.

NAME OF ENEMY UNDER BLACK CANDLE

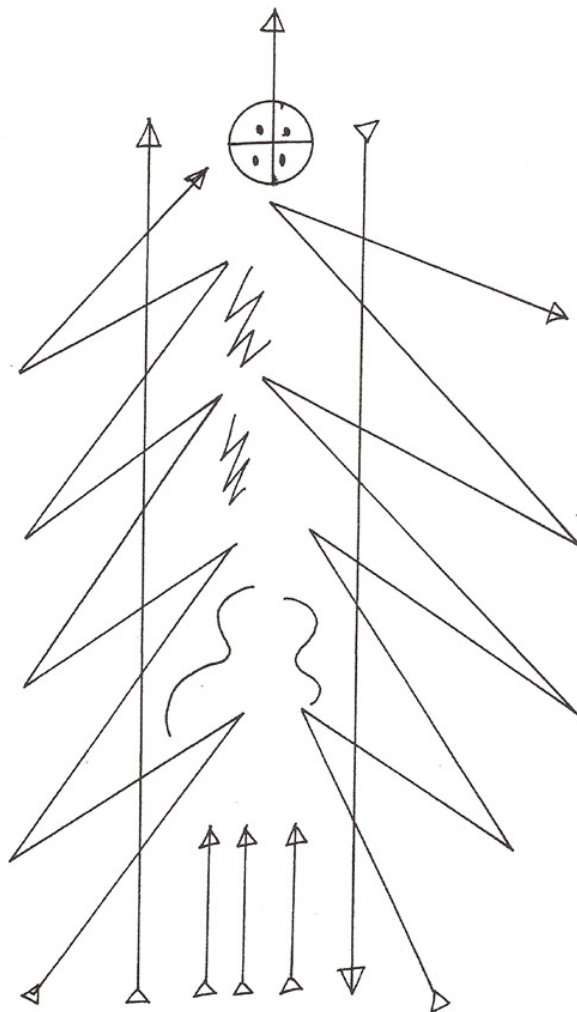

YOUR NAME ABOVE THE THREE ARROWS
THREE RED CANDLES OVER YOUR NAME

RUINING AND RIDDING OF ENEMIES

43. GREAT MENTAL HEALTH

This signature, for lack of a better term, is an anti-depressant. It helps one avoid all obstacles, whether they are people or situations, which can possibly put you in a bad mood.

This ritual is to be drawn on either a piece of wood or paper. It can be drawn in ink, chalk or crayon.

Once completed, it is to be placed under one's bed or mattress. The longer you leave it there, the longer it works.

That's it. No candles, no muss, no fuss. Like a smoke detector, you simply put it in the house and let it do its job. But, unlike the smoke detector, there are no batteries to check.

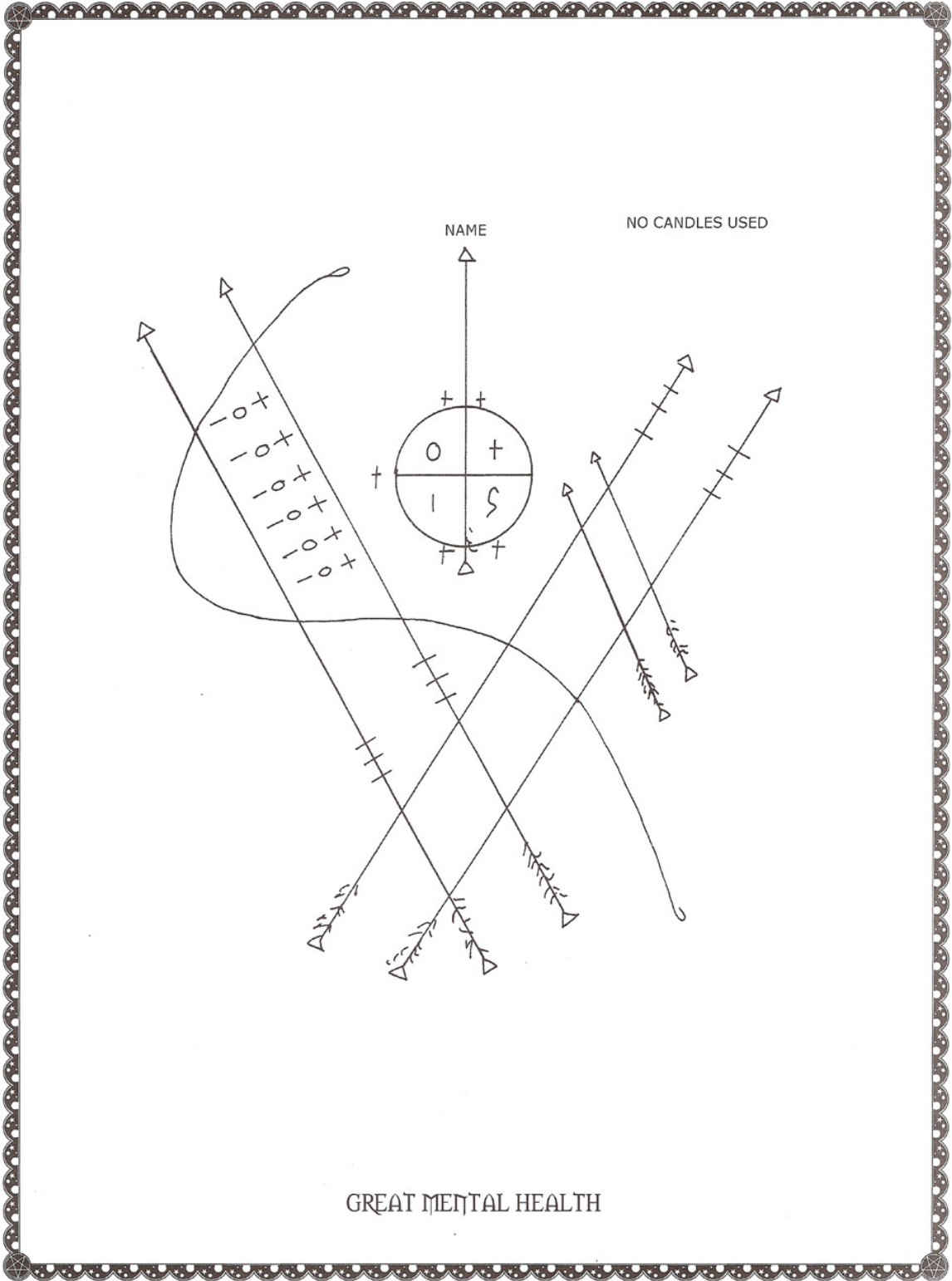

44. FOR HEALTH AND HEALING

This signature beseeches two Orishas, Obatala and Yemaya, to intercede on your behalf when death is eminent.

This one is to be drawn on wood only. The drawing may be made with white chalk, or purple crayon. When completed, your name must be written at the tips of the two large, diagonally crossed arrows.

After this, two white candles must be placed at the tips of the two vertical arrows to the right of the main drawing. Then, two more white candles must be placed at the tips of the two horizontal arrows which cross the vertical arrows in that same drawing.

As always, consult the diagram for the positions of the names and candles.

45. CREATIVE INFATUATION AND WILD ROMANCE

Another romance signature. This one is to be used when you want to turn up the heat in a relationship. It is for those within a relationship who feel that their partner is not infatuated with them to the desired degree. It makes the partner targeted more clinging, unable to see others in a romantic or desirable way.

It also fans the flames of their sexual desire. It will not make them want more sex than they can handle, but it will take the cork out of their personal bottle. Be certain you can handle what hidden depths they may have waiting for you because you will be on the receiving end once this ritual takes affect.

Draw this one on wood or paper in white crayon, chalk or pencil. Write your name at the tip of the uppermost arrow. Then, place a black candle over your name.

Write the name of your mate in the centermost circle of the main triangle. Place a pink candle over their name. Place pink candles in the center circles of the remaining two triangles. Burn the candles.

This casting can work instantly, or can take up to nine days to have an effect. Be patient.

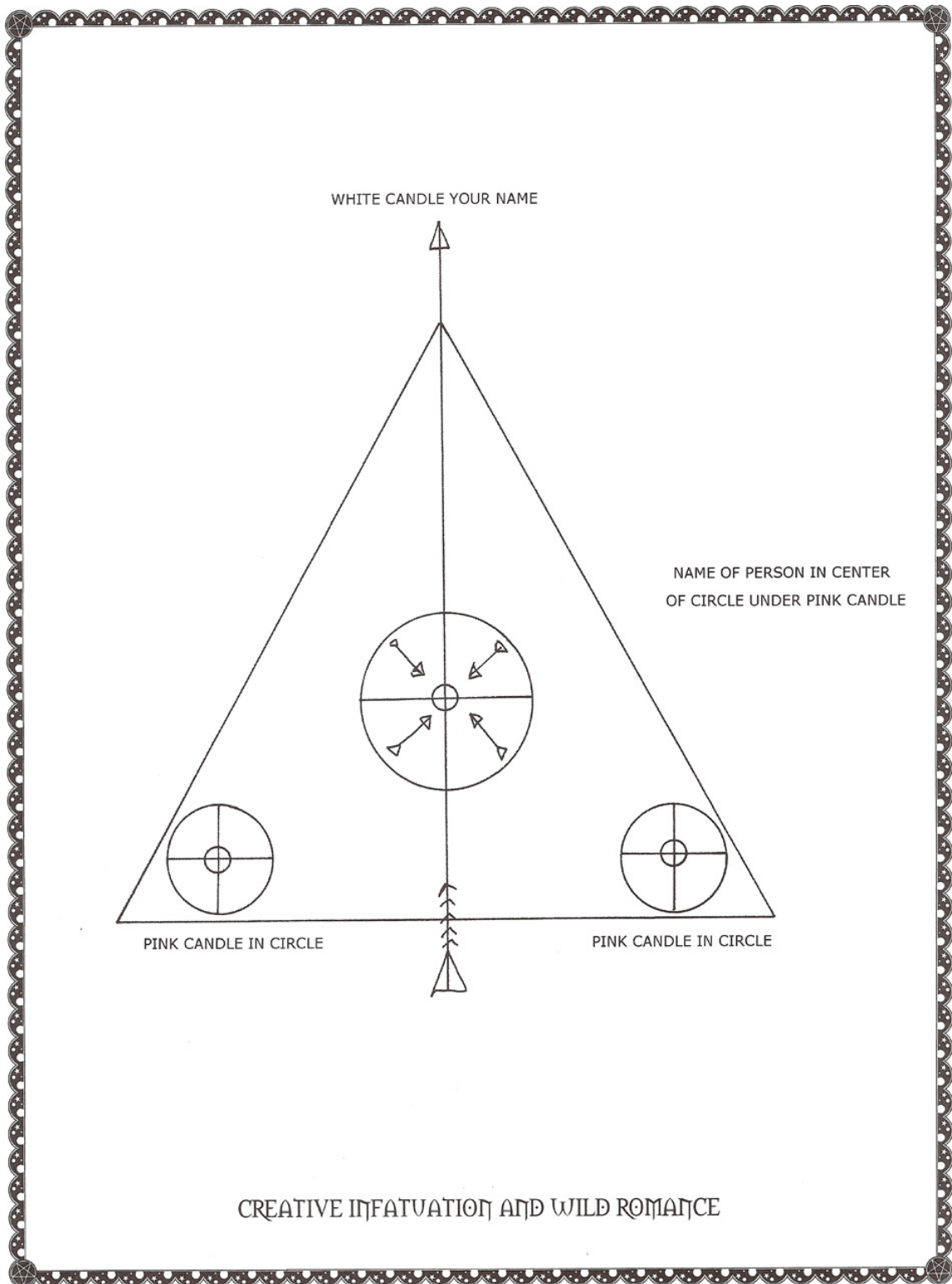

46. TO DESTROY OPPOSING FORCES

This signature is for overcoming opposition in any endeavor. In other words, if your husband or wife just wants to argue all the time, this one is not for you. This is for advancing against actual opponents.

To be drawn on wood, or on red cloth. Once completed, your name must be drawn at the lips of both of the snakes' mouths. Then, the name of your opponent(s) must be written at the tips of both the leftward-leaning, diagonal arrow and the rightward-leaning, diagonal arrow.

After this, your name must be written four times, once at each of the four tips of the two diagonal, crossed arrows. As always, see the diagram for positioning of all names.

No candles are needed. Place the wood under your bed or mattress. If drawn on red cloth, position in the same place, or carry on your person.

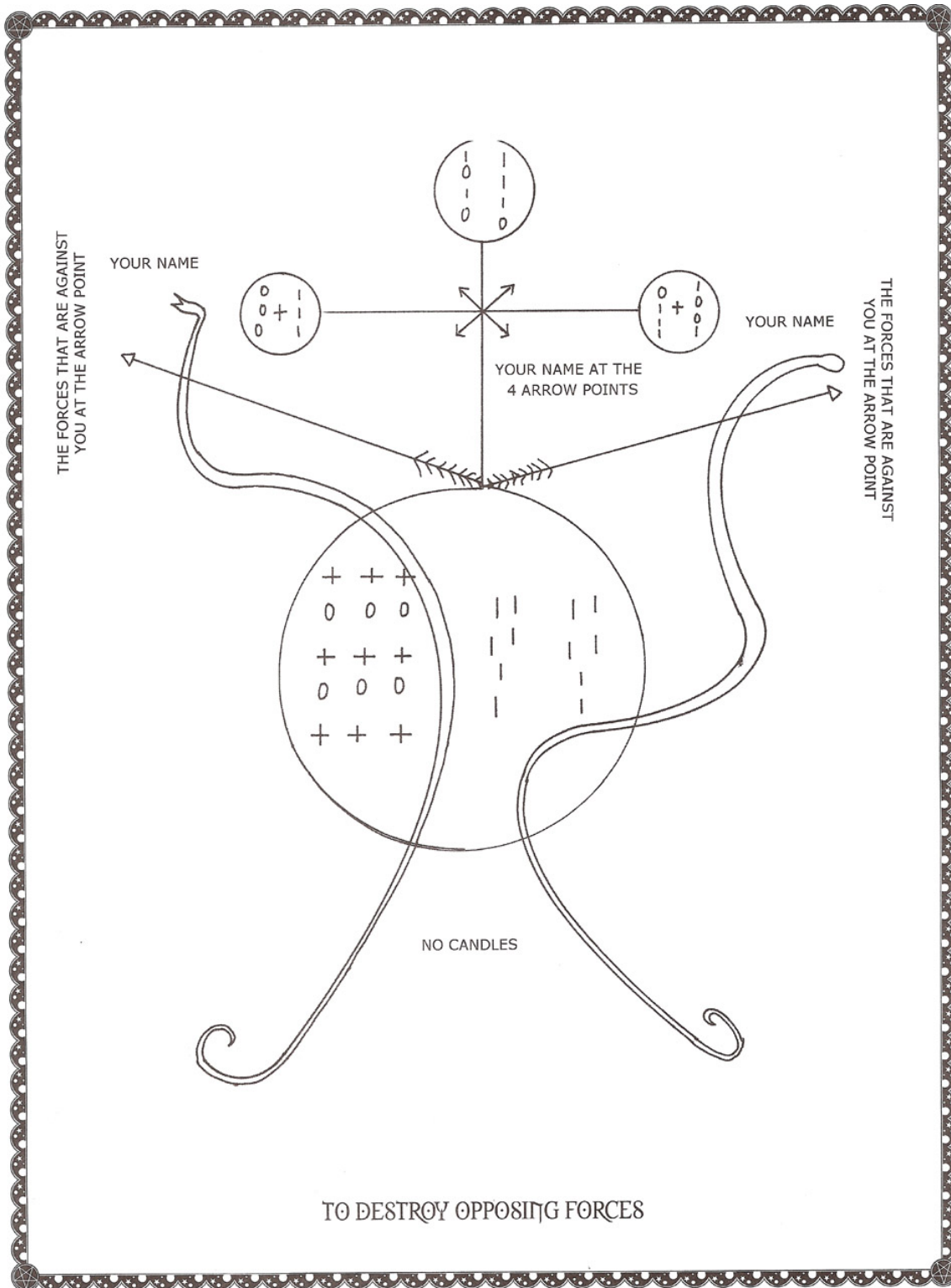

47. LOVE LADDER TO ROMANCE

This signature is for the purposes of seduction. Men or women can use this one.

This is a relatively simple ritual. The signature is to be drawn on wood. It can be drawn in chalk or crayon. Once the drawing is completed, you must write your wishes (what you want out of this seduction [be as specific as you want--the more details you provide, the more control of the situation you will be granted]) in the blank side of the large, central circle.

Then, you must write your name, and the name of the person desired above the uppermost circle. After this, a yellow candle should be placed over your names and burned.

YELLOW CANDLE AND NAME OF WHO YOU WANT

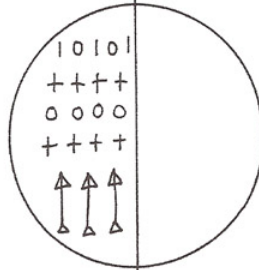
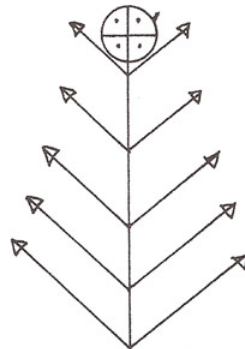

WRITE IN EMPTY CIRCLE WHO
AND WHAT YOU WANT

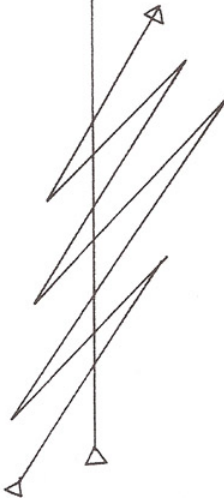

LOVE LADDER TO ROMANCE

48. SUCCESS IN BUSINESS

This signature is for turning an inch into a mile. Whenever things are going your way and you want them to not only continue along the same path, but to race ahead and get better and better, this is the one to use.

To be drawn on wood with white chalk only. Once the drawing has been completed, you must write your name at the tips of both ends of the central, vertical candle. After that, a white candle must be placed over the writing at the top of the ritual. Then, a green candle must be placed over the writing at the bottom of the ritual. As always, check the diagram for positions.

Once placed, the candles must be lit with the same flame.

YOUR NAME WHITE CANDLE

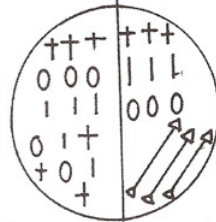
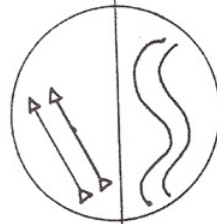
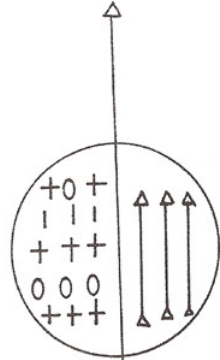

YOUR NAME GREEN CANDLE

SUCCESS IN BUSINESS

49. ENJOY LIFE, EASE OF EMOTIONAL PAIN, AND GOOD HEALTH

This signature works on a number of different things at the same time. Its primary function is as the "maker of dreams." As a granter of wishes, this ritual searches your soul for those things you truly desire and works to bring them to you. At the same time, it also purges your being, searching out and banishing negative vibrations, evil thoughts and ideas, as well as addictions.

Note, the user has little control over this one. Once it is unleashed, it proceeds on its own, bringing about those changes its creator needs, rather than something the creator wishes for in their active, or conscious, mind.

This one is to be drawn on wood with chalk. Once the drawing is complete, write your desires above the two sets of three arrows at the bottom of the ritual, and again over the set of three arrows in the center of the ritual (see diagram).

Note: you should write all of your wishes above each of these three sets of arrows. Remember, the signature may or may not grant the wishes you write down. In this one signature, the gods are free to follow their own plans for you. However, if the signature is created properly, there should be no adverse affect. This ritual works to your benefit, it just might not do what you ask.

After the wishes are written, your name must be written at the tips of the two long, central, vertical arrows. Write your name only one time, extended across the tips of the two arrows. Then, three white candles are to be placed at the tips of the three short vertical arrows to the left. After this, three white candles are to be placed at the tips of the three short vertical arrows to the right. (See diagram) Once all six candles are in place, light the candles on the left with a single flame. Then, light all the candles on the right with a single flame.

Note: A glass of rum must sit next to the signature while the candles burn. When the candles have extinguished themselves, clean the wood with the rum. Throw it away. Do NOT drink it.

50. SUPER PROTECTION

This signature is for personal protection. Quite simply, it casts out evil, evil thoughts, evil intentions, evil spirits, and so on.

This signature is for use in the home or on-site at a business. In the home, it protects all within while they are at home. In a business, it protects the interests of its creator at the site where it is employed. If one owns a chain of businesses, a separate ritual will need to be put in place for each branch being protected.

There are no candles, rum, et cetera, needed for this ritual. This is a permanent fixture. It must be done on wood in white chalk.

Note: this an absolute requirement. Do NOT play around with this ritual. It is the most dangerous one of all. The gods invoked here do not mix well. They do not like each other and when they are forced to work together, they are always willing to look for a way out. The rules to this one are so simple that anyone who does not follow them is insulting the gods greatly.

"This dog expects us to work together and then they are arrogant enough to not follow the rules. Let us bring them great suffering and hardship."

Do not toy with the gods. They will win every time.

When you have finished this signature, it must then be positioned so that it points out of the front door of the structure to be protected. Hide it under a welcome mat or rug if you have to, but keep it at the front doorway, pointed outside, at all times.

Also: Be sure to check this every one so often to make certain that people walking over it have not smeared it greatly. A little smearing will not offend the gods. They understand that things happen. But, taking them for granted, just invoking their power and then forgetting about them is an insult. And, please remember, this is one set of gods you DON'T want to insult.

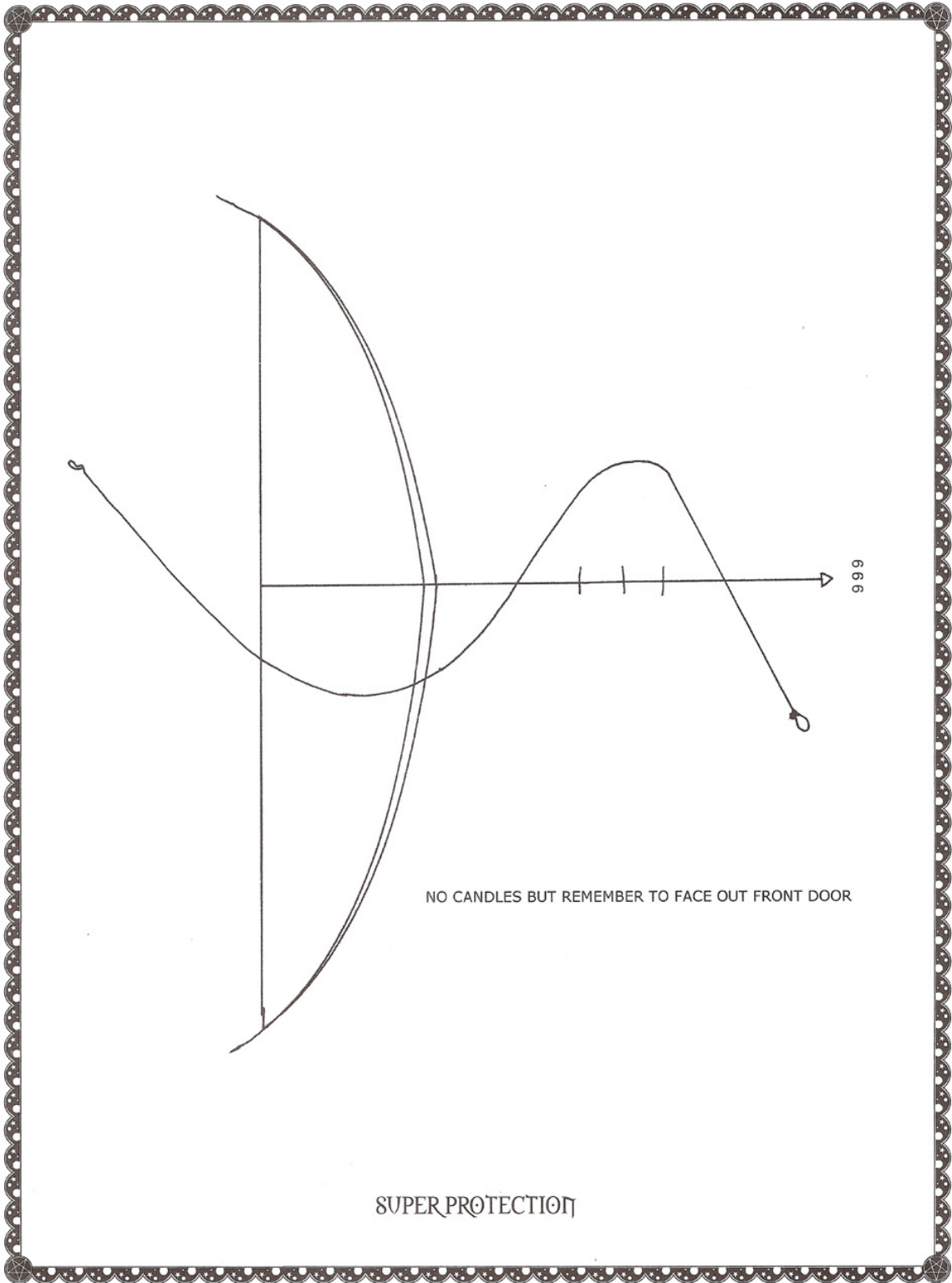



GARY BRODSKY

HOW TO USE THE POWERS OF DARKNESS

A BOOK OF SHADOWS

Centuries ago man understood and controlled forces of unbelievable power.

Imagine being able to control those around you. Imagine having sexual powers beyond your wildest imaginings. Imagine fearing no one. Imagine having the ability to create your own infinite source of wealth. Imagine wielding the power to bend the laws of nature. No matter what you can imagine, it was once reality.

Today little is known about the uses of such dark enchantments. In fact, most of what survives, such as Astrology, Crystals, and Tarot Cards is so watered-down as to be practically meaningless. The true origins of most New Age rituals are unknown to most modern-day practitioners, lost over the centuries as such wisdom became more and more shrouded in secrecy. Obviously, those with the knowledge and power weren't too eager to share it with others.

Now for the first time in centuries, the secrets of the ancient shamans are revealed and collected by Gary Brodsky in *How to Use the Powers of Darkness*. This isn't a dull history book — *How to Use the Powers of Darkness* is a simple step-by-step, how-to manual of the Dark Arts. All the long-lost diagrams, secret spells, and ancient incantations are laid out in easy-to-follow text and illustrations. Even if you never before attempted to cast a spell. *How to Use the Powers of Darkness* will help you harness the Dark Forces as easily as lighting a candle.

\$21.00

