

D I C T I O N A R Y O F

A R C H I T E C T U R A L

A N D B U I L D I N G

T E C H N O L O G Y

T H I R D E D I T I O N

HENRY J. COWAN & PETER R. SMITH

**Also available as a printed book
see title verso for ISBN details**

DICTIONARY OF ARCHITECTURAL AND
BUILDING TECHNOLOGY

To Renate and Heather

Dictionary of Architectural and Building Technology

Third edition

Henry J. Cowan

and

Peter R. Smith

With contributions by

José Carlos Damski

Gerard O'Dwyer

Fergus R. Fricke

Hilaire Graham

Graham E. Holland

Warren G. Julian

Craig Pearce

Michael A. Rosenman

David Rowe

E & FN SPON

An Imprint of Routledge

London and New York

First published 1998
by E & FN Spon, an imprint of Routledge
11 New Fetter Lane, London EC4P 4EE

This edition published in the Taylor & Francis e-Library, 2005.

“To purchase your own copy of this or any of Taylor & Francis or Routledge’s
collection of thousands of eBooks please go to www.eBookstore.tandf.co.uk.”

Simultaneously published in the USA and
Canada
by Routledge
29 West 35th Street, New York, NY 10001

© 1998 Henry J. Cowan and
Peter R. Smith

All rights reserved. No part of this book
may be reprinted or reproduced or utilized
in any form or by any electronic, mechani-
cal, or other means, now known or here
after invented, including photocopying and
recording, or in any information storage or
retrieval system, without permission in
writing from the publishers.

*British Library Cataloguing in
Publication Data*

A catalogue record for this book is
available from the British library

ISBN 0-203-47713-8 Master e-book ISBN

ISBN 0-203-78537-1 (Adobe eReader Format)
ISBN 0 419 22280 4 (Print Edition)

Contents

Contributors	vi
Preface	viii
Abbreviations	x
Note on typography	xiii
Dictionary	1

Contributors

All the contributors are associated with the Department of Architectural and Design Science of the University of Sydney.

Henry J.Cowan, the sole author of the first edition of this dictionary, is Professor Emeritus of Architectural Science in the University of Sydney. He has a PhD and a Doctorate of Engineering by examination from the University of Sheffield, and an Honorary Doctorate of Architecture from the University of Sydney. The Institution of Engineers, Australia, awarded him the Chapman Medal and the Monash Medal, and the Institution of Structural Engineers, London, a Special Service Award. He is a Past President of the Building Science Forum of Australia, an Honorary Fellow of the Royal Australian Institute of Architects, a Corresponding Member of the Accademia Pontaniana, and an Officer of the Order of Australia. He is the author of 23 other books and numerous articles.

Peter R.Smith, co-author of the second edition, has BArch, MArch and PhD degrees from the University of Sydney, and is a Fellow of the Royal Australian Institute of Architects. Following some years in architectural practice, he joined the Faculty of Architecture, where he has served as Department Head and Associate Dean, as well as teaching a wide range of technical subjects. He has served on professional, standards and industry committees dealing with concrete, timber, energy conservation, solar energy and general building industry matters. He has contributed as co-author or chapter author to ten books on building science subjects.

José Carlos Damski has more than 20 years' experience in computer science. Following an MSc in computer science and electrical engineering in Brazil, he obtained his PhD from the University of Sydney. He is currently a postdoctoral fellow, with research interests in computational models of design using AI techniques, in areas such as creativity, visual reasoning and design presentation.

Fergus Fricke, BE (Melbourne) and PhD (Monash), teaches acoustics to architecture, engineering and music students, and established the post-graduate audio programme. He held positions in Southampton, Sheffield, and Purdue

Universities, and is currently Associate Professor and Pro-Dean. He was a contributor to the second edition.

Hilaire Graham, BArch (Sydney) and MArch (London), has worked as an architect on major urban and building projects, and as an FM consultant. She currently lectures on facility management, and is the 1997 NSW Chairman of the Facility Management Association.

Graham E.Holland, BArch and PhD (Sydney), is a Senior Lecturer in the Department of Architecture. His special interest is in building construction, and he is the author of a book on owner building and of a number of articles, and a book on polychromatic brickwork on the World Wide Web. He was a contributor to the second edition.

Warren Julian, BSc, BE, MSc(Arch) and PhD (Sydney), originally an electrical engineer, is Associate Professor of Architectural and Design Science. He is the author of about 200 books and papers on lighting and related subjects, Life Fellow of IES(ANZ), Editor of *Lighting*, and Vice-President of the Commission Internationale de l'Éclairage (CIE). He was a contributor to the second edition.

Gerard A.O'Dwyer has BDesSc and BArch degrees from the University of Queensland, and an MDesSc from the University of Sydney. He is an Associate of the Royal Australian Institute of Architects, and worked for seven years as an architect before joining the Sydney University staff.

Craig Pearce, DipEE (Caulfield) and MDesSc (Sydney), after 30 years in the building industry, coordinated and taught several courses in the building services postgraduate programme. He is now acting in a senior capacity with Ove Arup and Partners.

Michael A.Rosenman, BArch, MBdgSc and PhD (Sydney), is an architect of 31 years' experience, concerned with design theory and method related to computer-aided design, in the fields of optimisation, knowledge-based systems, expert systems, and evolutionary design. He is a Senior Research Fellow, and the co-author of a book and some 80 book chapters, papers and reports.

David Rowe, ASTC (mechanical engineering), FIEAust, CPEng, has enjoyed a career which included some 30 years' involvement with design and construction of building services for public buildings in NSW. He joined the staff in 1991 to establish the building services post-graduate programme.

Preface

The first edition of this dictionary was published in 1973 and reprinted in 1976. The second edition, published in 1986, had about 1500 additional entries. This third edition has a further 2000 new entries, and many of those taken over from the previous editions have been updated.

National differences in terminology and spelling, and in the units of measurement, present some problems. This volume is published in England, and all the contributors are Australian. We have used the current British SI units, with the old British/American units in brackets, except for entries in fields such as illumination and acoustics, where SI units are also in general use in the USA. Following British practice, pressures are given in Pa and stresses in N/m²; but Australian and American SI-oriented readers need merely substitute Pa for N/m² for stresses. The spelling is in accordance with the Oxford Dictionary; there are additional entries with cross-references where American terminology or spelling differ notably from the British and Australian.

Dictionaries are generally consulted because the reader is unfamiliar with a particular word; people who know the meaning of a term will only rarely read the relevant entry. We have endeavoured to provide for the likely interest of readers by allowing the subject matter, as in the previous editions, to range somewhat beyond the field of building technology. A number of computer terms are included, mainly for the benefit of architects who may not spend as much time on computing as engineers do. For the same reason we have given data on the chemical elements in building materials, and quoted some basic laws of physics relevant to environmental design. For the benefit of engineers new to practical building, we have explained elementary terms of building construction.

A substantial number of obsolete terms of measurement are included, such as apostilb and Petersburg standard, which were still in use in the mid-twentieth century. These are rarely explained in books published at the time they were current. For the same reason some obsolete designations of materials are given. A few people are still familiar with the composition of aqua regia, but not many would know today what was meant by oil of vitriol; however, these terms were used without explanation as recently as the beginning of this century.

We have included the terminology of traditional masonry construction and carpentry, which has acquired a new importance because of the current interest in

heritage buildings; geometric terms for complex roof structures that are no longer employed for economic reasons; and terms used in analytical methods of engineering design that became obsolete with the advent of computers, but are still in books on library reference shelves. We have also explained a few terms of Ancient Roman building construction that are untranslatable, such as *opus reticulatum*.

On the other hand we have endeavoured to include all the new terms that have come into use since the publication of the second edition, by assembling a team of specialists in the various branches of building science and technology, and we have reviewed all the second-edition entries in the light of current knowledge. The third edition now includes terms used in the new field of facility management, and additional terms used in the increasingly important fields of building services engineering and solar energy.

Many of the entries have cross-references to other entries, indicated by the use of SMALL CAPITALS. These give further information, particularly on technical terms used in the entry, or on materials or equipment of a similar type.

The dictionary is fairly comprehensive on metals, stone, concrete, ceramics, and plastics, but names only a few widely used timbers, such as Douglas fir. The range of timbers used worldwide is too great for a complete listing in a general dictionary of building technology, and some names, such as oak, maple, and mahogany, denote different species in different parts of the world. May we refer readers to the glossaries that local timber industry organisations usually supply with their compliments.

We have included a substantial number of abbreviations, such as ASHRAE, DAR, PTFE, and HMSO. These are quite clear to people familiar, respectively, with air conditioning, timber, plastics, and British publications, but they can puzzle other readers. Generally we considered that it was sufficient to write out the words represented by the initials, without further explanation.

Finally we hope that readers who find mistakes, omissions or missing cross-references, which undoubtedly remain, will be so kind as to let us know about them, so that they can be corrected in a future edition or reprint.

H.J.C & P.R.S.
Sydney, September 1997

Abbreviations

Abbreviations explained in the entry in which they occur are not included in this list. Additional explanations of abbreviations are given in the following Dictionary entries.

Al	aluminium
Ba	barium
Btu	British thermal unit
C	carbon, Celsius
Ca	calcium
cal	calorie
cd	candela
CIE	Commission Internationale de l'Éclairage
Cl	chlorine
cm	centimetre
cos	cosine
cosh	hyperbolic cosine
Cu	copper
dB	decibel
dB(A)	decibel (A-scale)
e	base of the natural logarithm (=2.718...)
e.g.	for example
etc.	...and so on
ft	foot
ft ²	square foot
ft ³	cubic foot
F	Fahrenheit, fluorine
Fe	iron
h	hour
H	hydrogen

Hz	hertz (=cycles per second)
i.e.	that is
in.	inch
in ²	square inch
J	joule
K	kelvin, degree kelvin, potassium
kg	kilogram
kJ	kilojoule
kN	kilonewton
kVA	kilovolt-ampere
kW	kilowatt
kWh	kilowatt-hour
l, L	litre
lb	pound
lm	lumen
log	logarithm
lx	lux
m	metre, prefix milli
m ²	square metre
m ³	cubic metre
min	minute
mm	millimetre
mm ²	square millimetre
µm	micrometre (=0.000 001 m)
Mg	magnesium
MJ	megajoule (=1 000 000 J)
N	newton, nitrogen
Na	sodium
nm	nanometre (=0.000 000 001 m)
O	oxygen
π	circular constant (=3.1416...)
Pa	pascal
Pb	lead
psi	pounds per square inch
psf	pounds per square foot
S	sulphur
s,	sec second

Si	silicon
SI	SI metric system (Système International, the international metric system)
sin	sine
tan	tangent
V	volt
W	watt
WC	water closet
Zn	zinc
°	degree

Note on typography

Cross-references to other entries are printed in SMALL CAPITALS. *Italics* are used for emphasis, not as a cross-reference.

A

A abbreviation for AMPERE.

Abney level Same as CLINOMETER.

Abrams' law Experimental rule enunciated by D.A.Abrams in 1919: 'With given concrete materials and conditions of tests, the quantity of mixing water determines the strength of concrete, as long as the mix is of workable plasticity.' (see Figure).

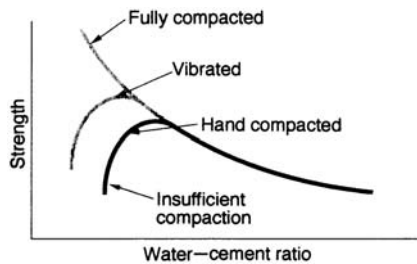

Abrams' law

abrasion The wearing away of the surface of a material by the cutting action of solids. There are numerous abrasion resistance tests. Comparing similar materials by the same test gives satisfactory results; however, the correlation between different tests is difficult, and the method of testing must always be specified. Abrasion tests may be rolling or sliding in nature, with or without abrasive. Usually the test is run for a definite number of strokes with a definite pressure, and the loss of weight is measured.

abrasion resistance The capacity of a surface to resist deliberate ABRASION or ordinary wear.

abscissa The x -axis, or horizontal axis, of a CARTESIAN COORDINATE system.

absolute humidity The mass of water vapour per unit volume of air.

absolute temperature Temperature measured from ABSOLUTE ZERO. When measured in CELSIUS (centigrade), it is called the *Kelvin* scale (K). Measured in FAHRENHEIT, it is called the *Rankine* scale, but this is rarely used.

absolute value The magnitude of a quantity irrespective of whether its sign is positive or negative.

absolute volume The actual volume of the particles of sand, concrete aggregate, etc. It is determined by immersing the aggregate in water, and measuring the volume displaced.

absolute zero The lowest temperature that can be reached in theory, when the molecules of a perfect gas would possess no kinetic energy, and its volume would become zero. This occurs at -273.16°C (-459.67°F). The *absolute temperature* scale is measured from absolute zero. See [KELVIN](#).

absorber, porous See [POROUS ABSORBER](#).

absorber, resonant See [RESONANT ABSORBER](#).

absorber, suspended See [SUSPENDED ABSORBER](#).

absorptance In lighting, the ratio of the LUMINOUS FLUX absorbed by a body to the flux that it received.

absorption (a) The process whereby a liquid is drawn into the permeable pores of a porous solid. (b) Transformation of radiant energy to a different form of energy by the intervention of matter, as opposed to *transmission*, which is the passage of radiation through matter without change of its frequency. (c) Absorption of sound. See [SOUND ABSORPTION](#).

absorption coefficient See [SOUND ABSORPTION COEFFICIENT](#).

absorption cycle A refrigeration cycle. It utilises two phenomena: (a) the absorption solution (absorbent plus refrigerant) can absorb refrigerant vapour; and (b) the refrigerant boils (flash cools itself) when subjected to a lower pressure. These two phenomena are used to obtain refrigeration. In the *lithium bromide* absorption machine, the bromide is used as an absorbent, and the water as a refrigerant. See also [VAPOUR COMPRESSION CYCLE](#).

absorption factor Same as [ABSORPTANCE](#).

absorption rate The amount of water absorbed by a brick in one minute. Also called *suction rate*.

absorptivity The ability of a surface to absorb solar or other forms of radiated energy.

ABS plastic Acrylonitrile-butadienestyrene, a thermoplastic material of good chemical resistance.

abutment A massive masonry or concrete structure that resists a THRUST.

AC Abbreviation for ALTERNATING CURRENT. Also *a.c.*

accelerated weathering Determination of the weather-resisting properties of materials (such as paints and plastics) by cycles imitating natural weathering conditions as closely as possible. Machines designed for this purpose are called WEATHEROMETERS.

acceleration The rate of change of velocity. The *acceleration due to the earth's gravity* has a mean value of 9.807m/s^2 (32.2ft/s^2).

accelerator A substance that speeds up a chemical reaction, as opposed to a RETARDER. (a) In concrete, an additive that increases the rate of hydration of the cement, and thus shortens the time of setting, or increases the rate of

hardening or of strength development. (b) In synthetic resins or glues, a CATALYST that increases the hardening rate. The accelerator is mixed with the resin immediately before use.

accelerometer, accelerograph An instrument for measuring, recording the acceleration of the surface to which it is attached. The recorded time history of acceleration is an *accelerogram*.

accent lighting Lighting used to emphasise a particular part of the visual field. See also [DIRECTIONAL LIGHTING](#).

acceptable indoor air quality Indoor air that contains no contaminants in concentrations known to be harmful to human occupants and is not offensive to a majority of people on initial entry to a space.

access In computing, the process of obtaining data from storage or an instruction from memory.

access control system System for control and monitoring of access to and within a building.

access floor See [RAISED FLOOR](#).

access for the disabled (handicapped) See [BARRIER-FREE DESIGN](#).

accidental error An error due to an accidental cause, which may be either positive or negative; it is therefore likely to be *self-compensating* if sufficient data are taken, as opposed to a SYSTEMATIC ERROR.

acclimatisation The process of adaptation by persons accustomed to a different climate, whereby the strain resulting from exposure to environmental stress is diminished. See also [COMFORT ZONE](#).

accommodation (visual) The process of focusing the eyes on objects at different distances.

accordion door A door consisting of more than two leaves, or of narrow vertical panels hung from an overhead track. The panels interlock or butt against each other to form a flat surface when the door is closed, but fold back like the bellows of an accordion when the door is opened.

ACD Automatic closing device.

acetone A quickly evaporating solvent (CH_3COCH_3) used in paint removers and thinners, and also for lacquers.

acetylene A highly flammable gas (C_2H_2), which is colourless and highly poisonous. It can be generated by the action of water on calcium carbide; however, it is more commonly used in bottled form. It is occasionally employed for heating and lighting. Combined with bottled oxygen (*oxyacetylene*), it is used for cutting and FUSION WELDING of Steel.

achromatic lens A lens designed to minimise CHROMATIC ABERRATION. See [FLINT GLASS](#).

ACI American Concrete Institute, Detroit.

acid A chemical compound containing hydrogen which can be replaced by metallic elements, and which produces hydrogen ions in solution. It neutralises BASES to form SALTS, has a PH VALUE of less than 7, and turns blue LITMUS red.

acid etched A finish to in situ and precast concrete made by washing with dilute acid to remove some of the surface mortar, giving a lightly textured finish. Hydrochloric acid has been used, but this contributed to corrosion and has been replaced by phosphoric acid.

acid rain Rain that is significantly more acidic than normal rain, especially with a pH VALUE below 5.0.

acid rock An igneous rock with a pre-ponderant silica content, e.g. *granite*.

acid soil A soil that produces an acidic reaction; a soil that has a PH VALUE below 6.5.

acid steel A steel made in a furnace lined with an acid refractory, such as silica, and under an acid slag.

ACID system Access Control and Intruder Detection, a computer-based building security system.

ACM Association for Computing Machinery.

acoustical cloud A reflecting surface suspended from the ceiling of an auditorium, which provides early reflections or prevents ECHO while still maintaining the reverberant qualities of the auditorium.

acoustic board A low density FIBREBOARD with good SOUND ABSORPTION. It is often perforated to provide improved absorption.

acoustic definition In acoustics, the degree to which individual notes (or parts of a note) in a musical performance stand apart from the sounds that have already been played. It depends on the ratio of the intensity of the direct and reflected sound as well as on the delay in the reflected sound. Also called *clarity*.

acoustic impedance The application of a periodic force or pressure at some point in a medium or dynamic system results in a periodic velocity of fixed phase. The acoustic impedance of a medium or system is the complex ratio of the SOUND PRESSURE to the particle velocity (due to the sound). The greater the change in acoustic impedance, from one part of a medium or system to another, the smaller the amount of acoustic energy transmitted. See also [IMPEDANCE TUBE](#).

acoustic insulation See [SOUND INSULATION](#) and [DISCONTINUOUS CONSTRUCTION](#).

acoustic model analysis Analysis of the behaviour of sound, especially in auditoria, by means of physical models. As the scale is reduced the WAVELENGTH of the sound has to be decreased (frequency increased) in accordance with DIMENSIONAL ANALYSIS.

acoustic perfume See [MASKING NOISE/ SOUND](#).

acoustic plaster Plaster with high sound absorption. It normally contains pores, which may be provided by gas bubbles resulting from aluminium powder or detergent (see [CELLULAR CONCRETE](#)), or by the use of VERMICULITE aggregate.

acoustic quality The acoustic quality of a room (for music especially) depends on many factors, including the size, shape and surface finishes. In order to describe and predict the acoustic quality of spaces many terms and criteria have been developed, but the combinations of these to attain acoustic quality is still

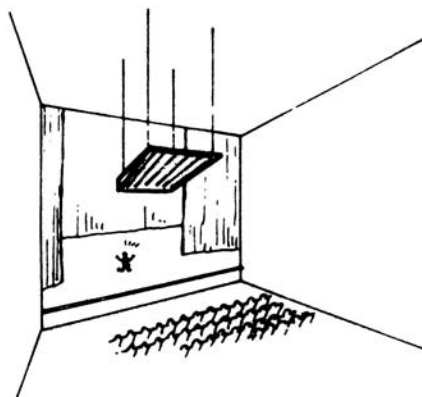

acoustic reflector

poorly understood. See also [BACKGROUND NOISE](#), [DEFINITION](#), [DYNAMIC RANGE](#), [ECHO](#), [ENSEMBLE](#), [LIVENESS](#), [LOUDNESS LEVEL](#), [REVERBERATION TIME](#), [TIMBRE](#) and [WARMTH](#).

acoustic ray tracing See [RAY TRACING](#).

acoustic reflector A panel installed above or alongside the position of a musician or speaker, in order to reflect additional sound towards an audience (see Figure).

acoustics The science of sound. See also under [NOISE](#) and [SOUND](#).

acoustic strain gauge A STRAIN GAUGE for measuring surface strains by vibrating a stretched wire, which is matched against a note from a similar wire vibrating in a reference gauge. The tension in the wire changes with the strain, and the note changes accordingly.

acoustic tile Rectangular sound-absorbing tile normally used as a ceiling, where it is either glued to a *substratum* or used in a grid as a SUSPENDED CEILING. The tile is usually lightweight, sometimes perforated, and it may have a fibreboard, fibreglass, cellulose or similar base.

acre A British/US unit for area, equal to 10 square CHAINS and to 0.404685 HECTARES.

acrylic resins Thermoplastic materials produced by the polymerisation of the monomeric derivatives of acrylic acid to form *polymethyl methacrylate*. They are obtainable in transparent and also in opaque form, and they have good resistance to outdoor weathering; however, they are attacked by many organic solvents. Being thermoplastic, they are not fire-resistant. They are known by the trade names *Plexiglas*, *Perspex* and *Lucite*. See also [POLYCARBONATE](#).

ACSA Association of Collegiate Schools of Architecture, Washington, DC, which has members in the USA and Canada.

activated carbon filter A filter employed in ventilating and air conditioning systems for the removal of odours.

activation energy Energy required to initiate a chemical reaction.

active earth pressure See [EARTH PRESSURE](#).

active noise control The reduction of a noise by the production of another (using a microphone, signal processor, amplifier and loudspeakers) that is out of phase with the first, at a position where the noise is to be reduced. Active noise control systems are now commonly used in ducted air conditioning systems where low-frequency noise needs to be controlled.

active solar energy A method for the utilisation of solar energy that employs solar collectors or requires the use of electricity, as opposed to *passive solar energy*, which utilises only the fabric of the building.

activity The term used in NETWORK programming to denote a basic component of the work required for a building project. *Critical activities* are those that lie on the critical path. *Non-critical activities* are those that do not lie on the critical path. *Near-critical activities* are those that come to lie on the critical path if circumstances alter, e.g. if CRASHED TIME is used.

activity settings Varied workplaces that provide for particular functional individual and group requirements.

acuity See [VISUAL ACUITY](#).

acute angle An angle of less than 90°.

AD Abbreviation for: (a) air dried; (b) Anno Domini; (c) area drain; (d) as drawn.

adaptation (a) The process taking place as the eye becomes accustomed to the luminance or the colour of the field in view, or to its darkness. (b) The final state of the process.

additions to a contract Further work added: a variation to a contract.

additive See [CONCRETE ADMIXTURE](#).

address (a) In computing, the location of an instruction or data in computer memory. (b) In telecommunications, the location of some hardware component where data can be sent from or to, e.g. EMAIL address.

adhesion The property of matter by which close contact is established between two or more surfaces when they are brought intimately together. Force is required to separate the interfacial surfaces.

adhesive Glue for joining two pieces of material. See also [ADHESION](#).

adiabatic A change in the condition of a body without any exchange of heat with the surroundings. An adiabatic change cannot normally be ISOTHERMAL.

adiabatic process A process in which no heat flows in or out of a system.

adjacency The locational requirement between planning units, which are ranked according to strength of adjacency as important, desirable, unimportant, undesirable.

admixture See [CONCRETE ADMIXTURE](#).

adobe Construction with large sunbaked, unburnt bricks. See also [COB WALLING](#) and [PISÉ DE TERRE](#).

adsorption Condensation of a gas on the surface of a solid. For example, SILICA GEL has the ability to collect water vapour by adsorption, and thus keeps dry the cases of instruments sensitive to moisture.

adz American spelling of ADZE.

adze One of the oldest traditional tools for working timber, now rarely used. It has a cutting blade mounted at right angles to a wooden shaft.

AEC Abbreviation for Architecture, Engineering and Construction.

aeolian Wind-blown, e.g. aeolian soil (*loess*).

aeolotropic Having physical properties that vary according to the direction in which they are measured, as opposed to ISOTROPIC. See also [ORTHOTROPIC](#).

aerated concrete A form of CELLULAR CONCRETE.

aerobic Describes a state where free oxygen is present (opposite of *anaerobic*).

aerodynamics That part of the mechanics of fluids that deals with the dynamics of gases, particularly the study of forces acting on bodies in moving air. See also [BOUNDARY LAYER](#), [MACH NUMBER](#) and [WIND TUNNEL](#).

aerosol paints Paints packaged for spray application in a container pressurised by compressed liquefied gas.

affinity analysis Analysis of adjacency requirements of particular functional spaces to produce a hierarchy of relationships used in space planning.

AFNOR Association Française de Normalisation, Paris.

aftershock Shock that follows a primary EARTHQUAKE.

Ag Chemical symbol for *silver* (argentum).

agate A natural aggregate of crystalline and colloidal silica (SiO₂), coloured by metallic oxide. It is sometimes translucent or attractively banded; these varieties are classed as semi-precious stones, and they have been used in sculpture and architecture. It is also extremely hard, and for this reason used for the bearings of scientific instruments.

age hardening The hardening of an ALLOY that results from the formation of tiny particles of a new PHASE within the existing solid solution. Also called *precipitation hardening* or *ageing*.

ageing of concrete The final stage in the chemical reaction between cement and water, during which the concrete continues to gain strength slowly. It continues for many years. See also [SETTING OF CONCRETE](#) and [HARDENING OF CONCRETE](#).

ageing of metals The process of AGE HARDENING.

agglomerate Small particles bonded together into an integrated mass.

aggregate See [CONCRETE AGGREGATE](#).

aging Same as AGEING.

AGL Above ground level.

agricultural drain, agricultural pipe drain An assembly of pipes for draining subsoil. The pipes may be porous or perforated.

AI Abbreviation for ARTIFICIAL INTELLIGENCE.

AIA American Institute of Architects, Washington, DC.

AIEE American Institute of Electrical Engineers, New York.

AIMA Acoustical and Insulating Materials Association.

AIRAH Australian Institute of Refrigeration, Air Conditioning and Heating.

air-bag loading A load applied in a model test or a full-scale test by pumping up a bag, pressing against a firm foundation, with an air compressor. Also called *pneumatic loading*.

air balance The condition achieved in an air distribution system when the maximum quantity of air that can be delivered to each point of use is just sufficient to meet heat load requirements at full load.

airborne sound Sound transmitted from one part of a building to another in which the initial transmission path is within air, e.g. speech, as opposed to STRUCTURE-BORNE SOUND or IMPACT SOUND where there is direct excitation of the structure of the building, e.g. by out of balance forces from machinery in a plantroom, hammer blows or footsteps. Airborne sound transmission through a masonry wall or floor will approximately conform to the MASS LAW.

air brick A brick perforated for ventilation purposes.

air change rate A unit of ventilation, defined as the volume of air passed through the ventilation system, per hour, divided by the volume of the room ventilated. The number of air changes required varies from 60 for laundries to 1 per hour for store rooms. The range for normal occupancies lies between 2 and 6. A more accurate method is to estimate the supply of air on the basis of persons occupying the space.

air compressor A machine that takes in air at atmospheric pressure, and compresses it to a much higher pressure, generally for the purpose of operating *pneumatic tools*.

air conditioning Artificial ventilation with air at a controlled temperature and humidity. Heating air, and moistening it if necessary, is relatively inexpensive. However, air conditioning normally implies cooling and DEHUMIDIFICATION of the air, which require appreciable expenditure of energy. Also written *airconditioning*. See also [EVAPORATIVE COOLING](#) and [NATURAL VENTILATION](#).

airconditioning See [AIR CONDITIONING](#).

air conditioning duct See [DUCT](#) (b) and [DUCT LINING](#).

air curtain A stream of temperature-controlled high-velocity air, projected downwards across an external opening.

air diffuser See [DIFFUSER](#) (d).

air door Same as [AIR CURTAIN](#).

air drying Drying a material, such as timber, in the air instead of seasoning it in a kiln. *Air dry timber* has a moisture content that is approximately in equilibrium with that in the surrounding atmosphere.

air duct See [DUCT](#) (b).

air-entraining agent An additive to cement or an admixture to concrete that causes minute air bubbles to be incorporated in concrete or mortar during mixing. It is claimed that this increases workability and frost resistance. See also [ENTRAPPED AIR](#).

air felting Forming a mat from an air suspension of fibres. It is used for certain types of particle board to prevent the absorption of moisture that necessarily occurs in *wet felting*.

air filter A device inserted in an air stream to trap entrained particulate matter.

air-inflated structure Same as PNEUMATIC STRUCTURE.

air lock A lobby or small room, with self-closing doors, to allow access between two other spaces while restricting the amount of air exchanged between them. Used between habitable spaces and contaminated areas, and also at the entrance to a building to restrict the ingress of outside air.

air outlet See [CEILING DIFFUSER](#), [PUNKAH LOUVRE](#) and [REGISTER](#).

air quality See [FILTER](#) and [VENTILATION](#).

air seasoning Same as AIR DRYING.

air slaking The process of exposing QUICKLIME to the air. It gradually absorbs moisture and breaks down into HYDRATED LIME powder.

air termination In a LIGHTNING PROTECTION SYSTEM, a conductor or rod positioned to intercept a lightning discharge and to create a ZONE OF PROTECTION. The *rod* is sometimes termed a *finial*.

air-to-air heat transmission coefficient Same as THERMAL TRANSMITTANCE.

air washer Component of an AIR CONDITIONING plant that removes suspended dirt by spraying or washing.

AISC American Institute of Steel Construction, New York; Australian Institute of Steel Construction, Sydney.

aisle (a) A wing (Latin *ala*) attached to the nave of a church, usually separated from it by a line of columns. (b) Hence, any division in a church, such as a passage between pews. (c) Hence, a passage between seats in any building, such as a theatre or concert hall.

AITC American Institute of Timber Construction, Washington, DC.

Al Chemical symbol for *aluminium*.

alabaster Pure GYPSUM in densely crystalline form. Because of its softness it is easily carved and polished.

alclad Steel sheet, or any other metal product, which has been coated with aluminium or aluminium alloy as a protection against corrosion.

algebraic mean The average of all values (i.e. their sum, divided by the number of values), considering their positive or negative sign: that is, what is usually meant by *the mean*. See also [ARITHMETIC MEAN](#), [GEOMETRIC MEAN](#), [MEDIAN](#) and [MODE](#).

algorithm Corruption of alKhowarazmi (a ninth century Arab mathematician); the term originally used to denote arithmetic using the Indian-Arabic (i.e. decimal) numerals. It now generally implies a sequence of logical processing rules, set up to solve a problem.

alidade See [PLANE TABLE](#).

alite See [TRICALCIUM SILICATE](#).

alkali (a) A synonym for BASE. (b) More correctly, and in a more limited sense, a generic term for the hydroxides of sodium, potassium, lithium, rubidium and caesium, which are called the *alkali metals*.

alkali-aggregate reaction Chemical reaction between certain aggregates and the sodium and potassium compounds contained in Portland cement. Aggregates liable to this type of reaction may cause deleterious expansion in mortar or concrete.

alkaline soil A soil that produces an alkaline reaction; a soil with a pH VALUE above 7.3.

alkyd paint Paint using ALKYD RESIN as the VEHICLE for the pigment. There are interior, exterior and fire-retardant types.

alkyd resin A THERMOPLASTIC synthetic resin, derived from an alcohol, such as glycerol, and an organic acid, such as phthalic acid.

Allen head A hexagonally shaped recess in the head of a screw, instead of the usual slot. See also [CROSS-HEADED SCREW](#).

allotropy The ability to exist in more than one state: for example, carbon has three allotropic varieties, which are diamond, graphite and amorphous carbon.

allowable stress Same as MAXIMUM PERMISSIBLE STRESS.

alloy A substance with metallic properties, composed of two or more elements, which after mixing in the molten state do not separate into distinct layers on solidifying. Normally alloys are mixtures of metals. Structural steel (which is a mixture of iron and carbon) is a notable exception. Alloys may be composed of chemical compounds, solid solutions, EUTECTICS, EUTECTOIDS, or of aggregations of these with each other and with pure metal.

alloy diagram Same as PHASE DIAGRAM.

alloy steel A steel to which one or more elements, other than carbon, have been added, as opposed to CARBON STEEL (although, strictly speaking, carbon steel is an alloy).

alluvial soil Soil deposited by flowing water (generally during a flood) in recent times (geologically speaking) on land that is not permanently submerged.

alpha brass A copper-zinc alloy that contains more than 64 per cent copper. It has good tensile strength and considerable ductility.

alpha iron Unalloyed iron below 910°C (1670°F). It has a body-centred cubic space lattice, and it is magnetic below the magnetic change point, which in pure iron is 767°C (1414°F). See also [GAMMA IRON](#) and [PHASE DIAGRAM](#).

alphameric character Same as ALPHANUMERIC CHARACTER.

alphanumeric character Any one of the letters of the alphabet (in upper or lower case), the ten numerical digits, punctuation marks and other printable characters. It requires at least seven BITS to express a character in binary notation.

alpha particle A helium nucleus, i.e. a helium atom that has lost two electrons and consequently has a double positive charge. It contains two protons and two neutrons. The *alpha radiation* emitted by radium etc. consists of a stream of alpha particles.

alternating current (AC or a.c.) An electric current that reverses its direction of flow at regular intervals (commonly at 50 or 60 cycles per second (50 or 60Hz)), as opposed to a DIRECT CURRENT.

alternative officing Accommodation strategy seeking to change an existing workplace.

alternator An alternating current generator. It is usually driven by a heat engine or a water turbine. See also [DYNAMO](#).

altitude The angle between a point on the surface of a sphere and its *horizon*. It is the vertical coordinate for locating the point; the horizontal coordinate is the AZIMUTH. See also [DECLINATION](#).

alum A double sulphate of aluminium and a univalent metal, such as potassium. It is used to make GYPSUM plaster harden faster. Alum was the raw material for the first production of metallic aluminium; this is now generally made from BAUXITE.

alumina Aluminium oxide (Al_2O_3). Hydrus alumina is BAUXITE.

aluminium A white metal of atomic weight 26.98. Its chemical symbol is Al, its atomic number is 13, it has a valency of 3, a specific gravity of 2.70, a melting point of 660.1°C , and a coefficient of thermal expansion of 23.5×10^{-6} per $^\circ\text{C}$. Most aluminium is produced from BAUXITE by an electrolytic process, which depends on a cheap source of electric power for its economy. Aluminium metal is silvery-white in colour. It oxidises very readily, but the oxide skin formed provides a protective coating, which inhibits further oxidation. Aluminium is readily alloyed with copper, silicon, nickel, manganese, magnesium and other metals, and a very wide range of alloys are available for casting, forging, stamping, rolling and extruding. Also called *aluminum* (USA).

aluminium bronze A copper-aluminium alloy, containing 3–11% of aluminium.

aluminium foil A thin sheet of aluminium, about 0.15mm thick. It is commonly used for REFLECTIVE INSULATION.

aluminous cement See [HIGH-ALUMINA CEMENT](#).

aluminum American spelling of ALUMINIUM.

AM Abbreviation for AMPLITUDE MODULATION.

amalgam An alloy of mercury and some other metal.

ambient The conditions (temperature, humidity, sound field or lighting) existing in the general surroundings, but excluding any local effects being studied.

ambient lighting The general background lighting, excluding the effects of TASK LIGHTING.

ambient sound The resultant sound, at a point of interest, from all sources near and far.

amenities Activities provided in association with a facility, which provide comfort and convenience.

American bond Same as COMMON BOND.

American Ephemeris Since 1960 published in the same form as the British NAUTICAL ALMANAC.

amino-plastics A generic term for urea FORMALDEHYDE and melamine formaldehyde resin.

ammeter An instrument for measuring electric current, graduated in AMPERES. See also [GALVANOMETER](#).

ammonia A colourless, alkaline, toxic gas of composition NH_3 , with a pungent odour. It has a boiling point of -33°C . It is used as a refrigerant in large VAPOUR COMPRESSION refrigeration plants. Not favoured in air conditioning applications because of its toxicity.

ammonium chloride Generally known as sal ammoniac.

amorphous Not crystalline.

amortisation A method of liquidating a debt by making annual payments to a sinking fund.

amp Abbreviation for AMPERE.

amperage The flow of electric current, measured in AMPERES, in a circuit.

ampere (A) The unit of electrical current, named after the nineteenth-century French physicist A.M.Ampère. One ampere is the constant current that, if maintained in two straight parallel conductors of infinite length, of negligible circular cross-section, and placed at a distance of 1 metre apart in a vacuum, produces between them a force equal to 2×10^7 NEWTON per metre length.

amphitheatre An oval, circular, or semi-circular building with seats rising in ascending rows around an ARENA.

amplifier A device for increasing the power level of a signal.

amplitude A measure of the extreme range of a fluctuating quantity, which is usually taken as the difference between the maximum (or minimum) value and the mean value.

amplitude modulation A method of encoding a signal on a carrier wave (for the purpose of recording or transmitting it) by varying the amplitude of the wave at a constant frequency. See also [FREQUENCY MODULATION](#).

anaerobic Describes a state where free oxygen is absent (opposite of *aerobic*).

anaerobic digestion A bacterial digestion process that removes the offensive odour of many organic wastes.

analogue computer A computer that accepts time-varying inputs. Analogue computers are generally designed to solve a specific problem, and they are therefore less versatile than DIGITAL COMPUTERS.

analogue to digital converter A unit for translating output signals from an analogue device (such as a sound level meter or temperature probe) into digital form for input into a digital computer system.

analogy Similarity or correspondence between different phenomena or concepts, usually through properties other than physical features; as in the analogy between a door and a tap representing the function of controlling flow.

analysis The process of resolving or separating a problem into its component parts and determining the relationships between them. The result of that process. Contrasted to *synthesis*. See also [SYSTEMS ANALYSIS](#).

anatase See [TITANIUM WHITE](#).



anchorage zone

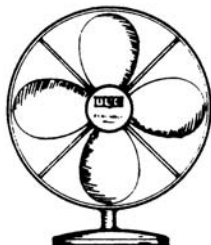

anemometer

anchor (or **rock anchor**) A cable or bar, held in a hole drilled into rock or pre-existing concrete by a fixed anchorage, and with provision for tensioning at the free end. Used to prevent the uplift of foundations, to tie back retaining walls, or to stabilise a rock face. See also [GROUND ANCHOR](#).

anchorage Device, frequently patented, for permanently anchoring the tendons at the ends of a POST-TENSIONED member, or for temporarily anchoring the tendons of PRE-TENSIONED members during hardening of the concrete.

anchorage zone (a) In POST-TENSIONED concrete, the region adjacent to the anchorage of the tendon, which is subjected to secondary stresses resulting from the distribution of the prestressing force (see Figure). Unless suitably reinforced, the concrete may split due to secondary tension. (b) In PRE-TENSIONED concrete, the region in which the transfer bond stresses are developed.

anechoic chamber A room for acoustic testing in which a FREE FIELD exists because all the surfaces are highly absorbent. Also called a *free-field room*. Anechoic chambers are used for measuring the SOUND POWER and DIRECTIVITY of sound sources amongst many other things. See also [REVERBERATION CHAMBER](#).

anemometer Instrument for measuring wind speed. High air velocities can be measured with the *deflecting vane anemometer*, which gives a direct reading, and the *rotating vane anemometer* (see Figure), which counts the rotations. Instruments suitable for lower air speeds are the KATA THERMOMETER (now largely obsolete), the HOT-WIRE ANEMOMETER, and the IONISATION ANEMOMETER.

aneroid barometer See [BAROMETER](#).

angiosperm One of the two main divisions of seed plants; it includes most of the world's flowering plants, and all hardwoods; the other main division is the GYMNOSPERMS.

angle cleat A small bracket formed of ANGLE IRON, which is used to locate or support a member of a structural framework.

angle grinder A hand-held powered grinder, in which the axis of the grinding wheel is at right angles to the machine. Used for cleaning up welds, and general small cutting and grinding tasks.

angle iron A steel section, either hot-rolled or cold-formed, consisting of two legs at an angle (which is almost invariably a right angle). An angle iron may be *equal* (both legs the same width) or *unequal*.

angle of friction The angle between the force due to the weight of a body resting on a surface, and the resultant force when the body begins to slide. The coefficient of friction $\mu = \tan \Phi$ See also [FRICTION](#).

angle of illumination The angle between a perpendicular to the surface that is illuminated and the axis through the illuminant.

angle of incidence The angle that an arriving ray or wave makes with the normal to the surface that is reflecting it. See also [ANGLE OF REFLECTION](#).

angle of internal friction The ANGLE OF FRICTION in granular soils. It is defined by the equation: shearing resistance = normal force on surface of sliding $\times \tan$ For perfectly dry or fully submerged granular soil (clean sand or gravel) it equals the ANGLE OF REPOSE. See also [RANKINE THEORY](#) and [BULKING](#).

angle of reflection The angle that a reflected ray or wave makes with the normal to the surface that is reflecting it. Same as *specular angle*.

angle of repose The steepest angle at which a heap of dry soil will stand.

angle of shearing resistance See [COULOMB'S EQUATION](#).

anglepoise A LUMINAIRE, mounted on a table, floor, wall or equipment, whose position and angle can be changed by pulling or pushing. The new position is usually held by means of links and strings or, rarely, by a GOOSENECK.

angle section See [ANGLE IRON](#).

ångström Obsolescent unit of measurement for very small lengths, equal to 1×10^{-10} metre or 0.1 nanometre; abbreviated as Å.

anhydride An oxide that produces an acid when combined with water.

anhydrite Anhydrous calcium sulphate (CaSO_4). It is found naturally as a mineral, or it may be made from GYPSUM by removing the water of crystallisation, usually by heating above 163°C (325°F). Anhydrite produced from gypsum is more reactive than the naturally occurring mineral.

anhydrous A term applied to minerals that do not contain water of crystallisation.

anhydrous lime Same as QUICKLIME.

animal glue GLUE made from animal waste products.

animation In computer graphics, the display of a series of frames in quick succession so as to achieve a computer-produced animated movie. Can be used

for the study of the behaviour of physical phenomena where time-variance is important, such as airflow, or bending of beams.

anion A negative ion, the opposite of a *cation*, which is positive.

anisotropic Having different physical properties in different directions, as opposed to ISOTROPIC.

annealing (a) Heating glass uniformly to its annealing temperature to remove residual stresses, and then cooling it slowly at a controlled rate. (b) Heating an alloy (such as steel) at a temperature about 50°C above the upper limit of the TRANSFORMATION TEMPERATURE range. By contrast, TEMPERING is carried out below this range. The object is to remove stresses induced by previous treatment and improve ductility. The annealing temperature is held for at least an hour (more for thick pieces), and cooling is slow.

annual cost (of a building) The cost of energy, services and insurance for operation during the year; the necessary maintenance; and the payments for taxes, leases and loan servicing.

annual rings Same as GROWTH RINGS.

annular Ringlike.

annulus A figure bounded by two concentric circles, i.e. a thick ring.

annunciator A dispatcher panel that provides information to lift passengers by means of display and/or sound.

anode The positive electrode of an electrolytic cell or battery. The *cathode* is the negative electrode.

anodising A process for producing a film of aluminium oxide on aluminium or aluminium alloys, to protect the surface from corrosion. The film is slightly porous, and it is usually sealed, e.g. with lanoline dissolved in spirit. Colours can be introduced before sealing. Aniline dyes are liable to fade if used externally. Mineral pigments are used externally.

ANSI American National Standards Institute, New York.

ant, white See **TERMITE**.

ant capping A TERMITE SHIELD made of galvanised iron.

ante-solarium A balcony that faces the sun.

anthropometry The comparative study of the sizes and proportions of the human body with a view to determining its average dimensions.

anticlastic A surface with a negative GAUSSIAN CURVATURE.

anticlockwise The opposite to CLOCKWISE. Also called *counterclockwise*.

anti-corrosive paint Paint that delays corrosion, particularly of steel. It is used as a *primer*, rarely as a finishing coat. Although paints, especially those containing zinc, are effective at reducing corrosion, the preparation of the surface is an essential part of the paint *system*.

anticyclone In meteorology, a high-pressure area with winds rotating CLOCKWISE in the northern hemisphere, and ANTICLOCKWISE in the southern hemisphere.

anti-friction metal A white metal based on ANTIMONY, LEAD or TIN, used to reduce friction.

antilogarithm If b is the LOGARITHM of a , i.e. $\log a=b$, then a is the antilogarithm of b , i.e. $a=\log^{-1}b$.

antimony A bluish-white metal. Its chemical symbol is Sb (Stibium), its atomic number is 51, its valency is 3 or 5, its atomic weight is 121.76, its specific gravity is 6.62, and its melting point is 630.5°C. Antimony and its alloys expand on solidification, thus reproducing the fine details of the mould.

antimony oxide A white pigment, which has flame-retardant properties. It has better OPACITY than whiting, but not as much as TITANIUM WHITE.

antinode A point, line or surface of an interference pattern at which the amplitude of the variable of interest (e.g. pressure or velocity) is a maximum.

antisiphon trap An air TRAP that contains an additional volume of water in an enlarged pipe, to increase the resealing quality of the trap.

anti-vibration mounts Flexible elements inserted between the base of a machine and its supporting structure to prevent transmission of vibration.

apartment A dwelling, usually one of many in a building. See also [CONDOMINIUM](#), [DUPLEX](#), [FLAT](#), [HOME UNIT](#), [MAISONETTE](#) and [OYO](#).

apex The highest point of any structure.

aphelion Point in the orbit of a planet or comet that is farthest from the sun; the opposite of *perihelion*.

apogee Point in the orbit of the moon, planet or satellite farthest from the earth; the opposite of *perigee*.

apostilb An obsolete unit of LUMINANCE. For matt surfaces, 1 apostilb=1 blondel = $1/\pi$ candela per square metre=0.318 cd/m².

apparent brightness The subjective response to the relationship between all the LUMINANCES in the visual field. Also called *luminosity* or SUBJECTIVE BRIGHTNESS.

apparent power In alternating current systems, the product of voltage and current (volt-amps or kVA). See also [POWER](#).

apparent solar time The time according to the position of the sun in the sky. It differs from *mean solar time* shown by a watch, because the sun's motion is not entirely uniform.

apparent volume (of a porous sub-Stance) The BULK VOLUME minus the open pores, or the true volume plus the closed pores. The *apparent density* is the mass divided by the apparent volume.

apron (a) A relatively wide vertical flashing, or a flashing that surrounds or partly surrounds a projecting construction. (b) A concrete slab on grade, in front of or around a building. (c) A guard installed on the underside of a lift car to prevent the trapping of objects or limbs of people while a car that uses advance opening LIFT DOORS is levelling at a landing.

AQL Acceptable quality level, the average quality at which the producer should work to satisfy the customer.

aqua fortis Concentrated nitric acid.

aqua regia A mixture of nitric acid and hydrochloric acid in the proportion of 1:3, so called by alchemists because it dissolves gold.

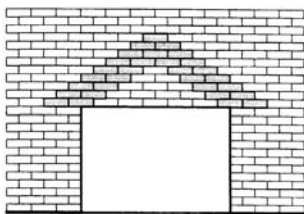

arching (c)

aqueduct An artificial channel for the conveyance of water; usually an ancient structure carried on masonry arches.

aquifer A layer of rock or soil that conducts water.

arch A structure designed to carry a load across a gap, mainly by compression. See [CATENARY ARCH](#), [CIRCULAR ARCH](#), [CORBELLED ARCH](#), [CROWN](#), [FLAT ARCH](#), [JACK ARCH](#), [PARABOLIC ARCH](#) and [SPRINGINGS](#).

arch bar A support for a FLAT ARCH, or for brickwork with normal bond (not an arch) carried above an opening.

arch brick, stone A brick, stone VOUSOIR.

Archimedes' principle See [PRINCIPLE OF ARCHIMEDES](#) and [LEVER PRINCIPLE](#).

arching (a) A system of arches. (b) The arched part of a structure. (c) The transmission of load in a horizontal structure of masonry or brickwork through arch action, instead of bending, due to the horizontal restraint exercised by the supports, as shown in the Figure. (d) Transfer of stress in foundation soil from a highly to a less highly stressed part due to arch action.

architrave (a) The lowest of the three parts of the entablature of the classical orders. It is beneath the frieze and rests on the capital of the column. (b) Hence the moulded frame surrounding a door or window. (c) Hence the trim that covers the joint between an opening in a wall and the wall finish, particularly for a wooden door or window in a plastered wall.

archival storage In computing, a means of storing information as files on a backup medium such as magnetic disk or tape, CD-ROM, or magneto-optical medium.

archiving The process of creating and maintaining files on an ARCHIVAL STORAGE medium.

arc light A high-intensity electric-discharge lamp employing an arc discharge between two electrodes.

arc of a circle A portion of its circumference. The length of an arc that subtends an angle θ degrees at the centre, is $\theta\pi D/360$, where D is the diameter.

arcuated Spanning with arches, as opposed to TRABEATED.

arc welding FUSION WELDING in which the heat is derived from an electric arc formed either between two electrodes, or between the parent metal and one

electrode. Air must be excluded from the arc, either by the use of a flux coating on the electrode, or by a shielding gas or powdered flux. See also [ACETYLENE](#), [ARGON-ARC](#), [HELIARC](#), [SHIELDED-ARC](#) and [SUBMERGED-ARC WELDING](#).

are A metric unit of area, equal to 100 m². It is customary to use the HECTARE, which equals 10000m².

area See [CROSS-SECTIONAL AREA](#) and [DUBOIS AREA](#).

area per person The net available area divided by the number of FULL-TIME EQUIVALENT employees.

arena (a) The sandy area forming the stage of an AMPHITHEATRE. (b) Any public place where contests are held.

arenaceous Sandy. Composed largely of sand; as opposed to *argillaceous*.

Argand lamp An oil lamp, invented by Francois Pierre Argand in the 1790s. Air passes both inside and outside a hollow tubular wick, surrounded by a glass chimney, which is fed with oil from an elevated oil reservoir.

argillaceous Clayey. Composed largely of clay or shale, as opposed to *arenaceous*.

argon-arc welding A form of SHIELDEDARC WELDING in which the arc is protected by the inert gas *argon*, or a mixed gas containing argon and carbon dioxide. See also [HELIARC WELDING](#).

arithmetic mean The average of all values, neglecting their sign, i.e. taking them all as positive, i.e. the sum of their ABSOLUTE VALUES divided by the number of items. See also [ALGEBRAIC MEAN](#), [GEOMETRIC MEAN](#), [MEDIAN](#) and [MODE](#).

arm See [LEVER ARM](#).

armature (a) In a relay, the moving part that is attracted to the electro-magnet. (b) In a generator, the windings in which a voltage is induced. (c) In a motor, the rotating part or rotor.

armoured cable An insulated electric cable wrapped with a flexible steel covering.

armoured concrete An obsolete term for reinforced concrete.

armoured wood Wood covered with metal.

armour-plate glass See [BULLET-RESISTING](#) and [TEMPERED GLASS](#).

array A table of related numbers or values.

arrestor An apparatus designed to intercept and retain silt, sand, oil, grease, sludge and other substances in a waste discharge.

arris A sharp edge formed by the meeting of two surfaces, particularly two mouldings.

arris gutter A V-shaped gutter.

arrival rate The number of passengers arriving for service at a lift system during a five-minute peak period.

arrow The graphic representation of an ACTIVITY in a CPM NETWORK. One arrow represents one activity; however, it is not a vector quantity, and not normally drawn to scale. The intersection of two arrows marks an EVENT.

articulated detail A detail in which the joints between materials, or the salient edges, are recessed to emphasise their location, but to hide any crack.

articulated structure A structure constructed with PIN JOINTS.

articulation The percentage of meaningless syllables correctly perceived by a listener or listeners. See also [SPEECH INTELLIGIBILITY](#).

articulation index A calculated prediction of ARTICULATION or SPEECH INTELLIGIBILITY.

artificial intelligence The endowing of machines with some of the characteristics of intelligence, such as learning, recognition and reasoning, normally associated with humans.

artificial light Light produced by electrical processes or the burning of fuel. The preferred term is *electric light* or, as appropriate, gaslight or oil-light. See [FILAMENT LAMP](#), [FLUORESCENT LAMP](#), [LUMINAIRE](#), [MAINTENANCE FACTOR](#) and [PSALI](#).

artificial seasoning Seasoning timber by some means other than NATURAL SEASONING.

artificial sky A hemisphere, usually 6–7 m (20–25ft) in diameter, lit inside to imitate the natural sky. A model, scaled in accordance with the principles of dimensional analysis, is placed at the centre of the hemisphere, and measurements of internal lighting conditions are made with PHOTOVOLTAIC CELLS. Most artificial skies are calibrated for the over-cast condition represented by the CIE STANDARD OVERCAST SKY. A simpler type of artificial sky, which can only be used to investigate windows in a wall, consists of a mirror-lined box lit from above; this creates lighting through the windows similar to that from an infinitely distant source.

artificial stone PRECAST CONCRETE made with careful attention to appearance, frequently in imitation of natural stone.

asbestos A mineral occurring in fibrous form, consisting of various silicates. It is highly resistant to high temperatures, and was widely used as a fire-resisting material. The fibres are flexible enough to be woven like textiles, or used as reinforcement in cement to form building boards, or sprayed onto surfaces with a cement binder. However, it has been found that the fine fibres can be inhaled, causing a hazard to the health of the miners and manufacturers, and possibly to the occupants of buildings with free asbestos. In most countries it has been replaced by other fibres.

asbestos cement sheet Building sheet made from cement with an admixture of ASBESTOS fibres. Although highly resistant to both fire and weathering, its use has been discontinued because of the hazard associated with asbestos fibres. See [FIBRE CEMENT](#) and [FIBRO](#).

A-scale on a sound-level meter A filtering system that has characteristics approximately matching the response of the human ear at low sound levels.

ASCE American Society of Civil Engineers, New York.

ASCII Abbreviation for American Standard Code for Information Interchange. This is the standard association of a pattern of seven bits with an

ALPHANUMERIC or control character so that components of a computer system can recognise input or output.

ASEE American Society for Engineering Education, Washington.

ashlar Squared stonework, as opposed to rubble. *Coursed ashlar* is laid in regular horizontal courses. *Random ashlar* consists of square blocks whose horizontal and vertical joints do not line up. *Ashlar brick* is brick that has been rough-hacked on the face to make it resemble stone.

ASHRAE American Society of Heating, Refrigerating and Air Conditioning Engineers, Atlanta.

ASHVE American Society of Heating and Ventilating Engineers, now ASHRAE.

ASME American Society of Mechanical Engineers, New York.

aspect The direction in which a building faces. Also the view beyond a workplace, generally to the exterior.

aspect ratio The ratio of the longer to the shorter side of a rectangle.

asphalt A black sticky mixture of hydrocarbons used for waterproofing basements and flat roofs. In the USA the term is used both for the naturally occurring product and for that obtained from the distillation of petroleum. Elsewhere the artificial asphalt is usually called *bitumen*.

asphalt mastic A thick adhesive, consisting of asphalt, bitumen or pitch, and a filler, such as sand. It is used for bedding woodblock floors, bedding and pointing window frames, and for laying and repairing flat roofs.

asphalt roofing Waterproof roof laid either with bituminous felt or with mastic asphalt.

asphalt shingles Roof shingles, widely used in the USA, made of felt saturated with asphalt or tar, and surfaced with mineral granules.

assay Estimation of metal content in an ore by chemical analysis or heat treatment.

asset management The management of building elements, systems, equipment, fixtures and fittings from procurement, operation and maintenance to renewal.

Assman psychrometer A pair of WET-AND-DRY BULB THERMOMETERS mounted in a nickel-plated cover to shield them from radiation. To achieve uniform ventilation, the air is drawn mechanically over the thermometers with a small fan.

ASTM American Society for Testing and Materials, Philadelphia.

astragal (a) A small semi-circular moulding, often decorated with a bead. (b) A moulding covering a joint around a door or window, and for glazing bars. (c) A small metal strap for fixing a pipe to a wall.

atm Atmosphere, an obsolescent unit of pressure. The PRESSURE exerted by the weight of the air at the surface of the earth is 101.325kPa (14.7psi), and this equals 1 atmosphere.

atmospheric layers The Earth's atmosphere is divided into four layers: the troposphere (nearest Earth), the stratosphere, the ionosphere, and the exosphere. Atmospheric conditions change with time and latitude; the layers are thicker at the equator and thinner at the poles.

atmospheric pressure See [PRESSURE,ATMOSPHERIC](#).

atomic heat The quantity of heat required to raise the temperature of one MOLE of an element through 1°C.

atomic number The number of a chemical element when arranged with the others in increasing order of ATOMIC WEIGHT, as in the PERIODIC TABLE OF THE ELEMENTS. It is equal to the total number of positive charges in the nucleus, or the number of orbital electrons in an atom of the element.

atomic weight The relative weight of an atom of an element, taking the weight of an atom of oxygen as 16. The classification was originally based on hydrogen as unity; hydrogen has now an atomic weight of 1.008. See also [ISOTOPES](#).

atomise To break up a liquid into very fine drops.

atrium (a) The inner hall of a Roman house, with an opening in the roof and a rectangular basin to receive the rain-water. (b) The forecourt of an early Christian basilica. (c) A central court-yard or sky-lighted space in a modern multi-storey building, surrounded by arcades or balconies.

attendant control Of lift systems: the direction of travel, door closing and lift car starting are under the control of an attendant.

attenuation Diminution or weakening, particularly of sound.

Atterberg limits See [LIQUID LIMIT](#) and [PLASTIC LIMIT](#).

attic Roof space between the top-storey ceiling and the roof.

attic fan or ventilator A mechanical fan in the attic of a house, which removes hot air from the roof space in hot weather.

attribute Information describing a property of an object. Attributes are assigned VALUES.

Au Chemical symbol for *gold* (aurum).

audible sound Acoustic oscillation of such character as to be capable of exciting the sensation of hearing. See also [AUDIO FREQUENCY](#).

audio frequency Any frequency in the range 16Hz to 16kHz, the conventional limits of human audition. The frequency range of 20Hz to 20kHz is also in common usage.

auditorium (a) Room especially designed to have satisfactory acoustics for speech, music or both. (b) In a theatre, the space assigned to the audience, as opposed to the stage. Fire regulations frequently require that the two spaces be capable of separation by means of a fire-resistant curtain.

auger (a) A tool for boring holes in wood. (b) A tool for boring holes in soil. The *post-hole auger* is a hand-operated tool, which can be used to obtain BORE-HOLE SAMPLES. Larger holes must be made with a power *earth auger*, or by conventional excavation methods.

austenite An allotropic form of GAMMA IRON, which has a face-centred lattice. It is not stable in carbon steels at room temperature. However, it exists in stable form in certain alloy steels containing nickel and chromium. See also [FERRITE](#).

austen steel See [CORTEN STEEL](#).

autoclave A pressure vessel in which materials are exposed to high-pressure steam. In the building industry, auto-claving is used for the rapid curing of precast concrete products, sand-lime bricks, fibre cement products, and hydrous calcium silicate insulation products.

autogenous healing The closing of fine cracks in concrete and mortar through chemical action. It occurs naturally if the concrete or mortar is kept damp and undisturbed.

automatic control valve A valve controlling the flow of fluids in response to signals from a sensor or controller.

automatic door A power-operated door, which opens automatically at the approach of a person or car, and closes automatically.

automatic fire alarm A FIRE DETECTOR that automatically initiates a signal notifying the existence of a fire.

automatic interference checking An automated process whereby a computer program checks whether two objects interfere with each other in space, e.g. ducts and beams.

automatic lift A lift that starts and stops in response to the pushing of a button; this is now the normal procedure.

automatic pushbutton control Of lift systems: the travelling passengers are able to control the movement of a lift car without an attendant. Door control and starting are automatic.

automation Automatic handling of work during production and in transit between machines. The word was coined by the Ford Motor Company.

auxiliary storage Storage external to a computer.

average recurrence interval (ARI) The average time between recurrences of a storm event of a certain severity at a particular location.

Avogadro's hypothesis 'Equal volumes of different gases at the same pressure and temperature contain the same number of molecules.' Named after the Italian physicist who enunciated it in 1811. *Avogadro's number* is the number of molecules contained in the MOLE of any gas; it is about 6.1×10^{23} .

avoirdupois weight From the Old French for *goods of weight*. The normal system of weights used in FPS UNITS.

A-weighting See [SOUND PRESSURE LEVEL](#) and [A-SCALE ON A SOUND-LEVEL METER](#).

AWG American Wire Gauge.

axial-flow fan A propeller fan with the blades mounted on the axis, as opposed to a CENTRIFUGAL FAN.

axial load See [CONCENTRIC COLUMN LOAD](#).

axiom A simple proposition of a self-evident nature, which requires no proof, and generally cannot be proved. Also called *postulate*.

axis, major and minor The greatest and the smallest diameter of an ELLIPSE.

axis, neutral See [NEUTRAL AXIS](#).

axonometric projection A pictorial PROJECTION that overcomes some of the limitations of the ISOMETRIC PROJECTION. The plan is drawn in true shape

but rotated at an angle, usually 45° . Vertical lines are drawn to true length, projected up from the plan. (*Axonometric projection* is sometimes used to describe a projection, similar to isometric, in which the plan axes are inclined at an angle other than 30° .)

azimuth The horizontal angle subtended by an object, such as the sun, with the standard MERIDIAN OF LONGITUDE. The vertical angle is the ALTITUDE.

B

backfill (a) Crushed stone or coarse soil placed around foundation walls to provide drainage for water. (b) Rough masonry or brickwork built behind a face or between two faces. (c) Brickwork in the spaces between studs of timber frames; also called NOGGING. (d) Filling over the EXTRADOS of an arch.

backflow (a) Flow in the direction contrary to the normal intended flow. (b) The unintended flow of water from a potentially polluted source into a *potable water* supply. See also [BACK SIPHONAGE](#).

background In computing: (a) used in multi-task processing systems for low-priority tasks carried out when the computer is not executing high-priority jobs (the *foreground*); (b) The plane on the computer screen used for the placing of windows etc.

background noise The AMBIENT SOUND (e.g. from air conditioning, traffic, wind or birds or a combination of these) in the absence of the sound of interest or under investigation (e.g. speech, music or aircraft).

backhand welding Welding with the blowpipe directed towards the completed weld.

back hoe A tractor-mounted shovel capable of digging below grade; it digs towards itself.

backing brick Low-cost brick used behind face brick or masonry.

backing coat A coat other than the finishing coat, particularly of plaster.

backlighting Lighting of an object from the rear.

back pressure In plumbing, air pressure in a pipe that is above atmospheric pressure.

back prop A strut placed at an angle to the vertical, used to support timbering in deep trenches.

back sawing Sawing a log into rectangular sections so that the longer dimension of the cross-section is roughly *tangential to* the growth rings (as opposed to QUARTER SAWING). Back sawing provides a more interesting FIGURE on the broad face of a board, but the board is liable to cup during drying.

back siphonage The flowing back of polluted or contaminated water from a plumbing fixture into the pipe that feeds it.

backup A copy of data kept as a means of security.

backup material A material placed at the back of a curtain wall, particularly for fire protection.

baffle A reflecting surface used to reduce the distribution of sound in an acoustical system.

bagasse Fibre obtained from sugar cane. It is used as raw material for both HARDBOARD and PARTICLE BOARD.

bag of cement The bag of cement is frequently used as the unit for batching the aggregates and the water. In the USA the standard bag weighs 94 lb (i.e. 24 bags to the LONG TON), while in most SI countries it is 40 or 50kg.

baked enamel See [VITREOUS ENAMEL](#).

baked finish A durable and tough paint or varnish finish obtained by baking, generally at a temperature above 65°C

Bakelite One of the earliest synthetic resins, named after its inventor L.H. Baekeland. It is produced by the condensation of phenol with FORMALDEHYDE. Many other plastics of different compositions are now marketed by the Bakelite Company.

balanced design In reinforced concrete, a design that produces simultaneous overstressing of the steel in tension and the concrete in compression, i.e. neither material reaches its limit before the other. It occurs only when a *balanced percentage of reinforcement* is used. A beam that has more steel is *over-reinforced*, and one that has less steel is *under-reinforced*.

balanced sash A vertically sliding sash in a SASH WINDOW.

balcony A platform projecting either from an inside or an outside wall of a building.

balcony beam A beam that supports a balcony. It usually has a horizontal projection, and is therefore subject to combined bending and torsion. A BOW GIRDER is a curved balcony beam.

balk A large squared timber, usually of softwood. Also spelt *baulk*.

ballast (a) An electrical inductance device used to control DISCHARGE LAMPS. (b) Heavy material to prevent uplift of part of a scaffolding or structure.

ball catch A type of door fastening in which a spring-controlled metal ball in the door engages a hole in the door frame.

ballcock or ball valve An automatic *float valve* for controlling the level of water in a cistern or storage tank (see figure). An empty ball of copper or plastic floats up as the level of water in the cistern rises, and shuts the valve when a predetermined level is reached

ball mill A mill in which material is finely ground by rotation in a steel drum with steel balls or pebbles. It is used for grinding cement.

balloon frame Timber frame in which the studs run in one piece to the ROOF PLATE. The floor joists are nailed to the studs. The development of the balloon frame in America in the 1830s led to a great reduction in the labour content of timber houses, by replacing the complex timber joints (such as *mortice and tenon*, *tongue and fork*, *dovetailing*) with simple nailed joints. It became possible

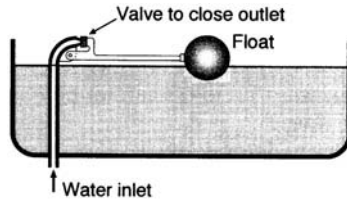

Cistern with ballcock

ballcock

only after suitable nails were mass-produced. The timber frame has become progressively lighter through efficient interconnection of members.

ball-peen hammer The engineer's hammer, used for metalwork and stone masonry. It has a hemispherical peen (or small end) and a flat face.

ball test A test for determining the WORKABILITY of freshly mixed concrete. A cylindrical metal weight with a hemispherical bottom is dropped from a standard height, and the depth of penetration is measured. See also [COMPACTING FACTOR TEST](#) and [SLUMP TEST](#).

ball valve Same as BALLCOCK.

balsa wood A very soft wood (although technically a hardwood) weighing only 110kg/m^3 (7lb/ft^3). It is widely used for models, and it can also be used as insulation in coreboard.

baluster Wooden post (in the past often elaborately carved or turned) holding up the handrail of a staircase, balcony, etc. Also called *banister*. The entire assembly of balusters is a *balustrade*.

bamboo A giant tropical grass with a hollow jointed stem, which is relatively strong and stiff. It is widely used in southern Asia for SCAFFOLDS, and to a lesser extent as a building material for houses, in place of timber. A major problem is that joints cannot be formed by nailing.

bandpass filter A device that transmits energy at all frequencies within a defined band/range of frequencies, and greatly attenuates the energy at all other frequencies. See also [CENTRE FREQUENCY](#).

band saw A saw consisting of an endless belt, one edge being cut to form the teeth; as opposed to a CIRCULAR SAW.

band shell A curved sounding board placed over a bandstand.

bandwidth The range of FREQUENCIES that can pass through a system. See also [CENTRE FREQUENCY](#) and [OCTAVE-BAND](#).

banister (a) Same as BALUSTER. (b) A handrail for a staircase.

bank guarantee The security offered by financial institutions to contract signatories supporting contractual obligations.

bank of lifts A number of GROUPS of lift cars located together physically. Each group serves a particular ZONE of the building.

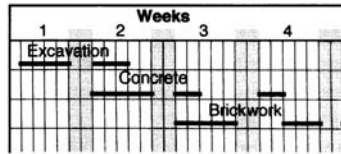

bar chart

bar An obsolescent unit of pressure, equal to 100 000Pa (approximately atmospheric pressure).

bar, deformed See [DEFORMED BAR](#).

bar chair A rigid device, usually of steel or plastic, which supports the reinforcement in concrete in its proper position and prevents its displacement both before and during concreting.

bar chart A chart that shows a magnitude by the length of a bar (see Figure). See [GANTT CHART](#) and [HISTOGRAM](#).

bar-code A type of code based on bands of lines of differing widths to be read by a BAR-CODE SCANNER to provide information to a computer.

bar-code scanner An optical device for reading data coded as BAR-CODES.

bare conductor An electrical conductor without insulation or other covering.

bare lamp An electric lamp, typically a GLS incandescent or tubular fluorescent, without shielding or other light control device. See also [BATTEN](#) (d).

barge board A sloping board covering the projecting portion of the timbers of a gable roof. In the nineteenth century it was often elaborately decorated. Also called *verge board*.

barite Barium sulphate (BaSO_4). It is used as aggregate for high density concrete, e.g. for concrete used in radiation shields for atomic reactors. Also spelt *baryte*.

barium A heavy alkaline earth metal. Its specific gravity is 3.59.

barium plaster A gypsum plaster containing barium salts, used to plaster X-ray rooms.

barium sulphate See [BARITE](#).

bark pocket A patch of bark, partially or wholly enclosed in a wooden board. It is a source of weakness.

bar mat Steel reinforcing bars assembled as a mat by welding or by ties. The bars are generally placed in two layers at right angles to one another.

barometer An instrument used for the measurement of *atmospheric* pressure. The *mercury barometer* consists of a vertical tube, about 800mm long, closed at the end, which is filled with mercury and placed in a pool of mercury. The atmospheric pressure on the pool of mercury balances the mercury column in the tube, and a vacuum forms above it. The *aneroid barometer* consists of a hermetically sealed metal box, exhausted of air so that the ends of the box approach or recede from one another with change in air pressure. The movement is magnified by levers.

barrel The normal measure of capacity used in the oil industry. It equals 42 US gallons, or 0.159m³.

barrel bolt A round bolt for locking a door or a window. It slides in a cylindrical barrel, usually formed from sheet metal.

barrel vault A semi-cylindrical or partly cylindrical roof structure of constant cross-section. It was widely used in masonry construction, particularly in Romanesque architecture. A much thinner form is today built in reinforced or prestressed concrete as a *shell roof*.

barrier-free design Design of buildings to remove barriers that would prevent persons confined to wheelchairs from gaining full access to all parts of the building.

bar schedule A listing of the reinforcement required for a concrete structure or structural member. It gives the size, length, and shape of each bar type, together with the dimensions of any bar bends needed, and the number of each type required.

bar support Same as BAR CHAIR.

baryte Same as BARITE.

basal metabolic rate The continuous and unconscious heat production associated with the life-supporting processes of the human body.

basalt A fine-grained, dark coloured IGNEOUS ROCK of basic composition.

base (a) A substance that neutralises acids, producing salt and water. It has a pH VALUE greater than 7, and turns red LITMUS blue. (b) The lowest part of a monument, column, wall or pier. (c) See [LAMP BASE](#).

baseboard Same as SKIRTING.

baseboard heater Same as SKIRTING HEATER.

base coat (a) The first coat of paint applied to a surface, i.e. the PRIMER COAT. (b) The first coat of PLASTER.

base line (a) In PERSPECTIVE PROJECTIONS, the intersection between the ground plane and the picture plane. (b) In construction work, a definitely established line from which other measurements for laying out a building are taken.

basement drive A lift drive located adjacent to the bottom of the lift well.

base moulding A wooden moulding used to trim the upper edge of an interior baseboard or SKIRTING.

base year The year used as the basis for relating past and future calculations in life-cycle costing and net present value analysis.

basket weave bond A checkerboard pattern composed of squares of bricks laid alternately at right angles to one another.

bas relief Sculpture carved in low relief, i.e. the figures project slightly from the face of the background.

bat (a) A piece of brick used for closing a gap. One end is whole, and the other is cut or broken. A HALF BAT is obtained by halving a brick across its length. (b) Short for BATTEN. (c) Alternative spelling for batt in BATT INSULATION.

batch box A container used to measure by volume the components of a batch of concrete, mortar or plaster. See also [MIX PROPORTIONS](#).

batch mixer A machine that mixes one batch of concrete or mortar at a time, as opposed to a *continuous mixer*.

batch of concrete Quantity mixed at one time.

batch processing A method of processing data by computers as a single unit rather than as it arises; as opposed to REAL-TIME PROCESSING.

batch splitting The division of a batch into two or more sub-batches.

batten (a) A narrow strip of wood used either as a support for light construction, or as a cover over a joint. (b) A wooden board fastened at an angle across several parallel boards to hold them together; also called a *cross batten*. (c) An incandescent lampholder attached directly to the surface. (d) A simple LUMINAIRE containing one or more tubular fluorescent lamps.

batter Inclination from the vertical or horizontal.

batter piles PILES driven at an angle to the vertical to provide lateral support to the structure.

battery A combination of electrical CELLS connected to increase the voltage (a *series connection*) or current (a *parallel connection*). The term is commonly used, incorrectly, to refer to a single cell.

batt insulation Flexible insulation, usually made from glass, rock, or slag fibres, and packaged into rectangular *batts*. These are frequently placed between the studs or joists of a timber frame. The batts generally have a VAPOUR BARRIER on one side.

baud rate The measure of signalling speed in telecommunications. The number of discrete signal events per second. Named after J.M.E.Baudot.

baulk Same as BALK.

bauxite Hydrous aluminium oxide, named after Les Baux in France. It is the principal raw material for the manufacture of aluminium metal. It is also used in the manufacture of HIGH-ALUMINA CEMENT. Also spelt *beauxite*.

bayonet cap A LAMP BASE used on electric lamps to provide positive anchoring into the lamp holder; sometimes it is also used to ensure correct polarity or geometrical position. A common base, particularly in Great Britain and Australia, for general lighting service lamps: it has two projecting studs that fit into grooves in the lampholder. See also [EDISON CAP](#).

BCD Binary-coded decimal.

BCR Benefit/cost ratio.

BCS British Computer Society.

bead See [GLAZING BEAD](#).

beam A structural member that supports loads across a horizontal opening by flexure (see [NAVIER'S THEOREM](#)). JOIST and GIRDER are synonyms for beam.

beam-and-slab floor A floor system, particularly in reinforced concrete, whose floor slab is supported by beams; as opposed to a FLAT PLATE and FLAT SLAB.

beam ceiling A ceiling formed by the underside of the floor, showing the beams supporting it. The term is also used for a false ceiling imitating exposed floor beams.

beam column A beam that transmits a direct axial load, as well as bending. The term is also used for a column subject to bending.

beam compass An instrument for drawing large circles. It consists of a long horizontal beam and two movable heads.

beam test A test of a specimen in bending. If not further defined, it means a bending test of an unreinforced concrete beam to determine the MODULUS OF RUPTURE of the concrete.

bearer A horizontal structural member, generally of timber, which supports a load.

bearing (a) Support for a rotating shaft. (b) Support for a beam or column.

bearing capacity The load that a PILE or a foundation can safely support.

bearing pile A PILE that carries a vertical load, as compared with a SHEET PILE, which resists earth pressure. The load may be carried on a load-bearing layer, such as rock (*end-bearing pile*) or by friction between the surface of the pile and the surrounding soil (*friction pile*).

bearing plate A plate placed under a heavily loaded support of a beam, column, frame etc. to distribute the load over a wider area.

bearing pressure The load on a bearing, BEARING PLATE, or FOUNDATION, divided by its area.

bearing span The length of a beam between its bearings.

bearing wall A wall or partition that supports the portion of the building above it in addition to its own weight, as opposed to a CURTAIN WALL or partition, which supports only its own weight.

Beaufort scale A scale for wind speed, which ranges from 0 for complete calm to 12 for a cyclone. The wind speed (in km/h) equals $3B^{1.5}$ where B is the Beaufort number of the wind.

beauxite Same as BAUXITE.

bed A strip of mortar on which bricks or (ridge, hip, verge and valley) tiles are laid.

bedding plane The surface between two beds or strata in a stratified SEDIMENTARY ROCK.

bed lift A lift for the movement of patients on beds or stretchers in hospitals etc., with a narrow and deep platform, capable of carrying a load of at least 20 passengers.

bedrock Solid rock underlying superficial formations.

beeswax The natural secretion of bees, from which the honeycomb is formed. It is soluble in turpentine and used in wax polishes and stains.

Beggs' deformeter The original device for indirect model analysis, developed by G.E.Beggs at Princeton University in 1922. It applies vertical, horizontal or rotational deformation at one end of a scale model of the structure, and the

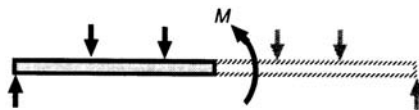

bending moment

corresponding thrust, shear or bending moment along the structure is then deduced from its deflected shape by the RECIPROCAL THEOREM.

bel A scale unit used in the comparison of powers, named after A.G.Bell, the inventor of the telephone. The practical unit is the DECIBEL=0.1 bel.

Belfast truss A wooden BOWSTRING GIRDER for spans up to 15m (50ft).

belfry A tower in which a bell is hung.

Belgian truss Same as FINK TRUSS.

belite See [DICALCIUM SILICATE](#).

bell-and-spigot joint Same as SPIGOT-and-socket joint.

bell push A button that rings a bell when pushed.

bell transformer A small transformer that changes the mains voltage to that used by a bell or chime, usually 12V.

belt drive An *indirect* lift drive, using a belt as the means of connection.

belt sander A powered SANDER in which a continuous belt of abrasive material is driven over rollers at both ends across a face plate.

belvedere A building, upper storey or turret, especially built because it commands a fine view.

BEMS Computer-based building energy monitoring system.

benchmark A permanent reference mark, fixed to a building or to the ground, whose height above a standard DATUM LEVEL has been accurately determined by a survey.

benchmarking (a) The process of identifying optimum performance characteristics. (b) Performing a task to measure the performance of systems. In computing, it is usually standardised so that the efficiency of different SOFTWARE and/or HARDWARE can be evaluated.

bench photometer A rail with a reference light source and an accurate scale, used to calibrate photometers.

bend A turn in a pipe whose radius of curvature is larger than that of an ELBOW.

bending formula See [NAVIER'S THEOREM](#).

bending moment (M) The moment at any section of a beam of all the forces that act on the beam on one side of that section (see Figure). If the equilibrium at any section is considered, the bending moment resisted by the beam must balance the loads acting on it. There are two opposite sign conventions. The one normally employed in architectural textbooks and in building codes states that a bending moment is positive when the beam is bent concave or downwards (*sagging*) and negative when it is bent convex or upwards (*hogging*). Thus the bending moment in a simply supported beam is positive, and that in a cantilever is negative. See Figure under [NEGATIVE BENDING MOMENT](#).

bending moment diagram Diagram showing the variation along the span of a member of the moment that is tending to bend that member. It indicates whether the bending moment is *positive* or *negative* and where the maximum bending moment occurs.

bending schedule See [BAR SCHEDULE](#).

bent A two-dimensional frame that is capable of supporting horizontal as well as vertical loads.

bentonite A clay composed principally of MONTMORILLONITE. Its expansion and contraction on wetting and drying are exceptionally high.

benzene A highly flammable hydrocarbon of the aromatic series (C_6H_6), obtained from the distillation of coal tar. It is used as a solvent and a paint remover.

benzine A highly flammable mixture of hydrocarbons obtained from the fractional distillation of petroleum. Apart from its use as a motor fuel, it is employed as a solvent in quick-drying finishes.

Berlin blue Same as PRUSSIAN BLUE.

Bernoulli's theorem 'Along any one streamline in a moving liquid, the total energy per unit mass is constant' It consists of the pressure energy, the kinetic energy, and the potential energy:

$$\frac{p}{\rho} + \frac{1}{2}v^2 + z = \text{constant}$$

where p is the pressure, ρ is the density, v the velocity and z the head of the liquid.

Berry strain gauge A demountable strain gauge. It consists of a long bar with one fixed and one movable point, which operates a DIAL GAUGE through a lever.

bespoke building A term coined by P.A.Stone to contrast industrialised or 'off-the-peg' building with traditional, tailor-made building.

Bessemer process A method, developed by H.Bessemer in 1856, of producing steel. Air was blown through molten pig iron contained in a refractory-lined, pear-shaped cylindrical vessel, open at the upper end for the escape of gases, called the *Bessemer converter*.

best practice Management practice that delivers optimum performance.

beta brass A copper-zinc alloy whose zinc content is between 46 and 50 per cent.

beta particle An electron. The *beta radiation* emitted by the atomic nuclei of radioactive substances during their spontaneous disintegration consists of a stream of electrons.

béton The French word for concrete; the same word is used in German and Russian.

béton translucide GLASS-CONCRETE CONSTRUCTION with clear glass inserts.

bevel A junction between two surfaces that is not a right angle. A CHAMFER is made by bevelling a square edge symmetrically.

bevelled washer A washer made from a tapered piece of steel plate, so that it is thinner on one edge than on the other. It was originally made for steel sections with tapered flanges.

bevel square An L-shaped tool used by carpenters for setting out, with one adjustable blade, which can be set to any angle.

bhp Abbreviation for BRAKE HORSEPOWER.

bidet A low basin-like plumbing fixture on which the user sits. It is intended especially for bathing the genital/anal region.

billet of steel An intermediate product in the hot-working of steel. It has been rolled or forged down from the ingot, and will be further worked into sections or forgings. A large billet is known as a *bloom*.

billion Formerly in Europe, 1×10^{12} i.e. a million million. In the USA, and generally worldwide, 1×10^9 , i.e. a thousand million.

bill of materials A list of information about the parts of an object including such ATTRIBUTES as identification, quantity, material, size, weight and cost.

bill of quantities A list of numbered items, which describe the work to be done on a building contract. Each item shows the quantity of work involved. When the contract is sent out to tender with a bill of quantities, the contractor is expected to submit a priced bill. Payments to the contractor are based on these prices and the measured work actually done, which usually varies at least in part from the work originally envisaged. Bills of quantities are normally drawn up by a QUANTITY SURVEYOR. They are not used in the USA.

bimetallic strip A strip fused together from two metals with widely differing coefficients of thermal expansion. It consequently deflects with a change in temperature. It is used as a control element in THERMOSTATS, and in FIRE DETECTORS.

binary alloy An alloy containing two principal elements.

binary arithmetic An arithmetic system based on the two digits 0 and 1. It is generally used by electronic computers, because the digits correspond to the two possible conditions of an electrical circuit (go or no go). The binary digits, or BITS, are converted by the computer to decimal arithmetic, so that it can be operated by the conventional decimal system.

<i>Binary system</i>	<i>Decimal system</i>	
0	0	
1	1	
10	2	
11	3	
100	4	
101	5	etc.

See also [BOOLEAN ALGEBRA](#).

binary digit A digit in BINARY ARITHMETIC, i.e. either 0 or 1. It is commonly abbreviated to BIT.

binder (a) An adhesive or cementing material. (b) A soil consisting mainly of fine particles for binding a non-cohesive soil. (c) A masonry unit used to bind an inner and an outer wall. (d) A structural member, particularly of timber, which binds together components of a structure.

binomial function Any function containing two, and only two, parameters, of which one is generally variable.

biochemical oxygen demand (BOD) The measure of the consumption of oxygen by biodegradable matter in an effluent over a specified period of time.

biocide A substance used in water treatment to prevent colonisation by microbiological organisms.

bioclimatic chart A graphical method of depicting the human thermal COMFORT ZONE. It is based on the interaction of four environmental variables (DRY-BULB TEMPERATURE, RELATIVE HUMIDITY, air velocity and thermal radiation) for a person engaged in a specific activity and wearing a specified amount of clothing.

bio-gas A fuel gas containing mostly methane (CH_4), produced from the ANAEROBIC breakdown of waste material.

birdsmouth A notch cut on the face of a sloping piece of material in order to join a horizontal piece.

biscuit Tiles, earthenware products, etc. in the intermediate stage of manufacture after the first firing, but before glazing.

bit (a) An interchangeable cutting tool used in a CARPENTER'S BRACE, in a rock drill, etc. (b) The tip of a soldering iron, which is heated and tinned. (c) An abbreviation for BINARY DIGIT, i.e. the smallest unit of information recognised by a DIGITAL COMPUTER.

bitmap In computing, a mapping between each PIXEL on a screen and a set of BITS in the memory.

bit string In computing, a sequence of related BITS.

bitumen A black sticky mixture of hydrocarbons used for waterproofing basements and flat roofs, and for damp-proof courses. It is obtained from natural deposits (*asphalt*) and from the distillation of petroleum.

bituminous felt Waterproof felt soaked in bitumen; used in BUILT-UP ROOFING.

bituminous paint A thick black coating material containing mainly BITUMEN, used for damp-proofing and for water-proofing, particularly on roofs.

black body The designation of a theoretical surface that absorbs all the radiation falling on it, irrespective of frequency; so called by analogy to the absorption of all light, making a surface appear black. Such a surface is said to be *non-selective*. Its nearest practical approximation is the inside of a hollow sphere with a matt black surface at a uniform temperature, viewed through a small hole.

black-body radiation The quality and quantity of radiation emitted by an ideal BLACK BODY. It conforms to the STEFAN-BOLTZMANN LAW.

black-body radiator See [FULL RADIATOR](#).

black-body temperature The temperature of a body whose emissivity is unity, i.e. an ideal BLACK BODY.

black bolt A hot-formed bolt for making site connections in steel structures. Because of imperfections in the surface, the holes in the pieces to be connected must be made a little larger than the bolt diameter, and perfect contact between the bolt and the sides of the holes is not possible; consequently the permissible loads are lower than for HIGH-TENSILE BOLTS or BRIGHT BOLTS.

blacklead Same as GRAPHITE.

black light Invisible ultraviolet radiation within the range of wavelengths that excite FLUORESCENT PAINTS and dyes, so that they become visible.

black mortar Mortar with the addition of ash, either because a black colour is required for pointing, or to reduce cost.

blanc fixe A white pigment, consisting of BARITE.

blanket insulation THERMAL INSULATION with a flexible lightweight blanket of MINERAL WOOL *or* a similar material.

blank window A walled-up window.

blast-furnace A tall, cylindrical, refractory-lined furnace used for the production of iron from iron ore.

blast-furnace slag A by-product of steel manufacture, which is sometimes used as a substitute for Portland cement. It consists mainly of the silicates and alumino-silicates of calcium, which are formed in the blast-furnace in molten form simultaneously with the metallic iron. Blast-furnace slag is blended with Portland cement clinker to form PORT-LAND BLAST-FURNACE SLAG CEMENT. It is also used for topping on built-up roofing, as lightweight aggregate, and for making MINERAL WOOL.

bleeder valve A small valve used to drain fluid from a pipe or container, such as a radiator.

bleeding (a) Accumulation of water and cement on the top of concrete due to settlement of the heavier particles. Bleeding may be caused by too high a water content, by overworking of the concrete near the surface, by excessive traffic on the wet concrete, or by improper finishing of the surface. The result is the formation of LAITANCE. (b) Exudation of gum, resin or sap from the surface of timber.

blended cement A blend of PORTLAND CEMENT and another material, such as POZZOLANA, BLAST-FURNACE SLAG, *or* HYDRATED LIME.

blinding glare Light received at the eye, so intense that it overloads the visual system during its presence and for a period of time afterwards. See also [DISABILITY GLARE](#).

blind nailing Same as SECRET NAILING.

blind rivet A RIVET for use where access is possible from only one side. A mandrel is drawn through the hollow rivet shank, snapping off after spreading its end against the blind side of the materials to be joined. Originally developed for the aircraft industry. Also called a *pop rivet*. See also [EXPLOSIVE RIVET](#).

bloated clay Expanded clay, used as LIGHTWEIGHT AGGREGATE.

block See BUILDING BLOCK.

blocking The process of arranging areas (blocks) horizontally to maximise the space occupancy in accordance with the required functional adjacencies, within a given physical envelope.

block insulation A slab of insulation that is rigid or semi-rigid.

blondel (also spelled *blandel*) An obsolete unit of LUMINANCE. 1 blondel=1 apostilb= $1/\pi$ candela per square metre =0.318 cd/m².

bloom (a) A large BILLET. (b) An efflorescence or coating (which can be removed by rubbing or brushing) on a masonry wall, a painted or varnished surface, etc.

blue brick A high-strength brick whose blue colour results from firing in a kiln with a flame that has a low oxygen content.

blue metal Broken stone used as a COARSE AGGREGATE for concrete, tarmacadam etc., crushed from any hard igneous or sedimentary rock of a bluish colour, e.g. dolerite.

blueprint (a) A contact print on ferroproussiate paper made from a drawing on transparent material; it can be printed in daylight, and developed in water. At one time this was the most common method for copying drawings. (b) Hence, a master plan for a project, irrespective of the form in which it is presented.

blue sky See CLEAR SKY.

bluestone A natural stone of dark blue colour; however, the term is also used for dark-coloured stones ranging from dark green to grey. The geological type of the rock varies from place to place, and the term 'bluestone' has been used for stones as diverse as basalt, dolerite, slate, and sandstone.

bluing Increasing the apparent whiteness of a white pigment by adding a small amount of blue.

BM Abbreviation for BENCHMARK and BENDING MOMENT.

BMCS Computer-based building monitoring and control system.

BMS Computer-based building monitoring system.

board foot An obsolete measure for timber, 1in thick by 12in square.

board insulation Same as INSULATING BOARD.

board-marked The finish to in situ and precast concrete made by sawn timber boards used as formwork.

BOD Abbreviation for BIOCHEMICAL OXYGEN DEMAND.

body-centred cubic lattice A crystal structure that has an atom at each corner of a cube, and one in the centre. It may be imitated by packing spheres in horizontal layers.

boiled oil Linseed oil used in quick-drying paint. It is heated for a short period to about 260°C (500°F), *not* boiled, and a small quantity of drier (e.g. manganese dioxide or LITHARGE) is added.

boiler A device for raising the temperature of a fluid, usually water, by transfer of heat from the combustion of a fossil fuel or a derivative such as electricity.

bole The main stem of a tree.

bolt See [BLACK BOLT](#), [BRIGHT BOLT](#) and [HIGH-TENSILE BOLT](#).

Boltzmann constant A constant, equal to $1.3805 \times 10^{-23} \text{J/K}$, used in statistical formulae relating to the behaviour of gases. See also [STEFAN-BOLTZMANN LAW](#), which refers to thermal radiation.

BOM Abbreviation for BILL OF MATERIALS.

bond (a) The system in which bricks, blocks and stones are laid in overlapping courses in a wall in such a way that vertical joints in any one course are not immediately above the vertical joints in an adjacent course. The basic distinction is between [ENGLISH BOND](#) and [DOUBLE FLEMISH BOND](#). See also [ENGLISH CROSS BOND](#), [SINGLE FLEMISH BOND](#), [DIAGONAL FLEMISH BOND](#), [STRETCHER BOND](#) and [COMMON BOND](#).

Most bonds require a [QUEEN CLOSER](#) to line up the joints at the corners. (b) The adhesion or grip exercised by concrete or mortar on surfaces to which it is required to adhere. The most important bond is between concrete and reinforcing bars. This is largely produced by the [SHRINKAGE](#) of the concrete, which creates a normal pressure between the concrete and the steel, and this produces a frictional force resisting pull-out of the steel. (c) Adherence of the plaster to the wall, and between the various coats of plaster. (d) Attraction between atoms which causes them to aggregate into larger units. (e) A sum of money held as security against the performance of some contractual duty.

bonded tendon A prestressing [TENDON](#) that is bonded to the concrete. In pre-tensioned members this is achieved directly by casting the concrete around them. In post-tensioned members the annular spaces around the tendons are grouted after stressing.

bonding conductor In a [LIGHTNING PROTECTION SYSTEM](#), a conductor intended to provide a connection between the lightning protection system and other metal parts and/or the structure.

bond stone A long stone, used as a [HEADER](#), running through the thickness of the wall to give additional transverse bond.

bond timber Horizontal timbers once used as a bond for a brick wall. The battens were sometimes secured to them. Bond timbers were liable to rot unless suitably protected.

Boolean algebra An algebra of logic, where a proposition may be either true or false, and therefore suited to [BINARY ARITHMETIC](#).

Boolean operation In solid geometry, the process of adding (*union*), subtracting (*difference*) or finding the overlapping volume (*intersection*) of two solid objects.

boom The member of a crane from which the load is suspended providing positioning of the load which can both [SLEW](#) and [LUFF](#). See also [JIB](#).

booster fan A fan used to step up the static pressure in an air distribution system in order to serve a remote area, used only intermittently (e.g. a conference room).

booster pump An auxiliary pump used to maintain the water pressure of a domestic water or a sprinkler system, if need be, or to increase it to meet a demand.

booting Short for BOOTSTRAPPING.

bootstrapping The loading of an operating system into a computer's working memory.

borax Sodium metaborate.

bore The internal diameter (ID) of a hole, pipe, etc.

bored pile A pile formed by pouring concrete, usually containing some reinforcement, into a hole bored in the ground, as opposed to a PRECAST PILE driven into the ground with a pile driver.

borehole (or core) sample Sample obtained by boring or drilling for the purpose of determining the nature of the foundation material. In the case of *clay*, it is necessary to obtain *undisturbed samples*, since the properties of clay are greatly affected by working. PENETRATION TESTS may be carried out in addition.

borrowed light A window in an internal wall that allows the admission of daylight from the adjacent space.

borrow pit A pit from which soil is taken for use as fill elsewhere.

bottom chord The bottom horizontal member of a truss.

bottom terminal lift landing The lowest landing in a building, served by a lift, where passengers are able to enter or leave the car.

boulder A naturally rounded rock, larger than GRAVEL.

boundary conditions for structural problems The known conditions of displacement, slope, force or moment at the edges of a structural member. The stresses in shell structures cannot normally be determined, unless the restraints at their edges are known.

boundary layer The layer of a fluid, such as air, adjacent to its boundary with a solid, for example a building. Inside this layer the velocity of the fluid f falls to zero at the boundary.

boundary layer wind tunnel In studying the effect of wind *around* buildings it is necessary to model the buildings in the path of the wind. The large buildings need to be represented with some accuracy, but the effect of small buildings can be included in a roughening of the surface that models the boundary layer.

boundary representation (B-rep) A solid geometry representation describing an object in terms of its surface boundaries: vertices, edges and faces.

Bourdon gauge A pressure gauge consisting of a tube bent into an arc, which tends to straighten out under internal pressure. It actuates a pointer, which moves over a scale.

Boussineq pressure bulb A bulb formed by the ISOSTATIC LINES in a semi-infinite elastic solid carrying a single concentrated load. The analysis, primarily used for determining the stresses in the soil beneath a heavy foundation, was published by the French mathematician J. Boussineq in 1885.

bow girder A girder curved horizontally in plan, i.e. an arch turned through a right angle. It serves as a SPANDREL on a curved facade, to support *balconies* etc. (see Figure). A bow girder is subject to combined bending and torsion.

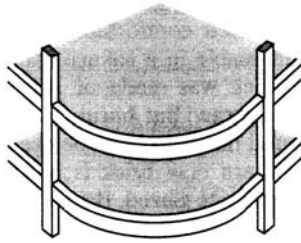

bow girder

Bow's notation Notation for the RECIPROCAL DIAGRAM, proposed by Robert Bow in 1873. It numbers the spaces in and around a truss, instead of the joints.

bowstring girder (or truss) A tied arch, which can be used like a girder, since the horizontal reactions are internally absorbed by a tie (the bowstring). The curved top chord is stiffened by light diagonal members. A *Belfast truss* is a wooden bowstring girder for spans up to 15m (50ft).

bow window A curved projecting window, usually on the ground floor. An ORIEL WINDOW usually projects from an upper storey.

box beam Same as BOX GIRDER.

boxed heart A piece of square-sawn timber, cut so that the pith, or central part, is cut out, e.g. by BACK SAWING. This is done in most Australian and some other hardwoods in which the HEART is unsound.

box frame (a) A rigid frame formed by load-bearing walls and floor slabs (see Figure). It is suitable for buildings that are permanently divided into small repetitive units. (b) The frame of a DOUBLE-HUNG WINDOW.

box girder A hollow beam whose cross-section is shaped like a box. It uses material where it is most highly stressed both by bending moments and by twisting moments. Consequently it is used for large spans and for locations where eccentric loading etc. causes torsion.

box gutter A gutter of rectangular cross-section, built behind a parapet or in a roof valley (see Figure).

Boyle's law 'The volume V occupied by a given mass of any gas at constant temperature varies, within moderate ranges of pressure, inversely as the pressure P to which it is subjected, i.e. $PV = \text{constant}$ ' It was proposed by the seventeenth-century English natural philosopher, Robert Boyle. See also [CHARLES' LAW](#).

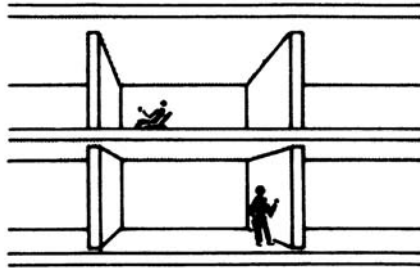

box frame

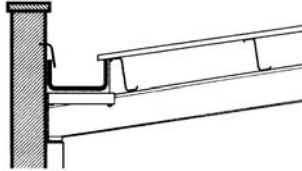

box gutter

bps Bits per second.

BRAB Building Research Advisory Board, Washington, DC.

braccia See [CUBIT](#).

brace See [CARPENTER'S BRACE](#).

bracing The ties and struts used for supporting and strengthening a frame, e.g. to resist horizontal loads.

bracket (a) A synonym for [KNEEBRACE](#). (b) An overhanging member projecting from a wall to support a weight. (c) A projecting gas or electrical wall fitting. (d) A piece of timber attached to the carrying member of a staircase supporting the [TREAD](#).

brake horsepower The useful mechanical power supplied by an engine. It can be measured with an absorption dynamometer or a friction brake applied to the flywheel of the engine.

brake shoes The moving parts of a brake, *lined* with a material with a high coefficient of friction, so that a vehicle can be brought to rest or a lift can be held in a stationary position, when applied to the brake drum.

brass A copper-zinc alloy. See [ALPHA BRASS](#) and [BETA BRASS](#).

Brazilian test Same as [SPLITTING TENSILE TEST](#).

brazing A process for joining two pieces of metal by means of *brazing solder*. Copper-zinc (brass), copper-zinc-silver, and nickel-silver alloys are used as brazing solders, and their melting point is generally above 500°C, but well below the melting point of the metal to be brazed. This is above the temperature used for [SOLDERING](#), but below that used for [WELDING](#).

BRE Building Research Establishment, Garston and Borehamwood, England.

breakdown (a) A term used for the separation of an EMULSION into its constituents. (b) The failure of an electrical insulating material, thereby allowing the flow of current.

breakdown maintenance Maintenance undertaken to return damaged components or equipment to satisfactory operation.

breakdown repairs Reactionary maintenance work carried out in response to a failure or wilful damage.

breaking load The ULTIMATE LOAD of a structural member that fails by FRACTURE.

breast beam Same as BREASTSUMMER.

breastsummer Originally a long and heavy timber beam (or *summer*) carrying the frontage of a building (or *breast*). It is a very large lintel supporting a masonry or brick wall. Also called *bressumer*. The term is still used for steel or concrete girders that provide an opening in a loadbearing wall, e.g. over a shop window.

breathing zone Occupied space in a building where human breathing normally occurs, usually considered as being between 100 and 1800mm above the floor and 600mm from walls. Also called *occupied zone*.

B-rep Abbreviation for BOUNDARY REPRESENTATION.

bressumer or breastsummer Same as BREASTSUMMER.

brick A building block, generally small enough to be lifted comfortably with one hand, and usable in a BONDED wall. The biblical brick was made of ADOBE reinforced with straw; but burnt bricks have been found that appear to be even older. The modern CLAY brick is hardburnt, and sometimes glazed. Bricks are also made of CONCRETE and of CALCIUM SILICATE. See also BOND, EXTRUDED BRICK, FACE BRICK, HEADER, STRETCHER and SUCTION RATE.

brick-and-stud work See BRICK NOGGING.

brick construction Construction in load-bearing brick, as opposed to BRICK VENEER or BRICK NOGGING.

brick earth A sandy clay suitable for making bricks.

brick elevator A powered continuous belt or chain for the inclined movement of materials, e.g. bricks. Also called *tile elevator etc.*

brick facing Same as BRICK VENEER.

brick nogging Brickwork infilling between the studs of wooden frame or a framed partition. Also called *brick-and-stud work*.

brick on edge A STRETCHER on its edge. This makes more economical use of bricks, but produces a thinner and weaker wall. Also called *rowlock*.

brick veneer A veneer of bricks (stretchers) built outside a timber frame; the frame supports the load. A brick veneer house looks like a brick building, but is essentially a timber-framed structure. Also called *brick facing*.

brickwork movement joint A joint between two adjoining brick walls, or between a brick wall and an adjacent structure, to permit temperature and moisture movement without impairing structural integrity.

bridging See [COLD BRIDGING](#) and [SOLID BRIDGING](#).

brief The detailed instructions given by a client to a design professional to describe the client's requirements for a project. In practice, the brief is usually developed during a series of discussions between the two parties.

bright bolt A steel bolt that has been turned to fit exactly into the holes of the steel pieces to be joined, as opposed to a [BLACK BOLT](#).

brightness The visual sensation that results from the luminance of an object, surface or light source. See [APPARENT BRIGHTNESS](#).

brilliance In acoustics, a bright, clear, ringing sound, rich in harmonics. It comes from the relative prominence of the treble and the slowness of its decay.

Brinell hardness test A test for hardness, using a hard 10mm ball. Named after its originator, the Swedish nineteenth century engineer J.A.Brinnell. The *Brinell hardness number* is the ratio of the load to the surface area of the indentation.

brise soleil A sun break or sunshading device, particularly of the type used by Le Corbusier.

British system of measurement The traditional units based on the foot and the pound, as opposed to the [METRIC SYSTEM](#).

British thermal unit (Btu) The amount of heat required to raise the temperature of 1lb of water through 1°F. In [SI UNITS](#) the [JOULE](#) is used. 1Btu=1055J.

brittle coating A technique used in experimental stress analysis, coating a model of the structure with a brittle lacquer (*Stresscoat*), which cracks at a definite strain. The direction and magnitude of the principal tensile stresses are thereby determined. Brittle lacquers can also be used to analyse residual stresses due to heat-treatment.

brittle-ductile range The range of temperature over which a material (particularly steel) may change from brittle to ductile, or vice versa. Above that range it is entirely ductile, and below it is entirely brittle.

brittle failure Sudden failure that is typical of concrete, brick and other [CERAMICS](#). It also occurs in metals, particularly in high-carbon steels and in cast iron. Low temperature increases the tendency to brittle failure, as does rapid application of the load (shock). See also [CRUSHING FAILURE](#) and [FRACTURE](#).

brittle lacquer See [BRITTLE COATING](#).

brittleness A lack of ductility. A brittle material ruptures with little or no [PLASTIC DEFORMATION](#). Brittle failure occurs by the rupture of interatomic bonds, and this occurs more readily in tension than in shear (or diagonal shear resulting from compression). Hence brittle materials have a much lower strength in tension than in compression. However, since plastic failure does not occur, their compressive strength is often high.

broadcast The sending of information to several receivers at once.

broken joints Joints arranged, as in a [BOND](#), so that they do not fall in a straight line and weaken the structure.

broken pediment A [PEDIMENT](#) with a gap at its apex.

broken white Off-white, generally with a touch of cream.



buckle

bronze An alloy of copper and tin, in varying proportions. Small quantities of zinc, nickel, phosphorus, aluminium and lead are sometimes added.

brownstone A reddish-brown or brown sandstone, used extensively in the eastern USA during the middle and late nineteenth century. Hence a building faced with brownstone.

BRS Building Research Station, Garston, England. Now incorporated in the Building Research Establishment (BRE).

BSI British Standards Institution, London.

Bthu or Btu See [BRITISH THERMAL UNIT](#).

bubble model A demonstration model devised in the 1930s by the English physicist W.L.Bragg to illustrate crystal structure. Uniform soap bubbles, about 1.5mm in diameter, are blown onto a water surface. These are then disturbed to form grain boundaries and DISLOCATIONS IN [THE] CRYSTALS.

Buckingham's theorem See [PI-THEOREM](#).

buckle To load a structural member, notably a column or strut, until it bends suddenly sideways (see Figure). The material is not necessarily damaged by buckling, but it loses its *elastic stability*. See [EULER FORMULA](#), [LATERAL BUCKLING](#), [LOCAL BUCKLING](#) and [TORSION BUCKLING](#).

budgetary control The process of comparing actual expenditure with budgeted amounts and the subsequent adjustment of expenditure in order to keep within total budgeted amounts.

buffer (mechanical) A device comprising a means of braking using fluids or springs, capable of absorbing the kinetic energy of motion of a descending lift CAR or COUNTERWEIGHT, when either has passed a normal limit of travel, by providing a resilient stop. An *oil buffer* dissipates energy; a *spring buffer* accumulates energy.

bug An error or malfunction in a computer program or system.

bugle-head screw A screw with the head smoothly curved to the shank, designed to embed itself into the paper covering of plasterboard without tearing it.

building block A masonry unit, usually larger than a brick. It is often hollow, and may be made of concrete, burnt clay or terra cotta.

building board Board used for ceilings and for the interior lining of walls generally less than 15mm thick and more than 0.6m (2ft) wide. The term is not precisely defined and includes boards made from a wide range of materials.

building efficiency A ratio of the rentable or net lettable area to the gross area, expressed as a percentage.

building model A representation of a building. In a computer this takes the form of a computer building model incorporating both graphic and non-graphic information.

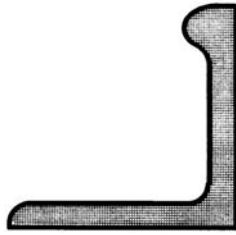

bulb angle

building paper Heavy paper, sometimes reinforced with fibres and waterproofed with bitumen.

building services A collective term for the services and utilities required to maintain the interior environment of a building.

built-in (or fixed-ended) beam or slab A condition of support that prevents the ends from rotating in the plane of bending. It does not imply longitudinal constraint. Built-in beams and slabs are **STATICALLY INDETERMINATE STRUCTURES**.

built-up roofing Flat roof built with multiple layers of **ROOFING FELT**, as distinct from a roof built with a single layer. Also called *composition roofing* or *roll roofing*.

bulb angle A steel or aluminium angle section enlarged at one end, i.e. a section intermediate between an angle and a channel (see Figure).

bulb of pressure See **BOUSSINECQ PRESSURE BULB**.

bulb tee A strengthened steel or aluminium T-section, used particularly as a sub-**PURLIN**. See also **BULB ANGLE**.

bulk density The weight of a porous material per unit volume, including the voids. See also **SPECIFIC GRAVITY** and **APPARENT VOLUME**.

bulking Increase in the volume of sand when it is in a damp condition, as compared with its volume when dry. It must be allowed for when measuring sand by volume, instead of by weight. Bulking increases appreciably with increasing moisture content, and then declines again; completely inundated sand occupies practically the same volume as dry sand.

bulk modulus of elasticity The ratio of the triaxial (tensile or compressive) stress, equal in all directions, to the corresponding change in volume. The most common example is that of **HYDROSTATIC PRESSURE** and the corresponding volumetric strain.

bulk replacement (of lamps) The replacement of electric lamps as part of a planned maintenance program before they fail; compared with **SPOT REPLACEMENT**.

bulk volume of a porous substance The total volume, including closed and open pores. See also **APPARENT VOLUME** and **TRUE VOLUME**.

bullet-resisting glass An armoured glass consisting of a laminated assembly of four or more sheets of glass alternating with sheets of transparent plastic resin, bonded under pressure and heat.

bull header A brick made with one long corner, or ARRIS, rounded. It is used for rounded sills and corners.

bullnose The rounding of an ARRIS.

bull's eye (a) A small circular or oval opening, or window. (b) The centre of a disc of CROWN GLASS.

bundled reinforcement A group of up to four parallel reinforcing bars in contact with each other, enclosed in stirrups or ties, and used as a reinforcing element in a concrete structural member.

bundled tube structure A structural system that consists of several TUBE STRUCTURES bundled together, e.g. in the Sears Tower in Chicago.

Bunsen burner A type of burner, widely used in laboratories, in which the amount of air to be mixed with gas can be adjusted before burning. The idea is attributed to R.W.Bunsen, a nineteenth-century German chemistry professor. The concept was used in gas lighting.

buoyancy The reduction in the weight of a body immersed in a liquid, particularly in water, due to the upward pressure exerted by the liquid. If the body floats in the liquid, its weight is equal to the weight of the liquid displaced. This is known as the PRINCIPLE OF ARCHIMEDES, after the Greek philosopher who discovered it in Sicily in the third century BC

buoyant foundation A reinforced concrete raft foundation so designed that the weight of the load carried by it (generally its own weight and that of the building) equals the weight of the soil and water displaced. It is particularly useful in fine-grained soils whose WATER TABLE is near the surface.

burette A cylindrical graduated glass tube fitted with a ground glass stop-cock, used for the measurement and delivery of small volumes of liquid in a laboratory.

burl A FIGURE in wood caused by an adjacent knot, enlarged rootstock or other large excrescence. It is decorative on veneers, but may be a source of weakness in boards. See also [CROTCHWOOD](#).

burlap A coarse fabric of hemp or jute. It is frequently used to cover concrete during curing to reduce evaporation. Also called *hessian*.

burnt sienna SIENNA that has been CALCINED, and consequently turned brown.

burnt umber UMBER that has been CALCINED, and consequently turned reddish-brown or red.

burr The rough or sharp edge left on metal by a drill, saw or other cutting tool.

bus bar A bare, i.e. uninsulated, electrical conductor, from which circuits can be tapped. Also spelt *busbar*.

bushel A unit of capacity, used particularly for grain. It equals 32 US quarts (=0.0352m³), or 32 British quarts (=0.0364m³).

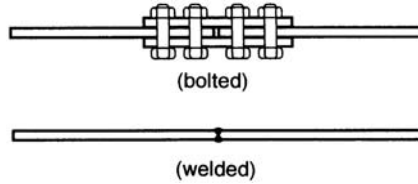
**butt joint**

bush hammered A finish to in situ and precast concrete made by hammering with a knurled-headed tool to remove the mortar surface and expose the aggregate.

butment Same as ABUTMENT.

butterfly roof A roof consisting of two sloping surfaces, connected at the *lower* edges.

butt joint A joint between two pieces of material that are in line *butting* against each other (see Figure), with or without cover plates; as opposed to a LAP JOINT. See also [FISHPLATES](#).

buttress A projecting structure built against a wall to resist a THRUST (see Figure (a) for *retaining wall*, (b) for *Gothic church*). A *flying buttress* is suspended in the air for the same purpose.

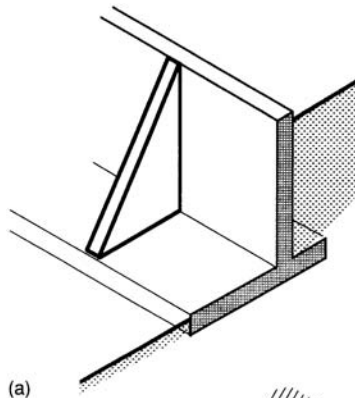

(a)

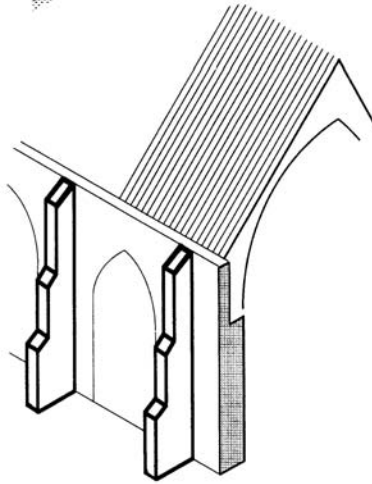

(b)

buttress

butt strap A cover plate used in a BUTT JOINT.

byte In computing, a set of BITS operating as a unit, usually 8 bits, corresponding to a single character.

C

°C Degree CELSIUS.

C Chemical symbol for *carbon*.

c Abbreviation for *centi*, one hundredth.

Ca Chemical symbol for *calcium*.

CAAD Computer-aided architectural design.

CAB plastic Abbreviation for CELLULOSE ACETATE BUTYRATE plastic.

cable (a) A structural member that is flexible and can therefore resist only tension, and not compression or flexure. See also [ARCH](#). (b) One or more electrical conductor enclosed in an insulating sheath.

cable, electric The conductor through which an electric appliance or lamp receives its power.

cable, prestressing See [TENDON](#).

cable, suspension See [SUSPENSION CABLE](#).

cable ducts Rigid metal ducts for insulated electric conductors with removable covers, used mainly above ground. Concrete or plastic pipes are generally used for this purpose below ground.

cable lay See [LAY](#).

cable management The management of reticulation required for electrical, data and telecommunications cables.

cable stays Straight cables connected directly to a roof or floor structure without suspenders, and anchored to a mast. They transfer the load from the structure to the top of the mast, whence it is transmitted to the ground, and thus allow substantial increases in the clear span of the structure (see Figure).

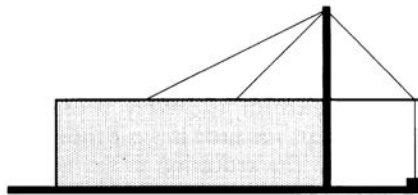

cable stay

cable structure See **SUSPENSION ROOF**.

cable tray A rectangular tray, in which cables travel through a building.

CACA Cement and Concrete Association, London or Sydney.

CAD Abbreviation for (a) computer-aided design; (b) computer-aided drafting.

CAD/CAM Computer-aided design/ computer-aided manufacturing.

CADD Computer-aided drafting and design.

cadmium plating Plating with metallic cadmium, applied to steel bolts used in conjunction with aluminium to prevent **ELECTROCHEMICAL CORROSION**.

cadmium yellow Cadmium sulphide, a permanent pigment ranging in colour from pale yellow to orange.

CAE Computer-aided engineering.

CAFM Computer-aided facility management.

caisson A watertight chamber used for construction in waterlogged ground, or below water.

caisson pile A cast-in-place concrete pile, made by driving a tube, excavating it, and filling the hole with concrete.

calcareous Containing calcium, or more commonly calcium carbonate (CaCO_3).

calcimine Same as **KALSOMINE**.

calcine An old-fashioned term, dating from the days of alchemy and early chemistry, for altering the composition of a substance by heating it below the temperature of fusion.

calcite The crystalline form of calcium carbonate, CaCO_3 . It is a common constituent of limestone, marble, and some igneous rocks.

calcium A silvery-white metal. Its chemical symbol is Ca, its atomic number is 20, its atomic weight is 40.08, its specific gravity is 1.55, its valency is 2, and its melting point is 851°C . Its oxide is **QUICKLIME**.

calcium-aluminate cement Same as **HIGH-ALUMINA CEMENT**.

calcium carbonate One of the abundant minerals in the earth's crust (CaCO_3). It is the material of which limestone, chalk and marble are composed, and a principal raw material for cement and mortar.

calcium chloride An **ACCELERATOR** used for concrete.

calcium hydroxide Slaked lime (Ca(OH)_2).

calcium oxide Quicklime (CaO).

calcium-silicate brick A light-coloured brick made principally from sand and lime. It is usually hardened by **AUTOCLAVING**. Also called a *sandlime brick*.

calcium sulphate Anhydrite (CaSO_4).

calcium sulphate hemihydrate Same as **PLASTER OF PARIS**.

caldarium The hot room in an Ancient Roman bath.

calibre Originally the diameter of a cannon-ball or bullet. Hence the bore of the gun, or of any pipe.

California Bearing Ratio (CBR) A standard test for determining the bearing capacity of a foundation. It is defined as the ratio of the force per unit area required to penetrate the foundation soil with a circular piston (area $3\text{in}^2 = 1935\text{mm}^2$) at a rate of 0.05in. (1.27mm) per minute, to the force required for

penetration of a standard material (usually crushed rock). The measurement is commonly made after 2min penetration.

calipers US spelling of CALLIPERS.

calking US spelling of CAULKING.

callipers A pair of steel legs, joined by a pivot. They may be *external* (curved convex for measuring the outside diameter) or *internal* (curved concave for measuring the inside diameter of a tube). Also spelled *calipers*.

callow brick An underburnt brick.

calorie (cal) The quantity of heat required to raise 1g of water through 1°C. The term is, however, commonly used (incorrectly) without prefix for the large or kilocalorie, which equals 1000 cal. In SI UNITS the calorie has been replaced by the JOULE; 1cal=4.187J. For conversion to FPS units, 1kilocalorie= 3.968Btu.

calorific value The amount of heat liberated by the complete burning of a unit weight of a fuel.

calorifier A closed tank in which water is heated by submerged hot pipes.

calorimeter (a) An instrument for measuring the heat exchange during a chemical reaction. It is particularly used for measuring the heat produced by the combustion of a material. (b) A vessel containing the liquid used in CALORIMETRY.

calorimetry The measurement of thermal constants, such as SPECIFIC HEAT, LATENT HEAT, or CALORIFIC VALUE. This is generally done by observing the rise of temperature that a heat exchange causes in a liquid (commonly water) contained in a calorimeter.

cam (a) A mechanism for converting circular into regular or irregular linear motion. It consists of a wheel, of a carefully designed non-circular form, attached to a shaft. For example, cams are used to open and close the valves in an internal-combustion engine. (b) An abbreviation for computer-aided manufacturing. See [CAD/CAM](#).

camber A slight upward curvature of a structure to compensate for its anticipated deflection.

cambium The cellular layer of wood tissue between the bark and the sapwood of a tree.

cameo A striated precious stone (such as ONYX) or a shell carved in relief to exhibit the various colours in the layers. Hence, any modelled relief exhibiting different colours.

comes Lead strips of H-section, used to assemble small pieces of glass, often diamond-shaped, into a LEADED LIGHT.

campanile A bell tower, particularly one that is tall and detached from the building.

Canada balsam A yellowish liquid of pine-like odour, soluble in ether, chloroform and benzene. It is used for lacquers and varnishes, and also as an adhesive for lenses, because its refractive index is almost identical with that of most optical glasses.

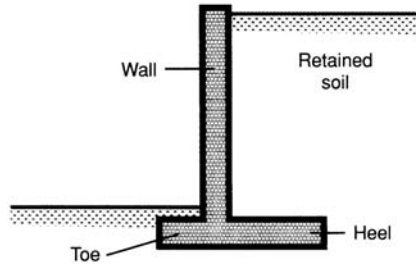

cantilever retaining wall

candela (cd) Unit of LUMINOUS INTENSITY, or luminous flux per unit solid angle. It is a fundamental unit defined in terms of the LUMINANCE of a standard radiator.

candle power An obsolete unit of luminous intensity whose place has been taken by the CANDELA.

canopy A roof-like covering, usually projecting, over an entrance or window, or along the side of a wall.

cantilever A projecting beam, truss or slab supported only at one end.

cantilever, propped See [PROPPED CANTILEVER](#).

cantilever bridge A bridge continuous over several spans, which is made STATICALLY DETERMINATE by the insertion of hinges, using the GERBER BEAM principle. It is particularly useful where bridges have to be supported on poor foundations that may settle, since the bridge can take up small foundation movements without statically indeterminate stresses.

cantilever retaining wall A wall retaining soil by cantilever action, as distinct from a retaining wall that spans between COUNTERFORTS or BUTTRESSES as a continuous slab. The wall normally consists of three cantilevers (see Figure): the wall that resists the horizontal EARTH PRESSURE, and the HEEL and the TOE, both of which resist vertical earth pressures.

cantilever steps See [GEOMETRICAL STAIR](#).

canvas A strong, unbleached, closely woven cloth of flax, hemp, or cotton.

cap (a) The topmost member or part of a structure or a building element. (b) A fitting used to close the end of a tube or pipe. (c) A PILE CAP. (d) Synonym for a *detonator*. (e) An alternative term for a LAMP BASE.

capacitance In electricity, the property of a system that allows it to store an electric charge. It is measured in FARADS.

capacitance strain gauge A strain gauge that utilises the principle that the capacitance of a parallel plate condenser is changed by varying the separation of the plates.

capacitor A device for accumulating electric charge; an electric component that introduces CAPACITANCE into a circuit.

capacity reduction factor A factor used in the ULTIMATE STRENGTH DESIGN of structures to provide a margin of safety against collapse or serious

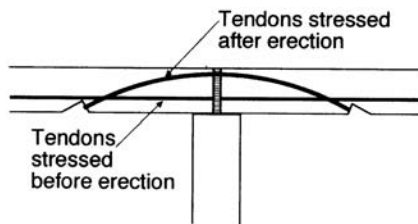

capping cables

structural damage. It allows primarily for deficiencies in the structural materials, and it is additional to the LOAD FACTOR. Also called *strength reduction factor*.

cap cables Same as CAPPING CABLES.

capillary action The action of a CAPILLARY TUBE, when dipped into a bucket of water, to cause the level in the tube to rise above that of the bucket. It is caused by SURFACE TENSION.

capillary tube A tube with a very fine bore.

capillary water Water held by CAPILLARY ACTION in the soil *above* the water table.

capital See COLUMN CAPITAL.

capital cost (of a building) The prime cost of construction, including acquisition of the land, design, materials, equipment and erection. See also ANNUAL COST and LIFE CYCLE COST.

capping cables Short TENDONS introduced into *statically indeterminate prestressed structures* in the zone of negative bending moment (see Figure).

car The load carrying unit of a LIFT (elevator) system, comprising the enclosure, or cab, the car frame, platform and doors.

carat (a) For weighing precious stones, 1carat=0.2gram. (b) For measuring the gold content of an alloy, pure gold= 24carat, so that 22carat gold contains 2 parts of alloying metal.

carbon A non-metallic element. Its chemical symbol is C, its atomic number is 6, its valency is 4, its atomic weight is 12.01, and its melting point is above 3500° C. It occurs in several allotropic forms: in crystalline form as diamond and as graphite, and in amorphous form as charcoal, coke, etc. Its specific gravity depends on its form.

carbon arc lamp A high-intensity electric-discharge lamp employing an arc discharge between two carbon electrodes.

carbonation Chemical reaction between calcium compounds and carbon dioxide; calcium carbonate is produced. The reaction occurs slowly when carbon dioxide is absorbed from the atmosphere.

carbon black Finely divided amorphous carbon, used as a mineral pigment in plastics, concrete, paint, etc. It is produced by burning petroleum or natural gas in a supply of air insufficient for complete combustion.

carbon dioxide A colourless gas normally found in the atmosphere at concentrations between 300 and 350ppm. It is absorbed by plants, and produced by the decomposition and/or combustion of fossil fuels and by animal metabolism. It is a contributor to global warming. It is sometimes used as a marker for the adequacy of ventilation in enclosed spaces.

carbon monoxide A colourless and odourless gas, toxic in very low concentrations. It is the product of incomplete combustion of fossil fuels.

carbon steel A STEEL containing up to 1.7 per cent of carbon, but generally less than 1.0 per cent. See also [PHASE DIAGRAM](#).

carborundum Silicon carbide (SiC), an abrasive, not to be confused with CORUNDUM.

carburising The introduction of carbon into the surface of steel by holding it at a suitable temperature in contact with carbon and nitrogen, for example by CASE HARDENING.

carcass In building construction, the load-bearing part of the building without the finishes. Also spelled *carcase*.

cardioid microphone A microphone containing two sensitive elements arranged so as to give a polar response that is substantially unidirectional.

car door closer A device attached to a LIFT DOOR, which ensures that the car doors and landing doors close automatically, using the stored energy of a spring or weights.

Carnot cycle An ideal cycle for a heat engine, described by S.Carnot in France in 1824. It gives the maximum theoretical efficiency for a heat engine, which cannot, however, be attained by any practical engine.

carpenter's brace A cranked hand tool used for turning the drilling BIT to make holes in timber. It has been largely superseded by electrical drills.

carpet A knitted, woven, or needle-tufted heavy fabric used as a floor covering. See also [WARP](#) and [WEFT](#).

carpet pile The tufts of yarn that stand erect from a carpet. The height of the pile is measured from the top of the backing material to the surface of the carpet.

carpet underlay or underlayment Material laid directly on the floor to act as padding for the carpet laid over it.

carport A shelter for a car, attached to or near a house, which contains a roof, but no door. It usually does not have walls on all sides.

carrel A small enclosure in the stack of a library, designed for individual study.

carriage bolt A bolt that is threaded at one end to receive a nut, and has a circular head at the other end. The circular head is prevented from rotating by a square or ribbed neck.

Cartesian coordinates The coordinates conventionally used for plotting a curve; a system of coordinates that defines the location of a point in terms of its perpendicular distances from each of a set of mutually perpendicular axes. They are named after the seventeenth-century mathematician René Descartes. In two dimensions, the horizontal axis is called the *abscissa* and the vertical axis the

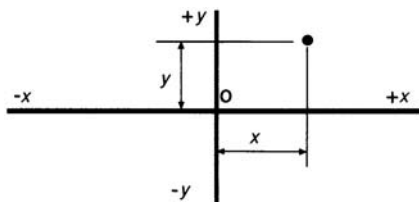

Cartesian coordinates

ordinate (see Figure). In three dimensions, Cartesian coordinates are usually called the x -, y - and z -axes.

car top inspection station Control panel located on the top of a lift car, which allows the lift to be removed from normal service, and controlled from the car top.

case hardening CARBURISING the exterior of a low-carbon steel, so as to increase its surface hardness without impairing its overall DUCTILITY. For example, the carbon may be absorbed from a molten bath of sodium cyanide, and the steel is then QUENCHED to produce a hard case.

casein glue Adhesive manufactured from milk powder.

casement window A window contained in case frames, which is hinged and opens outwards; as opposed to a SASH WINDOW. The more common type of casement window is hinged vertically, or *side-hung*. The *top-hung* casement or *awning* window is hinged horizontally, and must be held open with a *casement stay*.

CASE tools Computer-aided software engineering tools.

cash flow Receipts and expenditure of money by an organisation or individual during a period. See also [DISCOUNTED CASH FLOW METHOD](#).

casino Originally a small country house or summer house. Later a public room or building for social occasions, and more recently for gambling.

castellated Decorated with battlements.

castellated beam A steel beam formed by cutting a ROLLED STEEL JOIST along the web in a zigzag shape. The two halves are then welded together at the crests of the cuts. The resulting beam is deeper, but it has a series of holes in the web. The SECTION MODULUS can be doubled by this technique.

Castigliano's method See [STRAIN ENERGY METHOD](#).

casting resins PLASTICS that can be cast. They may be THERMOSETTING RESINS or COLD-SETTING resins.

cast in place Cast liquid in its permanent location, where it hardens as part of the building, as opposed to PRECAST. Monolithic concrete must be cast in place.

cast in situ CAST IN PLACE, as opposed to PRECAST.

cast iron Iron with a total carbon content between 1.8 and 4.5 per cent. It is one of the two traditional forms of iron, the other being WROUGHT IRON. Steel is intermediate between the two in carbon content, but prior to the invention of the BESSEMER PROCESS it could only be produced at great expense. Cast iron

was used extensively in the nineteenth century for structural members and for railings. It is hard, brittle, and easy to cast into moulds. *Grey cast iron* contains some free carbon in the form of GRAPHITE; in *white cast iron* all the carbon is present as IRON CARBIDE.

castor A wheel set in a swivel frame, attached to a piece of furniture or to a mobile machine.

cast stone Same as ARTIFICIAL STONE.

catalyst A substance that causes or ACCELERATES a chemical reaction without being itself transformed in the process.

catenary The curve assumed by a freely hanging cable of uniform section, due to its own weight. The stresses in it are purely tensile. Its mathematical equation is

$$y = a \cosh(x/a)$$

where a is a constant.

catenary arch An arch shaped like an inverted catenary, so that the stresses due to its own weight are purely compressive. See also PARABOLIC ARCH.

cathode The negative electrode of an electrolytic cell, or battery. The *anode* is the positive electrode.

cathode-ray tube An evacuated glass tube, in which a narrow beam of electrons, emitted from an electron gun, impinges on a fluorescent screen. The beam is subjected to transverse magnetic and electrostatic fields, whose intensities control the position of the luminous spot. It can thus be used for the graphic display of measurements, or In VISUAL DISPLAY UNITS.

cathodic protection A method of applying a small electric current to metal structures to counteract the corrosive effects of contact between dissimilar metals in the presence of an electrolyte.

cation A positive ion; the opposite of an *anion*, which is negative.

catwalk An elevated narrow walkway.

caulking The process of making a joint watertight. The term originally implied stopping up the joints with OAKUM and melted pitch. It is now also applied to stopping with mastics, rubber, silicone and other flexible sealants. Also spelt *calking* (USA).

caustic potash Potassium hydroxide (KOH).

caustic soda Sodium hydroxide (NaOH).

cavity shell See DOUBLE-WALLED SHELL.

cavity wall A wall built of an inner and outer leaf, or *wythe* (see Figure). It usually consists of two leaves of STRETCHER brickwork (110mm or in. nominal thickness) with a cavity of about 50mm, to make the wall 275mm or 11in. thick overall. It is usually used as an external wall, where the cavity drains any water penetrating the outer leaf. The cavity provides good acoustic insulation, and is of some assistance in insulating against solar heat loads. The wall has poor thermal resistance against heat loss. The two leaves are tied by metal wall ties at intervals. The inner leaf carries the floor joists and the roof

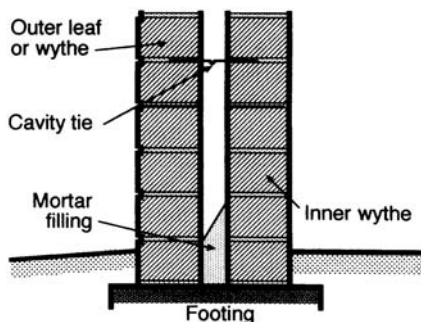

cavity wall

framing. Cavity walls are not used in very cold climates, such as the North-East of the USA, because the cavity would fill with ice. A BRICK VENEER WALL is also a cavity wall, with only the outer leaf being of brickwork.

CBD Central business district.

CBR Abbreviation for (a) California Bearing Ratio; (b) case-based reasoning.

cc Abbreviation for (a) cubic centimetre; (b) centre to centre.

CCT Abbreviation for CORRELATED COLOUR TEMPERATURE.

CCTV Closed-circuit television.

CD Abbreviation for COMPACT DISC.

CD-ROM Compact disc read-only memory.

cd/m² CANDELA per square metre, the unit of LUMINANCE.

CEBS Commonwealth Experimental Building Station, Sydney. Later renamed Experimental Building Station (EBS), the National Building Technology Centre, and now part of the Commonwealth Scientific and Industrial Research Organisation (CSIRO)

CEBTP Centre Experimental de Recherches et d'Études du Bâtiment et des Travaux Publics, Paris.

CEI Council of Engineering Institutions, London.

ceiling The upper surface of an interior space. It is usually *suspended* from the structure of the floor of the roof above, and covers it.

ceiling cavity In lighting design, the part of the room above the luminaire plane. The *ceiling cavity ratio* is a number calculated from its proportions, used in lumen- or flux-method calculations.

ceiling diffuser An air outlet from an air conditioning duct, which diffuses the air over a larger area to produce an even distribution and (a) avoid draught. It is often combined with (b) a LUMINAIRE (see Figure).

ceiling fan A slowly rotating overhead fan with a wide sweep. It moves large volumes of air at a low speed, and is widely used in hot-humid climates to improve thermal comfort.

ceiling joist A JOIST that carries the ceiling below it, but not the floor or roof over the ceiling.

ceiling plenum See [PLENUM](#).

ceiling tile See [ACOUSTIC TILE](#).

celerity Swiftness of movement, specifically the velocity of the surge wave travelling within a pipeline during a WATER HAMMER analysis.

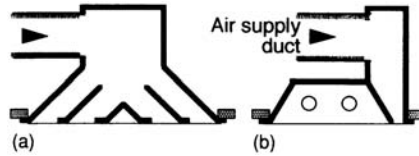

ceiling diffuser

cell, electrical A device for converting chemical energy to electrical energy, usually consisting of two electrodes in an electrolyte.

cellular concrete Lightweight concrete containing a substantial proportion of air or gas bubbles. It is produced by adding either a foaming agent (such as detergent) or a gas-forming agent (such as aluminium powder) to the mix. Cellular concrete, which contains sand, is lighter than LIGHTWEIGHT AGGREGATE concrete, but heavier than water. Cellular concrete, which floats on water, can be made from cement, water and a foaming or gas-forming agent; this material has insufficient strength for structural purposes, and is used mainly as a thermal insulator and as a stiffener for a light-gauge steel or aluminium structure. Also called *aerated concrete* or *foamed concrete*.

cellular plastic Same as EXPANDED PLASTIC.

celluloid One of the first THERMOPLASTIC materials to be made artificially, but now rarely used. It is made from plasticised NITROCELLULOSE with camphor.

cellulose acetate butyrate More commonly known as CAB plastic, it is used for pipes and injection mouldings. The cellulose is made from bleached wood pulp or cotton linters, and is esterised with butyric acid and acetic anhydride.

cellulose nitrate Same as NITROCELLULOSE.

celsius scale The temperature scale fixed by the boiling point of water (100°C) and its freezing point (0°C), suggested by the Swedish physicist Celsius in 1740. Also called *centigrade scale*. To convert to the Fahrenheit scale (°F), multiply by 1.8 and add 32.

cement See PORTLAND CEMENT; see also COLOURED CEMENT, EXPANSIVE CEMENT, HIGH-ALUMINA CEMENT, HYDRAULIC CEMENT, LOW-HEAT CEMENT, NATURAL CEMENT, PORTLAND BLAST-FURNACE SLAG CEMENT, PORTLAND-POZZOLAN CEMENT and WHITE CEMENT.

cementation Injecting cement grout under pressure, e.g. into fissured rock.

cement clinker The product of burning the raw cement mix. Cement is made by finely grinding the clinker. PORTLAND CEMENT mix is normally burnt at a temperature of approximately 1400°C (2600°F) in a rotary KILN.

cement grout A cement slurry that is sufficiently fluid to penetrate into rock fissures, masonry joints or prestressing ducts without segregation.

cement gun A machine for placing mortar or concrete through a nozzle under pressure. The mixture of cement and small aggregate is forced by compressed air

through a hose to the nozzle, where water is added from a separate pipe. The resulting material is known as *gunite*, *pneumatically applied mortar*, or *shotcrete*.

cementite The iron carbide (Fe_3C) constituent of cast iron and steel. It is crystalline, hard and brittle.

cement mortar A mixture of sand and cement.

cement paint A paint that can be used over cement. It is either a mixture of cement and pigment, or a paint based on alkali-resistant vehicles such as *casein* or *tung oil*.

cement slurry A liquid mixture of water and cement.

cement-stabilised soil Soil, usually natural but sometimes imported, formed into a pavement by the addition of cement and water, mixed in situ, and compacted with a roller. If the natural soil is suitable, it can constitute a cheap and effective light-duty pavement.

CEN Comité Européen de Normalisation, Brussels.

CENELEC Comité Européen de Normalisation Electrotechnique, Brussels.

centering A temporary structure on which the masonry of a vault or arch is supported until the structure becomes self-supporting.

centi The Latin prefix for hundred, used now for one hundredth, e.g. 1centimetre=0.01metre.

centigrade scale An obsolescent term for CELSIUS SCALE.

centimetre One hundredth of a METRE= 0.394in.

central processing unit The heart or nerve-centre of a computer. It coordinates and controls all the activities of the other units, thus carrying out all the arithmetic, logic and control operations.

centre frequency This term is used to define a BANDPASS FILTER. The centre frequency is the geometric mean of the upper and lower cut-off frequencies of the filter: e.g. an octave-band filter with an upper cut-off frequency of 1414Hz and a lower cut-off frequency of 707Hz would have a centre frequency of 1000 Hz and would be known as a 1000Hz octave-band filter.

centre of gravity Same as CENTROID.

centre of mass Same as CENTROID.

centre of pressure The point of action of the resultant force acting on an area subjected to liquid pressure. Since liquid pressure increases with depth, its location is below the centroid.

centre punch A small bar of hard steel with a blunt point. It is used to mark the centre of a hole to be drilled, so that the drill starts in the correct place.

centrifugal compressor, fan, pump A compressor, fan (see Figure), pump with an impeller of *paddle-wheel* form, in which the fluid enters axially at the centre and is discharged radially by centrifugal force (see Figure). By contrast, an AXIAL-FLOW FAN is a propeller fan, with the blades mounted on the axis.

centring Same as CENTERING.

centroid The point of any plane figure through which all CENTROIDAL AXES pass. It is often referred to as the *centre of gravity* or *centre of mass* of the figure,

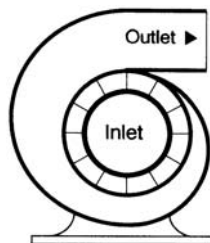

centrifugal fan

since a piece of cardboard or sheet metal of this shape balances if hung freely from the centroid.

centroidal axis An axis of any plane figure about which the moment of the area is zero. See [MOMENT OF AN AREA](#).

ceramic mosaic Ceramic tiles, arranged in patterns on a paper backing, and sold in sheet units ready for placing.

ceramics (a) In building, any component made from burned clay, such as brick, terra cotta, ceramic tile (glazed or unglazed), stoneware pipe, and other pottery. (b) In solid-state physics, compounds of metallic and non-metallic elements; these include clay, cement and natural stone.

ceramic tile Clay tile for wall, floor or roof.

ceramic veneer Large units of thin TERRA COTTA, generally moulded by EXTRUSION.

certification Documentation of the compliance with statutory requirements by an accredited third party.

CET Abbreviation for CORRECTED EFFECTIVE TEMPERATURE.

CF Abbreviation for CONFIGURATION FACTOR.

CFC Chlorinated fluorocarbons, also known as *fluorinated hydrocarbons*, or as *halocarbons*. Most are known under the trade name of *freons*. Synthetic non-toxic, non-flammable, non-corrosive, and non-irritant refrigerants. They were widely used as refrigerants for VAPOUR COMPRESSION CYCLE refrigeration machines until it was found that they have an OZONE DEPLETION potential. They are now being replaced by the use of HCFC and HFC.

CFD Abbreviation for COMPUTATIONAL FLUID DYNAMICS.

CG Abbreviation for CENTRE OF GRAVITY.

CGI Abbreviation for COMPUTER GRAPHICS INTERFACE.

CGS units The units of the traditional metric system, based on centimetre, gram and second. Another term is *MKS units*, based on the metre, kilogram and second. They have been replaced by SI UNITS.

chain An obsolete measure of length, equal to the surveyor's chain of 66ft= 20.12m.

chair, bar See [BAR CHAIR](#).

chalet Originally a herdsman's hut in the Swiss mountains; hence, a house built in the style of an Alpine cottage.

chalk A soft LIMESTONE.

chalking Disintegration of paint and other coatings, which produces loose powder at, or just beneath, the surface.

chalk line A length of string that has been thoroughly coated with chalk dust. It is pulled tight across a piece of timber or other material, and plucked, thus producing a straight chalky line, which serves as a guide during cutting.

chamfer A right-angled corner cut symmetrically, i.e. at 45°. See also [BEVEL](#) and [SPRAY](#).

chamfer strip An insert placed into an inside corner of concrete formwork to produce a chamfer.

channel section A metal section shaped [.

character See [ALPHANUMERIC CHARACTER](#).

characteristic curve A graph showing a relationship, for example between the fluid flow rate and the increase in pressure in a CENTRIFUGAL FAN.

character set The set of numbers, letters, graphics and symbols accepted as legal by a computer.

character string A sequence of ALPHANUMERIC CHARACTERS.

Charles' law 'The volume of a given mass of gas, kept at a constant pressure, increases by of its volume at 0°C for each degree rise of temperature.' Also known as *Gay-Lussac's law*. See also [BOYLE'S LAW](#).

Charpy test An impact test carried out on a notched specimen fixed at both ends. The energy absorbed during fracture is measured by a pendulum.

chase A groove cut into a wall or floor to receive a small pipe, conduit, cable or flashing. A very large chase is a DUCT.

check See [SEASONING CHECK](#).

check valve A valve used in pipework to allow the fluid to flow in one direction only.

chemical anchor A masonry anchor in which a high-strength adhesive is introduced into the hole to bond the bolt to the masonry.

cherry picker A platform at the end of an extendable boom, usually mounted on a wheeled vehicle for mobility. It is used for hoisting people and materials. Also called *hydraulic platform*.

chert A very fine-grained, hard siliceous rock, which sometimes includes the remains of siliceous organisms. It tends to splinter when it is fractured. See also [FLINT](#).

chevron (a) The meeting of two rafters at an angle at the ridge of a roof. (b) Hence a decoration consisting of two lines meeting at an angle, or a zigzag pattern of lines.

chiaroscuro The disposition of light and shade in the pictorial composition of a painting. The term is also used in sculpture and photography.

chicken-wire A netting of lightweight galvanised wire, usually with a hexagonal mesh.

chilled water Water at a temperature substantially below ambient temperature, used as a heat transfer medium for the cooling and dehumidification cycle in some air conditioning systems.

chimney cowl A revolving metal ventilator over a chimney.

China clay A pure white form of hydrated aluminium silicate, resulting from the decomposition of FELSPARS contained in igneous rock. It is the raw material for the best quality pottery (*porcelain*). Also called *kaolin*.

China wood oil Same as TUNG OIL.

Chinese white Zinc oxide (ZnO). A permanent, non-poisonous white pigment.

chip (a) An INTEGRATED CIRCUIT etched on SEMICONDUCTOR material and hermetically sealed; usually plugged into a printed circuit board. Chips may contain processing, memory, input-output or other circuits. (b) Small broken fragment. The term is commonly employed for small-size aggregates used for decorative concrete surface finishes (e.g. marble chips).

chipboard Same as PARTICLE BOARD.

chirp A sound consisting of a single tone, whose frequency is rapidly and continuously increased or decreased between two audible limits. It is often used as an emergency signal, because it can be easily heard.

chisel A metal hand-tool with a cutting edge at one end. Different chisels are used for working metal, wood, and stone. A *cold chisel* is used for cutting metal that has not been softened by heating, and it has a hardened and tempered steel edge. A *wood chisel* is usually mounted in a wooden handle.

chi-square test In STATISTICS, a test of compatibility of observed and expected frequencies, based on the function

$$\chi^2 = \sum_{i=1}^k \frac{(n_i - e_i)^2}{e_i}$$

where n_i and e_i are the i th pair of the observed and expected frequencies, and k is the number of frequencies.

chloride See CALCIUM CHLORIDE and POLYVINYL CHLORIDE.

chlorinated rubber A white powder formed when natural rubber is treated with chlorine under heat and pressure. It is soluble in coaltar solvents, and produces paint films of exceptionally good chemical resistance.

chlorination Disinfectant treatment of drinking water, and sometimes sewage, with a source of chlorine, such as bleaching powder (*calcium chloride*).

chlorine A highly reactive gas, and a powerful oxidising agent, frequently used in the form of bleaching powder (*calcium chloride*). Its chemical symbol is Cl, its atomic number is 17, its atomic weight is 35.5, and its boiling point is -34.6°C

chord (a) A principal member of a truss, usually on its top or its bottom. (b) A term sometimes used for the CLEAR SPAN of an arch. (c) A straight line connecting two points on a curve.

chroma The attribute of a colour that allows the observer to judge how much colour it contains; in the Munsell colour system (see

MUNSELL BOOK OF COLOR) the chroma scale correlates the saturation of the colour, and it ranges from/1in arbitrary steps to express departure from the equivalent grey.

chromatic aberration A lens defect, which results in coloured fringes on images due to the variation of the refractive index with the colour (or wavelength) of light.

chromaticity Of, pertaining to or characterised by a colour or colours.

chromaticity diagram See **CIE CHROMATICITY SYSTEM**.

chromatic scale Musical scale consisting of 12 equal semitones per OCTAVE, so that the ratio of the frequencies of any two successive semitones is $2^{1/12}$. See also **DIATONIC SCALE**.

chromium A bright, silvery metallic element, used in STAINLESS STEEL and other alloys. Its chemical symbol is Cr, its atomic number is 24, its atomic weight is 52.0, its specific gravity is 7.14, and its melting point is 1830°C.

chromium plating Electroplated surface of chromium applied as a protective finish, which is extremely hard. Chromium plating for steel is usually done over a coating of nickel; this in turn is electro-deposited on a coating of copper, which is the first coat on the steel.

CHU Centigrade heat unit, now obsolete. The heat required to raise 1lb of water through 1°C.

churn To change the location of people and furniture to suit new organisational requirements.

churn rate The total number of employee workspace moves per annum, expressed as a percentage of the total number of employees in the facility.

CI Abbreviation for CAST IRON.

CIA Concrete Institute of Australia, Sydney.

CIAM Congrès Internationaux d'Architecture Moderne. The first Congress was organised in 1928 by a group led by Le Corbusier and the art historian Siegfried Giedion. Altogether, ten congresses were held, and the organisation was formally dissolved after disagreement over its objectives in 1959.

CIB Conseil International du Bâtiment pour la Recherche, l'Étude et la Documentation, Rotterdam; the international coordinating body for building research.

CIBS Chartered Institute of Building Services, London; now called CIBSE.

CIBSE Chartered Institute of Building Services Engineers, London.

CIC Computer-integrated construction.

CIDB Le Centre d'Information et de Documentation du Bâtiment, Paris.

CIE Commission Internationale de l'Éclairage, Vienna. The international coordinating body for standardisation and research into light (visible and nonvisible) and its applications.

CIE chromaticity system A method of specifying colour using a coordinate system, Yxy . Other derived, transformed systems have been developed, such as *Lab* and *Luv*. The colorimetric specification of the CIE chromaticity diagrams describes colours by reference to two coordinates, x and y (or a and b or u and

v). This is in addition to the luminance (Y or L) of each colour, which must be determined (with a PHOTOMETER) in order to describe a light source (or surface) fully.

CIE contrast rendering factor (CRF) A measure of the revealing power of a lighting system compared with a reference system, usually the lighting within a uniformly illuminated sphere.

CIE general colour rendering index (CRI) This gives a measure of the colour-rendering properties of a light source compared with that of a full radiator at the same correlated colour temperature as the source. It uses a set of eight test colours to assess the properties of lamps used for general lighting applications. The scale is 0 to 100, with higher numbers indicating superior colour rendering. Most incandescent lamps have general CRIs of 100.

CIE standard clear sky An idealised sky whose luminance varies in accordance with a complex formula devised by Richard Kittler. The luminance is a maximum in the very bright aura around the sun (the circumsolar region) and a minimum at an angle of 90° to the aura. See also [INDIAN STANDARD CLEAR SKY](#).

CIE standard overcast sky An idealised fully overcast sky whose luminance at any point of ALTITUDE θ is

$$L_\theta = \frac{1}{3}L_z(1 + 2 \sin \theta),$$

where L_z is the luminance at the ZENITH. Also called a *Moon-Spencer sky*.

CIFM Computer integrated facility management.

cill Same as SILL.

CIM Computer-integrated manufacturing.

cinder concrete A concrete made with cinders as LIGHTWEIGHT AGGREGATE.

CINVA Centro Interamericano de Vivienda y Planeamiento, Bogotá, Colombia.

circadian rhythm Physiological responses due to the DIURNAL cycle.

circle The curve generated by a point equidistant from another point. It has a constant radius and constant curvature. It can consequently be drawn with a compass or even a piece of string.

circle, great, small See [GREAT CIRCLE](#) and [SMALL CIRCLE](#).

circuit breaker A device for opening an electric circuit automatically in case of an overload, usually by thermal means (heating a bimetallic strip) and/or magnetic means (creating an electromagnet) operating a spring-loaded latch. It is a more elaborate device than a FUSE.

circular arch or shell An arch or shell with a constant radius of curvature, i.e. forming part of the circumference of a circle, as opposed to an ELLIPTICAL, PARABOLIC or CATENARY ARCH. A *semicircular* arch is one forming a complete semicircle.

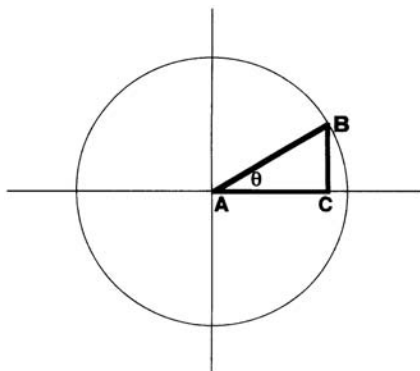

circular functions

$\sin\theta = BC/AB$; $\cos\theta = AC/AB$; $\tan\theta = BC/AC$; $\sec\theta = AB/AC$; $\operatorname{cosec}\theta = AB/BC$; $\cot\theta = AC/BC$

circular functions The functions obtained from the radius of a circle and its horizontal and vertical projections (see Figure). Also called *trigonometric functions*.

circular measure The measurement of an angle in *radians*. A radian is the angle subtended by an ARC equal in length to the radius of the circle. 1radian=57.296 degrees. 1degree=0.017453 radians.

circular saw A saw in the form of a circular steel blade with teeth along its rim. See also [BAND SAW](#).

circulation space The space within a facility that provides access between functional areas for people, goods and vehicles.

circumference The curve that forms an encompassing boundary, especially of anything rounded.

circus (a) In Ancient Rome, a large, *oval* arena surrounded by rising tiers of seats, for the performance of public spectacles. (b) In modern architecture, a circular arena surrounded by tiers of seats and covered by a tent or permanent roof, particularly for the performance of acrobatic or equestrian acts. (c) A circle placed at the junction of two or more streets.

cistern (a) A small tank containing water, for example for flushing a WATER CLOSET. See also [BALLCOCK](#). (b) A reservoir for storing rainwater.

CITC Canadian Institute of Timber Construction, Ottawa.

Cl Chemical symbol for *chlorine*.

cladding (a) A synonym for CURTAIN WALL. (b) Covering a structural material with a protective surfacing material, e.g. *Alclad*, which is aluminium alloy (for strength) covered with pure aluminium (for corrosion resistance). (c) Weatherproof material applied to the exterior of a building.

clapboard A long thin board, graduating in thickness from one edge to the other, used for WOOD SIDING. The thick edge overlaps the thin portion of the board. Called *weatherboard* in England and in Australia.

clarity See [DEFINITION](#).

class A group of objects or concepts with common characteristics.

classification of soils Soils in which gravel and sand predominate are classified by PARTICLE-SIZE ANALYSIS. For engineering purposes, clays are classified by their PLASTICITY INDEX, since it is not practicable to analyse them either by sieving or by sedimentation.

claw hammer A hammer with a split, claw-shaped peen, used by carpenters for drawing nails. See also [BALL-PEEN HAMMER](#).

clay A fine-grained COHESIVE soil produced either by the decomposition of rock, or as a sedimentary deposit. It generally consists of hydrated silicates of aluminium with various impurities, and is in part COLLOIDAL. When clay is mixed with coarser-grained soils, the clay fraction is usually considered to be the part that is finer than $2\mu\text{m}$ (0.002mm) diameter. Its UNCONFINED COMPRESSIVE STRENGTH depends greatly on the water content. Soils containing clay may cause *settlement* of the foundation. Clay is the principal raw material for the manufacture of *brick*. See also [CHINA CLAY](#).

clay puddle A mixture of clay, water and sometimes sand worked while wet into a water-impervious layer of foundation material. It is used as a cut-off wall to prevent the ingress or egress of water.

clay tile (a) Roof tile made from clay. (b) QUARRY TILE for flooring or Wall surfacing. (c) Glazed clay tile for flooring or wall surfacing.

cleanout Inspection opening in drainage pipework. Also called *rodding eye*.

clean room A room with air filters and air precipitators to keep lint, dust, and airborne pathogens below a level that is normally specified for that particular room, and with smooth surfaces that prevent dust collection. Clean rooms are required for certain biological and medical experiments, and for the assembly of precision products.

clearance The space by which an object avoids contact with another. In the case of LIFTS: (a) *Bottom car clearance* is the clear vertical distance from the pit floor to the lowest part (with the exception of guide shoes, rollers, safety jaw assemblies, platform aprons and guards), when a lift car is resting on its fully compressed BUFFERS. (b) *Top car clearance* is the shortest vertical distance between the top of the car crosshead and the nearest part of the overhead structure, or any other obstruction, when a lift car floor is level with the top landing floor. (c) *Running clearance* is the distance between the lift car sill and the lift well entrance sill.

clear sky (a) A sky with less than three-tenths cloud cover. (b) See [CIE STANDARD CLEAR SKY](#) and [INDIAN STANDARD CLEAR SKY](#).

clear span The distance between the inside faces of the supports.

clearstorey The portion of a high room extending above the single storey height of an adjacent portion of the building, and containing *high-light windows* for admitting daylight and sunlight. Also spelt *clearstory*, *clerestorey* and *clerestory*.

clear timber Timber practically free from defects.

cleat, angle See [ANGLE CLEAT](#).

cleavage fracture A fracture along the cleavage planes, characteristic of a BRITTLE fracture, and showing little plastic deformation. It usually occurs abruptly, without warning.

cleavage plane In natural stone, the plane along which natural stone can be split most easily, because of either bedding or metamorphic action. See [SLATE](#).

clepsydra Water clock used by the ancient Greeks, which measures time by the discharge of water.

clerestory or clerestorey See [CLEARSTOREY](#).

climate See [COMFORT ZONE](#).

climbing crane A crane that is moved up as the structure rises. It is eventually dismantled, and taken down in pieces.

climbing formwork Formwork that is raised or pulled in stages to speed the placement of concrete. See also [SLIPFORM](#).

clinker, cement See [CEMENT CLINKER](#).

clinker brick An over-burnt, and often deformed, brick.

clinometer A hand-held instrument for measuring vertical angles on a sloping site; also called an *Abney level* or an *inclinometer*.

clipping The process of cutting objects or a view by another object. For example, a view or a drawing can be clipped by using a clipping plane to hide those portions of the view behind the clipping plane, or a line may be used to clip or trim another line or several lines.

clo The unit for the insulating effect of clothing. It is an arbitrary measure ranging from 0.05clo for a brief swim-suit to 4.0clo for heavy outdoor clothing used in the Antarctic.

clockwise The direction in which the hands of a clock move. The movement of a screwdriver driving a righthanded screw into its hole is clockwise.

closed system A system in which all components for an INDUSTRIALISED BUILDING are made by one manufacturer, and are generally designed for only one type of building.

close grain Wood with narrow growth or annual rings. The opposite is *coarse grain*.

close-packed hexagonal lattice An arrangement of atoms in crystals, which may be imitated by close-packing spheres of identical diameter on a hexagonal grid.

closer See [CAR DOOR CLOSER](#), [KING CLOSER](#) and [QUEEN CLOSER](#).

cloud See [ACOUSTICAL CLOUD](#).

cloudy sky (a) A sky with majority cloud cover, usually more than seven-tenths. (b) See [CIE STANDARD OVERCAST SKY](#).

clout nail A nail with a large flat head, used for fastening sheet metal.

CMYK Abbreviation for Cyan, Magenta, Yellow (the primary subtractive colours), and black; used in subtractive colour mixing, as with dyes, paints and pigments. On colour display terminals, a CMYK option displays colours less saturated than RGB, to represent the appearance of the colours when printed.

CNC Computer numeric control.

coanda effect The surface tension effect by which a stream of air remains in contact with an adjacent surface of a space after discharge from a diffuser.

coarse aggregate The larger size of CONCRETE AGGREGATE used for mixing concrete, as opposed to *fine aggregate*.

coarse grain Wood with coarse growth or annual rings. The opposite is *close grain*.

coarse-grained soil A soil in which sand and gravel predominate.

coarse stuff A blend of sand, hair and lime putty (HYDRATED LIME) used as a BASE COAT for PLASTER.

coaxial cable A cable used for communication, consisting of a central core conductor surrounded by an outer conductor.

cob walling A term synonymous in some places with ADOBE and in others With PISÉ DE TERRE.

coding The process of translating an algorithm into a set of computer instructions in a computer language.

coefficient of elasticity Same as MODULUS OF ELASTICITY.

coefficient of expansion The THERMAL EXPANSION of a material per unit length per degree temperature change; it has different values for Celsius and Fahrenheit degrees, but is otherwise the same for metric and FPS units.

coefficient of friction The *coefficient of static friction* is defined as W/P , where W is the *limiting* FRICTION, or force at which the body just starts to move, and P is the contact force. The coefficient of *kinetic friction* (which is lower) is the W/P required to maintain motion against frictional resistance. ROLLING FRICTION is the resistance offered when a body rolls over a surface. The *coefficient of rolling friction* is Wr/P , where r is the radius of the rolling body. See also [ANGLE OF FRICTION](#).

coefficient of performance (of a heat engine or heat pump) A measure of the efficiency of conversion of mechanical work to cooling or heating effect in a refrigeration system. Because of the thermal balance of a heat pump, it may be greater than unity.

coefficient of utilisation In the USA and Canada, the term used in lighting for UTILISATION FACTOR.

coefficient of variation (CV) The ratio of the STANDARD DEVIATION of a series of results to their *mean*. In the manufacture of materials it may be taken as a measure of quality control.

coffer A recessed panel in a ceiling.

cofferdam A watertight enclosure built of piles or clay, for the purpose of providing dry ground for excavating foundations.

cog A HOOKED BAR with a 90° bend.

cogeneration On-site generation of electricity in parallel with mains supply. Electrical supply is drawn from the mains at times of peak site demand, and is supplied to the mains when site demand is low.

cohesion The property of a fine granular material, such as CLAY, whereby the particles cling together, especially when wet, but without the addition of an adhesive.

cohesionless soil A granular soil, which consists of clean sand and/or gravel. From COULOMB'S EQUATION, its shear strength depends entirely on the normal pressure, and it is zero on a free surface.

cohesive soil A sticky soil, which contains an appreciable proportion of fine-grained particles (CLAY).

coign, coin Same as QUOIN.

coincidence dip See [COINCIDENCE EFFECT](#).

coincidence effect A decrease in the SOUND TRANSMISSION LOSS or ATTENUATION of a partition, floor or wall over a range of frequencies where bending waves are the dominant method of transfer of energy in the partition. The part of the transmission characteristic over which this occurs is known as the *coincidence dip*, and the lowest frequency at which the coincidence effect occurs is the COINCIDENCE FREQUENCY.

coincidence frequency The lowest frequency at which the COINCIDENCE EFFECT occurs for a given partition. The coincidence frequency is often erroneously referred to as the frequency at which the greatest reduction in the transmission loss occurs because of bending waves.

cold bridging In a well-insulated construction, cold bridging occurs when elements (usually structural members or door and window frames), which have greater thermal conductivity than the rest of the construction, bridge across between its faces. This reduces the effectiveness of the insulation, and may give rise to a pattern of surface condensation and staining.

cold-cathode lamp An electric DISCHARGE LAMP using a high voltage glow discharge between unheated electrodes. Also called, generically, *neon lighting*.

cold chisel A chisel made sufficiently hard for cutting cold metal.

cold drawing (a) A method of relieving stresses anticipated as a result of expansion or contraction due to heating or cooling by deformation of a long pipe at a change of direction. (b) See [COLD-DRAWN WIRE](#).

cold-drawn wire Wire made from rods that have been hot-rolled from steel billets, and then cold-drawn through a die. This increases the strength, but also lowers the ductility of the steel. Cold-drawn wire is extensively used for reinforced and for prestressed concrete; for the latter, diameters range generally from 2mm (0.080in.) to 7mm (0.276in.).

cold riveting Closing the head of a RIVET by pressure without heating it. It is much simpler than hot riveting, but in building practice it is restricted to aluminium rivets.

cold-setting resin A resin that becomes rigid because of chemical reaction with a *hardener* at room temperature. Cold-setting resins usually set more quickly when heated.

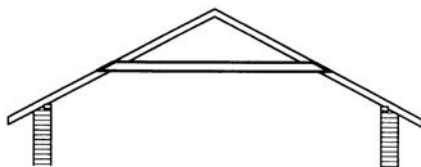

collar beam

cold soldering SOLDERING without the application of heat, for example with copper AMALGAM. Some glues containing metal powder are marketed, incorrectly, as cold solders.

cold-worked steel reinforcement Steel bars, wires or sections that, subsequent to hot-rolling, have been subjected to rolling, twisting or drawing at room temperature.

cold-working The shaping of a metal while at room (or at a slightly elevated) temperature which is below the temperature of recrystallisation, as opposed to *hot-working*. It includes cold-forging, cold-rolling, and wire-drawing. Cold-working may be used to produce a desired shape with a better surface finish than can be obtained by hot-working, and it always increases the strength. See also [WORK-HARDENING](#).

Colebrook equation An empirical relationship between the properties of a fluid and a pipe system in which it is flowing; used as a basis for estimating pipe friction loss.

collapse of timber A flattening of the cells of timber during drying, which is manifested by excessive or uneven shrinkage. It is liable to occur in certain Australian hardwoods, such as brush box, mountain ash and messmate stringybark. In quarter-sawn timbers it produces a washboard effect, and in back-sawn timbers it produces an unusually high degree of shrinkage. *Reconditioning* is a steam treatment, carried out in a sealed chamber for about six hours at about 90°C (195°F), which restores the timber to its normal condition.

collapsible forms Formwork that collapses to a reduced volume in order to be removed.

collar beam The horizontal member in a timber roof, connecting the two opposite rafters at points that are much higher than the wall plate (see Figure). A *collar-beam roof* thus gives more headroom than one with conventional trusses, but less than a rigid frame. Although commonly called a collar beam or collar tie, the horizontal member of a collar beam roof is actually in compression.

collective control Of lift systems: landing calls are registered on a single set of pushbuttons, passengers being unable to indicate their desired direction of travel. Also referred to as *simplex collective control*.

collimation line The line of sight, or *optical axis*, of a telescope, e.g. in a survey instrument. When properly adjusted, it passes through the CROSS-HAIR OF GRATICULE.

colloid A substance consisting of very fine material, 10^{-9} – 10^{-7} m (1–100nm) in diameter. When mixed with water, the particles are too fine to settle. If undisturbed, they remain in suspension to form a GEL. CLAYS are partly colloidal.

colloidal grout A grout that has an artificially induced ability to retain the dispersed solid particles in suspension.

colophony Same as ROSIN.

color US spelling for *colour*.

colorimeter A device for measuring the colour attributes of light or reflective surfaces.

colorimetry The process of measuring the attributes of colour.

colour See [CIE CHROMATICITY SYSTEM](#) and [MUNSELL BOOK OF COLOR](#).

colour appearance (of a lamp) The name (usually representing a band of CORRELATED COLOUR TEMPERATURES) that describes the appearance of a light source.

coloured cement PORTLAND CEMENT blended with a pigment, which does not chemically react with any of the components of concrete. Certain pigments, which are suitable for internal use, fade if used externally. Ordinary (grey) cement is satisfactory for the darker colours. WHITE or OFF-WHITE CEMENT is required with some lighter pigments.

colour rendering index (CRI) See [CIE GENERAL COLOUR RENDERING INDEX](#).

colour rendition The effect that the spectral characteristics of a light have on the appearance of coloured objects illuminated by it.

colour temperature See [CORRELATED COLOUR TEMPERATURE](#).

Colt ventilator A proprietary device for the improvement of ventilation in a building by assisting the natural circulation of air.

column An upright structural member, generally square, rectangular or round, designed to carry a compressive load, often in conjunction with bending. See also [PILLAR](#) and [STANCHION](#).

column, long A column with a high SLENDERNESS RATIO. Its load-bearing capacity is reduced by BUCKLING.

column analogy An analogy between the equations for SLOPE DEFLECTION and those for load and moment in short eccentrically loaded columns, published by Professor Hardy Cross in the USA in 1930. It was used for the design of rigid frames.

column capital (a) The head of a column. In Classical and Gothic architecture it was elaborately decorated. (b) In modern concrete construction, the enlargement at the head of a column, built as an integral unit with the column and the FLAT SLAB. It is designed to increase the shear resistance of the flat slab. See also [COLUMN STRIP](#).

column head Same as COLUMN CAPITAL.

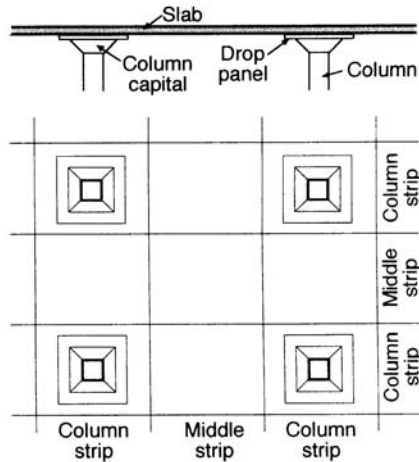

column strip

column strip The portion of a FLAT SLAB or FLAT PLATE over the column. Most building codes define the column strip as consisting of the two adjacent quarter panels on each side of the column centre line (see Figure).

combined footing A foundation supporting more than one column.

combined water Water in mineral matter that is chemically combined, and driven off only at temperatures above 110°C

combustible Describes a material that burns. If placed in a hot furnace (usually at 750°C) it raises the temperature of the furnace. A combustible material may or may not be *flammable*, i.e. burn with a flame. A material that does not support combustion is *non-combustible*.

comfort chart A graphical representation of the COMFORT ZONE. It usually has the dry-bulb temperature as an abscissa, and the wet-bulb temperature as an ordinate. The additional variable may be either the speed of the air movement, or the amount of radiant heat.

comfort equation A heat balance relationship between the physical variables of ambient temperature, mean radiant temperature, humidity, and velocity of air, clothing insulation, metabolic rate and mechanical work performed by a human being; used to predict the sensation of thermal comfort.

comfort zone The range of temperature, humidity, air movement and radiant heat at which people may rest or work comfortably, particularly in a hot climate, shown as a loop on a [COMFORT CHART](#).

command language In computing, a user-interface language based on a restricted set of commands.

comment Notes included in a computer program amongst the code to clarify its operation for a human reader; however, they have no effect on its execution.

common areas The unassigned space within a facility available for all users, such as lobbies, toilets and stairs.

common bond A brick BOND in which all courses are STRETCHERS, except the fifth, sixth or seventh course, which is a HEADER course. Also called *American bond*, or *Scotch bond*.

common brick An ordinary brick, as opposed to a FACE BRICK.

common rafter A RAFTER carried by the PURLINS, as opposed to a *principal rafter*.

common wall A wall forming part of two properties, and equally owned or leased by both parties. Also called a *party wall*.

community title A form of property title in which some common areas of a subdivision are owned jointly by all the property owners, while the separate houses or commercial premises are individually owned. See also CONDOMINIUM, OYO and STRATA TITLE.

commutator Segments on the rotor of a motor or generator that switch current at the correct instant to generate direct current or permit a motor to run from a source of direct current.

compact disc A disc on which information is recorded physically in digital code and read by a LASER beam.

compacting factor test A method for determining the WORKABILITY of freshly mixed concrete. The concrete is placed in a container of standard size, and allowed to fall under standard conditions into another container. Fully compacted concrete has a factor of 1. The test is more precise, but also more time consuming, than the SLUMP TEST. See also BALL TEST.

compatibility Two computers are said to be compatible if the same programs will run on both without alteration. Two components of a computer system (e.g. the computer and the printer) are said to be compatible if they can be used together without an intervening converter.

compensated balance A spring balance in series with a turnbuckle, used to measure a force in a structural *model*. As the spring balance extends or contracts, the turnbuckle is adjusted to keep the geometry of the structure correct.

compensating chain A chain used to offset the varying mass effect of the hoisting ropes of a lift system, which is connected at one end to the underside of the car frame, and at the other to the COUNTERWEIGHT.

compensating error An error due to an *accidental* cause, which may be either positive or negative, and is therefore likely to be self-compensating if sufficient data are taken. By contrast, an error due to a *systematic* cause is always in the same direction, and therefore *cumulative*.

compile To translate an algorithm written in a program language into machine code for a particular computer.

compiler In computing, a program that COMPILES.

complementary angle An angle that equals the difference between a given angle and a right angle (90°). For example, 60° is the complementary angle to 30°.

complex number The sum of a REAL and an IMAGINARY NUMBER.

component of a force See [RESOLUTION OF A FORCE](#).

composite construction (a) A type of construction made up of different materials. (b) Specifically, structural steelwork and reinforced concrete designed as a single structural system.

composite girder (a) A PLATE GIRDER. (b) A girder of COMPOSITE CONSTRUCTION (b).

composition roofing Same as BUILT-UP ROOFING.

compound (chemical) A substance in which several different types of *atoms* chemically combine to form new *molecules*, and thus a new substance, as opposed to a *mixture*, in which different substances retain their own chemical identity.

compound curve Normally defined as a curve consisting of two (or more) circular arcs, which have different radii, and a common tangent at their point of junction.

comprehensive maintenance A form of lift maintenance contract, whereby the system is inspected, lubricated, and adjusted. In the event of breakdown of equipment it is repaired only during normal working hours.

compressed fibre board Same as HARDBOARD.

compression A direct push in line with the axis of a body, and therefore the opposite of TENSION.

compression cycle See [VAPOUR COMPRESSION CYCLE](#).

compression failure Failure under the action of a compressive force, either due to the material's reaching its LIMITING STRENGTH, or due to BUCKLING, or due to a combination of both.

compression reinforcement Reinforcement used near the compression face of the concrete; it requires ties to prevent buckling.

compression wood A region of excessively dense wood; it is very brittle, and shows abnormal longitudinal shrinkage.

compressive strength of concrete Same as CUBE STRENGTH (in Europe) or CYLINDER STRENGTH (in the USA and Australia).

compressor See [AIR](#), [CENTRIFUGAL](#), [HERMETIC](#), [RECIPROCATING](#) and [SCREW COMPRESSOR](#).

computational fluid dynamics A technique for mathematically modelling and predicting the velocity of motion in fluids; and the distribution of heat, temperature, moisture and particulate matter in enclosed spaces and around objects.

computer An electronic device that receives, stores, and operates on data according to a program, and outputs the result. A computer is different from an electronic calculator because of the ability to change its program, i.e. altering its simulated behaviour. See [DIGITAL COMPUTER](#) and [ANALOGUE COMPUTER](#).

computer aid The process of using computers to aid in some application domain, e.g. *computer-aided design*, *computer-aided engineering*, *computer-aided learning* and *computer-aided manufacturing*.

computer-aided facility management The use of specific computer functions such as drawings and spreadsheets to provide FACILITY MANAGEMENT data.

computer architecture The way the components of a computer are organised.

computer graphics The use of computers to display information in pictorial form as opposed to textual form.

computer graphics interface See [GRAPHICAL USER INTERFACE](#).

computer hardware, software See [HARDWARE](#) and [SOFTWARE](#).

computer-integrated construction The process of integrating all the information pertaining to the design and construction of a facility (a building) in a computer system.

computer-integrated facility management The use of interrelated computer databases, integrating specific facility information, which makes FACILITY MANAGEMENT possible.

computer-integrated manufacturing See [CAD/CAM](#).

computer language A language whereby instructions are given to a computer.

computer memory The device in which information is stored for retrieval by a computer. Usually reserved for main memory, i.e. memory that is directly accessible by the central processor of the computer.

computer model A representation of an object in a symbolic form that can be manipulated by a computer.

computer-supported collaborative work A computer system for supporting collaboration between various participants, usually geographically distant from each other.

computing power The capacity of a computer to process data, usually measured in MIPS.

concave Describes a curve that bends inwards, like the inside of a circle, ellipse, etc. It is the opposite of *convex*.

concealed gutter Same as BOX GUTTER.

concealed lighting An artificial light source, recessed into a ceiling or wall, or concealed behind a decorative facing or a *pelmet*.

concealed nailing Same as SECRET NAILING.

concentrated load A load acting on a very small area of the structure's surface; the opposite of a DISTRIBUTED LOAD.

concentric column load A load that compresses a column without bending, as opposed to an ECCENTRIC column load. Also called an *axial load*.

concordant tendons Tendons in statically indeterminate prestressed concrete structures, which do not produce secondary moments. They must be coincident with the line of pressure produced by the tendons.

concrete An artificial stone made from stone chips or gravel, sand, and a cement (usually Portland cement). See also [CAST IN PLACE](#), [CELLULAR CONCRETE](#), [GLASS-CONCRETE CONSTRUCTION](#), [GRANOLITHIC CONCRETE](#), [GREEN CONCRETE](#), [LEAN CONCRETE](#), [NOFINES CONCRETE](#), [PLAIN CONCRETE](#), [POLYMER CONCRETE](#),

POLYMER-CEMENT CONCRETE, PRESTRESSED CONCRETE, READY-MIXED CONCRETE, REINFORCED CONCRETE and VACUUM CONCRETE.

concrete admixture See ACCELERATOR, AIR-ENTRAINING AGENT and RETARDER.

concrete aggregate The inert component of concrete. Heavyweight, or normal, aggregate consists of sand (FINE AGGREGATE) and gravel, crushed gravel, crushed stone, or crushed recycled concrete (COARSE AGGREGATE). See also LIGHT-WEIGHT AGGREGATE.

concrete block, brick A *block* or *brick* moulded in sand and cement, often with the addition of a mineral pigment.

concrete cancer A figure of speech describing the deterioration of concrete structures, usually associated with the penetration of moisture and chloride ions, and the corrosion of reinforcement.

concrete curing See CURING.

concrete-encased beam A steel beam cast into concrete, generally MONOLITHIC with the floor slab, and completely encasing it.

concrete hardener A chemical applied to a concrete floor to reduce wear and dusting. See also HARDENING OF CONCRETE.

concrete hardening See HARDENING OF CONCRETE.

concrete joist construction A floor structure consisting of a slab reinforced by joists (or ribs) in one direction, or in two directions at right angles to one another.

concrete mixer A machine for mixing the ingredients of concrete. See BATCH MIXER, CONTINUOUS MIXER, PAN MIXER, TILTING MIXER and TRANSIT MIXER.

concrete paint See CEMENT PAINT.

concrete pile A long, slender reinforced or prestressed concrete column embedded in the foundation. It may be driven, or cast in place. It may support the foundation as a BEARING PILE or as a FRICTION PILE.

concrete prestressing See PRESTRESSED CONCRETE.

concrete pump A pump that pushes concrete through a pipeline. It is widely used for transporting concrete from a TRANSIT MIXER to the place of pouring, particularly in a multistorey building or over difficult ground. It may also be used in conjunction with a CEMENT GUN.

concrete quality control Statistical control of the compressive strength of concrete.

concrete retarder See RETARDER.

concrete terrazzo Concrete made with marble aggregate, and frequently with WHITE CEMENT, and subsequently ground smooth for decorative floor or wall surfaces. It may be precast or cast in place.

concrete vibrator A mechanical device that delivers energy to fluid concrete in order to assist compaction. See also VIBRATED CONCRETE.

condensate Liquid formed by the condensation of vapour.

condensation The formation of water on a surface, caused by the air temperature's falling below its DEW POINT. The water content of SATURATED AIR falls with falling temperature, so that the dew point may be reached even though the moisture content remains constant. Condensation is particularly likely in cool weather when the temperature drops at night, since the RELATIVE HUMIDITY then tends to be high, even in relatively dry climates.

condensation groove A groove to collect the condensation on the inside of windows, from which the moisture escapes to the outside by means of WEEPHOLES.

condenser (a) An apparatus for condensing vapours, e.g. in a steam engine, or in the refrigeration plant of an air conditioning unit. (b) A lens or mirror used in an optical system to collect light and direct it onto a projecting lens. (c) A CAPACITOR in an electrical circuit.

condenser microphone A microphone in which the pressure fluctuations cause a displacement of a thin diaphragm, which forms one plate of a CAPACITOR. The change in capacitance is proportional to the magnitude of the pressure fluctuations. Condenser microphones are substantially omnidirectional in their response to sound.

condition appraisal A technical appraisal of the existing physical state of a facility's assets, including the building fabric, systems, services and functionality.

conditions of engagement The terms of contract between two parties, which set out each party's responsibility, such as fees, ownership of information and dispute resolution.

condominium US term for an APARTMENT that is sold and not rented. See also STRATA TITLE.

conductance, conduction, conductivity, thermal See THERMAL CONDUCTANCE etc.

conductance, electrical See ELECTRICAL CONDUCTANCE.

conduit (a) A natural or artificial channel for conveying liquids. (b) A tube, usually of plastic or metal, which encloses electrical wires or cables. Conduits are used partly for protection, and partly to allow cables to be pulled through after the concrete or other building material has been placed in position.

conduit box A junction box serving as an outlet and as a place from which to pull wires through the conduits.

cone (a) A figure whose base is a circle, with sides tapering uniformly towards a point. A *truncated cone* is one that is cut off before reaching the point. (b) One of the receptors in the retina of the eye, used in bright conditions, and capable of seeing in colour. See also ROD (a).

confidence limits The limits within which a random sample of a set of data is presumed to be included, with a preassigned degree of confidence.

configuration factor A factor that summarises the external obstruction to daylight at any given window, used in calculating the DAYLIGHT FACTOR.

confined compression test Same as TRIAXIAL COMPRESSION TEST.

conglomerate A rock composed of (usually rounded) pieces of pre-existing rock cemented together.

conic sections The CIRCLE, the ELLIPSE, the PARABOLA and the HYPERBOLA; produced by cutting a CONE at different angles.

conifer A tree belonging to the botanical group *Gymnospermae*, which bears cones. It includes all the softwoods used in building, particularly the pines and firs.

connecting rod The rod connecting the piston of a RECIPROCATING ENGINE to the flywheel. It converts the backward-and-forward motion into rotary motion.

conoid A SURFACE OF TRANSLATION generated by the motion of a straight line over a curve and a straight line, or two curves that are different, but of the same type. For example, a *parabolic conoid* is generated by a straight line moving over a flat parabola at one end and a more strongly curved parabola at the other. A conoid is a RULED SURFACE, and it can be utilised as a NORTHLIGHT SHELL.

conservatory (a) Same as GREENHOUSE. (b) US term for *conservatorium*, a school for teaching music or other arts.

consistency index A ratio for comparing the stiffness of cohesive soils. It is defined as

$$\frac{\text{liquid limit} - \text{water content of sample}}{\text{liquid limit} - \text{plastic limit}}$$

consistency limits The LIQUID and PLASTIC LIMITS of COHESIVE SOILS, which describe its range of workability. Also called *Atterberg limits*.

consistency of concrete The ability of freshly mixed concrete or mortar to flow, and fill the formwork without voids. Also called *workability*. It is measured with the BALL TEST, COMPACTING FACTOR TEST, and the SLUMP TEST.

console The manual control unit for a computer, providing a display of information and a means of communicating with the computer.

consolidation The gradual settlement of a COHESIVE SOIL under the weight of the structure that it carries. It results from the squeezing of water from the pores of the soil, and is a problem only in clays and other soils of low water permeability.

consolidometer Same as OEDOMETER.

consortium A group of firms that jointly undertake a project while still retaining their separate identities.

constant air volume system A method of air distribution in an air conditioning system in which air is circulated at constant volume with the temperature varied to maintain the desired space condition; in contrast to a VARIABLE AIR VOLUME SYSTEM.

constantan An alloy of about 55 per cent copper and 45 per cent nickel. Junctions of copper and constantan are widely used in THERMOCOUPLES for temperature measurement.

constitutional diagram Same as PHASE DIAGRAM.

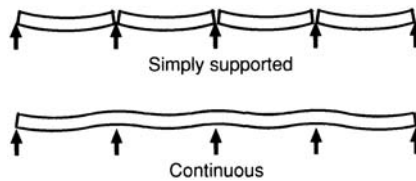

continuous beam

construction joint A joint (usually in *in situ* concrete) to enable the building process to be interrupted, without detracting from the strength of the structure. It may or may not be masked with a DUMMY JOINT.

construction loads The loads imposed on the building during construction due to the erection, assembly and installation of building components and building services.

construction management A method of procurement in which a head contractor is appointed as construction manager, to provide advice to the principal and to manage the construction phase of a project, including tendering of subcontract trade packages, award and administration of successful subcontractors.

constructive solid geometry A solid geometry representation using threedimensional GEOMETRIC PRIMITIVES and BOOLEAN OPERATIONS. For example, a wall with an opening is constructed by subtracting a piece of wall from the wall.

contact adhesive An adhesive that adheres instantly upon contact.

contaminant (of air) A substance present in air, causing it to be considered unclean.

contiguous piers A method of stabilising an excavation, by drilling and concreting a series of piers (usually 450–600mm diameter) around the perimeter before excavating a basement. As the excavation proceeds, GROUND ANCHORS may be installed through the piers to prevent them from collapsing inwards.

continental seating Auditorium seating unbroken by aisles. Access is from aisles at the ends of the rows of seats.

contingency A sum of money identified contractually to provide for unforeseen activities during the course of a contract.

contingency planning The process of anticipating and developing alternative actions, should a preferred course of action be terminated.

continuity Structural continuity implies that the SLOPE at a rigid joint or the support of a continuous beam is altered by the same amount on each side of the joint or the support by elastic deformation.

continuous beam A beam that is continuous over intermediate supports (see Figure), and thus *statically indeterminate*, as opposed to a *simply supported beam*.

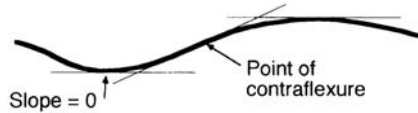

contraflexure

continuous footing A COMBINED FOOTING, which acts like a CONTINUOUS BEAM on the foundation.

continuous girder Same as CONTINUOUS BEAM.

continuous mixer A machine that mixes concrete in a continuous operation; as opposed to a *batch mixer*.

contract administration The management process of ensuring that all obligations of the contract are carried out during the contract period.

contract capacity The maximum legal load that a lift CAR is permitted to carry, measured in either a number of passengers or a specific mass in kilograms or pounds.

contraction joint A joint that allows shrinkage of concrete or brick to take place in a predetermined location, and so avoid objectionable shrinkage cracks elsewhere. It may be made by an insert or by a sawcut in a concrete slab. See also [EXPANSION JOINT](#) and [CONTROL JOINT](#).

contract load Alternative term for CONTRACT CAPACITY.

contract speed The linear car speed in the lift well that the lift manufacturer has contracted to supply.

contraflexure A change in the direction of bending of a beam (see Figure). The slope has a maximum value at this point, and therefore the differential coefficient of the slope $d\theta/dx=0$. From NAVIER'S THEOREM and the geometry of the figure,

$$\frac{d\theta}{dx} = \frac{M}{EI}$$

so that the bending moment is zero at the point of contraflexure. Consequently it is possible to insert a hypothetical 'hinge' at this point and remove a REDUNDANCY. Also called *inflection* or *inflexion*.

contrast In illumination engineering, the assessment of the difference in appearance of two parts of a field of view seen simultaneously or successively. More particularly as *luminance contrast*, a measure of the difference in the luminance or reflecting properties of sources or surfaces, respectively. It is usually expressed in terms relative to, say, the background luminance.

contrast rendering factor (CRF) See [CIE CONTRAST RENDERING FACTOR \(CRF\)](#).

control joint A generic name for EXPANSION JOINT and CONTRACTION JOINT. A joint or separation in a building that permits its component parts to move relative to one another. The most common cause of such movement is

thermal, but it may also be caused by shrinkage, creep, wind loads or seismic action. See also [BRICK-WORK MOVEMENT JOINT](#).

control of lift systems See [ATTENDANT](#), [AUTOMATIC PUSHBUTTON](#), [COLLECTIVE](#), [DIRECTIONAL COLLECTIVE](#), [GROUP COLLECTIVE](#), [GROUP SUPERVISORY](#), [NON-COLLECTIVE](#) and [SCHEDULED CONTROL](#).

convection The transmission of heat by natural or forced motion of a liquid or gas, i.e. by movement of the particles, as opposed to [THERMAL CONDUCTION](#) or [RADIATION](#).

convergent series An [INFINITE SERIES](#) whose sum is finite. For example, the series adds up to 2. The sum of all the terms of a *non-convergent series* is infinity.

conversion factor A number that converts a unit of one system into that of another.

conversion of timber The process of sawing timber from the log.

convex Describes a curve bending outwards; the opposite of *concave*. The curvature of the lens of a magnifying glass is convex.

conveyor A powered continuous belt for the horizontal or inclined movement of bulk materials, e.g. concrete, aggregate. A conveyor designed for the movement of discrete items is generally called a [BRICK ELEVATOR](#), *tile elevator* etc.

cooling load The quantity of heat required to be removed from air in order to maintain a desired thermal condition of air in a space.

cooling tower A device for cooling water to approximately the wet-bulb temperature of the outside air, to take heat away from the condenser of a heat engine.

cool white fluorescent lamp A lamp that contains more light in the blue-green part of the spectrum than an ordinary white lamp.

coordinates See [CARTESIAN COORDINATES](#) and [POLAR COORDINATES](#).

COP Abbreviation for [COEFFICIENT OF PERFORMANCE](#).

copal A hard natural resin, derived from the gum of tropical trees or from recently fossilised gum. It is used for varnishes and paints.

coping A capping of stone, brick, or concrete for the top of a wall. It frequently projects beyond either or both faces of the wall, partly for protection from the weather, and partly for decoration.

coping saw A bow saw with a narrow blade, which can be used for cutting sharp curves in timber.

copolymerisation Addition [POLYMERISATION](#) involving more than one type of [MER](#).

copper A metallic element. Its chemical symbol is Cu, its atomic number is 29, its valency is 1 or 2, it has an atomic weight of 63.54, its specific gravity is 8.96, and it melts at 1083°C. Copper is used in many alloys, notably brass, bronze and aluminium bronze. Because of its high electrical conductivity and good corrosion resistance it is used extensively as an electrical conductor.

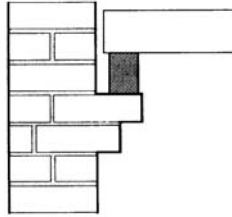

corbel

coprocessor A computer processor that assists the CENTRAL PROCESSING UNIT (CPU) to carry out specialised tasks, usually much faster, e.g. a graphics coprocessor.

corbel A projection of masonry, brick or concrete from a wall face, which serves as support for a lintel, beam or truss (see Figure). It is, in effect, a short cantilever.

corbelled arch An ARCH formed by courses of brick or masonry uniformly advancing from each side of an opening until they meet in the middle. Its joints are horizontal, instead of being normal to the line of thrust as in a true ARCH.

corbelling Masonry or brickwork consisting of a series of *corbels*, each projecting a little more than the one below. It is used for supporting ORIEL WINDOWS and forming chimney stacks. At one time it was used for forming CORBELLED ARCHES.

cord An obsolete measure for timber. 1 cord=128ft³ (4ft×4ft×8ft).

core Generally the same as SERVICE CORE.

core drilling Drilling holes with a hollow *bit* (usually a *diamond drill*), so that the cylinder of material inside the bit is recovered. It is often used to obtain samples of rock or concrete for testing, but it is also an economical way of drilling large holes because the amount of material to be cut is much less than with a solid bit.

core samples See BOREHOLE SAMPLES.

Coriolis force The effect of the earth's rotation, causing secondary rotational effects in air streams and ocean currents. It influences some of the large-scale meteorological patterns, particularly near the equator.

cork The bark of the cork-oak. It is used for stopping bottles, in granulated form as an insulating material, and as a floor-surfacing material that has good heat and sound insulation.

cork tiles Tiles made from compressed CORK. They form a floor covering with good insulating properties.

cork wood Same as Balsa wood.

cornice (a) In classical architecture, the projecting section of an entablature. (b) An overhanging moulding at the top of an outside wall, which throws water clear off the wall. (c) A ceiling moulding at its junction with the walls.

corrected effective temperature (CET) EFFECTIVE TEMPERATURE as modified to include the effect of the MEAN RADIANT TEMPERATURE.

corrective maintenance The restorative maintenance of an item that has ceased to be of adequate quality.

correlated colour temperature (CCT) (of a light source) In colorimetry, the temperature of the BLACK BODY (full radiator) that most closely resembles the colour distribution of the light source. The light source, say a lamp, may operate at a temperature much lower than its correlated colour temperature.

corrosion Destruction of material, particularly metal, by chemical means. See also [DECAY](#) (a).

corrugated sheet Roof sheet that has been corrugated, partly for flexural stiffness and partly to provide drainage channels for rainwater. The most common type is *corrugated iron*, which is normally galvanised mild steel. Corrugated sheets are also made from aluminium, fibre cement, PVC, polycarbonate, and glassfibre-reinforced translucent resin.

corten steel A high-strength, low-alloy steel, which does not need to be protected by paint because, like aluminium, it forms a protective oxide coating through weathering. The colour changes from light brown (after about 1 month) to dark brown or purple (after 1 to 2 years). However, the oxidation process may produce brown streaks on concrete or other materials at a lower level. Called *austen steel* in Australia.

corundum Aluminium oxide (Al_2O_3) used as abrasive. Not to be confused with CARBORUNDUM. See also [EMERY](#).

cos The COSINE of an angle.

cosec The COSECANT of an angle.

cosecant A CIRCULAR FUNCTION of an angle, the ratio of the length of the hypotenuse of a right-angled triangle to that of the side opposite the angle. Abbreviated *cosec*. The cosecant is the inverse of the SINE; $\text{cosec}\theta = 1/\sin\theta$

cosh Hyperbolic cosine. See [HYPERBOLIC FUNCTIONS](#).

cosine A CIRCULAR FUNCTION of an angle, the ratio of the length of the side adjacent to the angle in a right-angled triangle to that of the hypotenuse. Abbreviated *cos*.

cosine law of illuminance A law enunciated by J.H.Lambert in the eighteenth century, stating that the illuminance on a surface tilted at an angle θ is equal to the illuminance on a surface normal to the light source times $\cos\theta$.

cosine wave The same as a SINE WAVE, but displaced by one-quarter of a wavelength.

cost analysis An analytical technique involving an assessment of all costs and revenues in order to identify and assess as many costs and benefits as possible.

cost-benefit analysis A process of evaluation measuring expected financial benefits against present value.

cost planning A technique used to control the cost of a project within the budget during the design phase by reference to the historical costs of elements.

cost-plus contract Contract in which the actual prime cost of labour, plant and materials is paid for at net cost to the contractor plus a fee, based on a percentage of these, or a fixed fee, to cover the contractor's overheads and profit.

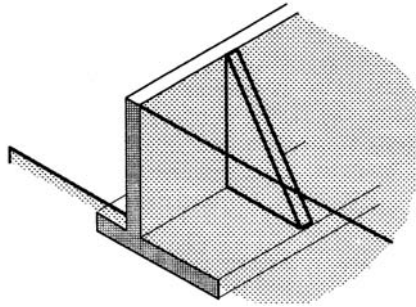

counterfort

This type of contract is used if there is insufficient time to design the entire project and complete the drawings and specification. Also called a *cost-reimbursement contract*.

cot The COTANGENT of an angle.

cotangent A CIRCULAR FUNCTION of an angle, the ratio of the side adjacent to the angle (other than the hypotenuse) in a right-angled triangle, to that of the side opposite the angle. Abbreviated *cot*. The cotangent is the inverse of the TANGENT; $\cot\theta=1/\tan\theta$

coulomb (C) Unit of electrical charge, named after the eighteenth-century French scientist and military engineer. It is the quantity of electricity transported by 1 ampere in 1 second.

Coulomb's equation A relation between the shear strength of a cohesive soil, v , and the normal (foundation) pressure, f ; devised by the French engineer C.A.Coulomb in 1776.

$$v = c + f \tan \theta$$

where c is the cohesion of the soil, and θ is its *angle of shearing resistance*. This is a straight limiting line, inclined at an angle θ , for a series of MOHR CIRCLES. The equation can also be applied to the compression failure of concrete as a failure criterion; the cohesion is contributed mainly by the cement paste, and the shearing resistance mainly by the aggregate.

counterclockwise The opposite of CLOCKWISE. Also called *anticlockwise*.

counterfort A pier at right angles to a RETAINING WALL, on the side of the retained material and therefore not visible. It can be used only to strengthen a structure capable of tensile resistance, such as reinforced concrete, since the earth pushes the wall away from the counterfort (see Figure). A BUTTRESS can also be used to strengthen a plain concrete or masonry retaining wall.

countersink To make a depression just sufficient to receive the head of a screw, rivet, or some other part of a joint that normally projects. It can be done in timber, metal or any other material, using a conically shaped cutting tool, or *bit*.

counterweight A component of a lift system used to ensure TRACTION between the drive SHEAVE and the hoisting ropes, comprising a set of weights

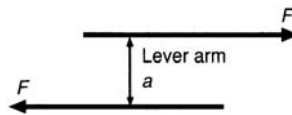
**couple**

to balance the car and a proportion of the car load, usually 50 per cent of the CONTRACT CAPACITY.

counterweight guard A screen installed in the pit of a lift system, and sometimes at the mid point of the lift well, to prevent inadvertent encroachment into the COUNTERWEIGHT runway space.

counterweight safety device A mechanical device attached to the counterweight frame of a lift system, designed to stop and hold the COUNTER-WEIGHT in the event of an overspeed, free fall, or the slackening of the suspension ropes.

couple A pair of equal and parallel forces, not in line and oppositely directed. The moment of a couple equals the magnitude of one of the forces, F , times the perpendicular distance between them, a (see Figure).

coursed ashlar ASHLAR laid in regular horizontal courses.

coursed rubble RUBBLE arranged to form courses by using small pieces or mortar to fill up the interstices between them.

cove A concave quadrant moulding, i.e. a hollow CORNICE, or a concave junction between a wall and a floor, to facilitate cleaning.

cover In reinforced concrete, the thickness of concrete overlying the steel bars nearest to the surface (see Figure). An adequate layer is needed to protect the reinforcement from rusting and from fire.

cover fillet or strip A moulding used to cover a joint.

covering power The HIDING POWER of a paint for a given spreading rate.

cowl A metal cover, often capable of rotating, and fitted with louvres. It is fixed on a roof ventilator or chimney to improve the natural ventilation or draught.

CPM Abbreviation for CRITICAL PATH METHOD.

cps Cycles per second. Since the introduction of SI UNITS, this is called HERTZ, abbreviated Hz.

CPU Abbreviation for CENTRAL PROCESSING UNIT.

Cr Chemical symbol for *chromium*.

crack See [CRAZING](#), [GRIFFITH CRACK](#) and [MICROCRACK](#).

cracked section In reinforced concrete design, a section that is designed on the assumption that the concrete has no resistance to tensile stresses, and that the tension is taken by the reinforcement.

cracking load The load at which cracks occur in a concrete structure because the tensile strength of the concrete is exceeded. The term generally refers to the appearance of visible cracks, not to the appearance of MICROCRACKS.

cramp (a) A U-shaped metal cramp used since Ancient Roman times to fasten adjoining stones to one another. It was generally inserted in recesses cut in the top of the stones, and often secured with molten lead. (b) A clamp with a

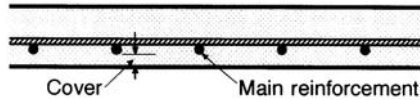

cover

tightening screw used to hold a frame in place during construction, or to compress two pieces of wood during gluing.

crane See [CLIMBING](#), [GANTRY](#), [HAMMERHEAD](#), [MOBILE](#), [SCAFFOLD](#), [SELF-CLIMBING](#) and [TOWER CRANE](#), [DERRICK](#) and [SHEAR LEGS](#).

crane, box girder A crane consisting of one or two box girders, supported on end carriages, which allows the rope and pulley to move along the box girders.

crank A bar with two right-angled bends, which gives it leverage, e.g. a crank handle for starting an internal combustion engine, or a crank shaft in a [RECIPROCATING ENGINE](#).

crash bar The cross bar of an exit door, which operates its opening device, so that the door can be opened from the inside, but not from the outside.

crashed time The fastest time in which an activity in a building project can be performed by making more labour and materials available than would normally be done. If the activity lies on the [CRITICAL PATH](#), it may be more economical to perform the activity in crashed time than in normal time. The critical path must be recalculated if any operation is speeded up, since it may no longer lie on it; however, this would not necessarily imply that the use of crashed time is uneconomical.

crawl space The space under a suspended floor needed for access to services.

crazing The development of fine, random cracks caused by shrinkage on the surface of plaster, cement paste, mortar or concrete. They are particularly noticeable if the material is finished to a smooth surface with a steel trowel. Crazing is more likely to occur in concrete if the cement is brought to the surface by excessive trowelling.

creep Time-dependent deformation due to load. It can be represented by a [RHEOLOGICAL MODEL](#). (a) In structural metals, creep occurs only at elevated temperatures (in steel above 300°C). It is caused by the increased mobility of atomic particles at higher temperatures. (b) In concrete, a sustained load squeezes water from the cement [GEL](#) at ordinary temperatures. Creep deformation may be two or three times as great as the [ELASTIC DEFORMATION](#), and it causes a substantial redistribution of stress, often transferring load from the concrete to the steel reinforcement. Because of creep, the [EFFECTIVE MODULUS OF ELASTICITY OF CONCRETE](#) is reduced. Creep is a major cause of [LOSS OF PRESTRESS](#) in both [POST-TENSIONED](#) and in [PRE-TENSIONED](#) concrete.

creep deflection Deflection of a beam due to [CREEP](#). Elastic deflection occurs instantly, whereas creep deflection requires time to develop; it may be several months before it becomes noticeable.

creosote oil A liquid distilled from coal tar heated between 240 and 270°C, which is used as a timber preservative.

CRF Abbreviation for CIE CONTRAST RENDERING FACTOR.

CRI Abbreviation for CIE GENERAL COLOUR RENDERING INDEX.

crippling load (of a column) The load at which a slender column BUCKLES.

critical activity An ACTIVITY that lies on the critical path.

critical angle The maximum angle of a ramp or a staircase that is considered safe.

critical distance In a room the sound field can be divided into a DIRECT SOUND FIELD, in which the direct sound from the source dominates, and the REVERBERANT SOUND FIELD, where the reflected sound dominates. The critical distance is the distance from the source at which the contribution from the direct and reflected sound is equal.

critical path The route through a NETWORK, from starting point to terminal point, that is critical for the project. The *critical time path* is the longest route through the network. The *critical resources path* may also have to be determined, if either labour or materials are limited.

critical path method (CPM) A method of scheduling complex building contracts to determine the critical operations that would, if neglected, lead to delays, and to determine the cost of finishing the work more quickly, or the saving in cost if it were finished more slowly. As in a progress chart, the normal time required for all operations is worked out, and the interrelation of the various operations is plotted as a NETWORK. The CRITICAL PATH through the network is then determined, which gives the completion period if all operations are performed on time. The operations that lie on this path are critical, and it may be worthwhile to perform them in CRASHED TIME, by making more material or labour available; this may, however, alter the critical path. See also [PERT](#).

critical slope The slope corresponding to the ANGLE OF REPOSE of a soil.

critical temperature In metallurgy, the temperature at which a critical transformation occurs in the heating or cooling curves of a PHASE DIAGRAM.

critical velocity The velocity at which fluid flow changes from streamline to turbulent.

CRO Cathode-ray oscilloscope.

crosscut saw A saw whose teeth have been set and sharpened to cut *across* the grain of the wood.

cross-hair A thread fixed across the diaphragm of a *level* or a *theodolite*. Modern instruments use a GRATICULE, a glass plate with lines engraved in it.

cross-hairs In computer graphics, two lines orthogonal to each other and extending over the full screen. The intersection defines the CURSOR position.

cross-headed screw A screw with a cross-shaped recess in the head (instead of a slot), such as a *Phillips head* or a *Pozidriv*. It is preferred for use with power screwdrivers, since the bit tends to slip out of a conventional slotted screw-head. See also [ALLEN HEAD](#).

cross-linking of polymers The tying together of adjacent polymer chains.

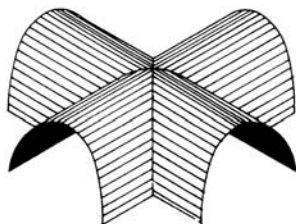

cross vault

crossover network An electrical network with one input port and two or more output ports, each of which delivers power in a different limited frequency band. Crossover networks are commonly used in audio systems to improve the performance of loudspeaker systems.

cross-sectional area The area of a cross section, i.e. of a section cut transversely to the longitudinal axis of a member.

cross vault A vault resulting from the intersection at right angles of two BARREL VAULTS of identical shape (see Figure). Also called a *groin vault*.

crotchwood The portion of a tree where a large limb branches from the trunk. The fibres of the branch produce a curly grain, and a veneer cut from crotchwood is highly FIGURED. See also BURL.

crown The highest point, or *vertex*, of an arch or dome. The stone at the crown of a masonry arch is called the KEYSTONE.

crown glass (a) Glass made by blowing a mass of molten material, which is then flattened into a disc, and spun into a circular sheet. It is limited in size to about 1.4m (4ft 6in.) diameter. Since the glass does not come into contact with any other material during manufacture it is free from the defects that occur in CYLINDER GLASS. The process was introduced into England in the seventeenth century, and the sash window with brilliantly clear, often slightly curved crown glass became one of the characteristics of Georgian architecture. The centre of the disc, or *bull's eye*, was originally used for inferior work. Later it was employed deliberately, often using cast imitations, for the windows of 'rustic' cottages. The crown glass process became obsolete in the nineteenth century. (b) GLASS of the alkali-lime-silica type, as opposed to FLINT GLASS.

CRT Abbreviation for CATHODE-RAY TUBE.

crucks Pairs of large curved timbers used for the principal framing of barns and primitive houses. They form a pointed arch, taking the place of both the posts and the rafters. Called *crutches* in the USA.

crushing failure The compression failure (due to diagonal shear) of many brittle materials, which results in the production of crushed material or debris. Since this takes time, it is much slower than a CLEAVAGE FRACTURE. The compression failure of concrete is a typical example.

crushing strength of concrete This is measured as CUBE STRENGTH or CYLINDER STRENGTH.

crutches See [CRUCKS](#).

crystal A body whose atoms are arranged in a definite pattern. The regular arrangement gives rise to the characteristic crystal faces.

crystalline fracture Fracture taking place between crystals, and exposing their faces. In a tension test particularly, this is evidence of BRITTLENESS.

crystal structure See [BODY-CENTRED CUBIC LATTICE](#), [CLOSE-PACKED HEXAGONAL LATTICE](#) and [FACE-CENTRED CUBIC LATTICE](#).

c/s Cycles per second. Since the introduction of SI units, this is called *hertz*, abbreviated Hz.

CSA Canadian Standards Association, Ottawa.

CSG Abbreviation for CONSTRUCTIVE SOLID GEOMETRY.

CSIR Council for Scientific and Industrial Research, a term employed in India, Pakistan, South Africa, and formerly in Australia.

CSIRO Commonwealth Scientific and Industrial Research Organisation, Australia.

CSTB Centre Scientifique et Technique du Bâtiment, Paris.

CT (colour temperature) See [CORRELATED COLOUR TEMPERATURE](#).

ctg Continental abbreviation for COTANGENT.

Cu Chemical symbol for *copper*.

cube One of the five regular *polyhedra*. It is bounded by six squares, and hence is also called a *hexahedron*.

cube strength (of concrete) In most European countries the compressive strength of concrete is ascertained by crushing a cube; this is expressed as the ultimate load per unit cross-sectional area. The size of the cube varies from 100mm (4in.) to 200mm (8in.). Because of the greater probability of the presence of flaws in large pieces of a brittle material the average cube strength decreases as the size of the cube increases. See also [CYLINDER STRENGTH](#).

cubic lattice See [BODY-CENTRED CUBIC LATTICE](#) and [FACE-CENTRED CUBIC LATTICE](#).

cubit The principal measure of length used in Ancient Egypt, Babylon, Israel and Greece. It was based on the length of the forearm, and varied from 525 to 445mm. The forearm measure was called *braccia* in medieval and Renaissance Italy, and it varied from city to city.

culls (a) In forestry, trees that are removed individually, because they are deformed, too closely spaced etc. They provide one source of raw material for FIBREBOARD. (b) Any pieces (such as bricks) rejected from a production run as inferior.

culvert A large drain below ground level, built in place of a small bridge. It is generally formed by a box or a large-diameter pipe.

cumulative error An error due to a *systematic* cause, which is always in the same direction, as opposed to a *compensating error*.

cup-and-cone fracture The typical fracture of a DUCTILE material, e.g. structural steel, in tension (see Figure). The bar first elongates plastically, and the

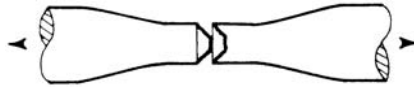

cup-and-cone fracture

consequent *necking* reduces the cross-sectional area until the ultimate tensile stress of the material is reached, when a brittle fracture occurs across the bar. After failure, one of the two parts of the bar is cup shaped and the other cone shaped.

cupola Same as DOME.

curing (a) The maintenance of an appropriate humidity and temperature in freshly placed concrete to ensure the satisfactory hydration of the cement, and proper hardening of the concrete. It may be necessary to provide a source of heat in very cold weather, or some cooling in very hot conditions. Evaporation of water is reduced by placing covers over the concrete, applying a *curing membrane* (a liquid sealing compound) to the exposed surface, or sprinkling the concrete periodically with water. (b) The chemical change, resulting in additional linkages between the molecules, which occurs when an ACCELERATOR is added to a COLD-SETTING RESIN, or when a THERMOSETTING plastic is heated above the critical temperature. The material gains the required strength and hardness through curing.

curl A fine, curved FIGURE in the grain of wood, frequently obtained by the conversion of CROTCHWOOD.

cursor A special symbol on a computer screen indicating the location of the next operation to be performed.

curtain wall A thin wall supported by the structural frame of the building, as opposed to a BEARING WALL.

curvilinear Consisting of or bounded by curved lines.

cusec Cubic feet per second.

cusp (a) A point where two branches of a curve meet, have a common tangent, and terminate. (b) An ornament of roughly this shape, used in Gothic tracery.

cut-off frequency The cut-off frequency of a MODE in a duct is the frequency below which a given mode of a travelling wave cannot be maintained. It is usually taken as the frequency at which the only mode that can propagate is a plane wave.

CV Abbreviation for COEFFICIENT OF VARIATION.

cyanide hardening CASE HARDENING of steel by immersion in a bath of molten sodium cyanide (NaCN).

cybernetics The science of automatic control.

cyberspace A conceptual space consisting of information elements as opposed to physical elements.

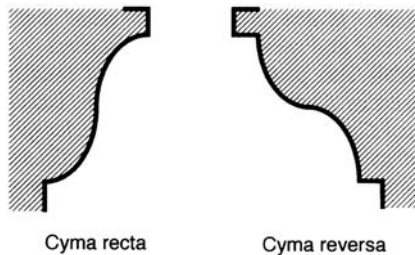

cyma

cycloid A curve generated by a point on a circle rolling over a straight line. It can be rotated to form a dome that, like a semielliptical dome, has vertical springings. See also [EPICYCLOID](#).

cyclone A wind of force 12 on the BEAUFORT SCALE. Also called *hurricane*.

cyclopean concrete Mass concrete containing a large number of PLUMS.

cyclopean masonry (a) Masonry composed of very large irregular blocks, particularly in prehistoric architecture. (b) RUSTICATED masonry in squared blocks, popularised by the Renaissance in the fifteenth century, which have either the rough-hewn texture resulting from quarrying, or an artful imitation thereof.

cylinder A solid bounded by a curved surface terminating in two parallel and equal plane figures (which are generally, but not necessarily, circles).

cylinder glass Glass made by blowing a mass of molten material into a hollow cylinder, which, while soft, was cut lengthwise, laid out on a preheated iron table, and placed in an annealing furnace to flatten. The process became obsolete in the 1930s.

cylinder lock A lock with a central cylinder, which rotates when the key lifts the internal tumblers.

cylinder strength (of concrete) In most parts of the USA and Australia the compressive strength of concrete is ascertained by crushing a 150mm (6in.) diameter cylinder, 300mm (12in.) long, and is expressed as the ultimate load per unit cross-sectional area. The cylinder strength of concrete is about 84 per cent of its 150mm CUBE STRENGTH.

cylindrical shell A roof structure, which forms a part of a cylinder. Its cross-section is generally a circular arc, although elliptical and CATENARY cylindrical shells have been built. Cylindrical shells are DEVELOPABLE and RULED SURFACES, and SURFACES OF TRANSLATION. See also [BARREL VAULT](#) and [NORTHLIGHT SHELL](#).

cyma A moulding whose profile has a double curvature. In a *cyma recta* the curvature is concave at the outer edge and convex at the inner edge; in a *cyma reversa* it is convex at the outer edge and concave at the inner edge (see Figure).

D

d Abbreviation for *deci*, one-tenth.

D1S Timber dressed one side only.

da Abbreviation for *deca*, ten times.

dado In classical architecture, the portion of the pedestal between the base and the cornice. In modern buildings, any border or panelling over the lower half of the walls of a room, which is above the skirting.

DAI Distributed artificial intelligence.

dais A raised platform at one end of a large room.

Dalton's law of partial pressure 'The total pressure exerted by a mixture of different gases is the sum of the pressures each would exert if they alone occupied the container.'

damage risk criterion (DRC) An empirical curve, relating the frequency to the upper limit of sound pressure (in DECIBELS), above which loss of auditory acuity or deafness is likely to result.

damp course See [DAMPPROOF COURSE](#).

damped oscillation A mechanical (e.g. acoustical) or electrical oscillation in which there is an appreciable diminution of amplitude during successive cycles. Reducing vibrations by damping is analogous to reducing movement by friction. Damping is measured by the DECAY FACTOR *or* DAMPING RATIO.

damper An adjustable metal plate inside a flue or air duct, used to restrict the flow. Also a plate inside a duct, operating automatically in the event of a fire to close off the duct completely.

damping See [DAMPED OSCILLATION](#).

damping, critical The least value of the damping that will allow a displaced oscillatory system to return to its rest condition without oscillation.

damping of structural vibrations Wind and earthquake loads may set up excessive vibrations, particularly in tall buildings of flexible construction. These can be damped by *viscoelastic* devices.

damping ratio A measure of decay rate of a decaying oscillating system: it is the ratio of the actual damping to the critical damping.

dampproof course (DPC) An impervious layer inserted into a pervious wall (such as a brick wall) to exclude water. A DPC is required above ground level (below the level of a timber floor) and below a roof parapet (above the roof

level). Traditional materials for a DPC are slate, vitrified brick and lead. BITUMEN with a core of lead, copper, zinc, aluminium or plastic is now more common. A DPC is sometimes, misleadingly, called a *damp course*. See also [FLASHING](#).

DAR Dressed all round (all four sides of a piece of timber dressed).

Darcy's law 'The velocity of percolation of water in saturated soil=HYDRAULIC GRADIENT×coefficient of PERMEABILITY.'

data In computing, the information represented by a group of characters; the building block of information.

databank See [DATABASE](#).

database Collection of interrelated data stored on files, to facilitate the addition, modification and removal of data, usually by computer.

database management system SOFTWARE that controls the operations on a DATABASE.

data exchange The process of transferring DATA between different applications.

data exchange standards Standards for the representation of data to allow transfer between different graphic programs, e.g. STEP, IGES, DXF.

data file See [FILE](#).

data link The medium over which data is transferred.

data network See [NETWORK](#) (c).

data transfer rate The rate at which data is transferred. Usually measured in bits per second (bps).

datum line or level A reference *line* or *level*, used to locate other lines or levels in a survey. See also [BENCHMARK](#).

daub See [WATTLE-AND-DAUB](#).

daylight Direct, diffused or reflected sunlight and skylight. Sometimes the term is used to refer only to *sky light*, with sunlight being treated separately. Also called *natural light*.

daylight factor A factor describing the efficiency of a window in a particular room, used in the design of rooms for daylight. It is defined as the ratio of the ILLUMINANCE at a point in a room to the illuminance at the same instant on a horizontal plane exposed to the unobstructed sky.

daylighting Generally, the lighting of a space using daylight, either from skylight alone or with direct or indirect sunlight. Daylighting is usually used in combination with ARTIFICIAL LIGHT.

daylight protractor A transparent mask, which is used in the graphical determination of the DAYLIGHT FACTOR.

db Abbreviation for DRY BULB. Sometimes used incorrectly as an abbreviation for DECIBEL.

dB Abbreviation for DECIBEL.

dB(A) A-weighted SOUND PRESSURE LEVEL in DECIBELS. See also [A-SCALE ON A SOUND LEVEL METER](#).

DBMS Abbreviation for DATABASE MANAGEMENT SYSTEM.

DBR Division of Building Research, Melbourne or Ottawa.

DBT Abbreviation for DRY-BULB TEMPERATURE.

DC Abbreviation for DIRECT CURRENT. Also *d.c.*

deadend anchorage The anchorage opposite to the jacking end of a tendon when POST-TENSIONING is carried out from one end only.

dead level This sometimes means perfectly level; but a small slope, up to 1:50 (approximately 1 degree), is often tolerated within that definition.

dead light A window that does not open, as opposed to an *open light*.

dead load A load that is permanently applied to a structure, and acting at all times, as opposed to a LIVE LOAD.

deadlock A lock that can be opened only with a key.

dead man A heavy weight used for anchorage, or a pole set in the ground for anchorage.

dead shore A temporary vertical support.

debugging The process of eliminating errors from a computer program or system.

deca (da) The Greek word for ten. Prefix for 10 times, e.g. 1 decagram (a unit popular in Austria)=10 gram. Also spelt *deka*. Not to be confused with *deci*.

decagon A ten-sided regular POLYGON. The angle included between the 10 equal sides is 144°.

decarburisation Removal of carbon from the surface of steel.

decay (a) The decomposition of timber, particularly by fungi. (b) The damping of an oscillation, particularly a sound wave. (c) Spontaneous transformation of an atomic particle into two or more different particles.

decay factor The factor expressing the rate of decay of oscillations in a DAMPED oscillatory system, defined as the natural logarithm of the ratio of two successive amplitude maxima, divided by the time interval between them. It is a measure of the damping, for example, of acoustical RESONANCE.

deci Latin prefix for e.g. 1 decimetre =0.1m.

decibel (a) A scale unit used in the comparison of powers, mainly in electronics and acoustics. The number of decibels is 10 times the logarithm to the base 10 of the ratio of the two powers. See [SOUND POWER LEVEL](#). (b) The sound *pressure* level in dB is defined as 20 times the logarithm to the base 10 of the ratio of two pressures, because the square of the pressure is proportional to the power of the sound. See [SOUND PRESSURE LEVEL](#).

deciduous tree A tree that loses its leaves in winter. In Northern Europe the term is largely synonymous with hardwood, since all native hardwoods lose their leaves and none of the commercially used softwoods lose their needles in winter. However, most hardwoods native to the tropics and subtropics are evergreen.

decimal arithmetic Arithmetic based on the ten digits, 0, 1, 2, 3, 4, 5, 6, 7, 8, 9. It originated from counting on the ten digits of one's fingers. Since the only factors of 10 are 2 and 5, this is not the most useful arithmetic system, and DUODECIMAL arithmetic has evident advantages. Electronic digital computers use BINARY ARITHMETIC.

decimal logarithm A LOGARITHM to the base 10. This is the logarithm normally employed. It is denoted by the abbreviation *log*. The other commonly used logarithm is the NATURAL LOGARITHM, or logarithm to the base *e*.

decimal system The system originally introduced by the new republican government of France in 1793, based on DECIMAL ARITHMETIC. The Original CGS UNITS have now been replaced by the slightly different SI UNITS.

declarative language A computer programming language that operates with logical relationships. In a declarative language a problem is expressed by describing it rather than how to solve it, as in a PROCEDURAL LANGUAGE. *Prolog* is a well-known example of a declarative language.

declination The vertical coordinate of the sun, moon or a star at any given time, measured from the earth's equatorial plane. It is listed in the NAUTICAL ALMANAC. See also [ALTITUDE](#) and [RIGHT ASCENSION](#).

defects liability period The period following practical completion of the works, during which the contractor must rectify or repair defects due to faulty materials or workmanship.

deferred maintenance The maintenance works that are not carried out as planned and are carried forward to the next financial year as a backlog of maintenance items.

defibrator Machine for disintegrating wood into fibres.

definition In acoustics, the degree to which individual sounds in a musical performance stand apart one from another. Also called *clarity*.

deflected tendon A TENDON whose eccentricity, with reference to the CENTROID of the section, varies along the length of the beam. The object of deflecting, or *draping*, the tendon is to set up a bending moment that opposes the moment due to the imposed load, and thus reduces the stresses in prestressed concrete under load by LOAD BALANCING.

deflection The flexural deformation of a structural member. Although ELASTIC DEFORMATION is recoverable, it may damage brittle finishes, such as plaster, if it is excessive. The deflection of concrete and timber increases over a period of time due to CREEP.

deflectometer An instrument for measuring deflection. The most common device is a DIAL GAUGE.

deformation Change of shape. It may be ELASTIC (instantly recoverable), PLASTIC (permanent) or viscous (recoverable over a time interval).

deformed bar A reinforcing bar with surface deformations, which provide an anchorage with the surrounding concrete, and thus increase the BOND with the concrete (see Figure). The deformed surface is produced during the hot-rolling of the bars, from indentations in the rolls of the steel mill. The deformations must provide sufficient anchorage without setting up excessive stress concentrations in the concrete.

deformeter See [BEGGS' DEFORMETER](#).

deg Abbreviation for degree.

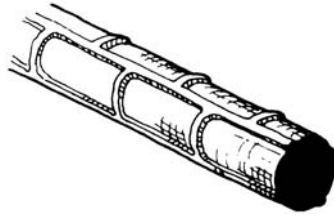

deformed bar

degradation Reduction of polymers to smaller molecules; also called *depolymerisation*.

degree-day A unit employed in estimating the fuel consumption and specifying the heating load for a building in winter. For any one day, when the temperature is below a specified value [usually 15°C (59°F) in Europe and 18°C (65°F) in the USA], there exist as many degree-days as the mean temperature for the day is below the specified value. The total for the winter is then compiled.

degree-hour A unit similar to the DEGREE-DAY, defined in terms of hours. It is used mainly for estimating the cooling loads for air conditioning.

degree of compaction The degree of density of a soil sample, given by the ratio $(V_1 - V_s)/(V_1 - V_d)$ where V_s = VOIDS RATIO of sample, V_1 = voids ratio of soil in its loosest state, and V_d = voids ratio of soil in its densest state.

degree of polymerisation Measured in MERS per average molecular weight.

degree of saturation A measure of the VOIDS in a soil that are filled with water (the remainder being filled with air). It is the ratio of the volume of water-filled voids to the total volume of voids.

degrees of freedom The number of variables, defining the state of a system, which may be fixed at will.

dehumidification of air Removal of moisture from the air. In AIR CONDITIONING plants it is accomplished by cooling the air below the DEW POINT, normally with a spray of chilled water, and draining off the condensate. In order to reduce the humidity to the desired level, it is usually necessary to cool the air below the temperature ultimately required and then reheat it. This is one reason why air conditioning is more expensive than heating. For small quantities of air, for example in instruments sensitive to moisture, the water vapour may be removed by an adsorbent, such as SILICA GEL. See also [ABSORPTION CYCLE](#) and [COMPRESSION CYCLE](#).

dehumidifier Component of an AIR CONDITIONING plant that reduces the moisture content of the air by cooling and condensation. See also [HUMIDIFIER](#).

dehydration of air DEHUMIDIFICATION of air. It generally refers specifically to the removal of moisture by ADSORPTION.

deka See [DECA](#).

delamination Separation of layers in a laminated assembly, either through failure in the adhesive or through failure at the interface of the adhesive and the lamination.

deliquescence The liquefying of certain salts due to their absorption of water from the air. Bricks or plaster containing chlorides may show an appearance of dampness due to this property.

delta connection In THREE-PHASE electrical systems, a *three-wire system* of connecting a balanced electrical load, making use of the higher line voltages. See also [STAR CONNECTION](#).

deluge system Automatic fire sprinkler system consisting of open sprinkler heads controlled by a quick-opening valve, which is activated by detectors installed in the same area as the open sprinklers. This system is employed for fire risks requiring total or zoned water coverage.

demand factor A factor by which the actual wattage of an electrical installation may be multiplied in designing the wiring system, to allow for the fact that the larger the house, the less likely it is that all lights etc. will be switched on at the same time. Demand factors are generally specified in electrical codes.

demand unit A standardised unit of demand related to fixture type, used for the estimation of peak demand in a water supply system.

demec strain gauge A demountable STRAIN GAUGE, which consists of a long bar with one fixed and one movable point, which operates a DIAL GAUGE through a lever. The points engage plugs glued to the structure under test.

demised premises Premises held under the terms of a lease.

demolition hammer A heavy hand-held machine with a reciprocating chisel-pointed bit, used for breaking up concrete, masonry etc. Same as *jack-hammer*, although a demolition hammer is more commonly electrically operated, and jackhammer is more commonly applied to a pneumatic tool.

demountable partition A PARTITION that can be easily installed, removed, and relocated without damage to its prefabricated components.

dendrite A tree-shaped crystal, caused by the tendency of some metals to grow by branches developing from a nucleus. The secondary branches growing from the primary branches produce the dendritic structure.

dense concrete Concrete made in the conventional way, as opposed to LIGHT-WEIGHT CONCRETE. It generally weighs $1900\text{--}2600\text{kg/m}^3$ ($120\text{--}160\text{lb/ft}^3$).

density Mass per unit volume. SPECIFIC GRAVITY is the ratio of the mass of a substance to the mass of an equal volume of water. In the metric and SI systems it has the same numerical value as the density in kg/m^3 .

depolymerisation Reduction of polymers to smaller molecules; also called *degradation*.

depreciation The reduction in the value of an asset through wear, tear and obsolescence.

derrick Originally the gallows at Tyburn in London, named after a sixteenth-century hangman. Now a crane consisting of a jib set up obliquely, with its head steadied by guy ropes. There are many different types, ranging from small, hand-

operated derricks to large power-operated derrick cranes. See also [SCOTCH DERRICK](#), [TOWER CRANE](#) and [GANTRY CRANE](#).

desiccant A chemical substance with the property of adsorbing moisture from air. Used in desiccant air driers.

desiccation Drying, e.g. of timber in a kiln.

design and construct contract A contract between a client and construction contractor to provide both design and construction services for an agreed financial return.

design load The working or service load for which a building is designed.

design review The formal review of a design proposal by independent reviewers; required as part of QUALITY ASSURANCE accreditation.

destructive distillation Distillation of a solid substance, accompanied by its decomposition.

detector See [FIRE DETECTOR](#).

detention basin Part of a stormwater drainage system formed by a constructed or natural basin in the ground, which receives flow from the site and regulates the outflow to achieve the rate of discharge that would be expected from the site if it had retained its natural ground cover of vegetation. See also [RETENTION BASIN](#).

determinant (of a matrix) A square array of quantities, and the sum of the products formed by evaluating it in accordance with certain mathematical rules.

detritus tank A settling tank through which SEWAGE is passed for the settlement of the heavier solids.

detrusion Shear strain.

developable surface A curved surface that can be flattened into a plane surface without shrinking, stretching or tearing. Cylindrical and other SINGLY CURVED SURFACES are developable. DOUBLY CURVED SURFACES are non-developable. Developable surfaces have zero GAUSSIAN CURVATURE.

development length In reinforced concrete, the length of reinforcing bar required to develop the stress at the critical section.

deviation (a) The amount by which one observation of a set of observed values differs from their mean. The STANDARD DEVIATION is a measure of the spread of the observations. (b) The bending of a ray of light as it passes through a prism or lens, or is reflected by a mirror.

deviation angle The total angular deviation by a ray after a series of refractions and/or reflections, through an optical system.

devitrification In glass, deterioration through crystallisation.

dewatering Keeping a building site dry and the soil in stable condition during construction by pumping the water from the excavation. See also [WELLPOINT DEWATERING](#).

dew point The temperature at which CONDENSATION of water vapour in the air takes place, i.e. the temperature at which the air is fully saturated.

dew-point hygrometer An instrument that measures the humidity of the atmosphere by determining the dew point. A refrigerating effect is produced on a

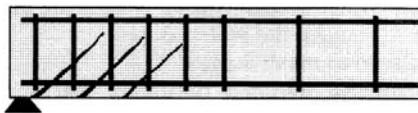

diagonal crack

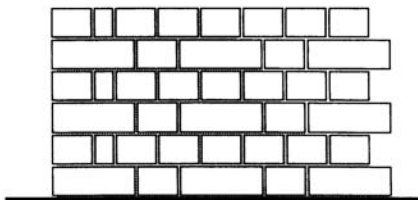

diagonal Flemish bond

silvered bulb by evaporating ether inside it, until dew appears on the silvered surface, where it can easily be recognised. The best-known type is the *Regnault hygrometer*.

dextrin A water-soluble gum made from starch, used as an adhesive.

DF Abbreviation for (a) DEGREE OF FREEDOM, 01 (b) DAYLIGHT FACTOR.

diagnostic program A computer program, usually an EXPERT SYSTEM, for the diagnosis of faulty performance. May also include a prescription for remedial actions.

diagonal (a) A straight line connecting two nonadjacent angles of a quadrilateral, polygon or polyhedron. (b) A strut or tie running at an angle to both the horizontal and the vertical in a TRUSS or a LATTICE STRUCTURE.

diagonal compressive stress One of the PRINCIPAL STRESSES resulting from the combination of horizontal and vertical shear stresses in a beam. Beams with slender webs such as steel plate girders must be provided with STIFFENERS to prevent web BUCKLING due to the diagonal compression.

diagonal crack An inclined crack caused by the DIAGONAL TENSILE STRESSES in a brittle material, such as concrete. It starts on the tension face and gradually disappears as it passes into the compression zone of the beam (see Figure). Small diagonal cracks are acceptable in concrete, but when the permissible shear stress is exceeded, SHEAR REINFORCEMENT must be provided across the cracks.

diagonal Flemish bond A brick BOND in which a course of HEADERS alternates with a course of headers and STRETCHERS; it shows a diagonal pattern (see Figure).

diagonal member Member used for BRACING.

diagonal tensile stress One of the PRINCIPAL STRESSES resulting from the combination of horizontal and vertical SHEAR STRESSES in a beam or slab. In brittle materials, such as concrete, it causes DIAGONAL CRACKS.

dial gauge An instrument for measuring deflection. It consists of a plunger whose movement is enlarged by a train of gears, operating a rotating pointer. It can readily measure a deflection of 1×10^{-3} mm or 1×10^{-4} in. A dial gauge may be used as a DEFLECTOMETER, as a measuring device in a STRAIN GAUGE or in a PROVING RING.

dial-up The process of accessing a computer via a telephone line using a MODEM.

diamagnetic Pertaining to bodies that are *repelled* by a magnet.

diametral compression test Same as SPLITTING TENSILE TEST.

diamond The crystalline form of CARBON. It is one of the hardest materials on earth and is classified 10 on the MOHS' SCALE.

diamond drill A drilling machine with a hollow cylindrical bit, coated on the cutting edge with industrial diamonds, used for CORE DRILLING in concrete, rock etc. Water is usually used to cool the bit and remove the material.

diamond mesh Same as EXPANDED METAL.

diamond pyramid hardness test See VICKERS DIAMOND HARDNESS TEST.

diamond saw A circular saw, with industrial diamonds on the cutting edge of the blade. It is commonly used for cutting brick and other hard materials.

diaphragm A relatively thin, usually rectangular element of a structural member, which is capable of withstanding shear in its plane. It serves to stiffen the structural member.

diaphragm pump A pump in which a flexible partition (or diaphragm) of rubber, leather or canvas is operated by a rod. The diaphragm takes the place of the piston in the usual *reciprocating* pump. The pump is very robust, and it can be used for pumping water containing mud, sand and even small stones.

diatomaceous earth A whitish powder consisting mainly of the frustules of diatoms (which are microscopic plants). It is nearly pure hydrous amorphous SILICA, and is resistant to heat and chemical action. It is used in insulating materials and fireproof cements, in filters, and also as an absorbent in the manufacture of explosives. Nobel's discovery of the 'safe' explosive dynamite consisted of the observation that nitroglycerin is absorbed by diatomaceous earth. Also called *kieselguhr*.

diatonic scale The scale used in most Western music, ascribed to J.S.Bach, which consists of 8 notes per OCTAVE. In a major scale the frequencies of the notes are in the ratios 1, $2^{2/12}$, $2^{4/12}$, $2^{5/12}$, $2^{7/12}$, $2^{9/12}$, $2^{11/12}$ and 2. In a minor scale the 3rd and 6th notes are reduced by a semitone. See also CHROMATIC SCALE.

dicalcium silicate One of the principal components of PORTLAND CEMENT. Its chemical composition is $2\text{CaO} \cdot \text{SiO}_2$, or C_2S in the notation used by cement chemists. It is the component named *Belite* by Tornebohm in 1897, before the chemical composition of cement had been properly established.



differential pulley

dichroic Literally, 'having two colours': in lighting, referring to the properties of filters and reflectors employing thin films of metal oxides to alter the spectral composition of reflected or transmitted light and infrared radiation.

die (a) (plural *dies*) A tool for drawing wire, extruding rods, cutting threads or stamping metal. (b) (plural *dice*) A cube whose faces are marked with one to six spots used in games of chance, or any small cube into which food is cut.

dielectric heating The process of generating heat at high frequencies in non-conducting materials by placing them in a strong alternating electric field.

dielectric strength Electric breakdown potential of an electrical insulator, per unit thickness.

differential pulley block A lifting tackle consisting of two pulleys of slightly different diameters and an endless chain (see Figure). The closer the diameter of the two pulleys, the greater the lifting power of the tackle, and the slower its speed of operation.

differential settlement Uneven sinking of different parts of a building. It endangers the safety of a building if it causes it to tilt (the Leaning Tower of Pisa is a classic example), or if it places severe strain on some of the structural members. Differential settlement may be due to a clay foundation of variable consolidation characteristics, or to grossly uneven load distribution (e.g. due to a tower block) on a compressible clay.

diffraction (a) The deviation of a ray (or wave) of light at an edge of an obstacle in its path, sometimes breaking up the ray into colours or dark and light fringes due to INTERFERENCE, e.g. when a ray passes through a narrow slot. (b) The similar breaking up of other types of electromagnetic waves. (c) The modification of a progressive acoustical wave due to the presence of an obstacle in the sound field.

diffuser (a) A device used to alter the spatial distribution of the luminous flux from a source by DIFFUSION. A perfectly *mat* surface is one in which the whole

of the incident light is redistributed uniformly in all possible directions in such a way that the LUMINANCE is the same in all directions. (b) A cone or wedge placed in front of a loudspeaker to obtain a more uniform polar distribution of sound with varying frequencies. (c) Any surface or surface irregularity introduced into a room in order to attain a more uniform distribution of sound. (d) A device used to introduce air to a conditioned space in such a way that it is gradually diffused into the space without creating a draft.

diffuse reflection The scattered reflection (as opposed to MIRROR reflection) of light or sound from a rough surface.

diffuse sound field A sound field whose properties are the same throughout. See also [REVERBERANT SOUND FIELD](#).

diffusing panel A translucent panel in a luminaire, used to reduce the brightness of the lamps by distributing the radiant flux over a larger surface area.

diffusion (a) The movement of atoms or molecules of one material into another without chemical combination. (b) Alteration of the spatial distribution of light or sound, which, after reflection at a surface or passage through a medium, travels on in numerous directions.

diffusivity See [THERMAL DIFFUSIVITY](#).

digit (a) One of the terminal divisions of the hand or foot (i.e. a finger or toe). (b) One of the first ten numbers (represented by the numerals 0 to 9), which can be counted on the fingers of one's hands. (c) A symbol used in a system of enumeration; see [BINARY ARITHMETIC](#) and [DECIMAL SYSTEM](#). (d) As a Roman measure of length, of a Roman FOOT.

digital calculator A portable electronic calculator, which superseded the SLIDE RULE. A calculator differs from a COMPUTER by having little or no memory, and by dealing with numbers but not alphabetical characters.

digital camera A camera that records images in digital form, and may be used as input to computer graphics systems.

digital computer A COMPUTER that operates on data represented in digital form, i.e. as a series of discrete elements, based on BINARY ARITHMETIC, as opposed to an ANALOGUE COMPUTER.

digital signal processor (DSP) Fast digital processor used to filter, add reverberation, synthesise, modify and analyse acoustic signals in real time.

digitise To convert an analogue representation into a digital form.

digitiser Any device that converts a physical quantity into a coded character form. Commonly used for a device for converting shapes drawn on a GRAPHICS TABLET into digital data, usually by pointing to the vertices of the shapes with a STYLUS or digitiser pen.

dihedral angle The angle of inclination of two meeting or intersecting planes.

dilution ventilation Supply of clean air to a space for the purpose of diluting contaminants that are or may be released as a result of occupation and use.

dimension (a) The measured distance between two points. (b) A measure shown on a drawing which is intended to become a precise distance between two points in a building. (c) The unit attached to a measurement (length, mass etc.)

dimensional analysis Analysis of structures, fluid flow, heat transfer, acoustics and other problems by means of dimensional similarity using the PI-THEOREM and involving DIMENSIONLESS NUMBERS. See also [ACOUSTIC MODEL ANALYSIS](#) and [DIRECT MODEL ANALYSIS](#).

dimensional coordination Design of building components to conform to a dimensional standard, which may be a MODULE.

dimensional stability The term usually implies that a material has little MOISTURE MOVEMENT and CREEP, since thermal and elastic deformation are unavoidable.

dimensionless (a) In mathematics, referring to a point, as distinguished from, say, a line, which has one dimension (length). (b) In physics and metrology, a quantity without any measurement (length, mass etc), i.e. a pure number. For example, *efficiency* is the ratio of two quantities with the dimensions of power, but their ratio has no dimensions.

dimensionless number A ratio of two quantities, with the same dimensions, or a grouping of several variables whose product has no dimension, used in DIMENSIONAL ANALYSIS and for experimental data. See for example [REYNOLDS' NUMBER](#).

dimetric projection An AXONOMETRIC PROJECTION in which the two horizontal axes are drawn at the same angle.

dimmer See [LAMP DIMMER](#).

DIN Deutsche Industrie Normung (German Standard).

diode A two-terminal electronic device that allows current to flow through in only one direction. Hence it can be used to rectify ALTERNATING CURRENT to produce DIRECT CURRENT.

dioptr A measure of the power of a lens; it is generally the reciprocal of the lens's focal length in metres.

diorite An IGNEOUS ROCK cooled slowly at great depth below the Earth's surface, and hence coarse-grained; it contains no quartz, and is more basic than GRANITE. In the industry classification of stone, diorite is called a granite.

direct current (DC or d.c.) A current that flows in one direction without significant pulsations, as opposed to an ALTERNATING CURRENT.

direct drive An *electric* lift drive whose motor is connected directly to the car frame.

direct expansion An air conditioning system in which the refrigerant is expanded (and therefore causes a cooling effect) in a coil located in the air-handling plant, as opposed to a CHILLED WATER system.

direct gain method The oldest and most common method for the collection of PASSIVE SOLAR ENERGY, by allowing sunlight penetration through windows in cool weather, while shading the windows in warm weather.

directional collective control Of lift systems: landing calls are registered on a set of up and down pushbuttons. Also referred to as *full collective control*.

directional lighting Lighting coming mainly from one direction, and therefore emphasising three-dimensionality by casting shadows and/or highlights.

directivity The directivity of a sound source at a specified frequency is the ratio of the intensity at a given distance from the source in the direction of interest to the average intensity of the sound over all directions, at the same distance from the source.

direct lighting Lighting using luminaires that direct most of the flux towards the surface being lit, as opposed to INDIRECT LIGHTING.

direct model analysis Analysis of structural problems and studies of lighting, ventilation or acoustics by means of models that are accurately scaled in accordance with the theory of DIMENSIONAL ANALYSIS. In the case of *structures*, the loads are accordingly reduced to a magnitude that can be easily handled in a laboratory. Measurements of deformations are usually made with DIAL GAUGES and with ELECTRIC RESISTANCE STRAIN GAUGES. The rules of dimensional analysis also apply to ACOUSTIC MODEL ANALYSIS, to the analysis of lighting problems in an ARTIFICIAL SKY, and to the investigation of air flow in a WIND TUNNEL.

direct modulus of elasticity The MODULUS OF ELASTICITY, as opposed to the MODULUS OF RIGIDITY.

directory In computing, an index giving the addresses of data, e.g. the location of files or other directories on a DISK.

direct plunger drive A *hydraulic* lift drive whose cylinder is connected directly to the car frame.

direct plunger hydraulic lift A *hydraulic* lift having a plunger or cylinder attached directly to the car frame. See also [ROPED HYDRAULIC LIFT](#).

direct solar gain Solar energy obtained directly through a window.

direct sound The sound received directly from the sound source, as opposed to the sound *reflected* from the boundaries of the auditorium.

direct sound field That part of a sound field in which the effect of reflections from the room surfaces may be neglected.

direct strain Elongation or shortening per unit length, caused by tensile or compressive stresses respectively.

direct stress A STRESS due to a tensile or compressive force.

direct view storage tube (DVST) A type of CATHODE-RAY TUBE whose screen surface is coated with a phosphor capable of retaining an image for some time. Changing this image requires erasing the entire screen, and redrawing it.

dirt resistance The ability of a surface, particularly a painted surface, to resist the accumulation of foreign material.

disability glare GLARE that impairs the vision without necessarily causing DISCOMFORT. It is a physiological effect.

disaster recovery plan A procedure or set of actions required to manage recovery from a catastrophe (fire etc.) occurring within a facility.

disc Same as DISK.

discharge lamp A LAMP in which light (or ultraviolet radiation) is produced by an electrical discharge through a vapour. See [FLUORESCENT LAMP](#), [COLD-CATHODE LAMP](#), [HOT-CATHODE LAMP](#) and [SULPHUR LAMP](#).

discharging arch An arch placed above the LINTEL of a door or a window to carry the weight of the wall above, i.e. discharge it to each side. Also called a *relieving arch*. These arches were frequently used in masonry and brick construction from Ancient Roman times until the early twentieth century, when reinforced concrete lintels were introduced. See also [ARCHING](#) (c).

discomfort glare GLARE that causes discomfort without necessarily impairing the vision of objects. It is a psychophysical effect.

discontinuous construction Construction that avoids continuous sound paths, particularly through a steel frame, to provide the greatest amount of IMPACT SOUND insulation with the least amount of insulating material, e.g. by the use of a FLOATING FLOOR. This sometimes conflicts with the structural requirements of the building.

discounted cash flow method Method in which a capital investment project is evaluated by considering all net receipts from the venture, and all necessary operating payments. Future receipts and payments are discounted at an appropriate rate.

dishing Grading of a pavement or a floor surface to form a shallow dish, generally with a drain at the lowest point.

disk A magnetic storage device containing addressable tracks. Data may be written to and read from these tracks by means of read/write heads. See [FLOPPY DISK](#), [HARD DISK](#) and [DISKETTE](#).

diskette Once synonymous with a 5.25 inch FLOPPY DISK. Now used for 3.5 inch disks.

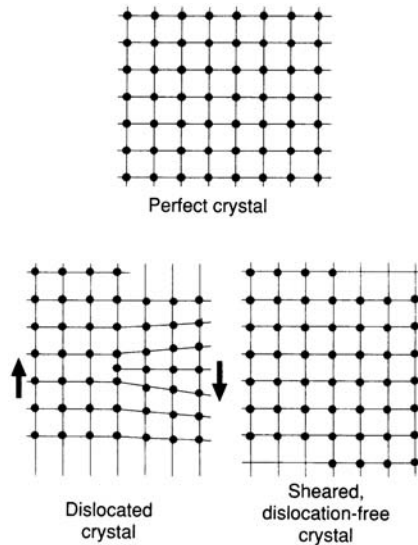

dislocation in a crystal

dislocation in a crystal An imperfection caused by a failure of the crystal planes in two portions to match (see Figure). Dislocations are closely related to slipping action. In an *edge dislocation* there is a linear displacement accompanied by zones of tension and compression. In a *screw dislocation* there is a distortion, with associated zones of shear. The dislocation can be demonstrated with a BUBBLE MODEL.

dispatcher panel An assembly of INDICATORS FOR LIFTS showing up/down and landing calls, direction, status and position for each lift in the system, with key-controlled switches. It is located outside a LIFT installation. See also [ANNUNCIATOR](#).

dispersion (a) The even distribution of finely divided drops in an EMULSION, e.g. in an emulsion paint, (b) The separation of electromagnetic radiation into constituents of different wavelengths, by REFRACTION or DIFFRACTION.

displacement ventilation A ventilation system operated on the principle of introducing air that is slightly cooler than room air at floor level and allowing it to rise because of thermal buoyancy, to be released from the space at high level.

display device Any device capable of displaying information. If it is capable of displaying graphical information it is called a VISUAL DISPLAY UNIT.

distemper A cheap paint with a binder of casein or some other glue; it usually is heavily pigmented, and thinned with water. *Washable distemper* contains some drying oil.

distillation Process of converting a liquid into vapour, condensing the vapour, and collecting the condensed liquid or *distillate*. It is used for separating a mixture of liquids with different boiling points.

distortion An undesired change in the waveform of a sound.

distributed computing A system in which a number of computers are organised in a network to cooperate in performing a single task.

distributed load A load distributed over the surface. Unless described otherwise, it is usually considered *uniformly distributed*.

distribution board A switchboard, usually controlling the final subcircuits in an electrical installation.

distribution reinforcement Small-diameter bars placed in concrete slabs at right angles to the main reinforcement to spread a concentrated load. It also serves to control *temperature* and *shrinkage* cracking.

distribution temperature (of a light source) See CORRELATED TEMPERATURE.

diurnal Belonging to each day, e.g. the *diurnal motion* of the sun, or the *diurnal rhythm* of the human body.

dividers An instrument for transferring a length from one part of a drawing to another location. It consists of two legs with pointed ends, hinged together at the other ends, similar to a compass.

dividing screen (for lift well) A screen installed between the paths of travel of two lifts sharing a common lift well, to enable the safe maintenance of one lift while the other is still in operation.

DL Abbreviation for DEAD LOAD.

DLOR (downward light output ratio) The ratio of the flux emitted in the lower hemisphere below a luminaire to the total flux emitted by the lamp(s) installed in the luminaire.

DN Abbreviation for (a) down, (b) nominal diameter.

docking saw A circular saw mounted above the work and cutting by pulling down on it.

dodecagon A 12-sided regular POLYGON. The angle included between the 12 equal sides is 150°.

dodecahedron A regular POLYHEDRON, bounded by 12 regular PENTAGONS. It has 20 vertices and 30 edges.

dog iron A short steel bar whose ends are bent at right angles, and pointed. It is hammered into adjacent pieces of timber to connect them. See also CRAMP (a).

dogman A person directing a crane's operations from the ground, from other parts of the building, or from riding on the load.

dolerite An igneous rock formed by MINOR INTRUSIONS or thick lava flows. It is a fine-grained rock of basic composition. In the industry classification of stone it is called a GRANITE.

dolly A block of hardwood used to cushion the blow from a PILE HAMMER.

dolomite The double carbonate of calcium and magnesium, CaMgCO_3 . It is used for REFRACTORY MATERIALS and as a lime for *jointless flooring*. Dolomite limestone is also known as *magnesian limestone*.

dome A vault of double curvature, both curves being convex upwards. Most domes are portions of a sphere; however, it is possible to have a dome of non-

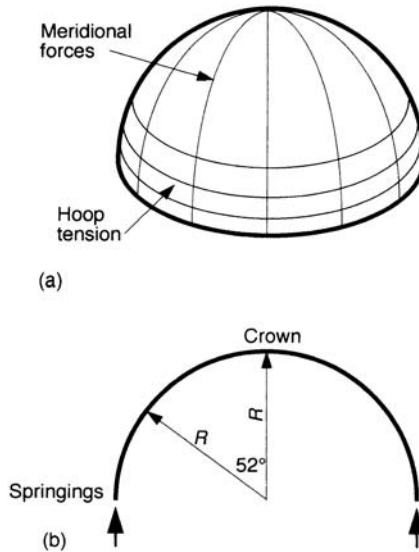

dome

spherical curvature on a circular plan, or to have a dome on a non-circular plan, such as an ellipse, an oval or a rectangle. In classical architecture, domes were normally constructed of masonry. A spherical dome is subject to hoop tension when the angle subtended at the centre of curvature exceeds 104° ; consequently hemispherical domes, which subtend 180° , are subject to HOOP TENSION for the lowest 38° , and this presents problems in masonry construction (see Figure).

door light The glass area in a door.

door louvres Blades or slats, which may or may not be adjustable, in a door to permit ventilation while the door is closed.

doorpost The vertical post on each side of a door opening.

door vane A mechanism mounted on a lift door, which transmits the operating power to the landing doors.

dormer window A vertical window inserted into a sloping roof. It usually has its own gable projecting through the main roof slope.

dot matrix printer A printer that prints by impacting an ink ribbon against paper using closely packed needles or pins.

double-acting engine A RECIPROCATING ENGINE in which the working fluid (e.g. steam) acts on each side of the piston alternately, so that each stroke is a working stroke, as opposed to a *single-acting* engine.

double-acting hinge A hinge that allows a door to swing both ways, through 180° . It usually has a spring to make the door also self-closing.

double-acting pump A RECIPROCATING PUMP in which both sides of the piston act alternately, giving two delivery strokes per cycle.

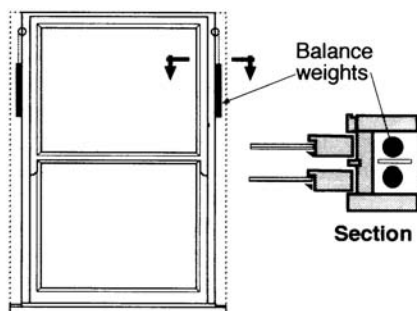

Outside elevation double-hung window

double-deck lift (or elevator) A two-storey lift, whose two compartments must stop at adjacent floors where both compartments can be unloaded and loaded simultaneously. This increases the capacity of the lift by about 25 per cent above that of a single-deck lift.

double Flemish bond Brickwork showing FLEMISH BOND on both faces (see Figure under FLEMISH BOND). As this is the only practical use of Flemish bond for walls less than two bricks in thickness, *double* is usually omitted.

double glazing Glazing in which two layers of glass are separated by an air space for thermal and acoustic insulation. It has been used traditionally in the very cold climates of northern and eastern Europe, and of north-east America, with the windows contained in separate wooden frames. Double glazing is common in all climates in air-conditioned buildings, where it saves operating costs at the expense of a higher prime cost. The two layers of glass are then placed in one frame, and the space between is sealed. VENETIAN BLINDS, if used, may be placed in this space.

double-headed nail A nail with two heads, one above the other, used on temporary structures such as scaffolds and formwork. The lower head bears on the surface into which the nail is driven. The upper head is used to withdraw the nail. Also called a *scaffold nail*.

double-hung window A SASH WINDOW with two vertically sliding sashes, each balanced by a set of sash weights (see Figure).

double-walled shell A structure with two parallel MEMBRANES, joined by DIAPHRAGMS at regular intervals. It can be used for long spans, since the two membranes, separated by the space between, provide bending resistance. Doubling the shell also improves the waterproofing, since any water penetrating the first membrane can be drained off before entering the interior of the building.

double window See [DOUBLE GLAZING](#).

doubly curved surface A surface curved in both directions, as opposed to a singly curved surface. Doubly curved surfaces are divided into domes, which have positive GAUSSIAN CURVATURE, and saddles, which have negative

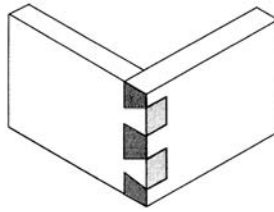

dovetail

Gaussian curvature. Doubly curved surfaces are non-DEVELOPABLE. They may or may not be RULED.

doubly prestressed concrete Concrete prestressed in two mutually perpendicular directions. By this means the diagonal tensile stresses due to shear and torsion can be completely eliminated.

doubly reinforced concrete Concrete with both tension and COMPRESSION REINFORCEMENT.

doubly ruled A surface that is RULED in two directions.

doughboy An underburnt brick.

Douglas fir A softwood widely used in the USA and Canada, and exported in large quantities to Europe and Australia, because it is obtainable in large sizes, which are straight grained and free from knots. It is light (about 530kg/m³ or 33lb/ft³) and comparatively strong. Also called *British Columbian pine*, *Oregon pine* or just *Oregon*.

dovetail An interlocking joint between two pieces of timber in which the interlocking pins are fanshaped, like the tails of certain pigeons. They are thicker at the ends than at the root, and are therefore not easily pulled out. Dovetail joints are used for joinery, drawers and boxes (see Figure).

dowel A pin of wood or metal, used in timber, masonry or concrete structures, usually to resist shear.

downconductor In a LIGHTNING PROTECTION SYSTEM, a conductor that connects the AIR TERMINATION with the EARTH TERMINATION.

downfeed system A system of water supply fed from a tank at the top of a building.

downlight A LUMINAIRE that directs the majority of its flux downwards, usually within a restricted cone, as opposed to an UPLIGHTER.

down peak Traffic condition existing in a lift system when the dominant or only traffic flow is in the downward direction, with all or the majority of the passengers leaving the system at the main terminal floor of the building.

down time The period during which an item of plant is unable to operate.

dozer A general term for bulldozers, angle dozers, tilt dozers etc., which are tractors, usually mounted on crawler tracks, with a blade mounted on the front in order to push material.

DP Abbreviation for (a) data processing, (b) dynamic programming.

DPC Abbreviation for DAMPPROOF COURSE.

DPI Dots per inch.

DPM Dampproof membrane.

draft See [DRAUGHT](#).

dragline An excavator with a toothed or cutting bucket suspended from a jib and filled by dragging action.

dragon's blood A red resin, obtained from certain trees, which is insoluble in water, but soluble in alcohol and ether. It is used for tinting varnish.

drain, vertical sand A vertically bored hole, subsequently filled with granular material in order to assist the drainage of impermeable soils.

drainage An assembly of pipes and fittings, *in the ground*, used for the removal of waste water or rainwater from a building or a site.

drainage hole A hole or open joint, particularly in a RETAINING WALL, to drain unwanted water.

drained joint To ensure that rain does not penetrate a wall of DRY CONSTRUCTION, it should be provided with a RAIN SCREEN at the outdoor face, an *airseal* at the indoor face, and a *drainage system* between the screen and the seal. This equalises the pressure in the drainage cavity to that outdoors, and allows water that enters the joint to drain to the outside.

draped tendon Same as DEFLECTED TENDON.

draught A pressure difference in a room, and more particularly in a chimney or ventilator, which induces natural air movement. Also spelt *draft* (USA).

drawings See [SHOP DRAWINGS](#) and [WORKING DRAWINGS](#).

DRC Abbreviation for DAMAGE RISK CRITERION.

drenchers Automatic fire devices similar to sprinklers, which deliver a curtain spray; usually used to protect the external face of a building from some adjacent fire risk.

dressed lumber See [DRESSED TIMBER](#).

dressed stone Stone that has been squared all round and smoothed or rusticated on the face.

dressed timber Timber that has been sawn and finished with a planing machine at the timber mill. It is customary to state the nominal size, which is the size of the timber *before* dressing. The dressed timber is 5 to 13mm to in.) smaller. Dressed timber is usually DAR (dressed all round, or dressed on all four faces) unless specifically ordered as dressed on one or two faces. Also called *dressed lumber*.

drier A compound that encourages oxidation of the DRYING OIL in a paint or varnish.

drift Movement of air away from an exhaust of a building under the influence of wind. It may carry contaminants toward fresh-air intakes.

drilled pile Same as BORED PILE.

drive See DISK DRIVE.

driven pile A precast concrete, steel or timber pile that is driven into the ground with a pile driver.

drop panel The portion of a FLAT SLAB or FLAT PLATE that is thickened throughout the area surrounding the column or COLUMN CAPITAL, to reduce the magnitude of the shear stress, and thus obviate the need for shear reinforcement. See illustrations under COLUMN STRIP and FLAT PLATE.

dropped panel Same as DROP PANEL.

drop saw Same as DOCKING SAW.

drum A vertical wall supporting a dome or cupola.

drum plotter A plotter in which the drawing is held on a drum. Lines are drawn with a pen by a combination of rotating the drum and moving a pen along its surface parallel to its axis of rotation.

dry-bulb temperature The temperature indicated by a normal thermometer, as distinct from the WET-BULB TEMPERATURE.

dry-bulb thermometer A normal thermometer, which does not have its bulb wrapped in a damp wick, as opposed to a WET-BULB THERMOMETER.

dry construction Building without the use of wet plaster, wet concrete or mortar on the site. However, the concrete may be precast, or the brickwork prefabricated; indeed, a large proportion of dry construction consists of precast concrete units joined with dry fasteners, which may or may not be sealed with mastic. Dry construction avoids damage to finishes through concrete and mortar droppings, and it is unnecessary to wait for the wet materials to dry; but the cost is often higher.

dry density The mass of soil or aggregate per unit volume, after it has been dried at 105°C.

dry ice Frozen carbon dioxide.

drying oil An animal or vegetable oil (the most common being linseed oil) that forms a tough film by oxidation when exposed to air in a thin layer. The process can be speeded up by the use of a DRIER.

drying shrinkage Contraction (of timber or concrete) caused by moisture loss.

dryness As an acoustic quality, the lack of LIVENESS.

dry rot Timber decay caused by a fungus, which flourishes only if the timber is *damp*. It is usually caused by inadequate ventilation.

dry wall (a) Stones or blocks laid without mortar. Dry stone walls were used in prehistoric times before the invention of mortar, often by wedging small stones into the joints; they are still in use in some country districts, particularly for walls around fields. In recent years, a number of concrete BLOCK types have been designed for precision fitting without the use of mortar. (b) (also spelled *drywall* in the USA) DRY CONSTRUCTION using plasterboard on timber or steel studwork.

DSP Abbreviation for DIGITAL SIGNAL PROCESSOR.

dual flush A WC cistern arranged so that the user can choose to flush the pan using the full quantity of water, or a reduced quantity. A considerable saving in water consumption can be achieved.

DuBois area The surface area of a person's skin in square metres, determined from a formula derived in 1915 by D. and E.F.DuBois. It is used in thermal comfort calculations.

duct (a) A pipe, conduit or runway for electric or telephone wires. (b) A pipe or cavity used to convey air for ventilation or air conditioning. (c) A cavity within a building (usually running vertically through several storeys) containing water pipes, drainage pipes, wires etc. (d) A hole formed in a concrete member to accommodate post-tensioning TENDONS.

ductility The property of certain metals that enables them, when cold, to undergo large permanent deformations without rupture; as opposed to brittleness. See also [PLASTIC MATERIAL](#).

duct lining An absorbent lining placed in an air conditioning duct to attenuate the noise caused by the equipment and air flow.

ductwork An assembly of ducts and duct fittings, usually of sheet metal, arranged for the distribution of air in air conditioning and mechanical ventilation systems.

dumbwaiter A lift for the vertical transportation of materials only, with its size and controls limited to ensure that it cannot be used to transport people. See also [GOODS LIFT](#).

dummy activity An arrow in a NETWORK that is used as a logical connector, but does not represent actual work items. It is usually shown as a dotted line.

dummy joint A groove formed or cut in concrete to imitate the appearance of a CONTROL JOINT, usually for aesthetic reasons to match other, genuine control joints, or to disguise CONSTRUCTION JOINTS.

dummy level A level in which the telescope and the SPIRIT LEVEL are attached rigidly to the vertical spindle. LEVELLING is performed with three (in old instruments sometimes four) levelling screws, and the instrument is then level in any direction. This used to be the most commonly employed instrument. However, the QUICKSET LEVEL has now become more common.

duodecimal system A system based on 12 units, e.g. 12 inches=1 foot. It was used by the Babylonians, and it is arithmetically versatile, since 12 is divisible by 2, 3, 4 and 6. From a mathematical point of view it may be superior to the DECIMAL system (10 being divisible only by 2 and 5), based on counting on ten human fingers, which became firmly established during the Roman Empire. However, since the 'digital' computer (which is really a BINARY calculator) has a keyboard based on the decimal system, duodecimal units are unlikely to survive, except for time and angle measurement.

duplex (a) A house with two separate two-storey dwellings, one on each side of a common party wall. (b) A two-storey house containing two separate apartments, one on each storey. (c) American term for MAISONETTE. (d) Two interconnected LIFT cars, sharing a common signalling system controlled under a simple group control system, operating under DIRECTIONAL COLLECTIVE principles.

duplex-head nail Same as DOUBLE-HEADED NAIL.

durability The ability of a material to resist ABRASION, CORROSION, weathering action and other conditions of normal service.

duralumin An aluminium alloy containing 3.5 to 5.5 per cent copper, 0.5 to 0.8 per cent magnesium, 0.5 to 0.7 per cent manganese and up to 0.7 per cent silicon. It is capable of AGE HARDENING at room temperature, and it can be cast, forged and rolled hot or cold.

DVST Abbreviation for DIRECT VIEW STORAGE TUBE.

dwelt time The time during which the doors of a lift or elevator are fully open to unload and load.

DWV piping Drain, waste and vent piping.

dye A colouring material that, unlike a PIGMENT, colours materials by penetration.

dynamic head (velocity head) The energy possessed by a unit mass of a fluid due to its velocity (v). It is expressed as a height (H_v) and calculated using the equation

$$H_v = v^2/2g$$

where g =gravitational acceleration.

dynamic load A *live load* due to moving machinery, EARTHQUAKE, or WIND, as opposed to a *static load*. Dynamic loads are frequently converted into equivalent static loads by means of an IMPACT FACTOR; however, where they exercise a controlling influence on the design of the structure, a dynamic analysis is required.

dynamic modulus of elasticity The MODULUS OF ELASTICITY determined from the vibration of a specimen or structure, or from the velocity of a pulse, which may be ULTRASOUND.

dynamic penetration test A PENETRATION TEST in which the testing device is forced into the soil with a specified number of blows with a standard hammer, as opposed to a STATIC PENETRATION TEST, which employs a measured force.

dynamic pressure (a) The pressure in pipework under flow conditions. (b) The pressure resulting from a change in velocity of a fluid stream.

dynamic range For an instrument or electro-acoustic system, the difference between the minimum and maximum levels it can accommodate.

dynamics The branch of the science of mechanics concerned with the action of forces and the motions they produce; as opposed to STATICS, which deals with the case when there is no motion, and the forces are in equilibrium.

dynamo A direct-current generator. See also ALTERNATOR.

dyne The force required to produce an acceleration of one centimetre in a mass of one gram. In SI UNITS the dyne is replaced by the newton ($1 \text{ dyne} = 10^{-5} \text{ N}$).

E

E Prefix meaning *exa*, one million million times, or 10^{18} .

E (a) The most common symbol for the MODULUS OF ELASTICITY. (b) The symbol for ILLUMINANCE.

e The base of the NATURAL LOGARITHM; $e=2.718\ 28\dots$

ear defender A device placed over the ear or in the ear canal to protect the wearer from loud sounds, e.g. ear muff, ear plug or ear canal cap.

early wood The lighter wood with thinner cell walls formed during the earlier stages of the growth of each GROWTH RING; also called *spring wood*. The denser wood with thicker walls, formed during the later stages, is called *late wood*, or *summer wood*.

earphone An electro-acoustic transducer, closely coupled to the ear, which transforms electrical signals into acoustic signals.

ear plug See [EAR DEFENDER](#).

earthed In reference to electrical wiring: connected to the earth, so as to ensure immediate and safe discharge of electricity. Also called *grounded*.

earth-integrated construction Building partly or wholly underground, or with an earth-covered roof.

earth leakage circuit breaker A CIRCUIT BREAKER designed to open (trip) a circuit when an imbalance of current is detected between the active and neutral (indicating a 'leak' to earth). Also known as *residual current detector*.

earth pressure The horizontal pressure exerted by soil on a retaining wall, or vice versa. The *active*, or minimum, earth pressure is that exerted by a retained soil on the wall retaining it. The *passive*, or maximum, earth pressure is exerted by soil in front of a wall sunk in the ground; it is the resistance offered by that portion of the soil to the movement of the wall (which is pushed by the active pressure due to the retained soil). The pressure due to granular soil is given by the RANKINE THEORY.

earthquake loading The forces exerted on a structure by earthquakes. Earthquakes occur mainly in regions where there are suitable GEOLOGICAL FAULTS, and many of these do not pass through centres of population; however, most of the American West Coast, Japan, New Zealand and several Mediterranean countries are liable to severe earth tremors. Earthquakes consist of ground vibrations. When the ground is moved beneath a structure, the building

tends to remain in the original position because of its inertia. The resulting vertical forces are usually within the load-bearing capacity of the structure, but it must be designed to resist the horizontal component of the earth's motion. Earthquake loading for small buildings may be treated as a static horizontal force, but for tall buildings a dynamic analysis is required.

earthquake scale See [MERCALLI SCALE](#) and [RICHTER SCALE](#).

earth termination The connection of a LIGHTNING PROTECTION SYSTEM to the earth by means of electrodes (rods) of sufficient number and depth to achieve a low electrical resistance to allow the dissipation of the energy of a lightning stroke.

easement An area, across land or within a building, over which someone (other than the owner or occupier) has the right of access for a specific purpose, such as a *services easement*.

eave The part of a roof that projects over a side wall. See [GABLE](#).

EBS Experimental Building Station, Sydney. Previously the Commonwealth Experimental Building Station.

eccentric load A compressive or tensile load that does not act through the CENTROID of the cross-section. The *eccentricity* is the distance of the line of action of the load from the centroid.

echo Sound that can be distinguished as being a repetition of a sound just heard. Whether an echo is heard, or whether the delayed sound is integrated with the original sound, depends on the delay time between the original and repeated sounds as well as on their relative intensities. If the two sounds are of approximately the same intensity most people will hear the second as an echo if the delay is more than 70ms.

economiser cycle Control cycle used in some air conditioning systems to save energy by circulating outdoor air instead of recycling return air when the heat content of the outdoor air is lower than that of the return air. See also [OUTDOOR AIR CYCLE](#).

eddy currents Currents introduced in surrounding masses of conducting material by circuits carrying alternating currents. They can result in a considerable loss of energy.

eddy flow *Turbulent flow* in which there is unsteady motion of the particles, as opposed to STREAMLINE FLOW.

edge beam A beam at the edge of a shell or plate structure. The stiffness that it provides may greatly increase the loadbearing capacity of the structure. However, it may also complicate the BOUNDARY CONDITIONS. While some edge beams merely add to the stiffness and strength of the structure (often at the cost of making it appear unduly heavy), others are essential for stability.

Edison cap A LAMP BASE or cap used on electric lamps, particularly in the USA. It is screwed into the lamp holder. See also [BAYONET CAP](#).

editor A computer program that facilitates the editing of data in text or graphical form. A screen editor allows a cursor to move about on the screen and change characters directly.

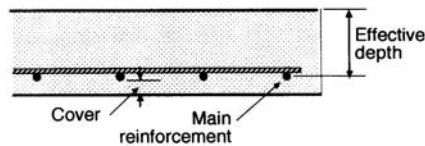

effective depth of reinforcement

effective depth of reinforced concrete beam or slab The distance of the *centroid* of the reinforcing steel from the compression face of the concrete (see Figure).

effective flange width (a) The width of the concrete slab adjoining the rib, which is assumed to function as the flange element of a T-BEAM or L-BEAM section. (b) The width of plate adjoining the web, which is assumed to function as the flange element of a metal section made from cold-rolled steel or aluminium sheet.

effective length (or height) of column The distance between the points of inflection or CONTRAFLEXURE of a column when it buckles. It is the length used in the SLENDERNESS RATIO.

effective modulus of elasticity of concrete The deformation of concrete under load is partly due to (instantaneous) ELASTIC DEFORMATION and partly due to (time-dependent) CREEP. To simplify calculations, an effective modulus of elasticity is introduced, which is the SECANT MODULUS OF ELASTICITY, i.e. the secant of the stress-strain diagram.

effective perceived noise level (EPNdB) The perceived noise level of a continuous reference sound, which in the same total time as a noise event (or a number of noise events) would give the same noise annoyance to a listener. It is used mainly for aircraft noise assessment.

effective prestress The stress remaining in the concrete due to prestressing after all LOSSES OF PRESTRESS have occurred.

effective sound pressure The ROOT MEAN SQUARE value of the pressure of a sound wave.

effective span The span used in computing the bending moment in a beam. A common rule is to take the lesser of (i) the distance between the centres of the supports and (ii) the clear distance between the supports, plus the depth of the beam or slab.

effective temperature The most commonly used criterion for determining the COMFORT ZONE, evolved by C.P.Yaglou in 1924, and adopted with slight modifications by ASHRAE. It takes account of temperature, humidity and air movement, but ignores radiation. The effective temperature of an environment connotes that temperature of still air, saturated with water vapour, in which an equivalent sensation of warmth was experienced by the subjects of a long series of experiments, carried out in the laboratory of the ASHVE in Pittsburgh. See also [EQUIVALENT TEMPERATURE](#) and [CORRECTED EFFECTIVE TEMPERATURE](#).

effective width (of flanges or slab) See [EFFECTIVE FLANGE WIDTH](#).

efficacy Similar to EFFICIENCY but used where the output and input quantities have different units, as in the *efficacy of a light source*, which has the units lm/W.

efficiency The ratio of the energy or power output of a system to the input, usually expressed as a percentage. See also [EFFICACY](#).

efflorescence A deposit, usually white, formed on the surface of a brick, block or concrete wall. It consists of salts leached from the surface of the wall. Although unsightly, it is harmless, and it can normally be removed by brushing. However, it is liable to lift any paint that has been applied to the area of wall where it occurs.

effluent Liquid discharge from a waste water treatment process.

EFT Earliest finish time (of an activity in a NETWORK).

EGA Enhanced Graphics Adapter.

eggshell gloss A painted surface intermediate between full gloss and a matt surface.

egress path The exit from a building or facility, to meet statutory requirements.

elastic constants The MODULUS OF ELASTICITY and POISSON'S RATIO.

elastic deformation Deformation that occurs instantly when a load is applied, and is instantly and fully recovered when the load is removed, as opposed to CREEP.

elastic design Design based on the assumption that structural materials behave elastically, and that the stresses therein should be as close as possible to, but not greater than, the MAXIMUM PERMISSIBLE STRESSES under the action of the SERVICE LOADS or WORKING LOADS. Also known as *working load design*. The main alternative approach is called *plastic design, ultimate strength design* or LIMIT STATES DESIGN.

elasticity The ability of a material to deform instantly under load, and to recover its original shape instantly when the load is removed.

elasticity, modulus of See [MODULUS OF ELASTICITY](#).

elastic limit The limit of stress beyond which the strain is not wholly recoverable. In MILD STEEL, the elastic limit is slightly lower than the YIELD STRESS. In concrete, it is difficult to determine its precise location, because some CREEP occurs even under rapid loading.

elastic loss of prestress The LOSS OF PRESTRESS that is due to the elastic shortening of the concrete. It need be considered only for PRE-TENSIONED units. When members are POST-TENSIONED the elastic shortening occurs during the operation, and is automatically compensated.

elastic modulus See [MODULUS OF ELASTICITY](#).

elastic shortening See [ELASTIC LOSS OF PRESTRESS](#).

elastic strain STRAIN that is instantly and fully recovered when the load causing it is removed.

elastomer A synthetic material with rubber-like qualities, which result from its coiled molecular structure.

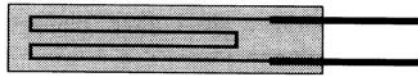

electric resistance strain gauge

elbow A sharp corner in a pipe or conduit, as opposed to a BEND, which has a larger radius of curvature.

electrical conductance The measure of the ability of a material to conduct an ELECTRIC CURRENT; the reciprocal of ELECTRICAL RESISTANCE, with the unit *mho*.

electrical insulation The prevention of the flow of an electric current; or the material used to prevent the flow of current.

electrical resistance The ratio of electric VOLTAGE to ELECTRIC CURRENT. It is measured in OHMS.

electrical services The system of reticulation required to deliver electrical energy within a facility.

electric arc welding See ARC WELDING.

electric current The passage of electricity through a body, caused by a drift of negatively charged ELECTRONS. It is measured in AMPERES.

electric drive A lift drive using an electric motor.

electric eye A PHOTOVOLTAIC cell used as a detector.

electric lamp See [ARC LIGHT](#), [DISCHARGE LAMP](#) and [FILAMENT LAMP](#).

electric lift A lift using an electrical drive machine for the movement of the car.

electric resistance strain gauge A STRAIN GAUGE based on OHM'S LAW. It consists of a zigzag wire (see Figure) or a zigzag thin FOIL, attached to a paper or lacquer backing. This is glued to the part of the structure to be examined. Tensile strain causes the wire to elongate, become thinner, and consequently pass less current. Compressive strain causes an increase in current. The current is measured with a WHEATSTONE BRIDGE, or some other suitable circuit. With careful choice of wire and adhesive, strains as low as 1×10^{-6} can be determined. See also [STRAIN ROSETTE](#).

electrochemical corrosion Corrosion caused by the gradual solution of the ANODE, when two electrochemically dissimilar metals are in contact in the presence of moisture. These then form a galvanic cell, which generates a direct current. Aluminium sheet used externally is subject to such damage if it is fixed with copper nails, or to a lesser extent when fixed with steel nails. Steel nails or bolts when used with aluminium should be plated with *cadmium* or *zinc*. The NOBLE METALS are resistant to electrochemical corrosion. See also [GALVANISING](#) and [SACRIFICIAL PROTECTION](#).

electrochemical series The sequence of elements in order of the electrode potential developed when immersed in a solution of normal ionic concentration. For commonly used metals the series is: (*cathodic end*) gold, platinum, silver, mercury, copper, hydrogen (*zero*), lead, tin, nickel, cadmium, iron, chromium,

zinc, aluminium, magnesium, sodium, calcium, potassium, lithium (*anodic end*). The use of dissimilar metals in contact in the presence of water may lead to ELECTROCHEMICAL CORROSION.

electrochromic glass Laminated glass that contains a layer of particles whose orientation can be changed by an electric current to vary the transparency and thus rate of transmission of solar gain through windows. Still under development.

electrode (a) The terminal through which a current is led into and out of an ELECTROLYTE. (b) A rod of metal, either bare or covered, used as a terminal in ARC WELDING.

electrodeposition The deposition of a layer of metal or alloy on to another while both are submerged in an ELECTROLYTE consisting of a solution of salts of the metal to be deposited. See GALVANISING.

electro-hydraulic lift A direct plunger lift; the hydraulic pressure is produced by an electrically driven pump.

electroluminescent panel An electric light source consisting of a phosphor (usually zinc sulphide) contained in a sandwich panel, and excited by an alternating current. It can be used to illuminate large surfaces at a low, uniform brightness when the spatial requirements of the lighting system must be kept to a minimum.

electrolyte A conducting medium (usually a solution) in which an ELECTRIC CURRENT flows by virtue of chemical changes. The process is known as *electrolysis*.

electromagnet A magnet formed by winding a coil of wire around a core of *soft iron*. This becomes magnetic when an electric current flows through the wire, and loses its magnetism when the current is switched off. It is therefore a temporary magnet.

electromagnetic induction A process in which a voltage is induced in a conductor whenever there is a relative motion between that conductor and a magnetic field.

electromagnetic radiation See RADIATION.

electromagnetic spectrum The set of all wavelengths of electromagnetic radiation, including ultraviolet radiation, light, heat and radio waves.

electromotive force (EMF) The force that tends to cause the movement of electrons in an electric circuit. It is measured in VOLTS.

electron (a) The Greek word for an *alloy* consisting of four parts of gold and one part of silver. This was widely used by the ancient Greeks, partly because they found it difficult to produce a purer gold (modern 'pure gold' is generally 22 carat, i.e. 11/12 pure). (b) The Greek word for *amber*, which was thought to present an appearance similar to that of electron metal. In the sixteenth century Dr Gilbert, an English natural philosopher, coined the term *electricity* to denote attractions between certain bodies, including amber, after rubbing in a certain way. (c) Sub-atomic particle having a mass of 9.04×10^{-28} gram, i.e. 1/1840 that

of the PROTON or NEUTRON, and bearing a negative electric charge. An electric current is a flow of electrons from the CATHODE to the ANODE.

electron gun The assembly of electrodes in a CATHODE-RAY TUBE that produces the electron beam. It comprises a cathode from which electrons are emitted, an apertured anode, and one or more focusing electrodes. Those electrons that pass through the aperture form the beam.

electronic digital computer See [DIGITAL COMPUTER](#).

electronic whiteboard A device that converts markings on a whiteboard to digital information.

electro-osmosis Flow of liquid through the pores of a membrane due to a difference of electric potential. The term is also used for WELLPOINT DEWATERING assisted by the passage of an electric current. When a direct current is passed through water-logged silt, water flows to the CATHODE. Cathodes are placed in the silt at intervals of about 10m (30ft), and water is pumped away from there; ANODES are placed at intermediate points.

electroplated Coated with a more precious or more corrosion-resistant metal by electrochemical deposition.

electrostatic filter A machine that imparts a positive electrical charge to particles suspended in an air stream, which are subsequently collected on electrically negative plates.

electrostatic plotter A plotting device that uses electrostatically charged paper.

element (a) A substance consisting entirely of atoms of the same atomic number. (b) The resistance wire constituting the heating unit of an electric heater. (c) One of the four elements of Aristotle (earth, water, air and fire), to which reference was commonly made in classical architectural and protoscientific texts.

elevation (a) The vertical distance of a point above or below the BENCHMARK or some other reference point. (b) Representation of an object as seen on a vertical plane, viewed from the front.

elevator A car or platform for the vertical transportation of persons or goods. Called a *lift* in Great Britain and in Australia. See also [BRICK ELEVATOR](#).

elevator hoistway US term for *lift well*.

elevator recall See [LIFT RECALL](#).

ellipse A closed loop obtained by cutting a right circular cone by a plane, if the whole of the section lies on one side of the vertex of the cone. It is also the locus of a point such that the sum of the distances of the point from two fixed points, or *foci*, is constant. Consequently an ellipse can be drawn by pinning the ends of a string at the foci, and running a pencil around with the string tightly stretched (see Figure). The greatest and smallest diameters are the *major* and the *minor* axes. The equation of the ellipse is of the form

$$\frac{x^2}{a} + \frac{y^2}{b} = 1$$

where *a* and *b* are constants. See also [OVAL](#).

ellipse of stress See [ELLIPSOID OF STRESS](#).

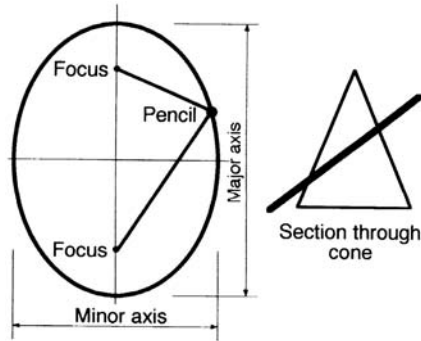

ellipse

ellipsoid A SURFACE OF REVOLUTION generated by an ellipse.

ellipsoid of stress An ELLIPSOID representing the state of stress at a given point in a body. Its semi-axes are the vectors representing the PRINCIPAL STRESSES at the point, and any radius vector represents the resultant stress on a particular plane through the point. When one of the principal stresses is zero (which includes the *plane-stress* condition), the ellipsoid reduces to an *ellipse*. See also [MOHR CIRCLE](#).

elliptical arch An arch whose elevation is half an ellipse. It comes vertically on to its SPRINGINGS. Whereas in a semicircular arch the rise must be half the span, an elliptical arch can have any ratio of rise to span.

elliptical paraboloid A surface of translation generated by a convex parabola moving over another convex parabola.

elongation (a) The extension of a structural member due to a tensile force. (b) The plastic extension of a metal test specimen at failure in a tensile test.

elutriation A method of separating grain sizes according to the velocities at which they sink in a liquid. The particle sizes are evaluated by STOKES' LAW.

email Electronic mail.

embedded column A column that is partly, but not wholly, built into a wall.

embodied energy The energy consumed in the activities of the production of materials, their use and subsequent disposal.

embossed Ornamental designs or figures in RELIEF, i.e. raised above the surface.

emergency lighting Lighting that is essential for the safe evacuation of a building in the event of a failure of normal electric power, as distinct from *safety lighting* or *standby lighting*.

emergency power The power that is available within 10 seconds of a normal power failure to operate emergency lighting or part of the normal lighting. *Standby power* is the power available within one minute.

emery An impure form of CORUNDUM. It consists mainly of alumina and iron oxide.

EMF Abbreviation for ELECTROMOTIVE FORCE. Also *e.m.f.*

EMI Electromagnetic interference.

emissivity The ratio of the rate of loss of heat per unit area of a surface at a given temperature to the rate of loss of heat per unit area of a BLACK BODY at the same temperature and with the same surroundings.

emulsifier A substance that modifies the surface tension of COLLOIDAL droplets, keeping them suspended, and keeping them from coalescing.

emulsion A COLLOIDAL suspension of one liquid in another.

emulsion paint A paint consisting of small particles of synthetic resin (such as POLYVINYL ACETATE) and pigments suspended in water. When the water evaporates, the resin particles form a film that binds the pigments.

enamel See VITREOUS ENAMEL.

enamelled brick A glazed brick.

enamel paint Hard-gloss paint that contains a high proportion of varnish, and consequently has less pigment. For that reason it requires one or two undercoats.

encased beam Iron and steel beams were at one time encased in a variety of materials for protection against fire. Today the term usually means a CONCRETE-ENCASED BEAM.

encastré BUILT-IN or fixed-ended, and consequently restrained from rotation. Also called *encastered*.

encaustic tiles Tiles whose coloured decoration has been fixed by the application of heat. They were much used in the Middle Ages, and subsequently in Neo-Gothic churches.

end-bearing pile A BEARING PILE that is carried on a load-bearing layer, such as rock.

end block A section at the end of a POST-TENSIONED member, which has been enlarged to reduce the bearing stresses to permissible values.

end grain The face of a piece of timber exposed when the fibres are cut transversely. It deteriorates easily when exposed to the weather without protection.

end joint Joint formed between the ends of two pieces of material that are in line. The term is commonly used for timber in preference to BUTT JOINT.

end lap The overlap of the ends of sheet material, as distinct from SIDE LAP.

end-lap joint Joint formed between the ends of two pieces of timber, normally placed at right angles. Each piece is halved for a distance equal to the width of the other piece, so that the surfaces are flush in the assembled joint (see Figure). Also called a *right-angled half-lap joint*.

endothermic reaction A reaction in which heat is absorbed, as opposed to an *exothermic* reaction.

endurance limit See FATIGUE STRENGTH.

energy The capacity for doing WORK. In classical physics, *mechanical energy* is divided into *kinetic energy*, due to motion of a mass, and *potential energy*, due to its position. The latter consequently includes the gravitational HEAD of water and the STRAIN ENERGY stored in a stressed material. Energy can be

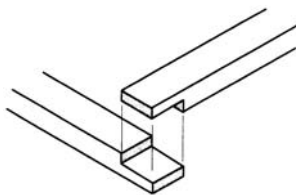

end-lap joint

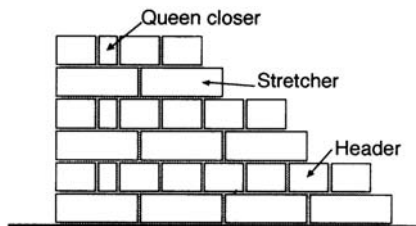

English bond

converted between the forms of mechanical, heat, sound, electrical, chemical energy etc. Much of the energy used in buildings comes from the combustion of fuels, a form of chemical energy that can produce undesirable by-products.

energy, embodied See [EMBODIED ENERGY](#).

energy audit Detailed and systematic investigation of energy use in a building or facility with a view to identifying opportunities to make savings.

energy management The management of the use and consumption of energy, to reduce its cost, or in response to a need for energy conservation.

energy simulation Computational method of constructing and operating a mathematical model of a building and its energy systems in order to estimate energy consumption over a period of time, usually for comparison of design options.

engaged column A column that is partly, but not wholly, built into a wall.

English bond A brick BOND that consists of alternate courses of HEADERS and STRETCHERS (see Figure). Also called *Old English bond*.

English cross bond An ENGLISH BOND that introduces a single header placed into alternate stretcher courses. This produces a diagonal pattern. Also known as *St Andrew's Cross bond*.

English tile A ROOF TILE, moulded with a plain surface.

ensemble The ability of the performers at a concert to hear one another so that they can play in unison. If the stage or orchestra pit is very wide and shallow, the two sides of an orchestra may not be able to hear one another.

enthalpy The heat content per unit mass, due to both LATENT HEAT and SENSIBLE HEAT. It is measured in kJ/kg (or Btu per lb).

entrained air Air incorporated in concrete by the use of an AIR-ENTRAINING AGENT.

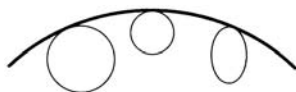

envelope

entrapped air Air voids in concrete which are not purposely ENTRAINED.

entropy A name coined in 1865 by the German physicist R.Clausius for one of the quantitative elements of THERMODYNAMICS. He explained it as follows: ‘A portion of matter at uniform temperature retains its entropy unchanged so long as no heat passes to or from it; but if it receives a quantity of heat without change of temperature, the entropy is increased by an amount of heat equal to the ratio of the mechanical equivalent of the quantity of the heat to the absolute measure of the temperature on the thermodynamic scale. The entropy of a system...is always increased by any transport of heat within the system; hence the entropy of the universe tends to a maximum.’

envelope The line formed by a series of common tangents to a family of related curves (see Figure).

environmental impact study An evaluation of the existing environmental conditions at a given location and the impact of subsequent development; required by statutory authorities as part of an approval process.

EPDM Ethylene propylene terpolymer, an elastomeric material, used mainly in waterproofing applications. Also called *EPT*.

ephemeris A table giving the computed position of a heavenly body. See [NAUTICAL ALMANAC](#).

epicentre Point on the Earth’s surface immediately above the focus of an earthquake.

epicycloid A curve generated by a point on a circle rolling on another circle. It is particularly useful for the design of smoothly operating gears. See also [CYCLOID](#).

epoxy resin A group of thermosetting plastics based on the epoxide grouping

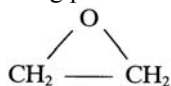

The uncured resin consists of shortchain polymer molecules with an epoxide group at either end. The epoxide group is very reactive, and many substances can be used as HARDENERS. The uncured resin and the hardener are kept separately and mixed just before use. Epoxy resins are appreciably more expensive than the POLYESTER RESINS, but they are better suited for many applications. They adhere strongly to metals, glass, concrete, stone and rubber, and thus make good glues, and solvents for paints. They are resistant to abrasion, weather, acids and alkalis, and to heat up to 100°C (212°F). In particular, they have been found useful for repairing damaged concrete, and for joining new

concrete to old; for this purpose they can be mixed with sand into an epoxy resin mortar.

equaliser An electronic instrument used to obtain a desired overall frequency response of a system. Mainly used in audio systems.

equation of time The difference between APPARENT SOLAR TIME and MEAN SOLAR TIME.

equator The only parallel of LATITUDE that is a GEODETIC LINE.

equatorial comfort index Criterion for determining the COMFORT ZONE, evolved by C.G.Webb in Singapore in 1952, also known as the *Singapore index*. It takes account of wet-bulb and dry-bulb temperature, and air movement, but ignores radiation. Its application is confined to the conditions that exist in the hot-humid equatorial zone, and it is intended for indoor conditions for people acclimatised to wet-bulb temperatures above 24°C (75°F).

equilateral Having all sides equal. An equilateral triangle has three equal sides, while an ISOSCELES triangle has only two equal sides.

equilibrant A force required to keep an unbalanced system of forces in equilibrium.

equilibrium In mechanics, the state of a body at rest, or moving with a uniform velocity. The resultant of all the forces acting on a body in equilibrium is zero.

equilibrium diagram Same as PHASE DIAGRAM.

equilibrium moisture content of timber The moisture content in the wood that balances that in the atmosphere, so that it neither gives off nor takes in any moisture from the surrounding air. It is expressed as a percentage of the oven-dry weight of the wood.

equinox Occurs when the length of day equals the length of night, because the sun crosses the celestial equator. It occurs about 21 March and 23 September. See also [SOLSTICE](#).

equivalent continuous sound level (L_{eq}) A constant sound level in dB(A) that would give the same total acoustic energy at a point as a fluctuating sound level of the same duration. It is used in occupational and environmental noise assessments.

equivalent sphere illuminance (ESI) Used mainly in North America, the illuminance that would produce, under reference lighting conditions, the same visibility as is found in the existing lighting system. See also [CIE CONTRAST RENDERING FACTOR \(CRF\)](#).

equivalent temperature Criterion for determining the COMFORT ZONE, evolved by A.F.Dufton in 1929. It takes account of temperature, air movement and radiation, but ignores humidity. Dufton in 1932 devised the EUPATHEOSCOPE for assessing the thermal environment in terms of equivalent temperature for research at the British Building Research Station. See also [EFFECTIVE TEMPERATURE](#).

ERC Abbreviation for EXTERNALLY REFLECTED COMPONENT (of the daylight factor).

erection stresses Stresses caused by CONSTRUCTION LOADS, and particularly by the self-weight of components while being lifted into position.

erg The unit of energy in CGS UNITS. It is the work done when a force of one DYNE moves one centimetre in the direction of the force. In SI UNITS the erg has been replaced by the JOULE, which equals 10^7 erg.

ergonomics The study of the interaction between work and people. Also called *human factors engineering*.

ERW Electric resistance welding.

escalator A moving staircase, consisting of an endless belt carrying a series of steps. It can be used for upward or downward movement; however, an escalator is frequently used for transporting people up, while a conventional stationary stair may be provided for downward movement.

escutcheon A protective plate surrounding a keyhole in a door.

ESD Ecologically sustainable development.

ESI Abbreviation for EQUIVALENT SPHERE ILLUMINANCE.

ET Abbreviation for EFFECTIVE TEMPERATURE.

etching (a) The process of biting lines into a metal plate by means of acid, and producing a picture from the plate. Also the picture produced by this process. (b) Revealing the structure of metal by selective chemical attack. In PERLITE, for example, the ferrite lamellae are electropositive to the cementite, so that they can be shown up by etching.

ethanol Ethyl alcohol (C_2H_5OH) intended for industrial use, rather than human consumption.

eucalypt An evergreen genus of trees, which sheds its bark. Many Australian hardwoods, with names such as white ash and red mahogany, are in fact eucalypts. Also called *gum tree*.

Euler formula A formula for the BUCKLING of slender columns, published by the French mathematician Leonard Euler in 1757. The buckling load of a column, P , is given by

$$P = \frac{\pi^2 EI}{L^2}$$

where π =circular constant, 3.1416..., E =modulus of elasticity, I =second moment of area, L =effective length. See also [RANKINE COLUMN FORMULA](#) and [SHORT-COLUMN FORMULA](#).

eupatheoscope A black, electrically heated cylinder, designed to have the same surface temperature as a clothed human under comfortable conditions; the heat input required for comfort is measured to determine the EQUIVALENT TEMPERATURE.

eutectic The alloy with the lowest melting temperature in its range of composition. It is readily apparent on the PHASE DIAGRAM as a point of intersection between two descending LIQUIDUS curves in a binary system, or three descending liquidus curves in a ternary system. The eutectic thus solidifies out of the liquid as a mixture with a definite composition.

eutectoid A mixture of two or more constituents that forms on cooling from a *solid solution*, and transforms again on heating. PERLITE is a typical eutectoid. The process is similar to the formation of a EUTECTIC, which solidifies from the liquid, or melt.

evacuated tubular collector Solar energy collector suitable for temperatures up to 150°C (300°F). The tubes are given a SELECTIVE SURFACE coating to increase the efficiency, and evacuated to limit convective heat loss.

evaporation Conversion of a liquid into a vapour, without necessarily reaching the boiling point.

evaporative cooling A simple method of air conditioning, which can be employed in hot-arid climates. The latent heat of the water evaporated is absorbed from the hot dry air, which is thus cooled. The humidity is increased by the evaporation of the water.

event A point in time representing the intersection of two arrows in a NETWORK, i.e. the start or finish of an activity. An event has no time duration.

exa Prefix meaning 10^{18} , or one million million million times, used particularly in SI UNITS. Abbreviated E, e.g. 1EJ = 10^{18} joule.

exfiltration Opposite of INFILTRATION.

exfoliation Swelling, peeling or scaling of mineral surfaces in thin layers, e.g. exfoliated VERMICULITE.

exhaust fan Fan that withdraws air that is not to be returned to the central air treatment system, and delivers it to the outside.

exhaust ventilation Circulation of air through a space by means of a fan or fans located at or near the outlet to produce a slight negative pressure. May be localised at a piece of process equipment such as a food fryer to prevent the general spread of contaminants.

exitance The ratio of luminous (radiant) flux leaving a surface to that arriving.

exosphere See [ATMOSPHERIC LAYERS](#).

exothermic reaction A reaction that occurs with the evolution of heat, as opposed to an *endothermic* reaction.

expanded clay An artificial LIGHTWEIGHT AGGREGATE.

expanded metal Metal network formed from sheet metal by cutting a pattern of slits, followed by pulling the metal into a diamond pattern. It is used as a metal *lath*, as concrete reinforcement, and for the making of screens. Also called *diamond mesh*.

expanded plastic A very light insulating material, obtainable as a loose fill, in sheets or in blocks. *Polystyrene*, for example, can be expanded 40 times by foaming. The density of expanded polystyrene or of rigid *polyurethane* foam is from 16 to 64kg/m³ (1 to 4lb/ft³), its compressive strength is between 100 and 400kN/m² (15 to 60psi), and its thermal conductivity is between 0.014 and 0.043 W/mK (0.1 to 0.3Btuin./hft²°F). Also called *cellular plastic*, *foamed plastic* or *rigid foam*.

expansion bolt An anchor into masonry, which consists of a bolt operating inside a split cone. As the bolt is turned, the cone expands and wedges into the hole.

expansion joint A CONTROL JOINT forming a separation between adjoining parts to allow for small (positive or negative) relative movements, such as those caused by temperature change. It requires a gap between the adjacent parts, usually filled with compressible material. See also [CONTRACTION JOINT](#).

expansion loop A loop or horseshoe bend inserted in a pipe to provide for its expansion and contraction due to temperature change.

expansion sleeve A tube covering a dowel bar, to allow its free longitudinal movement at a joint.

expansive cement A cement that, on setting, expands instead of shrinking. Depending on the amount of additive, the expansion may be merely sufficient to counter the shrinkage of PORTLAND CEMENT, or it may be sufficient to induce tensile stresses in the reinforcement, and thus POST-TENSION the concrete. The additives most commonly used to produce expansive cements are calcium sulphate (CaSO_4), free lime (CaO) and anhydrous aluminosulphate ($4\text{CaO} \cdot 3\text{Al}_2\text{O}_3 \cdot \text{SO}_3$).

experiential Relating to or derived from experience, empirical; as opposed to *experimental*.

experimental stress analysis See [BRITTLE COATING, DIRECT MODEL ANALYSIS](#), [INDIRECT STRUCTURAL MODEL ANALYSIS](#), [MOIRÉ FRINGES](#) and [PHOTOELASTICITY](#).

expert system In computing, a KNOWLEDGE-BASED SYSTEM, which Captures human expertise and emulates human experiential reasoning in specialised applications.

expert system shell A computer program that allows the input of knowledge to create an EXPERT SYSTEM. An expert system without the KNOWLEDGE BASE.

exploding In computer graphics, the process of decomposing a complex object into its constituent components.

explosion hazard Risk of explosion in a space due to accumulation of combustible gaseous or particulate matter in sufficient quantity to create an explosive atmosphere.

explosive-powered tool Tool used for driving hardened nails and threaded fasteners into hard materials such as concrete and steel, using an explosive cartridge as the power source.

explosive rivet A type of BLIND RIVET with a hollow shank, which contains an explosive charge. The rivet shank is expanded by exploding the charge with a hammer blow after the rivet has been inserted. It is used particularly in aluminium structures, but seldom in the building industry.

exponential function A function of the type $y=e^x$, where e is the base of the NATURAL LOGARITHM. It is thus the inverse of the natural logarithm.

Exponential functions occur as a result of integration of terms containing $1/x$, and also in HYPERBOLIC FUNCTIONS.

exponential horn A horn, the cross-sectional area of which increases exponentially with axial distance. Such horns are sometimes used on loudspeakers, loud-hailers and musical instruments, as ACOUSTIC IMPEDANCE matching devices, to increase the acoustical output.

exposed aggregate A decorative finish for concrete. The aggregate may be exposed by removing the outer skin of cement mortar from the surface before it has hardened, or the 'exposed' aggregate may be sprinkled on the wet concrete after placing.

exposure meter A device for estimating the exposure required for photography. It usually incorporates a PHOTOVOLTAIC CELL.

express run The non-stop run of a lift car from its departure floor to its destination floor, ignoring any possible stops on the way. See also [SKY LOBBY](#).

extensibility The maximum tensile strain of which a material is capable. It is much lower in BRITTLE than in DUCTILE materials.

extension of time An extension of a contract period to provide for delays arising from conditions over which the contractor has no control.

extensometer Same as STRAIN GAUGE.

external memory A memory that is under the control of a computer, but not necessarily permanently connected to it, such as a FLOPPY or HARD DISK.

externally reflected component (ERC) (of the DAYLIGHT FACTOR). The component due to the external reflecting surfaces.

extrados The outer or upper curve of an arch.

extrapolate To infer the position of a point belonging to a graph *beyond* the last known point, assuming that the curve is smooth. This is inherently less accurate than *interpolation*.

extruded brick A BRICK produced from a stiff but cohesive clay-shale mixture, which is extruded through a die. It may contain a series of holes, so that the bedding faces of the bricks are perforated. After extrusion, the ribbon of clay is cut to the height of the bricks with a set of taut wires.

extruding In computer graphics, the process of creating three-dimensional graphic objects by sweeping a two-dimensional form in two axes through a specified distance in the third axis. Also called

extrusion Producing a linear shape by pushing material through a die (see Figure). The process is used for the manufacture of sections in aluminium, as an alternative to hot-rolling. It is also used for plastics.

eye bolt A bolt with a ring forged on one end, or welded to one end.

eye of a dome An opening at the top of a dome to admit light. It may be glazed or open to the sky. See also [LANTERN](#).

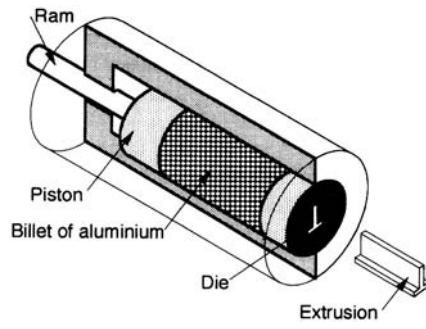

extrusion

F

°F Degree Fahrenheit.

F Symbol f or the unit of electrical capacitance, the FARAD.

fabric See [MESH REINFORCEMENT](#).

facade The face or front wall of a building.

face-bedded Natural stone built into a wall with the BEDDING PLANES parallel to the wall surface.

face brick A BRICK especially made to have an agreeable colour and texture. It is often weaker than a common brick.

face brickwork Brickwork made using FACE BRICKS and laid with a good standard of workmanship and jointing.

face-centred cubic lattice A crystal structure that has an atom at each corner of a cube and one at the centre of each face. It may be imitated by packing spheres to line up both vertically and horizontally.

faced plywood Plywood faced with metal, plastic or any material other than WOOD VENEER.

facia Same as FASCIA.

facility A physical environment designed to service an organisation's objectives, ranging from open space (parks and gardens) and infrastructure (roads, etc.) to built premises (offices, factories, schools, hospitals, residences, etc.).

facility audit A survey of a facility portfolio to establish the condition of the fabric and systems, and the functionality and risk associated with any part that does not comply with the requirements.

facility management The management of resources (people and assets), places and processes to optimise an organisation's business.

facility plan A planning tool for managing a facility's operations and maintenance to plan for current and future activities and requirements in a cost-effective manner.

factor analysis Statistical procedure for grouping associated variables.

factor of safety Factor used in ELASTIC DESIGN to provide a margin of safety against collapse and serious structural damage. It includes an allowance for inaccurate assumptions in the loading conditions, for inadequate control over the quality of materials, for imperfections in workmanship, and for minor

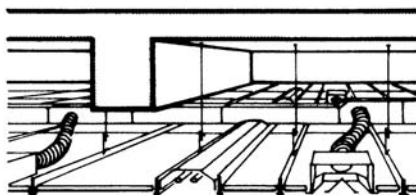

false ceiling

approximations made in the structural theory. It does not allow for arithmetical errors.

Fahrenheit scale Temperature scale used mainly in the USA. The scale was originally intended to run from 0 for the freezing temperature of a mixture of water and common salt to 100 for the blood temperature in the human body. However, it is now defined by the freezing point of water (+32°F) and the boiling point of water (212°F). To convert to the CELSIUS scale (°C) we subtract 32 and then divide by 1.8.

faience Originally the French word for *porzellana di Faenza*, a fine painted and glazed earthenware made in Faenza in Italy. In buildings, prior to the twentieth century, the term generally denoted glazed TERRA COTTA, which had been fired once without and once with the glaze. The term is now used for any decorative glazed tiles, and even for glazed plastic floor mosaic.

fail safe An automatic protective response initiated in the event of a failure.

failure The condition when a structure or material ceases to fulfil its required purpose. The failure of a structural member may be caused by *elastic deformation, fracture, cracking*, or *excessive deflection*. The non-structural failure of a material may be due to *weathering, abrasion* or *chemical action*.

fair market rent See [MARKET RENT](#).

false ceiling A ceiling *suspended* or *hung* from the floor above, which hides its SOFFIT, and which provides a space for cables and ducts (see Figure). See also [RAISED FLOOR](#).

false header A half-brick, which completes the visible bond, but is not a header.

false set The rapid development of rigidity in freshly mixed cement paste, mortar or concrete, with little evolution of heat. Plasticity can be regained by further mixing without addition of water. See also [SETTING OF CONCRETE](#) and [FLASH SET](#).

false window A walled-up window.

falsework A temporary structure erected to support work during construction, and subsequently removed.

fan See [AXIAL-FLOW FAN](#), [BOOSTER FAN](#) and [CENTRIFUGAL FAN](#).

fan coil unit A device used in air conditioning systems, consisting of a container, usually of metal, in which are installed a fan and cooling and/or heating coils for the purpose of cooling, heating and circulating air in a space. May also contain an air filter to remove contaminants.

fanlight Originally a fan-shaped window, with sash bars radiating like the ribs of a fan, located over a door. It was much used in Georgian and Colonial architecture, and in their revivals. The term is now sometimes applied to any window located over a door.

fan noise The noise caused by fans used in ventilating and air conditioning equipment. Fan noise can be attenuated by DUCT LININGS.

fan vault Gothic stone vaulting system decorated with fan tracery, formed by a convex line rotated in a semicircle around a vertical axis. The bottom of this convex line is tangential to the face of the column, which has numerous clustered shafts, and the top merges into an almost flat stone ceiling. Because flexural tension may develop in the flat parts of the vault, it often has stone pendants whose weight reverses any tension that occurs.

FAO Finish all over.

FAR Floor area ratio.

farad (F) Unit of electrical CAPACITANCE, named after Michael Faraday, an English scientist who discovered the laws of electromagnetic induction, and first produced electromotive power in 1831. The capacitance is 1F if a capacitor is charged with 1 coulomb, and the difference of potential between the plates is 1 volt.

far field That part of a FREE FIELD generated by a source where the SOUND PRESSURE and the air velocity (due to the passage of the sound) are in phase. In most cases the far field will exist at distances greater than one representative dimension of the source, where the INVERSE SQUARE LAW may be used to predict the sound pressure.

fascia A plain horizontal band on the surface of a building. In classical design, fascias were employed both in the CORNICE and in the ARCHITRAVE. The term is also used for the exposed EAVE of a building. Also spelled *facia*.

fascia board In timber construction, a wide board fixed to the wall, the wall plate, or the ends of the RAFTERS. It usually carries the gutter.

fast Fourier transform See FFT.

fast track A phasing technique between design and construction whereby construction starts before design is complete.

fathom A nautical measure equal to 6ft or 1.829m. It originated as the distance between the outstretched fingertips of a man.

fatigue The tendency of materials to fracture under many repetitions of a stress considerably lower than the ultimate static strength. The term *fatigue* is reserved for a large number of repetitions, while *repeated loading* is commonly used for a small number of load repetitions.

fatigue strength The greatest stress that can be sustained without failure for a given number of stress cycles. Also called *endurance limit*.

fat mortar A MORTAR that sticks to the trowel, as opposed to a *lean mortar*.

faucet US word for a water tap.

fault (a) See [GEOLOGICAL FAULT](#). (b) In electricity, a defect in a circuit, component or line, especially referring to the effect of the defect, as in *fault current* or *fault level*.

Fe Chemical symbol for *iron* (ferrum).

FEA Abbreviation for FINITE ELEMENT ANALYSIS.

feasibility study A study conducted in the initial stage of a project in order to determine physical, economic and legal viability.

feather edge A fine taper.

feature In product modelling, an important characteristic, usually regarding an aspect of the shape, e.g. a slot, chamfer etc.

feed and expansion tank A small tank connected to a system circulating a heat transfer liquid in heating and cooling systems to accommodate expansion or contraction of the fluid and make up any losses from the system.

feedback (a) A report on the production of an item, which shows defects by comparison with the required standard and how errors can be corrected. (b) The return of the output of a system to its input. Used to monitor and control the behaviour of a system. (c) In audio systems, the howling that occurs when the sound from a loudspeaker causes a self-reinforcement of the sound at the microphone.

feeler gauge An instrument for measuring the clearance in a gap, consisting of a series of blades of different thickness.

felspar A group of minerals consisting mainly of aluminium silicates. They are contained in granite and other rocks, and decompose into clay. Also spelt *feldspar*.

felt See [ROOFING FELT](#).

felting See [AIR FELTING](#).

FEM Finite element modelling.

fenestration The arrangement of the windows and other openings on the walls of a building, particularly with reference to the appearance of the facade.

ferrite A solid solution in which ALPHA IRON, as distinct from GAMMA IRON, is the solvent. It may contain in solid solution up to 30 per cent of chromium and up to 15 per cent of silicon, but no more than 0.03 per cent of carbon. Ferrite is the principal constituent of low-carbon steels and of many alloy steels. See also [AUSTENITE](#).

ferrocement Concrete made with several layers of finely divided reinforcement, instead of the conventional larger bars. It is usually made in thin panels, about 12 to 25mm to 1in.) thick. The maximum aggregate size is about 5mm (in.). It can be used for curved surfaces such as boat hulls or small domes, the concrete being applied to the reinforcement with a trowel in several layers, without the need for formwork. Also spelt *ferrocemento*, sometimes hyphenated.

ferroconcrete An old-fashioned term for reinforced concrete.

ferrous-metal A metal in which iron is the principal constituent.

ferruginous stone or sand Stone or sand containing iron. It generally has a reddish or brown colour.

FFR Abbreviation for FLUX FRACTION RATIO.

FFT Fast Fourier transform. A digital method of obtaining the SPECTRUM of complex signals in real time.

FHA Federal Housing Administration, Washington, DC.

fiber US spelling for *fibres*.

Fibonacci series An infinite series, credited to the twelfth-century Italian mathematician Leonardo Fibonacci of Pisa, in which successive pairs of numbers are added together to form the next number. The intervals increase rapidly. Thus the simplest Fibonacci series is 1, 1, 2, 3, 5, 8, 13, 21, 34...

fibrebord Building board made from felted wood or other fibres, and a suitable binder. It is a generic term, which includes ACOUSTIC BOARD, FLAXBOARD, HARD-BOARD, INORGANIC FIBREBOARD, INSULATING BOARD, MEDIUM-DENSITY FIBREBOARD, PARTICLE BOARD, PEG-BOARD and SOFTBOARD. Some of these terms overlap.

fibrecement Building board made using cement reinforced with fibres, usually of cellulose obtained from wood. Also called *fibrecement* or FRC. When glass fibres are used, it is called *glass-reinforced cement* or GRC. See also [ASBESTOS CEMENT SHEET](#).

fibreglass Strictly the fibre made from glass. However, the term also denotes glassfibre-reinforced plastic (commonly *polyester*), abbreviated FRP or GRP. The fibres are finely distributed in the plastic as reinforcement, either as a woven fabric or as a random mat. See also [OPTICAL FIBRE](#).

fiberoptics See [OPTICAL FIBRE](#).

fibrestress A term used to denote the longitudinal direct (tensile or compressive) stress in a beam. The *extreme fibrestress* is the stress in the fibre most remote from the NEUTRAL AXIS, and it is thus the maximum tensile or compressive stress. See [NAVIER'S THEOREM](#).

fibro (a) Formerly, Australian term for ASBESTOS CEMENT SHEET. (b) Hence, low-cost house built with a timber frame and an external lining of FIBRE CEMENT sheet, usually with an internal plasterboard or particle board lining.

fibrous concrete Concrete containing fibres of glass, rock wool or steel to improve its tensile strength.

fibrous—plaster Gypsum plaster reinforced with *sisal* fibres or with canvas. In Australia large sheets capable of supporting their own weight were at one time made from fibrous plaster by specialist craftsmen, called *fibrous plasterers*.

FIBTP Fédération Internationale du Bâtiment et des Travaux Publics, Paris.

FIC Foundation Industry Classes.

FID Fédération Internationale de Documentation, The Hague.

field moisture equivalent The minimum moisture content at which a drop of water placed on a smoothed soil surface is not immediately absorbed, thus giving the soil a shiny appearance.

field welding, field bolting, field riveting Same as SITE WELDING etc.

fifth-generation computing A project to produce computers and programs using ARTIFICIAL INTELLIGENCE and *parallel processing*.

figure The natural grain of timber, particularly when it is cut as a veneer. Highly figured timber, although it makes attractive veneer, is often structurally weak. See also [BURL](#) and [CROTCHWOOD](#).

figure 8 microphone A microphone in which the polar response is a maximum in two opposite directions, and the response is zero on an axis perpendicular to that of the maximum response.

filament Electrical conducting material in the form of a fine wire.

filament lamp An electric lamp in which a filament in a glass bulb, filled with an inert gas, is raised to incandescence by the passage through it of an electric current.

file In computing, an organised collection of data, such as a computer program or a piece of text, stored in a computer's memory.

file extension In computing, a label added to the end of a file name, after a period, to denote the type of file, e.g. '.doc', '.ps'.

file manager A computer program that controls operations on files such as creating, deleting, copying of files.

fillet weld A weld of approximately triangular cross-section joining two surfaces approximately at right angles to one another. The strength of the fillet weld depends on its THROAT.

film (a) A thin, not necessarily visible, layer of material. (b) A photo-sensitive emulsion, before or after processing, on a flexible base.

filter (a) A device to separate particles from air or from liquids. See also [HEPA FILTER](#). (b) A device to remove odours from the air. (c) A device that transmits energy at some frequencies differently from others. See also [BANDPASS FILTER](#).

final certificate A certificate issued to the contractor when all the obligations under the contract have been fulfilled.

final set (of cement mortar) Measured by the VICAT TEST.

fine aggregate The smaller size of aggregate used for mixing concrete, as opposed to COARSE AGGREGATE. It usually consists of SAND, but small-size crushed stone is sometimes used.

fine grained soil Soil consisting predominantly of fine sand, silt or clay.

fineness modulus A measure of the fineness of sand, cement or paint. It is obtained by adding the total percentage of a granular sample retained on each of a specified series of sieves, and dividing the sum by 100.

fine stuff The LIME PUTTY used in the finishing coat of a plastering operation. See also [COARSE STUFF](#).

finger joint An END JOINT made up of several meshing tongues or fingers of wood, made with a fingerjointing machine and normally glued (see Figure).

finial See [AIR TERMINATION](#).

finite element analysis (FEA) A method of analysis (usually for structural problems) based on modelling continuous elements as a large series of interconnected elements of various shapes.

finite element modelling (FEM) See [FINITE ELEMENT ANALYSIS](#).

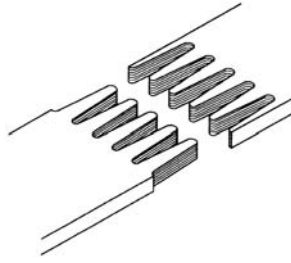

finger joint

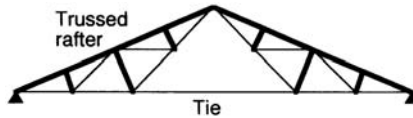

Fink truss

Fink truss A commonly used roof truss, suitable for spans of 12 to 15m (40 to 50 ft). It has two trussed rafters, each divided into four parts by purlins (see Figure). Also called a *Belgian* or *French truss*.

finned coil A bundle of tubes for the exchange of heat between fluids. The tubes have metal fins to extend the heat transfer surface.

fire and life safety management A plan for the protection and safety of building occupants in the event of life-threatening emergencies, such as fire and bomb threats.

fire barrier Any element of a building, such as a wall, floor or ceiling, so constructed as to delay the passage of fire from one part of a building to another.

fire compartment A part of a building bounded by FIRE-RESISTING walls and fire-resisting doors that close automatically in case of a fire.

fire control room A room containing systems controlling a facility's fire services. In an emergency it must be accessible directly by the emergency services.

fire curtain A fire-resisting curtain capable of being lowered into the proscenium opening of a theatre to protect the audience from the effects of a fire in the stage area. Originally made of ASBESTOS fabric, it is now made of other fire-resisting fibres.

firedamp Same as METHANE.

fire damper A DAMPER held open by a fusible link that melts at a predetermined temperature.

fire detector An automatic device that detects a *rise of temperature* by means of a BIMETALLIC STRIP, by an element melting at a low temperature, or by solid-state electronics; or by the *rate of rise of temperature* in an expanding sealed chamber; or which detects the flickering of a *flame*. See also [SMOKE DETECTOR](#).

fire door A SELF-CLOSING DOOR made of FIRE-RESISTING material. It delays or prevents the spread of fire and smoke by confining it to one compartment.

fire endurance The time taken to cause the failure of a structure in a fire.

fire hydrant A connection to a water main for extinguishing a fire.

fire indicator panel A control panel that indicates a signal from an alarm, and the zone where the signal was activated.

fire isolation See [ISOLATION](#) (b).

fire load The amount of heat generated if the contents and combustible parts of a building were to be *completely* burnt. It is calculated in J/m^2 (Btu/ft²) of floor area, assuming the burning material to be spread uniformly over the floor. The fire load depends on the type of occupancy.

firemen's lift A lift with controls that enable it to be used under the direct control of the fire brigade during an emergency. See also [FIREMAN'S SWITCH](#) and [LIFT RECALL](#).

fireman's switch A key switch, which when operated brings the designated FIREMEN'S LIFT car(s) under the control of the fire fighting service. See also [LIFT RECALL](#).

fireproof Now replaced by FIRE-RESISTING, as no construction is completely fireproof.

fire protection of steel structures Although steel does not support combustion, it is more vulnerable to fire than a heavy timber section (which burns, but is protected by the charcoal formed). At about 400°C (750°F) it suffers significant loss of strength; at 540°C (1000°F) only 50 per cent, and at 650°C (1200°F) only 20 per cent of its cold strength remains. The most common protection is a layer of reinforced concrete, [SPRAYED MINERAL WOOL](#), or sprayed [VERMICULITE](#).

fire resistance grading (or level, or rating) The grading of building components according to the minutes or hours of resistance in a *standard fire test*. The higher the FIRE LOAD, the higher the fire resistance grading required.

fire-resisting Attribute of a material that resists fire for some length of time. The term has replaced *fireproof*, since no material is completely proof against the effect of fire. See also [SLOW-BURNING CONSTRUCTION](#).

fire-retardant paint A paint based on silicone, casein, borax, polyvinyl chloride, urea formaldehyde or some other substance. A thin coating reduces the rate of flame spread of a combustible material, usually by intumescence under the effect of heat.

fire sprinkler system See [SPRINKLER SYSTEM](#).

fire test A standard test used to determine the FIRE RESISTANCE GRADING of a structural element.

firing Controlled heat treatment in a kiln, particularly of bricks and other ceramics.

first-angle projection See [ORTHOGRAPHIC PROJECTION](#).

first floor In the USA, the floor at ground level. In Europe and Australia, the first floor above ground level.

first moment of area Same as MOMENT OF AN AREA.

fishplates Plates on each side, making a connection between the two pieces of a BUTT JOINT. They are *fixed* with nails or with *fish-bolts*.

fixed-ended beam A BUILT-IN BEAM, or *encastré* beam.

fixed price contract A contract in which the work will be carried out for a fixed lump sum without rise and fall cost adjustments, usually used for minor and short-duration projects.

fixture (a) A LUMINAIRE, especially in the USA. (b) See PLUMBING FIXTURE.

fixture unit A unit of measure based on the rate of discharge, time of operation and frequency of use of a fixture. It expresses the hydraulic load imposed by that fixture on the plumbing installation.

flame cutting Cutting with an oxyacetylene torch.

flame-retardant paint Same as FIRE-RETARDANT PAINT.

flame spread The rate at which a flame spreads under intense radiant heat. The flame spread on wall and ceiling linings is classified by a standard test.

flammable Describes a material that burns with a flame.

flange (a) The top or bottom member of a rolled steel beam, or of a plate girder. (b) A projecting flat rim. (c) A disc-shaped rim at the end of a tube.

flanging Modulation of the frequency and duration of a sound.

flashing Sheet metal or other sheet material used to cover open joints in exterior construction, such as joints in parapets or roof valleys, and above and below window openings, to prevent ingress of water.

flashover During a fire, hot gases are formed that rise to the ceiling. When these have accumulated in sufficient quantities and ignite, a flashover occurs, after which a fire cannot be extinguished with simple equipment.

flash point The lowest temperature at which a substance ignites when a flame is put to it.

flash set The rapid development of rigidity in freshly mixed cement paste, mortar or concrete, usually with considerable evolution of heat. Plasticity cannot be regained by further mixing without the addition of water. See also SETTING OF CONCRETE and FALSE SET.

flash welding A resistance welding process. After the current has been turned on, the two parts are brought together. This produces arcing, which expels small particles of metal (flashing), and thus protects the metal from oxidation.

flat (a) A painted surface without sheen. (b) British and Australian term for an APARTMENT. The building is known as a *block of flats*.

flat arch An arch with a level EXTRADOS and SOFFIT made from wedge-shaped stones or bricks; also called a JACK ARCH. It has been superseded by steel and reinforced concrete lintels.

flat bed plotter A pen plotter in which the paper is held on a flat surface, while the pen moves along both axes.

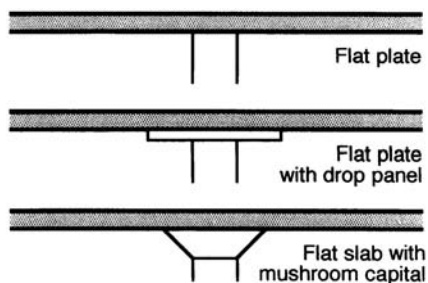

flat plate

flat jack A hydraulic jack consisting of light-gauge metal, bent and welded to a flat shape, which expands under internal pressure. It is particularly useful for prestressing concrete in confined locations, e.g. the springings or the crown of an arch.

flat plate A concrete slab reinforced in two directions, and supported directly on the columns without column capitals or beams (see Figure). By contrast, a FLAT SLAB has column capitals.

flat plate collector Solar energy collector suitable for temperatures up to 85°C (185°F). It is particularly suitable for heating water for the hot water supply. It consists of a black flat plate, which may be given a SELECTIVE SURFACE coating to increase its efficiency, connected to tubes containing water; or the water may circulate between two plates.

flat roof A roof with a slope just sufficient to ensure drainage, usually less than 1:25 (approximately 2°), or (rarely) a roof without any slope at all.

flat slab A concrete slab reinforced in two or more directions, and supported directly on COLUMN CAPITALS without beams; also called *mushroom slab* because of the shape of the enlarged capitals. In contrast, a FLAT PLATE has no column capitals. (See illustrations under COLUMN STRIP and FLAT PLATE.)

flax A plant whose blue flowers are succeeded by seed pods from which *linseed oil* is made. *Linen* is made from flax fibres. See also [MINERAL FLAX](#).

flaxboard FIBREBOARD manufactured from flax.

Flemish bond A brick BOND, which consists of alternate HEADERS and STRETCHERS in each course (see Figure). See also [DIAGONAL](#), [DOUBLE](#) and [SINGLE FLEMISH BOND](#).

fletton A common English brick made from Peterborough shale.

flexibility method Same as MATRIX-FORCE METHOD.

flexural rigidity Measure of the stiffness of a member in resisting bending. It is usually taken as the product EI , where E is the MODULUS OF ELASTICITY, and I is the SECOND MOMENT OF AREA.

flexure Same as BENDING.

flicker (a) In lighting, refers to the visible fluctuation in the light emitted from lamps when operated on alternating current supplies. (b) In photometry, refers to an obsolete method for determining luminance matches, flicker photometry. (c) Generally, any fluctuation of brightness from any cause that produces a visual sensation.

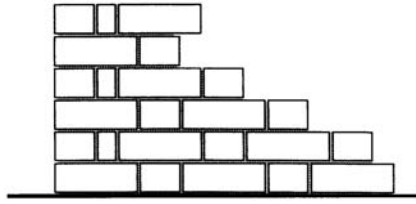

Flemish bond

flight A series of stairs unbroken by a landing.

flint Concretions of SILICA found in some limestone and dolomite beds. They are believed to be organic in origin, deriving from siliceous sponges. Flints were used extensively in stone-age tools. In certain parts of Europe, particularly in Southern England, split flints (called *knapped flints*) were used in a characteristic vernacular architecture. See also [CHERT](#) and [OBSIDIAN](#).

flint glass GLASS containing lead, as opposed to CROWN GLASS. It was traditionally used for cut glass, because it was easier to engrave, and for this reason the best source of silica, i.e. FLINT, was used. The name is today often used for any high-quality glass, of whatever chemical composition. The difference in the chemical composition of crown and flint glass gives them different refractive indices, and the two materials have been used in conjunction to produce ACHROMATIC LENSES.

flitch A large piece of converted timber, suitable for re-sawing into smaller sizes.

flitched beam A steel plate sandwiched between two pieces of timber, and connected to them with bolts.

float The difference between earliest (EFT) and latest (LFT) finish times of an activity in a NETWORK. The *free float* is the amount of time by which the start of an activity may be delayed without interfering with the start of any subsequent activity.

float finish A rather rough concrete finish, obtained by finishing with a wooden float.

float glass Sheets of glass made by floating the molten glass on a surface of molten metal, which produces a smooth, polished surface.

floating floor Separation of the floor wearing surface from the rest of the building to provide locally DISCONTINUOUS CONSTRUCTION for insulation against impact sound. A concrete floor may be insulated from the supporting structure by an insulating layer, such as mineral wool (see Figure), and a wooden floor may be similarly insulated by a resilient quilt.

floating-point number In computing, a representation for a REAL NUMBER consisting of a mantissa, an exponent and base, e.g. 2.15E3.

float valve See [BALLCOCK](#).

flocculation Clumping together of minute particles by means of coagulant chemicals to promote their sedimentation, e.g. in purifying water or sewage.

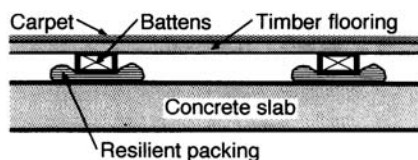

floating floor

floor cavity ratio A ratio used to represent the size of the space below the WORKING PLANE, used in the lumen or flux method of illuminance calculation.

floorspace ratio The ratio of the total floor area of a building to the site area on which the building is located. Same as PLOT RATIO.

floppy disk A small magnetic disk used for the external storage of computer data, as against the HARD DISK of a computer. Originally made of flexible material, hence the name.

FLOPS Floating-point operations per second.

flowchart, flow diagram A diagram that employs both writing and standardised graphical symbols to indicate the flow of an operation required to solve a particular problem. It is useful for planning any complicated operations, but is mainly used in writing computer programs.

flow meter An instrument for measuring the quantity of a fluid, such as water or gas, which flows through a pipe in a unit of time. A common type is based on the VENTURI TUBE.

flow rate, pedestrian See [PEDESTRIAN FLOW RATE](#).

flue A chimney used to take combustion products from a burner.

flue gas The waste gaseous products of the combustion of fossil fuels.

fluid A substance that flows, i.e. a liquid, a gas or a vapour.

fluid dynamics The science of dynamic effects giving rise to the motion of fluids.

fluidity The ability of a material to flow; the opposite of *viscosity*.

Fluon Trade name for POLYTETRAFLUOROETHYLENE.

fluorescence The emission of visible light (or other radiation) from certain materials when they are irradiated with ultraviolet (or other) radiation or particles, such as electrons.

fluorescent lamp An electric DISCHARGE LAMP, consisting of a tube coated inside with a fluorescent powder (see Figure). A current passing through a low-pressure mercury vapour emits ultraviolet radiation. The fluorescent coating on the tube changes the invisible radiation into visible light. Fluorescent lamps have a higher LUMINOUS EFFICACY than INCANDESCENT LAMPS.

fluorescent paint A pigment that converts invisible radiation to visible radiation, and therefore appears brighter than surrounding surfaces. Certain organic dyes, tungstates, borates and silicates have this property; but the brilliance of some of them dulls after a period of time because of weathering. Unlike PHOSPHORESCENT PAINT, it does not exhibit an afterglow.

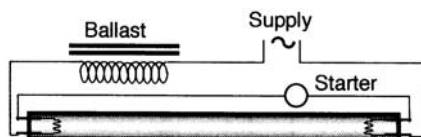

fluorescent lamp

fluorinated hydrocarbons See [CFC](#).

flushing Of pipe systems: circulation and discharge of fluid through a new pipe system to remove debris left by the processes of fabrication and installation.

flush joint A flat JOINT IN BRICKWORK or masonry.

flush switch A switch that has been recessed so that its front is flush with the wall.

flush valve A valve that, when opened, allows a set quantity of water to pass through to flush a water closet. In some countries the water may be supplied directly from the building's water supply system; but in others it must be fed from a separate supply tank, either because of a perceived danger of contamination of the water supply, or to avoid a sudden, heavy demand for water, which could reduce the pressure available to other outlets.

flutter (a) Undesirable forms of frequency modulation due to irregular motion of the recording or reproduction sound system. See also [wow](#). (b) Rapid vibration of small amplitude.

flutter echo A rapidly repeated ECHO, which usually occurs between two parallel walls in an auditorium.

flux See [LUMINOUS FLUX](#) and [SOLDERING](#).

flux fraction ratio (FFR) The ratio of upward light flux fraction of a luminaire to the downward light flux fraction. The FFR is numerically equal to the ratio ULOR/DLOR.

fly ash The finely divided residue resulting from the combustion of ground or powdered coal, which is transported from the fire box through the boiler by flue gases. It has POZZOLANIC properties, and is sometimes blended with cement for this reason.

flying buttress A BUTTRESS suspended in the air to resist the thrust of a roof structure.

flying shore A horizontal SHORE.

fly-jib An auxiliary jib, which may be fitted to the end of the BOOM or JIB of a crane.

FM FREQUENCY MODULATION.

f-number A measure of the light-gathering power, or speed, of a lens by reference to its focal length. The exposure time is proportional to the square of the f-number.

foamed concrete CELLULAR CONCRETE made with a FOAMING AGENT, such as detergent.

foamed plastic Same as EXPANDED PLASTIC.

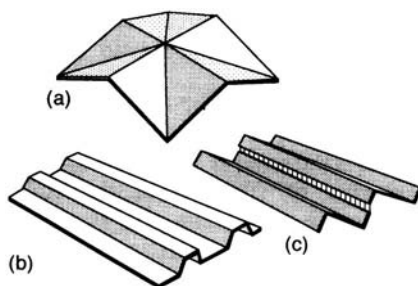

folded-plate roof

foaming agent A substance that creates a foamy structure to reduce the weight of a material, such as concrete, gypsum, various plastics, and rubber. The bubbles may be formed physically, as in detergent, or chemically by generating a gas.

fog room Same as MOIST ROOM.

foil (a) Thin metal SHEET, generally less than 0.1mm (0.005in.) thick. (b) A rounded ornament, once widely used as a decoration. It is a stylised leaf, commonly divided into three (*trefoil*), four (*quatrefoil*) or five (*cinquefoil*) divisions.

foil Strain gauge ELECTRIC RESISTANCE STRAIN GAUGE made from thin foil printed on a thin lacquer film.

FOK Free of knots.

folded-plate roof A roof structure formed by flat plates, usually of reinforced concrete, joined at various angles (see Figure). It has many of the properties of SHELL ROOFS, but since the component parts are not curved, they do not act in accordance with the MEMBRANE THEORY, and the structure is subject to substantial bending moments. Folded plates can be designed to perform the same function as DOMES (a), BARREL VAULTS (b) and NORTHLIGHT SHELLS (c).

folder In computing, an ICON representing a DIRECTORY, usually in the form of a folder.

foot (ft) A traditional measure of length based on the human foot. Its length varied from country to country, and in medieval times from city to city. The British/American foot equals 0.3048m. The Roman foot was 0.2956m.

foot, super Same as SQUARE FOOT.

footcandle An obsolete British unit for ILLUMINANCE, equal to 1lm/ft². 1 foot-candle=10.76 lux.

footing The base under a wall or column, immediately in contact with the ground. The ground that supports the footing is the FOUNDATION.

foot-lambert An obsolete British unit for LUMINANCE, equivalent to the APOSTILB. 1ft-L=1/πcd/ft²=0.318cd/ft².

foot-pound The FPS UNIT of ENERGY or work. The equivalent in SI UNITS is the JOULE. (The unit of bending moment or twisting moment is generally called *pound-foot*. Although the two units are dimensionally the same, they represent different physical concepts.)

footprint The projected area of a building or equipment on a horizontal surface.

force Defined as anything that changes or tends to change the state of rest of a body, or its motion in a straight line. The forces most commonly acting on buildings are the weight of the materials from which they are built, the weight of the contents, and the forces due to snow, wind and earthquakes. STATICS is the branch of science that deals with forces In EQUILIBRIUM.

forced circulation Circulation of fluid by pumping, as opposed to *gravity circulation*.

forced vibration The vibration imparted to a body by a periodic force. If its period is the same as that of the NATURAL FREQUENCY of vibration of the body, its effect is cumulative, and RESONANCE results.

force transmissibility See [TRANSMISSIBILITY](#).

forged A wrought metal product formed by hammering or pressing between dies (usually while hot).

form, slip See [SLIPFORM](#).

formaldehyde A gas (H.CHO) of pungent odour, readily soluble in water. The *amino-plastics* phenol formaldehyde and urea formaldehyde are condensation products of formaldehyde with phenol or urea; they are THERMOSETTING. BAKELITE, one of the earliest synthetic resins, is phenol formaldehyde.

form lining The lining of concrete FORM-WORK can be utilised to impart a smooth or patterned finish to the concrete surface; to absorb moisture in order to obtain a drier consistency at the surface; or to apply a set-retarding chemical, which enables the aggregate to be exposed.

form tie A device that both holds vertical forms apart before concrete is poured and holds them together when fresh concrete is poured.

formwork The mould for freshly placed concrete (which gives it its shape), as well as the supporting structure and bracing required to support its weight. Also called *shuttering*.

foundation The portion of the ground on which the FOOTINGS of a building are supported. *Foundation* is sometimes used interchangeably with *footing*.

foundation pressure See [BOUSSINECQ PRESSURE BULB](#), [COULOMB'S EQUATION](#) and [EARTH PRESSURE](#).

Fourier analysis See [FOURIER SERIES](#).

Fourier series The sum of an infinite number of SINE and COSINE WAVES of successively higher orders, which can be made to represent any periodic function with an accuracy depending on the number of terms used. It is named after the French physicist who developed it in 1822 for his work on heat transfer. *Fourier analysis* and *Fast Fourier transforms* are important for the frequency analysis of sounds.

fourth-power law of radiation See [STEFAN-BOLTZMANN LAW](#).

four-wire system See [STAR CONNECTION](#).

fovea The small region (pit) in the retina of the eye, on the optical axis, containing CONES but no RODS, and capable of the clearest vision in good lighting conditions.

FPS units The units of the traditional British system, based on foot, pound and second, as opposed to those used in the METRIC SYSTEM. They are used in the US CUSTOMARY UNITS.

fraction The ratio of two integers, e.g. . A fraction is a RATIONAL NUMBER. Some fractions become *approximate numbers* when expressed in decimal form.

fracture Failure caused by breaking of a material into two parts. It causes a sudden failure of a structural member, as distinct from the gradual failure caused by PLASTIC DEFORMATION or CRUSHING FAILURE. See also [BRITTLE FAILURE](#), [CLEAVAGE FRACTURE](#) and [GRIFFITH CRACK](#).

frame An assembly of structural members. Most frames are *rectangular*, i.e. they consist of horizontal and vertical members only. Most frames are also *plane*, i.e. they can be designed as two-dimensional structures, connected by additional members at right angles. Frames that cannot be so designed are called SPACE FRAMES.

frame construction Any type of construction in which the building is supported mainly by a frame, and not mainly by loadbearing walls. BALLOON FRAMED timber houses, BRICK VENEER houses, steel-framed buildings and reinforced concrete frame buildings all belong to this type.

framed tube structure Same as TUBE STRUCTURE.

frame grabber A device that allows the capture, storage and display of a frame of information, e.g. a single frame of video.

framing bracket or framing anchor A type of TIMBER CONNECTOR formed by folding a piece of galvanised steel sheet, with prepunched holes to enable nails to be driven in three mutually perpendicular directions. Used for making connections in three dimensions, e.g. joining a roof truss to the top of a wall.

frass Dust made by wood-boring insects, and one way of identifying them.

FRC See [FIBRE CEMENT](#).

free address Non-assigned workspaces available for use by employees on a first come, first served basis, usually located in OPEN PLAN offices.

free-body diagram A diagram obtained by making an imaginary cut through a structure, and considering the STATIC equilibrium of one or both parts separately as, for example, in the METHOD OF SECTIONS. Since the conditions of equilibrium must be satisfied by every stationary structure, the diagram can be drawn even for highly complex statically indeterminate structures. It is sometimes possible to obtain a simple answer for the critical forces by this approach, without having to analyse the entire structure.

free cooling The use of outdoor air without mechanical cooling to remove heat from a building space or spaces when its condition is suitable. See [ECONOMISER CYCLE](#).

freedom See [DEGREES OF FREEDOM](#).

free field A sound field in which the effects of the boundaries are negligible.

free-field room Same as ANECHOIC CHAMBER.

free float See [FLOAT](#).

freestone A building stone that can be freely carved in any direction. Most LIMESTONES and the finer-grained SANDSTONES are in this category.

free surface (in fluid mechanics) A surface separating a GAS from a LIQUID.

freezer Cabinet or room maintained for the storage of frozen food at a temperature of about $-12^{\circ}\text{C}(+10^{\circ}\text{F})$.

freight elevator US term for *goods lift*.

French chalk Finely ground TALC.

French door See [FRENCH WINDOW](#).

French polish SHELLAC dissolved in methylated spirits.

French roof Same as MANSARD ROOF.

French tile Flat roof tiles moulded with drainage channels and side interlock. The MARSEILLES PATTERN TILE has, in addition, interlocks with the tiles above and below.

French truss Same as FINK TRUSS.

French window or door A long window reaching to floor level, and opening in two leaves like a pair of doors.

Freon The trade name for CFC refrigerants.

frequency The number of cycles of a periodic phenomenon that occur in a given time interval. Frequency is measured in HERTZ (cycles per second). The product of frequency and *wave-length* equals the wave velocity. Thus the wavelength of any kind of electromagnetic RADIATION, multiplied by its frequency, equals the SPEED OF LIGHT. Similarly the wavelength of sound, or of any other vibration in air, multiplied by its frequency, equals the SPEED OF SOUND.

frequency, resonant See [RESONANCE](#).

frequency analyser An instrument for measuring the FREQUENCY BAND or SOUND PRESSURE LEVELS or determining the SPECTRUM of a sound. Frequency analysers have traditionally used either proportional bandwidth filters (e.g. OCTAVE BAND) or constant bandwidth filters but with the advent of fast Fourier transform (FFT) methods many current frequency analysers are capable of both.

frequency band A limited continuous range of frequencies. See also [OCTAVE BAND](#).

frequency distribution curve A curve relating the magnitude of a test result (or an observed variable characteristic) to its frequency (or the number of times it occurs). If the phenomenon varies only within a narrow range (as, for example, the test results for carefully controlled concrete), the curve is narrow and steep. As quality control declines, the curve becomes wider (see Figure). A normal frequency distribution produces a GAUSSIAN CURVE.

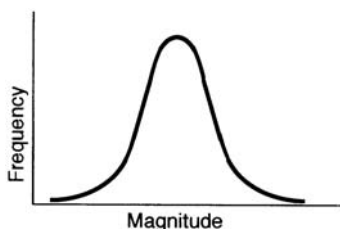

frequency distribution curve

frequency modulation (FM) A method of encoding a signal on a carrier wave (for the purpose of recording or transmitting it) by varying the frequency of the carrier. See also [AMPLITUDE MODULATION](#).

fresco Painting on wet lime plaster with pigments mixed with water. The colours dry and set with the plaster. The range of pigments is restricted to a small range that is sufficiently alkali resistant. The plasterer and the painter must work together, since the plaster does not absorb colour after it has reached a certain degree of dryness. Later alterations are impossible. The technique is now rarely employed, but it was the medium of the greatest wall and ceiling paintings of the Renaissance. Hence the term *fresco painting* is sometimes used, incorrectly, for painting on dry plastered walls and ceilings.

freshness The opposite of STUFFINESS. It is produced by air movement and cooler temperatures.

Fresnel lens A near-flat lens that focuses light. The lens has a series of prisms, of varying angles, cast into a glass or plastic sheet. Used in downlights, signal lanterns and spotlights. Also used in overhead projectors. Lighthouse lamps are similar, except that the prisms are not bonded to a sheet but are held in a frame.

Fresnel number A DIMENSIONLESS NUMBER (wavelength/distance) used in acoustics to define the degree of DIFFRACTION of a sound.

friction The resistance to motion that is brought into play when one body is moved over another. When the two surfaces are examined under a microscope, it is found that they touch only at a few points; hence the true area of contact is independent of the nominal area of contact. The contact area is, however, increased by the contact pressure. Frictional resistance is therefore proportional to the pressure between the bodies, and independent of the overall surface area of the bodies in contact. See also [ANGLE OF FRICTION](#) and [COEFFICIENT OF FRICTION](#).

friction, internal See [ANGLE OF INTERNAL FRICTION](#).

friction-grip bolt A HIGH-TENSILE BOLT tightened to a carefully controlled tension with a calibrated torsion wrench. This ensures on the one hand that the bolt is not damaged by over-tensioning, and on the other hand that it provides high frictional forces between the two pieces of steel to be connected. This form of jointing is more convenient than site *riveting* or *welding*, and more reliable than the use of BLACK BOLTS.

friction loss (in post-tensioning) The loss of stress resulting in curved TENDONS due to friction with the concrete or duct lining. Some friction loss occurs also in nominally straight cables because of the unavoidable imperfections of construction, which causes slight bends where the tendons touch the ducts.

friction pile A BEARING PILE whose load is carried by friction between the pile and the surrounding soil.

frigidarium The cool room in a Roman bath.

frog A depression on one or both of the larger faces of a brick or block. It provides a key for the mortar, and reduces the weight of the brick. The frog is not necessarily filled with mortar.

front end loader A tractor with a bucket mounted on the front; the tractor may be rubber tyred or crawler mounted.

frost heave Swelling of soil due to the expansion of the ground water when it turns into ice. It usually causes uplift, since the soil is restrained in other directions.

frozen-stress method Same as THREE-DIMENSIONAL PHOTOELASTICITY.

FRP Fibre-reinforced plastic. See [FIBREGLASS](#).

frustum of a cone or pyramid The portion left after cutting off the upper part by a plane parallel to the base.

ft Abbreviation for FOOT.

FTE Abbreviation for FULL-TIME EQUIVALENT.

FTP File transfer protocol.

fuel cell An electrochemical cell that operates by utilising the energy of spontaneous combustion, e.g. hydrogen or hydrocarbon fuel by oxygen. The reactants are fed to the cell at the rate required for generating the demand for electrical energy.

fulcrum The point of support, or pivot, of a lever.

full radiator A perfect, non-selective surface, previously termed a *black body radiator*. The radiation produced by the surface, BLACK BODY RADIATION, conforms to the STEFAN-BOLTZMANN LAW. Also Called a *Planckian radiator*.

full-time equivalent (FTE) A measure of the equivalent total number of employees, based on the hours worked by a full-time employee.

fully fixed Same as BUILT-IN.

fume cupboard An enclosure connected to an exhaust ventilation system and used to enclose a workspace where a process will cause the production of hazardous or noxious gases or vapours.

function key A key on a computer keyboard that allows a specific operation to be carried out.

fungicidal paint A paint that discourages fungal growth, e.g. by the inclusion of a metallic salt. It is particularly used in the tropics.

fungus Cryptogamous plant without chlorophyll. DRY ROT and mould are caused by the growth of fungi.

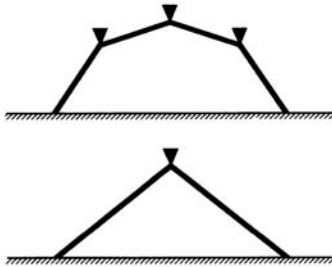

funicular arch

funicular arch An arch that is purely in compression under a series of point loads. It is the reverse of a string carrying the same load system as a suspension cable (see Figure). Also called a *linear arch*.

funicular polygon Same as LINK POLYGON.

furnace A chamber used for the combustion of fuel for the production of useful heat.

fuse A safety device for preventing the overloading of a circuit (which might start a fire), and for protecting electrical apparatus from excess current. It consists of a short length of metal, which conducts a safe current, but melts when the current is above the specified value. See also [CIRCUIT BREAKER](#).

fusible link A link that melts at a predetermined temperature, used for fire dampers, fire-resistant doors and sprinklers. See also [FIRE DOOR](#) and [SMOKE VENTING](#).

fusion welding The WELDING of metals or plastics solely by melting the edges of the pieces to be joined, without mechanical pressure. Additional weld metal may be provided by a filler rod. See [ARC WELDING](#).

G

G Abbreviation for *giga*, one thousand million times (10^9).

g The symbol for the acceleration due to gravity, about 9.8m/s^2 at the Earth's surface.

gabbro An IGNEOUS ROCK formed by plutonic intrusions; due to their slow cooling, the crystals are relatively large. It is of basic composition, and dark in colour. In the industry classification of building stones, gabbro is called a GRANITE.

gable The triangular part of the end wall of a building with a sloping roof; it is frequently of a material different from the rest of the wall.

gable roof A sloping roof with gables. It has inclined slopes on two sides, and vertical gables on the other two (see Figure). By contrast, a HIP ROOF has four inclined slopes.

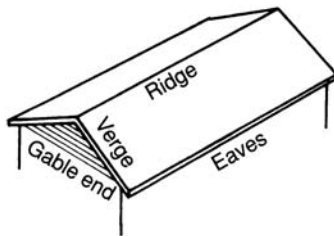

gable roof

gable wall A wall of which a gable forms a part.

gable window A window built into a gable. The room behind usually has a sloping ceiling. See also [DORMER WINDOW](#).

gage American spelling for GAUGE.

gale A wind of force 8 on the BEAUFORT SCALE. Its speed is approximately 65km/h (40mph) 10m (30ft) above ground. A gale blowing steadily on a vertical face exerts a pressure of about 200Pa (4psf).

gallery An elevated floor projecting from an interior wall.

gallon (gal) Liquid measure in FPS UNITS. The British gallon equals 4.546 litres and the US gallon equals 3.785 litres.

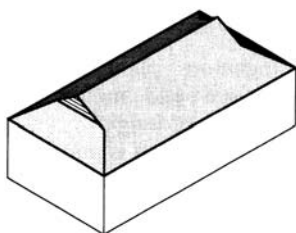

gambrel roof

Galton whistle An instrument for producing ULTRASOUND vibrations of constant amplitude and frequency.

galvanic cell A cell containing two dissimilar metals and an ELECTROLYTE.

galvanic corrosion Same as ELECTRO-CHEMICAL CORROSION.

galvanic protection Sacrificial protection given to a metal by making it the cathode to a sacrificial anode.

galvanic series The ELECTROCHEMICAL SERIES, named after the eighteenth-century Italian physicist Galvani, who discovered the generation of electricity by chemical means.

galvanised iron Normally GALVANISED STEEL (not iron) sheet. Also spelled *galvanized*.

galvanised steel Steel sheet, often corrugated, which has been protected against corrosion by GALVANISING.

galvanising The coating of steel or iron with ZINC, either by immersion in a bath of zinc covered with flux at a temperature of about 450°C or by ELECTRODEPOSITION from cold sulphate solutions. The zinc is capable of protecting the iron from atmospheric corrosion even when the coating is scratched, since the zinc is preferentially attacked by carbonic acid, forming a protective coating of basic zinc carbonates. A less brittle and more durable coating is formed by combining ALUMINIUM with the zinc. The resulting alloy cannot be soldered as readily as pure zinc, but it has become popular since plastic sealants have been available to take the place of soldered joints. See also [ZINCALUME](#) and [ZINC PLATING](#).

galvanometer Precision instrument for measuring *small* electric currents. A *galvanoscope* is an instrument capable of detecting, but not measuring, small currents. See also [AMMETER](#).

gambrel roof A sloping roof similar to a HIP ROOF, but with the addition of small gables part-way up the end sloping portions.

gamma iron Unalloyed iron in the temperature range from 910 to 1405°C (1670 to 2560°F). It has a FACE-CENTRED CUBIC space lattice. See also [ALPHA IRON](#).

gamma rays Electromagnetic RADIATION produced by radioactive materials. It is similar to X-RAYS, which are produced both naturally and by high-voltage apparatus.

Gang-Nail Trade name for a type of TIMBER CONNECTOR having preformed nails.

gantry crane A portal crane with four legs running on rails. It can pass over railway tracks, motor vehicles or even complete houses under construction. This is the most expensive type of crane, used only for large building projects or permanent installations (e.g. in PRECAST CONCRETE factories). See also CLIMBING CRANE, HAMMERHEAD CRANE, TOWER CRANE and DERRICK.

Gantt chart A BAR CHART that shows, for example, the duration of the various processes in a building operation by the length of a bar. It is named after Henry L. Gantt, who popularised its use in the early 1900s.

gap-graded aggregate Aggregate characterised by a particle-size distribution in which certain intermediate sizes are wholly or substantially absent. It is more common to use *continuous grading*. An extreme case of gap grading is NO-FINES CONCRETE.

gargoyle A water spout projecting from the gutter of a building, so that it throws the rainwater clear of the wall. It generally terminated in a grotesquely carved animal or human head with an open mouth, through which the water discharged. Neo-Gothic buildings of the nineteenth and twentieth century frequently used gargoyles for decorative purposes only, and avoided the discharge of the water on passers-by by connecting the gutters to downpipes.

garret A room in the ATTIC.

gas One of the states of matter, in which there is no shear strength, and therefore the material is formless. The volume, pressure and temperature are interdependent in accordance with CHARLES' LAW. (The other forms of matter are LIQUID, and SOLID.)

gas booster A mechanical device used to increase the pressure of gaseous fuel from a mains supply to suit the requirements of a burner.

gas burner A device for the combustion of gaseous fuel.

gas concrete CELLULAR CONCRETE made with a gas-forming agent, such as aluminium powder.

gas cutting Same as FLAME CUTTING.

gasket A piece of material placed around a joint to make it leakproof. An *inflatable gasket* is used around windows in some curtain walls; it is deflated by the maintenance crew, and filled again with air after cleaning the window.

gas laws See BOYLE'S LAW and CHARLES' LAW.

gas mantle See WELSBACH MANTLE.

gas welding Fusion welding with an OXYACETYLENE flame.

gate valve A casting machined to receive a gate which closes the opening. The gate may be lifted and lowered by turning a screw. For high fluid pressures a GLOBE VALVE is used.

gauge See BOURDON GAUGE, DIAL GAUGE and ELECTRIC RESISTANCE STRAIN GAUGE. Also spelled *gage* (USA).

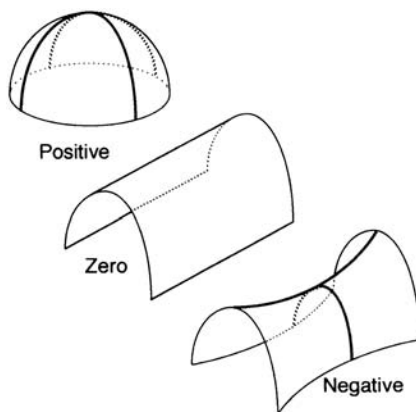

Gaussian curvature

gauged arch An arch built from gauged bricks, which are made with a taper to form a circular arch.

gauge length The length on a test piece or structural model over which a STRAIN measurement is made.

gauge pressure See [PRESSURE, HYDROSTATIC](#).

gauss The unit for measuring magnetic flux density, named after the German nineteenth-century scientist.

Gaussian curvature The product of the two principal curvatures at a point on a curved surface, e.g. a SHELL ROOF. The term is commonly used in differential geometry to classify surfaces (see Figure). A *dome-type* surface has positive Gaussian curvature, because the curvature is the same way in two mutually perpendicular directions. A *saddle-type* surface has a negative Gaussian curvature, because the curvature is upwards in one direction and downwards at right angles to that direction. A singly-curved surface has zero Gaussian curvature because the curvature in one direction is zero. A surface with zero Gaussian curvature is, by definition, DEVELOPABLE.

Gaussian curve An exponential curve fitting the normal FREQUENCY DISTRIBUTION CURVE, named after the early nineteenth-century German physicist:

$$y = Ke^{-\frac{1}{2}t^2}$$

where $t=(x-\mu)/\sigma$ is the standardised *normal variate*, σ =STANDARD DEVIATION, μ =MEAN, x =magnitude of phenomenon, y =frequency of phenomenon, K =a constant and e =the base of the natural logarithm.

Gay-Lussac's law Same as CHARLES' LAW.

gazebo A turret on top of a house, a bow window or a garden house commanding an extensive view.

geared traction drive A *traction* lift drive using gears.

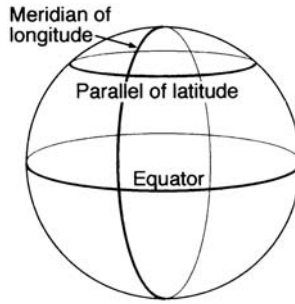

geodetic line

gearless traction drive A *traction* lift drive without intermediate gearing.

gel The apparently solid material formed from a COLLOIDAL solution that is undisturbed. The major part of hydrated PORTLAND CEMENT is in gel form.

general conditions of contract Clauses included as part of a contract to establish the legal and contractual relationship between parties to the contract.

generator See [ALTERNATOR](#) and [DYNAMO](#).

geodesic dome Originally a dome formed by structural members in the form of GEODETIC LINES intersecting to form spherical triangles. Later any dome whose structure consisted of light linear elements. See also [SCHWEDLER DOME](#).

geodesy The branch of surveying concerned with the mapping of extensive areas, in which allowance must be made for the curvature of the earth's surface (which is neglected in *plane surveying*).

geodetic construction Originally construction of a STATICALLY INDETERMINATE *space frame*, particularly in aircraft design, whose members follow GEODETIC LINES, each compression being braced by an ORTHOGONAL tension member. The term now generally implies STRESSED-SKIN CONSTRUCTION, in which the skin of the aircraft or other structure forms a statically indeterminate space frame with the ribs, which prevent the skin from BUCKLING.

geodetic line The shortest possible line that can be drawn from one point of a curved surface to another. The geodetic lines of a sphere are called GREAT CIRCLES, because they are the circles with the greatest diameter that can be drawn on a sphere. They correspond to straight lines on a plane surface. The *equator* and all the *meridians of longitude* on the earth's surface are great circles. The *parallels of latitude* (other than the equator) are SMALL CIRCLES, and travelling along them is not the shortest distance between two points. They correspond to curved lines on a plane surface (see Figure).

geographical information system (GIS) A computer system for handling data related to positions on the Earth's surface. Used for handling maps, e.g. the manipulation of land features.

geography The science of the earth's surface.



Gerber beam

geological fault A fracture in a rock formation, accompanied by displacement of one part relative to another. The displacement, or *throw*, may be a few millimetres or several metres. Faults are a source of weakness in foundations, since they may cause movement of the entire building, or of one part relative to the other. Movement along major faults is a common cause of earthquakes.

geology The science that describes the earth's crust. A *geological map* is one that shows the outcrops of all *rocks* and sedimentary deposits, without the top soil. See also [PETROGRAPHIC MICROSCOPE](#).

geometrical stair A winding staircase formed by cantilevered stone treads built into the wall, which support one another by shell action.

geometric mean The geometric mean of n values is the n th root of their product.

geometric primitive A building block of SOLID MODELLING, such as a cube, cone, sphere and cylinder.

geotechnical analysis The technical testing and reporting on the composition and condition of the soil and rock below the ground.

geotextile A textile material used to filter suspended solids from ground-water, to assist in drainage; or to provide reinforcement to stabilise ground.

geothermal energy Energy derived from the heat of the earth's interior, generally by tapping reservoirs of steam in geothermal regions to drive steam turbines.

Gerber beam A continuous beam that is made statically determinate by the insertion of two hinges in alternate spans (see Figure). It thus consists of cantilevered beams alternating with short spans simply supported from the ends of the cantilevers. Gerber beams are useful where continuous structures are assembled from heavy precast concrete elements, or where differential settlement of the foundations is a possibility, as in CANTILEVER BRIDGES.

gesso A hard white surf ace, prepared to serve as a basis for painting or bas-relief. It usually consists of PLASTER OF PARIS, or WHITING and glue. See [TEMPERA PAINTING](#).

GI Abbreviation for GLARE INDEX.

GIF Graphics Interchange Format.

giga Prefix denoting one thousand million (10^9), e.g. *gigajoule*.

girder A deep BEAM. It is generally a primary beam that supports secondary beams, as opposed to a JOIST. A *steel girder* may be a single large steel section, a PLATE GIRDER or a lattice girder (such as a HOWE, PRATT or WARREN TRUSS).

GIS Abbreviation for GEOGRAPHICAL INFORMATION SYSTEM.

GKS Abbreviation for GRAPHICAL KERNEL SYSTEM.

glare A condition of vision in which there is discomfort, or a reduction in the ability to see significant objects, or both, because of an unsuitable distribution or

range of luminance, or extreme contrasts in space or time. See [DISABILITY](#), [DISCOMFORT](#) and [REFLECTED GLARE](#).

glare index (GI) In lighting, one of a number of systems for indicating the possibility of discomfort glare from lighting. The most common are the British Glare Index (BGI), the CIE Glare Index (CGI) and the CIE Unified Glare Index (UGI).

glass A hard and brittle amorphous substance, made by fusing silica (sometimes in combination with the oxides of boron or phosphorus) with certain basic oxides (notably those of sodium, potassium, calcium, magnesium and lead) and cooling the product rapidly to prevent crystallisation or devitrification. Most glasses melt between 800°C and 950°C. Heat-resisting glass generally contains a high proportion of boric oxide. Glasses occur naturally, because of the rapid cooling of molten rock, e.g. [OBSIDIAN](#). See also [BULLET-RESISTING](#), [CROWN](#), [CYLINDER](#), [FLOAT](#), [HEAT-ABSORBING](#), [INSULATING](#), [LAMINATED](#), [OBSCURE](#), [OPAL](#), [PLATE](#), [REFLECTIVE](#), [ROLLED](#), [SAFETY](#), [SHEET](#), [SOLAR CONTROL](#), [TEMPERED](#) and [TRANSLUCENT GLASS](#).

glass, electrochromic See [ELECTROCHROMIC GLASS](#).

glass, photochromic A glass whose transmittance varies with the incident light flux. Used in some spectacle lenses and experimentally in window glazing.

glass brick A hollow block of glass, which is translucent but not transparent. It can be used in brick and block walls, or in [GLASS-CONCRETE CONSTRUCTION](#).

glass-concrete construction Reinforced concrete into which blocks of glass, capable of transmitting compressive stresses, have been cast. The glass may be in the form of hollow translucent blocks, which provide diffused white light, or it may be coloured, to provide a decorative pattern in the manner of stained glass. See also [BÉTON TRANSLUCIDE](#).

glass fibre See [FIBREGLASS](#).

glass paper An abrasive paper.

glass wool [MINERAL WOOL](#) made from molten glass.

glaze (a) To install glass panes in window or door frames. It normally implies the traditional method of using [PUTTY](#) to hold the glass in position. (b) To produce a shiny surface on photographic prints. (c) A brilliant glass-like surface given to tiles or bricks. It may be transparent or opaque, white or coloured. See also [SALT GLAZE](#). (d) A nearly transparent thin coat of colour put on paint to enhance the original colour.

glazed tile A glazed *clay tile*, which facilitates cleaning.

glazing bead A strip that presses the glass against the glazing bar. It is an alternative to the use of window [PUTTY](#).

global warming See [GREENHOUSE GASES](#) and [GWP](#).

globe thermometer Instrument devised by H.M.Vernon in 1930 as a means of indicating the combined effects of radiation and convection as they influence the human body. It consists of a hollow copper sphere containing an ordinary thermometer at the centre of the sphere. The temperature of the instrument

depends on the environment in which it is placed. If the mean radiant temperature is higher than the air temperature, the temperature recorded in the globe thermometer will be above the air temperature; conversely, with the surroundings cooler than the air, the globe thermometer temperature will be below air temperature. The copper globe may be left *bright* or it may be painted *black*, so that it behaves like a BLACK BODY. See also [WET-BULB GLOBE THERMOMETER INDEX](#).

globe valve A casting machined to receive a bulbous circular disc, which closes a circular opening between the two chambers. The disc is operated by a screw, and it can resist a higher fluid pressure than that of a GATE VALVE.

globoscope A paraboloidal mirror in which a distorted image of all the surrounding buildings is seen in STEREO-GRAPHIC PROJECTION, as observed from above. The image can be viewed, or photographed. It is possible to study sunlight penetration by superimposing a transparent sunpath diagram on a globoscopic view.

gloom In lighting, an interior that appears to be underlit as a result of either inadequate surface luminances or excessive contrasts, as from bright windows.

gloss The reflection of light from a painted surface. It ranges from full gloss (the smoothest mirror-like surface attainable), through semi-gloss, eggshell gloss and eggshell flat, to flat (a matt surface without sheen, even when viewed from an oblique angle).

GLS lamp General lighting service, the range (from 25W to 150W) of INCANDESCENT LAMPS used for general lighting purposes. They are usually spherical and can be clear, frosted (etched) or diffusing.

glue Sticky substance for joining two pieces, particularly of wood, by bonding of the contact surfaces. The traditional carpenter's glue is made from bones and other animal waste products. Other traditional glues are fish glue, casein glue, and vegetable glues such as soya glue and cassava glue. These have now been largely superseded by *synthetic resins*, particularly for exterior and other waterproof applications. See also [HYDRAULIC GLUE](#).

glycerin A trihydric alcohol ($\text{CH}_2\text{OH}.\text{CHOH}.\text{CH}_2\text{OH}$). It is a constituent of many paints and varnishes.

gneiss A coarse-grained metamorphic rock, predominantly dark coloured, and characterised by mineral banding. In the industry classification of building stones, gneiss is called a GRANITE.

gnomon The upstanding element on a sundial, which casts the shadow.

going The horizontal distance from face of RISER to face of riser on a staircase.

gold A metallic element, highly resistant to corrosion; one of the few to be found as a metal in the native state. Its chemical symbol is Au, its atomic number is 79, its atomic weight is 197.2, its specific gravity is 19.3, and its melting point is 1063°C .

golden section A geometric construction used by Euclid to draw the regular pentagon. From it can be derived the golden number [$\Phi=0.5(1+\sqrt{5})=1.618$], which was widely claimed in the nineteenth and twentieth centuries to be the key

to the beautiful proportions of Greek and other classical architecture. It has not been proved that the golden section was used in Greek architecture, or even that it was known in Pericles' lifetime. It was used in the revival of Greek and other classical architecture in the nineteenth century.

goods lift Called a *freight elevator* in the USA. A lift designed primarily for the transport of freight and goods. See also [DUMBWAITER](#).

gooseneck A flexible tube, usually metal, which retains the position to which it is bent; often used on desk and machine-mounted luminaires. See also [ANGLEPOISE](#).

governor A mechanical device that controls automatically the speed of a machine. In LIFT systems, it is used to detect overspeed.

GPM Gallons per minute.

grab A bucket that is split and hinged and which can dig into loose material.

grade (a) A system of angular measurement, in which a right angle is 100g, instead of 90°. (b) To reduce a slope to an easy or uniform gradient. (c) *At grade*, at ground level. See also [STRESS GRADING OF TIMBER](#).

grade beam or slab Reinforced concrete beam or slab that is normally placed directly on the ground.

gradient The slope of a line or curve, given by the ratio of rise to run of a tangent line drawn to the curve.

grading curve The graph obtained by PARTICLE-SIZE ANALYSIS.

grading of timber The sorting of timber according to the type and the number of defects. See also [STRESS GRADING OF TIMBER](#).

graffito A plaster surface decorated by scoring a pattern while it is still wet. The plaster is normally applied in two or more layers of different colour, and the lower coats are exposed by the graffito work. Also spelled *sgraffito* and *scraffeto*.

grain boundary The boundary between two CRYSTALS.

graining The now obsolete art of painting a surface to look like the grain of wood or marble.

gram molecule Obsolete term for MOLE.

granite An IGNEOUS ROCK formed by plutonic intrusions (consisting of relatively large crystals due to slow cooling). It is of acid composition, its main constituents being QUARTZ, FELSPAR and MICA. Granite is a little heavier than concrete, and generally much stronger (up to 140N/mm² or 20ksi); however, its fire resistance is poor. In the industry classification of building stones, the term 'granite' is also applied to other high-strength igneous rock, such as DIORITE, DOLERITE, GABBRO, trachyte and GNEISS.

granolithic concrete Concrete mixed with specially selected aggregate, whose hardness, surface and particle shape make it suitable for a wearing surface on a heavy-duty floor.

granular soil Consisting of GRAVEL, SAND and SILT, as distinct from a COHESIVE SOIL.

granulated cork Cork broken down into small particles for thermal insulation or for the manufacture of cork tiles.

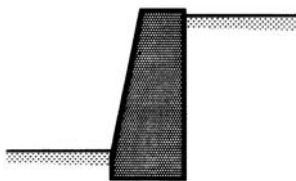

gravity retaining wall

graphical kernel system (GKS) In computing, a device-independent software standard for graphics.

graphical user interface (GUI) A user interface to communicate with computers based on a graphic form rather than a textual form.

graphics attribute A property of an object defining one of its geometric or graphical properties, e.g. shape, colour, line style etc.

graphics tablet A device for inputting graphics into a computer, in the form of a *digitiser board*, often used with a STYLUS and superimposed MENU, as a means of indicating commands to the drafting system of a computer.

graphite One of the allotropic forms of CARBON. It is present in grey CAST IRON. Colloidal graphite is an excellent lubricant, which can be used at high temperatures. Also called *blacklead*.

graticule A graduated scale placed in the eyepiece of a telescope or microscope; see also [CROSS-HAIR](#).

gravel Naturally occurring deposits of unconsolidated sediment, ranging from about 75 to 5mm (3 to in.), and resulting from the disintegration of rock. Larger samples are called *boulders*, and smaller material SAND. Most gravel consists of SILICA. Gravel, either whole or crushed, is used as COARSE AGGREGATE for concrete, and as a protective layer on top of built-up roofing.

gravitation The force of nature that causes a mutual attraction between masses. According to Newton's law, 'Any two particles of matter attract one another with a force inversely proportional to the square of the distance between them.' See also [g](#).

gravity circulation Circulation of fluid due to gravity, as opposed to *forced circulation* due to pumping.

gravity retaining wall RETAINING WALL that relies for its stability on the weight of the masonry or concrete (see Figure).

gravity tank system A water supply system that utilises an elevated storage tank to provide the necessary water pressure, as opposed to a HYDROPNEUMATIC TANK SYSTEM.

gray US spelling of *grey*.

GRC Glassfibre reinforced cement. See [FIBRE CEMENT](#).

great circle The shortest possible line that can be drawn on the Earth's surface between two points. It corresponds to a straight line on a plane surface. A great circle is also the circle with the largest diameter that can be drawn on the Earth's

surface. The equator and the meridians are great circles. Parallels of latitude are SMALL CIRCLES.

green brick A moulded brick prior to baking.

green concrete Concrete that has SET, but not sufficiently HARDENED.

greenhouse A building or room containing large areas of glass, which transmits solar radiation, but not the long-wave radiation produced by the surfaces of a building after absorbing solar radiation. In consequence a greenhouse exposed to sunshine becomes much hotter than a room with smaller windows. Also called a *conservatory*.

greenhouse gases Gases such as carbon dioxide and methane, which accumulate in the atmosphere and reduce the loss of heat to space, giving rise to global warming.

green wood Timber that still contains most of the moisture that was present in the living tree; this is reduced by SEASONING.

grey body A surface whose EMISSIVITY is the same at all wavelengths, but is significantly less than unity. See also BLACK BODY.

grey cast iron CAST IRON that contains some free carbon in the form of GRAPHITE, as distinct from WHITE CAST IRON.

grey scale A range of different shades of grey in a continuous tone image between black and white.

grey water Non-potable SULLAGE with minor pollution, and contaminated surface water. It can be collected, filtered, stored and recycled for flushing toilets, car washing and irrigation.

Griffith crack An ideal crack postulated in the theory of the fracture of brittle materials, particularly GLASS.

grillage foundation A foundation formed by a framework of cross beams of timber or steel.

grille A slotted or louvred opening to allow the passage of air through a wall or barrier from a space to another space or a duct.

gritstone SANDSTONE composed of large sand particles.

groin The curved line at which the soffits of two intersecting vaults meet. See CROSS VAULT.

groin vault Same as CROSS VAULT.

groove A narrow channel, machine-cut into a surface. (a) *U profile*: a groove cut into the drive SHEAVE of a LIFT machine, semicircular in shape and of a radius approximately equal to that of the suspension rope. (b) *V cut*: a groove cut into the drive SHEAVE of a LIFT machine, in the shape of a V. (c) *Under-cut* a groove cut into the drive SHEAVE of a LIFT machine. It is a modified V cut; the lower sides are cut in the shape of a U.

gross building area The gross floor area for development purposes, in accordance with individual authority definitions.

gross energy requirements The measure of all energy inputs in the processes of manufacturing materials for use in construction, from extracting raw materials to delivery for construction, including associated transport and facilities.

gross lettable area The total area available for lease, calculated by adding the NET LETTABLE AREA and the COMMON AREA of a floor or building.

ground anchor A device inserted into the ground, by screwing in like an auger, or by excavation and backfilling. It is used for stabilising a retaining wall, or for resisting uplift.

grounded In reference to electrical wiring, same as EARTHED.

group A number of lift cars located adjacent to each other, using a common signalling system and a common control system.

group address A space in a building assigned periodically to a team for working activities.

group collective control Of lift systems: a simple form of group control system. Two or three cars are collectively controlled, to allocate the best-placed car to each landing call.

group supervisory control Of lift systems: a control system that commands a GROUP of interconnected lift cars, to improve the overall system performance.

grout A cement, mortar or concrete slurry that is sufficiently fluid to penetrate into rock fissures, masonry joints or prestressing ducts without segregation of the constituents. A commonly used mixture consists of equal volumes of cement and sand, with an appropriate amount of water.

grout injection Stabilising or water-proofing the ground by injecting a liquid cement slurry under pressure. Grout-injected *piers* are made by drilling into sandy or unstable soil with an AUGER, and injecting the grout through the hollow drill-stem as the auger is withdrawn. This prevents the pier-hole from collapsing as the auger is withdrawn. If the grout is sufficiently fluid, a reinforcing cage can be inserted into it after the auger is withdrawn.

growth rings Rings on the transverse section of a trunk or branch of a tree, which mark successive cycles of growth. Also called *annual rings*. See also [COARSE GRAIN](#) and [CLOSE GRAIN](#).

GRP Glassfibre reinforced plastic. See [FIBREGLASS](#).

GUI Abbreviation for GRAPHICAL USER INTERFACE.

guide rail A set of vertical machined rails installed in a lift well to guide the travel of a lift car or counterweight.

guide shoes Devices to guide the movement of lift cars, counterweights and doors along their associated GUIDE RAILS. See also [LINER](#).

guide vane A blade placed in an air duct to influence the direction of flow, for example by turning vanes to assist air to turn around a bend or change direction. See also [SPLITTER](#).

gully trap An assembly used in a waste water system, which provides a water seal to prevent odours and gases from escaping into a building or into the atmosphere.

gum arabic A white powder obtained from certain acacia trees grown mostly in the Sudan and Senegal. It is used for GLUE, and as a base for transparent paint. See [TEMPERA PAINTING](#).

gum tree Australian term for EUCALYPT.

gum vein Local accumulation of natural resin, which occurs as a wide streak in certain hardwoods, particularly the eucalypts. It is a defect that can seriously weaken the timber.

gunite Same as SHOTCRETE.

gun metal An alloy containing about 90 per cent copper, 8 per cent tin and 2 per cent zinc.

gusset A piece of plate to which the members of a truss are joined, if they are too small or inconveniently shaped for a direct connection.

guy rope A rope that secures or steadies a DERRICK or a temporary structure.

GWP Global warming potential.

gymnosperm One of the two main divisions of seed plants. It includes all CONIFERS.

gypsum Calcium sulphate dihydrate ($\text{CaSO}_4 \cdot 2\text{H}_2\text{O}$). It is a natural mineral, which is the raw material of gypsum PLASTER. ALABASTER is a pure Variety of gypsum.

H

H (a) Chemical symbol for hydrogen. (b) The symbol for the unit of electrical inductance, the HENRY.

h Abbreviation for *hecto*, one hundred times.

Haas effect Effect by which, within certain limits of intensity and time difference, all the sound from two sources will appear to come from the source from which the sound arrives at the listener first.

ha-ha A barrier in the form of a trench, particularly one used in country houses built in the eighteenth and nineteenth centuries, to prevent livestock from crossing into the garden. A fence is usually built at the bottom of the trench, and is not seen from a distance.

hair Used as reinforcement for lime and gypsum plaster. Hair from bullocks and goats was once used; however, manila fibre, sisal and glass fibre are now more common. See [FIBROUS PLASTER](#).

hair cracks Fine cracks just visible with the naked eye.

hair hygrometer An instrument based on the experimental relation between the increase in the length of certain animal hairs and the relative humidity of the atmosphere, due to the absorption of moisture by the hair. They are used in [HYGROGRAPHS](#).

half bat One half of a brick, cut in two across the length (see Figure). See also [KING CLOSER](#) and [QUEEN CLOSER](#).

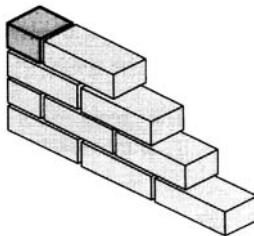

half bat

half-lap joint Same as [END-LAP JOINT](#).

half-round A semicircular moulding.

half-timbered Building constructed with a timber frame, the spaces between the frame timbers being filled with brick-work, plaster, or WATTLE-AND-DAUB. This is still a vernacular form of construction in some rural districts of Europe. It was widely used in Tudor England, even for large urban buildings. Modern 'half-timbered' suburban houses are often of brick or brick-veneer construction, with thin vertical and diagonal pieces of timber superimposed.

halftone The simulation of different shades of grey using dots of a single shade of black but of varying size. Used to reproduce photographs in print.

halides The binary salts (*chlorides, bromides, iodides* and *fluorides*) formed by the union of a *halogen* (chlorine, bromine, iodine or fluorine) with a metal. The best-known halide is common salt, NaCl.

hall In lift terminology, the word is synonymous with corridor, floor, landing or lobby.

halocarbons See [CFC](#).

halogen (a) One of the monovalent elements (fluorine, chlorine, bromine, iodine) that readily form negative ions. (b) In lighting, the common term used for low-voltage TUNGSTEN-HALOGEN LAMPS.

halophosphate A class of fluorescent materials having a broad emission spectrum over the visible part of the spectrum when excited, used in tubular fluorescent lamps. In high-efficacy lamps, these have been replaced by or are used in combination with narrow band phosphors.

hammer See [BALL-PEEN HAMMER](#) and [CLAW HAMMER](#).

hammer, pile See [PILE HAMMER](#).

hammer-beam roof A medieval timber roof without a tie. The hammer-beams are supported on brackets projecting from the wall, but (unlike a modern tie) they do not meet. Instead, the forces are transmitted by arched braces and struts. A well-known example is the roof of Westminster Hall in London, the only surviving part of the old Westminster Palace.

hammerhead crane A crane with a horizontal jib along which the lifting hook travels, and a shorter counter-balancing jib, rotating on top of a tower. Also called *saddle jib, horizontal jib*.

hand See [RIGHT-HAND](#).

hand level Same as CLINOMETER.

handling capacity (of a lift system) The number of people that a bank of lifts (elevators) can move in 5 minutes. This is usually expressed as a percentage of the population of the building.

handwinding The action of using a manual device to lower a lift car in an emergency.

hardboard A FIBREBOARD formed under pressure to a density of 500 to 1000kg/m³ (30 to 60lb/ft³). Most hardboards have one smooth and one textured surface; however, hardboards are also made with decorative and veneered surfaces, and they can be treated to be water-resistant. Also called *compressed fibreboard*.

hard copy A copy of the output of a computer on paper or film, as opposed to the visual display on a screen.

hard disk Non-flexible magnetic disk for the bulk storage of data. Usually an integral part of a computer. See [FLOPPY DISK](#).

hardener A CATALYST that increases the hardening rate of synthetic resins or glues. It is mixed with the resin immediately before use. Also called *accelerator*. See also [CONCRETE HARDENER](#).

hardening of concrete The stage in the chemical reaction between cement and water when the concrete hardens and gains sufficient strength to bear its own weight and that of the construction loads. See also [SETTING OF CONCRETE](#) and [AGEING OF CONCRETE](#).

hardening of metal See [CASE HARDENING](#), [COLD-WORKING](#) and [QUENCHING](#).

hardness The resistance of a material to permanent deformation of its surface.

hardness scale See [MOHS' SCALE](#).

hardpan An extremely hard soil containing gravel and boulders.

hard solder Same as SILVER SOLDER.

hardware The physical equipment of a computer, as opposed to the programs or SOFTWARE.

hard water Water containing calcium or magnesium salts in solution. These are picked up if water passes slowly through LIMESTONE or DOLOMITE. The salts react with soap, and thus make washing and laundering difficult. They are also deposited on heating as scale, and thus tend to block the pipes of hot-water systems. Water that is too hard must be treated with a WATER SOFTENER to remove some of the salt.

hardwood Timber from trees belonging to the botanical group *Angiospermae*, i.e. all trees but the CONIFER, which are called *softwoods*. While some softwoods are moderately hard, some hardwoods are very soft (e.g. Balsa wood). However, taken as a group, the hardwoods are much harder than the softwoods. Practically all Australian native timbers are hard, and many can be nailed only in their green state. See also [BOXED HEART](#).

Hardy Cross method Same as MOMENT DISTRIBUTION METHOD.

harmonic Any *overtone* in a single musical note of complex waveform with a frequency that is an exact multiple of the fundamental or pitch frequency. See also [OCTAVE](#).

hatchway A term historically used to describe a lift well, but now used only for the LIFT WELL of goods lifts and DUMBWAITERS.

haunch (a) The part of an arch near the SPRINGING. (b) A section of a beam whose depth is increased because of an increase in bending moment.

haydite A LIGHTWEIGHT CONCRETE aggregate produced by heating shale.

H-beam or H-section Same as WIDE-FLANGE SECTION.

HCFC Hydrochlorofluorocarbons, a family of synthetic refrigerants with less severe OZONE DEPLETION potential than CFC. See also [HFC](#).

HDTV High-definition television.

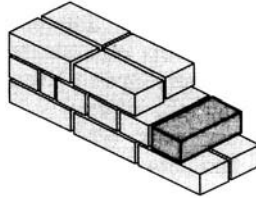

header

He Chemical symbol for *helium*.

head (a) The energy possessed by a liquid due to its elevation above some datum, or due to any other cause, such as its velocity. (b) The enlarged part of a bolt. (c) The upper end of a column. (d) The upper part of a vertical timber. (e) The topmost member of a door or window frame.

header A brick, block, or stone laid across the wall, to bond together the STRETCHER bricks (see Figure). The shorter length, or head, of the brick is visible on the face of the brickwork. See also [BOND](#) (a).

header, lift door Used in the lift industry for a horizontal structural member located above, and on the lift-well side of an entrance, to support the door hanger.

headroom (a) The clear vertical distance between the ground or floor and the lowest point overhead. (b) In audio systems, the difference (in dB) between the peak and average sound levels. 10dB is usually adequate for speech.

hearing threshold The sound level in dB, at a given frequency, that can just be heard in quiet conditions.

heart The centre of a wooden log. See also [BOXED HEART](#).

heat etc. See also [THERMAL](#) etc.

heat-absorbing glass Glass whose solar transmittance is reduced, particularly in the INFRARED end of the spectrum, by adding various colouring agents to the molten glass. The most common colours are bronze, grey and green. The visible light transmittance varies from 14 per cent to 83 per cent, depending on the colour and the thickness. See also [REFLECTIVE GLASS](#).

heat exchanger A device in which heat is exchanged between two fluids while the fluids themselves are kept separate. An automobile radiator is a water-to-air heat exchanger.

heat gain Heat migration into a *substance* or space by conduction, radiation or exchange of air.

heat gain, solar See [DIRECT SOLAR GAIN](#) and [THERMAL CAPACITY](#).

heat gun A tool that produces a stream of hot air, at a temperature suitable for softening and removing paint, or heat-welding of THERMOPLASTIC materials.

heat insulation Same as THERMAL INSULATION.

heat load The quantity of heat required to be removed or added to the air in a space to maintain a desired condition of temperature and/or relative humidity.

heat loss Heat migration from a substance or space by conduction, radiation or exchange of air.

heat of hydration The quantity of heat liberated or consumed when a substance takes up water.

heat pump An air conditioning installation which can act either as a heating or as a cooling unit. The refrigerant soaks up heat from the inside in summer, and from the outside in winter. After a COMPRESSION CYCLE, the heat is released (on the outside in summer, and on the inside in winter).

heat reclamation The process of recovery of waste heat from an effluent fluid for useful purposes.

heat-reflective glass See [REFLECTIVE GLASS](#).

heat rejection Discharge of surplus heat from a space to a sink such as the atmosphere by way of a cooling tower, air-cooled condenser or other arrangement

heat sink A receptacle for surplus heat, such as the atmosphere or a large body of water.

heat source Source of heat to make up losses, such as a boiler, electric resistance element etc.

heat stress A condition of distress arising from an increase in deep body temperature due to inadequate heat loss.

heat transfer A generic term for THERMAL CONDUCTION, CONVECTION and RADIATION.

heat-treated glass See [TEMPERED GLASS](#).

heat-treatment of metal See [ANNEALING](#), [NORMALISING](#), [TEMPERING](#) and [QUENCHING](#).

heat wheel A rotary device used to transfer heat from one moving air stream to another.

heavy metals In environmental terminology, those metals of a high atomic weight, which in certain concentrations can exert a toxic effect. The main heavy metals are cadmium, chromium, copper, lead, mercury, nickel and zinc.

hectare (ha) A metric unit of area, equal to 10000m² or 2.47acres.

hecto (h) Prefix for 100 times, from the Greek word for hundred; e.g. 1hectare =100are.

heel That part of the horizontal slab of a CANTILEVER RETAINING WALL that is Under the retained soil, as opposed to the TOE.

heliarc welding A form of SHIELDEDARC WELDING in which the arc is protected by the inert gas *helium*. It is used mainly in the USA, where helium is readily available. See also [ARGON-ARC WELDING](#).

helical reinforcement Small-diameter reinforcement wound around the main, OF LONGITUDINAL, REINFORCEMENT of columns. It restrains the lateral expansion of the concrete under compression, and consequently increases the column strength. Also called (incorrectly) *spiral reinforcement*.

helical stair A stair whose treads are arranged along a helix. Commonly (but incorrectly) called a *spiral stair*.

heliodon Same as SOLARSCOPE.

helium The lightest of the inert gases, used in HELIARC WELDING. Its chemical symbol is He, its atomic number is 2, its atomic weight is 4.002, and its boiling point is -268.9°C .

helmet-mounted camera A camera mounted on a helmet, which captures images and transmits them to a remote unit.

Helmholtz absorber See HELMHOLTZ RESONATOR and RESONANT ABSORBER.

Helmholtz resonator A resonant acoustical absorber, named after the nineteenth-century Prussian scientist. In its original form it consisted of a vessel with a narrow neck, within which the air resonated, which was connected to a large volume of air in the vessel which acted as the spring in the single degree of freedom system. The movement of the air in the neck of the vessel resulted in damping of the system and hence absorption of the sound at and around the resonant frequency.

hemihydrate A compound containing one-half of a molecule of water to one molecule of another substance. The hemihydrate most widely used in building is *calcium sulphate hemihydrate*, PLASTER OF PARIS.

hemispherical dome A DOME with a constant radius of curvature that comes vertically on its springings. Hence the horizontal component of the thrust is absorbed by HOOP TENSION.

henry The unit for measuring electrical inductance, named after the American nineteenth-century scientist.

HEPA filter High efficiency particulate arrestance air filter, used for removing very fine particulate matter from air.

heptagon A seven-sided regular POLYGON. The angle included between the seven equal sides is 128.6° .

hermetic compressor Refrigerant compressor that has the electric motor contained in the refrigerant circuit in a sealed vessel.

herringbone In masonry and carpentry, a zigzag pattern or bond.

herringbone strutting A form of LATERAL SUPPORT between deep, narrow timber or steel joists to prevent them from twisting. Small pieces, usually of timber about $38 \times 38\text{mm}$ or $1\text{in.} \times 1\text{in.}$, are fixed as cross-bracing between each adjacent pair of joists. Now generally superseded by SOLID BRIDGING.

hertz Unit of frequency. 1 hertz (Hz) = 1 cycle per second, 1 kilohertz = 1000 cycles per second. The hertz has the units s^{-1} . It is named after the German nineteenth-century physicist.

hessian Same as BURLAP.

hexagon A six-sided regular POLYGON. The angle included between the six equal sides is 120° .

hexagonal close-packed lattice See CLOSE-PACKED HEXAGONAL LATTICE.

hexagonally recessed screw head See ALLEN HEAD.

hexahedron Same as CUBE.

HFC Hydrofluorocarbons, a family of synthetic refrigerants with no OZONE DEPLETION potential. They are replacing the use of CFC and HCFC.

hidden line removal In *computer graphics*, the process of determining and removing HIDDEN LINES from a view, thus transforming a WIREFRAME display into a surface display.

hidden lines In *computer graphics*, in line drawings such as WIREFRAME drawings those lines that are hidden from view when the surfaces of the shapes are made opaque.

hidden surface removal In *computer graphics*, the process of determining and removing HIDDEN SURFACES from view in a three-dimensional display.

hidden surfaces In *computer graphics*, surfaces that are obscured by other surfaces from some viewpoint.

hiding power The ability of a paint to obscure existing colours and patterns; it is a measure of its *opacity*. *Covering power* is the hiding power for a given spreading rate.

hi-fi Abbreviation for HIGH FIDELITY.

high-alumina cement Cement manufactured from BAUXITE and limestone. It is chemically different from PORTLAND CEMENT, and gains its strength more rapidly than high-early-strength Portland cement. Also called *calcium aluminate cement*.

high-bond bar Same as DEFORMED BAR.

high-carbon steel CARBON STEEL containing more than 0.5 per cent of carbon. See also [LOW-CARBON STEEL](#).

high-density concrete Concrete of exceptionally high density, due to the use of very dense aggregates, such as BARITE or LIMONITE. It is used for radiation shielding. See also [BARIUM PLASTER](#).

high-early-strength cement A PORTLAND CEMENT that gains strength more rapidly than the ordinary variety, and costs slightly more. It has a higher SPECIFIC SURFACE through finer grinding, and thus allows the chemical action to proceed more rapidly. Also called *rapid-hardening cement*.

high fidelity Sound reproduction of a superior, but generally undefined quality.

high gloss An enamel-like finish on paint or varnish.

high-intensity discharge lamp A DISCHARGE LAMP in which the radiant energy exceeds 3 W/cm² of tube surface area. It includes MERCURY VAPOUR, METAL HALIDE and HIGH-PRESSURE SODIUM LAMPS.

high-level inversion See [INVERSION](#).

high-light window A window set high in the wall. Also called a CLEARSTOREY window.

high-pressure hot water Water raised to a high temperature under a pressure greater than atmospheric. Also called *high-temperature hot water*.

high-pressure mercury lamp A HIGH-INTENSITY DISCHARGE LAMP using mercury vapour in the discharge tube. The light is 'white' but with a cold appearance due to the strong mercury lines in the blue/green part of the spectrum. The colour appearance and colour rendering are improved by using a red

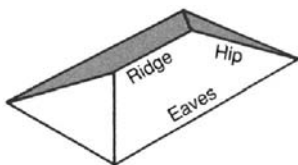

Hip roof

phosphor fluorescent coating on the inside of the outer bulb. This is now the common form of the lamp, often called a *mercury fluorescent lamp*. The other method for improving the colour is to add metals in the form of halides to produce the METAL HALIDE LAMP.

high-pressure sodium lamp A HIGH-INTENSITY DISCHARGE LAMP using sodium vapour in the discharge tube. The light is yellowish in colour (but not as yellow as the monochromatic LOW-PRESSURE SODIUM LAMP). The light can be made 'whiter' by increasing the pressure in the discharge tube, but at the cost of efficacy.

high-pressure steam curing See [AUTOCLAVE](#).

high-speed steel A high-alloy steel used in metal-cutting tools operating at high speeds. It contains 12 to 22 per cent of tungsten and is capable of intense hardening.

high-strength bolt Same as HIGH-TENSILE BOLT.

high-strength steel Steel with a high YIELD or PROOF STRESS, generally above 400N/mm² (60ksi).

high-temperature hot water See [HIGH-PRESSURE HOT WATER](#).

high-tensile bolt A bolt made of high-strength steel, and usually used as a FRICTION-GRIP BOLT.

high-velocity system An air distribution system that operates at high pressure and velocity to distribute conditioned supply air through ductwork of reduced size.

highway In computing and telecommunications, a channel over which information is transferred.

highway width Refers to the *bandwidth* and the capacity of a HIGHWAY to transmit information: the greater the width the faster the transmission.

hinge joint See [PIN JOINT](#) and [PLASTIC HINGE](#).

hipped plate roof HIP ROOF formed by folded plates.

hip roof A roof with four inclined slopes, that meet at the *hips* (see Figure).

histogram Literally, a diagram showing a web-like pattern. Its most common use is as a *frequency histogram*, which shows the relation between the magnitude of an observed variable characteristic and its frequency as a series of bars, or vertical rectangles; each rectangle is drawn so that its height corresponds to the frequency (see Figure). See also [FREQUENCY DISTRIBUTION CURVE](#).

HMSO Her (or His) Majesty's Stationery Office, London. Now privatised and known as *The Stationery Office*.

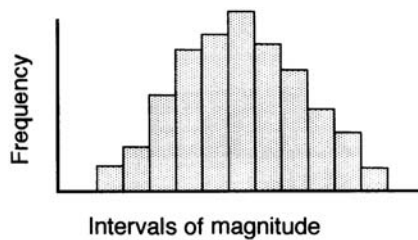

histogram

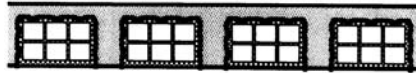

hollow-tile floor

Hoffmann kiln A continuous ring tunnel brick kiln of annular longitudinal arch design, as opposed to an INTERMITTENT KILN.

hog-backed Same as CAMBERED.

hogging moment A NEGATIVE BENDING MOMENT, such as occurs in a continuous beam at a support; it causes a 'hogging' deformation. A SAGGING MOMENT is positive.

hoist A platform for lifting people and/or materials. It is lifted by cables and within, or cantilevered from, an open frame supported by the building. It ranges in size from two storeys to any height. The platform can be open or enclosed.

hoisting The movement of a load vertically.

hoistway US term for LIFT WELL.

hole, effect on strength See [STRESS CONCENTRATION](#).

hollow block An extruded BLOCK of concrete or burnt clay, which consists largely of voids, and is consequently a good insulator, but of limited strength. It is used for partitions and in floors. Also called a *hollow tile*.

hollow-core door A door formed of a light timber frame, faced on both sides with hardboard or plywood. It may have a hollow or a HONEYCOMB CORE.

hollow-tile floor A reinforced concrete floor that is cast over a soffit consisting of hollow blocks (of burnt clay or concrete) between narrow ribs (see Figure). Its structural design is like that of a RIBBED SLAB; however, it presents a flat, uniform soffit after plastering, and its thermal insulation is superior to that of a solid slab. Also called a *pot floor*.

hologram A three-dimensional image of an object; created by a LASER.

homebase Assigned workplace from which most of an individual employee's work in a building is carried out.

home directory The starting point of the system of file organisation in a computer.

home page The entry point to an organisation of documents in the WORLD WIDE WEB.

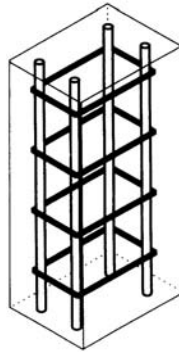

hoop reinforcement

home unit Australian term for an APARTMENT that is sold and not rented. See also [STRATA TITLE](#).

home working The process of engaging in work activities in the employee's home as the main place of work, with the agreement of the employer and with a contract that describes the employer's commitment to worker's compensation, occupational health and safety matters, and negotiated productivity outcomes.

homogeneous Having identical characteristics throughout.

honeycomb core A structure of air cells, resembling a honeycomb, placed between plywood panels. It has excellent insulating properties and adequate flexural strength. The honeycomb is commonly made of paper. See also [HOLLOW-CORE DOOR](#).

honeycombed concrete Concrete with voids caused by failure of the cement mortar to fill all the spaces between the particles of the coarse aggregate.

hooked bar A concrete reinforcing bar whose end is bent to improve its anchorage, generally through 90° or 180°. The minimum radius of the hook must be sufficient to avoid stress concentrations in the concrete, and a free length of bar is required at the end of the hook to prevent pull-out of the bar.

Hooke's law In 1678 Robert Hooke published his observation that all known elastic materials had deformations that were directly proportional to the applied loads. Today the law is usually stated as 'STRESS is proportional to STRAIN'. Hooke's law is the basis of the ELASTIC DESIGN of structures, and of the principle of SUPERPOSITION.

hoop reinforcement Closed hoops around the main, or longitudinal, reinforcement of columns to restrain the BUCKLING of the longitudinal steel (see Figure).

hoop tension The tension that occurs in the lower portion of a hemispherical DOME, in a cylindrical or spherical watertank, or in the *tension ring* that absorbs the horizontal components of the reactions of a shallow dome.

horizon The circle, as seen by an observer, which has an ALTITUDE of zero. If the true horizon is obstructed, e.g. by mountains or buildings, it may be

necessary to use an *artificial horizon*. The point above the observer that makes an angle of 90° to the horizon is the *zenith*.

horizontal Perpendicular to the direction of the gravitational forces.

horizontal shadow angle The angle measured in the horizontal plane between the position of the sun and the normal to a surface.

horsepower (hp) The performance of 33000 foot-pounds of work per minute (=746W); originally intended to equal the capacity of a horse when rating the power of a mechanical vehicle. However, a horse can perform better than 1hp, at least for a short time. The metric horsepower (force de cheval, ch, or Pferdestärke, PS) equals 4500kgfm/min, which is 0.986 hp. In SI UNITS the horsepower is replaced by the watt; 1ch=735.5W. See also [POWER](#).

host computer A main computer to which other terminals or computers are connected.

hot-air seasoning Drying timber in a kiln.

hot-cathode lamp A DISCHARGE LAMP, usually low pressure, in which the electrodes are heated, either by the arc or by a separate heating current.

hot desking The practice of sharing workplaces between individuals in different time periods.

hotelling The practice of allocating non-assigned workplaces in a building by reservation.

hot gas line The pipeline that transports hot gas from a refrigerant compressor to a condenser.

hot restrike In lighting, the technique used to restart high-pressure DISCHARGE LAMPS after an interruption to supply. These normally need a period of from 2 to 5 minutes for the arc materials to drop to a pressure sufficiently low for conventional starters/igniters to restart the lamp.

hot-rolled sections Steel structural sections produced by passing a red-hot BILLET through a series of rollers, gradually forming it closer to the desired shape. The surface finish is rough with *mill-scale*, as opposed to a *cold-formed* section, which is of thinner material and has a smoother finish.

hot smoke test A test conducted in a building to prove the effectiveness of the smoke management system. A controlled fire of nominated intensity is established, and synthetic smoke is injected into the hot effluent gas stream so that the flow patterns can be visualised.

hot spots Areas within an air-conditioned space, whose thermal performance is perceived to be unsatisfactory.

hot water See [WATER HEATER](#).

hot-wire anemometer A remotereading instrument for measuring low air speeds. An exposed fine resistance wire is heated by the passage of an electric current, and the effect of air movement on its temperature is measured. The probe is small enough to be used for model analysis in a wind tunnel.

hot-working The mechanical working of a metal above the temperature for recrystallisation; as opposed to COLD-WORKING.

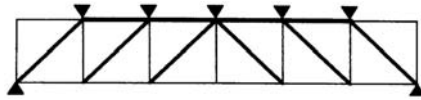

Howe truss

Howard diagram A polar diagram that provides a graphical solution for the buckling of laterally loaded struts; developed by the British aeronautical engineer H.B.Howard.

Howe truss A statically determinate truss consisting of top and bottom chords connected by diagonal *compression* members and vertical tension members (see Figure), as distinct from a PRATT TRUSS. See also [WARREN TRUSS](#).

hp Abbreviation for HORSEPOWER.

HSV Hue, saturation, value.

HT High Tensile.

hue In the MUNSELL BOOK OF COLOR, the hue describes the basic colour of a coloured material: red, yellow, green, blue and purple, and combinations identified by combinations of the letters R, Y, G, B and P.

Huggenberger tensometer A STRAIN GAUGE with a gauge length of 10 to 20mm, employing a compound lever system giving a magnification of about 1200.

human factors engineering The study of the interaction of work and people. Also called *ergonomics*.

human tolerance of noise See [DAMAGE-RISK CRITERION](#), [HEARING THRESHOLD](#) and [BACKGROUND NOISE](#).

humidifier Component of an AIR CONDITIONING plant that removes suspended dirt by spraying or washing, and raises the moisture content, if necessary. Also called an *air washer*. The spray equipment of an air conditioning plant may be used either for *humidification* or for DEHUMIDIFICATION.

humidistat A sensor used to measure relative humidity in air in an air-conditioned space and to signal the need for adjustment of it to meet a required condition.

humidity Water vapour within a given space. The *absolute humidity* is the mass of water vapour per unit volume. The *relative humidity* is the ratio of the quantity of water vapour actually present in the air, expressed as a percentage, to that present at the same temperature in a water-saturated atmosphere.

humus The dark-coloured, fertile portion of the topsoil, which contains a large proportion of rotting vegetation. It is excellent for growing plants, but a poor foundation material, and it is removed before construction commences.

hung ceiling Same as FALSE CEILING.

hungry joints Same as STARVED JOINTS.

hurricane A CYCLONE.

HVAC Heating, ventilation and air conditioning.

hybrid computer A mixed computer system combining analogue and digital computing devices.

hydrant A connection to a water main, usually for extinguishing a fire.

hydrated lime Calcium hydroxide ($\text{Ca}(\text{OH})_2$), also called *slaked lime*. It is formed by slaking QUICKLIME, i.e. adding water to it. The old-fashioned product was made in a lime-maturing pit, and the *lime putty* required some weeks to mature. It is now common practice to use *dry hydrate* (a dry powder supplied in bags) for *lime mortar*.

hydration Addition of water, particularly to cement, lime and plaster, and the subsequent chemical action.

hydraulic cement An old-fashioned term to distinguish cement proper from lime. Cement sets and hardens under water because of the interaction of the cement with the water. Lime is washed out if submerged for a long period in water, because hydrated lime is soluble.

hydraulic friction The loss of HEAD caused by roughness or obstruction in a pipe or channel.

hydraulic glue An old-fashioned term for a glue that retains its adhesion under water. Few of the traditional glues satisfied this requirement but most synthetic RESINS do. See also [MARINE GLUE](#).

hydraulic gradient The difference in the water level (in a pipe or in soil) between two points, divided by the shortest path between them.

hydraulic jack See [JACK](#).

hydraulic lift A life using hydraulic pressure as the motive force. See also [DIRECT PLUNGER HYDRAULIC](#), [ELECTRO-HYDRAULIC](#) and [ROPED HYDRAULIC LIFTS](#).

hydraulic platform See [CHERRY PICKER](#) and [SCISSOR LIFT](#).

hydraulics The science of the flow of fluids.

hydraulic services The services required to deliver water to and within a facility, and to remove waste water and stormwater from the facility.

hydrogen The lightest element. On burning it forms water (H_2O). Its chemical symbol is H, its atomic number is 1, its atomic weight is 1.008, it has a valency of 1, and its boiling point is -252.7°C

hydrograph A curve showing the variation of water flow over a period of time.

hydrometer An instrument for measuring the specific gravity of a liquid.

hydronic system A heat transfer system that employs hot or cold water in a closed loop, to convey heat between a point of production and a point of use or disposal.

hydropneumatic tank system A water supply system that utilises a pressurised tank to provide the necessary water pressure, as opposed to a GRAVITY TANK SYSTEM.

hydrostatic pressure The pressure at any point in a liquid that is at rest. It equals the density of the liquid multiplied by the depth of the point under consideration.

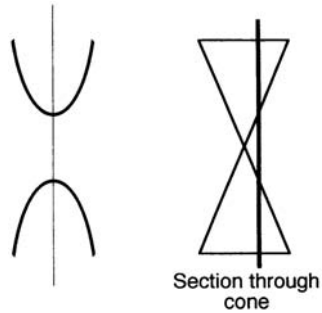

hyperbola

hygrograph A recording hygrometer, which plots the change in RELATIVE HUMIDITY with time on a clock-driven drum. Many hygrographs are HAIR HYGROMETERS combined with a clock mechanism.

hygrometer An instrument for measuring the humidity in the air. The simplest type is the WET-AND-DRY BULB THERMOMETER.

hygroscopic material A material that readily absorbs water vapour.

hypar Abbreviation for HYPERBOLIC PARABOLOID.

hyperbola The section of a right circular CONE by a plane that intersects the cone on both sides of the apex. Its equation is of the form where a and b are constants (see Figure).

hyperbolic functions A set of six functions *sinh*, *cosh*, *tanh*, *coth*, *sech* and *cosech*, which are analogous to the CIRCULAR FUNCTIONS, but arc derived from the properties of the hyperbola instead of the circle. They can also be interpreted in terms of EXPONENTIAL FUNCTIONS:

$$\sinh x = \frac{1}{2}(e^x - e^{-x})$$

and

$$\cosh x = \frac{1}{2}(e^x + e^{-x}).$$

hyperbolic paraboloid A geometric surface that has the equation $z=kxy$, where x , y and z are the Cartesian coordinates, and k is a constant (see Figure). It has a negative GAUSSIAN CURVATURE, i.e. it is saddle-shaped. It is a RULED SURFACE, and can be generated by moving a straight line over two other straight lines inclined to one another. Frequently abbreviated to *hypar*.

hyperbolic paraboloid shell A shell in the form of a HYPERBOLIC PARABOLOID. Since the shape can be generated by two systems of straight lines, its formwork is more readily constructed from straight pieces of timber than that of a dome.

hyperboloid of revolution See [SURFACE OF REVOLUTION](#).

hypermedia An extension of HYPERTEXT including graphics, sound, and video.

hyperstatic structure Same as STATICALLY INDETERMINATE STRUCTURE.

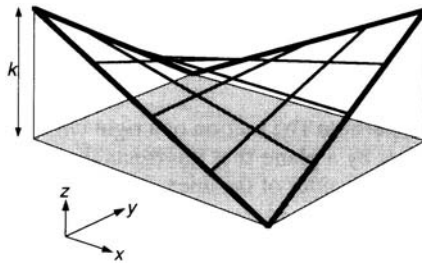

hyperbolic paraboloid

hypertext An organisation of textual documents containing cross-references or links allowing a reader to move easily from one referenced subject to another in any order.

hypo (a) A colloquial term for *sodium thiosulphate*, a material commonly used for fixing photographic film after developing. It removes the unreduced silver halide emulsion. (b) A prefix meaning 'below', as in *hypothermia*.

hypocaust A central UNDERFLOOR HEATING system used in Ancient Roman baths and (occasionally) villas. Hot air and gases from a fire were passed through masonry chambers and flues under the floors.

hypotenuse The longest side of a right-angled triangle, which is opposite the right angle.

hypsoneter An instrument in which water is boiled and the boiling temperature measured. It may be used at ground level for calibrating thermometers, or in conjunction with a calibrated thermometer to measure the altitude above ground level, since water has a lower boiling point when the air pressure is reduced.

hysteresis See [MECHANICAL HYSTERESIS](#).

Hz Abbreviation for HERTZ.

I

I The symbol for luminous intensity, the CANDELA.

I The most common symbol for the SECOND MOMENT OF AREA (MOMENT OF INERTIA).

i Symbol for $\sqrt{-1}$.

IABSE International Association for Bridge and Structural Engineering, Zurich.

IAI Abbreviation for International Alliance for Interoperability. An alliance of the building industry formed to integrate the AEC/FM industry through the specification of industry foundation classes (IFC) as a universal language.

I-beam, I-section A metal section, particularly a rolled steel JOIST, shaped like the letter I.

IC Abbreviation for INTEGRATED CIRCUIT.

ICE Institution of Civil Engineers, London.

Iceland spar A pure, transparent and crystalline form of calcium carbonate (CaCO_3). It is noteworthy for its double reflection and perfect cleavage, and hence is utilised for producing planepolarised light in the form of NICOL PRISMS.

icon In computing, a symbol used to represent a command or an object. The icon usually depicts some object familiar to a user, for example a pen in a drafting system.

icosahedron A regular POLYGON. It is bounded by 20 equilateral triangles. It has 12 vertices and 20 edges.

ID Internal diameter.

IEA International Energy Agency.

IEAust Institution of Engineers, Australia, Canberra.

IEC The International Electrotechnical Commission, responsible for international standards in electrotechnology.

IEE Institution of Electrical Engineers, London.

IEEE Institute of Electrical and Electronics Engineers.

IES Illuminating Engineering Society. The shortened abbreviation used both by the Illuminating Engineering Society of North America (IESNA) and by the Illuminating Engineering Society of Australia and New Zealand (IESANZ).

IESANZ Illuminating Engineering Society of Australia and New Zealand.

IESNA Illuminating Engineering Society of North America.

IFC Industry foundation class. Industrydefined classes of elements to be used universally in a shared project model.

IFIP International Federation for Information Processing, Geneva.

IGES Initial graphics exchange specification. An ANSI standard for the digital representation and exchange of information between CAD/CAM systems.

igneous rock Rock formed by the solidification of magma, injected from the earth's interior into its crust, or extruded on its surface. Igneous rocks are classified according to whether they are predominantly acid or basic, and according to their grain size (which depends on the rate of cooling).

ignition temperature The temperature at which flammable material will ignite.

ignitor In lighting, a device used to start high-pressure DISCHARGE LAMPS, particularly metal halide and high-pressure sodium, by means of very high-voltage pulses usually generated electronically. In retrofit lamps these may be internal; however, it is usual to locate them externally but near to the lamp.

IL Abbreviation for INVERT LEVEL.

illuminance The area density of luminous flux. It is measured in LUX (LUMEN per square metre) in the SI SYSTEM or (rarely) lm/ft² or FOOTCANDLES in the British system.

illuminance meter Same as LUX METER.

illuminant (a) In COLORIMETRY and PHOTOMETRY, the term used to describe one of the standard light sources, e.g. Illuminant D₆₅ (which simulates daylight with a CCT of 6500K). (b) In lighting, the general term to refer to a light source or LUMINAIRE.

illumination (a) Until 1981 the Illuminating Engineering Society of North America used the term ILLUMINATION for what is now called ILLUMINANCE. (b) The process of lighting.

image processing The processing of images using computer techniques, including image enhancement etc.

imaginary number A REAL NUMBER multiplied by $\sqrt{-1}$, usually represented by the symbol *i* (or *j* in electricity), e.g. *i*56. Thus the square root of a positive number is real, the square root of a negative number is imaginary. A COMPLEX NUMBER is the sum of a real and an imaginary number. See also [IRRATIONAL NUMBER](#).

imaginary (reactive) power See [REACTIVE \(IMAGINARY\) POWER](#).

IMechE Institution of Mechanical Engineers, London.

immersion heater An electric resistance heater immersed in a water tank.

immersion vibrator See [VIBRATED CONCRETE](#).

immiscible Incapable of being mixed to form a homogeneous liquid, e.g. water and oil are immiscible.

impact drill A hand-held power drill that can provide a light longitudinal impact as well as rotary motion to the BIT. Also called *percussion drill*. See also [ROTARY HAMMER](#).

impact factor A factor by which a DYNAMIC LOAD is multiplied to allow for the vertical impact that it makes on the floor. Impact factors for bridges generally range from 1.0 to 1.6. Impact factors are rarely used in the design of buildings.

impact resistance Capacity of a material to resist suddenly applied or shock loads. It is measured by the CHARPY TEST or the IZOD IMPACT TEST.

impact sound Noise transmitted through the structure of a building as a result of direct excitation by impacts on the structure, e.g. footsteps. Sound insulation against impact sound is best achieved by DISCONTINUOUS CONSTRUCTION. See also AIRBORNE SOUND, SOUND INSULATION and STRUCTURE-BORNE SOUND.

impedance, acoustic See ACOUSTIC IMPEDANCE.

impedance tube An instrument for measuring SOUND ABSORPTION on small samples for normal (90°) sound incidence only. It consists of a long tube, with the test sample at one end. At the other end is a loudspeaker. The incident wave is partly reflected and partly absorbed by the sample, and the reflected wave interferes with the incident wave. The pressure distribution is examined with a travelling microphone, which is small enough not to disturb the sound field. From the ratio of the pressures at the maximum and minimum positions, the sound reflection coefficient and the absorption coefficient can be determined. Also called a *standingwave tube*. See also REVERBERATION CHAMBER.

impeller The rotating element in a centrifugal machine (pump, fan or compressor) that imparts energy to a fluid, thus increasing its pressure.

impermeable, impervious Resistant to the penetration of fluids into or through the material. *Impermeable* is commonly used to include resistance to both water and water vapour; *impervious* is commonly used to mean resistant to water.

impluvium A pool for receiving the water draining from the roof in an Ancient Roman ATRIUM. The term is not used for the pools sometimes placed in modern atria.

impregnation of timber The process of saturating timber with a preservative, such as CREOSOTE OIL.

impulse turbine A turbine that has fixed jets impinging on a moving wheel; as opposed to a REACTION TURBINE.

in. Abbreviation for INCH.

incandescence The production of light by a hot body, such as the filament of a lamp.

incandescent lamp (a) Originally a WELSBACH MANTLE impregnated with the oxides of thorium and cerium, made white-hot by a gas flame. (b) A small filament, usually of tungsten, placed inside a glass bulb in an inert gas, made white-hot by the passage of an electric current, i.e. the electric FILAMENT LAMP, as opposed to a FLUORESCENT LAMP or a DISCHARGE LAMP.

incentive A discount or contribution offered to a lessee of a property or facility.

inch (in.) As a measure of length, of a FOOT. The British-American inch equals 25.4mm.

inching With manually operated goods lifts, the use of a button or switch to move the car in small increments until it is level with the landing sill.

incise To cut into a material, e.g. masonry or wood. The term implies a shallow cut as in an engraving, rather than a sculptural carving.

inclinator A platform running on (a) an inclined rail for taking passengers, supplies, dustbins etc. from the street to a house at a much higher or lower level otherwise accessible only by steps; or (b) internally on the side of a staircase. See also [STAIR LIFT](#).

inclined lift A lift that moves at an inclination of 15° or greater.

inclinometer Same as [CLINOMETER](#).

incombustible A material that does not burn in a standard test in a furnace (usually lasting hours). Also called *non-combustible*.

indented wire Wire with machine-made surface indentations. Unlike the hot-rolled deformations of [DEFORMED BARS](#), the indentations can be cold-rolled, and therefore placed also on high-tensile wires. They are used to improve the bond, particularly in [PRE-TENSIONING](#) tendons.

index of plasticity See [PLASTICITY INDEX](#).

index of thermal comfort A single measure intended to provide an indication of the likelihood that the thermal condition of an enclosed space will satisfy the requirements for human comfort, e.g. [EFFECTIVE TEMPERATURE](#), [EQUIVALENT TEMPERATURE](#), or [PREDICTED MEAN VOTE](#).

Indian standard clear sky A simple luminance distribution for the portion of a clear sky away from the sun. The luminance at any point of [ALTITUDE](#) θ is $L_{\theta} = L_z / \sin \theta$ for θ between 90° and 15°, and $L_{\theta} = L / \sin 15^\circ$ for θ between 15° and 0°, where L_z is the luminance at the [ZENITH](#). See also [CIE STANDARD CLEAR SKY](#).

indicators for lifts (a) *Call accepted*: indicates when the call has been accepted. (b) *Car position*: shows the position of the car in the lift well. (c) *Car direction*: shows the direction of travel of the lift car. (d) *Next car*: indicates the next car, in sequence, to leave the floor. (e) *Car approaching*: indicates when the lift car is approaching the calling landing. Used in lift installations with very simple supervisory control systems. (f) *Lift in use*: indicates when the lift car is busy. Used in lift installations with very simple supervisory control systems. (g) *Excess load*: an indicator on the lift car operating panel, illuminated when the load exceeds the rated value. It may also give an audible alarm.

indirect drive An electric lift drive whose motor is connected to the [SHEAVE](#), shaft or drum by belts or chains.

indirect lighting Usually lighting reflected from the ceiling, not received directly from a luminaire, because the luminaire emits most of its light upwards.

indirect structural model analysis Analysis of a structural problem by means of a model that represents an analogy to the behaviour of the structure. It may be considered as an [ANALOGUE COMPUTER](#), although the model bears a physical resemblance to the structure under investigation.

individual-mould pre-tensioning See [PRE-TENSIONING](#).

induction box An air distribution terminal device used in some air conditioning systems, in which discharge of primary air through a nozzle or nozzles induces a secondary circulation of air over a cooling or heating coil.

induction heating The production of heat utilising the principle that an eddy current is produced in an electric conductor that is subject to a changing magnetic field. The magnetic field is produced by a coil carrying an alternating current. The heater is placed within that coil.

industrialised building Building with factory-made components (which may be small or comprise several rooms in one piece) to reduce the amount of work on the site. Work in the factory is deliberately increased to speed up construction and/or reduce cost. The term *industrialised building* superseded *prefabrication* (with which it is practically synonymous) in the 1950s, after prefabricated houses had acquired a poor reputation in the late 1940s because of several unsatisfactory designs, which gave 'prefab' the quality of a term of abuse. Industrialised building may be in accordance with a CLOSED SYSTEM or an OPEN SYSTEM.

inelastic Not ELASTIC. Inelastic deformation is not immediately recovered when the load is removed. It may be permanent, i.e. it remains permanently when the stress is removed (see PLASTIC DEFORMATION), or it may be recoverable over a period of time (see CREEP).

inert gases HELIUM, NEON, ARGON and krypton, which do not react with other substances. Gases such as CARBON DIOXIDE and NITROGEN are also considered inert under some circumstances, as they do not support combustion.

inertia, moment of See MOMENT OF INERTIA.

inert pigment A pigment that does not undergo chemical change.

infiltration of air The uncontrolled inflow of air, through openings in the building envelope caused by the dynamic pressure of the wind and the buoyant pressure of indoor-outdoor temperature differences; opposite of *exfiltration*.

inf inite series A regular arrangement of mathematical terms, which can be continued indefinitely. It may be CONVERGENT or non-convergent.

inflammable Same as FLAMMABLE, *not* the opposite. The word *flammable* is to be preferred.

inflatable gasket See GASKET.

inflection, inflexion Same as CONTRAFLEXURE.

influence line A diagram showing the effect of moving a load along a beam . (frame, arch etc.). Thus an influence line for BENDING MOMENT shows the variation of bending moment at *one point* of the beam as the load (usually a concentrated unit load) is moved along the beam; by contrast, the bending moment diagram shows the variation of bending moment along the beam due to *one combination of loads*.

information Processed data in a meaningful form.

information technology A general term describing all areas of information processing using computers and telecommunications.

infrared radiant heating Heating for human comfort by exposure to infrared radiation generated by the elevated surface temperature of an emitter.

infrared radiation Electromagnetic radiation with wavelengths longer than 760 nm, i.e. beyond the red end of visible light. It is RADIANT HEAT, and forms part of the radiation received from the sun.

infrasound An acoustic oscillation whose frequency is below the lower audible limit of 16Hz.

ingle-nook A corner by an open fire, usually with a built-in seat.

ingot A mass of metal cast into a mould. It is the raw material for rolling and forging.

inhibiting pigment A pigment that prevents corrosion of a metal surface. See also [PRIMER](#).

initial flux See [INITIAL LUMENS](#).

initial lumens The luminous flux emitted by a lamp when new or, in the case of discharge lamps, after about 100 hours' operation (when the lamps have stabilised). Also called *initial flux*.

initial prestress The force applied to the concrete by a TENDON at the time of the prestressing operation, before the LOSS OF PRESTRESS.

initial set Measured by the VICAT TEST.

initial Stress See [INITIAL PRESTRESS](#).

initial-time-delay gap The interval between the arrival of the direct sound and its first reflection from the ceiling or the walls.

injection moulding The moulding of liquid plastics, liquid metal or other material by injection into a mould.

inorganic fibreboard Board made from inorganic fibres, such as fibreglass.

input In computing, information or data entered into a computer, using a keyboard, tape or graphic device.

input/output device A device for entering INPUT into a computer and receiving OUTPUT from it.

in situ See [CAST IN SITU](#).

in-situ pile A concrete pile cast, with or without a casing, in its final location, as distinct from a pile that is precast and subsequently driven.

insolation The radiation received from the sun.

inspection station, lift car top See [CAR TOP INSPECTION STATION](#).

insula In Ancient Rome an apartment building occupying an entire city block.

insulating board FIBREBOARD of a density not exceeding 400kg/m³ (25lb/ft³), specifically designed to give good thermal insulation. See also [ACOUSTIC BOARD](#).

insulating glass Two or more panes of glass that enclose hermetically sealed air spaces.

insulation (a) The prevention of the flow of an electric current, or the reduction of the flow of heat or passage of sound. (b) The material used to achieve insulation.

insulation, sound See **SOUND INSULATION, DISCONTINUOUS CONSTRUCTION**.

insulation, thermal See **THERMAL INSULATION**.

intaglio Originally a design INCISED or carved into a material, as opposed to a design carved in RELIEF; now also used for a shallow design *pressed* into a surface.

integer A whole number, which may be positive, negative or zero. The term excludes fractions and imaginary numbers. In computing, an integer differs from a FLOATING-POINT or REAL NUMBER by omitting the decimal point.

integral number Same as INTEGER.

integral waterproofing Waterproofing concrete by an admixture to the cement or the mixing water, as opposed to using a SURFACE WATERPROOFER subsequently. It should be pointed out, however, that carefully placed concrete is often as waterproof as concrete with an admixture.

integrated ceiling A ceiling in which the LUMINAIRES and the air conditioning ducts are integrated so that the air is exhausted through the light fittings and cools the lamps.

integrated circuit An imprint of a large number of electronic circuits, etched on to a single piece of *semiconductor* material, such as a silicon CHIP.

integrating sphere A sphere or polyhedron with a non-selective white interior, which by inter-reflection produces a uniform illuminance on its surface. It is used to determine the LOR (light output ratio) of a luminaire.

intelligent building A building designed with extensive automated systems to detect, diagnose and control the response to varying environmental requirements.

intensity (a) The radiant flux per unit solid angle, emitted from a small radiant source in a particular direction. *Radiant intensity* is measured in WATTS per steradian. (b) *Luminous intensity* is measured in LUMENS per steradian, or in CANDELAS. (c) In acoustics, intensity is the energy per unit area (watt/m^2) at a point in a sound field. Intensity is a vector quantity having both magnitude and direction. See also **MERCALLI SCALE** and **WIND LOAD**.

interactive Relating to the use of computers, whereby the user and computer program interact with each other via commands, questions and answers, or graphic input.

intercolumniation The clear space between two adjacent columns, particularly in the Classical Orders.

interface A connection or common boundary between two separate units, e.g. of a computer's HARDWARE and/or SOFTWARE, or two different modes of transportation.

interference The effect of superimposing two or more trains of waves of equal wavelength. The resultant amplitude is the algebraic sum of the amplitudes of the interfering trains. When two sets of circular waves interfere, a system of hyperbolic stationary nodes and antinodes is formed, which are known as *interference fringes* in the case of visible light. See also **MOIRÉ FRINGES** and **ISOCLINICS**.

interfloor distance The vertical distance between two adjacent landing floors of a lift installation.

interior span A span, other than the end span, in a CONTINUOUS BEAM. If the spans are equal, the positive bending moments are generally highest in the end span.

interior support A support, other than the end support, in a CONTINUOUS BEAM. If the spans are equal, the negative bending moment is generally highest at the first interior support.

interlock of lift doors A device that prevents the operation of a lift-driving machine unless the car and landing doors are closed.

intermediate switch A switch used with TWO-WAY SWITCHES to alter the control of lighting from more than two locations.

intermittent kiln A *non-continuous* kiln for making bricks and other clay products, as opposed to a HOFFMANN KILN.

internal friction See [ANGLE OF INTERNAL FRICTION](#).

internally reflected component (of the DAYLIGHT FACTOR) The component due to the internal reflecting surfaces.

internal memory or internal storage RAM and ROM memory contained within the main memory of a computer, as distinct from memory on removable or peripheral devices.

internal vibrator A poker vibrator that is immersed in the concrete.

International System of Units See [SI UNITS](#).

interpolate To infer the position of a point on a graph defined by several other known points, by assuming that the curve is smooth. *Extrapolation* is the same process, continuing the graph at either end *beyond* the last known points.

interstitial condensation CONDENSATION that occurs within spaces inside the construction, as opposed to *surface* condensation. It is likely to dry out more slowly than moisture on the surface, and therefore more likely to cause WET ROT or corrosion.

interval time (for lifts) See [TIME INTERVAL](#).

intimacy As an acoustic quality, the impression that music is played in a small hall. The listener's impression regarding the size of the hall is determined by the INITIAL-TIME-DELAY GAP.

intrados The inner or lower curve of an arch.

inverse square law 'As a spherical wave of light or sound travels outwards from a point source, its intensity decreases in inverse proportion to the square of its distance.'

inversion (of temperature) A meteorological state that causes the temperature to rise with height above ground instead of falling. Since the colder and heavier air is below, there is no tendency for the air to rise, and turbulence is suppressed. If inversion occurs at a high level above the ground (upwards of 300m or 1000ft), it acts as a lid, preventing the ascent of chimney plumes and the escape of automobile exhaust gases. This increases air pollution. See also [SMOG](#).

invert level The level of the lowest portion at any given section of the inside surface of a drain, sewer or other liquid-carrying conduit. It determines the HYDRAULIC GRADIENT available for moving the liquid in the conduit.

I/O (a) Abbreviation for INPUT/OUTPUT DEVICE (of a computer). (b) Inspection opening (in a drainage pipe).

ion A molecule, atom, or group of atoms, which carries a charge, either positive or negative.

ionisation anemometer A remote reading instrument for measuring low air speeds, which is less sensitive to natural convection than the HOT-WIRE ANEMOMETER. It consists of a sphere coated with radioactive material, which is surrounded by a collecting cage and an earthed screen.

ionisation smoke detector A *fire detector*, which monitors the electrical conductivity of ionised air, and detects the presence of smoke by comparing it with a sealed reference chamber.

ionosphere See [ATMOSPHERIC LAYERS](#).

IPENZ Institution of Professional Engineers New Zealand, Wellington; formerly called NZIE.

IRC Internally reflected component (of the daylight factor).

iridescence The play of the colours of the spectrum on a surface. It is produced by interference of light reflected from the front and back of a very thin film.

iron A metallic element that exists in the three forms ALPHA IRON, GAMMA IRON and *delta iron*. Its chemical symbol is Fe, its atomic number is 26, its atomic weight is 55.84, its specific gravity is 7.87, and its melting point is 1535°C. See also [WROUGHT IRON](#), [STEEL](#) and [CAST IRON](#).

iron carbide A hard and brittle crystalline compound of iron and carbon (Fe_3C), also called *cementite*. It is a constituent of high-carbon steel and of cast iron.

iron oxides Apart from their use as a raw material from which metallic iron is made, the oxides also provide a number of traditional *mineral pigments*, mostly named after the place in Italy from which they were originally obtained. Haematite (Fe_2O_3) provides *venetian red*. Magnetite (Fe_3O_4) provides purple and black pigments. Ferrous oxide (FeO) is the main ingredient of *ochre* (yellow), *sienna* (yellow) and *burnt sienna*. It is one of the ingredients of *umber* (dark brown), manganese oxide being the major constituent.

irradiance The area density of radiant flux, with the units W/m^2 .

irradiation Exposure to radiant or solar energy over a period of time.

irrational number A REAL NUMBER that cannot be expressed as a fraction of two integers. $\sqrt{2}$ and π are irrational, but not IMAGINARY, numbers. See also [RATIONAL NUMBER](#).

ISI Indian Standards Institution, Delhi.

ISO International Organization for Standardization, Geneva. A world wide federation of national standards bodies.

isobaric process A process that occurs at constant pressure.

isobars Curves relating points at the same pressure, e.g. atmospheric or barometric pressure.

isochromatics Lines of equal colour; in PHOTOELASTICITY the colour fringes denote lines of equal difference between the principal stresses. When MONOCHROMATIC LIGHT is used, the fringes are black and white, but the term *isochromatic* is still applied; they can be separated from the ISOCLINICS with QUARTER-WAVE PLATES.

isoclinics Lines in a stressed body that connect the points at which the principal stresses have the same direction. In photoelastic analysis the light is extinguished when the direction of polarisation is the same as that of the principal stresses, and the isoclinics thus show up as dark lines superimposed on the ISOCHROMATICS.

isohyets Lines drawn on a map through places having equal amounts of rainfall.

isolation (a) The reduction of vibration or STRUCTURE-BORNE SOUND, which usually involves resilient surfaces or mountings or discontinuous construction. See also VIBRATION ISOLATOR and RUBBER MOUNTING. (b) The separation of parts of a facility or building by FIRE-RESISTING construction.

isolux diagram A diagram showing contours of equal illuminance.

isomers Molecules with the same composition, but with different structures.

isometric projection A pictorial PROJECTION in which the elevation, the plan and the side elevation are all drawn at an angle. Vertical lines remain vertical, but all lines that are horizontal in the ORTHOGRAPHIC PROJECTION are drawn at 30° to the horizontal in the isometric projection. While the plan, elevation and side elevation are all given equal prominence, the object frequently appears distorted. However, all dimensions on the vertical and on the 30° axes are accurately to scale.

isosceles Equal-legged. An isosceles triangle has two equal legs. A triangle with three equal legs is *equilateral*.

isostatic line A line tangential to the direction of one of the PRINCIPAL STRESSES at every point through which it passes. Also called *stress trajectory*. It is useful for visualising STRESS CONCENTRATIONS.

isostatic structure Same as STATICALLY DETERMINATE STRUCTURE.

isothermal (a) A line on a thermodynamic, psychrometric or meteorological chart connecting points of equal temperature. (b) A reaction proceeding at a constant temperature. An isothermal change cannot normally be ADIABATIC.

isotopes Atoms of the same chemical element with identical chemical properties, but different atomic weights. The *atomic weight* of the entire element is determined by the proportions in which the various isotopes are present. Some isotopes are radioactive, but the term *isotope* does not imply radioactivity as such, although it is often used that way.

isotropic Having the same properties in all directions, as opposed to AEOLOTROPIC. In structural theory, the term usually means having the same strength, MODULUS OF ELASTICITY and POISSON'S RATIO in all directions.

IStructE Institution of Structural Engineers, London.

IT Abbreviation for INFORMATION TECHNOLOGY.

Italian tile A type of PANTILE.

ITBTP Institut Technique du Bâtiment et des Travaux Publics, Paris.

Izod impact test An impact test carried out on a notched specimen, which is cantilevered from one end. The energy absorbed during fracture is measured with a pendulum.

J

J Abbreviation for JOULE.

jack A portable machine for lifting heavy loads through short distances. The smaller jacks are operated by a square-threaded screw, the larger by a hydraulic ram.

jack arch (a) A shallow arch of brick or plain concrete, spanning about 1 m (3ft), used in the nineteenth century. (b) A FLAT ARCH.

jackblock method A method for erecting a multi-storey prestressed concrete building, while carrying out most of the construction at ground level. The ground-floor slab is cast first, and serves as a casting bed for the other floors. The roof slab is cast next, and jacked up one floor. The top floor and its loadbearing walls are then constructed and jacked up one floor; and so on.

jackhammer See [DEMOLITION HAMMER](#).

jamb The vertical side posts used in the framing of a doorway or window. The outer part of the jamb, which is visible, is called the *reveal*.

Japanese lacquer An extremely durable glossy varnish obtained from tapping the sap of the Japanese varnish tree (*Rhus vernicifera*).

Japanese mat See [TATAMI](#).

jib The member of a crane from which the load is suspended, providing positioning of the load: it can SLEW but not LUFF. See also [BOOM](#).

jigsaw A narrow-bladed reciprocating saw for cutting thin material, and particularly for cutting curved shapes.

joggle (a) To bend a steel angle to make it fit as a web stiffener over the angles at the top and bottom of a built-up girder. (b) A form of tongue-and-groove joint in stone or precast concrete.

Johansen's method The YIELD-LINE THEORY for the ultimate strength of reinforced concrete slabs.

joint The space between two adjacent components, irrespective of whether it is filled with a jointing material or not.

jointer See [PLANER](#).

joint in brickwork The principal mortar joints for brickwork are: (a) flush joints, (b) RAKED JOINTS, (c) Tooled joints, (d) STRUCK JOINTS and (e) weather-struck joints (see Figure).

jointless flooring A term used for MAGNESITE FLOORING.

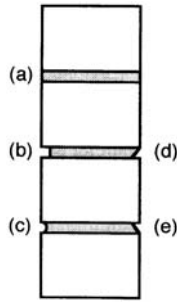

joints in brickwork

joint sealant or filler Material used to exclude water and foreign solid matter from joints. See also **MASTIC** (b).

joist A small BEAM. It is generally the member that directly supports the floor or roof, as opposed to a GIRDER. A *steel joist* may be a ROLLED STEEL JOIST or an OPEN-WEB JOIST.

joule (J) Unit of energy, named after the nineteenth-century English physicist. It is the energy dissipated in 1 second by a current of 1 ampere flowing across a potential difference of 1 volt. In SI UNITS the joule also replaces the erg and the calorie; 1 joule = 10^7 erg = 0.239 calories.

Joule's laws The three laws of the nineteenth century English physicist, J.P. Joule, are as follows: (a) The intrinsic energy of a given mass of gas is a function of temperature alone; it is independent of the pressure and volume of the gas. (b) The molecular heat of a solid compound is equal to the sum of the atomic heats of its component elements in the solid state. (c) The heat produced by a current I passing through a conductor of resistance R for a time t is proportional to I^2Rt .

Joule's mechanical equivalent See **MECHANICAL EQUIVALENT OF HEAT**.

Jourawski's method The method of RESOLUTION AT THE JOINTS.

joystick In computing, a lever controlling the movement of a CURSOR on a screen.

jump form A type of *formwork* system in which the formwork for the vertical surfaces of a wall or shaft is prefabricated, usually one storey high. After the concrete has gained sufficient strength, the forms are released and lifted to the next storey level without substantial dismantling.

K

K (a) Chemical symbol for *potassium* (kalium, the latinised version of the Arabic *alkali*). (b) (Degree) *Kelvin*.

k Abbreviation for *kilo*, 1000 times.

kalsomine A cheap white or tinted wash made of WHITING and glue mixed with water. Also spelled *calcimine*.

kaolin Same as CHINA CLAY.

kaolinite A finely crystalline form of hydrated aluminium silicate ($\text{Al}_2\text{Si}_2\text{O}_5(\text{OH})_4$).

katabatic wind A local, cold wind flowing down a hillside. High-altitude ground cools more rapidly at night than that at lower altitudes because of virtually unimpeded radiation exchange to the sky. Thus the air is chilled, becomes denser and flows down the hillside.

kata thermometer Instrument devised by L.Hill in 1914 to measure the physiological effect of the environment, and determine the COMFORT ZONE; it can also be employed as an ANEMOMETER. It is an alcohol thermometer with a large bulb. It is now rarely used.

kathode Same as CATHODE.

Kb or KB Abbreviation for KILOBYTE.

KBS Abbreviation for KNOWLEDGE-BASED SYSTEM.

Keene's cement A hard plaster used for finishing coats. It consists of ANHYDRITE, i.e. anhydrous gypsum plaster (CaSO_4), and an ACCELERATOR. It can be applied over Portland cement rendering, but should not be mixed with lime. Also called *Parian plaster*.

Kelly ball test See [BALL TEST](#).

Kelvin (K) The temperature scale referred to absolute zero, which is -273.15°C

kentledge Ballast used to give stability to a crane, provide a reaction for a jack etc. It may consist of scrap iron, concrete, or any heavy building material.

key (a) In construction, a mechanical bond, e.g. between old and new concrete. (b) In computing, an index used to identify an item such as a record in a file. (c) A button on a keyboard used for entering a character.

keyboard A device containing a set of keys for entering characters.

keypad A small keyboard, usually hand-held, with a character set usually restricted to numerals and numeric operation keys.

keystone The stone at the CROWN of an arch. A VOUSOIR arch becomes self-supporting only after the keystone has been placed in position. Hence it was frequently made larger, and especially decorated. Since the key-stone need only resist the horizontal thrust, it is less heavily loaded than any of the stones lower down the arch.

kg Kilogram.

kgf An abbreviation for *kilogram-force*, also used for KILOPOND.

kick plate Plate used at the bottom of cabinets, doors, lift car enclosures and step risers to protect them from shoe marks.

kieselguhr Same as DIATOMACEOUS EARTH.

kiln A large oven used for the artificial seasoning of timber, for the firing of pottery, for the baking of brick, for the burning of lime, or for the burning of cement clinker. See also [HOFFMANN KILN](#) and [INTERMITTENT KILN](#).

kilo (k) Prefix for one thousand times, from the Greek word for 1000, e.g. 1kg =1000gram.

kilobyte 2^{10} (=1024) BYTES, which is approximately 1000 bytes. The power of 2 is used because computers employ BINARY ARITHMETIC.

kilomega Prefix meaning 10^9 (one thousand million). The prefix used in SI UNITS is GIGA.

kilometre (km) The metric measure for longer distances. 1km=0.62137 miles.

kilopond The unit of force in CGS UNITS. It is not used in SI UNITS. It is the gravitational pull on a mass of 1 kilogram. The abbreviations *kp*, *kgf* (kilogram-force) and *kg* are all in use, and have the same meaning if applied to forces. 1kp=9.807 NEWTON.

kilowatt-hour (kWh) A unit of energy, equal to 1000 WATT-HOURS. 1kWh=3.6 MJ.

kinematics The study of the geometry of motion in time and space. It is used to relate displacement, velocity, acceleration and time without reference to the cause of the motion.

kinematic viscosity The ratio of viscosity to density

kinetic energy The ENERGY that a body possesses by virtue of its motion.

kinetic friction, coefficient of The ratio of the FRICTION to the contact pressure required to *maintain* motion against frictional resistance.

king closer A three-quarter brick used as a closer. A diagonal piece is cut off one corner (see Figure). See also [HALF BAT](#) and [QUEEN CLOSER](#).

king-post roof truss A traditional timber truss consisting of a pair of rafters, held by a horizontal tie beam, a vertical *king post* between the tie-beam and the ridge, and usually also two struts to the rafters from the foot of the king-post (see Figure). Contrary to appearances, the kingpost is usually in tension.

knapped flint FLINT split in half and used with the split side showing.

kneebrace A diagonal member joining the top of a column to the roof truss, used to improve resistance to wind loading (see Figure).

knocked down Prefabricated, but not assembled.

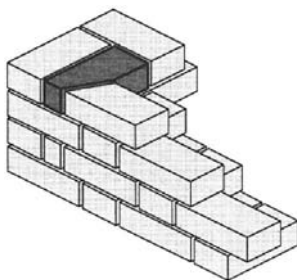
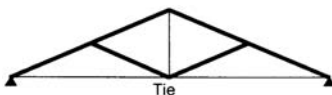
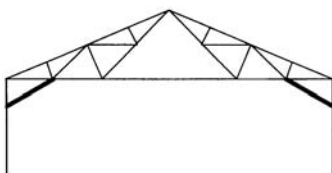
**king closer****king-post roof truss****kneebrace**

knot (a) A branch or limb embedded in a tree, and cut through in the process of manufacture. It may be a source of weakness (comparable to a hole drilled into the timber), if it is *loose*, *hollow* or *decayed*. On the other hand, a *sound*, *tight* or *intergrown* knot may be quite harmless. (b) A unit of velocity, equal to 1 NAUTICAL MILE per hour.

knowledge base That part of a KNOWLEDGE-BASED SYSTEM where the knowledge is stored without explicit control or procedures.

knowledge-based system Computer system that represents and manipulates knowledge explicitly. It separates the knowledge from its control, as opposed to conventional (procedural) systems. See [EXPERT SYSTEM](#).

knowledge engineering The process of acquiring and representing knowledge in a form suitable for use by knowledge-based systems.

knurl To mill or otherwise roughen a surface to provide a better grip, e.g. on the head of a thumb screw.

kp Abbreviation for KILOPOND.

kraft paper A strong brown paper, made from wood pulp and sulphate.

ksi Kilo-pounds per square inch, or thousands of pounds per square inch.

kVA Kilovolt-amperes, thousands of VOLT-AMPS.

k-value The measure of THERMAL CONDUCTIVITY.

kW Kilowatt=1000 W.

kWh Kilowatt-hour.

L

l or L Abbreviation for LITRE.

lac Purified SHELLAC.

lacquer A glossy finish that dries quickly by evaporation of the vehicle. See also [JAPANESE LACQUER](#) and [VARNISH](#).

lagging Insulating material applied to the outside of heating equipment and pipes to prevent heat loss.

laitance A layer containing cement and very fine aggregate, brought to the surface of concrete by BLEEDING. It has poor durability and strength, and generally is removed if it forms.

lake A pigment that consists of a DYE precipitated on an inorganic base.

lambert An obsolete measure of LUMINANCE, equal to 3183 candelas per square metre.

Lambert's cosine law See COSINE LAW.

lamella roof A roof frame consisting of a series of intersecting skew arches, made up of relatively short members, called lamellas or lamellae, fastened together at an angle so that each is intersected by two similar adjacent members at its midpoint, forming a network of interlocking diamonds.

laminar flow Same as STREAMLINE FLOW.

laminated arch A wooden arch made from LAMINATED TIMBER.

laminated glass Two or more layers of glass bonded with polyvinyl butyral.

laminated plastic A stiff board made from sheets of paper, cloth, linen or silk, soaked with synthetic resin (e.g. MELAMINE RESIN) and sandwiched between layers of that resin. One side is usually given a glossy or matt decorative finish. Laminated plastics imitating wood are produced by printing the grain of the wood, from a photograph, on a sheet of paper, which forms the top lamination.

laminated timber Timber beam or arch manufactured from four or more wood layers, each about 25mm (1in.) in thickness, bonded together with waterproof adhesive. It differs from PLYWOOD, which is made from thinner layers, and in the form of sheets.

laminating The process of bonding *laminations*, or thin plates, together with adhesive.

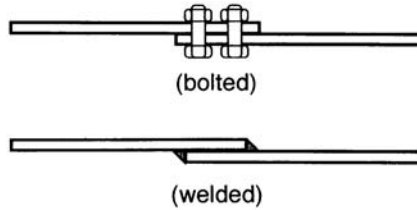

lap joint

lamp base The means by which an electric lamp is supported by the LAMPHOLDER. It also makes the electrical connection. See [BAYONET CAP](#) and [EDISON CAP](#).

lamp black Same as CARBON BLACK.

lamp dimmer Variable resistance or, more typically, other electronic device, which controls the amount of light by varying the voltage (waveform) to the lamp.

lampholder The device that mechanically supports and electrically connects a lamp.

LAN Abbreviation for LOCAL AREA NETWORK.

landing (a) The portion of floor or corridor adjacent to a lift entrance where passengers enter or leave the lift cars. (b) A level space within a stair, usually at a change in direction, but also within a long straight flight to provide rest and safety for persons using the stair.

landlord and tenant A phrase used to refer to the contractual relationship between the two parties.

langley An obsolete unit of solar radiation measurement. $1 \text{ langley} = 1 \text{ calorie per square centimetre} = 41868 \text{ J/m}^2$.

lantern (a) A LUMINAIRE, particularly a light in a street or garden. (b) A circular or polygonal turret with windows all around, crowning a DOME or other roof.

lap The length by which one piece of material overlaps another.

lapis lazuli A decorative variety of calcite, stained a deep blue by three minerals (lazurite, sodalite and hauyne). It is used as a stone veneer, and in powdered form it is the original ULTRAMARINE pigment.

lap joint A joint between two pieces of material that overlap, as opposed to a BUTT JOINT. (a) In metal the two pieces of material to be joined are generally not in line, and are joined by bolting or welding (see Figure). (b) In timber the pieces are generally halved, which makes it possible to align them. For *timber lap joints at right angles* see [DOVETAIL](#) and [END-LAP JOINT](#).

lapping of reinforcing steel The overlapping of steel bars or fabric to provide transfer of stress from one piece of steel to the next through BOND with the concrete. Same as SPLICE.

large calorie Same as *kilocalorie* = 1000 cal.

large numbers See [LAW OF LARGE NUMBERS](#).

laser An intense monochromatic source of coherent radiation (either visible light or infrared), capable of being focused into a very narrow, non-divergent beam. Used in surveying for both alignment and distance measurement, and for communications. (The name is an acronym for Light Amplification by Stimulated Emission of Radiation.)

laser disc See [COMPACT DISC](#).

latent heat Thermal energy expended in changing the state of a body without changing its temperature, e.g. converting water to steam at 100°C. See also [SENSIBLE HEAT](#).

lateral buckling [BUCKLING](#) of a deep narrow beam sideways. It is prevented by limiting the ratio of depth to width, or by providing [LATERAL SUPPORT](#).

lateral loading See [EARTHQUAKE LOADING](#) and [WIND PRESSURE](#).

lateral reinforcement Ties, hoops, helical or other secondary reinforcement used in concrete columns, as opposed to the main or longitudinal reinforcement. Also called *transverse reinforcement*.

lateral support The horizontal propping of a beam or column to reduce its [EFFEC](#)

[TIVE LENGTH](#). See also [HERRINGBONE STRUTTING](#) and [SOLID BRIDGING](#).

late wood Same as [SUMMER WOOD](#).

latex Originally the viscous, milky fluid that is exuded when the rubber tree (*Hevea brasiliensis*) is tapped. It is a colloid of caoutchouc dispersed in water, which forms rubber by coagulation. The term is now also applied to artificial emulsions of natural or artificial rubber, or of certain synthetic resins (such as polyvinyl acetate), used in [EMULSION PAINTS](#).

lath Originally a sawn strip of timber, 25–40 mm wide and 6–10 mm thick fixed to timber framing with small gaps between adjacent laths, used as a foundation for plastering. Now applied to other materials used for the same purpose, e.g. *metal lathing*.

lathe A machine for turning metal or wood. The piece to be turned is mounted on a face plate, in a chuck, or between two centres, and the cutting tool is stationary. The cutting speed is higher for small-diameter pieces and for soft materials (such as wood). See also [MILLING MACHINE](#).

latitude The angle subtended by any point on the Earth's surface with the equator, measured along its [MERIDIAN OF LONGITUDE](#). Except for the equator, the parallels of latitude are [SMALL CIRCLES](#), and thus not [GEODETIC LINES](#). They correspond to curved lines on a plane surface, and travelling along them is not the shortest distance between two points.

lattice structure An open girder (*open-web joist*), column, cylindrical shell, dome (*geodesic dome*) or other structural type, built up from members intersecting diagonally to form a lattice. Lattice structures may be built in any material, but lightness is usually a prime objective.

lattice window Same as [LEADED LIGHT](#).

lava The molten IGNEOUS ROCK material that issues from a volcanic fissure or vent, and consolidates on the surface as OBSIDIAN or PUMICE.

lavatory Literally, a wash basin. By extension a room containing a wash basin and a wc, and a room containing a wc without a wash basin.

law of large numbers 'If n successes are obtained in N trials of an event, then the ratio n/N approaches a fixed probability as N increases.' This is one of the basic postulates of STATISTICS.

lay The number of helix diameters in which the strand of a cable or wire rope makes one complete turn of 360° in its helix. The lay of a cable may be righthand or left-hand, the former being the more common.

layer In computer-aided drawing, a grouping of objects for convenience of display. Equivalent to a transparent overlay.

layer, neutral See NEUTRAL AXIS.

layering The process of dividing a drawing into separate LAYERS, each representing a different component of the whole drawing.

lay light A window fixed horizontally in a ceiling.

lazy Susan Same as REVOLVING SHELF.

lb Abbreviation for POUND.

L-beam A beam whose section has the form of an inverted L. It is usually formed by the combination of an edge beam (or SPANDREL) and the adjacent portion of the floor slab. See also EFFECTIVE FLANGE WIDTH.

lbf Symbol for pound as a force, i.e. the gravitational pull on a mass of 1lb. The symbol *lb* is frequently used both for mass and for force.

LCD Liquid crystal display.

lead A grey metal that is soft and easily deformed plastically at room temperature; however, at a sufficiently low temperature it shows elastic behaviour. Because of its corrosion resistance and the ease with which it can be formed it was widely used for pipes, roofing, flashings and dampproof courses. Because of its increasing cost, and recognition of its toxicity, it has largely been replaced by other less easily worked materials. Lead is an excellent insulator against radiation, including X-RAYS, and also a good sound insulator in the form of limp panels. Its symbol is Pb, its atomic number is 82, its atomic weight is 207.21, its specific gravity is 11.34, and its melting point is 327.3°C . See also BLACK, RED and WHITE LEAD.

leaded light A window consisting of relatively small pieces of glass, often diamond shaped, held in lead strips of H-section (called *comes*). Also called a *lattice window*. The method evolved in the Middle Ages, because of the difficulty of making large sheets of glass; it became obsolete in the seventeenth century with the perfection of the broadglass process, but it was revived in the nineteenth century.

lead-free paint Containing no lead compounds, in particular no WHITE LEAD.

lead-lined door A door lined internally with sheets of lead, as a protection from radiation. See also HIGH-DENSITY CONCRETE.

lead monoxide Litharge (PbO).

lead paint Usually synonymous with WHITE LEAD, an exterior undercoat containing basic lead carbonate. Now generally superseded by paints containing oxides of zinc or titanium. (Lead paints are considered to present a long-term health hazard.)

lead primer Same as RED LEAD, which contains red oxide of lead.

leaf In brickwork, same as WYTHER.

lean concrete A concrete with a low cement content, as opposed to a *rich concrete*.

lean-to roof Same as SHED ROOF.

learning curve A decrease in the cycle time due to increased experience.

lease An agreement granting possession of a property for a specified time period, usually for a specified payment or rent, without conferring ownership.

leaseback A transaction that occurs when a property owner sells property to another, who subsequently leases back possession of the property to the original owner.

lease expiry The date on which the period of a lease ends and possession of the leased premises returns to the lessor.

leasehold improvements Improvements, such as repairs, maintenance, additions, made by the LESSEE during the lease period.

lease proposal A preliminary offer of terms to be included in a LEASE.

lease term The period for which the tenant has possession of the premises.

least squares See [METHOD OF LEAST SQUARES](#).

LED Light-emitting diode.

ledger A main horizontal member of wooden or steel formwork. It is normally supported on the vertical scaffold poles (uprights), and it in turn supports the SOFFIT of the formwork, or the PUTLOGS that support the soffit.

leeward On the side sheltered from the wind, as opposed to *windward*.

Legionella pneumophila The micro-organism responsible for LEGIONNAIRES' DISEASE. It colonises places where warm water collects, and it may be carried in aerosol drifts into fresh air intakes in buildings.

legionnaires' disease A disease of the lungs that can be fatal, caused by inhalation of aerosols bearing *LEGIONELLA PNEUMOPHILA* organisms.

lengthening joint A joint between two pieces of material, normally timber, which run in the same direction; as opposed to an *angle joint*. Most lengthening joints are END JOINTS.

lessee The recipient of the right to possession and use of a property under a LEASE agreement.

lessor The owner of a property granting the right to possession and use under a LEASE agreement.

level See [DATUM LINE](#), [DEAD LEVEL](#), [DUMPY LEVEL](#), [QUICKSET LEVEL](#), [SPIRIT LEVEL](#) and [WATER LEVEL](#). See also [SOUND PRESSURE LEVEL](#).

level 1 The lowest level in a multistorey building. The FIRST FLOOR is generally at a higher level.

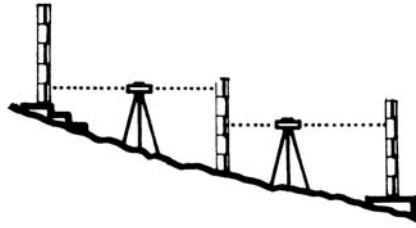

levelling

level, spirit See [SPIRIT LEVEL](#).

levelling The determination of differences in level between various points on a site (see Figure). Sights are taken through a LEVEL on a graduated staff placed vertically on the ground at various points where levels are required. The differences between the graduations on the staff, as seen through the telescope, equal the differences in level.

levelling device A mechanism that moves a lift car at a reduced speed toward the landing, when it is in the LEVELLING ZONE, and stops it there. See also [RE-LEVELLING](#).

levelling zone A distance near to each landing floor where a lift car slows and INCHES towards the floor.

lever arm The distance between the resultant tensile force and the resultant compressive force at a section. These two forces and the lever arm form the MOMENT OF RESISTANCE. See Figure under COUPLE.

lever principle The principle used for the composition and resolution of parallel forces. If a lever is in equilibrium under the action of a number of parallel forces, then the sum of the moments of these forces about any point is zero. The principle was discovered by Archimedes of Syracuse ca. 250 BC, and reputedly used by him to devise machines for throwing missiles in the defence of Syracuse when it was attacked by the Romans.

lewis A steel contrivance for gripping heavy blocks of stone for lifting. It consists of a DOVETAILED tenon, made in sections, which is fitted into a dovetailed recess in the stone (see Figure).

lewis bolt A steel anchor bolt with an enlarged conical lewis-shaped base, generally with a roughened surface (see Figure). It is fixed into concrete by casting it in during construction, or by leaving a hole in the concrete, and grouting it in later. It is fixed into stone by cutting a hole, and filling it with molten lead or with cement mortar.

LFT Latest finish time (of an activity in a NETWORK).

library (a) In computing, a collection of, usually standard, programs or subroutines. (b) In CAD, a collection of common objects in design, e.g. a library of elements such as furniture elements, wall types.

life-cycle cost The cost of a design feature that allows for prime capital cost, running cost and maintenance.

life safety See [FIRE AND LIFE SAFETY MANAGEMENT](#).

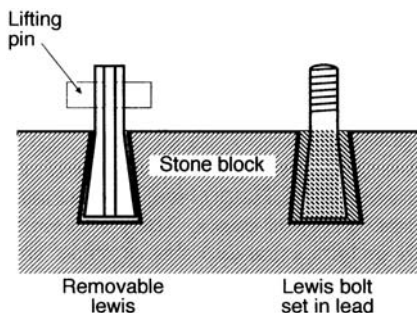

lewis and lewis bolt

lift A car or platform for the vertical transportation of persons or goods. Called an *elevator* in the USA.

lift doors The movable portions of lift CAR and LIFT WELL entrances. (a) *Advance opening*: the initiation of door opening while a lift car is slowing, usually when the car is 300mm from the floor level. (b) *Centre opening*: a door with two horizontally sliding panels linked to operate simultaneously. (c) *Multiple panel*: door comprising two or more panels, which telescope behind each other as the door opens. (d) *Side opening*: sliding door opening to one side of a lift well. (e) *Single panel*: a single-leaf *side-opening* door. (f) *Two-speed side- or centre-opening*: door with one panel sliding behind another at double the speed, so that both panels arrive at the open position simultaneously.

lift drive The power unit providing the energy required to raise and lower a lift. See [BASEMENT](#), [BELT](#), [DIRECT](#), [DIRECT PLUNGER](#), [ELECTRIC](#), [GEARED TRACTION](#), [GEARLESS TRACTION](#), [INDIRECT](#), [HYDRAULIC](#), [OVERHEAD](#), [RACK AND PINION](#), [ROPED HYDRAULIC](#), [SCREW](#), [TRACTION](#) and [WORM-GEARED DRIVES](#).

lifting frame A purpose-made steel frame for the lifting by crane of prefabricated components, e.g. PRECAST CONCRETE.

lifting tackle See [DIFFERENTIAL PULLEY BLOCK](#), [DERRICK](#) and [WHIP](#).

lift machine See [LIFT DRIVE](#).

lift of concrete The concrete placed between two successive construction joints. In columns, it is generally the height of one storey.

lift passenger journey time The TIME INTERVAL that a passenger spends travelling to a destination floor, measured from the instant the passenger registers a landing call until the instant the passenger alights at the destination.

lift recall A fire control system for lifts. In Phase I all lifts are automatically recalled to the ground floor in the event of a fire, and they remain there. In Phase II the lifts are operable by the fire brigade.

lift round trip time The average TIME INTERVAL, usually during an up peak traffic condition, for a single lift car trip through a building, measured from the

time the car doors open at the main terminal, until they reopen there after the car has completed its trip.

lift slab (a) A reinforced or prestressed concrete FLAT PLATE cast at ground level, and jacked up to its correct level after the concrete has hardened. (b) An entire system of floor slabs and roof cast on top of one another at ground level, and hoisted into position by the lift-slab method.

lift systems, control of See ATTENDANT, AUTOMATIC PUSHBUTTON, COLLECTIVE, DIRECTIONAL COLLECTIVE, GROUP COLLECTIVE, GROUP SUPERVISORY, NON-COLLECTIVE and SCHEDULED CONTROL.

lift types See BED, DIRECT PLUNGER HYDRAULIC, ELECTRIC, ELECTRO-HYDRAULIC, FIREMEN'S, GOODS, HYDRAULIC, INCLINED, MULTI-DECK, OBSERVATION, PASSENGER, PASSENGER/GOODS, ROPED HYDRAULIC, SERVICE and STAIR LIFTS.

lift well The vertical opening through a building in which lifts travel. It extends from the lift PIT at the bottom to the underside of the lift machine room (if it is on top), or the roof. Called an *elevator hoistway* in the USA.

light Synonym for window; see DEAD, LAY and OPEN LIGHT. See also VISIBLE SPECTRUM.

light/air fitting A recessed fluorescent light fitting to which is attached an air supply terminal device that delivers conditioned air through a linear diffuser or pair of diffusers at the side(s) of the fitting.

light alloys Alloys of low specific gravity. They include the aluminium alloys; the others are too expensive for use in buildings at present.

light-gauge structure Structure built up from cold-rolled steel or aluminium sheet. See also LOCAL BUCKLING.

lighting See ARTIFICIAL LIGHT, COLOUR, DAY-LIGHT and GLARE.

lighting level A commonly used term for ILLUMINANCE.

light loss factor Same as MAINTENANCE FACTOR.

lightness The attribute of visual sensation by which a body is judged to transmit or reflect a greater or smaller proportion of the incident light. It is the visual correlate of REFLECTANCE. This is the property called VALUE in the MUNSELL BOOK OF COLOR.

lightning protection system A system of conductors and other components to reduce the injurious and damaging effects of lightning, comprising at least AIR TERMINATIONS, DOWNCONDUCTORS and EARTH TERMINATIONS.

light output ratio See LUMINAIRE EFFICIENCY.

light pen A form of INPUT device that is used in conjunction with a CATHODE-RAY TUBE to enter graphical information into a digital computer.

light pipe A hollow tube with a reflective surface used to 'pipe' light from a source to where needed. Different from fibre optics (see OPTICAL FIBRE), since *total internal reflection* is not used. Light pipes can be used to light coolrooms and hazardous locations from outside.

light source The generic term for any source of light, electric, gas, oil or natural.

light timber frame See [BALLOON FRAME](#).

lightwatt A term sometimes used to describe the LUMEN.

lightweight aggregate Concrete aggregate that weighs less than gravel or crushed stone. Natural materials include VERMICULITE and PUMICE. Artificial materials include expanded clay or shale, and products made from FLY ASH or BLAST-FURNACE SLAG. The resulting *lightweight concrete* reduces the dead load on the columns, and the consequent saving in space may be more significant than the higher cost of the lightweight aggregate.

lightweight concrete (a) Concrete made with LIGHTWEIGHT AGGREGATE. Usually sand is used as FINE AGGREGATE, but the weight can be reduced further by using small-size lightweight aggregate also for the fines. (b) CELLULAR CONCRETE made without lightweight aggregate.

lightweight structure See [CABLE STAYS](#), [GEODESIC DOME](#), [LIGHT-GAUGE STRUCTURE](#), [MEMBRANE STRUCTURE](#), [PNEUMATIC STRUCTURE](#), [SADDLE SURFACE](#), [SCHWEDLER DOME](#) and [SUSPENSION ROOF](#).

light well A small court commonly placed in large buildings before artificial light of adequate brightness was developed. It admitted daylight through windows opening on to it. Now also called an ATRIUM.

lignin The most important constituent of wood after cellulose, consisting of resins that bind the wood fibres together. It can be recovered from wood pulp, and is used as a binder in PARTICLE BOARD, in the manufacture of some PLASTICS, and in some anticorrosive coatings.

lime A generic term for calcium oxide (CaO), which is QUICKLIME, and calcium hydroxide (Ca(OH)₂), which is HYDRATED LIME.

lime mortar Mortar made of LIME and sand. It was the general medium for laying stone and brick until the nineteenth century. However, it is water soluble, and it has now been largely superseded by PORTLAND CEMENT mortar, which is water-resistant, and also stronger. However, as cement mortar is stronger than many types of stone and brick, cracks due to foundation settlement, temperature and moisture movement are liable to pass through the stone or brick, rather than through the mortar joints. This causes irreparable damage, whereas a crack in a joint can be repaired by repointing. Thus an admixture of lime with cement mortar is favoured by some designers and builders. See also [MASONRY CEMENT](#).

lime putty Same as HYDRATED LIME.

limestone SEDIMENTARY rock containing a large proportion of calcium carbonate (CaCO₃). It is formed by the consolidation of calcareous ooze, which may be formed by organisms, by chemical precipitation, or by the weathering of preexisting limestone. Most limestones are easily carved (see [FREESTONE](#) and [PORTLAND STONE](#)). In the building industry classification of building stones, the polishable limestones are called MARBLE. Limestone is a raw material for LIME MORTAR and for PORTLAND CEMENT. See also [MARBLE](#) and [TRAVERTINE](#).

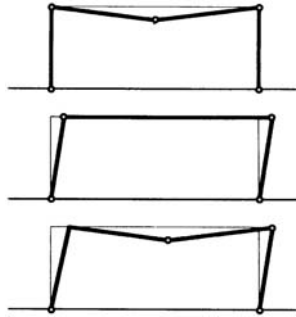

limit design

limewash Same as WHITEWASH.

limit design Design based on the *limiting loads* at which the structure collapses. PLASTIC HINGES are reached first at the sections subjected to the greatest curvature. Formation of these hinges allows redistribution of bending moments, and the formation of further hinges with increase in load. The limit is reached when sufficient hinges have formed to turn the STATICALLY INDETERMINATE STRUCTURE into a MECHANISM. It then collapses (see Figure for *alternative collapse mechanisms*). A separate ELASTIC DESIGN is needed if deformations need to be determined.

limiting strength The strength above which a material ceases to contribute to the strength of the structure. It is usually defined, for convenience, in terms of standard tests that approximate to the limiting strength. In structural steel, it is taken as the YIELD STRESS, since the steel suffers very large deformations above that point, which are liable to cause structural collapse. In concrete, it is the CYLINDER STRENGTH or the CUBE STRENGTH. The limiting strength is used directly in LIMIT DESIGN. In elastic design MAXIMUM PERMISSIBLE STRESSES are used, which are derived from the limiting strength.

limit of liquidity, plasticity See LIQUID, PLASTIC LIMIT.

limit of proportionality See PROPORTIONAL LIMIT.

limits of size The range of TOLERANCE of a dimension.

limit states design A structural design which considers both the *ultimate limit states*, which determine the ultimate load-carrying capacity of the structure, and the *serviceability limit states*, relating to the criteria governing the normal use of the structure.

limonite Iron ore composed of a mixture of hydrated ferric oxides.

line (a) In graphics, a graphic element defined by a sequence of points. A straight line is defined by its start and end points. (b) In telecommunications, a channel for the transmission of signals. (c) In electricity, an active conductor. Hence, in three-phase systems, *line voltage* is measured line-to-line. See also PHASE (b).

lineal foot A foot, as distinct from a square foot or a cubic foot.

linear arch Same as FUNICULAR ARCH.

linear diffuser A terminal device used in air conditioning, which distributes air to a space from a linear slot.

linear equation An equation that can be plotted as a straight line. A linear algebraic equation is one of the type $y=ax + b$, where a and b are constants.

linear programming A mathematical programming technique for OPTIMISATION, where the objectives and constraints can be expressed as linear functions of variables.

linear regression Statistical technique that predicts the most likely association between variables assuming a linear relationship.

line drawing A drawing whose graphic elements are all LINES.

line of thrust The curve produced by the points through which the resultant THRUST passes, e.g. in an arch.

liner (a) The replaceable part of a sliding GUIDE SHOE, sometimes called a *gib*, which slides against the guide rail and steadies a lift car in its travel. (b) *Hydraulic*: an insert placed inside the original cylinder of a hydraulic JACK to stop leaks. (c) The liner of BRAKE SHOES.

link (a) An obsolete measure of length, equal to 1/100 of a surveyor's 66ft chain, or 201mm. (b) In computing, a connection for transmitting signals between two terminals.

link polygon A graphical construction for solving problems of static equilibrium, based on the POLYGON OF FORCES. It can be used for determining the forces in roof trusses, drawing bending moment diagrams, and determining the line of thrust in an arch. It is also called a *funicular polygon*. Instead of a graphical construction, an experimental solution can be obtained with a freely hanging string, which produces a *string polygon*.

linoleum Floor covering made from jute or similar fabric, impregnated with oxidised linseed oil, resin and a filler, such as cork.

linseed oil A vegetable oil obtained by crushing the seeds of FLAX. When exposed to the air, it thickens and darkens through oxidation, forming a tough skin. It is used for paints and varnishes, for linoleum and for glazier's putty.

lintel (a) In classical architecture, the horizontal member which spans between the posts in TRABEATED construction. (b) A short beam, particularly one spanning a door or window opening, and carrying the wall above it.

liquefied petroleum gas (LPG) The gaseous fraction remaining after the catalytic cracking process used in refining crude oil. Stored under high pressure and used as a portable source of gaseous fuel.

liquid A state of matter in which the shape of a given mass depends on the containing vessel, but its volume is independent thereof; liquids are practically incompressible, but their shear strength is zero. The other states of matter are GAS and SOLID.

liquid chiller A self-contained refrigeration machine, which incorporates a refrigerant compressor and a heat exchanger to produce chilled liquid (often

water) for distribution to air handling unit(s) in an air conditioning system or to other systems where cooling may be required. Also called *water chiller*.

liquid limit The water content of a (clayey) soil that marks the boundary between its plastic and liquid states as determined by a standard test. The wet soil is placed in a cup, which is raised by a cam and allowed to drop to close a groove over a specified length. The liquid limit is the water content corresponding to 25 drops of the cup. See also [PLASTICITY INDEX](#).

liquid line The pipeline that carries liquid refrigerant from the condenser to the pressure-reducing device in a refrigeration circuit

liquid-membrane curing CURING of concrete with a liquid sealing compound.

liquidus line The line separating the liquid from the liquid-solid phase. In a PHASE DIAGRAM it shows the variation of the composition of an alloy with the temperature at which solidification is complete.

L-iron Same as ANGLE IRON.

liter US spelling for LITRE.

litharge Lead monoxide (PbO).

lithium bromide Absorbent used in the ABSORPTION CYCLE for refrigeration.

lithopone An opaque white pigment, which is non-poisonous, unlike WHITE LEAD. It is a co-precipitated mixture of zinc sulphide (ZnS) and barium sulphate (BaSO₄).

litmus An organic colouring matter used as a reagent to test the alkalinity or acidity of liquids. It turns red in acid solutions, and blue in basic solutions.

litre (l or L) The metric measure for capacity. 1L=0.001m³=0.220 British gallons=0.264 US gallons (=1 US quart approx.).

live load A load that is not permanently applied to a structure, as opposed to a DEAD LOAD. It may *or* may not be acting at any given time. See also [SUPERIMPOSED LOAD](#).

liveness The reverberant quality of an auditorium. A hall that reflects too little sound back to the listener is called dead or *dry*. See also [REVERBERATION TIME, DEFINITION](#) and [WARMTH](#).

LL Abbreviation for LIVE LOAD.

Ln Continental abbreviation for NATURAL LOGARITHM (log_e).

LOA Length overall.

load (a) See [DEAD LOAD](#), [LIVE LOAD](#), [EARTHQUAKE LOADING](#), [SUPERIMPOSED LOAD](#) and [WIND LOAD](#). (b) In computing, to enter data or program instructions into the memory of a computer.

load balancing Arranging the prestressing tendons in concrete so that the load is completely balanced by the prestress, and the member is subject purely to compression. For example, a beam or slab carrying a uniformly distributed load (which produces a parabolic bending moment diagram) requires a parabolic cable for load balancing (see Figure).

loadbearing wall See [BEARING WALL](#).

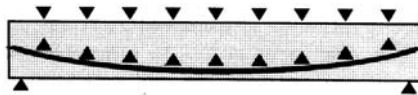

load balancing

load-extension curve See [STRESS-STRAIN DIAGRAM](#).

load factor (a) In LIMIT DESIGN, a factor used to provide a margin of safety against collapse. It is possible to apply a different factor to each type of load; for example, the dead load that can be accurately predicted requires a factor only a little above 1, whereas a much higher factor is required for live loads. See also [CAPACITY REDUCTION FACTOR](#). (b) In an electrical installation, a factor to allow for the probability that only a portion of the whole load will be in use at any one time.

load-indicating bolt A high-tensile bolt embodying a small projection, which is compressed as the bolt is tightened. The gap thus indicates the tension in the bolt, and it can be measured with a feeler gauge.

loading dock The area of a building accessible from the street that provides for the loading and unloading of commercial vehicles, convenient to transportation systems within the building.

load platform A platform cantilevered from a building frame to receive crane loads.

load shedding Reduction of electrical load by turning off non-essential plant or equipment in order to avoid exceeding a predetermined level of electricity demand and thus save cost.

loadstone Same as [LODESTONE](#).

load tails In an electrical installation, the conductors extending from a part of the installation back to the supplier's meters or protective devices.

loam A soil that contains sand, silt and clay in roughly equal proportions.

lobby (a) The entrance of a public building giving direct access from the street to transportation systems for building occupants and visitors. (b) A room or space that gives access to other rooms and spaces, or to a bank of [LIFTS](#). See also [SKY LOBBY](#).

local area network (LAN) A network linking electronic equipment within a single geographic location, as opposed to a [WIDE AREA NETWORK \(WAN\)](#).

local buckling Crinkling of a strut or of the compression flange of a beam because it is too thin. Local buckling is particularly liable to occur in *thin-walled sections* and [LIGHT-GAUGE STRUCTURES](#), and it can be prevented by the corrugation of excessively long straight runs of sheet.

lock See [CYLINDER LOCK](#) and [DEADLOCK](#).

lock-nut A secondary nut used to prevent the first nut from working loose.

lodestone A form of [MAGNETITE](#) that exhibits polarity, and was used by the early navigators as a magnetic compass. It points to magnetic north and south when freely suspended. Also spelled *loadstone*.

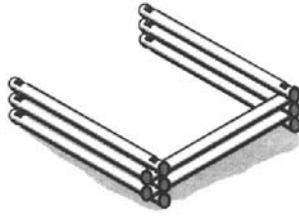

log cabin

loess Silt deposited by wind (*aeolian action*).

log A rough, unshaped piece of tree trunk.

log LOGARITHM. Unless otherwise stated it means \log_{10} , i.e. a *decimal logarithm*.

log_e NATURAL LOGARITHM.

logarithm A mathematical function. If a and b are two numbers, and $a=10^b$ then the decimal logarithm of a , $\log_{10}a=b$, and the *antilogarithm* of b is a . The suffix 10 is generally omitted for decimal (or common) logarithms. It follows that the logarithm of the product cd is given by

$$\log cd = \log c + \log d$$

so that the process of multiplication can be reduced to the simpler operation of adding the logarithms. This was utilised in *logarithmic tables* and in SLIDE RULES, and it was the common method of calculation before the invention of DIGITAL CALCULATORS and COMPUTERS. See also [DECIMAL LOGARITHM](#) and [NATURAL LOGARITHM](#).

logarithmic scale A scale plotted to the logarithm of the variable. An increase of one unit of the scale represents a tenfold increase in the quantity. *Logarithmic graph paper* (log paper) has logarithmic scales for both the ordinate and the abscissa. *Semi-logarithmic paper* (semilog paper) has one logarithmic and one ordinary scale.

log cabin A small house with walls constructed of horizontal logs laid on top of one another, and held in place by notches at the corners (see Figure).

log file A file that keeps records of all of a series of transactions.

log column A column whose SLENDERNESS RATIO is sufficiently high to make it liable to a BUCKLING failure.

longitude See [MERIDIAN OF LONGITUDE](#).

longitudinal reinforcement The main reinforcement parallel to the long dimension of a structural member, as opposed to the *lateral reinforcement*.

long-line prestressing See [PRE-TENSIONING](#).

long-term deflection Total deflection over a long period of time. It consists of both the *elastic deflection* and the *creep deflection*.

long-term lease Generally a LEASE agreement whose lease period exceeds ten years.

long ton The British TON of 2240 pounds.

long-wave radiation In the context of solar design, radiation with a wave-length exceeding $3\mu\text{m}$, emitted from low-temperature surfaces on the Earth's surface as a result of absorbing SHORT WAVE SOLAR RADIATION.

loop In computing, a sequence of instructions that is carried out repeatedly until some specified condition terminates it.

LOR (light output ratio) The ratio of LUMINOUS FLUX from a LUMINAIRE to the total flux emitted by the lamp(s) installed in the luminaire. $\text{LOR} = \text{DLOR} + \text{ULOR}$.

loss of prestress The loss of INITIAL PRESTRESS by the SHRINKAGE of the concrete, and by CREEP in the steel and the concrete. The reduction in the prestressing force due to friction between the tendon and the duct, and the ELASTIC LOSS OF PRESTRESS, are often considered separately.

loudness level The subjective assessment of the intensity of a sound, expressed logarithmically. The unit is the PHON.

loudspeaker An electroacoustic TRANSDUCER for audition by a number of people.

louver US spelling for LOUVRE.

louvre A ventilator, used particularly in the hot-humid tropics where ventilation is important for COMFORT. It permits the passage of air with as little obstruction as possible, while blocking vision and excluding rain. Window louveres usually consist of horizontal slats of wood or metal, set at an angle across the path of vision. The term 'louvre' is also applied to the grilles covering the openings in the overhead ducts of an air conditioning, heating or ventilating installation. See also [SUNSHADING](#), [PUNKAH LOUVRE](#) and [VENETIAN BLIND](#).

low-alloy steel Steel containing less than 10 per cent of alloying elements.

low-carbon steel CARBON STEEL containing less than 0.25 per cent of carbon.

low-emissivity glass Glass coated very thinly with metallic salts, which reduce its emissivity in the infrared spectral range.

low-heat cement A PORTLAND CEMENT in which the generation of heat during setting is reduced by a modification of its chemical composition. It is used in dams and other massive concrete structures where the heat cannot easily be dissipated.

low-pressure sodium lamp A DISCHARGE LAMP using sodium vapour at low pressure in the discharge tube. It produces a monochromatic orange-yellow light of high LUMINOUS EFFICACY but without any colour-rendering properties.

low-pressure steam curing Steam curing at normal atmospheric pressure, as opposed to AUTOCLAVING.

LP Abbreviation for LINEAR PROGRAMMING.

LPG Abbreviation for LIQUEFIED PETROLEUM GAS.

LSI Large-scale Integration.

Lucite Trade name of an ACRYLIC RESIN.

Lüders' lines Lines that appear on the polished surface of a crystal, or a polished metal surface that is polycrystalline, after it has been stressed beyond the elastic limit; first reported by W.Lüders in 1860. They represent the intersection of the surface by planes on which the shear stress has produced plastic slip. Also called *slip lines*.

luffing The raising or lowering of a crane BOOM.

lumber In the USA, the product derived from LOGS of timber in a sawmill. Elsewhere the word *timber* is used for both the round logs and the rectangular pieces.

lumen (lm) Unit of LUMINOUS FLUX.

lumen maintenance (a) The ability of a lamp to maintain its INITIAL LUMENS over time. (b) The curve or table that shows the depreciation of lamp flux with time.

lumen method The method commonly used for calculating illuminances in interiors from regular arrays of luminaires. Also used to determine the number of lamps required. Also a method for the design of daylit rooms, particularly favoured in the USA. Also called the *flux method*. The calculations require tables of UTILISATION FACTORS, usually produced by manufacturers of luminaires.

lumen-second The unit of luminous energy, the radiometric equivalent of the W_s or J.

luminaire A device for providing mechanical support and electrical connections to a lamp or lamps, together with any light control materials and a means of fixing the luminaire to a support (such as a ceiling). Also called a *light fitting*, a *fixture* (in the USA), a *lantern* (in roadlighting) or a *lamp* (as in table and floor-mounted luminaires).

luminaire efficiency The ratio of the luminous flux emitted by a luminaire to the luminous flux emitted by the lamps inside it. It is the same as the *light output ratio*.

luminance The area density of luminous intensity, equivalent to the radiometric quantity, RADIANCE. Luminance has the units candelas per square metre, cd/m^2 . Luminance is sometimes referred to as the photometric brightness of an illuminated surface or a light source.

luminance contrast See [CONTRAST](#).

luminance factor The ratio of the luminance of a reflecting surface to that of a perfect diffuse reflector, similarly illuminated. With perfect and near-perfect diffusers it is usual to use REFLECTANCE; the luminance factor takes into account the degree of specularity and the direction of the illuminant.

luminescence The emission of light as a result of any cause other than high temperature, e.g. the effect of ultraviolet light on certain chemicals. See also [ELECTROLUMINESCENT PANEL](#).

luminosity Same as APPARENT BRIGHTNESS.

luminous ceiling A lighting system in which the whole ceiling is translucent (or louvred), with lamps above it. The ceiling becomes an approximately uniform luminous source.

luminous efficacy The ratio of the luminous flux in LUMENS emitted by a source to the power input (or radiant power in the case, say, of the sun) in WATTS. It has the units lumen per watt, lm/W.

luminous flux The light flux (power) from a light source. It is measured in LUMENS. It is distinguished from radiant flux by weighting the radiant flux from the source by the response of the human visual system $V(\lambda)$ and applying the luminous efficacy of vision, 683lm/W.

luminous intensity The LUMINOUS FLUX per unit solid angle, in a particular direction, measured in CANDELAS (LUMENS per steradian).

luminous paint See [FLUORESCENT PAINT](#) and [PHOSPHORESCENT PAINT](#).

luminous reflectance The ratio of reflected to incident luminous flux.

luminous transmittance The ratio of transmitted to incident luminous flux.

lump sum tender A tender at a fixed, but not necessarily firm, price for which a contractor undertakes to carry out specified work.

lux (lx) The SI UNIT of ILLUMINANCE. It is the same as LUMENS per square metre (lm/m^2).

lux meter A meter, usually portable or handheld, used for measuring illuminance; often called, generically a PHOTOMETER.

lx Abbreviation for the unit of luminous flux, the LUX.

M

μ Abbreviation for *micro* (one millionth).

M Abbreviation for *mega* (one million times), or for the basic *module*.

m Abbreviation for *milli* (one thousandth) and *metre*.

macadam Uniformly sized stones rolled to form a surface; a process developed by the Scottish road-builder J.L. McAdam in the early nineteenth century. *Macadamising* is the process of laying the surface. *Tarmacadam* is a waterproof surface whose stones are bound together by tar, bitumen or asphalt, as distinct from *waterbound macadam*.

machine room A room or space that houses machinery and equipment, usually for lifts.

Mach number The ratio of the velocity of an object to the local speed of sound, named after the nineteenth-century Austrian physicist. A Mach number below 1 means subsonic flow, and a number above 1 means supersonic flow.

macro In computing, a code in which a single instruction will generate several computer instructions. For example, a macro for a spiral stair will generate all the instructions for drawing such a stair.

macro library A LIBRARY of macro routines.

macroscopic Visible to the naked eye, as opposed to *microscopic*. Also called *megascopic*.

made ground or made-up ground Ground built-up with excavated material or refuse, as distinct from the natural, undisturbed soil. Its loadbearing capacity is often very low.

magnesia Magnesium oxide.

magnesian limestone Limestone containing DOLOMITE.

magnesite Carbonate of magnesium ($MgCO_3$).

magnesite flooring A composition of OXYCHLORIDE CEMENT with a filler of sawdust, wood flour, sand or ground silica. It is used to cover concrete floors, and is commonly floated in a layer about 40mm thick. Also called *jointless flooring*.

magnesium A very light, silvery-white metal, which burns in air with a brilliantly white light when ignited. It is produced for commercial purposes by electrolysis from seawater. Its alloys weigh less than aluminium alloys and have

comparable strength. They are used in aircraft and automobile design, but are too expensive for use in building.

magnetic disk See [DISK](#).

magnetite Ferrous ferric oxide (Fe_3O_4). It is a black iron ore, which is attracted by a magnet, but does not attract particles of iron to itself. **LODESTONE** is a form of magnetite that exhibits polarity. Red, purple and black pigments are produced from some magnetite ores.

magnet steel A steel capable of retaining its magnetism after removal from an external magnetic field, and therefore usable for *permanent magnets*. It is usually an alloy steel containing tungsten, cobalt or nickel, quenched from about 900°C. By contrast, an **ELECTROMAGNET** is a *temporary magnet*.

mahogany A large hardwood tree, *Swietenia mahogoni*, found originally in the American tropics. Its straight-grained yellowish to reddish brown wood was much in demand for fine furniture and panelling. Similar timber from other trees is now often called mahogany.

Maihak strain gauge A type of **ACOUSTIC STRAIN GAUGE**.

main memory See [COMPUTER MEMORY](#).

maintenance The work required keeping buildings and assets at a standard appropriate and adequate for use. See also [BREAKDOWN](#), [BREAKDOWN REPAIRS](#), [COMPREHENSIVE](#), [CORRECTIVE](#), [DEFERRED](#), [PERFORMANCE GUARANTEED](#), [PERIODIC](#), [PLANNED/ SCHEDULED](#), [PREVENTIVE](#), [PROGRAMMED](#), [REPLACEMENT](#), [ROUTINE](#), [RUNNING](#), [SHUTDOWN](#) and [STATUTORY MAINTENANCE](#).

maintenance factor The ratio of the **FLUX** in a lighting installation after a period of time to the initial flux in the same installation. It is usually the product of the maintenance factors for lamps, luminaire surfaces and room surfaces. Also called *light loss factor*.

main tie The tension member joining the feet of a roof truss, generally at wall-plate level.

maisonette British term for a two-level **APARTMENT**, with the bedrooms at the upper level. See also [DUPLEX](#) (c).

make good (a) To restore the condition of parts of a building damaged during other work, such as cutting a new doorway into a wall. (b) The **LESSEE'S** obligation to return premises to their original condition at the end of the **LEASE** period.

make-up air Air introduced to a space either by infiltration or by forced supply, to replace that removed by a process of exhaust ventilation or air leakage.

malachite A variety of copper carbonate, used in buildings as a highly polished veneer. It is bright green, and harder than most marbles. In the industry classification of building stones, it is called a **MARBLE**. See also [SERPENTINE](#).

malleable Able to be shaped by the application of compressive force, by hammering or rolling. Generally synonymous with **DUCTILE**.

mallet A hammer made of wood, rubber, leather, or a soft metal, but not of steel.

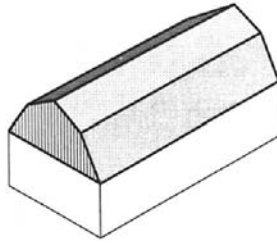

mansard roof

management information system A computer system for providing management with organisational information, such as annual reports.

manganese A hard and brittle metallic element. Its chemical symbol is Mn, its atomic number is 25, its atomic weight is 54.93, its specific gravity is 7.39, and its melting point is 1245°C. It is used in alloy steels for toughness, and also in the alloys of aluminium and copper.

man-hour Unit of work. The amount of work done by one person in one hour.

manifold A pipe or chamber with several outlets or inlets for smaller pipes.

manometer A PRESSURE GAUGE. It commonly takes the form of a U-tube filled with water, oil or mercury. One limb is connected to the air or other fluid whose pressure is to be measured, and the other is open to the atmosphere or connected to some other standard pressure.

mansard roof A roof, similar to a GABLE ROOF, with two slopes on each side. The lower slope is longer and steeper than the upper. It was named after the French architect Francois Mansart, and is also called a *French roof*.

MAP Manufacturing automation protocol.

marble A granular crystalline calcareous rock, formed *metamorphically* from limestone; greatly esteemed by sculptors because it can be polished to a smooth finish, and used in modern architecture because of the ease with which it can be cut by machine into thin slabs and polished. The term 'marble' is also used in the industry classification for non-metamorphic limestones and for other decorative rocks capable of taking high polish. See also [LIMESTONE](#), [MALACHITE](#) and [SERPENTINE](#).

marbling The now obsolete art of painting a surface to look like marble.

margin The addition to the direct costs and overhead to cover risks and profit.

margin of safety See [FACTOR OF SAFETY](#).

marine glue Waterproof or HYDRAULIC GLUE, usually consisting of about three parts of pitch, two parts of shellac, and one part of rubber. It has been largely superseded by the development of waterproof synthetic RESINS.

market rent The current rental value of a property, which varies according to market conditions.

market valuation A valuation of the current market rent of a property, obtained by comparison with equivalent properties. See also [VALUE ANALYSIS](#) and [VALUE MANAGEMENT](#).

mark-up The MARGIN added to an estimate in order to determine the tender price.

marl A clay that contains a substantial quantity of calcareous material. It is particularly suitable for making bricks without the addition of other substances.

Marseilles pattern tile Moulded clay tile with drainage channels. It interlocks at the sides, as well as above and below. Originating in France, it was at one time very common in Australia. Also called a *French tile*.

marsh gas A form of METHANE.

martensite A constituent of steel, which appears needle-shaped under the micro- scope. It is produced when steel is cooled very rapidly from the hardening temperature, i.e. at a speed greater than its critical cooling rate, so that the transformation of AUSTENITE occurs at 400°C or lower. It is essentially ALPHA IRON in non-equilibrium condition, formed directly from the under-cooled austenite. It is the hardest of the decomposition products of austenite, and very BRITTLE. See also [TEMPERING](#).

masking noise/sound A sound or noise that raises a listener's HEARING THRESHOLD for another sound. The masking sound may be detrimental, as in the case of air conditioning noise in a lecture theatre or concert hall, or beneficial, as in the case of sound or music purposely introduced (sometimes referred to as *acoustic perfume*) to prevent conversations from being overheard.

masking tape Adhesive paper tape used to cover surfaces adjacent to new paint work, to keep them free from paint.

masonry Originally work consisting of blocks of carved stone laid in mortar. Now also work consisting of bricks or blocks.

masonry cement A cement that has greater plasticity and water retention than can be obtained with Portland cement mortar (see also [LIME MORTAR](#)). In addition to Portland cement it may contain hydrated lime, pulverised limestone, pozzolan, clay, gypsum, or talc. It may also contain an AIR-ENTRAINING additive.

mass A property of the amount of matter in an object. Unlike weight, it is not dependent upon the presence of a gravitational field. In SI and CGS units the unit of mass is the KILOGRAM; in FPS UNITS it is the POUND.

mass centre Same as CENTROID.

mass concrete PLAIN CONCRETE placed in considerable thickness, so that the dissipation of the heat of hydration generated by the cement may become a problem. It often uses COARSE AGGREGATE of very large size, and also PLUMS.

mass law of sound insulation For a single wall the average INSULATION against AIRBORNE SOUND is largely determined by its mass per unit area. For sound normally incident on a wall the mass law can be written in the form of the following equation:

$$TL = 10 \log_{10} \left[1 + (\pi f m / \rho c)^2 \right] \text{decibels}$$

where TL is the SOUND TRANSMISSION LOSS of the wall, f is the frequency of the sound, m is the surface density of the wall, ρ is the density of air, and c is the velocity of sound in air. The mass law predicts a 6dB increase in the transmission loss for a doubling of the frequency of the sound or a doubling of the mass of the wall. In practice, for random incident sound, the increase is approximately 5dB, as edge fixing and other factors have some effect.

mass retaining wall Same as GRAVITY RETAINING WALL.

masterkeying An arrangement whereby individual locks are operable by separate, different keys; but in addition groups of these locks can all be operated by a single key, thus creating a hierarchy of access.

mastic (a) The resin of the mastic tree, a small evergreen tree found near the Mediterranean Sea, which is used in chewing gum and, dissolved in alcohol, as a varnish. (b) A jointing compound that dries on the surface, but remains permanently plastic underneath. The term covers a variety of compounds used in DRY CONSTRUCTION for sealing joints between precast concrete facing panels, curtain walls, windows, pipes etc. It is usually inserted into the joint with a pressure gun. (c) A thick adhesive, consisting of asphalt, bitumen or pitch, and a filler, such as sand. It is used for bedding woodblock floors, bedding and pointing window frames, and for laying and repairing flat roofs.

matched veneer A sliced WOOD VENEER made in successive cuts, which are used left-face and right-face, so that the figure of the wood is repeated, in mirror image, in the matched pair.

materials science Application of the physics and chemistry of the internal structure of materials to the interpretation of their engineering behaviour. See also [STRENGTH OF MATERIALS](#).

mathematical model A mathematical formulation that describes the known behaviour of a structure or other physical process. See also [MODEL ANALYSIS](#).

matrix (a) A rectangular array of numbers or mathematical terms, used in the solution of simultaneous equations. Because large matrices are easily handled by electronic *digital computers*, a substantial proportion of mathematical theory (e.g. for structural design) is now written in *matrix algebra*. (b) The cement that binds together the aggregate of concrete. (c) The principal constituent of an alloy or mechanical mixture, in which the other constituents are embedded. (d) The mould from which printers' type was formerly cast. See also [STEREOTYPE](#).

matrix-displacement method A matrix solution for STATICALLY INDETERMINATE STRUCTURES, intended for evaluation by electronic digital computer, in which the equations are framed in terms of the unknown joint displacements. Also called *stiffness method*.

matrix-force method A matrix solution for STATICALLY INDETERMINATE STRUCTURES, intended for evaluation by electronic digital computer, in which

the equations are framed in terms of the redundant actions. Also called *flexibility method*.

matt surface (a) A surface without sheen, even when viewed from an oblique angle. (b) A surface that redistributes the incident light uniformly in all directions, so that the LUMINANCE is the same in all directions.

maximum allowable stress Same as MAXIMUM PERMISSIBLE STRESS.

maximum permissible stress The greatest stress permissible in a structural member under the action of the SERVICE or WORKING LOADS. It is usually defined as (LIMITING STRENGTH)/(FACTOR OF SAFETY).

mb Abbreviation for MILLIBAR.

MB or Mb Abbreviation for MEGABYTE.

mean The *algebraic mean*, often just called the *mean*, is the average of all values (i.e. their sum, divided by the number of values), considering their positive or negative sign; it may be either positive or negative. The *arithmetic mean* is the average of all values, neglecting their sign, i.e. taking them all as positive. The *geometric mean* of n values is the n th root of their product. See also **MEDIAN** and **MODE**.

mean radiant temperature The weighted average of the surface temperatures of all elements in a room in line of sight of an occupant.

mean solar time The time shown by a watch that operates at a uniform rate. Since the Earth's actual movement around the Sun is not entirely uniform, it differs slightly from APPARENT SOLAR TIME.

mechanical advantage The ratio of the load raised by a machine, such as a lifting tackle or a lever, to the force required to operate it. The *velocity ratio* is the ratio of the distance through which the operating force has to be moved, to the distance moved by the load. In an ideal machine the two ratios would be equal; however, because of friction the mechanical advantage is less. The *efficiency* of the machine is

$$\text{efficiency} = \frac{\text{mechanical advantage}}{\text{velocity ratio}}$$

mechanical analysis of particles PARTICLE-SIZE ANALYSIS by sieving.

mechanical equivalent of heat In FPS UNITS, 1Btu=778ft-lb. In the old metric units, 1 calorie=4.18J. In SI UNITS the same unit, the joule, is used both for mechanical and for thermal energy. See **THERMODYNAMICS**, *First Law*.

mechanical hysteresis The dissipation of energy as heat during a stress cycle. It shows as a loop when the STRESS-STRAIN DIAGRAM is plotted for successive loading and unloading. If the ascending and descending branches coincide, then there is no hysteresis.

mechanical services The part of the BUILDING SERVICES involving mechanical power, and heating and cooling devices.

mechanical strain gauge A gauge for measuring strains by levers or other mechanical means, as opposed to an electrical, an acoustical or an optical gauge.

mechanisation The substitution of machinery for manpower.

mechanism A frame that is capable of movement. In terms of structural mechanics, a mechanism may be considered as a **STATICALLY DETERMINATE STRUCTURE** from which one or more members have been removed. The removal of each member gives a **DEGREE OF FREEDOM**, just as the addition of each member adds one redundancy.

median The middle item of a group of observations, arranged in order of magnitude. For example, if there are 21 observations, it is the 11th, and if there are 20 it is the mean of the 10th and 11th. See also **MEAN**.

medium The liquid part of a paint, in which the pigment is suspended. After the paint has hardened it becomes the binder of the paint film. Also called *vehicle*.

medium-density fibreboard Fibreboard with a density of 480 to 800kg/m³ (30 to 50lb/ft³), used for structural building and furniture applications. See also **INSULATING BOARD** and **HARDBOARD**.

mega (M) Prefix for one million, from the Greek word for large; e.g. 1MW= 1 megawatt= 1×10^6 watt.

megabyte 10^{20} (=1048576) BYTES, which is approximately 1000000 bytes. The power of 2 is used because computers employ **BINARY ARITHMETIC**.

megaflops A million floating-point operations per second. A measure of computing performance for numerical work.

megascopic Same as **MACROSCOPIC**.

melamine resin A material used in **LAMINATED PLASTICS**. It is produced by the reaction of melamine (C₃H₆N₆) and formaldehyde (H.CHO) with a suitable catalyst. Melamine resin-bonded laminates are characterised by extreme hardness.

melt The molten portion of the raw materials in a furnace.

membrane (a) A thin, sheet-like structure. (b) A thin, impervious sheet.

membrane analogy An analogy between the mathematical equations for the elastic *torsion* function and the transverse deformation of a stretched membrane, proposed by the German physicist L.Prandtl in 1903. It was utilised as an **ANALOGUE COMPUTER** for the torsional strength of complex shapes. The apparatus consists of a rubber membrane stretched over an opening shaped like the cross-section under investigation, and its slope and volume are determined. See also **SANDHEAP ANALOGY**.

membrane curing **CURING** with a liquid sealing compound.

membrane forces Three distinct internal forces are possible in a membrane: N_x and N_y , which are direct forces and may be either tensile or compressive, and the membrane shear V (see Figure). It is rarely possible to achieve equilibrium with membrane forces alone near the boundaries of the structure.

membrane structure A roof of flexible membranes of canvas or plastic, supported by cables or ropes.

membrane theory Theory for the design of *thin* shell structures, based on the assumption that all forces are **MEMBRANE FORCES** that act *within* the membrane.

memory See **COMPUTER MEMORY**.

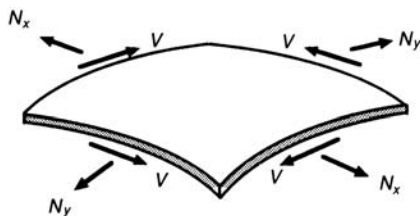

membrane forces

MEN Abbreviation for MULTIPLE EARTH NEUTRAL.

meniscus The curved surface formed when a liquid touches the surface of a solid, caused by SURFACE TENSION. The water at the edges of a glass tube rises above the general water level, and this must be allowed for when making sensitive measurements.

menu In computing, a list of options usually either displayed on a screen or fixed to a DIGITISER, from which the user can select the next program action.

mer The smallest repetitive unit in a POLYMER.

Mercalli scale Scale for classifying the *effect* of an earthquake, devised by G. Mercalli and modified in 1931 by H.O. Wood and F. Neumann. It is a 12-point scale based on the observed symptoms. Number 1 on the scale is not felt, number 6 causes some structural damage, and number 9 destroys weak masonry structures and damages frame buildings; number 12 causes nearly total destruction. The RICHTER SCALE measures the *magnitude* of an earthquake.

mercury A white metallic element, also called *quicksilver*, with a melting point of -38.5°C , and a boiling point of $+356.7^{\circ}\text{C}$. Its chemical symbol is Hg, its atomic number is 80, its atomic weight is 200.61, and its specific gravity is 13.56. It is a solvent for most metals, and the resulting alloys are called AMALGAMS. These played a prominent part in medieval alchemy. Mercury BAROMETERS are used for measuring air pressure, which is consequently often expressed in millimetres of mercury. At a temperature of 0°C , 760mm of mercury=1 atmosphere=14.7 psi= 101.3 kPa.

mercury fluorescent lamp A HIGH-INTENSITY DISCHARGE LAMP using mercury vapour in the discharge tube, with an outer bulb coated with fluorescent material to convert some of the ultraviolet to visible light at the red end of the spectrum. See also [HIGH-PRESSURE MERCURY LAMP](#).

mercury vapour lamp An electrical DISCHARGE LAMP that employs mercury at a higher pressure than in fluorescent lamps to produce visible radiation. It is also the basis of other discharge lamps such as *mercury fluorescent* and *metal halide lamps*. See also [HIGH-PRESSURE MERCURY LAMP](#).

meridian of longitude A GREAT CIRCLE on the Earth's surface, ORTHOGONAL to the equator, which passes through the north and south poles. The observer's meridian is the great circle passing through his location and the poles.

mesh The open spaces of a net; hence the net itself. Wire mesh is used in *sieves* and *screens* to separate materials, such as sand, into sizes. The larger sizes are specified by the size of the opening; the smaller sizes by a standard number. The test sieve numbers standardised by the ASTM and the BSI are similar, but not quite the same.

mesh reinforcement Welded-wire fabric used as reinforcement for concrete, particularly in slabs. See also [EXPANDED METAL](#).

met The unit of measure for the METABOLIC RATE for various activities, used in determining the COMFORT ZONE. 1met= 58W/m² (of body surface area) is the metabolic rate of an average person who is sitting up, but not working.

metabolic rate The rate at which heat of metabolism is produced. It is an important component of cooling load in air conditioning design practice.

metabolism The chemical and physical processes continuously going on in living organisms, whereby food is assimilated and energy released.

metal (a) An element that is malleable, conducts heat and electricity, and can replace the hydrogen of an acid. Metals are electropositive, and their atoms readily lose their ELECTRONS. When untarnished, metals have a characteristic 'metallic' lustre. (b) Broken stone used as a COARSE AGGREGATE for concrete, tarmacadam etc. (c) The liquid glass during the process of manufacture.

metal coating See [GALVANISING](#), [SHERAR DISING](#) and [CADMIUM PLATING](#).

metal halide lamp A HIGH-PRESSURE MERCURY LAMP using *metal halides* in the discharge tube to add spectral lines to those of the main mercury discharge. By suitable combination of halides, colour rendering properties are improved.

metal lath See [LATH](#) and [EXPANDED METAL](#).

metal roof ing Roof covering with metal sheets of steel, aluminium, copper, lead or zinc. Flat sheets can be supported on closed sheathing; profiled steel or aluminium sheets are self-supporting on purlins. Steel sheet must be GALVANISED or ZINCALUMEd for corrosion protection.

metamorphic rock IGNEOUS or SEDIMENTARY ROCK that has been changed by chemical or physical action in the Earth's crust into a distinctly new type. *Marble* is metamorphic limestone, and *slate* is metamorphic shale.

meter (a) A measuring instrument, particularly for fluids, e.g. flow meter. (b) US spelling of METRE.

methane The name of the shortest hydrocarbon chain, CH₄. It is a colourless gas, which occurs in *natural gas*, and is given off in marshes as *marsh gas* and in coal mines as *fire damp*.

methanol Methyl alcohol (CH₃.OH), generally produced from the fermentation of woody plant materials.

method of least squares A method for fitting the best linear equation to a set of experimental results by making the squares of the residuals a minimum. The 'squaring' is necessary to eliminate the effect of positive and negative signs.

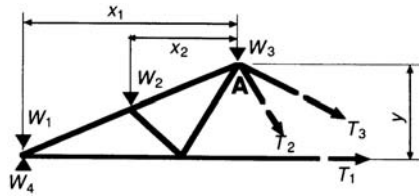

method of sections

method of sections A method for the design of STATICALLY DETERMINATE trusses, proposed by the German engineer A. Ritter in 1862. It is particularly useful if the magnitude of the force in only one member is required. If the truss shown in the figure is cut across the main tie, the force in it, T_1 , can be obtained in one operation by taking moments about A. The two other unknown forces pass through A, and therefore have no moment about it. This is a simple example of a FREE-BODY DIAGRAM. In Figure:

$$T_1 y = \sum Wx$$

methylated spirits ETHANOL to which some METHANOL has been added to make it poisonous, and therefore undrinkable.

methyl methacrylate See [ACRYLIC RESINS](#).

metre The unit of length in the metric system, introduced by the French Academy in 1791. It was originally defined as 1×10^{-7} of the distance from the north pole to the equator of the Earth's MERIDIAN OF LONGITUDE passing through Paris, but it has since been redefined in terms of the wavelength of light at a particular frequency. $1\text{m}=39.37\text{in}$. See also [SI UNITS](#).

metrication The act of converting any other unit to its metric equivalent.

metric system The system based on the *metre* used in CGS UNITS and SI UNITS.

mezzanine An intermediate storey of lower height. It is usually a gallery between the main floor and the floor above it.

MF Melamine FORMALDEHYDE.

MFLOPS Abbreviation for MEGAFLOPS.

Mg Chemical symbol for *magnesium*.

mho Unit of conductance. It is the reciprocal of the OHM.

mica A group of minerals found in igneous rocks; some are characterised by perfect cleavage, so that they can be split into thin sheets. Different types vary in chemical composition. Some micas are excellent electrical or thermal insulators and some are transparent.

micro (μ) (a) Prefix for one millionth, from the Greek word for small, e.g. $1\mu\text{s}=1\text{microsecond}=1 \times 10^{-6}\text{second}$. (b) Used commonly to signify smallness, as in microfiche, microcomputer.

microchip A small CHIP.

microclimate The local climate of a small area.

micro-concrete Concrete for use in small-scale structural models. Its aggregate is scaled down.

microcrack A crack too fine to be visible with the naked eye, but detectable with ultrasonic pulses.

microfiche A type of film containing photographically reduced documents.

micrometer (a) An instrument for the precision measuring of length, which consists of a G-shaped frame, one of whose legs is a round bar accurately threaded. A nut running on it is marked in 10^{-2} mm or 10^{-3} in. See also [VERNIER](#). (b) $1\mu\text{m}=10^{-6}\text{m}$ when US spelling is used.

micrometre In SI UMS 1 $\mu\text{m}=10^{-6}\text{m}$. Previously called a *micron*.

micron One-millionth of a metre; an obsolescent unit, now called a *micrometre*.

microphone A transducer that responds to variations in pressure in the air due to sound. It also responds to hydrodynamic pressure fluctuations. See also [CARDIOID MICROPHONE](#), [CONDENSER MICROPHONE](#), [FIGURE 8 MICROPHONE](#), [MOVING-COIL MICROPHONE](#) and [UNIDIRECTIONAL MICROPHONE](#).

microprocessor A general-purpose computer processor, contained within a CHIP.

microscopic Visible with a microscope only, as opposed to *macroscopic*.

microwave An ultra-high-frequency radio wave in the electromagnetic *spectrum* with a wavelength of less than 300mm, i.e. a frequency of more than 1000MHz.

middle strip The portion of a flat slab or flat plate between the COLUMN STRIPS. Most building codes define the middle strip as the middle half of the slab.

middle-third rule ‘Provided the resultant force lies within the middle third, no tension is developed in a wall or foundation.’

MIG welding Metal-inert-gas, a form of SHIELDED-ARC WELDING using an inert gas such as argon or helium, to surround the electrode, which is a wire continuously fed into the arc to provide the weld metal.

mil One thousandth: (a) of an inch; (b) of a right-angle; (c) of a radian; (d) of a litre.

mild steel Steel with a carbon content of 0.1 to 0.2 per cent. It is ductile, and has a yield stress of 200–250 N/mm² (30–35 ksi).

mile A measure of length. 1British/ American mile=1.609km; 1Admiralty NAUTICAL MILE=1.853km; 1international nautical mile=1.852km.

milk of lime SLAKED LIME in water.

milli (m) Prefix for one thousandth, from the Latin word for 1000, e.g. 1millimetre=0.001metre.

millibar (mb) Unit of pressure used in meteorology. 1mb=100NEWTONS per square metre=100PASCALS=0.750mm of mercury (measured with a mercury barometer at 0°C).

milling machine A machine that removes shavings from a surface by pushing it on a moving table past a *rotating* cutter. Because both the work and the tool

move, it can be used for making complex parts, such as gears. See also [PLANING MACHINE](#).

mill scale The oxide layer formed on structural steel sections and reinforcing bars during hot rolling. If it is loose, it must be removed before concreting or painting, to ensure proper adhesion.

MIME Abbreviation for multipurpose Internet mail extensions. A format for transferring non-textual data such as graphics, video and audio through EMAIL.

MIMS cable Mineral insulated metal sheathed, a cable having compressed powder mineral insulation enclosed in solid-drawn metal sheathing. Cables may be either single-core or multicore.

mineral flax Fiberised asbestos or mineral wool.

mineral pigment Pigment made by processing materials mined from the earth.

mineral wool An aggregate of fine filaments, which can be formed into a flexible and resilient mat. It is produced by blowing air or steam through molten blast-furnace slag (*slag wool*), through molten rock (*rock wool*), or through molten glass (*glass wool*). It has excellent thermal insulating properties, particularly in loose form, and it is vermin-proof and rot-proof.

minimal surface The shortest surface that can be formed between a given set of boundaries. It can be obtained experimentally by forming the boundaries out of wire, and then dipping them into a solution (e.g. detergent or latex) that contracts to a minimal surface by surface tension. The minimal surface is always a SADDLE SURFACE.

minor intrusions IGNEOUS ROCKS formed by intrusions in fissures etc., and consequently much finer grained than PLUTONIC INTRUSIONS.

MIPS Abbreviation for million instructions per second. A measure of computing power.

mirror A surface capable of reflecting light (or sound) without appreciable diffusion. The *angle of reflection* equals the *angle of incidence*. See also [PARABOLIC REFLECTOR](#), [SOUND MIRROR](#) and [SPECULAR SURFACE](#).

mirror glass Same as REFLECTIVE GLASS.

mirroring In computer graphics, the process of copying and rotating graphic elements 180° around an axis so as to produce a reverse-image copy.

MIS Abbreviation for MANAGEMENT INFORMATION SYSTEM.

mission tile Roof tile of approximately semi-cylindrical shape, laid alternately up and down. Also called *Roman tile* and *Spanish tile*.

miter See [MITRE BOX](#), [JOINT](#), [SQUARE](#).

mitre box A U-shaped open box with cuts at 45°, which facilitate the making of 90° mitred joints. The piece of timber to be mitred is placed in the box, and the cuts guide the saw to cut at an angle of 45°. Also called a *mitre block*.

mitre joint A timber joint formed by fitting together two pieces of board on a line bisecting their junction. *Mitring* is the operation of cutting the boards and fitting them together at an angle, usually a right angle.

mitre square A square for setting out timber. It has one edge of the handle set at 45°, so that it can be used for laying out right-angled mitre joints.

mixed-mode climate control A system of indoor climate control in which natural ventilation is supplemented by mechanical cooling and/or heating when considered necessary by the occupant(s) of a space.

mixer See [CONCRETE MIXER](#).

mix proportions The ratio in which the various components of a composite material, such as concrete, mortar or plaster, are mixed together. Mix proportions may be specified by volume, which merely requires the filling of a bucket or gauge box, or by weight, which is more accurate for materials subject to BULKING. See also [BATCH BOX](#), [WATER-CEMENT RATIO](#) and [WEIGH BATCHER](#).

mixture Two or more ingredients, intimately mixed together but each retaining its own chemical identity; as opposed to a COMPOUND.

MKS units The units of the metric system, based on the metre, kilogram and second. Some of its units, such as the CALORIE and the units of stress, have been further rationalised in the SI system.

Mn Chemical symbol for *manganese*.

mobile crane A crane, usually with an extending jib and outriggers, but able to travel on normal roads under its own power.

Möbius' law A rule defining the number of members required for a STATICALLY DETERMINATE STRUCTURE, published by A.F. Möbius in 1837. The simplest plane PIN-JOINTED frame consists of three members, and it has three joints. Each additional joint requires two additional members. Consequently the number of members required is

$$n = 2j - 3$$

where j is the number of joints. The simplest SPACE FRAME is a tetrahedron, which has six members and four joints. Each additional joint requires three additional members, so that

$$n = 3j - 6$$

mode (a) The most common item of a group of observations. If these are plotted as a bar chart, or HISTOGRAM, the mode is the observation corresponding to the longest bar. See also [MEAN](#). (b) The *mode of vibration* of a system is the displacement amplitude pattern of the system. In a linear system the natural mode of vibration is such that the motion of every particle is simple harmonic with the same frequency.

model A representation of an aspect of reality which illustrates its properties. See also [MATHEMATICAL MODEL](#).

model analysis Analysis of structural, lighting, ventilation, acoustic or other problems by means of physical as opposed to MATHEMATICAL MODELS. See [ACOUSTIC MODEL ANALYSIS](#), [ARTIFICIAL SKY](#), [DIRECT MODEL ANALYSIS](#), [INDIRECT STRUCTURAL MODEL ANALYSIS](#), [PERISCOPE](#), [SOLARSCOPE](#) and [WIND TUNNEL](#).

modelling (a) The process of producing a representation of some abstraction of a situation. (b) In computing, the process of producing a computer representation, e.g. a building product model. (c) In lighting, a description of the ability of a lighting system to reveal form.

modelscope A PERISCOPE for viewing models.

modem Abbreviation for MODulator/DEModulator, i.e. a device used to convert *digital* signals to analogue signals (modulate) and vice versa (demodulate). It is used, for example, to enable a *digital* signal, as produced by a computer, to be transmitted over a telephone network.

modular coordination Design of building components to conform to a dimensional standard based on a modular system.

modular grid A *reference grid* in which the grid lines are spaced at exact multiples of the MODULE.

modular ratio Of reinforced concrete: the ratio of the MODULUS OF ELASTICITY of the reinforcing steel to the EFFECTIVE MODULUS OF ELASTICITY OF CONCRETE.

modular size A dimension that is a multiple of the basic MODULE M , i.e. nM , where n is an integer. The modular size nM is normally considered to include allowances for joints and TOLERANCES.

modulation See [AMPLITUDE MODULATION](#) and [FREQUENCY MODULATION](#).

module A unit of length particularly specified for MODULAR COORDINATION.

modulus, bulk See [BULK MODULUS OF ELASTICITY](#).

modulus of elasticity The ratio of direct STRESS to STRAIN in an elastic material obeying HOOKE'S LAW. It is also called *Young's modulus*, after Thomas Young, a British scientist who introduced the concept in 1807. See also [MODULUS OF RIGIDITY](#) and [SECANT MODULUS OF ELASTICITY](#).

modulus of rigidity The ratio of shear STRESS to shear STRAIN in a material obeying HOOKE'S LAW.

modulus of rupture The nominal stress

$$f = \frac{M}{Z}$$

(where M is the ultimate BENDING MOMENT, and Z the SECTION MODULUS) at which a beam breaks. It is a common test for the tensile strength of brittle materials, such as concrete, whose flexural strength is controlled by tension. Stress distribution at rupture is no longer elastic, and consequently the true tensile stress is lower than M/Z .

modulus of section See [SECTION MODULUS](#) and [PLASTIC SECTION MODULUS](#).

Mohr circle A graphic construction devised by the nineteenth-century German engineering professor, Otto Mohr, which enables the stresses acting on a cross-section oriented in any desired direction to be determined if the PRINCIPAL

STRESSES are known. It can be used either for two-dimensional or, with an additional construction, for three-dimensional stress problems. See also [ELLIPSOID OF STRESS](#).

Mohr's theorem The theorem proposed by Professor Otto Mohr at Dresden Technical University in 1868, which states that the slope and deflection bear the same relation to the bending moment as the shear force and bending moment respectively do to the load. Consequently the slope and deflection can be determined from a fictitious load, which equals the bending moment divided by EI (where E is modulus of elasticity and I is the second moment of area); this is the *moment-area method*.

Mohs' scale A hardness scale defined by Friedrich Mohs, a German mineralogist, in 1812. It consists of a comparison with ten standard minerals: (1) talc, (2) gypsum, (3) calcite, (4) fluorite, (5) apatite, (6) orthoclase, (7) quartz, (8) topaz, (9) corundum and (10) diamond. A material of number 8 hardness is scratched by corundum, but scratches quartz.

moiré fringes Patterns produced by interference between two series of lines: an undistorted parallel grid, and a similar grid distorted by a loaded MODEL. This can be achieved either by reflection from the surface of the model, in a manner similar to the PHOTOSTRESS METHOD, or by refraction, i.e. by light passing through the model. The patterns resemble those of PHOTOELASTICITY, but the technique measures slope, and consequently *flexural curvature*. (Isochromatics give the difference between the two principal stresses.)

moist room A room in which the relative humidity is kept above 98 per cent, and the temperature is kept constant (usually $23^{\circ}\text{C}\pm 2^{\circ}$). It is used for curing test specimens of building materials (particularly concrete) under standard conditions. Also called a *fog room*.

moisture barrier Either a VAPOUR BARRIER or a DAMPPROOF COURSE.

moisture content The weight of water in a material, such as a soil, divided by the weight of the solids.

moisture equivalent, field See [FIELD MOISTURE EQUIVALENT](#).

moisture gradient The variation in moisture content between the outside and the inside of a piece of material, particularly wood.

moisture meter Instrument for determining the moisture content of timber by measuring the electrical resistance between two points on its surface.

moisture movement (a) The movement of moisture through a porous material. (b) The effect of changes in moisture content on the dimensions of the material. In concrete it causes mainly SHRINKAGE. In timber it may cause shrink-age, swelling or distortion, particularly if the timber is inadequately SEASONED. (c) Moisture movement due to a sustained load. It causes CREEP in concrete.

molding US spelling for MOULDING.

mole The amount of a substance whose mass in gram is numerically equal to the molecular mass of the substance. Abbreviated *mol*. The same as *gram-molecule*, which it replaces in the SI system.

molecular heat The product of the SPECIFIC HEAT of a substance and its molecular weight.

molecular weight The weight of a molecule of a substance, expressed as a multiple of the weight of an atom of hydrogen. See also [ATOMIC WEIGHT](#).

moment See [BENDING MOMENT](#), [COUPLE](#), [MOMENT OF A FORCE](#) and [TWISTING MOMENT](#).

moment-area method See [MOHR'S THEOREM](#).

moment arm Same as LEVER ARM.

moment distribution method A technique devised by Professor Hardy Cross at the University of Illinois in 1930 for the solution of the bending moments in rigid frames and continuous beams by successive approximations. It was widely used until less laborious computer methods were devised, such as the MATRIX-DISPLACEMENT METHOD.

moment of a force The moment of a force about a given point, or briefly 'the moment', is the turning effect, measured by the product of the force and its perpendicular distance from the point. See also [COUPLE](#).

moment of an area The sum of the products obtained by multiplying each element of area, dA , by its distance from the reference axis, y . It is therefore

$$\sum y dA \quad \text{or} \quad \int y dA$$

The CENTROIDAL AXIS is the axis about which the moment of an area vanishes.

moment of inertia (a) A measure of the resistance offered by a body to angular acceleration. It is the SECOND MOMENT OF AREA of the body, multiplied by its density. (b) The term *moment of inertia* is also commonly used as a synonym for the SECOND MOMENT OF AREA. See also [POLAR MOMENT OF INERTIA](#).

moment of resistance The moment produced by the internal forces in a beam. For equilibrium, it must equal the BENDING MOMENT due to the external forces.

momentum The product of the mass of a body and its velocity.

monitor (a) A series of windows on both sides of a single-storey factory roof, which admit daylight, and sometimes also provide ventilation. The monitor is a linear version of the LANTERN used in classical domes. Monitor frames (see Figure) and roof trusses are shaped to include the monitor as an integral part of the steel frame. See also [NORTHLIGHT ROOF](#). (b) Any device or process

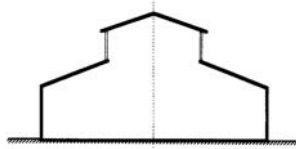

monitor (a)

that inspects the state of some other device or process. (c) Commonly used for the visual display unit of a computer.

monochromatic light Light of a single colour, produced by a filter (which absorbs the other colours), or by a monochromatic lamp, e.g. a sodium lamp.

monolith A single block of stone or concrete. Hence *monolithic construction*, which is concrete cast with no joints other than construction joints.

monomer A molecule containing a single MER, as opposed to a *polymer*.

Monte Carlo method A procedure that utilises the techniques of statistical sampling to obtain an approximate solution of a mathematical or physical problem.

montmorillonite A mineral consisting of finely divided hydrous aluminium or magnesium silicate, characterised by a sheet-like molecular structure. Its expansion and contraction on wetting and drying are exceptionally high. It is the main constituent of BENTONITE.

Moon-Spencer sky The CIE STANDARD OVERCAST SKY proposed by Parry Moon and Domenica Spencer.

mortar A mixture of sand and a cementing medium, such as PORTLAND CEMENT or LIME.

mortice US spelling of MORTISE.

mortise A rectangular slot cut into one piece of timber, into which a tenon or tongue, from another piece is fitted to form a *mortise-and-tenon joint*. A *mortise lock* is one that fits into a mortise in the edge of a door, as opposed to a RIM LOCK.

mosaic Inlaid surface decoration for floors and walls formed by small pieces (or *tesserae*) of tile, glass or marble. Present-day mosaics are generally laid in geometric patterns, but representational designs were common in earlier days.

motor-generator set A set that controls the speed of large electric motors, such as those for lifts (elevators). It consists of an induction or shunt motor, which drives a variable-voltage direct-current generator, and this in turn drives a direct-current motor, whose speed is thus infinitely variable, and whose direction of driving can be reversed. Also called *Ward Leonard control*. Now largely superseded by solid-state electronic controls.

mould Also spelt *mold* (USA): (a) FORMWORK; (b) a FUNGUS.

moulding A strip of wood, stone, metal or plastic, either plane or curved, used to cover a joint, or used for decoration. Hand-carved mouldings played an important

part in classical architecture. Mass-produced mouldings can now be bought in many different shapes and sizes.

mouse In computing, a hand-held device that allows a user to position a CURSOR on the screen. A mouse can have one, two or three buttons allowing a number of functions such as selecting and/or dragging and drawing.

movement See [MOISTURE MOVEMENT](#) and [TEMPERATURE MOVEMENT](#).

moving-coil microphone A microphone in which the diaphragm exposed to sound pressure is connected directly to a movable coil. The movement of the coil in the magnetic gap produces a voltage.

moving stair An ESCALATOR.

moving walk A continuously moving endless belt on which passengers can stand or walk; an ESCALATOR without steps.

mph Miles per hour.

MRT Mean radiant temperature.

MS Abbreviation for MILD STEEL.

mu (μ) Abbreviation for *micro*.

mullion A vertical dividing member of a traditional window, capable of supporting weight. The corresponding horizontal member is a *transom*. Windows may be further subdivided by *glazing bars*.

multi-deck lift A lift having two or more compartments located to form a vertical stack. See also [DOUBLE-DECK LIFT](#).

multi-element prestressing Assembly of an integrated structural member from several individual units by means of PRESTRESSING CABLES.

multiple earth neutral system A system of earthing used in electrical distribution systems, in which the neutral is bonded to the earth at each point of connection (to a property). This provides parallel earth connections, via the neutral, reducing the impedance to earth. It also ensures that the neutral does not 'float' above earth potential.

multi-zone system An air conditioning system in which the thermal condition of air supplied to separate zones within a space is independently controlled.

Munsell Book of Color One of the standard methods for specifying physical (surface) colours by means of an atlas of colour chips. Munsell arranges colour according to HUE, VALUE and CHROMA. The colours are matched against the standard colours in the *Book of Color* for identification. This was first published by A.H.Munsell in 1905, and is now produced by the Munsell Color Co., Baltimore.

muntin Same as SASH BAR.

muntz metal An alloy of 3 parts of copper and 2 parts of zinc.

muriatic acid Hydrochloric acid (HCl).

mushroom column A column with an enlarged head in a FLAT SLAB. (See Figure under FLAT PLATE.)

N

N (a) Chemical symbol for *nitrogen*. (b) Abbreviation for *newton*.

n Abbreviation for *nano*, one thousandth of a millionth, or 10^{-9} .

Na Chemical symbol for *sodium* (natrium).

nailable concrete Concrete into which nails can be driven. It usually contains LIGHTWEIGHT AGGREGATE, often with the addition of sawdust.

nailer A strip of wood attached to steel, built into a brick wall, or cast into concrete, so that other building elements can be fixed with nails. Also called *nailing strip*.

nail-glued roof truss A glued roof truss with plywood gusset plates. The nails hold the truss together until the glue dries; thereafter the strength of the joints is presumed to depend on the glue alone.

nail gun A hand-held machine for driving nails. The nails are automatically fed from a magazine attached to it. The power is usually supplied by compressed air (from an air hose attached to the gun) driving a piston, but there are also self-contained gas-powered guns, using a small gas cylinder and a battery for ignition.

nailplate A type of TIMBER CONNECTOR. It is variously used to mean a galvanised steel plate with prepunched holes through which nails are driven, or with preformed nails punched from the sheet. Also written *nail plate*.

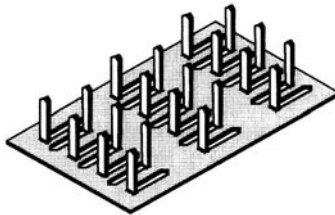

nailplate

nano Prefix for one thousandth of a millionth (from the Greek word for dwarf), e.g. $1\text{nm}=1\text{nanometer}=1\times 10^{-9}\text{meter}$

Naperian logarithm An alternative name for NATURAL LOGARITHM, named after the sixteenth-century mathematician John Napier, who invented logarithms.

nappe A sheet of water flowing over a weir.

natural asphalt See ASPHALT.

natural cement A cement obtained by grinding calcined argillaceous limestone burned at a temperature no higher than is necessary to drive off the carbon dioxide. In contrast to PORTLAND CEMENT, it is produced from a natural mixture of argillaceous and calcareous material. Natural cements were common before the manufacture of Portland cement was perfected. The earliest example is the *Roman cement* patented by J.Parker in England in 1796.

natural frequency The frequency of free oscillation of a system, when acted upon by no external forces other than an original excitation. Also known as the *resonant frequency* or frequency at which the system resonates.

natural gas Hydrocarbon gas obtained from underground deposits.

natural language processing (NLP) In computing, the process by which a computer understands and generates natural language.

natural light Same as DAYLIGHT.

natural logarithm A logarithm to the base $e=2.71828\dots$, also called a *Naperian logarithm*. This is of practical importance because the solution of the integral

$$\int \frac{dx}{x} = \log_e x$$

See also EXPONENTIAL FUNCTION.

natural seasoning The drying of timber by stacking it so that it is exposed to the flow of air, but is sheltered from rain and sun. It is an older method than KILN seasoning, and it takes much longer to achieve the same result. Since sufficient time is not always allowed, the extent of the seasoning is open to doubt.

natural stone Stone that has been quarried and cut, but not crushed into chips and reconstituted as *cast stone*.

natural ventilation Ventilation without the use of mechanical power, by the suitable location of windows and doors.

Nautical Almanac A book of tables, published annually, of the daily movements of the sun, moon and stars. Since 1960 the *British Nautical Almanac* and the *American Ephemeris* have been published in the same form.

nautical mile One international nautical mile=1852 metres. One British Admiralty and US Coast Survey nautical mile =6080ft=1853.2m. Originally defined as one minute of arc on a GREAT CIRCLE on the Earth's surface.

Navier's theorem The simple theory of bending. It is based on the experimental result that sections that were plane before bending remain plane after bending, but converge on a centre of curvature. Consequently the relation between STRAIN (and consequently STRESS) and distance from the NEUTRAL AXIS is linear. In 1826 L.M.H.Navier, Professor at the *École des Ponts et Chaussées* in Paris, published the solution in the now accepted form:

$$\frac{M}{I} = \frac{f}{y} = \frac{E}{R}$$

where M is the BENDING MOMENT at the section, I is the SECOND MOMENT OF AREA of the section, f is the extreme fibre stress, y is the extreme fibre distance, E is the MODULUS OF ELASTICITY, and R is the radius of curvature at the section. The equation is often quoted in two different forms:

$$M = FZ$$

where F is the MAXIMUM PERMISSIBLE STRESS for the material in the beam and Z is the SECTION MODULUS of the beam, and

$$R = \frac{EI}{M}$$

which is used for determining the slope and deflection of the beam.

NBRI National Building Research Institute, Pretoria.

NBS National Bureau of Standards, Washington, DC; now NIST, the National Institute of Standards and Technology.

NC Abbreviation for: (a) NOISE CRITERIA CURVES; (b) NUMERICAL CONTROL.

near-critical activity See [ACTIVITY](#).

near field That part of a sound field, produced by a source in a FREE FIELD, in which the SOUND PRESSURE and the air velocity (caused by the passage of the sound) are not in phase, i.e. at a distance that is usually within one representative dimension of the source. The INVERSE SQUARE LAW does not apply in this region, and SOUND PRESSURE LEVEL measurements cannot be used to predict sound INTENSITY or SOUND POWER of the source.

neat cement Cement used without sand, as opposed to cement mortar.

necking The contraction in area that occurs when a ductile material, such as mild steel, fails in tension. See [CUP-AND-CONE FRACTURE](#).

needle A short, stout timber or steel beam that is passed horizontally through a wall, to support the end of a SHORE.

needlepoint screw A screw with a sharp point, intended for use with a power screwdriver, to penetrate thin sheet-metal without pre-drilling. See also [SELF-DRILLING SCREW](#).

NEF Abbreviation for NOISE EXPOSURE FORECAST.

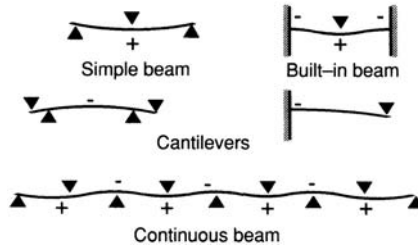

negative bending moment

negative bending moment A BENDING MOMENT that causes hogging, or convex, curvature (see Figure). In continuous beams and frames, the negative moments occur over the columns, and the positive moments near mid-span.

negative reinforcement Reinforcement placed in concrete beams to resist the NEGATIVE BENDING MOMENT, i.e. near the top face.

neon A colourless, odourless and inert gas. Its chemical symbol is Ne, its atomic number is 10, its atomic weight is 20.183, and its boiling point is -245.9°C . It is used in lamps as both a source of light and as part of a starting mixture of gases.

neon lamp or tube A lamp containing neon at low pressure. A discharge of electricity through neon produces an intense orange-red glow, which is used for neon signs and glow DISCHARGE LAMPS. The term *neon* is used generically for COLD CATHODE LAMPS containing other gases or fluorescent coatings.

neoprene An oil-resistant synthetic rubber.

NERDCC National Energy Research, Development and Demonstration Council, Australia.

net lease A LEASE under which the LESSEE agrees to payment of all property charges such as taxes, insurance and maintenance as well as rent.

net lettable area The area of possession for which rent is paid. Its method of measurement varies.

net occupiable area The area occupied in a LEASE agreement. It is generally the same as the NET LETTABLE AREA.

network (a) Generally any set of interconnected elements that form an overall organisation. (b) A diagram representing a series of interconnected events, as in the representation of a building project (see Figure). It forms the basis of both the CRITICAL PATH METHOD and PERT. A network must have one starting point and one terminal point. However, it may have many branches between, and may become so complex that the CRITICAL PATH can be determined only with the aid of a computer. In the diagram, the events are indicated by the circles, and the activities by arrows, with their duration shown. Dummy activities are shown by dotted lines, and have no duration. The critical path is shown by the double line. See also [ACTIVITY](#), [CRASHED TIME](#), [DUMMY ACTIVITY](#), [EVENT](#) and [FLOAT](#). (c) In computing and information technology, refers to a system of physically distributed computers interconnected by telecommunication channels.

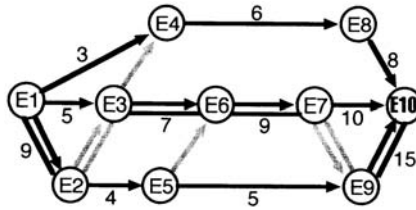

network

network analysis An analysis of operations in which the logical relationships between activities are shown in terms of precedence, the times of activities and the resources required. See [CRITICAL PATH METHOD](#).

neutral axis The line in the cross-section of a beam where the flexural stress changes from tension to compression, i.e. the line where the direct stress is zero. In sections subject to pure bending, the neutral axis passes through the CENTROID. Also called *neutral layer* (of the beam).

neutral conductor The electric conductor in a single-phase or polyphase system that is at a uniform electric potential, usually by *earthing*. (In a balanced three-phase system it carries no current.)

neutral file In computing, a FILE written in a format that is common to many applications. Used for transferring data from one application to another without having to write specific translators for each pair of applications.

neutron Sub-atomic particle of the same mass as a PROTON, but having no electric charge.

newel An upright post supporting the hand rail at the top and bottom of a staircase, and also at the turn on a landing.

newton (abbreviated N) In SI UNITS, the unit of force and weight; it is named after the seventeenth-century English scientist. 1 newton is the force that, applied to a mass of 1 kilogram, produces an acceleration of 1 metre per second per second. Unlike the units of force used in CGS and FPS UNITS, it is independent of the Earth's gravity. The newton is a small unit, and it is frequently necessary to use the kN or MN. See also [KILOPOND](#).

NFPA Abbreviation for National Fire Protection Association, Quincy, MA, USA, and National Forest Products Association, Washington, DC (formerly NLMA).

NIBS National Institute of Building Science, Washington, DC.

nickel A bright silvery metal, used as an alloying element to increase the strength, ductility and corrosion resistance of steel, and for electroplating metals that require corrosion protection. It is a major component of many STAINLESS STEELS. Its chemical symbol is Ni, its atomic number is 28, its atomic weight is 58.7, its specific gravity is 8.85, and its melting point is 1450°C.

Nicol prism A device for obtaining plane-polarised light, e.g. for PHOTOELASTICITY. It consists of a crystal of ICELAND SPAR, cut and

cemented together in such a way that a plane-polarised ray of light is freely transmitted, while an ordinary ray of light is reflected out at the side of the crystal.
NIST National Institute of Standards and Technology, Washington DC, previously the NBS.

nitrocellulose Produced by the action of a mixture of nitric and sulphuric acid on cellulose. Nitrocellulose with a low nitrogen content is not explosive, and it is used as a solvent of LACQUER. Nitrocellulose with a high nitrogen content is the explosive *gun cotton*.

nitrogen A colourless and odourless gas. It constitutes about 78 per cent by volume of the atmosphere. Its chemical symbol is N, its atomic number is 7, its atomic weight is 14.008, it has a valency of 3 or 5, and its boiling point is -195.8°C . See also [OXIDES OF NITROGEN](#).

NLMA National Lumber Manufacturers' Association, Washington, DC (now NFPA).

NLP Abbreviation for NATURAL LANGUAGE PROCESSING.

nm nanometre, one billionth of a metre. $1\text{nm}=10^{-9}\text{m}$ Now replacing the ÅNGSTRÖM unit.

NNI Noise and number index; an index for the measurement of disturbance from aircraft noise, developed in Britain in 1961.

noble metals Metals, such as silver, gold and platinum, that have a high positive electrode potential in the ELECTROCHEMICAL SERIES, and consequently are resistant to most types of corrosion, and specifically to atmospheric oxidation.

node A point of minimum displacement in a system of stationary waves.

no-fines concrete Concrete made without sand. It therefore contains a high proportion of communicating pores, which provide thermal insulation and drainage.

nogging (a) Horizontal short timbers that stiffen the vertical studs of a framed partition. (b) Brick infilling in the spaces between the studs of a timber frame.

noise (a) A disturbance affecting an electrical signal. (b) An undesirable sound. See also [ACOUSTIC](#) and [SOUND](#).

noise, background See [BACKGROUND NOISE](#).

noise, fan See [FAN NOISE](#).

noise absorption See [SOUND ABSORPTION](#).

noise criteria curves Curves that provide a method of obtaining singlefigure ratings for the acceptability of sounds in buildings, using OCTAVE-BAND SOUND PRESSURE LEVELS. The rating obtained is known as an NC rating, e.g. NC 45. NC ratings are often used to rate noise from air conditioning systems and are usually approximately equal to the dB(A) rating of the sound. See also [NOISE RATING](#).

noise dose The dimensionless ratio of the NOISE EXPOSURE experienced by a person in eight hours, to a reference value of noise exposure. The reference value is often taken as $3.2\text{Pa}^2\text{h}$.

noise exposure The time integral of the square of the A-weighted sound pressure received by a person, in any stated measuring period.

noise exposure forecast (NEF) A calculated value of the noise climate near an airport, based on forecast estimates of the various numbers of different aircraft using an airport at some future stated dates, and the flight paths that will be used.

noise pollution level A specialised noise rating based on the *energy equivalent sound level*, which also takes into account the variability of the sound level.

noise rating A single-figure rating of the sound in a given environment, based on OCTAVE-BAND SOUND PRESSURE LEVELS, which is similar to the NOISE CRITERIA rating but which covers a greater range of sound levels.

noise reduction The difference in SOUND PRESSURE LEVEL between two adjacent rooms when the source of sound determining the sound level in both rooms is in one of the rooms.

noise reduction coefficient The arithmetic mean of the SOUND ABSORPTION COEFFICIENTS of a material at the frequencies of 250, 500, 1000 and 2000 Hz.

nominal diameter (DN) A numerical designation of size that is common to all components in a piping system other than components designated by outside diameters or by thread size. It is a convenient round number for reference purposes, and only approximates the manufacturing dimensions.

nominal rent A rent agreed between two parties for mutual benefit, which is not necessarily related to market value.

nominal size of timber The size of timber before it is DRESSED, and usually before it is SEASONED. Sizes of dressed timber are usually given as nominal sizes, and the actual size is 5–13mm smaller.

nominated subcontractor A supplier selected by the principal to carry out work or supply materials, specifically defined in the contract documents. The supplier then enters into a contractual agreement with the head contractor.

nomogram A diagram used for the evaluation of an equation. Its simplest form consists of three straight lines, each graduated for one variable. By joining any two of them with a straight edge, the third can be read off. However, more complicated forms can be constructed, using more lines, including curved and inclined lines.

nonagon A nine-sided regular POLYGON. The angle included between the nine equal sides is 140°.

non-bearing wall See [PARTITION](#).

non-collective control Of lift systems: the simplest form of control. A lift car will answer a landing call only if it is available.

non-combustible Same as INCOMBUSTIBLE.

non-critical activity See [ACTIVITY](#).

non-destructive testing Testing that does not destroy the test piece. It is often performed on the actual structure. X-RAYS, ULTRASOUND, magnetic particles and BRITTLE COATINGS have been employed for non-destructive strength tests. Tests based on elastic deformation, as in the STRESS GRADING OF TIMBER, in the testing of concrete with the SCHMIDT HAMMER, or in experimental stress analysis with STRAIN GAUGES, are also non-destructive.

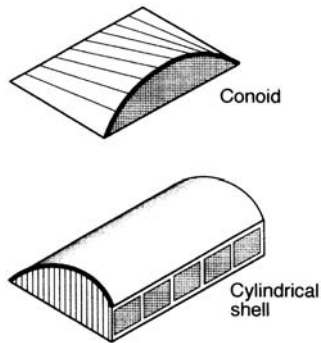

northlight shell

non-developable surface A curved surface that cannot be flattened into a plane surface without shrinking, stretching, and tearing. Most DOUBLY CURVED SURFACES are non-developable.

non-ferrous metal A metal that does not contain iron, or only a little iron.

non-graphic attribute An attribute of an object defining a property that is not graphic in nature, e.g. material, cost, supplier, thermal properties, function.

non-habitable area The area of a building that cannot be utilised. It includes the structure, partitions, and ducts.

non-recoverable costs The leasing commission, legal fees and owner's contribution to marketing funds that are not charged to tenants.

normal direction Direction perpendicular to the cross-section under consideration.

normal frequency distribution curve Same as GAUSSIAN CURVE.

normalising Heating steel to about 50°C above the TRANSFORMATION TEMPERATURE, followed by cooling in still air at room temperature, so that moderately rapid cooling occurs. The object is to eliminate internal stresses, refine the grain size and render the structure of the metal more uniform.

normal stress A direct stress, as opposed to a shear stress.

northlight roof A sloping factory roof having one gentle slope without glazing, and a glazed roof face pointing north. In the temperate zone this has a slope to admit more daylight, but in the subtropics it is usually vertical to exclude direct sunlight. Also called a *sawtooth roof*. In the southern hemisphere a *southlight roof* is used instead. See also [MONITOR](#).

northlight shell A shell designed as a NORTHLIGHT (or in the southern hemisphere, southlight) ROOF. It may take the form of a parabolic *conoid*, with the parabolas facing north, or a cylindrical shell that has been cut (see Figure).

no-sky line A line separating all points on the WORKING PLANE at which the sky is directly visible from those at which the sky is not directly visible.

no-slump concrete Concrete with a SLUMP of 25mm (1in.) or less.

notch effect A locally increased stress in a section due to a notch, or sharp change in section. It is normally employed to test IMPACT RESISTANCE.

novated contract A contract with parties (such as design consultants), transferred from an original client to another participant, who may be the project manager or the head contractor.

NPL National Physical Laboratory, Teddington, England.

NR See [NOISE RATING](#).

NRC (a) Noise reduction coefficient. (b) National Research Council (USA or Canada).

N-truss Same as PRATT TRUSS.

nudging When automatically operated lift doors remain open for longer than a specified time, the doors are made to close at a reduced speed in order to remove the obstruction.

numerical control The automatic control of machines by means of numerical instructions, which can be generated by computers.

nylon The generic name of a group of *polyamides*; it is derived from the initial letters of New York and London. Nylons are among the stronger plastics. They have good resistance to wear and corrosion, and are used in buildings for hardware, e.g. door fittings.

NZIA New Zealand Institute of Architects, Wellington.

NZIE New Zealand Institution of Engineers, Wellington, now called IPENZ.

O

Ω Symbol for OHM.

O Chemical symbol for *oxygen*.

O & M See [OPERATION AND MAINTENANCE MANUALS](#).

OA On drawings, abbreviation for overall.

oakum Loose fibre, which may be produced by picking old rope, used in CAULKING.

oblique parallel projection A pictorial PROJECTION in which the elevation is drawn as for the ORTHOGRAPHIC PROJECTION, and the plan and side elevation are then attached to the same picture at an angle of 45°. The object invariably looks too deep if drawn this way, and consequently an artificially foreshortened scale is sometimes used along the 45° lines.

obscure glass Glass that has been patterned so that it is not transparent.

observation lift A lift designed as an architectural feature to provide a panoramic view for passengers, while travelling in a partially enclosed or glazed well.

obsidian A natural GLASS of granitic composition, originating as a LAVA. It is generally black with a vitreous lustre. It fractures with a sharp, hard edge, and has therefore been used in building tools by civilisations that did not have metal tools, e.g. the Aztecs and the Incas.

occupancy cost The total cost of occupying space, including rent, operating and capital costs, taxes, insurances and depreciation allowances.

occupancy rate The number of persons or users per unit of space, such as a room or a building.

ochre A yellow mineral pigment. It consists of ferrous oxide (FeO).

OCR Abbreviation for OPTICAL CHARACTER RECOGNITION.

octagon An eight-sided regular POLYGON. The angle included between the eight equal sides is 135°.

octahedron A regular POLYHEDRON bounded by eight equilateral triangles. It has six vertices and 12 edges.

octave A range of eight notes on the DIATONIC (i.e. the conventional) musical scale. The FREQUENCY of the octave is precisely twice that of the base note, and it is the first HARMONIC of the base note.

octave band A range of frequencies where the ratio of the highest frequency to the lowest frequency is 2.

octave-band analyser See [FREQUENCY ANALYSER](#).

octave-band sound pressure level The SOUND PRESSURE LEVEL measured in a given OCTAVE BAND.

OD Outside diameter.

oedometer A machine for determining the CONSOLIDATION characteristics of COHESIVE SOILS. An *undisturbed* sample is loaded between two porous stone plates, which allow free passage of water in and out of the sample, and the settlement is measured.

office automation The use of electronic devices to replace manual processes, e.g. to produce a paperless or electronic office.

office space utilisation rate The ratio of the total number of office workers to the total number of offices and work-stations, expressed as a percentage.

off-peak water heater A STORAGE WATER HEATER in which water is heated only during the electricity supplier's off-peak hours, usually at night, but at a lower cost.

off-premises workplace A workplace that is remote from the principal organisation workplace, requiring alternative work practices.

off-the-form The finish to in situ and precast concrete made by the formwork surface.

off-white White, with the addition of a small amount of another colour, but insufficient to identify any colour other than white. Also called *broken white*.

off-white cement Cement that has very little of the grey colour of normal Portland cement. It is not as 'white' as WHITE CEMENT, but it is much cheaper, and suitable for many applications.

ogee A doubly curved line, made up of a convex curve passing without a break into a concave.

ohm (Ω) The unit of *electrical resistance*. It is defined by OHM'S LAW.

Ohm's law Law governing the flow of a steady current in an electric circuit, enunciated by the German physicist G. S. Ohm in 1827. It states that the voltage drop produced by the current is proportional to the magnitude of the current. The resistance is defined as the ratio of voltage to current, and its unit is the *ohm* (Ω).

oil-alkyd paint Same as OLEORESINOUS PAINT.

oil paint Paint with a binder of DRYING OIL, as opposed to water paint.

oil stain A thin oil paint with very little pigment, used for staining timber. See also [SPIRIT STAIN](#).

Old English bond Same as ENGLISH BOND.

oleoresinous paint A paint whose vehicle consists of a mixture of drying oil and resin (such as phenolic or alkyd resin), combined by a cooking process. Also called *oil-alkyd paint*.

one-way slab Slab designed to span in one direction only, as opposed to a *two-way slab*.

on grade At ground level or supported directly on the ground.

on-line Describes any device that is under direct control of the central processor of a computer.

on-premises workplace A workplace located at the organisation's place of work.

onyx A banded variety of silica, consisting of very small quartz crystals. The bands are straight, not curved as in AGATE, and as a result it has been widely used for CAMEOS.

oolitic limestone A limestone formed by the agglomeration of oolites. These are tiny spherical concretions (less than 2mm in diameter) of calcium carbonate, usually showing a concentric-layered or radiating fibrous structure. The structure resembles the roe of fish cemented together. The best-known oolitic limestone is PORTLAND STONE.

opacity The opposite of *transparency*. In painting, it denotes the HIDING POWER of a paint.

opal Amorphous hydrous silica ($\text{SiO}_2 \cdot n\text{H}_2\text{O}$). Apart from the gemstone, there are less precious varieties, e.g. in opaline cherts, which find application as building materials.

opal glass Glass containing calcium phosphate derived from bone ash. This renders it white and opaque. Also called *milk glass*.

open cut Excavation from the ground downwards, as opposed to *tunnelling*.

open drained joint See [DRAINED JOINT](#).

open-frame girder Same as VIERENDEEL GIRDER.

open-hearth process Process for making steel in an open hearth from iron and limestone. The process was developed in 1858 by William Siemens, and it is also known as the Siemens Martin process.

open light A window that can be opened, as opposed to a *dead light*.

open plan An office space designed without partitions.

open stairs Stairs without risers.

open stairway Stairway with one or both sides open to a room.

open system (a) A system whereby an INDUSTRIALISED BUILDING is assembled from stock components, which may be produced by different manufacturers. (b) In computing: a system that allows any computer HARDWARE or SOFTWARE from different manufacturers to communicate with each other.

open-web joist A lattice JOIST welded from light steel sections, which directly supports the roof or floor. It is mass produced to certain standard lengths. It permits the passage of plumbing and electrical conduits.

open-well stair A stair built around a well, leaving an open space.

operable walls Walls or partitions that can be opened or closed to combine or separate spaces to suit a variety of activities.

operating costs The total costs associated with operating a facility, comprising total fixed costs and total variable costs.

operating profit The difference between operating revenue and operating costs, excluding abnormal adjustments.

operating revenue The income minus deductions, including taxes and monies collected on behalf of a third party.

operating system In general, any program that controls a data processing system. More usually, the program in a computer that controls the running of other programs.

operation and maintenance manuals Manuals provided by the services contractors following the installation of building services, describing operation and maintenance (O&M) requirements.

operations research The analysis and solution of problems through the development of mathematical models, usually using computer-based methods.

optical axis Same as COLLIMATION LINE.

optical character recognition The recognition of printed characters by an optical scanning device. The characters are converted into digital form.

optical fibre Very thin fibre of glass allowing for very high-speed transmission of data and for multiplexing of a large number of data channels on one single glass fibre.

optimisation An approach for finding the maximum efficiency of a system, i.e. its OPTIMUM value for some purpose. This may entail finding a minimum or maximum value as in the lowest cost, lowest energy consumption or maximum loadbearing capacity. See [LINEAR PROGRAMMING](#).

optimum The best or most favourable solution for a particular purpose. This may be a minimum or maximum value as in the lowest cost, lowest energy consumption or maximum loadbearing capacity. See also [PARETO OPTIMUM](#).

opus incertum Ancient Roman masonry consisting of small stones set irregularly in mortar.

opus quadratum The Ancient Roman term for ASHLAR, frequently laid with dry joints.

opus reticulatum Permanent formwork for Ancient Roman concrete, consisting of stones or bricks set diagonally.

opus signinum Ancient Roman STUCCO, which had very low water penetration because of its HYDRAULIC properties.

opus spicatum Ancient Roman brick-work in herringbone pattern.

opus testaceum Ancient Roman facing of broken tiles set horizontally in mortar.

orbital sander A powered SANDER in which the face plate oscillates with an orbital motion.

order of magnitude A number rounded to the nearest power of 10.

ordinate The y-axis, or vertical axis, of a CARTESIAN COORDINATE system.

Oregon or Oregon pine Same as DOUGLAS FIR.

organic chemistry The study of those compounds of carbon that form chains or rings. Many organic materials are POLYMERS.

organic clay or silt A clay or silt that contains the remains of plants or animals. It is normally recognisable by smell when the soil is moulded. Its bearing capacity is generally very low.

oriel window A projecting window on an upper floor, CORBELLED from the wall. A BOW WINDOW usually projects from the ground floor.

orientation The arrangement of a building in relation to the north point.

orifice plate An obstruction to a fluid flow (as in the outlet from a stormwater DETENTION BASIN), consisting of a plate with a hole of appropriate size to regulate the flow.

origin The point of intersection of CARTESIAN COORDINATES, i.e. the zero point for the *x*-, the *y*- and (in three dimensions) the *z*-axes. Also used with a similar meaning in computer graphics.

ormolu From the French for powdered gold; this was dissolved in mercury. Hence article or furniture decorated with mercury-gilded bronze.

orthogonal Crossing one another at right angles.

orthographic projection The PROJECTION most commonly used for drawing buildings. It shows the object by means of three separate drawings: the *plan*, the *elevation* and the *side elevation*. In the *first-angle* projection (commonly used in Great Britain) each view is placed so that it represents the side of the object remote from it in the adjacent view. In the *third-angle* projection (commonly used in the USA and Australia) each view is placed so that it represents the side of the object near to it in the adjacent view. While the orthographic projection is true to scale in every respect, it fails to give a pictorial representation of the object.

orthotropic Having physical properties that vary at right angles, e.g. the strength of timber along and across the grain. It is a special case of AEOLOTROPIC.

oscillation See [VIBRATION](#).

osmosis The diffusion of a solvent or of a dilute liquid through a skin, permeable only in one direction, into a more concentrated solution.

outdoor air Air introduced to the supply to air-conditioned space for the purpose of dilution of contaminants that have their origin within the space.

outdoor air cycle A control cycle on an air conditioning system arranged to replace recycled return air with outdoor air when the heat content of the outdoor air is lower than that of the return air. The purpose is to save cooling energy. See also [ECONOMISER CYCLE](#).

outlet (a) A point at which current can be taken from an electric wiring system; an electric SOCKET. (b) A connection to which a gas-burning appliance can be attached. (c) A ventilator. It could be a louvred opening in an attic or in the upper part of a window, or a discharging air duct.

out of plumb Not aligned with the plumb line, not perfectly vertical.

out of square Not at right angles.

output The results produced or the information transmitted by a computer or other data-processing system, using a printer, graphic display unit, PLOTTER etc.

outsourcing The process of contracting with an external party to provide services traditionally performed by employees within an organisation.

oval Any plane figure resembling the longitudinal section of an egg. The term is commonly used for closed curves resembling an ELLIPSE, but not precisely conforming to its mathematical definition.

oven-dry soil Soil dried in an oven at 105°C.

oven-dry timber Timber that does not lose moisture in a ventilated oven heated to 100°C.

overcast sky See [CIE STANDARD OVERCAST SKY](#).

overhead drive A lift drive located at the top of the lift well.

overheated period A term used in the design of SUNSHADING devices to denote the period when the temperature exceeds a specified limit (such as 21°C or 70°F). This period can be shown on a STEREOGRAPHIC PROJECTION of the sunpath, or incorporated into a computer program.

overlay A sheet of transparent paper or film used to represent some aspect of a building, e.g. the electrical layout, the furniture layout etc. Several sheets can be placed over each other so that interactions between the various aspects can be seen. The same result is achieved by LAYERING in a computer-generated drawing.

over-reinforced section A reinforced concrete section with more steel than is needed for a BALANCED DESIGN.

overrun The space provided, e.g. in a LIFT WELL, to allow for the OVERTRAVEL of the lift car.

overtravel The safe distance that a moving object, such as a lift, may travel past its normal range of movement without striking any fixed object. Also called *runby*.

oxidation The chemical combination of an element with oxygen. A fire is caused by rapid oxidation. Corrosion of some materials, e.g. steel, is caused by slow oxidation. The opposite process is called *reduction*.

oxides of nitrogen (NOX) Trace contaminants of air arising from the combination of nitrogen with oxygen during the combustion of fuels. They are an irritant of the human respiratory system.

oxides of sulphur Trace contaminants of air arising from the combination of atmospheric oxygen with sulphur during the combustion of fuels. They are an irritant of the human respiratory system, and cause corrosion of some building materials. They are soluble in water, and a cause of ACID RAIN.

oxyacetylene welding and cutting See [ACETYLENE](#).

oxychloride cement A composition of magnesium chloride ($MgCl_2 \cdot 6H_2O$) and magnesia (MgO), also called *Sorel's cement*. The magnesia is derived from MAGNESITE; hence the floor finish in which this cement is used is called MAGNESITE FLOORING.

oxygen A colourless and odourless gas, which supports combustion. It is the most abundant of all chemical elements, since it forms 21 per cent by volume of the Earth's atmosphere, 89 per cent of the weight of water, and almost 50 per cent of the weight of the rocks in the Earth's crust. Its chemical symbol is O, its

atomic number is 8, its atomic weight is 16, its valency is 2, and its boiling point is -183°C .

OYO 'Own-your-own', a form of STRATA TITLE in which each apartment in a block is separately owned. Also called *home unit* (Australia) and *condominium* (USA).

ozone A toxic, unstable form of oxygen, which contains three atoms per molecule (O_3) instead of the normal two (O_2). It occurs naturally in the stratosphere, where it plays an important part in screening out ultraviolet radiation. It also occurs in minute concentrations at lower levels.

ozone depletion Reduction in concentration of stratospheric ozone due to complex reactions with the chlorine that originates from manufactured substances such as CFC and HCFC.

P

π The circular constant 3.1416...

p Abbreviation for *pico*, one millionth millionth, or 10^{-12} .

Pa Abbreviation for PASCAL.

PA Polyamide, more commonly called NYLON.

PABX Private automatic branch exchange. An exchange for a telephone system within an organisation.

package deal A tender for the design and construction of a project.

padstone A block of stone or concrete, built into a wall to distribute the pressure from a concentrated load.

paint See [ALKYD PAINT](#), [ANTI-CORROSIVE PAINT](#), [CEMENT PAINT](#), [CHLORINATED RUBBER](#), [DISTEMPER](#), [FIRE-RETARDANT PAINT](#), [FRESCO](#), [GRAINING](#), [KALSOMINE](#), [LACQUER](#), [LATEX](#), [MARBLING](#), [OIL PAINT](#), [OIL STAIN](#), [PLASTIC PAINT](#), [PLASTICS](#), [PRIMER](#), [SPIRIT STAIN](#), [TEMPERA PAINTING](#), [VARNISH](#), [WATER PAINT](#) and [WATER STAIN](#).

paint program In computing, a program for drawing based on pixel representation.

paint remover (or stripper) A liquid that softens paint and varnish so that it can be scraped or brushed off.

paint roller A modern alternative to the traditional paint brush, which greatly increases the speed of painting. It is a roller coated on the outside with non-woven fibres of wool, mohair, or nylon.

paint thinner See [THINNER](#).

PAL (a) Permanent artificial lighting during daylight hours. (b) An abbreviation for *phase alternate line*, the major colour-television colour-encoding method used in Europe and Australia. In North America and Japan the NTSC system is used, while France and some Eastern European countries use SECAM.

pallet A lifting tray used for stacking materials with a fork-lift truck.

panel, drop See [DROP PANEL](#).

panel heating A system of heating in which the heating units are concealed in special panels, or else built into the walls or ceiling.

panelled door A wooden door built with a framed surround, with the spaces between the framing members filled with panels of a thinner material. It has less

moisture movement than a door built of parallel planks, and it was used for the better-quality buildings before the development of plywood (which has even less moisture movement). ‘Panelled’ doors used in modern buildings are often plywood doors with mouldings attached.

panhead A head on a screw or rivet in the shape of a truncated cone.

pan mixer A mixer composed of a horizontal pan in which mixing is accomplished by paddles.

panning In computer graphics, the process of changing the visible part of a drawing on a screen without changing its magnification. Panning can be done dynamically or in one step. SCROLLING is a special case of panning.

pantile Roof tile of S-shape, laid with single horizontal lap. Also called *Italian tile* or *Spanish tile*.

pantograph A mechanism, consisting of a jointed parallelogram with projecting sides, used at one time for the copying of illustrations. By altering the location of the pen or pencil the scale can be reduced or increased.

paper See [BUILDING PAPER](#), [KRAFT PAPER](#) and [WALLPAPER](#).

paper sizes The international A-series of paper sizes is based on a $1:\sqrt{2}$ proportion, so that each time a sheet is folded in half the resulting size is in the same proportion. American paper sizes follow a similar principle, rounded off to even inches.

International designation (mm)		American designation (in.)	
A0	841×1189	A	34×44
A1	594×841	B	22×34
A2	420×594	C	17×22
A3	297×420	D	11×17
A4	210×297	E	8.5×11

parabola A curve produced by plotting the equation $y=ax^2+b$ where a and b are constants. It is also the shape made by cutting a right circular CONE parallel to one edge. A *cubic parabola* has the equation $y=ax^3+b$.

parabolic arch An arch whose curvature is parabolic. The bending moment diagram for a uniformly distributed load is parabolic, and consequently a parabolic arch carrying a uniformly distributed load is free from bending stresses. See also [CATENARY ARCH](#).

parabolic conoid A SURFACE OF TRANSLATION generated by a straight line moved over a flat parabola at one end and a more strongly curved parabola at the other. It is used as a NORTHLIGHT SHELL.

parabolic reflector A mirror whose cross-section forms a parabola. If the lamp is placed at the focus of the parabola, it produces a parallel beam. This is due to the parabola’s property (see Figure) that any parallel ray, such as A, meeting the parabola at B makes the same angle with the tangent at B as a ray coming from the focus F. Hence all rays reflected by the mirror surface from F are parallel.

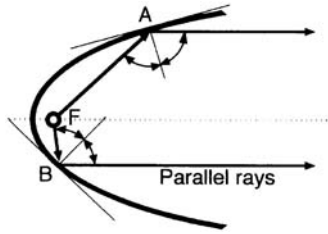

parabolic reflector

paraboloid A SURFACE OF REVOLUTION generated by rotating a parabola about a vertical axis.

paraboloid, elliptical See [ELLIPTICAL PARABOLOID](#).

paraboloid, hyperbolic See [HYPERBOLIC PARABOLOID](#).

parallel Always the same distance apart. Thus two parallel straight lines meet only at infinity.

parallelepiped A solid bounded by six parallelograms, any two opposite ones being parallel to one another. In a *right* parallelepiped all edges are parallel or perpendicular to the base. The CUBE is a special case of a right parallelepiped.

parallel gutter See [BOX GUTTER](#).

parallel of latitude See [LATITUDE](#).

parallelogram A QUADRILATERAL with two pairs of parallel sides.

parallelogram of forces 'If two forces acting at one point be represented in magnitude and direction by two sides of a parallelogram, their resultant is represented by the diagonal drawn from that point.' In structural design two sides of the parallelogram are usually omitted, leaving the other two sides and the diagonal forming a *triangle of forces*. The parallelogram of forces was published by Stevinus of Bruges in 1586.

parameter A variable in a mathematical relation, which is kept constant for a particular investigation. Variation of the parameter thus produces a family of curves or surfaces.

parapet The portion of a wall that extends above roof level.

Pareto optimum Where there is more than one objective for a design there is rarely a single optimal solution. A Pareto optimum, named after an early-twentieth-century Italian professor of political economy, is a solution such that no other solution can be found that is better in at least one objective and no worse in the others. There may be many Pareto optimal solutions to a design problem. Which one is used depends on a TRADE-OFF decision.

Parian plaster Same as KEENE'S CEMENT.

Paris, plaster of See [PLASTER OF PARIS](#).

Paris white Same as WHITING.

parking area An area set aside for the parking or storage of vehicles.

parking of lift The act of moving a lift car to a specified floor, or leaving it at the last served floor, whenever there is no further service assigned to it.

parking ratio The number of car parking spaces required per unit area of developed floor area. It is generally determined by the requirements of the building or planning authority.

parquetry Small pieces of wood, sometimes of different species, fitted together to form a geometrical design. They are usually glued to a floor.

partially fixed joint Same as SEMI-RIGID JOINT.

partial prestressing Prestressing to a lower level than full prestressing (which eliminates all possibility of cracking under service or working loads). In partially prestressed members, tensile stresses exist in the precompressed tensile zone of the concrete at the working load.

particle board A FIBREBOARD formed with only a small amount of pressure (unlike HARDBOARD), or by EXTRUSION. The binder is usually urea or phenol resin, and only a small amount (>12 per cent) is required. It can be joined and veneered like plywood, but is cheaper and has better insulation. Also called *chipboard*.

particle-size analysis Determination of the proportion of particles of each size in a granular mixture, such as soil or aggregate. When the result is plotted on semilogarithmic graph paper, the particle *grading curve* is obtained. The larger particles are separated by *sieving* or *screening*. For those particles too fine to pass through a sieve (74 μ m) the SPECIFIC SURFACE is determined, usually by STOKES' LAW; or a TURBIDIMETER may be used. See also GRAVEL, SAND, SILT and CLAY.

particulates, particulate matter Very small particles of solid matter suspended in air.

partition A wall that supports its own weight, but not the weight of the building above it.

partly cloudy sky A sky that has between three-tenths and seven-tenths cloud cover.

party wall Same as COMMON WALL.

pascal (Pa) Unit of pressure in SI UNITS. It equals 1 NEWTON per square metre, and is named after the seventeenth-century French mathematician. The pascal is also used as the unit of *stress* (which is equivalent to pressure) in some countries, whereas others use N/m² and its multiples.

passageway A narrow pedestrian access path within a building or between buildings.

passenger detector An automatic electronic device, which causes door reopening of a lift whenever a passenger is detected in the doorway, using photo-electric, electromagnetic, electrostatic or ultrasonic detection means. See also SAFE-EDGE.

passenger/goods lift A lift designed to carry goods and/or passengers.

passenger lift A lift designed to carry passengers.

passive earth pressure See EARTH PRESSURE.

passive solar energy Collection of solar energy, using only the fabric of the building; as opposed to ACTIVE SOLAR ENERGY.

PA system A system of microphones, signal processors, amplifiers and loudspeakers for amplifying and distributing sound to an audience. Where the audience is in the vicinity of the source the term *sound reinforcement system* is often used.

patent glazing Any system of dry glazing, i.e. without the use of putty.

paternoster lift A passenger lift consisting of a series of open compartments that proceed slowly up or down in a lift shaft without stopping. Most were installed on the European continent in the 1930s.

patina Surface alteration due to the ageing process: (a) green or greenishblue deposit forming on copper or brass as copper oxide gradually changes to copper sulphate because of atmospheric contamination; (b) Gloss produced by ageing on woodwork.

patio An atrium or interior open courtyard.

pattern staining Discoloration of plaster ceilings of composite construction, caused by the different thermal conductances of the backing. The air circulates more freely over the warmer parts, and deposits more dust on them.

pavement light A window of GLASS BRICKS built into a pavement surface, to admit natural light to a space below ground level.

pavilion (a) Originally a large tent. (b) A light ornamental structure, roofed but only partially enclosed in a garden or sports ground. (c) A projecting subdivision of a building, often elaborately decorated.

pawl A single tooth that engages a RATCHET.

Pb Chemical symbol for *lead* (plumbum).

PC Abbreviation for PRIME COST.

PCA Portland Cement Association, Skokie, IL, USA.

PCB Printed circuit board.

PDES Product data exchange specification. A US industry group formed for the development of product data exchange standards. Now allied with the STEP effort.

PE Abbreviation for POLYETHYLENE.

pea gravel Screened gravel, from which particles larger than 10mm and smaller than 5mm have been removed by sieving.

pearlite Same as PERLITE (b).

pearl lamp An electric light bulb etched to diffuse the emitted light. The etching is generally applied to incandescent lamps on the inside, and to tungstenhalogen lamps on the outside. Called a *frosted lamp bulb* in the USA.

peat Dead, gelatinous, compressible vegetable matter preserved by humic acid in the ground. It is unsuitable as a foundation material. However, it can be used as a fuel after drying.

pebble-dash An external plaster that has been surfaced with small stones, thrown on while the plaster is still wet.

pedestal The base of a classical column or superstructure. In modern construction, a short column whose height does not exceed three times its least lateral dimension.

pedestrian flow rate The movement of persons in passages and on stairs depends on the crowd density and the walking speed. If the crowd density exceeds 0.3 persons per square metre (0.03 persons per square foot), the walking speed is reduced.

pediment In classical architecture, a low-pitched GABLE above a PORTICO.

peen See [BALL-PEEN HAMMER](#).

pegboard A perforated hardboard. A pattern of holes is drilled during manufacture. These may serve a decorative or acoustic purpose, or they may, with special hooks, be used to support shelves and other fixtures.

pelmet A built-in head to a window for hiding the curtain rail.

Pelton wheel An impulse turbine, consisting of a wheel carrying buckets on its perimeter, which are struck by a fast-flowing water jet.

pendant (a) A hanging ornament. (b) A suspended LUMINAIRE. (c) A decorated boss in stone, stucco or timber, elongated so that it hangs down.

pendentive A set of spherical wall surfaces. These provide a transition from a dome to its supporting structure, which may be a set of walls or a set of arches. In Roman, Medieval and Islamic construction the pendentives were built of brick or stone, but they can also be built of concrete or reinforced concrete in modern construction. See also [SQUINCH](#).

penetration The intersection of two vault surfaces. See also [PILE PENETRATION](#) and [VICAT TEST](#).

penetration test Test of undisturbed soil with a *penetrometer*. It may be either STATIC or DYNAMIC. The information obtained supplements that collected from BOREHOLE SAMPLES.

penetrometer An instrument used for conducting a PENETRATION TEST.

pentagon A five-sided regular POLYGON. The angle included between the five equal sides is 108° .

penthouse A room, apartment, or separate dwelling built on the roof of a building.

penumbra (a) A partly shaded region around the total shadow (UMBRA) of the moon or Earth in eclipse. (b) The partly lit area around any area of full shadow.

perceived noise level (PNdB) The sound pressure level of a reference sound, which is judged to be equally *noisy* (not to be confused with equally *loud*) as the observed sound.

percentage reinforcement One hundred times the cross-sectional area of the reinforcement in concrete, divided by the width and the EFFECTIVE DEPTH.

percentage rent Rental income calculated according to a percentage clause in the lease document.

percent exceedance level The level of a fluctuating sound in the environment that is exceeded for N per cent of the observing time is called the N per cent exceedance level, L_N . The two most commonly used per cent exceedance levels are the L_{10} (used mainly for road traffic noise) and the L_{90} (usually taken as the BACKGROUND NOISE level).

percussion drill See [IMPACT DRILL](#) and [ROTARY HAMMER](#).

perforated hardboard Same as PEGBOARD.

performance guaranteed maintenance A lift maintenance contract that guarantees a certain performance of the lift system: for example, the number of lifts in service at any time, the lowest periods of downtime, and the longest mean time between failures.

performance indicator A measure of some aspect of the performance of activities, which enables a comparison to be made, for management purposes, against a standard target or norm.

performance specification A detailed description, which sets criteria of performance of an item but does not state how these are to be achieved.

performance testing Testing carried out on completion of building engineering services systems to demonstrate compliance with design intent as specified.

perigee Point in the orbit of the moon, planet or satellite that is nearest to the Earth (opposite of *apogee*).

perihelion Point in a planet's or comet's orbit that is nearest to the sun (opposite of *aphelion*).

perimeter air conditioning or heating A system that feeds air through registers located along the outer walls, supplied through ducts from a central plenum chamber.

perimeter grouting Injection of grout at low pressure around the periphery of an area. When the area is subsequently grouted at a higher pressure, the grout injection is confined by the perimeter, with consequent saving in grout.

period contract A fixed-term contract for services or goods, which is retendered or re-negotiated at the expiry of the contract.

periodic maintenance Maintenance carried out to a repeated schedule.

periodic table of the elements A classification table of the chemical elements, arranged in ascending order of atomic weight (the ATOMIC NUMBERS). The table is arranged in nine vertical columns, and the properties show periodicity in accordance with these nine groups. The system was initiated by the Russian chemist Dimitri Mendeleev in 1869.

periscope An apparatus consisting essentially of two prisms or two inclined mirrors, which enable an observer to obtain a view of objects at a different level. Although it is best known for its use in submarines to see objects above while remaining below water, the process can be reversed. The observer can insert a periscope into a model, and thus obtain from above the view that a person would get if it were possible to stand inside the model (*model scope*). The periscope can be used visually, or in conjunction with a television camera (*urban scope*).

perlite (a) A volcanic glass, usually with a higher water content than OBSIDIAN. It can be expanded by heating. *Expanded perlite* is used as an insulating material, and as LIGHTWEIGHT AGGREGATE. (b) A EUTECTOID composed of alternate laminae of iron and iron carbide, formed at about 720°C when steel is slowly cooled. The etched section has a pearly appearance. The proportion of perlite in carbon steels increases with the carbon content. Also spelled *pearlite*.

permafrost Permanently frozen ground, which exists in the northern parts of Russia, Canada and Alaska. Buildings erected on it must be specially insulated to prevent the heat generated by the building from melting the frozen soil and turning it into mud.

permanent memory In computing, memory that is not lost when power is switched off.

permanent supplementary lighting See [PSALI](#).

permeability The rate of diffusion of a gas or liquid under pressure through a material such as soil or concrete.

permeameter A laboratory instrument for measuring the coefficient of permeability, using DARCY'S LAW. The head of water has to be kept constant for highly permeable materials, such as sand or gravel; however, for the slowly permeable clays and silts it can be allowed to drop from an initial head (*falling-head permeameter*).

permissible stress See [MAXIMUM PERMISSIBLE STRESS](#).

permutation The number of permutations of n things, taken all at a time, is $n!$. The number of permutations of n things, taken r at a time, is $n!/(n-r)!$.

perpendicular A line or plane that meets another at right angles.

perpends The vertical joints on the face of brickwork.

Perry-Robertson formula A formula for the design of columns, which is more sophisticated than the RANKINE COLUMN FORMULA; the work of J.Perry (who derived it) and A.Robertson (who checked it experimentally in 1924). It is assumed that every slender strut has an unavoidable slight curvature, which is defined by the empirical constant in the formula.

perspective projection A pictorial PROJECTION in which the object is drawn the way the eye sees it. Lines that are parallel in plan are drawn to converge on a vanishing point, and lines that are parallel in the elevation and side elevation are also drawn to converge on their vanishing points.

Perspex Trade name of an ACRYLIC RESIN.

perspiration Moisture on the skin produced by sweating as part of the human thermoregulatory system. It is an important contributor to metabolic heat loss in conditions of high ambient temperature or when a person is subject to high rates of metabolic activity.

PERT Originally an abbreviation for program evaluation research technique, now interpreted as performance evaluation and review technique. This form of network analysis, developed mainly for military and aerospace work, differs in terminology, rather than in substance, from the CRITICAL PATH METHOD, developed for the construction industry.

Petersburg standard or Petrograd standard An obsolete measure of timber, which equals 1980 BOARD FEET (165ft³ or 4.67m³).

petrographic microscope A micro-scope fitted with a pair of NICOL PRISMS, one serving as a polariser and the other as an analyser. The characteristic colours produced by polarised light help to identify the minerals, particularly in igneous rocks.

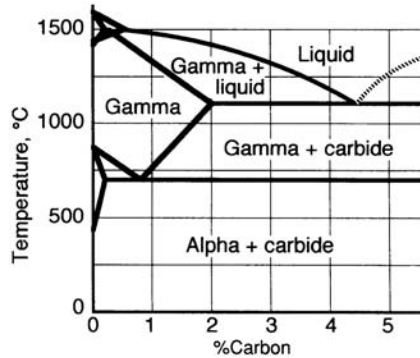

phase diagram

petrography Descriptive PETROLOGY.

petrology The science of rocks.

pewter An alloy consisting predominantly of TIN.

PF Phenol formaldehyde.

PFA Pulverised fuel ash, i.e. FLY ASH.

phase (a) A physically and chemically homogeneous portion of an alloy system, as shown in a PHASE DIAGRAM. (b) One of the windings or circuits of a polyphase electrical apparatus; also the recurring sequence of the electric wave. See also [THREE-PHASE SYSTEM](#). (c) State of existence of a substance, i.e. solid, liquid or gaseous.

phase change material A substance that undergoes a reversible phase change from the solid to the liquid state within a useful temperature range. It may be employed for the storage and subsequent release of heat.

phase diagram A diagram that shows the temperature as ordinate, and the composition range of an alloy as the abscissa. Although its main use is in metallurgy, it can be used to show the variation of the phases in non-metallic solutions and solid solution. The phase diagram can be used to illustrate the temperatures at which alloys made of any proportion of two or three elements exist in the liquid and the solid state, the temperatures at which transformations occur, the manner in which solubility changes with temperature, and other features of the behaviour of an alloy system. It is also called a *constitutional diagram*, an *equilibrium diagram* or an *alloy diagram*. See also [LIQUIDUS LINE](#) and [SOLIDUS LINE](#). The Figure shows the phase diagram for iron and carbon, which is important because it deals with carbon steel, cast iron and wrought iron.

phenol formaldehyde See [FORMALDEHYDE](#).

Phillips head A type of CROSS-HEADED SCREW.

phon A dimensionless unit used to define the loudness level of a sound. The HEARING THRESHOLD of an average young adult is defined as 0 phons. See also [A-SCALE ON A SOUND LEVEL METER](#).

phosphor A material capable of emitting light when irradiated by particles or ELECTROMAGNETIC RADIATION.

phosphorescent paint A paint which emits visible light for some minutes or hours after visible or ultraviolet light has fallen on it. It usually contains calcium sulphide, strontium sulphide or zinc sulphide. See also [FLUORESCENT PAINT](#).

photocell See [PHOTOVOLTAIC CELL](#).

photochemical reaction A chemical reaction aided by radiation, particularly from the visible and ultraviolet spectrum.

photochromic glass Glass that has the property of reduced transparency when exposed to higher levels of incident light. Currently under development for use in buildings, but in use for smaller items such as spectacle lenses.

photodetector See [PHOTOVOLTAIC CELL](#).

photoelasticity The property of certain transparent materials to break up the incident light, ordinarily oriented at random, into two components polarised in the directions of the PRINCIPAL STRESSES. By inserting a POLARISING FILTER, only light in one plane is transmitted. A model is placed between two filters at right angles, and no light is transmitted when the model is unstressed. When the model is stressed, coloured fringes (ISOCHROMATICS) appear, which connect points of equal difference between the two principal stresses (see also [MOIRÉ FRINGES](#)). Although the colours give a clear visual picture, and often make fascinating patterns, they make precise measurement difficult, and MONOCHROMATIC LIGHT is used for numerical analysis. The photoelastic effect was discovered in 1816 by David Brewster and first applied to model analysis by E.G. Coker in the 1920s.

photoelastic material A material that has the property, when stressed, of breaking up light into two components polarised in the directions of the principal stresses. It is possessed by several glasses, thermoplastics and casting resins, such as BAKELITE, PERSPEX, PLEXIGLAS, Catalin and Araldite. See also [THREE-DIMENSIONAL PHOTOELASTICITY](#) and [PHOTOSTRESS METHOD](#).

photoelectric cell Same as [PHOTOVOLTAIC CELL](#).

photoelectric effect The ejection of electrons from a solid by sufficiently energetic electromagnetic radiation.

photometer An instrument for measuring light, but the term is used to describe one measuring ILLUMINANCE. A photometer can be adapted for the measurement of LUMINANCE.

photometric Referring to LIGHT (visible ELECTROMAGNETIC RADIATION) as opposed to *radiometric*.

photometry (a) The branch of physics concerned with the measurement of light. (b) The measurement of lighting quantities.

photomicrography The production of photographic negatives and prints of very small objects, obtained by attaching a camera to a microscope.

photon A QUANTUM of light.

photo-optical smoke detector A fire detector that ‘sees’ the presence of smoke by means of a photo-optical device, such as a PHOTOVOLTAIC CELL.

photostress method PHOTOELASTIC analysis by means of photoelastic coatings, applied to a model in sheet form or as a solution backed by a reflective surface. The method was developed by the French engineer F. Zandman in the 1950s for determining surface strains. It does not require a transparent model.

photosynthesis The production of carbohydrates from carbon dioxide and water in the green cells of plants, using light as the source of energy.

phototropic Strictly, the response of plant growth to light, but extended to apply to people’s attraction to light.

photovoltaic cell An electric cell, comprising a thin layer of material on a dissimilar material, which produces a current at a constant voltage by absorbing radiation. Most PHOTOMETERS, EXPOSURE METERS of cameras, and PHOTO-OPTICAL SMOKE DETECTORS employ photovoltaic cells. By using a large enough array of cells it is possible to generate sufficient electricity from SOLAR ENERGY to operate electric equipment and lights. Also called *photoelectric cell*. See also SELENIUM and SILICON.

pH value The logarithm to the base 10 of the reciprocal of the concentration of hydrogen ions in an aqueous solution, in moles per litre. Water has a pH value of 7; basic solutions are higher than 7, and acid solutions lower than 7. It is normally measured with an electrical instrument, and used particularly to express small differences in the alkalinity or acidity of neutral solutions.

physical depreciation The reduction in property value due to deterioration of the physical fabric because of wear and tear, inadequate maintenance, and weathering and decay.

pi (π) The circular constant 3.1416....

piano nobile In Renaissance and neo-Renaissance architecture, the storey containing the reception rooms, usually one flight of stairs above ground level.

pica See POINT.

pickled The state of a metal surface that has been oxidised by an acid treatment.

pico (p) Prefix for one millionth millionth, from the Spanish word for a little bit, e.g. 1pm=1 picometre= 1×10^{-12} metre.

pict Abbreviation for PICTURE files.

picture rail A moulding fixed to an interior wall. Pictures may be suspended from it by means of metal hooks, which fit over the top of the moulding.

picture window A large window whose bottom ledge is less than waist high.

piecework A scheme for payment of a uniform price per unit produced.

pier A massive compression member.

piezoelectric effect The production of electricity as a result of the distortion of some crystalline materials. This effect is used in inexpensive gramophone cartridges and MICROPHONES and in load cells for measuring forces. The term is also used for the reverse effect where an electric field will distort a crystal: hence piezoelectric transducers are used in ULTRASOUND and audio applications, such as alarms.

piezometer An instrument for measuring pore water pressure.

pig A mass of metal, such as cast iron, lead or copper, cast into a simple shape, which is subsequently remelted for purification, alloying or processing. The term originated with the now obsolete method of running the liquid metal from the blast furnace into a channel in a bed of sand, called a *sow*. From there it ran into smaller lateral channels, called *pigs*.

pigment An *opaque* colouring agent (for paints etc.), as distinct from a *dye*, which is a transparent colour. See [BLANC FIXE](#), [CADMIUM YELLOW](#), [CARBON BLACK](#), [CHINESE WHITE](#), [IRON OXIDES](#), [LAKE](#), [LITHOPONE](#), [MINERAL PIGMENT](#), [PRUSSIAN BLUE](#), [RED LEAD](#), [RED OXIDE](#), [ULTRAMARINE](#), [VERMILION](#), [WHITING](#) and [WHITE LEAD](#). See also [FLUORESCENT PAINT](#) and [PHOSPHORESCENT PAINT](#).

pilaster A column built into a wall, and projecting slightly from it.

pile A long slender column of timber, concrete or steel embedded in the foundation. It may be driven, jacked, jetted or (in the case of concrete) cast in place. See also [BEARING PILE](#), [IN-SITU PILE](#) and [SHEET PILE](#).

pile cap (a) A protective cap fitted over the head of a pile during driving. (b) A structural member designed to distribute the load from a column or wall to a group of piles.

pile hammer A hammer for driving piles into the soil. Drop hammers, which depend purely on gravity, go back to Roman times, but are still commonly used because of their reliability. Power-operated double-acting hammers, however, are faster since they can deliver up to 300 blows per minute.

pile head The top of a pile. Since the penetration of piles driven to REFUSAL cannot be accurately predicted, the heads are often cut off after driving.

pile penetration The depth reached by the tip of a pile. It generally refers to the depth at REFUSAL.

pile shoe A point of cast steel or cast iron at the foot of a driven pile of timber or precast concrete.

pillar (a) A vertical compression member. (b) In classical architecture, a vertical compression member that was not circular.

pin joint A joint between two or more members of a structure that transmits no moment, as opposed to a RIGID or SEMI-RIGID JOINT. Pin joints are so called because in the mid-nineteenth century they frequently consisted of pins pushed through a hole in each of the members to be joined. True pin joints are today rare, except for very large spans where complete certainty of freedom to rotate is required. Normally 'pin joint' denotes a flexible joint, or a joint at the end of a flexible member, which transmits only a negligible moment. Pin joints may be deliberately introduced into structures to render them STATICALLY DETERMINATE. See also [PLASTIC HINGE](#).

pink noise Broadband noise, which randomly varies in phase and intensity at each frequency and which has equal energy per *unit* bandwidth. See also [WHITE NOISE](#).

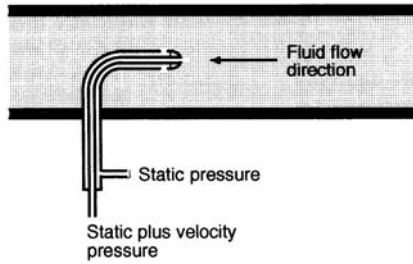

pitot-static tube

pipe column A column made from steel tubing. It is frequently filled with concrete to increase its stiffness and strength.

pipework An assembly of pipes and fittings used for the conveyance of fluids.

pipe wrench An adjustable spanner in which the grip is tightened by load application.

pisé de terre Wall of unburnt clay or chalk, rammed in a damp condition into formwork without reinforcement, except sometimes straw. This is a vernacular form of construction in several arid regions. With a protective coating it can also be used in areas of moderate rainfall. See also [COB](#) and [ADOBE](#).

pit The part of a LIFT WELL situated below the lowest landing served.

pitch (a) In acoustics, subjective assessment of the frequency of a tonal sound. (b) Dark viscous residue remaining after distillation of wood tars, petroleum or coal.

pitch mastic See [MASTIC](#) (c).

pitch of a roof The angle of a sloping roof, usually defined by the *ratio* of rise to span.

pith A soft core in the centre of a wooden log.

pi-theorem (π -theorem) A theorem published by E. Buckingham in 1914, which establishes the number of dimensionless ratios (π s) required for dimensional similarity between two physical phenomena (e.g. a prototype and its model). If the two phenomena are determined by r parameters, which can be expressed in terms of n primary dimensions (length, mass, time, etc.), then the number of π s is $(r-n)$. See also [DIMENSIONAL ANALYSIS](#).

pitot-static tube An open-ended tube within a closed outer tube with holes in the circumference near the end (see Figure). The open end faces in the direction of motion of a fluid and provides a measure of total (i.e. static plus velocity) pressure in the fluid. The holes in the circumference of the outer tube provide an indication of static pressure; the difference indicates the velocity pressure. The two tubes can be connected to a manometer to provide direct readings of static, velocity or total pressure as required.

pit switch An isolating switch located in a lift PIT to remove the electrical supply from the drive machine and brake.

pixel Abbreviation for picture element, the smallest part of an image on a computer screen.

pixel image An image on a screen composed of a number of PIXELS.

plain bar or wire A reinforcing bar or wire without deformation to improve bond, as opposed to a DEFORMED BAR or an INDENTED WIRE.

plain concrete Concrete that is neither reinforced nor prestressed.

plain tile See [ROOF TILE](#).

plan Representation of an object as seen on a horizontal plane, viewed from above.

planar Lying in one plane; flat.

Planckian radiator See [FULL RADIATOR](#).

Planck's radiation law An expression for the spectral distribution of radiant energy from a FULL RADIATOR, in terms of its temperature. WIEN'S LAW gives the wavelength corresponding to the maximum ordinate of the Planck curve, and the STEFAN-BOLTZMANN LAW gives the area under the curve.

plane A hand tool for smoothing timber. A sharp blade, inclined to the surface of the timber, projects by a small and adjustable distance below the sole of the tool. See also [PLANER](#).

plane angle An angle measured in two dimensions, as distinct from a SOLID ANGLE.

plane frame See [FRAME](#).

plane of saturation The water table in soil.

planer A powered tool for smoothing timber. Several sharp blades, attached to a rotating drum, remove small shavings as they pass over the timber: (a) in the case of a hand planer, the blades are mounted in the tool which is pushed over the (stationary) timber; (b) in the case of a floor-mounted machine, also called a *thicknesser* or *jointer*, the timber is pushed by hand or driven by rollers, past the rotating blades.

plane table A device for plotting the results of a survey directly from the observations. It consists of a drawing board mounted on a tripod, a SPIRIT LEVEL, and a ruler (called an *alidade*) with two sights, which are pointed at the object to be observed. If the distances are substantial, an alidade with a telescope is used.

planimeter An instrument for measuring areas by mechanical means. It is a simple type of integrator.

planing machine A machine that removes shavings from a metal surface by pushing it past a stationary tool. See also [PLANER](#), which usually describes a woodworking machine, and SHAPING MACHINE.

planned/scheduled maintenance Preventive maintenance scheduled to be performed at specific intervals, or after a number of operations.

planning grid A network of horizontal and perpendicular lines to assist the designer with a layout plan.

plant room A room set aside for the installation of the equipment used for the engineering services of a building.

plaster Any pasty material of mortar-like consistency, used for covering the walls or ceilings of a building. The traditional plasters based on lime or gypsum are now rare, and Portland cement, mixed with sand and water, is the common material for plastering.

plasterboard A building board made of a core of gypsum or anhydrite plaster, faced with two sheets of heavy paper.

plaster lath See [LATH](#).

plaster of Paris Hemihydrate of GYPSUM ($\text{CaSO}_4 \cdot \frac{1}{2}\text{H}_2\text{O}$). It occurs naturally, and there were large deposits near Paris; hence the name. It is more commonly made from gypsum by driving off some of its water by heat. When mixed with water it sets rapidly with formation of heat, and expands in the process. Hence it is particularly useful for making accurate casts. Also known as *hemihydrate* plaster. The setting is too rapid for many building applications, and *retarded hemihydrate plaster* contains a retarder, usually *keratin*. If plaster is to be used in conjunction with iron or steel reinforcement, it is necessary to add about 5 per cent of hydrated lime to prevent corrosion.

plastic cracking Cracking that occurs on the surface of fresh concrete soon after it is placed. It is often confused with SHRINKAGE CRACKING; however, plastic cracks can be filled in by trowelling, while shrinkage cracks occur during the HARDENING stage.

plastic deformation Continuous permanent deformation in metals, which occurs above a critical stress, the YIELD or PROOF STRESS. The ELASTIC DEFORMATION results from straining of the crystal lattice. Plastic deformation normally occurs by slipping action at a DISLOCATION IN A CRYSTAL when the interatomic forces become too high. It depends on the ability of the metal to sustain distortion of the crystal structure without fracture.

plastic design LIMIT DESIGN based on the formation of PLASTIC HINGES.

plastic hinge After structural steel has reached its LIMITING STRENGTH, which is the YIELD STRESS, it continues to deform at a constant stress until its deformation is several times as much as the total elastic deformation. Once it becomes a fully PLASTIC MATERIAL (See Figure), a hinge forms, which can be rotated without further increase in the bending moment. When sufficient hinges have formed to turn the structure into a mechanism, it collapses. See [LIMIT DESIGN](#).

plasticiser (a) An admixture to mortar or concrete, which increases its workability. However, some plasticisers also reduce the strength. (b) A non-volatile substance mixed with the medium of a paint, lacquer or varnish to improve the flexibility of the hardened film.

plasticity index The numerical difference between the LIQUID LIMIT and the PLASTIC LIMIT. It is indicative of the range of water content through which a soil remains plastic.

plastic limit The water content at which a damp clayey soil just begins to crumble when rolled into a thread approximately 3mm diameter. See also [PLASTICITY INDEX](#).

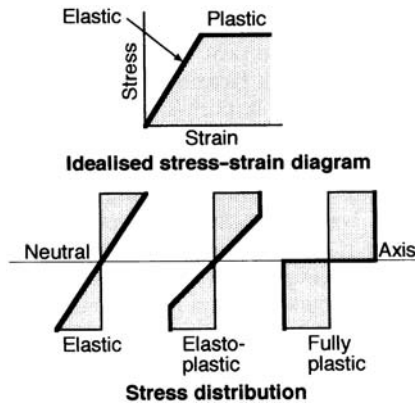

plastic hinge

plastic material A term that is often confusing in discussions between architects and engineers. In materials science and in rheology, plasticity denotes the ability of a material to deform at a constant stress without fracture. Thus structural steel is the plastic material par excellence, from an engineer's point of view. In sculpture, a plastic material is one that can be freely moulded, unlike stone or steel, which must be finished by cutting. From this point of view, concrete is the ideal plastic material of architecture because it can be cast into any mould chosen by the designer. However, as an engineering material concrete is BRITTLE, which is the very opposite of plastic. See also [PLASTICS](#).

plastic mortar A mortar of a consistency that allows it to be readily deformed during bricklaying or blocklaying without disintegrating. Plasticity is sometimes improved by additives, called plasticisers.

plastic paint (a) A vague term for a paint whose medium is a *plastic*, i.e. a synthetic resin. (b) A *texture paint*, i.e. a paint that can be used plastically for relief modelling.

plastics A generic term for organic substances, mostly synthetic and formed by condensation or polymerisation, which become plastic under heat or pressure. They can then be shaped by moulding or extrusion. They are also used for laminates, paints, lacquers and glues. The main distinction is between THERMOPLASTIC and THERMOSETTING plastics.

plastic section modulus (S) The SECTION MODULUS used in PLASTIC DESIGN, which is tabulated in section tables. The *shape factor* is the ratio

$$\frac{\text{plastic section modulus}}{\text{elastic section modulus}}$$

and its value for structural steel sections is about 1.15.

plastic tile A tile made from plastic, commonly PVC, as opposed to a ceramic tile.

plastic wood A paste of wood flour, synthetic resin, and a volatile solvent. It is used for filling holes and cracks in timber. Its surface can be painted about an hour after application, so that the stopping of holes is frequently undertaken by the painter, and not by the carpenter.

plate, flat See [FLAT PLATE](#).

plate, metal Thicker than metal SHEET.

plate compactor A machine consisting of a flat metal plate on which is mounted an internal combustion engine with an eccentric flywheel, to cause vibration. It is pushed over the surface of sand, gravel or other filling material in order to compact it.

plate girder A steel girder built up from vertical web plates and horizontal flange plates. Also called a *welded beam*.

plate glass Glass of better quality than ordinary SHEET GLASS. It is usually thicker, with a smoother surface free of blemishes. Now largely superseded by FLOAT GLASS.

platen (a) The plate in a printing machine that presses the paper against the inked type. (b) A hot steel plate used in presses that make plywood with thermosetting glues. (c) A smooth steel plate used to compress a specimen in a testing machine.

plenum (a) A duct maintained at a pressure slightly above atmospheric, so that it can be used for the supply of air but return air is kept out by the excess pressure. (b) The air space in an INTEGRATED CEILING, which may be above atmospheric pressure if used for the air supply or below atmospheric pressure if used for the air exhaust.

plenum chamber An air compartment maintained at a pressure slightly above atmospheric, to distribute that air to one or more ducts or outlets.

plenum system A method of heating or air conditioning whereby the air forced into the building is at a pressure slightly above atmospheric.

Plexiglas Trade name of an ACRYLIC RESIN.

plinth In classical architecture, the projecting base of a wall or column PEDESTAL, moulded or chamfered at the top. The term is now used for a platform, or a slight widening at the base of a wall or column.

plot ratio The gross floor area of a building divided by the area of its site. The basic ratio permitted is frequently modified by providing a bonus for arcades, setbacks, plazas, and the incorporation of existing buildings of architectural significance.

plotter An output device for a digital computer, which presents the results in graphical form on paper or film; usually used as an output device for graphics. See [DRUM PLOTTER](#), [FLAT BED PLOTTER](#) and [ELECTROSTATIC PLOTTER](#).

plum A random-shaped stone weighing 50kg (100lb) or more, which is dropped into MASS CONCRETE to economise on cement and reduce the generation of heat. *Cyclopean concrete* is mass concrete containing a large number of plums.

plumb (a) To determine the direction of the vertical with a line weighted with lead (*plumbum*). (b) Any other method of lining up a building element in the vertical direction. (c) Vertical.

plumbago *Black lead*, an obsolete term for GRAPHITE.

plumb bob A weight of any material at the end of a line to give it a vertical alignment.

plumber's solder An alloy of lead and tin. *Coarse solder* consists of 3 parts of lead to 1 of tin; it melts at 250°C. *Fine solder* consists of equal parts of lead and tin; it melts at 188°C.

plumbing An assembly of pipes, fittings and fixtures used for: (a) the supply and distribution of water under pressure, whether in the ground or within a building; (b) the removal of waste water or rainwater by gravity flow, within a building. The system for removal of this material in the ground is called *drainage*.

plumbing fixture See BALLCOCK, BIDET, CISTERN, FAUCET, GREY WATER, WATER CLOSET, WATER HAMMER, WATER HEATING, INSTANTANEOUS, WATER HEATING, STORAGE and WATER SEAL.

plutonic intrusions IGNEOUS ROCKS that have cooled slowly at great depth below the Earth's surface, and are therefore coarse-grained.

ply A thickness of material, used for building up several layers, as in plywood and built-up roofing.

plywood Material consisting of two or more plies of wood, with the grains of adjacent plies usually at right angles to one another. The outer plies are often veneers of decorative timber, while thicker and cheaper timber may be used inside. Plywood overcomes the inherent weakness of timber across the grain by lamination at right angles.

PMMA Polymethyl methacrylate, an ACRYLIC RESIN.

PMV Abbreviation for PREDICTED MEAN VOTE

pneumatically applied mortar Same as SHOTCRETE.

pneumatic caisson A CAISSON whose working chamber is kept sealed so that work may proceed inside under compressed air.

pneumatic loading Same as AIR-BAG LOADING.

pneumatic structure A structure held up by a slight excess of internal air pressure above the pressure in the atmosphere outside. It must be sufficient to balance the weight of the roof membrane, and must be maintained by air compressors or fans.

pneumatic tool A tool worked by compressed air.

POE Abbreviation for POST-OCCUPANCY EVALUATION.

point As a measure of length: (a) 1 point of rainfall=1/100in. (0.254mm); (b) 1 printer's point=1/72in. (0.351mm); 12 printers' points=1 pica (4.2mm).

point bearing pile An END-BEARING PILE.

pointing (a) Pressing surface mortar into a RAKED JOINT. Pointed mortar joints are not as durable as joints made with the original bedding mortar; however,

the practice of pointing joints in white, black or coloured mortar was once common. (b) The finishing operation on a mortar joint, without the addition of surface mortar.

pointing device A generic name for a device that moves a CURSOR on a computer screen, such as a MOUSE or TRACKBALL.

point load A concentrated load, as opposed to a distributed load.

point of contraflexure See [CONTRAFLEXURE](#).

point of inflection Same as POINT OF CONTRAFLEXURE.

point source A source of radiant energy of negligible dimensions compared with the distance between source and receptor.

poise A unit for measuring dynamic viscosity; it equals 0.1 pascal-second.

Poisson's ratio The ratio of lateral unit STRAIN to longitudinal unit strain, when a piece of material is subjected to a uniform and uniaxial longitudinal stress; defined by S.D.Poisson, a French mathematician, in 1829. For a fully plastic material it is 0.5. For steel it is about 0.25, and for concrete about 0.12. See also [MODULUS OF RIGIDITY](#).

poker vibrator An internal vibrator that is immersed in the wet concrete.

polar coordinates A system of coordinates based on the radial distance r from a reference point and the angle θ with a reference axis, in place of the conventional CARTESIAN COORDINATES x and y . It is useful for problems framed in terms of circular functions. Polar graph paper greatly facilitates a graphical solution.

polariscope An instrument for showing phenomena connected with PHOTOELASTICITY. It consists of two POLARISING FILTERS or NICOL PRISMS, a MONOCHROMATIC light source, and a holder or testing device for the model. QUARTER-WAVE PLATES are frequently added.

polarised light Light whose waves are confined to a single plane. Normal light, whose waves vibrate in space, can be polarised in a plane by passing it through a NICOL PRISM or a POLARISING FILTER, or by reflecting it from a glass plate at a particular angle.

polarising filter A filter for producing POLARISED LIGHT.

polarising microscope See [PETROGRAPHIC MICROSCOPE](#).

polarity (a) The negative and positive terminals in an electric circuit. (b) The north and south poles of a magnet.

polar moment of inertia Moment of inertia about an axis *normal* to the plane of the section or area. The term *moment of inertia* without prefix implies a moment about an axis *in* the plane of the section.

Polaroid (a) A (trade name for a) type of plastic that can (plane) polarise a transmitted beam of light as a result of the orientation of the long molecules. (b) A camera (*Polaroid Land camera*) capable of producing finished photographs 'in the camera' using a sandwich of negative, chemicals and print paper.

poles The two points where the MERIDI ANS OF LONGITUDE intersect.

polyamide (PA) A group of plastics better known by their trade name NYLON.

polycarbonate A thermoplastic used for moulded parts and in sheet form where high impact strength and heat resistance is required.

polyester resins A group of resins that contain an ester (—COO—) link. Some are used with FIBREGLASS reinforcement.

polyethylene (PE) A low-cost thermoplastic polymer of ethylene. It is an ELASTOMER, which is completely waterproof, and is therefore widely used for bags, protective wrapping, and pipes. It forms a cheap waterproof membrane, but must be protected against puncture. Also called *Polythene*.

polygon A many-sided plane figure. A *regular* polygon is one that is equiangular and equilateral. The included angle of a regular (commonly called equilateral) *triangle* is 60° , and that of a regular *quadrilateral (square)* is 90° . Other included angles are: regular pentagon 108° ; regular hexagon 120° ; regular heptagon 128.5° ; regular octagon 135° ; regular nonagon 140° ; regular decagon 144° ; regular dodecagon 150° .

polygon of forces A figure analogous to the TRIANGLE OF FORCES, representing the statical equilibrium of more than three forces.

polyhedron A solid figure bounded by plane surfaces. There are only five *regular* polyhedra, bounded by identical polygons: the TETRAHEDRON, the CUBE, the OCTAHEDRON, the DODECAHEDRON and the ICOSAHEDRON. In addition there are a large number of semi-regular polyhedra, which are bounded by two or more types of regular polygon but are otherwise symmetrical. These are important for the design of GEODESIC DOMES.

polyline In computer graphics, a single linear entity composed of a series of connected LINE elements.

polymer See [POLYMERISATION](#).

polymer-cement concrete A concrete in which a blend of cement and plastic is used as a binder.

polymer concrete A concrete in which a plastic is used as a binder, instead of Portland cement.

polymerisation The combination of several molecules to form a more complex molecule, having the same empirical chemical formula as the simpler ones. It is often a reversible process (see [DEPOLYMERISATION](#)). Some of the most successful plastics used in buildings are produced by polymerisation (which is also called CURING (b)).

polymethyl methacrylate (PMMA) An ACRYLIC RESIN.

polymorphism The existence of more than one *crystal structure* for a single composition.

polynomial An expression consisting of many terms, but all of the type ax^n where a is a constant, x is the variable, and n is a positive integer.

polypropylene (PP) A low-cost thermoplastic material, whose properties are similar to those of high-density polyethylene.

polystyrene (PS) A *thermoplastic* material formed by the polymerisation of styrene ($\text{C}_6\text{H}_5\cdot\text{CH}:\text{CH}_2$). It is resistant to moisture, strong alkalis, several acids, and alcohol, but softens at 60°C (140°F). In transparent form it is brilliantly

clear. Expanded polystyrene is one of the EXPANDED PLASTICS used as an insulating material.

polysulphide A thermosetting resin, used as a building sealant. It is usually polymerised by mixing it with a catalyst immediately before application, and is then poured in place.

polytetrafluoroethylene (PTFE) A crystalline, linear polymer, unique among organic compounds in chemical inertness. It is resistant to all alkalis and acids, even to AQUA REGIA. It does not have a melting point, but undergoes a phase transformation at 330°C (620°F), with a sharp drop in strength. It is marketed under the trade names *Teflon* and *Fluon*.

Polythene Trade name of a make of POLYETHYLENE.

polyurethane A group of plastics used mainly as a light insulating material in the form of flexible or rigid foam (see EXPANDED PLASTIC); also as a high-gloss waterproof paint finish, and as a sealant.

polyvinyl acetate (PVA) A thermoplastic material formed by the polymerisation of vinyl acetate ($\text{CH}_3\text{COOCH}:\text{CH}_2$). It is the binding agent in many EMULSION PAINTS.

polyvinyl chloride (PVC) A low-cost thermoplastic material formed by the polymerisation of vinyl chloride ($\text{CH}_2:\text{CHCl}$). It is a rubbery material, used for insulating electrical cables. It does not sustain combustion, and is resistant to water, oil and many chemicals. Thus it can be used for cold water pipes, as a flooring material (particularly in the form of tiles), as a water-proof membrane, and as an expansion joint.

ponding Accumulation of water on a *flat roof* due to an insufficient slope or inadequate drainage. It may cause excessive loads, producing additional and progressive deflection.

pop rivet See BLIND RIVET.

population (a) In statistical terminology, the totality of all possible values of a particular characteristic for a UNIVERSE. A universe could have several populations associated with it. For example, we could interview the same group of persons in an office, and ascertain their response to noise (population 1), their response to the thermal conditions (population 2), and their response to the level of illumination (population 3). (b) In computing, used in evolutionary programming to denote a set of individuals to be evolved.

population factor The average floor space occupied by a person in a building: that is, the total floor space available divided by the number of people who use it.

pop-up menu In computing, a MENU that appears during execution.

porcelain Glazed pottery made from CHINA CLAY, used for fine tableware, for electric insulators, and for dielectrics.

porcelain enamel Same as VITREOUS ENAMEL.

pore One of the small interstices between the particles of permeable solids (e.g. masonry materials, soils, timber etc.). The term usually applies to spaces into which water will penetrate by capillary attraction.

pore-water pressure The pressure of water in a saturated soil.

porosity The ratio of the volume of voids to the total volume of a sample of soil. It equals $v/1+v$, where v is the VOIDS RATIO.

porous absorber A material that absorbs sound because of the damping of the air movement due to the passage of the sound through pores or over fibres of a material.

porphyry A generic term for IGNEOUS ROCKS that contain a few large crystals in a fine-grained groundmass.

port A socket in a computer for connecting an input/output device.

portal A monumental door or gateway. Hence, a frame consisting of two columns and a member, which may be horizontal, sloping or arched.

porte-cochère A porch that can be entered by a vehicle.

portfolio management The acquisition, use and disposal of an organisation's property assets in accordance with strategic requirements.

portico A roofed space, open or partly enclosed, which forms the entrance to a building.

Portland blast-furnace slag cement Cement consisting of a mixture of PORTLAND CEMENT and BLAST-FURNACE SLAG in specified proportions. It can be produced by mixing the Portland cement clinker with granulated blast-furnace slag before grinding, or by blending the ground cement with finely granulated slag.

Portland cement The most common form of cement. It is made by burning together chalk or limestone and clay or shale, and grinding the resulting clinker into a fine powder. The result is a complex mixture of calcium silicates (see [DICALCIUM SILICATE](#) and [TRICALCIUM SILICATE](#)) and calcium aluminates, which sets into a hard paste when it comes into contact with water. Portland cement, mixed with sand and AGGREGATE, forms CONCRETE. The name *Portland cement* is due to J.Aspsden, who patented the first artificial cement in England in 1824.

Portland-pozzolan cement A blend of PORTLAND CEMENT with finely ground POZZOLANA, or a cement made by grinding a mixture of Portland cement clinker and pozzolana.

Portland stone An OOLITIC LIMESTONE, quarried on the Isle of Portland, off the coast of Southern England. Because of its durability and the ease with which it can be carved, it has been a particularly popular stone for monumental and residential buildings in London.

positive bending moment A BENDING MOMENT that causes sagging or concaveup curvature. In simply supported and continuous beams the maximum positive bending moments occur near mid-span. See [NEGATIVE BENDING MOMENT](#) for illustration.

positive reinforcement Reinforcement placed in concrete beams to resist the POSITIVE BENDING MOMENT, i.e. near the bottom face.

post-and-beam construction A system of construction in which posts and beams are the main loadbearing members.

post-hole auger A hand-operated AUGER for boring holes in soil.

post-occupancy evaluation The process of evaluating an occupied facility, considering factors such as conformance to brief, user satisfaction, functionality, technical performance and cost efficiency.

post-stressing Obsolete term for *post-tensioning*.

post-tensioning PRESTRESSED CONCRETE in which the TENDONS are tensioned *after* the concrete has hardened; as opposed to PRE-TENSIONING.

postulate A simple proposition of a self-evident nature, which requires no proof, and generally cannot be proved. Also called *axiom*.

potable water Water that is suitable for human consumption.

potassium A very reactive ALKALI metal. Its chemical symbol is K, its atomic number is 19, its atomic weight is 39.096, and its specific gravity is 0.86. It has valency of 1, a melting point of +62.5°C, and a boiling point of 762°C.

potential energy ENERGY due to position, as opposed to *kinetic energy*.

pot floor Same as HOLLOW-TILE FLOOR.

pot life Time interval after mixing during which a liquid material is useable, e.g. an adhesive mixed from a powdered resin and a liquid HARDENER. See also [SHELF LIFE](#).

pound The unit of mass and weight in FPS UNITS, abbreviated *lb*, and sometimes *lbf* for pound-force.

poundal An obsolete unit of force in the FPS system, which causes a mass of 1 pound to accelerate at 1ft per second per second.

pound-foot, pound-inch The unit of bending moment and twisting moment in FPS UNITS. The unit of energy and work is usually called FOOT-POUND.

powder coat A form of surface decoration in which a fine powder is applied to the surface of the item by *electrostatic attraction*; the item is then baked in an oven to cause the powder to melt, coalesce, and adhere to the surface. The result is a smooth and durable coating, but since it must be done in a factory before installation, any subsequent damage is difficult to repair to the same standard.

powder metallurgy The technique of agglomerating metal powders into engineering components.

powder post borings Worm holes filled with a fine, dust-like flour from the boring of worms.

power (a) In electrical systems, the vector product of voltage and current. Hence, in direct current systems, it is identical to watts. In alternating current systems, it has two components: the REAL POWER (measured in watts) and the imaginary or REACTIVE POWER (measured in VAR or volt-amps-reactive).

(b) In mechanics, the rate of doing *work* or converting ENERGY from one form to another. The SI unit of power is the watt (W), which is one joule per second (J/s). See also [HORSEPOWER](#). (c) Of a colour: in the MUNSELL BOOK OF COLOR the power scale is the composite of VALUE and CHROMA. Thus 4/14 means a colour slightly darker than the middle value between black and white, and 14 arbitrary steps from the equivalent grey.

power factor In alternating current electrical systems, the ratio of the REAL POWER to the APPARENT POWER. It is also the cosine of the phase difference between the voltage and current waveforms.

power float A powered machine, the base of which consists of a three-bladed propeller-like device, about a metre (3 ft) in diameter. The blades rotate on a fresh concrete surface to act as trowels. Their angle of inclination is adjustable to achieve the desired finish. Also called *trowelling machine* or, colloquially, *helicopter*.

Pozidriv head screw A type of CROSS-HEADED SCREW.

pozzolana (also pozzolan, pozzuolana) (a) A volcanic dust, first discovered on the slopes of Mount Vesuvius near Pozzuoli, called *pulvis puteolanus* by Vitruvius. When mixed with lime mortar, it produces a waterproof or HYDRAULIC CEMENT. It was used in Ancient Rome for high-quality work. (b) Any natural deposit, usually of volcanic origin, which has pozzolanic properties. See [SANTORIN EARTH](#) and [TRASS](#). (c) An artificial substance, usually a siliceous, or a siliceous and aluminous material, with pozzolanic properties. Although it possesses little cementitious value by itself, it reacts, in finely divided form and in the presence of water, with HYDRATED LIME ($\text{Ca}(\text{OH})_2$) to form a HYDRAULIC CEMENT. The reaction takes place at ordinary temperatures, whereas the manufacture of PORTLAND CEMENT requires burning of the silica and the lime.

PP Abbreviation for POLYPROPYLENE.

PPD Percent predicted dissatisfied. Derived by P.O.Fanger from his PREDICTED MEAN VOTE equation to predict the proportion of a large sample of occupants likely to be dissatisfied in a particular thermal environment.

ppm Parts per million.

practical completion The point in the execution of a contract at which the works are deemed to be essentially completed and ready for use, subject to minor defects, acknowledged by the issue from the superintendent of the works of a certificate of practical completion to the contractor.

Prandtl number A non-dimensional ratio used as a criterion for the similarity of temperature gradients in fluids. It is the ratio

$$\frac{\text{specific heat} \times \text{viscosity}}{\text{thermal conductivity}}$$

Prandtl's membrane analogy See [MEMBRANE ANALOGY](#).

Pratt truss A STATICALLY DETERMINATE truss, also called *N-truss*, consisting of top and bottom chords, regularly spaced vertical compression members, and diagonal *tension* members; as distinct from a HOWE TRUSS. It is used for medium to long spans in buildings and for small bridges (see Figure). See also [WARREN TRUSS](#).

precast concrete Concrete cast and cured, and subsequently placed in its final location, as opposed to CAST IN PLACE concrete.

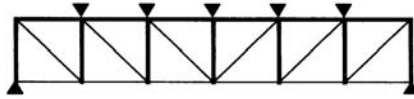

Pratt truss

precast pile A concrete pile that is cast and subsequently driven, as opposed to a BORED PILE, which is cast in place.

precast stone Same as ARTIFICIAL STONE.

precipitation (a) Separation and deposition of a substance in solid form from solution in a liquid. (b) Condensation and deposition of moisture from water vapour held in the air or in clouds. (c) That which is so deposited, i.e. a collective term for dew, rain, hail and snow.

precipitation hardening Same as AGE HARDENING.

pre-cooling The cooling of air prior to mixing with return air in an air conditioning system. Air may also be *pre-heated*.

predicted mean vote (PMV) A concept developed by P.Fanger in Denmark as an index of thermal comfort. It is a number calculated from the physical variables that influence human thermal comfort, which represents the mean vote likely to be recorded from a large sample of building occupants when required to indicate thermal sensation by voting on a seven-point scale from -3 (cold) to +3 (hot). It is the basis of the International Standards Organization Document 7730, which is widely used in Europe as a standard for defining thermal comfort. See also [PPD](#).

prefabrication Same as INDUSTRIALISED BUILDING.

preferred angle The preferred angle of inclination of stairs, ramps etc. Building codes specify the acceptable range of angles for stairs and ramps, and industrial regulations control the use of ladders.

premature stiffening Of mortar and concrete: see [FALSE SET](#).

premises The property, including the buildings, structures and grounds, that is included in a title to ownership, or a deed of conveyance.

preservative A substance that inhibits decay, infection or attack by fungi, insects, marine borers etc. (as distinct from corrosion by chemicals), e.g. in timber. See also [PRIMER](#).

pressed brick A brick without holes made by pressing a relatively dry clay mix in a mould, as opposed to an EXTRUDED BRICK.

pressure Force per unit area. The SI unit of pressure is the pascal; $1 \text{ Pa} = 1 \text{ N/m}^2$.

pressure, atmospheric The pressure exerted by the weight of the air at the surface of the Earth at sea level is 1 atmosphere = 101.325 kPa = 14.7 psi = 760 mm of mercury = 1013.25 mb. See also [ATM](#), [MERCURY](#) and [MILLIBAR](#).

pressure, hydrostatic The pressure of a fluid at rest where all forces act normally to a boundary surface and are independent of viscosity. In the case of an incompressible fluid in contact with the atmosphere, the *gauge pressure* is a

product of the specific weight of the fluid and the vertical depth below the free surface; pressure varies linearly with depth.

pressure bulb See [BOUSSINECQ PRESSURE BULB](#).

pressure differential A difference in pressure of air maintained between adjoining spaces to control direction of flow, e.g. from a clean to a dirty area in a hospital.

pressure drop The reduction in pressure due to friction when a fluid flows in a pipe, duct or conduit.

pressure gauge See [BOURDON GAUGE](#) and [MANOMETER](#).

pressure gradient Average rate of pressure drop due to flow of a fluid in a pipe, duct or conduit.

pressure vessel A closed tank designed to hold a fluid under a pressure higher than that of the atmosphere in which it is located.

pressurisation The maintenance of a pressure in a contained fluid above that of the surrounding atmosphere.

prestressed concrete Concrete that is precompressed in the zone where tensile stresses occur under load; consequently cracking of the concrete due to tension is avoided. The prestressing can be accomplished by jacking the concrete against a rigid abutment; but the usual technique is to tension TENDONS of high-tensile steel. Prestressing is classified as PRE-TENSIONED or POST-TENSIONED, depending on whether the tendons are tensioned before or after the concrete has hardened.

prestressed shell A SHELL containing some prestressing TENDONS in addition to normal reinforcement, e.g. in edge beams. It is uncommon to prestress the membrane surface of the shell.

prestressing cable A cable or TENDON of high-tensile steel, used to impart pre-stress to concrete when the cable is tensioned.

pre-tensioning PRESTRESSED CONCRETE in which the TENDONS are tensioned *before* the concrete has hardened, and generally before it is cast, as opposed to POST-TENSIONING. Pre-tensioning may be carried out *individually* for each mould, or a *long line* of wire may be tensioned against fixed anchorages, the concrete units being cast around the wires, which are flame-cut after the concrete has hardened.

preventive maintenance Maintenance to prevent deterioration below the level of adequate quality.

primary beam Also called GIRDER.

primary circulation space Those parts of the building or floor that are aisles, lobbies, or corridors; as well as space required for access to stairs, lifts, toilets and building exits.

primary colours (a) The colours of three *coloured lights* or *pigments* from which many transmitted or nearly all reflected colours can be produced by colour mixing. These colours are usually identified as red, green and blue (in additive colour mixing; mixing lights); or sometimes as magenta, yellow and cyan (in subtractive colour mixing; mixing pigments). (b) In colorimetry, the three

theoretical colours from which all other colours, including the spectral colours, can be created using additive colour mixing.

prime cost (PC) sum A sum entered in a BILL OF QUANTITIES by the architect or consulting engineer. Its original purpose is to specify the quality of the item, and not allow any choice to the contractors tendering for it. However, prime cost items are also inserted for parts of a building that have not yet been fully designed, and therefore cannot be priced.

prime mover A machine that converts natural energy into mechanical power, e.g. a water turbine or an internal combustion engine.

primer or priming coat (a) Ground coat of paint applied to timber and other materials as a PRESERVATIVE and as a filler for the pores, which serves as a base for the further coat(s) of paint. (b) ANTI-CORROSIVE PAINT applied to steel.

priming Filling a SIPHON or a pump with water so that it can be operated.

princess post Used in large roof trusses, particularly QUEEN-POST ROOF TRUSSES. It is a short vertical post between the queen post and the support of the truss.

principal The party in a contract to whom the contractor is legally bound; also known as the *client* or *proprietor*.

principal planes Three mutually perpendicular planes on which the stresses are purely normal tension or compression. The stresses on these planes are the PRINCIPAL STRESSES.

principal rafter See [RAFTER](#).

principal stresses The stresses acting across the *principal planes*. They are the greatest and smallest direct (tensile or compressive) stresses. The greatest shear stresses occur at an angle of 45° to the principal planes. See also [MOHR CIRCLE](#).

principle of Archimedes 'If a body floats in a liquid, its weight is equal to the weight of the liquid displaced.'

principle of superposition See [SUPER-POSITION](#).

prism A POLYHEDRON consisting of two parallel and equal faces (the *bases*), connected by parallelograms. The best-known example is the *right triangular prism*, consisting of two right-angled triangles connected by rectangles, which is used in optics. The *cube* is the only prism that is also a regular polyhedron.

prismatic glass ROLLED GLASS that has parallel prisms on one face. These refract the transmitted light, and thus change its direction.

prismoid A solid that has two parallel polygonal faces. The volume of a prismoid is where h is the height of the prismoid, A_b and A_t the areas of the polygons on the parallel top and bottom faces, and A_m is the area at mid-height. This formula is used for the computation of the volume of excavation of earthworks by the *prismoidal rule*, also known as SIMPSON'S RULE.

prismoidal rule See [SIMPSON'S RULE](#).

probability A measure of the likelihood of the occurrence of a chance event. If the event can occur in N mutually exclusive and equally likely ways, and if n of

these possess a characteristic E , then the probability that the event has this characteristic E is the fraction n/N .

probable simultaneous demand In plumbing, the probable maximum flow rate for a pipe network based on the usage pattern of the PLUMBING FIXTURES.

procedural language In computing, a programming language whose statements are instructions of procedures the computer is to execute; as opposed to a DECLARATIVE LANGUAGE.

process A general term for any operation that transforms an item from one state to another in a period of time.

profile A sectional drawing, usually vertical.

program A series of statements or instructions that direct a computer to perform a sequence of operations.

programmed maintenance Maintenance to be implemented and completed within a specified time period.

programming In computing, the activity of writing a PROGRAM.

progress certificate A certificate issued to both the principal and the contractor at identified stages of the works, confirming the percentage or agreed stage of work completed against which payment may be made by the principal to the contractor.

progress chart A graph or, more commonly, a BAR CHART showing the time when the various operations required for the construction of the building should commence and finish. The actual times can be shown on the same chart to see how far the progress made conforms to the original intention. See also [CRITICAL PATH METHOD](#).

progress payment The payment made by the principal to the contractor subject to the issuance of a PROGRESS CERTIFICATE.

projection A method of representing a three-dimensional object on a sheet of drawing paper. The most common projection is the ORTHOGRAPHIC PROJECTION, which shows the object by means of three separate drawings, all true to scale; but it fails to give a pictorial representation of the object. The most common pictorial projections are the ISOMETRIC, the AXONOMETRIC and the PERSPECTIVE PROJECTION. Different projections are needed to represent the surface of a sphere. The STEREOGRAPHIC PROJECTION is commonly used in the design of SUNSHADING devices.

project management The practice of developing, planning, procuring and controlling the services and activities required for the satisfactory completion of a project according to an agreed time, cost and brief.

project management contract The agreement for a person or organisation to be responsible for the PROJECT MANAGEMENT of a project.

prompt In computing, a message given by a program to an operator, requiring some information before it can proceed.

proof stress The nominal stress (i.e. load per unit of original cross-sectional area) that produces a specified permanent STRAIN, e.g. of 0.1 per cent or 0.2 per cent.

It is specified for metals that exhibit significant PLASTIC DEFORMATION without showing a marked YIELD STRESS.

propeller fan Same as AXIAL-FLOW FAN.

property portfolio The collection of facilities or buildings that are an organisation's assets.

proportional band The range within which a proportional controller maintains a required condition.

proportional bandwidth filter A frequency filter for which the ratio of the upper to lower frequency limit is constant. See also [FREQUENCY BAND](#).

proportional control Control of a variable by means of a device that operates a control element in proportion to the demand for change necessary to maintain a desired condition.

proportional limit The greatest stress that a material can sustain without departing from a proportional stress-strain relationship in accordance with HOOKE'S LAW.

proportioning of mixes See [MIX PROPORTIONS](#).

propped cantilever A beam with one built-in and one simple support. It is STATICALLY INDETERMINATE.

protective finish of metals See [ANODISING](#), [CADMIUM PLATING](#), [GALVANISING](#) and [SHERARDISING](#).

protocol A set of rules or conventions specifying the format of information to be exchanged between communication systems.

proton A positively charged subatomic particle of mass 1.66×10^{-24} . Its charge is equal and opposite to that of an ELECTRON. Its mass is 1840 times that of an electron.

protractor An instrument, usually in the form of a graduated circle or semicircle, for plotting and measuring angles.

proving ring A device for accurately measuring a load, or for calibrating a testing machine. It consists of a steel ring whose deflection under a diametral compressive force is measured, e.g. with a DIAL GAUGE. The ring is calibrated in a standard testing machine.

provisional sum A financial sum allowed for items of work not described or specified at the time of tendering. The actual sum payable is adjusted when the details of that part of the work are known.

proximity See [ADJACENCY](#).

prussian blue Ferric ferrocyanide, $\text{Fe}_4.[\text{Fe}(\text{CN})_6]_3$.

prussic acid A highly poisonous solution of hydrogen cyanide (HCN) in water.

PS Abbreviation for POLYSTYRENE.

PSALI Permanent supplementary artificial lighting in interiors; the deliberate use of electric light in daytime, introduced in the 1940s. Rooms could be made deeper if the back part was lit by luminaires, and the windows were required to light only part of the room.

psf Pounds per square foot.

psi Pounds per square inch.

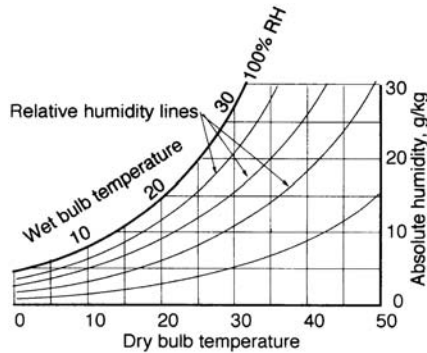

psychrometric chart

psychophysics The study of the relationship between physical stimuli and their effects on an organism. Often called HUMAN FACTORS ENGINEERING when the study involves people.

psychrometer Instrument for measuring relative humidity. The simplest type is the WET-AND-DRY BULB THERMOMETER. See also ASSMAN PSYCHROMETER, DEW-POINT HYGROMETER, HAIR HYGROMETER, HYGROGRAPH, THERMOHYGROGRAPH and WHIRLING PSYCHROMETER.

psychrometric chart A graphical representation of certain thermodynamic relations (see Figure), devised by William Carrier. The DRY-BULB TEMPERATURE is the abscissa and the ABSOLUTE HUMIDITY is the ordinate. The RELATIVE HUMIDITY is then plotted as a series of curves, and the WET-BULB TEMPERATURE as a series of diagonal lines. The ENTHALPY is also plotted as a series of diagonal lines. The chart can therefore be used to determine the amount of heating or cooling power required to change air at one temperature and humidity to that at another temperature and humidity by AIR CONDITIONING.

psychrometry The study of the properties of a mixture of air and water vapour. *Psychros* is the Greek word for 'cold'.

PTFE Abbreviation for POLYTETRAFLUOROETHYLENE.

P-trap A plumbing TRAP constructed with the inlet leg vertical and the outlet leg inclined below the horizontal within specified limits. The shape of the trap resembles the letter P.

public address system See PA SYSTEM.

puddle A mixture of clay, water, and sometimes sand, worked while wet into a water-imperious layer of foundation material. It is used as a cut-off wall to prevent the ingress or egress of water.

pull-down menu In computing, a MENU that is displayed when selected from a higher-level menu.

pulverised fuel ash Same as FLY ASH.

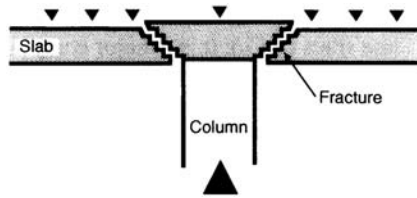

punching shear

pumice A vesicular glass formed from the froth on the surface of gaseous LAVAS. It has a high silica content, and is thus classed as an acid rock. Its highly porous structure makes it suitable as a light-weight aggregate for concrete. The sharp edges of the gas vesicles enable pumice to be used as an abrasive.

pump See [BOOSTER](#), [CENTRIFUGAL](#), [CONCRETE](#), [DIAPHRAGM](#), [DOUBLE-ACTING](#), [HEAT](#), [RECIPRO-CATING](#) and [ROTARY PUMP](#).

pumped concrete Concrete that is transported through a pipe or hose by a pump.

pumping The ejection of water or mud from the joints between paving slabs under load, caused by the accumulation of water in the subbase.

punching shear The shear caused by the tendency of a column, column head or column base to punch through a foundation slab, a FLAT SLAB or a FLAT PLATE (see Figure).

punkah A large swinging fan, traditional to the hot-humid regions of Asia. It is usually made of cloth stretched on a rectangular frame, hinged at the top, suspended from the ceiling or the rafters, and worked by a cord. See also [CEILING FAN](#).

punkah louvre A circular air supply nozzle, which can be rotated about a joint; used particularly for ventilating ships. If the temperature is high it can be directed on the occupant of a cabin. At other times the air can be admitted without causing undue draughts.

purlin A horizontal beam in a roof, at right angles to the trusses or rafters. It carries the roofing material, if it is in sheet form, or the COMMON RAFTERS, if the roof consists of tiles, shingles or slates.

putlog Cross piece in a scaffold. It normally rests on the LEDGERS and supports the SOFFIT boards or sheets.

putty Compounds used for glazing windows. The most common is one made from powdered chalk and linseed oil.

PVA Abbreviation for POLYVINYL ACETATE.

PVC Abbreviation for POLYVINYL CHLORIDE.

pycnometer An instrument for measuring density. The most common type is a jar or bottle of known volume. It is weighed with and without its contents.

pyramid A solid bounded by plane surfaces, one being a polygon with any number of sides, and the others being triangles. The most elementary pyramid is

the *tetrahedron*, which is a regular *polyhedron*, bounded by four equilateral triangles. The most common type of pyramid has a square base. The top of the pyramid is called the *apex*.

pyrometer Instrument for measuring temperatures. The term is used for instruments that measure high temperatures beyond the range of thermometry, and (less commonly) for instruments that measure temperature by electrical means.

pyrometric cone A small, pyramid-shaped cone whose composition is adjusted so that it melts at a definite temperature. The cones are made in series to cover a range of furnace temperatures, and the series constitutes a high-temperature thermometer. The SEGER CONE is a commonly used type.

Pythagoras' theorem 'The square on the longest side of a right-angled triangle equals the sum of the squares on the other two sides.' This theorem is credited to the Greek philosopher, who lived in the sixth century BC.

Q

Q-factor A measure of the sharpness of a RESONANCE.

quadrangle A rectangular space or court, the sides of which are occupied by a large building, such as a college.

quadrant An arc of a circle, forming one quarter of its circumference. It subtends an angle of 90° or $\pi/2$ radians at the centre. Hence an instrument for measuring ALTITUDES with a graduated quarter-circle; this has now been superseded by the *sextant*, a reflecting instrument which measures angles up to 120° .

quadratic equation An algebraic equation that contains the square, but no higher powers, of an unknown quantity.

quadrilateral Plane figure bounded by four straight lines. If two of the lines are parallel, it is called a *trapezium*. If two pairs of lines are parallel, it is called a *parallelogram*. A right-angled parallelogram is a rectangle. An equilateral parallelogram is a rhombus. A right-angled rhombus is a *square*.

quadruplex A group of four lift cars sharing a common control system.

quality assurance The management of quality at all stages in the manufacture of product and delivery of services, as standardised internationally by ISO 9000.

quality control Statistical control of the performance of products. See also [FREQUENCY DISTRIBUTION CURVE](#) and [COEFFICIENT OF VARIATION](#).

quality management The management of systems developed to deliver a quality policy.

quality of lift service The passenger perception of the effectiveness of a lift system, measured in terms of passenger waiting time. See [TIME INTERVAL](#).

quantity of lift service The handling capacity of a lift system.

quantity surveyor Surveyor who is responsible for the technical accountancy of building contracts, particularly in Great Britain and South Africa. The quantity surveyor undertakes the preparation of the BILL OF QUANTITIES and the final measurement of the work.

quantum The minimum, indivisible quantity of radiant energy.

quarry tile A hard-burnt unglazed CLAY TILE.

quarter bend A bend through an arc of 90° .

quarter closer A brick that has been cut to one quarter of its normal length.

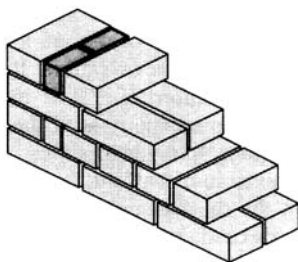
**queen closer**

quarter round A moulding that presents a profile of a quarter of a circle, inserted into corners.

quarter sawing Sawing a log into rectangular sections so that the longer dimension of the cross-section is roughly *radial* to the log; as opposed to BACK SAWING. Quarter sawing provides sections that are less subject to distortion during drying.

quarter-wave plates Crystal plates inserted into a POLARISCOPE at 45°. The first plate produces a retardation of a quarter of the wavelength of the MONOCHROMATIC LIGHT. A second plate imparts a retardation by the same amount, but in the opposite sense. It is thus possible to show the ISOCHROMATICS without the ISOCLINICS (which are liable to cause confusion). Quarter-wave plates are usually cut from mica or quartz, which has been split down to the required thickness.

quartz A mineral consisting of crystalline silica (SiO₂). It is a major component of many igneous and sedimentary rocks. Although pure quartz is colourless and transparent (*rock-crystal*), it is commonly coloured by impurities. Many varieties are used as gemstones, e.g. AGATE, *amethyst*, *cairngorm*, ONYX and *tiger-eye*. Most SAND consists of small quartz grains with some impurities.

quartz (halogen) lamp A common name for a TUNGSTEN-HALOGEN LAMP.

quartzite A rock consisting of firmly compacted quartz grains.

queen closer A brick cut in half along its length to keep the BOND correct at the corner of a brick wall (see Figure). Also called *queen closure*. See also [HALF BAT](#) and [KING CLOSER](#).

queen closure Same as QUEEN CLOSER.

queen-post roof truss A traditional timber truss similar to the KING-POST ROOF TRUSS, except that it has no central king post, but instead two queen posts on each side of the centre (see Figure). See also [PRINCESS POST](#).

quenching Rapid cooling of steel from an elevated temperature, normally by immersing it in oil or water. The usual effect of quenching is to produce a hard steel, by suppressing the formation of PERLITE from austenite, and forming MARTENSITE instead. Quenching is often followed by TEMPERING.

quicklime Calcium oxide (CaO). It is the raw material for HYDRATED LIME, which is used in lime mortar.

quicksand A sand through which water moves *upwards* at sufficient speed to hold it in suspension. It has therefore negligible bearing capacity. The remedy is to reduce the flow of water. Although quicksand is due to water flow, the

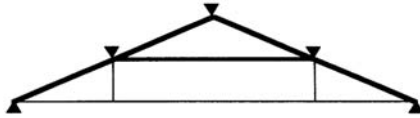

queen-post roof truss

condition is more likely to occur with sand that is uniformly grained and also fine grained.

quickset level An instrument for LEVELLING, whose vertical spindle is adjusted only approximately, and the telescope is levelled for each sight. If only two readings are required at one station, it is quicker to use than the DUMPY LEVEL.

quicksilver Same as MERCURY.

quoin An outer corner of a wall. Hence dressed natural stone placed at the corners of a brick building, or face brick placed at the corners of a building with stone rubble walls. The quoins may be for additional strength, or for decoration, or both. Also spelled *coin*.

QWERTY keyboard The keyboard used in normal English typewriters.

R

rabbit or rabbet Same as REBATE.

raceway Channel for routing electrical cables.

rack and pinion drive An *electric* lift drive whose lift car movement is achieved by power-driven pinions mounted on the car, running on a stationary rack fixed to the structure, or the lift well wall.

rack rent The rent that a tenant might reasonably be expected to pay in the open market.

radial arm saw A circular saw sliding on an arm above the work, and cutting by pulling horizontally over the work. Usually adjustable for horizontal and vertical angles.

radial shrinkage The drying SHRINKAGE of timber at right angles to the growth rings. It is less than the *tangential shrinkage* that is normally considered; for many timbers the ratio is about 1:2.

radian (rad) The angle subtended between two radii of a circle on the circumference by an ARC equal in length to the radius. 1 radian=57.296 degrees. 1 degree=0.017453 radians. See also [STERADIAN](#).

radiance The area density of radiated power, per unit projected area of the source and per unit solid angle ($\text{Wsr}^{-1} \text{m}^{-2}$). The equivalent term in photometry is LUMINANCE.

radiant asymmetry An asymmetric sensation of warmth or coolness on one side of the body due to a radiant heat exchange with a surface that is warmer or cooler in one direction to the body.

radiant energy Energy in the form of electromagnetic radiation. Measured in JOULES or equivalent units.

radiant heat Heat transmitted to a body by electromagnetic waves, as distinct from heat transferred by THERMAL CONDUCTION or CONVECTION. See also [INFRARED RADIATION](#) and [STEFAN-BOLTZMANN LAW](#).

radiation Energy transmitted by electromagnetic waves. It ranges in decreasing order of wavelengths from radio waves through heat rays, infrared rays, visible light, ultraviolet rays, X-rays and gamma rays to cosmic rays.

radiator A device for the transfer of heat to a space. When used as a terminal device in a central heating system a large proportion of the transfer may be by CONVECTION.

radiography The production of photographs of invisible features, e.g. defects in welds, by means of X-RAYS.

radiometry The measurement of radiant energy. See also [PHOTOMETRY](#).

radius of gyration A convenient shorthand notation for where I is the second moment of area, and A is the cross-sectional area. The radius of gyration is required for certain dynamic problems, and for computing the SLENDERNESS RATIO in buckling problems.

radon A chemical element, the heaviest of the inert gases. It is formed by the radioactive decay of radium, and is emitted by some soils and rocks in small quantities as a natural process. However, it may collect in buildings if there insufficient ventilation, and may then become a health hazard.

rafter A sloping timber extending from the WALL PLATE to the ridge of a roof. The roofing material may be supported on BATTENS (small horizontal members placed on top of the rafters), or on PURLINS (larger horizontal members spanning widely spaced *principal rafters*). In some traditional roof constructions, the principal rafters support large purlins, which in turn support intermediate rafters or common rafters. These are smaller and more closely spaced than the principal rafters. The battens are carried by the common rafters.

raft foundation A slab of concrete, usually reinforced, extending under the whole area of a building. It is used when loads are heavy and/or the bearing capacity of the soil is low.

rag bolt Same as LEWIS BOLT.

rag felt An asphaltic ROOFING FELT made from fibres or rag.

RAIA Royal Australian Institute of Architects, Canberra.

RAIC Royal Architectural Institute of Canada, Ottawa.

rain gauge An instrument for measuring rainfall. It usually consists of a funnel from which the water drips into a cylinder, graduated in inches or millimetre of rainfall per funnel area.

rain screen A system for the construction of external walls in which durable panels form the outer surface, intercepting the force of wind-driven rain; but the narrow joints between them are not waterproofed. Behind the panels is a cavity, and the face of the inner wall is made sufficiently waterproof to resist the small amount of moisture that penetrates the joints. This waterproofing material is not exposed to the weather, and is not seen. See also [DRAINED JOINT](#).

raised floor A false floor, which provides a space for cables or ducts above the structural floor, in the same way as a FALSE CEILING (see Figure).

rake The slope, or angle of inclination. The context usually indicates whether it is measured from the vertical or the horizontal.

raked joint A mortar JOINT IN BRICKWORK, or blockwork that has been scraped clean of mortar for about 12mm back from the face. It may be left raked, or else it may subsequently be POINTED.

raking shore A sloping SHORE.

RAM Abbreviation for RANDOM ACCESS MEMORY.

rammed earth construction Same as PISÉ DE TERRE.

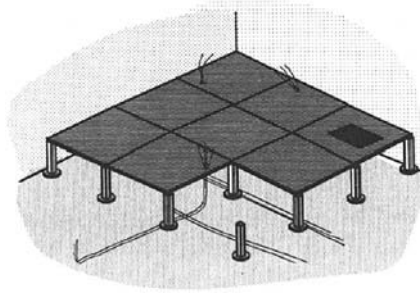

raised floor

random access memory (RAM) Computer memory available for the storage of programs and data; its contents can be altered, as distinct from the READ ONLY MEMORY (ROM). RAM is usually *volatile*, i.e. it is lost when the power is turned off.

random ashlar See [ASHLAR](#).

random noise Noise due to a large number of elementary disturbances with random occurrence in time. See also [WHITE NOISE](#) and [PINK NOISE](#).

random numbers (a) A set of numbers obtained by chance. (b) A set of numbers, generated by an algorithm in a computer or given in a *table of random numbers*, which may be considered free from any statistical bias.

random sample A [SAMPLE](#) selected without bias.

range of measured data The difference between the largest and the smallest measurement.

Rankine column formula One of the oldest formulae for the practical design of slender columns (see [Figure](#)). The [EULER FORMULA](#) gives the correct load P_e for very slender columns, but it is unsafe for the buckling of columns with intermediate slenderness ratios (which includes most of the practical problems in the design of buildings). Similarly the *short-column* load P_s is unsafe for slender columns. The Scottish engineering professor, W.J.M.Rankine proposed in 1858 a gradual transition for the column load P :

$$\frac{1}{P} = \frac{1}{P_s} + \frac{1}{P_e}$$

See also [PERRY-ROBERTSON FORMULA](#) and [SECANT FORMULA](#).

Rankine cycle An ideal cycle for a steam engine, proposed by W.J.M.Rankine in Scotland in the mid-nineteenth century. It can also be used for the analysis of refrigeration machines.

Rankine theory A theory for the [EARTH PRESSURE](#) developed by a granular soil (loose sand or gravel) on a retaining wall, proposed by W.J.M.Rankine in 1857. It gives the magnitude of the *active earth pressure* as

$$\frac{1 - \sin \varphi}{1 + \sin \varphi} \rho h$$

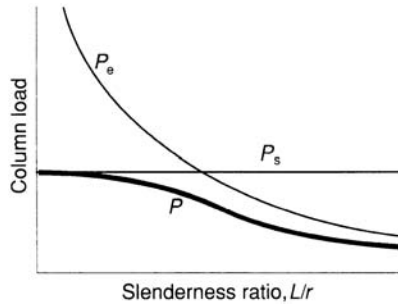

Rankine column formula

where γ is the soil density, ϕ its ANGLE OF INTERNAL FRICTION, and h is the depth of the soil below the surface. For most granular soils, ϕ is approximately 35° , and the active earth pressure is then $0.27 \gamma h$. The magnitude of the *passive earth pressure* is

$$\frac{1 + \sin \phi}{1 - \sin \phi} \gamma h$$

which is 3.7 approximately. The theory does not apply to COHESIVE SOILS.

rapid-hardening cement Same as HIGH-EARLY-STRENGTH CEMENT.

raster A grid of a visual display unit dividing the display area into discrete units, i.e. PIXELS.

raster graphics A form of computer graphics employing a matrix of PIXELS, as opposed to VECTOR GRAPHICS.

raster image See [PIXEL IMAGE](#).

raster scan The process of sweeping a display screen line by line to read or produce an image.

ratchet A wheel with saw-like teeth, which a *pawl* (or single tooth) may engage for the purpose of preventing reversed motion.

ratchet clause The clause in a LEASE agreement that establishes an agreed lower rental limit in the event of a reduced market value.

rational number An INTEGER or a FRACTION. See also [IRRATIONAL NUMBER](#).

raw data Data that have not been processed.

ray tracing (a) A method of determining information about *wave phenomena*, using a computer analysis, which assumes that the energy leaves the source as rays. The rays are reflected and absorbed by surfaces. (b) A computer graphics technique for creating realistic images by calculating paths of *light rays*. Used to display various visual properties of objects, e.g. shadows, specular properties etc.

RC Abbreviation for REINFORCED CONCRETE.

reaction The opposition to an action, e.g. to the downward pressure of a loaded beam. For static equilibrium the reaction must balance the action.

reaction turbine A turbine in which the jets or nozzles are on the moving wheel, as opposed to an *impulse turbine*.

reactive concrete aggregate Aggregate that is capable of combining chemically with Portland cement, under normal conditions, because of ALKALI-AGGREGATE REACTION, and may thus cause harmful expansion.

reactive (imaginary) power In alternating current electrical systems, the imaginary component of the vector product of voltage and current. It has the units of volt-amps-reactive or VAR. See also [REAL POWER](#) and [POWER FACTOR](#).

read only memory (ROM) Computer memory that can only be read; its contents cannot be altered, as distinct from RANDOM ACCESS MEMORY (RAM).

ready-mixed concrete Concrete mixed at a central plant and transported to the building site. Frequently some or all of the mixing water is added during transportation. Also called *transit-mixed*. See also [TRANSIT MIXER](#).

real estate See [REAL PROPERTY](#).

real number One of the infinitely divisible range of values between minus and plus infinity. A real number may be RATIONAL or IRRATIONAL, but not IMAGINARY nor COMPLEX. In computing, a difference is made between a real number and an INTEGER in that real numbers are represented (approximately) as FLOATING-POINT NUMBERS.

real power In alternating current electrical systems, the real component of the vector product of voltage and current. It has the units of watts. It is also the product of voltage, current and the POWER FACTOR. See also [POWER](#), [POWER FACTOR](#) and [REACTIVE POWER](#).

real property Land with or without buildings, fences and other fixtures. Also called *real estate*.

real-time processing In computing, any processing in which the response to an input happens almost instantaneously.

reamer A tool used for finishing holes that have previously been drilled.

rebar US abbreviation for a reinforcing bar.

rebate A recessed timber edge, designed to receive a door, window sash, or some other piece. Also spelled *rabbet* and *rabbit*.

recall See [LIFT RECALL](#).

recessed luminaire A LUMINAIRE recessed into a ceiling, so that its lower edge is flush with the ceiling, as opposed to *surface mounted*.

reciprocal diagram A graphical solution for the design of STATICALLY DETERMINATE trusses, proposed by the British physicist Clerk Maxwell in 1864. It consists of a series of triangles and polygons of force, drawn together so that all have at least one line in common. BOW'S NOTATION is commonly used for this construction.

reciprocal theorem A theorem published by the British physicist Clerk Maxwell in 1864, which relates the deflection of a structure at two points, and the reciprocal (or corresponding) loads at the same points. It is the basis of

several methods for the analysis of STATICALLY INDETERMINATE structures.

reciprocating compressor A machine used for raising the pressure of a gas by the reciprocating action of a piston in a cylinder. Commonly used for compressing air, or the refrigerant in refrigeration systems.

reciprocating engine An engine consisting of a piston moving *backwards and forwards* in a cylinder. The reciprocating motion is converted into rotary motion by means of a connecting rod and a crankshaft or flywheel. A *rotary engine* produces rotary motion directly.

reciprocating pump A pump in which a reciprocating piston draws liquid into a chamber and expels it through valve action.

reconditioning of collapsed timber A steam treatment for the COLLAPSE OF TIMBER.

reconstituted stone Same as ARTIFICIAL STONE.

recoverable outgoings The difference between the total operating costs and non-recoverable operating costs.

recrystallisation The formation of new crystals, e.g. ANNEALED crystals from previously strain-hardened crystals.

rectangle A right-angled PARALLELOGRAM.

rectangular coordinates Same as CARTESIAN COORDINATES.

recurrent costs The expenses that can be expected annually in the general operation of a business.

recycled concrete Hardened concrete that has been crushed for reuse as concrete aggregate.

recycling The collection and reprocessing of materials to produce new products, instead of throwing them away. The concept can be applied to the refurbishment and reuse of buildings.

redirection In lighting, referring to the change of direction of light flux by reflection, refraction or diffraction.

red lead Red oxide of lead (Pb_3O_4). It was commonly used as a rust-inhibiting PRIMER on steel, but has been largely superseded by zinc-rich primers because of the toxicity of lead.

red oxide Red IRON OXIDE, a pigment that does not inhibit corrosion. See also [RED LEAD](#).

reduced level (RL) Surveying term used for the level of a position with respect to a datum.

reducing power The strength of a white pigment in reducing the colour of a coloured pigment. It is a measure of the paleness of tint produced, and is the opposite of STAINING POWER.

reduction A chemical process involving a decrease in the state of OXIDATION.

reduction in area The contraction in cross-sectional area that occurs when a ductile material is tested in tension. It is one of the quantities normally measured during the test. See [CUP-AND-CONE FRACTURE](#).

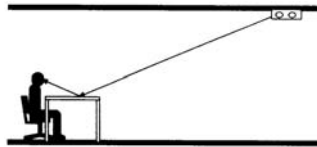

reflected glare

redundancy In structural engineering, a structural member or restraint in excess of those required by MÖBIUS' LAW. A structure with redundancies is **STATICALLY INDETERMINATE**; one without redundancies is **STATICALLY DETERMINATE**.

re-entrant angle An angle of less than 180° on the observer's side of a wall; the opposite of a *salient angle*. It forms the equivalent of a *concave* as opposed to a *convex* surface.

re-entrant corner An internal angle or corner; the opposite of a *salient corner*.

reflectance The ratio of total reflected to total incident flux for a surface. It is a scalar quantity, so a non-matt surface's reflective properties are described by its *luminance factor*.

reflectance factor The **REFLECTANCE** of a surface, expressed as a percentage.

reflected glare **GLARE** produced by specular reflections of luminous objects, especially reflections appearing on or near the object viewed (see Figure).

reflected sound Sound that has undergone at least one reflection from a surface in a room, as opposed to **DIRECT SOUND**, which reaches an observer without undergoing a reflection.

reflection The process whereby energy reaching a surface partly or fully leaves that surface without change of wave-length, on the same side as it arrived. Reflection may be **DIFFUSE** or **SPECULAR**.

reflective glass Glass coated with a thin layer of metal or metal oxide, which reflects some of the solar radiation. See also **HEAT-ABSORBING GLASS**.

reflective insulation Metal that reflects infrared radiation, and therefore reduces the amount of heat entering a building, particularly via the roof. It commonly takes the form of aluminium foil, 0.15mm (0.006in.) or less in thickness, backed by **KRAFT PAPER**.

reflector, parabolic See **PARABOLIC REFLECTOR**.

reflector lamp An electric lamp that has a reflective metal coating applied directly to part of the inside of the lamp.

refraction The change in direction that occurs when a ray of light passes from one medium to another with a different density or impedance. The ratio of the sine of the angle of incidence to the sine of the angle of refraction is the *refractive index*. See also **REFLECTION**.

refractory brick A brick made from a **REFRACTORY MATERIAL**.

refractory material Material that can withstand a high temperature, and is thus suitable for lining a furnace. CHINA CLAY, ALUMINA, SILICA, DOLOMITE and *chromite* make suitable refractories.

refrigerant The fluid circulated in a REFRIGERATION system that acts as the heat transfer medium in the cooling process.

refrigeration The process of mechanically extracting heat from a thermodynamic system in order to cool it by transferring the heat to another place.

refrigeration cycle The most commonly used refrigeration cycles are the ABSORPTION CYCLE and the VAPOUR COMPRESSION CYCLE.

refusal A term applied to the resistance offered by a FRICTION PILE to continued driving. It is often defined as the failure to penetrate more than 10mm (0.4 in.) in four blows.

regeneration of energy The transformation of mechanical kinetic energy from a lift or escalator on a *down* run into electrical energy, which is fed back into the electrical supply system.

regenerative heating Utilisation of heat that has been rejected in another part of the cycle, by heat transfer.

register (a) An air grille with a damper in a ventilating or air conditioning duct or in a chimney. (b) In computing, a storage location that holds data, instructions or addresses on a temporary basis.

Regnault hygrometer A type of DEW-POINT HYGROMETER.

reinforced brickwork or masonry Brickwork or masonry, that has reinforcement embedded (usually in the joints) to increase the resistance to flexural tension.

reinforced concrete Concrete that contains reinforcement, normally of steel, to improve its resistance to tension. It is designed on the assumption that the two materials act together in resisting the stresses in the composite material due to the loads. PRESTRESSED CONCRETE, in which the concrete is prestressed by steel before the loads are applied, is normally considered to be a separate form of construction. See also **BALANCED DESIGN**, **COMPRESSION REINFORCEMENT** and **T-BEAM**.

reinforcement for concrete See **COLD-DRAWN WIRE**, **COLD-WORKING**, **DEFORMED BAR**, **DIAGONAL CRACK**, **DISTRIBUTION REINFORCEMENT**, **EFFECTIVE DEPTH**, **EXPANDED METAL**, **HELICAL REINFORCEMENT**, **HOOP REINFORCEMENT**, **LATERAL REINFORCEMENT**, **LONGITUDINAL REINFORCEMENT**, **MESH REINFORCEMENT**, **REINFORCED CONCRETE**, **SECONDARY REINFORCEMENT** and **TENDON**.

reinforcing bar See **COLD-DRAWN WIRE**, **DEFORMED BAR**, **MESH REINFORCEMENT** and **TENDON**.

relamping In lighting, the process of replacing electric lamps by either SPOT REPLACEMENT (when a lamp has failed) or BULK REPLACEMENT (as part of a planned maintenance program).

relative density Same as SPECIFIC GRAVITY.

relative humidity The ratio of the quantity of water vapour actually present in the air, expressed as a percentage, to that present at the same temperature in a water-saturated atmosphere. See also ABSOLUTE HUMIDITY and WET-BULB TEMPERATURE.

relaxation of steel Decrease in the stress of steel due to CREEP in the steel under prolonged strain. The term is also applied to the LOSS OF PRESTRESS due to shrinkage and creep of the concrete, which results in a decreased steel strain.

relay A device in which a small electrical power is used to control a larger electrical power. Many relays employ electromagnets.

re-levelling An operation permitting the stopped position of a lift car to be corrected during loading and unloading by successive car movements. See also LEVELLING DEVICE.

relief The elevation or projection of a design from a plane surface in order to give a solid appearance, as opposed to INTAGLIO. Relief may be high, middle or low (*bas relief*).

relief air Air that is allowed to escape to the atmosphere from an air conditioning system in order to be displaced by outdoor air for ventilation.

relieving arch See DISCHARGING ARCH.

remoulded clay Clay whose internal structure has been disturbed. Its SENSITIVITY RATIO is the ratio of the strength of an undisturbed to that of a remoulded clay sample.

rendering (a) The application of mortar or plaster by means of a float or trowel. (b) In computer graphics, the application of colour, texture and shading to an image, usually to simulate photo-realism.

rent The payment for the use or occupation of land or premises; categories of rent include contract, economic, ground and gross rent.

repeated loading Normally interpreted as a much smaller number of repetitions than are needed to produce a FATIGUE failure.

replacement maintenance The replacement of components and equipment that may be faulty through wear, or may be at the end of their useful life.

repose See ANGLE OF REPOSE.

representative sample A SAMPLE selected to be representative of the whole POPULATION.

resilience The ability of a material to absorb and return strain energy without permanent deformation.

resin (a) The produce from the secretions of certain plants and trees, consisting of highly POLYMERISED substances. They are insoluble in water, but soluble in certain organic solvents, and fusible. Most resins are hard and brittle. (b) Synthetic imitation of a natural resin. The term *synthetic resin* is often used as a synonym for a THERMOSETTING plastic. See also ROSIN.

resistance See [ELECTRICAL RESISTANCE](#), [MOMENT OF RESISTANCE](#) and [THERMAL RESISTANCE](#).

resistance arm Same as [LEVER ARM](#).

resistance strain gauge See [ELECTRIC RESISTANCE STRAIN GAUGE](#).

resistance welding Welding two parts by holding them in tight contact with electrodes through which a heavy current flows momentarily, causing them to fuse together.

resolution In computing, the number of [PIXELS](#) in the horizontal and vertical rows of a screen.

resolution at the joints A method for the design of statically determinate trusses, proposed by the Russian engineer D.J.Jourawski in 1850. Since each joint (as well as the whole truss) is in equilibrium, it is possible to resolve horizontally and vertically to produce $2j$ equations for j joints. According to [MÖBIUS' LAW](#), the truss has $2j-3$ members, in which we must determine the forces. The method thus produces three check equations. See also [RECIPROCAL DIAGRAM](#) and [METHOD OF SECTIONS](#).

resolution of a force Determination of the *components* of a [FORCE](#), usually horizontally and vertically.

resonance Resonance occurs when a system oscillates, with minimum impedance, in response to an excitation at a given frequency. The maximum response is at the *resonant frequency*. The phenomenon occurs in acoustics, and in the vibration of buildings subject to vibrations from machinery, earthquake, or wind. See also [DECAY FACTOR](#).

resonant absorber An object or construction that absorbs sound because of the physical [RESONANCE](#) of part or all of its structure or the medium associated with it. Two examples of resonant absorbers are [HELMHOLTZ RESONATORS](#) and panels of wood, glass, plasterboard etc.

resonant frequency See [NATURAL FREQUENCY](#).

respirable particulates Particles suspended in air that may be inhaled deep into the lungs because of their very small size.

restricted area An area whose access is limited to identified persons.

restrictive covenant A requirement to adhere to a specified restriction on the use or development of real property.

restrike The process of restarting an electric [DISCHARGE LAMP](#). See also [HOT RESTRIKE](#).

resultant The [VECTOR](#) sum of two or more forces.

retaining wall A wall, usually with a batter, which retains a weight of earth or water. It may rely for its stability on the weight of the masonry or concrete ([GRAVITY RETAINING WALL](#)), or on the cantilever strength of the wall (which may be of steel or timber, but is usually of reinforced concrete). In a [CANTILEVER RETAINING WALL](#) the weight of soil lying above the heel is utilised to improve the stability of the wall.

retarded hemihydrate plaster [PLASTER OF PARIS](#) with the addition of a retarder, usually keratin.

retarder A substance that slows down a chemical reaction, as opposed to an ACCELERATOR. In concrete, an additive that delays the setting of the cement, and thus allows more time for placing the concrete.

retention The holding of a percentage of a progress payment to cover possible defects or other contingencies.

retention basin Hydraulic structure designed to retain stormwater for the purpose of improving water quality and/or recharging the ground water table. See also [DETENTION BASIN](#).

reticulate To divide so as to form a network.

reticulated work See [OPUS RETICULATUM](#).

retina The membrane lining the interior surface of the back of the eye, containing photoreceptors (RODS and CONES) and the ends of the optic nerve.

retrofit (a) To make an improvement, for example to thermal insulation or sunshading, to an old building. (b) In lighting, to replace one type of lamp with another (newer) type having the same electrical and optical characteristics.

retro-reflective (a) A material that reflects light back along the same or similar path to the incident light, usually employing tiny spheres in a carrier. Used as a reflective material on safety clothing, in road signs and road marking paints. (b) 'Cats-eyes'.

return (a) A return circuit, pipe or duct. (b) A change in the direction of a wall or other building component, usually at right angles.

return air The air returned from an air conditioned space and recirculated in order to reduce energy consumption by the air conditioning system.

reveal (a) The part of the JAMB between the frame and the outside wall, which is revealed, inasmuch as it is not covered by the frame. (b) The visible side of an open fireplace. (c) The entire JAMB or vertical face of an opening.

reverberant sound field The sound field in an enclosure resulting from sound that has been reflected from the enclosure boundaries and where the DIRECT SOUND has an insignificant effect. The reverberant sound field approximates a *diffuse sound field*, whose properties of the sound field are the same throughout.

reverberation chamber A room for acoustic testing, in which a DIFFUSE SOUND FIELD exists because all the surfaces are highly reflecting. Reverberation chambers are used for measuring the SOUND ABSORPTION COEFFICIENT and SOUND TRANSMISSION LOSS of materials amongst many other things. See also [ANECHOIC CHAMBER](#).

reverberation radius See [CRITICAL DISTANCE](#).

reverberation time The time required for the average sound intensity, in a room or enclosure, to decrease to 10^{-6} of the initial value (60dB) after the emission by the source has ceased. See [SABINE FORMULA](#).

reverse cycle heating See [HEAT PUMP](#).

reversed door A door opening in the direction opposite to that considered regular, e.g. a cupboard door opening inward.

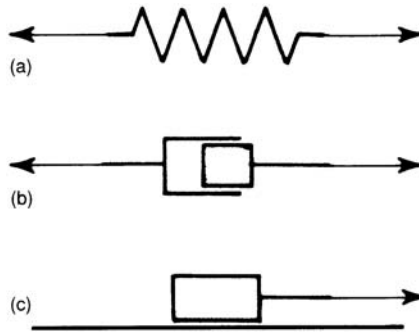

rheological model

reverse video A display in which the background and foreground colours are reversed. For example, white characters on a black background.

revetment A protective covering to a soil or soft rock surface, to protect it against scouring by water or other effects of weathering. It may consist of grass or other plants, bundles of brushwood, asphalt, stone slabs, or concrete.

revolution, surface of See [SURFACE OF REVOLUTION](#).

revolving shelf A shelf designed to give access to inner corners where two cupboards meet, by rotating it on a vertical pivot. Also called a *lazy Susan*.

Reynolds' critical velocity The velocity at which flow changes from *streamline* to *turbulent*.

Reynolds' number A non-dimensional ratio used for assessing the similarity of motion in viscous fluids, named after the British hydraulic engineer, who proposed it in 1883.

$$\text{Reynolds' number, } Re = \frac{Lu}{\nu}$$

where L is any typical length, u is the velocity of the fluid, and ν is its KINEMATIC VISCOSITY. In model analysis, in order to satisfy the PI-THEOREM, the Reynolds' number must be the same for the prototype and the model. In practice it is often difficult to satisfy this condition, and some distortion may have to be accepted.

RF (a) Abbreviation for REFLECTANCE FACTOR. (b) Abbreviation for radio frequency, the range of frequencies at which radio and TV signals are transmitted.

RGB Abbreviation for red, green, blue.

RH Abbreviation for RELATIVE HUMIDITY.

rheological model A physical model used to illustrate a theory in the field of RHEOLOGY (see Figure). Rheological models are composed mainly of (a) springs for ELASTIC DEFORMATION, (b) dashpots for viscous or CREEP deformation, and (c) heavy weights resting on a rough surface, which offer frictional resistance for PLASTIC DEFORMATION.

rheology The science of the flow of materials. In building science, rheological studies are valuable for determining the flow of liquid concrete, paint or mastics; and for the CREEP deformation of timber and concrete.

rheostat A resistance that can be adjusted to vary the total resistance in an electrical circuit.

rib (a) A small beam projecting from a concrete slab. (b) The vertical member of a T-BEAM. Also called *web*.

RIBA Royal Institute of British Architects, London.

ribbed slab A panel composed of a thin slab reinforced by ribs in one or two directions (usually at right angles to one another). The latter is also called *waffle slab* because of its appearance; it is commonly used with mushroom columns in a FLAT SLAB. When used in a FLAT PLATE, the ribbed slab is made solid in the area surrounding the column for extra shear resistance.

rich concrete A concrete with a high cement content, as opposed to a *lean concrete*.

Richter scale Scale devised by C.F. Richter in California for determining the *magnitude* of an earthquake. For this purpose *standard earthquake* is defined as one providing a maximum trace amplitude of 0.001mm on a certain type of seismograph at a *standard distance* of 100km. The magnitude on the Richter scale was originally defined as the logarithm (to the base 10) of the ratio of the amplitude of any earthquake at the standard distance to that of the standard earthquake. To make the scale independent of the type of recording instrument it was later defined by the equation

$$\log E = 4.8 + 1.5M$$

where M is the magnitude on the Richter scale, and E is the energy released by the earthquake in joules. The smallest earthquakes recorded by very sensitive instruments at short distances have an energy of 0.01J, and the largest an energy of 10^{18} J. The variation on the Richter scale is from 0 for the smallest earthquake to 8.6 for the largest recorded. The MERCALLI SCALE classifies the *intensity* of an earthquake.

RICS The Royal Institution of Chartered Surveyors, London.

ridge A horizontal line caused by the junction of two sloping roof surfaces.

ridge board A horizontal board at the apex of the roof, set on edge. The rafters are nailed to it.

ridge tile A tile moulded to cover the ridge of a roof and prevent entry of rain-water. Its moulding sometimes incorporates a decoration, particularly at the gable.

right angle An angle of 90° .

right-angled half-lap joint Same as END-LAP JOINT.

right ascension The horizontal co-ordinate of the sun, moon, or a star at any given time, measured in the Earth's equatorial plane. It is listed in the NAUTICAL ALMANAC. The vertical coordinate is the *declination*. See also [AZIMUTH](#).

right-hand Supposedly a fitting convenient to a right-handed person. A *right-hand screw* is one that tightens clockwise. A *right-hand stair* is one that has its handrail on the right going up. In Great Britain a right-hand door is one whose hinges are on the right, when it swings *towards* the hand opening it. However, in the USA a *right-hand door* is one whose hinges are on the right, when it swings *away* from the hand opening it. A *right-hand lock* is one that fits a right-hand door, according to local convention.

right line A straight line between two points.

rigid foam See [EXPANDED PLASTIC](#).

rigid frame A FRAME with RIGID JOINTS, which are capable of transmitting moments. See also [TUBE STRUCTURE](#).

rigidity See [MODULUS OF RIGIDITY](#).

rigid joint A joint that is capable of transmitting the full moment at the end of a member to the other members framing into the joint. See also [SEMI-RIGID JOINT](#) and [PIN JOINT](#).

RILEM Réunion Internationale des Laboratoires d'Essais et des Recherches sur les Matériaux et les Constructions, Paris.

rim lock A lock that is screwed to the face of the door, as opposed to a MORTISE lock.

ring, proving See [PROVING RING](#).

ring, tension See [TENSION RING](#).

rise (a) The vertical height of an arch, roof truss or rigid frame. The vertical height of a cable structure is its *sag*. (b) The vertical distance from the top of one tread to the top of the next tread of a staircase. See also [GOING](#). (c) The total vertical distance which a stair rises from floor to floor.

rise and fall Upward or downward cost adjustments, for unforeseen or unquantified variations in the cost of labour and materials.

riser (a) The vertical board under the TREAD of a step. (b) A vertical supply pipe for a SPRINKLER SYSTEM. (c) A pipe for water, drainage, steam, gas, or venting which extends vertically through one or more full storeys and services other pipes. Also called a *rising main*. (d) An electrical cable that extends vertically through one or more storeys, and distributes power to electric panels on different floors of the building. Also called a *rising main*. (e) A vertical duct of a ventilating or air conditioning system that extends vertically through one or more storeys, and distributes air to branch ducts.

rise-time A measure of the time it takes an instrument or control system to respond to a sudden change in the input signal.

rising main See [RISER](#) (c) and (d).

risk management The management of an activity, accepting a level of risk, which is balanced against the benefit of the activity, usually on the basis of an economic assessment model.

Ritter's method See [METHOD OF SECTIONS](#).

rivet A headed shank for making a permanent joint between two pieces of metal. It is inserted into holes in the two pieces, and closed by forming a head on the

projecting shank. In steel structures the head must be formed while the rivet is red-hot, and because of the inconvenience of handling the red-hot rivets, riveting has been gradually replaced by welding and by FRICTION-GRIP BOLTING. The heads of aluminium rivets can be formed cold, provided the diameter of the rivets is not too large. BLIND and EXPLOSIVE RIVETS can be used in inaccessible locations.

RL Abbreviation for REDUCED LEVEL.

RMS Abbreviation for ROOT MEAN SQUARE.

rock See [SEDIMENTARY](#), [IGNEOUS](#) and [METAMORPHIC ROCK](#).

rock anchor See [ANCHOR](#).

rockbreaker A hydraulically operated reciprocating hammer, attached to the arm of a backhoe or excavator, used for excavating in rock or breaking-up concrete.

rock flour SILT-sized crushed rock.

Rockwell hardness test A method for determining hardness by indenting the test piece with a diamond cone or a hard steel ball, and measuring the depth of penetration. A smaller load is used for the *Rockwell superficial hardness* test.

rock wool MINERAL WOOL made from molten rock.

rod (a) One of the receptors in the retina of the eye, used in low light conditions, not capable of seeing in colour. See also [CONE](#) (b). (b) An obsolete measure of length, 16.5ft or 5.03m. Also, any stick of known length used for setting out the dimensions of a building, such as a *brick rod*.

rodding Using a system of rods, which may be progressively joined, to clear blockages in sewage and stormwater drains.

rolled glass Molten glass from a furnace, passed through rollers to produce a pattern on one or both surfaces.

rolled steel joist (RSJ) A rolled steel section of I-shape.

rolled steel section Any hot-rolled steel section, including joists, angles, channels and rails.

roll-formed sections Sheet metal sections, usually 1 to 3mm to in thickness, formed from a continuous strip by passing longitudinally through successive sets of rollers; as opposed to *folding* in a *brake press*. The length of roll-formed sections is limited only by handling and transport.

rolling friction The frictional resistance offered when a body rolls over a surface. See also [COEFFICIENT OF FRICTION](#).

roll roofing Same as BUILT-UP ROOFING.

ROM Abbreviation for READ ONLY MEMORY.

Roman tile Same as MISSION TILE.

Röntgen rays Same as X-RAYS.

roof See [CRUCKS](#), [DORMER WINDOW](#), [FLAT ROOF](#), [GABLE ROOF](#), [HIP ROOF](#), [MANSARD ROOF](#) and [RAFTER](#).

roof dormer See [DORMER WINDOW](#).

roofing felt Waterproof felt, soaked in asphalt, bitumen or tar, used in BUILT-UP ROOFING.

rooflight Any glazed roof opening used for the purpose of admitting daylight.

roof plate A timber plate that receives the lower ends of the RAFTERS.

roof space The space between the structure of the ceiling of the highest storey and the underside of the roof structure and the roof cladding.

roof structure See DOME, FOLDED-PLATE ROOF, PNEUMATIC STRUCTURE, ROOF TRUSS, SHELL ROOF, SPACE FRAME, SUSPENSION ROOF, TOP-HAT STRUCTURE and VAULT.

roof tile Clay or concrete tile used for covering sloping roofs; it may be moulded with a plain surface (sometimes called an ENGLISH TILE), or with drainage channels (see MARSEILLES PATTERN TILE, MISSION TILE, PANTILE and S-TILE). See also SHINGLE and SLATE.

roof truss A TRUSS used as the supporting structure for a roof. See BELFAST, FINK, HOWE and WARREN TRUSS; KING-POST ROOF TRUSS, PRINCESS POST, QUEEN-POST ROOF TRUSS and HAMMER-BEAM ROOF; also KNEE-BRACE and TRUSSED RAFTER.

room air A term used in air conditioning practice to denote the air in the occupied space, as distinct from supply or return air.

room air conditioner A self-contained machine inserted in a window or external wall of a room and used to circulate air cooled by refrigeration in the room while rejecting heat outdoors. May be used as a HEAT PUMP to supply heat if appropriately circuited.

room cavity That portion of a room between the plane of the luminaires and the WORKING PLANE. See also ROOM INDEX.

room constant The room constant of an enclosure is a measure of the sound absorption in the enclosure, given by the equation

$$\text{room constant} = \frac{\text{total absorption of the enclosure}}{1 - \left\{ \begin{array}{l} \text{average} \\ \text{absorption coefficient} \\ \text{of the enclosure} \end{array} \right\}}$$

room index In lighting, in the LUMEN or flux METHOD, a number that indicates the largeness of a room (actually, of the ROOM CAVITY). It is the ratio of the areas of the horizontal surfaces to those of the vertical surfaces. The symbol is usually K_R . In the IESNA system, it is called the *room cavity ratio*, and it is proportional to the inverse of the room index.

root mean square The square root of the mean value of the squares of individual test results or statistical data. In the measurement of time-varying wave-forms, especially in electricity, the root mean square represents the *effective* voltage, current, or power, in terms of its ability to do work.

roped hydraulic drive A *hydraulic* lift drive whose cylinder is connected to the lift car frame by ropes.

roped hydraulic lift A *hydraulic* lift whose piston is connected to the car frame by means of wire ropes. See also DIRECT PLUNGER HYDRAULIC LIFT.

rosette See [STRAIN ROSETTE](#).

rosin A RESIN obtained as a residue from the distillation of turpentine. It is used as a varnish, as a drier in paint, and as a soldering flux. Also called *colophony*.

rot See [DRY ROT](#) and [WET ROT](#).

rotary engine An engine that produces rotary motion directly, as opposed to a RECIPROCATING ENGINE.

rotary hammer A hand-held power drill that provides a hammer action as well as rotary motion to the BIT. It is usually possible to stop the rotation to use the tool as a chipping hammer. The impact action is usually more vigorous than that of an IMPACT DRILL, although the two terms are sometimes used interchangeably.

rotary pump A pump with a rotating impeller, also called a *centrifugal pump*.

rotary veneer WOOD VENEER cut on a lathe.

rotational surface Same as SURFACE OF REVOLUTION.

roughcast Plaster mixed with small stones or shells, used on the outside of buildings.

router A hand-held or fixed timber-working machine with a high-speed rotating cutter for cutting grooves, or moulding the edges of timber.

routine maintenance Short-term maintenance activities to maintain operations to an adequate quality level.

rowlock Same as BRICK ON EDGE.

rpm Revolutions per minute.

RSI Repetitive strain injury.

RSJ Abbreviation for ROLLED STEEL JOIST.

rubbed finish A finish obtained by using a surface abrasive to remove irregularities.

rubber-banding In computer graphics, a dynamic process for drawing a series of straight lines in succession, where one point of a line segment is fixed on the screen and the other is attached to the moving CURSOR. This obviates the need to input two points for connected line segments (other than the first line).

rubber mounting A vibration-isolation mounting for a machine that is liable to transmit vibration to its supports.

rubble Rough stones of irregular shape and size. They may result from quarrying, from the demolition of old buildings, or (more rarely) from the natural disintegration of large pieces of rock. Squared stone is called ASHLAR. See also [COURSED RUBBLE](#) and [DRY WALL](#) (a).

ruled surface A surface on which it is possible to draw straight lines. Consequently such a surface can be generated by a straight line, and concrete form-work can be constructed from straight pieces of timber. A surface is *singly ruled* if at every point only a single straight line can be drawn. It is *doubly ruled* if at every point two straight lines can be drawn. CYLINDRICAL SHELLS and CONOIDS are singly ruled. HYPERBOLIC PARABOLOIDS and HYPERBOLOIDS OF REVOLUTION are doubly ruled.

ruler In computing, the display at the top and/or side of an application. Used in word processing for setting margins, tabs etc.

runby See [OVERTRAVEL](#).

rung A bar that forms a step in a ladder.

running maintenance Maintenance implemented while an item is still functioning.

run-off The surface discharge of water derived from precipitation on a surface.

rupture See [MODULUS OF RUPTURE](#).

rust Hydrated iron oxide ($2\text{Fe}_2\text{O}_3 \cdot 3\text{H}_2\text{O}$) formed on unprotected iron by exposure to air and moisture.

rusticated column A circular column whose shaft is interrupted by square blocks.

rustication (a) Construction of natural stonework with recessed joints. Rusticated stonework may be *smooth* or *diamond pointed* (both with a dressed surface), *cyclopean* (rockfaced, with a finish as quarried, or an artful imitation thereof), or VERMICULATED. (b) Simulation of rusticated stonework in STUCCO. (c) Simulation of rusticated stonework in concrete, by moulding a groove in the concrete surface with a *rustication strip*.

rustication strip A strip of timber fixed to concrete formwork to produce a 'rusticated' surface, i.e. a series of grooves imitating the rustication of natural-stone blocks.

rustic brick A brick whose surface has been roughened by impressing it with a pattern, or by coating it with sand. Also called *texture brick*.

rutile See [TITANIUM WHITE](#).

R-value The measure of THERMAL RESISTANCE.

S

S Chemical symbol for *sulphur*.

S US symbol for the (elastic) SECTION MODULUS. In Britain and Australia, the symbol *Z* is used for the section modulus, and *S* for the PLASTIC SECTION MODULUS.

s, sec Abbreviation for *second*.

SAA Standards Association of Australia, Sydney; now Standards Australia.

saber saw US term for JIGSAW.

sabin Unit of SOUND ABSORPTION, equal to 1m² (metric units) or 1ft² (FPS units) of open window. It is named after W.C.Sabine, Professor of Natural Philosophy at Harvard University, who founded the science of architectural acoustics at the end of the nineteenth century.

Sabine formula An equation for predicting the REVERBERATION TIME of an enclosure, which was determined empirically by W.C.Sabine:

$$T = 0.049 \frac{V}{A}$$

where *T* is the reverberation time in seconds, *V* is the volume of the enclosure in ft³, and *A* is the total absorption in the enclosure in ft² SABINS. In SI units, the formula becomes

$$T = 0.16 \frac{V}{A}$$

SABS South African Bureau of Standards, Pretoria.

sack of cement Same as BAG OF CEMENT.

sacrificial protection Galvanic protection given to a metal by making it the cathode to a sacrificial ANODE.

saddle surface A doubly curved surface of negative GAUSSIAN CURVATURE; the term is synonymous with *anticlastic surface*. If a DOME may be said to correspond to the top of a mountain, then a saddle corresponds to a mountain pass.

safe-edge A mechanically actuated device mounted on the leading edge of a LIFT DOOR, which when striking a passenger or other object causes the car and landing doors to re-open. See also **PASSENGER DETECTOR**.

safetray A watertight tray fitted under an appliance to intercept condensation, spillage or leakage, and provided with a waste pipe to direct any discharge to a safe location.

safety factor See [FACTOR OF SAFETY](#).

safety glass (a) Glass containing thin wire reinforcement. (b) Glass laminated with transparent plastic; this prevents splinters flying if the glass is broken. (c) Glass, toughened by heat treatment, which breaks into small fragments without splintering.

safety lighting Normally refers to [STANDBY LIGHTING](#) to allow processes to continue, or to be safely stopped.

safety valve A pressure-relief valve fitted to a pressure vessel.

sag The [LEVER ARM](#) of a [SUSPENSION CABLE](#).

sagging moment A positive bending moment, such as occurs in simply supported or continuous beams near mid-span; it causes a ‘sagging’ deformation. A *hogging moment* is negative. See also [NEGATIVE BENDING MOMENT](#) for an illustration.

Saint-Venant’s principle ‘Forces applied at one part of an elastic structure will induce stresses which, except in the region close to that part, will depend almost entirely upon their resultant action, and very little on their distribution.’ The principle was originally proposed by the French mathematician in 1864.

sal ammoniac Ammonium chloride (NH_4Cl).

salient corner Projecting corner; the opposite of a *re-entrant corner*.

salmon brick A relatively soft, underburnt brick of salmon colour.

salt A substance obtained by the union of an acid and a base radical, or by displacing the hydrogen of an [ACID](#) by a metal. In *double salts* the replacement is by two metals. Most salts are crystalline. *Common salt* is sodium chloride (NaCl), which crystallises in the cubic system.

salt glaze Glaze formed on stoneware by inserting common salt into the hot kiln.

sample A group of members of large [POPULATIONS](#), used to give information as to the larger quantity. A *random sample* is selected without bias, so that each member has an equal chance of inclusion. A *representative sample* is selected to be representative of the whole population.

sample, borehole See [BOREHOLE SAMPLE](#).

samson truck Heavy-duty low-wheeled platform for transporting goods or equipment.

sand Naturally occurring deposits of [COHESIONLESS SOIL](#), ranging from 10mm to 0.1mm (0.004in.), and resulting from the disintegration of rock. Most sands are white or yellow, and consist of [SILICA](#); however, *black sands* occur naturally near volcanic rock deposits, and *coral sands* occur near coral reefs. Sand is used as [FINE AGGREGATE](#) for concrete, in cement and in [lime MORTAR](#), and in [CALCIUM-SILICATE BRICKS](#).

sandblasting Abrading a surface, such as concrete, by a stream of sand ejected from a nozzle by compressed air. It may be used merely to clean up construction joints, or it may be carried deeper to [EXPOSE](#) the [AGGREGATE](#), or to produce

a sculpture. It is also used to clean metal surfaces prior to painting. See also [SANDING](#).

sander A machine for [SANDING](#) surfaces, usually of timber, and for smoothing the joints in soft materials such as [PLASTER-BOARD](#). See also [BELT SANDER](#) and [ORBITAL SANDER](#).

sand-faced brick A facing brick coated with sand to give it a rustic finish.

sandheap analogy An analogue for the plastic torsional resistance of a section, proposed by A.Nadai, which is an extension of the [MEMBRANE ANALOGY](#). If the cross-section subject to torsion is suspended horizontally and covered with sand, the natural slope of the sand represents the constant plastic shear stress. The volume of the sand gives a measure of the section's plastic torsional resistance moment.

sanding The operation of finishing surfaces, particularly those of wood, with sandpaper or some other abrasive. It may be done by hand, or with a machine employing a belt or a revolving disc, faced with abrasive paper. See also [SANDBLASTING](#).

sandlime brick Same as [CALCIUM-SILICATE BRICK](#).

sandstone Sedimentary rock containing a large proportion of rounded silica grains, generally ranging from 1mm to 0.1mm in diameter. The sand is normally cemented into a solid mass by a matrix, which may be composed of silica (*siliceous sandstone*), of lime (*calcareous sandstone*), or of iron ore (*ferruginous sandstone*). The finer-grained sand-stones are easily carved if the matrix is sufficiently soft (see [FREESTONE](#)). Sedimentary rocks composed of larger sand particles are called *gritstones*. See also [QUARTZITE](#).

sandwich construction Composite construction with a light, insulating core, which would have inadequate strength without outer layers of higher density and greater strength.

sanitary plumbing, drainage The assembly of pipes, fittings, fixtures and appliances that remove the [SANITARY WASTE](#).

sanitary waste The dirty water from kitchens, bathrooms, laundries etc. See also [STORMWATER](#).

Santorin earth A natural [POZZOLANA](#) found on a Greek island of that name (also called Thera). It has been used since antiquity.

sap The watery fluid circulating in trees, which is necessary for their growth.

sapwood The outer layers of the wood of a tree, in which food materials are conveyed and stored during the life of the tree. They are usually of lighter colour than the *heartwood*.

sarking A continuous layer placed under tiles or other roofing, to keep out wind and wind-driven rain. Originally it was a layer of boarding, but now it is often a waterproof plastic material. It may also have an aluminium foil facing to reduce radiant heat transfer.

sash A frame into which window panes are set. It normally implies a sliding frame in a [SASH WINDOW](#), but the term is also used for [CASEMENT WINDOWS](#) and fixed windows.

sash bars The strips of wood that separate the panes of glass in a window sash composed of several panes. Also called *muntings*.

sashless window Window composed of panes of glass that slide along parallel tracks in the window frame towards each other to leave openings at the sides.

sash window A window contained in a cased frame that slides, as opposed to a CASEMENT WINDOW. The normal sash window (also called a *vertical sash* or *balanced sash*) slides up and down, and is supported by sash cords passing over sash pulleys and balanced by counter-weights. It was introduced into England in the seventeenth century, and was a prominent feature of residential building from the Restoration to the Georgian period, and subsequently. Also called a DOUBLE-HUNG WINDOW. The less commonly used *sliding sash window* moves horizontally.

saturated air Air that contains as much water vapour as it is capable of absorbing, i.e. air at the DEW POINT. If the moisture content is increased, CONDENSATION or fogging occurs. The amount of water vapour that air can absorb decreases with temperature, so that air that is partly saturated may become fully saturated as it is cooled.

saturated solution A solution containing the maximum amount of a particular substance that it can dissolve at a particular temperature.

saturated vapour pressure The pressure of a vapour in contact with its liquid form. It falls as the temperature falls.

saturation temperature The air temperature at which, for any given vapour content, air is saturated. Any further decrease results in CONDENSATION.

saw arbor The spindle on which a circular saw is mounted.

saw doctor A craftsman who sharpens, sets and maintains the saws in a sawmill.

sawdust concrete Concrete whose aggregate consists mainly of sawdust, i.e. the waste product of timber. It has a low strength, but it can be *nailed*.

sawn timber Timber reduced from the log by sawing, but not subsequently DRESSED. In North America, called LUMBER.

sawtooth roof Same as NORTHLIGHT ROOF.

Sb Chemical symbol for *antimony* (stibium).

SC Sky component (of the daylight factor).

scabble To rough-dress a surface.

scaffold A temporary structure of steel, timber or aluminium, to support workers and materials during construction, or for shoring concrete during hardening. Bamboo is widely used in Southern Asia.

scaffold crane A small self-contained motorised crane attached to scaffolding for lifting relatively small loads, up to about 200kg.

scaffold nail Same as DOUBLE-HEADED NAIL.

scagliola An imitation of ornamental marble, made from cement or lime, gypsum, marble chips and colouring matter. It was used in Ancient Rome, and its use was revived in the seventeenth and eighteenth centuries.

scalar A quantity that has magnitude, but no direction. A VECTOR has both magnitude and direction.

scale (a) Accumulation of salts deposited from HARD WATER on surfaces of a container such as a boiler or calorifier when the water is heated. (b) See [MILL SCALE](#). (c) See [CHROMATIC SCALE](#) and [DIATONIC SCALE](#).

scale drawing A drawing that shows all parts of the objects illustrated in the same proportion of their true size. Some pictorial PROJECTIONS do not result in scale drawings.

scanner A device for transferring printed material into a digital form suitable for manipulation by a computer.

scantling A piece of timber of comparatively small dimensions.

scarf joint An END JOINT between two pieces of timber, tapered to form sloping surfaces that match. It may be glued or bolted. A *stepped* or *hooked* scarf joint is one in which the jointing plane is discontinuous, and both pieces are machined to form matching steps or matching hooks. This facilitates alignment of the two ends.

scattering The effect of DIFFRACTION from an unordered array of discontinuities in a medium. In acoustics sound scattering may occur because of objects in a room or because of surfaces that are irregular.

SCF Abbreviation for SHORT-COLUMN FORMULA.

scheduled control Of lift systems: a supervisory control system that dispatches lift cars to serve landing calls according to a fixed schedule. See also [LIFT RECALL](#).

Schmidt hammer An instrument used for the NON-DESTRUCTIVE TESTING of hardened concrete. It is based on the proposition that the rebound of the steel hammer from the concrete surface is proportional to the compressive strength of the concrete.

Schwedler dome A braced dome (devised by a German engineer of that name in the late nineteenth century) consisting of hoops and meridional bars, connected together to form a series of trapezia, lined up along horizontal polygonal rings. To stiffen the structure, each trapezium is divided into two triangles by a diagonal; however, symmetrical loading introduces no stresses in these diagonals, if the dome is pinjointed. See also [GEODESIC DOME](#).

scissor lift A work platform mounted on wheels, capable of rising vertically by a scissor-like mechanism. Often designed for indoor operation, for maintenance in tall rooms. See also [CHERRY PICKER](#)

sclerometer An instrument for the determination of hardness by means of a scratch with a diamond pyramid.

Scotch bond Same as COMMON BOND.

Scotch derrick A crane with a LUFFING and SLEWING jib pivoting at the base of a mast, the top of which supports jib cables, and which is supported by two rigid guys connected to each other and to the mast at their counterbalanced bases. See also [DERRICK](#).

scraffeto or sgraffito See [GRAFFITO](#).

scratch-coat The first coat of stucco or plaster applied to a surface in three-coat work.

screed (a) A heavy rule used for forming a concrete surface to the desired level or shape. Also called *screed board*, *tamper* or *strikeoff*. (b) The operation of striking off concrete lying above the desired level or shape. (c) A layer of concrete or mortar laid to finish a floor surface and hide the construction joints. This is sometimes called *jointless flooring*. (d) A bed of mortar laid as a base for ceramic or glass tiles. (e) A layer of concrete placed on a 'flat' roof to provide the correct gradient for drainage.

screen analysis PARTICLE-SIZE ANALYSIS for the larger particle sizes.

screenings The rejects from screening a granular material. They may consist of either oversize or undersize particles.

screen resolution See [RESOLUTION](#).

screen size (a) A measurement of the diagonal size of a computer or television screen, usually in inches. (b) The measurement of the openings in a sieve screen.

screw anchor A shell that expands and wedges itself into a hole drilled for it when a screw is inserted into it.

screw cap For a lamp: same as EDISON CAP.

screw drive A lift driven by a screw assembly, whose power is supplied by an electric motor.

screw compressor A machine for compressing a gas or vapour by the action of two meshing helical rotors.

screw jack A lifting device actuated by means of a square-threaded screw. Its lifting capacity is more limited than that of a hydraulic JACK.

screw nail A fastening device used where the holding power required exceeds that of a nail. It is intended to be driven with a hammer, but removed with a screwdriver.

screw pile A pile with a spiral-bladed shoe, which is twisted into the ground. Because of the low torsional strength of reinforced concrete, the pile is rarely precast; instead the driving shaft is usually withdrawn, and the pile cast in the BORED hole.

scroll bars Horizontal and vertical bars at the edges of windows on a computer screen, with sliding elements allowing the movement of displayed information, e.g. lines of text or graphics.

scrolling In computing, a type of PANNING restricted to horizontal or vertical movement using keys or SCROLL BARS.

scrubber A device for removing contaminants from a stream of air or gas(es) by passing it through a water spray.

scupper (a) An opening in a parapet to drain rainwater. (b) A screen to prevent clogging of the drain.

Se Chemical symbol for *selenium*.

seal See [TRAP](#).

sealing compound See [JOINT SEALANT](#) and [MEMBRANE CURING](#).

seasoning The drying of timber by NATURAL SEASONING or in a KILN.

seasoning check Separation of wood extending longitudinally, formed during drying. It is commonly caused by the immediate effect of a dry wind or hot sun

on freshly sawn timber. It usually extends only a few inches in length, whereas a longitudinal SHAKE may be several feet long.

sec Secant of an angle; $\sec\theta=1/\cos\theta$.

secant (a) A straight line that intersects a curve. See also TANGENT. (b) A CIRCULAR FUNCTION of an angle, the ratio of the length of the hypotenuse of a right-angled triangle to that of the side adjacent to the angle. Abbreviated *sec*.

secant column formula A formula for the design of columns, which is more sophisticated than the RANKINE FORMULA; it contains a secant term. The formula deals with the buckling of eccentrically loaded columns, treating the unavoidable imperfections in long concentrically loaded columns as equivalent to an initial slight eccentricity of loading, defined by the empirical constant in the secant formula. See also PERRY-ROBERTSON FORMULA.

secant modulus of elasticity Many materials (e.g. concrete) do not conform strictly to HOOKE'S LAW because of deviations caused by INELASTIC behaviour. If the deviation is significant, it becomes necessary to define the MODULUS OF ELASTICITY as the tangent or secant to the STRESS-STRAIN DIAGRAM.

secondary beam A beam or joist carried by the main or primary beams or girders, and transmitting its load to them.

secondary colour A colour obtained by mixing two or more PRIMARY COLOURS.

secondary floor A floor or platform, within a LIFT WELL, located just below the overhead machinery room. It gives access to the *diverter sheaves*, and may contain other items of equipment.

secondary reinforcement Reinforcement that is subsidiary to the main reinforcement, such as DISTRIBUTION REINFORCEMENT in slabs, TIRRUPS in beams, and LATERAL REINFORCEMENT in columns.

secondary stresses Stresses that are of secondary importance, and do not determine the main dimensions of a structural member. The member may have to be checked for secondary stresses after it has been dimensioned for the primary stresses.

second moment of area (*I*) The sum of the products obtained by multiplying each element of an area dA , by the square of its distance from the reference axis, drawn through the CENTROID of the section. It is therefore

$$\sum y^2 dA \text{ or } \int y^2 dA$$

The second moment of area is a geometric property essential to the solution of bending problems. It is frequently (incorrectly) called the MOMENT OF INERTIA.

secret nailing Driving nails (e.g. sideways into a joint) so that they cannot be seen. Also called *blind nailing* or *concealed nailing*.

section modulus (*Z*) A convenient notation for the ratio I/y , where I is the SECOND MOMENT OF AREA and y is the *extreme fibre distance*. It is used

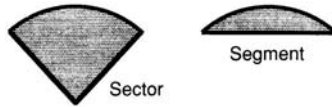

sector of a circle

extensively in the design of beams (see [NAVIER'S THEOREM](#)). Section moduli for standard sections in steel, aluminium, timber and concrete are available in *section tables*. See also [PLASTIC SECTION MODULUS](#).

sector In lift industry terminology, a GROUP either of landings, or of landing calls considered together for lift car allocation or parking purposes.

sector of a circle A figure bounded by two radii and an ARC (see Figure).

security control system A system of automated locks and sensors arranged to monitor and control access to building spaces.

security glass See [BULLET-RESISTING GLASS](#), [SAFETY GLASS](#) and [TEMPERED GLASS](#).

sedimentary rock A rock produced as a sediment on the floors of oceans, lakes or rivers, or on land. It may consist of fragments of pre-existing rock, or the hard parts of organisms. See [LIMESTONE](#), [SANDSTONE](#) and [SHALE](#). See also [IGNEOUS](#) and [METAMORPHIC ROCK](#).

sedimentation See [STOKES' LAW](#).

Seger cone A type of PYROMETRIC CONE, made of a mixture of clay and salt of known melting point.

segment of a circle A figure bounded by a straight line (a SECANT) and an ARC. See illustration for [SECTOR OF A CIRCLE](#).

seismic loading See [EARTHQUAKE LOADING](#).

seismic restraint A device designed to limit movement of equipment and furnishings of a building during the motion set up by an earthquake.

seismograph An instrument for recording the magnitude and frequency of an earthquake. See also [RICHTER SCALE](#).

selective surface The surface whose solar absorptance is much higher than its emittance of long-wave infrared radiation. Thus it retains most of the solar energy absorbed.

selective tender The invitation and receipt of tenders from a selected group of contractors who are considered suitable to perform the work.

selenium A non-metallic element, the first to be used in PHOTOVOLTAIC CELLS and in rectifiers. Its chemical symbol is Se, its atomic number is 34, its atomic weight is 78.96, and its specific gravity is 4.45. It has a melting point of 220°C, and its valency is 2, 4 or 6. There are several allotropic forms. The grey (or 'metallic') selenium is a conductor of electricity when illuminated.

self-climbing crane A TOWER CRANE able to increase the height of the tower by lifting and adding sections without the aid of another crane.

self-closing door A door for fire or smoke control, which closes itself by the action of a spring or weight. It may be held open either by a fusible link, which

melts in a fire, or by an electric circuit linked to the fire alarm system, causing the door to close in case of fire.

self-drilling screw A screw with a drillpoint, intended for drilling its own hole when driven with a power screwdriver. Usually used for fixing to steel sections from 1 to about 6mm in thickness, but screws with a modified point to assist drilling into timber are also available. (For fixing to steel less than about 1mm in thickness, a NEEDLE-POINT SCREW is sufficient.)

self-embedding screw A screw whose head has a roughened underside. It is intended to embed the head flush into timber or other soft material, without first countersinking. See also [BUGLE-HEAD SCREW](#).

self-stressing concrete PRESTRESSED CONCRETE that is post-tensioned by the use of EXPANSIVE CEMENT.

self-tapping screw A screw, usually of hardened steel, capable of cutting a thread when driven into metal. It may or may not also be SELF-DRILLING.

semicircular arch A circular arch, which forms a complete semicircle so that it comes vertically on its SPRINGINGS. Its rise therefore equals one half of its span.

semiconductor A material, such as SILICON, which can be made to conduct electricity or to insulate. It is used in TRANSISTORS, INTEGRATED CIRCUITS and PHOTOVOLTAIC CELLS.

semi-detached house One of two houses erected as a single building separated by a COMMON WALL.

semidome One quarter of a sphere, used in traditional construction to cover a semicircular area, such as an apse.

semi-flexible joint Same as SEMI-RIGID JOINT.

semigloss See [GLOSS](#).

semi-logarithmic graph paper (semi-log paper) Graph paper that has one LOGARITHMIC SCALE and one ordinary scale.

semi-rigid joint A joint that is designed to permit some rotation, either in steel or in reinforced concrete construction. It is intermediate between a RIGID JOINT and a PIN JOINT. Also called a *semi-flexible joint* or a *partially fixed joint*.

semi-specular The reflective properties of materials that exhibit a combination of SPECULAR and DIFFUSE reflection.

semitone Frequency interval that is approximately 6 per cent of an OCTAVE. It is the interval between notes on the CHROMATIC SCALE.

sensible cooling Cooling of air in a building without changing the moisture content.

sensible heat The heat absorbed or emitted by a fluid or solid when temperature changes, without a change of state; as distinct from the LATENT HEAT.

sensible heat factor The ratio of sensible heat to total heat (sensible heat plus latent heat).

sensitivity ratio The ratio of the unconfined compressive strength of clay in its undisturbed state to that of REMOULDED CLAY. For some clays this is only

slightly above unity, but for clays sensitive to remoulding the ratio may be as high as 8.

sensor An instrument used to detect change in a variable function.

septic tank A tank for the purification of domestic sewage, used in districts not served by sewer pipes. Disintegration of organic matter is effected by natural bacterial action, and the effluent is discharged into the ground.

serpentine Hydrated silicate of magnesium, found in ultrabasic IGNEOUS ROCKS. Some varieties, which are dark green and polishable, are called MARBLE in the building industry classification. See also [MALACHITE](#).

service agreement An agreement between service providers and principals that describes the scope of service, the standard of service and performance review.

service areas (a) Those areas of a building set aside for cupboards, plant rooms and risers. (b) Functional areas that support the operation of the building, such as loading, parking, tea rooms and waste collection.

service core A vertical element in a multistorey building, containing the lifts (elevators), the vertical runs of most of the mechanical and electrical services, and fire stairs. It is frequently the first part of the building to be erected, and is then used for vertical transportation during construction. The service core is usually a stiff element, contributing substantially to the building's resistance to horizontal forces such as wind loads. See [TUBE STRUCTURE](#) and [TOP-HAT STRUCTURE](#).

service life The period of time during which a building element is expected to provide satisfactory service with an acceptable return on investment.

service lift A lift designed to carry goods and service personnel. See also [GOODS LIFT](#), [PASSENGER/GOODS LIFT](#) and [DUMBWAITER](#).

service load The normal WORKING LOAD that the structure is required to support in service.

service riser See [RISER](#) (e).

services easement See [EASEMENT](#).

service stair A stair not in general use, giving access to specific areas such as roofspace and plant rooms, usually for maintenance purposes.

sesqui One-and-a-half times: e.g. Fe_2O_3 (ferric oxide) is also called iron sesquioxide.

set (a) As a mathematical concept, a group of different elements, having at least one common characteristic. (b) Strain remaining after removal of stress.

setback The withdrawal of the face of a building to a line some distance from the boundary of the property, or from the street. A building may be set back at the level of the ground floor, or merely at the upper floors.

setscrew A screw used to fix a detachable part to a machine, e.g. a collar to a shaft.

set theory A mathematical theory dealing with the relationship between SETS (a).

setting block A block used to position and support glass in glazing systems.

setting of concrete The initial stage in the chemical reaction between cement and water, when the concrete stiffens and loses the fluidity necessary to fill the formwork. It gains significant strength only during the next, or HARDENING, stage. See also [VICAT TEST](#).

setting time The time taken for a mixture to reach an acceptable strength.

settlement See [CONSOLIDATION](#) and [DIFFERENTIAL SETTLEMENT](#).

sewage Human wastes, and the water used to carry them away.

sewerage A system of drainage used for removing SEWAGE.

sextant A reflecting instrument for measuring ALTITUDES up to 120°. See also [QUADRANT](#).

SfB Abbreviation for Samarbetskom-mittén for Byggnadsfrågor, a Swedish committee that devised a classification system for building information, used internationally under the auspices of the CIB.

sg Specific gravity.

sgraffito Same as GRAFFITO.

shading In computer graphics, the process of adding shadows and shade to surfaces taking into account light sources and surface characteristics.

shading coefficient Of a window: a measure of the reduction in the solar heat gain through the use of sunshades and/or of heat-absorbing or heat-reflecting glass. It is defined as the ratio on a particular day of the solar heat gain through the window under consideration, as glazed and shaded, to the solar heat gain through a similar unshaded window of clear glass 3mm thick.

shadow angle protractor A transparent overlay for the SUNPATH CHART, used for the design of sunshades.

shake (a) A partial or complete separating between adjoining layers of wood, due initially to causes other than drying. A *felling shake* is one caused by the felling of the tree. A *water shake*, *ring shake* or *cup shake* is one occurring between two adjacent growth rings. A *heart shake* or *star shake* is one extending from the pith of the tree, and existing in the log before conversion. A *wind shake* is one caused by wind action on the growing tree. A *transverse shake* runs across the fibres, and a *longitudinal shake* parallel to them. See also [SEASONING CHECK](#). (b) A wood SHINGLE, particularly one made by splitting a short log into tapered radial sections.

shale A laminated and fissile sedimentary rock consisting primarily of clay and silt particles.

shape factor See [PLASTIC SECTION MODULUS](#).

shaping machine A machine that removes shavings from a metal surface fixed to a stationary table with a tool that moves backwards and forwards. See also [PLANING MACHINE](#).

shared space A workplace shared between two or more employees, usually at different times.

shear box A laboratory SHEAR TEST, which determines the strength of soil by applying a shear force directly to a soil sample, contained in a box split horizontally.

shear connector A welded stud, angle or spiral bar, which transfers shear from concrete to steel in COMPOSITE CONSTRUCTION.

shear force (V) The resultant of all the vertical forces acting at any section of a beam (or slab) on one side of the section. This force tends to shear or cut through the beam. The shear force is the vertical resultant of the statical equilibrium equations at the section, while the BENDING MOMENT is the moment resultant (and generally the more important consideration).

shearhead The COLUMN CAPITAL (b) in a FLAT SLAB.

shear legs A hoist consisting of two or more poles lashed together at the top, with a pulley hung from the lashing. Used for lifting moderately heavy weights. See also CRANE.

shear modulus of elasticity Same as MODULUS OF RIGIDITY.

shear reinforcement Reinforcement designed to resist the shear or diagonal tensile stresses in concrete. Shear reinforcement is generally required only when shear stresses are in excess of the permissible.

shear strain See STRAIN.

shear stress See STRESS.

shear tests for soil See SHEAR BOX and TRIAXIAL COMPRESSION TEST (which are laboratory tests), UNCONFINED COMPRESSION TEST (a laboratory or site test) and VANE TEST (a site test).

shear wall A wall that resists shear forces in its own plane due to wind, earthquake forces, explosions etc.

sheath (a) An enclosure for post-tensioned tendons. The tendon is placed in the concrete enclosed in the sheath, and bond is prevented until after the tendon has been prestressed. (b) The tough plastic covering placed over the electrical insulation of cables to provide mechanical protection. See TPS CABLE.

sheave A wheel with a GROOVE or grooves in its circumference for receiving rope(s), particularly in LIFT systems. See WRAP, *single and double*.

shed roof A roof having one slope only. The one set of rafters has a fall from the higher to the lower wall. Also called *lean-to roof* or *skillion roof*.

sheet Material produced in thin layers. Sheet metal is thinner than metal *plate*, but thicker than metal foil. Metal *strip* is narrower than sheet metal.

sheet glass Glass of the type used in windows. It is thinner than PLATE GLASS. It is specified either by thickness or by weight per unit area.

sheet pile A PILE in the form of a plank, driven in close contact with others to provide a tight wall to resist the lateral pressure of water, adjacent earth, or other materials. It may be made interlocking if made of metal, or tongued and grooved if made of timber or concrete. See also WELLPOINT DEWATERING.

shelf life Maximum interval during which a perishable material, e.g. an adhesive, may be stored, and remain in usable condition. See also POT LIFE.

shellac An encrustation, which is a natural resin, formed on certain tropical trees by an insect. The purified form is *lac*. It is soluble in alcohol, and is used in spirit varnishes and in *French polish*.

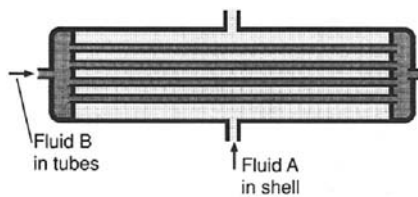

shell-and-tube heat exchanger

shell-and-tube heat exchanger A heat exchange device consisting of a series of parallel tubes inside a (usually cylindrical) vessel in which heat is exchanged between a fluid passing through the tubes and another surrounding fluid contained in the vessel (see Figure).

shell roof A roof structure built with thin curved slabs. See [BARREL VAULT](#), [DEVELOPABLE SURFACE](#), [DOME](#), [DOUBLE-WALLED SHELL](#), [EDGE BEAM](#), [GAUSSIAN CURVATURE](#), [HYPERBOLIC PARABOLOID SHELL](#), [MEMBRANE THEORY](#), [NORTHLIGHT SHELL](#), [RULED SURFACE](#), [SADDLE SURFACE](#), [SURFACE OF REVOLUTION](#), [SURFACE OF TRANSLATION](#) and [UMBRELLA SHELL](#).

sherardising A method of applying a protective zinc coating to steel. The steel parts are packed in boxes filled with sand mixed with zinc, and heated to a temperature below the melting point of zinc. See also [GALVANISING](#).

SHF Abbreviation for [SENSIBLE HEAT FACTOR](#).

shielded-arc welding [ARC WELDING](#) in which the arc is surrounded by an atmosphere of an inert gas (argon, a mixture of argon and carbon dioxide, or helium). The gas is held under pressure in a cylinder and released around the electrode to exclude air, which would oxidise the weld metal and also allow nitrogen to combine with it. The process is used for stainless and other alloy steels, and for aluminium and magnesium alloys which oxidise readily, as well as for steel, especially in light gauges. See also [ARGON-ARC](#), [MIG](#), [TIG](#) and [HELIARC WELDING](#).

shim A thin piece placed or driven into a joint to level or plumb a structural member.

shingle (a) Thin piece of wood, asphalt-impregnated felt, or other material used for covering sloping roofs. (b) Rounded stone of variable size and shape, but coarser than [SAND](#).

shoe See [PILE SHOE](#).

shooting concrete Placing of [SHOTCRETE](#).

shop drawings Drawings, usually prepared by a specialist supplier or fabricator, showing sufficient detail to allow the off-site manufacture of a part of a building. The shop drawings show some different items of information to those required on site, but it is essential to ensure that they are compatible with the building drawings, before manufacture commences. See also [WORKING DRAWINGS](#).

shop welding, shop riveting Welding or riveting carried out in the workshop, as opposed to work carried out on the site.

shore A temporary support, of timber or other material, used in compression as temporary support for excavations, formwork, or propping of unsafe structures. It is usually sloping (*raking shore*), but occasionally horizontal (*flying shore*) or vertical (*dead shore*).

short-circuit An accidental connection, of zero or low resistance, joining two sides of an electrical circuit.

short-column formula (SCF) The strength of a column which has no tendency whatsoever towards BUCKLING,

$$P = fA$$

where A is the cross-sectional area and f is the failing stress, i.e. the yield stress of steel, or the crushing strength of concrete. Note that, unlike the EULER FORMULA, the SCF is independent of the modulus of elasticity. See also RANKINE FORMULA.

short-term deflection Primarily elastic deflection that occurs over a short period of time; as opposed to LONG-TERM DEFLECTION.

short ton A TON of 2000 pounds.

short-wave solar radiation Radiation with a wavelength of 0.3 to $3\mu\text{m}$ received directly from the sun, as distinct from LONG-WAVE RADIATION.

shotblasting Cleaning a steel surface by projecting steel shot against it with compressed air or with a centrifugal steel impeller.

shotcrete Cement mortar or concrete placed under pressure through the nozzle of a CEMENT GUN. Also known as *gunite*, or as *pneumatically applied mortar*.

shot fixing Installing fixings using an EXPLOSIVE-POWERED TOOL.

shrinkage Contraction due to moisture movement. The two building materials most affected are timber and concrete. The maximum fractional shrinkage of timber is about 100×10^{-3} parallel to the growth rings, 50×10^{-3} at right angles to the rings (RADIAL SHRINKAGE), and 1×10^{-3} along its length. Timber is normally SEASONED before use to reduce shrinkage after the timber has been fixed in the building. The shrinkage of concrete is less: about 3×10^{-4} .

shrinkage-compensating cement An EXPANSIVE CEMENT, which on setting expands sufficiently to compensate the contraction due to SHRINKAGE.

shrinkage cracking Cracking caused by SHRINKAGE when contraction is resisted by restraints.

shrinkage joint Same as CONTRACTION JOINT.

shrinkage limit The limiting water content for a clay soil, below which a reduction in water content causes no further decrease in volume. It is often accompanied by a change in colour, and marks the limit between the plastic and the solid states.

shrinkage loss LOSS OF PRESTRESS caused by the shrinkage of the concrete.

shrinkage reinforcement Secondary reinforcement designed to resist shrinkage stresses in the concrete. Same as DIS TRIBUTION REINFORCEMENT.

shrinkage stresses Stresses caused when the shrinkage of concrete (or timber) is resisted by restraints or (non-shrinking) metal reinforcement.

shutdown maintenance Maintenance requiring that an item be removed from service for implementation.

shuttering Same as FORMWORK.

shutters Protective covering for the outside of windows. Shutters usually consist of vertically hinged wooden frames, and are closed at night to prevent heat loss, and for privacy. *Louvred* shutters are used for ventilation, in conjunction with inward-opening *casement* windows. *Steel shutters* are used in fortifications, or in ordinary buildings if rioting or cyclonic winds are a frequent occurrence.

shuttle lift (elevator) An express lift from a street lobby to a SKY LOBBY, where transfer is made to local lifts.

Si Chemical symbol for *silicon*.

side flash A discharge between nearby metallic objects, or from such objects to the LIGHTNING PROTECTION SYSTEM or to earth.

side-hung window Same as CASEMENT WINDOW.

side lap The overlap required for two adjacent building components, such as two sheets of corrugated steel or two tiles, to prevent rain penetration.

side-sway Sideways movement of a frame, or of a member of a frame, due to wind or other lateral loads, to the asymmetry of the vertical loads, or to plastic collapse (see [LIMIT DESIGN](#)).

siding Wall cladding for small frame building, other than masonry or brick. The term is particularly used in the USA, and includes CLAPBOARD (also called *weatherboard*), metal, fibre cement and asphalt.

Siemens Martin process Same as OPEN-HEARTH PROCESS.

sienna Yellow mineral pigment. It consists of ferrous oxide (FeO). See also [BURNT SIENNA](#).

sieve analysis PARTICLE-SIZE ANALYSIS by passing material through successively finer sieves.

SIGGRAPH Abbreviation for the ACM'S Special Interest Group for Graphics.

sight rail A horizontal board set at some specified height above, say, the INVERT LEVEL of a drain. With a vertical pole it is possible to set out the drain between two sight rails accurately without surveying instruments.

SIL Abbreviation for SPEECH INTERFERENCE LEVEL.

silencer An acoustical transmission system that attenuates the sound energy. In an air conditioning duct, this may take the form of a section of duct lined with sound-absorbing material and absorbent splitters within the duct.

silica Silicon dioxide, SiO₂. About 60 per cent of the Earth's crust consists of silica, and it is the chief constituent of sand and clay. Its crystalline form is QUARTZ.

silica brick Same as CALCIUM-SILICATE BRICK.

silica gel A colloidal form of silica made by treating sodium silicate with hydrochloric or acetic acid. It has a high capacity for adsorbing water vapour, and it is used as a drying agent in instrument cases etc.

silicon A non-metallic element, the second most abundant in the Earth's crust (next to oxygen). It is an amorphous brown powder, or a grey crystalline substance; however, it commonly occurs as SILICA, or in the form of silicates, which are constituents of most rocks, clays and soils. It is a major constituent of Portland cement, an alloying element for steel and aluminium, and the principal material used in PHOTO-VOLTAIC CELLS. Silicon's chemical symbol is Si, its atomic number is 14, its valency is 4, its atomic weight is 28.06, its specific gravity is 2.4 and its melting point is 1420°C.

silicon carbide In the form of CARBORUNDUM, used as an abrasive.

silicon chip A CHIP based on silicon SEMI-CONDUCTOR material.

silicone A heat-stable compound in which silicon atoms are linked with oxygen atoms; the remaining valencies of the silicon atoms are saturated with hydrogen or organic radicals. There are many different silicones. All are chemically inert, and they are used as sealants, insulators and lubricators, e.g. in water-resistant films, heat resistant paints, synthetic rubbers, or resins for electrical insulation.

sill (a) The lowest horizontal member of a frame for a house or other structure.

(b) The horizontal member below a door or window opening.

silt Natural deposit resulting from the disintegration of rock, whose particles are intermediate in size between sand and clay, ranging from about 2 to 50µm in diameter.

silver A metal of characteristic 'silvery' colour. Its chemical symbol is Ag, its atomic number is 47, its atomic weight is 107.88, and its specific gravity is 10.50. It has a valency of 1, and a melting point of 960°C. *Sterling silver* is 92.5 per cent silver and 7.5 per cent copper.

silver solder A high-melting point SOLDER used where high strength is required. For plumbing work, it contains between 1 and 5 per cent silver. Also called *hard solder*.

silver steel Bright drawn steel containing about per cent of carbon, but no silver.

SI metric See [SI UNITS](#).

similarity, dimensional See [DIMENSIONAL ANALYSIS](#).

simple beam or simply supported beam A beam without restraint or CONTINUITY at the supports, as opposed to a *built-in beam* or a *fixed-ended beam*.

Simpson's rule A rule for the evaluation of an irregular area. Let the area be divided into an *even* number n of parallel strips of width x . The lengths of the boundary ordinates, or separating strips, are measured, and these are

$$y_0, y_1, y_2, \dots, y_{n-1}, y_n$$

The area of the figure is then

$$\frac{1}{3}x[y_0 + y_n + 2(y_2 + y_4 + \dots + y_{n-2}) + 4(y_1 + y_3 + \dots + y_{n-1})]$$

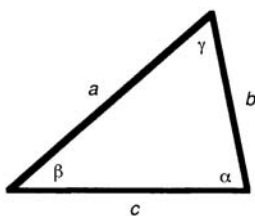

sine theorem

The PRISMOIDAL RULE is an extension of Simpson's rule to solid geometry, and it is used for measuring the volume of an excavation. Simpson's rule is more accurate than the TRAPEZOIDAL RULE.

simulation The process of representing or modelling a situation. Used for analysing behaviour, usually using mathematical modelling, but the process is more general, e.g. visual simulation.

simultaneous equations A set of equations that are all satisfied by the same values of the variables. There must be as many equations as variables. A large number of simultaneous equations are most conveniently solved by *matrix algebra*.

sin The SINE of an angle.

sine A CIRCULAR FUNCTION of an angle, the ratio of the side opposite to the angle to the hypotenuse of a right-angled triangle.

sine theorem A trigonometric theorem

$$\frac{a}{\sin \alpha} = \frac{b}{\sin \beta} = \frac{c}{\sin \gamma}$$

relating the sine of an angle to the length of the side opposite (see Figure).

sine wave A curve having the form $y = a \sin x$. Simple harmonic motion can be represented by the general equation

$$y = a \sin 2\pi \left(\frac{t}{T} - \frac{x}{\lambda} \right)$$

where x and y are the Cartesian coordinates of the curve, and t is the time. T (the period), λ (the wavelength) and a are constants. A *cosine wave* has the same shape, displaced by one-quarter of a wavelength. See also [FOURIER SERIES](#).

Singapore index Same as EQUATORIAL COMFORT INDEX.

single-acting engine A RECIPROCATING ENGINE in which the working fluid acts on one side of the piston only. Most internal combustion engines are of this type, so that only 1 in 2 or 1 in 4 strokes are working strokes.

single-event noise exposure level The constant sound level L_{AX} that, if maintained for 1 second, would deliver the same A-weighted noise energy to the receiver as the actual event itself. It is therefore an *equivalent continuous sound level* (L_{eq}) normalised to a period of one second.

single Flemish bond A brick bond that shows FLEMISH BOND on one side only. See also [DOUBLE FLEMISH BOND](#).

single-pitch roof A roof that slopes in only one direction, such as a *skillion roof*, *shed roof* or a *lean-to roof*.

single-sized aggregate Aggregate in which most of the particles lie between narrow limits of size. It is usually produced by removing larger and smaller particles by sieving. See [PEA GRAVEL](#).

singly curved surface A surface with zero GAUSSIAN CURVATURE, as distinct from a doubly curved surface. It is DEVELOPABLE and RULED.

singly ruled See [RULED SURFACE](#).

sinh Hyperbolic sine. See [HYPERBOLIC FUNCTIONS](#).

siphon A closed pipe that rises partly above the hydraulic gradient of the pipe. Provided the siphon has been PRIMED, and the pipe rises nowhere above the head due to atmospheric pressure (approximately 10m or 30ft), it conveys water. The term *inverted siphon* is often used for a sagging pipe, even though this presents no problems of siphonage. See also [BACK SIPHONAGE](#).

sisal A coarse natural fibre, once used as reinforcement in a variety of building materials; now largely superseded by *plastics* fibres. See also [FIBROUS PLASTER](#).

site-cast concrete Concrete cast *monolithically* in its final position in the structure, as opposed to *precast concrete*.

site contamination The degradation of land and buildings due to exposure to materials, processes or organisms detrimental to health.

site instruction An instruction delivered on site by the contract administrator or others authorised under the contract and subsequently confirmed in writing, itemising any variation to the contract.

site welding, site bolting, site riveting Welding, bolting or riveting carried out on the site, as opposed to work carried out in the shop. Also called *field welding* etc.

SI units The units used in the *Système International d'Unités*. This modified version of the *metric system* has now been adopted by most countries. It differs from the traditional metric, or CGS UNITS: (a) by using millimetre and metre in preference to centimetre; (b) by using the NEWTON as the unit of force and weight; and (c) by using the JOULE as the sole unit of measuring work and energy.

size A thin, pasty substance used as a sealer, binder or filler. It generally consists of a diluted glue, oil or resin.

size analysis See [PARTICLE-SIZE ANALYSIS](#).

skates Relatively small, low, wheeled platforms for transporting goods or equipment.

skeleton construction Construction in which the loads are transmitted to the ground by a FRAME, as opposed to construction with loadbearing walls.

skew Oblique; at an angle to the main direction.

skid steer A small tractor having four wheels without any steering mechanism. The pair of wheels on each side is driven separately from those on the other side,

so that steering is achieved by driving the two sides at different speeds (or in opposite directions). It is thus highly manoeuvrable.

skillion roof A roof with only one slope, formerly used when abutting another building, but now applied to any roof with a single slope other than a flat roof. Also called a *lean-to roof* or a *shed roof*.

skip (a) A movable refuse container. (b) A bucket with a hinged handle and openable bottom for lifting concrete by crane.

skirting A finishing board, which covers the joint between the wall and the floor of a room. Also called *baseboard*.

skirting heater A space convection heater installed at floor level against the wall (s) of a building in lieu of a skirting board. Also called *baseboard heater*.

sky See [CIE STANDARD CLEAR SKY](#), [CIE STANDARD OVERCAST SKY](#), [INDIAN STANDARD CLEAR SKY](#) and [UNIFORM SKY](#).

sky component (of the DAYLIGHT FACTOR). The ratio of the part of daylight illuminance received directly from a sky of assumed or known luminance distribution, to the illuminance on a horizontal plane due to an unobstructed hemisphere of this sky. A special case of this component is obtained when the sky is of uniform luminance and the window apertures are unglazed; it is called the SKY FACTOR.

sky factor The ratio of the part of the daylight illuminance that would be received directly through unglazed openings from a sky of uniform luminance, to the illuminance on a horizontal plane due to an unobstructed hemisphere of this sky; direct sunlight is excluded. The term has special legal significance in England.

skylight A window placed in a flat or sloping roof.

sky lobby A lift (elevator) lobby at an upper floor. A 90-storey building, for example, could be divided into three sections of 30 storeys, each with its separate lift system and lift lobby. The two sky lobbies are served by express lifts. By stopping the upper lift units at the sky lobbies, an appreciable amount of space is saved (see Figure).

sky-luminance distribution See [CIE STANDARD CLEAR SKY](#), [CIE STANDARD OVERCAST SKY](#), [INDIAN STANDARD CLEAR SKY](#) and [UNIFORM SKY](#).

skyscraper A term originally coined for the 10-storey Montauk Building in Chicago, built in 1882 with loadbearing walls. Buildings of this height were originally made possible by the development of the passenger lift (elevator), but soon rose much higher with the development of steel FRAME CONSTRUCTION.

slab In concrete construction, a flat surface that forms the floor or roof. Slabs may be directly supported on the ground (on GRADE); supported on beams as a BEAM-AND-SLAB FLOOR spanning *one way* or TWO-WAY between supporting beams; supported without beams on column capitals (FLAT SLAB); or supported directly on the columns without capitals or beams (FLAT PLATE).

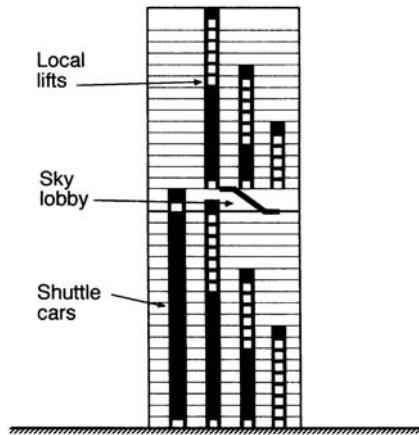

sky lobby

When the slab spans two-way, it is divided into MIDDLE STRIPS and COLUMN STRIPS in each direction.

slack The scheduling flexibility available for an activity in a PERT network. It is equivalent to the total FLOAT in a CPM network.

slag See [BLAST-FURNACE SLAG](#).

slag wool MINERAL WOOL made from molten BLAST-FURNACE SLAG.

slaked lime Same as HYDRATED LIME.

slate A fine-grained METAMORPHIC ROCK formed from clay, silt, shale or volcanic ash by high pressure. This gives the slate a CLEAVAGE PLANE across the original bedding planes. The material can be split into thin slabs. The terms *princess*, *duchess*, *countess* etc., used in conjunction with slate for covering roofs, refer to the size of the pieces, not to their quality.

slats See [VENETIAN BLIND](#).

sleeve (a) Conduit built into a structure of a building to allow another element to pass through, giving protection and allowing for relative movement. (b) A form of double SOCKET for joining two elements. (c) A flexible membrane used to protect the external surface of an element from corrosion or damage.

slenderness ratio The ratio of the EFFECTIVE LENGTH of a COLUMN to the least value of the RADIUS OF GYRATION. The longer the column, and the thinner it is, the more likely is it to BUCKLE.

slewing The action of horizontal rotation as applied to a crane jib.

sliced veneer WOOD VENEER cut transversely.

slide rule An analogue calculator. The common slide rule has two scales, which may be slid past one another to perform addition or subtraction of the *scales*. Both scales are LOGARITHMIC, so that the slide rule actually performs multiplication and division. The slide rule was widely used until cheap DIGITAL CALCULATORS became available.

sliding formwork See [SLIPFORM](#).

sliding sash window A SASH WINDOW that moves horizontally.

sling A wire or chain supporting a crane load.

sling psychrometer Same as WHIRLING PSYCHROMETER.

slip circle An assumed line of shear failure of a CLAY slope, which produces a rotational or cylindrical slide. The resistance of the slope to failure then equals the shear strength of the clay, multiplied by the surface of failure (the product of the length of the circular arc and the length of the slope).

slipform Formwork that is raised or pulled in a continuous operation to speed the placement of the concrete. Also called *sliding formwork*.

Slip lines Same as LÜDERS' LINES.

slope The angle of inclination of a beam or a surface, particularly to the horizontal. The slope of structural members due to elastic deformation is usually expressed in RADIANS.

slope deflection A technique devised independently by G.A.Maney and A. Bendixen in 1914 for the solution of the bending moments in rigid frames and continuous beams by a series of simultaneous equations. Since all joints are assumed RIGID, the change in slope and the deflection are the same for all members framing into any one joint, and these equalities supply sufficient equations to solve the redundancies of the STATICALLY INDETERMINATE STRUCTURE. The concept is used in the MATRIX-DISPLACEMENT METHOD.

slope of timber grain The angle between the axis of a piece of timber and the general direction of the grain.

slot diffuser See [LINEAR DIFFUSER](#).

slotted angle Steel angle prepunched with slotted holes. It is used for shelving and other utility structures, particularly those of a temporary nature.

slow-burning construction (a) Construction with materials chemically treated to make them more FIRE-RESISTING. (b) Construction with heavy timber sections; these are protected by the layer of charcoal formed during initial combustion, and are more fire-resisting than unprotected steel frames.

slow-burning insulation Insulating material that chars or burns without a flame or blaze. Some plastic materials used for thermal insulation are highly COMBUSTIBLE.

slug An obsolete British unit of mass. It is defined as the mass in pounds multiplied by g (the acceleration due to gravity). Also called a *geepound*.

slump test A method of measuring the WORKABILITY of freshly mixed concrete. The concrete is placed in a mould, which consists of a truncated cone 300mm (12in.) high, with a base diameter of 200 mm (8in.) and a top diameter of 100mm (4in.). The mould is then lifted, and the subsidence measured. See also [BALL TEST](#) and [COMPACTING FACTOR TEST](#).

slurry A finely ground solid suspended in a liquid, e.g. a fluid mixture of cement and water, or of sand, cement and water.

small circle A circle on the surface of a sphere that is smaller than a GREAT CIRCLE. The *parallels of latitude* (except the *equator*) are small circles on the Earth's surface. They are not GEODETIC LINES, and thus correspond to curves on a plane surface.

SMF Abbreviation for SYNTHETIC MINERAL FIBRE.

smog Originally a mixture of smoke and fog; hence any objectionable mixture of air and pollutants. See also [INVERSION](#).

smoke The products of combustion (usually incomplete combustion) consisting of finely divided particulate matter and liquid droplets suspended in air and in gaseous products. In the atmosphere, smoke is one of the forms of air pollution. In a building fire, it is the principal hazard to life, because the smoke from some building materials is toxic; it contains little oxygen to sustain life; and thick smoke prevents people from finding their way to the exits.

smoke control system A system to control the movement of smoke during a fire within a building.

smoke detector A device used to detect smoke in a part of a building, and then to operate an alarm procedure. Smoke detectors are often placed in the return air ducts, as this is a place where smoke from a fire within the building is likely to be detected early. See [IONISATION SMOKE DETECTOR](#) and [PHOTO-OPTICAL SMOKE DETECTOR](#). See also [FIRE DETECTOR](#).

smoke load That part of the FIRE LOAD that has the potential to produce smoke.

smoke tunnel A WIND TUNNEL in which a smoke generator is used to indicate the movement of the air.

smoke venting Provision for allowing smoke from a building fire to escape rapidly to the atmosphere. In a single-storey building, smoke vents may be placed in the roof, where they remain closed until opened by a fusible link, or by the operation of a SMOKE DETECTOR. In a multistorey building, the return air of the normal air conditioning system can be spilled to the outside, or a special set of ducts and fans can be installed to operate only in the event of a fire. The disadvantage of smoke venting is that it allows more air to enter and support the fire. This is outweighed by the removal of toxic smoke, and the clearing of the air to allow occupants to escape and firefighters to find the source of the fire.

smouldering The combustion of solid materials without a visible flame.

Sn Chemical symbol for *tin* (stannum).

snaphed An approximately hemispherical head used on rivets, bolts, and screws. Also called *buttonhead*.

Snellen notation See [VISUAL ACUITY](#).

snow guard A board that prevents snow from sliding off a sloping roof.

snow load The superimposed load assumed to result from severe snow falls in any particular region. Snow loads range from zero in most parts of Australia to 3kN/m² (60lb/ft²) in Northern Canada.

soapstone Same as TALC.

socket (a) The female end of a SPIGOT-and-socket joint. (b) A point at which electric current can be taken from an electric wiring system.

sodium A very reactive ALKALI metal. Its chemical symbol is Na (Natrium), its atomic number is 11, its atomic weight is 22.997, and its specific gravity is 0.98. It has a melting point of 97.7°C, and a valency of 1.

sodium lamp See [LOW-PRESSURE SODIUM LAMP](#) and [HIGH-PRESSURE SODIUM LAMP](#).

sodium silicate Used as a waterproofer and surface hardener under the name of WATER-GLASS.

soffit The underside of any horizontal member of a structure, e.g. a beam or a slab.

softboard A low-density FIBREBOARD.

soft solder A low melting point solder. See [SOLDERING](#).

software The computer programs for running a computer, as opposed to the HARDWARE.

software house An organisation that develops tailored SOFTWARE applications.

soft water See [HARD WATER](#).

softwood Timber from *coniferous* trees, e.g. DOUGLAS FIR.

soil auger See [AUGER](#) (b).

soil cement A mixture of Portland cement and locally available soil. It serves as a soil stabiliser.

soil classification See [LIQUID LIMIT](#), [PARTICLE-SIZE ANALYSIS](#), [PLASTIC LIMIT](#) and [STOKES' LAW](#).

soil drain A drain that carries sewage, sanitary drainage and trade effluent to the sewer; as opposed to a STORM DRAIN.

soil mechanics A term coined in 1936 by Karl Terzaghi, who systematised the subject, to embrace all aspects of the scientific study of soils as engineering materials. See [CONSOLIDATION](#), [COULOMB'S EQUATION](#), [DIFFERENTIAL SETTLEMENT](#), [EARTH PRESSURE](#), [RANKINE THEORY](#), [SHEAR TESTS](#) and [SLIP CIRCLE](#).

soil profile A vertical section showing the variation of the soil below the surface of a site.

soil samples See [BOREHOLE SAMPLES](#).

sol-air temperature The hypothetical external shade temperature that would have the same effect on the internal temperature of the building as the actual shade temperature *and* the solar radiation:

$$T_{SA} = T_{SDB} + \frac{aI}{h_o}$$

where T_{SA} =sol-air temperature, T_{SDB} = dry bulb shade temperature outside building, a =absorptivity of solar radiation of building surface, I =intensity of solar radiation, and h_o =boundary layer heat transfer coefficient on outside of wall.

solar altitude angle The ALTITUDE of the sun.

solar azimuth angle The AZIMUTH of the sun.

solar cell See [PHOTOVOLTAIC CELL](#).

solar collector See [EVACUATED TUBULAR COLLECTOR](#), [FLAT PLATE COLLECTOR](#), [PHOTO-VOLTAIC CELL](#) and [SOLAR WATER HEATER](#).

solar constant The mean value of the solar radiation outside the Earth's atmosphere, before some of it is absorbed by the atmosphere. It is taken as 1395W/m^2 ($442\text{Btu/ft}^2\text{h}$).

solar control See [SUNSHADING](#) and [SOLAR CONTROL GLASS](#).

solar control glass See [HEAT-ABSORBING](#), [INSULATING](#) and [REFLECTIVE GLASS](#).

solar degradation See [DEGRADATION](#) and [ULTRAVIOLET RADIATION](#).

solar energy Energy from the Sun that reaches the Earth in the form of radiation.

solar energy systems See [ACTIVE SOLAR ENERGY](#), [EVACUATED TUBULAR COLLECTOR](#), [FLAT PLATE COLLECTOR](#), [PASSIVE SOLAR ENERGY](#), [SOLAR GAIN](#), [SOLAR ORIENTATION](#) and [SOLAR WATER HEATER](#).

solar gain, solar heat gain See [DIRECT GAIN METHOD](#), [DIRECT SOLAR GAIN](#) and [THERMAL CAPACITY](#).

solarium A room, terrace or balcony, generally with some glass walls, exposed to the rays of the sun. The term is particularly used for hospitals and sanatoria; for private houses *sunroom* is more common.

solar noon The moment the sun crosses the observer's MERIDIAN OF LONGITUDE. At this moment the sun is at its greatest ALTITUDE for that day.

solar orientation The position of the building in relation to the north (or south), with particular reference to the amount of sunshine falling on the walls and windows, and the penetration of the sun through the windows into the building.

solar radiation See [SOLAR CONSTANT](#).

solarscope A device for studying, with the aid of MODELS, sunlight penetration and the shadows to be cast by and on buildings. There are two types. In one the model is placed on a platform, and a lamp at the end of a long arm is moved to imitate the position of the sun at various times of the day and the year; the latitude can also be altered. This apparatus is simple to use and direct-reading, but the location of the sun at the end of an arm conflicts with the requirement of 'infinite' distance. The other type consists of a platform that can be rotated in ALTITUDE and AZIMUTH, which must be calculated for the sun's position. The sun is represented by a horizontal light at the far end of a long room. This is more accurate, but the interpretation requires some computation. For either type the platform can be made transparent, to obtain a view of internal shadows. Also called a *heliodon*.

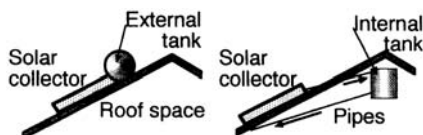

solar water heater

solar spectrum The wavelengths of the radiation received from the sun range approximately from 300 to 3000nm (0.3 to 3×10^{-6} m). The spectrum of visible light ranges from 390nm (violet) to 760 nm (red).

solar water heater Water heated in pipes running through a solar collector is stored in a tank until required (see Figure). See also [THERMOSIPHON](#). A solar water heating system needs a subsidiary conventional heating system for use when there is insufficient sunshine, unless the user is willing to shower in cold water. In climates where water may freeze, the solar collector heats a non-freezing liquid, and the heat is then transferred from that to water.

soldering A process for joining two pieces of metal by means of *solder*, i.e. an alloy that has a lower melting point than the pieces to be joined. For satisfactory jointing, the surfaces to be joined must be kept free from oxide films, and this is accomplished by using a *flux*, which melts at a lower temperature than the solder. For the lower-strength solders, known as *soft solders*, *zinc chloride* is a suitable flux. PLUMBER'S SOLDER, an alloy of lead and tin, is in this category. For the higher-strength solders (*hard solder* or SILVER SOLDER), BORAX is a suitable flux.

soldier course A course of bricks laid with their longest dimension vertical.

solenoid A multi-turn coil of wire wound on a cylindrical former. It behaves like a bar magnet when carrying a current. It is used in RELAYS, CIRCUIT BREAKERS, switches and brakes.

solid One of the states of matter, in which a material has shear strength, maintains its shape without external restraint, but can suffer breakage or permanent deformation under excessive stress. (The other states are GAS and LIQUID.)

solid angle An angle measured in three dimensions, as distinct from a PLANE ANGLE. See also [STERADIAN](#).

solid bridging A form of lateral stiffening between deep, narrow timber joists to prevent them from twisting. Short lengths of material, similar to the joists but slightly shallower, are fixed between each adjacent pair of joists. It uses more material, but less labour, than HERRING-BONE STRUTTING.

solid door A flush door with a solid core; as opposed to a HOLLOW-CORE DOOR.

solid modelling In computer graphics, the process of representing solid objects by adding and subtracting primitive solids such as cubes, cones, spheres and cylinders; as opposed to SURFACE MODELS and WIREFRAME MODELS.

solid state In electronics, referring to the use of TRANSISTORS or INTEGRATED CIRCUITS, but not thermionic valves.

solidus line The line separating the solid phase from the liquid+solid phase. In a PHASE DIAGRAM it shows the variation of the composition of an alloy with temperature when melting is complete.

solid-web joist A conventional joist with a solid web formed by a plate or a rolled section; as opposed to an OPEN-WEB JOIST.

solstice The dates when the Sun attains its maximum distance from the celestial equator; they occur at about 21 June and 22 December. Consequently these are the longest and shortest days of the year.

solute A dissolved substance.

solvent A liquid used for dissolving a solid.

sommer (also spelled *summer*) See [BREASTSUMMER](#).

son An obsolete unit to specify the loudness of a sound.

Sorel's cement See [OXYCHLORIDE CEMENT](#).

sound A disturbance, propagated in an elastic medium by a wave motion, which is of such a character as to be capable of being heard by a listener. See also [ACOUSTIC](#) and [NOISE](#).

sound, airborne See [AIRBORNE SOUND](#).

sound, impact See [IMPACT SOUND](#).

sound absorption The transformation of acoustic (sound) energy into heat by solid materials or the medium through which the sound is propagating. In rooms the amount of sound absorption largely determines the amount of REVERBERATION and the SOUND PRESSURE LEVEL in the room. Sound absorption is often confused with SOUND INSULATION.

sound absorption coefficient The ratio of the sound energy absorbed by a surface to the energy incident upon the surface. Its value ranges from about 0.01 for a polished marble to 1.0 for the absorbing fibreglass wedges used in ANECHOIC CHAMBERS. See also [NOISE REDUCTION COEFFICIENT](#).

sound attenuation Reduction in sound intensity.

sound frequency analyser See [FREQUENCY ANALYSER](#).

sound insulation A term used to describe the ability of a wall or floor to ATTENUATE the sound passing through it. Good insulation against AIRBORNE SOUND requires a partition with high mass. Insulation against STRUCTURE-BORNE and IMPACT SOUND is usually best achieved by a resilient floor covering, VIBRATION ISOLATOR or FLOATING FLOOR. See also [SOUND ABSORPTION](#).

sound intensity See [INTENSITY](#) (c).

sound knot See [KNOT](#) (a).

sound level See [SOUND PRESSURE LEVEL](#).

sound level meter An instrument having a microphone, amplifier and indicating device designed to measure a frequency-weighted and time-weighted value of the SOUND PRESSURE LEVEL (in DECIBELS). See also [FREQUENCY ANALYSER](#).

sound mirror A plane or curved surface that reflects sound. See also [ECHO](#) and [WHISPERING GALLERY](#).

sound mixer An electronic device that accepts a number of audio input signals, controls their relative power levels, and combines them into an output signal.

soundness Freedom of a metal casting or of concrete from cracks, flaws and fissures; this is sometimes checked by listening to the sound that the casting makes when struck. The term is also used to denote freedom from excessive volume change, and from deterioration due to exposure to the weather.

sound perfume A figure of speech for a MASKING NOISE.

sound power The sound power of a source is the total acoustic energy radiated per unit time.

sound power level Defined as 10 times the logarithm (to the base 10) of the ratio of the SOUND POWER of a sound source to a reference sound power (usually taken as 10^{-12} W). See [DECIBEL](#) (a).

sound pressure The alternating pressure in an acoustic field due to the presence of a sound. The term *sound pressure* may be qualified by ‘RMS’, ‘instantaneous’, ‘peak’ etc., but where it is unqualified it is usual to imply the RMS or EFFECTIVE SOUND PRESSURE value.

sound pressure level A measure of the intensity of a sound. The sound pressure level (also known as SOUND LEVEL or just *level*) of a sound in DECIBELS is defined as 20 times the logarithm to the base 10 of the ratio of the RMS sound pressure to a reference sound pressure; (usually 20 μ Pa, the threshold of hearing at 1000Hz, is used as the reference). Most environmental and occupational sound pressure levels are quoted in dB(A). These measurements are made using a SOUND LEVEL METER with an A-weighting filter, which has a frequency characteristic similar to that of the ear. See [DECIBEL](#) (b).

soundproofing A non-technical term for reducing sound transmission into a space.

sound reduction index See [SOUND TRANSMISSION LOSS](#).

sound reflector See [SOUND MIRROR](#) and [ACOUSTICAL CLOUD](#).

sound reinforcement See [PA SYSTEM](#).

sound spectrum A graphical representation of a complex sound, in which energy or pressure is plotted as a function of frequency.

sound spectrum analyser See [FREQUENCY ANALYSER](#).

sound transmission See [SOUND TRANSMISSION LOSS](#).

sound transmission class The sound transmission class (STC) of a partition separating two spaces is a single-number rating of its ability to reduce the sound passing between the two spaces. For example, a single 110mm unrendered brick wall has an STC rating of approximately 45. This is considered a minimum requirement for common walls separating dwellings.

sound transmission loss Also known as *sound reduction index*. The abbreviation is TL or SRI. A measure of the sound transmission of a partition at a particular frequency or frequency band. It is 10 times the logarithm to the base 10 of the ratio of the sound INTENSITY on the source side of the partition to the sound intensity on the receiver side of the partition. In practice, because sound

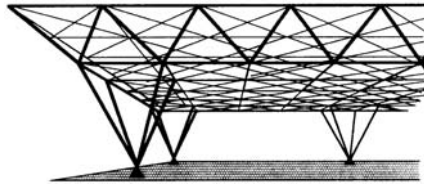

space frame

intensity is difficult to measure, sound transmission loss (in decibels) is measured using

$$TL = L_1 - L_2 + 10\log_{10}(S/A)$$

where L_1 is the sound level on the source side of the partition, L_2 is the sound level on the receiver side, S is the area of the partition common to both rooms, and A is the total absorption in the receiving room. See also [SOUND TRANSMISSION CLASS](#).

sound wave A disturbance in a medium whereby energy is transmitted by virtue of the inertial, elastic and other dynamic properties of the medium.

southern roof The equivalent of a NORTHLIGHT ROOF in the southern hemisphere.

sow See [PIG](#).

spa (spa bath) A bath with the facility for injecting air and jets of turbulent water into the water contained in the bath.

space allocation The process of generating spatial designs by allocating units of functional spaces to physical space locations. Commonly a process of optimising a sum of distances between functional spaces.

space audit A physical survey and record of space occupied, and its functional use.

space frame A FRAME that can be solved only by considering its behaviour in space, i.e. in two mutually perpendicular planes at the same time (see [Figure](#)). Space frames may be *statically determinate* or *indeterminate* (see [MÖBIUS' LAW](#)).

space planning The definition of space requirements in terms of size, type, activity and adjacency for particular premises.

space utilisation The ratio of the number of people using a space to its potential use capacity, multiplied by the ratio of the hours of actual usage to the total available hours, and expressed as a percentage.

spackle A paste to fill holes, cracks and defects in the surfaces of various materials.

span The distance between the supports of the structure. See also [CLEAR](#), [BEARING](#) and [EFFECTIVE SPAN](#).

spandrel The part of the wall between the head of a window and the *sill* of the window above it. The term is also used as a synonym for *spandrel beam*, which is a beam placed within a spandrel, or a structural beam on the edge of a building

frame. *Spandrel* also denotes the triangular infilling under the outer string of a stair, and the triangular infilling above the extrados of an arch, between the abutment and the crown.

Spanish tile A term used in some parts of the world for MISSION TILE, and in others for a type of PANTILE.

spatterdash A rich mixture of cement and coarse sand thrown hard onto a brick or concrete wall, to form a thin, coarse-textured, continuous coat.

specification A document accompanying the drawings, describing the materials and workmanship required to carry out the works for each particular trade.

specific gravity The ratio of the MASS of a given volume of a substance to the mass of an equal volume of water (at 4°C, when water has its minimum volume). Since water weighs 1 kilogram per litre, the density of a substance in metric units is numerically equal to its specific gravity, which is a dimensionless ratio. In FPS units, the specific gravity must be multiplied by the density of water, which is 62.41b/ft³.

specific heat The ratio of the quantity of heat required to raise a substance through a given temperature range, to that required to raise the same mass of water through the same temperature range.

specific surface The total surface area of the particles contained in a unit weight or absolute unit volume of a material. The smaller the particle size, or the finer the powder, the greater the specific surface. See also [STOKES' LAW](#).

specific volume The volume of a unit mass. It is the reciprocal of density.

specified compressive strength of concrete The strength of the concrete used in ULTIMATE STRENGTH DESIGN.

spectrophotometer A PHOTOMETER capable of reading the distribution of luminous flux across the visible spectrum. That can be done using prisms or gratings to disperse the spectrum prior to the measurement of narrow bands of light, or by using three coloured filters, when the instrument is called a *tricolorimeter*.

spectrum A range of frequencies, and the way in which the energy of a particular source is distributed across those frequencies; particularly the VISIBLE SPECTRUM and SOUND SPECTRUM.

specular angle Same as ANGLE OF REFLECTION.

specular surface A mirror surface (from the Latin for *mirror*).

speech intelligibility The percentage of meaningful speech that is correctly interpreted by a listener or listeners. See also [ARTICULATION](#).

speech interference level The arithmetic average of the octave-band sound pressure levels of a noise at 500Hz, 1000 Hz and 2000Hz (together with the level at 250Hz if it exceeds the level at 500Hz by 10dB or more).

speech recognition In information technology, the process of identifying human speech by electronic means.

speed The ratio of the distance covered to the time taken. See also [VELOCITY](#).

speed of light The speed of electromagnetic radiation, which includes light, is a universal constant. Its value in a vacuum is 299796km/s (186293miles/s).

speed of sound The speed of propagation of a disturbance in an elastic medium. In air at standard conditions (STP) the speed of sound is 344m/s (1130 ft/s).

spelter An alloy containing about 99 per cent zinc.

sp gr Abbreviation for SPECIFIC GRAVITY.

spherical dome See [DOME](#).

spherical trigonometry The TRIGONOMETRY of triangles drawn on the surface of a sphere.

spigot The plain end of a length of pipe, which is fitted into an enlarged *socket* or *bell* at the beginning of the next pipe. The *spigot-and-socket joint* (also called *bell-and-spigot joint*) is made tight by CAULKING.

spiral reinforcement More correctly called HELICAL REINFORCEMENT.

spiral stair More correctly called HELICAL STAIR.

spirit level An instrument for testing horizontal or vertical alignment. It consists of a STRAIGHTEDGE incorporating a slightly curved glass tube filled partially with alcohol or other liquid. The horizontal position is indicated by the central location of the air bubble. See also [WATER LEVEL](#).

spirits of alum Sulphuric acid.

spirits of salt Hydrochloric acid.

spirits of sulphur Sulphurous acid.

spirits of vitriol Sulphuric acid.

spirit stain A dye dissolved in METHYLATED SPIRITS, usually with SHELLAC or some other resin as a binder. It is used for darkening a wood surface, but emphasises the grain of the timber less than a *water stain* (in which water is the solvent for the dye). See also [OIL STAIN](#).

SPL Abbreviation for SOUND PRESSURE LEVEL. It is measured in DECIBELS.

splay An inclined surface, i.e. a large BEVEL or CHAMFER, running across the full width of the surface.

splice A joining of two structural pieces. The joint is generally designed to be as strong, or stronger, than the pieces to be joined.

splice of reinforcing bars Transfer of force from one bar to another. This may be achieved by welding or by mechanical connection. However, the normal procedure is to overlap the bars in the concrete, usually without touching; the force is transferred by bond between the concrete and the steel.

split ring connector A TIMBER CONNECTOR in the form of a ring made from a flat steel bar, inserted into annular grooves in the mating faces of two timber members. The whole is held together by a bolt. It is now virtually superseded by NAILPLATES, which require much less labour.

splitter A metal plate or diaphragm arranged to divide the air stream in a duct or duct fitting to guide the flow in a desired direction. See also [GUIDE VANE](#).

splitting tensile test Determination of tensile strength of concrete by testing a cylinder (see [CYLINDER STRENGTH](#)) on its side in compression. The cylinder splits across the vertical diameter. Also known as *Brazilian test* and *diametral compression test*.

spoil Material excavated that is in excess of the fill required.

spontaneous combustion A bursting into flames of a mixture of substances, because of the evolution of heat through chemical action between them.

spot cooling Supply of cool air at a local point in a building where a high local output of heat, often from a piece of equipment, may distress a worker or other person in its vicinity.

spotlamp Any lamp or luminaire that produces a narrow or near-parallel beam of light.

spot replacement (of lamps) The replacement of electric lamps as they fail; compared with BULK REPLACEMENT.

spot welding Joining two or more overlapping pieces by local fusion of small areas or spots.

spray chamber An enclosure in an air distribution system in which the air stream is passed through a bank of water sprays for the purpose of humidifying and/or cleaning it.

sprayed mineral wool Mineral wool blown onto a surface with a spray gun. It provides thermal insulation and FIRE PROTECTION OF STEEL STRUCTURES that is rot-proof, vermin-proof and incombustible.

spray gun A tool for applying paint, mortar etc. through a nozzle under pneumatic or fluid pressure. See also CEMENT GUN.

spreader A fitting attached to the end of a pipe that has a slotted or perforated outlet.

spread footing A footing made especially wide to reduce its pressure on the foundation.

springings or spring The level at which an arch springs from its supports. See also CROWN.

spring washer A steel ring cut once and bent into a shallow helix. Used as a washer, it prevents the nut from unscrewing.

spring wood Same as EARLY WOOD.

sprinkler head The temperature-sensitive element in a SPRINKLER SYSTEM. It is sealed by a metal plug, which melts at the predetermined temperature; or by a plastic plug, which contains liquid bursting it at the predetermined temperature (see Figure). This is usually 68°C (155 °F), which is low enough to control a fire in its early stages, but also high enough to ensure that the system does not go off on a hot day without a fire.

sprinkler system A system that sprinkles a fire with water as soon as it breaks out, and thus extinguishes it, or controls it until the fire brigade arrives. It consists of pipes installed in or below the ceiling throughout the building. Branches projecting from these pipes are sealed by SPRINKLER HEADS, which open at a predetermined temperature.

square (a) A surface measure exactly equal to 100ft². It is approximately equal to 10m². (b) An equilateral RECTANGLE. (c) An L-shaped tool for setting out right angles.

squared log Same as BALK.

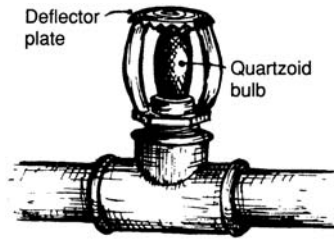

sprinkler head

squared stone Same as ASHLAR.

square matrix A MATRIX (a) in which the number of rows equals the number of columns.

square metre The basic metric surface measure. It is approximately one tenth of a SQUARE (a).

squinch Corbelling at an upper corner of the structural bay of a brick or masonry structure to support a dome or its drum. It is an alternative to the construction of a PENDENTIVE.

sr Abbreviation for *steradian*.

SRI See [SOUND TRANSMISSION LOSS](#).

SS Abbreviation for STAINLESS STEEL.

stabilised soil Soil that has been treated with a binder to reduce its movement. Suitable binders are Portland cement, waste oil, bitumen, resin or a more stable soil, but low cost is a prime consideration.

stability, dimensional See [DIMENSIONAL STABILITY](#).

stability, elastic See [BUCKLE](#).

stack A vertical drainage or vent pipe within a building, or attached to the side of a building.

stack effect Natural ventilation caused by air pressure differences due to variations in air density with height.

Stain See [OIL STAIN](#), [SPIRIT STAIN](#) and [WATER STAIN](#).

stained glass A decorative panel or window composed of pieces of coloured glass, joined by means of lead beads (*comes*) or concrete. The glass colouring is usually not a stain, but is fired into the glass.

staining power The amount of colour given to a white pigment by a given amount of coloured pigment. It is the opposite of REDUCING POWER.

stainless steel Steel that is highly resistant to atmospheric corrosion and attack by organic and dilute mineral acids. It is used for cutlery, facing panels for curtain walls, wash basins and urinals. There are many different alloys, but all contain between 8 and 30 per cent CHROMIUM, in addition to a smaller amount of other elements, especially NICKEL.

stair One *step* in a flight of stairs; also the entire flight. See also [BALUSTER](#), [RISER](#) and [TREAD](#).

stair lift A lift installed on a stairway. See [INCLINATOR](#).

stair riser See [RISER](#) (a).

stair well A space around which a staircase is disposed.

stanchion (a) A column, particularly of structural steel. (b) An upright bar placed intermediate between the [MULLIONS](#) to strengthen a [LEADED LIGHT](#).

standard (a) A document prepared by a standards institution or a government agency prescribing methods or materials for safe use. (b) A [STANDARD LAMP](#) (a), measure, resistance etc. used to calibrate those that are substandard. (c) An old measure of timber; see [ST PETERSBURG STANDARD](#). (d) A term for anything standing upright, as in a [STANDARD LAMP](#) (b).

standard atmosphere Air at the reference condition of standard temperature and pressure. See [STP](#).

standard deviation The square root of the *variance*, i.e. the root of the average of the squares of the *deviations* of a number of observations from their mean value in a [FREQUENCY DISTRIBUTION CURVE](#). It is a measure of the spread of the observations, and it is necessary first to square the variances, and then take the root of their mean, because otherwise the positive and negative variances would largely cancel out. By squaring the deviations, all values become positive. See also [COEFFICIENT OF VARIATION](#).

standard fire test A standard test for determining the [FIRE RESISTANCE GRADING](#).

standard hook A [HOOKED BAR](#) bent in accordance with the minimum radius and free length specified by the standard to prevent pullout. It is usually bent through 180°. A standard bend through 90° is often called a *cog*.

standardised normal variate See [GAUSSIAN CURVE](#).

standard lamp (a) An electric lamp that has been calibrated for intensity or flux, used in photometric laboratories to calibrate instruments or to create *substandard lamps*. (b) A floor-mounted, portable luminaire used for local lighting.

standard section A metal section that has been standardised. In the case of hot-rolled sections, this is much cheaper than a section specially made to order; however, the difference is less marked for cold-formed and extruded sections.

standard sky See [CIE STANDARD CLEAR SKY](#), [CIE STANDARD OVERCAST SKY](#), [INDIAN STANDARD CLEAR SKY](#) and [UNIFORM SKY](#).

standard temperature and pressure See [STP](#).

standby lighting A lighting system that supplies adequate illumination if the normal lighting system should fail.

standby power The power that is available within 1 minute of a normal power failure to operate life safety equipment and continuously operating equipment. *Emergency power* is the power available within 10 seconds.

standing-wave tube Same as [IMPEDANCE TUBE](#).

St Andrew's Cross bond Same as [ENGLISH CROSS BOND](#).

staple A loop of bent wire, sharpened to two points, to be used as a fastener.

star connection In THREE-PHASE electrical systems, a means of obtaining or supplying PHASE voltages by means of a common connection (star) point for one terminal of each of the phase windings or loads. The phase voltages are $1/\sqrt{3}$ of the line voltages. The conductor connected to the common point is often called the *neutral*, and results in a four-wire system. In a *balanced* three-phase system the neutral current is zero. Also called a WYE (Y) CONNECTION. See also DELTA CONNECTION.

starter (a) A device for starting an electric motor and enabling it to accelerate to operating speed. The starter limits the heavy current that would otherwise be drawn by some types of motor when starting. (b) A device for electrically heating the electrodes of a fluorescent lamp, to enable them to emit electrons at a sufficient rate to start the discharge process.

starved joints Glued joints that do not contain enough adhesive, because of the use of insufficient adhesive, excessive pressure, or adhesive of inadequate viscosity. Also called *hungry joints*.

statically determinate structure A structure that can be solved by the use of STATICS alone; also called an *isostatic structure*. A statically determinate structure must have the appropriate number of members in accordance with MÖBIUS' LAW. If a structural member or restraint is removed, it becomes a MECHANISM; if one is added, it becomes a STATICALLY INDETERMINATE STRUCTURE.

statically indeterminate structure A structure that cannot be solved by the use of statics alone, unlike a STATICALLY DETERMINATE STRUCTURE. It is necessary in addition to consider its elastic deformation, as in the MATRIX-DISPLACEMENT METHOD or the *matrix-stiffness method*; or to consider its collapse mechanism, as in LIMIT DESIGN. Also called a *hyperstatic structure*.

static friction The limiting FRICTION when a body just starts to move.

static head The energy possessed by a liquid due to its elevation.

static load A load that is not a DYNAMIC LOAD, i.e. a normal DEAD or SUPERIMPOSED LOAD.

static moment A term used for the first MOMENT OF AN AREA.

static penetration test A PENETRATION TEST in which the testing device is pushed into the soil by a measurable force, as opposed to a DYNAMIC PENETRATION TEST which employs a specified number of blows with a standard hammer.

static regain The regain of static pressure in accordance with BERNOUILLI'S THEOREM in an airstream contained in a duct after its velocity has been reduced by expansion of area or by the delivery of some of the air to a branch duct.

statics The branch of the science of mechanics that deals with forces in equilibrium; as opposed to dynamics. The condition of static equilibrium is generally expressed in terms of three equations:

$$\Sigma H = 0$$

$$\Sigma V = 0$$

$$\Sigma M = 0$$

which means that the forces are zero in the *horizontal* and *vertical* directions, and the *moments* about any one chosen point are zero. If a structure can be solved with these equations alone, it is Called **STATICALLY DETERMINATE**. If there are more unknown structural restraints than can be solved by these equations, it is **STATICALLY INDETERMINATE**.

statistics Numerical data systematically collected; the science of collecting and interpreting numerical data. See also **CHI-SQUARE TEST**, **GAUSSIAN CURVE**, **LAW OF LARGE NUMBERS**, **POPULATION**, **PROBABILITY**, **SAMPLE** and **STANDARD DEVIATION**.

stator The stationary part of an electric motor or generator.

statutory maintenance Maintenance required to maintain conformance with statutory requirements.

Stanchion Same as **STANCHION**.

stave (a) A vertical plank, particularly in a traditional Scandinavian wooden church. (b) A narrow board used to build up a curved surface. (c) A rounded wooden step in a ladder.

STC Abbreviation for **SOUND TRANSMISSION CLASS**.

STD Subscriber trunk dialling.

steam Water converted into an invisible vapour by heating it above its boiling point. Steam containing some condensed water vapour becomes visible as a white mist.

steam boiler A boiler in which water is raised to or above saturation temperature at a desired pressure and the resulting steam is drawn off for use in process or heating equipment.

steam curing Accelerating the **CURING** of precast concrete by exposing it to steam in an oven at ordinary pressure, or at high pressure in an **AUTOCLAVE**.

steatite Same as **TALC**.

steel A malleable alloy of iron with a carbon content between 0.1 and 1.7 per cent. Iron with a lower carbon content is classified as **WROUGHT IRON**, and iron with a higher carbon content as **CAST IRON**. Prior to the invention of the **BESSEMER PROCESS**, Steel could be produced only at great expense. **ALLOY STEEL** contains other elements in addition to carbon. See also **ALPHA IRON**, **ANNEALING**, **AUSTENITE**, **CEMENTITE**, **FERRITE**, **GAMMA IRON**, **HIGH-SPEED STEEL**, **HIGH-STRENGTH STEEL**, **MARTENSITE**, **NORMALISING**, **OPEN-HEARTH PROCESS**, **PERLITE**, **PHASE DIAGRAM**, **QUENCHING**, **REINFORCEMENT FOR CONCRETE**, **STAINLESS STEEL** and **TEMPERING**.

steel concrete Obsolete term for **REINFORCED CONCRETE**.

steel frame A **FRAME** assembled from structural steel members.

steel reinforcement See **REINFORCED CONCRETE**.

Steel sheet See **SHEET** and **CORRUGATED SHEET**.

steelyard An instrument for weighing, which consists of a lever with unequal arms, with a single weight moving along a graduated scale. It was the type of balance used in Ancient Rome.

Stefan-Boltzmann law Derived by two Austrian physicists in the late nineteenth century. The total radiation from a BLACK BODY is proportional to the fourth power of the absolute temperature, or σT^4 , where T is the temperature in degrees Kelvin, and σ is a constant, which equals $5.67 \times 10^{-8} \text{W/m}^2\text{K}^4$. It also depends on the EMISSIVITY of the surface.

STEP Abbreviation for STandard for the Exchange of Product data. A standards development effort within the International Organisation for Standardization (ISO).

steradian (sr) Unit of solid angle. 1 steradian is the SOLID ANGLE that, having its vertex in the centre of a sphere, cuts off an area of the surface of the sphere equal to that of the radius squared. A sphere subtends 4π steradians.

stereochemistry The study of the spatial arrangements of atoms in complex molecules.

stereogram A drawing or photograph that can be viewed three-dimensionally. One common method is to superimpose one print of a stereoscopic pair in one colour on the other in a different colour, and to view the composite picture through two appropriately coloured glasses.

stereographic projection Two dimensional representation of the surface of a sphere. It is a PERSPECTIVE PROJECTION, whose perspective centre is on the point of the sphere diametrically opposite to the point where the pictorial plane touches the sphere. It has the remarkable property that all arcs of GREAT CIRCLES and SMALL CIRCLES are shown either as arcs of circles or as straight lines. Hence it is used for the analysis of SUNLIGHT PENETRATION. See also [GLOBOSCOPE](#).

stereography The science of PERSPECTIVE PROJECTION.

stereometry Solid geometry.

stereophonic sound Sound reproduced by multiple loudspeakers, which gives the illusion of auditory perspective.

stereopsis See [STEREOSCOPIC VISION](#).

stereoscope An instrument for viewing a stereoscopic pair of photographs three-dimensionally. It consists of two lenses set at the correct distance apart to correspond with the separation of the STEREOSCOPIC CAMERA lenses

stereoscopic camera A camera designed to give two displaced images (called a *stereoscopic pair*) by means of two matched lenses and shutters, so that the pair when viewed by both human eyes in a *stereoscope* gives a three-dimensional view of the object photographed.

stereoscopic vision The three-dimensional vision (*stereopsis*) due to the eyes being set a small distance apart.

stereotomy The science of making sections of solid bodies.

stereotype The printing process in which a solid plate of typemetal, cast from a papier-maché mould taken from the surface of a *forme* of type, is used for

printing, instead of the forme itself. Hence something that is repeated constantly without change, like so many printed sheets run off the same stereo-type. See also [MATRIX](#) (d).

Stevenson screen A fully ventilated louvred enclosure used to measure the temperature of air in the shade. The enclosure is usually mounted at a height of 1.2 to 1.8m above the ground.

stiffener A small member added to a thin section to prevent BUCKLING, e.g. an angle welded or riveted to the web of a deep steel or aluminium girder, which strengthens the web plate against buckling in diagonal compression due to the shear force.

stiff-jointed frame Same as RIGID FRAME.

stiffness Resistance to deformation. In rigid frames the flexural stiffness, which determines the moment distribution between members, is defined as EI/L , where E is Young's modulus, I is the second moment of area, and L is the effective length.

stiffness method Same as MATRIX-DISPLACEMENT METHOD.

stilb An obsolete unit for LUMINANCE. 1stilb=10000cd/m².

S-tile A strongly curved PANTILE.

stile (a) A vertical member at the outer edge of a window, door, or lift car frame.
(b) A set of steps for crossing over a fence or a low wall.

still A vessel for the distillation of liquids.

stilt house A house built on stilts, to allow passage of air under the floor, and to provide shaded storage or living space. It is a traditional form of construction in many hot-humid countries.

stirrup In concrete construction, reinforcement to resist shear. It is normally a bar of U-shape, properly anchored to the longitudinal steel and placed perpendicular to it.

stock brick The brick type that is most widely used in any particular region.

stock size A size that is generally available from warehouse stock, and does not have to be especially ordered.

Stokes' law A formula developed by G. G. Stokes in 1851 for the velocity of sedimentation (or settlement) of spherical particles in a liquid. From the observed terminal velocity the particle diameter, and thus the SPECIFIC SURFACE, may be derived:

$$d = \sqrt{\left(\frac{18\mu z}{(\gamma_s - \gamma_l)t} \right)}$$

where d is the particle diameter, z is the depth to which it has settled, t is the time taken for it to settle, μ is the viscosity of the liquid (for water at 20°C, 1 centipoise, or 1mN.s/m²) and γ_s and γ_l are the specific gravity of the solids (generally assumed to be 2.7) and of the liquid (1.0 for water). The sample is taken with a pipette at a depth z after a time t , and the amount of solid is measured. See [PARTICLE-SIZE ANALYSIS](#).

stone (a) Natural stone; see [ASHLAR](#), [COARSE AGGREGATE](#), [IGNEOUS](#), [METAMORPHIC](#) and [SEDIMENTARY ROCK](#), and [RUBBLE](#). (b) A whetstone, usually of CARBORUNDUM, for sharpening tools. (c) Crystalline inclusion in glass.

stone, cast Same as ARTIFICIAL STONE. stonechips Broken stone used for road metal and for the COARSE AGGREGATE of concrete.

stone sand Granular material in the particle-size range of sand, made from stone. It may be a quarry by-product, or deliberately manufactured.

stone slabs or slates Thin-bedded slabs of stone, generally limestone or sandstone, which are used as a roof covering, like SLATES. They were widely used in the European Middle Ages in regions where they existed but slates were not available, until clay tile manufacture became common. Their use is rare today because their greater weight requires a heavier roof structure. Stone slates, being sedimentary rocks, split along their bedding planes, unlike true slates, which, being metamorphic, split along their cleavage planes.

stopping Filling cracks and nail holes with putty before painting.

storage device In computing, any device used for the storage of computer information in either COMPUTER MEMORY or in a backing store.

storage water heater See [WATER HEATER](#), [STORAGE](#).

storey In Europe and Australia the first floor or storey is normally the one above the ground floor. In the USA this is normally called the second story, the ground floor being the first story. Moreover, in large buildings the level of the ground floor may depend on the door chosen. The terms 'floor' and 'storey' are therefore being displaced by *level*, level 1 being the lowest level served by a stair or lift (elevator); this is usually below ground.

storey height The vertical distance from the finished floor on one storey to the finished floor on the storey above.

storeypost A column, generally of timber, which rests on the floor structure and supports the beam of the floor above.

storm door An extra door for protection against bad weather.

storm drain Drain that carries only rainwater, as opposed to a SOIL DRAIN, *sanitary drain*, or SEWER.

stormwater Water deposited on the ground by rainfall. In older cities it was drained in the general sewer with the SEWAGE, but modern practice uses a separate *stormwater drainage system* whose effluent requires less or no treatment.

storm window An additional window sash, generally placed on the outside of the existing window, particularly as a protection against heavy rain.

Story US spelling of STOREY.

STP Standard temperature and pressure, which is 0°C and 1atm (101.325kPa).

St Petersburg standard An obsolete measure of timber, which equals 1980 BOARD FEET (165ft³ or 4.67m³).

straight arch Same as FLAT ARCH.

straightedge A long piece of wood or metal whose edges are true and parallel. It is used for setting out, and for testing the accuracy of straight lines in buildings.

straight grain Timber grain that is straight and in line with the axis of the piece, not *sloping*. See also [FIGURE](#).

straight-line theory A theory based on a linear relationship; specifically, a structural theory based on HOOKE'S LAW.

strain Change in the dimensions or shape of a body per unit length or angle. A *shear strain* is a distortion caused by shear STRESSES. A *direct strain* is an elongation or shortening caused by tensile or compressive stresses respectively. Strains may be ELASTIC or INELASTIC.

strain energy Mechanical ENERGY stored up in a stressed material. The elastic strain energy equals the work done by the external forces in producing the strains, and it is recoverable. It is divided into strain energy due to direct forces, shear forces, bending moments and twisting moments.

strain energy method The oldest method for the solution of STATICALLY INDETERMINATE STRUCTURES, published by the Italian engineer A.Castigliano in 1870. It is based on the assumption that the structure optimises its STRAIN ENERGY.

strain gauge An instrument for measuring strain, also called an *extensometer* or *tensometer*. See [ELECTRIC RESISTANCE STRAIN GAUGE](#), [HUGGENBERGER TENSOMETER](#), [DEMEC STRAIN GAUGE](#), [ACOUSTIC STRAIN GAUGE](#) and [CAPACITANCE STRAIN GAUGE](#).

strain hardening Increase in strength and hardness due to COLD-WORKING.

strain rosette Device measuring strain at one point in three directions. The unknown quantities are the magnitude of the two (mutually perpendicular) PRINCIPAL STRESSES and their direction. If all three are unknown, then three measurements are required at each point. Strain rosettes are usually arranged along 60° (equilateral triangle), or two at right angles and the third at 45°.

strand Wires twisted around a centre wire or core; a TENDON made in the form of a strand.

S-trap A plumbing TRAP constructed with the inlet and outlet legs vertical. The shape of the trap resembles the letter S.

strata title A form of title that enables each occupancy in a group to be separately owned. The boundaries between occupancies may be vertical or horizontal, and parts of the property are held in common for access or use by all the owners. See also [CONDOMINIUM](#), [HOME UNIT](#) and [OYO](#).

stratosphere See [ATMOSPHERIC LAYERS](#).

streamline flow Fluid flow that is continuous, *steady* and *laminar*, as in a viscous fluid. The upper limit is REYNOLDS' CRITICAL VELOCITY, above which it becomes TURBULENT FLOW, i.e. unsteady and eddying.

Strength See [LIMITING STRENGTH](#), [STRESS](#) and [TESTING MACHINE](#).

strength of materials A conventional subdivision of the theory of structures, which deals with the calculation of stresses and strains due to tension, compression, shear torsion and flexure, and any combination thereof. The *theory*

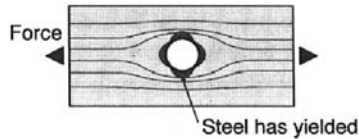

stress concentration

of structures proper is then considered to cover the stresses and strains in structural members when they are combined into trusses, frames etc. See also [MATERIALS SCIENCE](#).

strength reduction factor Same as [CAPACITY REDUCTION FACTOR](#).

stress Internal force per unit area, considering an infinitesimally small part of a body. When the forces are tangential to the plane they are called *shear stresses*; when they are perpendicular to the plane, they are called *direct stresses*. Direct stresses may be *compressive* or *tensile*, depending on whether they act towards or away from the plane of separation. The deformation caused by the stress is called STRAIN.

stress analysis See [EXPERIMENTAL STRESS ANALYSIS](#) and [PRINCIPAL STRESSES](#).

stress circle See [MOHR CIRCLE](#).

Stresscoat A trade name for a BRITTLE COATING.

stress concentration A local high stress, or crowding of the ISOSTATIC LINES, caused by a sudden change in section, such as occurs at a NOTCH, the base of a screw thread, or a hole (see Figure). Stress concentrations are particularly serious in brittle materials, where they may lead to premature failure. In plastic materials local plastic yielding reduces the high stresses at the point of concentration, and raises them over a wider zone. Stress concentrations are shown up particularly well by PHOTOELASTICITY.

stress corrosion Corrosion of a metal, accelerated by its being highly stressed.

stress diagram See [STRESS-STRAIN DIAGRAM](#).

stressed-skin construction A form of construction in which the outer skin acts with the framework to contribute to the membrane and flexural strength of the unit, instead of being merely a cladding that protects the inside from the weather. The term was originally applied to aircraft frames, and later to prefabricated houses in LIGHT-GAUGE construction. See also [GEODETIC CONSTRUCTION](#).

stress grading of timber (a) Grading timber mechanically into several categories of strength. The most common machine is based on an empirical relation between the strength and the deflection of timber. Each piece of timber is deflected at several points along its length, and the deflection category marked by means of a spot of dye. The timber is then classified by its colour markings. (b) Grading by visual inspection, observing knots and imperfections in the grain of the timber.

stress relaxation See [RELAXATION OF STEEL](#).

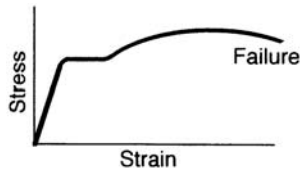

stress-strain diagram

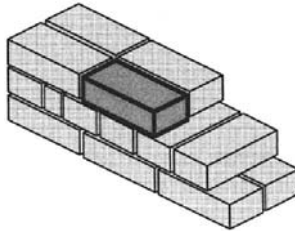

stretcher

stress relieving Heating of a metal or alloy, followed by slow cooling, to relieve internal stresses built up by hot or cold-working. See [ANNEALING](#), [NORMALISING](#) and [TEMPERING](#).

stress-strain diagram The diagram obtained by plotting the stresses in a test specimen against the strains (see Figure, which shows the diagram for mild steel). It is used to assess the structural suitability of materials, since it shows the strength of the material, its elastic and inelastic deformation, and its ductility or brittleness. The *load-extension diagram* has the same shape.

stress trajectory Same as ISOSTATIC LINE.

stretcher A brick, block or stone laid with its length parallel to the wall (see Figure). Usually stretchers are interspersed with HEADERS to achieve a proper BOND.

stretcher bond A bond in which all bricks are laid as STRETCHERS. It is the bond used in CAVITY WALLS.

strikeoff Same as SCREED (a).

string In computing, a sequence of characters.

string course A continuous projecting horizontal band set in the surface of a wall, sometimes moulded. Its function is partly decorative and partly to throw the water off the facade.

stringer (a) A horizontal piece of steel or timber, connecting uprights in a framework and supporting the floor. (b) The inclined member that supports the treads and risers of a stair.

string polygon Same as LINK POLYGON.

strip A metal strip is narrower than SHEET metal.

strip footing A footing for a wall, or a joint footing for a line of columns.

stroboscope Instrument for the inspection of objects rotating at high speed. It can be timed to light up the object only when it is in the same position, so that it appears stationary.

struck joint A mortar JOINT IN BRICKWORK, formed with a recess at the bottom of the joint, by pressing the trowel in at the lower edge. This work can be done as the wall goes up, and it is therefore more durable than POINTING. A *struck joint* is suitable only for interior work because it would collect water at the lower edge. For exterior work, a *weather-struck joint* or *weather joint* is produced by pressing the trowel in at the upper edge, so that the recess is formed at the top of the joint, and the water is thrown off the joint.

structural failure See [FAILURE](#).

structural frame See [FRAME](#).

structural model analysis See [DIRECT MODEL ANALYSIS](#) and [INDIRECT STRUCTURAL MODEL ANALYSIS](#).

structural steel STEEL rolled to one of the standard cross-sectional shapes, ready for fabrication into a structure.

structure-borne sound Sound resulting from direct excitation of part of the structure of a building, as opposed to sound passing from the air in the building to the structure (AIRBORNE SOUND). Structure-borne sound may be a result of TRANSIENT forces, such as the impact of a closing door or footsteps on a floor, or it may be from steady-state excitation, such as that from a fan, pump or compressor attached to the structure. See also [DISCONTINUOUS CONSTRUCTION](#).

strut A compression member that is liable to BUCKLE; the opposite of a tie.

stub mortise A MORTISE that does not pass entirely through a timber.

stub tenon A TENON cut to fit into a STUB MORTISE, or a short tenon used at the lower end of a post to prevent it from slipping out of position.

stucco External plastering. The term originally had a wider meaning, and in historical books it is used also for interior and decorated work. See also [ROUGHCAST](#).

stud (a) An upright timber. (b) A threaded rod or bolt without a head. It may be fixed to a steel frame by resistance *welding*, or a pointed stud may be shot with a *stud gun* into timber, masonry or concrete.

stud wall A timber-framed wall. The studs, or vertical members, are usually spaced at 300–600mm (12–24in.) centres. Also a similar wall built with *steel studs*.

stuffiness A feeling of being in a close or ill-ventilated room. Thomas Bedford carried out experiments in the 1930s that suggested that the sensation was more likely to occur in warm rooms, in the absence of ventilation touching the thermal receptors in the skin. By contrast the sensation of FRESHNESS is associated with cooler conditions, and with sensations re-cognisable as those of touch, caused by air.

stuffy Unpleasant condition of air in a room; a sensation of excessive warmth associated with perceived lack of air movement and possibly an unpleasant odour. See also [STUFFINESS](#).

stylus A hand-held pointer for computer input, such as a DIGITISER pen or LIGHT PEN.

styrene-butadiene coating A lacquer-type paint, which can be used on masonry and wood.

sub-basement A basement, other than the first one below ground level.

subdivision The division of land into allotments with separate titles approved by a statutory authority.

subgrade The natural ground below a foundation, road, or airport runway.

subjective brightness The subjective impression of the luminance of a surface. It will depend not only on the *objective* LUMINANCE, but also on the rest of the visual field, and on the previous exposure of the visual system. Also called *luminosity*.

sublimate or sublime Solid obtained by the direct condensation of vapour without passing through the liquid state. This is possible only for materials whose melting point and boiling point are very close together.

sublimation The process whereby a substance goes from the solid to vapour state without the liquid stage, as in the loss of TUNGSTEN from lamp FILAMENTS.

submerged-arc welding ARC WELDING using a powdered flux deposited around the arc. The weld metal is supplied by a continuously fed wire, which also carries the welding current. Because of the equipment involved, and the fact that the arc is obscured from view, it is used for automatic welding. See also [SHIELDED-ARC WELDING](#).

subsidence Settlement caused by mining operations.

subsoil The soil below the TOPSOIL.

subsonic flow Airflow at a speed below the speed of sound. Its MACH NUMBER is less than 1.

substation An enclosure for a TRANSFORMER (and associated switch and control gear), which changes the voltage of an AC electricity supply up or down.

substratum (substrate) A part that lies beneath and supports another.

substructure The foundation and footings, as opposed to the SUPERSTRUCTURE.

subsurface exploration Determination of ground conditions beneath a building to provide data for the design of the foundations.

suction, wind A negative WIND PRESSURE.

suction line The pipeline connecting a refrigeration evaporator to the compressor.

suction rate The amount of water absorbed by a brick in 1 minute. Also called *absorption rate*.

sulfur US spelling for SULPHUR.

sullage Domestic wastes from bath, basins, showers, laundries and kitchens, including floor wastes from these sources.

sulphur A non-metallic element of yellow colour. Its chemical symbol is S, its atomic number is 16, its atomic weight is 32.06, and its valency is 2, 4 or 6. α -sulphur crystallises in rhombic form, has a lemon-yellow colour, melts at 112.8°C and has a specific gravity of 2.07. β -sulphur crystallises in monoclinic form, has a deeper yellow colour, melts at 119.0°C and has a specific gravity of 1.96. Also spelled *sulfur* (USA, and increasingly in international scientific usage). See also [OXIDES OF SULPHUR](#).

sulphuric anhydride Sulphur trioxide (SO₃). It combines with water to form *sulphuric acid* (H₂SO₄).

sulphur lamp An electric DISCHARGE LAMP using sulphur in a quartz glass sphere rotating in a microwave field.

summer Also spelt *sommer*. See [BREASTSUMMER](#).

summer comfort zone See [COMFORT ZONE](#).

summer wood Dense wood formed in summer, as opposed to EARLY WOOD.

sun bearing See [AZIMUTH](#) and [HORIZONTAL SHADOW ANGLE](#).

sunlight Direct radiation from the Sun. Strictly it includes only the visible portion of the spectrum, but the context may indicate that the whole solar spectrum is intended.

sunlighting Lighting making use of sunlight directly, or indirectly by reflection. Direct use can be by refractor and reflector systems incorporated into the building, such as a LIGHT PIPE.

sunlight penetration The penetration of sunlight through windows can be predicted by model analysis with a SOLARSCOPE, by graphical methods using a STEREOGRAPHIC PROJECTION, or by means of a computer program. See also [PASSIVE SOLAR ENERGY](#) and [DIRECT SOLAR GAIN](#).

sunpath chart A chart that shows the ALTITUDE and the AZIMUTH of the Sun at a particular location throughout the year. It can be used for the design of sunshades in conjunction with a SHADOW ANGLE PROTRACTOR.

sunroom See [SOLARIUM](#).

sunshading Controlling the entry of the sun into a building by means of LOUVRES, projecting EAVES, projecting balconies, vertical slats, or specially designed sunshading devices. As they are prominent features on the facade of the building, their visual aspect must be considered as well as their technical efficiency.

supercomputer Term used for the fastest computers.

supercooling Cooling a liquid below its normal freezing point. In the case of a mixture, cooling below the LIQUIDUS LINE in a phase diagram.

super-flat floor A floor laid to much higher flatness tolerances than normal, usually for automated storage systems.

super foot Same as SQUARE FOOT.

superheated steam Steam whose temperature exceeds its SATURATION TEMPERATURE.

superimposed load The load superimposed on the DEAD LOAD of the building. The term is generally synonymous with LIVE LOAD, although a distinction is sometimes made between the superimposed dead load caused by movable partitions etc. and the live load caused by people.

superposition 'If a material is elastic and obeys HOOKE'S LAW, the relation between load and deformation is linear, and the effect of the various loads can therefore be computed separately and subsequently added, or superimposed on one another.' This *principle of super-position* greatly simplifies the design of elastic structures. It cannot, however, be used where the load-deformation relation is non-linear, as in some elastic problems relating to suspension structures or to buckling.

supersonic flow Air flow at a speed above the speed of sound. Its MACH NUMBER exceeds 1.

superstructure The structure above the main supporting level, as opposed to the foundation or *substructure*.

supplementary angle The difference between a given angle and 180° (the given angle should be less than 180°). See also [COMPLEMENTARY ANGLE](#).

supplementary lighting Addition to the quantity or quality of general lighting, usually for specific work requirements.

supply air The air supplied to a space from an air conditioning plant at a thermal condition suitable to produce the required room condition.

support area A non-assigned functional space catering for activities that complement the principal work activity.

support moment The negative bending moment at a fixed-ended or continuous support.

surcharge (a) Overflow from a sewer or drain caused by overloading or blockage. Usually used in reference to wet weather infiltration or inflow. (b) Earth supported by a retaining wall, at a level above the top of the wall.

surface model In computer graphics, a model in which solid objects are defined by their surfaces; as opposed to SOLID MODELS and WIREFRAME MODELS.

surface mounted Mounted *on* the surface (of a wall, ceiling etc.), and therefore projecting out rather than set in flush.

surface of revolution A surface generated by rotation. For example, a *sphere* is generated by the rotation of a circle, a *paraboloid* by a parabola, and an *ellipsoid* by an ellipse. A *hyperboloid of revolution* (see Figure) is generated by a straight line at an angle to a vertical axis. See also [TORUS](#).

surface of translation A surface generated by the motion of a plane curve parallel to itself over another curve. A *cylinder* (see [CROSS VAULT](#)) is generated by a curve, such as a circle, moving along a straight line. A HYPERBOLIC PARABOLOID is generated by an inclined straight line moving along two other inclined straight lines, or alternatively by a convex parabola moving along a concave parabola. An ELLIPTICAL PARABOLOID is generated by a convex parabola moving over another convex parabola. A

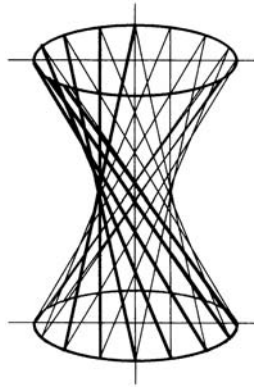

surface of revolution

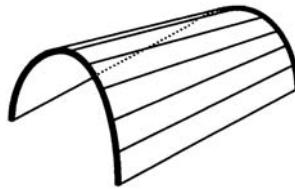

surface of translation

parabolic conoid (see Figure) is generated by a straight line moving over a flat parabola at one end, and a more strongly curved one at the other.

surface retarder See [RETARDER](#) and [EXPOSED AGGREGATE](#).

surface spread of flame See [FLAME SPREAD](#).

surface tension A property possessed by liquid surfaces whereby they appear to be covered with a thin elastic membrane in a state of tension. It is due to the unbalanced molecular cohesive forces near the surface. [CAPILLARY ACTION](#) is due to surface tension.

surface water The run-off after rain, as opposed to soil or waste water. The two are often drained separately, and the surface water discharged at a suitable place in the open to save sewer capacity.

surface waterproofer Waterproofing concrete and other materials by painting a liquid on the surface, as opposed to an [INTEGRAL WATERPROOFER](#). The liquid may be colourless, or a pigmented paint. Many surface waterprooferers contain silicone or epoxy resins.

surveyor's level See [CLINOMETER](#), [DUMPY LEVEL](#) and [QUICKSET LEVEL](#).

suspended absorber A prefabricated sound absorber suspended within a room to improve its acoustic performance. It may be hung from the ceiling, from the structural system, or from a secondary suspension system, such as stretched

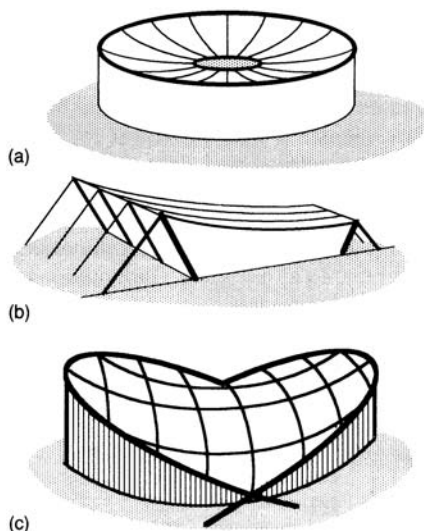

suspension roof

wires. See also [ACOUSTIC REFLECTOR](#) and [ACOUSTICAL CLOUD](#), whose purpose is to *reflect*.

suspended ceiling A FALSE CEILING suspended from the floor above.

suspended formwork Formwork that is suspended from the supports for the concrete floor to be cast, and not propped from below.

suspended luminaire A luminaire, hung from a ceiling by rigid or flexible supports. There is a space, the CEILING CAVITY, between the luminaire and the ceiling.

suspended span A short span freely supported from the ends of cantilevers, as in a GERBER BEAM.

suspension cable A cable hanging freely. If carrying mainly its own weight, it assumes the shape of a CATENARY. If carrying mainly a load uniformly distributed in plan it assumes the shape of a PARABOLA.

suspension roof A roof supported by suspension cables (see Figure). The simplest geometric forms are: (a) a dished DOME, i.e. a series of cables hanging from an outer compression ring and terminating at a central tension ring; (b) a dished cylindrical shell (BARREL VAULT), which has parallel cables anchored to the banked seats; and (c) a saddle shell (HYPERBOLIC PARABOLOID) whose cables are anchored to crossed arches.

swage The spread of a tooth on each side of a timber saw to provide a clearance for the blade. Also called *set*.

swale A shallow depression in the ground, with a gentle slope, and usually covered in grass, to allow stormwater to run over the surface in a controlled manner without erosion.

swallow tail Same as DOVETAIL.

sway See [SIDE-SWAY](#).

sway brace A diagonal member, or a pair of diagonals, designed to resist wind or other horizontal forces acting on a light structural frame. See also [SHEAR WALL](#).

SWG Standard wire gauge.

synchronous In computing, with constant time between successive events controlled by a clock, as in *synchronous data transmission*.

synclastic A surface with positive GAUSSIAN CURVATURE.

synthetic mineral fibre (SMF) Fibre produced from molten mineral material such as glass or rock, as used in FIBREGLASS and MINERAL WOOL.

synthetic resin See [RESIN](#).

synthetic stone Same as CAST STONE.

systematic error An error that is always in the same direction, and therefore cumulative, as opposed to a COMPENSATING ERROR.

system building INDUSTRIALISED BUILDING in accordance with a CLOSED or an OPEN SYSTEM.

Système International d'Unités See [SI UNITS](#).

system furniture Modular office furniture elements with provision for integrated electrical and data reticulation, including desktops, shelving, drawers and vertical screens. They can be interconnected in a variety of combinations to create appropriate individual or linked WORKSTATIONS.

systems analysis The definition and interpretation of problems, particularly for computer-aided solution.

T

T Abbreviation for tera, a million million times, or 10^{12} .

table form A formwork system for casting the floors of a building, resembling a series of tables butted together. After the concrete has gained enough strength, the legs are lowered and the tables are transferred by crane or hoist to the next floor.

tablet See [GRAPHICS TABLET](#).

tacheometer A surveying telescope with two additional cross-hairs, which make it possible to determine distance from a staff intercept, without running a tape or chain along the ground.

tack weld A weld designed not to carry a load, but to make a non-structural connection.

tail The built-in end of a cantilevered stone.

tailing in Fixing the end of a member that is cantilevered from a wall by laying stones or any heavy weight on it.

tailings Stones that do not pass through a screen used to separate particle sizes. Generally, a residue.

talc Acid metasilicate of magnesium ($H_2Mg_3Si_4O_{12}$). It is a soft mineral, with a soapy or greasy feel, which can be used for intricate carvings. Also called *soap-stone* or *steatite*. Finely ground talc is called *French chalk*.

tamper Same as [SCREED](#) (a).

tan The [TANGENT](#) of an angle.

tangent (a) A straight line that just touches a curve at a single point, but does not intersect it. See also [SECANT](#). (b) A [CIRCULAR FUNCTION](#) of an angle, the ratio of the side opposite to the angle in a right-angled triangle, to the adjacent side. Abbreviated *tan*.

tangential shrinkage The shrinkage of timber which is normally considered, i.e. in the direction tangential to the growth rings. See also [RADIAL SHRINKAGE](#).

tangential stress A shear [STRESS](#).

tangent modulus of elasticity Many materials (e.g. concrete) do not conform strictly to [HOOKE'S LAW](#) because of deviation is significant, it becomes tions caused by [INELASTIC](#) behaviour. If necessary to define the [MODULUS OF ELASTICITY](#) as the tangent or secant of the [STRESS-STRAIN DIAGRAM](#).

taper A gradual reduction in size, e.g. the narrowing of a column towards the top or the bottom.

tapered washer A bevelled washer for use with, for example, a rolled steel joist that has non-parallel flanges.

taper thread A standard screw thread used on pipes and their fittings to ensure watertight, steamtight or gastight joints. The taper is generally 1 in 16: that is, the threaded portion is part of a cone whose length is 16 times its diameter.

tar A bituminous substance obtained from the destructive distillation of coal. It has a lower melting point than ASPHALT.

tare The weight of a vehicle, as distinct from its load.

tarmacadam See [MACADAM](#).

tarpaulin A covering of canvas impregnated with tar or paint, used to protect materials or unfinished work against rain.

task lighting Lighting provided specifically over an area at which a visual task is expected to be performed, in addition to AMBIENT LIGHTING.

tatami The Japanese mat, which provides the MODULE for the design of traditional Japanese houses. Each room is an exact multiple of the size of the mat, which measures approximately 2m by 1 m (6ft by 3ft).

T-beam (a) In metal, a section shaped like the letter T. It is an I-BEAM with only one flange. (b) In concrete, the T-beam is commonly formed by the RIB and the portion of the floor slab above it. It is part of a MONOLITHIC beam-and-slab floor, not a separate T-shaped beam. See [EFFECTIVE FLANGE WIDTH](#) and [L-BEAM](#).

Teflon Trade name for POLYTETRAFLUOROETHYLENE.

telecommuting The use of technology that enables home-based employees to link directly with the principal office workplace by telecommunications. See also [HOME WORKING](#).

teleconferencing The interconnection of a number of participants at remote locations using telecommunication links so that information is shared in real time. Teleconferencing includes computer and video conferencing as well as hybrid configurations.

temper Moisten and mix to the proper consistency, especially MORTAR for brick-laying and plastering, or BRICK EARTH prior to its manufacture into bricks. See also [TEMPERED GLASS](#), [TEMPERED HARDBOARD](#) and [TEMPERING](#).

tempera painting A mural painting technique widely used in the Middle Ages and the Renaissance, which uses transparent colours on GESSO. The powdered pigment is bound with egg or GUM ARABIC, and thinned with water.

temperature The degree of hotness or coldness, measured with reference to an arbitrary zero (CELSIUS SCALE and FAHRENHEIT SCALE), or with reference to ABSOLUTE ZERO.

temperature gradient The change in temperature per unit length, e.g. through a wall that is warm on one side and cold on the other.

temperature inversion See [INVERSION](#).

temperature movement Thermal expansion and contraction.

temperature reinforcement Same as DISTRIBUTION REINFORCEMENT.

temperature stress A stress caused by a change in temperature. All materials expand with rising temperature and contract with falling temperature. Stresses are caused only if the movement is restrained.

tempered glass Glass prestressed by heating followed by QUENCHING; the rapid cooling produces a compressively stressed surface layer, which more than doubles the strength of the glass. Also called *toughened glass*. See also SAFETY GLASS.

tempered hardboard HARDBOARD that has been treated during manufacture to improve water resistance and strength. Its density usually exceeds 1000 kg/m³ (60lb/ft³).

tempering Heating hardened steel to a few hundred degrees and cooling it slowly to reduce the brittleness induced by the MARTENSITE. The steel loses some hardness and strength in the process. Many bright steels acquire a characteristic colour on tempering, caused by an oxide film, which can be used to determine the temperature to which they have been heated. For plain carbon tool steels, heated for a normal period, these are: straw 225°C, yellow-brown 255°C, red-brown 265°C, purple 275°C, violet 285°C, dark blue 295°C and light blue 310°C. At higher temperatures the skin turns grey. See also ANNEALING.

template or templet A sheet or light frame of wood or metal, used for marking out work to be done, or as a guide for a cutting tool.

tenacity A term generally synonymous with the ultimate tensile strength.

tenancy The premises to which a tenant has access under the terms of a LEASE agreement.

tenant The party to a LEASE agreement responsible for paying rent.

tender An offer to execute a specified amount of work for a rate or price.

tendon A bar, wire, strand or cable of high-tensile steel, used under a PRE-STRESSING CABLE when the element is tensioned.

tenon A tongue that fits into a MORTISE.

tension A direct pull in line with the axis of the body, and therefore the direct opposite of *compression*.

tension coefficient A shorthand notation for force divided by length.

tension ring A ring that absorbs the horizontal component of the thrust in a DOME.

tension structure See PNEUMATIC STRUCTURE and SUSPENSION ROOF.

tension wood Abnormal wood, which may be formed on the upper sides of branches and inclined stems of hardwood trees.

tenso-meter Same as STRAIN GAUGE.

tenso-tast A demountable STRAIN GAUGE with one fixed and one movable point, which engage plugs glued to the structure under test.

tera Prefix meaning 10¹², a trillion, or one million million, used particularly in SI UNITS. Abbreviated T.

teraflops Abbreviation for one TRILLION floating point operations per second.

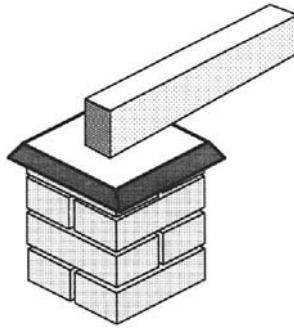

termite shield

terminal reheat The supply of heat to conditioned air before delivery to a space to bring it to a suitable condition for the thermal requirement to avoid overcooling the space.

termite An insect that shuns light, and is highly destructive to seasoned timber, especially soft wood. Australian cypress pine and several eucalypts are naturally resistant, but in the tropics and subtropics most timbers require protection by TERMITE SHIELD or IMPREGNATION. Termites are killed by arsenic or CREOSOTE OIL. Also called *white ant*.

termite barrier A barrier to prevent termites travelling from the ground, through holes or cracks in a concrete floor slab, into a building. It may be a TERMITE SHIELD or a *chemical* barrier, by impregnating the soil with a *termiticide*; but many previously used chemicals are now banned. Other methods include the use of a fine stainless steel mesh, and a layer of fine compacted granite.

termite shield A protective shield placed between the foundation piers and a timber floor (see Figure), around pipes etc. It usually consists of galvanised iron, bent down at the edges. Termites cannot stand daylight, and they can get past the inedible iron only by building an earthlike shelter tube; this shows up on the metal cap. Moreover, termites are very reluctant to pass over the downward bend.

termiticide See [TERMITE BARRIER](#).

terne coating A corrosion-protective coating for steel sheet used for roofing. It consists of 80–90 per cent lead and 10–20 per cent tin.

terrace Originally a raised level earth surface for walking on sloping ground, sometimes provided with a balustrade. Hence an enclosed level platform in front of a house; a gallery or a balcony attached to a house; a row of houses on a raised platform; and any row of houses of uniform style.

terra cotta Burnt clay units for ornamental work. Their colour varies from yellow to reddish brown. They are very durable, even unglazed. The glazed terra cotta is called FAIENCE. See also [CERAMIC VENEER](#).

terrazzo Marble-aggregate concrete that is either cast in place as a TOPPING or precast. It is subsequently ground smooth for decorative surfacing on floors or walls.

tessera A piece of glass or marble used to form a MOSAIC.

test cube or cylinder See [CUBE STRENGTH](#) and [CYLINDER STRENGTH](#).

testing machine A machine used for loading test pieces, usually to destruction, to determine their *deformation* and *strength*.

test pit Pit dug for SUBSURFACE EXPLORATION.

tetrahedron A regular POLYHEDRON bounded by four equilateral triangles. It has four vertices and six edges.

texture brick Same as RUSTIC BRICK.

texture paint A paint that can be manipulated after application to give a textured finish.

tg Continental abbreviation for TANGENT.

T & G joint Abbreviation for TONGUE AND GROOVE JOINT.

thatch A roof covering of reed, straw or rushes. It has a high insulating value, but burns very easily. The fire risk can be somewhat reduced by soaking the thatch in a fire-resisting solution before laying.

theatre dimmer See [LAMP DIMMER](#).

theodolite A surveyor's instrument for measuring horizontal and vertical angles. It has a telescope rotating on a horizontal (*trunnion*) axis, to which is attached the vertical measuring circle. The trunnion axis is carried on a standard fixed to the upper plate, whose rotation relative to the lower plate measures the horizontal angles. The lower plate is fixed through levelling screws to a tripod. Modern theodolites almost invariably are capable of transiting about the trunnion axis, and in the USA the instrument is commonly called a *transit*. See also [DUMPY LEVEL](#).

theorem of three moments A theorem, derived by the French mathematician B. P.E.Clapeyron in 1857, for calculating the redundant support moments in CONTINUOUS BEAMS. Once these REDUNDANCIES have been determined, the problem becomes STATICALLY DETERMINATE.

therm An obsolete measure of thermal energy, equal to 100000Btu or 105.5MJ.

thermal etc. See also [HEAT](#) etc.

thermal bridging See [COLD BRIDGING](#).

thermal capacity The capacity for storing heat or cold. In cold climates thick walls with a high thermal capacity are useful to conserve fuel. In hot-dry climates thick walls are also used to keep the house cooler during the hottest part of the day. In hot-humid climates, ventilation is more important, and light construction with a low thermal capacity is traditional. Also called *thermal inertia*.

thermal comfort See [COMFORT ZONE](#) and [INDEX OF THERMAL COMFORT](#).

thermal conductance The rate at which heat passes through a unit area of a building material, of the thickness normally used in the building, because of a difference of temperature of 1°C between the two faces. It may be expressed in British or metric units. The thermal conductance is related to the THERMAL CONDUCTIVITY (*k-Value*), which is heat passing through a unit thickness. It is

also related to the THERMAL TRANSMITTANCE (*U-value*) which is based on temperatures measured in the air beyond the roof or wall, instead of temperatures measured on the surface of the building material.

thermal conduction The process of heat transfer through a material medium in which heat is transmitted from particle to particle, not as in convection by movement of particles, nor by radiation.

thermal conductivity (*k-value*) Rate of transfer of heat along a body by THERMAL CONDUCTION, measured by the amount of heat per unit surface area flowing through a unit thickness for a temperature difference of 1 degree, in unit time. For most building materials the *k-value* is approximately proportional to their densities. See also [THERMAL CONDUCTANCE](#).

thermal conductor A material that readily transmits heat by conduction.

thermal diffusivity The rate of propagation of temperature change through a material. It is the ratio of the thermal conductivity to the heat capacity per unit volume.

thermal expansion Increase in the length of members of a building due to an increase in temperature. Unless provision is made for EXPANSION JOINTS, thermal movement is liable to produce cracking.

thermal inertia Same as THERMAL CAPACITY.

thermal insulation The reduction of the flow of heat. Its measure is the THERMAL RESISTANCE (called the *R-value*).

thermal movement See [THERMAL EXPANSION](#).

thermal radiation See [RADIANT HEAT](#).

thermal resistance (*R-value*) The resistance to the passage of heat provided by the roof, wall or floor of a building. It is the *reciprocal* of the THERMAL TRANSMITTANCE (or *U-value*).

thermal shock A very high THERMAL STRESS produced by a sudden large change of temperature.

thermal storage wall Wall with high THERMAL CAPACITY used for the storage of heat or coolness in *passive solar* design. See [TROMBE WALL](#).

thermal stress Stress produced by thermal movement that is resisted by the building. If the thermal stresses are higher than the capacity of the materials to resist them, expansion or contraction joints are required. Thermal stresses are particularly important in brittle materials, such as concrete and brick, because of their tendency to crack at comparatively small tensile stresses.

thermal transmittance (*U-value*) The amount of heat transmitted through a roof, wall or floor due to a temperature difference in the *air* on both sides. It is expressed as the amount of heat per unit surface area transmitted per hour for a temperature difference of 1 degree. The *U-values* of various forms of construction have been determined experimentally. Some countries, particularly those with a cold climate, lay down maximum permissible *U-values*. Also called *air-to-air heat-transmission coefficient*. The *R-value* (or THERMAL RESISTANCE) is the reciprocal of the *U-value*. See also [THERMAL CONDUCTANCE](#).

thermal unit See [BRITISH THERMAL UNIT](#).

thermic boring A method of boring holes into concrete by means of a high temperature, produced by burning a steel lance packed with steel wool, which is ignited and kept burning by a gas such as an oxyacetylene mixture.

thermionic Relating to the emission of electrons from hot bodies. It generally concentrates on the subsequent behaviour and control of such electrons, particularly *in vacuo*. A *thermionic vacuum tube* was the principal means for the rectification, amplification or detection of electric currents before the development of SEMICONDUCTORS. Thermionic emission is essential for the operation of low-pressure DISCHARGE LAMPS.

thermistor A temperature-sensitive resistance element of metallic oxide, whose electrical resistance decreases with increase in temperature.

thermochromic glass Glass that has the property of reduced transparency when exposed to higher levels of incident heat.

thermocline Stratification layer separating hot and cold regions of a fluid.

thermocouple A thermometer consisting of a pair of electric wires so joined as to produce a *thermoelectric effect*. When the ends of two dissimilar metals are joined, an electric potential is produced by a change in temperature, which is proportional to the temperature difference between the hot and the cold junctions. Thermocouples are remote-reading thermometers, but for room temperatures they are not as accurate as the conventional mercury-in-glass type. A cheap combination of wires consists of copper and CONSTANTAN. Precious metals such as platinum and rhodium are required for high temperatures.

thermodynamics The study of the relation between heat and energy. The two often-quoted laws of thermodynamics are: (a) *First law*: 'Heat and mechanical energy are mutually convertible; there is a constant relation between the amount of heat lost and energy gained or vice versa, which is called the MECHANICAL EQUIVALENT OF HEAT.' (b) *Second law*: 'Heat can never pass spontaneously from a colder to a hotter body; consequently the ENTROPY of the universe tends to a maximum'.

thermohygrograph A clock-driven recording instrument, which records both the dry-bulb and the wet-bulb temperature, or the dry-bulb temperature and the relative humidity.

thermopile An assembly of thermoelectric elements connected in series or in parallel, which can be used for measuring temperature.

thermoplastic Becoming soft when heated and hard when cooled. See also [THERMOSETTING](#).

thermosetting Becoming rigid on heating due to chemical reaction, usually between a resin and a HARDENER. Thermosetting resins cannot normally be softened, and they do not soften significantly on heating. See also [THERMO-PLASTIC](#) and [COLD-SETTING RESIN](#).

thermosiphon The circulation of water in a hot-water system by gravity without the use of a pump. The hotter fluid has a lower density and thus rises to the top.

thermostat A device, such as a BIMETAL-LIC STRIP, for maintaining a constant temperature. It is commonly used in conjunction with heating and air conditioning plants.

thinner Any volatile liquid that lowers the viscosity of a paint or varnish, and thus makes it flow more easily. It must be compatible with the medium of the paint. The most common thinners are TURPENTINE and WHITE SPIRIT.

thin shell A SHELL that can be designed using the MEMBRANE THEORY.

thin-walled section A section liable to LOCAL BUCKLING.

third-angle projection See [ORTHOGRAPHIC PROJECTION](#).

thixotropic Stiffening when left standing for a short period, and acquiring a lower viscosity on mechanical agitation. The process is reversible, and is characteristic of certain COLLOIDAL gels.

three-dimensional graphics In computer graphics, the process of drawing and displaying graphical objects in three dimensions.

three-dimensional modelling The process of modelling three-dimensional objects using either surface modelling, e.g CONSTRUCTIVE SOLID GEOMETRY, or solid modelling.

three-dimensional photoelasticity For certain PHOTOELASTIC MATERIALS, particularly phenol formaldehydes, the stress patterns can be frozen above room temperature at 75°C. The model can therefore be stressed in an oven, and cooled while still under load. It is then cut into parallel slices, which are examined in a POLARISCOPE at room temperature to obtain the three principal stresses. Also called the *frozen-stress method*.

three-dimensional sound See [STEREO-PHONIC SOUND](#).

three-dimensional vision See [STEREO-SCOPIC VISION](#).

three-hinged arch Same as THREE-PINNED ARCH.

three-phase system An alternating-current system in which the currents, flowing in three independent circuits, are displaced in phase by 120 electrical degrees.

three-pin (or three-prong) plug An electric plug that has two pins connecting to the main circuit, and one to the earth.

three-pinned arch (or portal) An arch (or portal) with two pin joints at the supports and a third pin at the crown (or the centre of the beam). The third pin renders the structure *statically determinate*.

three-wire system See [DELTA CONNECTION](#).

threshold Of a physical stimulus: the lowest value of the stimulus that can be expected, with a certain level of confidence, to be detected by an observer.

threshold of audibility See [HEARING THRESHOLD](#).

throat The minimum thickness of a FILLET WELD; it is the dimension that determines the strength (see Figure).

through car A lift car having two entrances at opposite ends of the car.

thrust A pushing force exerted by one part of a structure on an adjoining part. The term is more particularly used for horizontal or inclined forces in ARCHES, BUTTRESSES and RETAINING WALLS.

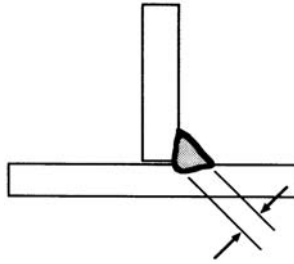

throat

thrust, line of The curve produced by the points through which the resultant THRUST passes, e.g. in an arch.

thrust bearing Support for a rotating shaft, which is capable of resisting an end thrust.

thunderday A day on which thunder is heard, used in the determination of the need for a LIGHTNING PROTECTION SYSTEM.

tie (a) A tension member; the opposite of a *strut*. (b) In reinforced concrete columns, the lateral or HOOP REINFORCEMENT. (c) A WALL TIE.

tied arch See [BOWSTRING GIRDER](#).

tied column A reinforced concrete column laterally reinforced with *ties* or HOOPS.

TIG welding Tungsten-inert-gas, a form of SHIELDED-ARC WELDING using an inert gas such as argon or helium to surround a tungsten electrode. The weld metal comes from the parent metal plus a wire added to the arc zone; the tungsten is not consumed.

tile A thin slab used for covering a roof, a wall or a floor. It may be made of unglazed or glazed ceramics, of natural stone, concrete, or various plastics.

tile, PVC See [POLYVINYL CHLORIDE](#).

tile, roof See [ROOF TILE](#).

tilting mixer A small BATCH MIXER for concrete or mortar, which discharges its contents by tilting the entire drum.

tilt-up construction A method of precast concrete construction in which members are cast horizontally in a location adjacent to their final position, and tilted into place after removal of the moulds.

timber connector Originally, one of several types of steel device, used in conjunction with a bolt, to make connections between timber members that overlap each other. Now used to include connectors made of galvanised steel sheet, either with holes for nailing, or with preformed nails, used for connecting light timber members that lie in the same plane. See [FRAMING BRACKET](#), [GANG-NAIL](#), [NAILPLATE](#), [SPLIT RING CONNECTOR](#), [TOOTHED PLATE CONNECTOR](#) and [TRUSS PLATE](#).

timber frame See [FRAME CONSTRUCTION](#) and [BALLOON FRAME](#).

timber preservative See [WOOD PRESERVATIVE](#).

timbre The quality of a sound that distinguishes one instrument from another, and one voice from another. It derives from the particular combination and relative strength of the HARMONIC overtones. *Tone colour* is the effect produced by a combination of timbres, i.e. of instruments and/or voices in a particular musical composition.

time, crashed or normal See **CRASHED TIME**.

time interval (for lifts) (a) *Down peak*: the average time between successive lift car arrivals at a defined floor during a DOWN PEAK condition. (b) *Loading*: the minimum time a lift car is held at a floor before it departs. (c) *Up peak*: the average time between successive lift car arrivals at a defined floor, during the up peak condition. (d) *Waiting*: the time a passenger waits for service. See also **LIFT PASSENGER JOURNEY TIME** and **LIFT ROUND TRIP TIME**.

time lapse photography The study of work processes by use of a series of photographs taken at intervals.

time of set The time taken for a mixture to reach an acceptable strength.

time sharing The apparent simultaneous use of a computer by several users or programs. The processor shares its operating time between processes in small time slices.

time study The establishment of times for a worker to carry out specific tasks under specified conditions.

time switch A switch controlled by an electrical clock, which opens and closes a circuit at a predetermined time.

tin A white metallic element, once widely used for tableware and other utensils (PEWTER), and one of the constituents of BRONZE; now mainly used as a protective coating for steel in *tinplate*. Its chemical symbol is Sn, its atomic number is 50, its atomic weight is 118.7, its specific gravity is 7.3, its melting point is 232°C, and its valency is 2 or 4.

tin roof Literally a roof covered with *tinplated* steel sheet. In practice it usually means a roof covered with GALVANISED or ZINCALUME sheets (which are coated with zinc or a zinc-aluminium alloy).

tinted glass Generally a HEAT-ABSORBING GLASS.

tints Coloured pigments softened by white.

T-iron A section shaped like the letter T. It is an I-beam with only one flange.

titanium white A white pigment consisting mainly of titanium dioxide, which occurs naturally as *anatase* and as *rutile*. It has almost entirely replaced WHITE LEAD, which is poisonous. Titanium white has good permanence and a high HIDING POWER.

TL Abbreviation for SOUND TRANSMISSION LOSS.

TNO Nederlands Centrale Organisatie voor Toegepast Natuurwetenschappelijk Onderzoek, the Dutch Government Organisation for Applied Scientific Research, which has several divisions interested in building research.

toe Short horizontal slab of a CANTILEVER RETAINING WALL, on the side opposite to the retained soil.

toilet A room containing a WATER CLOSET, and sometimes also a wash basin.

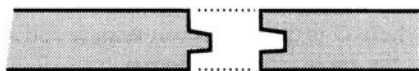

tongue and groove joint

tolerance The permitted variation from a given dimension. It is of particular importance when components are factory produced by different manufacturers, since compliance with the specified tolerance is essential if the parts are to be fitted without cutting or filling gaps on the site. A tolerance may be negative (as for a partition to fit between two existing walls) or positive (as for a door frame to fit a given door), or both positive and negative (if there is no definite restriction either way). The *limits of size* are the two extreme sizes between which the actual size must lie, and the difference between them is the tolerance.

tolerance of noise See [DAMAGE RISK CRITERION](#) and [BACKGROUND NOISE](#).

ton 1 long ton=2240lb; 1 short ton= 2000lb. 1 metric ton (tonne)=1000kg =0.984 long tons=1.102 short tons. In the USA ton usually means a short ton, but in most other English-speaking countries it commonly means a long ton. The metric ton is usually spelled tonne in English, to distinguish it from the other two.

tone (a) A sound producing a sensation of PITCH. (b) Frequency interval, which is approximately 12% of an OCTAVE.

tone colour See [TIMBRE](#).

tongue and groove joint (T & G joint) A joint in timber, and also in precast concrete piles, with projecting and grooved edges, which provide a sliding fit (see Figure). Floorboards, in particular, are frequently made with T & G joints, to allow the timber to move with change in moisture content while maintaining a satisfactory joint.

tonne A metric TON, equal to 1000kg.

ton of refrigeration The cooling effect obtained when 1 (short) ton of ice at 0 °C (32°F) melts to water at 0°C (32°F) in 24 hours. It is the unit heat flow rate used in designing air conditioning plants. 1 ton of refrigeration=12000 Btu per hour=3517W (or joules per second).

tooled joint A JOINT IN BRICKWORK (see illustration), compressed and shaped with a tool.

toothed plate connector (a) A NAILPLATE with preformed nails punched from the sheet metal. It is normally fixed with a hydraulic press, but can also be formed with knuckle-shaped nails that can be driven in with a hammer. (b) A toothed ring, squeezed between two (soft) timber members as a TIMBER CONNECTOR.

topcoat The final coat of paint applied to a surface, over the PRIMER and/or UNDERCOAT.

top-hat section A light-gauge metal section shaped

top-hat structure A tall building frame with a stiffened upper floor, generally used for accommodating building services. This reduces the cantilever deflection

of the frame under lateral loading, and increases its strength, with consequent saving of structural material.

top-hung window A CASEMENT WINDOW hinged horizontally.

topping A layer of high-quality concrete placed to form a floor surface on a concrete base.

topsoil The layer of soil that by its HUMUS content supports vegetation. It is valuable for agriculture and gardening, but must usually be removed before the foundation of a building is put down.

torque Same as TWISTING MOMENT.

torr Unit used in vacuum technology, equal to 1mm of mercury, or 133Pa.

torsional moment Same as TWISTING MOMENT.

torsional rigidity A measure of the stiffness of a member in resisting torsion. It is usually taken as the product GJ , where G is the MODULUS OF RIGIDITY and J is the POLAR MOMENT OF INERTIA.

torsion buckling Buckling of a column through rotation due to inadequate elastic stability.

torsion wrench A wrench (spanner) with an indicating dial so that the TWISTING MOMENT applied to the nut can be accurately determined. Used for tightening FRICTION-GRIP BOLTS to the correct torque.

torus (a) A surface or solid generated by the revolution of a circle or other conic section about any axis, e.g. a solid ring of circular or elliptical section. (b) A large convex moulding of approximately semicircular section, used especially at the base of a classical column.

total equivalent warming potential An indicator of the likely influence of a substance on atmospheric warming. See also GREENHOUSE GASES.

touch screen In computing, a screen that is sensitive to touch so that commands can be activated.

toughened glass Same as TEMPERED GLASS.

toughness The ability to resist fracture by shock or impact.

tough sheath See TPS CABLE.

tower crane A crane in which the lifting mechanism is mounted on top of a tower totally or partially structurally independent of the building it is servicing.

TPS cable Tough plastic sheathed; a type of electrical cable in which each conductor is insulated in plastic, and the whole is then covered with a separate layer, usually of PVC. It is intended for use in building cavities and protected locations, without the need of a conduit.

trabeated In traditional construction, spanning with stone lintels (i.e. beams), as opposed to ARCUATED construction.

trackball In computing, similar to a MOUSE, a palm-sized freely spinning ball used to control the movement of a CURSOR.

traction drive A *direct* lift drive through friction between the suspension ropes and the driving sheave. See also GEARED TRACTION and GEARLESS TRACTION DRIVES.

trade-off The giving up of some desirable design characteristic (such as low energy consumption in a building) in return for improvement in another characteristic (such as low capital cost).

trajectory, stress Same as ISOSTATIC LINE.

trammel A beam compass used for scribing unusually large circular arcs.

transducer A device for transforming mechanical vibrations or sound waves into electrical or magnetic energy (or vice versa).

transfer column A column in a multistorey building that does not go down to the foundation, but is supported by a *transfer girder*, which transfers its load to adjacent columns.

transfer function A coefficient that expresses the relationship between a heat output function at a given time to the value of one or more heat input functions at a given time and for a period immediately preceding. Employed in the *transfer function method* of estimating space cooling loads.

transfer length The distance at the end of a pre-tensioned tendon necessary to develop the full tensile stress in the tendon by BOND. Also called *transmission length*.

transfer of prestress The process of transferring the anchorage of the prestress in the TENDON from the POST-TENSIONING jacks, or from a PRE-TENSIONING bed to the concrete member.

transformation temperature Temperature at which one phase of an ALLOY system changes to another.

transformed section A hypothetical section of one material that has the same elastic properties as a composite section of two materials. It is a device for simplifying calculations for composite materials.

transformer An electrical apparatus for converting from one time-varying voltage to another, either up or down. In a large building electrical power is received at a high voltage, and in a SUBSTATION this is transformed to the standard voltage used in the building (normally 220/240V in Europe and Australia, 120V in the USA). *Current transformers* are used in electrical measurements.

transient A phenomenon that occurs during the change of a system from one state to another, e.g. the 'spike' in a signal when the frequency or amplitude is suddenly changed.

transillumination In lighting, the process of lighting by means of transmission through a translucent material, as in X-ray viewing boxes.

transistor An electronic device that utilises *solid-state* SEMICONDUCTORS for rectifying or amplifying an electrical current.

transit (a) The apparent passage of a heavenly body across the meridian of a place due to the Earth's daily revolution, i.e. the moment when it reaches its culmination or highest point. The Sun's transit is *apparent noon*. (b) A TRANSIT THEODOLITE.

transit mixer A truck-mounted concrete mixer, used for transporting concrete from a central batching plant to a site. The mixer slowly rotates during the

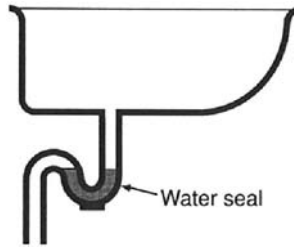

trap

journey, mixing the concrete ingredients and preventing them from settling and segregating.

transit theodolite A THEODOLITE that can be completely rotated about its horizontal axis. Virtually every modern instrument is designed to be able to do so. Frequently abbreviated to *transit*.

translation Linear movement of a point in space without *rotation*.

translation, surface of See [SURFACE OF TRANSLATION](#).

translucent concrete See [GLASS-CONCRETE CONSTRUCTION](#).

translucent glass Glass that has been patterned so that it is *not* transparent.

transmissibility The ratio of the response amplitude of a vibrating system to the excitation amplitude. The ratio may be one of forces, displacements, velocities or accelerations.

transmission A general term for the passage of energy through a medium from one side to the other.

transmission length Same as TRANSFER LENGTH.

transmission loss See [SOUND TRANSMISSION LOSS](#).

transmittance The ratio of transmitted energy to incident energy. See also [THERMAL TRANSMITTANCE](#).

transom A horizontal dividing member of a traditional window. The corresponding vertical member is a *mullion*.

transverse loading Loading perpendicular to a structural member, e.g. vertical loading on a horizontal beam.

transverse reinforcement Same as LATERAL REINFORCEMENT.

trap A bend or dip in a SOIL DRAIN, so arranged that it is always full of water and provides a *water seal*, which prevents odours from entering the building (see Figure).

trapdoor A door, flush with the surface, in a floor, roof or ceiling, or in the stage of a theatre.

trapezium A QUADRILATERAL with two parallel sides. If the lengths of the two parallel sides are y_1 and y_2 , and the height of the trapezium, at right angles to them, is x , then the area of the trapezium is This is the basis of the TRAPEZOIDAL RULE.

$$x \left(\frac{1}{2} y_0 + y_1 + y_2 + \dots + y_{n-1} + \frac{1}{2} y_n \right)$$

trapezoidal rule A rule for the evaluation of an irregular area, or for graphical integration. Let the area be divided into a number of parallel strips of width x . The lengths of the boundary ordinates, or separating strips are measured and these are y_0, y_1, \dots, y_{n-1} and y_n . The area of the figure is then This calculation is quicker, but less accurate, than SIMPSON'S RULE.

trass A natural POZZOLANA of volcanic origin found in Germany near the River Rhine.

travel The vertical distance a lift can move, measured from the bottom to the top terminal floor or SKY LOBBY of a building.

travelator Same as MOVING WALK.

traveller gantry A stationary gantry that carries a traveller, i.e. a hoist moving on rails across the top.

travelling gantry A gantry built on wheels so that it can travel.

travertine A light-coloured TUF; particularly the stone used in Ancient and Modern Rome, and exported world-wide.

tread (a) The level part of a step in a staircase. (b) the horizontal distance between one RISER and the next, exclusive of the nosing; also called the *going*.

tremie A hopper with a pipe at the bottom, used for placing concrete under water.

trastle A braced frame used to support horizontal working platforms.

triangle A plane figure bounded by three straight lines. Its internal angles add up to 180° . A triangle with two equal sides is *isosceles*, and one with three equal sides is *equilateral*. A triangle with one angle of 90° is *right-angled*, and its longest side is called a *hypotenuse*.

triangle of forces The same as the PARALLELOGRAM OF FORCES, leaving out two sides of the parallelogram.

triangulation (a) A method used in the design of plane and space frames to ensure that they are isostatic. According to MÖBIUS LAW, a truss whose members are all arranged in the form of adjacent triangles is statically determinate. (b) A method of surveying with ground stations forming a triangular network. One leg of one triangle is measured accurately on the ground. All other legs are then determined by angular measurement.

triaxial compression test A test on a sample (normally soil) contained in a rubber bag surrounded by liquid, which exerts lateral pressure in two perpendicular directions. The vertical pressure (in the third direction) is applied by a piston. Unlike the UNCONFINED COMPRESSION TEST, it can be used on cohesionless soils.

tribophysics The physics of friction.

tricalcium silicate One of the principal components of PORTLAND CEMENT. Its chemical composition is $3\text{CaO} \cdot \text{SiO}_2$, or C3S in the notation used by cement chemists. It is the main constituent of the component named *Alite* by Tornebohm

in 1897, before the chemical composition of cement had been properly established.

trigonometry The mathematics of CIRCULAR FUNCTIONS. *Plane trigonometry* deals with triangles drawn on a plane surface. *Spherical trigonometry* deals with triangles drawn on the surface of a sphere.

trillion 1×10^{12} , a million million. Some Europeans, who equate 1×10^{12} to a BILLION, take a trillion to mean 1×10^{18} .

trim (a) The edging of an opening in a colour or material different from that of the wall surface. (b) A generic term for architraves, skirtings etc., which cover open joints. (c) A generic term for all visible interior finishing work, including hinges and locks.

trimetric projection An AXONOMETRIC PROJECTION in which the two horizontal axes are drawn at different angles.

trip coil A SOLENOID-operated circuit breaker.

triphosphor In lighting, the term used to describe FLUORESCENT LAMPS employing narrow-band phosphors. Sometimes also called *three-band lamps* or *multiphosphor lamps*.

triplex Three interconnected lift cars, sharing a common signalling system controlled under a simple group control system, operating under directional collective principles.

tripod A three-legged support.

tristimulus Referring to three colour receptors (types of *cones*) in the RETINA and, by extension, to COLORIMETRY.

troland The unit of retinal illuminance, used in experimental psychology and physiology.

Trombe wall A THERMAL STORAGE WALL, devised by Felix Trombe in France, for PASSIVE SOLAR houses

tropics The parallels of *latitude* $23^{\circ} 26'$ north and south that represent the furthest movement of the Sun from the equator. The tropic zone is the region between the tropic circles.

troposphere See [ATMOSPHERIC LAYERS](#).

trough gutter Same as BOX GUTTER.

true volume Of a porous material, the volume excluding both the open and the closed pores. The BULK VOLUME includes the pores.

trunnion axis The horizontal axis of rotation of a THEODOLITE.

truss A structural member, acting like a beam, but made up of smaller members in a triangulated arrangement. See also BELFAST, FINK, HOWE and WARREN TRUSS; KING-POST ROOF TRUSS, PRINCESS POST, QUEEN-POST ROOF-TRUSS and HAMMERBEAM ROOF, and MÖBIUS' LAW.

trussed beam or purlin (a) A beam or purlin stiffened with a tie rod. (b) A beam or purlin in the form of a truss.

trussed rafter A triangulated rafter in a roof truss. The FINK TRUSS is a large-span example.

truss plate Same as NAILPLATE.

try square A gauge consisting of two pieces of metal accurately set at right angles, used for laying out work, and for testing finished work for squareness.

tube structure or tube-in-tube structure Structural system for a tall building, which considers the columns and SPANDRELS on the facades as forming a pierced tube, cantilevered from the ground. The lift well (elevator shaft) forms another tube inside this outer tube.

tubular scaffolding Scaffolding built up from galvanised steel or aluminium tubes with clamps. The tubes are usually of 50mm (2in.) external diameter.

tuck pointing An obsolete method of emphasising the joints in brick and natural stone by grooving the mortar to form a *tuck*, which is then filled with mortar or putty of a distinctive colour, usually white or black.

tufa A porous limestone, deposited from solution around springs of water. See also TRAVERTINE. The term is also sometimes used as a synonym for *tuff*, a porous rock of volcanic origin.

tumbler switch A switch operated by pushing a short lever up or down.

tung oil An oil obtained from the seeds of *Aleurites cordata*, used in the manufacture of paints, varnishes and enamels. It has excellent water resistance. Since the trees were found mainly in China and Japan, it is also called *China wood oil*.

tungsten A metallic element used as an alloy for hard steels, and as filaments and electrodes in electric lamps. Its chemical symbol is W (wolframium), its atomic number is 74, its atomic weight is 184, its specific gravity is 19.3, and its melting point is 3300°C.

tungsten-halogen lamp An INCANDESCENT LAMP, which has a halogen (iodine, chlorine or bromine) added to the normal gas filling. This produces a regenerative cycle whereby the tungsten, sublimed from the filament and otherwise deposited on the glass, is kept in vapour form until it nears the filament when it is redeposited on the filament.

turbidimeter A device for the PARTICLESIZE ANALYSIS of finely divided material. Successive measurements are taken of the turbidity of a suspension of the fluid.

turbine A rotating PRIME MOVER, as distinct from a RECIPROCATING ENGINE.

turbulence index An index used to quantify the turbulence of air movement in a mechanically ventilated space. It is the ratio of the air velocity, measured as standard deviation. a time-weighted 3min average, to the

turbulent flow Unsteady flow with eddies, as opposed to STREAMLINE FLOW.

turnbuckle A coupling between the ends of two rods, one having a left-hand and the other a right-hand thread. Hence rotation of the buckle adjusts the tension in the rods. A simpler type has only one right-hand thread, and a swivel at the other end.

turning Making an object on a LATHE.

turnkey contract A contract where the contractor undertakes the complete design and construction and hands over the project ready for occupation. See also [TURNKEY SYSTEM](#).

turnkey system A complete system supplied by a single supplier. See also [TURNKEY CONTRACT](#).

turpentine A THINNER obtained by distilling the sap of certain pine trees. WHITE SPIRIT is frequently used as a substitute.

twisting moment The moment of all the forces acting on a member about its polar axis, i.e. the moment NORMAL to the section. Also called *torsional moment* or *torque*.

two-and-a-half-dimensional graphics The process of creating three-dimensional graphic objects by drawing them in two dimensions and adding the third dimension by EXTRUDING the two-dimensional object in the third dimension.

two-dimensional graphics In computer graphics, the process of drawing and displaying graphical objects in two dimensions using graphic elements such as points, lines, polylines and polygons.

two-part adhesive A synthetic glue supplied in two parts, a powdered resin and an ACCELERATOR, which are mixed only just before use.

two-way slab A SLAB spanning beams in two directions.

two-way switch An electric switch used to control a light or lights from two locations. Two two-way switches are required, one in each location.

U

U-bolt A steel bar bent into a U-shape, and fitted with screw threads and nuts on each end. Also called a *U-clip*.

UF Urea FORMALDEHYDE.

U-gauge A U-tube MANOMETER.

UHF Ultra high frequency.

UIA Union Internationale des Architectes, Paris.

ULOR Upward light output ratio; the ratio of the flux emitted in the upper hemisphere above a luminaire to the total flux emitted by the lamps installed in the luminaire.

ultimate load In ULTIMATE STRENGTH DESIGN, the actual working load multiplied by the LOAD FACTOR.

ultimate strain The strain at which a material fails. In ULTIMATE STRENGTH DESIGN, the ultimate strain of concrete is assumed to be the same for all types of concrete, and equal to 3×10^{-3} (USA and Australia) or 3.5×10^{-3} (UK).

ultimate strength The highest load that a test piece can sustain before breaking.

ultimate strength design Design based on the ultimate strength of the structure, or of a structural member, as opposed to ELASTIC DESIGN.

ultramarine A characteristic blue pigment, originally made by grinding the semi-precious LAPIS LAZULI. It was synthesised in the 1820s by calcining china clay, soda, sulphur and coal, and its cost was greatly reduced.

ultrasonic See **ULTRASOUND**.

ultrasound Mechanical vibration in a solid, liquid or gas, which has a frequency higher than that of audible sound (16kHz), and a speed equal to that of sound in the same medium. It is reflected and refracted at the boundaries of a solid, and can therefore be used for the NON-DESTRUCTIVE detection of cracks and flaws in concrete structures, in metal casings, etc.; or to determine the thickness of a piece of material when only one surface is accessible.

ultraviolet radiation Electromagnetic radiation with wavelengths shorter than 390nm, i.e. beyond the violet end of visible light. It forms part of the radiation received from the Sun, and it has a destructive effect on some materials, including a number of plastics. Hence ultraviolet radiation cycles are included in some WEATHEROMETERS. Short-wave UV radiation produces erythema (reddening of the skin) and with sufficient exposure can trigger skin cancers.

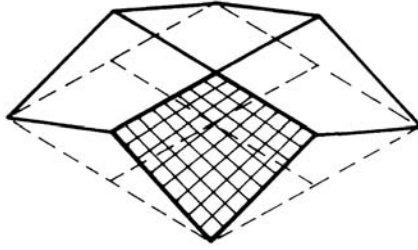

umbrella shell

umber Brown mineral pigment. It consists of iron oxide and manganese oxide. See also [BURNT UMBER](#).

umbra Total shadow cast by an opaque body or by the Earth or moon in eclipse. See also [PENUMBRA](#).

umbrella shell A shell roof formed by four HYPAR shells (see Figure), or by other suitable arrangements of hypar shells.

unbonded tendon A tendon in PRE-STRESSED CONCRETE that is not bonded to the concrete by grouting after it is stressed.

unconfined compression test A compressive test on a sample of a material without lateral restraint, which is normal practice for structural materials. The term is mainly used for a soil test, to distinguish it from a TRIAXIAL COMPRESSION TEST.

unconfined compressive strength of clay This depends greatly on the water content, and it may range from less than 35 kN/m² (5psi) for a very soft clay to more than 275kN/m² (40psi) for a very stiff clay. It may be seriously reduced by REMOULDING.

undercoat A coat of paint that is not the TOPCOAT. It may be the first coat, or applied over the PRIMER or another previous coat.

underfloor heating Heating provided below the finished floor by electric cables or hot-water pipes. These are frequently cast into a concrete slab. See also [HYPOCAUST](#).

underlay Material laid directly on the floor to act as padding, generally for a carpet.

underpin To provide a new foundation for a wall or column in an existing building without removing the superstructure.

under-reinforced section A reinforced concrete section with less steel than is needed for a BALANCED DESIGN.

undisturbed samples See [BOREHOLE SAMPLES](#).

unidirectional microphone A micro-phone that picks up sound from one direction only.

uniform gravel or sand Material retained between two adjacent sieves so that all particles are of approximately the same size. See also [PEA GRAVEL](#).

uniform load A load that is uniformly distributed. For the sake of simplicity, this is usually assumed in structural calculations, even when there is some variation in distribution.

uniform sky An idealised sky whose luminance is the same at all altitudes. It is used in many daylight calculations because of its simplicity. See also [CIE STANDARD CLEAR SKY](#), [CIE STANDARD OVERCAST SKY](#) and [INDIAN STANDARD SKY](#).

unit stress A term generally synonymous with STRESS.

unit weight The density of a material, i.e. its weight per unit volume.

universal testing machine A TESTING MACHINE capable of exerting tensile, compressive or flexural forces on a specimen under test, as opposed to a machine designed for one kind of test only.

universe In statistical terminology, a specified group, e.g. of persons or concrete cylinders. A universe may have several POPULATIONS associated with it.

unreinforced concrete Concrete that is *plain*, neither REINFORCED nor PRESTRESSED.

upfeed system A system of water supply fed by mains pressure, or a pump, at the bottom of the building.

uplift An upward force. See also [FROST HEAVE](#) and [QUICKSAND](#).

uplighter A LUMINAIRE, usually floor-mounted or furniture-mounted, used to light the ceiling.

uprights Vertical members, usually of timber, e.g. the sides of a door frame.

upstand beam A beam projecting above an adjoining slab.

urea formaldehyde See [FORMALDEHYDE](#).

usable floor area The area of a space that can actually be occupied by a user; it is normally less than the NET LETTABLE AREA.

USASI United States of America Standards Institute, now called American National Standards Institute Inc.

US customary units The system of FPS UNITS as defined by the National Bureau of Standards, Washington. There are some differences between the customary units of the USA and those of the UK, e.g. in the GALLON and the TON.

user-friendly A term describing an attribute of a system that can be used easily by untrained users.

U-tie A U-shaped WALL TIE.

utilisation factor A factor used in the LUMEN METHOD for the calculation of both daylight and electric light illuminances, which allows for both direct and interreflected light in interiors.

utility services The services traditionally provided for the community, such as water, gas, electricity, sewerage and garbage disposal.

U-tube See [MANOMETER](#).

U-value The measure of THERMAL TRANSMITTANCE.

V

V Abbreviation for VOLT.

V Abbreviation for SHEAR FORCE.

vacancy rate The ratio of the currently vacant area to the total available area.

vacuum An empty space. A perfect vacuum is unobtainable on Earth, and a pressure of 10^{-4} Pa is considered a good vacuum.

vacuum concrete Concrete from which water is extracted with a vacuum mat before hardening occurs. The concrete has a water content adequate for placing in the formwork, but this is subsequently reduced to give a higher strength concrete; see [ABRAMS' LAW](#).

vacuum lifting Raising an object, e.g. a precast concrete panel, with a suction attachment. It allows uniform distribution of the lifting force, but the cost of the capital equipment is appreciable.

valency The combining power of an atom. Thus oxygen, which is bivalent, combines with two univalent hydrogen atoms to form water. Some elements have more than one valency: e.g. sulphur may have a valency of 2, 4 or 6.

valley The intersection between two sloping surfaces of a roof; the opposite of *hip*. A valley must itself have a slope so that it can discharge rainwater.

valuation See [MARKET VALUATION](#).

value (a) Of a colour, in the [MUNSELL BOOK OF COLOR](#), value correlates with the lightness of the colour perceived to belong to it, and it ranges from 0/ for ideal black to 10/ for ideal white. (b) In computing, a fixed constant, being a number or a [STRING](#). See [ATTRIBUTE](#).

value analysis A technique used to examine the evolving design in order to achieve design objectives as economically as possible; it involves criticisms of the design and subsequent analysis of alternative ideas.

value management A review process to assess the impact of decisions made, usually during design or design development, with respect to cost, function and quality of the proposed building project.

valve (a) A device for regulating the flow of a liquid or gas in a pipeline. (b) A [THERMIONIC](#) tube used as an electronic rectifier or amplifier.

vane See [DOOR VANE](#).

vane anemometer See [ANEMOMETER](#).

vane test A SHEAR TEST for determining the strength of soil on the site. A four-bladed vane is inserted into the soil at the foot of a *borehole*. It is rotated by a rod at the surface, and the force is measured when the soil shears.

vanishing point The point where parallel lines receding from the observer are drawn to meet in a PERSPECTIVE PROJECTION.

vapour A gas that is at a temperature below its critical temperature, and can therefore be liquefied by a suitable increase in pressure.

vapour barrier An airtight skin, e.g. of aluminium or polyethylene, which prevents moisture from the warm damp air in a building from passing into and condensing within a colder space. It is particularly needed in cool climates, at night and in winter, to protect the insulation from filling with condensation water or ice, and it is therefore placed on the inner, warm face of the insulation. A barrier that satisfactorily stops the ingress of liquid water is not necessarily sufficient to stop water vapour.

vapour compression cycle A refrigeration cycle. It utilises two phenomena: (a) the evaporation of a liquid refrigerant absorbs heat to lower the temperature of its surroundings; (b) the condensation of the refrigerant vapour gives off heat to raise the temperature of its surroundings. The refrigerant vapour has its pressure raised by a mechanical compressor, as opposed to the ABSORPTION CYCLE.

vapour pressure The pressure exerted by a vapour. The term is generally taken as synonymous with SATURATED VAPOUR PRESSURE, which is the pressure of a vapour in contact with its liquid form. The saturated vapour pressure falls as the temperature falls. See [SATURATED AIR](#).

variable In computing, an element of a computer program whose VALUE can be changed during the execution of the program.

variable air volume system (VAV) Method of air distribution in an air conditioning system, in which air is circulated at a constant temperature, and the volume flow rate is varied to maintain the desired condition, in contrast to a CONSTANT AIR VOLUME SYSTEM.

variance The square of the STANDARD DEVIATION.

variation An approved modification of the design shown in the contract documents.

varnish A resin dissolved in oil or spirit, which dries to a brilliant, thin, protective film. Varnish may be put on unpainted wood, put over paint to increase its gloss, or mixed with paint. The term LACQUER is usually reserved for finishes based on cellulose compounds.

vasoconstriction, or -dilation Constriction or dilation of capillary blood vessels under the surface of the skin as part of the human thermoregulatory response.

vault (a) A vaulted roof, i.e. an arched masonry or concrete roof. See also [BARREL VAULT](#) and [CROSS VAULT](#). (b) A room or passage with an arched masonry roof. (c) A room below ground, of massive construction, not necessarily with a vaulted roof. (d) A safe room for the storage of valuables, usually below ground, but rarely with a vaulted ceiling.

VAV Abbreviation for VARIABLE AIR VOLUME.

VDU Abbreviation for VISUAL DISPLAY UNIT.

vector (a) A quantity that has magnitude as well as direction. It may be represented by a straight line drawn from a point in a given direction for a given distance. A SCALAR has magnitude, but no direction. In vector algebra, vectors are usually distinguished from scalars by the use of bold type. (b) In computer graphics, a graphic element represented by a line allowing the addressing of such elements as whole elements rather than as a collection of PIXELS. See [VECTOR GRAPHICS](#).

vector graphics In computer graphics, the use of VECTORS to represent graphic elements, as opposed to RASTER GRAPHICS.

vehicle The liquid part of a paint, as opposed to the pigment. Also called *medium*.

veiling reflection Reflections in a surface that partially or totally obscure other visual information contained in the surface.

velocity In common parlance, the same as SPEED. In physics, velocity is a VECTOR quantity, which determines direction as well as speed.

velocity head The energy possessed by a liquid because of its velocity. See also [HEAD](#) (a).

velocity of light, sound See [SPEED OF LIGHT](#) and [SPEED OF SOUND](#).

velocity pressure Pressure in a fluid as a result of its motion.

velocity ratio In a lifting tackle, the ratio of the distance through which the force has moved to the distance moved by the load. In an efficient machine it is only slightly greater than the MECHANICAL ADVANTAGE.

veneer See [BRICK VENEER](#) and [WOOD VENEER](#)

Venetian blind A window blind composed of numerous thin slats, which can be raised and lowered with ease. The slats (formerly of timber, now usually of aluminium or plastic) can be rotated by pulling a cord, to admit varying amounts of light and air. A Venetian blind is normally placed inside the window to protect it from the weather, and it is thus only partially effective in excluding *thermal radiation*. In air-conditioned buildings with double glazing the blinds are therefore fixed between the inner and outer panes of glass. See also [LOUVRE](#).

venetian red Red mineral pigment made from haematite (Fe_2O_3).

ventilating brick Same as AIR BRICK.

ventilation The supply of clean outdoor air to a space for the purpose of cooling, and diluting concentrations of undesirable contaminants that may be released in it as a result of occupation and use.

venting (a) Of smoke produced by a fire: automatic vents are installed in single-storey buildings that cover large areas; these are operated by smoke detectors. (b) Of a gas explosion: the vents are provided by singly glazed windows, or other panels that are blown out by the pressure of the explosion. This relieves the pressure and removes some of the flammable gases.

Venturi tube A constriction inserted in a line of piping, together with a MANOMETER to measure the loss of pressure over the convergent part of the constriction. From this the rate of flow can be calculated by BERNOULLI'S THEOREM.

verdigris The green basic copper carbonate formed on copper roofs and statues exposed to the atmosphere. Although a corrosion product, it gives a highly esteemed *patina* if properly controlled.

verge The edge of a sloping roof that overhangs a GABLE.

verge board Same as BARGE BOARD.

vermiculation Literally, a worm-eaten state. Decoration of masonry with shallow, irregular channels, resembling worm tracks; it is one form of RUSTICATION.

vermiculite A generic name for hydrous silicates of aluminium, magnesium and iron, which occur as minerals in plate form, and show marked exfoliation on heating. The term often implies exfoliated vermiculite, which is used for thermal insulation and fire protection, often as an aggregate in plaster or concrete.

vermilion A brilliant red, slightly orange-coloured pigment, derived from cinnabar, which is mercuric sulphide (HgS). It is one of the traditional pigments, but is now too expensive for general use.

vernier A device for measuring length more accurately than is possible with an ordinary scale. It consists of a subsidiary (*vernier*) scale, which slides alongside the main scale. This carries one additional division; i.e. ten vernier divisions equal nine divisions on the main scale. By noting which division on the vernier scale is exactly in line with the main scale, the measurement can be taken to one more decimal place than is shown in the main scale. See also [MICROMETER \(a\)](#).

versioning In computing, the process of generating, maintaining and displaying information from a number of versions of a project.

vertical In line with the direction of the gravitational forces, i.e. the dead loads. The *horizontal* direction is at right angles to the vertical. See [PLUMB BOB](#) and [SPIRIT LEVEL](#).

vertical sash A normal sash in a SASH WINDOW.

vertical shadow angle The angle, measured in the plane normal to a surface, between the position of the Sun and the horizontal.

vestibule A space located between the main entrance door and the remainder of the premises.

VGA Video graphics array.

VHF Very high frequency.

vibrated concrete Concrete compacted by vibration during and after placing. Since vibration helps to place a comparatively dry concrete with satisfactory compaction (see [ABRAMS' LAW](#)), it increases the effective concrete strength. On the other hand, displacement of the reinforcement is a possible danger. The vibrator can be fixed to the formwork, or an internal (or poker) vibrator can be immersed in the wet concrete.

vibration A periodic motion in a medium. There are two types of vibration: (a) *forced vibration*, where the motion of a system is maintained by one or more periodic forces, and where the frequency is related to the frequencies of the forces; (b) *free vibration*, where the motion of a system results from a

disturbance to the system, and where the period of oscillation depends only on the properties of the system. See also

DAMPING OF STRUCTURAL VIBRATIONS.

vibration isolator A spring and damper system designed to reduce the dynamic forces, from a machine or other vibrating object, transmitted to a building structure.

vibration transducer See **ACCELEROMETER.**

vibrator See **CONCRETE VIBRATOR.**

Vicat test Used to determine the onset of stiffening in Portland cement after water has been added. The Vicat test consists in placing a weighted test needle on the hydrated cement pat. The *initial set* is defined by failure of the initial-test needle to penetrate the pat. The *final set* is defined by failure of the final-test Vicat needle to make a 0.5mm indentation on the cement pat.

Vickers diamond hardness test An indentation hardness test employing a diamond pyramid. The impression of the diagonal is converted into the hardness number from a table.

video conferencing A form of TELECONFERENCING using video transmission so that participants can see as well as hear other participants.

Vierendeel girder A girder (named after a Belgian engineering professor) without diagonals, so that it can be used in walls that require openings for windows or doors. All the joints are rigid. Also called an *open-frame girder*.

viewpoint In computer graphics, a point in three-dimensional space that represents the observer's point of view.

viewport In computer graphics, that part of a WINDOW (b) that is visible at a given time.

vinyl See **POLYVINYL.**

virtual Pertaining to conceptual rather than physical.

virtual memory The use of the external storage of a computer as an extension of its main memory.

virtual office A workplace that is determined by where the employee happens to be engaged in carrying out work at a particular time, remote from the main organisation workplace.

virtual organisation An organisation that exists only as a result of telecommunications, an electronic organisation existing in virtual space.

virtual reality The simulation of the real world in virtual space, allowing for the virtual interaction of users, such as *walk-throughs*, *fly-bys*.

viscosity Internal friction (due to cohesion) in fluids, or in solids with flow characteristics. The opposite of *fluidity*.

viscous deformation Continuous deformation of flow over a period of time. It is generally proportional to the applied stress, and it may occur at quite low stresses.

visible spectrum The visible range of electromagnetic RADIATION, ranging in wavelength from 760 to 390nm (from red to violet light).

visionproof glass Glass that has been patterned, so that it is not transparent.

visual acuity (a) The capacity of seeing distinctly objects very close together or of very small size; the ability to resolve fine detail. (b) The measure of the ability to see visual detail both *near* and *distant*. The *Snellen notation* (e.g. 6/6) is common for distance visual acuity.

visual angle The angle subtended by an object or a detail of an object, at the eye. Usually measured in minutes of arc.

visual display unit (VDU) A computer screen using a CATHODE-RAY TUBE or other form of electronic display.

visual field All the surfaces and objects that can be seen while the eyes are kept stationary.

visualisation The process of displaying realistic visual images of an object for evaluation. Visual simulation.

vitreous enamel Hard, impervious and weather-resistant finish, also called *porcelain enamel*, applied to steel and aluminium sheet, particularly for CURTAIN WALLS. The process consists of fusing a thin coating of glass to the metal base at temperatures above 800°C (1500°F) for steel and 550°C (1000°F) for aluminium. At these temperatures the metal and the glass combine, producing a product with the surface hardness of glass and the strength of metal. Thicker layers of vitreous enamel, usually white, are used on steel and cast iron for baths, and occasionally washbasins. The thicker layers are necessary for abrasion resistance, but they are more easily chipped by a hard blow because of the brittleness of the enamel.

vitriified pipes or tiles Clay pipes or tiles that have been baked hard and then glazed to make them impervious to water.

vitrine A glass display case or cabinet, as used in museums.

vitriol (a) *Oil of vitriol*: concentrated sulphuric acid (H_2SO_4). (b) *Blue vitriol*: copper sulphate ($\text{CuSO}_4 \cdot 5\text{H}_2\text{O}$). (c) *Green vitriol*: ferrous sulphate ($\text{FeSO}_4 \cdot 7\text{H}_2\text{O}$). (d) *White vitriol*: zinc sulphate ($\text{ZnSO}_4 \cdot 7\text{H}_2\text{O}$).

VLSI Very large-scale integration.

VOC Volatile organic compound.

voids The spaces between the particles of soil or concrete aggregate, whether occupied by air or water or both.

voids ratio (v) The ratio of voids to solids in a sample. The *porosity* is $v/(1+v)$.

volatile Readily evaporating at room temperature.

volt (V) Unit of electrical potential, or electromotive force (*emf*), named after the eighteenth-century Italian physicist A.G.A.A. Volta. It represents the potential difference against which one JOULE of work is done in the transfer of one COULOMB.

voltage Electromotive force measured in VOLTS.

voltage transformer See [TRANSFORMER](#).

volt-amps The units of the APPARENT POWER in an alternating current circuit, distinguished from the REAL POWER measured in *watts* and REACTIVE POWER measured in *volt-amps-reactive*.

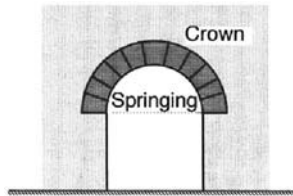

voussoir arch

voltmeter Instrument for measuring the electromotive force (or electric potential) directly, calibrated in volts.

volute casing A casing around the impeller of a centrifugal compressor, fan or pump, which gradually increases in cross-sectional area towards the outlet for the purpose of conversion of velocity pressure to static pressure.

vortex A whirl of fluid.

voussoir A wedge-shaped stone or brick, used in the construction of an arch. The voussoir at the CROWN is called the *keystone*.

voussoir arch An arch, often circular, built from VOUSSIORS (see Figure).

VR Abbreviation for VIRTUAL REALITY.

VRML Virtual reality mark-up language.

vulcanisation Treatment of rubber with sulphur to cross-link the elastomer chains.

W

W (a) Chemical symbol for *tungsten* (wolframium). (b) Abbreviation for WATT.

waffle Slab A two-way RIBBED SLAB.

wagon vault Same as BARREL VAULT.

wainscot Wood-panelling of the lower part of an interior wall, usually terminating with a DADO.

waiting time The time a passenger waits for a lift (elevator) from the time the call is registered until the lift arrives.

wake The region of turbulent flow downstream from the point of separation, characterised by a reversal of flow.

Waldram diagram A projection method for depicting the sky component of day-lighting for a particular reference point. The diagram is a specially scaled grid representing half the hemisphere of sky. The area of visible sky seen through the window from the reference point is plotted onto the grid, and this area is proportional to the sky component at the reference point.

walk-up apartment house An apartment house without a lift (elevator), generally four storeys or less.

wall, retaining See [RETAINING WALL](#).

wall board BUILDING BOARD suitable for interior walls.

wall column (a) A column that is so wide that it might also be considered a short loadbearing wall. (b) A column EMBEDDED in the Wall.

wall-floor ratio The ratio of wall area to floor area of a particular space. It is one measure of plan efficiency.

wallpaper Decorative printed paper usually sold in rolls, for sticking on a plastered wall. The wall requires a sealer, to prevent it from discolouring wallpaper.

wall plate A horizontal piece of timber, laid flat along the top of the wall at the level of the eaves; it carries the RAFTERS.

wall tie (a) Tie in a CAVITY WALL (see Figure). (b) Tie that secures the facing material to its backup wall.

wall tile See [TILE](#).

wallwasher A ceiling-mounted LUMINAIRE used to light the walls of a room.

WAN Abbreviation for WIDE AREA NETWORK.

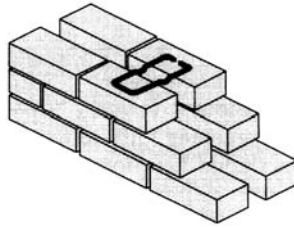

wall tie

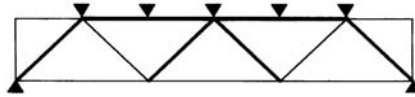

Warren truss

warble tone A tone whose frequency is continually varying in a regular manner within certain frequency limits.

Ward-Leonard control See [MOTOR-GENERATOR SET](#).

warmth As an acoustic quality, the LIVENESS of the bass, or fullness of bass tone relative to that of the mid-frequency tone.

warp (a) Distortion in the shape of a plane timber surface, usually due to MOISTURE MOVEMENT. (b) Yarn that is stretched lengthwise in the loom, and runs along the *length* of the fabric of a carpet, passing alternately under and over the WEFT.

warping Distortion from a plane surface, particularly in timber; it may be caused by careless seasoning.

Warren truss A STATICALLY DETERMINATE truss consisting of top and bottom chords connected only by diagonals without vertical members (see Figure), as distinct from a HOWE and a PRATT TRUSS. Some of the diagonals are in tension and some are in compression.

washer A ring placed under a nut or a bolt head. See also [SPRING WASHER](#) and [TAPERED WASHER](#).

washing soda Sodium carbonate (Na_2CO_3).

waste pipe The pipe that discharges liquid waste into the SOIL DRAIN.

waste water treatment *Primary treatment* involves screening, grit removal, sedimentation, sludge digestion or other means of sludge disposal. *Secondary treatment* involves primary treatment plus a biological process to remove organic matter. *Tertiary treatment* involves secondary treatment plus filtration and/or disinfection.

water, combined See [COMBINED WATER](#).

water balance The condition achieved in a HYDRONIC SYSTEM when the maximum quantity of fluid that can be delivered to each point of use is just sufficient to meet its heat transfer requirement at full load.

water-cement ratio The ratio of the amount of water, excluding that absorbed by the concrete aggregate, to the amount of cement in concrete or mortar. It has a determining influence on the strength of concrete and mortar. See [ABRAMS' LAW](#) and [MIX PROPORTIONS](#).

water closet (WC) A plumbing fixture used to receive human excrement, and to discharge it through a waste pipe, using water for conveyance. Hence a room containing a water closet.

water-cooled condenser A *heat sink* for a refrigeration system, in which coils containing the hot refrigerant gas are cooled by spraying with water in an air stream. The evaporation of some of the water adds to the cooling effect of the air.

water gauge A U-tube MANOMETER, filled with water.

water-glass A concentrated solution of *sodium* or *potassium silicate*. It is used for waterproofing brick, stone and concrete, and as a surface hardener for concrete floors.

water hammer A sudden, very high pressure in a pipe, often indicated by a loud noise, caused by stopping the flow of water too rapidly.

water heater, instantaneous A device in which the water is heated only as needed, as opposed to a *storage* water heater. When a hot-water tap is turned on, a high-powered (usually gas or electric) heater is applied to the pipe through which the water is flowing.

water heater, storage A device in which water is heated and stored for later use. A storage heater can therefore cope with a sudden large demand, better than an *instantaneous* heater. See also [OFF-PEAK WATER HEATER](#), [THERMOSIPHON](#) and [SOLAR WATER HEATER](#).

water level A simple instrument for setting out levels on a building site. It consists of a transparent tube filled with water, with the two ends held up. The level of the water in both is the same, if there are no air locks in the tube. See also [SPIRIT LEVEL](#).

water of capillarity Water held in CAPILLARY ACTION in the soil *above* the water table.

water paint Any paint that can be thinned with water. The term includes oil-bound or emulsion paints, whose binder is insoluble in water, but which can be thinned with water.

waterproof ing See [SURFACE WATERPROOFER](#) and [INTEGRAL WATERPROOFING](#).

water seal The seal in the TRAP of a drain, which prevents odours from the sewer from entering the building.

water softener A material that removes the calcium and magnesium salts from HARD WATER, usually by an ion exchange. See [SCALE](#) and [ZEOLITE](#).

water stain (a) Water-soluble dye used for staining timber. See also [OIL STAIN](#) and [SPIRIT STAIN](#). (b) Discoloration on converted timber, caused by water.

water supply riser See [RISER](#) (c).

water table The level below which the ground is saturated with water.

water treatment The addition of chemicals to water to achieve control of corrosion, scale or harmful contaminants such as bacteria.

watt (W) The derived SI UNIT of power. One watt is dissipated by doing 1 joule of work for one second: that is, $1W=1Js$. In electricity $1W=1VA$. Named after J.Watt, the eighteenth-century inventor of the steam engine.

watt-hour (Wh) A unit of electrical energy. It is the energy delivered by 1 watt in 1 hour. It is customary to use kilowatt-hours; $1kWh=1000Wh=3.6 \times 10^6 \text{ JOULE}=3.6 \text{ MJ}$.

wattle-and-daub Infilling for the walls of HALF-TIMBERED houses, traditional in some parts of Europe, and widely used in the early colonial period in Australia. It consists of branches or thin laths (*wattles*) plastered with clay (*daub*).

wavelength The distance between successive maxima or minima in a periodic function (i.e. a regular wave).

wax stain A semi-transparent pigment dispersed in BEESWAX, thinned with turpentine.

WBG Abbreviation for WET-BULB GLOBE THERMOMETER INDEX.

WBT Abbreviation for WET-BULB TEMPERATURE.

WC Abbreviation for WATER CLOSET.

wear tests See [ABRASION](#).

weatherboard A long, thin board graduating in thickness from one edge to the other, used for WOOD SIDING. The thick end overlaps the thin portion of the board. Called *dapboard* in the USA.

weatherometer A machine for determining the weather-resisting properties of materials (such as paints and plastics) by cycles imitating as closely as possible natural weathering conditions. Most machines employ ultraviolet light, high or low temperatures, and moisture. The result is not as accurate as placing the samples on an exposed site for natural weathering; however, since the cycles are speeded up, the result is obtained very much more quickly. Like ABRASION testing machines, weatherometers are useful for comparing a new material with a similar material of known performance. Their reliability for predicting the performance of a completely new type of material is questionable.

weather-struck joint or weather joint A STRUCK JOINT for exterior work.

web (a) The vertical part of a JOIST. (b) The plate connecting the flanges of a PLATE GIRDER. (c) The RIB of a concrete T-beam. (d) See [WORLD WIDE WEB](#).

web Stiffener See [STIFFENER](#).

wedge theory A theory for the stability of a retaining wall, based on the weight of the wedge of soil which would slide forward if the wall failed. It was originally proposed by C.A.Coulomb in 1776 and revised by C.F.Jenkin in 1931.

weep hole A small hole left at the base of a retaining wall, cavity wall, window or curtain wall to allow accumulated condensation or other moisture to escape.

weft Yarn that runs across the *width* of a woven fabric, from edge to edge. It is made to pass over and under the WARP.

weigh batcher A batching plant for concrete in which all materials (except the water) are weighed.

weight The force resulting from the action of gravity upon a mass. In SI UNITS, weight is measured in newtons; in CGS and FPS UNITS, and in common language, *weight* and MASS are used interchangeably.

weighting statistical data Multiplying the data by a factor, or weight, if the data are of unequal reliability, and if the difference between their trustworthiness and importance can be properly assessed.

welded beam A large steel I-section, fabricated by welding from plates instead of *hot-rolling*. Essentially the same as *plate girder*.

welding Uniting two pieces of metal by raising the temperature of the metal surfaces to a plastic or molten condition, with or without the addition of additional welding metal, and with or without the addition of pressure. SOLDERING and BRAZING are carried out at a lower temperature. See ARC WELDING, [SHIELDED ARC WELDING](#), [ACETYLENE, FUSION WELDING](#) and [RESISTANCE WELDING](#).

well See [LIFT WELL](#).

wellpoint dewatering Draining a volume of soil to be excavated by sinking wellpoints around it, and pumping the water from them. Well-points are usually tubes, approximately 50mm (2in.) in diameter, which are jetted into the soil. The method is particularly suitable for soils that do not contain too much fine material, when it may be much cheaper than SHEET PILING. WPD can be assisted by ELECTRO-OSMOSIS.

Welsbach mantle An INCANDESCENT LAMP mantle composed of cotton impregnated with thorium and cerium oxide, invented by Welsbach in 1885 to improve the performance of *gas-light*.

wet-and-dry bulb thermometer A PSYCHROMETER, consisting of an ordinary thermometer (*dry-bulb thermometer*), which records air temperature (DRY-BULB TEMPERATURE) in the ordinary way; and another thermometer (WET-BULB THERMOMETER) whose bulb is wrapped in a damp wick dipping into water. The *wet-bulb temperature* is lower because of the cooling effect of the wick due to evaporation. Tables are provided that give the RELATIVE HUMIDITY in terms of the wet-bulb and the dry-bulb temperature. See also [ASSMAN PSYCHROMETER](#) and [WHIRLING PSYCHROMETER](#).

wet-bulb depression The difference between the DRY-BULB and the WET-BULB TEMPERATURES.

wet-bulb globe thermometer index (WBGT) Criterion for determining the COMFORT ZONE, evolved by Yaglou and Minard in 1957 for the control of heat casualties at military training centres in the USA. It takes into account the temperature and humidity of the air, and radiation from the Sun and the terrain, and it makes some allowance for wind speed. See [GLOBE THERMOMETER](#).

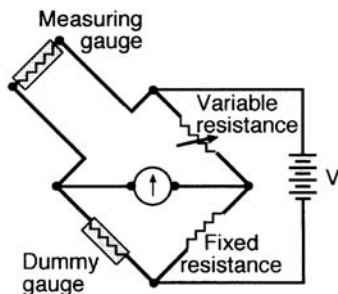

Wheatstone bridge

wet-bulb temperature (WBT) The temperature recorded by a WET-BULB THERMOMETER. It is lower than the DRY-BULB TEMPERATURE; the difference increases as the RELATIVE HUMIDITY decreases. The relative humidity is determined from a table.

wet-bulb thermometer A thermometer whose bulb is wrapped in a damp wick dipping into water.

wet construction Conventional construction, which relies for jointing on wet concrete, mortar or plaster; as opposed to DRY CONSTRUCTION.

wet mix A concrete mix containing too much water. To the untrained observer it may look like a better concrete than a correctly proportioned mix, and it is also easier to place and to finish; however, its strength is lower, and it may produce LAITANCE. See [ABRAMS' LAW](#).

wet rot A fungus disease in timber caused by excessive and continuous dampness. It results in decomposition of the fibres of the timber.

wetting agent A substance that lowers the surface tension of liquids, and thus facilitates the wetting of solid surfaces and the penetration of liquids into capillaries.

WF Abbreviation for WIDE-FLANGE SECTION.

WG Wire gauge.

Wh Abbreviation for WATT-HOUR.

Wheatstone bridge An apparatus for measuring electrical resistance by the zero method, comprising two parallel resistance branches, each branch consisting of two resistances in series (see Figure). It is employed in conjunction with THERMISTORS and ELECTRIC RESISTANCE STRAIN GAUGES.

whip A small hoist or crane.

whirling psychrometer A psychrometer in which the WET-AND-DRY-BULB THERMOMETERS are mounted on a handle, so that they can be rotated in the air to give an approximately standardised rate of ventilation.

whispering gallery A room with curved surfaces, which allows faint sounds, made at one part of the room, to be heard clearly at another part without the sound being audible throughout the room.

white ant See [TERMITE](#).

white cast iron CAST IRON in which all the carbon is in the form of IRON CARBIDE, as distinct from GREY CAST IRON.

white cement A pure white PORTLAND CEMENT. Since the grey colour of Portland cement comes from impurities, a white cement requires raw materials of low iron content, or firing of the clinker by a reducing flame. The resulting material is much more expensive than ordinary (grey) Portland cement. It is used for decorative surface finishes, and as the basis for the lighter COLOURED CEMENTS. See also [OFF-WHITE CEMENT](#).

white gold Gold alloyed with palladium, nickel or zinc.

white lead An opaque white pigment, used extensively as an undercoat for exterior paint, and for pottery glazes. Because it is poisonous (see [LITHOPONE](#) and [TITANIUM WHITE](#)) it is now rarely used for finishing coats. It consists of basic lead carbonate ($2\text{PbCO}_3 \cdot \text{Pb}(\text{OH})_2$).

white metal A general term covering alloys based on antimony, lead or tin, used to reduce friction.

white noise Broadband noise, which randomly varies in phase and intensity at each frequency, and which has equal energy per *proportional* bandwidth. See also [PINK NOISE](#).

white spirit A THINNER for oil paint, distilled from petroleum at 150 to 200°C. It is frequently used as a substitute for TURPENTINE.

whitewash A cheap finish for external walls formed by soaking QUICKLIME in an excess of water. A binder, such as casein, is sometimes added. Also called *limewash*.

whiting Crushed chalk (CaCO_3), probably the cheapest white pigment. Also called *Paris white*. It is used in distemper, putty, and as an extender for other pigments.

WI Abbreviation for WROUGHT IRON.

wide area network A network covering a much larger geographic area than a LOCAL AREA NETWORK.

wide-flange section A structural section whose cross-section resembles the letter H rather than the letter I. It is particularly used for columns, because it has a relatively high RADIUS OF GYRATION, both parallel and perpendicular to its web. Abbreviated *WF section*.

Wien's law The law relating the wave-length of the peak intensity of radiation from a hot body, to the temperature of the body:

$$\lambda_{\max} = \frac{2.88 \times 10^{-3}}{T} \text{ metre}$$

where λ_{\max} is the wavelength and T is the absolute temperature of the body in kelvins.

Williot-Mohr diagram A graphical method for determining the deflection of pinjointed trusses.

wind bracing Structural members, usually diagonal, specially designed to resist wind forces.

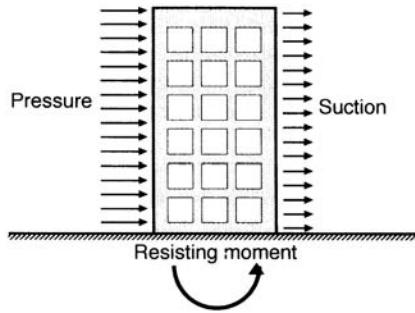

wind load

wind load The (positive or negative) force of the wind acting on a building. Wind applies (positive) pressure to the windward side of buildings, and (negative) suction to the leeward side (see Figure). From fluid mechanics and the density of the air, the horizontal wind pressure (in Pa) is approximately

$$p = 0.6v^2$$

where v is the wind velocity in m/s. The wind velocity increases with height, and it can be obtained from the empirical formula

$$\frac{v_1}{v_2} = \left(\frac{h_1}{h_2} \right)^{\frac{1}{7}}$$

See also [DAMPING OF STRUCTURAL VIBRATIONS](#).

window (a) See [CASEMENT WINDOW](#), [SASH WINDOW](#), [DEAD LIGHT](#), [SKYLIGHT](#) and [LANTERN](#). (b) In computing, an area of a screen defined so as to allow an application to be processed independently of other applications.

window glass See [SHEET GLASS](#).

windowing In computing, creating [WINDOWS](#) (b).

window shutters See [SHUTTERS](#).

window wall An outside wall consisting largely of glass.

window weights Balance weights used in [SASH WINDOWS](#).

wind pressure and wind suction The wind blowing against a building exerts positive pressure on a windward vertical face and negative pressure, or *suction*, on a leeward vertical face. A flat roof is invariably subject to suction, irrespective of the direction of the wind. A sloping roof also is always subject to suction if the wind blows parallel to the ridge. If it blows perpendicular to the ridge, then the windward side is subject to positive wind pressure only if the slope of the roof is more than 30° (see Figure). See also [WIND LOAD](#).

wind rose A graphical method of depicting the frequency of monthly prevailing wind direction for a particular location.

wind scoop Ventilation device with large intake openings, used to provide a controlled air supply by capturing wind above roof level and channelling air movement into the space.

wind shadow Low-pressure area on the leeward side of an object.

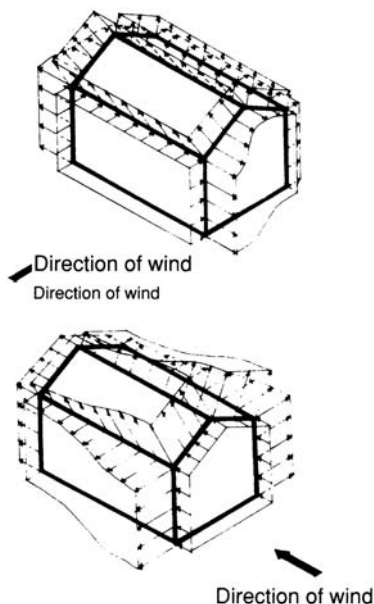

wind pressure

wind tunnel An apparatus for AERO-DYNAMICS investigations on MODELS to study: ventilation inside a building; the wind pressure acting on a building; the vibrations produced by wind in a tall, flexible structure; the eddies in circular courtyards, etc. See also [ANEMOMETER](#), [BOUNDARY LAYER WIND TUNNEL](#) and [SMOKE TUNNEL](#).

windward On the side exposed to the wind; the opposite of *leeward*.

wing Part of a building projecting from one side of the main body.

wirecut brick Bricks shaped by extrusion and then cut to length by a set of wires. They are less dense than PRESSED BRICKS, and they have no FROG.

wired glass Safety glass containing thin wire reinforcement.

wireframe model In computer graphics, a three-dimensional display consisting of lines; as opposed to SURFACE MODELS and SOLID MODELS.

wire rope See [SUSPENSION CABLE](#) and [TENDON](#).

withdrawal load The resistance of a nail to being pulled out after driving.

withe Same as WYTHE.

wood alcohol Same as METHANOL.

wooden lath See [LATH](#).

wood preservative A substance that inhibits decay, infection, or attack by fungi, insects, or marine borers in timber.

wood siding Wall cladding for frame building consisting of wooden boards. Called *weatherboard* in England and Australia, and *dapboard* in the USA.

wood veneer Thin layer of wood of uniform thickness, used as a facing. The object may be to strengthen the wood by varying the direction of the grain (as in PLYWOOD) or to attach a decorative surface to a less attractive timber. Decorative veneers are made as thin as possible. They may be *sliced*, i.e. cut transversely, or *rotary*, i.e. cut on a lathe. See also [MATCHED VENEER](#).

wool See [MINERAL WOOL](#); see also [CARPET](#).

work The product of an applied force and the distance moved by that force. The SI unit for work is the JOULE (J). See also [ENERGY](#).

workability of concrete The ability of freshly mixed concrete or mortar to flow, and fill the formwork without voids. Also called *consistency*. It is commonly measured by the SLUMP TEST, the BALL TEST, or the COMPACTING FACTOR TEST.

work hardening Increasing the strength of metal by COLD-WORKING. It is the normal method for producing cables for suspension structures and tendons for prestressed concrete by drawing high-carbon steel wires through a die.

working drawings Drawings containing the information needed for construction. See also [SHOP DRAWINGS](#).

working load The normal dead, live, wind and earthquake load that a structure is required to support in service. It is generally specified in building codes; also called *service load*. In limit design the working load is multiplied by a load factor to give the ultimate load at which the building is designed to fail.

working load design Design based on the working loads. The stresses in the structure under these loads may not exceed the MAXIMUM PERMISSIBLE STRESSES.

working plane The real or imaginary surface at which work is normally done, and at which consequently the illumination is specified and measured. This plane is normally horizontal, and 850mm or 2ft 9in. above the floor.

working stress The MAXIMUM PERMISSIBLE STRESS under the action of the working loads, specified in the building code.

working stress design See [WORKING LOAD DESIGN](#).

workplace (a) The place of employment. (b) The location of a specific task.

workplane Same as WORKING PLANE.

workspace A work area occupied by one or more employees, exclusive of support spaces.

workstation (a) Usually a desk or more complex furniture arrangement, complete with computers and communications facilities and, sometimes, local lighting and other services. (b) A *desktop computer*, usually connected to a network.

World Wide Web (WWW) A virtual network operating over the *Internet*, allowing multimedia interaction.

worm-gear drive A *direct* lift drive connected to the sheave or drum through worm gearing.

wow Low-frequency (<10Hz) FLUTTER.

WP Word processor or word processing.

wrap of suspension rope (a) *Single*: a roping arrangement where the suspension ropes joining the lift car and counterweight pass over the drive SHEAVE once. (b) *Double*: a roping arrangement where, in order to increase the traction, the suspension ropes joining the lift car and counterweight pass over the drive SHEAVE twice.

write-protected In computing, the protection of data so that it cannot be overwritten.

written-down value The value of an asset after depreciation.

wrot timber Same as DRESSED TIMBER.

wrought iron Iron with less than 0.1 per cent of carbon. It is one of the two traditional forms of iron, the other being CAST IRON. Steel is intermediate between the two, but prior to the invention of the BESSEMER PROCESS it could be produced only at great expense. Wrought iron is soft, easily worked, and rusts less than steel.

wrought timber Same as DRESSED TIMBER.

WWW Abbreviation for WORLD WIDE WEB.

wye connection Same as STAR CONNECTION, especially in the USA.

wythe (a) One leaf of a cavity wall. (b) A half-brick wall. Also spelt *withe*.

X

xenon lamp An electric DISCHARGE LAMP employing a short-length arc in xenon gas, and replacing the CARBON ARC LAMP in cine projectors and similar applications.

X-rays Electromagnetic RADIATION of very short wavelength; also called *Röntgen rays* after W.J.K.von Röntgen, the German physicist who discovered them in 1895. They have the capacity to penetrate materials opaque to light, and are employed in *radiography* to produce photographic pictures of certain invisible features. Apart from the important medical applications, they can be used for non-destructive testing, e.g. to show up defects in WELDING. GAMMA RAYS are similar rays produced by radioactive materials.

xyz space Three-dimensional space defined orthographically by x -, y - and z -axes.

Y

yard A traditional measure of length, equal to 3ft=0.9144m.

Y-connection Same as STAR CONNECTION, especially in the USA.

yield-line theory A theory for the ULTIMATE STRENGTH of reinforced concrete slabs, proposed by the Danish engineer K.W.Johansen in 1943. It is based on the observation that concrete slabs fail following the formation of a number of large cracks, just sufficient to turn the statically indeterminate slab into a MECHANISM. Their failing loads can therefore be derived from considerations of LIMIT DESIGN.

yield stress The lowest stress at which STRAIN increases without increase in STRESS. It shows up as a horizontal line on a STRESS-STRAIN DIAGRAM. Only a few materials (including structural steel) delineates the boundary between the exhibit a marked yield point, which elastic and plastic state. For other materials the transition from elastic to plastic behaviour is gradual, and a PROOF STRESS is defined as an artificial boundary. Also called *yield point*.

YMCK Abbreviation for Yellow, Magenta, Cyan, black. See [CMYK](#).

Young's modulus Same as MODULUS OF ELASTICITY.

Z

Z Symbol for the SECTION MODULUS in Britain and Australia. (The symbol *S* is used in the USA.)

zenith The highest point in the sky, immediately overhead at the time of an observation. Its altitude is 90°.

zeolites Alumino-silicates of light metals, used in WATER SOFTENERS.

zero energy band The part of the control cycle of some air conditioning systems when neither supplementary heating nor cooling is provided because the indoor temperature falls within a range or band considered acceptable. An energy conservation measure. Also called *dead band*.

zinc A white metallic element, which is highly resistant to atmospheric corrosion, and is consequently used to protect steel by GALVANISING or SHERARDISING. It is one of the constituents of BRASS. Its chemical symbol is Zn, its atomic number is 30, its valency is 2, its atomic weight is 65.38, its specific gravity is 7.14, and its melting point is 419°C.

Zincalume Trade name for a protective treatment on steel sheet, similar to GALVANISING, but using an alloy of zinc and aluminium instead of zinc alone.

zinc coating See GALVANISING.

zinc plating Applying a protective layer of zinc to steel items by electroplating. The zinc layer is thinner (and therefore less effective) than GALVANISING, but the finish is smoother, and it does not interfere with the fit of nuts and bolts as galvanising does.

zinc white Zinc oxide (ZnO), a permanent, non-poisonous white pigment. Also called *Chinese white*.

Zn Chemical symbol for *zinc*.

zonal flux The luminous flux emitted through cones of either constant solid angles (Russell angles) or plane angles; used in the calculation of UTILISATION FACTORS for the LUMEN METHOD.

zone (a) A number of floors, usually adjacent, in a building served by a GROUP, or groups, of LIFTS. (b) A defined separate part of an air-conditioned space that is subject to heat gains or losses of different magnitude from those occurring at the same time in other parts of the space, not necessarily defined by physical

boundaries. It is usual to arrange the control system to control conditions separately in each zone. See also [ZONING](#).

zone of protection In a LIGHTNING PROTECTION SYSTEM, the space considered to be protected from a lightning strike.

zoning The allocation of land use by a statutory authority for planning purposes.

zoom In computer graphics, a facility for increasing or decreasing the size of an image without redefining the parameters of the elements. Carried out either by specifying the zoom factor or by defining the area to occupy the screen.

Z-section A metal section shaped

Z-tie A Z-shaped WALL TIE.