

colors

architecture in detail

R O C K P O R T



*oscar riera ojeda and james mccown
photography by paul warchol*

colors

colors

architecture in detail

edited by oscar riera ojeda
written by james mccown
photography by paul warchol



© 2004 by Rockport Publishers, Inc.
First paperback edition published 2006.

All rights reserved. No part of this book may be reproduced in any form without written permission of the copyright owners. All images in this book have been reproduced with the knowledge of and prior consent of the artists concerned, and no responsibility is accepted by producer, publisher, or printer for any infringement of copyright or otherwise arising from the contents of this publication. Every effort has been made to ensure that credits accurately comply with information supplied.

Library of Congress Cataloging-in-Publication data available.

ISBN-10: 1-59253-287-X
ISBN-13: 978-1-59253-287-2

First published in the United States of America by Rockport Publishers, Inc., a member of the Quayside Publishing Group
33 Commercial Street
Gloucester, Massachusetts 01930-5089
Telephone: (978) 282-9590
Fax: (978) 283-2742
www.rockpub.com

design and layout by oscar riera ojeda

Manufactured in China

Cover photograph: Toshiko Mori Architect, Issey Miyake Pleats Please, New York, 1998. Previous page: Steven Holl Architects, D.E. Shaw & Co. Offices, New York, 1992. This spread: Gisela Stromeier Design, Club Incognito, Zurich, 1998. Contents page: Gabellini Associates, Ultimo Boutique, San Francisco, 1997.





rockport publishers

contents

introduction 8

white 14 black 38 red 58 blue 76 yellow 92 brown 110 gray 134 green 156 polychrome 172

acknowledgments & dedications 192



introduction

by james mccown

Hundreds of towns and cities throughout the United States have ordinances controlling the exterior color of houses and buildings. In a wealthy Massachusetts town in late 2003, a resident ran afoul of one such ordinance by painting her house a bright red/orange. The woman's argument that the chosen color had been part of the lively palette of American Georgian architecture of the eighteenth century did little good. Those who rule over such things were not swayed. In order to preserve the "quaintness" of the town, white, tan, and beige were the orders of the day. The subtle tyranny of chromatic "good taste" had triumphed again. ■ Alone among the arts, architecture invites collective decision making, and one of the key decisions is always color. The old legal aphorism, "Your right to swing your fist ends at my chin" could be altered to something like, "Your right to paint your house chartreuse ends at my cornea." We all have to live with the colors other people choose, and so the prevailing wisdom errs on the side of bland and conventional. ■ And yet color matters. It matters in nature, it matters in history, it matters greatly in the art of building. Eric de Maré discusses the color red: "Red is the most positive of colours, the most violent, aggressive and exciting. It attracts the eye more than any other. It was the first colour to have been given a name in early languages, and it has been used more often than any other in primitive art . . . [it] penetrates mists better than other colours. It is also associated with warfare; the battle flags of the Roman legions were red, and we had scarlet soldiers' tunics for centuries. It is also associated with revolutionary ardor, as in the Red Flag, and even the

excess and the attendant extravagant use of color. *Circumcludere albo esse sanctus*. To be fully surrounded by white is to be holy. ■ The connection of white with purity in architecture has a long history. Le Corbusier had long infused white with a quasi-religious importance, naming one of his seminal written works *Quand les Cathédrales Étaient Blanches (When the Cathedrals Were White)*. In 1925, he wrote of dismissing exotic colors in favor of a blank nothingness: "What shimmering silks, what fancy, glittering marbles, what opulent bronzes and golds! What fashionable blacks, what striking vermilion, what silver lamés from Byzantium and the Orient! Enough. Such stuff founders in a narcotic haze. Let's have done with it . . . It is time to crusade for whitewash and Diogenes."² ■ Le Corbusier's frequent trips to the Mediterranean [figure 3], had also convinced him of the superiority of white, as described by Stephen Gardiner: "Whitewash was . . . a visual bond between the buildings of the island villages; like the bare essentials that hold people together, whitewash was a bond that held aesthetics together . . . Thus white became the bond between Le Corbusier's early buildings. In consequence, it became the bond between all the European architectural modern movements of the 1920s and 1930s . . ."³ ■ Author Mark Wigley, in his 1995 book *White Walls, Designer Dresses*, ascribes to Le Corbusier the notion that the "whole moral, ethical, functional and technical superiority of architecture is seen to hang on the whiteness of its surfaces."⁴ And yet, Wigley argues, to imbue white with a sacredness is to indulge in a "very particular fantasy. It is the mark of a certain desire, the

the color imperative

kindly Salvation Army knows the rousing force of its strange slogan: "Blood and Fire"¹ [figure 1, pages 72–73]. ■ Despite the historic primacy of color, a certain achromatic chic has a powerful cultural hold. In the early 1990s, there seemed to be a consensus among editors of design magazines, they who are famous for eschewing any sartorial expression save black. The previous decade, they decreed, had been bacchanal of style excess, and part of that excess had been expressed in color. The Reagan years had given us bright red dresses favored by the First Lady, the lurid fuchsia ball gowns worn by socialites, uncountable bolts of pastel chintz meant to recall some mythical past in English baronial homes. A "return to simplicity" was called for, and fashion designers such as Calvin Klein, and Jil Sander built flagship stores that were studies in pristine white geometry [figure 2, pages 18–19]. Against this vast nullity, simple clothes and housewares in the most basic noncolors—black, gray, dark brown—were laid out in sparse displays meant to evoke Zen Buddhism and other Eastern religions. The subliminal message: "Buy my \$3,000 bedspread and be cleansed." Purge yourself of the

seemingly innocuous calling card of an unspoken obsession." Far from being "above fashion," as so many achromatic devotees and their architects fancy themselves to be, they in their white worlds are in fact the very epitome of fashion. Corbu becomes Calvin, and vice versa. ■ As if to anticipate the Bauhaus and its allied movements, a certain reductive approach to architectural color held sway in Europe, beginning in the seventeenth century with the advent of various styles that would fall under the broad rubric of neoclassicism. In the Greek Revival period, white held a particular iconic power, nowhere more so than in the American South. Here again, a white building was imbued with a certain mystic power, but in this case on behalf of a make-believe aristocracy that constructed a fictional attachment to antiquity. Gamble discusses this power architectural iconography: "Classicism, or at least their version of it, [was] the predominate architectural theme of the antebellum South. But the houses built were seldom academic representations of neoclassicism, with correctly proportioned temple-type façades appropriately adorned with entablature and pediment . . . the houses

were large and white-painted, so that in this crude, semi-frontier land of wide fields and spreading pinewoods they seemed very imposing."⁵ ■ Decades later, as a new century approached, Daniel Burnham and all of the other grandees of American architecture created for the 1893 Columbian Exhibition in Chicago the White City, an impossibly grand assemblage of classical buildings that seemed to herald the century of American power and confidence. ■ However appealing this white-on-white view of architectural classicism might have been, it had no basis in classical fact. The Greeks and Romans were effusive colorists of their buildings. The notion of pure white marble set against an inky blue Aegean Sea is largely a figment of the eighteenth-, nineteenth- and twentieth-century imagination. Neoclassicism had, particularly in England, flourished in the wake of James Stuart and Nicholas Revett's Grecian travels and their subsequent publishing of *Antiquities of Athens* in 1762. More than two thousand years had neutralized any color on the Acropolis and in other sites, and it was assumed that the ruins represented what had existed in the Golden Age. ■ This hegemony began to give way only as research by the *Academie des Beaux-Arts* yielded clues of the reds, blues and golds that had once adorned buildings like the Parthenon [figure 4]. As Van Zanten states: "With their discovery of this world of transient and immediate adornment, the students were coming to see [academie Secretaire] Quatremere's orders as the mere dry bones of a dead architecture, bleached white in the Mediterranean sun."⁶ Despite the wide knowledge of classical

■ In *Aratra Pentelici*, Ruskin laid his vision of color, or lack thereof, as the source of human perdition: "Colours have been the sign and stimulus of the most furious and fatal passions that have rent the nations; blue against green, in the decline of the Roman Empire; black against white in that of Florence; red against white, the wars of the royal houses of England; and at this moment, red against white, the contest of anarchy and loyalty in all the world." For Ruskin and his Anglican contemporaries, brilliant coloration in buildings—particularly as seen in the stained glass of Gothic cathedrals [figure 5] and in the extravagant tile and terra cotta decorations of Venice—was meant to be an early taste of paradise, as in St. John the Divine's description of the New Jerusalem: "And the building of the wall of it was jasper, and the city was pure gold, like unto clear glass. And the foundations of the wall of the city were garnished in all manner of precious stones. The first foundation was jasper; the second, sapphire; the third, a chalcedony; the fourth, an emerald . . . And the twelve gates were twelve pearls . . ." (New Testament) ■ While Ruskin was passionately advocating for color on moral and religious grounds and influencing American architecture [figure 6], another Victorian was laying out a prescient color scheme for one of the era's most important buildings, Joseph Paxton's Crystal Palace for the Great Exhibition of 1851 in London. Like the buildings of the ancients, this seminal glass and iron structure in Hyde Park is generally imagined to have been pure white. But closer inspection would have revealed an interesting choice of colors by architect

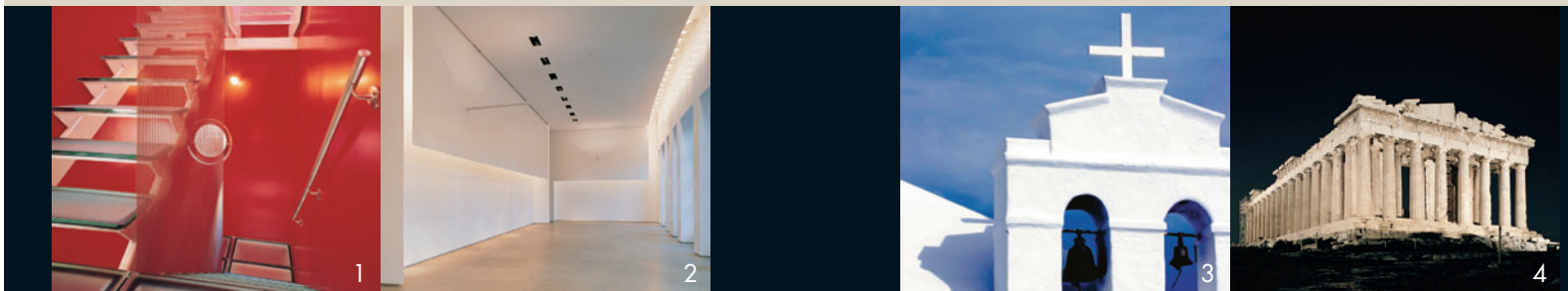

polychromy, the Bleached White Temple as architecture's most primal, essential expression continued to have tremendous cultural power—witness the mid-1980s Calvin Klein Adonis propped against an alabaster column in his equally blinding-white underwear. ■ John Ruskin's ideas about color were the opposite of those of aficionados of chromatic vacuity. This eminent Victorian saw multi-hued building as nothing less than the symbol of the divinely ordained natural order of things. Far from the adjectives like "pure, pristine, silent and essential" so regularly applied to it, he thought of achromatic architecture as a sign of decadence. As Lauren Weingarden writes: "In *The Seven Lamps of Architecture* and *The Stones of Venice*, Ruskin viewed medieval building practices as the direct expression of people living in harmony with nature and, in turn, with God. As a result, he assigned to polychromy symbolic functions representing organic processes . . . Since Ruskin considered the white classical-revival style of his own time a sign of moral corruption and artistic decay, he asserted that all authentic 'living' schools of architecture 'love color.'"⁷

and designer Owen Jones, charged with the task of "decorating" the building. Braham explains: "The exterior of the iron structure was painted in blue and white strips, while the interior was painted with carefully separated and proportioned strips of red, yellow and blue on a white field . . . In a manner similar to the 'dynamic' coloring later proposed by . . . Le Corbusier, Jones placed the colors according to precise formal properties: 'blue, which retires, on the concave surfaces; yellow, which advances, on the convex; and red, the colour of the middle distance, on the horizontal planes.'⁸ ■ Almost a century later, Siegfried Giedion, chronicler of the modern age of architecture, acknowledged how predictive the work had been: "[Jones] visualizes color as components of planes, not as coloring for illusionistic purposes. He seeks a return to elementary colors: 'Use Primary colors—pure blue, red, yellow, and use them in architecture for inherent spatial interaction; forms and planes for their advancing and receding value.' It is as if Le Corbusier were taking one through a building to make clear the function of color . . . The building is not

decorated with color, but built of it."⁹ ■ Anyone doubting the prescience of Jones's work need only look at the architectural drawings of Theo van Doesburg, so familiar as to serve almost as a logotype for modernism itself. Spaces are expressed as interlocking planes, painted in the primary colors of red, blue and yellow, a color triumvirate that van Doesburg shared with Mondrian and other artists in the DeStijl and allied modernist movements. ■ With the tendency toward a glorification of white, in certain quarters of the modern movement, color was an act of revolutionary ardor. A 1919 issue of *Die Bauwelt* read: "Color! If there is anything that typifies today's educated philistine, it is his fear of color . . . Colorlessness is the mark of education, white like the Europeans' skin! Civilized people of our climes look down on chromatic art and chromatic architecture . . . Where European-ness [sic] ends, that's where the beauty of the world begins."¹⁰ ■ German artist Josef Albers was one of the leading theorists of color in the twentieth century. Rasmussen discusses Albers' ideas about room color: ". . . color can be used to emphasize not only what is large and what is small but also what is up and what is down. The floor [Albers] says, like the earth we walk on, should give an impression of gravity. Therefore it should have the gray or brown tones of clay or rocky ground. Walls, on the other hand, should have more color, like flowering shrubs and trees and everything that rises about the solid earth. And, finally, the ceiling should be light and airy, in tones of white or delicate shades of pink and blue, like the sky over our heads.

the 1970s, ubiquitous browns and oranges, speaking to a nascent environmental sensibility; the campy pastels of the 1980s as epitomized by turquoise stucco and pink keystones; and of course the aforementioned sacred whites of the 1990s. ■ Michael Graves and James Stirling were two of the most prolific architectural colorists of the post-modern era. Graves explains his rationale: "One can think of the meanings ascribed to color as being derived primarily from associations found in nature . . . What one might call normal associations of color and material, cream or ranges of white for limestone, travertine, etc., ranges of green for the general landscape, blue for sky, and so on. It is within this deliberately simple range that we start to identify the placement of such associative colors and that of form itself."¹³ ■ Riley goes on to discuss Stirling's Sackler Museum at Harvard University: ". . . the radical color accents of the late James Stirling's buildings suggest the daunting wing of Postmodern poetics . . . One indication of the problematic twist Stirling gave to color is the sheer number of names critics have given to the tone he chose for the railings of the Sackler Museum . . . [Paul] Goldberger, in addition to 'garish' and 'electric,' cites an acquaintance who calls it 'Kermit the Frog green,' while his colleague James Markham describes its 'jungle-like glow.' . . . Wolf von Eckardt in *Time* complained . . . of 'bilious green,' and Manuela Hoelterhoff of *The Wall Street Journal* described the . . . 'poison green' railings of the Sackler."¹⁴ ■ As equally controversial as Stirling's color choices was Renzo Piano's exterior palette for the Centre Pompidou in Paris, completed



It would give a feeling of insecurity, [Albers] claims, to walk on pink or blue floors, and we would feel the ceiling as a heavy load weighing us down if it were painted a dark color."¹¹ ■ The late architect John Hejduk built on the work of the early modernists by assigning specific colors to rooms based on their functions: "All rooms have colored exteriors . . . Thus, looking from outside the blue room denotes water and bathrooms; the yellow room sun, energy and the kitchen; the green room represents grass, nourishment and dining; the red element indicates warmth, chimney and fireplace; black is for night and the bedrooms [figure 7, pages 54–55]; brown for earth and the living room; gray indicates the library 'because when you read you're in the twilight between reality and non-reality, imagination.'"¹² ■ Given the vagaries of fashions, color now appears more associated with specific decades than with domestic function. Witness the bold primary colors of the 1950s, influenced by the abstract impressionist painters of the day; the day-glo hues of the 1960s, beholden to the Pop Art movement; the earth tones of

in 1976. "The story of the Pompidou Center's audacious blue and red 'pipes' offers a parable of contemporary architectural colorism. Piano, hell-bent on shocking the Parisian conservatives, spent a year working out the color scheme of the Center . . . The initial reasoning behind the powerful color choices for the Center involved the standard code for building engineers, by which, for example, air conditioning ducts in building plans are rendered in blue and electrical structures are depicted in red and yellow. Piano started with the code and proceeded to break it, pushing colorism further and making up his own associations when he found that the set language was too constricting."¹⁵ ■ Examples in this book show as equally inventive color approaches being used by leading architects today. At Simmons Hall at MIT [figure 8, pages 174–177], Steven Holl took an original structural engineer's diagram of the façade that showed areas of highest stress in red, areas of lowest stress in blue, and those in between appearing in orange and yellow. He used this schema to map out the coloration of the building's façade, which ends up recalling not only the effusive

colors of the Pompidou but also the work of the early masters like van Doesburg and Gerrit Rietveld. ■ The Mondrianesque notion of spare, reductive planes of white defined and regulated by black lines and punctuated with bright colors is interpreted by Peter Marino for his Chanel stores in Paris and New York [figure 9, pages 42–47]. Marino seems to take this language out of the two dimensions, with the stores' black metal railings assuming a sculptural appearance while allowing for bright colors that seem to be all the more powerful against this dichromatic background.

■ Sometimes the most “obvious” color choices are the most compelling. A design by LOT/EK for the Management Artist Organization in New York [figure 10, pages 82–83], features a highly polished resin floor in what the architects describe as “Mediterranean blue.” The reflective surface picks up the minor imperfections in the floor’s surface, and combined with the corrugated steel partitions evokes an image of a container ship on the high seas. For the Joop! showroom in New York by Baratloo-Balch Architects [figure 11], the low-ceiling entry is a bright red cube that acts almost like a telescope, focusing attention on the expansive white main space and the verdure of Bryant Park beyond. ■ With her Museum for African Art in Manhattan [figure 12, pages 102–105], Architect Maya Lin “challenged the white-box modern orthodoxy of SoHo’s gallery world,”¹⁶ according to *Progressive Architecture*. Visitors first enter and descend to the basement in a dark stairwell. They then proceed to a sun-lit space that is painted no less than five different shades of yellow, each

Notes

1. Enid Verity, *Color Observed* (New York: Van Nostrand Reinhold, 1980), 117. ■ 2. Le Corbusier, “The Decorative Art of Today,” in *Essential le Corbusier: L’Esprit Nouveau Articles*, trans. J. Dunnett (Oxford Press, 1998), 135. ■ 3. Quoted in Mark Wigley, *White Walls, Designer Dresses: The Fashioning of Modern Architecture* (Cambridge, MA: MIT Press, 1995), xvii. ■ 4. Wigley, xvi. ■ 5. Robert Gamble, “The White-Column Tradition: Classical Architecture and the Southern Mystique” in *Southern Humanities Review*, Special Edition, 1977. ■ 6. David Van Zanten, “Architectural Polychromy: Life in Architecture,” in *The Beaux-Arts and Nineteenth-Century French Architecture*, ed. Robin Middleton (Cambridge, MA: MIT Press, 1982), 197. ■ 7. Winterthur Portfolio, Vol. V, 1985, 244. ■ 8. William W. Braham, *Modern Color, Modern Architecture* (Hants, England: Ashgate Publishing Limited, 2002), 70. ■ 9. Quoted in Braham, 71. ■ 10. Quoted in Martina Duttmann, Friedrich Schmuck and Johannes Uhl, *Color in Townscape* (London: The Architectural Press, 1981), 21. ■ 11. Steen Eiler Rasmussen, *Experiencing Architecture* (Cambridge, MA: The MIT Press, 1959), 216. ■ 12. Beverly Russell, “Color: The Architectural Search for Joy” in *House & Garden*, March, 1976, 90. ■ 13. Quoted in Charles A. Riley II, *Color Codes* (Hanover: University Press of New England, 1995), 216. ■ 14. Riley, 217. ■ 15. Riley, 208. ■ 16. Mark Alden Branch, “Maya Lin After the Wall” in *Progressive Architecture*, August, 1994, 62. ■ 17. Quoted in Solon, Leon V., *Polychromy: Architectural and Structural Theory and Practice* (New York: F.W. Dodge Corporation, 1924), ix.

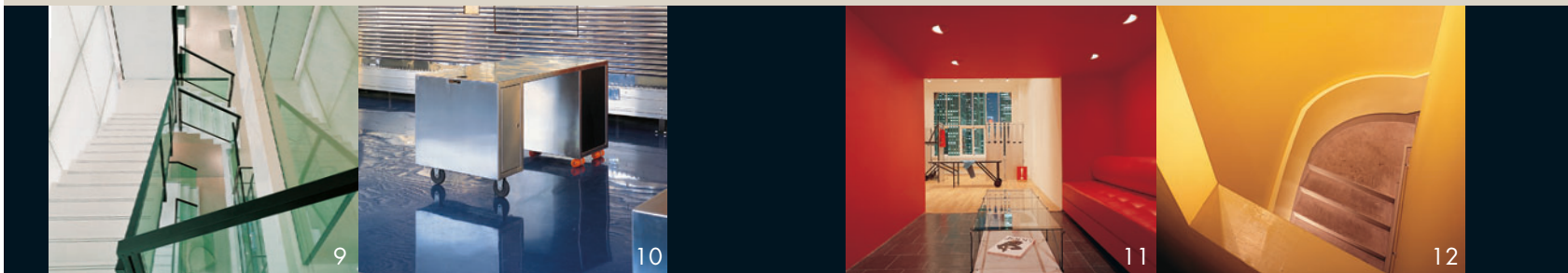

progressively lighter as the eye ascends. This not only emphasizes the stair’s outwardly spiraling form, but also acts as a metaphor for rising, like a bright solar beacon of cultural understanding.

■ Color is like oxygen. It is a force of nature. It is the neon signs of Las Vegas, the brilliant pink stucco walls of Mexico, the luscious red roof of the Duomo in Florence, the shimmering blue tiles of a mosque in Jerusalem. In its brilliance, color defies any attempts to legislate or stylize it away. ■ The august Boston architect Ralph Adams Cram once wrote: “. . . it was from the East that the revelation came of the powers of color as a spiritual force through the emotion it engenders.”¹⁷ ■ And so in this spirit, we read the description by the George Rawlinson of the tower-like walls of Ecbatana, located in present-day Iran: “Thus the building rose up in stripes of varied colours, arranged almost as Nature’s cunning arranges the hues of the rainbow—tones of red coming first, succeeded by a bright stripe of yellow, the yellow being followed by blue. Above this the glowing silvery summit melted into the bright sheen of the sky.”¹⁸

- 18. Quoted in Van Zanten, David, *The Architectural Polychromy of the 1830’s* (New York and London: Garland Publishing, 1977), 5.

Image Captions

1. Studio Petrarca, Reade Street Townhouse, New York, 2001. ■ 2. Gabellini Associates, Jil Sander Showroom, Milan, 2000. ■ 3. Greek church, Eastern Mediterranean, Corbis (stock photo), 2001. ■ 4. The Parthenon, Athens, 1988. ■ 5. Gothic cathedral, France, Corbis (stock photo), 2001. ■ 6. Memorial Hall, Harvard University, Cambridge, James McCown, 2001. ■ 7. Gabellini Associates, Park Avenue Apartment, New York, 1998. ■ 8. Simmons Hall, Steven Holl Architects, Cambridge, 2003. ■ 9. Peter Marino + Assoc Architects, Chanel Store, Osaka, 2001. ■ 10. LOT/EK, Management Artist Organization, New York, 2000. ■ 11. Joop! Jeans USA Showroom, Baratloo-Balch Architects, New York, 1995. ■ 12. Maya Lin Studio, Museum for African Art, New York, 1993. ■ 13. Sam Trimble Architect, Roberts Apartment, New York, 2003.



white

White is the great backdrop, the nullity against which all else stands out. ■ The modernists invested white with an almost mystical power. ■ One of Le Corbusier's great treatises was entitled *When the Cathedrals Were White*. ■ Kasimir Malevich's messianic description of his seminal painting *White on White*: "I have come out into the white. Follow me, comrade aviators! I have set up the semaphores of Suprematism. I have overcome the lining of the colored sky." ■ Gilbert Keith Chesterton: "White is not a mere absence of color. It is a shining and affirmative thing, as fierce as red, as definite as black."





Previous spread: Tai Soo Kim Partners, American Embassy, Tunisia, 2002. This spread: Asymptote, Carlos Miele Store, New York, 2003. This store for a Brazilian-born designer has clear influences of the white free-form concrete architecture of the tropical modernist Oscar Niemeyer. In this instance, white does not serve the purpose of neutrality—it takes on a very active role by casting and reflecting subtle shadows that allow the sculptural forms to define and enliven the space.

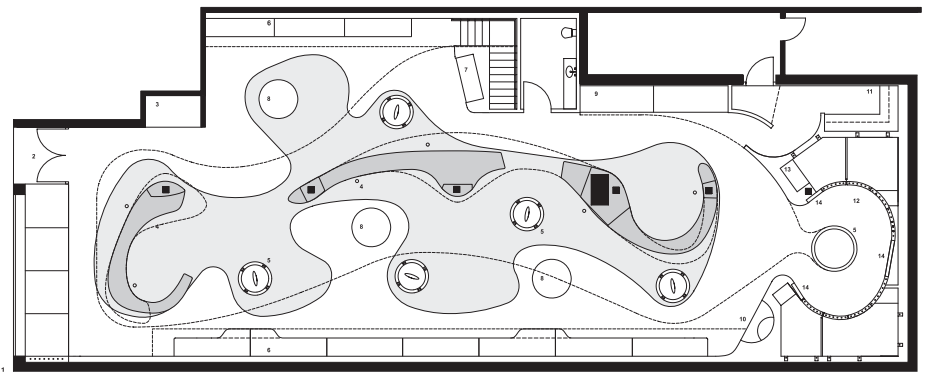

floor plan

- 1 west 14th street
- 2 entry
- 3 art niche
- 4 "altar"
- 5 light ring
- 6 clothes rack
- 7 display niche
- 8 display table
- 9 backlit clothing
- 10 mirror/video piece
- 11 cashier
- 12 changing area
- 13 bench
- 14 mirror

section

- 1 track light
- 2 transformer
- 3 staggered fluorescent light
- 4 10mm stainless steel rod
- 5 wall mounted steel tube support arms
- 6 continuous steel plate at underside of steel support members
- 7 removable access panel
- 8 stainless steel hang bar
- 9 customized stainless steel hanger
- 10 roll formed metal shell

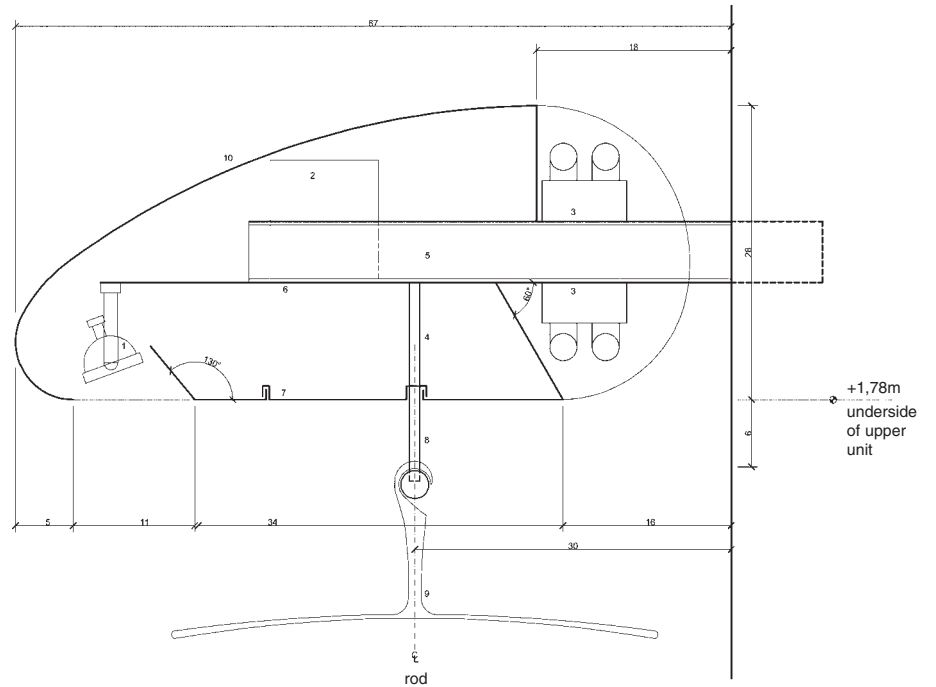

detail section @ upper hanging unit





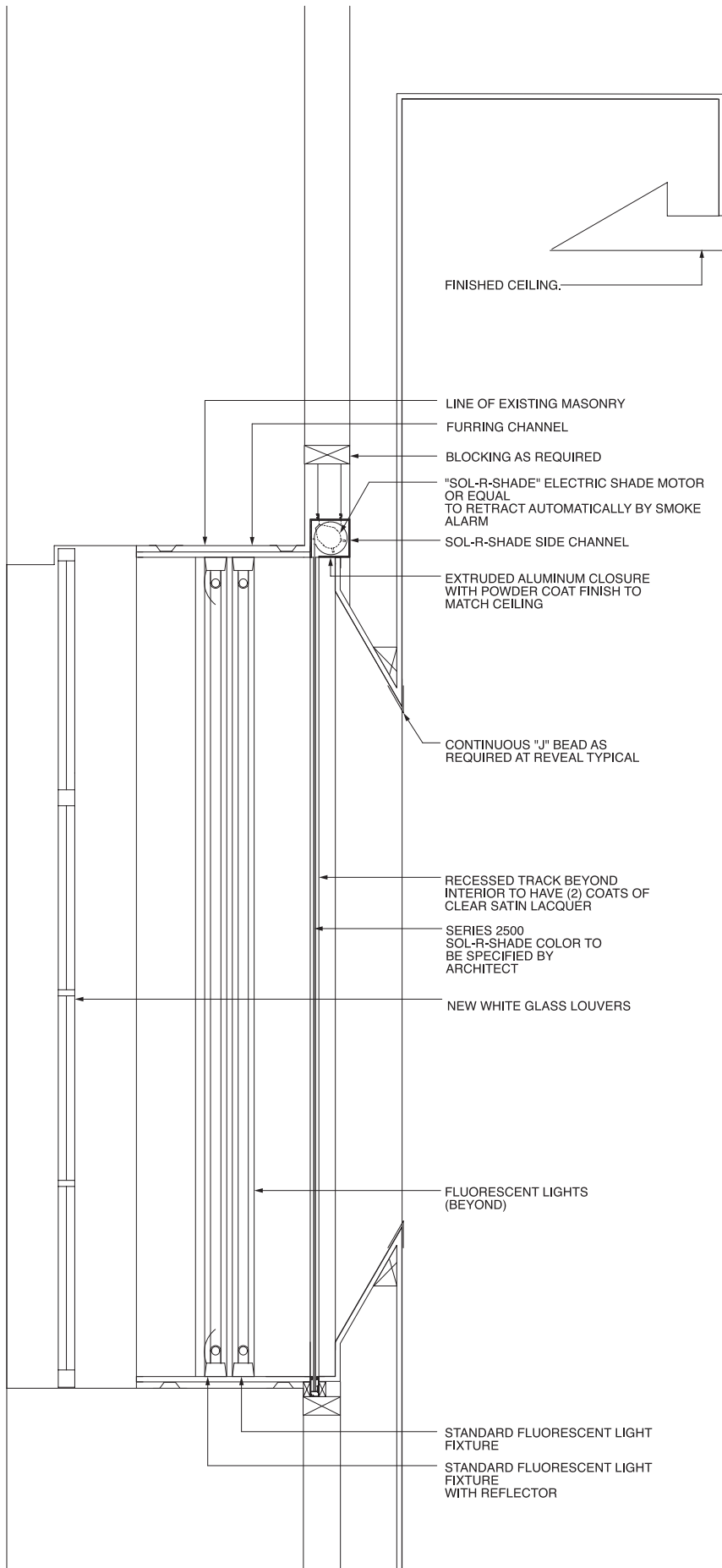

Gabellini Associates, Jil Sander Showroom, Milan, 2000. A spare and reductive approach to merchandising allows each item to stand out against the neutral background, which reads as many subtle variations of white because of the dramatic effects of lighting. The designer's collection punctuates the carefully proportioned and lit white space. Glass railings add to the overall feeling of lightness and clarity, and recessed lighting gives the impression of suspended planes.

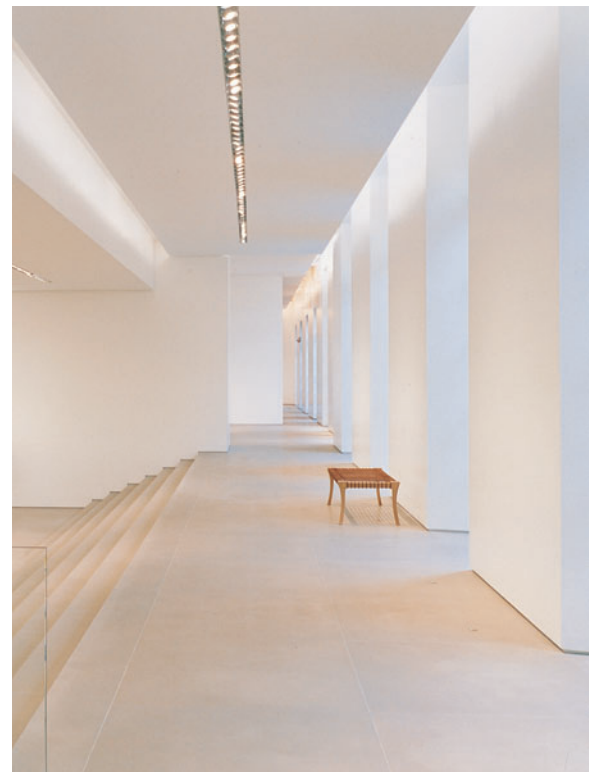





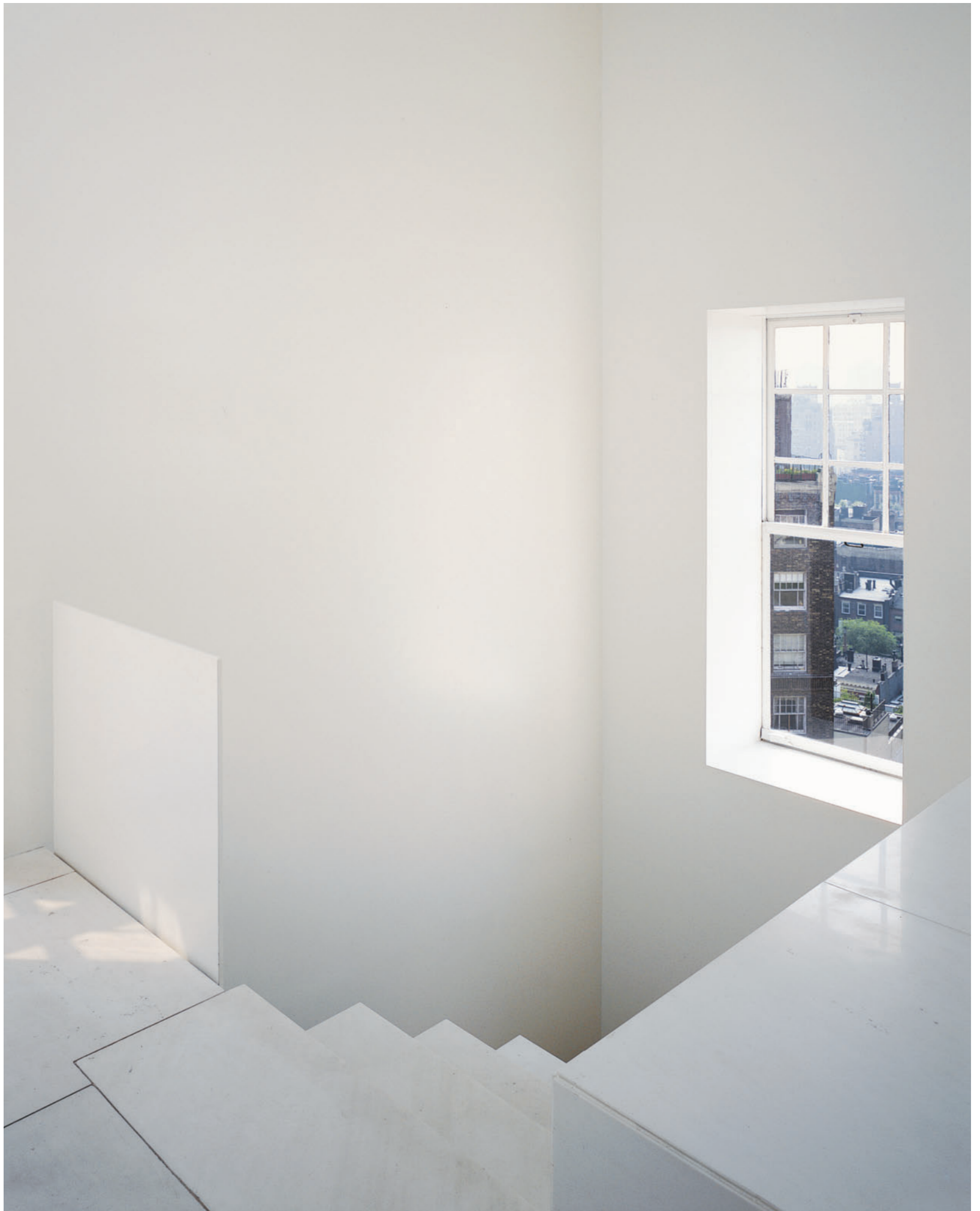

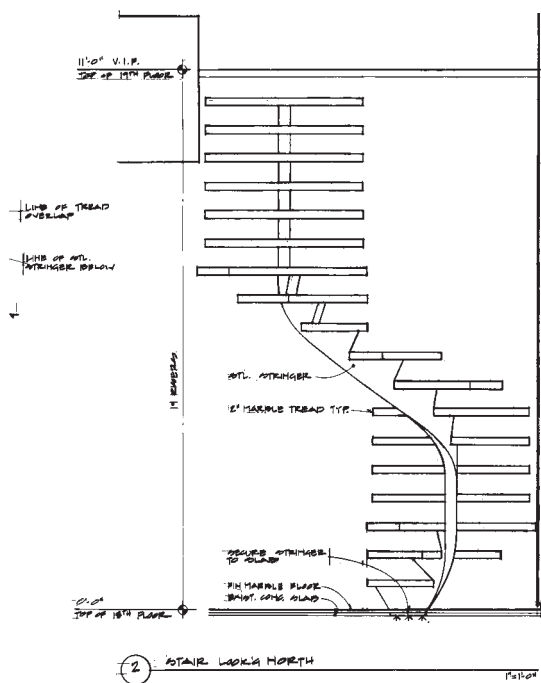
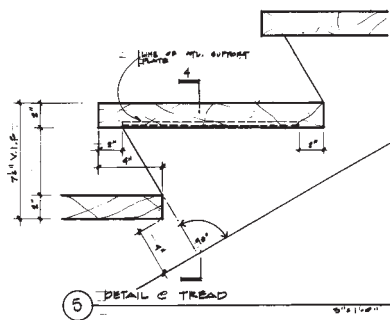
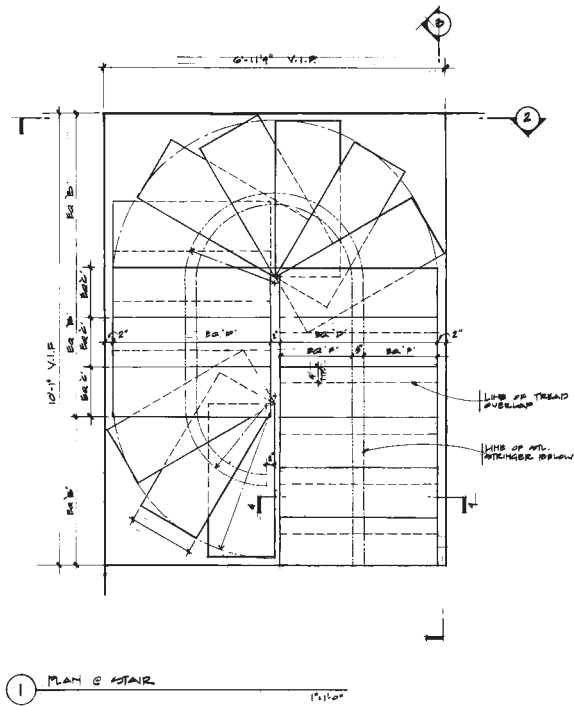

This and previous spread: Michael Gabellini of Gabellini Associates in collaboration with Jay Smith, West 12th Street Residence, New York, 1989. In a New York duplex, a stair is formed by individual slabs of marble balanced on a central spine. The rigidly controlled use of white focuses attention on the surfaces of the materials and their textures, and the scheme adds to the sense of equilibrium and silence. It is an elusive combination that the designer refers to as "aura."

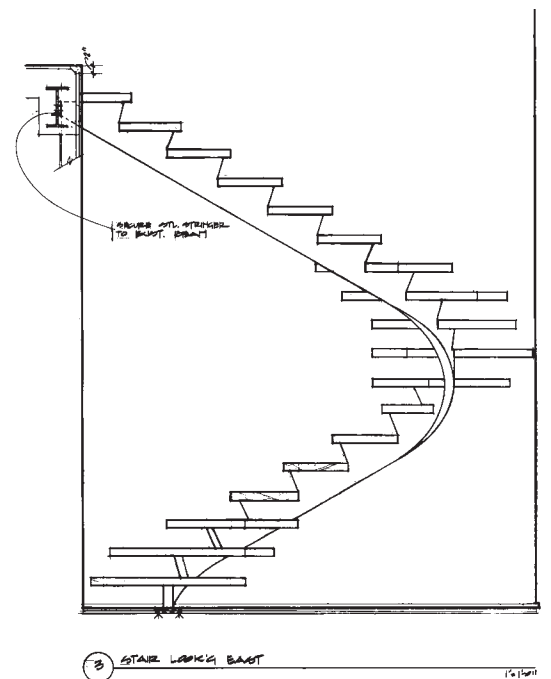



Gwathmey-Siegel and Associates, Steel Loft, New York, 2001. The space's original structural columns are treated as the central organizing and aesthetic element, not unlike an ancient Greek or Roman colonnade. The spare white walls of this space are complemented by the lightness of the bleached maple floors. The 14 windows throw shards of light across this relatively blank architectural canvas.

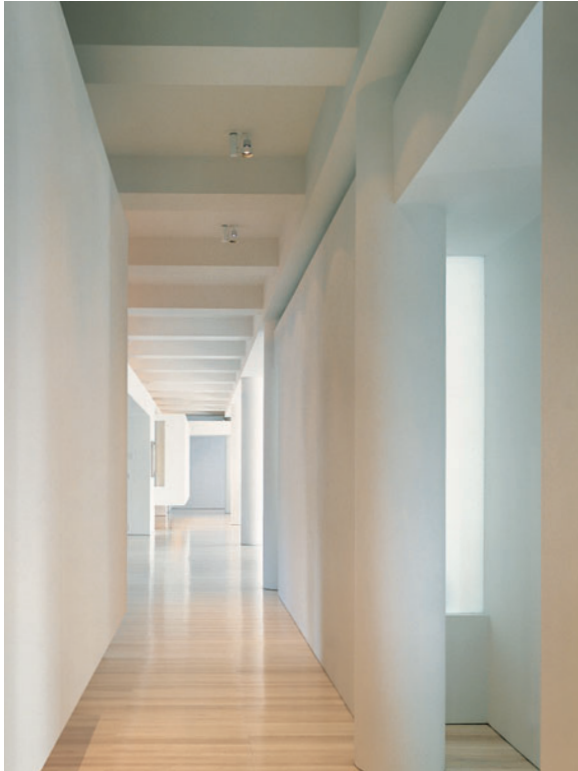

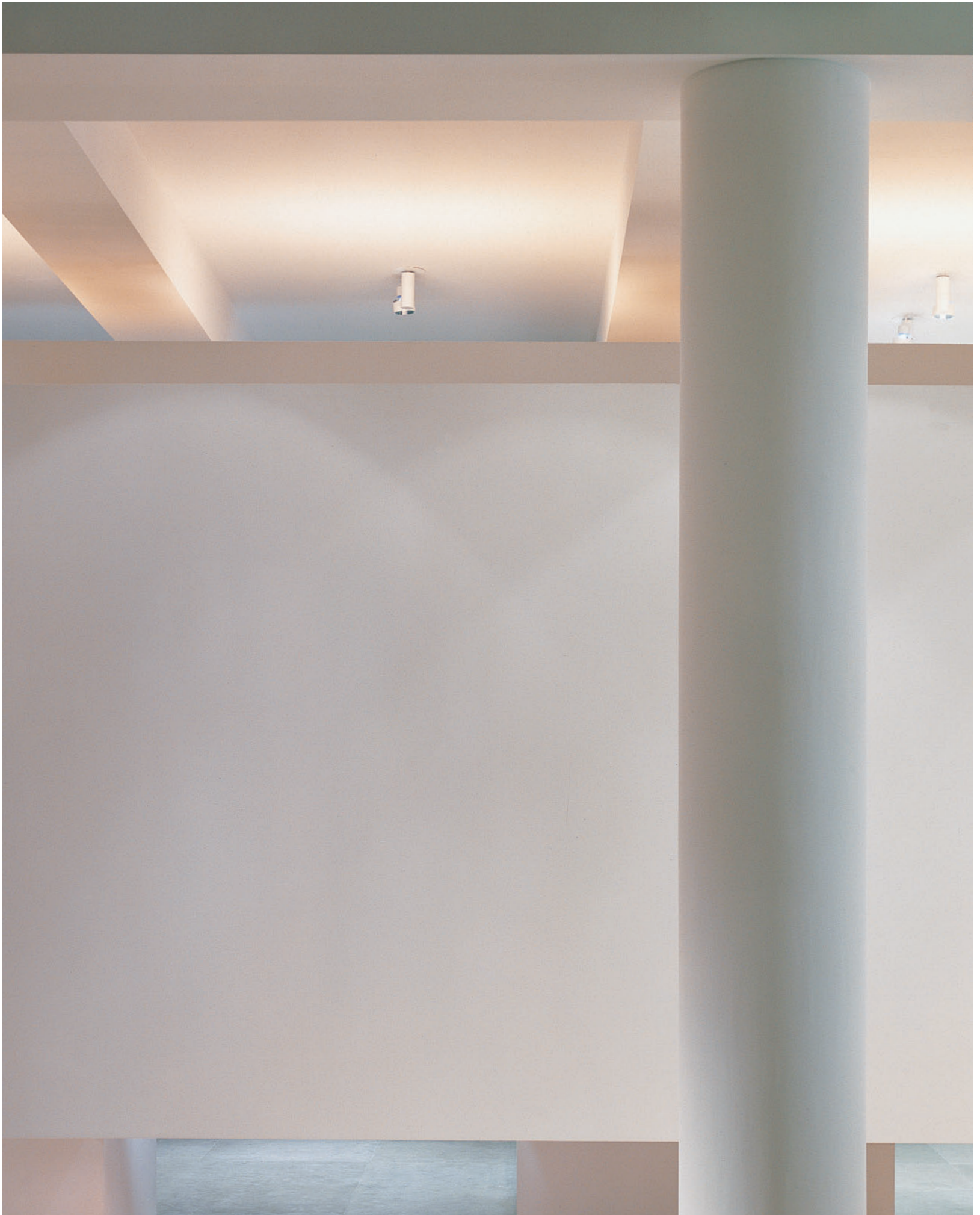



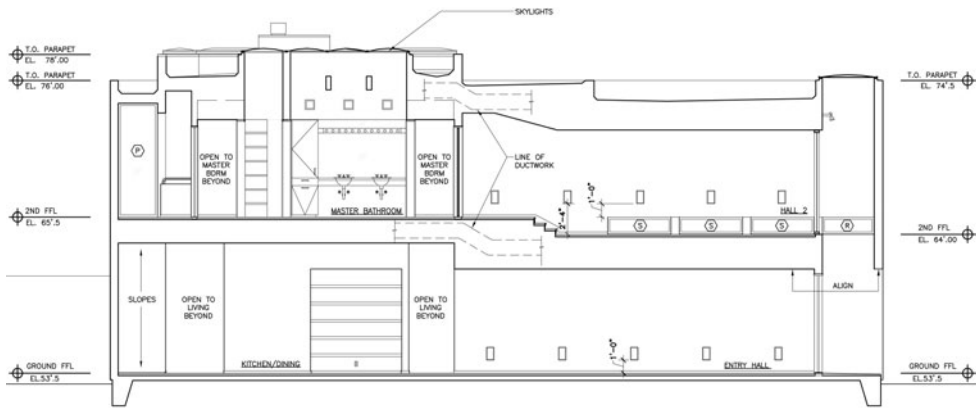

north/south section looking west

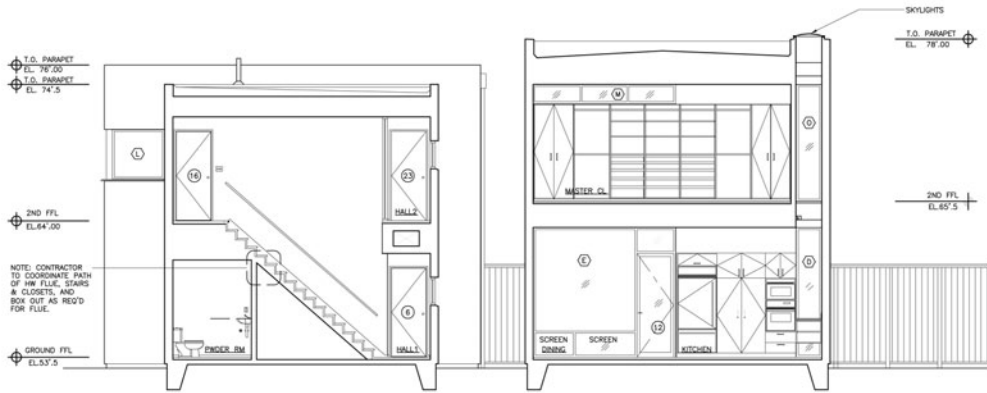

north/south section looking east

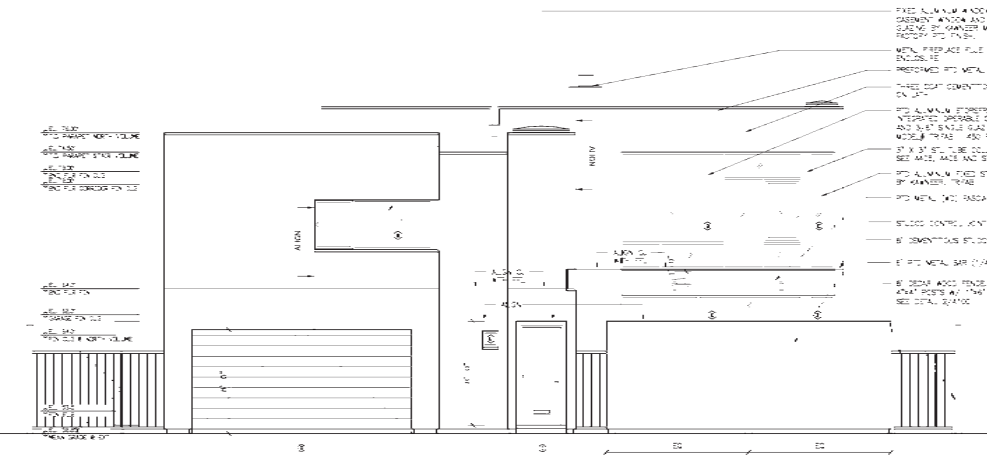

north elevation



This and following spread: François de Menil, Architect, Bank Street Residence, Houston, 2000. The carefully sculptured exterior volumes are surfaced in white stucco. The scoring of the surface adds another opportunity for play of forms and geometries. In this subtropical climate, white walls take on a brilliance not unlike that savored by Le Corbusier in Greece and the Mediterranean, with dramatic shadow playing on otherwise pristine surfaces.







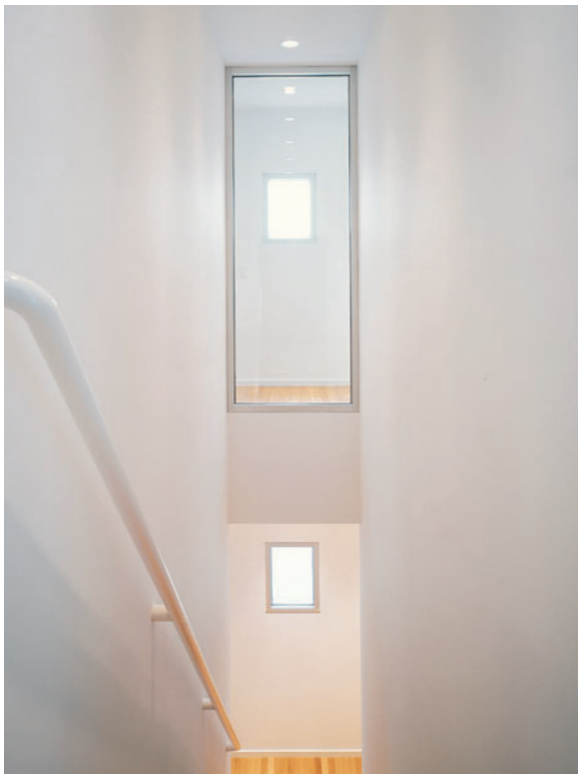

François de Menil, Architect, Bank Street Residence, Houston, 2000. In a sun-washed stairwell, a mingling of different shades of white and off-white walls form a constantly changing geometric composition. But it is not without visual interest. Note the flat surface of the walls compared to the tubular-shaped handrails with their slight gloss—a subtle interplay between metal and plaster.

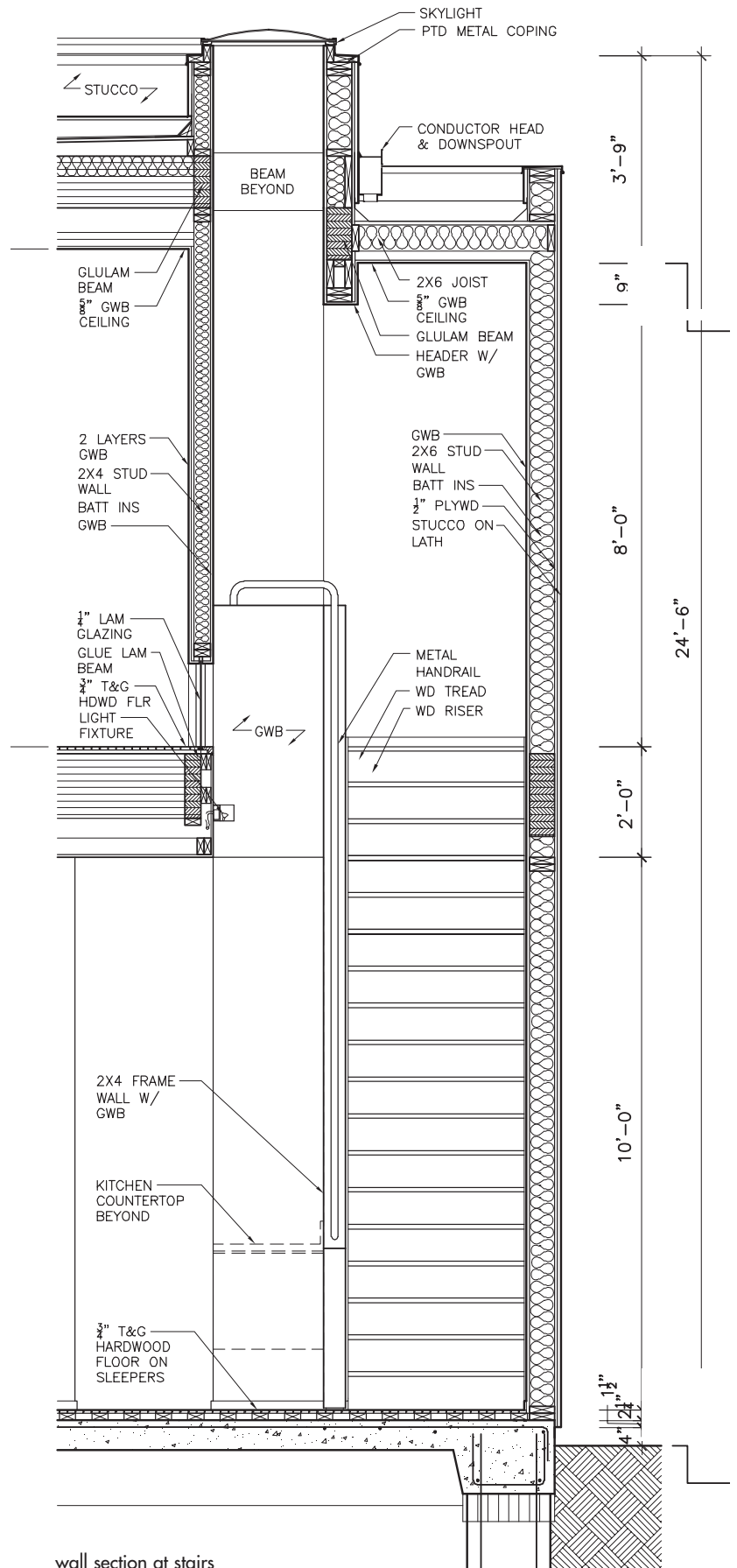

wall section at stairs







Zoran with the collaboration of Peter Moore and Peter Pennoyer, Zoran Loft, New York, 1994. All extraneous partitions in the loft were removed; only five white columns and two sets of shallow stairs, one leading up to the main living area and the other descending into a sleeping cove, remain. Walls and columns were given a glossy finish and the floor is a highly reflective epoxy. The result is kind of a house of mirrors rendered in pure white—even the slightest visual occurrence from the windows is reflected in minute detail. The entire space becomes a theater of reflected images and refracted light.





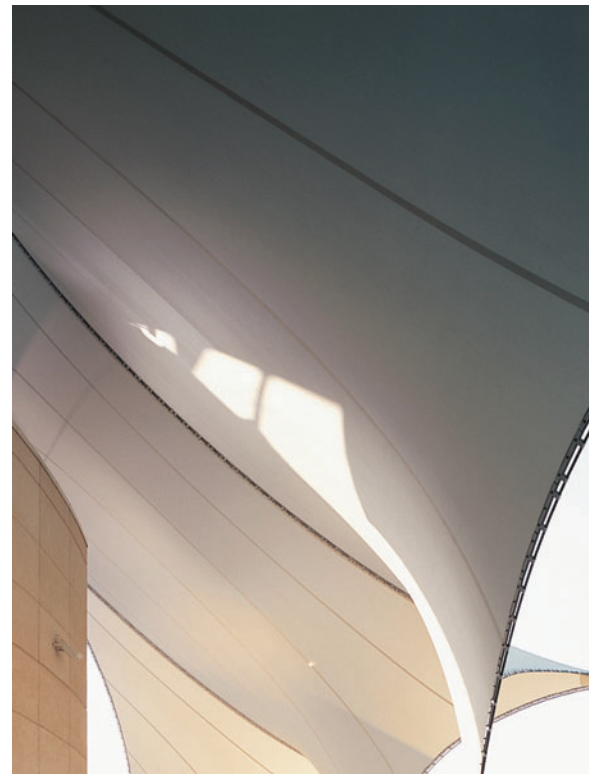

Rockwell Group, Cirque du Soleil, Walt Disney World, Florida, 1999. It is hardly a coincidence that traditional desert tents were white – the lightness of the structures helped fend off the merciless sun. In the same way, this innovative tensile structure is at once adaptable to the hot Central Florida sun as well as evocative of the traditional and iconic circus tent. The light gray of the circular central structure allows the much lighter tent surfaces, made of Teflon-coated fiberglass, to stand out as well as provide shade for visitors milling about or waiting to enter the performance space.

black

"True equilibrium is expressed by the straight line," wrote Piet Mondrian. For him and his modernist allies, that line was inevitably black. ■ Architects like Rietveld, and later the Eameses, gave architectural expression to arrangements of brightly colored planes organized by black. ■ In the same way, today's architects and designers use black as an essential structural element. ■ Aloof from the vagaries of fashion and trendiness, black is a timeless choice. ■ It represents at once a totality—a convergence of all colors—and the most primal act of a designer: Taking black ink to white paper.



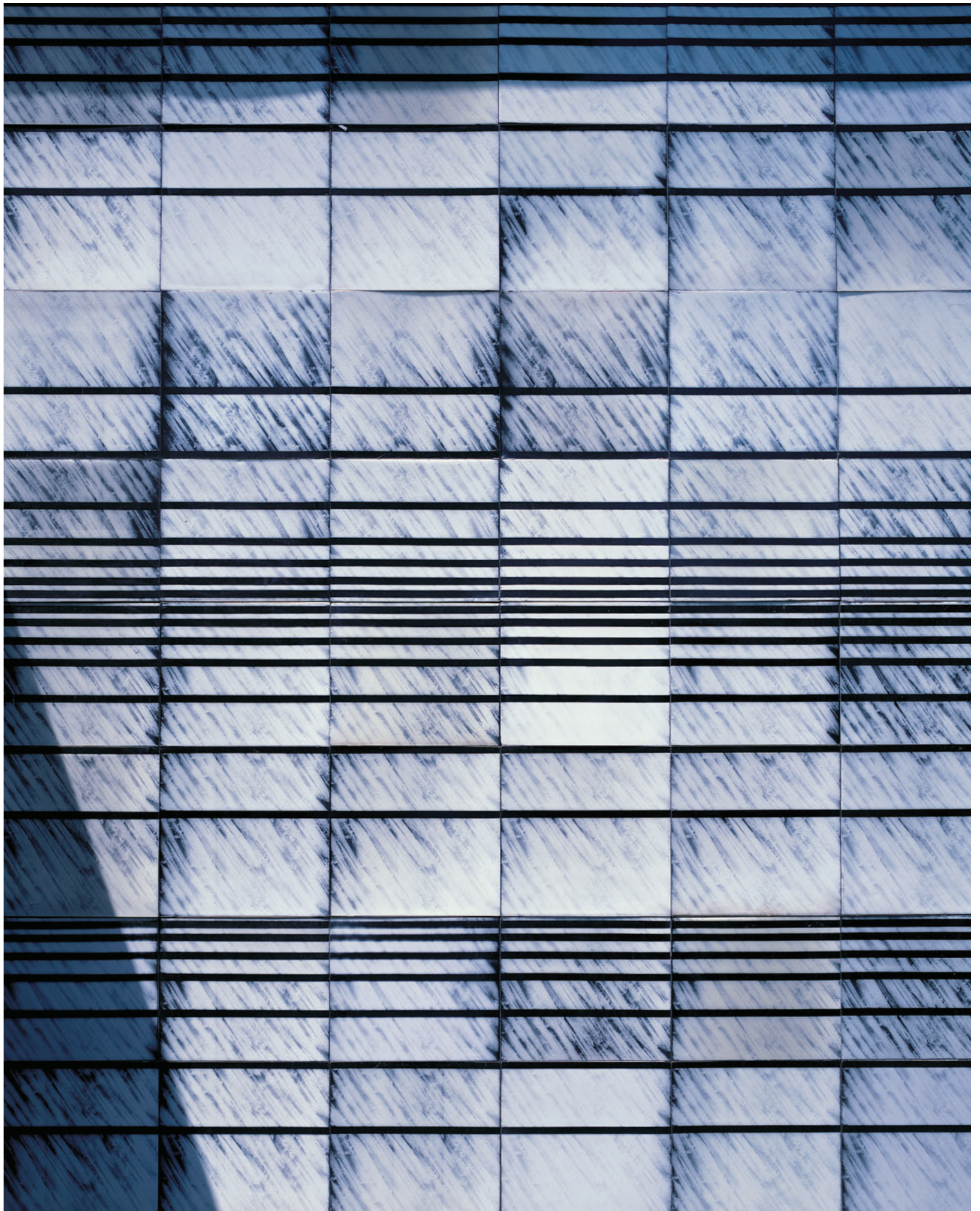



Previous spread: Diane Lewis Architects, Dworkin Apartment, New York, 1991. This spread: Harrison and Abramovitz, Corning Glass Center, Corning, New York, 1951. Black mullions for glass walls make for a different reading than lighter choices such as brushed steel, aluminum or chrome. Black is stronger, more definitive, more weighty. A wing in the original museum has a wall of sheets of photo-sensitive glass over concrete block, the end result resembling marble. In responding to the original building, for the new Corning Museum of Glass, Phase Two, built in 1999 by Smith-Miller + Hawkinson Architects, the designers chose to use black in columns, window frames and other elements.





Peter Marino + Assoc Architects, Chanel Store, Paris, 2003. Coco Chanel set the tone for her company when she adopted an elegant *sans serif* black logotype. In this store, black railings and window frames seem to take this elegant design *parti* and bring it into three dimensions, organizing the space and making it more seductive. Like the proverbial “little black dress” that Chanel helped make a fashion staple, here black architectural elements are reserved and timeless.

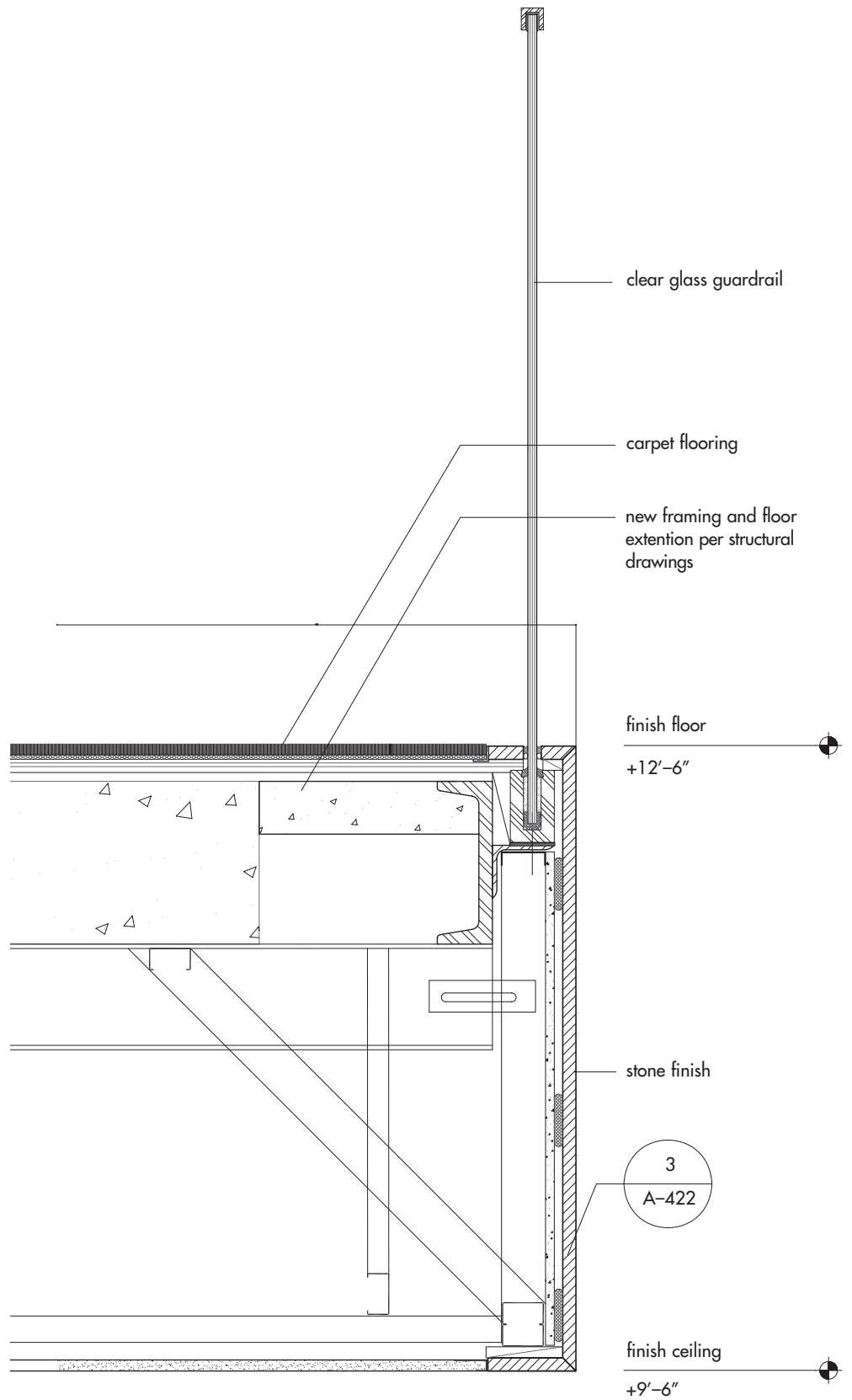









This and previous spread: Peter Marino + Assoc Architects, Chanel Store, New York, 2003. Tiny perforations in a random pattern along the store's walls are back-lit, lending a scale and complexity to otherwise unadorned gloss surfaces. Everywhere in the store, black forms a rigid controlling presence, from the walls to the floor to the framing of the display cases and furniture. This is deft and elegant use of this sum of all colors, resulting in a space that is at once Spartan and filled with visual interest.





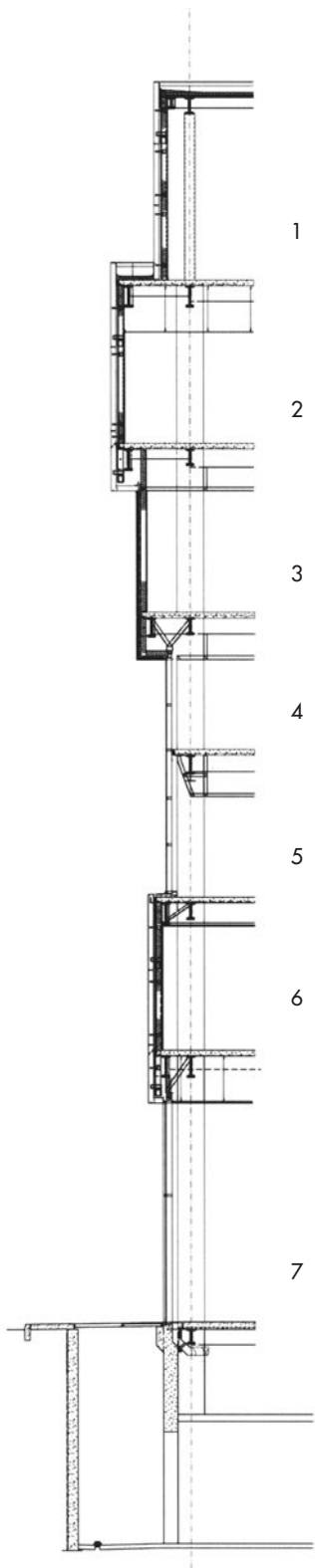

Exterior Wall Section

- 1 penthouse
- 2 unmuseum
- 3 gallery
- 4 office
- 5 office
- 6 gallery
- 7 lobby

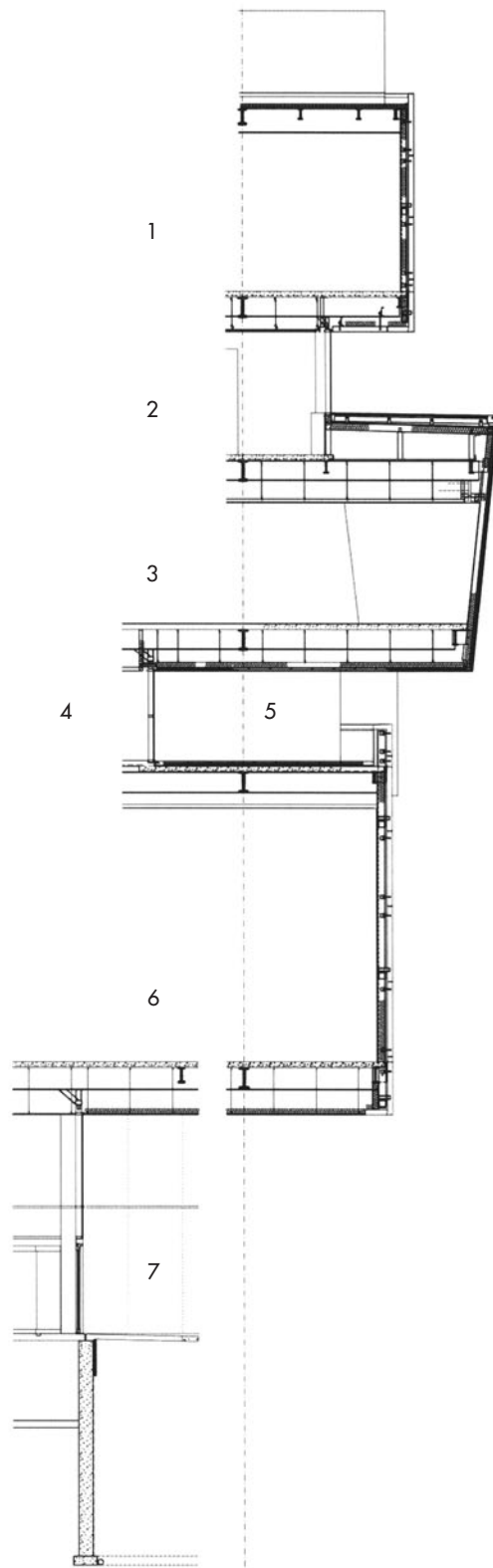

Exterior Wall Section

- 1 penthouse
- 2 unmuseum
- 3 gallery
- 4 boardroom
- 5 terrace
- 6 gallery
- 7 entry



Zaha Hadid Architects, Museum of Contemporary Art, Cincinnati, 2003. Through a deft use of black, the architect focuses attention on a single but important part of the façade's composition. The building's exterior massing is formed by a series of extruded squares and rectangles that seem to lunge aggressively forward. As if to underscore the notion of black as a singular and rebellious chromatic force, the square that protrudes the farthest stands out, provocatively.





Zaha Hadid Architects, Museum of Contemporary Art, Cincinnati, 2003. Hadid uses black skillfully to emphasize certain forms while minimizing others. The organizing stair of the museum appears to be multiple ships converging on a single port when seen from below or above. Their swarthy color adds to the sense of aggressiveness. In rejecting the accepted “neutral white box” museum design paradigm, Hadid replaces it with a inciting parti.





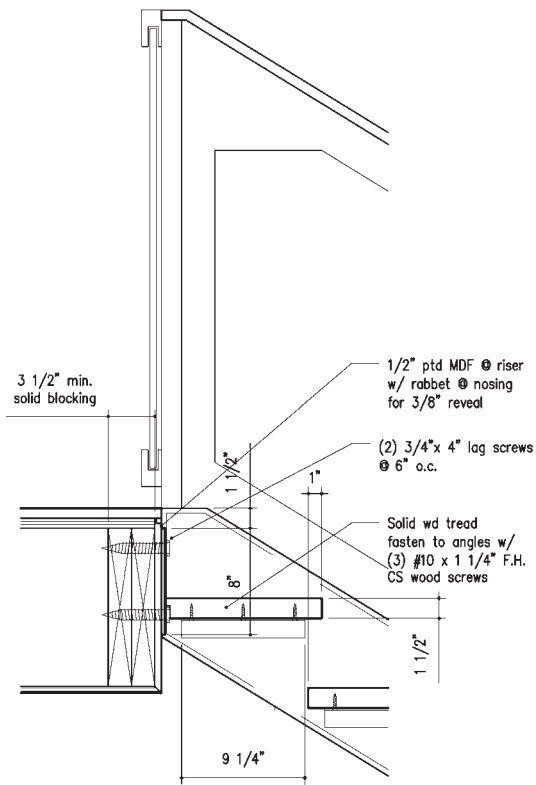

Eric J. Cobb Architect, Stretch Residence, Seattle, 2003. In rooms where black is used sparingly, it nonetheless has impact. In the great room, the steel fireplace offers a planar counterpart to a flat-black topped table. In the corner fenestration system, black steel window frames are exposed wide-flange steel I-beams that form an ordered grid through which to take in the expansive views.

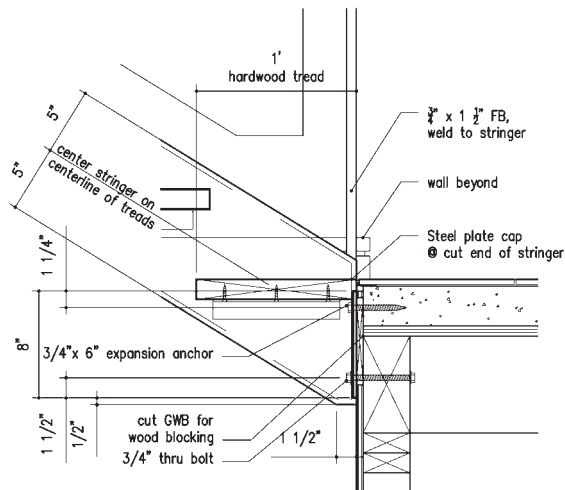



Gabellini Associates, Park Avenue Apartment, New York, 1998. Because the client is a collector of black-and-white photography, a certain color discipline was brought to bear. Especially important were the monolith-like, black, solid cubic masses anchoring the living room, dining room and bedroom. The virtual opposite of these elements is the ethereal walls of opaque glass and the signature use of Sivec white marble on countertops and other key surfaces. In this apartment, black-and-white photography finds not only a repository but a worthy subject as well.

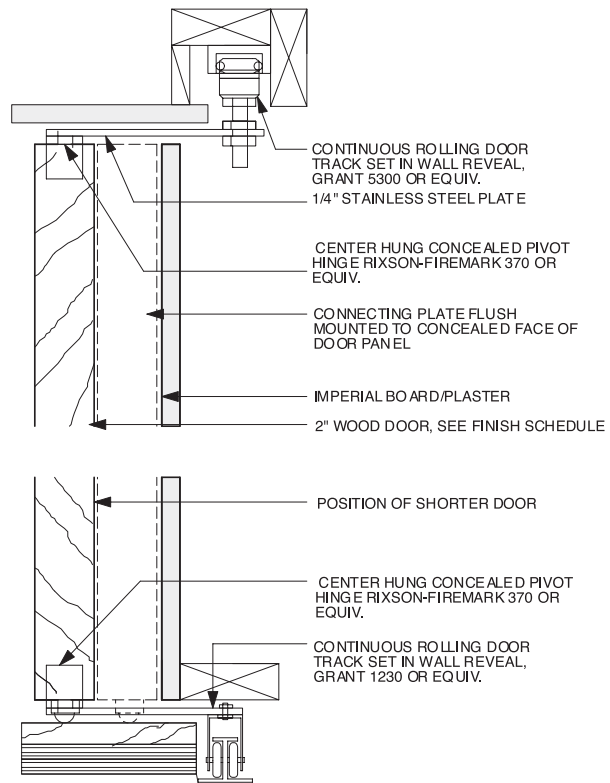
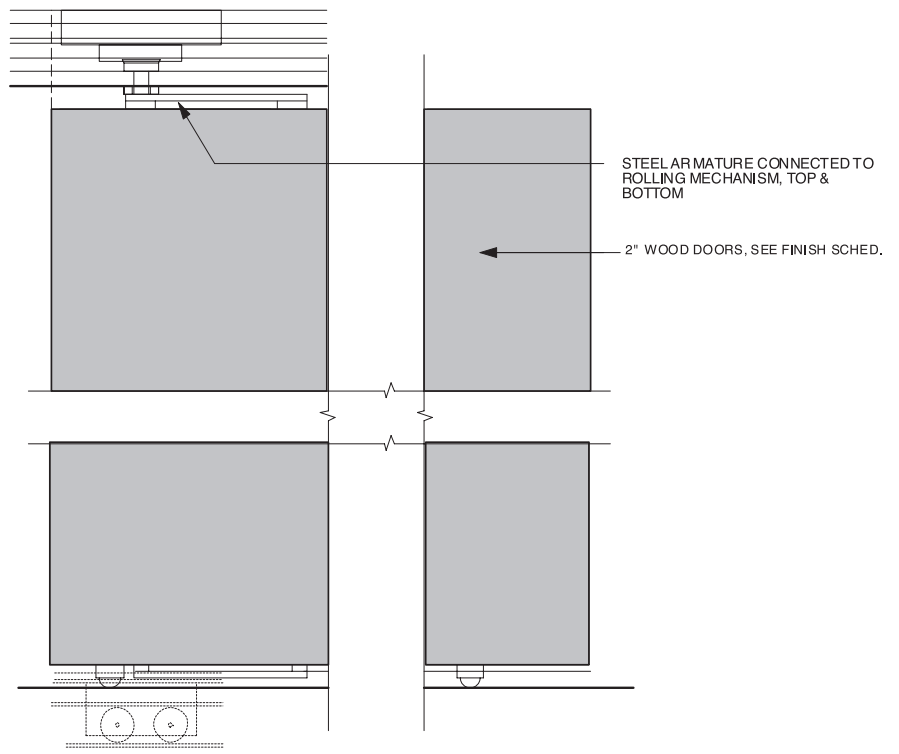

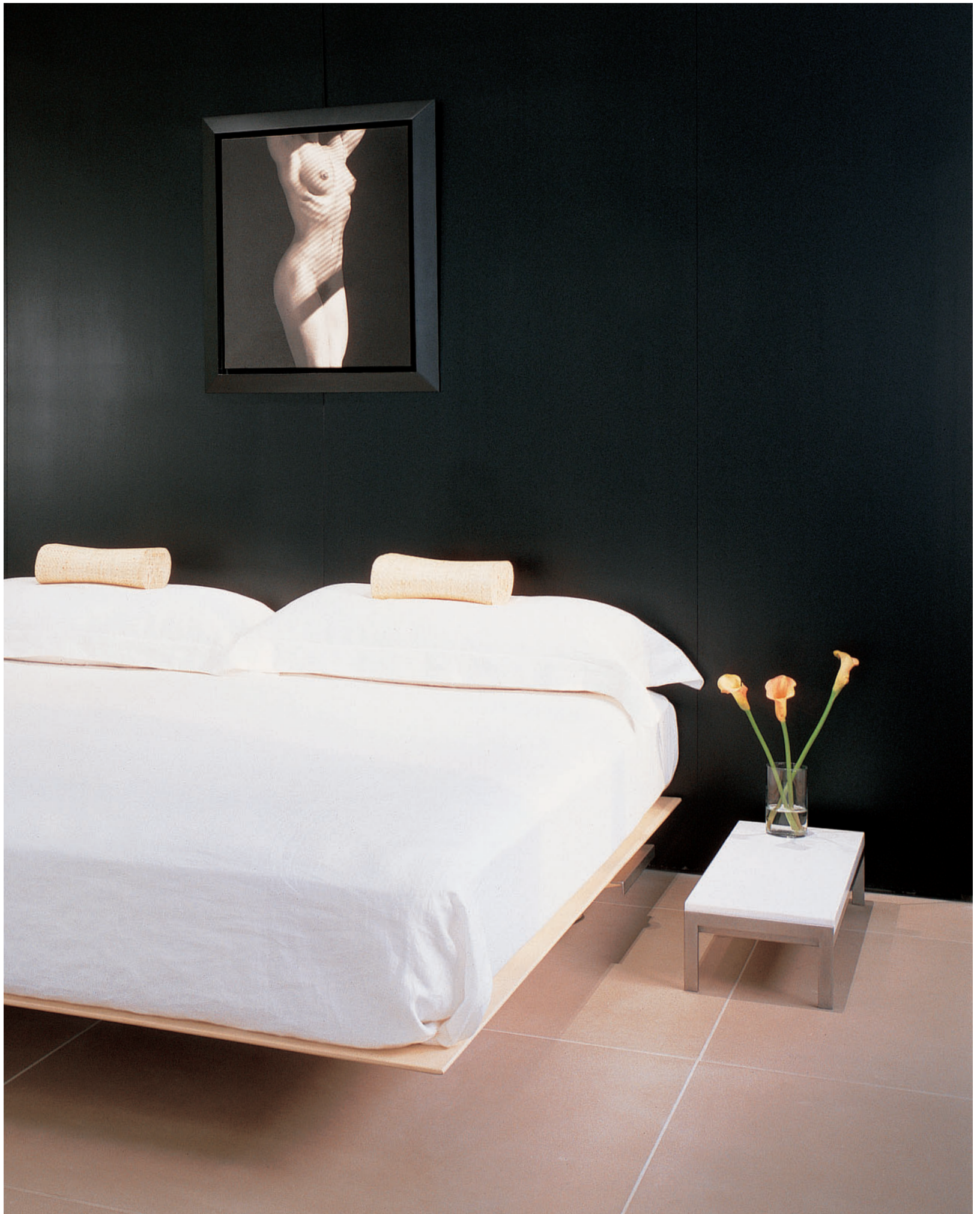





Henderson-Sigler Studio, Nickerson-Wakefield Loft, New York, 2003. Black floors and dark blue ceilings establish a sense of enclosure and comfort for the bathroom. The dark ceiling has the effect of making the space more intimate. Nearby black shelving helps establish a datum, wherein the top of the shelving roughly corresponds to the height of the open bathroom ceiling.

red

“Red is the most positive of colors, the most violent, aggressive and exciting. It attracts the eye more than any other,” said Eric de Maré. ■ The earliest human form of art and decoration were red cave drawings, often from the blood of animals. ■ Architectural terra cotta is invariably red, suggesting the most primordial of hues, a material lifted from the earth and touched with fire. ■ In Chinese culture, red represents the active (yin) inextricably wed to the passive black (yang). ■ Emily Dickinson: “Today I tasted life. It was a vast morsel. A circus passed the house—still I feel the red in my mind . . .”



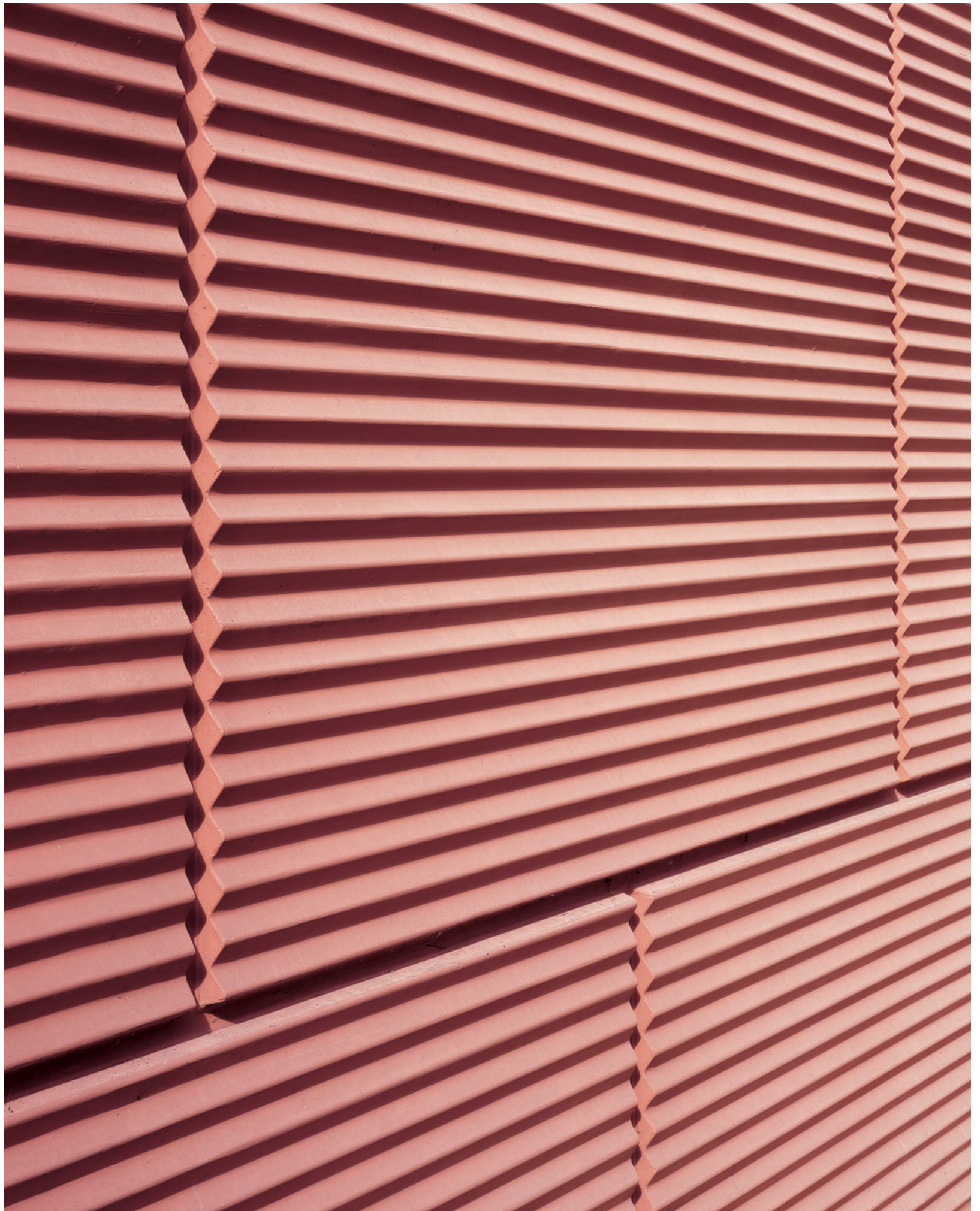

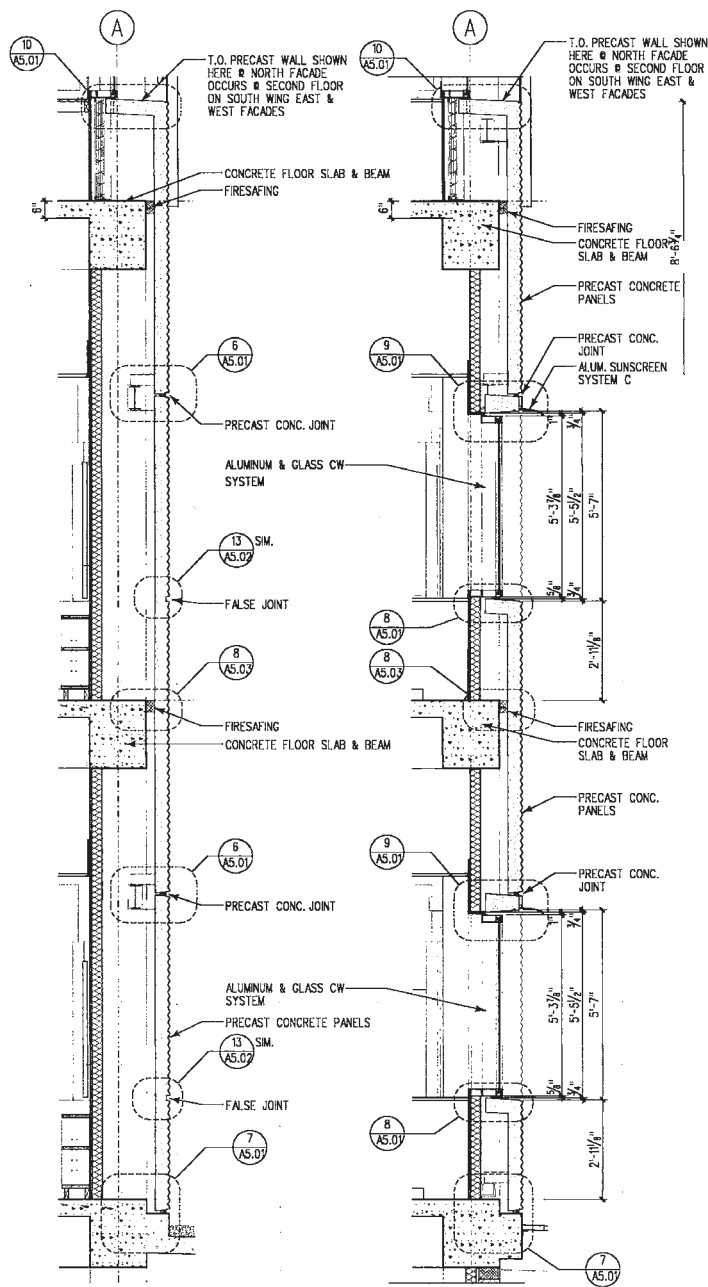

5 TYP. PRECAST SECTION
SCALE: 3" = 1'-0"

4 TYP. PRECAST SECTION @ OPENING
SCALE: 3" = 1'-0"

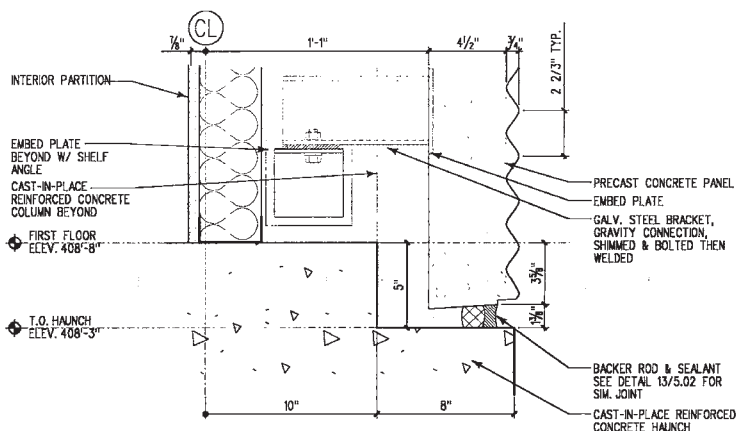

7 TYP. DETAIL @ PRECAST BASE
SCALE: 3" = 1'-0"



Previous spread: Steven Holl Architects, Y House, Upstate New York, 1999. This spread: Bohlin Cywinski Jackson, Natural Sciences Laboratory Building, University of California, San Diego, 2003. Red is a color that advances. That is, it can call particular attention to certain parts of a building's façade or massing. These tinted precast concrete panels are given a pale terra cotta hue that alludes to the Mediterranean climate of San Diego and acts to make certain parts of the building stand out. Undulating profiles on the panels provide depth and character to the surface while generating different tones. Aluminum eyebrow accents above the windows cast moving shadows.

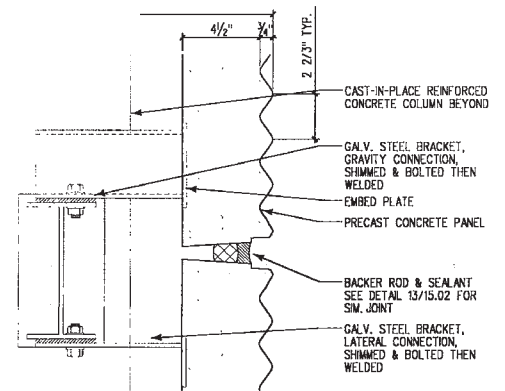

6 TYP. DETAIL @ HORIZ. JOINT
SCALE: 3" = 1'-0"



Steven Holl Architects, Makuhari Housing, Chiba, Japan, 1996. As a way to differentiate the public meeting hall of this group of residential buildings, Holl chose metal panels that were oxidized to form a ruddy, complex hue. While they read unquestionably as red, on closer inspection they have elements of green, gray and brown while standing out from the more neutral colors of the rest of the structures.







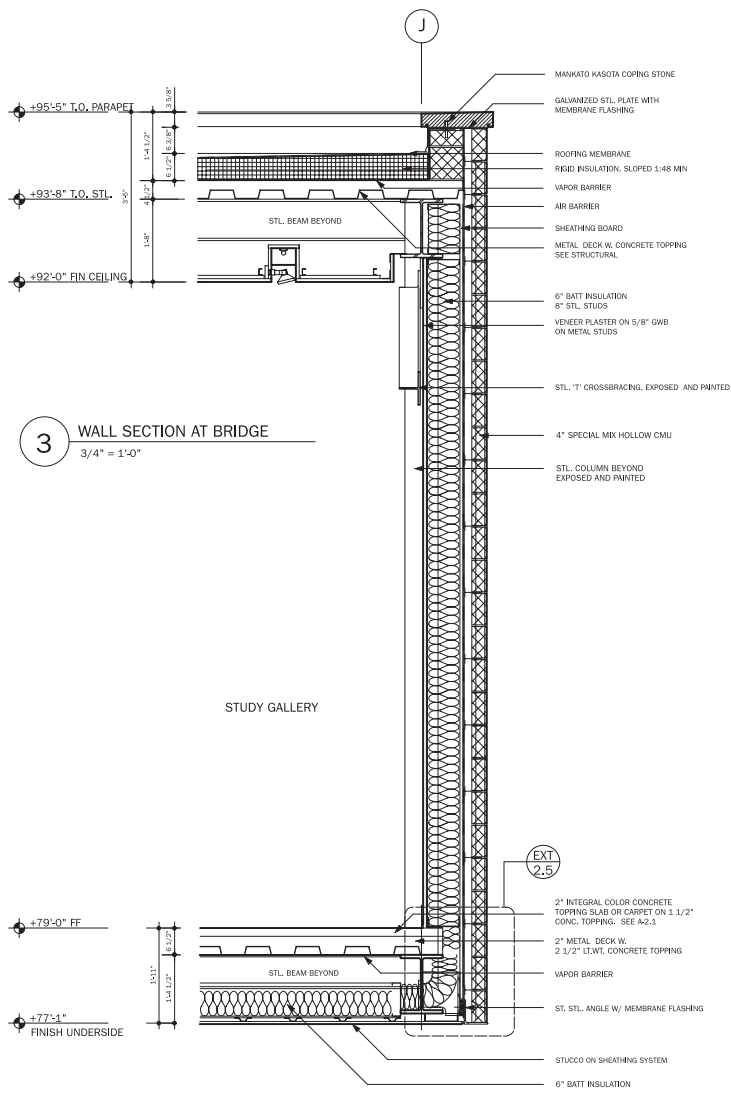

Steven Holl Architects, Cranbrook Institute of Science, Bloomfield Hills, Michigan, 1999. In discussing his concept of "chromatic space," Steven Holl states: "Color is a property of light. Yet physics does not hold the key to unlocking the enigma of colors, as the experiences of chromatic space are bound up in mystical effects and philosophical potential . . . The recent discovery that the expansion of the universe is accelerating was made using red-shift measurements of visible wavelengths from receding stars. Astonishing advances in the physics of color may provoke us to rethink our everyday spatial experiences."







This and following spread: Gabellini Associates, Ultimo Boutique, San Francisco, 1997. Despite its Italian name, an Asian design sense pervades this store. The red is deep and strong, and it dominates the space rather than being used as an accent. Banners of raw silk and reflective gold leaf on key walls complete the Eastern-influenced retail assemblage.











Studio Petrarca, Reade Street Townhouse, New York, 2001. For a stairway that also serves as a fire exit, a luscious gloss red is complemented by stair treads made of glass and a silky metal veil that hangs the entire height of the space. From the outside, the color gives a sense of dynamism and exciting activity within. Red is picked up again for the carpet in the conference room of the office, which occupies the street level while a private residence is located on the upper floors.



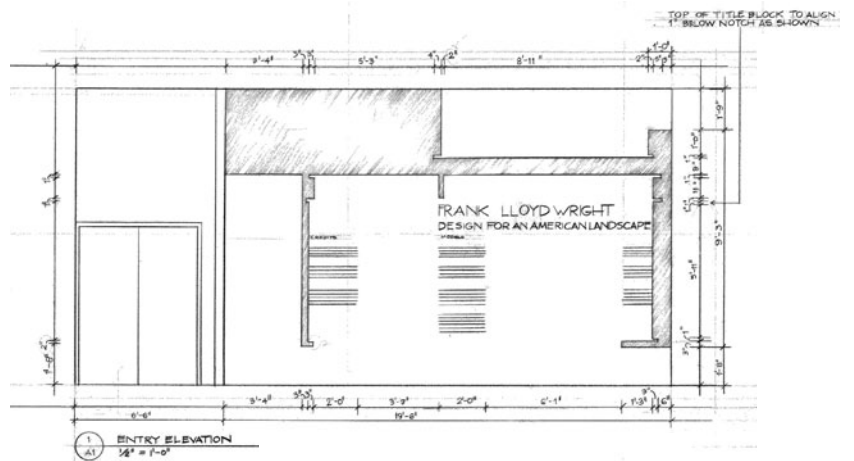
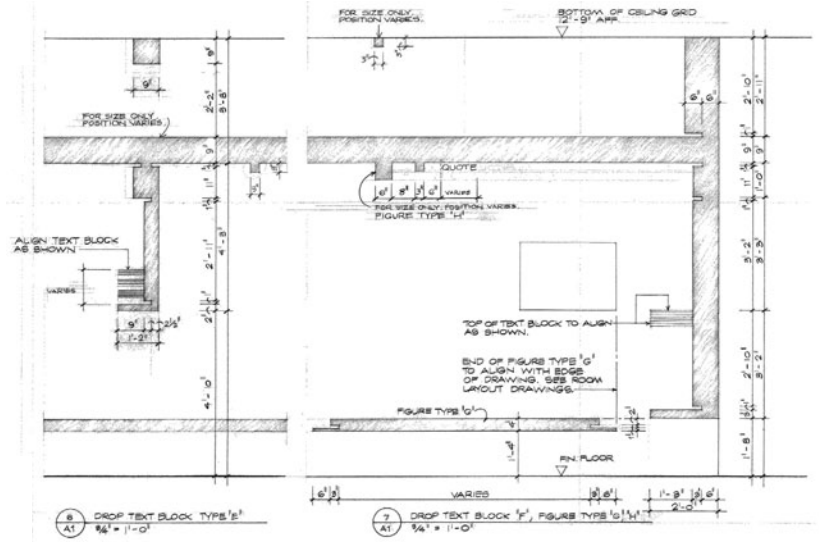
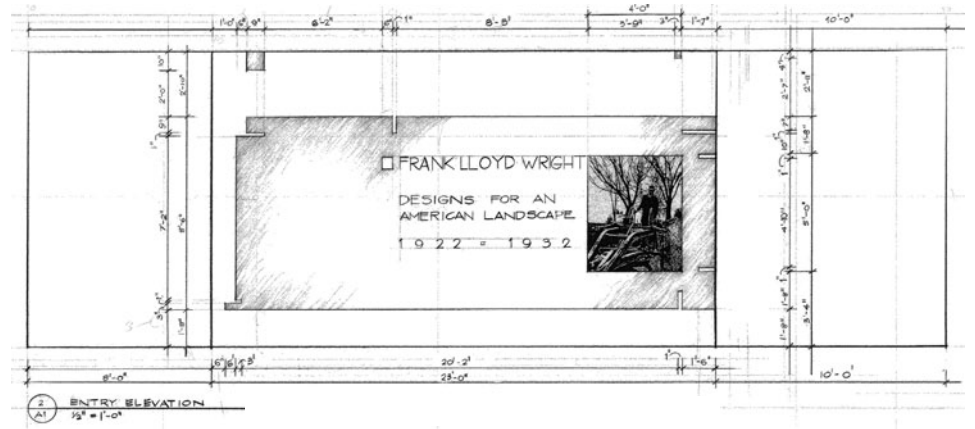

George Ranalli Architect, *Frank Lloyd Wright: Design for an American Landscape* Exhibition, Whitney Museum, New York, 1997. The display partitions make extensive use of a color closely associated with the master builder. The hue so loved by Wright, his trademark "Navajo Red," seems to be at once raw and authentic, springing from the earth, uniquely American. In other words, like the architect.

blue

"Blueness doth express trueness," said Ben Jonson of this perennial favorite color. ■ As if it were some foretaste of celestial bliss, blue predominated the cathedral stained glass of the Middle Ages. ■ During the Renaissance, the pigment ultramarine was made from semiprecious minerals, thus reserving blue for the most sacred images and linking the color with royalty. ■ A particularly strong twentieth-century design gesture is blue for ceilings and skylights, bringing some sense of the sky indoors. ■ Tennyson: "And drowned in yonder living blue, the lark becomes a sightless song."



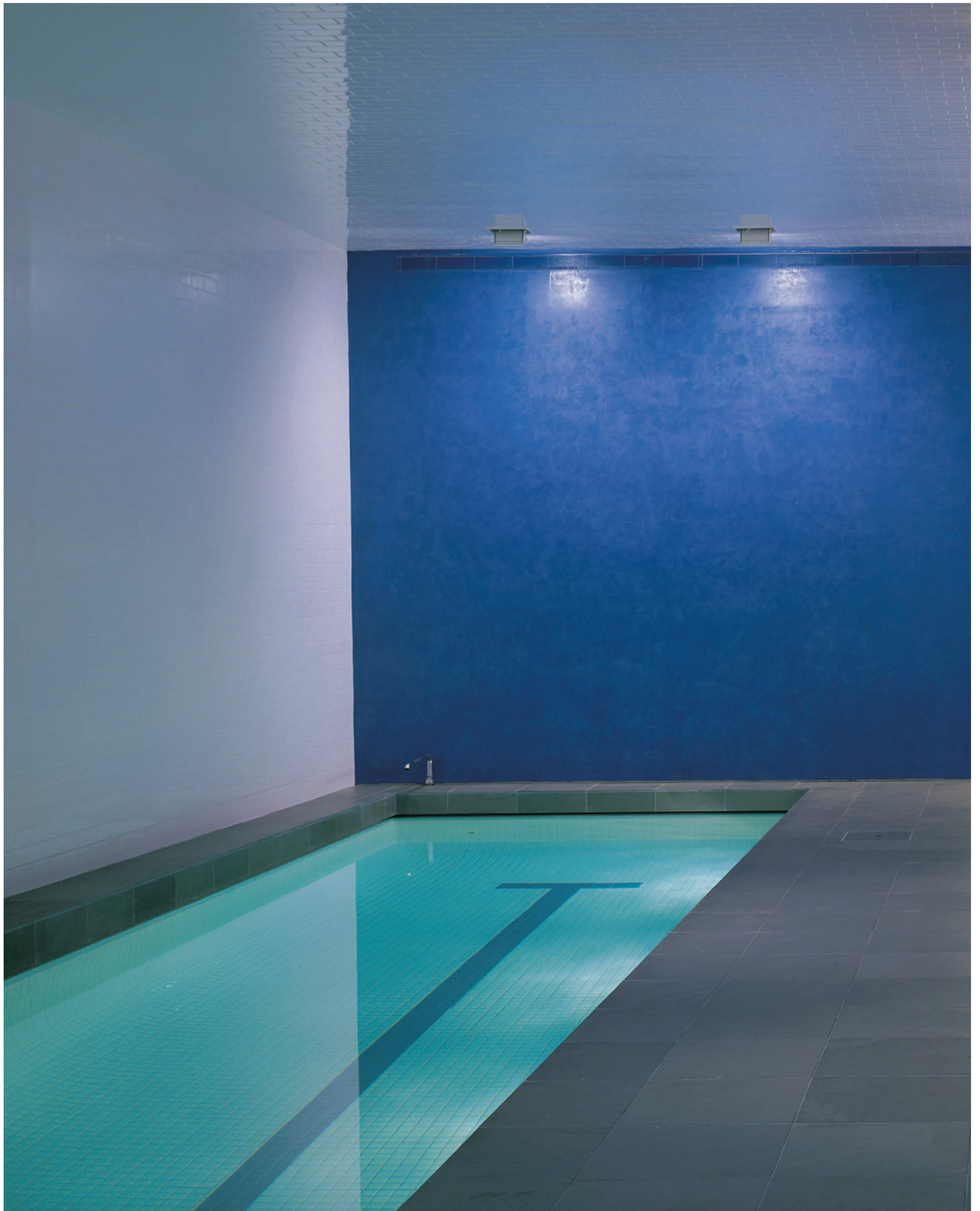

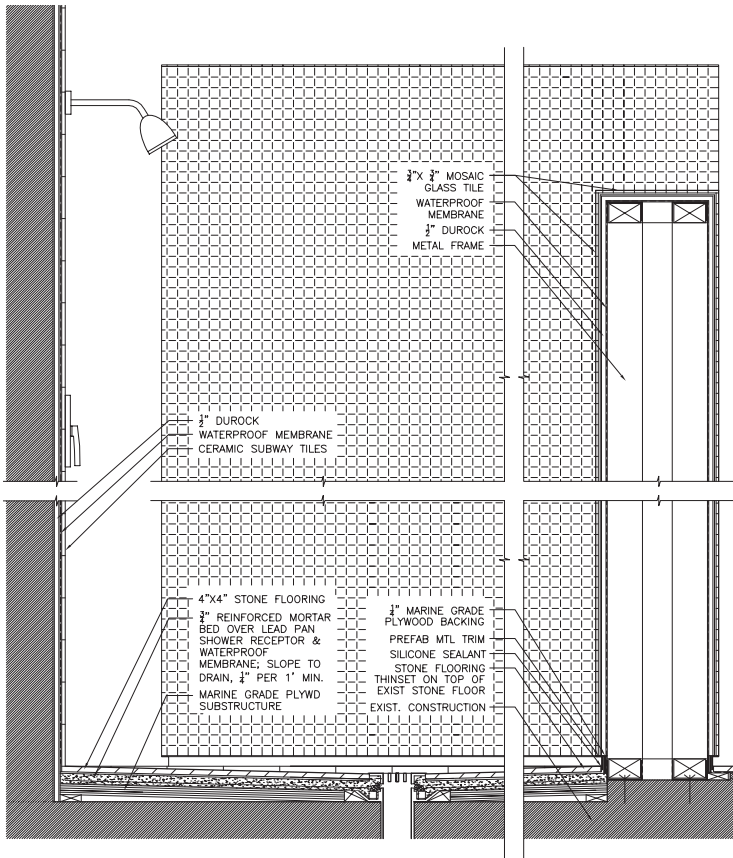

section detail at pool shower



Previous spread image: Zaha Hadid Architect, Vitra Fire Station, Weil am Rhein, Germany, 1994. This spread: François de Menil, Architect, Private Townhouse, New York, 2000. "Swimming pool blue" is a part of the popular color lexicon. But here the architect has countered the aquamarine tint of the lap pool with a deep blue stucco wall, creating not just an interesting color combination but a vertical/horizontal planar relationship. The goal was to create more than a swimming and exercise space, but to use the natural appeal of being poolside and to turn it into a causal entertainment area as well. The corner shower is clad in black mosaic tiles while the floor is gray slate.

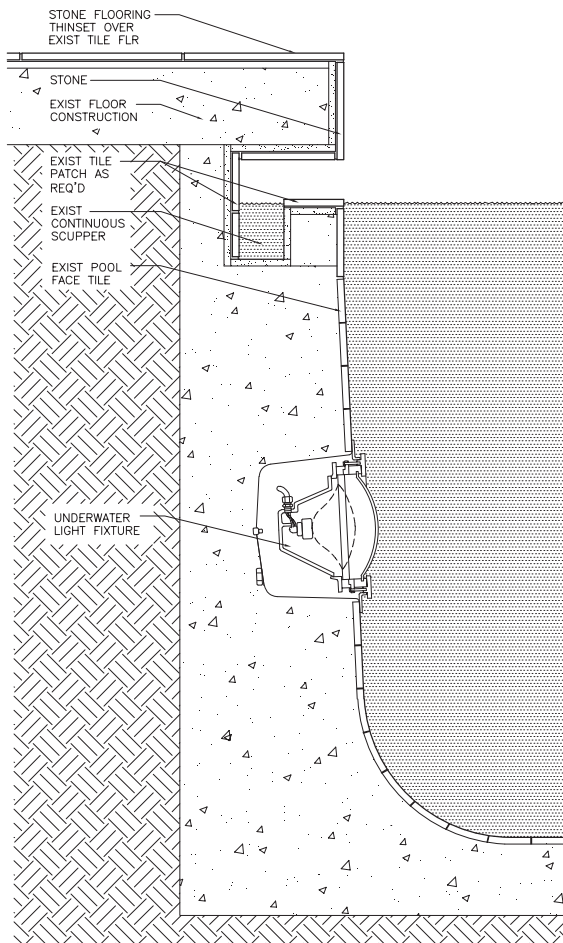

pool coping detail



LOT/EK, The Bohen Foundation, New York, 2003. A blue band on exposed brick walls unites the kitchen space and serves as an eye-level organizing element, matching the cool hues of the stainless steel sinks and cabinets. For a nonprofit organization that commissions film, video and installation pieces, the kitchen adopts a spare and elegant aesthetic without resorting to the white cube motif.

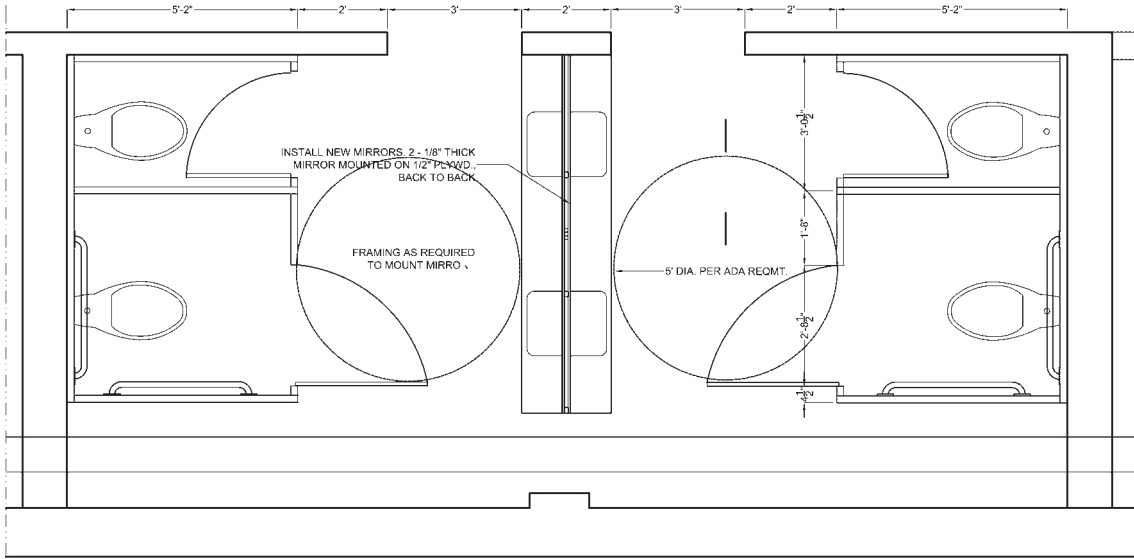

restrooms - enlarged partial plan







LOT/EK, Management Artist Organization, New York, 2000. Afloat on a sea of blue: This agency space has a highly polished resin floor that intensifies the slight surface imperfections. The resulting reflections of the corrugated steel partitions evoke images of a container ship on the high seas.



Resolution: 4 Architecture, Simint Fashion Corporation Showroom, New York, 1993. A curving blue wall is canted 5 degrees on the Z axis and serves as the main organizing element. It draws visitors down the corridor toward the showroom, compressing first against the blue glass walls of the offices opposite and then seeming to recede, as if to present the main space as an extension of the city sky beyond the windows.

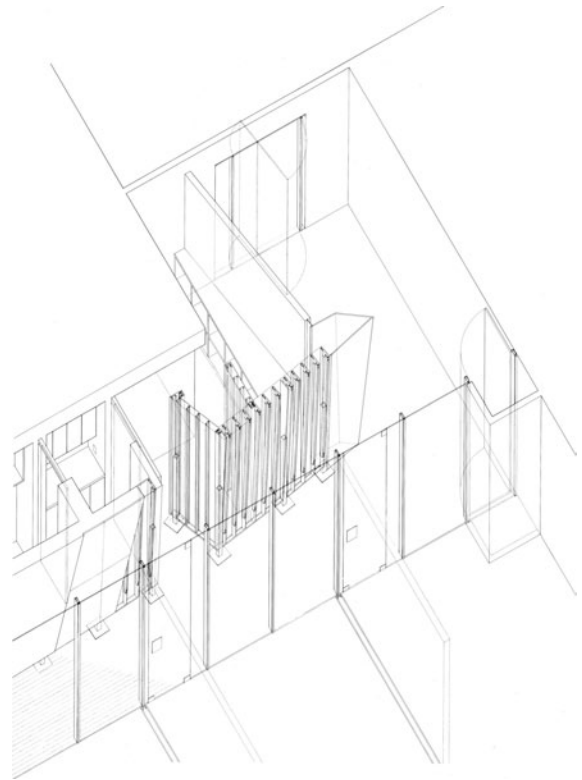
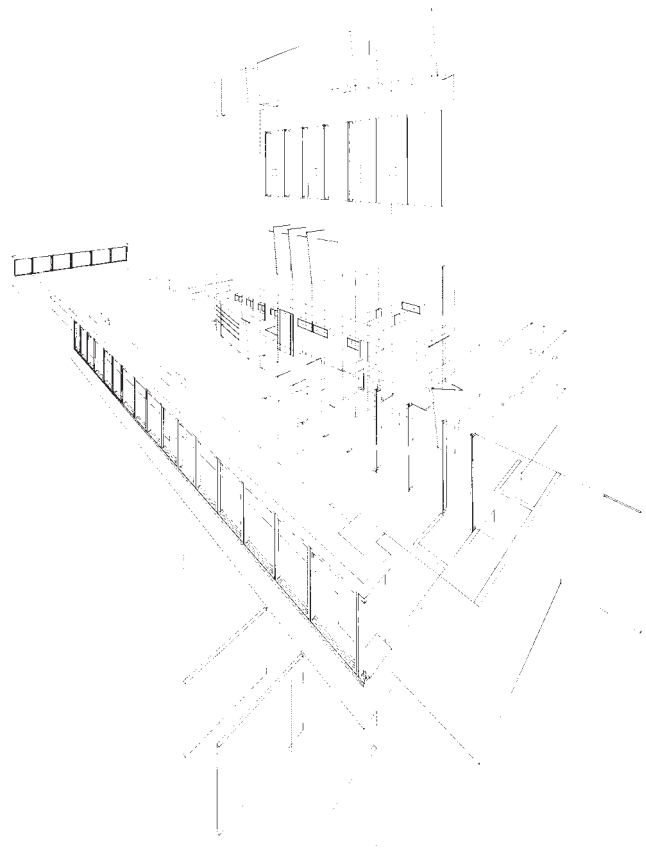





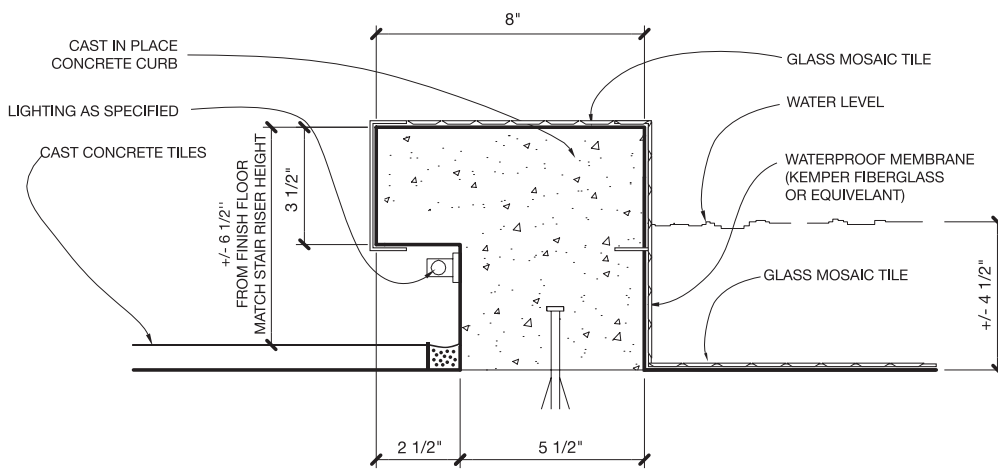

section detail at pool curb scale: 3"=1'-0"

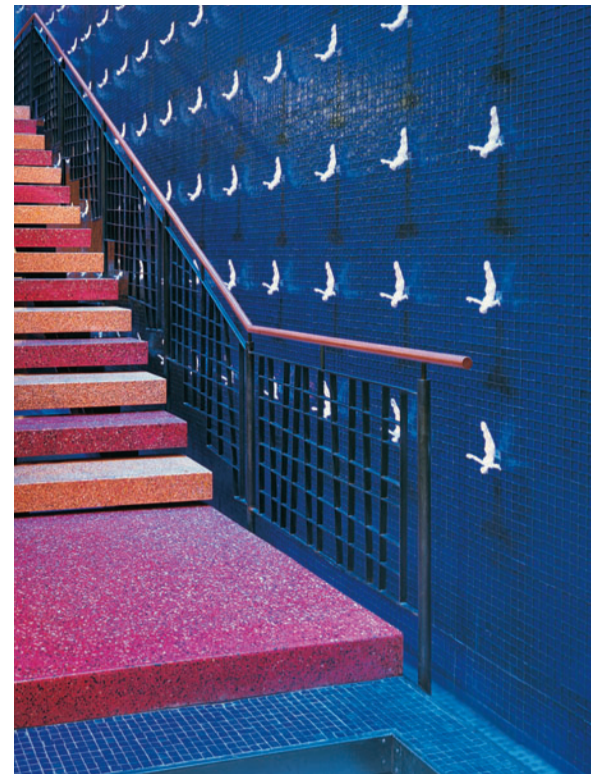

Rockwell Group, Rosa Mexicano Lincoln Center, New York, 2000. The cobalt blue tile wall shimmering with water recalls the work of the great modernist master Luis Barragán, and the deep color gives the impression of a shaft of ocean somehow replicated indoors. Guido Grunenselder and Francesca Zwicker of Pescapella Design created the white figurines that allude to the daredevil divers of the cliffs of Acapulco.



Gensler, Discovery Communications Headquarters, Silver Spring, Maryland, 2003. This blue color scheme was less inspired by nature than by that ubiquitous object of the digital age, the blue computer screen. In the elevator lobby, translucent acrylic panels are backlit, giving the impression of screens about to come alive with moving images; in the main auditorium, cylinders carved into the ceiling are given a blue cast and create an atmosphere of anticipation, a sense of a show about to begin.







LOT/EK, TV-Tank, Deitch Projects/Henry Urbach Architecture Gallery, New York, 1998 (left and top), and Mixer, New York, 2000 (bottom). For this exhibition, petroleum tanks were cut in sections and turned into lounges for relaxing and watching television. Blue predominates the scene both through the color of the tubular cushions and the hue cast by artificial lighting. It was an intuitive choice—blue predominates the other pixels on a television screen; further, it suggests water and thus the protection of the womb, as well as the endless horizons of sky and space.



yellow

The color of longing, the hue of that brick road leading to a mystical city on the horizon, yellow is almost invariably upbeat and optimistic. ■ As did blue in Europe, in Ancient China yellow occupied a position of royal and religious privilege. ■ As a primary, it joined red and blue in the modernists' definitive palette. ■ As the pigment that most closely resembles the sun, itself the source of all color, yellow lends chromatic brilliance to almost any space, if also urging measured caution. ■ "Much have I travelled in the realms of gold, and many goodly states and kingdoms seen," wrote John Keats.





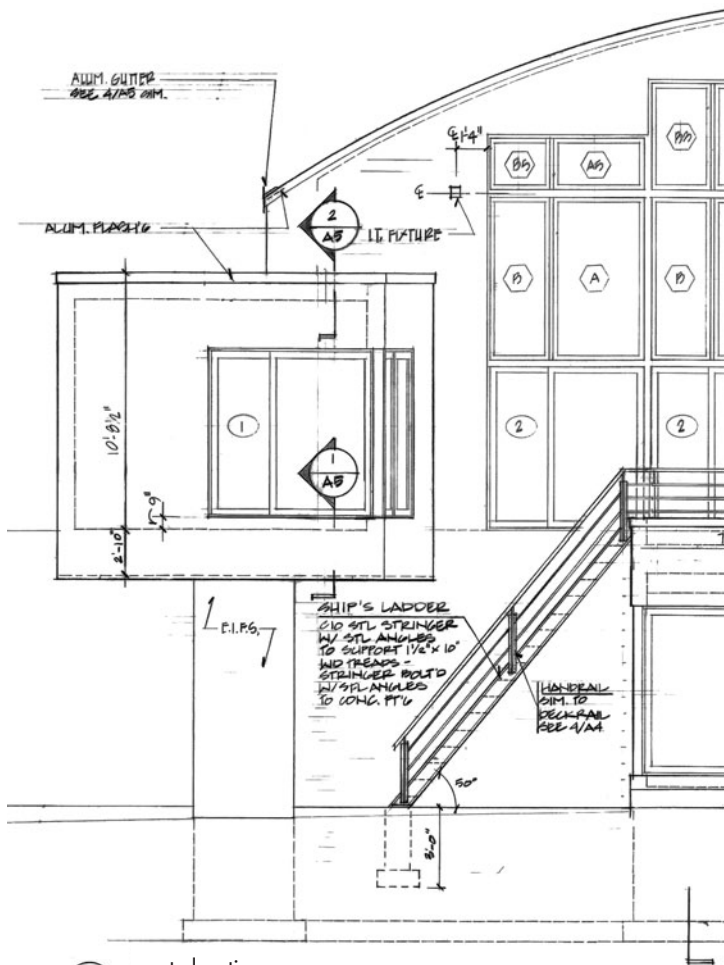

1 west elevation
1/4" = 1'0"



Previous spread: Peter Stamborg & Paul Aferiat Architects, East Side Apartment, New York, 1991. This and following spread: Schwartz/Silver Architects, Private Home, Copake, New York, 1992. Yellow as a magnet in the landscape: A cubic guest suite is suspended above the hillside via an exposed concrete ledge. Several colors were tested, including the same gray as the side wings, but none had the visual impact of yellow, which while a small percentage of the façade's mass, makes the house a lively visual beacon in a rural idyll.

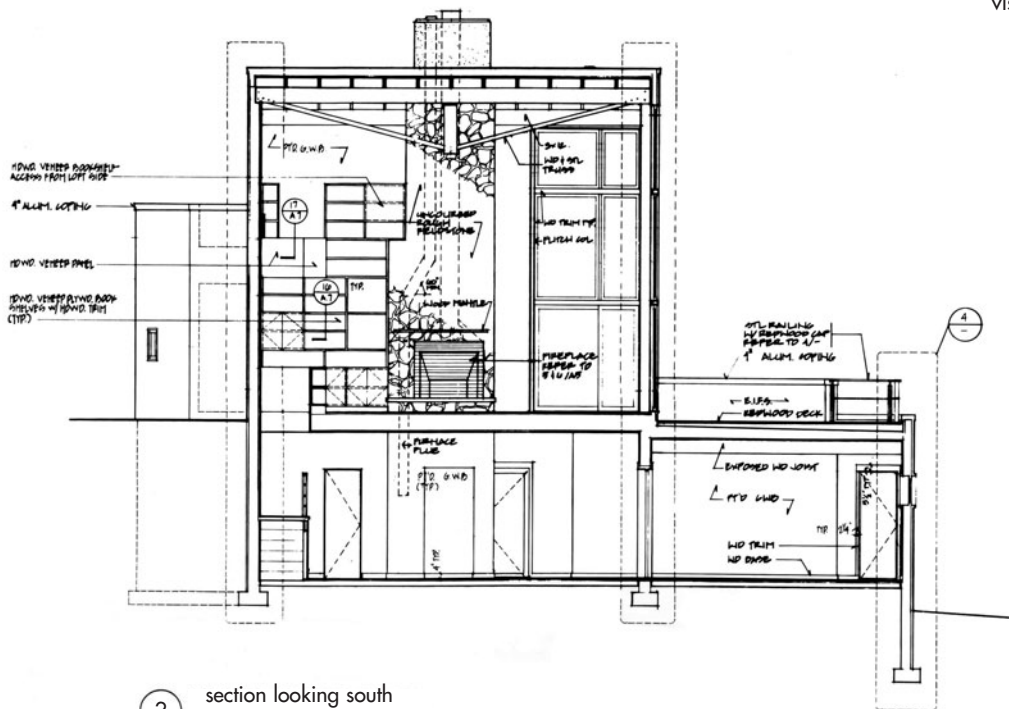

2 section looking south
1/4" = 1'0"







Steven Holl Architects, Makuhari Housing, Chiba, Japan, 1996. Yellow is an active color. Holl designed this complex as divided between “heavy, silent” structures and “lightweight, activist” ones. Here, as if to underscore this building’s falling into the latter category, he chooses a yellow for interior walls similar to that of the building’s façade.









Steven Holl Architects, D.E. Shaw & Company Architects, New York, 1992. Notches in the wall of the double-height reception area are strategically lit so as to show the solid/void contrast. A yellow halo effect is created by reflections of the backside of the panels, which are painted yellow and refract light from the outside.

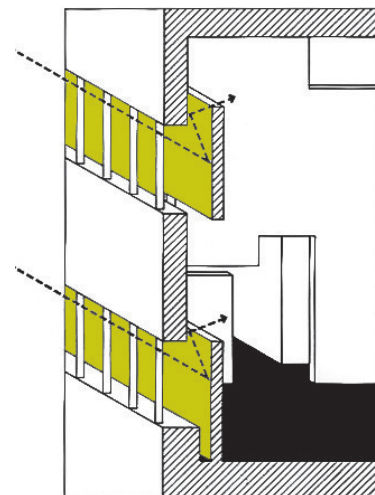







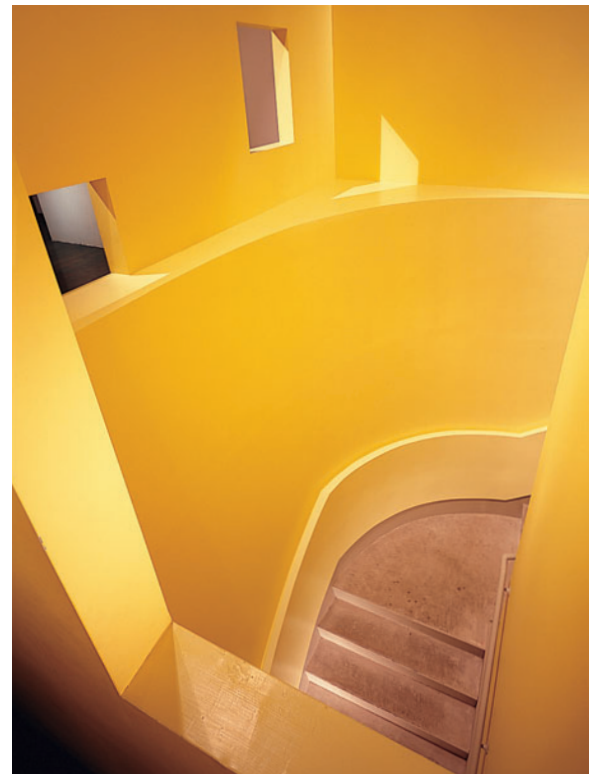

This and previous spread: Maya Lin Studio, Museum for African Art, New York, 1993. Yellow serves to direct the sequence of movement within an exhibition space. Upon entering, visitors see a stairwell in the distance whose walls seem a hearth of warmth and light. Descending first to take in the lower level galleries, they then proceed into the golden well, whose coloration subtly lightens as they move upward.

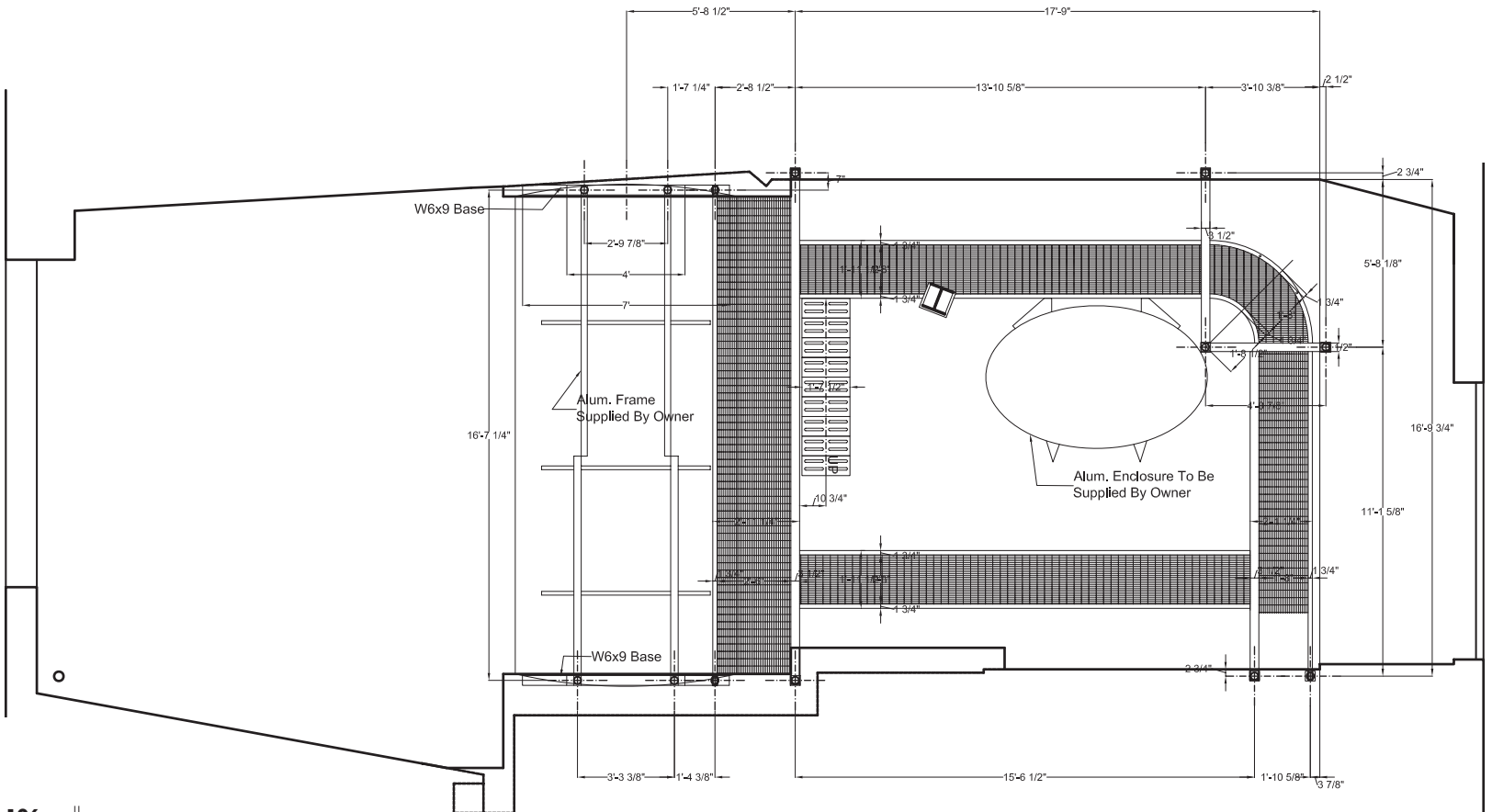
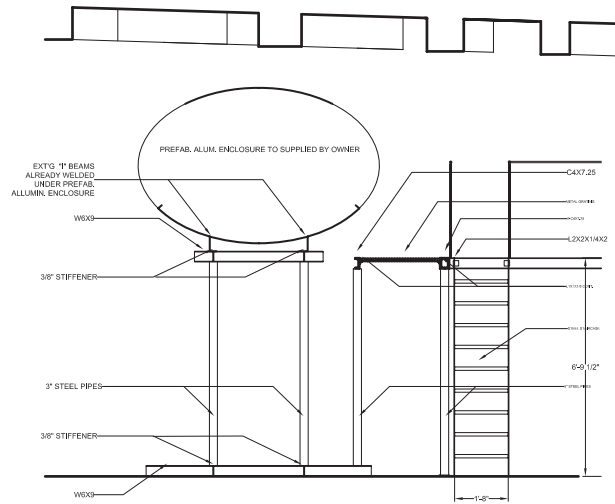







LOT/EK, Morton Residence, New York, 1999. A used petroleum trailer tank was hoisted into this loft, then cut in two sections, one placed vertically and fitted out as a bathroom with a bright yellow interior. The twin section is converted into a sleeping chamber.



brown

Brown is comforting and familiar, a color rife throughout nature, where it appears in innumerable shades. ■ It is stone, brick, terra cotta and other materials wrought from the earth. ■ It is the infinite variety and pattern of wood. ■ Lewis Mumford used brown as a metaphor for a nineteenth-century decline in taste: "By the time the [Civil] war was over, browns had spread everywhere: mediocre drabs, dingy chocolate browns, sooty browns that merged into black. Autumn had come." ■ In a less dark interpretation, T.S. Eliot wrote: "I think that the river is a strong brown god—sullen, untamed and intractable."



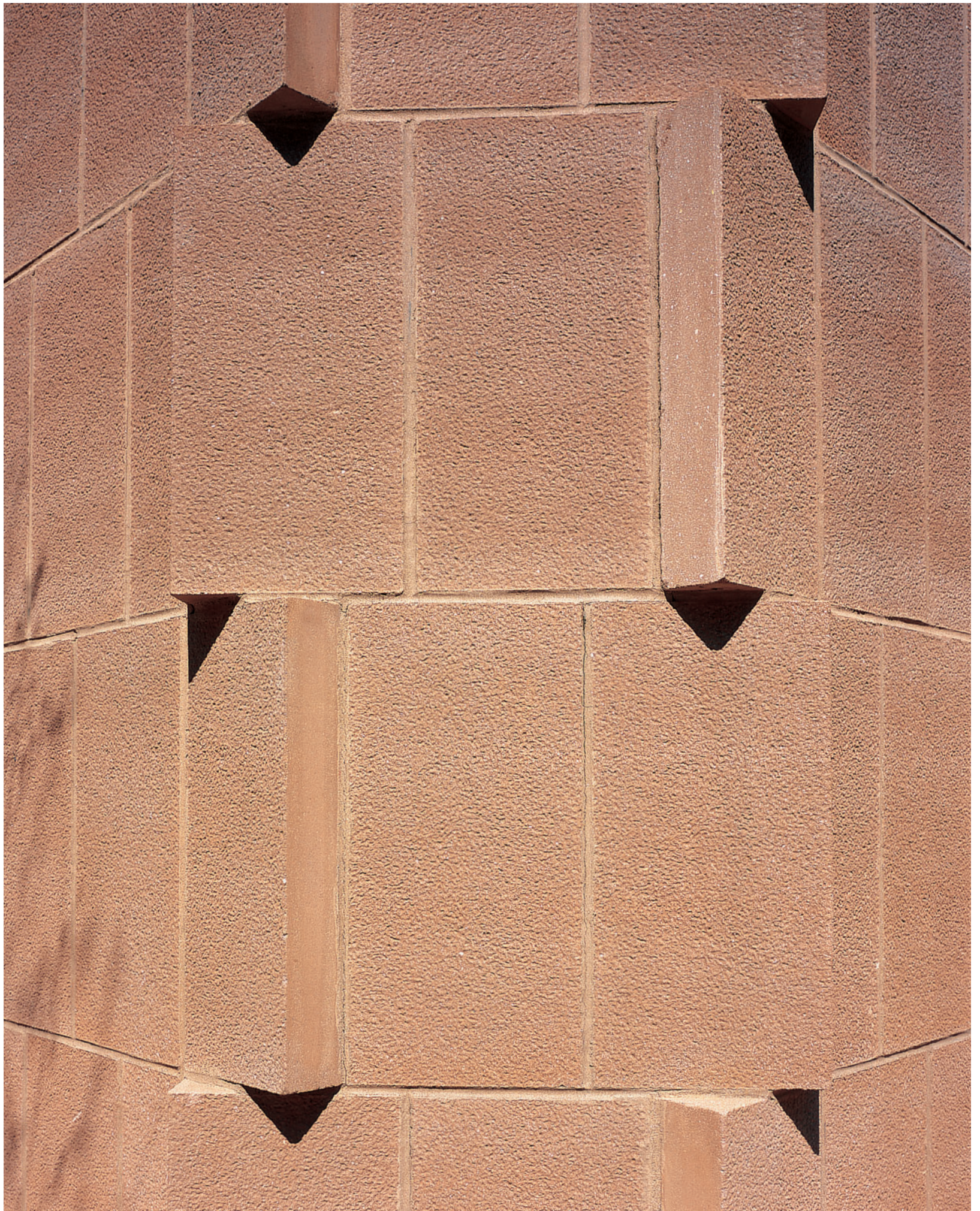

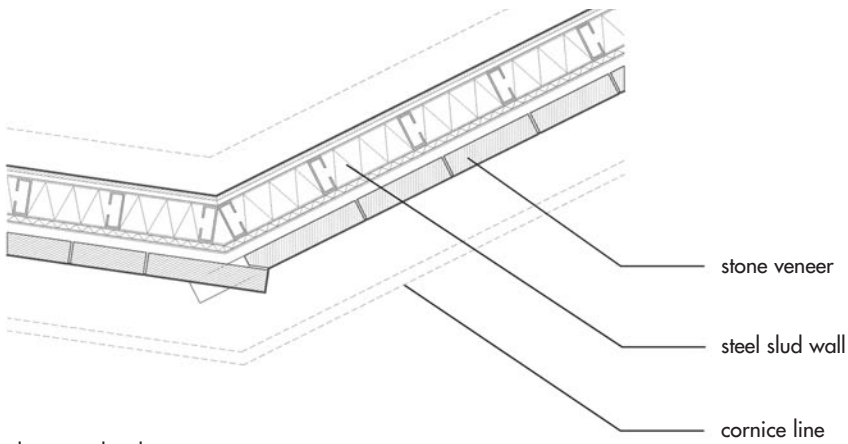

elevation detail

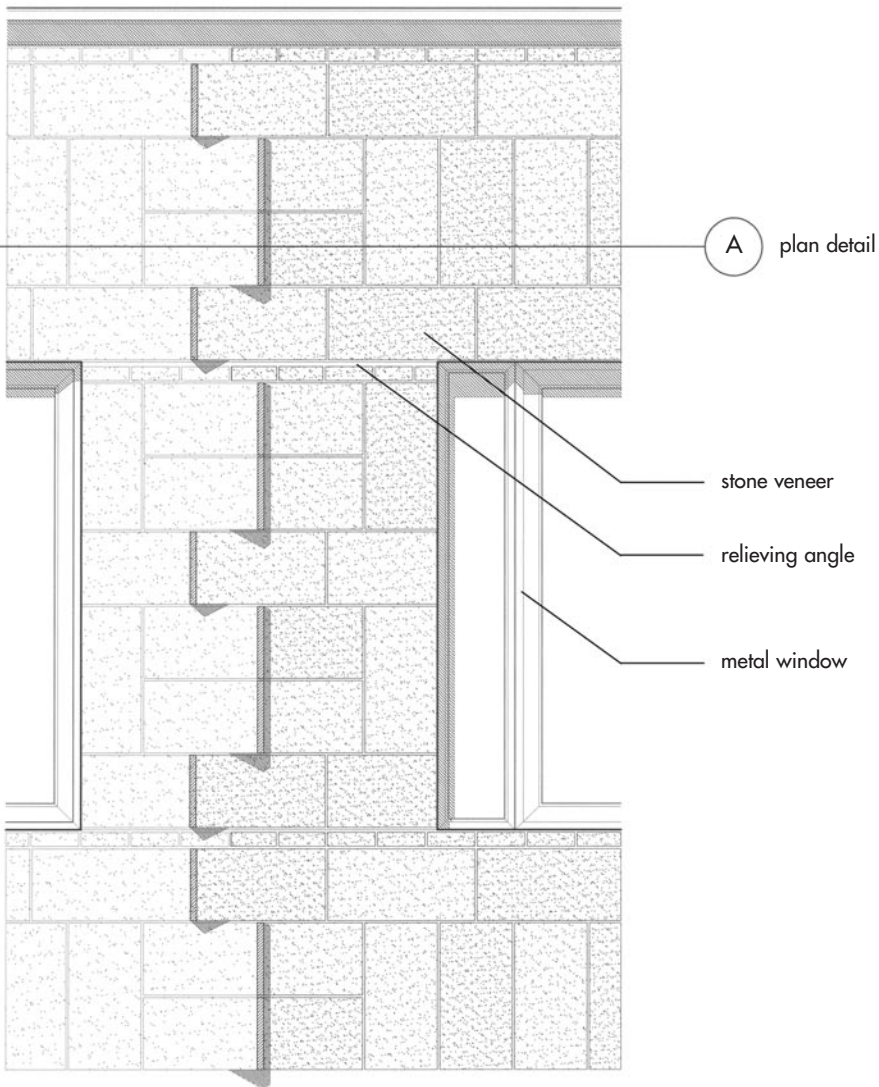

A plan detail



Previous spread: Kohn Pedersen Fox Associates, Morgan Grenfell Offices, New York, 1989. This spread: Douglas Dolezal Architecture, Wilkes Passage Building, Boston, 2003. Cast stone blocks in a rich tobacco color are overlaid with a veneer of stone in a lighter color for the main façade of this apartment building. The architect strove at once to emphasize the essentially non-structural nature of the stone—the building is steel-framed—and to provide a context with many of the neighborhood's stone churches. Unlike brick and concrete block, this cast stone can be meticulously sliced, and the architect uses the building's corners as an opportunity to show off the finely honed ends that result.

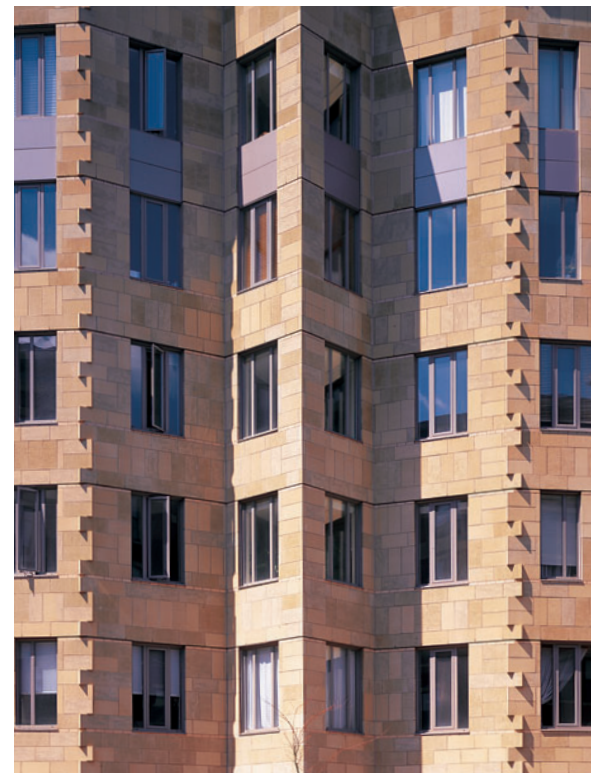

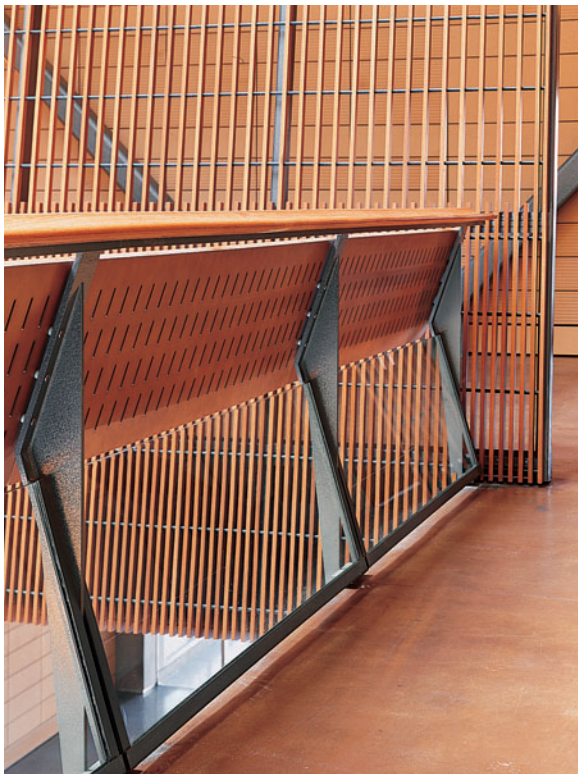

Steven Ehrlich Architects, 675 West Kendall Street, Cambridge, Massachusetts, 2004. For this biotechnology office building, the architects searched for a counterpoint to the slick surfaces of metal and glass that exist elsewhere within the vast 6-story central space. They chose in slats of hemlock, which they stained to match the darker teak of the atrium handrails. Acid-etched concrete floors treated to resemble brown leather also serve as a warm foil to the otherwise machine-like materials and sensibilities within the atrium.

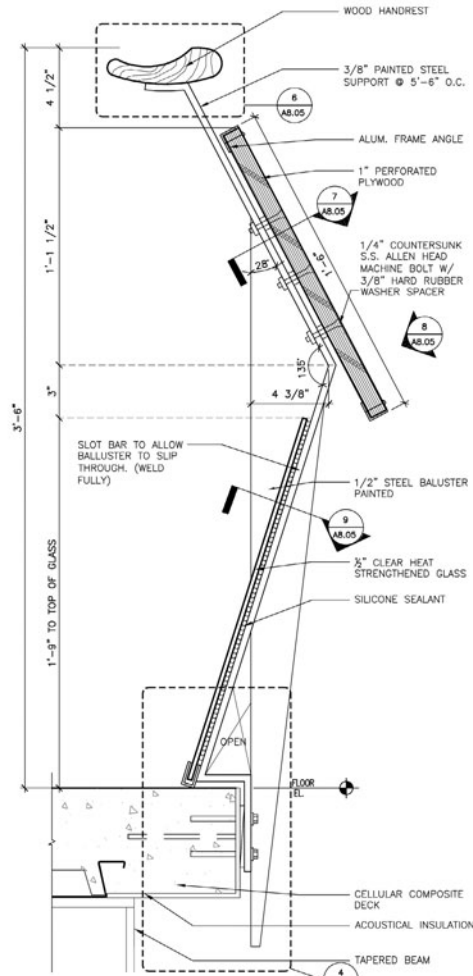

5 guardrail #2
scale: 3"=1'-0"

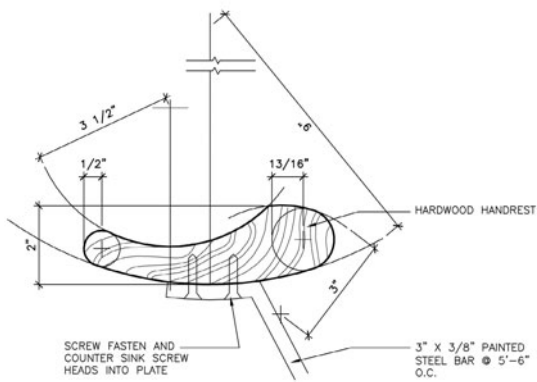

6 guardrail #2 handrest
scale: 6"=1'-0"

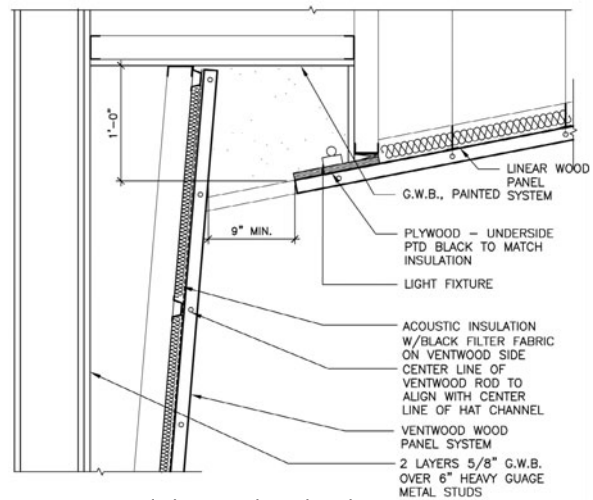

4 section at light cove above bench
scale: 1-1/2"=1'-0"

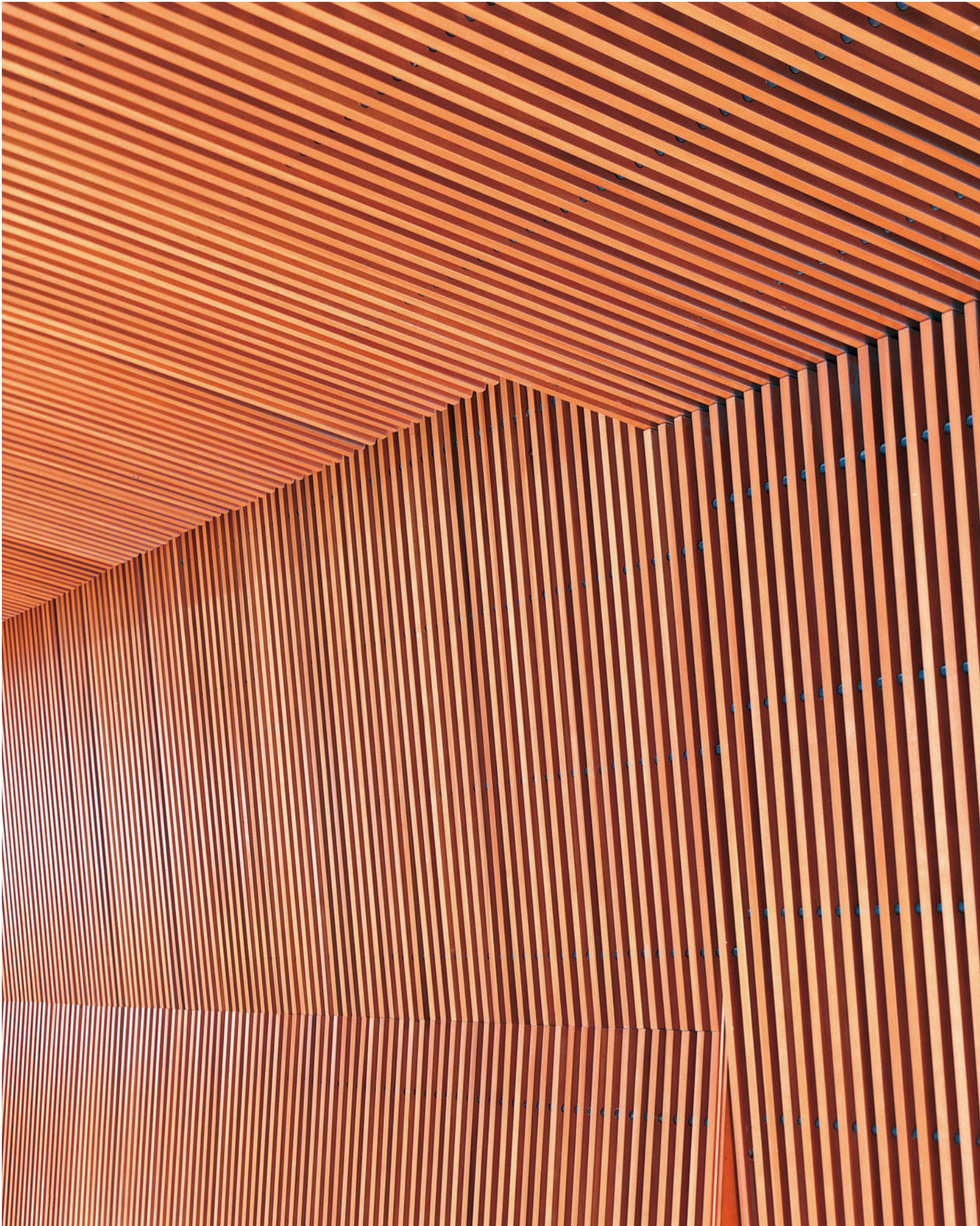





Asfour & Guzy Associates Architects, Offices of Kirshenbaum Bond & Partners, New York, 1996. Some designers attempt to either divorce color from form or to set the two against each other—an aggressive object rendered in a calming color. But here the architects have opted to mix strength with strength—this russet-colored stairway reads in elevation like a lightning bolt, cutting up through the center of the space. Adding to the effect is a totemic column of light that runs the entire four-story vertical height.









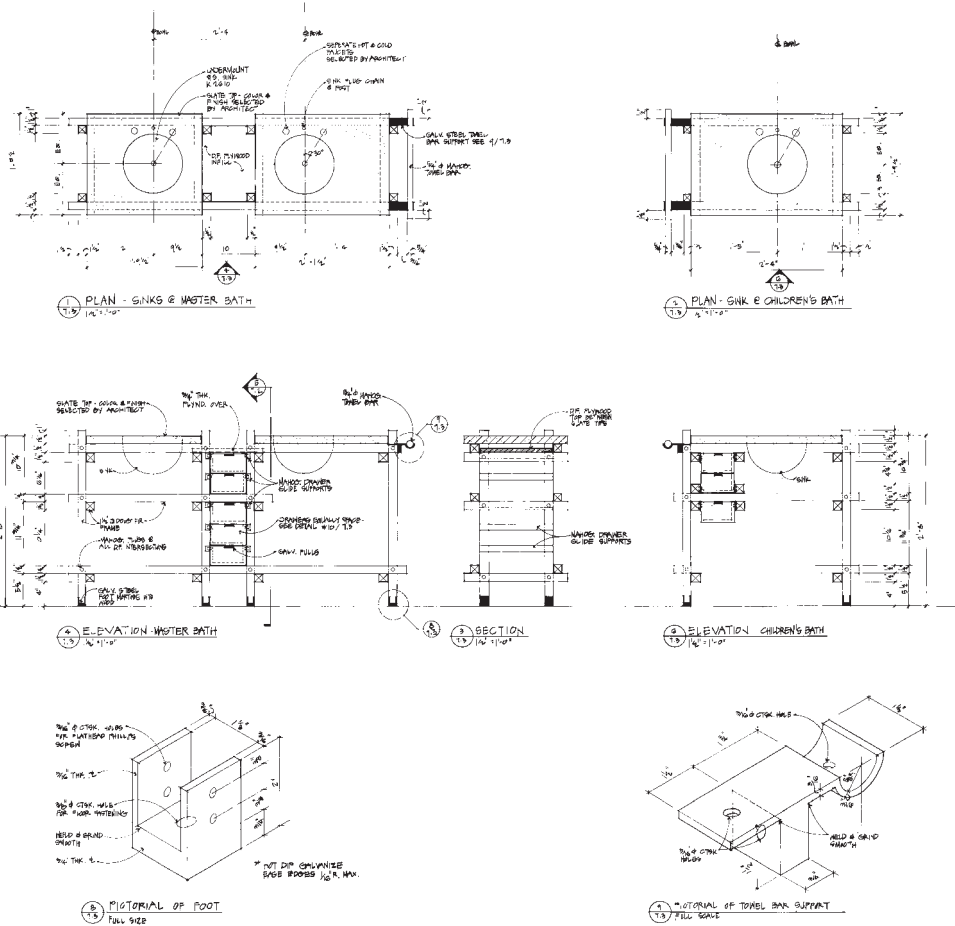
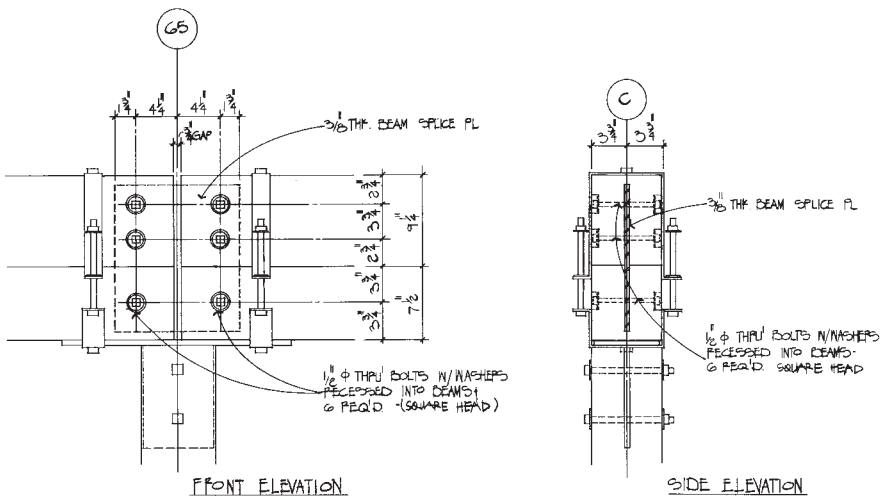

Previous spread: Yoshi Matsuyama Architecture, Sushi Yasuda Restaurant, New York, 2000. Located in the heart of bustling midtown Manhattan, this Japanese restaurant is rendered largely in golden-colored solid bamboo planks. The planks have slightly different finishes and express a variety of colorations, while the geometric grid pattern creates a sense of calm and order. This spread: Bohlin Cywinski Jackson, Ledge House, Catocin Mountains, Maryland, 1996. Brown as a backdrop for a house overlooking the forest and a stream. Logs, milled timbers and stonework create an evocative quarry-like place in the forest. The living area unfolds between a cedar wall on a stone ledge and a transparent glass face.



Smith and Thompson Architects, Private Apartment, New York, 1995. Not all tranquil, Zen-like spaces need to be white. This design shows how an Asian sensibility can be brought to bear using the light honey color of maple. The wood is used as a surface throughout the apartment, while virtually invisible but handy storage units are placed at key points.









Archi-Tectonics, Wooster Street Loft, New York, 1998. The soft and warm brown tones help counterbalance the use in other parts of this space of an aluminum and blue/green glass organizing partition. Here for the bedroom oak floors are matched with custom-built walnut shelving and cabinetry. A fireplace adds a darker note in a color that hovers between brown and black.

7 ELEVATION STEEL STRUCTURE TABLE WITH WOOD TOP
1" = 1'-0"

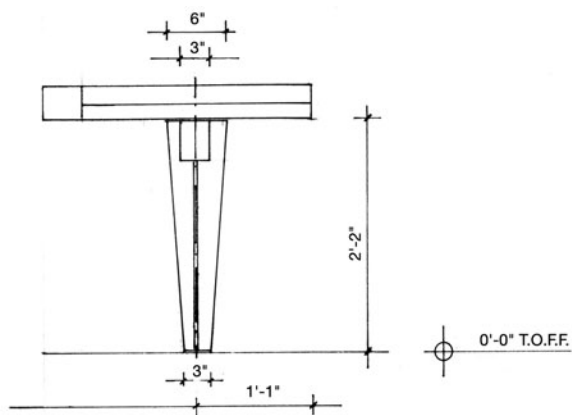
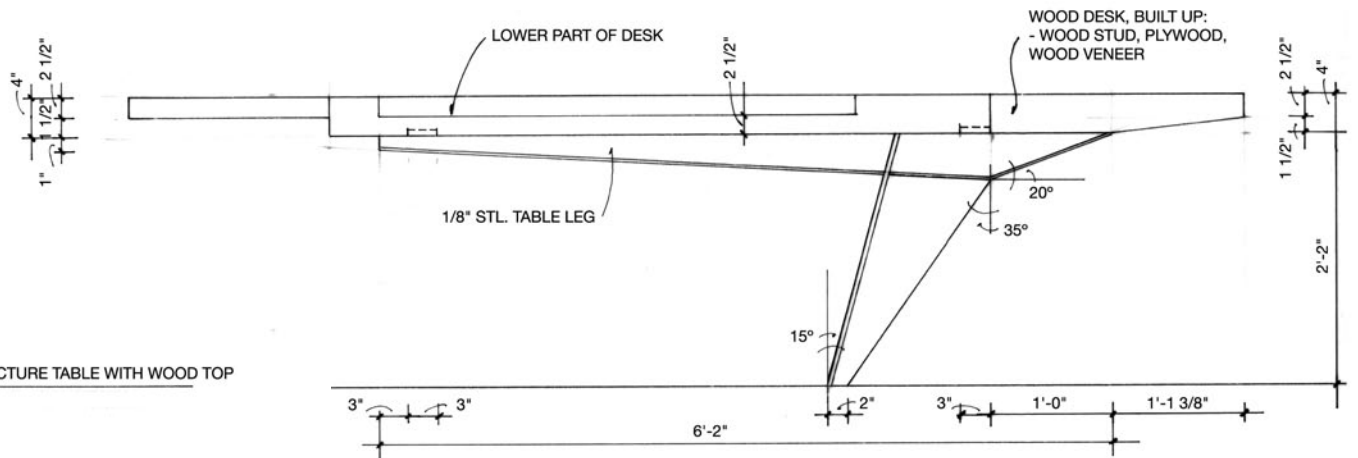

8 ELEVATION TABLE LEG
3" = 1'-0"

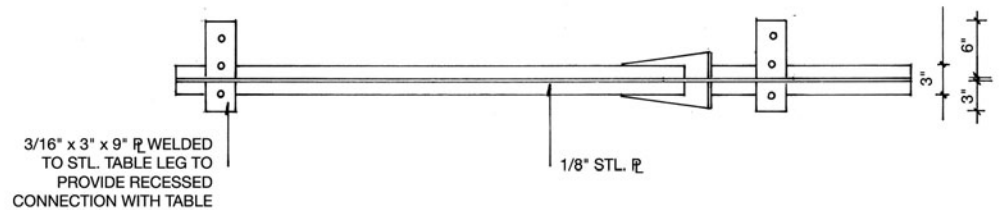

12 TOP VIEW TABLE LEG
1" = 1'-0"



Karen Fairbanks-Scott Marble Architects, Private Loft, New York, 1997. A weathered brown/black steel screen is perforated with tiny holes and can be slid closed and open to separate the kitchen from the guest room or to transform this space into the dining room. Against this backdrop are light brown leather Parisian club chairs and the iconic Z-shaped chair in blonde wood.



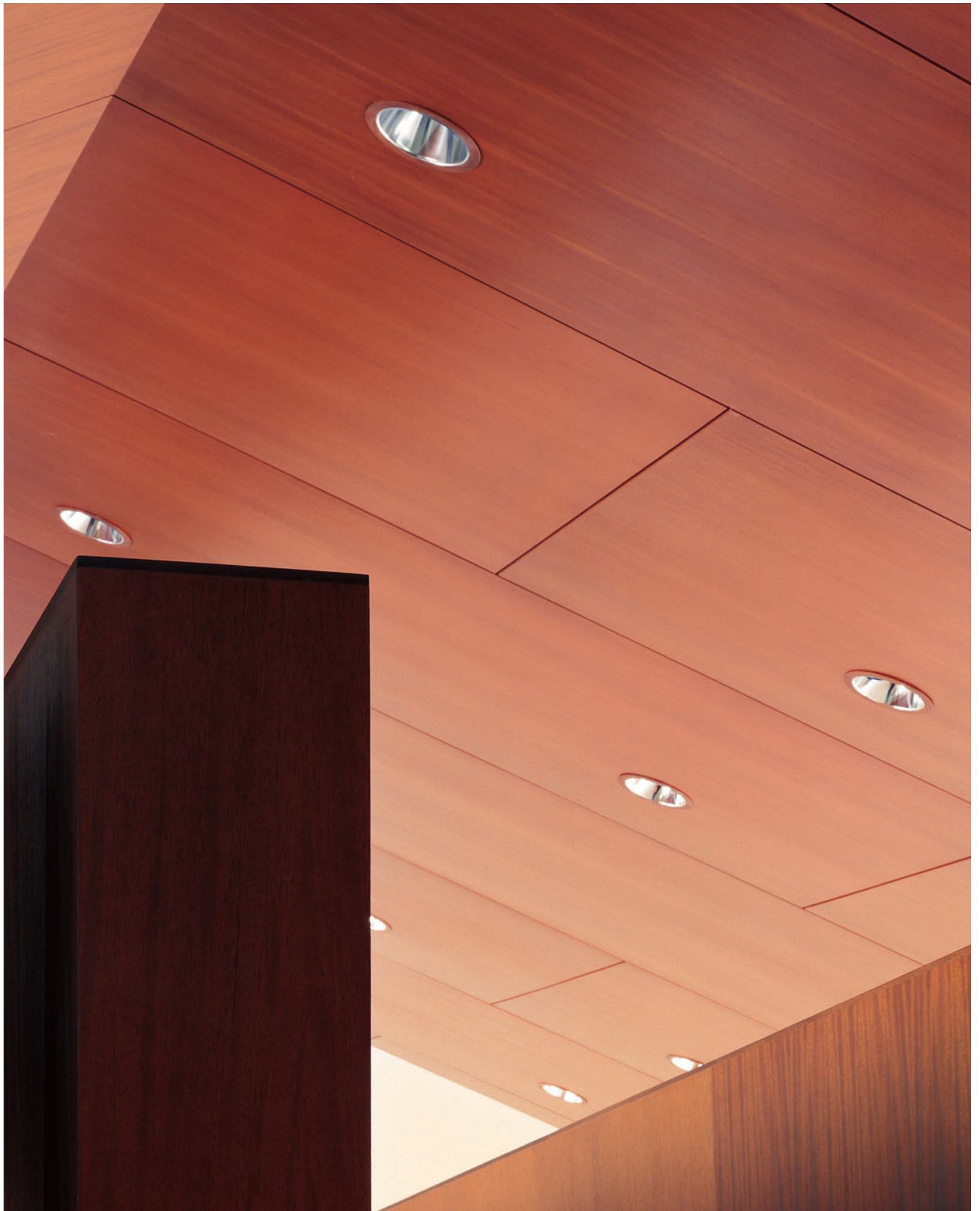

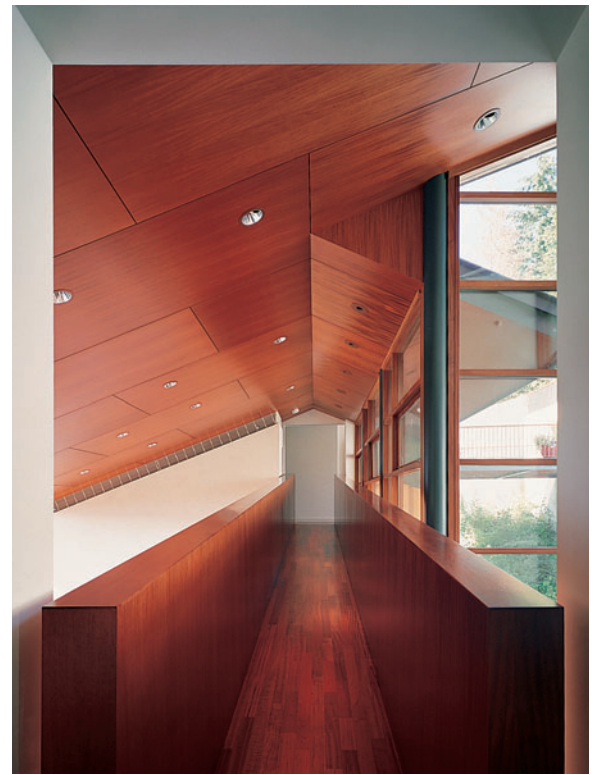
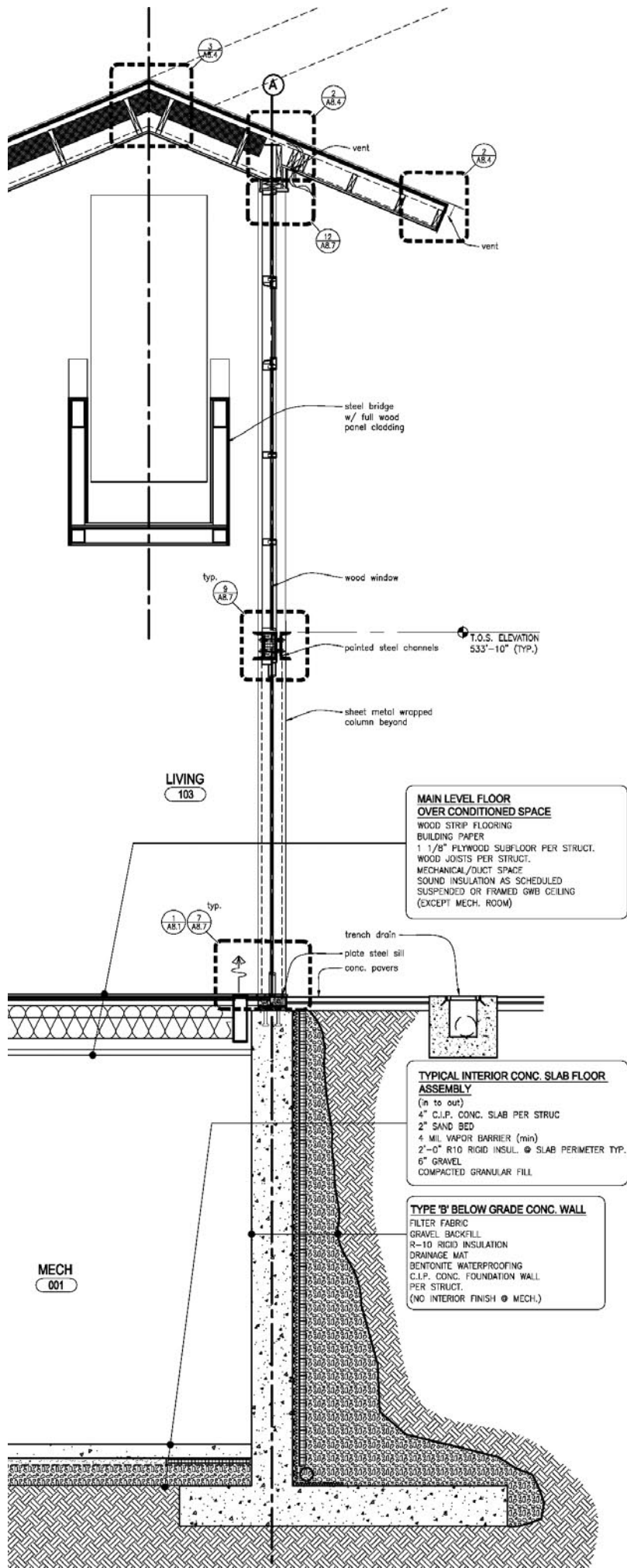

Olson Sundberg Kundig Allen Architects, Hill House Residence, Mercer Island, Washington, 2003. Mahogany in its natural, rich brown color is used here for the floor, cabinetry, railings and window frames. The ceiling is constructed of panels that are mahogany veneered plywood. The wood was chosen for its durability, and was given a clear finish to bring out its natural hue.

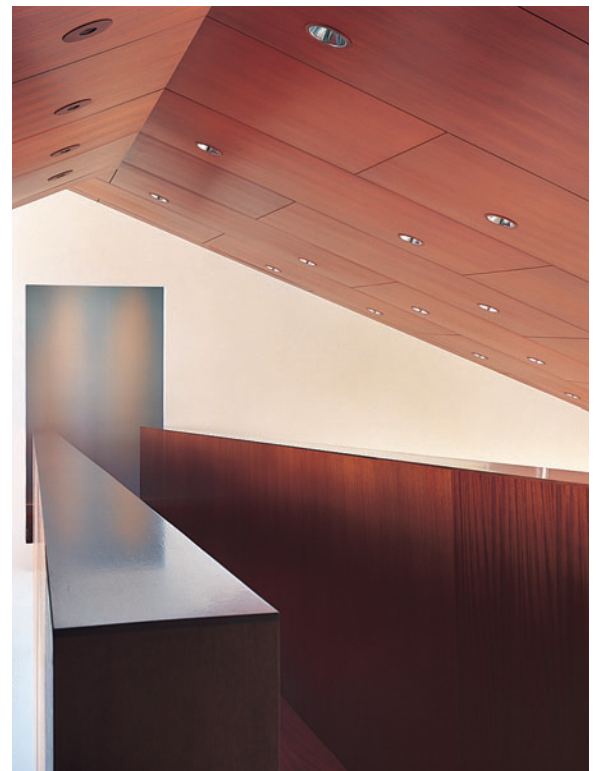



Smith-Miller + Hawkinson, Private Apartment, New York, 1993. Cherrywood and pearwood are browns that tend toward pink and red. Therefore, they are bold and assertive browns, as contrasted with the softness usually associated with the color. Here floors are cherrywood while built-in shelving and cabinetry are pearwood. In the bedroom a single unit serves the function of headboard, counter and folding bedside table, all in the same vibrant hue.







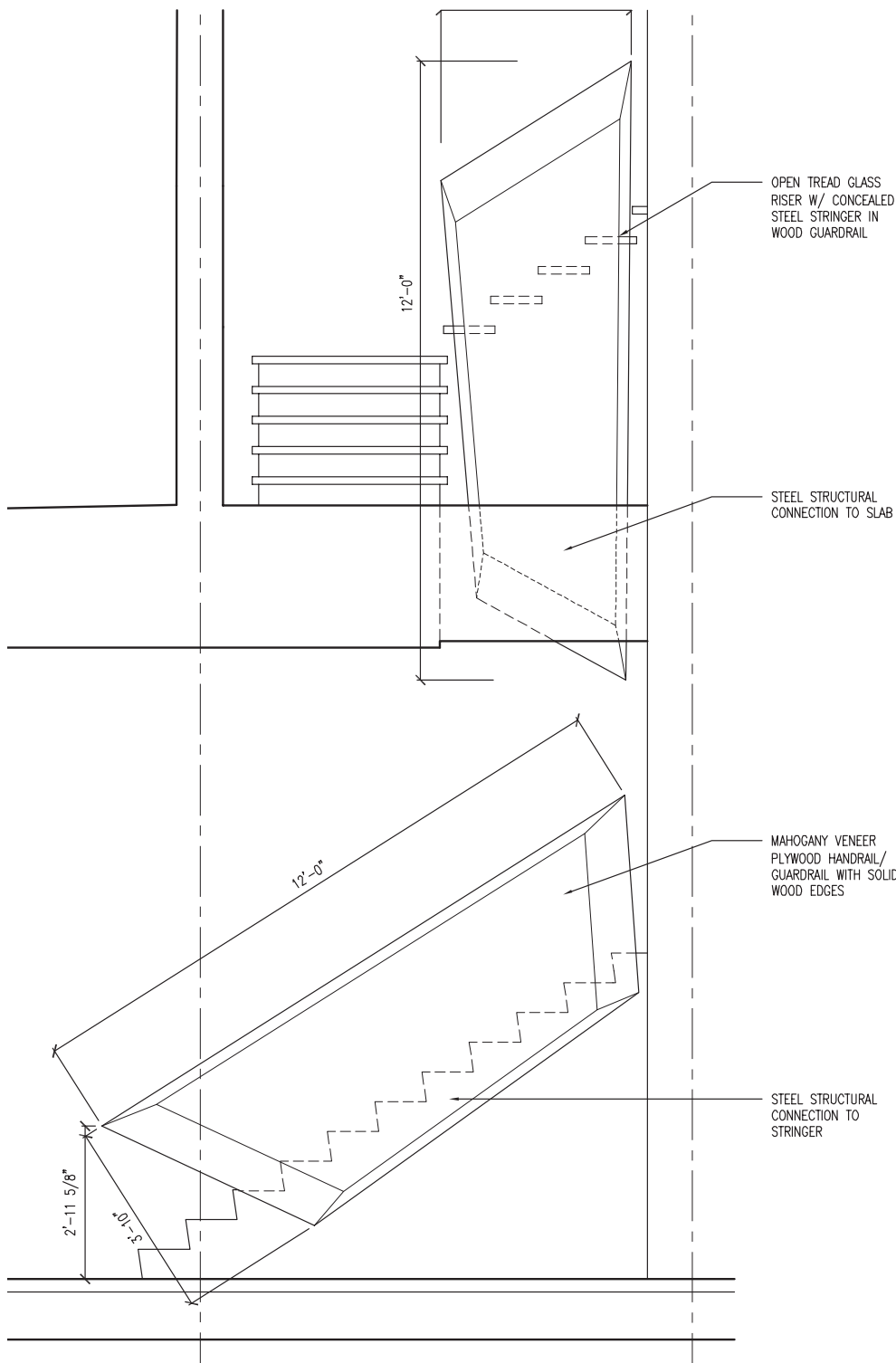

Rogers Marvel Architects, Penthouse Loft, New York, 2003. An opening along the main stairwell is framed in rich dark wood, which focuses attention on the great room beyond, itself a study in lighter colors and bathed in natural light from sheer curtains. The same type of wood is reprised in slablike banisters that form angular, geometric elements for both of the apartment's staircases.



gray

Gray-colored stone conjures up images of venerability and permanence—an English country church, an Oxford quadrangle, a granite entablature. ■ Contrast this and other natural building materials with the raw, brutal authenticity of gray concrete. ■ Sleek gray metals such as brushed stainless steel add a machine-like edge, and as handles and railings are often cool and silky to the touch. ■ But stone continues to hold fascination as a primordial material. ■ “The spacious plain of Sarum, spread like ocean’s boundless round, where solitary Stonehenge, gray with moss, ruin of ages, nods,” wrote John Dyer.







Previous spread: Hariri & Hariri, Buziak Penthouse, New York, 1989. This spread: Steven Holl Architects, Basilica Palladiana Exhibition, Vicenza, 2002. Contrasting the somber, machine-like gray of metal panels against the effusive and polychromatic Basilica at Vicenza by Palladio, Holl here constructs a facsimile of his New Mexico Turbulence House for an self-designed exhibition on his work.

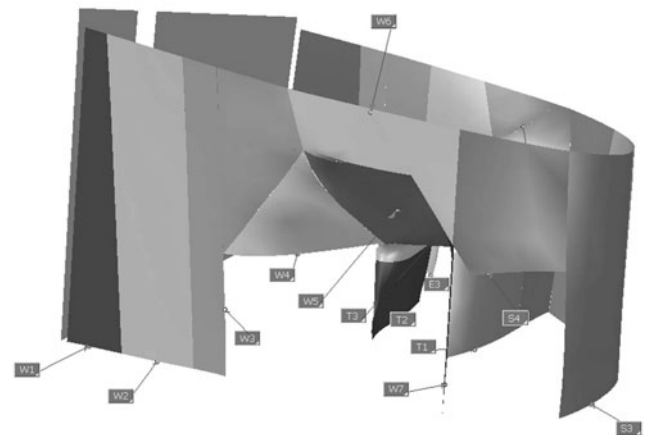



Steven Holl Architects, Makuhari Housing, Chiba, Japan, 1996. Gray is the most deferential of colors. Like the proverbial flannel suited Japanese executive, it is loathe to call attention to itself, preferring to seek the greater harmonious whole. Here we notice not the hue of these metal and concrete objects, but their shapes, their textures and the various shadows falling on and near them.





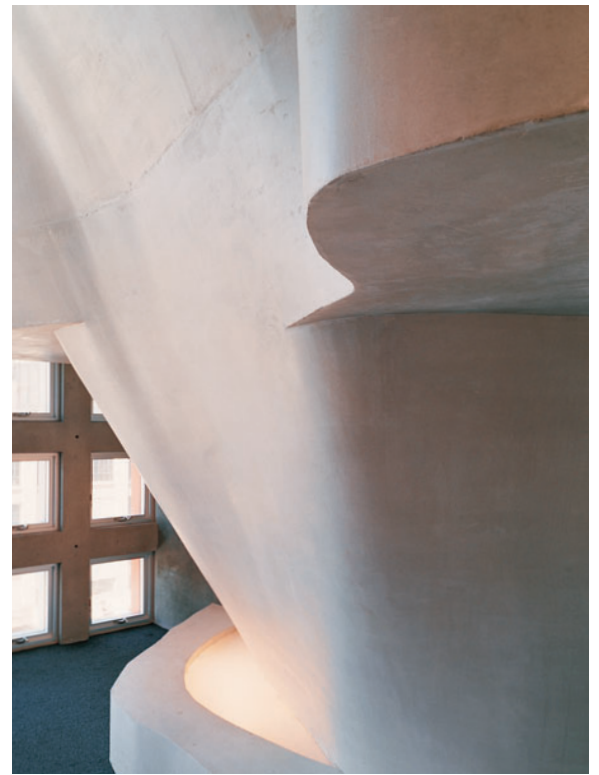
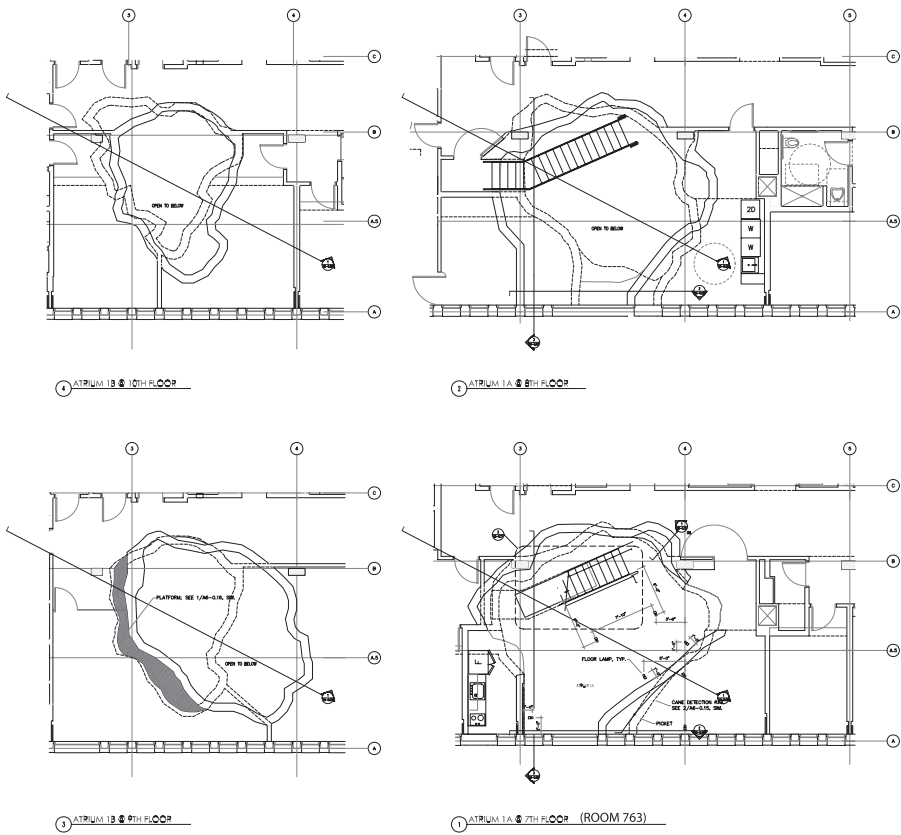

Steven Holl Architects, Simmons Hall MIT, Cambridge, Massachusetts, 2002. Just as the right-angle grid of the exterior of the building gives little hint of these curved interior spaces, so the interior/exterior color scheme is reversed, to wit: Outside brightly colored, inside restrained and tranquil. The gray color of these amorphous student common areas suggests that they are neutral places where all can gather, as well as places of quiet respite.

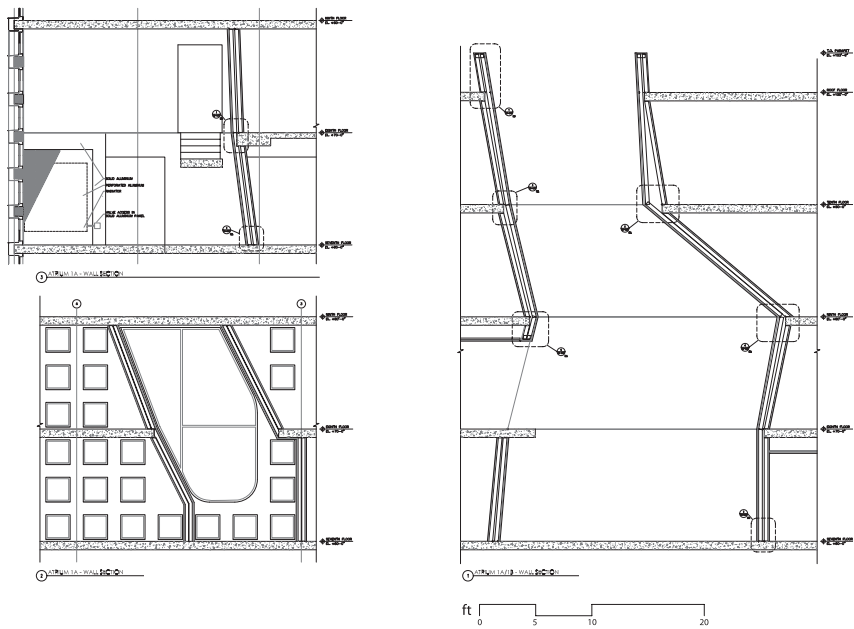
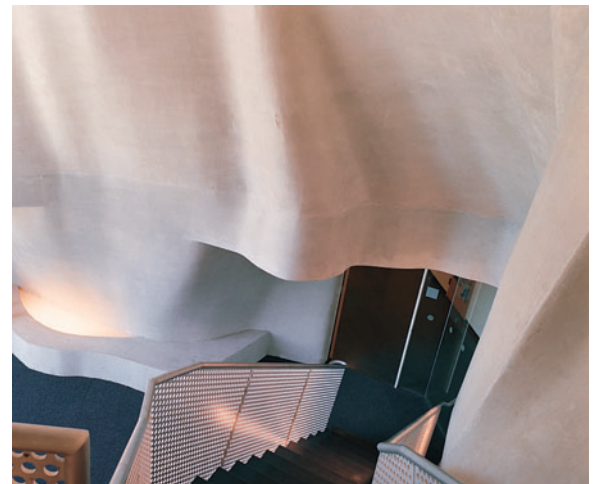



Steven Holl Architects, College of Architecture and Landscape Architecture (CALA), University of Minnesota, Minneapolis, 2002. Holl exploits the character of poured-in-place concrete by leaving it in its natural coloration and rendering it in sculptural forms. Thus this sunlit stairway shows variation in tone on its surfaces, all the more emphasized by the natural illumination.











This and previous spread: Zaha Hadid Architects, Vitra Fire Station, Weil am Rhein, Germany, 1994. The poured-in-place concrete walls and the metal spears supporting the canopy are both nominally gray, but with vastly different effects. The concrete seems to absorb light, the brushed metal plays with it and bounces it back and around its origins; the former is rough and grating to the touch, the latter is smooth and silky.



Zaha Hadid Architects, Vitra Fire Station, Weil am Rhein, Germany, 1994. Poured-in-place concrete's natural color is gray, owing to the presence of iron and manganese oxides. But the rough surface adds yet another chromatic dimension—the minor holes and imperfections become small black canyons that speckle the surface; weather conditions during curing and an infinite number of washes, rubbings and treatments can add tones from dark brown to almost white. Under a blue sky, Hadid's strikingly aggressive forms become like arrows shooting across the heavens.





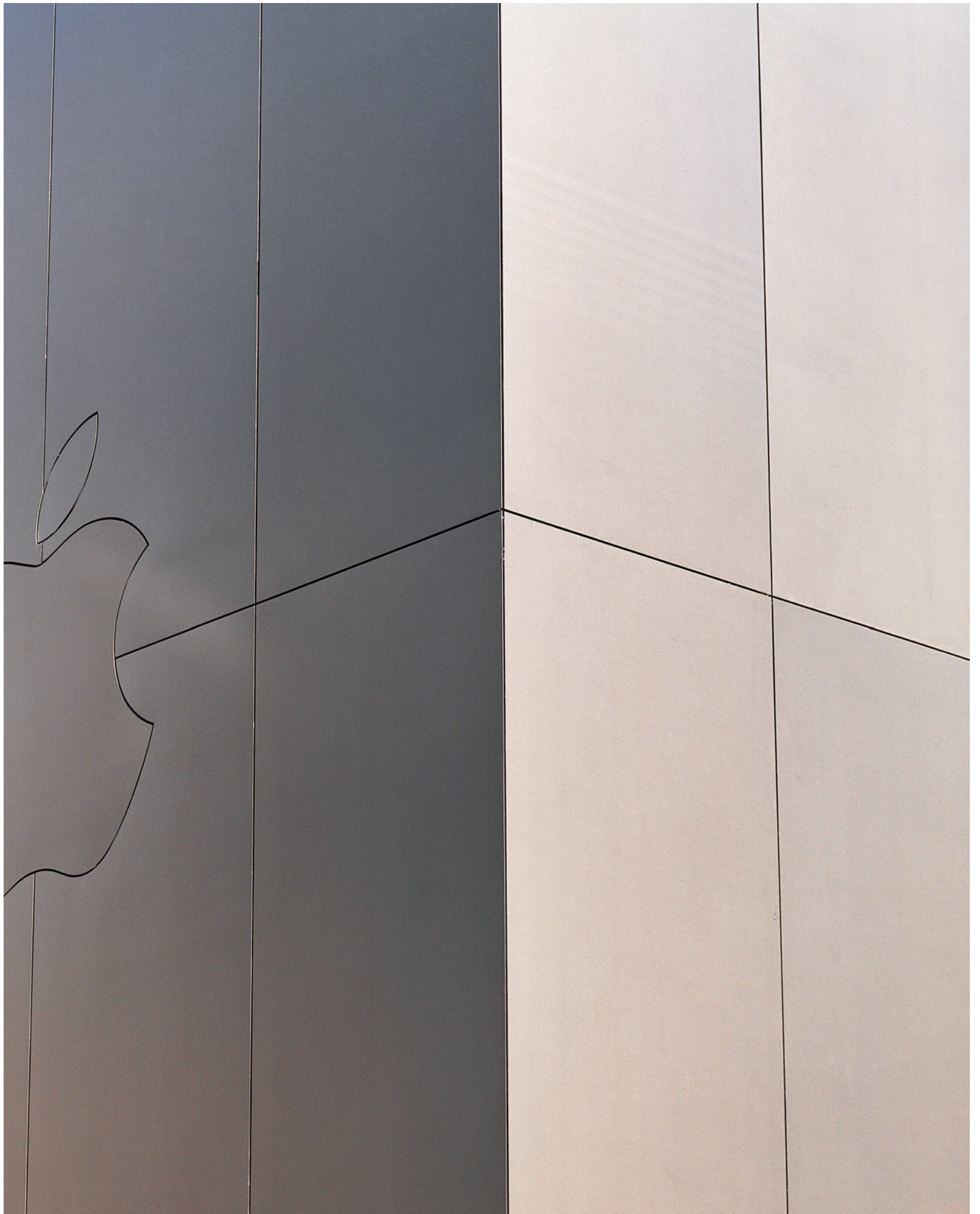



Bohlin Cywinski Jackson, Apple Store, Tokyo, 2003. Stainless steel panels in a precise rectangular grid are broken only by the company logo, which is subtly integrated into the design. Because they are bead blasted and thus slightly reflective, the panels appear to change color with the weather, ranging from cool gray to warm green/gray.

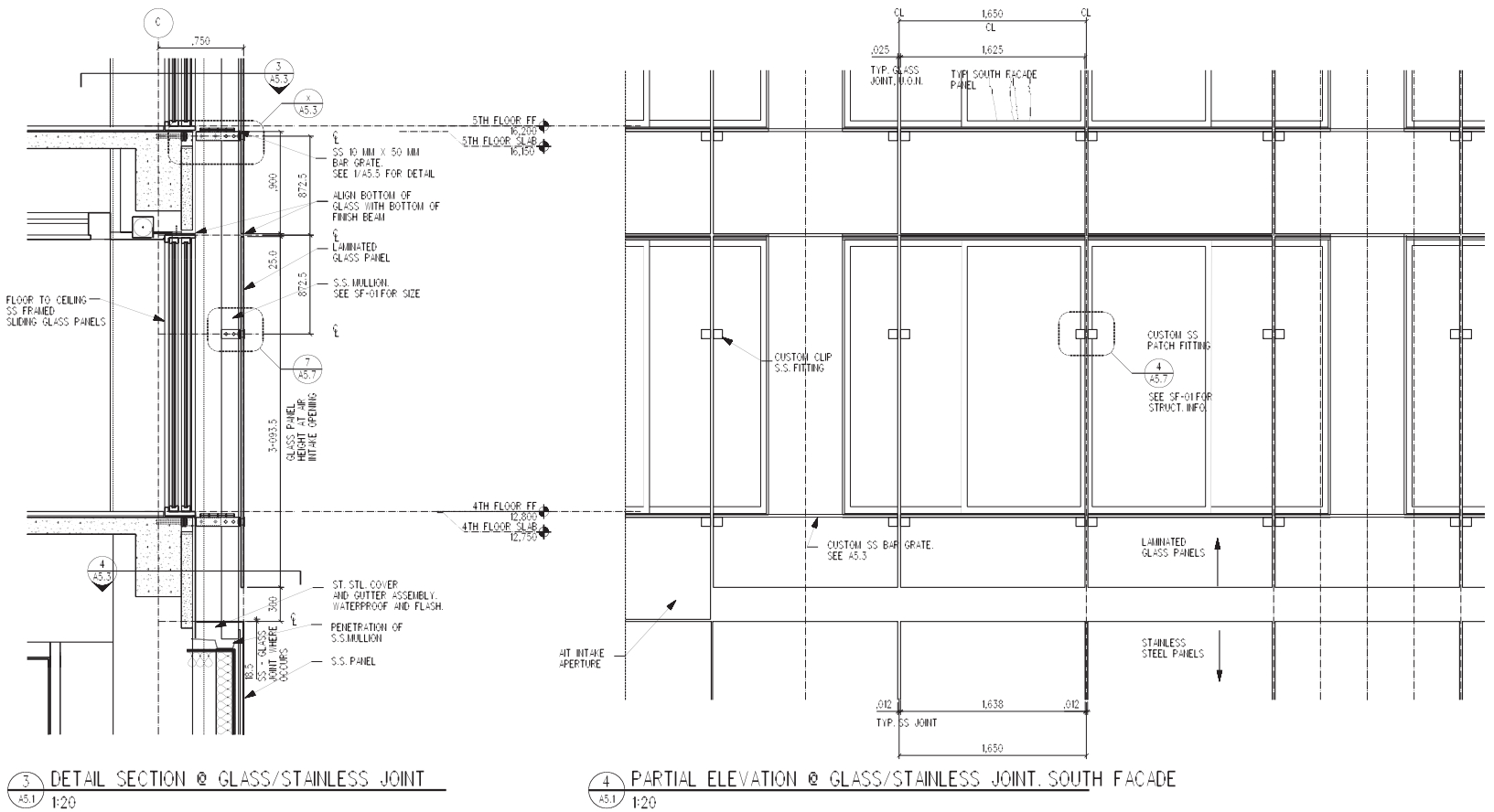







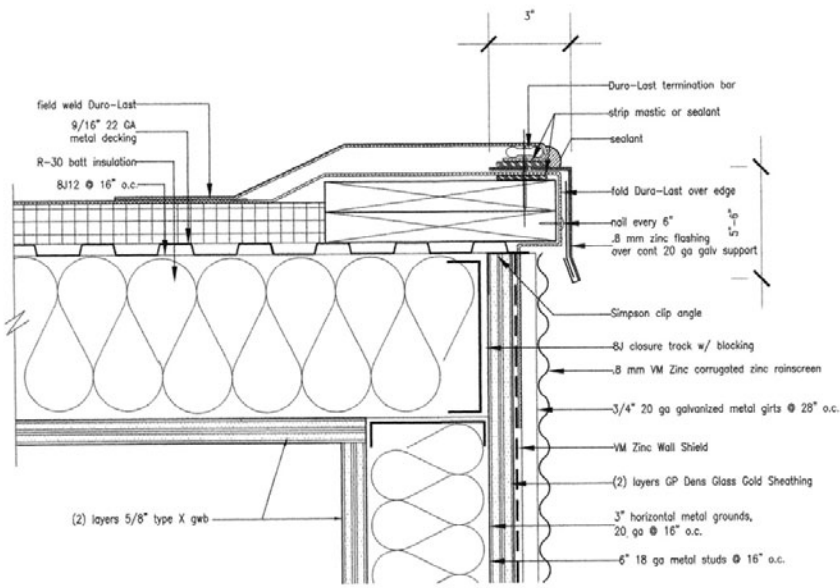

flashing detail @ bulkhead 3"=1'-0"



Previous spread: Peter L. Gluck and Partners, Fowler Residence, New Canaan, Connecticut, 2002. This residence is divided into two masses, a cylinder and a box. The cylinder is meant in form and material to recall humble New England farm structures. This spread: Peter L. Gluck and Partners, Little Sisters of the Assumption Family Health Services, New York, 2003. Gray contains no hue, only tones. And yet the reading of colors often depends greatly on their level of reflection. So here this zinc siding has a tone that is very similar to that of the shiny steel rivets that fasten it to the building. And yet because of the rivets' reflective surface, the two tones seem vastly different.

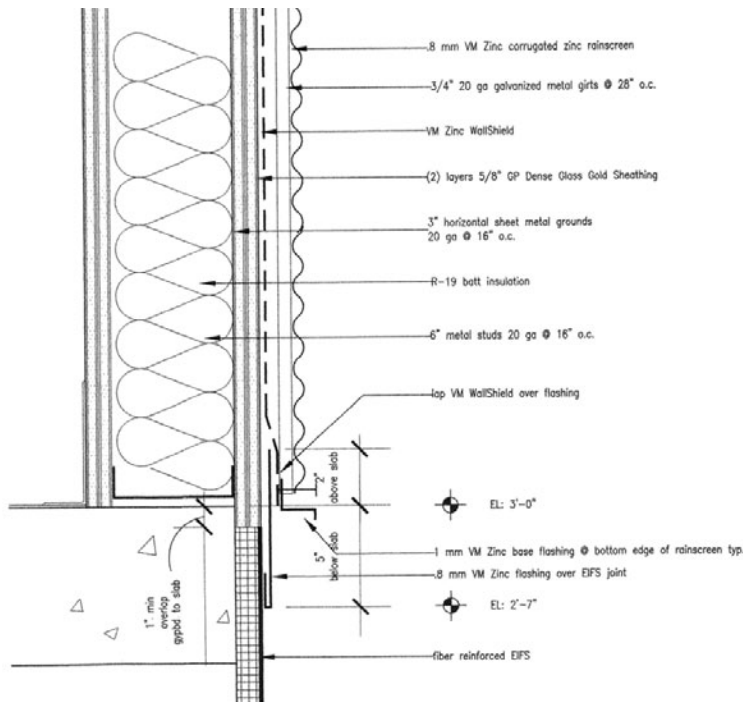

flashing detail 3"=1'-0"



green

"All theory, dear friend, is gray, but the golden tree of actual life springs ever green," said Goethe. ■ The word green comes from the Anglo-Saxon *grene*, which is derived from the old Teutonic root *gro* meaning "growth." ■ As the color most abundant in nature, it was distrusted by the doctrinaire Mondrian, who banished it from his palette. ■ Meanwhile Kandinsky compared green to "the middle note of a violin." ■ It is green's link to the outdoors that explains its appeal. A green indoor space is a refuge, a cool respite from urban life's hard edges. ■ All is green and new and brimming with life.





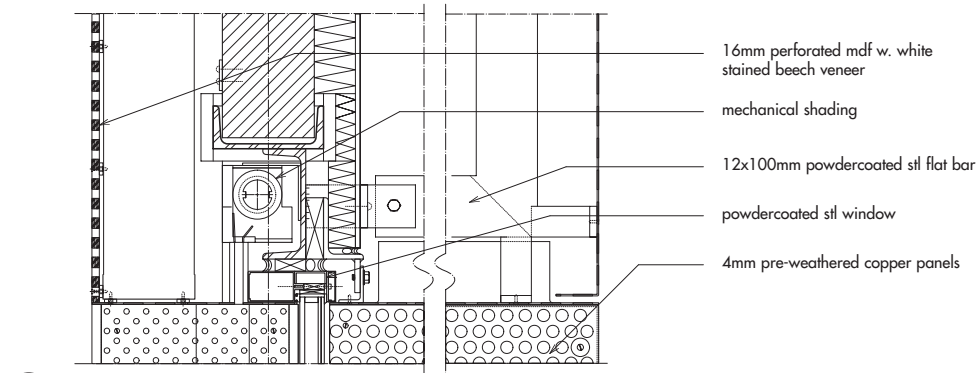

1 window type A, head
scale 1:5

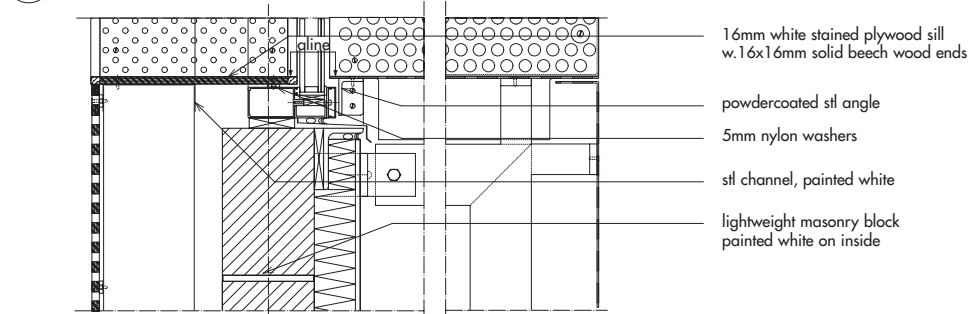

2 window type A, sill
scale 1:5

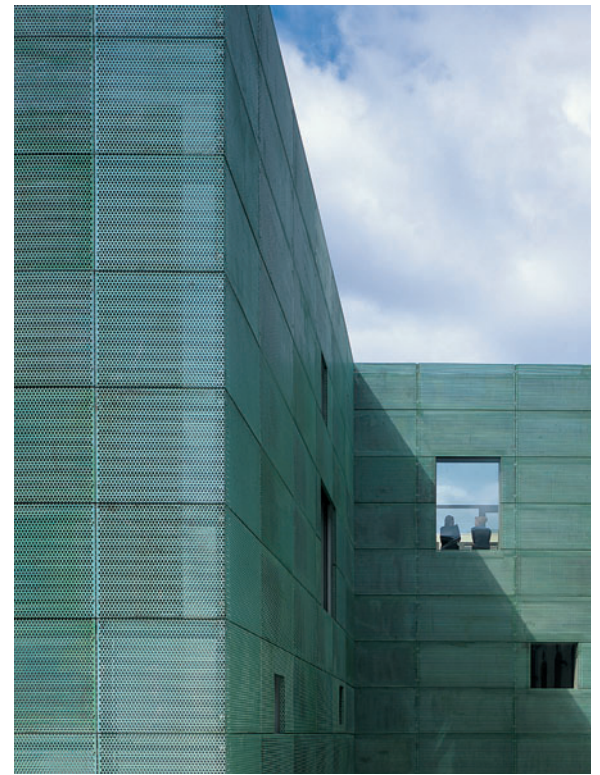

Previous spread: NBBJ, Central Washington Hospital, Wenatchee, Washington, 1992. This and following spread: Steven Hall Architect, Sarphatistraat Offices, Amsterdam, 2000. Just as green weathered copper forms a color contrast to large religious and government buildings in Amsterdam, so this waterside pavilion was designed to stand out from the nineteenth century brick building to which it is attached. So somber brown brick is placed against bright green perforated copper, which turns from its native color to this brilliant green as a direct result of the corrosive action of the atmosphere. Thus, the patination process is twice as quick in urban areas as in rural areas.

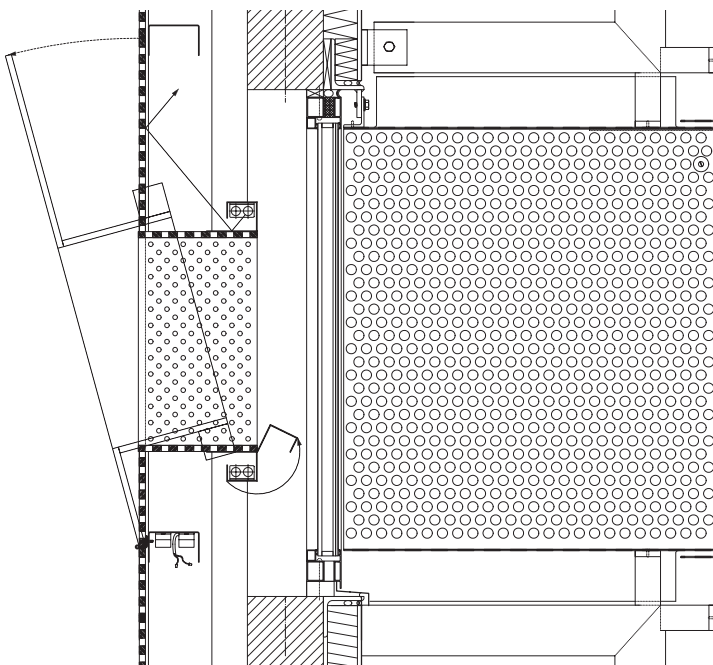

2 window type C, sill
@#4, #15, #35





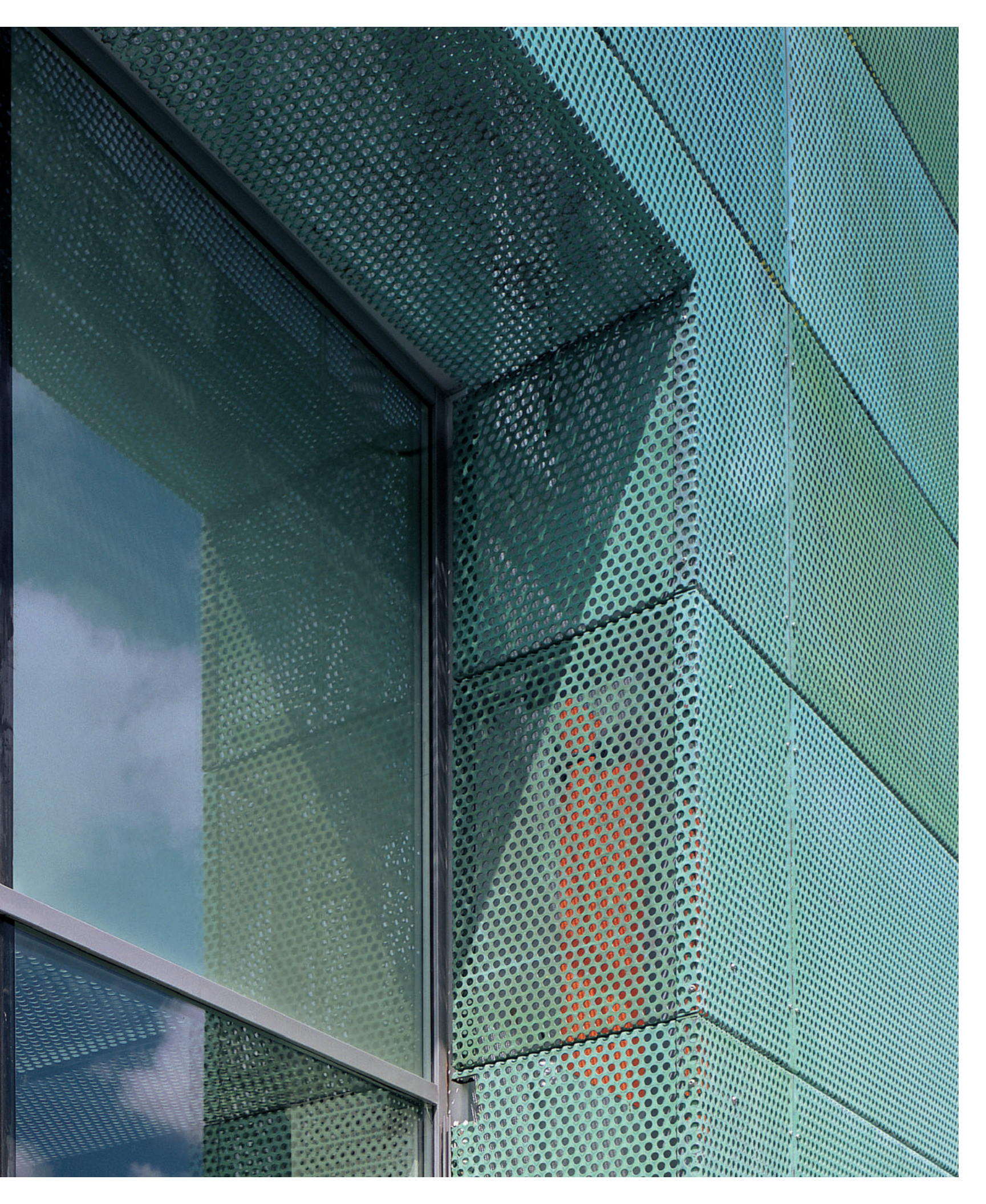



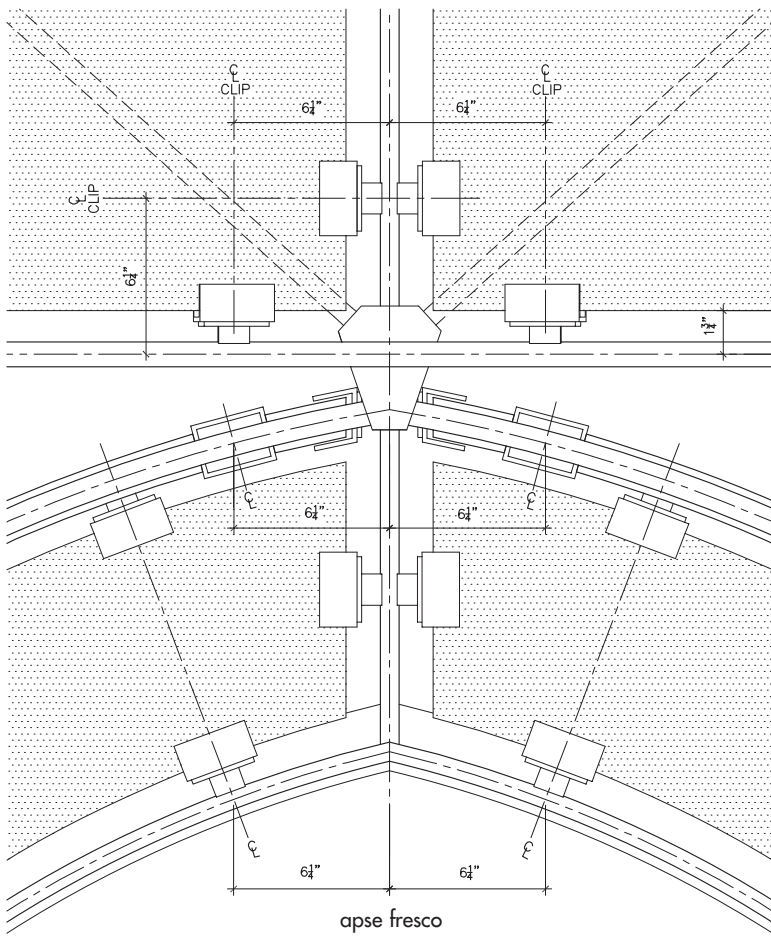

glass clip elevation at drum

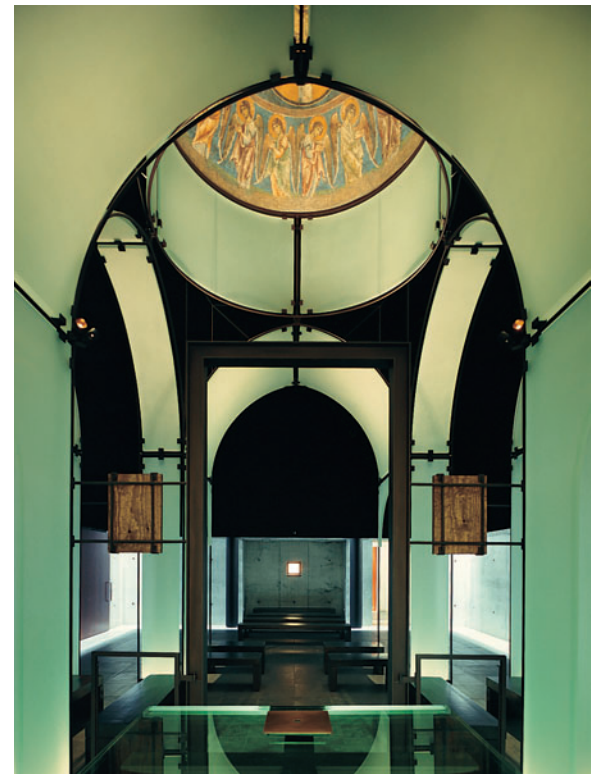

François de Menil, Architect, Byzantine Fresco Chapel Museum, Houston, 1997. Laminated sheets of frosted glass have a light green shade that contrasts with the dark void beyond, drawing the eye upward and lending the space a serene but powerful spiritual presence. The design recalls vaulting and other elements of Byzantine architecture.



Gabellini Associates, Council of Fashion Designers of America Exhibition, New York, 1995. For the entry lobby of a landmark Raymond Hood Art Deco building fronting on Bryant Park, the designers chose a deep cool green for all three perimeter walls of the space, the fourth being the large window overlooking the park. The accessories on display are given a theatrical headdress, translucent material pulled tautly into cone shapes and splashed with varying forms of light. The green background and the green of the park act in symbiosis to bracket and project forth the items on display.









Toshiko Mori Architect, Issey Miyake Pleats Please, New York, 1998. Green is widely known to be associated with coolness and comfort. The designer creates an engaging cubic volume that appears to shelter and soothe, and in perhaps a playful design gesture, also holds the store's cash register.



Karen Bausman Architects, Supermodels Exhibition, Graduate School of Design, Harvard University, Cambridge, Massachusetts, 2002. The architect Karen Bausman chose this “cultivating” single shade of green for the display of her work, stating in the catalog of the exhibition: “My inherently organic processes are expressed overtly, invoking nature or its graphical representations (seeds, shoots, petals, botanical prints, star charts) as abstract templates or iconographic reference points. Tendrils from one project take root in another, double back and cross-germinate.”





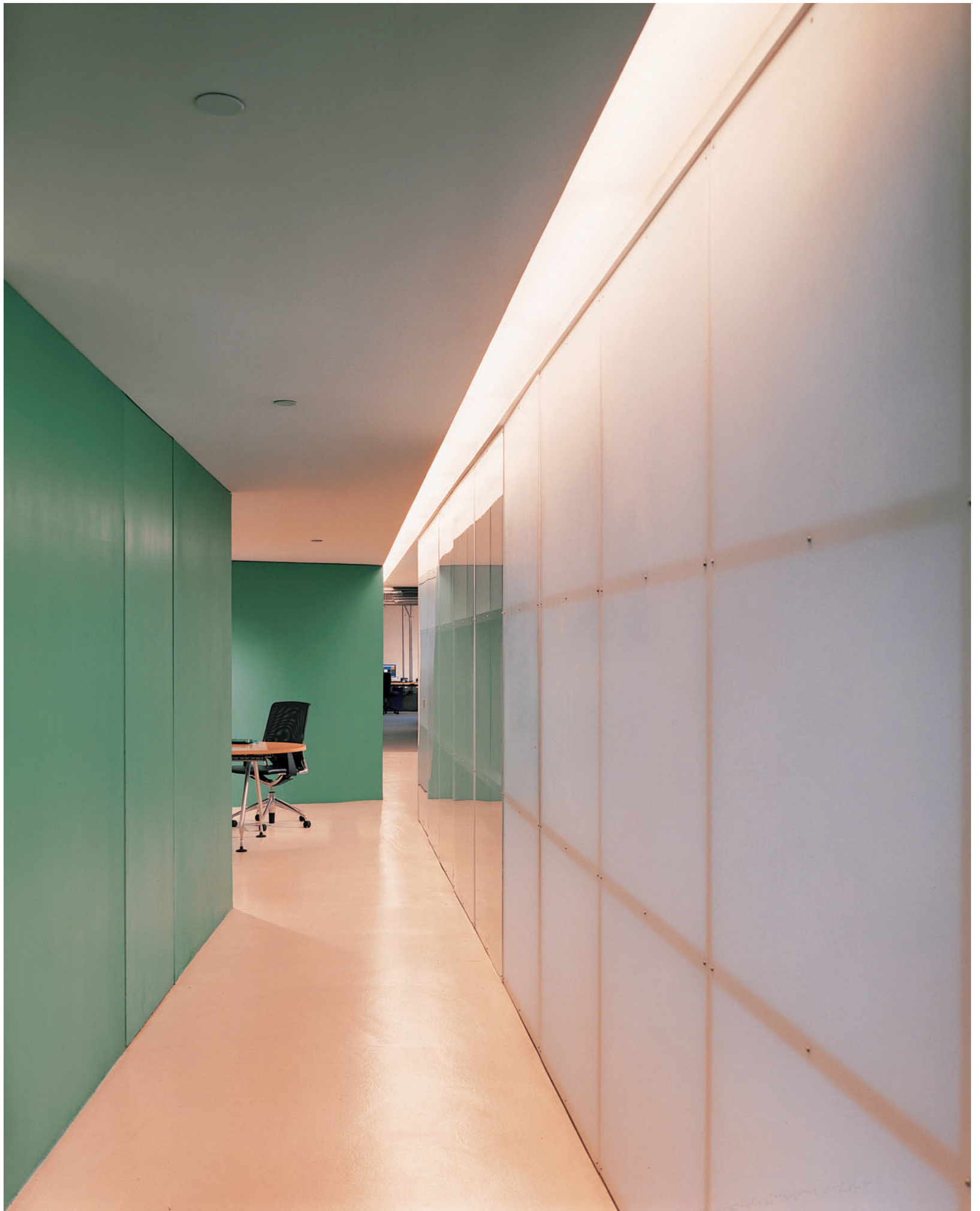



STUDIOS Architecture, RiskMetrics Group, New York, 1999. Translucent and clear acrylic wall panels in a precise grid are attached to aluminum frames with round-headed fasteners. A system of aluminum and glass pivoting doors divides the reception with the conference room, the latter being closed off as needed for meetings. The substantial daylight that filters through the translucent panels is augmented by recessed fluorescent lighting.

polychrome

The image of classical architecture as pristine white marble temples set against the blue sky is largely a figment of the twentieth-century imagination. ■ The great Greek and Roman sites were, in their day, effusively polychromous—blue friezes, red capitals, statuary as tarted up as any in Las Vegas. ■ The multicolored architecture of the Renaissance is epitomized by the white, green and red scheme of the Duomo in Florence. ■ In the gray ashes of World War I, the modernist *Die Bauwelt* published an issue titled “A Call for Color in Building.” Polychromy had become an act of revolution.





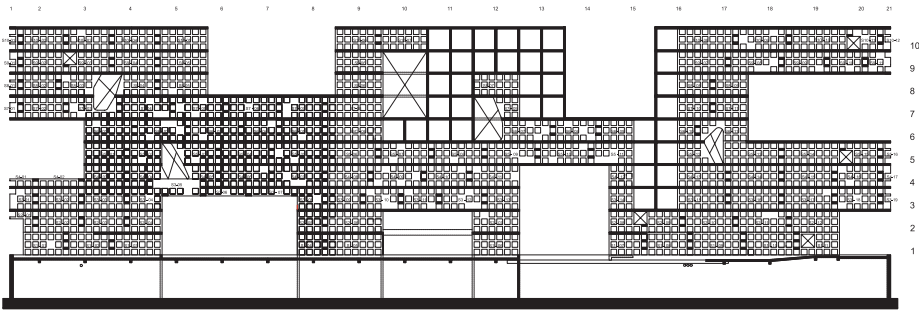

structure south

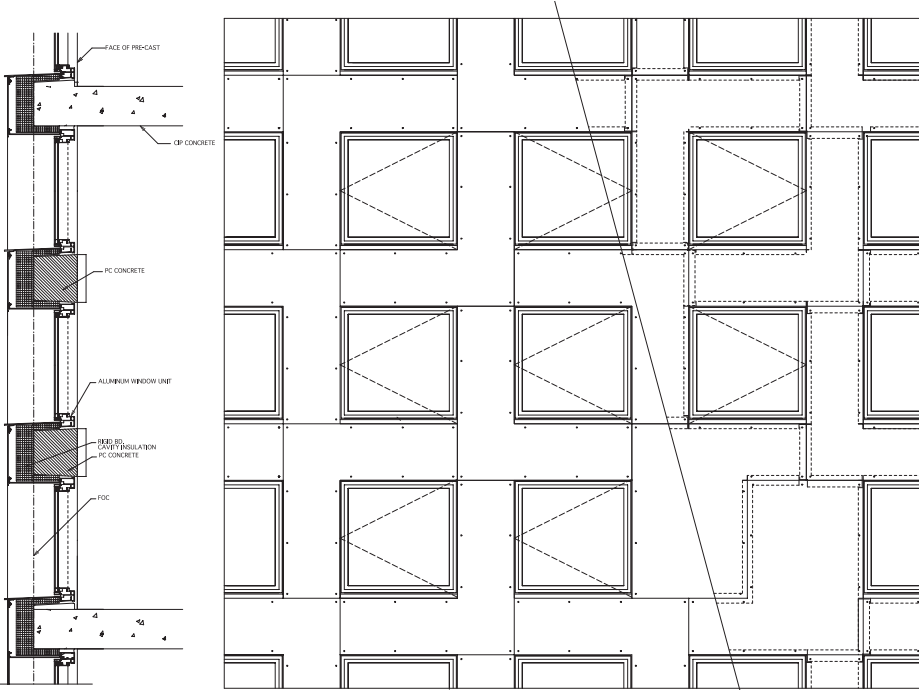

wall section

partial elevation

structure north

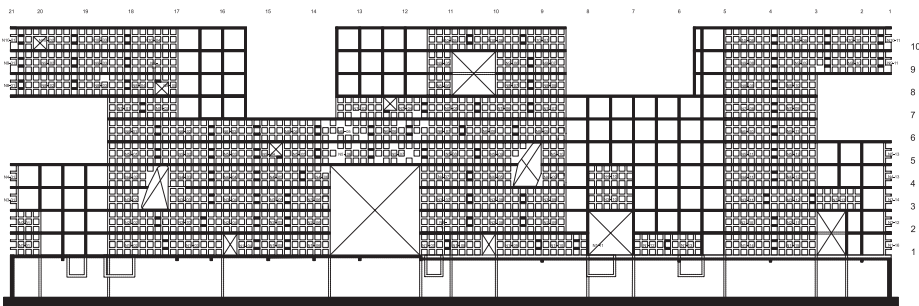

Previous spread: Rockwell Group, Pod Restaurant, Philadelphia, 2000. This and following spread: Steven Holl Architects, Simmons Hall MIT, Cambridge, Massachusetts, 2003. As a response to a structural engineer's drawing showing the gravitational loads along the building's façade, the architect decided to allow this sketch to drive the exterior color scheme. Thus, areas in red denote the heaviest loads, those in blue the lightest, with yellow and orange in between.

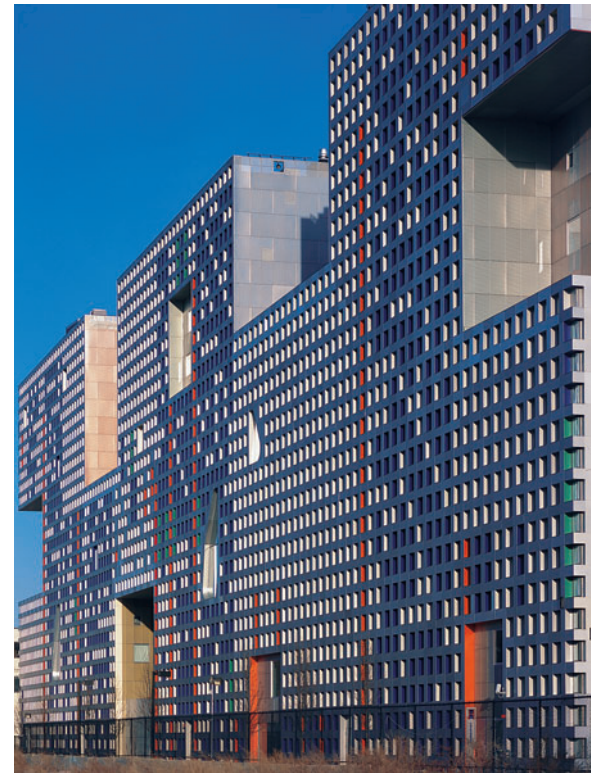



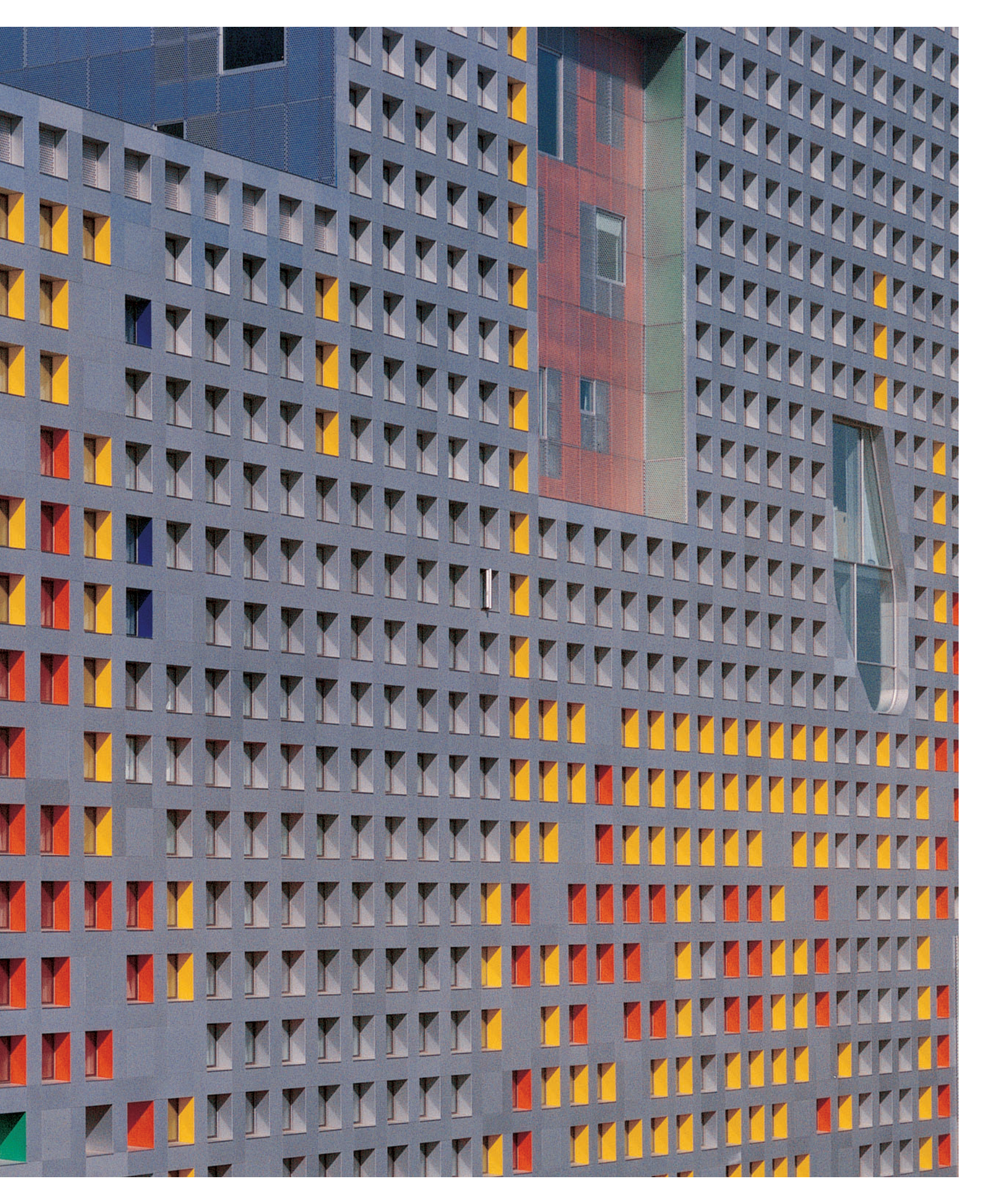



Sherwood Mills and Smith, St. Mark's Church, New Canaan, Connecticut, 1961. This is a modern take on the splendid multi-colored stained glass windows that were the artistic achievement of the Middle Ages. Here the windows are set in a staggered pattern within walls in a brick herringbone pattern, the light brown color allowing the effusive glass to stand out. Also blending into the background is the white ceiling, acting like a screen onto which streaming shards of color project at key times of the day.



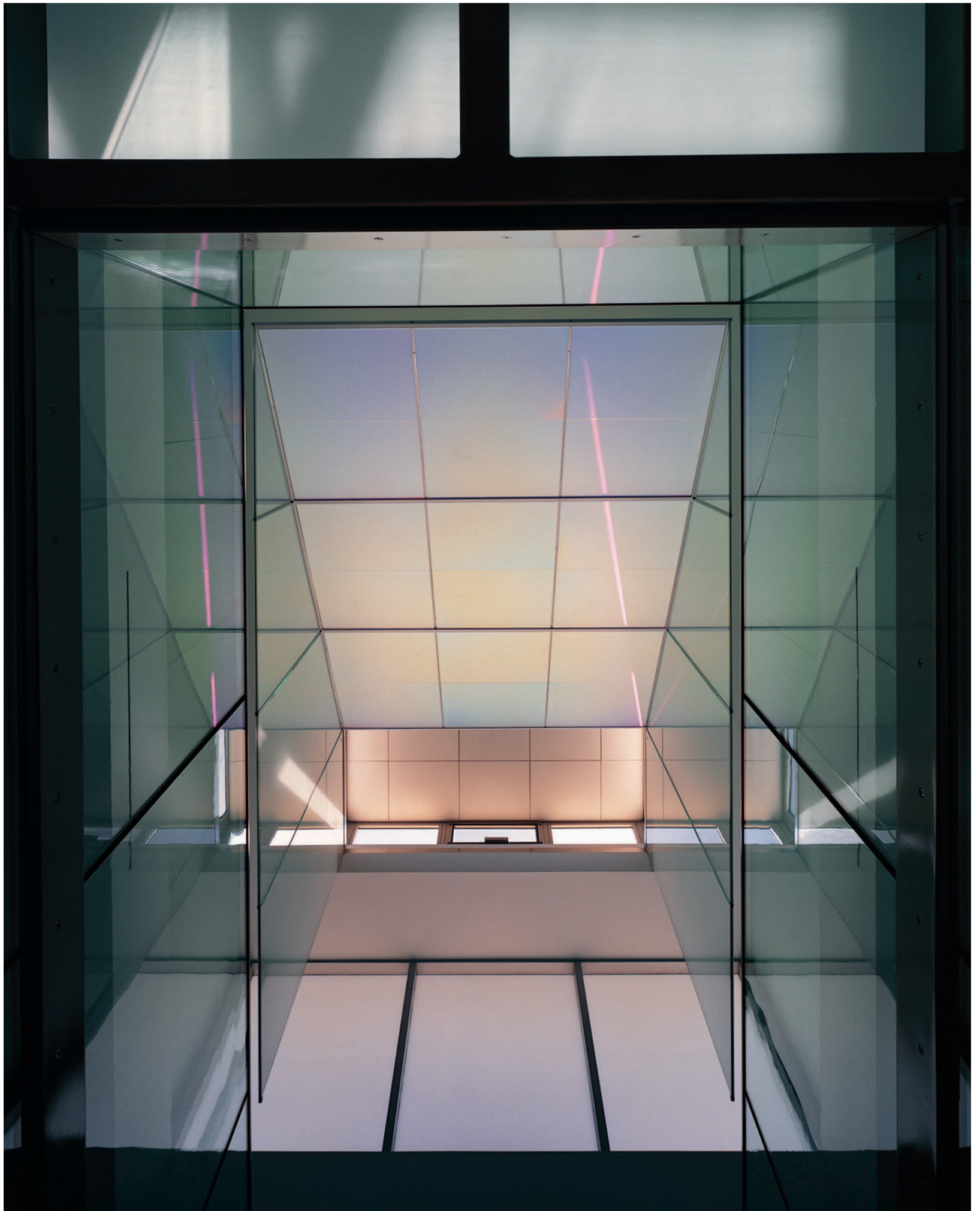



Toshiko Mori Architect, Compound on the Gulf of Mexico, Sarasota, Florida, 2002. An entrance hall to a beachfront house sports a prism-shaped skylight whose glass surface manages to change color with the time of day, indeed at times replicating the soft blues and pinks of a Gulf of Mexico sunset. Direct light pours in from an adjoining clerestory window, bouncing off of the angled glass surface and providing diffused light for the owner's collection of modern art.

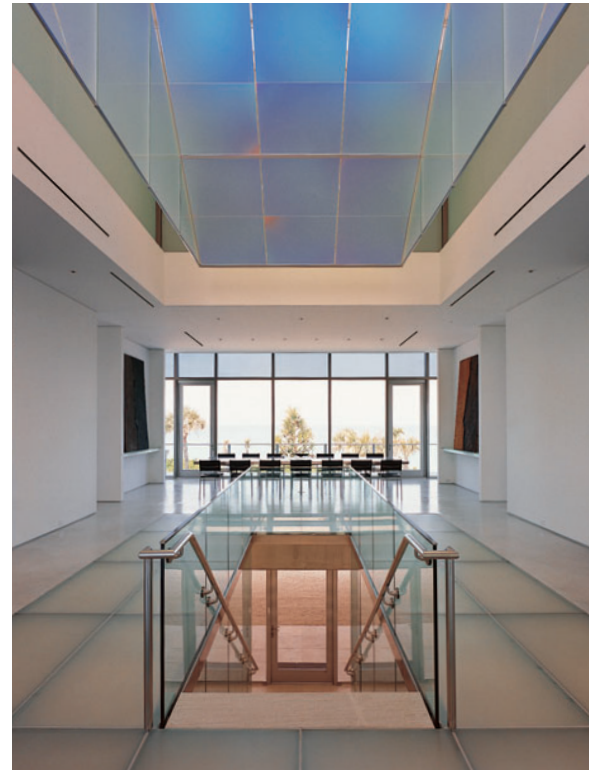



Gisela Stromeyer Design, Club Incognito, Zurich, 1998. Five lanterns made of spandex stretched with fiberglass rings are illuminated. This effusive display of color and geometrics is something of a lesson in color interaction. The translucence and transparency of the fabric allows various layers to overlap; thus, blue over yellow yields green; yellow over red, orange.









The Moderns LTD, Rewarding Lives Exhibition for American Express, New York, 2002. The multi-hued spatial effects of the fabric-and-steel "tent" structures contrasts with the strictly black-and-white photography of Annie Leibovitz that was on display within. Because of the reflective nature of the fabric, only a small amount of color light is sufficient to give them the appearance of brilliant, oversized gems.

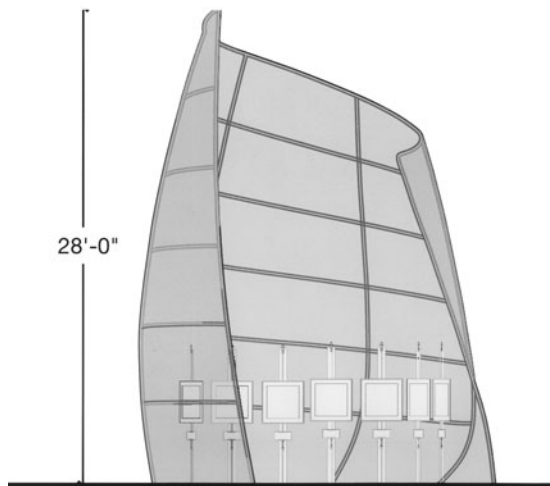

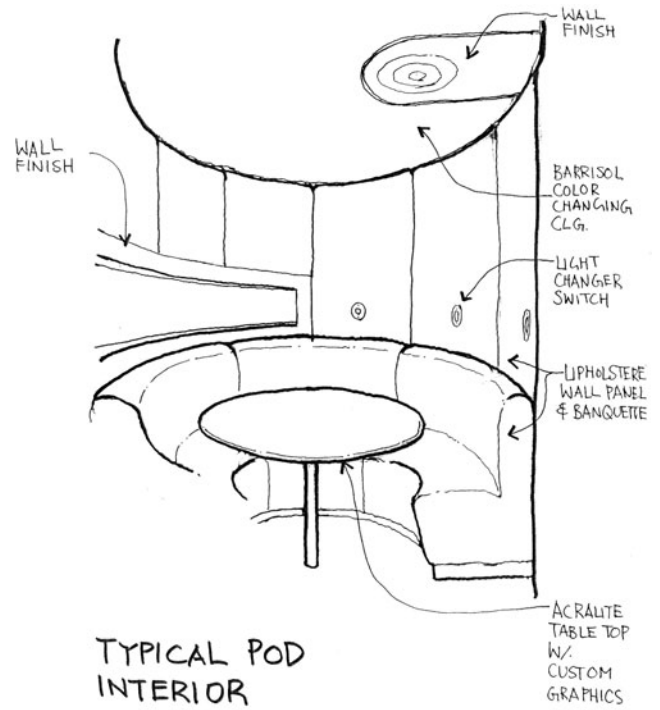
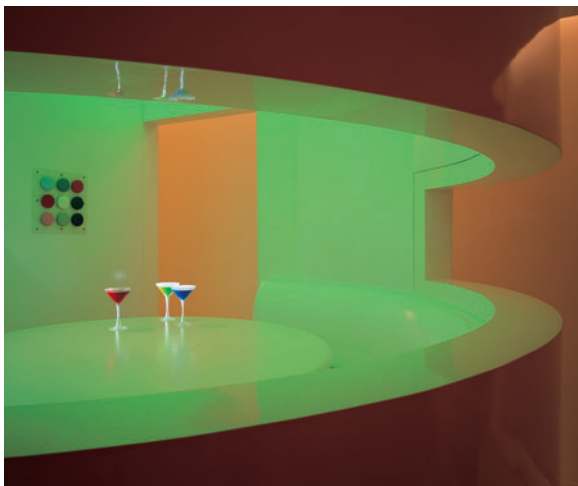

TYPICAL POD INTERIOR

Rockwell Group, Pod Restaurant, Philadelphia, 2000. Individual "seating pods" have internal illumination, the color of which can be changed at will, thus reflecting the occasion or particular wishes of the diners occupying them at any given time. Because of the essentially neutral white surface of the walls and partitions, colors can be fine tuned and mixed and matched as easily as cocktails. Your space is the color you want it to be—and an ever-changing bit of architectural theater.





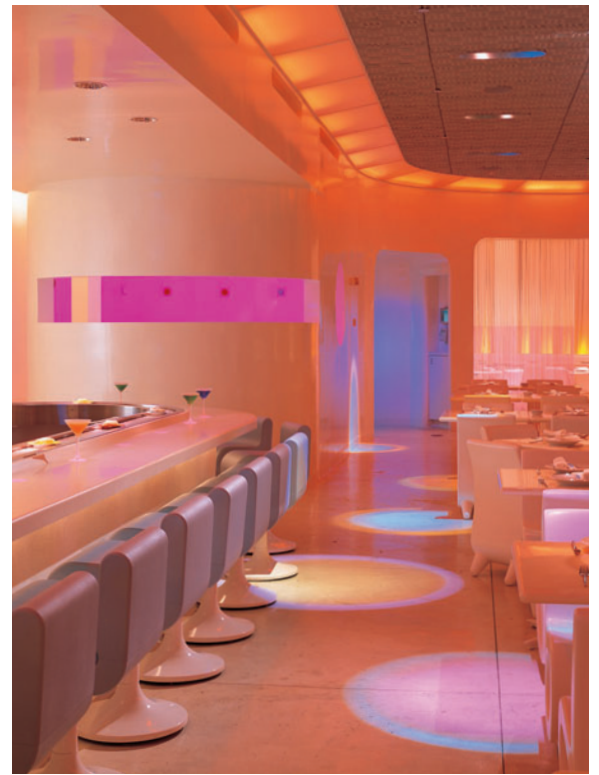

Rockwell Group, Pod Restaurant, Philadelphia, 2000. This space is marked by a series of womblike pod enclosures. Instead of paint and a brush, architects color with high technology. Inspired by a whole range of retro-futuristic visions from Stanley Kubrick's *A Clockwork Orange* to the work of Eero Saarinen, the white amorphous shapes are enlivened by lighting to form wildly chromatic eye candy.





Ken Kennedy Architect, Midtown New York Apartment, 1998. Bursts of color at strategic points animate these rooms. A crisp set of white shelves and storage units in the kitchen which continues out into the great room, are punctuated with wedges that contain recessed lighting of various shades. In the great room proper, a bright green bar area is counterbalanced by the recessed dining room ceiling, which is painted bright red.

bar - bookshelf unit

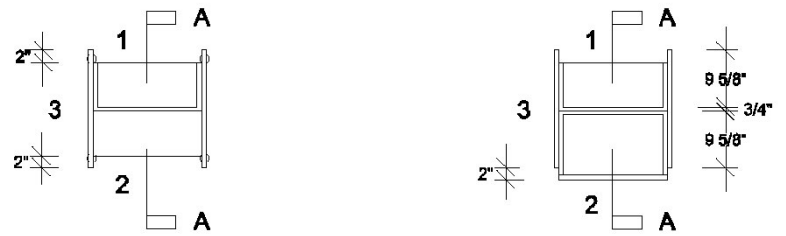

plan at lower level

plan at high level

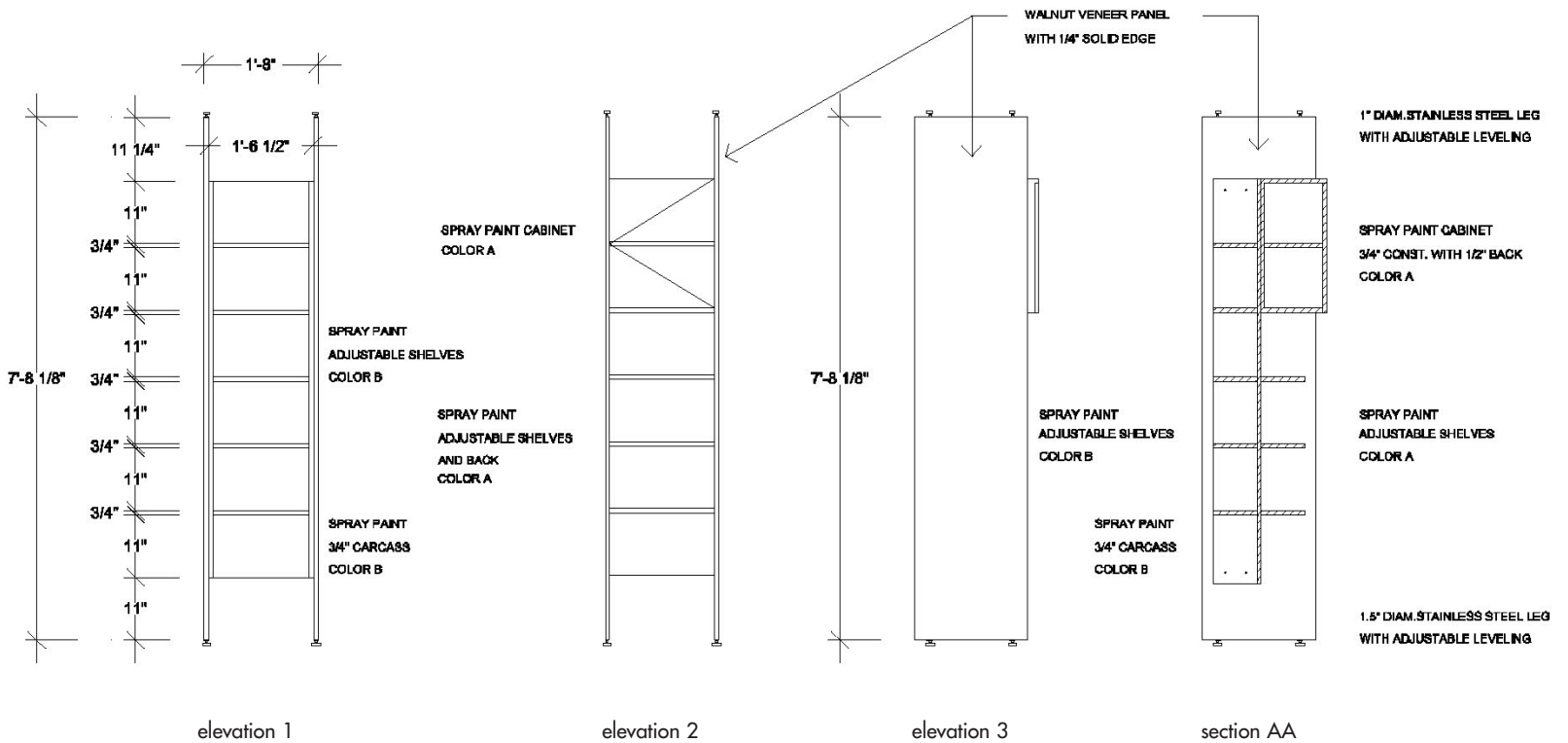

elevation 1

elevation 2

elevation 3

section AA



We are indebted to a large number of people whose help was indispensable in the creation of this book. At Rockport Publishers, our appreciation extends to Ken Fund and Winnie Prentiss for their enormous and unconditional support, the trust they placed in us, and the creative freedoms they allowed. Special thanks for generously providing images and, in some cases, commentary at various stages of the book's development are due to Peter Bohlin, Michael F. Conner, Marika Simms, and Sterling Alexander from Bohlin Cywinski Jackson; Rosemary Suh from Peter L. Gluck and Partners; Gary L. Shoemaker, principal of Gary Shoemaker Architects PC; Adam Yarinsky and Kim Yao from Architecture Research Office LLP. To Mark Pasnik, and Lisa Pascarelli, we owe a substantial debt of gratitude for their willingness to be enlisted at the most strenuous moments of editing and production. Rodolfo Machado and Jorge Silvetti provided support without which this project would never have occurred. To Paul Warchol, who opened his extensive photography library to us, we cannot sufficiently express the appreciation and respect we feel for his work. During several trips to his studio and while sifting through thousands and thousands of images in his archives, we depended upon the kind assistance of Michele Convery, Bilyana Dimitrova, Amy Barkow, Gabrielle Bendiner-Viani, Devon Banks, and Ursula Warchol. And most of all, we are indebted to the creative forces behind the details we have showcased—a list of architects and designers too numerous to recount here. We thank each of them.

acknowledgments & dedications

In loving memory of my parents,
John D. and Eugenia S. McCown.—JMc

To Peter and Sally Bohlin for their constant support.—ORO

The third book in the *Architecture in Detail* series, *Colors* looks at ways in which leading architects exploit the possibilities of the chromatic spectrum. The subtle way in which black is applied to frame and organize space, the daring punctuation of red and orange, and the ways in which natural materials are used and altered in unexpected ways all suggest not just the attention of the designer, but the presence of a passion for subtle gestures, that taken together, form powerful spatial images. Designed by Oscar Riera Ojeda and featuring the exquisite photography of Paul Warchol, *Colors* chronicles recent work in residential, civic, and commercial buildings. An introductory essay by James McCown places the subject of architectural color within a historical perspective. Far from being frivolous and capricious, color in nature and throughout human history has been of extreme importance. Preferences for and feelings about color are highly personal and subjective, making their application in architectural practice all the more fascinating. See the primary colors of red, blue, and yellow—and many other hues—and how the varied palette informs, influences, and enlivens building in our time.

ABOUT THE AUTHORS

James McCown is a writer and communications executive focusing on architecture and design. He is Director of Communications and Marketing for Schwartz/Silver Architects in Boston. As a freelance writer, his byline appears regularly in *Boston* magazine, the *Boston Globe*, *Art New England*, and *Architecture Boston*. He holds a B.A. in journalism from Loyola University in New Orleans, and is working on a master's degree in the history of art and architecture from Harvard University.

Oscar Riera Ojeda is an editor and designer born in Buenos Aires, Argentina. He is vice-director of the Spanish quarterly magazine *Casas Internacional*, and has created a number of successful architectural book series for Rockport Publishers.

Also Available:



Spaces
Architecture in Detail
ISBN: 1-59253-288-8



Elements
Architecture in Detail
ISBN: 1-59253-133-4



Materials
Architecture in Detail
ISBN: 1-59253-132-6

www.rockpub.com

