

# Mechanical Circulatory Support

## *Principles and Applications*

David L. Joyce  
Lyle D. Joyce



OXFORD

# MECHANICAL CIRCULATORY SUPPORT



# MECHANICAL CIRCULATORY SUPPORT PRINCIPLES AND APPLICATIONS

SECOND EDITION

---

EDITED BY

**David L. Joyce**

*Surgical Director of Heart and Lung Transplant  
Division of Cardiothoracic Surgery  
Department of Surgery  
Medical College of Wisconsin  
Milwaukee, Wisconsin*

**Lyle D. Joyce**

*Section Chief of Adult Cardiac Surgery  
Division of Cardiothoracic Surgery  
Department of Surgery  
Medical College of Wisconsin  
Milwaukee, Wisconsin*

---

MAYO CLINIC SCIENTIFIC PRESS

OXFORD UNIVERSITY PRESS

**OXFORD**  
UNIVERSITY PRESS

Oxford University Press is a department of the University of Oxford. It furthers the University's objective of excellence in research, scholarship, and education by publishing worldwide. Oxford is a registered trade mark of Oxford University Press in the UK and certain other countries.

Published in the United States of America by Oxford University Press  
198 Madison Avenue, New York, NY 10016, United States of America.

© Oxford University Press 2020

All rights reserved. No part of this publication may be reproduced, stored in a retrieval system, or transmitted, in any form or by any means, without the prior permission in writing of Oxford University Press, or as expressly permitted by law, by license, or under terms agreed with the appropriate reproduction rights organization. Inquiries concerning reproduction outside the scope of the above should be sent to the Rights Department, Oxford University Press, at the address above.

You must not circulate this work in any other form  
and you must impose this same condition on any acquirer.

Library of Congress Control Number: 2019953023  
ISBN 978-0-19-090929-1

This material is not intended to be, and should not be considered, a substitute for medical or other professional advice. Treatment for the conditions described in this material is highly dependent on the individual circumstances. And, while this material is designed to offer accurate information with respect to the subject matter covered and to be current as of the time it was written, research and knowledge about medical and health issues is constantly evolving and dose schedules for medications are being revised continually, with new side effects recognized and accounted for regularly. Readers must therefore always check the product information and clinical procedures with the most up-to-date published product information and data sheets provided by the manufacturers and the most recent codes of conduct and safety regulation. The publisher and the authors make no representations or warranties to readers, express or implied, as to the accuracy or completeness of this material. Without limiting the foregoing, the publisher and the authors make no representations or warranties as to the accuracy or efficacy of the drug dosages mentioned in the material. The authors and the publisher do not accept, and expressly disclaim, any responsibility for any liability, loss or risk that may be claimed or incurred as a consequence of the use and/or application of any of the contents of this material.

9 8 7 6 5 4 3 2 1

Printed by Integrated Books International, United States of America

# Contents

---

Preface **vii**

Contributors **ix**

1 • A Historical Perspective on the Development of Mechanical Circulatory Support Devices **1**

*O. H. Frazier*

2 • Indications for Mechanical Circulatory Support **9**

*Michael Dickinson, Stephen Wilkinson, and Milena Jani*

3 • Frailty Assessment and Associations with Outcomes **16**

*Shannon M. Dunlay*

4 • Palliative Care in Mechanical Circulatory Support **23**

*Regina M. Mackey and Jacob J. Strand*

5 • Psychosocial Assessment of Patients Considered for Mechanical Circulatory Support **29**

*Jenessa S. Price and Stephanie C. Zanoski*

6 • Left Ventricular Assist Device Backup for Conventional Surgery **35**

*Noelle C. Garster and Asim Mohammed*

7 • Preoperative Strategies for Optimizing Mechanical Circulatory Support **41**

*Evan C. Klein and Mitchell T. Saltzberg*

8 • Mechanical Circulatory Support in Patients with Pulmonary Hypertension **47**

*David Ishizawar*

9 • Selecting Children for Mechanical Circulatory Support **54**

*Devon O. Aganga, Charlotte S. Van Dorn, and Jonathan N. Johnson*

10 • Device Selection for Short- and Long-Term Mechanical Circulatory Support **61**

*Rabea Asleh and Sarah Schettle*

11 • The HeartMate II™ Continuous-Flow Left Ventricular Assist System **70**

*David J. Farrar*

12 • The Abbott HeartMate 3™ Left Ventricular Assist System **78**

*Kevin Bourque and John B. O'Connell*

13 • The HeartWare™ HVAD™ Left Ventricular Assist Device **84**

*Nicholas Hiivala and Thomas Vassiliades*

14 • The Medtronic Miniature Left Ventricular Assist Device (MVAD)™ System **96**

*Nicholas Hiivala and Thomas Vassiliades*

15 • The ReliantHeart aVAD® **103**

*Bryan E. Lynch*

16 • The Syncardia Total Artificial Heart **110**

*Steven Langford and Francisco A. Arabia*

17 • Counterpulsation Circulatory Assist Devices **119**

*Reza Salabat and Valluvan Jeevanandam*

18 • Abiomed Impella Platform **127**

*Shiva K. Annamalai, Aditya Chennojwala, Sina Foroutanjazi, Samuel J. Karmiý, Allen A. Razavi, and Navin K. Kapur*

19 • The Tandem: Life System Device Description, Implantation, and Clinical Results **138**

*Danny Ramzy and Joshua Chung*

- 20 • **The Abbott CentriMag™ Acute Circulatory Support System and the HeartMate Percutaneous Heart Pump™ 145**  
*David J. Farrar*
- 21 • **Extracorporeal Membrane Oxygenation 152**  
*J. Kyle Bohman and Gregory J. Schears*
- 22 • **The Berlin Heart Ventricular Assist Devices 159**  
*Lucian A. Durham III*
- 23 • **EVAHEART® 2 Left Ventricular Assist Device System 168**  
*Tadashi Motomura*
- 24 • **Anesthesia 175**  
*Christopher J. Plambeck, Michael K. Loushin, and Michael F. Sweeney*
- 25 • **Perfusion Considerations 188**  
*Phillip Scott and Jeffrey Riley*
- 26 • **Echocardiography in Left Ventricular Assist Device Recipients 195**  
*Yan Topilsky and Ofer Havakuk*
- 27 • **Implantation of Continuous-Flow Left Ventricular Assist Devices via Sternotomy Technical Considerations 208**  
*Andrew Shaffer and Ranjit John*
- 28 • **The Less-Invasive (Lateral) Approach to Left Ventricular Device Implantation 225**  
*Edwin C. McGee, Jr.*
- 29 • **Concomitant Cardiac Valve Procedures with Circulatory Support Device Implantation 232**  
*Walt Dembitsky, Robert Adamson, Karl Limmer, and Craig Larson*
- 30 • **Providing Mechanical Support to Children Size and Anatomical Considerations 246**  
*Kyle W. Riggs and David L. S. Morales*
- 31 • **Postoperative Management after Assist Device Implantation 255**  
*Christoph E. Brehm*
- 32 • **Anticoagulation Strategies for Patients on Mechanical Circulation Support 261**  
*Scott D. Nei*
- 33 • **Acquired von Willebrand Syndrome with Mechanical Circulatory Support 269**  
*Evan C. Klein and Lisa Baumann Kreuziger*
- 34 • **Gastrointestinal Bleeding in Patients with Left Ventricular Assist Devices 277**  
*Shivtej Kaushal and Nunzio Gaglianella*
- 35 • **Pump Thrombosis 281**  
*Jacob N. Schroder and Carmelo A. Milano*
- 36 • **Infectious Complications of Mechanical Circulatory Support 291**  
*Joyce L. Sanchez, Timothy J. Baures, Patrick B. Mazi, and Samuel L. Windham*
- 37 • **Cerebral Blood Flow and Stroke in Patients with Left Ventricular Assist Devices 299**  
*Michael Eugene Kiyatkin and Joshua Zebadiah Willey*
- 38 • **Right Heart Dysfunction 309**  
*Renee L. Kursel O'Brien*
- 39 • **Renal Failure and Mechanical Circulatory Support Devices 323**  
*Krishna Keri and Mohit Agarwal*
- 40 • **Arrhythmia/Ventricular Tachycardia Ablation 330**  
*Suraj Kapa*
- 41 • **Aortic Regurgitation in Patients with Left Ventricular Assist Devices 338**  
*Marisa Cevasco, Koji Takeda, Masahiko Ando, and Yoshifumi Naka*
- 42 • **Modalities of Left Ventricular Assist Device Optimization 345**  
*Nikhil Narang, Gabriel Sayer, and Nir Uriel*
- 43 • **The CardioMEMS Heart Failure Monitoring System 353**  
*Brent C. Lampert and William T. Abraham*
- 44 • **Mechanical Circulatory Support as a Bridge to Recovery 360**  
*Thomas C. Hanff, Joyce Wald, and J. Eduardo Rame*
- 45 • **Cardiac and Physical Rehabilitation 369**  
*Erik H. Van Iterson and Thomas P. Olson*
- 46 • **The VAD Coordinator Roles and Responsibilities in Caring for Patients with Ventricular Assist Devices 382**  
*Brittany Butzler and Kristen Kiehl*
- Index 389

# Preface

---

It has now been a little over eight years since publishing the first edition of *Mechanical Circulatory Support: Principles and Applications*. The world has changed a great deal in that time, but perhaps nowhere has this been more pronounced than in the field of mechanical circulatory support. Durable LVAD outcomes now rival those of cardiac transplantation, short-term devices are changing the landscape in cardiogenic shock, and perioperative decision-making has now benefited from over three decades of experience. It has been an exciting time to be a part of this journey, and we have been truly blessed to join with some of the most well-established thought leaders in the field to develop a reference that we hope will synthesize this wisdom in a way that is accessible to all who participate in the care of patients with advanced heart failure.

The second edition could never have taken place without substantial contributions from a very large team of supporters. We would like to specifically thank Craig Panner, William Allen, and the rest of the team at Oxford University Press for their tremendous partnership throughout this effort.

This project was officially launched in May 2017 as part of a much larger vision on the part of Drs. Paul Pearson and Doug Evans when they placed their bets for the heart transplant and MCS program at the Medical

College of Wisconsin on a father/son team from the Mayo Clinic. We remain immensely grateful to them for inviting us to join in this adventure, supporting us on projects like this, and dreaming with us on what comes next. In the words of Lin-Manuel Miranda in *Hamilton*, “There’s a million things [we] haven’t done . . . but just you wait!”

Editing a textbook of this magnitude could never be accomplished by two busy cardiac surgeons without the commitment of very talented colleagues, especially Chris Quandt, Jodi Burgess, and Tom Lang, who not only kept us on schedule but demanded excellence in the final product. We also appreciate the tremendous effort put forth by each of the authors.

Of course, those who pay a huge toll are our families, who have spared us the time to complete this task. We are most grateful to Tina (Mom/wife), Joyce (wife/daughter-in-law), and Lyle and Lucia (children/grandchildren).

Our desire is that you will find this book useful at whatever level of heart failure patient care you are providing and that it will serve as a handbook at the bedside as well as a thought provoker when studying some of the most complex physiological challenges that this exciting frontier provides.

David L. Joyce and Lyle D. Joyce





# Contributors

---

**William T. Abraham, MD**

Division of Cardiovascular Medicine  
The Ohio State University Wexner Medical Center  
Columbus, Ohio

**Robert Adamson, MD**

Sharp Cardiovascular and Thoracic Center  
San Diego, California

**Devon O. Aganga, MD**

Department of Pediatrics  
Division of Critical Care Medicine  
Department of Anesthesiology and Perioperative  
Medicine  
Division of Pediatric Anesthesiology  
Mayo Clinic  
Rochester, Minnesota

**Mohit Agarwal, MD**

Department of Internal Medicine  
Division of Nephrology  
Medical College of Wisconsin  
Milwaukee, Wisconsin

**Masahiko Ando, MD, PhD, MPH**

Department of Surgery  
Division of Cardiothoracic and Vascular Surgery  
Columbia University Medical Center  
New York, New York

**Shiva K. Annamalai, MD**

The Molecular Cardiology Research Institute  
The Acute Mechanical Circulatory Support  
Working Group  
The Cardiovascular Center  
Tufts Medical Center and Tufts University School of  
Medicine  
Boston, Massachusetts

**Francisco A. Arabia, MD, MBA**

Banner/University of Arizona  
Heart Institute  
Phoenix, Arizona

**Rabea Asleh, MD, PhD, MHA**

Division of Cardiology  
Johns Hopkins University School of Medicine  
Baltimore, Maryland

**Timothy J. Baures, MD**

Department of Medicine  
Division of Infectious Diseases  
Medical College of Wisconsin  
Milwaukee, Wisconsin

**J. Kyle Bohman, MD**

Assistant Professor of Anesthesiology  
Department of Anesthesiology and Perioperative  
Medicine  
Mayo Clinic  
Rochester, Minnesota

**Kevin Bourque, MSME**

Division Vice President, Mechanical Circulatory Support  
Research and Development  
Abbott Laboratories  
Burlington, Massachusetts

**Christoph E. Brehm, MD**

Penn State Heart and Vascular Institute—I. O. Silver  
Hershey, Pennsylvania

**Brittany Butzler, BSN, RN**

Froedtert & the Medical College of Wisconsin  
Milwaukee, Wisconsin

**Marisa Cevasco, MD, MPH**

Department of Surgery  
Division of Cardiovascular Surgery  
Hospital of the University of Pennsylvania  
New York, New York

**Aditya Chennojwala, MS**

The Molecular Cardiology Research Institute  
The Acute Mechanical Circulatory Support  
Working Group  
The Cardiovascular Center  
Tufts Medical Center and Tufts University School of  
Medicine  
Boston, Massachusetts

**Joshua Chung, MD**

Division of Cardiothoracic Surgery  
Cedars-Sinai Medical Center  
Los Angeles, California

**Walt Dembitsky, MD**

Sharp Cardiovascular and Thoracic Center  
San Diego, California

**Michael Dickinson, MD, FACC, FHSA**

Spectrum Health  
Grand Rapids, Michigan

**Shannon M. Dunlay, MD, MS**

Department of Cardiovascular Medicine and Division of  
Health Care Policy and Research in the Department of  
Health Sciences Research  
Mayo Clinic  
Rochester, Minnesota

**Lucian A. Durham III, MD, PhD**

Associate Professor  
Department of Surgery  
Division of Cardiothoracic Surgery  
Medical College of Wisconsin  
Milwaukee, Wisconsin

**David J. Farrar, PhD**

Abbott Laboratories  
Pleasanton, California

**Sina Foroutanjazi, BS**

The Molecular Cardiology Research Institute  
The Acute Mechanical Circulatory Support  
Working Group  
The Cardiovascular Center  
Tufts Medical Center and Tufts University School of  
Medicine  
Boston, Massachusetts

**O. H. Frazier, MD**

Director, Cardiovascular Surgery Research  
Texas Heart Institute  
Houston, Texas

**Nunzio Gaglianella, MD**

Medical Director of Mechanical Circulatory Support  
Department of Medicine  
Division of Cardiovascular Medicine  
Milwaukee, Wisconsin

**Noelle C. Garster, MD, MS**

Department of Medicine  
Division of Cardiovascular Medicine  
Medical College of Wisconsin  
Milwaukee, Wisconsin

**Thomas C. Hanff, MD**

Penn Heart and Vascular Center  
Perelman Center for Advanced Medicine  
Philadelphia, Pennsylvania

**Ofer Havakuk, MD**

Department of Cardiology  
Sackler Faculty of Medicine  
Tel Aviv Medical Center  
Tel Aviv University  
Tel Aviv, Israel

**Nicholas Hiivala, BME**

Senior Medical Writer  
Medtronic, Inc.  
Jamaica Plain, Massachusetts

**David Ishizawar, MD**

Department of Medicine  
Division of Cardiovascular Medicine  
Medical College of Wisconsin  
Milwaukee, Wisconsin

**Milena Jani, MD**

Spectrum Health  
Grand Rapids, Michigan

**Valluvan Jeevanandam, MD**

Department of Surgery  
Cardiothoracic Surgery  
The University of Chicago  
Chicago, Illinois

**Ranjit John, MD**

Division of Cardiothoracic Surgery  
University of Minnesota  
Minneapolis, Minnesota

**Jonathan N. Johnson, MD**

Department of Pediatrics  
Division of Pediatric Cardiology  
Department of Cardiovascular Diseases  
Mayo Clinic  
Rochester, Minnesota

**Suraj Kapa, MD**

Department of Cardiovascular Diseases  
Mayo Clinic College of Medicine  
Rochester, Minnesota

**Navin K. Kapur, MD**

The Molecular Cardiology Research Institute  
The Acute Mechanical Circulatory Support  
Working Group  
The Cardiovascular Center  
Tufts Medical Center and Tufts University School of  
Medicine  
Boston, Massachusetts

**Samuel J. Karmiy, BS**

The Molecular Cardiology Research Institute  
The Acute Mechanical Circulatory Support  
Working Group  
The Cardiovascular Center  
Tufts Medical Center and Tufts University School of  
Medicine  
Boston, Massachusetts

**Shivtej Kaushal, MD**

Department of Internal Medicine  
Milwaukee, Wisconsin

**Krishna Keri, MD**

Department of Internal Medicine  
Division of Nephrology  
Medical College of Wisconsin  
Milwaukee, Wisconsin

**Kristen Kiehl, BSBME**

Froedtert & the Medical College of Wisconsin  
Milwaukee, Wisconsin

**Michael Eugene Kiyatkin, MD**

Department of Anesthesiology  
Columbia University Medical Center  
New York-Presbyterian Hospital  
New York, New York

**Evan C. Klein, MD**

Department of Medicine  
Division of Cardiovascular Medicine  
Medical College of Wisconsin  
Milwaukee, Wisconsin

**Lisa Baumann Kreuziger, MD, MS**

BloodCenter of Wisconsin  
Blood Research Institute  
Department of Medicine  
Division of Hematology  
Medical College of Wisconsin  
Milwaukee, Wisconsin

**Renee L. Kursel O'Brien, MD**

Advanced Heart Failure and Transplant Cardiology  
Cardiology/Cardiovascular Medicine  
Medical College of Wisconsin  
Milwaukee, Wisconsin

**Brent C. Lampert, DO**

Assistant Professor of Clinical Medicine  
Heart Failure & Transplantation  
Division of Cardiovascular Medicine  
The Ohio State University Wexner Medical Center  
Columbus, Ohio

**Steven Langford, BSEE**

Banner/University of Arizona  
Heart Institute  
Phoenix, Arizona

**Craig Larson, DO**

Sharp Cardiovascular and Thoracic Center  
San Diego, California

**Karl Limmer, MD**

Sharp Cardiovascular and Thoracic Center  
San Diego, California

**Michael K. Loushin, MD**

Department of Anesthesiology  
Regions Hospital  
Minneapolis, Minnesota

**Bryan E. Lynch**

ReliantHeart, Inc.  
Houston, Texas

**Regina M. Mackey, MD**

Department of Family Medicine  
Center for Palliative Medicine  
Mayo Clinic  
Rochester, Minnesota

**Patrick B. Mazi, MD**

Department of Medicine  
Medical College of Wisconsin  
Milwaukee, Wisconsin

**Edwin C. McGee, Jr., MD**

Professor of Surgery  
Loyola Stritch School of Medicine  
Surgical Director, Heart Transplantation and Mechanical Assistance  
Loyola University Medical Center  
Maywood, Illinois

**Carmelo A. Milano, MD**

Division of Thoracic and Cardiovascular Surgery  
Duke University School of Medicine  
Durham, North Carolina

**Asim Mohammed, MD**

Department of Medicine  
Division of Cardiovascular Medicine  
Medical College of Wisconsin  
Milwaukee, Wisconsin

**David L. S. Morales, MD**

Division of Cardiothoracic Surgery  
Cincinnati Children's Hospital Medical Center  
Cincinnati, Ohio

**Tadashi Motomura, MD, PhD**

EVAHEART, Inc.  
Houston, Texas

**Yoshifumi Naka, MD, PhD**

Department of Surgery  
Division of Cardiothoracic and Vascular Surgery  
Columbia University Medical Center  
New York, New York

**Nikhil Narang, MD**

Section of Cardiology  
Department of Medicine  
University of Chicago  
Chicago, Illinois

**Scott D. Nei, PharmD**

Assistant Professor of Pharmacy  
Department of Pharmacy  
Mayo Clinic College of Medicine and Science  
Rochester, Minnesota

**John B. O'Connell, MD**

Consultant, Mechanical Circulatory Support  
Medical Affairs  
Abbott Laboratories  
Pleasanton, California

**Thomas P. Olson, PhD**

Department of Cardiovascular Medicine  
Mayo Clinic  
Rochester, Minnesota

**Christopher J. Plambeck, MD**

Assistant Professor of Anesthesiology  
Department of Anesthesiology  
Medical College of Wisconsin  
Milwaukee, Wisconsin

**Jenessa S. Price, PhD**

Assistant Professor of Surgery and Psychiatry  
Division of Transplant Surgery  
Department of Surgery  
Department of Psychiatry and Behavioral Medicine  
Medical College of Wisconsin  
Milwaukee, Wisconsin

**J. Eduardo Rame, MD**

Penn Heart and Vascular Center  
Perelman Center for Advanced Medicine  
Department of Medicine  
Philadelphia, Pennsylvania

**Danny Ramzy, MD**

Division of Cardiothoracic Surgery  
Cedars-Sinai Medical Center  
Los Angeles, California

**Allen A. Razavi, MS**

The Molecular Cardiology Research Institute  
The Acute Mechanical Circulatory Support Working Group  
The Cardiovascular Center  
Tufts Medical Center and Tufts University School of Medicine  
Boston, Massachusetts

**Kyle W. Riggs, MD**

Division of Cardiothoracic Surgery  
Cincinnati Children's Hospital Medical Center  
Cincinnati, Ohio

**Jeffrey Riley, MHPE, CCP**

State University of New York Upstate  
Medical University  
Syracuse, New York

**Reza Salabat, MD**

Department of Surgery  
Cardiothoracic Surgery  
The University of Chicago  
Chicago, Illinois

**Mitchell T. Saltzberg, MD**

Department of Medicine  
Division of Cardiovascular Medicine  
Medical College of Wisconsin  
Milwaukee, Wisconsin

**Joyce L. Sanchez, MD**

Department of Medicine  
Division of Infectious Diseases  
Medical College of Wisconsin  
Milwaukee, Wisconsin

**Gabriel Sayer, MD**

Section of Cardiology  
Department of Medicine  
The University of Chicago  
Chicago, Illinois

**Gregory J. Schears, MD**

Professor of Anesthesiology  
Department of Anesthesiology and Perioperative  
Medicine  
Mayo Clinic  
Rochester, Minnesota

**Sarah Schettle, PAC, MS**

MCSD Coordinator  
Department of Cardiac Surgery  
Mayo Clinic  
Rochester, Minnesota

**Jacob N. Schroder, MD**

Division of Thoracic and Cardiovascular Surgery  
Duke University School of Medicine  
Durham, North Carolina

**Phillip Scott, MS, CCP**

Cardiovascular Perfusionist  
Mayo Clinic  
Rochester, Minnesota

**Andrew Shaffer, MD, MS**

Division of Cardiothoracic Surgery  
University of Minnesota  
Minneapolis, Minnesota

**Jacob J. Strand, MD, FACP, FAAHPM**

Division of General Internal Medicine  
Department of Medicine  
Center for Palliative Medicine  
Mayo Clinic  
Rochester, Minnesota

**Michael F. Sweeney, MD, FCCP**

Professor Emeritus  
Department of Anesthesiology  
University of Minnesota  
Minneapolis, Minnesota

**Koji Takeda, MD, PhD**

Department of Surgery  
Division of Cardiothoracic and Vascular Surgery  
Columbia University Medical Center  
New York, New York

**Yan Topilsky, MD**

Department of Cardiology  
Sackler Faculty of Medicine  
Tel Aviv Medical Center  
Tel Aviv University  
Tel Aviv, Israel

**Nir Uriel, MD, MSc**

Section of Cardiology  
Department of Medicine  
The University of Chicago  
Chicago, Illinois

**Charlotte S. Van Dorn, MD**

Department of Pediatrics  
Division of Critical Care Medicine  
Division of Pediatric Cardiology  
Mayo Clinic  
Rochester, Minnesota

**Erik H. Van Iterson, PhD**

Section of Preventive Cardiology and Rehabilitation  
Heart and Vascular Institute  
Cleveland Clinic  
Cleveland, Ohio

**Thomas Vassiliades, MD**

Chief Medical Officer  
Medtronic, Inc.  
Minneapolis, Minnesota

**Joyce Wald, MD**

Associate Director, Mechanical Circulatory Support  
Penn Heart and Vascular Center  
Perelman Center for Advanced Medicine  
Philadelphia, Pennsylvania

**Stephen Wilkinson, MD**

Departments of Internal Medicine & Pediatrics  
Spectrum Health  
Grand Rapids, Michigan

**Joshua Z. Willey, MD**

Department of Neurology  
Columbia University Medical Centre  
New York, New York

**Samuel L. Windham, MD**

Department of Medicine  
Medical College of Wisconsin  
Milwaukee, Wisconsin

**Stephanie C. Zanowski, PhD**

Assistant Professor of Surgery and Psychiatry  
Director, Transplant Mental Health Program  
Division of Transplant Surgery  
Department of Surgery  
Department of Psychiatry and Behavioral Medicine  
Medical College of Wisconsin  
Milwaukee, Wisconsin

# MECHANICAL CIRCULATORY SUPPORT





# 1

## A Historical Perspective on the Development of Mechanical Circulatory Support Devices

O. H. FRAZIER

### Introduction

**T**he cardiac surgical field has progressed from a belief that the heart was an untouchable organ to the reality that it is an organ that can be surgically repaired, supported, and even replaced with great success. The invention and development of mechanical circulatory support devices has led the way in this endeavor. The first attempts were to replicate the pulsatile human heart. The first permanent implant of the Jarvik 7 total artificial heart (TAH) implant by Devries and Joyce in 1982, under a clinical trial directed by the Food and Drug Administration (FDA), opened the door for the investigation of not only TAHs but also multiple left ventricular assist devices (LVAD). The Jarvik 7-70 TAH first implanted in a woman by Joyce in 1985 is the same pump still used today, giving it the longest track record of any manufactured implantable support device. The field has turned to continuous-flow devices (axial and centrifugal) for the most part because of durability issues, but the long-term impact that this change in physiology has on the body remains only partially understood.

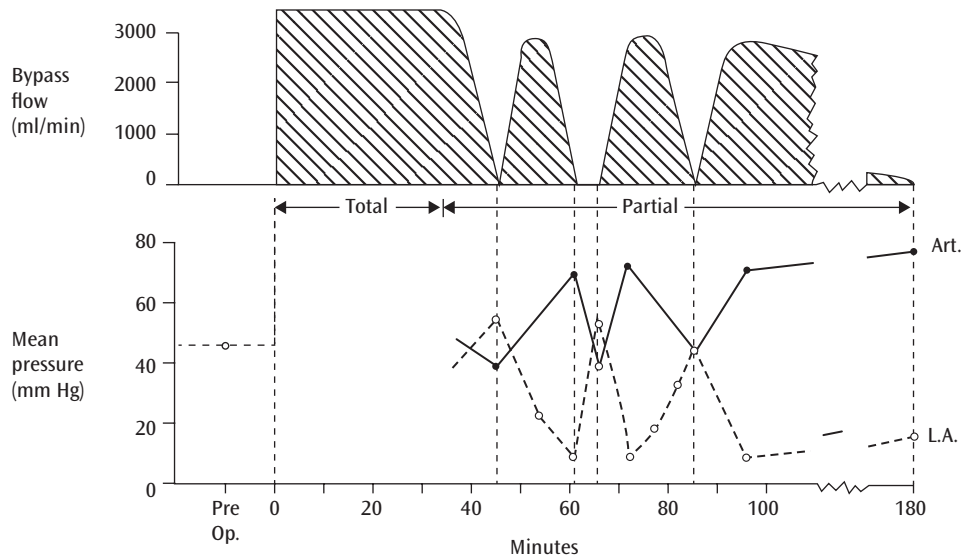
### The History

The evolution and subsequent development of the field of mechanical cardiac assist and replacement for the failing heart has been indelibly linked to similar advances in the evolution of open heart surgery and, subsequently, cardiac transplantation. The first successful use of the heart-lung machine by Dr. John Gibbon for open cardiac repair in 1953 was initially viewed as being of limited value, as it was successful in only one case of a simple secundum atrial-septal

defect (ASD) repair. John Lewis at the University of Minnesota had already performed the first successful case of intracardiac surgery on September 2, 1952.<sup>1</sup> He closed a secundum ASD in a 5-year-old girl utilizing inflow stasis and total body hypothermia. Dr. Gibbon, in fact, did not want to report his initial experience with the heart-lung machine, as he thought the heart itself was irreversibly injured and the idea of surgical correction of a “sick heart” without hope of meaningful recovery, in spite of successful anatomic correction, would limit the application of this technology. Dr. Walter Lillehei, with Lewis at the University of Minnesota, had encouraged Dr. Gibbon to report his case, which he ultimately did.<sup>2</sup> As a result, this important historic event was first recorded only locally in a regional publication, the *Minnesota State Medical Journal*.

The first open heart surgery, however, was actually performed by Dr. Clarence Dennis et al. in April 1951, again at the University of Minnesota, for what was thought to be a secundum ASD, but in fact proved to be a more complicated A-V canal anomaly, and the patient died intraoperatively.<sup>3</sup> A second case less than one month later died of a massive intraoperative air embolism. Contributing to the mortality of both patients was the large amount of return of intracardiac blood flow in the open heart. This obscured the pathology in both cases and was a primary factor in the early mortality of these two patients.

Dr. Lillehei was an important early contributor to the success of open-heart surgery; in fact, he was considered the most important by all of the pioneers interviewed by this author. His studies of the survival of anesthetized dogs with only azygos blood flow indicated that the normal resting blood flow in anesthetized humans was not required for survival in open heart surgery.<sup>4</sup> This seminal observation



**Figure 1.1.** Effect of resting the failing heart on cardiopulmonary bypass when unable to wean after initial operation.

Reprinted from DeBakey ME, Left ventricular bypass pump for cardiac assistance, *American Journal of Cardiology* 1971;27:3–11, with permission from Elsevier.

was fundamental for the subsequent success of open heart surgery because in patients perfused at baseline physiologic flows, the blood return to the open heart on the heart-lung machine (as in Dennis's experience) was too high to allow adequate visualization and successful correction of an intracardiac defect. By utilizing the azygos low flow concept, the actual successful repair of intracardiac (ventricular) defects was initiated by Dr. Lillehei by applying minimal support with cross circulation.<sup>3</sup> The evolution and subsequent successful open heart surgery by the use of the cardiopulmonary bypass machine by Dr. Denton Cooley in Houston, and Dr. Lillehei and Dr. John Kirklin in Minnesota, led to a meaningful application and expansion of cardiac surgery.<sup>5,6,7</sup>

In the early 1960s Dr. Michael DeBakey also became active in the field of open-heart surgery. He was particularly intrigued with the possibility of longer-term support of patients who could not be weaned from the heart-lung machine. While he was at Tulane, Dr. DeBakey had worked with Dr. George Burch, who had applied complete bed rest with subsequent heart rest as a therapy for chronic heart failure. Dr. DeBakey began investigating a similar approach of resting, with a true LVAD, the heart of patients who could not be weaned from the heart-lung machine. Dr. Domingo Liotta, who had worked on the TAH with both Dr. William Kolff and Dr. Tetsuzo Akutsu, was recruited in 1961 by Baylor College of Medicine to work with Dr. DeBakey in the Baylor Research Labs. The efforts of Dr. Liotta were focused on the development of both a device for total heart replacement and a device for left ventricular assistance following failure to wean from cardiopulmonary bypass. This author was introduced to the field as a student by Dr. Domingo

Liotta and Dr. DeBakey and made it his professional research effort from this time (1963). Dr. DeBakey observed clinically that a patient who could not be weaned from the heart-lung machine could occasionally recover enough to be weaned by simply resting the heart longer, with longer support on cardiopulmonary bypass<sup>8</sup> (Figure 1.1). This case was the stimulant to pursue longer-lasting support with a true LVAD.

The rest-and-recovery approach to this problem with an LVAD soon became Dr. DeBakey's main goal. He utilized this in the first successful case of bridge-to-recover utilizing an LVAD, performed in September 1966 (Figure 1.2).

Dr. DeBakey's role was pivotal in the effort to develop mechanical circulatory cardiac devices, not only in his initial clinical application of devices, but more importantly, in his efforts to achieve National Institutes of Health (NIH) funding for this research in this difficult, demanding, and time-consuming field. This was achieved at the urging of Dr. DeBakey and the support of President Lyndon B. Johnson and philanthropist Mary Lasker in the early 1960s (Figure 1.3).

At that time, the National Heart and Lung Institute, now known as the National Heart, Lung, and Blood Institute, began dedicating significant research funds, which were essential for the further advancement of this field.

The cardiac surgery field was further impacted at this time with the initiation of cardiac transplantation by Christiaan Barnard in December 1967.<sup>9</sup> Although Dr. Christian Barnard, following Dr. Norm Shumway and Dr. Richard Lower's pioneering research, had initiated cardiac transplantation, a significant number of these early transplants were in fact performed in Houston by Dr. Cooley. Dr. Liotta began visiting



**Figure 1.2.** Dr. DeBakey's first patient, who was successfully bridged to recovery with a left ventricular assist device. Reprinted from DeBakey ME, Left ventricular bypass pump for cardiac assistance, *American Journal of Cardiology* 1971;27:3–11, with permission from Elsevier.

Dr. Cooley in December 1968 to encourage him to consider use of the total heart replacement device he had fabricated as a bridge to transplant (BTT), and perhaps saving a patient facing imminent death who could not be weaned from the heart-lung machine. This was in fact undertaken by Dr. Cooley in April 1969.<sup>10</sup> The Liotta total heart replacement gave short-term support to a patient suffering certain, imminent death from heart failure after unsuccessful resection of a left ventricular aneurysm. Dr. Cooley implanted this pump in only 34 minutes. The patient recovered from this surgery, and his circulation was successfully maintained by the Liotta heart. In retrospect, however, he was grossly over-immune suppressed and subsequently prematurely transplanted (despite a white blood count of <2,000 at the time of transplant). He died quickly of subsequent overwhelming sepsis. The first implantation of an artificial



**Figure 1.3.** Dr. DeBakey and President Lyndon Johnson after signing the bill to create the US Artificial Heart Program in 1964.

Photo downloaded from <http://resource.nlm.nih.gov/101676363>.

heart (better defined as a biventricular replacement by pneumatically activated dual cardiac support devices) did show success, however, in supporting this patient. The field of transplantation was plagued with poor results during this initial experience, so that in the United States programs in 1972 were restricted to a research program at Stanford with Dr. Shumway and a similar program at the Medical College of Virginia with Dr. Lower.

The initial failure of the use of the application of cardiac transplantation was an important impetus to further research in mechanical support and replacement of the heart. In 1972 a meeting was held with the experts in the field of heart failure at the NIH, and this panel initiated research development of a long-term implantable LVAD. This was not for a BTT (as transplants were not routinely performed); rather, the device to be developed was the final goal of the therapy. This goal was further supported with generous research funding. Successful operation for 2 years was the arbitrary endpoint of the program. The application of this support led to the development of the implantable pulsatile LVAD. Two devices, the Novacor and the TCI HeartMate pumps, were both introduced clinically as a bridge-to-transplant device in the mid-1980s. This became feasible with the renewal of cardiac transplantation by the discovery of an improved immunosuppressant cyclosporine in 1982. Prior to the introduction of cyclosporine, three bridge-to-transplant operations had been performed, all at the Texas Heart Institute: one with an LVAD (as it was the only device available at that time) functioning as a total heart replacement<sup>11</sup> (in a patient suffering from a post-cardiotomy

**Table 1.1 • Two-Stage Cardiac Replacement: Texas Heart Institute**

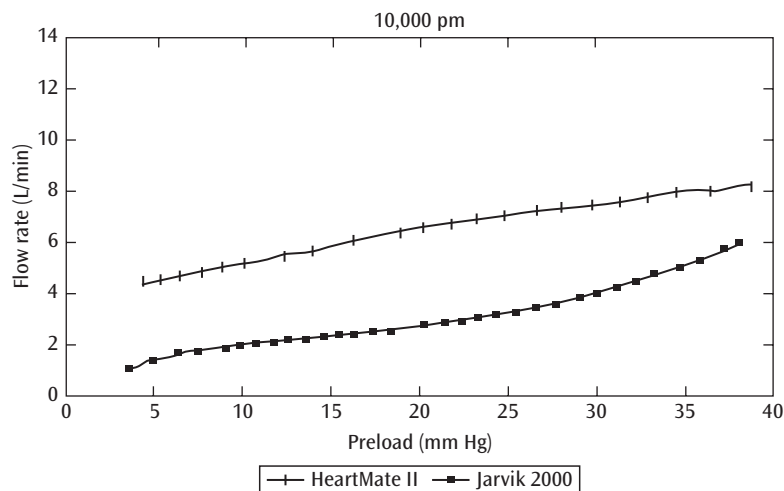
Patient	Diagnosis	Date	Procedure	Duration
47-year-old man	CAD, LVA	4/4/1969	TAH	64 hours
		4/7/1969	OHTx	32 hours
21-year-old man	SBE, MR, AR, stone heart	2/9/1978	LVAD	5 days
		2/14/1978	OHTx	14 days
36-year-old man	CAD	7/23/1981	TAH	54 hours
		7/25/1981	OHTx	7 days

Abbreviations: AR, aortic regurgitation; CAD, coronary artery disease; LVA, left ventricular aneurysm; LVAD, left ventricular assist device; MR, mitral regurgitation; OHTx, orthotopic heart transplant; SBE, subacute bacterial endocarditis; TAH, total artificial heart

“stone heart”), the other two with total (biventricular) heart replacements. The patient with the LVAD acting as total support received a heart-kidney transplant after five days of successful support. This was the first such dual-organ transplant (Table 1.1).<sup>11</sup>

Although the pumps worked well in all cases, the patients all died of overwhelming sepsis post-transplant. This seemed to be a finite barrier of this device application (BTT) as long as the pan-immune suppressant azathioprine was the primary immune drug therapy. The development of cyclosporine, a more forgiving immunosuppressant which spared the non-specific immune system, was the key both to successful heart transplants and to patients who had a previous device implant. This drug allowed the successful application of transplantation even to patients who were markedly septic.<sup>12</sup> In particular, the successful transplantation of a young woman suffering from Streptococcal and Staph sepsis was the case that opened the possibility of the use of pulsatile

LVADs as a BTT. Although the devices proved important as a life-saving device for patients facing imminent death from heart failure, their limited duration of 2 years of function or thereabouts (in most cases, due to fatigue of the flexing membranes) and the large size of the pulsatile implantable LVADs limited their practical application to that of a rescue device for larger patients that could subsequently be bridged to transplant. The REMATCH trial compared the pumps’ use as destination (solo) therapy to a randomized medical cohort. The patients treated with the pumps had a statistically superior survival to the medical group, but the limited survival at 2 years of both groups trivialized the epidemiologic impact of the pulsatile pumps. With this in mind, and with recognition of the limitations, this author began solo the development of implantable continuous-flow pumps as potentially a smaller and more durable approach. The first continuous-flow pump to be used with any short-term success was the Biomedicus pump. This constrained vortex centrifugal flow pump was



**Figure 1.4.** Starling-like response of the HeartMate II and Jarvik 2000 to preload changes without making speed changes. Reprinted by permission from Springer Nature, *Mechanical Circulatory Support: Principles and Applications*, Morgan JA, Civitello AB, Frazier OH, eds., 2018.



**Figure 1.5.** The Nimbus Hemopump impeller. Reprinted by permission from Springer Nature, *Mechanical Circulatory Support: Principles and Applications*, Morgan JA, Civitello AB, Frazier OH, eds., 2018.

a valuable adjunct for short-term external support, both in extracorporeal membrane oxygenation (ECMO) and as temporary LVAD support as a bridge-to-recovery. Not only was the smaller size of the non-pulsatile pumps appealing, but the inherent Starling-like flow response of continuous-flow pumps to elevated inflow pressure would balance automatically the disparate flow between the right and left ventricles (due to bronchial flow) in a total heart replacement (Figure 1.4). This was an important challenge and a potential limitation to the totally implantable pulsatile flow artificial heart.

An additional virtue of a continuous-flow pump is that its smaller size would allow its use in smaller adult patients and even in children. The application of a centrifugal type continuous-flow pump as a right-sided support was also important. The bulky pulsatile devices were anatomically not satisfactory for even short-term use as right-sided support due to the presence of the liver. The first implanted right-sided pump was the Jarvik pump at the Texas Heart Institute in 2003.<sup>13</sup>

The problem with implantation of a continuous-flow pump, however, was challenging from both mechanical and physiologic aspects. The chief mechanical limitation of a continuous-flow pump was twofold: that the RPM required to produce a significant amount of flow with the implantable continuous-flow pump in the bloodstream would be so high that inevitable destruction of blood cells by the device would limit its application, even for short-term use. The other limitation seemed to be a complete barrier. It was an obvious problem in the early 1980s that the only implantable continuous-flow pump designs in use were those that involved axial flow. These devices would require a bearing, and a bearing, of course, requires lubrication, and the lubrication of a bearing in the blood flow path was not thought to be possible. There were numerous assumed physiologic limitations, particularly



**Figure 1.6.** First clinical patient saved by Hemopump. Dr. Bud Frazier (left); patient (center); Dr. Rich Wampler (right).

Photo courtesy of Dr. O. H. Frazier. Reprinted by permission from Springer Nature, *Mechanical Circulatory Support: Principles and Applications*, Morgan JA, Civitello AB, Frazier OH, eds., 2018.

that of the baroreceptors and their adjustment to a decreased pulsatility. The concern was that this would result in physiologic feedback to decreased pulsatility and hypotension (i.e., vasoconstriction), and the sympathetic response would increase the likelihood of the complications of hypertension seen so commonly in the era prior to antihypertensive medications, particularly both ischemic vasospastic strokes and their possible conversion to hemorrhagic strokes, which were generally fatal. We also would face the barrier of the decreased pulsatility being perceived by the kidneys as renal artery obstruction and this causing an increase in renin output with resultant renal hypertension. With these barriers, both physiologic and mechanical, we nonetheless proceeded with research in the application of the continuous-flow pump as a mechanical support to the heart.

In 1986 we began working on both the short-term Hemopump, which was developed by Dr. Rich Wampler working for the Nimbus Corporation, while simultaneously working with Dr. Rob Jarvik on a continuous-flow pump that would, in fact, be a long-term implantable device. Our animal research was particularly encouraging with the Hemopump because we found that even with RPMs up to 27,000 with this small pump implanted in vivo as a temporary support, significant hemolysis was avoided (Figure 1.5). Long-term pump research with Dr. Jarvik proved more of a challenge. In fact, the early pumps with a non-lubricated bearing in the bloodstream did prove unsuccessful in the initial in vivo testing. In the first animal tested, the pump worked only about three days. However, Dr. Jarvik continued to work diligently on this bearing problem over the ensuing years, and by the early 1990s this technology showed the potential for long-term successful implantation.

The clinical introduction of the Hemopump in April 1988 was an important step in the development of this technology. The patient was dying of rejection following cardiac transplant. Although his cardiac function had deteriorated below what we would expect for survival, we were able to revive this patient with the insertion of a Hemopump. Reversal of the rejection was achieved by the use of the immune suppressant OKT 3 over a period of five days of Hemopump support. The pump was removed and the patient subsequently successfully discharged (Figure 1.6).

A multi-institutional study of the Hemopump's efficacy was then instituted. In this study, 41 study group patients were enrolled with excellent efficacy. However, as this was the first implantable continuous-flow pump to be presented to the FDA, and the entry criteria were a broad amalgam of heart failure patients from a variety of etiologies, the FDA understandably requested more data with more precise entry-group criteria. However, the financing of this study was from the capricious efforts of venture capitalists who then withdrew funding, and there was no way to complete the study. Shortly after it became obvious that we were not going to carry forward this technology, I contacted Helmuth Reul, who was a pioneer in the field of biomedical engineering. He had trained in Houston and was a long acquaintance. I made him aware of the virtue of this technology and he and colleagues, then working in Aachen, Germany, successfully turned this technology into a device that is now the most widely used temporary support pump in both Europe and the United States (the Impella pump). The Jarvik pump required solving other problems of commercialization before moving into clinical utilization. Dr. DeBakey had reviewed one of Dr. Jarvik's applications for an NIH grant and, although he turned it down, shortly after his review he introduced his own modification of an axial flow pump. This pump was the DeBakey or Micromed pump. Although it is no longer in use, it accelerated the introduction of the Jarvik pump. Implanted first at the Texas Heart Institute in April 2000, the Jarvik pump remains in clinical use. The work of Dr. Wampler in demonstrating the tolerance of the circulation to a high RPM pump and that of Dr. Jarvik in mastering the blood immersed-bearing problem are the two most important contributions in the initiation of the field of continuous-flow cardiac support devices, as their genius and diligence overcame what were perceived as finite barriers to the use of this technology.

The next pump to be introduced clinically was also an axial flow device. This pump was a modification of the Hemopump into a long-term implantable device. This author was the medical advisor for both the Jarvik and the Nimbus companies, as there was no widespread clinical interest in an implantable continuous-flow blood pump at that time. The engineer at Nimbus, John Moise, a very capable PhD in biomedical engineering from Cal Tech, was attempting to magnetically spin the rotating portion of the intended implantable long-term axial-flow modification

of the Hemopump. I told him of our success with Jarvik's blood-washed bearings, but he was skeptical as he recited the conventional view that blood-washed non-lubricated bearings were not feasible. I told him that long-term animal survival with a blood-washed bearing had already been achieved in our lab. This was a virtue of the limited interest in this technology. With that in mind, work was then directed for the HeartMate II axial flow pump with blood-washed bearings. Following the company's dissolution in the mid-1990s, this technology underwent further modification by Thoratec and TCI (Thermocardio System, Inc.), the developer of the HeartMate I pump. This pump was only then designated as the HeartMate II. It was initially implanted in Europe with poor results. Initially sintered titanium was placed on the inner aspect of the pump, similar to its application in the pulsatile vented electric HeartMate. However, in the small clearance of the blood-flow pathway of the HeartMate II, this was an impediment to the function and predisposed this pump to clot formation. This reflects the minute details involved in the success of this life-saving technology. The sintered titanium was removed and the first clinical HeartMate II was implanted at the Texas Heart Institute in November 2003. An advantage of the HeartMate II is the restriction of inflow generated by the cannula not being incorporated with the pump. This ensures the presence of an adequate blood reservoir. This of course also resulted in more early complications, related particularly to hypertension. We also discovered that if the aortic valve was not opening, blood pressure could not be measured with the usual pressure cuff. We presented this to company and cardiology leaders in 2006 and as a result instituted a policy in all clinical centers of using the Doppler device to measure the blood pressure and in controlling the blood pressure to a much lower level. This resulted in a marked decrease in the incidence of strokes and allowed us to move forward with the rapid expansion of the use of this important technology.

The next important advance in this field was the development of a magnetically levitated centrifugal force continuous-flow pump. This work was initiated in 1994, working again with Dr. Wampler. The pump evolved into what is now known as the HeartWare device. The appeal of this approach would be the potential of only requiring a hydrodynamic bearing, or possibly not requiring any bearing at all. Although we were confident the axial flow pumps would be more durable than the pulsatile pumps, we did not envision the long-term durability that we would eventually achieve with these blood-washed bearings. There is always a potential for bearing wear and failure. Another very important advantage of the flat surface of the centrifugal continuous-flow pump was its potential for intrapericardial placement. This made it ideal for right ventricular support. The flat surface of the pump allowed easy placement on the anterior diaphragmatic surface of the right ventricle. The company that was originally formed was called

Kriton Medical, but for financial reasons it was reformed under the name HeartWare, Inc., in 2000. This pump was eventually brought to clinical fruition and was implanted in Australia and in Europe in 2005. We began implanting the HeartWare pump in the United States in 2008. Both the HeartMate II and the HeartWare pumps have been approved by the FDA as both bridge-to-transplant and destination therapy devices.

In 1994, after working with Victor Poirier and Kurt Dasse for more than 20 years, I suggested that they start working on a totally magnetically suspended pump with no bearings. They were leaders in the development of the pneumatic and vented electric HeartMate pumps. This work came to fruition about 20 years later with the successful FDA approval of the HeartMate 3 implantable pump as a long-term device and a short-term extracorporeal pump that was further developed by Kurt Dasse (the Centrimag pump). This evolved into an important short-term, external pump that is widely used today. Both pumps were subsequently developed and brought to market by Thoratec Corporation.

As of January 2019, roughly 60,000 pumps have been implanted: the HeartMate II has been implanted in over 26,000 patients, the HeartMate 3 in over 4,000, the HeartWare in over 17,000 patients, and the Jarvik in over 10,000. Hence, the use of these pumps is widespread and the pulsatile LVAD pumps have not been made since 2012. These pumps are in use in over 500 hospitals throughout the United States and in other countries, and the durability of these pumps (one of the main reasons for pursuing their use) has certainly been proven. The data on the HeartMate II alone has shown patients implanted for up to 14 years with one device. There have been 6 such patients with this pump alone for over 7 years, and over 110 patients have had one pump for over 10 years, and more than 300 over 8 years. We have solved the dilemma of the 2-year durability limitation that the pulsatile pumps demonstrated. In 2016, the number of continuous-flow pumps implanted was twice that of heart transplants.

However, these pumps have numerous problems that may be related to this abnormal physiology that we have introduced. It must be recalled that the technologies (valves, pacemakers, circulation, etc.) that we have introduced surgically in cardiovascular disease have in general mimicked the physiology of the natural heart and circulation. Even the pulsatile pumps we developed worked to mimic the functioning left ventricle, pumping one-third systole and two-thirds diastole. The problems that we have seen with the continuous-flow pump may be tied to the role of this altered physiology. This remains to be properly investigated. We have permanently altered diastolic flow from passive to active through the cardiac cycle. This could affect some of the complications we see with the technology. Certainly, there was a relationship to the strokes and the elevated blood pressure, as well as the difficulty with obtaining

proper blood pressure levels by the conventional method. This still has not been extensively investigated by cardiovascular physiologists. We must try to see if even more precise data can be related to the pressure and its subsequent complications that we see. The problems that we have seen with the continuous-flow pumps, such as gastrointestinal (GI) bleeding and hemorrhagic strokes, in particular, have not been approached in a disciplined physiologic manner. The proper pressure is still in question, particularly in non-pulsatile flow (the aortic valve not opening).

In 1963 Drs. DeBakey and Liotta began working to develop an artificial heart. In 1965 Dr. DeBakey stated that by 1980, there would be “a hundred thousand Americans with a functional artificial heart.” Likewise, NIH studies from the late 1960s predicted that a clinically practical artificial heart would be in widespread use by the mid-1980s. But the problems associated with developing such a device proved to be far more formidable than was commonly assumed, based on the perception at the time that an artificial heart could be a simple pump. The continuous-flow pumps now in widespread use as LVADs also may offer the best answer to total heart replacement. Many patients still would benefit from TAH technology. In the 1970s, we developed a plutonium-powered internal battery that could power a 50-watt pump for more than 82 years. Obviously, this was not pursued because we did not have a pump that would last more than 2 years. These continuous-flow pumps, however, have not yet been pumped to mechanical failure, and their long durability evidences their potential as meaningful long-term pumps.

In 2005 at the Texas Heart Institute, we replaced the ventricles in an experimental animal with two continuous-flow pumps. We repeated these experiments numerous times and found that animals with continuous-flow pumps performed well, grew normally, and had a normal activity response on the treadmill; many of them survived long term (para 90 days). We began working in 2012 with an investigator in Australia, Daniel Timms, who had devised a continuous-flow TAH. This pump is small but can produce up to 20 L of flow if needed. It has only one moving part, which is magnetically levitated. It perfuses both the pulmonary and systemic circulation simultaneously. We have demonstrated the feasibility of this pump in experimental animals and have even showed a Starling response, much like the normal heart, without changing the pump speed, when calves implanted with this pump are on the treadmill. This technology offers great promise for the future and for the meaningful prevention of premature death from the loss of natural heart function.

Finally, the concept of continuous flow stems from short-term use of low flows on the early patients who could not be weaned from the heart-lung machine. The first pulsatile devices introduced for this support in the 1980s were, in fact, left ventricular replacement devices. With both the TCI pump and the Novacor device in the normal operating



mode, the aortic valve never opened. The non-pulsatile device, however, is best suited as a true assist device; that is, the lowest flow possible to allow normalization of function to the native heart should be sought. The entire function of the left ventricle can be successfully achieved by these pumps, but this should only be used if clinically necessary. Minimization of complications can be optimized by preservation of pulsatility.

The present movement is clearly in the direction of continuous flow, and thousands of lives are being successfully prolonged. However, it must be reiterated that this represents a unique physiology never before encountered in mammalian species. We have patients doing well who have not had a pulse in more than 11 years and yet are totally asymptomatic. We must, however, study and address the complications and the role played by the altered physiology seen with the use of this technology, in both its short-term and long-term application, to optimally benefit the heart failure patient.

## REFERENCES

- Lewis FJ, Taufic M. Closure of atrial septal defects with the aid of hypothermia: experimental accomplishments and the report of one successful case. *Surgery*. 1953;33(1):52–59.
- Gibbon JH, Jr. Application of a mechanical heart and lung apparatus to cardiac surgery. *Minn Med*. 1954;37(3):171–185; passim.
- Dennis C, Spreng DS, Jr., Nelson GE, et al. Development of a pump-oxygenator to replace the heart and lungs: an apparatus applicable to human patients, and application to one case. *Ann Surg*. 1951;134(4):709–721.
- Cohen M, Lillehei CW. A quantitative study of the azygos factor during vena caval occlusion in the dog. *Surg Gynecol Obstet*. 1954;98(2):225–232.
- Lillehei CW, Varco RL, Cohen M, Warden HE, Patton C, Moller JH. The first open-heart repairs of ventricular septal defect, atrioventricular communis, and tetralogy of Fallot using extracorporeal circulation by cross-circulation: a 30-year follow-up. *Annals Thorac Surg*. 1986;41(1):4–21.
- Kirklin JW, Donald DE, Harshbarger HG, et al. Studies in extracorporeal circulation. I. Applicability of Gibbon-type pump-oxygenator to human intracardiac surgery: 40 cases. *Ann Surg*. 1956;144(1):2–8.
- Cooley DA, Belmonte BA, DeBakey ME, Latson JR. Mechanical heart lung for temporary cardiopulmonary by-pass: report of 95 cases. *Tex State J Med*. 1957;53(6):397–400.
- DeBakey ME. Left ventricular bypass pump for cardiac assistance: clinical experience. *Am J Cardiol*. 1971;27(1):3–11.
- Barnard CN. The operation. A human cardiac transplant: an interim report of a successful operation performed at Groote Schuur Hospital, Cape Town. *S Afr Med J*. 1967;41(48):1271–1274.
- Cooley DA, Liotta D, Hallman GL, Bloodwell RD, Leachman RD, Milam JD. Orthotopic cardiac prosthesis for two-staged cardiac replacement. *Am J Cardiol*. 1969;24(5):723–730.
- Norman JC, Brook MI, Cooley DA, et al. Total support of the circulation of a patient with post-cardiotomy stone-heart syndrome by a partial artificial heart (ALVAD) for 5 days followed by heart and kidney transplantation. *Lancet*. 1978;1(8074):1125–1127.
- Frazier OH, Cooley DA, Okereke OU, Radovancevic B, Chandler LB. Cardiac transplantation in a patient with septicemia after prolonged intraaortic balloon pump support: implications for staged transplantation. *Tex Heart Inst J*. 1986;13(1):13–18.
- Frazier OH. History of mechanical circulatory support. In: Morgan JA, Civitello AB, Frazier OH, eds. *Mechanical Circulatory Support for Advanced Heart Failure*. Cham: Springer International; 2018:1–13.

# 2

## Indications for Mechanical Circulatory Support

MICHAEL DICKINSON, STEPHEN WILKINSON, AND MILENA JANI

### Indications for Mechanical Circulatory Support (MCS) Therapy

**I**dentifying and selecting optimal patients is key for success with MCS. Understanding the indications can help.<sup>1,2,3</sup> But patient selection goes well beyond a list of indications. It encompasses multiple factors that must be carefully balanced.

The key elements around selecting patients can be summarized as the following:

1. **Survival:** Will the patient's survival be better with or without MCS? What tools are available to help us estimate his or her odds of survival?
2. **Quality of Life (QOL) and Risks for Complications:** Will the patient's life be better from MCS? What is the likelihood of a good outcome vs. a life-limiting complication?
3. **Timing:** What is the appropriate timing? Should MCS be implanted early? What are the risks in delaying implant?
4. **Shared Decision-Making:** How do we optimally engage patients in the decision-making process?

Each of these elements is very complex. Some data are available but much of it is retrospective and observational. Ultimately, teams are tasked with using the data plus a large degree of clinical expertise ("expert opinion") to make these complicated decisions. This chapter will lay out the principles upon which both referring and implanting clinicians can build for mature decision-making.

### Referral for Evaluation for MCS

A robust list of indications includes features that could suggest an adverse prognosis. These are helpful to decide

which patients should be referred (and when) for evaluation. These are summarized in Table 2.1. Patients with one or more of these clinical features are at risk for adverse outcomes and should be considered for MCS.

A practical guide to referral is as follows:

1. *Persistent symptoms:* Either the patient or the physicians are not happy with how the patient is doing based on the patient's symptoms or inability to tolerate disease-modifying heart-failure treatments.
2. *An adverse trajectory:* Is this a patient who is improving, stable, or likely to worsen?<sup>2</sup> MCS and goals of care should be explored for those with an adverse trajectory.
3. *High-risk clinical features:* Does the patient have one or more clinical features that have demonstrated a risk for decline and adverse outcome (as in Table 2.1)?

### Standard Indications for MCS

Traditionally MCS has been divided into categories:<sup>3</sup>

- *Bridge to Transplant (BTT)* = Patients being implanted to be able to get to a heart transplant.
- *Destination Therapy (DT)* = Patients who do not meet criteria for heart transplant but could have good survival with MCS. The goal is to improve longevity and quality of life.
- *Bridge to Candidacy (BTC)* = Patients for whom the MCS is implanted who do not currently meet BTT criteria. These patients start as DT, but with the hope that they could cross over to the BTT category.

These divisions are somewhat artificial. Patients in the Momentum 3 Trial were not enrolled based on these

**Table 2.1 • Indicators of Advanced Heart Failure That Should Trigger Consideration for Evaluation of Advanced Therapies<sup>1</sup>**

- Need for intravenous inotropic therapy for symptomatic relief or to maintain end-organ function
- Peak VO<sub>2</sub> <14 mL kg/l/min or <50% of predicted
- 6-minute walk distance <300 m
- >2 HF admissions in 12 months or >2 unscheduled visits (e.g., ED or clinic) in 12 months
- Worsening right heart failure and secondary pulmonary hypertension
- Diuretic refractoriness associated with worsening renal function
- Circulatory-renal limitation to RAAS inhibition or beta-blocker therapy
- Progressive/persistent NYHA functional class III–IV symptoms
- Increased 1-y mortality (e.g., 20%–25%) predicted by HF survival models
- Progressive renal or hepatic end-organ dysfunction
- Persistent hyponatremia (serum sodium <134 mEq/L)
- Recurrent refractory ventricular tachyarrhythmias; frequent ICD shocks
- Cardiac cachexia
- Inability to perform ADL

Reprinted from Fang JC et al., Advanced (stage D) heart failure: a statement from the Heart Failure Society of America Guidelines Committee, *Journal of Cardiac Failure* 2015;21:519–534, with permission from Elsevier.

categories.<sup>3,4</sup> Instead, cohorts were described as short term (ST, outcomes at 6 months) or long term (LT, outcomes at 2 years). When using devices capable of giving good LT outcomes, the decision is simplified to whether patients can benefit from MCS or not. Some will also meet transplant criteria. For these patients the question is whether they can wait for transplant without MCS, or whether MCS is necessary to protect their survival until they can become transplanted.

In the United States, the Centers for Medicare and Medicaid Services (CMS) criteria for MCS for DT are as follows:<sup>5,6</sup> Patients who are New York Heart Association (NYHA) functional class IV and for whom all of the following are true:

1. Failed to respond to optimal medical management for at least 45 of the last 60 days. Alternative are patients who have been depending on an intra-aortic balloon pump (IABP) for 7 days or intravenous (IV) inotropes for 14 days.

2. Have a left ventricular ejection fraction (LVEF) <25%.
3. Have a significant functional limitation defined as a peak oxygen consumption (pVO<sub>2</sub>) ≤14 ml/kg/min, or are dependent on an IABP or IV inotropes, or are physically unable to perform an exercise test.

Contraindications for MCS include factors such as life expectancy of less than 2 years not expected to be reversed by MCS, irreversible kidney or liver dysfunction, severe pulmonary disease, or any other factors likely to result in poor 2–3-year survival.<sup>6</sup>

## Estimating Patient Survival without or with MCS

### Mortality Risk Prediction without MCS

Most commonly, patients who receive MCS are dependent on inotropes. Such patients have approximately 50% 1-year survival.<sup>7</sup> For those not dependent on inotropes, a variety of techniques and scores have been developed to help assess patient survival. Mancini et al. observed that patients with a pVO<sub>2</sub> on cardiopulmonary exercise testing (CPXT) >14 ml/kg/min had equivalent or better survival with medical management than with heart transplant.<sup>8</sup> Patients with pVO<sub>2</sub> ≤14 therefore are considered appropriate candidates for transplant or MCS. Subsequent studies have suggested that multiple measures on the CPXT should be considered, including lean body mass adjusted pVO<sub>2</sub> (high risk is ≤19) and VE/VCO<sub>2</sub> slope.<sup>9</sup> Strong data for adverse outcome are present for patients with pVO<sub>2</sub> <10 or slope ≥45.<sup>10</sup> For patients with peak VO<sub>2</sub>s between 10 and 14, attention to other clinical predictors should help to drive decision-making.

A number of clinical risk predictors have also been developed using data from large clinical trials. These are summarized in Table 2.2.

Comparisons between the Heart Failure Survival Score (HFSS) and Seattle Heart Failure Model (SHFM) showed comparable performance. Calculation of multiple scores may provide complementary information and improve accuracy.<sup>10–16</sup> A review of the SHFM and MAGGIC suggested that while these tools may perform well on a population level, they did not reliably predict 1-year survival on an individual level.<sup>17</sup> The risk predictors should be best thought of as tools or guides, rather than absolute indications for or against MCS. Decisions for MCS remain a matter of clinical judgment—supported, but not replaced, by the use of pVO<sub>2</sub> and risk-prediction tools.

### Mortality Risk Prediction with MCS

The INTERMACS registry tracks the outcomes of patients implanted with MCS at centers throughout the United States.<sup>18</sup> The 2019 INTERMACS registry reported survival

**Table 2.2 • Selected Heart Failure Clinical Risk Predictors**

Clinical Risk Predictor	Comments
The Heart Failure Survival Score (HFSS) <sup>11</sup>	HFSS = 0.0464*LVEF + 0.0255*MAP + 0.0546*pVO2 + 0.0470*Sodium -0.0216*resting HR. Subtract 0.6931 if ischemic cardiomyopathy and 0.6083 if conduction delay. HFSS $\geq$ 8.1 are low risk. Others should be considered for MCS.
The Seattle Heart Failure Model (SHFM) <sup>12</sup>	Online calculator at <a href="https://depts.washington.edu/shfm/">https://depts.washington.edu/shfm/</a>
The MAGGIC risk calculator <sup>13</sup>	Online calculator at <a href="http://www.heartfailure-risk.org">http://www.heartfailure-risk.org</a>
CHARM tool <sup>14</sup>	Uses 24 different variables in a complex model
GISSI-HF predictor <sup>15</sup>	Uses 12 independent variables

based on the implant strategy. Survival for BTT, BTC, and DT populations was 88%, 85%, and 80%, respectively, at 1 year. These statistics can be balanced against the clinical risk predictors to help guide patient-selection decisions.

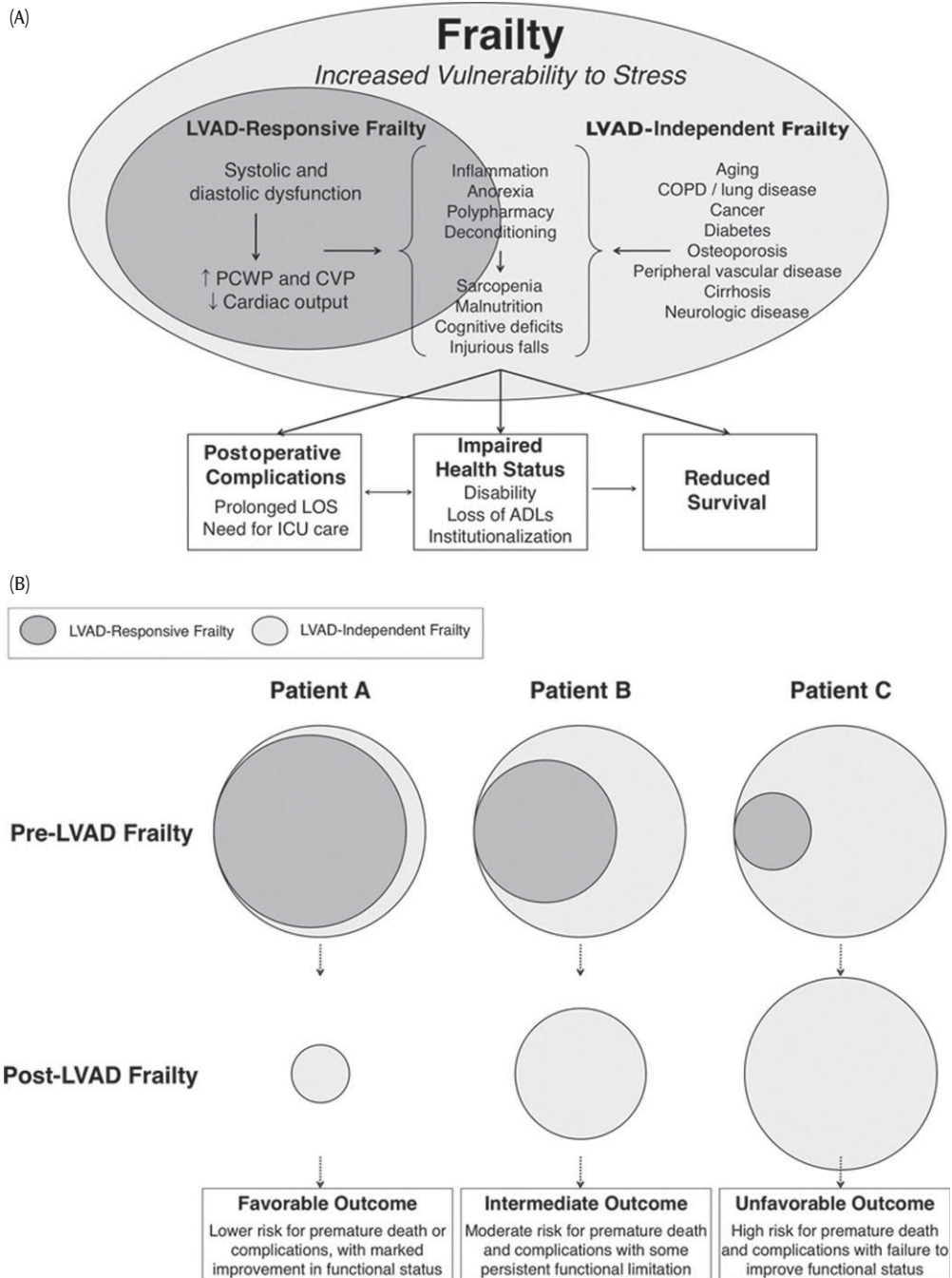
## Impact on Quality of Life (QOL) and Estimating Risks of Complications or Poor Outcome

The INTERMACS registry, as well as clinical trial data, has shown consistent large improvements in QOL after MCS in terms of the Visual Analog Scale (VAS) from the EuroQol questionnaire, the Kansas City Cardiomyopathy Questionnaire (KCCQ), NYHA functional class, and six-minute walk distances.<sup>18,19</sup> The primary predictor of impact on QOL is based predominantly on the risk of death or complications from MCS. Assessing the risk for an adverse outcome based on all clinical, surgical, and psychosocial factors is a key task for the MCS team. There are a few measures that have been developed to try to predict outcomes. These are summarized in Table 2.3. Nonetheless, prediction remains strongly a matter of overall clinical judgement.

Frailty also has been shown to be a strong predictor of survival and days alive out of the hospital with MCS.<sup>25</sup> More work is needed, however, to develop the optimal measures of frailty in the MCS population. Figure 2.1 depicts the

**Table 2.3 • Predictors of Outcome After MCS**

Predictor (Score)	Measures	How to Calculate
Destination Therapy Risk Score <sup>20</sup>	<ul style="list-style-type: none"> <li>• Platelet count <math>\leq</math>148 (7 points)</li> <li>• Albumin <math>\leq</math>3.3 g/dl (5 points)</li> <li>• INR <math>&gt;</math>1.1 (4 points)</li> <li>• Vasodilator therapy (4 points)</li> <li>• Mean pulmonary artery pressures <math>\leq</math>25 mmHg (3 points)</li> <li>• Aspartate aminotransferase <math>&gt;</math>45 (2 points)</li> <li>• Hematocrit <math>\leq</math>34% (2 points)</li> <li>• BUN <math>&gt;</math>51 (2 points)</li> <li>• No intravenous inotropes (2 points)</li> </ul>	<ul style="list-style-type: none"> <li>• Add all points</li> <li>• Low risk = 0–8 points (90-day in-hospital mortality <math>&lt;</math>1%)</li> <li>• Medium risk = 9–14 points (mortality 0.7%–3%)</li> <li>• High risk = 15–19 points (mortality 5%–10%)</li> <li>• Very high risk = <math>&gt;</math>19 points (mortality 24%)</li> </ul>
Heartmate II Risk Score <sup>21</sup>	<ul style="list-style-type: none"> <li>• Age (per 10 years)</li> <li>• Albumin (per g/dl)</li> <li>• Creatinine (per mg/dl)</li> <li>• INR (per unit)</li> <li>• Center volume <math>&lt;</math>15</li> </ul>	Via online calculation tools such as: <a href="http://www.pmidcalc.org/?sid=23265328&amp;newtest=Y">http://www.pmidcalc.org/?sid=23265328&amp;newtest=Y</a>
Bayesian model derived from INTERMACS <sup>22</sup>	<ul style="list-style-type: none"> <li>• Multiple variables</li> </ul>	Via online calculation at <a href="http://mycora.org">http://mycora.org</a> Integrates data from multiple models plus Bayesian analysis using data from the INTERMACS registry
Right Ventricular Failure Risk Model <sup>23</sup>	<ul style="list-style-type: none"> <li>• Vasopressor requirement (4 points)</li> <li>• AST <math>\geq</math>80 (2 points)</li> <li>• Bilirubin <math>\geq</math>2 (2.5 points)</li> <li>• Creatinine <math>\geq</math>2.3 (3 points)</li> </ul>	Predicts RV failure as a marker of poor outcome: <ul style="list-style-type: none"> <li>• Low risk = Score 3 or less (npv 80%)</li> <li>• Intermediate risk = Score 3–5.5</li> <li>• High risk = Score 5.5 or greater (ppv 80%)</li> </ul>
CRIT Score <sup>24</sup>	1 point each for: <ul style="list-style-type: none"> <li>• CVP <math>&gt;</math>15 (C)</li> <li>• Severe RV dysfunction (R)</li> <li>• Intubation/ventilation (I)</li> <li>• Severe Tricuspid Regurgitation (T)</li> <li>• Tachycardia (T)</li> </ul>	Also predicts RV failure as a marker of poor outcome: <ul style="list-style-type: none"> <li>• Low risk = 1 or less (7% RV failure)</li> <li>• Intermediate risk = 2–4</li> <li>• High risk = 4–5 (80% RV failure)</li> </ul>



**Figure 2.1.** Frailty in MCS.

Reprinted with permission from Flint KM, Matlock DD, Lindenfeld J, Allen LA, Frailty and the selection of patients for destination therapy left ventricular assist device. *Circ Heart Fail.* 2012;5:286–293. <https://www.ahajournals.org/journal/circheartfailure> © American Heart Association, Inc.

complex interactions between left ventricular assist device (LVAD)-responsive frailty and LVAD-independent frailty.<sup>26</sup> If the frailty is able to be reversed by MCS, the patient might do well. If the patient, however, has factors that will be unchanged by MCS, then there is substantial risk for poor outcome.

### Timing of Implantation: Early versus Late

The INTERMACS registry has consistently shown better outcomes for patients not implanted in a time of critical cardiogenic shock.<sup>27</sup> The ROADMAP study looked at

implantation in non-inotrope-dependent advanced heart failure patients.<sup>28</sup> The early implantation population had a higher rate of survival with improved functional capacity. The 30-day mortality was only 1% in both the MCS and the medical management groups. This suggests that early implantation may be appropriate for select patients. Delayed implantation can result in increased risks based on worsening of right ventricular function or other declines (such as frailty, renal or hepatic dysfunction). On an intent-to-treat basis, survival was equivalent between the groups because of a strong crossover to subsequent MCS implantation. For many patients it is “not if, but when.” In the non-inotrope-dependent patient, decision for implant or delay is based on patient symptoms and preferences and clinical stability. A decision to delay warrants close monitoring for worsening clinical status to avoid increasing the patient’s risks for MCS.

## Shared Decision-Making (SDM)

SDM is essential in MCS.<sup>29</sup> In the DECIDE-LVAD trial, decision-making using additional aids improved concordance between patient’s values and ultimate choice of therapy.<sup>30</sup> In the VADDA trial, a decision aid was associated with higher 1-month QOL, suggesting that effective SDM can improve outcomes.<sup>31</sup> Patients should be engaged in a clear detailed dialogue about risks versus benefits, including data on survival, QOL, and risks of complications.

## The Special Case of Acute MCS

### When to Use Acute MCS

Acute MCS is used to treat cardiogenic shock to stabilize patients or as a bridge to decision. In somewhat less emergent states, acute MCS is indicated as support for high-risk percutaneous coronary interventions (PCI). Novel uses (such as LV unloading in ST elevation myocardial infarction [STEMI]) are being studied. The indications for acute MCS are summarized in Table 2.4.<sup>32</sup>

Hemodynamic criteria for acute MCS include systolic BP <90 for >30 minutes, hypotension requiring pressors resulting in oliguria or other signs of impaired organ perfusion, low cardiac index (<2.2 in the setting of myocardial infarction or <1.8 despite the use of inotropes), and pulmonary capillary wedge pressure >15 mmHg.<sup>32</sup>

### When Not to Use Acute MCS

Contraindications to acute MCS include the following:<sup>33</sup>

- **Absolute:** Severe irreversible non-cardiac organ failure, irreversible cardiac failure if transplantation or long-term ventricular assist device (VAD) will not

be considered, severe aortic insufficiency, and aortic dissection.

- **Relative:** Severe coagulopathy or contraindication to anticoagulation, limited vascular access, severe peripheral arterial disease.

Age (<60) and cardiac index ( $\geq 1.5$ ) at the time of acute MCS predict better outcomes.<sup>34</sup> More research is needed

**Table 2.4 • Indications for Acute MCS<sup>32</sup>**

Indication	Examples
Complications of acute myocardial infarction (AMI)	Acute ischemic mitral regurgitation, acute severe left ventricular (LV) dysfunction before, during, or after percutaneous coronary intervention (PCI), acute RV infarction (right heart MCS)
Severe heart failure from non-ischemic cardiomyopathy	Severe decompensations of chronic heart failure or as a result of conditions such as fulminant myocarditis, stress cardiomyopathy, or peripartum cardiomyopathy
Acute cardiac allograft failure or post-transplant RV failure	
Failure to wean from cardiopulmonary bypass following heart surgery	
Refractory arrhythmias	Recurrent ventricular tachycardia or fibrillation resulting in hemodynamic compromise
During high-risk PCI	Patients with severe LV dysfunction (EF<35%) and PCI involving sole remaining vessel or left main
During ablation of ventricular tachycardia (VT)	Complex VT ablations that might require prolonged periods of VT to facilitate successful ablation
During high-risk percutaneous valve interventions	Balloon valvotomy or transcatheter aortic valve replacement (TAVR) in patients with severe LV dysfunction

Reprinted from Rihal CS et al., SCAI/ACC/HFSA/STS clinical expert consensus statement on the use of percutaneous mechanical circulatory support devices in cardiovascular care: endorsed by the American Heart Association, the Cardiological Society of India, and Sociedad Latino Americana de Cardiología Intervencionista; Affirmation of Value by the Canadian Association of Interventional Cardiology-Association Canadienne de Cardiologie d’intervention, *Journal of the American College of Cardiology* 2015;65:2140–2141, copyright (2015), with permission from Elsevier.

to better define which patients will or will not survive with acute MCS. Factors influencing survival include the severity of the shock and multisystem organ dysfunction at the time of presentation and the ability of the patient to tolerate a significant physiologic insult. Expert consensus statements advocate for multidisciplinary teams to optimize outcomes with acute MCS.<sup>35</sup> These “shock teams” include advanced heart failure specialists, interventional cardiologists, VAD and transplant surgeons, and intensivists. The collective experience and insight from such teams can help with the complex decision-making and rapid deployment of resources necessary to be successful with acute MCS.

## Conclusions

Indications for MCS go beyond lists of indications and contraindications. Patient selection for MCS starts with identification of characteristics that should prompt evaluation for candidacy. It continues with a robust assessment of the risks versus benefits utilizing clinical team judgment supported by pVO<sub>2</sub> and other decision-making aids. Shared decision-making is a key component in matching patient goals with outcome. Future research needs remain, especially in regard to improving predictions of individual patient outcomes and complications of chronic MCS and in determining optimal candidates for acute MCS.

## REFERENCES

- Fang JC et al. Advanced (stage D) heart failure: a statement from the Heart Failure Society of America Guidelines Committee. *J Card Fail*. 2015;21:519–534.
- Allen LA et al. Decision making in advanced heart failure: a scientific statement from the American Heart Association. *Circulation*. 2012;125:1928–1952.
- Teuteberg JJ et al. Implant strategies change over time and impact outcomes: insights from the INTERMACS (Interagency Registry for Mechanically Assisted Circulatory Support). *JACC Heart Fail*. 2013;1:369–378.
- Heatley G et al. Clinical trial design and rationale of the Multicenter Study of MagLev Technology in Patients Undergoing Mechanical Circulatory Support Therapy With HeartMate 3 (MOMENTUM 3) investigational device exemption clinical study protocol. *J Heart Lung Transplant*. 2016;35:528–536.
- Jacques LB, Syrek Jensen T, Schafer JH, Baldwin J, Ulrich MM. *Decision Memo for Ventricular Assist Devices as Destination Therapy* (CAG-00119R2). 2010.
- Miller LW, Guglin M. Patient selection for ventricular assist devices: a moving target. *J Am Coll Cardiol*. 2013;61:1209–1221.
- Gorodeski EZ et al. Prognosis on chronic dobutamine or milrinone infusions for stage D heart failure. *Circ Heart Fail*. 2009;2:320–324.
- Mancini DM et al. Value of peak exercise oxygen consumption for optimal timing of cardiac transplantation in ambulatory patients with heart failure. *Circulation*. 1991;83:778–786.
- Corrà U et al. Cardiopulmonary exercise testing in systolic heart failure in 2014: the evolving prognostic role: a position paper from the committee on exercise physiology and training of the heart failure association of the ESC. *Eur J Heart Fail*. 2014;16:929–941.
- Guazzi M et al. EACPR/AHA Scientific Statement. Clinical recommendations for cardiopulmonary exercise testing data assessment in specific patient populations. *Circulation*. 2012;126:2261–2274.
- Koelling TM, Joseph S, Aaronson KD. Heart failure survival score continues to predict clinical outcomes in patients with heart failure receiving beta-blockers. *J Heart Lung Transplant*. 2004;23:1414–1422.
- Levy WC et al. The Seattle Heart Failure Model: prediction of survival in heart failure. *Circulation*. 2006;113:1424–1433.
- Pocock SJ et al. Predicting survival in heart failure: a risk score based on 39 372 patients from 30 studies. *Eur Heart J*. 2013;34:1404–1413.
- Pocock SJ et al. Predictors of mortality and morbidity in patients with chronic heart failure. *Eur Heart J*. 2006;27:65–75.
- Barlera S et al. Predictors of mortality in 6975 patients with chronic heart failure in the Gruppo Italiano per lo Studio della Streptochinasi nell’Infarto Miocardico-Heart Failure trial: proposal for a nomogram. *Circ Heart Fail*. 2013;6:31–39.
- Goda A, Williams P, Mancini D, Lund LH. Selecting patients for heart transplantation: comparison of the Heart Failure Survival Score (HFSS) and the Seattle heart failure model (SHFM). *J Heart Lung Transplant*. 2011;30:1236–1243.
- Allen LA et al. Use of risk models to predict death in the next year among individual ambulatory patients with heart failure. *JAMA Cardiol*. 2017;2:435–441.
- Kormos RL et al. The Society of Thoracic Surgeons INTERMACS database annual report: evolving indications, outcomes, and scientific partnerships. *J Heart Lung Transplant*. 2019;38:114–126.
- Mehra MR et al. A fully magnetically levitated left ventricular assist device: final report. *N Engl J Med*. 2019.
- Lietz K et al. Outcomes of left ventricular assist device implantation as destination therapy in the post-REMATCH era: implications for patient selection. *Circulation*. 2007;116:497–505.
- Cowger J et al. Predicting survival in patients receiving continuous flow left ventricular assist devices: the HeartMate II risk score. *J Am Coll Cardiol*. 2013;61:313–321.
- Kanwar MK et al. A Bayesian model to predict survival after left ventricular assist device implantation. *JACC Heart Fail*. 2018;6:771–779.
- Matthews JC, Koelling TM, Pagani FD, Aaronson KD. The right ventricular failure risk score a pre-operative tool for assessing the risk of right ventricular failure in left ventricular assist device candidates. *J Am Coll Cardiol*. 2008;51:2163–2172.
- Atluri P et al. Predicting right ventricular failure in the modern, continuous flow left ventricular assist device era. *Ann Thorac Surg*. 2013;96:857–863; discussion 863.
- Dunlay SM et al. Frailty and outcomes after implantation of left ventricular assist device as destination therapy. *J Heart Lung Transplant*. 2014;33:359–365.
- Flint KM, Matlock DD, Lindenfeld J, Allen LA. Frailty and the selection of patients for destination

- therapy left ventricular assist device. *Circ Heart Fail*. 2012;5:286–293.
27. Kirklin JK et al. Eighth annual INTERMACS report: Special focus on framing the impact of adverse events. *J Heart Lung Transplant*. 2017;36:1080–1086.
  28. Estep JD et al. Risk assessment and comparative effectiveness of left ventricular assist device and medical management in ambulatory heart failure patients: results from the ROADMAP Study. *J Am Coll Cardiol*. 2015;66:1747–1761.
  29. Boothroyd LJ et al. Challenge of informing patient decision making: what can we tell patients considering long-term mechanical circulatory support about outcomes, daily life, and end-of-life issues. *Circ Cardiovasc Qual Outcomes*. 2014;7:179–187.
  30. Allen LA et al. Effectiveness of an intervention supporting shared decision making for destination therapy left ventricular assist device: the DECIDE-LVAD randomized clinical trial. *JAMA Intern Med*. 2018;178:520–529.
  31. Kostick KM et al. A multisite randomized controlled trial of a patient-centered ventricular assist device decision aid (VADDA Trial). *J Card Fail*. 2018;24:661–671.
  32. Rihal CS et al. 2015 SCAI/ACC/HFSA/STS clinical expert consensus statement on the use of percutaneous mechanical circulatory support devices in cardiovascular care: endorsed by the American Heart Association, the Cardiological Society of India, and Sociedad Latino Americana de Cardiología Intervencionista; affirmation of value by the Canadian Association of Interventional Cardiology-Association Canadienne de Cardiologie d'intervention. *J Am Coll Cardiol*. 2015;65:2140–2141.
  33. Abrams D et al. Position paper for the organization of ECMO programs for cardiac failure in adults. *Intensive Care Med*. 2018;44:717–729.
  34. Garan AR et al. Predictors of survival and ability to wean from short-term mechanical circulatory support device following acute myocardial infarction complicated by cardiogenic shock. *Eur Heart J Acute Cardiovasc Care*. 2018;7:755–765.
  35. Doll JA et al. A team-based approach to patients in cardiogenic shock. *Catheter Cardiovasc Interv*. 2016;88:424–433.



# 3

## Frailty: Assessment and Associations with Outcomes

SHANNON M. DUNLAY

### Introduction

**P**atients receiving left ventricular assist devices (LVADs) have advanced heart failure refractory to usual medical therapy. In addition, they are often elderly and have concomitant non-cardiac comorbidities and functional limitations that may affect their prognosis independent of their heart failure. Frailty, which has been defined as a “state of increased vulnerability to adverse outcomes,”<sup>1</sup> is a clinical syndrome that may manifest in response to accumulating physiological declines that often accompany aging, comorbidities, and disability. Frailty is common in patients with heart failure and is associated with adverse outcomes.<sup>2-4</sup> The importance of frailty in patients undergoing LVAD implantation and its potential reversibility in response to implantation has been a topic of great interest and ongoing investigation. In this chapter, we first review definitions and pathophysiology of frailty and then examine the associations of pre-implantation frailty with post-implantation outcomes and investigations into whether LVAD therapy can modify frailty.

### Definitions and Pathophysiology of Frailty

Frailty is a syndrome of decreased reserves in response to stressors as a result of cumulative declines across multiple physiologic systems.<sup>5</sup> Physiological reserves gradually decline with normal aging, but in frailty, the process is accelerated. The inability to adequately respond to stressors results in vulnerability to adverse outcomes, including, hospitalization, falls, and death.<sup>6,7</sup>

Aging results from the lifelong accumulation of molecular and cellular damage. At some point, these cumulative

declines across multiple physiologic systems reach a threshold where frailty is evident.<sup>8</sup> The physiologic aspects most studied in frailty include the brain,<sup>9,10</sup> the immune system,<sup>11</sup> and skeletal muscle.<sup>12</sup> However, frailty has also been associated with impaired physiologic reserve across other organ systems, including the cardiovascular system.<sup>13</sup> Frailty is common in patients with heart failure,<sup>4</sup> which are each associated with circulating inflammatory cytokines and sarcopenia. Clearly, heart failure can exacerbate, and contribute to, frailty.<sup>14</sup> However, limited data also suggest that frailty itself may contribute to the development of heart failure. Among older individuals enrolled in the Health, Aging, and Body Composition Study, frailty at baseline was associated with an increased 10-year risk for heart failure.<sup>15</sup>

### Frailty Assessment

There is no agreement on the best way to assess frailty, although several frailty-assessment tools exist.<sup>16</sup> Most of these tools defined frailty either as a biologic phenotype, characterized by decreased reserves resulting from cumulative declines across multiple physiologic systems, or as an accumulation of deficits (impairments, disabilities, and diseases) summarized in a frailty index.<sup>17</sup> Phenotypic frailty<sup>2</sup> and the Frailty Deficit Index<sup>17</sup> identify overlapping, but not identical, patient populations.

### The Physical Frailty Phenotype

Phenotypic frailty is thought to result from multisystem biological decline that leads to specific symptoms, such as weakness and slowness. The most common and well-cited approach to identifying the frailty phenotype was validated in the Cardiovascular Health Study and is often referred as “Fried frailty” or the Physical Frailty Phenotype (or

**Table 3.1 • The Physical Frailty (Fried) Assessment Tool, from the Cardiovascular Health Study: Frailty Is Considered to Be Present if Three or More of the Five Criteria Are Met**

Component	Assessment	Definition
1. Weakness	Grip strength of dominant hand measured with a Jamar dynamometer	<b>Lowest 20%</b> <ul style="list-style-type: none"> <li>Men BMI: weight           <ul style="list-style-type: none"> <li>≤24: ≤29 kg</li> <li>24.1–28: ≤30kg</li> <li>&gt;28: ≤32kg</li> </ul> </li> <li>Women BMI: weight           <ul style="list-style-type: none"> <li>≤23: ≤17kg</li> <li>23.1–26: ≤17.3kg</li> <li>26.1–29: ≤18kg</li> <li>&gt;29: ≤21kg</li> </ul> </li> </ul>
2. Physical exhaustion	Self-report (2 questions from the Center for Economic Studies Depression Scale questionnaire)	Self-report of <ol style="list-style-type: none"> <li>(1) feeling “everything was an effort” or</li> <li>(2) “could not get going” at least 3–4 days in the last week</li> </ol>
3. Slowness	Gait speed (time to walk 15 feet)	<b>Slowest 20% of the population</b> <ul style="list-style-type: none"> <li>Men (distance: time)           <ul style="list-style-type: none"> <li>≤173 cm: ≥7 seconds</li> <li>&gt;173 cm: ≥6 seconds</li> </ul> </li> <li>Women           <ul style="list-style-type: none"> <li>≤159 cm: ≥7 seconds</li> <li>&gt;159 cm: ≥6 seconds</li> </ul> </li> </ul>
4. Low physical activity	Kilocalories expended per week (Minnesota Leisure Time Activities Questionnaire)	<b>Lowest 20%</b> <ul style="list-style-type: none"> <li>&lt;383 Kcals/week men</li> <li>&lt;270 Kcals/week women</li> </ul>
5. Shrinking	Unintentional weight loss (questionnaire)	≥10 pounds lost unintentionally in prior year

Reprinted from Fried LP, Tangen CM, Frailty in older adults: evidence for a phenotype, *Journals of Gerontology—Series A: Biological Sciences and Medical Sciences* 2001;56(3): M146–156, by permission of Oxford University Press.

“Fried frailty phenotype”). These terms are all used interchangeably (Table 3.1).<sup>18</sup> In this approach, patients were classified as frail if they met three or more of the following criteria: weakness, physical exhaustion, slowness, low physical activity, and shrinking. Intermediate frailty was defined as meeting one or two criteria. Weakness is generally assessed by grip strength using a Jamar dynamometer. Slowness is often assessed as 15-foot gait speed. Shrinking is operationalized as unintentional weight loss in the

last year (by direct measurement of weight or by questionnaire). Exhaustion and physical activity are usually assessed by questionnaire. In the numerous adaptations of this phenotype approach, one or more criteria are assessed using varying questionnaires and other mechanisms.

One challenge in implementing the phenotype approach is that the components are not routinely assessed clinically. Although individuals can be assessed relatively easily, a separate assessment for frailty status is sometimes not feasible in large populations.

### The Frailty Deficit Index

The Frailty Deficit Index is based on the idea that patients accumulate deficiencies that can be counted to determine frailty status.<sup>1,17</sup> Potential deficits may be indicated by symptoms, signs, disabilities, diseases, and abnormal laboratory values. The Frailty Deficit Index is the proportion of potential deficits present in a patient. A cutoff of at least 25% of deficits has been suggested to define frailty.<sup>1</sup> One potential advantage of this index is the ability to use data extracted from medical records. The index can be modified based on the data available.<sup>1</sup> Variables can be included in a deficit index if they are associated with health status, if their prevalence increases with age, and, when considered as a group, if they encompass a range of physiologic and organ systems. Even though not every deficit index contains the same deficits, a greater proportion of deficits has been consistently predictive of adverse outcomes across multiple indices.<sup>1,2</sup>

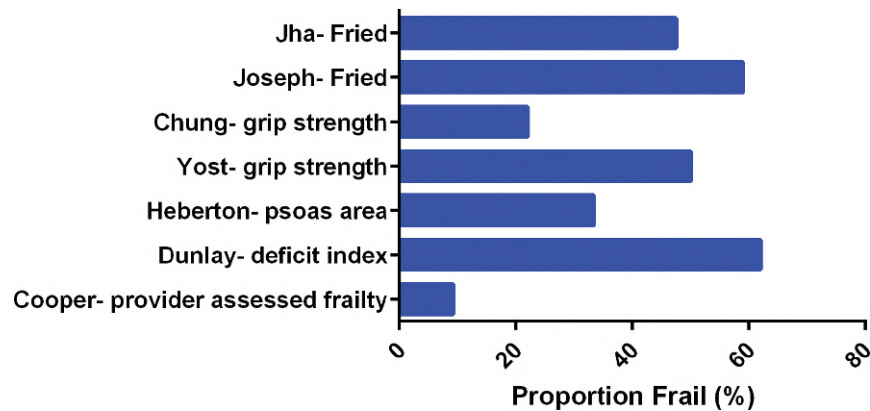
### Other Frailty Assessment Tools

Several other tools have been used to assess frailty in patients before LVAD implantation (Table 3.2). The proportion of patients categorized as frail varies by the method of assessment and the population studied (Figure 3.1). Two single-center studies assessed frailty before LVAD implantation in patients using the Physical Frailty Phenotype. In one study of 40 patients undergoing LVAD as bridge-to-transplant, 19 (47.5%) were frail.<sup>19</sup> A similar assessment in 75 patients before LVAD as bridge to transplant ( $n = 53$ ) or destination therapy ( $n = 22$ )<sup>20</sup> was limited by the fact that 31 (43%) patients could not complete the gait speed test because of illness and immobility. The authors thus proposed a modified score based on three of the original five criteria: exhaustion, inactivity, and grip strength. Frailty was defined as having two of the three criteria. Using this definition, 34 (45%) patients were classified as frail. The frequent inability to complete gait speed testing was also noted in patients undergoing LVAD implantation as destination therapy, as represented in Society of Thoracic Surgery’s Interagency Registry for Mechanically Assisted Circulatory Support (INTERMACS).<sup>21</sup> Of 2,469 patients, only 320 (13%) completed gait speed testing.

**Table 3.2 • Summary of Studies Assessing Frailty in Recipients Receiving Left Ventricular Assist Devices**

Author Year	Frailty Assessment Tool	Setting	N	Indication (DT, BTT)	Frailty Reassessed after Receiving LVAD	Outcomes	Major Findings
Chung 2014 <sup>22</sup>	Handgrip strength (<25% body weight = frail)	Single- center	72	Both	Yes	Long-term mortality Postoperative complications	<ul style="list-style-type: none"> <li>• Grip strength improved after implantation.</li> <li>• Poor grip strength was associated with increased risks of death, bleeding, and infection.</li> </ul>
Cooper 2018 <sup>21</sup>	Provider-assessed frailty	INTERMACS registry	2469	DT	No	LOS 1-year mortality 1-year readmission	<ul style="list-style-type: none"> <li>• Frailty associated with longer LOS, trend toward higher 1-year mortality. No association with 1-year readmission.</li> </ul>
Dunlay 2014 <sup>27</sup>	Frailty Deficit Index (>25%= frail)	Single- center	99	DT	No	Long-term mortality Readmission	<ul style="list-style-type: none"> <li>• Frailty was associated with increased risks of death and readmission.</li> </ul>
Heberton 2016 <sup>25</sup>	Psoas muscle area by CT (lowest tertile by sex = frail)	Single- center	333	Both	No	Combined endpoint of inpatient mortality or LOS >30 days Long-term mortality	<ul style="list-style-type: none"> <li>• Frailty (sarcopenia) was associated with increased risk of combined endpoint of inpatient mortality or prolonged LOS.</li> </ul>
Jha 2017 <sup>19</sup>	Physical Frailty Phenotype	Single- center	40	BTT	Yes	LOS, intubation time, ICU time, 1-year mortality	<ul style="list-style-type: none"> <li>• Frailty associated with longer LOS, ICU stay, and lower 1-year survival</li> <li>• 12 of 13 frail patients improved frailty scores after implantation</li> </ul>
Joseph 2017 <sup>20</sup>	Physical Frailty Phenotype	Single- center	75	Both	No	Combined endpoint of inpatient mortality or LOS >30 days Long-term mortality	<ul style="list-style-type: none"> <li>• 5-component Index did not predict combined endpoint, but abridged set of 3 criteria (exhaustion, inactivity, grip strength) did.</li> </ul>
Maurer 2017 <sup>37</sup>	Physical Frailty Phenotype	Single- center	29	Both	Yes	—	<ul style="list-style-type: none"> <li>• Average frailty criteria decreased after implantation; half frail at 6 months</li> </ul>
Teigen 2017 <sup>26</sup>	Pectoralis muscle are by CT (no frailty cutoff defined)	Single- center	354	Both	No	Long-term mortality	<ul style="list-style-type: none"> <li>• Lower pectoralis muscle mass and attenuation were each associated with increased risk of death</li> </ul>
Yost 2017 <sup>23</sup>	Handgrip strength (<28.5% body weight = frail)	Single- center	90	Both	No	LOS	<ul style="list-style-type: none"> <li>• Poor grip strength was associated with longer LOS</li> </ul>

Abbreviations: BTT = bridge to transplant; CT = computed tomography; DT = destination therapy; INTERMACS = Interagency Registry for Mechanically Assisted Circulatory Support registry; LOS = length of stay; LVAD = left ventricular assist device.



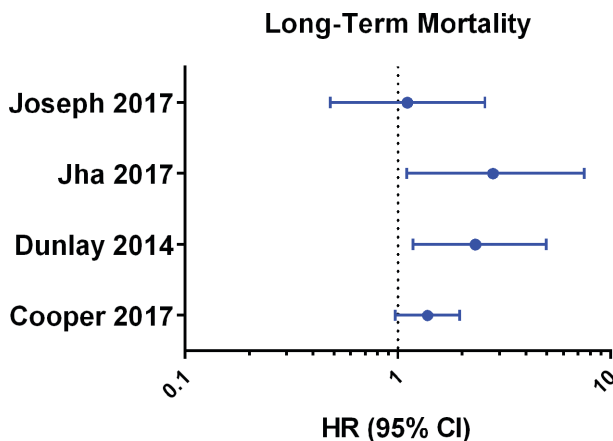
**Figure 3.1.** Prevalence of frailty in candidates for left-ventricular assist devices. Prevalence varies across studies according to the assessment tool used.

Several single-center studies have assessed phenotypic frailty using a single criterion. In 72 patients before LVAD implantation,<sup>22</sup> frailty, defined as a grip strength less than 25% of body weight, was identified in 16 (22%). In a similar study in which frailty was defined as handgrip strength less than 28.5% of body weight, 50% of patients were frail.<sup>23</sup>

Two single-center studies assessed sarcopenia (loss of skeletal muscle mass) before LVAD implantation on the premise that skeletal muscle mass decreases in end-stage heart failure before overt weight loss.<sup>24</sup> In 333 patients before LVAD implantation, sarcopenia, defined as the lowest tertile of psoas muscle area (measured on computed tomographic scans), adjusted for sex, occurred in

one-third of the patients.<sup>25</sup> The second, similar analysis measured pectoralis muscle attenuation from preoperative computed tomographic scans of the chest in 354 patients before LVAD implantation. Each unit increase in the pectoralis muscle index (computed as the cross-sectional area of the muscle in centimeters squared divided by height in meters squared:  $\text{cm}^2/\text{m}^2$ ) was significantly associated with a 27% reduction in the hazard of death over an average follow-up of 18 months after LVAD implantation.<sup>26</sup> The authors point out that computed tomographic measures are easily obtained in patients who may not be well enough to perform other phenotypic frailty assessments.

In a single-center study, the Frailty Deficit Index was used to assess frailty before LVAD as destination therapy in 99 patients.<sup>27</sup> Deficits, including difficulty with activities of daily living, use of assistive devices, and comorbidities, were assessed from questionnaires and electronic medical record data. On average, patients had deficits in 29% of the 31 areas assessed preoperatively. When defining frailty as greater than 25% deficits, 61 (62%) of patients were frail.



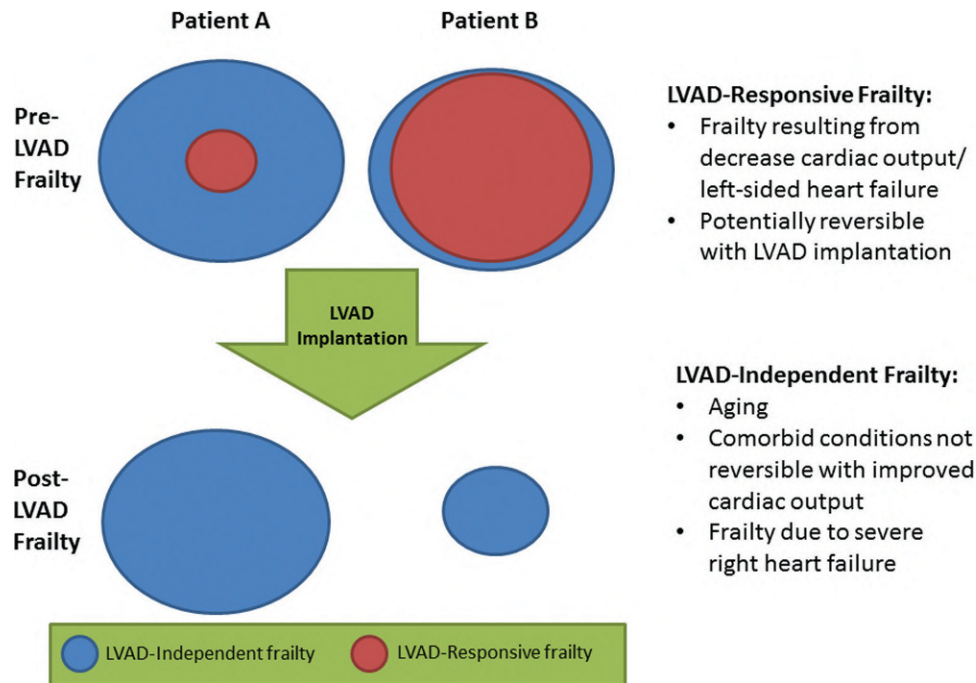
**Figure 3.2.** Risk of death associated with frailty in patients scheduled to receive a left-ventricular assist device.

Reprinted from Tse G et al., Frailty and clinical outcomes in advanced heart failure patients undergoing left ventricular assist device implantation: a systematic review and meta-analysis, *Journal of the American Medical Directors Association* 2018;19:255–261.e1, Copyright (2018), with permission from Elsevier.

## Frailty and Outcomes after Mechanical Circulatory Support

In patients with heart failure, frailty predicts adverse outcomes, including death,<sup>2,28</sup> hospitalization,<sup>3</sup> and persistently poor quality of life.<sup>29</sup>

In patients with advanced heart failure receiving LVADs, preoperative frailty identifies patients at high risk for poor postoperative outcomes. A 2018 meta-analysis revealed that preoperative frailty was associated with a longer time to extubation (mean [SD] difference, 45 [6] hours), longer hospital length of stay (mean [SD] difference



**Figure 3.3.** Potential responses to left ventricular assist device (LVAD) implantation in patients with LVAD-responsive and LVAD-independent frailty.

Adapted with permission from Flint KM, Matlock DD, Lindenfeld J, Allen LA, Frailty and the selection of patients for destination therapy left ventricular assist device. *Circ Heart Fail.* 2012;5:286–293.

<https://www.ahajournals.org/journal/circheartfailure> © American Heart Association, Inc.

2.9 [1.2] days), and increased risk of long-term mortality (pooled hazard ratio 1.44, 95% CI 1.15 to 1.80; Figure 3.2).<sup>30</sup> The Physical Frailty (Fried) Phenotype,<sup>19</sup> handgrip strength,<sup>22,23</sup> sarcopenia,<sup>25,26</sup> and the Frailty Deficit Index<sup>27</sup> all predict adverse outcomes after LVAD implantation, although the data are too limited to know which is better at risk stratification. The increased mortality among frail patients may reflect a lack of resilience and an inability to recover from the insult of surgery. Preoperative frailty has also been associated with worse surgical outcomes after transcatheter or surgical aortic valve replacement<sup>31–33</sup> and other cardiac surgeries.<sup>34,35</sup>

## Reversibility of Frailty and Response to Intervention

Implantation of an LVAD may reverse frailty resulting directly from heart failure (“LVAD-responsive frailty”), but not the frailty resulting from other comorbidities (“LVAD-independent frailty”; Figure 3.3).<sup>36</sup> If a patient has frailty mainly from left-sided heart failure, restoring normal cardiac output with an LVAD should improve or reverse most of the frailty. Although patients with this type of pre-LVAD frailty may be at increased risk for adverse outcomes soon after LVAD implantation, their frailty would be expected to

improve and not affect their long-term risk. Conversely, in patients with frailty mainly from aging and other comorbid conditions that are independent of left-sided heart failure, LVAD placement may do little to reduce the frailty.

Limited data suggest that frailty is at least partially reversed in many individuals after LVAD implantation.<sup>19,22,37</sup> Of 19 frail patients before LVAD implantation, the average number of phenotypic criteria per patient decreased from a mean (SD) of 3.9 (0.9) before implantation to 2.8 (1.4) at 6 months after implantation. Overall, 9 of the 19 patients (47%) were no longer classified as frail.<sup>37</sup> In another 40 patients before LVAD implantation as bridge to transplant, frailty scores improved in 12 of 13 frail patients after implantation.<sup>19</sup> Finally, handgrip strength improved by an average of 18% at 3 months and by 46% at 6 months after LVAD implantation in 72 patients.<sup>22</sup> Further work is needed to understand how to better identify which patients have LVAD-responsive versus LVAD-independent frailty before implantation.

## The Value of Assessing Frailty

Frailty alone is not an absolute contraindication to implantation. However, assessing frailty may be helpful as a part of the LVAD evaluation process for several reasons. Because frailty is associated with an increased risk

of adverse post-implant outcomes, knowing its presence may help predict whether survival and quality of life will improve after implantation.

Musculoskeletal disease that impairs rehabilitation is a relative contraindication to LVAD.<sup>38</sup> If frailty is accompanied by other high-risk features, multidisciplinary teams may need to carefully consider whether to recommend LVAD. Knowledge of frailty status can be useful when counseling frail patients about a potentially higher risk of adverse outcomes, including death, compared with non-frail individuals after implantation. This information may help patients and families decide whether to pursue LVAD therapy. Finally, frailty status may help identify patients who may require or benefit from additional rehabilitative efforts after implantation.

## Improving Frailty

Interest is great in knowing whether additional interventions could help improve or reverse frailty in LVAD candidates. Cardiac rehabilitation has been associated with greater improvement in functional capacity, including peak  $\text{VO}_2$  and six-minute walk distance, after implantation.<sup>39,40</sup> Although cardiac rehabilitation is recommended in all patients after implantation,<sup>38,41</sup> the adherence rate is unknown. In addition, many patients, including those who are frail, may benefit from inpatient rehabilitation before hospital discharge.<sup>42–44</sup> Whether additional specialized interventions may help either before or after implantation remains to be determined and needs to be investigated.

## Summary

Frailty is common before LVAD implantation and is associated with worse post-implantation outcomes. There is no consensus on the optimal method to assess frailty before implantation. The Physical Frailty Phenotype may be challenging to determine because many patients cannot complete gait-speed testing. The various frailty assessment methods need to be compared in multi-center studies on their ease of use and on their ability to accurately predict outcomes before implantation. Frailty can be modified with LVAD therapy in some patients. Further work is needed to understand how to identify which patients have LVAD-responsive versus LVAD-independent frailty at the time of LVAD evaluation. In addition, new therapeutic strategies to improve or reverse frailty in patients undergoing LVAD therapy are needed.

## REFERENCES

- Searle SD, Mitnitski A, Gahbauer EA, Gill TM, Rockwood K. A standard procedure for creating a frailty index. *BMC Geriatr*. 2008;8:24.
- McNallan SM, Chamberlain AM, Gerber Y, et al. Measuring frailty in heart failure: a community perspective. *Am Heart J*. 2013;166(4):768–774.
- McNallan SM, Singh M, Chamberlain AM, et al. Frailty and healthcare utilization among patients with heart failure in the community. *JACC Heart Fail*. 2013;1(2):135–141.
- Denfeld QE, Winters-Stone K, Mudd JO, Gelow JM, Kurdi S, Lee CS. The prevalence of frailty in heart failure: a systematic review and meta-analysis. *Int J Cardiol*. 2017;236:283–289.
- Clegg A, Young J, Iliffe S, Rikkert MO, Rockwood K. Frailty in elderly people. *Lancet*. 2013;381(9868):752–762.
- Shamliyan T, Talley KM, Ramakrishnan R, Kane RL. Association of frailty with survival: a systematic literature review. *Ageing Res Rev*. 2013;12(2):719–736.
- Vermeiren S, Vella-Azzopardi R, Beckwee D, et al. Frailty and the prediction of negative health outcomes: a meta-analysis. *J Am Med Dir Assoc*. 2016;17(12):e1161–1163; e1117.
- Fried LP, Xue QL, Cappola AR, et al. Nonlinear multisystem physiological dysregulation associated with frailty in older women: implications for etiology and treatment. *J Gerontol A Biol Sci Med Sci*. 2009;64(10):1049–1057.
- Boyle PA, Buchman AS, Wilson RS, Leurgans SE, Bennett DA. Physical frailty is associated with incident mild cognitive impairment in community-based older persons. *J Am Geriatr Soc*. 2010;58(2):248–255.
- Robertson DA, Savva GM, Kenny RA. Frailty and cognitive impairment: a review of the evidence and causal mechanisms. *Ageing Res Rev*. 2013;12(4):840–851.
- Wilson D, Jackson T, Sapey E, Lord JM. Frailty and sarcopenia: the potential role of an aged immune system. *Ageing Res Rev*. 2017;36:1–10.
- Dhillon RJ, Hasni S. Pathogenesis and management of sarcopenia. *Clin Geriatr Med*. 2017;33(1):17–26.
- Afilalo J, Karunanathan S, Eisenberg MJ, Alexander KP, Bergman H. Role of frailty in patients with cardiovascular disease. *Am J Cardiol*. 2009;103(11):1616–1621.
- Bellumkonda L, Tyrrell D, Hummel SL, Goldstein DR. Pathophysiology of heart failure and frailty: a common inflammatory origin? *Aging Cell*. 2017;16(3):444–450.
- Khan H, Kalogeropoulos AP, Georgiopoulos VV, et al. Frailty and risk for heart failure in older adults: the health, aging, and body composition study. *Am Heart J*. 2013;166(5):887–894.
- Buta BJ, Walston JD, Godino JG, et al. Frailty assessment instruments: systematic characterization of the uses and contexts of highly-cited instruments. *Ageing Res Rev*. 2016;26:53–61.
- Rockwood K, Andrew M, Mitnitski A. A comparison of two approaches to measuring frailty in elderly people. *J Gerontol A Biol Sci Med Sci*. 2007;62(7):738–743.
- Fried LP, Tangen CM, Walston J, et al. Frailty in older adults: evidence for a phenotype. *J Gerontol A Biol Sci Med Sci*. 2001;56(3):M146–M156.
- Jha SR, Hannu MK, Newton PJ, et al. Reversibility of frailty after bridge-to-transplant ventricular assist device implantation or heart transplantation. *Transplant Direct*. 2017;3(7):e167.
- Joseph SM, Manghelli JL, Vader JM, et al. Prospective assessment of frailty using the Fried criteria in patients

- undergoing left ventricular assist device therapy. *Am J Cardiol.* 2017;120(8):1349–1354.
21. Cooper LB, Hammill BG, Allen LA, et al. Assessing frailty in patients undergoing destination therapy left ventricular assist device: observations from inter-agency registry for mechanically assisted circulatory support. *ASAIO J.* 2018;64(1):16–23.
  22. Chung CJ, Wu C, Jones M, et al. Reduced handgrip strength as a marker of frailty predicts clinical outcomes in patients with heart failure undergoing ventricular assist device placement. *J Card Fail.* 2014;20(5):310–315.
  23. Yost G, Bhat G. Relationship between handgrip strength and length of stay for left ventricular assist device implantation. *Nutr Clin Pract.* 2017;32(1):98–102.
  24. Fulster S, Tacke M, Sandek A, et al. Muscle wasting in patients with chronic heart failure: results from the studies investigating co-morbidities aggravating heart failure (SICA-HF). *Eur Heart J.* 2013;34(7):512–519.
  25. Heberton GA, Nassif M, Bierhals A, et al. Usefulness of psoas muscle area determined by computed tomography to predict mortality or prolonged length of hospital stay in patients undergoing left ventricular assist device implantation. *Am J Cardiol.* 2016;118(9):1363–1367.
  26. Teigen LM, John R, Kuchnia AJ, et al. Preoperative pectoralis muscle quantity and attenuation by computed tomography are novel and powerful predictors of mortality after left ventricular assist device implantation. *Circ Heart Fail.* 2017;10(9). pii: e004069.
  27. Dunlay SM, Park SJ, Joyce LD, et al. Frailty and outcomes after implantation of left ventricular assist device as destination therapy. *J Heart Lung Transplant.* 2014;33(4):359–365.
  28. Cacciatore F, Abete P, Mazzella F, et al. Frailty predicts long-term mortality in elderly subjects with chronic heart failure. *Eur J Clin Invest.* 2005;35(12):723–730.
  29. Mlynarska A, Mlynarski R, Golba KS. Influence of frailty on the quality of life patients qualified for pacemaker implantation. *J Clin Nurs.* 2018;27(3-4):555–560.
  30. Tse G, Gong M, Wong SH, et al. Frailty and clinical outcomes in advanced heart failure patients undergoing left ventricular assist device implantation: a systematic review and meta-analysis. *J Am Med Dir Assoc.* 2018;19(3):255–261 e251.
  31. Afilalo J, Lauck S, Kim DH, et al. Frailty in older adults undergoing aortic valve replacement: the FRAILTY-AVR Study. *J Am Coll Cardiol.* 2017;70(6):689–700.
  32. Chauhan D, Haik N, Merlo A, et al. Quantitative increase in frailty is associated with diminished survival after transcatheter aortic valve replacement. *Am Heart J.* 2016;182:146–154.
  33. Arnold SV, Afilalo J, Spertus JA, et al. Prediction of poor outcome after transcatheter aortic valve replacement. *J Am Coll Cardiol.* 2016;68(17):1868–1877.
  34. Lytwyn J, Stammers AN, Kehler DS, et al. The impact of frailty on functional survival in patients 1 year after cardiac surgery. *J Thorac Cardiovasc Surg.* 2017;154(6):1990–1999.
  35. Zuckerman J, Ades M, Mullie L, et al. Psoas muscle area and length of stay in older adults undergoing cardiac operations. *Ann Thorac Surg.* 2017;103(5):1498–1504.
  36. Flint KM, Matlock DD, Lindenfeld J, Allen LA. Frailty and the selection of patients for destination therapy left ventricular assist device. *Circ Heart Fail.* 2012;5(2):286–293.
  37. Maurer MS, Horn E, Reyentovich A, et al. Can a left ventricular assist device in individuals with advanced systolic heart failure improve or reverse frailty? *J Am Geriatr Soc.* 2017;65(11):2383–2390.
  38. Cook JL, Colvin M, Francis GS, et al. Recommendations for the use of mechanical circulatory support: ambulatory and community patient care: a scientific statement from the American Heart Association. *Circulation.* 2017;135(25):e1145–e1158.
  39. Kerrigan DJ, Williams CT, Ehrman JK, et al. Cardiac rehabilitation improves functional capacity and patient-reported health status in patients with continuous-flow left ventricular assist devices: the Rehab-VAD randomized controlled trial. *JACC Heart Fail.* 2014;2(6):653–659.
  40. Mahfood Haddad T, Saurav A, Smer A, et al. Cardiac rehabilitation in patients with left ventricular assist device: a systematic review and meta-analysis. *J Cardiopulm Rehabil Prev.* 2017;37(6):390–396.
  41. Feldman D, Pamboukian SV, Teuteberg JJ, et al. The 2013 international society for heart and lung transplantation guidelines for mechanical circulatory support: executive summary. *J Heart Lung Transplant.* 2013;32(2):157–187.
  42. Alsara O, Reeves RK, Pyfferoen MD, et al. Inpatient rehabilitation outcomes for patients receiving left ventricular assist device. *Am J Phys Med Rehabil.* 2014;93(10):860–868.
  43. Yost G, Coyle L, Milkevitch K, Adair R, Tatooles A, Bhat G. Efficacy of inpatient rehabilitation after left ventricular assist device implantation. *PM R.* 2017;9(1):40–45.
  44. Nguyen E, Stein J. Functional outcomes of adults with left ventricular assist devices receiving inpatient rehabilitation. *PM R.* 2013;5(2):99–103.

# 4

## Palliative Care in Mechanical Circulatory Support

REGINA M. MACKEY AND JACOB J. STRAND

**P**alliative care teams work to reduce pain and other symptoms of a serious illness. Made up of a team of physicians, nurses, chaplains, and social workers, a palliative care team works with a patient's primary management team to enhance quality of life (QOL) and reduce the caregiver burden. Besides the management of physical symptoms affecting quality of life, palliative care teams integrate psychological and spiritual aspects of patient care and attend to adaptive coping strategies aimed at both patients and caregivers.

Several authors have called for palliative medicine (PM) involvement in patients with advanced heart disease to improve health status and quality of life.<sup>1-6</sup> Indeed, in a recent randomized study early palliative care versus standard care demonstrated improved QOL and mood for patients with advanced heart failure.<sup>7</sup>

Implantation of a mechanical circulatory support (MCS) device, either as destination therapy or as a bridge to transplant, often leads to increased survival as well as improved overall quality of life when compared to medical management alone. However, complications ranging from hospitalization for gastrointestinal bleeding to more severe complications such as cerebrovascular accident may affect patient quality of life and caregiver fatigue. Additionally, destination therapy for left ventricular devices presents unique challenges for patients and their loved ones at the end of life.

Palliative care teams are increasingly involved in the care pathway of patients undergoing MCS device implantation due to their expertise in symptom management and communication strategies. Currently, the International Society of Heart and Lung Transplantation Guidelines for Mechanical Circulatory Support include a Class IIa recommendation to include palliative care consultation prior to left ventricular assist device (LVAD) implantation (Figure 4.1).<sup>8</sup> From a regulatory standpoint, the Joint Commission

for advanced certification in Ventricular Assist Device for Destination Therapy and the Centers for Medicare and Medicaid Services require that all programs that implant ventricular assist devices as destination therapy include a palliative care specialist as a member of the mechanical circulatory support team at the time of evaluation.<sup>9</sup> Despite these recommendations, significant variation exists in the implementation due to a national shortage of palliative medicine clinicians, along with limited exposure and training in circulatory failure settings. Consequently, there is significant heterogeneity in the care process model implementation of this integration.<sup>10</sup>

A key focus of palliative care teams in the pre-implantation period is a focus on more in-depth advance care planning, as well as preparedness planning as it relates to device implantation. Helping to improve coping techniques of patients and caregivers, addressing patient and caregiver fears regarding possible complications (e.g., hemorrhage, sepsis, stroke), defining the healthcare proxy or power of attorney (POA), and establishing the patient's wishes regarding quality of life and end-of-life care are key components of this work. A summary of the palliative care goals is given in Figure 4.2.

### Advance Directives

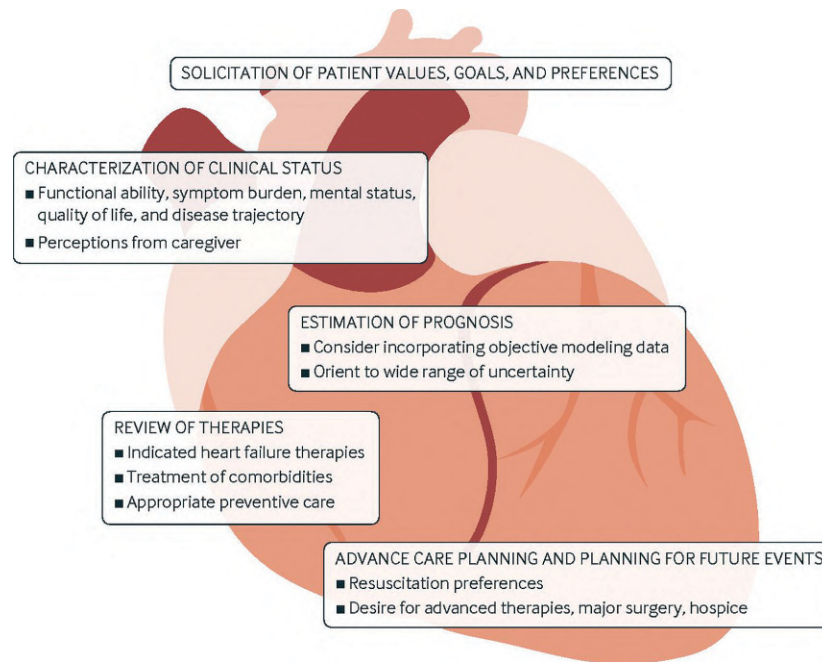
An advance directive is a document that should highlight patient preferences for his/her medical treatment, ideally centered around the patient's understanding of his/her current illness and the patient's goals, preferences, and values for treatment as it relates to his/her illness (Figure 4.3). This should be updated with each significant change in treatment, or in the event that the patient expresses a change in preferences related to the treatment. Therefore, while advance directives are based in a patient's goals



Professional organization	Class (strength) of recommendation	Level of evidence	Guideline
2013 ACC/AHA Guidelines for the Management of Heart Failure	Class 1	<b>B</b>	Consider palliative care or hospice care throughout the hospital stay, before discharge, at the first visit after discharge, and during follow-up visits in selected patients
	Class 1	<b>B</b>	Palliative and supportive care are effective for patients with symptomatic advanced heart failure to improve quality of life
2013 ISHLT Guidelines for Mechanical Circulatory Support	Class IIa	<b>C</b>	Palliative care consultation should be a component of the treatment of end stage heart failure during the evaluation phase for mechanical circulatory support. In addition to symptom management, goals and preferences for end of life should be discussed with patients receiving mechanical circulatory support as destination therapy
	Class 1	<b>C</b>	Consultation with palliative medicine should be considered before mechanical circulatory support implantation to facilitate discussion of end of life issues and establish an advance directive or living will, particularly when implanted as destination therapy
2012 ESC Guidelines for the Diagnosis and Treatment of Acute and Chronic Heart Failure	Class 1	<b>A</b>	It is recommended that patients with heart failure are enrolled in a multidisciplinary care management program to reduce the risk of hospital admission for heart failure
		<b>C</b>	It is recommended that patient and family or caregiver discussions about quality of life and prognosis be included in the disease management of heart failure
2010 HFSA Comprehensive Heart Failure Practice Guideline		<b>C</b>	It is recommended that end of life care strategies be individualized and include core heart failure pharmacologic therapies, effective symptom management, and comfort measures, while avoiding unnecessary testing. New life prolonging interventions should be discussed with patients and caregivers, with careful discussion of whether they are likely to improve symptoms
		<b>C</b>	It is recommended that a specific discussion about resuscitation be held in the context of planning for overall care and for emergencies with all patients with heart failure. The possibility of sudden cardiac death for patients with heart failure should be acknowledged. Specific plans to reduce sudden cardiac death (for example, with an ICD) or to allow natural death should be based on the individual patient's risks and preferences for an attempt at resuscitation, with specific discussion of risks and benefits of inactivating the ICD. Preferences for attempts at resuscitation and plans for approach to care should be readdressed at turning points in the patient's course or if potentially life prolonging interventions are considered

ACC=American College of Cardiology; AHA=American Heart Association; ISHLT=International Society of Heart and Lung Transplantation; ESC=European Society of Cardiology; HFSA=Heart Failure Society of America; ICD=implanted cardioverter defibrillator

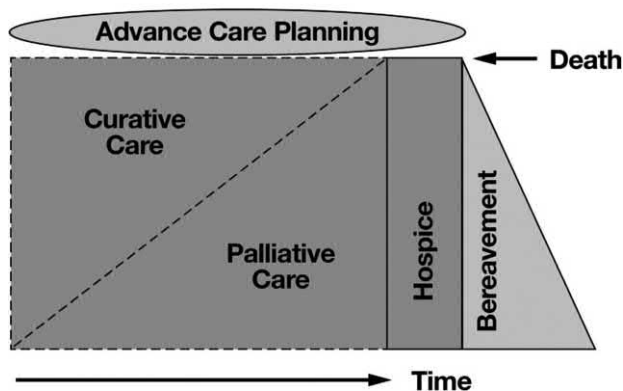
**Figure 4.1.** A summary of the various guidelines pertaining to the palliative care management of advanced heart failure. Reproduced from McIlvennan CK, Allen LA, Palliative care in patients with heart failure. *BMJ*. 2016;353:i1010, with permission from BMJ Publishing Group Ltd.



**Figure 4.2.** A summary of the key goals and strategies in the palliative care management of the heart failure patient.

Reproduced from McIlvennan CK, Allen LA, Palliative care in patients with heart failure. *BMJ*. 2016;353:i1010, with permission from BMJ Publishing Group Ltd.

and values, they should reflect the current medical realities and prognostic disclosures. Despite the fact that LVAD implantation significantly alters a patient's current medical condition and can have a major impact on end-of-life experiences, advance care planning documentation is often lacking for this patient population.<sup>10,11</sup>



**Figure 4.3.** An integrated model of palliative care.

Reproduced from Radwany S, von Gruenigen V, Palliative and end-of-life care for patients with ovarian cancer, *Clinical Obstetrics and Gynecology* 2012;55(1):173–184, <https://journals.lww.com/clinicalobgyn/pages/default.aspx>; Copyright © The Authors. Published by Wolters Kluwer Health, Inc. on behalf of the International Federation of Fertility Societies.

## Preparedness Plan

Given the significant changes in the health care trajectory of patients undergoing mechanical device implantation, advance directives should be tailored to the relevant medical and surgical circumstances, as well as complications of these devices. These should include clearly defined goals and explanations about possible outcomes, expected overall level of functioning, and what life may look like with mechanical support therapies, and anticipated stressors with respect to the financial and psychosocial issues related to the therapy. Without this type of proactive approach, patients are at risk for burnout and isolation, particularly in the setting of limited community support.<sup>3,12,13</sup>

Preparedness plans are typically conducted as part of the standard palliative care consultation prior to LVAD implantation. The role of the PM clinician is to assist the patient and his/her family in formulating their goals, preferences, and values related to treatment options and to translate these objectives into a clinically relevant documentation in the electronic medical record. Swetz et al. outlined several different domains that can be addressed to establish a robust preparedness plan focused on commonly encountered situations after implantation. These examples are highlighted in Table 4.1.<sup>14</sup> Importantly, these discussions should start before the device implantation, when the patients are already receiving information about disease/procedure specific risks, benefits, possible complications, alternative treatments, and what to expect after surgery.

**Table 4.1 • Differences between Advance Directives and Preparedness Plans**

Measure to Be Considered	Rationale	Sample Statement
Goals/expectations	Understanding what the patient hopes to accomplish helps to set appropriate expectations for after implantation	“What do you hope to achieve by getting a VAD? What are some things that you look forward to doing after getting your VAD?”
Hemodialysis	Preexisting renal disease or renal injury during/after VAD implantation puts patients at risk for developing dialysis-dependent renal failure. This may not be readily feasible in the patient’s local community for patients with VADs	“If you have kidney failure, you may require dialysis, and the center closest to you may not do this with a VAD. How do you feel about hemodialysis long term? What if you had to move to somewhere closer?”
Intracranial hemorrhage or embolic stroke	Patients may develop stroke owing to bleeding diatheses (acquired or from anticoagulation), embolism of a thrombus developed on the pump, or a central nervous system insult after trauma. These problems may alter the goals of care.	“Bleeding or strokes can develop in up to 20% of patients at some time. If a stroke affected your quality of life, how would you feel about continuing VAD therapy if you could not accomplish what was originally intended?”
LVAD failure	The VADs may fail acutely. Older series devices routinely failed, but now devices may fail because of electrical or power issues.	“If the VAD stops working, this might result in your death quickly. In the event your VAD fails—or just stops working—would you want heroic measures or to just be kept comfortable and let things go?”
LVAD infection, need for long-term antibiotics	There is a significant risk of infection of driveline, device, or bloodstream with VADs.	“Patients may develop infections as the VAD driveline catheter is a pipeline between the outside world and the bloodstream. Infections and treatment with antibiotics can impact quality of life for some patients. Are there circumstances when you would want this treatment limited?”
Artificial nutrition and hydration (AHN)	If patients have stroke or prolonged intensive care unit stays, AHN may become an issue (i.e., feeding tube after stroke).	“How do you feel about needing a feeding tube long term if you are unable to eat or drink because of a complication, such as a stroke?”
Blood transfusions	Blood products are likely to be an essential part of care, whether intraoperatively or postoperatively (owing to acute or chronic blood loss).	“Blood transfusions are a common part of the VAD process; do you or one of your loved ones have any concerns about you receiving these?”
Organ donation	In some situations, organ donation may be possible. A patient’s preference regarding a desire to donate organs can be assessed.	“Have you ever considered how you feel about organ donation, and if you are or are not interested in learning more?”
Mechanical ventilation	Patients may have prolonged chronic critical illness, including need for tracheostomy and mechanical ventilation.	“If your lungs and breathing did not get better after you got your VAD and you needed to be on a breathing machine/ventilator long term, how do you feel about this? How would you feel if you had to go to a special nursing home or hospital for ventilator care because of this?”
Postoperative rehabilitation plans	Rehabilitation varies for patients, some recovering in a few days, some several weeks to month.	“What is your current plan for rehabilitation after surgery? Have you thought about staying around the hospital or going back closer to home?”
Healthcare power of attorney appointed	Patient will be incapacitated for a variable period of time, thus it is essential that the patient have a spokesperson who can speak on his/her behalf.	“After you have your VAD implanted, there will be a period of time when you are likely going to be unable to make decisions. This is also true if some complications are encountered. Who should we ask to make decisions on your behalf only if and when you cannot make them for yourself? Have you spoken with them about your wishes?”

Table 4.1 • Continued

Measure to Be Considered	Rationale	Sample Statement
Psychosocial assessment; social dynamics reviewed	Many psychosocial situations may lead to suboptimal outcomes after VAD, and outcomes may improve if these are identified and acted on early.	“Are there other factors for you or your family emotionally or for your family situation that will lead to an optimal outcome, or some that may suggest problems might occur?” (Suggest review by social worker and/or psychologist)
Review perioperative morbidity and mortality	This is very variable based on the patient’s pre-implantation functional status and potential complicating factors. We recommend you talk to your cardiovascular providers to have a sense of their concerns regarding morbidity and mortality.	“The surgeon has quoted a 20% mortality rate, which means there is a one in five chance you may not leave the hospital. You may have heard that you ‘can either get a VAD or die’; what do you understand about your situation?”
Spiritual and/or religious preferences	End-of-life issues are inevitable, either early on or as one approaches death. Do spiritual factors exist which may impact how one views VAD management at life’s end?	“Are there any spiritual or religious preferences that may affect your care? Do these beliefs affect how you view life and death, what your values are, or attitudes toward a life-sustaining treatment such as VAD?”

Abbreviations: VAD = ventricular assist device; LVAD = left ventricular assist device.

Reprinted from Swetz KM et al., Preparedness planning before mechanical circulatory support: a “how-to” guide for palliative medicine clinicians, *Journal of Pain and Symptom Management* 2014;47:926–935, e926, copyright (2014), with permission from Elsevier.

An important component of preparedness plans is the designation of a surrogate decision-maker or healthcare power of attorney. This agent can communicate on behalf of the LVAD recipient, who may periodically be unable to make medical decisions, to carry out a plan of care consistent with the previously established goals and values using substituted judgment. Because it is anticipated that all patients undergoing device implantation will experience at minimum a transient period of incapacity after the surgery, this is a critical step in preparedness planning.

## End-of-Life Care

Critical components of end-of-life care for patients with mechanical support devices include clear knowledge of patient wishes, location of anticipated death and care resources in place, and an understanding of both the underlying device and patient physiology. Similarly, understanding the care pathway of patients dying with a mechanical support device and proceeding with device deactivation at the end of life require different considerations and care teams in place.

For patients with LVADs who wish to die outside of a hospitalized setting, close communication with a hospice team and the patient’s treating physicians is critical to ensure skilled symptom management at the end of life. Hospice staff often lack training and experience with MCS and require close collaboration with the heart failure team.

For patients whose goals are no longer being met by continued use of their LVAD, device deactivation may be considered, particularly in a patient at the end of life. Close collaboration with the treating MCS team, as well as palliative care and/or hospice clinicians, is needed to ensure that removal of artificial life-sustaining technologies does not result in increased adverse symptom burden.

In summary, the PM team can provide invaluable support to the patient and his/her family during the heart failure journey. By establishing a plan that is consistent with the goals and priorities of the patient, the complex clinical scenarios that often arise in the postoperative period can be managed in a way that optimizes the patient’s derived benefit from MCS.

## REFERENCES

1. Boyd KJ, Worth A, Kendall M, et al. Making sure services deliver for people with advanced heart failure: a longitudinal qualitative study of patients, family caregivers, and health professionals. *Palliat Med.* 2009;23(8):767–776.
2. Goodlin SJ. Palliative care in congestive heart failure. *J Am Coll Cardiol.* 2009;54(5):386–396.
3. Jaarsma T, Beattie JM, Ryder M, et al. Palliative care in heart failure: a position statement from the palliative care workshop of the Heart Failure Association of the European Society of Cardiology. *Eur J Heart Fail.* 2009;11(5):433–443.
4. O’Leary N, Murphy NF, O’Loughlin C, Tiernan E, McDonald K. A comparative study of the palliative care needs of heart failure and cancer patients. *Eur J Heart Fail.* 2009;11(4):406–412.

5. Pantilat SZ, Steimle AE. Palliative care for patients with heart failure. *JAMA*. 2004;291(20):2476–2482.
6. Widera E, Pantilat S. Hospitalization as an opportunity to integrate palliative care in heart failure management. *Curr Opin Support Palliat Care*. 2009;3(4):247–251.
7. Rogers JG, Patel CB, Mentz RJ et al., Palliative care in heart failure: the PAL-HF randomized, controlled clinical trial. *J Am Coll Cardiol*. 2017 Jul 18;70(3):331–341.
8. McIlvennan CK, Allen LA. Palliative care in patients with heart failure. *BMJ* (Clinical research ed). 2016;353:i1010.
9. Centers for Medicare and Medicaid Services. Proposed decision memo for ventricular assist devices for bridge-to-transplant and destination therapy (CAG-00432R) 2013. Accessed from <http://www.cms.gov/medicare-coverage-database/details/ncaproposed-decision-memo.aspx>
10. Verdoorn BP, Luckhardt AJ, Wordingham SE, et al., *J Pain Symptom Manage*. 2017 Aug;54(2):231–236.
11. Rhee C, L., Michael C. Palliative care and advance care planning in pulmonary hypertension. *Adv Pulm Hypertens*. 2018;17(1):15–19.
12. Landzaat LH, Sinclair CT, Rosielle DA. Continuous-flow left ventricular assist device [letter]. *N Engl J Med*. 2010;362(12):1149
13. Schwarz ER, Philip KJ, Simsir SA, et al. Maximal care considerations when treating patients with end-stage heart failure: ethical and procedural quandaries in management of the very sick. *J Relig Health*. 2011 Dec;50(4):872–879.
14. Swetz KM, Kamal AH, Matlock DD, et al. Preparedness planning before mechanical circulatory support: a “how-to” guide for palliative medicine clinicians. *J Pain Symptom Manage*. 2014;47(5):926–935.e926.

# 5

## Psychosocial Assessment of Patients Considered for Mechanical Circulatory Support

JENESSA S. PRICE AND STEPHANIE C. ZANOWSKI

### Introduction

**T**he International Society of Heart and Lung Transplantation and the American Heart Association recommend that patients being considered for mechanical circulatory support (MCS) undergo a comprehensive psychosocial evaluation.<sup>1-3</sup> This assessment is typically done by a social worker, but may also involve a psychologist or other mental health providers. Transplant centers may also routinely obtain an evaluation from a transplant psychologist for bridge-to-transplant candidates. The social worker typically compiles a detailed personal and social history with the patient and caregivers as part of assessing overall preparedness for MCS therapy. If appropriate, the social worker discusses and helps the patient complete the Power of Attorney for Healthcare and reviews the patient's history of substance use (including current use), mental health issues, and current cognitive and emotional challenges. When indicated, the social worker refers patients to appropriate mental health professionals; in particular, patients being considered for bridge to transplant. Finally, social workers also assess the patient's caregiving needs, both before and after VAD implantation, and confirm that the caregiving plan is adequate. Understanding the caregiving aspect of the psychosocial assessment is essential to the treatment strategy that patients and their caregivers follow to achieve optimal outcomes after VAD placement.

### Psychosocial Factors in Determining Candidacy

Psychosocial risk factors affect both medical (e.g., graft success, mortality) and psychosocial outcomes (e.g., compliance, abstinence) after cardiac transplantation.<sup>4,5</sup> Consequently, some groups have considered current substance abuse or serious mental instability to be contraindications to MCS placement and transplant listing.<sup>2</sup> Although some research has considered how psychosocial risk and protective factors affect transplantation outcomes, far less is known about how these factors affect MCS outcomes.<sup>1</sup> These studies are not easily compared because the criteria for candidacy are poorly defined and are not consistent among studies.<sup>6</sup> Further, patients considered for destination therapy may differ from those considered for bridge to transplant, but whether the psychosocial evaluation should reflect such a distinction is unclear.<sup>7</sup> As such, the potential psychosocial challenges for both destination therapy and bridge-to-transplant candidates should be considered when determining risks, identifying opportunities to intervene, and thus ensuring equal access to VAD treatment if medically indicated.

### Depression

Depression, impaired functional status, and inadequate self-care are potential risk factors for poor outcomes of LVAD support. Although clinically important, depression might be associated with the development of advanced

heart failure; the incidence of heart failure among patients with depression varies by how depression is assessed, with clinical diagnostic evaluations having rates of 19.3% and self-reported measures having rates between 33% and 41%. Higher rates of morbidities are common among patients self-reporting various other medical illnesses as well.<sup>8-10</sup>

Retrospective, single-center studies have reported depression rates of about 30%<sup>10</sup> in patients considered for destination therapy and about 28%<sup>11</sup> in the combined group of patients considered for destination therapy or bridge to transplant. In studies defining depression on clinical criteria (as opposed to scores on self-report measures), current or past depression was associated with increased risk of readmission after implantation<sup>10,11</sup> and VAD infection.<sup>12,13</sup> To date, no study has reported a direct causal relationship between depression and mortality in these patients.

Anxiety is also a risk factor for post-MCS readmission, with up to one-quarter of readmitted patients reporting these symptoms in one study.<sup>11</sup>

Several studies have evaluated the relationship between mental illness and quality of life after MCS implantation. However, the interpretation of these data is confounded by the interrelatedness between perceived quality of life, functional status, and overall psychological well-being.<sup>14-16</sup> In addition, pre-implantation measures of “functional status,” which may include physical functioning, as well as self-care abilities, might predict depression and overlap considerably with depressive symptoms. Depressive symptoms are not synonymous with a diagnosis of depression.<sup>6</sup> In addition to psychiatric symptoms, the adequacy of coping strategies may provide a more reliable assessment of a patient’s current functioning and help to identify indications for MCS intervention.<sup>17,18</sup>

### Substance Use

Findings related to alcohol, illicit drugs, and tobacco use as they pertain to post-VAD outcomes are less consistent than those for depression. However, it is difficult to measure the duration and quantity of use, recency of use, and aspects of current or historical use disorders (e.g., severity). Relevant and accurate data on substance use must generally be collected in interviews by trained assessors and corroborated with toxicology screening. Of the few studies examining the effect of substance use on implantation outcomes, one found that current smokers at admission for LVAD implantation had a higher 1-year mortality, but smoking was the only psychosocial factor linked to mortality,<sup>11</sup> and another linked current smoking to gastrointestinal bleeding after implantation.<sup>19</sup> A third study<sup>10</sup> reported no important differences in the risk of death related to substance use but did note a lower readmission rate among the 14 current tobacco smokers.

A history of alcohol use has been reported to predict post-implantation infection,<sup>20</sup> but the degree of consumption was not clearly defined and not controlled for in the analysis. Further, when the duration of VAD support was included in the model, the finding was no longer statistically significant.<sup>20</sup> Two studies have reported that the risk of death was 3.2 times as high among drug users identified at the time of VAD implantation than among non-drug users undergoing implantation.<sup>21</sup> Patients self-reporting a history of drug abuse may also have an increased rate of readmissions.<sup>10</sup>

### Social Support

Although adequate caregiver support is mandatory for MCS therapy in many centers, data assessing the effect of social support on post-surgical outcomes are limited. The one study addressing this question (a retrospective review) found that three caregiver factors significantly reduced the risk of death: a good understanding of the severity of the patient’s illness and treatment options, the ability to provide appropriate logistical support, and having a back-up support strategy.<sup>22</sup> In this study, the risk of death was 3.1 times as likely among patients who lived alone, suggesting that a consistent caregiver presence is strongly related to improved survival. The quality of the caregiver relationship may also affect the patient’s quality of life while on LVAD support.<sup>23</sup>

### Cognitive Functioning

The risk of cognitive impairment in individuals with heart failure is 4 times that in the general population. These individuals are also at increased risk for Alzheimer’s disease and other dementias.<sup>24,25</sup> Cardiac insufficiency, which may cause cerebral hypoperfusion or cerebral emboli, is thought to impair attention control, executive function, and memory.<sup>26-28</sup> Although cognition is not routinely assessed when screening patients for MCS, marked neurologic insult and limitations in cognitive status or the ability to understand the severity of the medical condition warrant further evaluation.<sup>29</sup>

Although MCS support and heart transplantation may provide short-term improvement in general cognitive functioning, this improvement is relative to baseline function and is still lower than that of the general population.<sup>30-32</sup> Another study found that improvements in global cognitive function, verbal memory, and executive ability after LVAD implantation were associated with shorter lengths of stay.<sup>33</sup>

### Psychosocial Assessment Tools

Psychosocial assessment tools have been developed to evaluate candidates for solid-organ transplant (Table 5.1).

**Table 5.1 • Tools for Assessing the Psychosocial Fitness of Patients Being Considered for Mechanical Circulatory Support**

Assessment Measure	Structure and Domains	Interpretation	Strengths	Limitations
Psychosocial Assessment for Candidates for Transplant; PACT <sup>34</sup>	10 items, including Initial and Final Rating; 8 of the items within 4 domains (5-point Likert scale): Social Support, Psychological Health, Lifestyle Factors, Understanding of Transplant, and Follow-up	Final Rating selection:  0: Poor, Surgery Contraindicated  1: Borderline, Acceptable under Some Conditions  2: Acceptable with Reservations  3: Good Candidate  4: Excellent Candidate	Inter-rater reliability	<ul style="list-style-type: none"> <li>• Not specific to MCS candidacy</li> <li>• Final rating based on overall judgment</li> </ul>
Transplant Evaluation Rating Scale; TERS <sup>35</sup>	9 domains (3-point levels): Psychiatric History, Substance Use/Abuse, Compliance, Health Behaviors, Quality of Family/Social Support, History of Coping, Coping with Disease and Treatment, Quality of Affect, Mental Status	Weighted summary score ranging from 26.5 to 79.5, with higher scores reflecting poorer psychosocial functioning	<ul style="list-style-type: none"> <li>• Inter-rater reliability</li> <li>• Associated with length of hospitalization post-LVAD<sup>4</sup></li> </ul>	<ul style="list-style-type: none"> <li>• Not specific to MCS candidacy</li> <li>• Findings based on single center, analysis of patients receiving LVAD<sup>4</sup></li> </ul>
Stanford Integrated Psychosocial Assessment for Transplant; SIPAT <sup>37</sup>	18 factors within 4 domains (variable weighting): Patient's Readiness Level, Social Support System, Psychological Stability and Psychopathology, Effect of Substance Use	Additive risk severity score:  0–6: Excellent  7–20: Good  21–39: Minimally Acceptable  40–69: Poor  >70: High Risk	—	—
Modified Psychosocial Assessment for Candidates for Transplant; mPACT <sup>37</sup>	10 items within 4 domains (variable weighting 0–2 points): Social Support, Psychological Health, Lifestyle Factors, Capability to Understand Care Requirements	Additive total score ranging from 12–20, with lower score reflecting increased psychosocial risk	<ul style="list-style-type: none"> <li>• Applicable to MCS candidacy</li> <li>• Increased accuracy for MCS vs. PACT</li> <li>• Associated with readmission rates<sup>37</sup></li> </ul>	<ul style="list-style-type: none"> <li>• Not routinely implemented in most centers</li> <li>• Findings based on a single-center, retrospective analysis<sup>37</sup></li> </ul>



In particular, the Stanford Integrated Psychosocial Assessment for Transplant (SIPAT)<sup>4,5,35</sup> is based on psychosocial factors that affect transplant outcomes, including treatment adherence, quality of life, and graft function. The SIPAT standardizes assessments across all psychosocial domains and can identify modifiable risk factors that may improve candidacy at reassessment. It also has predictive potential; scores 1 year after abdominal or cardiothoracic transplant were positively related with rejection, hospitalization, infection, psychiatric decompensation, and limited social support.<sup>5</sup> The two studies evaluating these tools in patients who had received LVADs are methodologically limited, but the modified Psychosocial Assessment for Candidates for Transplant (mPACT) tool can be applied to patients being considered for MCS.<sup>4</sup> The mPACT performed better than the original PACT at identifying psychosocial outcomes when retrospectively applied to 48 patients with LVADs, and better mPACT scores were associated with lower readmission rates. In another study, 125 patients who received LVADs were evaluated with the Transplant Evaluation Rating Scale. Patients with high scores had significantly fewer days out of the hospital, but no other post-surgical outcomes differed by risk score.<sup>36,37</sup> These preliminary findings support the utility in standardizing MCS assessments, but these tools are not routinely used in most centers.

## Advantages of a Dedicated Mental Health Team

At our institution, a dedicated Transplant Mental Health team is embedded in the Solid Organ Transplantation Clinic and the Division of Transplant Surgery, providing ready access for patients, patient support personnel, and members of the multidisciplinary team. Ideally, each candidate for MCS is evaluated by a social worker and members of the multidisciplinary team, as well as by a clinical health psychologist and possibly by an addiction specialist, who may also assess any past or current substance use, including the patient's willingness to accept lifetime abstinence.

In our clinic, we developed treatment and therapy groups for substance abuse relapse prevention, peer mentorship programs, and VAD education classes. Psychiatry services are available in the Transplant Clinic. A comprehensive evaluation identifies psychosocial risks and protective factors, which guide treatment recommendations and discussions of candidacy. The psychologist recommends an individualized treatment plan that helps patients manage the medical and other life stressors surrounding MCS support.

## Challenges in Multidisciplinary Care

There are no standard criteria defining acceptable psychosocial risks for MCS treatment, but a multidisciplinary team should have consistent, minimum expectations of and for candidates, especially those with severe and complex medical, personal, and social circumstances. A case in point concerned a 19-year-old African American woman with chronic ACC/AhHA Stage D heart failure from non-ischemic cardiomyopathy who had been referred to us for MCS as destination therapy. Other diagnoses included hypertension, morbid obesity, and obstructive sleep apnea. She also had intermittent, trauma-related visual hallucinations and a history of inpatient psychiatric hospitalizations. Her cognitive function was low, and although she knew that "her heart wasn't working," she did not understand her diagnoses or the need for treatment. Her mother, who had taken a leave from work to care for her daughter, had been incarcerated for illicit drug and alcohol use and was being screened for these substances regularly as part of her probation and work requirements.

This patient's critical illness indicated that MCS should be considered, despite the psychosocial risk of failure. Both the patient and her mother wanted treatment and agreed that the goal of care was "to live." The mother had assumed healthcare power of attorney for her daughter and was committed to supporting her daughter in adhering to medical recommendations and in receiving psychiatric care. Although team members were concerned about the patient's history of poor adherence and engagement with providers, they also believed that these behaviors were modifiable. Consequently, the patient and her mother were offered a 6-week period to improve adherence to prescribed medications, dietary changes, and weekly appointments, in addition to regular follow-up in the Transplant Psychology and Palliative Care clinics. The patient did well during the intervention and was approved for MCS therapy after reassessment. As an outpatient, she was followed by a VAD Social Worker, and for nearly a year after implantation, she was medically stable, and her clinical status was not compromised by psychosocial challenges.

## Recommendations for Practice

As the preceding case illustrates, a comprehensive psychosocial evaluation is important and should include full psychological and neuropsychological assessments. Periodically reassessing the patient provides a better understanding of risk factor status and the stability of protective factors over time. An awareness of cultural factors

can be important in understanding the patient's psychosocial challenges and in developing rapport throughout treatment. These cultural considerations can include issues such as ethnic minority status, socioeconomic status, gender roles and expectations, and exposure to socio-environmental stresses, such as community violence and personal trauma (we have documented an average of 6–7 episodes of community violence among our ethnic minority patients with traumatic injuries<sup>37</sup>).

In caring for the patient described in the preceding, our Transplant Psychology team had regular discussions with her and her mother about how cultural factors might affect their trust of providers, fears related to health care, and beliefs about being judged in the context of a VAD evaluation. The psychologist educated the team in empathetic listening and validation techniques to improve members' understanding of the patient's emotional experiences and the potential impact of these experiences on their communication with her and her mother. This perspective was then balanced with the team approach to care, which prioritized adherence to treatment and appropriate engagement with providers. Transplant Psychology provided feedback to team members, including the physician and nursing staff, so that their expectations of the patient were reasonable and realistic. The patient and her mother also regularly received information on her progress, which proved to be critical during some unexpected medical challenges that occurred during the patient's recovery from surgery.

## Summary

The psychosocial risk factors affecting VAD outcomes are poorly defined, although depression, substance use, and cognitive challenges should be identified and treated early. That said, individuals with heart failure often experience depressed mood and cognitive impairment, which by themselves need not contraindicate MCS treatment. Adequate social support continues to be important in clinical practice. Psychosocial stressors are often complex and may be exacerbated by low health literacy and cultural factors. Given the importance of these factors, a dedicated mental health team is critical to successful MCS treatment.<sup>10</sup> Experienced mental health providers with expertise in transplant and MCS issues should not only assess patients for psychosocial factors, but also identify likely psychosocial challenges, given the patient's medical condition; identify and weigh the importance of both risk and protective factors related to treatment success, including which factors may be modifiable; and be able to provide immediate interventions in coordination with the medical team.

## REFERENCES

1. Dew MA, DiMartini AF, Dobbels F, et al. The 2018 ISHLT/APM/AST/ICCAC/STSW recommendations for the psychosocial evaluation of adult cardiothoracic transplant candidates and candidates for long-term mechanical circulatory support. *J Heart Lung Transplant.* 2018;37(7):803–823.
2. Feldman D, Pamboukian SV, Teuteberg JJ, et al. The 2013 International Society for Heart and Lung Transplantation guidelines for mechanical circulatory support: executive summary. *J Heart Lung Transplant.* 2013;32(2):157–187.
3. Peura JL, Colvin-Adams M, Francis GS, et al. Recommendations for the use of mechanical circulatory support: device strategies and patient selection: a scientific statement from the American Heart Association. *Circulation.* 2012;126(22):2648–2667.
4. Maldonado JR, Dubois HC, David EE, et al. The Stanford Integrated Psychosocial Assessment for Transplantation (SIPAT): a new tool for the psychosocial evaluation of pre-transplant candidates. *Psychosomatics.* 2012;53(2):123–132.
5. Maldonado JR, Sher Y, Lolak S, et al. The Stanford Integrated Psychosocial Assessment for Transplantation: a prospective study of medical and psychosocial outcomes. *Psychosom Med.* 2015;77(9):1018–1030.
6. Bruce CR, Delgado E, Kostick K, et al. Ventricular assist devices: a review of psychosocial risk factors and their impact on outcomes. *J Card Fail.* 2014;20(12):996–1003.
7. Grogan S, Kostick K, Delgado E, Bruce CR. Ventricular assist devices as destination therapy: psychosocial and ethical implications. *Methodist Debaque Cardiovasc J.* 2015;11(1):9–11.
8. Rutledge T, Reis VA, Linke SE, Greenberg BH, Mills PJ. Depression in heart failure a meta-analytic review of prevalence, intervention effects, and associations with clinical outcomes. *J Am Coll Cardiol.* 2006;48(8):1527–1537.
9. Rutledge T, Reis VA, Linke SE, Greenberg BH, Mills PJ. Depression in heart failure a meta-analytic review of prevalence, intervention effects, and associations with clinical outcomes. *J Am Coll Cardiol.* 2006;48(8):1527–1537.
10. Moraska AR, Chamberlain AM, Shah ND, et al. Depression, healthcare utilization, and death in heart failure: a community study. *Circ Heart Fail.* 2013;6(3):387–394.
11. Snipelisky D, Stulak JM, Schettle SD, Sharma S, Kushwaha SS, Dunlay SM. Psychosocial characteristics and outcomes in patients with left ventricular assist device implanted as destination therapy. *Am Heart J.* 2015;170(5):887–894.
12. Lundgren S, Lowes BD, Zolty R, et al. Do psychosocial factors have any impact on outcomes after left ventricular assist device implantation? *ASAIO J.* 2018;64(4):e43–e47.
13. Gordon RJ, Weinberg AD, Pagani FD, et al. Prospective, multicenter study of ventricular assist device infections. *Circulation.* 2013;127(6):691–702.
14. Holman WL, Park SJ, Long JW, et al. Infection in permanent circulatory support: experience from

- the REMATCH trial. *J Heart Lung Transplant*. 2004; 23(12):1359–1365.
15. Dew MA, Kormos RL, Winowich S, et al. Human factors issues in ventricular assist device recipients and their family caregivers. *ASAIO J*. 2000;46(3):367–373.
  16. Grady KL, Meyer P, Mattea A, et al. Predictors of quality of life at 1 month after implantation of a left ventricular assist device. *Am J Crit Care*. 2002;11(4):345–352.
  17. Wray J, Hallas CN, Banner NR. Quality of life and psychological well-being during and after left ventricular assist device support. *Clin Transpl*. 2007;21(5):622–627.
  18. Allman E, Berry D, Nasir L. Depression and coping in heart failure patients: a review of the literature. *The J Cardiovasc Nurs*. 2009;24(2):106–117.
  19. Jalowiec A, Grady KL, White-Williams C. Predictors of perceived coping effectiveness in patients awaiting a heart transplant. *Nurs Res*. 2007;56(4):260–268.
  20. Singh G, Albeldawi M, Kalra SS, Mehta PP, Lopez R, Vargo JJ. Features of patients with gastrointestinal bleeding after implantation of ventricular assist devices. *Clin Gastroenterol Hepatol*. 2015;13(1):107–114, e101.
  21. Poston RS, Husain S, Sorce D, et al. LVAD bloodstream infections: therapeutic rationale for transplantation after LVAD infection. *J Heart Lung Transplant*. 2003;22(8):914–921.
  22. Cogswell R, Smith E, Hamel A, et al. Substance abuse at the time of left ventricular assist device implantation is associated with increased mortality. *J Heart Lung Transplant*. 2014;33(10):1048–1055.
  23. Bruce CR, Minard CG, Wilhelms LA, et al. Caregivers of patients with left ventricular assist devices: possible impacts on patients' mortality and interagency registry for mechanically assisted circulatory support-defined morbidity events. *Circ Cardiovasc Qual Outcomes*. 2017;10(1).pii:e002879. SOURCE
  24. Bidwell JT, Lyons KS, Mudd JO, et al. Patient and caregiver determinants of patient quality of life and caregiver strain in left ventricular assist device therapy. *J Am Heart Assoc*. 2018;7:e008080. doi:10.1161/JAHA.117.008080.
  25. Sauve MJ, Lewis WR, Blankenbiller M, Rickabaugh B, Pressler SJ. Cognitive impairments in chronic heart failure: a case controlled study. *J Card Fail*. 2009;15(1):1–10.
  26. Qiu C, Winblad B, Marengoni A, Klarin I, Fastbom J, Fratiglioni L. Heart failure and risk of dementia and Alzheimer disease: a population-based cohort study. *Arch Intern Med*. 2006;166(9):1003–1008.
  27. Hoth KF. Heart failure and cognitive function. In: Cohen RA, Gunstad J, eds. *Neuropsychology and Cardiovascular Disease*. Oxford: Oxford University Press; 2010.
  28. Jesus PA, Vieira-de-Melo RM, Reis FJ, et al. Cognitive dysfunction in congestive heart failure: transcranial Doppler evidence of microembolic etiology. *Arq Neuropsiquiatr*. 2006;64(2a):207–210.
  29. Pressler SJ, Subramanian U, Kareken D, et al. Cognitive deficits in chronic heart failure. *Nurs Res*. 2010;59(2):127–139.
  30. Casida JM, Wu HS, Abshire M, Ghosh B, Yang JJ. Cognition and adherence are self-management factors predicting the quality of life of adults living with a left ventricular assist device. *J Heart Lung Transplant*. 2017;36(3):325–330.
  31. Fendler TJ, Spertus JA, Gosch KL, et al. Incidence and predictors of cognitive decline in patients with left ventricular assist devices. *Circ Cardiovasc Qual Outcomes*. 2015;8(3):285–291.
  32. Petrucci RJ, Rogers JG, Blue L, et al. Neurocognitive function in destination therapy patients receiving continuous-flow vs pulsatile-flow left ventricular assist device support. *J Heart Lung Transplant*. 2012;31(1):27–36.
  33. Hajduk AM, Kiefe CI, Person SD, Gore JG, Saczynski JS. Cognitive change in heart failure: a systematic review. *Circ Cardiovasc Qual Outcomes*. 2013;6(4): 451–460.
  34. Olbrisch Me, Levenson JL, Haner, R. The PACT: a rating scale for the study of clinical decision making in psychosocial screening of organ transplant candidates. *Clin Transpl*. 1989;3:164–169.
  35. Twillman RK, Manetto C, Wellisch DK, Wolcott DL. The Transplant Evaluation Rating Scale: a revision of the psychosocial levels system for evaluating organ transplant candidates. *Psychosomatics*. 1993;34(2):144–153.
  36. Maltby MC, Flattery MP, Burns B, Salyer J, Weinland S, Shah KB. Psychosocial assessment of candidates and risk classification of patients considered for durable mechanical circulatory support. *J Heart Lung Transplant*. 2014;33(8):836–841.
  37. Yost GL, Bhat G, Ibrahim KN, Karountzos AG, Chandrasekaran M, Mahoney E. Psychosocial evaluation in patients undergoing left ventricular assist device implantation using the transplant evaluation rating scale. *Psychosomatics*. 2016;57(1):41–46.

# 6

## Left Ventricular Assist Device Backup for Conventional Surgery

NOELLE C. GARSTER AND ASIM MOHAMMED

### Introduction

**C**oronary artery disease is a contributing factor in 50%–70% of all cases of heart failure.<sup>1</sup> As heart failure is associated with significant morbidity and mortality, revascularization plays a significant role in the management of patients with ischemic cardiomyopathy.<sup>1</sup>

However, the clinical manifestations of ischemic cardiomyopathy and impact on a patient's overall condition can be varied. Often, patients with severe left ventricular systolic dysfunction may also have significant comorbidities, such as mitral regurgitation, atrial fibrillation, diabetes, and renal dysfunction. Therefore, not all patients with ischemic cardiomyopathy have equivalent risk with regard to surgical revascularization, and in fact, some may be viewed as high-risk candidates.

However, advanced heart failure or low left ventricular ejection fraction (LVEF) is not an absolute contraindication to conventional cardiac surgery,<sup>2</sup> and ventricular support devices may offer an opportunity to optimize outcomes for these critically ill patients.

In this chapter, we will highlight case examples from our institution in which temporary left ventricular assist devices (LVADs) were utilized in order to optimize patients for conventional coronary artery bypass graft surgery (CABG). We will briefly review the utility of preoperative viability assessment, as well as propose key factors for the identification of patients who may benefit from this novel strategy.

### Case Examples

#### Off-Pump High-Risk CABG

##### Case 1

A 55-year-old white male arrived at our institution as an emergent outside hospital transfer via medical helicopter

after presenting with acute coronary syndrome due to an anterior non-ST elevation myocardial infarction. At the outside hospital he had a cardiac arrest due to ventricular tachycardia, was treated with direct-current cardioversion which restored sinus rhythm and pulse, and was subsequently started on IV amiodarone. He had multiple medical comorbidities, including known heart failure with reduced ejection fraction (LVEF 20%–25%) due to severe multivessel coronary artery disease (90% left main stenosis, 90% left circumflex stenosis, 90% right coronary artery stenosis), moderate mitral and tricuspid regurgitation, insulin-dependent diabetes, chronic kidney disease stage IV due to diabetic nephropathy, hypertension, hyperlipidemia, tobacco use, and chronic obstructive pulmonary disease. He had been hospitalized at an outside institution 3 months prior to presentation for volume overload and was diagnosed with new systolic heart failure during that admission. He underwent ischemic evaluation with coronary angiography at that time, and consultation for CABG was completed. He was scheduled for CABG surgery; however, his acute presentation occurred approximately 2 weeks prior to his posted surgical date.

On presentation he was found to be in cardiogenic shock and was admitted to the cardiovascular intensive care unit. Right heart catheterization revealed mean right atrial pressure of 13 mmHg, right ventricular pressure of 44/14 mmHg, pulmonary artery pressure of 47/28/35 mmHg, and a pulmonary capillary wedge pressure of 24 mmHg. Cardiac output and index were 2.34 L/min and 1.27 L/min/m<sup>2</sup> by Fick calculation, and 2.63 L/min and 1.43 L/min/m<sup>2</sup> by thermodilution method. Central mixed venous oxygen saturation was 21%. He underwent emergent placement of an intra-aortic balloon pump (IABP) and was initiated on inotropic therapy with IV dobutamine and milrinone. A Swan-Ganz catheter was placed for close hemodynamic monitoring and medication titration.

With these interventions, his clinical picture stabilized and his cardiogenic shock began to improve. His central mixed venous oxygen saturation improved to 64%. However, his renal function remained tenuous (serum creatinine 4.2 mg/dL, GFR <20 mL/min/1.73m<sup>2</sup>). He had a Thallium nuclear medicine viability study which demonstrated myocardial viability in all territories other than a fixed inferior defect. Advanced heart failure consultation was obtained, and temporary mechanical left ventricular support with an Impella 5.0 device for pre-, intra- and perioperative optimization was recommended. After discussion of the patient's overall clinical case with our multidisciplinary team, including cardiothoracic surgery, critical care anesthesia, cardiology, and advanced heart failure, the decision was made to place an Impella 5.0 device via right axillary artery and remove the IABP. This was completed on hospital day 3. The patient remained in the cardiovascular ICU with Impella support and underwent CABG on hospital day 17 (left internal mammary artery sequential graft to the diagonal branch and distal left anterior descending artery, saphenous vein graft to the first obtuse marginal branch, and saphenous vein graft to the right coronary artery). His postoperative course was complicated by development of cardiac tamponade on postop day 4, requiring emergent open evacuation of pericardial clot and left hemothorax. He recovered well after this. The Impella support device was removed on hospital day 24 (postoperative day 7). He required continuous veno-venous hemofiltration for volume removal due to acute on chronic kidney disease from hospital day 6–24. He was discharged on hospital day 34. His LVEF had improved to 35%–40% on discharge. No Impella 5.0–related complications, such as hemolysis, stroke, or limb ischemia, were noted.

### Case 2

A 70-year-old African-American male presented to an outside institution with an anterior ST-elevation myocardial infarction. He had multiple comorbidities, including diabetes, chronic kidney disease due to obstructive uropathy status-post nephrostomy tube placement and ureteral stenting, abdominal aortic aneurysm, diffuse large B-cell lymphoma (in remission after chemotherapy), and history of deep-venous thrombosis and pulmonary embolism. He was loaded with clopidogrel and taken emergently for cardiac catheterization and found to have severe multivessel coronary artery disease (95% left anterior descending stenosis that had recanalized, 100% second obtuse marginal stenosis, 99% third obtuse marginal stenosis, and 100% right posterior descending artery occlusion). No stents were placed, but the patient was referred to cardiothoracic surgery for consideration of surgical revascularization. A transthoracic echocardiogram was completed and showed new reduction in LVEF to 20%. The LVEF had been 60% just 1 year previously. His cardiac index by Fick calculation was low at 1.87 L/min/m<sup>2</sup>. He was started on

IV dobutamine for inotropic support. He also experienced sustained ventricular tachycardia while admitted and was started on IV amiodarone. A Thallium nuclear medicine viability study was performed and demonstrated that all areas of the myocardium appeared viable except the apical septum. However, the initial cardiothoracic surgery consultants felt that given his severe left ventricular dysfunction, low-cardiac index, and multiple comorbidities, he would be too high risk for surgery. He was then transferred to our institution for a second surgical opinion.

On admission to the cardiovascular intensive care unit, his serum creatinine was 3.94 mg/dL (GFR <20 mL/min/1.73m<sup>2</sup>). On hospital day 5 he underwent surgical revascularization via CABG (left internal mammary artery to left anterior descending artery). An Impella 5.0 temporary left ventricular support device was also placed via a 10 mm graft sewn to the ascending aorta at the time of surgery to aid with perioperative recovery. Postoperative course was complicated by development of a mediastinal hematoma which required chest exploration and evacuation on postoperative day 5. He also developed *C. difficile* infection. His Impella was removed on hospital day 27 (postoperative day 22). Due to difficulty weaning from the ventilator, he ultimately required a tracheostomy and PEG tube placement. He also was started on hemodialysis. He was discharged to a long-term acute care facility on hospital day 34. No Impella 5.0–related complications were noted.

### Case 3

A 66-year-old white female with a history of hypertension, hyperlipidemia, obesity, tobacco use, and abdominal aortic aneurysm was admitted to an outside hospital with a new left bundle branch block and flash pulmonary edema in the setting of elevated troponin T concerning for acute coronary syndrome. She underwent emergent coronary angiography which revealed significant multivessel coronary artery disease (95% distal left main stenosis, 80% proximal left anterior descending stenosis, 100% first obtuse marginal stenosis, 100% second obtuse marginal stenosis, 100% proximal right coronary artery stenosis). Transthoracic echocardiogram demonstrated global hypokinesia with a severely reduced LVEF of 25%–29%. She was transferred to our facility for urgent cardiac surgery. She presented in cardiogenic shock with lactic acidosis and oliguria. She was intubated and taken directly to the operating room for placement of an Impella 5.0 temporary left ventricular support device as a temporizing measure for stabilization prior to surgery. She underwent 2-vessel CABG (left internal mammary artery to left anterior descending artery, saphenous vein graft to first obtuse marginal) on hospital day 7. The Impella temporary support device remained in place until postoperative day 9. Her hospital course was complicated by sepsis, thought secondary to aspiration. Unfortunately, her known abdominal aortic aneurysm spontaneously ruptured on hospital day

24. Her family elected to pursue comfort care and she died hours later.

### VAD as Bridge-to-Recovery Post-CABG

#### Case 4

A 53-year-old white male with a history of insulin-dependent diabetes mellitus, hypertension, hyperlipidemia, coronary artery disease, irritable bowel disease, and gastroesophageal reflux presented to an outside hospital with dyspnea and lower extremity edema and was diagnosed with acute decompensated heart failure. Transthoracic echocardiogram demonstrated a severely reduced LVEF <20%, severe mitral regurgitation, moderate tricuspid regurgitation, and an elevated estimated pulmonary artery systolic pressure of 71 mmHg. Coronary angiogram demonstrated diffuse multivessel disease (highly eccentric 80% stenosis of the left anterior descending between proximal 70% stenosis of both the first and second diagonals, 100% occlusion of the left circumflex artery beyond a very slender first marginal branch, and right coronary artery with 100% occlusion of the posterior lateral branch). Right heart catheterization demonstrated elevated filling pressures (CVP 11 mmHg, mean PA 40 mmHg, pulmonary capillary wedge pressure of 26 mmHg), and the cardiac output/index calculated by Fick was low at 2.7/1.8 L/min/m<sup>2</sup>. An IABP was placed. His severe systolic dysfunction was presumed due to ischemic cardiomyopathy and severe global ischemia. He was transferred to our institution with cardiogenic shock for consideration of surgical revascularization.

Upon arriving at our institution, advanced heart failure and cardiothoracic surgery teams were urgently consulted. On hospital day 2 he underwent urgent two-vessel CABG (left internal mammary artery to left anterior descending, and saphenous vein graft to the obtuse marginal) along with placement of a HeartMate II LVAD. His hospital course was complicated by monomorphic ventricular tachycardia requiring amiodarone and upper gastrointestinal bleeding requiring blood transfusions. After prolonged hospitalization, he was discharged for rehabilitation on hospital day 43. With careful outpatient management, medication titration, and follow-up, his left ventricular systolic function improved by 6-months postop. His device was explanted 10 months after his initial surgery with no complications. His post-explant transthoracic echocardiogram demonstrated a normal LVEF of 60%–65%.

## Identifying Surgical Patients Who May Benefit from Temporary LVAD Support

### Classification of Patients with Ischemic Cardiomyopathy in Need of Revascularization

The benefit of surgical revascularization via CABG for patients with significant angina is widely accepted and

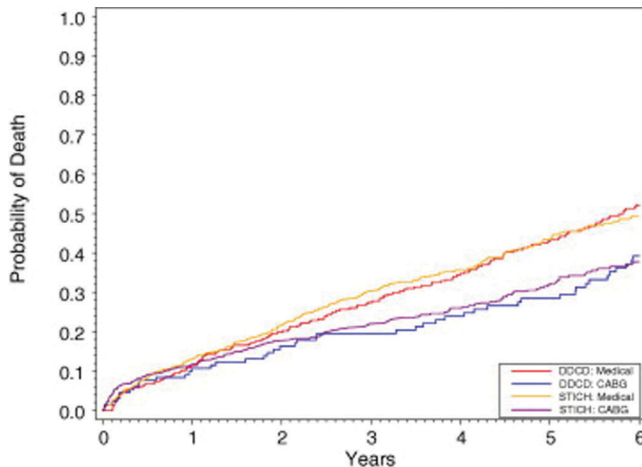
has been well described in the literature in landmark trials such as the Coronary Artery Surgery Study (CASS trial)<sup>3</sup> and the Veterans Administration Coronary Artery Bypass Surgery Cooperative Study Group.<sup>4</sup> In these trials, subgroups of patients with significant multi-vessel coronary artery disease and left ventricular dysfunction experienced improved survival compared to standard medical therapy alone.<sup>3,4,5</sup> The primary population studied in these landmark trials, however, is most representative of those patients who have been traditionally considered optimal candidates for surgical revascularization, including those with preserved left ventricular systolic function, few medical comorbidities, and low calculated Society of Thoracic Surgeons (STS) surgical risk scores.

The authors of the Surgical Treatment for Ischemic Heart Failure study (STICH)<sup>5</sup> aptly identified that historically, trials have omitted patients with severe left ventricular dysfunction or clinical heart failure from the primary study population, therefore limiting the generalizability of the results. The STICH trial aimed to demonstrate that surgical revascularization with CABG in addition to optimal medical therapy in patients with both coronary artery disease and heart failure with reduced LVEF ( $\leq 35\%$ ) would decrease all-cause mortality.<sup>6</sup> Initial data failed to demonstrate statistically significant differences between the two groups.

Recent publication of 10-year follow-up data has demonstrated that in this cohort of patients with ischemic cardiomyopathy, death from any cause (58.9% vs. 66.1%,  $p = 0.02$ ), death from cardiovascular causes (40.5% vs. 49.3%,  $p = 0.006$ ), and death from any cause or hospitalization for cardiovascular causes (76.6% vs. 87%,  $p < 0.001$ ) were significantly lower among patients who underwent CABG in addition to optimal medical therapy compared to medical therapy alone.<sup>5</sup> These findings are consistent with those from several smaller, single institutional studies (Figure 6.1). Nevertheless, patients with ischemic cardiomyopathy undergoing CABG are exposed to an early risk related to surgery itself.

The implantation of LVADs has revolutionized the treatment for patients with advanced heart failure over the past two decades. The landmark REMATCH trial<sup>7</sup> demonstrated that in class IV heart failure patients, those with circulatory support from LVADs had a 48% reduction in all-cause mortality compared to optimal medical therapy alone. There was also significant increase in the survival rates at both 1 year (52% vs. 25%) and 2 years (23% vs. 8%).<sup>7</sup>

In present-day practice, there is a substantial subset of patients who are now more often being referred for surgical revascularization than in past decades, namely those with severely reduced LVEF, clinical heart failure, and/or cardiogenic shock. As previously mentioned, these patients often have comorbidities such as mitral regurgitation, atrial fibrillation, diabetes, and renal dysfunction, leading to higher



**Figure 6.1.** Kaplan Meier estimates of time to death, taken from the Surgical Treatment for Ischemic Heart Failure (STICH) trial and Duke Databank for Cardiovascular Disease (DDCD) patients.

CABG = coronary artery bypass grafting.

Reprinted from Velazquez EJ et al., Long-term survival of patients with ischemic cardiomyopathy treated by coronary artery bypass grafting versus medical therapy, *Annals of Thoracic Surgery* 2012;93:523z-530, Copyright (2012), with permission from Elsevier and the Society of Thoracic Surgeons and the Southern Thoracic Surgical Association.

surgical risk. We propose that in order to produce the best outcomes for these complex patients, additional mechanical circulatory support should be considered as an adjunct to CABG plus optimal medical therapy.

In order to select the best possible strategy for surgical revascularization, as well as identify the potential need for mechanical circulatory support device utilization, we propose classification of patients into three distinct categories: (1) traditional CABG candidates, (2) ischemic cardiomyopathy with reduced LVEF, and (3) advanced heart failure as defined by severely reduced LVEF, low cardiac output, and/or cardiogenic shock. The classification scheme and recommendations are summarized in Table 6.1.

While the cases we outlined in the preceding from our institution all represent patients experiencing acute coronary syndrome, there is growing interest in utilizing VADs in relatively stable patients with ischemic cardiomyopathy and reduced LVEF as well. These patients are often high risk due to multiple comorbid conditions but require conventional cardiac surgery for revascularization of coronary disease. Temporary/short-term LVAD (such as the Impella device) can both preoperatively optimize hemodynamics to lower surgical risk and aid in postoperative recovery via avoidance of low-output syndrome. This is critically important, as in-hospital mortality for high-risk end-stage heart failure patients undergoing conventional cardiac surgery is most commonly due to low-output syndrome.<sup>2</sup> In the case of patients who may have received anti-platelet agents such as clopidogrel or ticagrelor prior to cardiac catheterization only to find they need urgent bypass surgery, these devices may also help buy time for patients to undergo a safer operation with lower bleeding risk after several days in the intensive care unit.

### Assessing Viability

At our center, myocardial viability in patients with severely reduced left ventricular systolic function aids in the identification of appropriate cases for Impella 5.0 supported off-pump CABG. Ideally, a patient should have significant viability to be confident of myocardial recovery. In patients in whom no myocardial viability is found, consideration is given instead to durable ventricular support.

Hibernating myocardium is an adaptive response of the myocardium to chronically reduced blood supply. It is defined as a state of persistently reduced myocardial contractility due to reduced coronary blood flow at rest, which is partially or completely reversible upon revascularization.<sup>1</sup> As such, hibernating myocardium is thought to be an ideal target for revascularization, either with Percutaneous Coronary Intervention (PCI) and stenting or CABG. Recovery of contractile function has been well described and supported by observational studies in the literature.<sup>1</sup>

Various imaging modalities have been developed for the detection of viable, hibernating myocardium by utilizing

**Table 6.1 • A Comparison of Different Patient Profiles in the Setting of Coronary Artery Disease with Left Ventricular Dysfunction**

	Traditional CABG Candidates	Ischemic Cardiomyopathy	Advanced Heart Failure
LVEF	>35%	25%–35%	<25%
Myocardial Viability	Presumed	Uncertain	Absent
STS Risk	Low	Moderate	High
Type of MCS	None	Short-term LVAD	Durable LVAD
Presurgical Optimization Strategy	None	Short-term LVAD	Intra-aortic balloon pump or short-term LVAD

different characteristics of this tissue. These have been well described in the literature. In brief, assessment of the integrity of cell membranes can be done via 99m Technitium Sestamibi and 201 Thallium Single Photon Emission CT (SPECT); assessment of metabolic activity can be done via FDG position emission tomography (PET); scar assessment can be done via cardiac magnetic resonance (CMR); and dobutamine stress echocardiography, SPECT, and CMR can all assess contractile reserve.<sup>1</sup> Selection of viability modality is often based on patient comorbidities (such as presence or absence of renal dysfunction), the ability of the patient to tolerate the selected test (based on duration, presence or absence of claustrophobia, etc.), as well as the availability and experience of an individual clinical center with the various imaging options.

Unfortunately, viability studies have often failed to consistently discriminate patients who will have myocardial recovery.<sup>11</sup> Furthermore, there is likely variability in the length of time required for ventricular remodeling and thus improvement in cardiac function post-revascularization.

### Surgical Strategies and Impact on Myocardial Injury

Patients with heart failure and coronary artery disease should be considered for revascularization strategies that minimize myocardial injury. Despite a substantial amount of clinical trial data existing in the medical literature to compare different technical approaches to CABG, there is very little data on the strategies implemented for myocardial protection in the advanced heart failure population at present.

Broadly speaking, CABG can be performed on cardiopulmonary bypass (typically by arresting the heart after cross-clamping the aorta) or using stabilizing devices to

facilitate off-pump revascularization (OPCAB). In patients with severe LV dysfunction, there are concerns about compounding the degree of myocardial injury during the ischemic period that typically accompanies an on-pump approach. Although OPCAB has the potential to minimize the degree of myocardial ischemia during revascularization, this depends to some degree on the technique that is implemented. Many surgeons achieve optimal visualization through placement of a silastic vessel loop around the proximal extent of the artery to occlude blood flow. Oftentimes this is done with a period of “pre-conditioning” where the vessel is occluded for a brief period prior to the more prolonged period required for the distal anastomosis. A second approach involves placing a coronary shunt which both permits visualization and reperfusion of the distal vessel. An example is given in Figure 6.2.

Although data are somewhat lacking in the differences in myocardial injury between these different approaches, our preference has been to utilize coronary shunting as part of an off-pump revascularization in order to minimize myocardial injury. We are currently conducting a clinical trial in order to study this hypothesis. The implications of this technique may be of critical importance in patients with ischemic cardiomyopathy with significantly depressed LVEF, as this patient population experiences a significantly increased mortality rate with CABG than comparable patients with normal ejection fraction. As such, there may be downstream clinical benefits to enhanced myocardial protection.

Alternative revascularization strategies to traditional CABG in high-risk patients include multivessel PCI with added Impella support, hybrid revascularization, off-pump CABG with intracoronary shunting (as previously described),

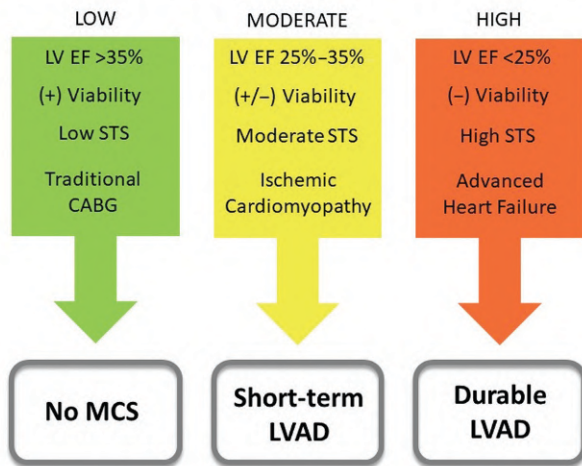


**Figure 6.2.** Typical coronary artery shunts that are used during beating heart revascularization.

Copyright 2018 Getinge AB. All rights reserved.



### MCS for Cardiac Surgery Optimization by Patient Risk



**Figure 6.3.** Stratification of treatment options in patients with ischemic cardiomyopathy depends on degree of LV dysfunction, viability, and surgical risk.

CABG with VAD backup, and CABG with added durable LVAD as bridge to recovery<sup>8,9,10</sup> (Figure 6.3). We believe that treatment of coronary artery disease in patients with low LVEF should focus on preserving myocardium during therapy. Patients who fail to achieve long-term symptomatic relief should then be referred for durable LVAD. In summary, the approach to revascularization in the patient with ischemic cardiomyopathy must take into account the complexity and extent of coronary artery disease, vessel target size, myocardial viability, STS surgical risk, degree of LVEF, and patient preferences. Discussion of care plans for these complex patients is also best done within a heart team approach.

## Conclusions

The case series we have presented demonstrates that mechanical circulatory support including temporary LVADs such as the Impella 5.0 and durable VADs can be used to support off-pump CABG in complex patients who are considered high risk for conventional cardiac surgery.

Despite our favorable outcomes, it is important to be aware of potential complications with this approach. Some of the described complications include the following: hemolysis, device thrombosis, stroke from embolization, valve injury, device malfunction, device damage, high purge pressure, valve dysfunction, ventricular perforation, and other vascular complications spanning from dissection to thrombosis or bleeding.<sup>12,13</sup> Accordingly, extreme caution should be exercised when using Impella 5.0 for mechanical support for off-pump CABG.

In conclusion, temporary LVAD support is becoming increasingly used in the care of hospitalized patients

with advanced heart failure and cardiogenic shock. The adaptation of this technology for use to optimize surgical outcomes in high-risk patients with severe left ventricular systolic dysfunction and multiple comorbidities undergoing conventional cardiac surgery is likely to continue to grow. Further study and future outcomes research will be needed to fully assess the added clinical benefit of this practice, but our anecdotal experience suggests that selected patients may benefit from this approach.

## REFERENCES

- Patel P, Ivanov A, Ramasubbu K. Myocardial viability and revascularization: current understanding and future directions. *Curr Atheroscler Rep*. 2016;18:32.
- Kawajiri H, Manlhiot C, Ross H, et al. High-risk cardiac surgery as an alternative to transplant or mechanical support in patients with end-stage heart failure. *J Thorac Cardiovasc Surg*. 2017;154:517–525.
- Coronary Artery Surgery Study (CASS): a randomized trial of coronary artery bypass surgery: survival data. *Circulation*. 1983;68:939–950.
- The Veterans Administration Coronary Artery Bypass Surgery Cooperative Study Group. Eleven-year survival in the Veterans Administration randomized trial of coronary bypass surgery for stable angina. *N Engl J Med*. 1984;311:1333–1339.
- Velazquez EJ, Lee KL, Jones RH, et al. Coronary-artery bypass surgery in patients with ischemic cardiomyopathy. *N Engl J Med*. 2016;374(16):1511–1520.
- Velazquez EJ, Lee KL, O'Connor CM, et al. The rationale and design of the Surgical Treatment for Ischemic Heart Failure (STICH) trial. *J Thorac Cardiovasc Surg*. 2007;134:1540–1547.
- Rose EA, Gelijns AC, Moskowitz AJ, et al. Long-term use of a left ventricular assist device for end-stage heart failure. *N Engl J Med*. 2001;345(20):1435–1443.
- Akay MH, Frazier OH. Impella Recover 5.0 assisted coronary artery bypass grafting. *J Card Surg*. 2010;25(5):606–607.
- Pepino P, Coronella G, Oliviero P, et al. Successful use of the Impella Recover LP 5.0 device for circulatory support during off-pump coronary artery bypass grafting. *J Surg Case Rep*. 2014; 5(11):803–805.
- Szafron B, Smoczyński RH, Drobiński D, et al. Impella LD microaxial pump supporting combined mitral and coronary surgery in a patient with dilated cardiomyopathy. A short bridge to recovery? *Kardiochirurgia Pol*. 2015;12(1):56–59.
- Holly TA, Bonow RO, Arnold MO, et al. Myocardial viability and impact of surgical ventricular reconstruction on outcomes of patients with severe left ventricular dysfunction undergoing coronary artery bypass surgery: results of the Surgical treatment of Ischemic Heart Failure trial. *J Thorac Cardiovasc Surg*. 2014;148:2677–2684.
- Elhussein TA, Hutchison SJ. Acute mitral regurgitation: unforeseen new complication of the Impella LP 5.0 ventricular assist device and review of literature. *Heart Lung Circ*. 2014;23:e100–e104.
- Ranc S, Sibellas F, Green L. Acute intraventricular thrombosis of an Impella LP 5.0 device in an ST-elevated myocardial infarction complicated by cardiogenic shock. *J Invasive Cardiol*. 2013;25:E1–E3.

# 7

## Preoperative Strategies for Optimizing Mechanical Circulatory Support

EVAN C. KLEIN AND MITCHELL T. SALTZBERG

### Introduction

**O**ptimizing preoperative mechanical circulatory support (MCS) starts with appropriate patient selection. Although patients are best selected with a multidisciplinary approach, several risk stratification models may assist in selection. Once the team decides to proceed with MCS, a detailed understanding of these risk models can then be used to develop a systematic approach to the perioperative preparation of these patients before device implantation. Here, we review several risk-stratification models, as well as approaches for optimizing the preoperative treatment of patients before left ventricular assist device (LVAD) implantation.

### Managing Patients with Heart Failure before Device Implantation

The Medical College of Wisconsin's Comprehensive Heart Failure and Transplant Program has refined its preoperative approach to selecting and managing patients with mechanical circulatory support (Figure 7.1). Patients are selected after a thorough evaluation by the multidisciplinary team, which considers risk scores and hepatic, renal, synthetic, nutritional, and functional characteristics. We then develop an individualized care plan for ensuring the best possible surgical outcome. Here, we review several techniques that can help assess a patient's preoperative clinical condition.

#### Hemodynamic Monitoring

Invasive hemodynamic monitoring with a Swan-Ganz catheter is essential to measure cardiac output through thermodilution or Fick's methodology. With this approach, a cardiac index of 2.2 L/min/m<sup>2</sup> or less is considered

consistent with poor perfusion and suggests that either inotropic support or temporary mechanical circulatory support should be considered to restore adequate perfusion. In addition, assessing the degree of pulmonary hypertension and right ventricular (RV) reserve by measuring the pulmonary artery pulsatility index and central venous pressure (CVP) can help prepare for the possibility of RV failure after LVAD implantation.

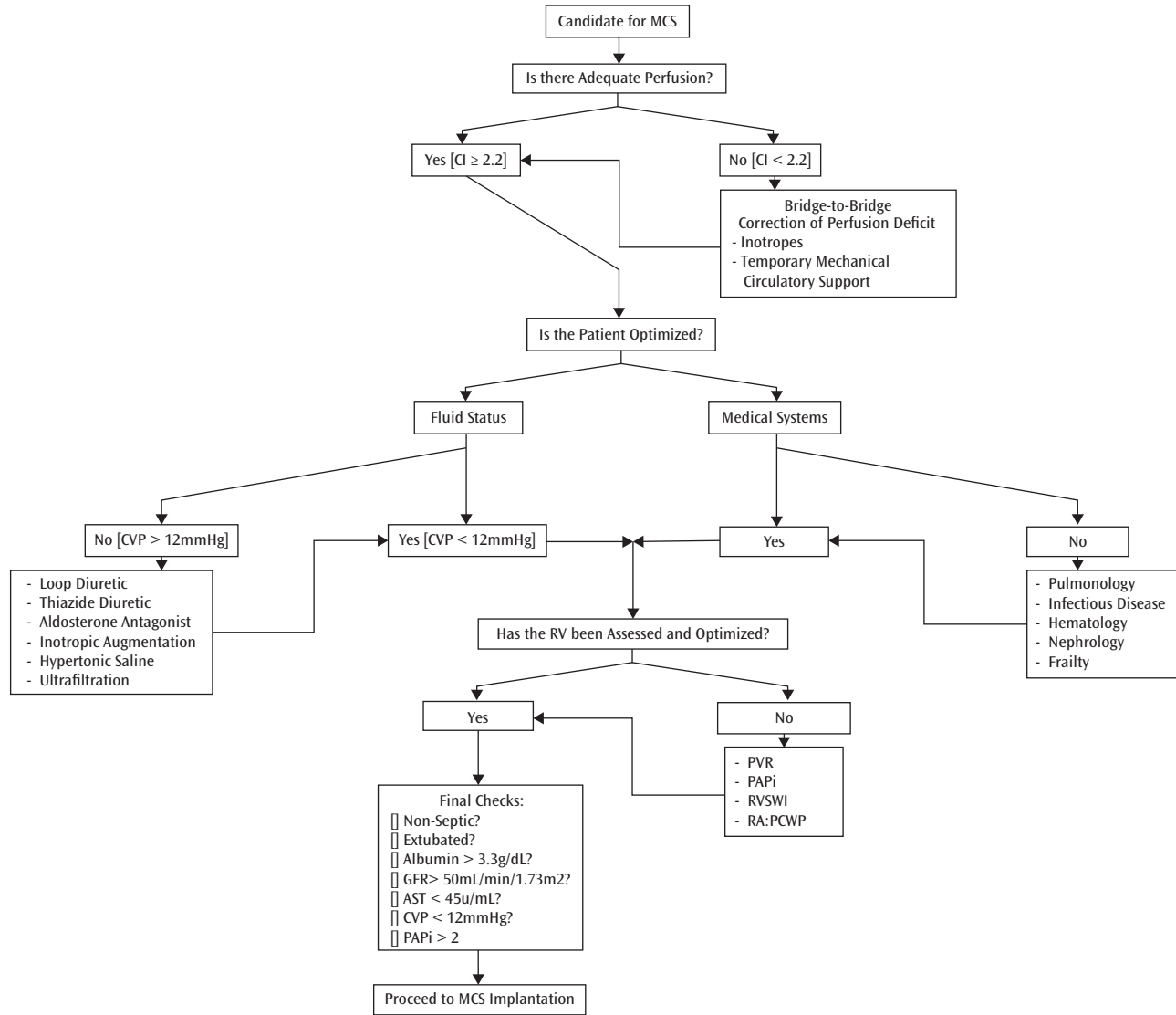
#### Inotropic Support

Inotropic drugs, such as milrinone and dobutamine, remain the primary pharmacologic therapy for augmenting myocardial contractility in patients with poor perfusion. However, given their association with increased morbidity<sup>1</sup> and mortality<sup>2,3</sup> these drugs are now primarily used as a bridge-to-decision, bridge-to-bridge (i.e., to a temporary mechanical circulatory support device), or bridge-to-definitive-VAD-transplant therapy.

Inotropes can be titrated by either direct hemodynamic measures or by secondary markers of perfusion such as blood urea nitrogen (BUN), creatinine, liver function studies, lactic acid, or mixed venous gases. With direct hemodynamic monitoring, inotropes should be titrated to maintain a cardiac index greater than 2.2 L/min/m<sup>2</sup>. With secondary markers of poor perfusion, the dose should be titrated based on an overall clinical assessment, including laboratory values (e.g., creatinine clearance aminotransferase levels, lactic acidosis) and physical exams (e.g., extremity warmth/coolness, urine output, mentation).

#### Temporary Mechanical Circulatory Support

Several versions of temporary mechanical circulatory support (TMCS) can augment perfusion in patients unresponsive to bridging inotropic therapy, ranging from intra-aortic balloon pumps, to percutaneously placed axial flow



**Figure 7.1.** The Medical College of Wisconsin’s Comprehensive Heart Failure and Transplant Program approach to preoperative management of patients with heart failure before implanting a durable mechanical circulatory support device. Abbreviations: MCS = mechanical circulatory support, CI = cardiac index, CVP = central venous pressure, RV = right ventricle, PVR = pulmonary vascular resistance, PAPI = pulmonary artery pulsatility index, RVSWI = right ventricular stroke work index, RA:PCWP = right atrial:pulmonary capillary wedge pressure, GFR = glomerular filtration rate, AST = aspartate aminotransferase.

pumps, or to centrally placed extracorporeal membrane oxygenation systems with centrifugal external pumps. The best choice of a TMCS device depends on various factors, including the amount of flow support required, the anticipated duration of support, the need for left- or right-ventricular support, and the ability for early ambulation with the TMCS in place. A complete review of current TMCS devices is outside the scope of this chapter; however, our approach has primarily been to provide adequate flow with devices that allow for continued ambulation during the remaining preoperative period.

For LV support, we favor a surgically placed subclavian Impella 5.0 microaxial circulatory support system. This system is an effective bridge to transplantation or durable long-term MCS therapy in patients with acute cardiac decompensation<sup>4,5</sup> or with cardiogenic shock,<sup>6</sup> and its placement through the subclavian artery allows for continued ambulation and physical therapy during the remaining preoperative period. Frailty is associated with an increased risk of morbidity and mortality after cardiac surgery,<sup>7</sup> and continued physical therapy in patients with appropriate TMCS devices can help decrease preoperative frailty by improving

physical function.<sup>8</sup> About 20% of our patients require temporary MCS, as either a bridge-to-transplant directly or to durable MCS.

For RV support, we favor the TandemHeart Protek-Duo percutaneously placed veno-venous circulatory support system, paired with an external centrifugal pump which allows continued preoperative ambulation and can be paired with an oxygenator if needed.

### Medical Management

Most patients with advanced heart failure waiting for durable MCS implantation have lived with suboptimal perfusion for a long time. As a result, they often have multisystem involvement of their disease and can require preoperative input from several specialists.

#### Pulmonology

Respiratory failure requiring prolonged postoperative intubation greatly hinders postoperative recovery and increases 1-year mortality after LVAD implantation.<sup>9,10</sup> Fortunately, several risk factors for postoperative respiratory failure can be modified before VAD implantation. Specific goals include avoiding preoperative intubation when possible, correcting hypoalbuminemia by improving nutritional status, and improving the INTERMACS profile with inotropic and TMCS therapies.<sup>9</sup>

#### Infectious Diseases

Preoperative leukocytosis is associated with greater 1-year mortality after device implantation,<sup>9</sup> and postoperative infection remains a major source of morbidity in patients with LVADs. All active infectious processes should be treated preoperatively and infectious disease specialists consulted when necessary. Additionally, potential sources of future infection (e.g., indwelling lines, Foley catheters) should be minimized whenever possible. Patients should also be thoroughly screened for open wounds or ulcerations, tooth abscesses, or other sources of infection. These should be treated before consideration of device implantation.

#### Hematology

Postoperative bleeding remains a major complication of LVAD insertion, and patients with advanced heart failure are at a greater risk for baseline anemia from hemodilution, as well as from decreased erythropoietin production from angiotensin-induced inhibition or altered liver and/or renal function.<sup>11</sup> As a result, preoperative assessment and optimization of the hematologic system are important, both to avoid bleeding events and to mitigate their impact when they occur. At a minimum, the initial evaluation of patients considered for LVAD therapy should include assessing hemoglobin and hematocrit concentrations and platelet counts, as well as measuring baseline

markers of adequate function of the coagulation cascade. Additionally, all patients should be screened for a history of recurrent bleeding or thrombotic events.

Patients with anemia should be evaluated for iron-deficiency anemia with follow-up gastroenterological testing when appropriate. If iron-deficient, patients should begin repletion before device implantation whenever possible. If anemia is present without iron deficiency, patients should be assessed for myelodysplastic syndrome or malignancy because these patients may not respond to the increased need for red-blood cell production after device implantation or postoperative bleeding events. Patients with a history of recurrent bleeding or thrombotic events should be further evaluated for thrombophilia, as well as heparin-induced thrombocytopenia, if appropriate.

#### Nephrology

Preoperative assessment of renal function in patients with advanced heart failure is often complicated by cardiorenal syndrome. Cardiorenal syndrome (Table 7.1<sup>12</sup>) is subclassified into five types, with type I and type II being the most common in patients with advanced heart failure. Although the pathophysiology of type I and type II cardiorenal syndrome remains unclear, current theories postulate a decreased renal perfusion gradient resulting from the increased renal afterload of cardiovascular congestion or poor cardiac output, overactivation of the sympathetic nervous system, or increased systemic inflammation from acute decompensation, iatrogenic toxicity from prescribed medications (e.g., angiotensin converting enzyme inhibitors, angiotensin receptor blockers, diuretics), or intrinsic renal dysfunction from comorbidities (e.g., obesity, hypertension, diabetes, atherosclerotic disease.)<sup>13,14</sup>

**Table 7.1 • The Five Types of Cardiorenal Syndrome**

Type	Description
I. Acute Cardiorenal	Abrupt worsening of cardiac function leading to renal injury
II. Chronic Cardiorenal	Chronic abnormalities of cardiac function leading to progressive renal injury
III. Acute Renocardiac	Abrupt worsening of renal function causing an acute cardiac disorder
IV. Chronic Renocardiac	Chronic kidney disease contributing to decreased cardiac function and/or an increased risk of adverse cardiovascular events
V. Secondary Cardiorenal	Other systemic conditions causing both cardiac and renal dysfunction

Reprinted from Cole RT et al, Renal dysfunction in heart failure, *Medical Clinics of North America* 2012;96:955–974, Copyright (2012), with permission from Elsevier.

Fortunately, although preoperative glomerular filtration rates appear to be inversely related to all-cause mortality after LVAD implantation,<sup>15,16</sup> lower rates are primarily driven by baseline chronic kidney disease and not by transient renal injury from congestion or diuresis.<sup>15,17</sup> Restoring perfusion early, achieving adequate decongestion, and avoiding nephrotoxic agents are therefore the key strategies for optimizing preoperative renal function. Nuclear imaging with a Mag-3 renal scan can help differentiate acute (pre-renal/cardio-renal) from chronic kidney dysfunction if the acuity of renal dysfunction is a concern, despite improving perfusion and attempts at decongestion.<sup>18</sup>

### Frailty

Frailty before LVAD implantation<sup>19,20</sup> or other cardiac surgery<sup>7</sup> is consistently associated with greater morbidity and mortality. Although frailty has no widely accepted definition, common elements of frailty scores include ambulatory function, muscle strength, nutritional status, and cognitive function. Fortunately, each of these variables, other than cognitive function, is readily modifiable with consistent physical<sup>21,22</sup> and nutritional therapies.

To treat frailty before LVAD implantation, every effort should be made to preserve ambulatory status and functional capacity. Additionally, these patients should have daily physical and occupational therapy and appropriate nutrition intake.

### Treating Hemodynamic Congestion

Hemodynamic congestion is associated with a greater risk for cardiorenal syndrome, hospitalization,<sup>23</sup> and death,<sup>10,23–25</sup> and is most commonly indicated by an elevated LV end diastolic pressure, pulmonary capillary wedge pressure, or central venous pressure (CVP).<sup>26</sup> Although “normal” CVP ranges from 2 to 6 mm Hg, the target CVP in patients with ambulatory heart failure is often 8 to 12 mm Hg, given the increased preload dependency of the failing RV, which is common in these patients. In addition, the target CVP in a patient before LVAD insertion should be less than 18 mm Hg because persistent congestion before LVAD insertion is associated with greater 90-day mortality<sup>10</sup> and the need for biventricular support. Guidelines have suggested that, if a Swan-Ganz catheter is in place, a target pulmonary capillary wedge pressure before VAD insertion should be less than 24 mm Hg; however, at these pressures, the risks of RV failure are unacceptably high.<sup>27</sup> Our practice is to treat CVP and wedge pressure much more aggressively to reduce the postoperative risk of RV failure.

Strategies for decongesting a patient with decompensated heart failure and elevated right atrial pressure start with loop diuretic therapy. Patients should be started on an intravenous loop diuretic at a dose that is at least the milligram equivalent of their home oral dose, although the DOSE trial suggests that high-dose therapy (intravenous

furosemide at 2.5 times the milligram equivalent of the patient’s home oral dose) is associated with increased fluid loss and increased relief of dyspnea without any marked difference in renal function.<sup>28</sup> Unfortunately, the efficacy of loop diuretic can be limited by neurohormonal activation, renal dysfunction, intrinsic diuretic resistance, and low cardiac output.<sup>29</sup>

In patients with poor response to loop diuretic therapy, sequential nephron blockade is the next strategy. Loop diuretics lead to natriuresis and diuresis by blocking the reabsorption of sodium in the ascending loop of Henle. Because these non-reabsorbed sodium ions exit the ascending loop of Henle, a large proportion can be reabsorbed by the sodium-chloride transporters in the distal tubule. Therefore, sequential blockade of the distal tubule’s sodium-chloride transporters with a thiazide diuretic can allow increased natriuresis and diuresis in patients resistant to loop diuretic therapy.<sup>30</sup> Similarly, sequential nephron blockade with an aldosterone antagonist at natriuretic dosages (e.g., spironolactone >50 mg per day) can augment decongestion as well.<sup>31</sup>

Rarely, decompensated patients with advanced heart failure are not adequately decongested, despite escalating dosages of diuretics. In these patients, hypertonic saline<sup>32,33</sup> and, potentially, extracorporeal ultrafiltration<sup>34–37</sup> can aid in decongestion. Efforts to decongest the patient should continue until CVP is less than 10 mm Hg and can be maintained through the preoperative period.

### Right Ventricular Assessment and Management

Right ventricular failure after LVAD implantation is one of the major causes of post-LVAD morbidity and mortality,<sup>38</sup> often requiring prolonged inotropic treatment, emergent RV mechanical support, or both. In fact, several of the risk factors for postoperative LVAD mortality can be at least partially attributed to preoperative RV dysfunction (e.g., abnormal metabolic and synthetic liver function from persistent hepatic congestion, elevated serum creatinine from increased glomerular afterload).

Given the important prognostic implications of RV function, several risk factors and risk indices have been identified to help assess or identify patients at greater risk for postoperative RV failure. Clinical risk factors include systemic hypotension<sup>39</sup> and elevated serum creatinine concentrations.<sup>39</sup> Imaging-based risk factors include severe RV dysfunction detected by echocardiography<sup>39,40</sup> or magnetic resonance imaging (MRI). Hemodynamic risk factors include a low preoperative cardiac index,<sup>39</sup> elevated right-atrial-pressure-to-pulmonary-capillary-wedge-pressure ratio,<sup>41</sup> and reduced RV stroke work index<sup>39,40</sup> and pulmonary artery pulsatility index.<sup>41,42</sup> Currently, the pulmonary artery pulsatility index is the most commonly used risk index, given its ease of use and validated predictive value for 6-month mortality or rehospitalization in patients with

advanced heart failure,<sup>43</sup> as well as its predictive value for postoperative RV dysfunction.<sup>41,42</sup>In general, we suggest that the RV be assessed with a combination of hemodynamic, clinical, and radiologic risk factors, with the goal of optimizing these values in whatever way possible through medical or short-term MCS techniques to avoid the need for right heart support post-LVAD implantation. This should also help in identifying patients who may benefit from use of the total artificial heart in preference to LVAD. If the patient is not a total artificial heart candidate, this preoperative assessment and treatment success (or failure) should forewarn the team of the likely need of prolonged postoperative inotropic therapy or temporary RV mechanical circulatory support before LVAD implantation.

## Conclusions

The algorithm in Figure 7.1 is a generalized approach to the preoperative management of a patient potentially needing MCS. By adhering to this algorithm, we have standardized our approach to selecting and treating these patients, optimized our inotropic or TMCS strategies, and taken the extra time to address modifiable patient risk factors to improve clinical outcomes.

We have presented a model that systematically evaluates pre- and postoperative risk factors that predict RV failure and subsequently worsened outcomes. Risk models can be helpful in identifying high-risk patients, directing the application of temporary support to minimize risk factors going into surgery, and identifying patients who benefit from aggressive early postoperative RV support.

A multidisciplinary team approach is critical to address each of the organ systems most directly affected by hypoperfusion and to correct factors that can be modified preoperatively to improve surgical outcomes. A thorough preoperative approach pays dividends in reducing the risks of postoperative complications in high-risk patients with advanced heart failure.

## REFERENCES

- Lee DH, Buth KJ, Martin BJ, Yip AM, Hirsch GM. Frail patients are at increased risk for mortality and prolonged institutional care after cardiac surgery. *Circulation*. 2010;121(8):973–978.
- McGarrigle L, Caunt J. Physical therapist-led ambulatory rehabilitation for patients receiving Centrimag short-term ventricular assist device support: retrospective case series. *Phys Ther*. 2016;96(12):1865–1873.
- Sagebin F, Ayers B, Barrus B, et al. Predictors of respiratory failure in patients supported with continuous flow ventricular assist devices and the effect on survival. *J Heart Lung Transplant*. 2018;37(4):S375.
- Sabashnikov A, Mohite PN, Zych B, et al. Outcomes and predictors of early mortality after continuous-flow left ventricular assist device implantation as a bridge to transplantation. *ASAIO J*. 2014;60(2):162–169.
- Tang YD, Katz SD. Anemia in chronic heart failure: prevalence, etiology, clinical correlates, and treatment options. *Circulation*. 2006;113(20):2454–2461.
- Ronco C. The cardiorenal syndrome: basis and common ground for a multidisciplinary patient-oriented therapy. *Cardiorenal Med*. 2011;1(1):3–4.
- Guglin M, Rivero A, Matar F, Garcia M. Renal dysfunction in heart failure is due to congestion but not low output. *Clin Cardiol*. 2011;34(2):113–116.
- Ronco C, Di Lullo L. Cardiorenal syndrome. *Heart Fail Clin*. 2014;10(2):251–280.
- Mohamedali B, Bhat G. The influence of pre-left ventricular assist device (LVAD) implantation glomerular filtration rate on long-term LVAD outcomes. *Heart Lung Circ*. 2017;26(11):1216–1223.
- Kirklin JK, Naftel DC, Kormos RL, et al. Quantifying the effect of cardiorenal syndrome on mortality after left ventricular assist device implant. *J Heart Lung Transplant*. 2013;32(12):1205–1213.
- Nohria A, Hasselblad V, Stebbins A, et al. Cardiorenal interactions: insights from the ESCAPE trial. *J Am Coll Cardiol*. 2008;51(13):1268–1274.
- Grande D, Terlizze P, Iacoviello M. Role of imaging in the evaluation of renal dysfunction in heart failure patients. *World J Nephrol*. 2017;6(3):123–131.
- Dunlay SM, Park SJ, Joyce LD, et al. Frailty and outcomes after implantation of left ventricular assist device as destination therapy. *J Heart Lung Transplant*. 2014;33(4):359–365.
- Tse G, Gong M, Wong SH, et al. Frailty and clinical outcomes in advanced heart failure patients undergoing left ventricular assist device implantation: a systematic review and meta-analysis. *J Am Med Dir Assoc*. 2018;19(3):255–261, e251.
- Fiatarone MA, O'Neill EF, Ryan ND, et al. Exercise training and nutritional supplementation for physical frailty in very elderly people. *N Engl J Med*. 1994;330(25):1769–1775.
- de Vries NM, Staal JB, van der Wees PJ, et al. Patient-centered physical therapy is (cost-) effective in increasing physical activity and reducing frailty in older adults with mobility problems: a randomized controlled trial with 6 months follow-up. *J Cachexia Sarcopenia Muscle*. 2016;7(4):422–435.
- Cayley WE Jr. Prognostic importance of elevated jugular venous pressure and a third heart sound in patients with heart failure. *N Engl J Med*. 2001;345(26):1912; author reply, 2001;345(26):1913.
- Lucas C, Johnson W, Hamilton MA, et al. Freedom from congestion predicts good survival despite previous class IV symptoms of heart failure. *Am Heart J*. 2000;140(6):840–847.
- Gheorghiade M, Gattis WA, O'Connor CM, et al. Effects of tolvaptan, a vasopressin antagonist, in patients hospitalized with worsening heart failure: a randomized controlled trial. *JAMA*. 2004;291(16):1963–1971.
- Gheorghiade M, Follath F, Ponikowski P, et al. Assessing and grading congestion in acute heart failure: a scientific statement from the acute heart failure committee of the heart failure association of the European Society of Cardiology and endorsed by the European Society of Intensive Care Medicine. *Eur J Heart Fail*. 2010;12(5):423–433.
- Russell S, Pagani F. *HeartMate III LVAS: Patient Management Guidelines*. Santa Clara, CA: Abbott Vascular; 2018.

22. Felker GM, Lee KL, Bull DA, et al. Diuretic strategies in patients with acute decompensated heart failure. *N Engl J Med*. 2011;364(9):797–805.
23. Felker GM, Mentz RJ. Diuretics and ultrafiltration in acute decompensated heart failure. *J Am Coll Cardiol*. 2012;59(24):2145–2153.
24. Jentzer JC, DeWald TA, Hernandez AF. Combination of loop diuretics with thiazide-type diuretics in heart failure. *J Am Coll Cardiol*. 2010;56(19):1527–1534.
25. Bansal S, Lindenfeld J, Schrier RW. Sodium retention in heart failure and cirrhosis: potential role of natriuretic doses of mineralocorticoid antagonist? *Circ Heart Fail*. 2009;2(4):370–376.
26. Wan Y, Li L, Niu H, et al. Impact of compound hypertonic saline solution on decompensated heart failure. *Int Heart J*. 2017;58(4):601–607.
27. Paterna S, Di Gaudio F, La Rocca V, et al. Hypertonic saline in conjunction with high-dose furosemide improves dose-response curves in worsening refractory congestive heart failure. *Adv Ther*. 2015;32(10):971–982.
28. Marenzi G, Grazi S, Giraldo F, et al. Interrelation of humoral factors, hemodynamics, and fluid and salt metabolism in congestive heart failure: effects of extracorporeal ultrafiltration. *Am J Med*. 1993;94(1):49–56.
29. Marenzi G, Lauri G, Grazi M, Assanelli E, Campodonico J, Agostoni P. Circulatory response to fluid overload removal by extracorporeal ultrafiltration in refractory congestive heart failure. *J Am Coll Cardiol*. 2001;38(4):963–968.
30. Agostoni P, Marenzi G, Lauri G, et al. Sustained improvement in functional capacity after removal of body fluid with isolated ultrafiltration in chronic cardiac insufficiency: failure of furosemide to provide the same result. *Am J Med*. 1994;96(3):191–199.
31. Costanzo MR, Guglin ME, Saltzberg MT, et al. Ultrafiltration versus intravenous diuretics for patients hospitalized for acute decompensated heart failure. *J Am Coll Cardiol*. 2007;49(6):675–683.
32. Kirklin JK, Naftel DC, Pagani FD, et al. Long-term mechanical circulatory support (destination therapy): on track to compete with heart transplantation? *J Thorac Cardiovasc Surg*. 2012;144(3):584–603; discussion 597–588.
33. Fitzpatrick JR 3rd, Frederick JR, Hsu VM, et al. Risk score derived from pre-operative data analysis predicts the need for biventricular mechanical circulatory support. *J Heart Lung Transplant*. 2008;27(12):1286–1292.
34. Neragi-Miandoab S, Goldstein D, Bello R, Michler R, D'Alessandro D. Right ventricular dysfunction following continuous flow left ventricular assist device placement in 51 patients: predictors and outcomes. *J Cardiothorac Surg*. 2012;7:60.
35. Morine KJ, Kiernan MS, Pham DT, Paruchuri V, Denofrio D, Kapur NK. Pulmonary artery pulsatility index is associated with right ventricular failure after left ventricular assist device surgery. *J Card Fail*. 2016;22(2):110–116.
36. Kang G, Ha R, Banerjee D. Pulmonary artery pulsatility index predicts right ventricular failure after left ventricular assist device implantation. *J Heart Lung Transplant*. 2016;35(1):67–73.
37. Kochav SM, Flores RJ, Truby LK, Topkara VK. Prognostic impact of Pulmonary Artery Pulsatility Index (PAPi) in patients with advanced heart failure: insights from the ESCAPE Trial. *J Card Fail*. 2018;24(7):453–459.
38. Cuffe MS, Califf RM, Adams KF Jr, et al. Short-term intravenous milrinone for acute exacerbation of chronic heart failure: a randomized controlled trial. *JAMA*. 2002;287(12):1541–1547.
39. Ishihara S, Gayat E, Sato N, et al. Similar hemodynamic decongestion with vasodilators and inotropes: systematic review, meta-analysis, and meta-regression of 35 studies on acute heart failure. *Clin Res Cardiol*. 2016;105(12):971–980.
40. O'Connor CM, Gattis WA, Uretsky BF, et al. Continuous intravenous dobutamine is associated with an increased risk of death in patients with advanced heart failure: Insights from the Flolan International Randomized Survival Trial (FIRST). *Am Heart J*. 1999;138(1 Pt 1):78–86.
41. Hall SA, Uriel N, Carey SA, et al. Use of a percutaneous temporary circulatory support device as a bridge to decision during acute decompensation of advanced heart failure. *J Heart Lung Transplant*. 2018;37(1):100–106.
42. Bansal A, Bhama JK, Patel R, et al. Using the minimally invasive Impella 5.0 via the right subclavian artery cutdown for acute on chronic decompensated heart failure as a bridge to decision. *Ochsner J*. 2016;16(3):210–216.
43. Lima B, Kale P, Gonzalez-Stawinski GV, Kuiper JJ, Carey S, Hall SA. Effectiveness and safety of the Impella 5.0 as a bridge to cardiac transplantation or durable left ventricular assist device. *Am J Cardiol*. 2016;117(10):1622–1628.

# 8

## Mechanical Circulatory Support in Patients with Pulmonary Hypertension

DAVID ISHIZAWAR

### Introduction

**P**ulmonary hypertension (PH) is a heterogeneous group of diagnoses including pulmonary vascular disease, left-sided heart failure, lung disease, and thromboembolic disease (Table 8.1). Regardless of the cause, PH is often associated with increased morbidity and mortality that require proper diagnosis, differentiation, and optimal management to avoid. Mortality rates range from 2.8% in low-risk patients to as high as 21% in patients with high-risk pulmonary arterial hypertension (PAH).<sup>1</sup> In the United States, deaths associated with PH have a heterogeneous distribution based on etiology and risk factors, but rates routinely exceed 6 deaths per 100,000 population (Figure 8.1).

In systolic heart failure, the development of irreversible PH precludes cardiac transplantation because the risk of allograft right-ventricular failure and death is increased. In these cases, left ventricular assist devices (LVADs) can provide circulatory support and the potential to reverse PH.

A diagnosis of PAH requires not only an elevated main pulmonary artery pressure, but also a normal LV filling pressure (e.g., a pulmonary artery occlusion pressure >15 mm Hg) and an elevated pulmonary vascular resistance greater than 3 Wood units.<sup>2</sup> Chronic thromboembolic pulmonary hypertension (CTEPH) has hemodynamic characteristics similar to those of PAH, but also requires radiographic evidence of chronic thromboembolic disease, usually provided by ventilation-perfusion nuclear scintigraphy, angiography, computed tomography, or an invasive pulmonary angiogram. In the United States, the most common form of pulmonary hypertension is that caused by left-heart failure (HF), which affects up to 65% of HF patients.<sup>3</sup> In contrast to

pre-capillary PH, left-sided PH is characterized by elevated LV filling pressures.

### Classification of Pulmonary Hypertension

#### Group 1: Pulmonary Arterial Hypertension

Patients with PAH have pulmonary vascular diseases of heterogeneous causes (e.g., autoimmune, drug or toxin related, congenital shunts, etc.), as well as both idiopathic and heritable genetic mutations that affect the pulmonary vasculature.<sup>4</sup> These patients have in common the development of intimal thickening and medial hypertrophy, and eventually plexiform lesions in the small pulmonary arterioles. Frequently, histologic samples also reveal evidence of an in situ thrombosis different from thromboembolic disease. Current pulmonary vasodilator therapies (prostacyclin analogues, endothelin receptor antagonists, phosphodiesterase type-5 inhibitors, and soluble guanylate cyclase stimulators) are directed to patients with PAH.

#### Group 2: Pulmonary Hypertension from Left-Heart Disease

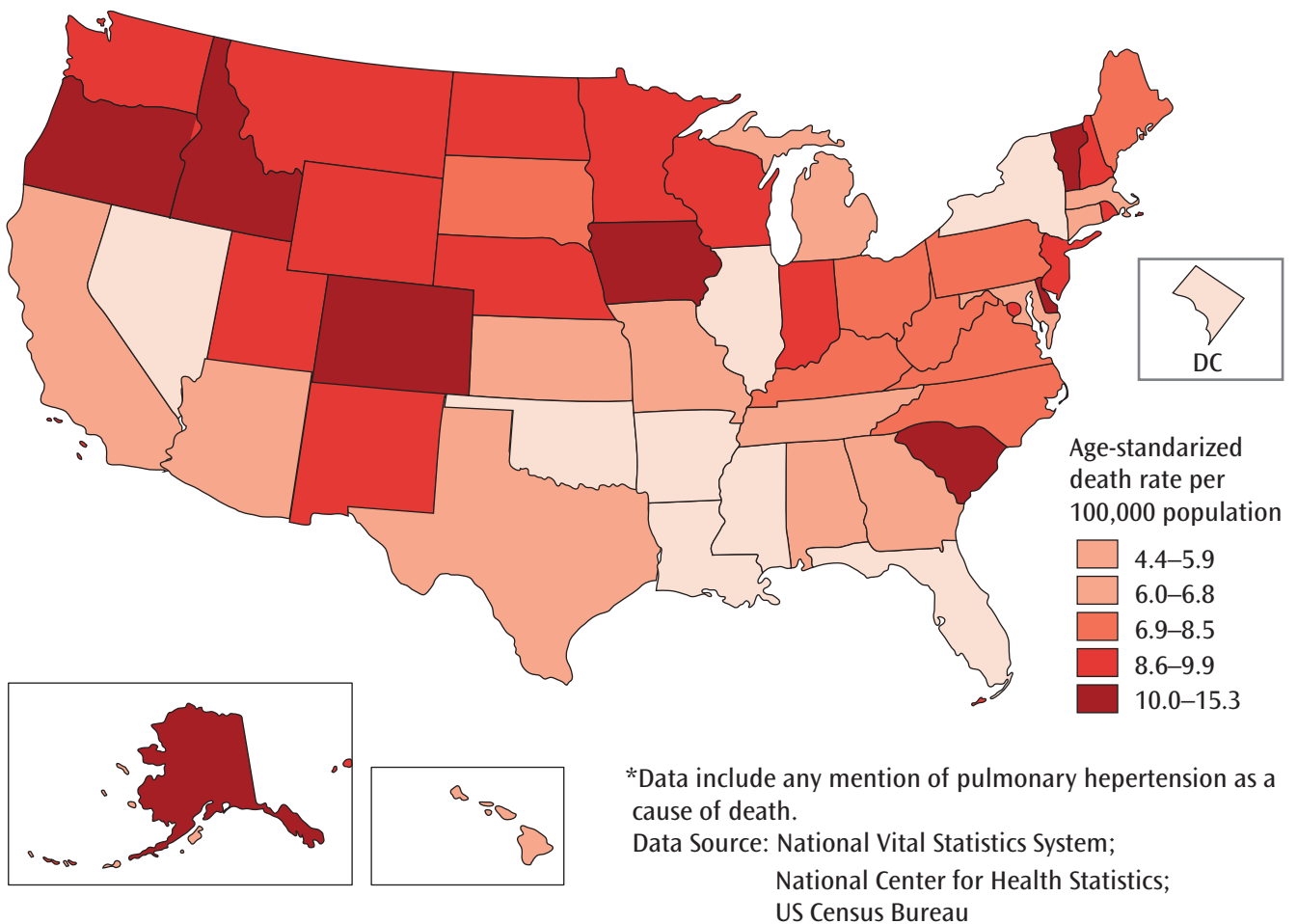
In North America, PH is probably most often caused by left-heart failure (with either preserved or reduced ejection fraction). About two-thirds of patients with left-heart failure experience PH. Most cases of group 2 PH are presumed to be related to passive congestion and elevated LV filling pressures that resolve or improve with diuresis. However, autopsies of patients with transplanted hearts have revealed medial hypertrophy without intimal fibrosis as a result of chronic heart failure that causes pulmonary vascular remodeling.<sup>5</sup>



**Table 8.1 • World Health Organization’s Classification of Pulmonary Hypertension**

WHO Group	Examples of Specific Underlying Diseases
1. Pulmonary arterial hypertension	Idiopathic PAH, heritable PAH, connective tissue disease, portopulmonary hypertension, congenital heart disease, HIV, drug (e.g., methamphetamine), anorexigen, schistosomiasis, pulmonary veno-occlusive disease
2. Left heart disease	Systolic heart failure, diastolic heart failure, valvular heart disease
3. Lung disease, chronic hypoxemia	Interstitial lung disease (e.g., idiopathic pulmonary fibrosis, hypersensitivity pneumonitis), COPD/emphysema, sleep disordered breathing, alveolar hypoventilation syndromes
4. Chronic thromboembolic pulmonary hypertension	Chronic pulmonary embolism
5. Pulmonary hypertension from blood or other disorders	Hematologic disorders (e.g., chronic hemolytic anemia, myeloproliferative diseases), systemic disorders (e.g., sarcoidosis, pulmonary histiocytosis, Gaucher disease, lymphangioleiomyomatosis), metabolic disorders (e.g., glycogen storage disease, thyroid disorders), tumoral obstruction, fibrosing mediastinitis

Abbreviation: PAH = pulmonary arterial hypertension.



**Figure 8.1.** Rates of pulmonary hypertension-associated deaths in the United States, 2016.  
 Reprinted from [https://www.cdc.gov/dhdspl/data\\_statistics/fact\\_sheets/fs\\_pulmonary\\_hypertension.htm](https://www.cdc.gov/dhdspl/data_statistics/fact_sheets/fs_pulmonary_hypertension.htm).

### Group 3: Pulmonary Hypertension from Lung Disease or Chronic Hypoxia

Pulmonary hypertension in lung disease may occur because of parenchymal lung disease with loss of pulmonary circulatory volume, vasoconstrictive responses to reduce shunting in hypoxemia, or a combination of both. In some lung diseases, such as pulmonary fibrosis, coexisting inflammatory mediators and endothelin activity may mediate the development of PH. Pulmonary arterial flow to lung tissue less affected by lung disease often occurs in the setting of maximal vasodilation, rendering vasodilator therapy less beneficial in these patients. In idiopathic pulmonary fibrosis, ambrisentan and riociguat have been associated with a greater risk of clinical worsening or death.<sup>6,7</sup>

### Group 4: Pulmonary Hypertension from Blood Clots

In chronic thromboembolic pulmonary hypertension (CTEPH), the initial pulmonary thromboembolic event is frequently asymptomatic, with anywhere between nearly 1 to 4 years before the diagnosis is made.<sup>8–10</sup> The true incidence of CTEPH is unknown. Although a prospective study following patients after their initial pulmonary embolism reported an incidence of nearly 4% at 2 years of follow-up,<sup>11</sup> the fact that initial embolic events are missed and the lack of diagnostic awareness may mean that the true incidence is higher.

Pulmonary thromboendarterectomy remains the treatment of choice for these patients. Three-year survival is nearly 90% after thromboendarterectomy, but only 70% without it.<sup>12</sup> For patients who are not candidates for surgery, either from unfavorable distal disease or comorbidities that make the risk of thromboendarterectomy excessive, first-line medical therapy includes the soluble guanylate cyclase stimulator riociguat, which improves functional capacity and reduces pulmonary vascular resistance (PVR).<sup>13</sup> Macitentan, a non-selective endothelin receptor antagonist, can also improve hemodynamics and reduce PVR in these patients.<sup>14</sup> Although RV failure has traditionally been viewed as a contraindication to thromboendarterectomy, we have successfully used percutaneous, perioperative RVADs to support patients with CTEPH and profound RV failure.

## Pathophysiology of Pulmonary Hypertension Secondary to Left-Heart Failure

Pulmonary hypertension secondary to left heart disease most commonly has three manifestations: (1) elevated pulmonary capillary wedge pressure (PCWP) without pulmonary vascular remodeling, such that the hypertension improves or resolves with diuresis alone; (2) elevated PCWP with evidence of pulmonary vascular remodeling characterized by elevated PVR, and (3) after diuresis,

improved PCWP but persistently elevated PVR.<sup>5</sup> The latter two manifestations are characterized by pre- and post-capillary PH and persistently elevated PVR, despite volume reduction or increased cardiac output. Autopsy results of patients with HF who underwent heart transplantation revealed medial hypertrophy without intimal fibrosis and that the degree of medial hypertrophy was not correlated with either mean PA pressure, the diastolic pressure gradient, or PVR.<sup>15</sup>

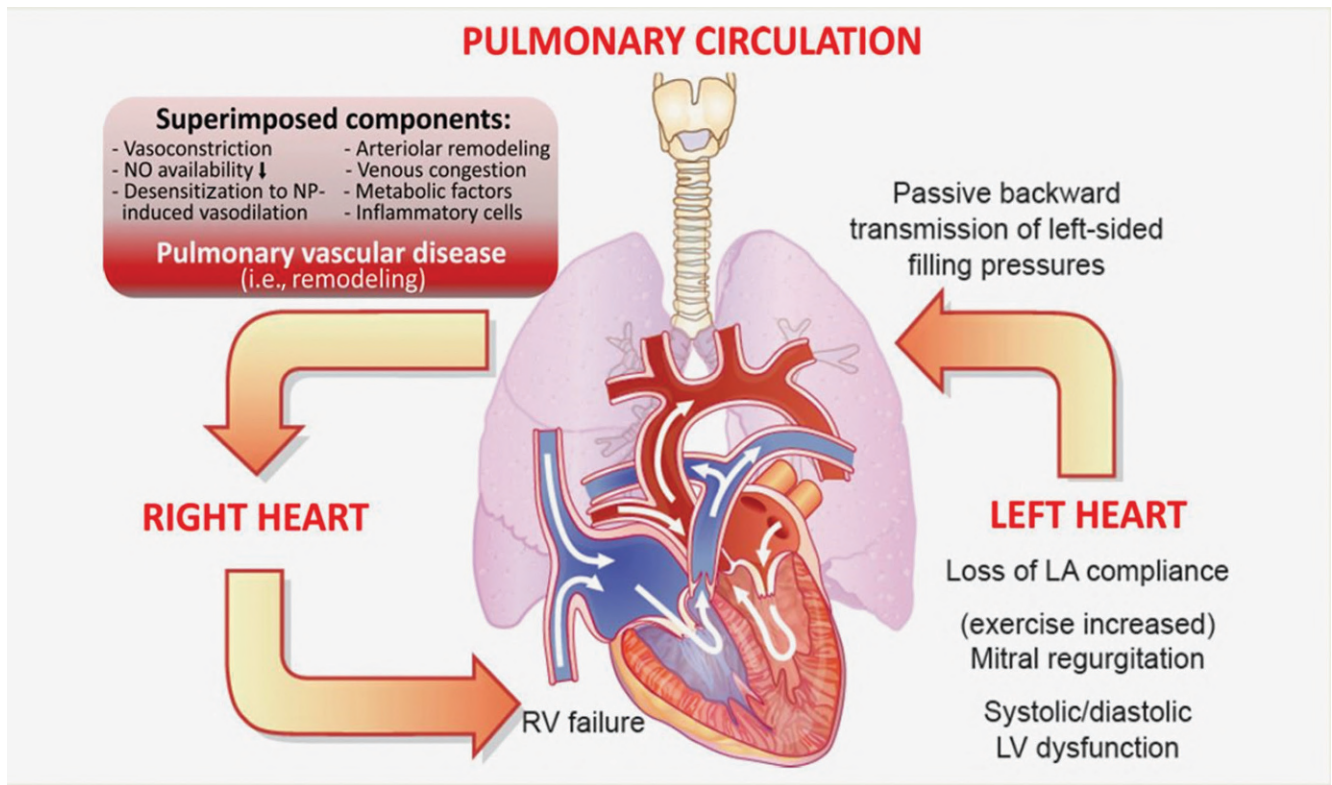
In left heart disease, PH may start as a compensatory mechanism to maintain forward flow when LV filling pressures are chronically elevated. This mechanism is often described as a “passive” pressures rise that may resolve with volume unloading. However, chronically increased pressures may lead to more permanent metabolic and physiologic changes that contribute to pre- and post-capillary PH and, with enough time, to right ventricular dysfunction (Figure 8.2).<sup>16</sup>

Both nitric-oxide deficiency and excess endothelin-1 appear to contribute to the development of PH in left HF.<sup>17,18</sup> Endothelial nitric oxide synthase constitutively produces basal concentrations of nitric oxide but is regulated by various stimuli or physical conditions; in heart failure, nitric oxide-dependent pathways of pulmonary vasodilation are diminished.

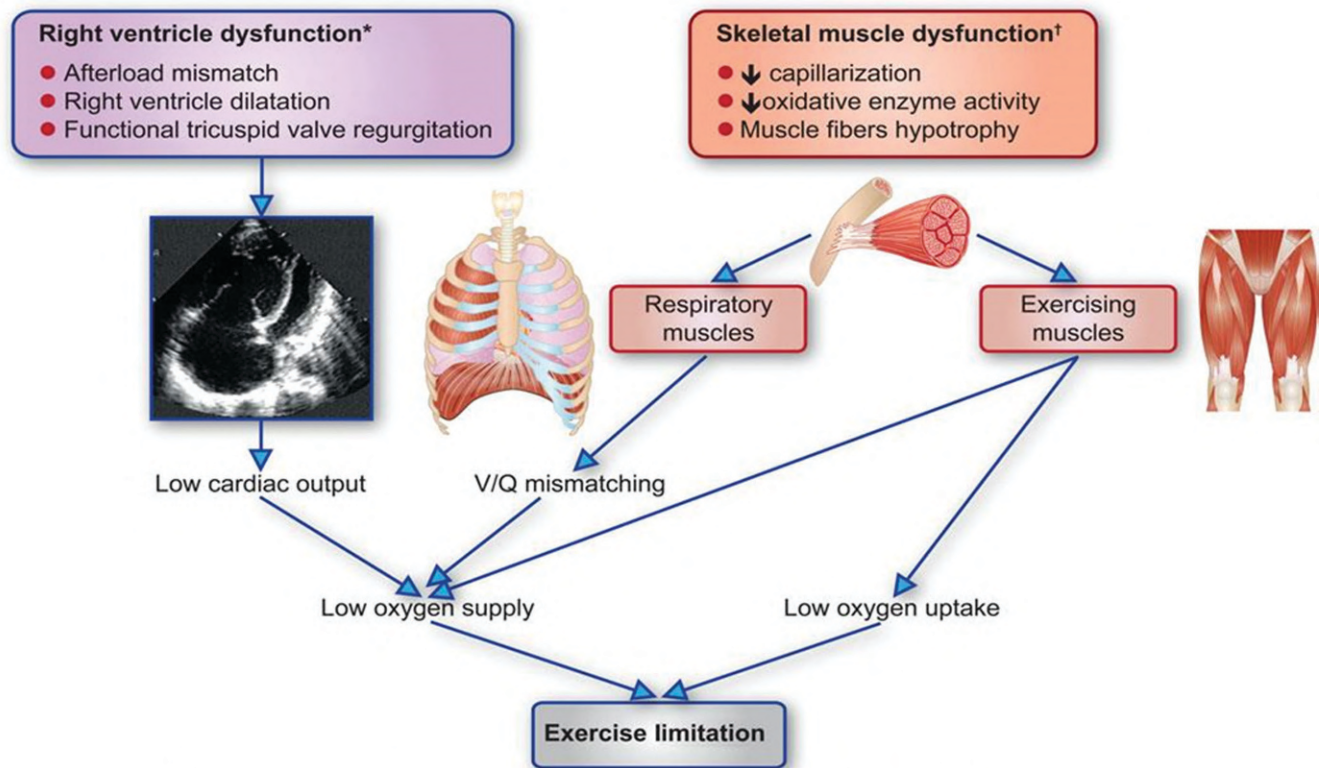
Excess endothelin-1 is a potent vasoactive peptide autoregulated by endothelin-type B receptor-mediated endothelial clearance. This mechanism is downregulated in HF, elevating circulating endothelin-1 concentrations that correlate with a rise in PVR. Thus, the mechanisms causing PH secondary to left HF are similar to those causing pulmonary vascular dysfunction in patients with PAH. Despite this similarity, treatment for PH secondary to left HF is not the same as that for pulmonary vasodilator therapy for PAH, which does not improve clinical outcomes in left HF and that sometimes, can be detrimental.<sup>19</sup>

## Pulmonary Hypertension and Heart Failure

Comorbid PH in patients with left HF is associated with decreased exercise tolerance and functional capacity, as well as with poor clinical outcomes.<sup>20</sup> In these patients with elevated PVR, cardiac output at peak exercise was 15%–30% less than that of patients with mildly elevated PVR (1.5–3.5 Wood units) and 37% less than that of patients with normal PVR (<1.5 Wood units). A PVR of 2.5 Wood units or higher was also associated with lower peak oxygen consumption.<sup>21</sup> Aside from reduced cardiac output that decreases oxygen delivery, pulmonary vascular dysfunction and pulmonary edema also reduce oxygen uptake. Additionally, deconditioning from chronic cardiopulmonary diseases reduces skeletal muscle oxygen delivery (through loss of capillary volume) and reduced oxygen uptake<sup>22</sup> (Figure 8.3).



**Figure 8.2.** Pulmonary hypertension and right-ventricular failure secondary to left heart failure. Reproduced from Rosenkranz S, Gibbs JSR, Wachter R, et al., Left ventricular heart failure and pulmonary hypertension, *European Heart Journal* 2015;37(12):942–954, by permission of Oxford University Press and the European Society of Cardiology.



\*Improved by approved drug therapy by reducing right ventricular afterload  
 †Improved by exercise training by increasing capillary density and oxidative enzyme activity

**Figure 8.3.** Mechanisms of exercise limitation in pulmonary hypertension. Reproduced from Galie N, Manes A, Palazzini M, Exercise training in pulmonary hypertension: improving performance but waiting for outcome, *European Heart Journal* 2015;37(1):45–48, by permission of Oxford University Press and the European Society of Cardiology.

**Table 8.2 • Vasodilator Agents That Can Reverse Pulmonary Hypertension**

Vasodilator Agent	Administration Route	Dose Range	Hemodynamic Effects
Nitric oxide	Inhaled	10–80 ppm	↓PVR, ↑PCWP, ↑CO
Nitroprusside	Intravenous	1.0–1.5 mcg/kg/min	↓PVR, ↓PCWP, ↑CO
Prostaglandin E1	Intravenous	2–10 ng/kg/min	↓PVR, ↓PCWP, ↑CO
Milrinone	Intravenous	50 mcg/kg	↓PVR, ↓PCWP, ↑CO

Abbreviations: PVR = pulmonary vascular resistance; PCW = pulmonary capillary wedge pressure; CO = cardiac output.

## Pulmonary Hypertension in Selecting Candidates for Heart Transplant

In cardiac transplantation, exposure of the donor heart to elevated pulmonary pressures in the recipient patient increases the risk of RV failure in the allograft and places the transplant recipient at increased risk of death after transplant.<sup>23–26</sup> This perioperative risk also extends to long-term post-transplant outcomes.<sup>27</sup>

Reversing PH in patients with HF can allow bridge to transplant and reduce the risk of post-transplant allograft dysfunction.<sup>23</sup> Various agents can reverse PH in these patients (Table 8.2).<sup>28–30</sup> Among vasodilator agents, prostaglandin is more effective than nitroglycerin or nitroprusside in quickly reducing PVR.<sup>31</sup> To bridge patients medically, intravenous milrinone also reverses PH and is commonly preferred to dobutamine, which is less effective. However, in the current era of organ allocation, depending on IV milrinone as a bridge to transplant while keeping PA pressures reduced will likely prolong wait-list time relative to other listing strategies. During this period, wait-list mortality and re-increase in the pulmonary pressure to the detriment of the patient are potential consequences. As a result, earlier transition to mechanical circuit support is generally advised.

## Mechanical Circulatory Support as a Bridge to Transplant in Patients with Secondary Pulmonary Hypertension

Before VAD therapy, patients with HF and reversible PH might be bridged to transplant with inotropic support, often with milrinone. However, the limited availability of donor hearts, as well as infusion-related complications, such as catheter infections, often jeopardized this strategy. The increased contractility induced by inotropic agents is mediated by adjusting the myocardial pressure-volume relationship to increase cardiac output. The effectiveness

of this therapy depends on the mix of contractile myocytes and extracellular fibrotic content caused by cell necrosis. Myocardial scar tissue from a previous myocardial infarction may distort ventricular mechanics as well as valve function, which limits the effectiveness of bridging inotropic therapy.

Ventricular assist devices unload the LV, which results in morphologic and histologic changes in the myocardium.<sup>32</sup> Indeed, VAD therapy can reverse PH in patients with PH refractory to medical therapy.<sup>33</sup> In general, PH reverses 3 to 6 months after VAD implantation.<sup>34–36</sup> However, despite the effectiveness of VAD therapy in reducing pulmonary pressures, PH and elevated PVR will persist in some patients. In those treated with VAD, sildenafil has decreased PVR from about 6 Wood units to just under 3 Wood units after 4 weeks of therapy and has sustained the decrease for at least 15 weeks. In similar patients treated with placebo, PVR did not improve.<sup>37</sup>

In some patients in whom chronic PH has led to permanent and more advanced RV dysfunction, the risks of cardiectomy-induced RV failure during LVAD implantation may require temporary RVAD support. In some cases, patients can be weaned from RVAD support, but in other cases, biventricular support may be necessary as a bridge-to-transplant. In patients where RV dysfunction is advanced and irreversible, implanting a total artificial heart should also be considered. Often, the choice between biventricular support and a total artificial heart may be heavily influenced by surgical experience with the various options.

## Conclusion

Pulmonary hypertension is an all too common complication of left heart failure that worsens symptoms and functional capacity. In patients with systolic HF, PH not only worsens clinical outcomes but may prevent consideration for heart transplantation. In many instances, mechanical circulatory support as a bridge to candidacy has permitted successful cardiac transplantation in these challenging patients.

## REFERENCES

- Hoepfer MM, Kramer T, Pan Z, et al. Mortality in pulmonary arterial hypertension: prediction by the 2015 European pulmonary hypertension guidelines risk stratification model. *Eur Respir J*. 2017;50(2):1700740, 1–10.
- Hoepfer MM, Bogaard HJ, Condliffe R, et al. Definitions and diagnosis of pulmonary hypertension. *J Am Coll Cardiol*. 2013;62(25, Supplement):D42–D50.
- Oudiz RJ. Pulmonary hypertension associated with left-sided heart disease. *Clin Chest Med*. 2007;28(1):233–241.
- Simonneau G, Gatzoulis MA, Adatia I, et al. Updated clinical classification of pulmonary hypertension. *J Am Coll Cardiol*. 2013;62(25, Supplement):D34–D41.
- Georgiopoulou VV, Kalogeropoulos AP, Borlaug BA, Gheorghide M, Butler J. Left ventricular dysfunction with pulmonary hypertension. Part 1: Epidemiology, pathophysiology, and definitions. *Circ Heart Fail*. 2013;6(2):344.
- Raghu G, Behr J, Brown KK, et al. Treatment of idiopathic pulmonary fibrosis with ambrisentan: a parallel, randomized trial. *Ann Intern Med*. 2013;158(9):641–649.
- Harari S, Elia D, Humbert M. Pulmonary hypertension in parenchymal lung diseases. *Chest*. 2018;153(1):217–223.
- Fedullo PF, Auger WR, Kerr KM, Rubin LJ. Chronic thromboembolic pulmonary hypertension. *N Engl J Med*. 2001;345(20):1465–1472.
- Becattini C, Agnelli G, Pesavento R, et al. Incidence of chronic thromboembolic pulmonary hypertension after a first episode of pulmonary embolism. *Chest*. 2006;130(1):172–175.
- Pepke-Zaba J, Delcroix M, Lang I, et al. Chronic thromboembolic pulmonary hypertension (CTEPH): results from an international prospective registry. *Circulation*. 2011;124(18):1973–1981.
- Pengo V, Lensing AWA, Prins MH, et al. Incidence of chronic thromboembolic pulmonary hypertension after pulmonary embolism. *N Engl J Med*. 2004;350(22):2257–2264.
- Delcroix M, Lang I, Pepke-Zaba J, et al. Long-term outcome of patients with chronic thromboembolic pulmonary hypertension: results from an international prospective registry. *Circulation*. 2016;133(9):859–871.
- Ghofrani H-A, D'Armini AM, Grimminger F, et al. Riociguat for the treatment of chronic thromboembolic pulmonary hypertension. *N Engl J Med*. 2013;369(4):319–329.
- Ghofrani H-A, Simonneau G, D'Armini AM, et al. Macitentan for the treatment of inoperable chronic thromboembolic pulmonary hypertension (MERIT-1): results from the multicentre, phase 2, randomised, double-blind, placebo-controlled study. *Lancet Respir Med*. 2017;5(10):785–794.
- Delgado JF, Conde E, Sánchez V, et al. Pulmonary vascular remodeling in pulmonary hypertension due to chronic heart failure. *Eur J Heart Fail*. 2005;7(6):1011–1016.
- Rosenkranz S, Gibbs JSR, Wachter R, De Marco T, Vonk-Noordegraaf A, Vachiéry J-L. Left ventricular heart failure and pulmonary hypertension. *Eur Heart J*. 2015;37(12):942–954.
- Deuchar GA, Docherty A, MacLean MR, Hicks MN. Pulmonary hypertension secondary to left ventricular dysfunction: the role of nitric oxide and endothelin-1 in the control of pulmonary vascular tone. *Brit J Pharmacol*. 2002;135(4):1060–1068.
- Moraes DL, Colucci WS, Givertz MM. Secondary pulmonary hypertension in chronic heart failure: the role of the endothelium in pathophysiology and management. *Circulation*. 2000;102(14):1718–1723.
- Califf RM, Adams KF, McKenna WJ, et al. A randomized controlled trial of epoprostenol therapy for severe congestive heart failure: the Flolan International Randomized Survival Trial (FIRST). *Am Heart J*. 1997;134(1):44–54.
- Kalogeropoulos AP, Georgiopoulou VV, Borlaug BA, Gheorghide M, Butler J. Left ventricular dysfunction with pulmonary hypertension. Part 2: Prognosis, non-invasive evaluation, treatment, and future research. *Circ Heart Fail*. 2013;6(3):584.
- Butler J, Chomsky DB, Wilson JR. Pulmonary hypertension and exercise intolerance in patients with heart failure. *J Am Coll Cardiol*. 1999;34(6):1802–1806.
- Galie N, Manes A, Palazzini M. Exercise training in pulmonary hypertension: improving performance but waiting for outcome. *Eur Heart J*. 2015;37(1):45–48.
- Costanzo MR, Augustine S, Bourge R, et al. Selection and treatment of candidates for heart transplantation: a statement for health professionals from the Committee on Heart Failure and Cardiac Transplantation of the Council on Clinical Cardiology, American Heart Association. *Circulation*. 1995;92(12):3593–3612.
- Murali S, Kormos RL, Uretsky BF, et al. Preoperative pulmonary hemodynamics and early mortality after orthotopic cardiac transplantation: the Pittsburgh experience. *Am Heart J*. 1993;126(4):896–904.
- Delgado JF, Gómez-Sánchez MA, Sáenz de la Calzada C, et al. Impact of mild pulmonary hypertension on mortality and pulmonary artery pressure profile after heart transplantation. *J Heart Lung Transplant*. 2001;20(9):942–948.
- Chang PP, Longenecker JC, Wang N-Y, et al. Mild vs severe pulmonary hypertension before heart transplantation: different effects on posttransplantation pulmonary hypertension and mortality. *J Heart Lung Transplant*. 2005;24(8):998–1007.
- Sahar G, Berman M, Kogan A, et al. Persistent high pulmonary artery pressure following orthotopic heart transplantation: inevitable poor prognosis? *Transplant Proc*. 2003;35(2):629–630.
- Murali S, Uretsky BF, Reddy PS, Tokarczyk TR, Betschart AR. Reversibility of pulmonary hypertension in congestive heart failure patients evaluated for cardiac transplantation: comparative effects of various pharmacologic agents. *Am Heart J*. 1991;122(5):1375–1381.
- Givertz M, Hare J, Loh E, Gauthier D, Colucci W. Effect of bolus milrinone on hemodynamic variables and pulmonary vascular resistance in patients with severe left ventricular dysfunction: a rapid test for reversibility of pulmonary hypertension. *J Am Coll Cardiol*. 1996;28(7):1775–1780.
- Guglin M, Mehra S, Mason TJ. Comparison of drugs for pulmonary hypertension reversibility testing: a meta-analysis. *Pulm Circ*. 2013;3(2):406–413.
- Murali S, Uretsky BF, Armitage JM, et al. Utility of prostaglandin E1 in the pretransplantation evaluation of heart failure patients with significant pulmonary hypertension. *J Heart Lung Transplant*. 1992;11(4 Pt 1):716–723.

32. Bruckner BA, Stetson SJ, Perez-Verdia A, et al. Regression of fibrosis and hypertrophy in failing myocardium following mechanical circulatory support. *J Heart Lung Transplant*. 2001;20(4):457–464.
33. Etz CD, Welp HA, Tjan TDT, et al. Medically refractory pulmonary hypertension: treatment with nonpulsatile left ventricular assist devices. *Ann Thorac Surg*. 2007;83(5):1697–1705.
34. Al-Kindi SG, Farhoud M, Zacharias M, et al. Left ventricular assist devices or inotropes for decreasing pulmonary vascular resistance in patients with pulmonary hypertension listed for heart transplantation. *J Cardiac Fail*. 2017;23(3):209–215.
35. Martin J, Siegenthaler MP, Friesewinkel O, et al. Implantable left ventricular assist device for treatment of pulmonary hypertension in candidates for orthotopic heart transplantation: a preliminary study. *Eur J Cardio-Thorac Surg*. 2004;25(6):971–977.
36. Mikus E, Stepanenko A, Krabatsch T, et al. Reversibility of fixed pulmonary hypertension in left ventricular assist device support recipients. *Eur J Cardio-Thorac Surg*. 2011;40(4):971–977.
37. Tedford RJ, Hemnes AR, Russell SD, et al. PDE5A inhibitor treatment of persistent pulmonary hypertension after mechanical circulatory support. *Circ Heart Fail*. 2008;1(4):213–219.

# 9

## Selecting Children for Mechanical Circulatory Support

DEVON O. AGANGA, CHARLOTTE S. VAN DORN, AND  
JONATHAN N. JOHNSON

### Introduction

**M**echanical circulatory support (MCS) has become an essential tool for managing children with impending respiratory and cardiac failure. Extracorporeal life support for infants, children, and teenagers is limited to extracorporeal membrane oxygenation (ECMO) and ventricular assist devices (VADs). Temporary support devices, such as intra-aortic balloon pumps, are also used in adolescents, but they are not as well-studied in infants and small children. Here, we describe the indications and contraindications for MCS in children, discuss the goals of support, review current devices, and explain how timing and length of support factor into patient and device selection.

The considerable technological advances and increased availability of VADs in adults have not been matched with those in infants and children. Nonetheless, as cardiovascular surgical outcomes improve in increasingly complex patients, and as heart transplantation is increasingly available as a “next step” for children, mechanical circulatory support in children is being used more often.

### Circulatory Support in Children

#### Indications for Circulatory Support

Common indications for MCS in children include a failure to oxygenate or ventilate that progresses to respiratory or cardiac failure secondary to anatomic abnormalities or primary myocardial failure.<sup>1</sup> Although the indications for MCS in children continue to increase, both the absolute and relative contraindications remain important considerations in children. For small children with complex

anatomy and serious comorbidities, the timing and type of MCS deserve special attention, given their substantial effects on outcomes.

Recently, the indications for pediatric MCS have evolved greatly, probably because of the increasing availability of MCS options, as well as the improved management of the comorbidities that once disqualified some children for MCS. For children with impending respiratory failure, from failure of oxygenation or ventilation, MCS should be considered early, especially if the child has to be transferred to a center specializing in pediatric MCS. The oxygenation index and the P/F ( $\text{PaO}_2/\text{FiO}_2$ ) ratio can help detect early deterioration of children who may benefit most from MCS. Although threshold values for the oxygenation index or the P/F ratio have not been established for children, MCS should be considered in patients with indexes approaching 40 and with P/F ratios decreasing to less than 100, despite maximal medical therapy.<sup>1</sup>

The indications for MCS in children with primary cardiac failure continue to evolve, but can be divided into post-cardiotomy and organic causes of cardiac failure (Table 9.1).<sup>1,2</sup> Children born with congenital heart disease may benefit from MCS, especially during the perioperative period for surgical repair of the heart defect. Persistently low cardiac output, despite rapidly escalating or maximal medical therapy, indicates the potential need for MCS.<sup>3</sup> The early deployment of MCS improves survival and post-heart-transplantation outcomes.<sup>4</sup> These outcomes are also improved in children without congenital heart disease who require additional support for primary myocardial failure secondary to either myocarditis or cardiomyopathy. Early implementation of MCS, either as a bridge to recovery or transplantation, should be considered for all children with deteriorating cardiac status.

**Table 9.1 • Indications for Mechanical Circulatory Support in Pediatric Respiratory and Cardiovascular Disease**

Respiratory Disease	Cardiovascular Disease
Severe, reversible respiratory failure	Preoperative stabilization
Lack of response to conventional measures	Failure to wean from cardiopulmonary bypass
Severe hypoxemia	Refractory low cardiac output syndrome
Elevated mean airway pressures	Cardiopulmonary arrest
High risk of ventilator-induced lung injury	Myocarditis
Pulmonary hypertension	Cardiomyopathy
	Intractable arrhythmias

### Contraindications for Circulatory Support

Although the indications for MCS in children are rapidly expanding as technology advances, the absolute and relative contraindications to MCS have been gradually reduced (Table 9.2). In general, MCS should be used with caution for children with hemorrhage (especially intracranial

**Table 9.2 • Absolute and Relative Contraindications for Pediatric Mechanical Circulatory Support**

Absolute Contraindications	Relative Contraindications
Large intracranial bleed with mass effect	Vessel anomalies not allowing cannula placement
Cardiac arrest without adequate cardiopulmonary resuscitation	Small intracranial bleeds
Irreversible underlying cardiac or lung pathology <sup>a</sup>	More than 10 days of ventilator support (<2 years)
More than 2 weeks of high-pressure ventilation	More than 7 days of ventilator support (>2 years)
Pulmonary hypertension and chronic lung disease <sup>a</sup>	Prematurity
Chronic multi-organ dysfunction	Severe central nervous system disease
Incurable malignancy	
Allogenic bone marrow recipient with lung failure	
Lethal chromosomal abnormality	

<sup>a</sup> Not amenable to transplantation

hemorrhage), extreme prematurity, complex congenital heart disease, and prolonged ventilatory support.<sup>1</sup> A guiding principle in applying MCS to children is to avoid these devices when the outcome is likely to be futile.<sup>1</sup>

### Bridging to an Outcome

The most common indication for ECMO or VADs in children is as a bridge to transplant or to functional recovery.<sup>5-8</sup> The term “bridging” emphasizes the desired transient nature of the support. However, in some circumstances, transplant may not be the desired outcome of the patient, the family, or the clinical team.

### Destination Therapy

The idea of destination therapy is common in adults. In the 2012 INTERMACS report, 24% of adults received MCS as a destination strategy, with no expectation for transplantation or recovery.<sup>9</sup> In these circumstances, transplant is typically deemed inappropriate by either the care team or the patient.<sup>10</sup> In contrast, destination therapy is relatively rare in children. In the first PEDIMACS report from 2016, only eight such cases were reported.<sup>11</sup> In several centers worldwide, destination therapy is most commonly used in young patients with Duchenne muscular dystrophy, although this practice remains controversial.<sup>12-14</sup>

### Bridging to Decision or Candidacy

Mechanical circulatory support can be used as a bridge to decision or candidacy, allowing the care team more time to decide about transplant eligibility. In the 2016 PEDIMACS report, only 64% of children were listed for transplant at the time the VAD was implanted, and a further 29% of children received LVADs with the intent of listing for transplant.<sup>11</sup> A bridge-to-decision strategy is most often used in children with fulminant myocarditis or graft dysfunction soon after heart transplantation, where recovery is likely.<sup>15,16</sup> This strategy has also been reported in cases of multisystem organ dysfunction or with unclear social support.<sup>17</sup>

### Recovery and Explantation

A short-term support strategy, ECMO is flexible because it can be instituted quickly and removed quickly if recovery occurs. Myocardial recovery and subsequent device explantation in children with VADs has been reported, although these cases are few. The Berlin Heart has the highest successful weaning rate of available devices, having been explanted in 6% of the patients in the original United States Berlin Heart cohort.<sup>18</sup> Some rare cases of weaning and removing implantable VADs have been reported.<sup>19,20</sup> The optimal timing and process of weaning remains understudied.<sup>18,21</sup>



## Timing the Initiation of Circulatory Support

Timing is important in initiating MCS because the consequences can be severe if support is begun either too early in the patient's course or too late, when complications may have arisen. Unfortunately, patient selection criteria based on the timing of MCS institution in children have not been standardized because the literature is limited to reports from single centers, or because the criteria have been modified from those for adults.

Studies of the timing of MCS initiation in adults have reported higher post-VAD implant mortality in patients with evidence of non-cardiac, end-organ dysfunction (renal dysfunction, coagulopathy, hypoalbuminemia).<sup>22</sup> Data from the initial Berlin Heart studies in children found that elevated bilirubin concentrations, lower weight, and the need for biventricular support were risk factors for post-VAD implant mortality.<sup>18</sup> In general, most centers caring for children with heart failure consider beginning MCS for children who have any evidence of evolving end-organ dysfunction despite escalating medical therapy. Dysfunctions may include worsening renal function, need for mechanical ventilation, feeding intolerance, worsening hepatic function, or any clinical evidence of impending cardiac shock. Notably, unless children are being considered for destination therapy or as a bridge to decision, they should be considered as appropriate transplant candidates before receiving MCS.

The ability to place a VAD as the first form of MCS appears to be associated with improved outcomes. The Pediatric Heart Transplant Study Group compared children who had a VAD as their first device with those who received emergent ECMO treatment who were later transitioned to a VAD.<sup>23</sup> Children tolerating a VAD as the first form of MCS had better survival and transplantation rates, likely because the VAD was placed before the occurrence of the serious complications that are common during prolonged cardiac failure.

## Device Selection

The technology of MCS continues to broaden the boundaries of patient selection.

Other chapters in this volume describe current MCS options, many of which are suitable for children (Table 9.3). Here, we focus on the challenges of choosing the right MCS device for infants and children.

### Extracorporeal Membrane Oxygenation

Extracorporeal membrane oxygenation remains the most commonly used MCS modality in infants and children, despite the rapid evolution of VAD technology (Figure 9.1). Reasons for preferring ECMO include its suitability

**Table 9.3 • Adult Mechanical Circulatory Support Devices Successfully Used on Children**

Intra-aortic Balloon Pump	Short-term support—Counterpulsation
Centrimag/Pedimag <sup>a</sup>	Short-term support—Centrifugal
Jostra Rotaflow <sup>b</sup>	Short-term support—Centrifugal
Berlin Heart EXCOR <sup>c</sup>	Long-term support—Pneumatic
HeartMate II <sup>a</sup>	Long-term support—Axial
HeartMate 3 <sup>a</sup>	Long-term support—Centrifugal
HeartWare HVAD <sup>d</sup>	Long-term support—Centrifugal
SynCardia Total Artificial Heart <sup>e</sup>	Long-term support—Pneumatic

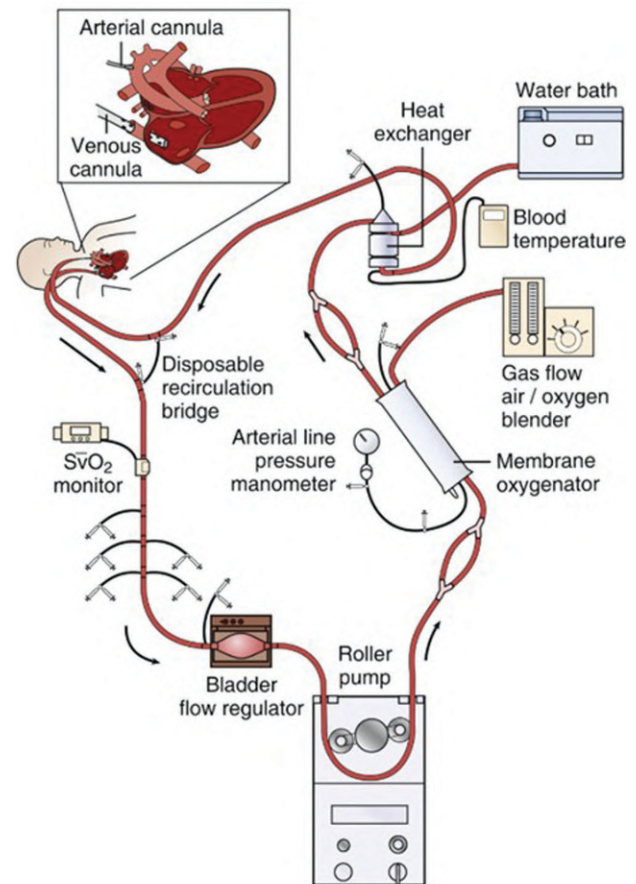
<sup>a</sup> Abbott Laboratories (Thoratec Corp., Pleasanton, CA)

<sup>b</sup> Rostra Rotaflow (Maquet, Rastatt, Germany)

<sup>c</sup> Berlin Heart EXCOR (Berlin Heart AG, Berlin, Germany)

<sup>d</sup> Medtronic (HeartWare Inc., Framingham, MA)

<sup>e</sup> Total Artificial Heart (SynCardia Systems Inc., Tucson, AZ)



**Figure 9.1.** Schematic of a routine ECMO circuit.

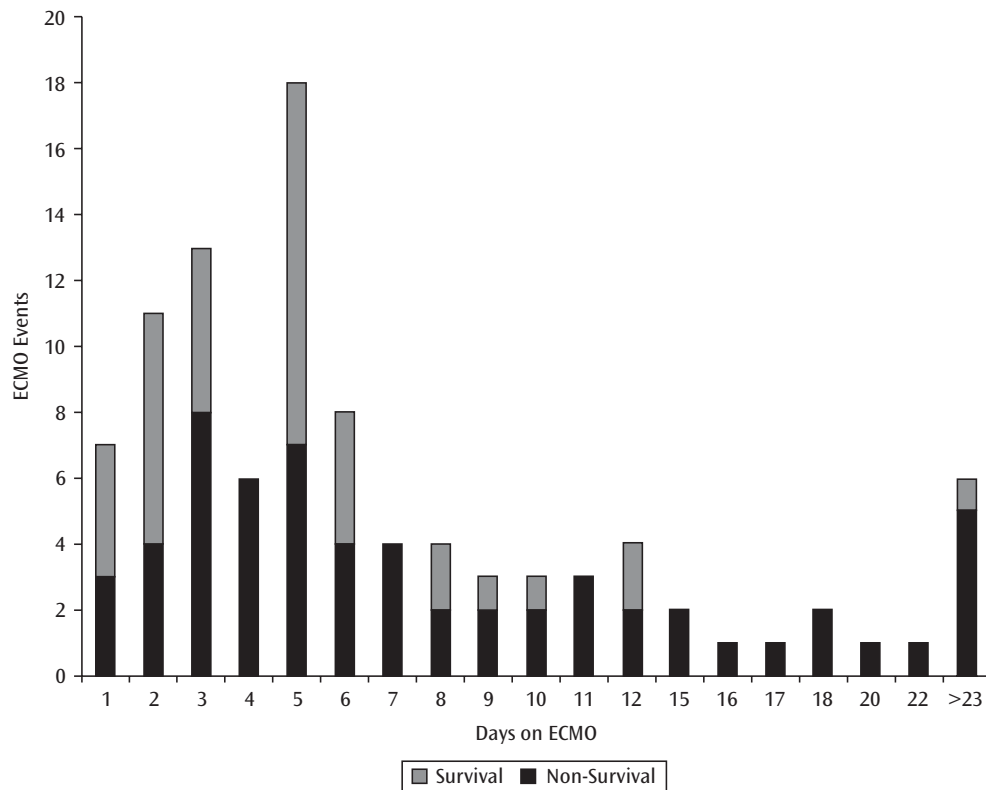
Reproduced with permission of Elsevier, from textbook *Pediatric Critical Care*, Fuhrman and Zimmerman, editors. <(permission pending)>

for all age groups, its widespread use and familiarity at many centers, its ability to provide both respiratory and circulatory support, and the rapidity with which it can be deployed in a deteriorating patient. The applications of ECMO in cardiopulmonary resuscitation in children are also expanding. Neurologic outcomes and survival to discharge were improved in children who received CPR for more than 10 minutes with rapid placement of ECMO during cardiac arrest.<sup>24</sup> The technology is also used to support neonates with congenital diaphragmatic hernia who are deemed surgical candidates but in whom conventional therapies for managing persistent pulmonary hypertension have been unsuccessful.

In addition to cardiac and respiratory failure from more traditional causes, such as acute respiratory distress syndrome, myocarditis, dilated cardiomyopathy, and failure to separate from cardiopulmonary bypass, other reported successful uses of ECMO in treating infants and children include septic shock, hypothermic arrest without asphyxiation, circulatory collapse from drug overdose, and severe congenital heart disease, including single-ventricle pathology.

### Extracorporeal Membrane Oxygenation in Congenital Heart Disease

Treating children who have univentricular physiology with ECMO is challenging, with each stage of palliation providing its own nuances. In children placed on ECMO with a systemic-to-pulmonary artery shunt, the conduit can be occluded or partially occluded to reduce run-off to the pulmonary circulation and improve systemic perfusion. Patients can also be managed by leaving the shunt untouched and maintaining an ECMO circuit flow of up to 200 mL/kg/min to compensate for the pulmonary run-off. This latter approach has been reported to improve outcomes.<sup>25</sup> Among 738 neonates who had undergone stage 1 palliation surgery and required ECMO, the mortality rate was 69%.<sup>26</sup> Survival-to-discharge among 103 infants with bidirectional cavopulmonary anastomoses who required ECMO was 41% (Figure 9.2).<sup>27</sup> Because the superior and inferior central venous circulations are separated in these patients, dual cannulae are often required to achieve adequate venous flow and to decompress the cerebral venous system.<sup>28</sup> Fontan patients are also a challenge for MCS, often requiring both jugular and femoral venous



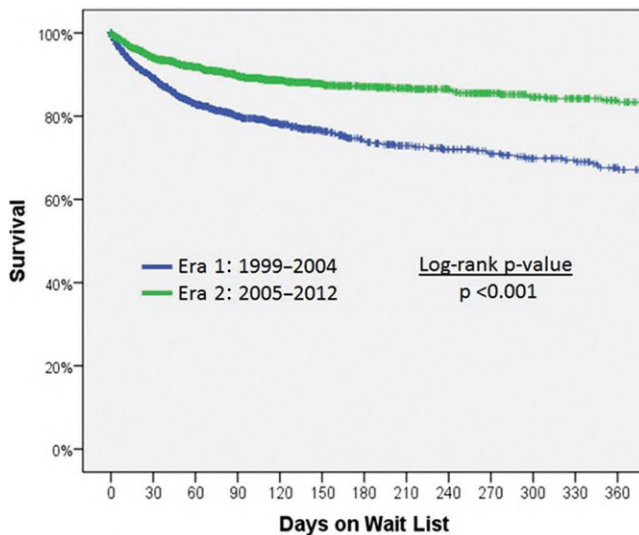
**Figure 9.2.** Survival-to-discharge among 103 infants with bidirectional cavopulmonary anastomoses who required extracorporeal membrane oxygenation. Only 41% of these patients survived to hospital discharge, with time on ECMO support a major predictor of mortality (OR 7.2, 95% CI 1.8–28).

Reprinted from the Jolley M et al., Extracorporeal membrane oxygenation in patients undergoing superior cavopulmonary anastomosis, *Journal of Thoracic and Cardiovascular Surgery* 2014;148:1512–1518, Copyright (2014), with permission from Elsevier.

cannulation to achieve adequate venous drainage and systemic perfusion.<sup>28</sup> Survival to discharge in children requiring ECMO after a Fontan procedure has been reported to be as low as 35%.<sup>29</sup>

### Bridging to Transplant

In children with heart failure from congenital and non-congenital heart disease, ECMO can provide short-term and long-term support as a bridge to recovery, decision, VAD implantation, or transplantation. However, recent large retrospective studies have reported poor outcomes in children using ECMO as bridge to heart transplant, with survival worse than that in children bridged with VADs and the worst in children under 1 year old.<sup>4,30</sup> The Berlin Heart EXCOR and continuous-flow VADs over the past decade have greatly improved heart transplant waiting list survival among infants and children. The 1-year survival of children up to 18 years old on the heart transplant waiting list increased from 74% before VADs were common (1999–2004) to 86% in the period after introduction of VADs into the pediatric practice (2005–2012) (Figure 9.3).<sup>31</sup> However, subgroup analysis revealed that mortality was higher in infants in the VAD era than in older age groups (21% vs. 14%; Figure 9.3).<sup>31</sup>



**Figure 9.3.** One-year survival of children up to 18 years old on the heart transplant waiting list in two eras: before (Era 1: 1999–2004) and after (Era 2: 2005–2012) initiation of pediatric-specific ventricular assist devices. Note the marked improvement in survival since the introduction of pediatric-specific devices.

Reprinted from the Zafar F et al., Pediatric heart transplant waiting list mortality in the era of ventricular assist devices, *Journal of Heart and Lung Transplantation* 2015;34:82–88, Copyright (2015), with permission from Elsevier.

### The Berlin Heart EXCOR

The only long-term MCS device currently approved for use in the United States for neonates and infants is the Berlin Heart EXCOR (Figure 9.4). This paracorporeal pneumatic pulsatile pump has various cannula and pump sizes, which allow the technology to be applied to neonates with a body weight less than 3 kg. However, outcomes remain poor in younger and smaller infants.<sup>32</sup> One advantage of the Berlin Heart EXCOR system is that it allows pump size to be increased as the child grows.

Although considered safe for long-term MCS, the Berlin Heart EXCOR is prone to several complications, the most feared being neurologic events from either thromboembolic or hemorrhagic stroke. A review of all children receiving the Berlin Heart EXCOR between 2007 and 2010 in pediatric centers in the United States and Canada found that 6-month survival was about 30% for children weighing less than 10 kg but about 80% for larger children. Six-month survival for children weighing less than 5 kg was less than 20%, with the most common causes of death being neurological events, followed by respiratory failure, bleeding and multi-organ system failure, infection, right-ventricular failure, and renal failure. Congenital heart disease and elevated



**Figure 9.4.** Berlin Heart EXCOR. This paracorporeal pneumatic pulsatile pump has cannula and pump sizes, which allow the technology to be applied to neonates with a body weight less than 3 kg.

Reproduced with permission of © 2019 Berlin Heart, All rights reserved.

serum bilirubin concentrations independently predicted poor outcomes.<sup>33</sup>

### Continuous-Flow Devices

Continuous-flow VADs are increasingly being used to support infants and children as a bridge to heart transplantation, with the Levitronix PediMag and Maquet Rotaflow providing operational flow ranges below 1,000 mL/min, a rate commonly required to support young infants. The PediMag pump can provide flow rates of up to 1,500 mL/min and is primarily used in ECMO circuits; however, its use without an oxygenator as an LVAD or RVAD has been increasing.<sup>32</sup> The Rotaflow can provide up to 10 L/min in flow and can support neonates and adults.<sup>32</sup> Although these short-term devices are FDA-approved for up to 6 hours of LV support, data from longer-term use in children is limited to case reports and single-institution experiences.<sup>34,35</sup>

### Devices Designed for Adults

Several devices originally designed and used in adults are increasingly used in children, particularly in those more than 8 years old. These devices are discussed elsewhere in this book, so here we discuss them in the context of patient selection.

The HeartWare HVAD (Framingham, MA, USA) is an FDA-approved intrapericardial, centrifugal, continuous-flow device that has been used in children as young as 3 years old<sup>36,41</sup> and adolescents, including those with single-ventricle physiology.<sup>6,7,36–40</sup> The HVAD is successful as a bridge to transplantation,<sup>42,43</sup> although clinicians need to be vigilant for potentially serious morbidities, including respiratory, right-heart, and renal failure.<sup>43</sup> In many centers, the HVAD has become the preferred device for children over the age of 8 (or younger, depending on the center) with solely LV failure.

The Thoratec HeartMate II (Thoratec Corporation) is a continuous-flow VAD that was approved for children by the US Food and Drug Administration (FDA) in 2008.<sup>40</sup> The HeartMate II has been widely used in adults but less so in children, particularly in those with a body surface area less than 1.2 m<sup>2</sup>. However, its use in teenagers has largely been successful as bridge to transplantation, with complications and outcomes similar to those of young adults.<sup>44–46</sup>

### Conclusions

The use of MCS in children has rapidly increased over the past two decades. The timely initiation of MCS can improve survival for children with respiratory and cardiac failure, but its use in complex patients remains challenging. Appropriate patient and device selection are critical to improving outcomes.

### Acknowledgments

The authors would like to thank their colleagues in Pediatric Cardiology, Cardiovascular ICU, and Cardiac Surgery at the Mayo Clinic.

### REFERENCES

1. BroganTV, Lequier L, Lorusso R, MacLaren G, Peek G, eds. *Extracorporeal Life Support: The ELSO Red Book*. 5th ed. Ann Arbor, MI: Extracorporeal Life Support Organization; 2017.
2. Platts DG, Sedgwick JF, Burstow DJ, Mullany DV, Fraser JF. The role of echocardiography in the management of patients supported by extracorporeal membrane oxygenation. *J Am Soc Echocardiogr*. 2012;25:131–141.
3. MacLaren G, Conrad S. Extracorporeal Life Support. In: Nichols DG, Shaffner DS, eds. *Rogers' Textbook of Pediatric Intensive Care*. Alphen aan den Rijn, The Netherlands: Wolters Kluwer; 2016:581–599.
4. Dipchand AI, Mahle WT, Tresler M, et al. Extracorporeal membrane oxygenation as a bridge to pediatric heart transplantation: effect on post-listing and post-transplantation outcomes. *Circ Heart Fail*. 2015;8:960–969.
5. Hetzer R, Kaufmann F, Delmo Walter EM. Paediatric mechanical circulatory support with Berlin Heart EXCOR: development and outcome of a 23-year experience. *Eur J Cardiothorac Surg*. 2016;50:203–210.
6. Miera O, Potapov EV, Redlin M, et al. First experiences with the HeartWare ventricular assist system in children. *Ann Thorac Surg*. 2011;91:1256–1260.
7. Imielski BR, Niebler RA, Kindel SJ, Woods RK. HeartWare ventricular assist device implantation in patients with fontan physiology. *Artif Organs*. 2017;41:40–46.
8. Morales DL, Almond CS, Jaquiss RD, et al. Bridging children of all sizes to cardiac transplantation: the initial multicenter North American experience with the Berlin Heart EXCOR ventricular assist device. *J Heart Lung Transplant*. 2011;30:1–8.
9. Kirklin JK, Naftel DC, Pagani FD, et al. Long-term mechanical circulatory support (destination therapy): on track to compete with heart transplantation? *J Thorac Cardiovasc Surg*. 2012;144:584–603; discussion 597–598.
10. Purkey NJ, Lin A, Murray JM, et al. Long-term pediatric ventricular assist device therapy: a case report of 2100+ days of support. *ASAIO J*. Jan–Feb 2018;64(1):e1–e2.
11. Blume ED, Rosenthal DN, Rossano JW, et al. Outcomes of children implanted with ventricular assist devices in the United States: first analysis of the Pediatric Interagency Registry for Mechanical Circulatory Support (PediMACS). *J Heart Lung Transplant*. 2016;35:578–584.
12. Ryan TD, Jefferies JL, Sawnani H, et al. Implantation of the HeartMate II and HeartWare left ventricular assist devices in patients with Duchenne muscular dystrophy: lessons learned from the first applications. *ASAIO J*. 2014;60:246–248.
13. Stoller D, Araj F, Amin A, et al. Implantation of a left ventricular assist device to provide long-term support for end-stage Duchenne muscular dystrophy-associated cardiomyopathy. *ESC Heart Fail*. 2017;4:379–383.

14. Perri G, Filippelli S, Adorisio R, et al. Left ventricular assist device as destination therapy in cardiac end-stage dystrophinopathies: midterm results. *J Thorac Cardiovasc Surg.* 2017;153:669–674.
15. Kouretas PC, Kaza AK, Burch PT, et al. Experience with the Levitronix CentriMag in the pediatric population as a bridge to decision and recovery. *Artif Organs.* 2009;33:1002–1004.
16. Okada N, Murayama H, Hasegawa H, et al. Peripheral veno-arterial extracorporeal membrane oxygenation as a bridge to decision for pediatric fulminant myocarditis. *Artif Organs.* 2016;40:793–798.
17. Gandolfo F, De Rita F, Hasan A, Griselli M. Mechanical circulatory support in pediatrics. *Ann Cardiovasc Surg.* 2014;3:507–512.
18. Almond CS, Morales DL, Blackstone EH, et al. Berlin Heart EXCOR pediatric ventricular assist device for bridge to heart transplantation in US children. *Circulation.* 2013;127:1702–1711.
19. Cavigelli-Brunner A, Schweiger M, Knirsch W, et al. VAD as bridge to recovery in anthracycline-induced cardiomyopathy and HHV6 myocarditis. *Pediatrics.* 2014;134:e894–e899.
20. Lara DA, Jeewa A, Elias BA, et al. Titanium plug closure after HeartWare ventricular assist device explantation in a 15-year-old girl: first U.S. experience. *Tex Heart Inst J.* 2017;44:66–69.
21. Cavanaugh JL, Miyamoto SD, da Cruz E, et al. Predicting recovery: successful explant of a ventricular assist device in a child with dilated cardiomyopathy. *J Heart Lung Transplant.* 2010;29:105–108.
22. Cowger J, Sundareswaran K, Rogers JG, et al. Predicting survival in patients receiving continuous flow left ventricular assist devices: the HeartMate II risk score. *J Am Coll Cardiol.* 2013;61:313–321.
23. Dipchand AI, Kirk R, Naftel DC, et al. Ventricular assist device support as a bridge to transplantation in pediatric patients. *J Am Coll Cardiol.* 2018;72:402–415.
24. Lasa JJ, Rogers RS, Localio R, et al. Extracorporeal cardiopulmonary resuscitation (E-CPR) during pediatric in-hospital cardiopulmonary arrest is associated with improved survival to discharge: a report from the American Heart Association's Get With The Guidelines-Resuscitation (GWTG-R) Registry. *Circulation.* 2016;133:165–176.
25. Jagers JJ, Forbess JM, Shah AS, et al. Extracorporeal membrane oxygenation for infant postcardiotomy support: significance of shunt management. *Ann Thorac Surg.* 2000;69:1476–1483.
26. Sherwin ED, Gauvreau K, Scheurer MA, et al. Extracorporeal membrane oxygenation after stage 1 palliation for hypoplastic left heart syndrome. *J Thorac Cardiovasc Surg.* 2012;144:1337–1343.
27. Jolley M, Thiagarajan RR, Barrett CS, et al. Extracorporeal membrane oxygenation in patients undergoing superior cavopulmonary anastomosis. *J Thorac Cardiovasc Surg.* 2014;148:1512–1518.
28. Van Dorn CS, Aganga DO, Johnson JN. Extracorporeal membrane oxygenation, Berlin, and ventricular assist devices: a primer for the cardiologist. *Curr Opin Cardiol.* 2018;33:87–94.
29. Rood KL, Teele SA, Barrett CS, et al. Extracorporeal membrane oxygenation support after the Fontan operation. *J Thorac Cardiovasc Surg.* 2011;142:504–510.
30. Wehman B, Stafford KA, Bittle GJ, et al. Modern outcomes of mechanical circulatory support as a bridge to pediatric heart transplantation. *Ann Thorac Surg.* 2016;101:2321–2327.
31. Zafar F, Castleberry C, Khan MS, et al. Pediatric heart transplant waiting list mortality in the era of ventricular assist devices. *J Heart Lung Transplant.* 2015;34:82–88.
32. Maeda K, Rosenthal DN, Reinhartz O. Ventricular assist devices for neonates and infants, seminars in thoracic and cardiovascular surgery. *Semin Thorac Cardiovasc Surg Pediatr Cardiac Surg Annu.* 2018;21:9–14.
33. Conway J, St Louis J, Morales DL, Law S, Tjossem C, Humpl T. Delineating survival outcomes in children <10 kg bridged to transplant or recovery with the Berlin Heart EXCOR Ventricular Assist Device. *JACC Heart Fail.* 2015;3:70–77.
34. Conway J, Al-Aklabi M, Granoski D, et al. Supporting pediatric patients with short-term continuous-flow devices. *J Thorac Cardiovasc Surg.* 2016;35:603–609.
35. Gerrah R, Charette K, Chen, JM. The first successful use of the Levitronix PediMag ventricular support device as a biventricular bridge to transplant in an infant. *J Thorac Cardiovasc Surg.* 2011;142:1282–1283.
36. Kirk R, Peng E, Woods A, et al. Successful HeartWare bridge to recovery in a 3-year old: a game changer? *Ann Thorac Surg.* 2016;101:1984–1987.
37. Padalino MA, Bottio T, Tarzia V, et al. HeartWare ventricular assist device as bridge to transplant in children and adolescents. *Artif Organs.* 2014;38:418–422.
38. Miera O, Kirk, R Buchholz H, et al. A multicenter study of the HeartWare ventricular assist device in small children. *J Heart Lung Transplant.* 2016;35:679–681.
39. Niebler RA, Ghanayem NS, Shah TK, et al. Use of a HeartWare ventricular assist device in a patient with failed Fontan circulation. *Ann Thorac Surg.* 2014;97:e115–e116.
40. Chopski SG, Moskowitz WB, Stevens RM, Throckmorton AL. Mechanical circulatory support devices for pediatric patients with congenital heart disease. *Artif Organs.* 2017;41:E1–E14.
41. Adachi I, Burki S, Zafar F, Morales DL. Pediatric ventricular assist devices. *J Thorac Dis.* 2015;7:2194–2202.
42. Stein ML, Yeh J, Reinhartz O, et al. HeartWare HVAD for biventricular support in children and adolescents: the Stanford experience. *ASAIO J.* 2016;62:e46–e51.
43. Ferro G, Murthy R, Williams D, Sebastian VA, Forbess JM, Guleserian KJ. Early outcomes with HeartWare HVAD as bridge to transplant in children: a single institution experience. *Artif Organs.* 2016;40:793–798.
44. Owens WR, Bryant R 3rd, Dreyer WJ, Price JF, Morales DL. Initial clinical experience with the HeartMate II ventricular assist system in a pediatric institution. *Artif Organs.* 2010;34:600–603.
45. Chen S, Lin A, Liu E, et al. Outpatient outcomes of pediatric patients with left ventricular assist devices. *ASAIO J.* 2016;62:163–168.
46. Cabrera AG, Sundareswaran KS, Samayoa AX, et al. Outcomes of pediatric patients supported by the HeartMate II left ventricular assist device in the United States. *J Heart Lung Transplant.* 2013;32:1107–1113.

# 10

## Device Selection for Short- and Long-Term Mechanical Circulatory Support

RABEA ASLEH AND SARAH SCHETTLE

### Introduction

**M**echanical circulatory support (MCS) technology continues to evolve to meet the needs of advanced heart failure patients. Following the first successful implantation of a Jarvik 7 total artificial heart (TAH) in Barney Clark in 1982<sup>1</sup> and approval of left ventricular assist devices (LVADs) as bridge to cardiac transplantation (BTT) by the US Food and Drug Administration (FDA),<sup>2</sup> the drive toward miniaturization, device optimization, and expanding technology utilization persists. Support ranging from short-term devices to durable implantable systems affords a myriad of options available to meet varying patient support needs. Geographically, North America and Europe comprise the largest MCS markets, but other areas of the world are experiencing significant growth in the adoption of these devices for patients presenting with acute cardiogenic shock or those with chronic end-stage heart failure refractory to medical therapy.

### Cardiogenic Shock

Cardiogenic shock is generally defined as the combination of low cardiac index (below 2.2 l/min/m<sup>2</sup>), hypotension, elevated pulmonary capillary wedge pressure, and sustained end-organ hypoperfusion. Cardiogenic shock can develop as a result of various pathologies that affect the heart, largely due to acute coronary syndrome (in approximately 75% of cases), but also due to exacerbation of heart failure (10%–15%), other valvular and mechanical causes (5%–10%), myocarditis (1%–5%), and stress-induced cardiomyopathy (1%–5%). Given the complexity of the disease, prompt diagnosis and referral to a tertiary or quaternary medical facility with a multidisciplinary heart

team are crucial for achieving the best outcomes. Despite advances in pharmacological, mechanical, and reperfusion therapies, cardiogenic shock remains a devastating complication, with in-hospital mortality of more than 60%.<sup>3</sup>

In patients presenting with acute coronary syndrome and cardiogenic shock, an early invasive strategy for revascularization with percutaneous coronary intervention or coronary artery bypass grafting is recommended regardless of the time of onset of symptoms or preceding administration of fibrinolytic therapy.<sup>4</sup> Continuous hemodynamic monitoring is essential in patients with cardiogenic shock for optimizing medical therapy, including administration of inotropes to maintain adequate cardiac output and tissue perfusion. Furthermore, close monitoring of blood pressure, heart rate and rhythm, ventilation and oxygenation, and end-organ function (including urine output) is mandatory. Patients who continue to develop hemodynamic derangements despite optimal medical management should be considered for acute MCS. The type of device and appropriate timing for the use of MCS devices should be individualized based on the clinical scenario to achieve the maximal benefit. Following hemodynamic stabilization, durable MCS may be considered in suitable candidates who require long-term hemodynamic support.

### Short-Term Mechanical Circulatory Support

Temporary MCS devices include intra-aortic balloon pump (IABP), the left ventricle (LV) to ascending aorta non-pulsatile microaxial Impella 2.5, 5.0, and CP pumps (Abiomed, Inc., Danvers, MA), the left atrium (LA) to femoral artery Tandem Heart (Cardiac Assist, Inc., Pittsburgh, PA), and the right atrium (RA) or central vein to a systemic artery pump with oxygenation (venoarterial extracorporeal

**Table 10.1 • Technical Features of Most Available Short-Term Mechanical Circulatory Support Devices**

Features	IABP	Impella 2.5	Impella 5.0	Impella CP	TandemHeart	CentriMag	VA-ECMO
Flow (L/min)	0.3–0.5	Max 2.5	Max 5.0	3.7–4.0	Max 4.0	Max 9.9	Max 7.0
Pump speed (RPM)	N/A	Max 51,000	Max 33,000	Max 51,000	Max 7,500	Max 5,500	Max 5,000
Insertion approach	PC (FA)	PC (FA)	PS (FA)	PC (FA)	PC (FA/FV)	Surgical (Sternotomy/ minimal thoracotomy)	PC (FA/FV) or surgical thoracotomy)
Recommended duration of support	Weeks	7–10 days	7–10 days	7–10 days	14 days	30 days	7–10 days
LV unloading	+	++	+++	++	+++	++	–
Afterload	↓	↓	↓	↓	↑	↓	↑↑
MAP	↑	↑↑	↑↑	↑↑	↑↑	↑↑	↑↑
PCWP	↓	↓	↓	↓	↓	↓	↔
LVEDP	↓	↓↓	↓↓↓	↓↓	↓↓↓	↓↓	↔
Coronary perfusion	↑	↑	↑↑	↑	↔	↑↑	↔
Myocardial oxygen demand	↓	↓↓	↓↓	↓↓	↓	↓↓	↔
Anticoagulation	+	+	+	+	+	+	+

Abbreviations: FA = femoral artery; FV = femoral vein; LV = left ventricle; LVEDP = left ventricular end-diastolic pressure; IABP = intra-aortic balloon pump; MAP = mean arterial pressure; Max = maximum; PC = percutaneous; PS = peripheral surgical; RPM = rotations per minute; VA-ECMO = veno-arterial extracorporeal membrane oxygenation.

membrane oxygenation [VA-ECMO]). Other pumps under investigation include the pulsatile iVAC 2L (PulseCath BV, Arnhem, Netherlands) and HeartMate percutaneous heart pump (Abbott, Lake Bluff, IL).

The purpose of using these devices is to improve hemodynamics and tissue perfusion by maintaining normal arterial blood pressure and cardiac output, as well as to unload the failing ventricle to facilitate recovery (in patients with reversible cardiac injury) or as a bridge to durable MCS or heart transplantation (in those with continued refractory heart failure). Selection of the device may vary between the different centers but largely should be based on the level of support needed, patient characteristics, and clinical presentation. Other factors, such as device availability and expenses, operator expertise, and technical challenges may also play a role in device selection. Table 10.1 summarizes the technical features of currently available percutaneous and surgically implanted short-term MCS devices.

### Intra-Aortic Balloon Pump

The IABP has been the most widely used device for temporary support since its introduction in the 1960s. The IABP is more widely available and technically easier to use than other temporary MCS devices. It is usually inserted via femoral arterial access, though percutaneous or surgical axillary, subclavian, or brachial approaches are also feasible and can enable ambulation in stabilized patients with

advanced heart failure. IABP support is driven by balloon inflation at the onset of diastole that results in increased coronary perfusion and balloon deflation at the end of diastole that results in a decreased aortic end-diastolic and systolic pressures, decreased afterload, decreased cardiac work, and decreased myocardial oxygen demand. Despite these favorable effects, the increase in cardiac output is minimal and it therefore may not be an ideal device for improvement of end-organ perfusion among patients with profound cardiogenic shock. Moreover, the benefit from IABP has been recently questioned due to recent studies showing no improvement in survival with IABP use in patients with cardiogenic shock. The CRISP-AMI trial showed no survival benefit with IABP among patients with acute anterior myocardial infarction without shock.<sup>5</sup> Similarly, the Shock II trial failed to show differences in 30-day, 1-year, or 6-year mortality when IABP support was instituted in patients with acute MI and cardiogenic shock.<sup>6,7,8</sup> Based on the AHA/ACC guidelines, IABP is still recommended as class IIa (should be considered) in patients with cardiogenic shock, particularly in those with mechanical complications, such as severe ischemic mitral regurgitation and ventricular septal defect, or in centers where other acute MCS devices are not available. Anticoagulation therapy is generally recommended for patients supported with an IABP to prevent thrombotic events including limb ischemia. Other complications associated with IABP use

include bleeding, local vascular injury, infection, and thrombocytopenia. The use of an IABP is contraindicated in patients with aortic disease and in those with moderate to severe aortic valve regurgitation. With the emergence of newer short-term support strategies that provide greater hemodynamic support, the role for IABP support in the setting of cardiogenic shock may well continue to decline as experience grows with more promising short-term MCS options that have become available.

### Impella Devices

The Impella 2.5 and CP devices (Abiomed, Inc., Danvers, MA) are non-pulsatile microaxial flow devices that can be placed percutaneously. The Impella 5.0 and Impella LD (Abiomed, Inc., Danvers, MA) devices are larger LV assist axial flow pumps that require surgical cut-down and can provide up to 5.0 L/min of cardiac output. Percutaneous Impella devices are inserted most commonly through the femoral artery and then are advanced in a retrograde fashion to the LV. These devices provide hemodynamic support by unloading the LV and provide blood flow between 1 and 4 L/min. Despite the comparably higher cost, the use of Impella has been steadily increasing over the last several years owing to its relative ease of deployment and efficient hemodynamic support. However, there are currently limited available data to establish a significant clinical benefit of Impella use in patients with cardiogenic shock. In small randomized studies (the ISAR-SHOCK trial in patients with cardiogenic shock and the PROTECT I and PROTECT II trials in patients undergoing high-risk percutaneous coronary intervention), there were no significant differences identified in survival outcomes.<sup>9,10</sup> Nevertheless, Impella 2.5 provided greater hemodynamic support with a more pronounced increase in cardiac output.<sup>11</sup> A meta-analysis of three randomized clinical studies comparing percutaneous LVADs (two with TandemHeart and one with Impella 2.5) with IABP showed more significant improvement in hemodynamic measures, but similar 30-day mortality and increased bleeding complications with percutaneous LVADs.<sup>12</sup> Recently, a randomized prospective study in 48 patients with cardiogenic shock complicating acute coronary syndrome showed no survival benefit with Impella CP use over IABP.<sup>13</sup> Finally, the USpella registry, which included patients with refractory cardiogenic shock complicating acute coronary syndrome, has shown that Impella 2.5 is associated with higher rates of complete revascularization and with improved survival.

### TandemHeart

The TandemHeart is an LA-to-femoral artery continuous flow centrifugal pump that provides 3–5 L/min of flow. It unloads the LV by drawing blood from the LA through a transseptal cannula that pumps blood back into the femoral/iliac arteries through an arterial cannula using a

centrifugal pump at a speed of 3,500 to 7,000 rpm. Although the TandemHeart decreases preload and increases cardiac output, it can increase afterload, and an IABP may rarely be required for additional support. Small studies have shown a significant improvement in hemodynamics with TandemHeart use, but with no improvement in survival. TandemHeart is contraindicated in patients with moderate to severe aortic regurgitation, severe peripheral arterial disease, ventricular septal defect, and those with LA thrombus. Its use may be complicated with limb ischemia, air emboli, thromboembolic events, and rarely can cause hemodynamic collapse and hypoxemia if the LA cannula migrates into the RA.

### Veno-Arterial Extracorporeal Membrane Oxygenation (VA-ECMO)

The VA-ECMO provides cardiac support as well as gas exchange and is ideally used in patients with refractory shock with biventricular failure and hypoxia.<sup>14</sup> This is different from veno-venous ECMO (VV-ECMO), which is reserved for patients with respiratory failure with no significant cardiac dysfunction. When peripherally inserted, VA-ECMO bypasses both the right and left side of the heart by drawing blood from a central vein (venous cannula) and pumps oxygenated blood into the femoral/iliac arteries (arterial cannula). Due to the ease of insertion, it can be applied as a bridge to recovery or as a bridge to placement of durable devices or heart transplantation in patients presenting with cardiogenic shock. Use of VA-ECMO results in increased cardiac output and mean arterial pressure. However, it is limited by retrograde blood flow, leading to LV afterload mismatch and inadequate LV decompression. The concurrent use of IABP or Impella 2.5 can add further support by direct unloading of the LV and decreasing afterload. Recently, a rotation speed modulation system that changes rotational speed in synchrony with the cardiac cycle of the native heart provides a combined ECMO and IABP support mechanism in one device. Though promising, this device has only been applied in a large animal model and has yet to be tested in humans.

According to data from the Extracorporeal Life Support Organization (ELSO) registry, the number of ECMO devices and the number of centers utilizing ECMO are increasing. Survival to hospital discharge in adults receiving ECMO from 1989 through 2015 was 41%, with survival only marginally increased to 42% in the year 2015. Survival was dependent on the indication for VA-ECMO, with the highest survival to discharge rates observed in patients with myocarditis (65%) who presented with cardiogenic shock. Patients with congenital defects demonstrated a survival rate of 37%. Based on the ELSO 2013 guidelines, absolute contraindications to VA-ECMO use include patients with unrecoverable cardiac failure who are not candidates for VAD or transplantation, who have chronic organ



dysfunction (renal failure, cirrhosis, and emphysema) and prolonged cardiopulmonary resuscitation (CPR) without adequate tissue perfusion. Advanced age, contraindications to anticoagulation, and obesity are relative contraindications for ECMO support. Adverse events related to VA-ECMO are common and include thromboembolic events, vascular injuries, limb ischemia, air embolism, bleeding, and infection.

### Investigational Devices

The iVAC 2L pulsatile pump has been recently evaluated in patients undergoing high-risk percutaneous coronary intervention (PCI), demonstrating 100% angiographic success prospectively in a pilot study of 14 patients. The Heart Pump (Thoratec, Abbott, Alameda, CA) is a percutaneous transvalvular microaxial flow device that is inserted through the femoral artery and has a self-expandable sheath with a diameter of 24-Fr when deployed across the aortic valve, providing hemodynamic support of up to 5.0 L/min. The Aortix (Procyron, Houston, TX) and Reitan (Cardiobridge, Hechingen, Germany) devices are investigational devices that are placed in the descending aorta, similar to IABPs.

### Temporary Right Ventricular Mechanical Support Devices

Isolated RV failure has become a common clinical challenge, prompting the development of devices specific to RV support. These pumps offer advantages in the setting of biventricular failure or isolated severe RV failure and cardiogenic shock. The Impella RP is an intracardiac microaxial pump designed to provide RV support and can be inserted through the femoral vein to draw blood from the inferior vena cava with an outflow to the pulmonary artery. The safety of the RP Impella has been established in the prospective RECOVER RIGHT study. Complications related to its use may include bleeding, thrombosis, or infection.<sup>15</sup>

The TandemHeart can also provide RV support, with the unique feature of right internal jugular vein insertion using the Protek Duo cannula, which permits ambulation while on device support. Complications associated with its use may include hemolysis, bleeding, thrombosis, and infection. An superior vena cava (SVC)-type syndrome can occur in patients with a history of venous thrombotic disease and small caliber vasculature. In patients with acute massive pulmonary embolism resulting in severe RV failure and cardiogenic shock, an oxygenator can be incorporated into the circuit to provide VV-ECMO support.

### Surgically Implanted Temporary Mechanical Support Devices

Surgically placed temporary MCS devices can be inserted via standard cannulation techniques with connection to

one of several commercially available external devices, including the CentriMag device (Aboott, Lake Bluff, IL) the TandemLife device (dba Cardiac Assist, Inc.), and the Maquet cardiohelp (Maquet Cardiopulmonary AG). The CentriMag ventricular assist device can be used in patients with univentricular or biventricular failure and cardiogenic shock.<sup>16</sup> It was the first FDA-approved implantable VAD with biventricular capability. CentriMag is a centrifugal pump with a magnetically levitated rotor that is implanted via median sternotomy and can pump flow up to 10 L/min. The inflow cannula is placed in the LA or in the LV apex and outflow cannula in the ascending aorta. For RV support, the inflow cannula is placed in the RA and the outflow cannula in the pulmonary artery. Recently, Takeda et al. have developed a minimally invasive surgical approach for combined ECMO and CentriMag VAD in patients with cardiogenic shock that provides temporary biventricular hemodynamic and pulmonary support.<sup>17</sup> This system demonstrated non-inferior 30-day and 1-year survival when compared with CentriMag BiVAD alone, but eliminated the need for concomitant cardiopulmonary bypass and also reduced bleeding events requiring blood product administration. The Impella 5.0 and Impella LD (Abiomed, Inc., Danvers, MA) are LV assist axial flow pump devices that require surgical placement and can provide up to 5.0 L/min of cardiac output.

### Recommendations for Use of Mechanical Circulatory Support Devices

The recommendations on the use of a specific MCS device are based on the anticipated hemodynamic effects and risks as well as clinical outcomes data. Given the lack of data showing benefit with positive inotropes and vasopressors, which have been historically used as first-line therapy for patients with cardiogenic shock, MCS may be considered in selected patients with severe hemodynamic instability.<sup>18</sup> Table 10.2 presents the most common indications for the use of MCS devices for providing hemodynamic support, which is adopted from the recent SCAI/ACC/HFSA/STS Clinical Expert Consensus Statement.<sup>19</sup> Patients with cardiogenic shock unresponsive to pharmacologic support should undergo right heart catheterization for hemodynamic evaluation and continuous hemodynamic monitoring, and MSC should be inserted as soon as possible to attenuate the adverse consequences of systemic hypoperfusion and worsening ischemia. These devices should provide support from a few hours up to several weeks in selected cases of prolonged cardiogenic shock. The decision regarding the type of MCS device should be made by a team approach, with input from advanced heart failure specialists and MCS/transplant surgeons; multiple factors should be considered when choosing MCS device, including the patient's hemodynamic condition, type of

**Table 10.2 • Suggested Indications for Percutaneous MCS**

Indication	Comments
Complications of AMI	Ischemic mitral regurgitation is particularly well-suited to these devices as the hemodynamic disturbance is usually acute and substantial. Acutely depressed LV function from large AMI during and after primary PCI is an increasing indication for temporary MCS use. Cardiogenic shock from RV infarction can be treated with percutaneous right ventricular support.
Severe heart failure in the setting of non-ischemic cardiomyopathy	Examples include severe exacerbations of chronic systolic heart failure as well as acutely reversible cardiomyopathies such as fulminant myocarditis, stress cardiomyopathy, or peripartum cardiomyopathy. In patients presenting in INTERMACS profiles 1 or 2, MCS can be used as a bridge to destination VAD placement or as a bridge to recovery if the ejection fraction rapidly improves.
Acute cardiac allograft failure	Primary allograft failure (adult or pediatric) may be due to acute cellular or antibody-mediated rejection, prolonged ischemic time, or inadequate organ preservation.
Post-transplant RV failure	Acute RV failure has several potential causes, including recipient pulmonary hypertension, intraoperative injury/ischemia, and excess volume/blood product resuscitation. MCS support provides time for the donor right ventricle to recover function, often with the assistance of inotropic and pulmonary vasodilator therapy
Patients slow to wean from cardiopulmonary bypass following heart surgery	Although selected patients may be transitioned to a percutaneous system for additional weaning, this is rarely done.
Refractory arrhythmias	Patients can be treated with a percutaneous system that is somewhat independent of the cardiac rhythm. For recurrent, refractory, ventricular arrhythmias, ECMO may be required for biventricular failure.
Prophylactic use for high-risk PCI	Particularly in patients with severe LV dysfunction (EF <20%–30%) and complex coronary artery disease involving a large territory (sole-remaining vessel, left main, or three-vessel disease)
High-risk or complex ablation of ventricular tachycardia	Similar to HR-PCI, complex VT ablation can be made feasible with percutaneous support. MCS use allows the patient to remain in VT longer during arrhythmia mapping without as much concern about systemic hypoperfusion.
High-risk percutaneous valve interventions	These evolving procedures may be aided with the use of MCSs.

hemodynamic support, ease and rapidity of device insertion, and ultimate goals of support.<sup>20,21</sup>

In acute cardiogenic shock refractory to medical therapy, IABP is often selected to obtain hemodynamic stability, especially in the setting of acute myocardial infarction due to its beneficial effects on coronary blood flow. When available, insertion of Impella 2.5 or CP device is favorable for providing greater systemic perfusion and hemodynamic support and may be as rapid as IABP in experienced centers. For patients who continue to deteriorate, TandemHeart using the larger arterial outflow cannula, VA-ECMO, or surgical cut-down for delivery of an Impella 5.0 is recommended. In patients with anticipated 1–2 hours of hemodynamic stability, we recommend the use of Impella 5.0 via right axillary cut-down (if the vessel diameter is larger than 7 mm), right carotid artery cut-down if axially access is inadequate, or upper ascending aorta access if both axillary and carotid access are inadequate. Continuous monitoring of PaPi and RV pressures using pulmonary arterial catheter and RV function assessment with repeat transesophageal echo (TEE) are necessary for early diagnosis of RV failure in these patients. If RV failure develops, RVAD should be

rapidly inserted for RV hemodynamic support. In addition, if patients develop respiratory compromise, then an oxygenator should be considered. In patients who present with obvious biventricular or cardiopulmonary failure, VA-ECMO with direct cannulation or graft to aorta is recommended. In patients who present with isolated respiratory failure, VV-ECMO with Avalon or Protek Duo should be considered (depending on RV function and the potential benefit of increasing pulmonary blood flow, such as those with a pulmonary thromboembolic event or those undergoing lung transplantation). In cases of RV failure post-cardiotomy, patients should be considered for Protek Duo with RVAD support, whereas patients with post-cardiotomy biventricular failure can benefit from VA-ECMO with central cannulation.

## Long-Term Mechanical Circulatory Support

Durable MCS is typically achieved through ventricular assist device (VAD) support or total artificial heart (TAH)

support. VADs may be utilized to support the right side of the heart (RVAD), the left side of the heart (LVAD), or for biventricular support with combined LVAD and RVAD. Determination of the appropriate degree of support and which mechanical circulatory support system to select for the advanced heart failure patient is aided by thorough patient evaluation and testing. Durable MCS provides end-organ perfusion while improving cardiac output. Device-related complications include stroke, infection, bleeding, pump thrombosis, and ventricular arrhythmias. Non-device-related complications include RV failure.

LVAD and RVAD utilization occurs primarily as a bridge to cardiac transplantation (BTT) or as permanent support, called destination therapy (DT), with a small subset of patients considered for bridge to recovery (BTR). Durable, or long-term, RVAD support is less frequently utilized compared with LVAD support. RV failure necessitating RVAD support is less common than advanced heart failure for which LVAD support is sufficient. Furthermore, dischargeable RVAD support may not be a coverable health-care option in certain countries, though LVAD support is broadly covered. While transplant remains the gold standard treatment for advanced heart failure patients who are candidates for this intervention, prolonged periods of time on wait lists have prompted the utilization of VAD support options for patients until donor organs become available. Limited donor organ availability and movement between BTT and DT categorizations may result in long durations of VAD support regardless of patient implant categorization. Efforts have focused on tailoring device-specific therapy to the individual patient directed by BTT/DT categorization, patient body habitus, desired surgical approach for device placement with the advent of minimally invasive implant techniques, and comorbidities including bleeding history and hypercoagulable status to minimize risk of complications. With approval of minimally invasive surgical approaches for LVAD implantation, HeartWare HVAD (Medtronic, Minneapolis, MN) implantation in patients who may require a sternal-sparing approach or who have a smaller body habitus has been utilized, whereas the HeartMate 3 (Abbott Laboratories, Abbott Park, IL) may be selected for patients with thrombotic risks. Emphasis has also been placed on patient optimization prior to implantation to reduce morbidity and mortality associated with patients in cardiogenic shock and other acutely decompensated states who proceed immediately to durable support. RV failure after LVAD implant can be minimized with careful patient selection and appropriate optimization pre-VAD. Other complications post-VAD may include bleeding, stroke, pump thrombosis, arrhythmias, and infection, among others. Migration toward support with short-term devices as a bridge to a durable VAD in place of initial durable VAD or TAH support as a rescue or emergency option has aided in patient optimization.

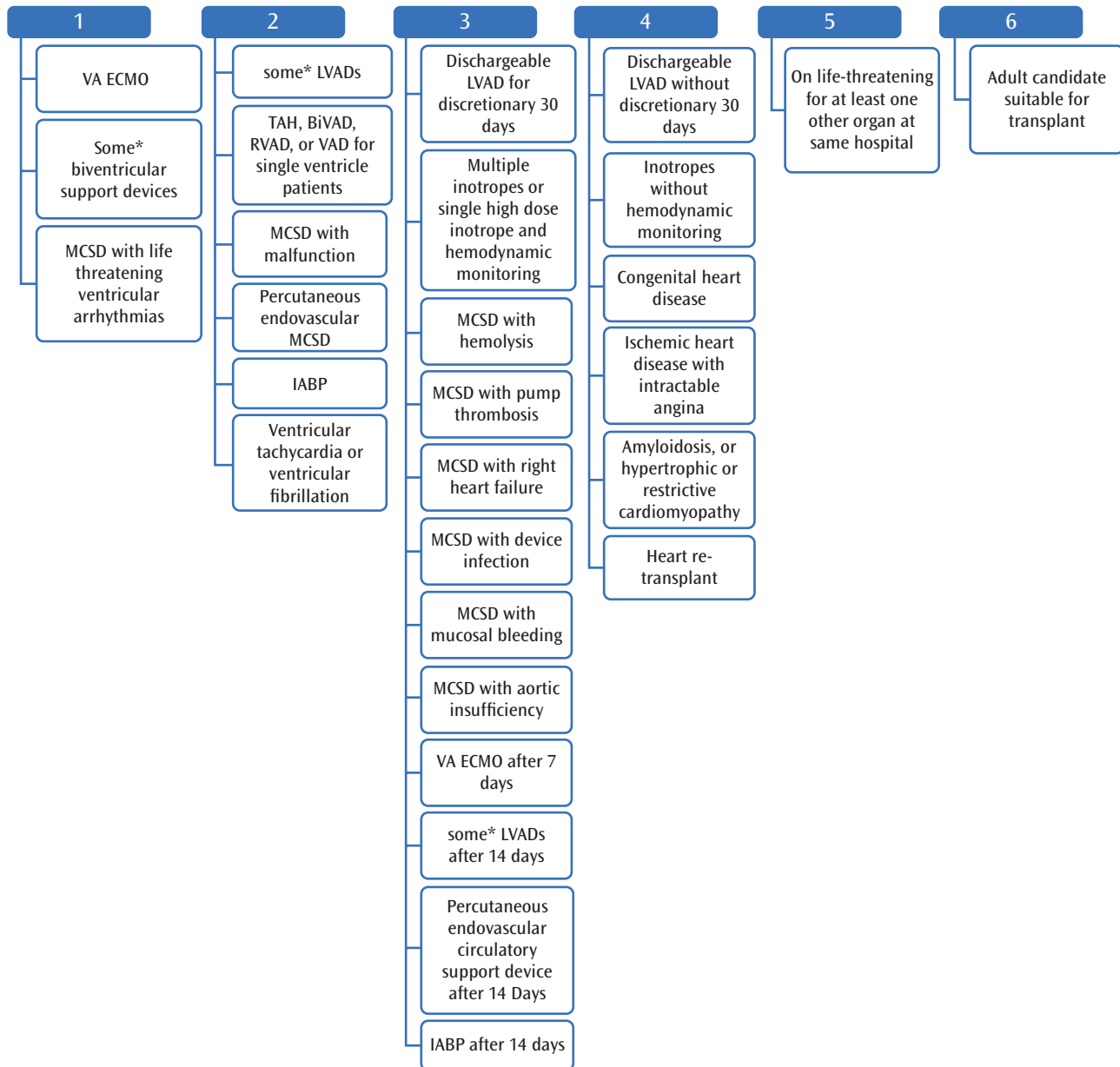
TAH support is predominantly used to sustain patients with biventricular heart failure where a VAD may be insufficient, when combined LVAD and RVAD support may not be feasible, or when underlying intractable arrhythmias are present and are unlikely to improve with VAD support. Most TAHs are implanted in patients who otherwise meet transplant listing criteria and are BTT candidates. Assessment of patient size is an important consideration in selecting an appropriately sized TAH. Recently, TAH support has also been considered for long-term support as DT. There are fewer medical centers that have the capacity and training to utilize TAH technology, which may also influence the overall volume of TAH patients.

### Bridge to Transplant

Patients with advanced heart failure not amenable to medical or surgical interventions may be evaluated for cardiac transplantation candidacy and consideration for VAD or TAH therapy as a BTT, particularly when wait times may be prohibitive to proceeding directly to transplant without undue morbidity and mortality. Strict criteria, including assessment of end-organ function, psychosocial evaluation and substance usage, age appropriateness, malignancy, infection, nutritional status, and other factors, are employed by cardiac transplantation programs when evaluating potential candidates to ensure optimal outcomes with a limited resource.

The shortage of donor organs and suboptimal outcomes associated with optimal medical management led to the development of durable MCS options to sustain patients until cardiac transplantation. Outcomes in the BTT population are generally superior to the DT population, with very few patients expiring on support over the first 6 months after implant.<sup>22,23</sup> In the United States, a new organ allocation system was implemented in October 2018 (Table 10.3), which may influence selection of short-term and long-term mechanical support systems. Greater percentages of patients awaiting cardiac transplantation are requiring VAD support as a bridge to transplant. Outcomes for biventricular support with LVAD and RVAD or biventricular replacement with TAH are superior to support with optimal medical management, but have not yet approached outcomes reported with LVAD support alone.

From the REMATCH trial to recent international publications demonstrating further improvements in survival with contemporary VADs, technological innovations in MCS continue to drive the field forward. Newer smaller devices allow for less invasive surgical techniques and off-pump implantation. With these technological advances, improvements in morbidity and mortality profiles were observed. Potential expansion of MCS technology to less ill advanced heart failure patients may result if these trends continue over time. Currently implanted devices are outlined in Table 10.4.

**Table 10.3 • United Network for Organ Sharing (UNOS) Allocation System for Heart Transplant**

Adapted from: [https://optn.transplant.hrsa.gov/media/2413/adult\\_heart\\_criteria.pdf](https://optn.transplant.hrsa.gov/media/2413/adult_heart_criteria.pdf)

\* some = non-dischargeable, surgically implanted, non-endovascular.

### Destination Therapy

Many advanced heart failure patients are not candidates for cardiac transplantation but may still benefit from advanced heart failure support with MCS. Strict criteria must still be met to utilize MCS as DT to ensure that implantation occurs before heart failure or other disease progression has advanced to the point of irreversibility with optimization. These criteria may be center or country specific or may be driven by regulatory bodies

to ensure appropriate utilization of this technology in patients who would most benefit. Thorough evaluation with laboratory studies, imaging findings, medical and surgical consultations, and components of the aforementioned criteria utilized in cardiac transplantation should inform the decision for MCS utilization, and may also guide selection of specific MCS devices. As with MCS patients who are transplant candidates, identification and solidification of a caregiver or caregiver team offer

**Table 10.4 • Durable Adult Mechanical Circulatory Support Devices**

Features	Evaheart	Jarvik 2000	HeartMate II	HeartMate 3	HeartWare HVAD	SynCardia TAH
Company	Sun Medical Technology Research Corp.	Jarvik Heart, Inc.	Abbott Laboratories	Abbott Laboratories	Medtronic, Inc.	SynCardia Systems, LLC
CE approval	Approved	2000	2005	2015	2009	1999
Indication	BTT/DT*	BTT	BTT/DT	BTT/DT	BTT/DT	BTT*
Support capability	Years	Years	Years	Years	Years	Years
Flow type	Centrifugal, continuous	Axial, continuous	Axial, continuous	Centrifugal, q2s washing	Centrifugal, Lavare cycle	Pulsatile
Flow capability (L/min)	Up to 14	Up to 12	Up to 10	Up to 10	Up to 10	Up to 9.5 for 70 cc; up to 7.5 for 50 cc
Pump speed (RPM)	1,600–2,200	8,000–12,000	6,000–15,000	2,000–5,500	1,800–4000	100–130 beats per min
Anticoagulation	+	+	+	+	+	+

Abbreviations: CE = Conformité Européene; RPM = rotations per minute; BTT = bridge to transplant; DT = destination therapy; \* = DT may not be reimbursable in Japan; \*\* = some consideration as DT; Q2s = pump speed changes every 2 seconds to enable washing of the pump.

great benefits to the DT patient as their duration of MCS is often greater.

Patients who elect to proceed with DT MCS must weigh the potential improvement in survival and quality of life with the challenges posed by adverse outcomes related to LVAD support. Discussion regarding benefits and risks can help to ensure informed consent of patients proceeding with MCS. Age at implant and severity of illness can influence outcomes after MCS. Risk score models have also been employed to evaluate risk and aid in selection of appropriate candidates. Overall survival with BTT MCS is superior compared with DT support, but DT support remains significantly superior to medical management alone. DT implants continue to increase worldwide and rival the volume of patients who are implanted as BTT.

There may be transition between BTT and DT categorizations throughout the continuum of device support. If a patient is unable to complete transplantation evaluation before MCS implantation, evaluation for transplant after surgical recovery may result in that patient becoming BTT eligible. Conversely, a patient may decompensate from a medical, social, or other perspective and may no longer be eligible for transplant, or may no longer wish to be considered for transplant, and thus would be supported with MCS as DT.

### Bridge to Recovery

Utilization of MCS to promote cardiac recovery occurs in a small subset of MCS patients, with the majority of advanced heart failure patients who undergo MCS implantation continuing to require durable MCS to maintain hemodynamic

stability. Rates of sustainable recovery and explanation of MCS are low, but regular functional assessments during follow-up visits and medical optimization with MCS afford the greatest possibility of recovery. Ventricular off-loading with MCS can improve myocardial function in patients for whom recovery is possible. Various recovery proposals have been introduced and published to guide optimization of patients toward ventricular recovery. Patients with myocarditis or other acute onset etiologies of heart failure have a higher likelihood of experiencing some degree of cardiac recovery compared with paired counterparts with long-standing advanced heart failure. Factors including younger age, shorter duration of time after MCS implant, and cardiomyopathy etiology have been implicated in helping predict which patients may be recoverable.<sup>24</sup>

## Conclusion

Mechanical circulatory support offers viable advanced support options for patients with univentricular and biventricular failure. Over the past decades, technological innovations and trends toward miniaturization, durability, and hemodynamic compatibility have driven circulatory support technologies forward, resulting in a myriad of short-term and long-term support options for patients with a variety of indications. Medical providers are able to incorporate technical expertise, patient-specific factors, and technical challenges, as well as outcomes profiles, to best pair devices with patients while minimizing risk. With expanded indications for use and minimally invasive approaches for device placement, more patients around

the world are experiencing the benefit of mechanical circulatory support in the hospital setting and at home.

## REFERENCES

- DeVries WC, Anderson JL, Joyce LD, et al. Clinical use of the total artificial heart. *N Engl J Med*. 1984 Feb 2;310(5):273–278.
- Helman DN, Rose EA. History of mechanical circulatory support. *Prog Cardiovasc Dis*. 2000 Jul-Aug;43(1):1–4.
- Van Diepen S, Katz JN, Albert NM, et al. Contemporary management of cardiogenic shock: a scientific statement from the American Heart Association. *Circulation*. 2017;136:e232–e268. doi:10.1161/CIR.0000000000000525.
- Thiele H, Akin I, Sandri M, et al. PCI strategies in patients with acute myocardial infarction and cardiogenic shock. *N Engl J Med*. 2017;377:2419–2432.
- Patel MR, Smalling RW, Thiele H, et al. Intra-aortic balloon counterpulsation and infarct size in patients with acute anterior myocardial infarction without shock: the CRISP AMI randomized trial. *JAMA*. 2011 Sep 28;306(12):1329–1337.
- Thiele H, Zeymer U, Neumann F-J, et al. Intraaortic balloon support for myocardial infarction with cardiogenic shock. *N Engl J Med*. 2012;367:1287–1296. doi:10.1056/NEJMoa1208410.
- Thiele H, Zeymer U, Neumann FJ, et al. Intra-aortic balloon counterpulsation in acute myocardial infarction complicated by cardiogenic shock (IABP-SHOCK II): final 12 month results of a randomised, open-label trial. *Lancet*. 2013 Nov 16;382(9905):1638–1645.
- Thiele H, Zeymer U, Thelemann N, et al. Intraaortic balloon pump in cardiogenic shock complicating acute myocardial infarction: long-term 6-year outcome of the randomized IABP-SHOCK II Trial. *Circulation*. 2019;139:395–403.
- Dixon SR, Henriques JPS, Mauri L, et al. A prospective feasibility trial investigating the use of the Impella 2.5 System in patients undergoing high-risk percutaneous coronary intervention (the PROTECT I Trial): initial U.S. experience. *JACC: Cardiovascular Interventions*. 2009;2(2):91–96.
- O'Neill WW, Kleiman NS, Moses J, et al. A prospective, randomized clinical trial of hemodynamic support with impella 2.5 versus intra-aortic balloon pump in patients undergoing high-risk percutaneous coronary intervention: the PROTECT II study. *Circulation*. 2012 Oct 2;126(14):1717–1727.
- Burkhoff D, Sayer G, Doshi D, Uriel N. Hemodynamics of mechanical circulatory support. *J Am Coll Cardiol*. 2015 Dec 15;66(23):2663–2674.
- Cheng JM, Den Uil CA, Hoeks SE, et al. Percutaneous left ventricular assist devices vs. intra-aortic balloon pump counterpulsation for treatment of cardiogenic shock: a meta-analysis of controlled trials. *Eur Heart J*. 2009 Sep;30(17):2102–2108.
- Ouweneel DM, Eriksen E, Sjauw KD, et al. Percutaneous mechanical circulatory support versus intra-aortic balloon pump in cardiogenic shock after acute myocardial infarction. *J Am Coll Cardiol*. 2017 Jan 24;69(3):278–287.
- Ouweneel DM, Schotborgh JV, Limpens J, et al. Extracorporeal life support during cardiac arrest and cardiogenic shock: a systematic review and meta-analysis. *Intensive Care Med*. 2016 Dec;42(12):1922–1934.
- Anderson MB, Goldstein J, Milano C, et al. Benefits of a novel percutaneous ventricular assist device for right heart failure: the prospective RECOVER RIGHT study of the Impella RP device. *J Heart Lung Transplant*. 2015 Dec;34(12):1549–1560.
- John R, Long JW, Massey HT, et al. Outcomes of a multicenter trial of the Levitronix CentriMag ventricular assist system for short-term circulatory support. *J Thorac Cardiovasc Surg*. 2011 Apr;141(4):932–939.
- Takeda K, Garan AR, Ando M, et al. Minimally invasive CentriMag ventricular assist device support integrated with extracorporeal membrane oxygenation in cardiogenic shock patients: a comparison with conventional CentriMag biventricular support configuration. *Eur J Cardiothorac Surg*. 2017 Dec 1;52(6):1055–1061.
- Thiele H, Ohman EM, Desch S, Eitel I, De Waha S. Management of cardiogenic shock. *Eur Heart J*. 2015 May 21;36(20):1223–1230.
- Rihal CS, Naidu SS, Givertz MM, et al. 2015 SCAI/ACC/HFSA/STS clinical expert consensus statement on the use of percutaneous mechanical circulatory support devices in cardiovascular care. *J Am Coll Cardiol*. 2015 May 19;65(19):e7–e26.
- Csepe TA, Kilic A. Advancements in mechanical circulatory support for patients in acute and chronic heart failure. *J Thorac Dis*. 2017 Oct;9(10):4070–4083.
- Chakravarthy M, Tsukashita M, Murali S. A targeted management approach to cardiogenic shock. *Crit Care Clin*. 2018 Jul;34(3):423–437.
- Kirklin JK, Naftel DC, Pagani FD, et al. Seventh INTERMACS annual report: 15,000 patients and counting. *J Heart Lung Transplant*. 2015 Dec;34(12):1495–1504.
- Kirklin JK, Xie R, Cowger J, et al. Second annual report from the ISHLT Mechanically Assisted Circulatory Support Registry. *J Heart Lung Transplant*. 2018;37(6):685–691. doi:10.1016/j.healun.2018.01.1294.
- Drakos SG, Wever-Pinzon O, Selzman CH, et al. Magnitude and time course of changes induced by continuous-flow left ventricular assist device unloading in chronic heart failure: Insights into cardiac recovery. *J Am Coll Cardiol*. 2013 May 14;61(19):1985–1994.

# 11

## The HeartMate II™ Continuous-Flow Left Ventricular Assist System

DAVID J. FARRAR

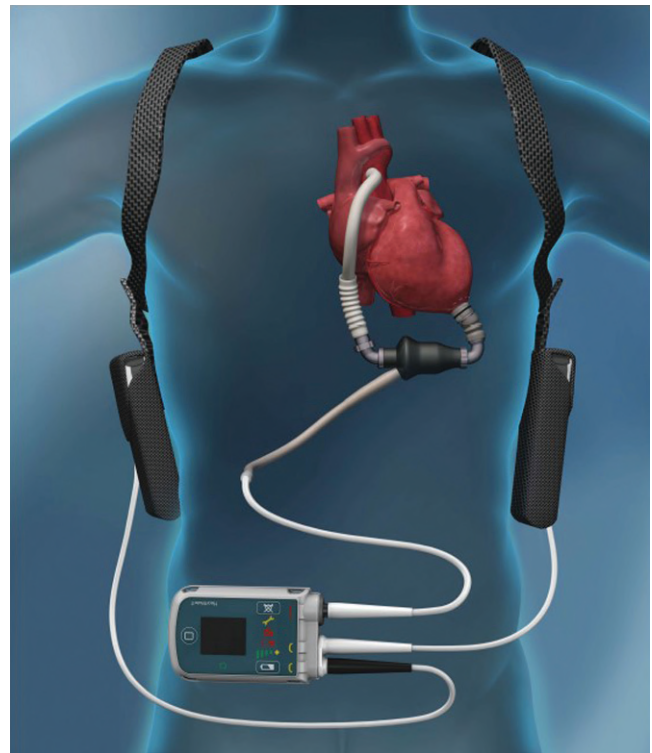
**T**he HeartMate II™ Left Ventricular Assist Device (LVAD; Abbott, Pleasanton, CA), which has been implanted in more than 26,000 patients, is the most widely used durable mechanical circulatory support device in patients with advanced heart failure. Some patients have survived more than 10 years on the original device. The HeartMate II system is also the most studied mechanical circulatory support device, generating more than 1,000 peer-reviewed articles, including those reporting the results from a multicenter clinical trial, post-approval studies,<sup>1-7</sup> and post-market studies, such as ROADMAP<sup>8-10</sup> and PREVENT.<sup>11</sup> More than 15,000 patients with HeartMate II devices are included in the annual INTERMACS registry.<sup>12</sup>

The HeartMate II is intended for use as bridge to transplantation in candidates at risk of imminent death from non-reversible left ventricular (LV) failure. The HeartMate II is also indicated for destination therapy for use in patients with New York Heart Association (NYHA) Class IIIB or IV end-stage LV failure who have received optimal medical therapy for at least 45 of the last 60 days and who are not candidates for cardiac transplantation.

### Description of the HeartMate II System

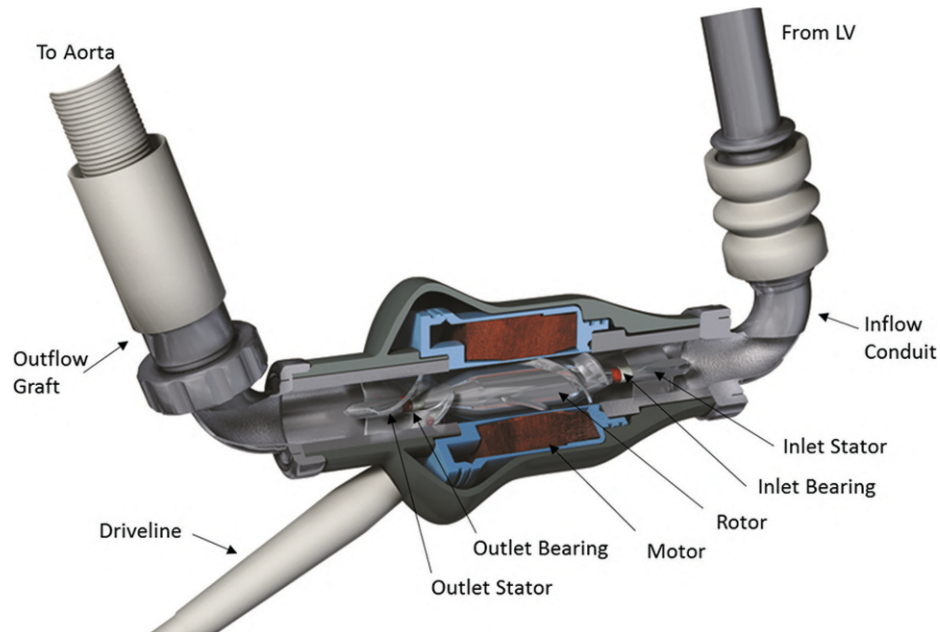
The HeartMate II system consists of an implanted axial flow blood pump or LVAD, a System Controller and batteries worn by the patient, and external system components for external power and monitoring. The pump is implanted just below the heart. A flexible inflow conduit is attached to the apex of the LV, and a polyester outflow graft is anastomosed to the ascending aorta (Figure 11.1). Blood is pumped continuously throughout systole and diastole

from the conduit in the LV apex, through the blood pump, and to the ascending aorta.



**Figure 11.1.** The HeartMate II left ventricular assist device is implanted below the heart and is connected by a drive-line to a controller and batteries worn by the patient. Blood is pumped continuously throughout systole and diastole from a cannula inserted into the left ventricular apex with flow directed to the ascending aorta.

Reproduced with permission of Abbott, © 2019. All rights reserved.



**Figure 11.2.** Internal view of the HeartMate II left ventricular assist device. Reproduced with permission of Abbott, © 2019. All rights reserved.

The LVAD is controlled and powered through a driveline connected to the System Controller and power source. The pump has only one moving part, the rotor (Figure 11.2). The rotor is suspended between the inlet and outlet stator with ball-and-cup bearings designed for long-term durability. Vanes on the spinning rotor move blood through the pump, which is capable of providing flow from 2.5 to 10 liters per minute. There are no valves. Both the inflow conduit and outflow elbow have textured titanium microsphere blood-contacting surfaces, designed to reduce pump thrombosis.

The pump's internal components in contact with blood (the pump rotor, stators, and pump chamber) have smooth, polished titanium surfaces.

External components include the HeartMate II™ System Monitor and Power Module, Mobile Power Unit™ Module, and batteries and battery charger (Figure 11.3). In addition, the Controller (Figure 11.4) is a small computer that controls and monitors system operation and serves as the primary user interface for the device. The System Controller delivers power to the pump; identifies hazard

(A)



(B)



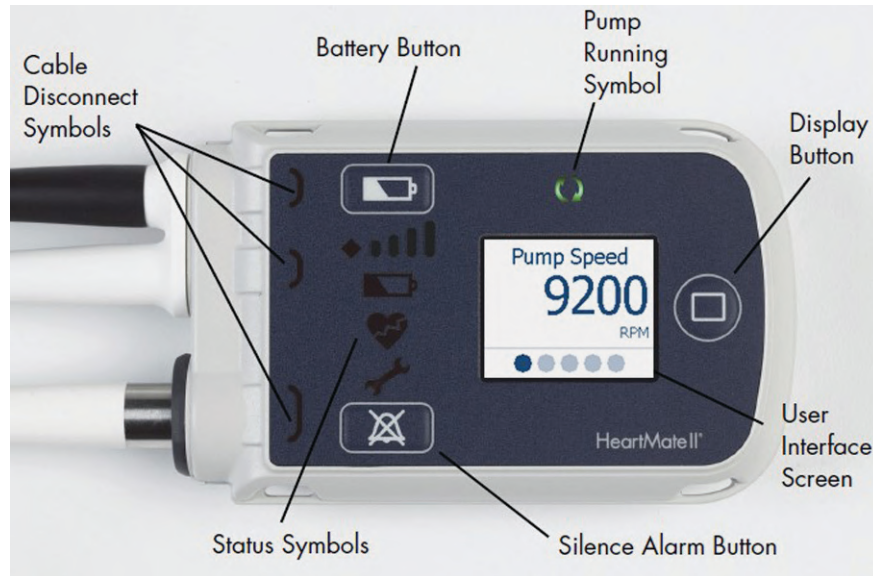
(C)



**Figure 11.3.** The HeartMate II™ (A) system monitor and power module, (B) mobile power unit module, and (C) battery charger with 14 V lithium-ion batteries.

Reproduced with permission of Abbott, © 2019. All rights reserved.





**Figure 11.4.** The HeartMate II™ System Controller User Interface. Reproduced with permission of Abbott, © 2019. All rights reserved.

and advisory alarm conditions; displays pump settings, provides visual alarms with actionable instructions and alarm history; provides driveline diagnostic capability; records and stores device performance and alarm data; and transfers system performance data to the System Monitor.

The System Controller connects to the LVAD through a driveline that passes through the patient's abdomen. The driveline carries power to the pump and supplies information from the pump to the System Controller. The System Controller has two power cables for connecting to its power source: either the Power Module–Mobile Power Unit, or two 14-volt lithium-ion batteries. The white power cable also contains a data cable that transmits information from the System Controller to the System Monitor during tethered operation. A battery in the Controller provides backup power to the pump and audible alarms for about 15 minutes during a power-loss emergency.

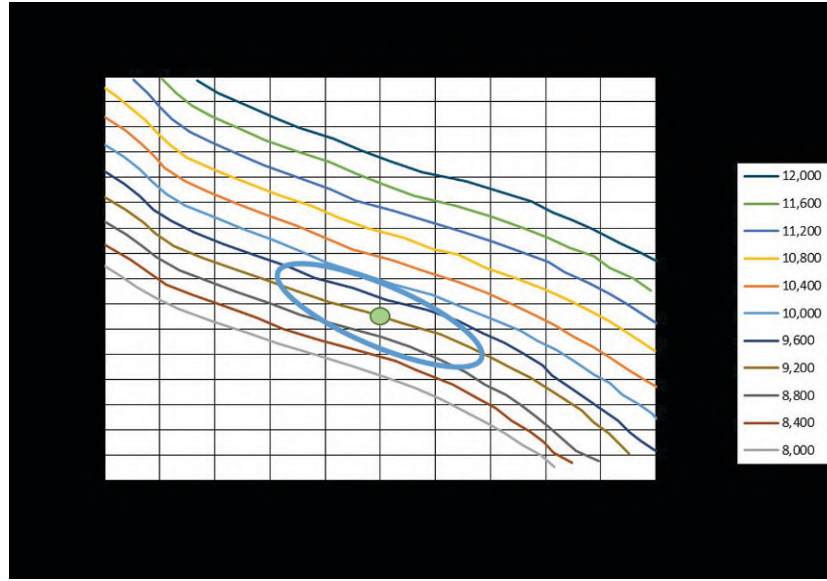
The Power Module or Mobile Power Unit provides AC electrical power to the LVAD during tethered operation, for example, at night or when the patient requires monitoring using the System Monitor. The Mobile Power Unit is for home or clinical use when the patient does not require monitoring using the System Monitor. The battery charger charges, calibrates, and tests the 14-volt lithium-ion batteries. The System Monitor functions as a display and control monitor when connected to the Power module. It is used for close monitoring of system operations during LVAD implantation and during regular checkups, for changing settings, to view system settings, to adjust speed settings, and to review pump status.

## Description of the HeartMate II Pump

The HeartMate II is an axial-flow, rotary blood pump. A rotor inside the pump contains a magnet and is rotated by the electromotive force generated by the motor. The rotating rotor provides the driving force that propels blood from the LV through the pump to the systemic circulation. Pump output depends on the rotational speed of the rotor, as well as the pressure difference between the inlet and outlet of the pump. The HeartMate II operates at a fixed rotational speed, which can be changed by a qualified person through the System Monitor. The patient cannot change the speed of the pump.

Blood flow through the HeartMate II has lower pulsatility than that of the native heart or of the volume displacement pulsatile-flow LVADs. The HeartMate II pulsatility pattern follows the native cardiac cycle that varies during diastole and systole. The amount of flow generated by the pump is determined by the pump speed and by the pressure gradient across the pump, which is the difference between the pressure at the pump outlet (connected to the aorta) and pump inlet (connected to the LV) (Figure 11.5). For a specified pump speed, flow varies inversely with pressure across the pump. Therefore, increasing pressure gradient across the pump decreases flow, and decreasing the pressure gradient increases flow. Changing pump speed can also change the pump flow, assuming sufficient inflow is available to the pump inlet.

The Pulsatility Index (PI) is a measure of the magnitude of the pulsatile power through the pump during the cardiac cycle. It is calculated as:  $PI = [(maximum\ power - minimum$



**Figure 11.5.** The HeartMate II H-Q Curve showing the relationship between pump flow and pressure gradient across the pump at different pump speeds. The green dot indicates a nominal operating condition of 5.0 L/min at 65 mmHg at a pump speed of 9,200 rpm, and the blue ellipse indicates the typical physiologic range for most patients.

Reproduced with permission of Abbott, © 2019. All rights reserved.

power) x 10]/average power. It is measured and averaged over a 15-second interval and is displayed on the monitor.

## Description of the System Controller and System Monitor after Implantation

For details about the proper use of the HeartMate II, refer to the manufacturer's instructions<sup>13</sup> and to the comprehensive clinical management guidelines for the HeartMate II continuous-flow LVAD.<sup>14</sup>

Implantation and postoperative care should follow the recommendations from the PREVENT study (PREVENTion of HeartMate II Pump Thrombus Through Clinical Management.)<sup>11,13</sup> This study found that the incidence of pump thrombus could be reduced by adopting a predetermined set of surgical techniques designed to assure unobstructed blood flow<sup>15</sup> and medical recommendations that include postoperative heparin bridging, optimal speed management ( $\geq 9,000$  rpm), and blood pressure control (Table 11.1).

## The System Controller User Interface

The System Controller is the primary interface for routine system operation. Sounds, lights, symbols, and on-screen

messages communicate how the system is working. The interface visually displays aspects of system operation and on-screen instructions on how to respond to alarms and other situations (Figure 11.4). Seeing information about the pump is useful when recording daily values or trying to resolve system problems on the telephone. When the System Controller is running, the user interface can display five separate screens with the following information about current system operations:

1. Pump speed, in revolutions per minute (rpm)
2. Flow, in liters per minute (L/min)
3. Pulsatility Index (abbreviated as PI on the screen)
4. Power, in watts (W)
5. Charge status of the System Controller's backup battery.

Each push of the display button brings up the next screen. Each screen illuminates for 15 seconds before it goes black, unless another button is pushed. The screens are always displayed in the same order, starting with the first (speed) screen. A dot at the bottom of each screen provides navigational information about which of the five screens is in view.

The System Controller is connected to the System Monitor during start-up in the operating room and postoperatively for changing the pump speed and diagnostics. Pump settings are also available on the System Monitor when connected to the controller: speed, power, flow, and pulsatility index (PI; Figure 11.6). The power used by the

**Table 11.1 • Overview of the PREVENT Surgical Recommendations for Implanting a HeartMate II Left Ventricular Assist Device**

#### Surgical Recommendations

- 1) Create an adequately sized pump pocket, located inferiorly, deep and lateral.
- 2) Position the inflow cannula parallel to the septum, oriented to the central LV.
- 3) Position the outflow graft right of the sternal midline to avoid compression of the RV.
- 4) Position the pump below the diaphragm.
- 5) Fixate the pump (e.g., to the diaphragm or the chest wall) to prevent migration.

#### Anticoagulation and Antiplatelet Management

- 1) In patients without persistent bleeding, begin bridging with unfractionated heparin or low-molecular-weight heparin within 48 hours of implantation, with a goal PTT of 40–45 seconds in the first 48 hours, followed by titration up to a PTT 50–60 by 96 hours. If heparin is contraindicated, consider other alternatives, including argatroban, intravenous warfarin, and bivalirudin.
- 2) Initiate warfarin within 48 hours to obtain an INR goal of 2.0–2.5 by 5–7 postoperative days, at which time heparin therapy may be discontinued.
- 3) Once there is no evidence of bleeding, initiate aspirin therapy (81–325 mg daily), 2–5 days after HMII implantation.
- 4) Maintain the patient throughout LVAD support on aspirin and warfarin with an INR goal of 2.0–2.5.

#### Pump Speed Management

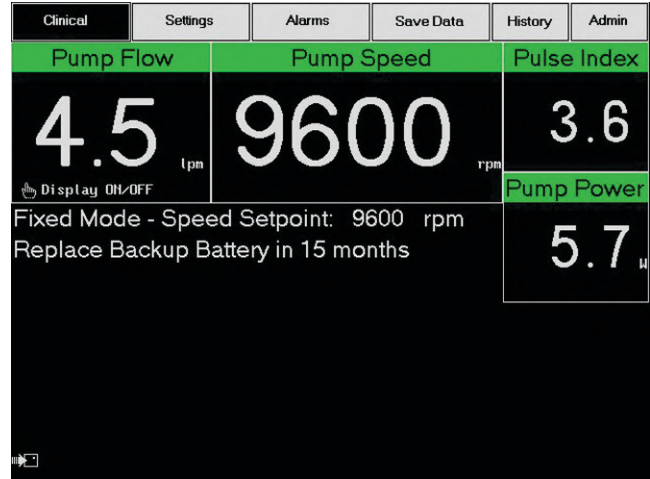
- 1) Run pump speeds above 9,000 rpm and avoid speeds below 8,600 rpm.
- 2) Adjust pump speed to permit intermittent aortic valve opening only after the preceding speed goals are achieved.

#### Blood Pressure Management

- 1) Maintain a mean arterial pressure less than 90 mm Hg.

Reprinted from Maltais S et al., PREVENTion of HeartMate II pump thrombosis through clinical management: the PREVENT multi-center study, *Journal of Heart and Lung Transplantation* 2017;36:1–12. Copyright (2017), with permission from Elsevier.

pump is determined by pump speed and blood flow through the pump. Under normal conditions, the power increases with either pump speed or flow. Gradual power increases (over hours or days) may signal a deposition of thrombus inside the pump, but thrombus should not be diagnosed on pump settings alone; additional information should include the inability to decompress the LV during a speed-ramp test using echocardiography, heart failure symptoms, and elevated low-density lipoprotein concentrations.<sup>16</sup> Transient power elevations greater than 10 W in the first 14 days after



**Figure 11.6.** The clinical screen on the HeartMate II LVAS System Monitor.

Reproduced with permission of Abbott, © 2019. All rights reserved.

implantation are not related to development of subsequent pump thrombus and typically are resolved before hospital discharge.<sup>17</sup> No single device setting can replace the importance of monitoring the clinical status of the patient, which should be the first priority.

The System Controller issues two types of alarms: hazard alarms and advisory alarms. Hazard alarms are for potentially life-threatening conditions and require immediate attention. Advisory alarms are for serious, but not life-threatening conditions. When an alarm occurs, messages appear on the System Controller user interface screen to help resolve the problem. These on-screen messages indicate the type and duration of the alarm, and the action required to resolve the problem (Tables 11.2 and 11.3).

The System Controller estimates blood flow out of the pump. This estimate is based on pump speed and the amount of power provided to the pump motor. The relationship between flow and power at any particular speed is mostly linear, but it can be nonlinear at the low and high ends of the speed range. The System Controller also monitors the flow estimate, compares it to the known operational range of the pump, and verifies that for the given speed and power, the flow presented is within expected physiological ranges. If the flow estimate is outside these ranges, it will display “+ + +” or “- - -” (Figure 11.7).<sup>14</sup> In the HeartMate II BTT trial, after 6 months of support, the mean (SD) estimated flow was 5.6 (0.9 L/min), pump power was 6.8 (1.2) watts, the pulsatility index was 5.0 (0.9), and the pump speed was 9,450 (490) rpm.

Pump speed is optimal when the cardiac index and LV size are normal and there is no rightward or leftward shift

**Table 11.2 • The HeartMate II System Controller Hazard Alarms and Actions: Hazard Alarms Are Indicated by a Continuous Audio Tone and Flashing Symbols**

Hazard Alarm Images and Their Meaning		
Red heart: alarm condition	Red battery: meaning	Red bar: needed action
Pump off	Pump has stopped running or has been turned off.	<ol style="list-style-type: none"> <li>1. Verify that the System Controller is connected to a working power source.</li> <li>2. Push any button on the System Controller to try to restart the pump.</li> <li>3. If the pump does not restart, check the fixed speed setting. If it is below 8,000 rpm AND the System Controller's backup battery is not installed, the pump can only be started from the System Monitor's Clinical or Settings screen by pressing the Pump Start button.</li> <li>4. Switch to backup System Controller if the pump does not restart.</li> </ol>
Low flow	Pump flow is <2.5 L/min.	<ol style="list-style-type: none"> <li>1. Ensure that the driveline is connected to the System Controller.</li> <li>2. Ensure that a power source is connected to the System Controller.</li> <li>3. Clinically evaluate the patient and treat underlying conditions that could result in inadequate preload to the pump.</li> <li>4. Perform echocardiography, if needed, to assess LV and RV function, to adjust pump speed, and to rule out inflow cannula obstruction.</li> <li>5. Treat systemic hypertension because high afterload may decrease flow through the pump.</li> </ol>
Driveline disconnected	Driveline is disconnected from the System Controller.	<ol style="list-style-type: none"> <li>1. Immediately reconnect the driveline to the System Controller and move the driveline safety tab on the System Controller to the locked position.</li> <li>2. If alarm persists after reconnecting the driveline, press any button on the System Controller to attempt to start the pump.</li> <li>3. If the pump does not restart, check the fixed speed setting. If it is below 8,000 rpm AND the System Controller's backup battery is not installed, the pump can only be started from the System Monitor's Clinical or Settings screen by pressing the Pump Start button.</li> <li>4. If the driveline is connected and the alarm persists, replace the System Controller with the pre-programmed backup System Controller.</li> </ol>
No external power	Both power cables are disconnected from, or are not receiving, power.	Immediately connect to a working power source (Power Module, Mobile Power Unit™ Module, or two fully charged HeartMate 14-volt lithium-ion batteries).
Low battery power	<5 minutes of battery power	Immediately replace the depleted batteries with fully charged batteries, one at a time, or connect to the Power Module or Mobile Power Unit Module.

Reproduced with permission of Abbott, © 2019. All rights reserved.

of the septum. Additionally, it may be desirable to have some pulsatility with intermittent aortic valve opening. However, the PREVENT study showed that the incidence of pump thrombus was significantly lower in patients who had been supported with pump speeds greater than 9,000 rpm at 30 days than in those supported at speeds less 9,000 rpm (3% vs. 14%,  $P < 0.01$ ). In that study, the immediate postoperative median pump speed was 8,800 rpm (and was greater than 9,000 rpm in 41% of patients). After 30 days, the median pump speed had increased to 9,200 rpm. Therefore, to reduce the risk of pump thrombosis, whenever possible, the pump speed should be above 9,000 rpm, and pump speeds below 8,600 rpm should be avoided for extended periods (Table 11.1).

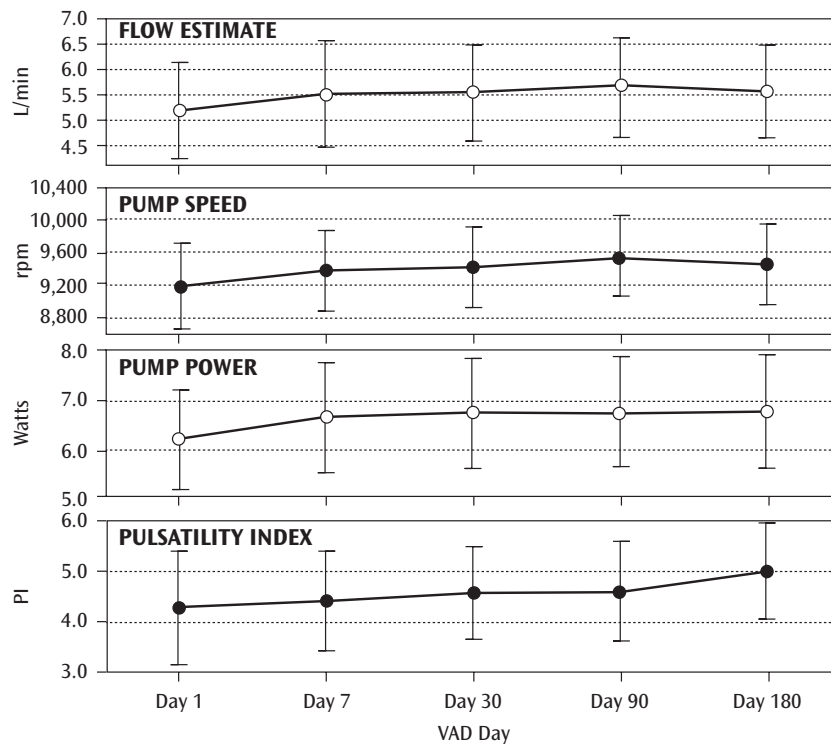
A ramped-speed study using echocardiography and hemodynamic assessment is the most direct method to

determine the speed that provides the desired level of cardiac support for each patient.<sup>14,18</sup> Ideally, a ramped-speed study is performed in the operating room after the patient is stable and before the transesophageal echocardiography probe is removed. A transthoracic echocardiogram may be acquired in the ICU when the patient is stable and before invasive monitoring lines are removed, and again before hospital discharge. Throughout the procedure, LV size, position of the septum, blood pressure, and aortic valve opening should be monitored to determine the appropriate combination of factors that define the optimum operating point. Additional studies should be performed when there are symptoms of inadequate support. Maintaining mean arterial pressure at less than 90 mm Hg will also help achieve optimal blood flow through the device and with systemic perfusion.

**Table 11.3 • System Controller Advisory Alarms and Needed Actions: Advisory Alarms Are Indicated by an Intermittent Alarm Tone and a Flashing Image**

Advisory Alarms and Needed Action		
Yellow wrench: alarm name	Yellow diamond: alarm meaning	Yellow bar: needed action
Power cable disconnected	One of the two power cables is disconnected or loose.	Promptly reconnect the disconnected power cable to a power source (functioning Power Module, Mobile Power Unit Module, or two fully-charged HeartMate 14-volt lithium-ion batteries).
Low battery power	Less than 15 min. remaining	Replace the depleted batteries with fully charged batteries, one at a time, or connect to the Power Module or Mobile Power Unit Module.
Controller fault	Internal malfunction of the System Controller	1. Switch to the backup System Controller. 2. Provide patient with a new System Controller. Note: This alarm will be displayed on the System Monitor and may be displayed on the System Controller.
Low speed	Low pump speed	1. Use the System Monitor to check that the fixed speed and low speed limit have been appropriately set. 2. If alarm persists, replace the System Controller.
Backup battery fault	System Controller backup battery has been compromised or has expired.	Replace the 11-volt lithium-ion backup battery. Note: If replacing the battery does not resolve the alarm, the System Controller may need to be replaced, or additional steps may be required.
Backup battery not installed	System Controller backup battery was not installed or was installed incorrectly.	1. Install the 11-volt lithium-ion backup battery in the System Controller. 2. If alarm persists, obtain and install a new backup battery. Note: If replacing the battery does not resolve the alarm, the System Controller may need to be replaced, or additional steps may be required.

Reproduced with permission of Abbott, © 2019. All rights reserved.



**Figure 11.7.** Average flow estimate, pump speed, pump power, and pulsatility index from the bridge to transplant clinical trial. Reprinted from Slaughter MS et al., Clinical management of continuous-flow left ventricular assist devices in advanced heart failure, *Journal of Heart and Lung Transplantation* 2010;29:S1–29, Copyright (2010), with permission from Elsevier.

## REFERENCES

1. Miller LW, Pagani FD, Russell SD, et al. Use of a continuous-flow device in patients awaiting heart transplantation. *N Engl J Med*. 2007;357:885–896.
2. Pagani FD, Miller LW, Russell SD, et al. Extended mechanical circulatory support with a continuous-flow rotary left ventricular assist device. *J Am Coll Cardiol*. 2009;54:312–321.
3. Slaughter MS, Rogers JG, Milano CA, et al. Advanced heart failure treated with continuous-flow left ventricular assist device. *N Engl J Med*. 2009;361:2241–2251.
4. Starling RC, Naka Y, Boyle AJ. Results of the post-FDA-approval study with a continuous flow left ventricular assist device as a bridge to heart transplantation: a prospective study using the INTERMACS Registry. *J Am Coll Cardiol*. 2011;57(19):1890–1898.
5. Park SJ, Milano CA, Tatroles AJ, et al. Outcomes in advanced heart failure patients with left ventricular assist devices for destination therapy. *Circ Heart Fail*. 2012;5(2):241–248.
6. Rogers JG, Aaronson KD, Boyle AJ, et al. Continuous flow left ventricular assist device improves functional capacity and quality of life of advanced heart failure patients. *J Am Coll Cardiol*. 2010;55:1826–1834.
7. Jorde UP, Kushwaha SS, Tatroles AJ, et al. Results of the destination therapy post-Food and Drug Administration approval study with a continuous flow left ventricular assist device: a prospective study using the INTERMACS registry (Interagency Registry for Mechanically Assisted Circulatory Support). *J Am Coll Cardiol*. 2014;63(17):1751–1757.
8. Estep JD, Starling RC, Horstmanshof DA, et al. Risk assessment and comparative effectiveness of left ventricular assist device and medical management in ambulatory heart failure patients: results from the ROADMAP study. *J Am Coll Cardiol*. 2015;66(16):1747–1761.
9. Starling RC, Estep JD, Horstmanshof DA, et al. Risk assessment and comparative effectiveness of left ventricular assist device and medical management in ambulatory heart failure patients: the ROADMAP Study 2-year results. *JACC Heart Fail*. 2017;5(7):518–527.
10. Stehlik J, Estep JD, Selzman CH, et al. Patient-reported health-related quality of life is a predictor of outcomes in ambulatory heart failure patients treated with left ventricular assist device compared with medical management: results from the ROADMAP Study (Risk Assessment and Comparative Effectiveness of Left Ventricular Assist Device and Medical Management). *Circ Heart Fail*. 2017;10(6). pii: e003910. doi: 10.1161/CIRCHEARTFAILURE.116.003910
11. Maltais S, Kilic A, Nathan S, et al. PREVENTion of HeartMate II pump thrombosis through clinical management: the PREVENT multi-center study. *J Heart Lung Transplant*. 2017;36(1):1–12.
12. Kirklin JK, Pagani FD, Kormos RL et al. Eighth annual INTERMACS report: special focus on framing the impact of adverse events. *J Heart Lung Transplant*. 2017;36:1080–1086
13. *HeartMate II Left Ventricular Assist System Instructions for Use*. Document 10000987. Abbott, Pleasanton, CA. (Available from company upon request)
14. Slaughter MS, Pagani FD, Rogers JG, et al. Clinical management of continuous-flow left ventricular assist devices in advanced heart failure. *J Heart Lung Transplant*. 2010; 29:S1–S39.
15. Adamson RM, Mangi AA, Kormos RL, Farrar DJ, Dembitsky WP. Principles of HeartMate II implantation to avoid pump malposition and migration. *J Card Surg*. 2015;30:296–299
16. Goldstein DJ, John R, Salerno C, et al. Algorithm for the diagnosis and management of suspected pump thrombus. *J Heart Lung Transplant*. 2013;32(7):667–670.
17. Salerno CT, Sundareswaran KS, Schleeter TP, Moanie SL, Farrar DJ, Walsh MN. Early elevations in pump power with the HeartMate II left ventricular assist device do not predict late adverse events. *J Heart Lung Transplant*. 2014;33(8):809–815.
18. Uriel N, Sayer G, Addetia K, et al. Hemodynamic ramp tests in patients with left ventricular assist devices. *JACC Heart Fail*. 2016;4(3):208–217.

## 12

# The Abbott HeartMate 3™ Left Ventricular Assist System

KEVIN BOURQUE AND JOHN B. O'CONNELL

## Introduction

**T**reatments for advanced heart failure, defined as persistent NYHA Class III–IV symptoms despite optimal guideline-directed medical and device therapy, are limited to heart transplantation, durable mechanical circulatory support (MCS), and palliative care. Although the treatment of choice for many cardiologists and surgeons may be transplantation, the donor pool is limited to between 2,000 and 3,000 candidates per year. Fortunately, outcomes with MCS have improved substantially, which will enhance access to the 50,000 to 70,000 patients living with advanced heart failure.

The HeartMate II™ Left Ventricular Assist System (HMII), which has now been implanted more than 25,000 times, provides a 2-year survival rate for destination therapy of about 80%.<sup>1</sup> The quality of life is excellent, with 80% of patients returning to NYHA Class I–II 3 to 6 months after implantation.<sup>2</sup> However, as an axial-flow pump requiring a pump pocket and an external driveline and controller, adverse events with the HMII are unfortunately common.<sup>3</sup> New designs have specifically targeted the most serious of these adverse events: stroke, pump thrombosis, driveline infection, and right heart failure.

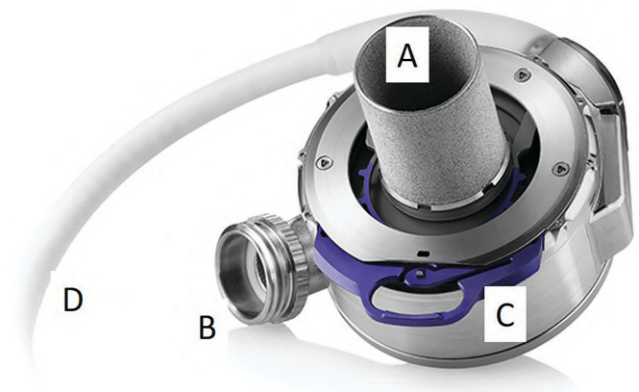
In a recent study,<sup>4</sup> the incidence of HMII pump thrombosis was 8.4% at 3 months. Because the design, materials, and manufacturing of the HMII have not been changed, and because the incidence of pump thrombosis at high-volume centers varied widely, the *PREVENTION* of HeartMate II Pump Thrombosis through Clinical Management (*PREVENT*) study was conducted to assess the efficacy of particular clinical measures hypothesized to reduce pump thrombosis.<sup>5</sup> In this trial, in which the surgical procedure was specified, adherence to treatment after implantation was monitored, anticoagulation was tightly controlled, and pump speed was maintained above 9,000 rpm, the incidence of pump

thrombosis at 3 months dropped to 2.9%. Although altering the design of this particular pump seems unlikely, a pump requiring less rigorous attention to detail in terms of surgical procedure, treatment adherence, anticoagulation, and pump speed is clearly desirable as more and more pumps are implanted.

The HeartMate 3™ Left Ventricular Assist System (HM3) (Figures 12.1 and 12.2) was specifically designed to be more hemocompatible to address the incidence of related adverse events, specifically pump thrombosis.<sup>6</sup>

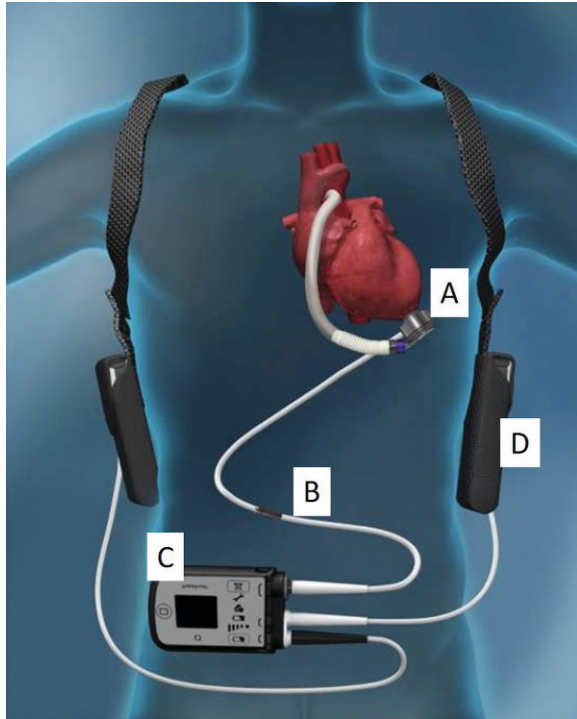
## Design of the HM3

The HM3 pump was designed to meet two objectives: to minimally affect the blood it pumps and to be minimally



**Figure 12.1.** The HeartMate 3 Pump includes an inflow cannula (A), an outflow conduit (B), a quick connection for pump attachment (C), and a percutaneous driveline (D).

Reproduced with permission of Abbott, © 2019. All rights reserved.



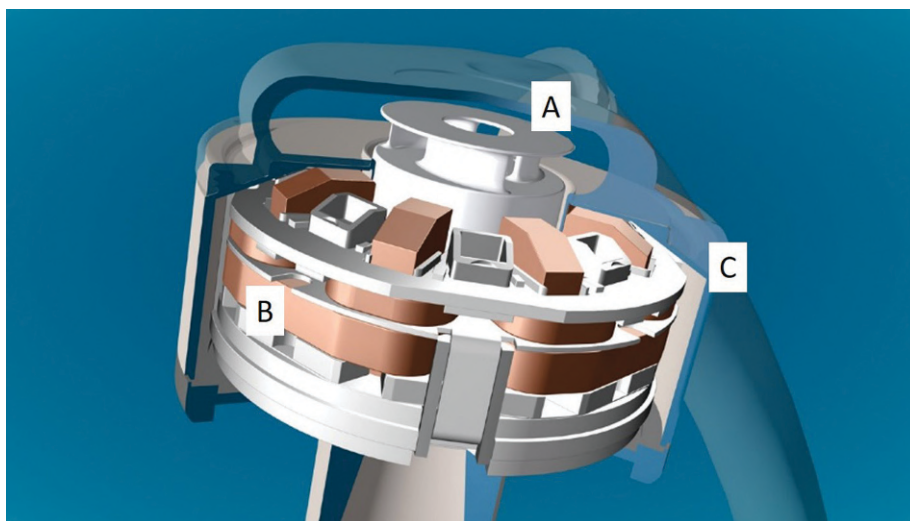
**Figure 12.2.** The HeartMate 3 system includes the pump (A), a percutaneous driveline (B), a controller (C), a pair of batteries (D), and a mobile power unit for untethered and tethered configurations, respectively. Other accessories for surgery and patient usage not shown include a ventricular coring tool, ventricular sewing cuff, tunneling lance, skin punch, and holsters and a belt for carrying batteries and the controller.

Reproduced with permission of Abbott, © 2019. All rights reserved.

affected by the blood it pumps, a concept analogous to designing modern electronic equipment to be electromagnetically compatible in both *emissions* and *immunity*. In the HM3, this concept entails reducing the shear stress on the patient's blood and to avoid stasis ("emissions") and in being impervious to the vagaries of the circulatory system ("immunity").

The HM3 is intended for the full, long-term support of patients with advanced heart failure. At the core of the HM3 is a motor that both levitates and turns a rotor that angularly accelerates blood to produce flow and pressure (Figures 12.3 and 12.4). Magnetic levitation is accomplished with a permanent magnet enclosed in the rotor and with eight electromagnets in the motor. The rotor's radial position is continuously measured and, as the rotor deviates from the central axis, the appropriate electromagnets are energized in proportion to the deviation to restore the rotor's central position. This process maintains relatively large gaps between the rotor and pump housing, reduces shear stress, and nearly eliminates stasis, the need for complex rotor and pump housing geometries in the hydraulic path, and critical fabrication tolerances. Because the levitation and turning functions are independent, the levitation mechanism does not limit the range of rotational speeds. In principle, these factors reduce the vulnerability of magnetic bearings to incipient thrombus formation or ingestion relative to mechanical or hydrodynamic bearings.

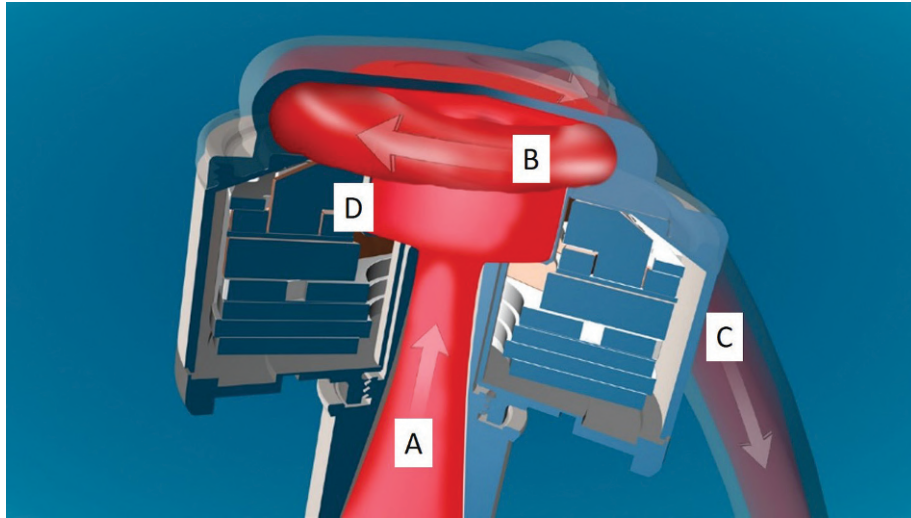
The absence of critical positioning and mechanical friction between the rotor and housing enables the *artificial pulse* feature. This feature involves rapid speed changes from the physician-selected speed, or set point, first to 2,000 rpm below the set point, then to 2,000 rpm above the set point, before a return to the set point (Figure 12.5). This



**Figure 12.3.** In the HeartMate 3, a rotor (A) with its incorporated permanent magnet is levitated and driven (i.e., turned) by appropriately powered electromagnets in (B) the motor, which is enclosed within the housing (C).

Reproduced with permission of Abbott, © 2019. All rights reserved.

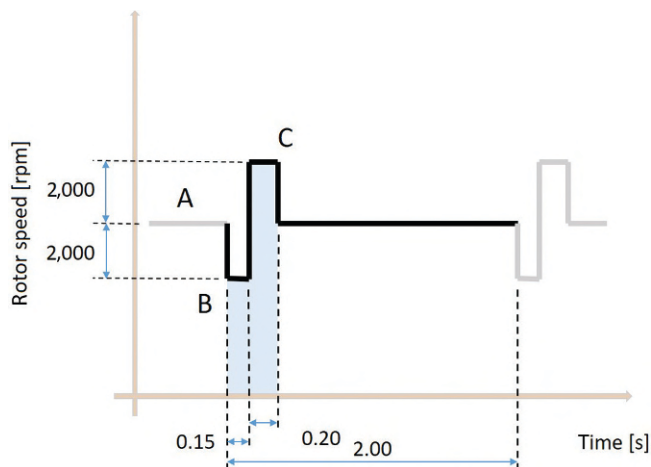




**Figure 12.4.** In the HeartMate 3, blood enters the pump inflow cannula (A), is centrifugally accelerated by the rotor into a volute (B) and is expelled through the outflow graft (C). Recirculation paths surround the rotor (D).

Reproduced with permission of Abbott, © 2019. All rights reserved.

speed change sequence is repeated 30 times per minute and is asynchronous with native contraction. A primary benefit of the artificial pulse is that it varies the flow to disrupt any regions of stasis that otherwise might develop in the pump, especially in patients with poor native contractility and a high degree of pump support. Whether this benefit extends outside the pump and whether synchronizing (or counter-synchronizing) the artificial pulse with the native contraction augments such effects remain to be studied.



**Figure 12.5.** The HeartMate 3 artificial pulse feature involves rapidly changing from the physician-selected setpoint speed (A), first to a speed 2,000 rpm lower than the setpoint (B), then to a speed 2,000 rpm faster than the setpoint (C), before returning to the setpoint.

Reproduced with permission of Abbott, © 2019. All rights reserved.

The HM3 pump is implanted in the thorax, in parallel to the native circulation, with the inflow cannula inserted into the ventricle and the polyester outflow graft anastomosed to the ascending aorta. Except for the rotor and the wall of the housing that faces the rotor, the entire blood-contacting surface of the titanium housing is covered with sintered titanium microspheres. This covering is an alternative to polishing blood-contacting surfaces, avoids seams and joints between connecting parts, and was used successfully in the HeartMate XVE and HMII. The premise is that, should a circulating protein adhere to the surface, the protein will stabilize and remain adherent to the interstices of the textured surface.

## Clinical Outcomes of the HM3

The initial clinical experience with the HM3 in Europe was a series of 50 patients that led to CE (Conformité Européenne) Mark approval (that is, the pump met the requirements of applicable European Union directives). The 6-month survival with the HM3 (92%) was better than the INTERMACS performance goal of 88%, and the HM3 reduced the risk of mortality by 66%, which was lower than the 78% predicted by the Seattle Heart Failure Model ( $P = 0.009$ ).<sup>7</sup> Rates of bleeding (14%), gastrointestinal bleeding (8%), driveline infection (10%), and debilitating stroke (8%) were similar to those with the HMII. Importantly, there were no pump thromboses, hemolysis events, pump malfunctions, or pump exchanges. Functional assessment, as measured by NYHA Classification, 6-minute walk test, and quality-of-life scores, showed progressive and sustained improvement for up to 2 years. A post-approval

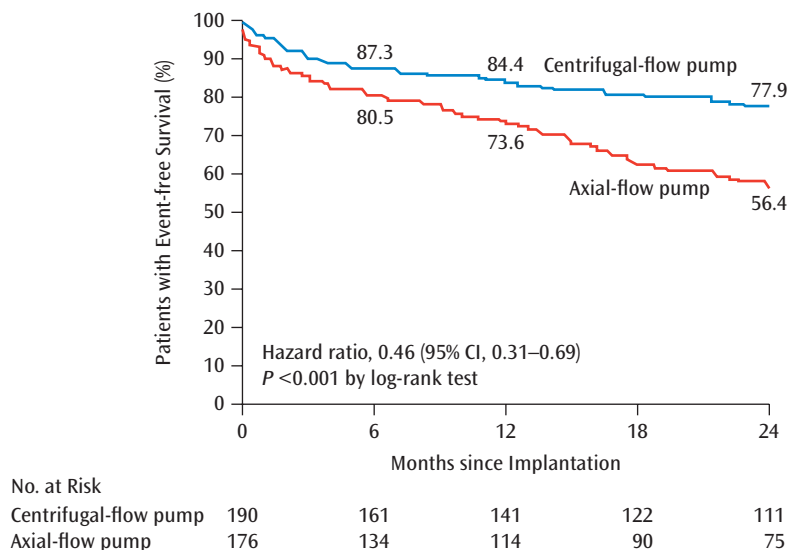
registry (ELEVATE; <https://clinicaltrials.gov/ct2/show/NCT02497950>) of 523 patients was started in August 2017 to track long-term follow-up results.

The Multicenter Study of MagLev Technology in Patients Undergoing Mechanical Circulatory Support Therapy with the HeartMate 3 (MOMENTUM 3; ClinicalTrials.gov number, NCT02224755) had an innovative adaptive design.<sup>8</sup> Patients with heart failure were enrolled under a single inclusion/exclusion criterion regardless of the intended use of the device (bridge to transplant, destination therapy, or bridge to recovery). Patients were randomly assigned 1:1 to the HMII or HM3. The trial design included a prespecified safety phase in which 30 patients were studied initially and in which these data informed the follow-up of an additional 264 patients to determine short-term outcomes, with a total enrollment of 366 patients to determine long-term outcomes. The primary end point was a composite of survival to transplant, recovery, or LVAD-support free of debilitating stroke (a modified Rankin Score >3 or reoperation to replace the pump in the intention-to-treat analysis. An additional 662 patients were enrolled, bringing the total sample to 1,028 patients, for which the secondary end point, the incidence of pump replacement at 2 years, was determined.

Of the 294 patients in the short-term cohort, 152 were assigned to the HM3 and 142 to the HMII. In the intention-to-treat analysis, the primary end point occurred in 86.2% in the HM3 and 76.8% in the HMII groups ( $P < 0.001$  for non-inferiority and  $P = 0.04$  for superiority).<sup>9</sup> Death and adverse event rates were similar for both groups, but the reoperation rate for pump malfunction was 0.7% in the HM3 group and 7.7% in the HMII group ( $P = 0.002$ ). Although the incidence

of suspected or confirmed pump thrombosis was 10.1% in the HMII group, it was zero in the HM3 group. As a result of these studies, the FDA approved the HM3 as a bridge to transplant in October 2017.

The burden of hemocompatibility-related adverse events, including any non-surgical bleeding, thromboembolic events, pump thrombosis, and neurological events, was measured by the hemocompatibility score in the short-term cohort.<sup>10,11</sup> In the 289 patients in the “as treated” analysis, survival free of hemocompatibility-related adverse events was 69% in the HM3 group and 55% in the HMII group ( $P = 0.012$ ). Patients with the HM3 had fewer instances of pump thrombosis requiring reoperation (0 vs. 5;  $P < 0.001$ ), medically managed pump thrombosis (0 vs. 12;  $P = 0.002$ ), and non-disabling strokes (3 vs. 12;  $P = 0.03$ ) than did the HMII group. There was no interaction between the primary end point and prespecified subgroups, including age, sex, race, therapeutic intent, and severity of illness.<sup>12</sup> Heart-related quality of life was measured with the European Quality of Life and the Kansas City cardiomyopathy questionnaires. Functional capacity was measured by NYHA class and the 6-minute walking test.<sup>13</sup> “Living well on an LVAD” was defined as NYHA Class I or II with a Kansas City cardiomyopathy score greater than 50. All patients in both groups improved significantly and equally from baseline on all four measures at 6 months ( $P < 0.001$  each). Quality of life in patients with serious adverse events did not differ from those without. However, serious adverse events were associated with lower 6-minute walking scores in both groups (HM3,  $P = 0.003$ ; HMII,  $P < 0.001$ ). Finally, 65% of patients in both groups were “living well on an LVAD” at 6 months.



**Figure 12.6.** Long-term (2-year) event-free survival for patients with the HeartMate 3 (centrifugal-flow) and HeartMate II (axial-flow) mechanical assist devices in the MOMENTUM 3 trial.

From Mehra MR et al., Two-year outcomes with a magnetically levitated pump in heart failure, *New England Journal of Medicine* 2018;387:1386–1395. Copyright © (2018) Massachusetts Medical Society. Reprinted with permission from Massachusetts Medical Society.

The 2-year follow-up of 366 patients in the MOMENTUM 3 trial found that the primary end point of event-free survival was better in the HM3 than in the HMII group (77.9% vs. 56.4%; hazards ratio [HR], 0.46;  $P < 0.001$ ; Figure 12.6). The 2-year survival rate of 82.8% with the HM3 was better than the 76.2% rate with the HMII and was the highest 2-year survival yet reported in an LVAD clinical trial.<sup>14</sup> The groups differed primarily in the rates of reoperation or device removal for pump malfunction (HM3, 1.6% vs. HMII, 17%; HR, 0.08;  $P < 0.001$ ). Suspected or confirmed pump thrombosis was present in 2 patients in the HM3 group (1.1%, although neither diagnosis was confirmed), and in 27 patients in the HMII group (15.7%; HR, 0.06;  $P < 0.001$ ). None of the HM3 pumps was replaced. A total of 22 strokes occurred in 19 patients (10.1%) in the HM3 group, and 43 strokes occurred in 33 patients (19.2%) in the HMII group (HR, 0.46;  $P = 0.02$ ). Other adverse events were similar between the two groups.

The HM3 was designed primarily to prevent pump thrombosis, and the trial data indicate that this goal has been met.

## Future Technologic Enhancements

The HM3's full MagLev platform can likely be modified to address other adverse events in mechanical circulatory support. To reduce the number of wires required in the percutaneous driveline, the motor and levitation control electronics were embedded in the pump. If these imbedded electronics can be further miniaturized, the more compact configuration could enable decreasingly invasive (e.g., sternal-sparing) surgical approaches to implantation. By positioning sources of heat dissipation where heat can be transferred harmlessly to the circulating blood, these imbedded electronics may allow a fully implanted pump that would eliminate driveline infection, a common adverse event in mechanical circulatory support. Simultaneously, increased capabilities to understand and test hemocompatibility, especially in relationship to existing devices with clinical histories, may help reduce morbidities beyond thrombosis, such as stroke, bleeding, and inflammation.

With the long-term prospect of adjunctive therapy providing a meaningful hope of remission to patients with heart failure, attention has turned toward “smart pumps” that will measure relevant physiologic variables and automatically adjust the nature and degree of circulatory support; optimize artificial pulse variables, which may involve synchronicity or counter-synchronicity with native systole; and adjust therapy during convalescence, such as shifting from one mode during acute decompensation to another during cardiac remission.

## Conclusions

The HM3 was designed in part to prevent thrombosis, and early clinical results indicate that it is, in fact, more hemocompatible than are other pumps. This innovative technology is a step in reducing adverse events and increasing the attractiveness of mechanical circulatory support as a desired treatment for end-stage congestive heart failure. Further clinical studies are needed to assess the optimal use of the pulse and appropriate anticoagulation and baroreceptor responses. Miniaturization is expected to enhance the ease of surgical implantation, allow fully implantable systems, and enhance communication to the pump, which will drive further physiologic adaptations and accelerate progress toward a truly “smart” pump that is “forgettable” and that will lead to broader application in these patients.

## REFERENCES

1. Jorde UP, Kushwaha SS, Tatooles AA, et al. Results of the destination therapy post-food and drug administration approval study with a continuous flow left ventricular assist device: a prospective study using the INTERMACS registry (Interagency Registry for Mechanically Assisted Circulatory Support). *J Am Coll Cardiol*. 2014;63:1751–1757.
2. Rogers JG, Aaronson KD, Boyle AJ, et al. Continuous flow left ventricular assist device improves functional capacity and quality of life of advanced heart failure patients. *J Am Coll Cardiol*. 2010;55:1826–1834.
3. Farrar DJ. HeartMate II continuous flow left ventricular assist system. In: Joyce DL, Joyce LD, Loebe M, eds. *Mechanical circulatory support: principles and applications*. 1st ed. New York: McGraw-Hill; 2012:206–211.
4. Starling RC, Moazami N, Silvestry SC, et al. Unexpected abrupt increase in left ventricular assist device thrombosis. *N Engl J Med*. 2014;370:33–40.
5. Maltais S, Kilic A, Nathan S, et al. PREVENTion of HeartMate II Pump Thrombosis Through Clinical Management: the PREVENT multi-center study. *J Heart Lung Transplant*. 2017;36:1–12.
6. Bourque K, Cotter C, Dague C, et al. Design rationale and preclinical evaluation of the HeartMate 3 left ventricular assist system for hemocompatibility. *ASAIO J*. 2016;62:375–383.
7. Netuka I, Sood P, Pya Y, et al. Fully magnetically levitated left ventricular assist system for treating advanced HF: a multicenter study. *J Am Coll Cardiol*. 2015;66:2579–2589.
8. Heatley G, Sood P, Goldstein D, et al. Clinical trial design and rationale of the Multicenter Study of MagLev Technology in Patients Undergoing Mechanical Circulatory Support with HeartMate 3 (MOMENTUM 3) investigational device exemption clinical study protocol. *J Heart Lung Transplant*. 2016;35:528–536.
9. Mehra MR, Naka Y, Uriel N, et al; MOMENTUM 3 Investigators. A fully magnetically levitated circulatory pump for advanced heart failure. *N Engl J Med*. 2017;376:440–450.
10. Mehra MR. The burden of haemocompatibility with left ventricular assist systems: a complex weave. *Eur Heart J*. 2017;40(8). doi:10.1093/eurheartj/ehx036

11. Uriel N, Colombo PC, Cleveland JC, et al. Hemocompatibility-related outcomes in the MOMENTUM 3 Trial at 6 months: a randomized controlled trial of a fully magnetically levitated pump in advanced heart failure. *Circulation*. 2017;135:203–212.
12. Goldstein D, Mehra M, Naka Y, et al. The impact of age, sex, therapeutic intent, race, and severity of advanced heart failure on principal outcomes in the MOMENTUM 3 Trial. *J Heart Lung Transplant*. 2018;37:7–14.
13. Cowger JA, Naka Y, Aaronson KD, et al. Quality of life and functional capacity outcomes in the MOMENTUM 3 Trial at 6 months: a call for new metrics for left ventricular assist device patients. *J Heart Lung Transplant*. 2018;37:15–24.
14. Mehra MR, Goldstein DJ, Uriel N, et al. Two-year outcomes with a magnetically levitated pump in heart failure. *N Engl J Med*. 2018;378:1386–1395.

# 13

## The HeartWare™ HVAD™ Left Ventricular Assist Device

NICHOLAS HIIVALA AND THOMAS VASSILIADES

### Introduction

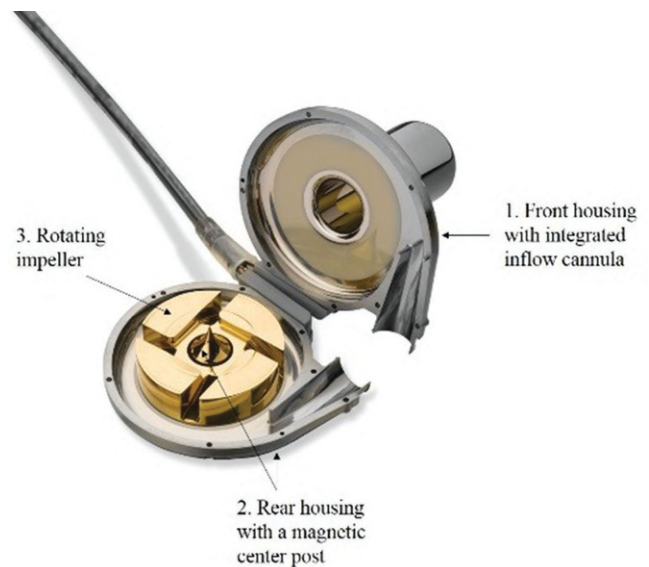
**T**he most recent estimates from the American Heart Association are that 6.5 million adults in the United States have heart failure (HF), with 960,000 new cases occurring each year. The prevalence of HF is projected to increase 46% by 2030, at which time more than 8 million adults will be affected.<sup>1</sup> The number of patients who die or endure a greatly diminished quality of life from HF continues to increase, despite new medical treatments and electrophysiological interventions.

Although cardiac transplantation remains the preferred treatment for advanced HF, the number of donors is limited, and the annual number of heart transplants has remained fairly constant for the past 15 years, despite a 34% increase in the number of candidates added to the wait list every year.<sup>2</sup> During the past 20 years, as improved technology has increased survival and decreased morbidity, bridging patients to cardiac transplantation (BTT) with continuous-flow left ventricular assist devices (LVADs) has gained wider use. Alternatively, and for the same reasons, more patients are being treated permanently with LVADs under the label of destination therapy (DT) for the remainder of life. In fact, the proportion of LVADs implanted for DT has increased over the past decade. By 2015, nearly 50% of continuous-flow LVAD implants were implanted as DT.<sup>3</sup>

Early pump technology sought to mimic the fill-eject pumping mechanism of the native heart, necessitating complex components and many moving parts that limited long-term use. Implantation also required a large body habitus. The HeartWare™ HVAD™ System uses a proprietary centrifugal, continuous-flow blood pump that is designed to be small, durable, and easy to insert and operate.<sup>4</sup> The pump was first implanted in humans on March 22, 2006.

### A Description of the HVAD System

The HVAD pump consists of a small, disc-shaped titanium housing that displaces a volume of 50 mL and weighs 160 g. Incorporated into the pump housing is the sintered inflow cannula that is placed in the apex of the left ventricle (LV). The pump uses magnetic and hydrodynamic forces to elevate and rotate the only moving part of the pump, the impeller. The pump has three main parts: a front housing with an integrated inflow cannula, a rear housing with a magnetic center post, and a rotating impeller (Figure 13.1). The front and rear housing are hybrid titanium-ceramic



**Figure 13.1.** The three components of the HeartWare HVAD pump.

Reprinted with permission from Medtronic, Inc.



**Figure 13.2.** The HVAD pump with the outflow graft, ringed strain relief, and driveline.  
Reprinted with permission from Medtronic, Inc.

assemblies that contain hermetically sealed dual-motor stators to improve efficiency and to provide redundant power sources for the impeller.

Attached to the pump housing is the 10-mm Gelweave™ gel-impregnated outflow graft that is attached to the aorta. A ringed strain relief secures the outflow graft to the pump and prevents kinking. A driveline, 4.8 mm in diameter, connects the HVAD pump to the external controller. The driveline includes six pacemaker-grade wires, each of which is insulated and individually wrapped. A Carbothane™ outer sheath helps inhibit cracking and discoloration. A portion of the driveline is encased in woven polyester velour to promote tissue ingrowth and intracorporeal driveline fixation (Figure 13.2) (Table 13.1).

## Theory of Operation

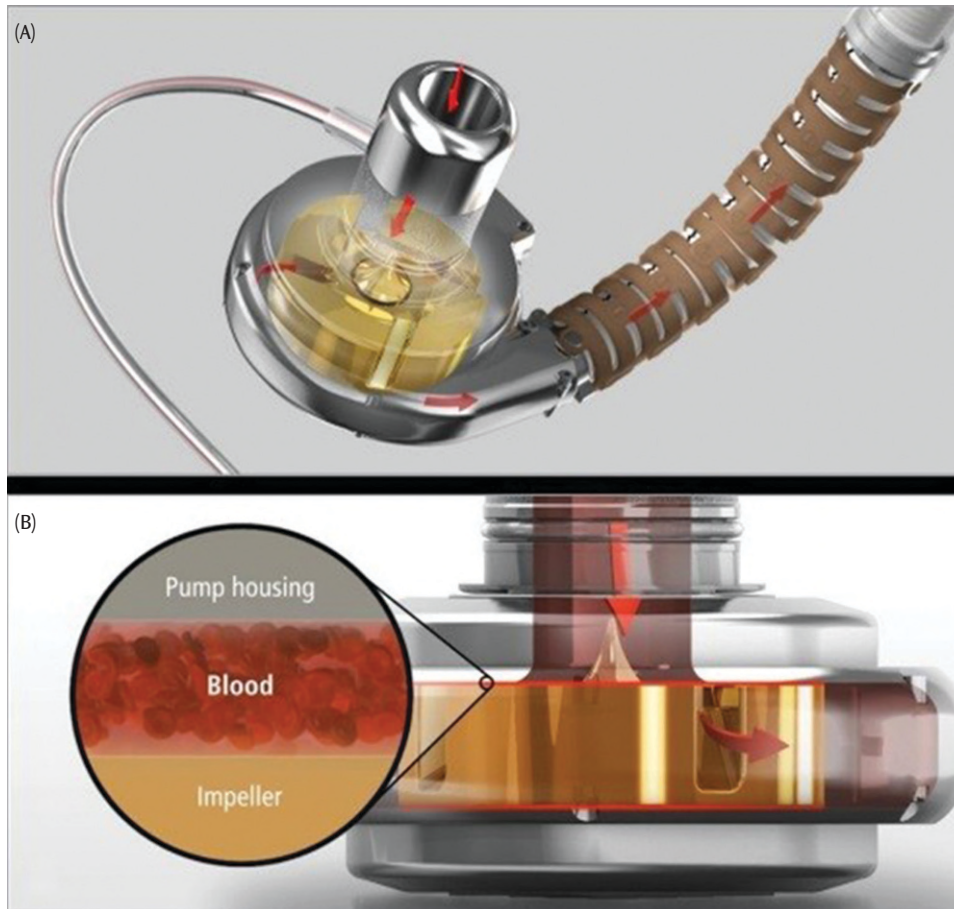
The pump is designed to use magnetic and hydrodynamic bearings. The wide-bladed impeller houses four large, rare-earth motor magnets that permit a short axial height and high motor efficiency. The impeller also contains a stack of three rare-earth magnets with like poles that contribute to the impeller suspension system. Another set of magnets stacked in the impeller post provides repulsive magnetic forces that maintain radial support for the impeller. The vertical alignment of the magnets within the center post is shifted downward relative to the impeller magnetic stack to develop an axial magnetic force that “pushes” the impeller toward the front housing. When the pump is on, blood entering the pump through the inflow cannula is distributed to the flow channels on the impeller by the center post (Figure 13.3). As the impeller rotates, the hydrodynamic thrust bearings that continuously push the impeller away from the front housing create lift. A blood barrier maintains the gap between the impeller and the front housing (Figure 13.3).

The impeller rotates at between 1,800 and 4,000 rpm and can produce a maximum flow rate of 10 L/min. The operating range of 2,400 to 3,200 rpm generates flows of 3.0 to 8.0 L/min under physiologic conditions. Blood flow through the HVAD is generated by three factors: pressure at the inlet of the pump (left ventricular pressure), pressure at the outlet

**Table 13.1 • Technical Features of the HeartWare HVAD Pump**

Feature	Description
Pump technology	Centrifugal, continuous-flow
Maximum flow	10 L/min
Pump weight	160 g
Pump volume	50 cm <sup>3</sup>
Wear-less (no mechanical bearings)	Yes
Impeller suspension	Hydrodynamic, passive magnetic
Electric motor-driveline redundancy	Yes
Pump speed	1,800 to 4,000 rpm
Operating speed	2,400 to 3,200 rpm
Operating power	3.0 to 6.0 W
Inflow cannula length	25 mm
Inflow cannula outside diameter	21 mm
Outflow graft inside diameter	10 mm
Driveline outside diameter	4.8 mm

Reprinted with permission from Medtronic, Inc.



**Figure 13.3.** (a) Primary blood flow path through the HVAD pump. (b) Blood barrier between the impeller and the front housing.

Reprinted with permission from Medtronic, Inc.

of the pump (aortic pressure), and the rotational speed of the impeller (Figure 13.4). The pressure difference between the aorta and the LV is known as the pressure differential ( $\Delta p$ ) and varies inversely with flow through the pump.

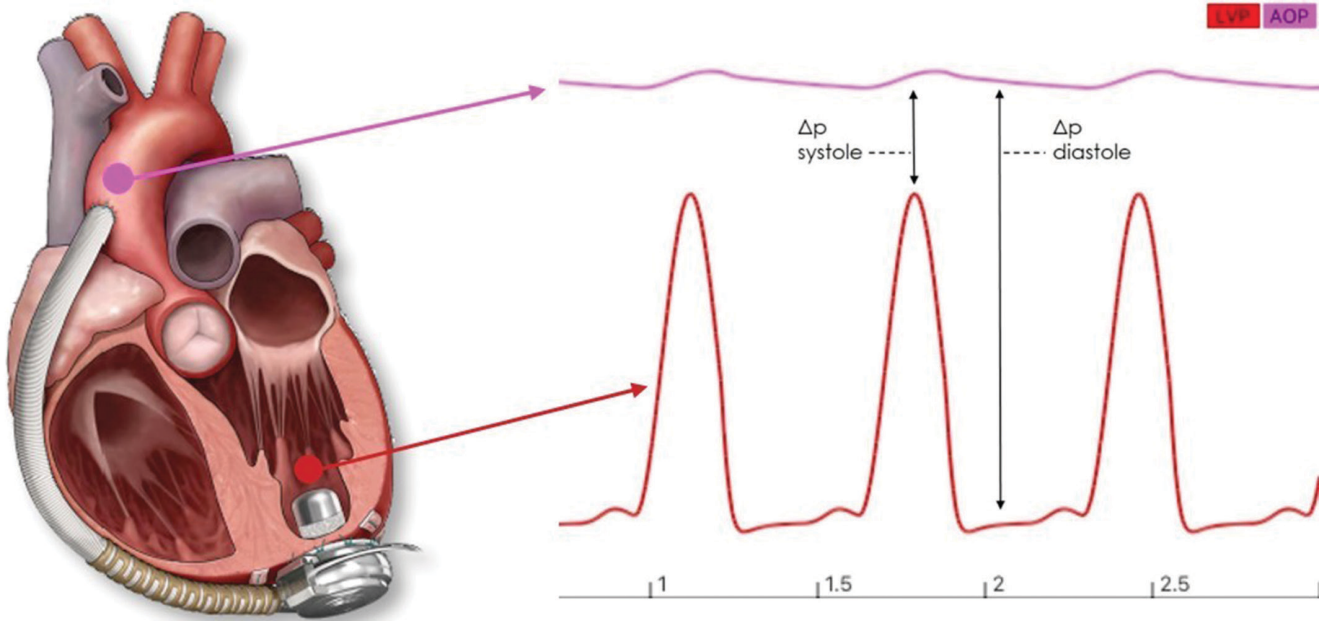
Implanting the HVAD introduces the inflow cannula into the left ventricle, potentially altering ventricular flow and creating areas of blood stasis that may lead to adverse events.<sup>5</sup> The HVAD has an optional speed modulation feature, the Lavare™ cycle, designed to alter flow patterns and reduce areas of stasis within the LV. When the Lavare™ cycle is on, pump speed is altered every 60 seconds. First, the speed is reduced by 200 rpm from the set speed for 2 seconds, then it is increased by 400 rpm (200 above the set speed) for 1 second before returning to baseline for 57 seconds, until the cycle starts again (Figure 13.5).

## Surgical Implantation

The HVAD was designed to be implanted entirely in the pericardial space above the diaphragm, without the need

for an abdominal pocket or sub-diaphragmatic dissection (Figure 13.6). It can be implanted through a median sternotomy or a left thoracotomy under cardiopulmonary bypass. The device has been successfully implanted without bypass, although with considerable risk.<sup>6</sup> Once the heart and LV apex have been exposed, a sewing ring is attached to the apex using pledgeted sutures, and a left apical core is removed using a proprietary coring tool. It is critical that the inside of the LV be inspected for thrombi, debris from the coring, and any intraventricular structures that may impede blood flow or affect inflow cannula position within the LV (Figure 13.7). The optimal inflow cannula position is aimed toward the mitral valve, parallel to the intraventricular septum.

Once the inflow cannula has been inserted through the sewing ring into the LV, the sewing ring set screw is tightened, securing the pump to the heart. Next, the outflow graft is cut to the desired length and anastomosed end-to-side to the ascending aorta. Implants have been successfully done with the outflow graft directed to the descending aorta and axillary artery, although these methods introduce



**Figure 13.4.** Blood flow depends on the set pump speed and the pressure difference ( $\Delta p$ ) between the left ventricle (red) and the aorta (pink). Under normal conditions and fixed speed, flow decreases when  $\Delta p$  is large and increases when  $\Delta p$  is small. Reprinted with permission from Medtronic, Inc.

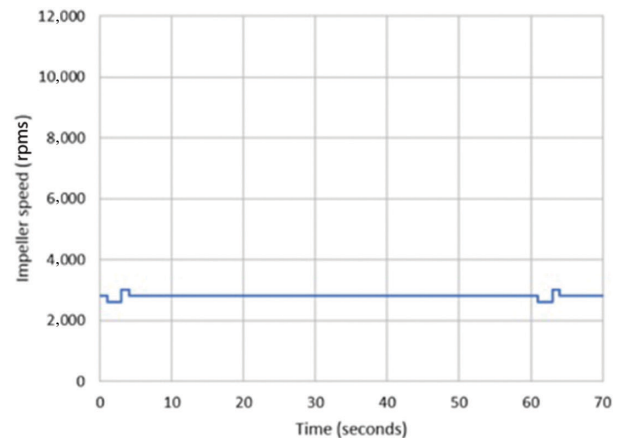
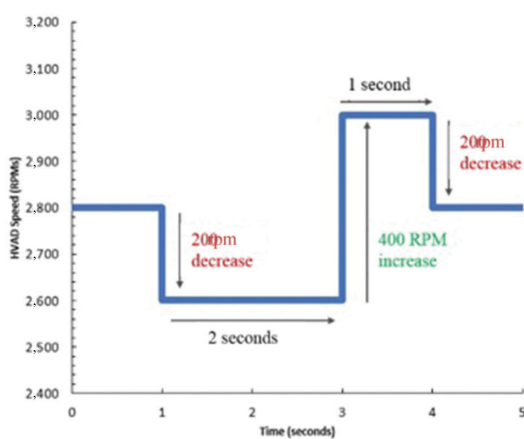
additional complications (e.g., ensuring aortic root washing with a descending aorta anastomosis). The driveline is tunneled subcutaneously to the percutaneous exit site in either the right or left upper abdominal quadrant using a proprietary driveline tunneling tool. The driveline connects to the external system controller (Figure 13.8), and once de-airing vents are in place, the pump can be turned on. The HVAD is started at 1,800 rpm and initially runs at low speeds until the system has been fully de-aired. Once de-airing is complete, pump speed is increased as cardiopulmonary bypass

support is decreased. The surgical incisions are then closed as usual.<sup>7</sup>

## External Components

The HeartWare HVAD System includes the following external components: a monitor, system controller, power sources, battery charger, and carrying bags.

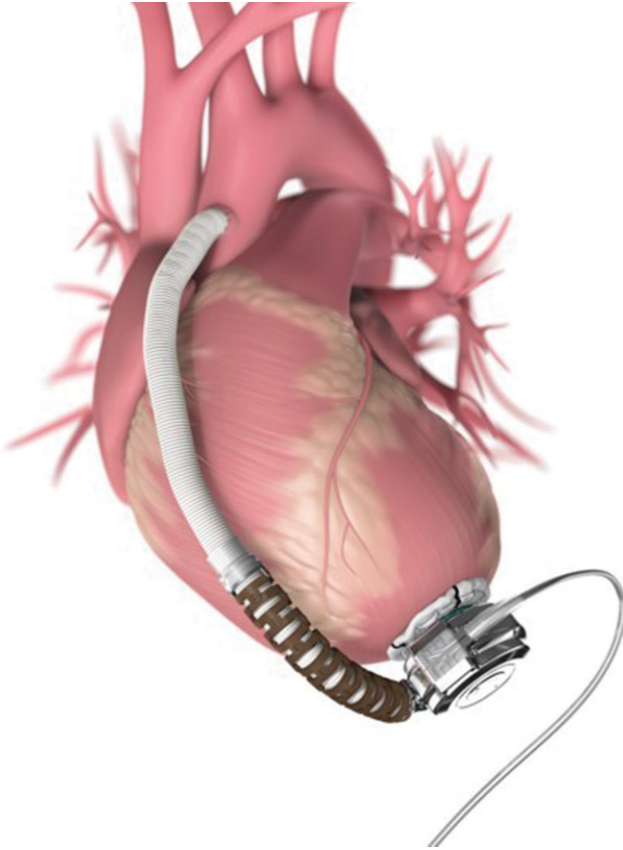
The **HeartWare Monitor** is a touch-screen tablet PC computer (Figure 13.9) that displays pump information,



**Figure 13.5.** Periods of the Lavare™ cycle for an HVAD with a baseline speed of 2,800 rpm (left) and Lavare™ cycle periodicity of one cycle every 60 seconds (right).

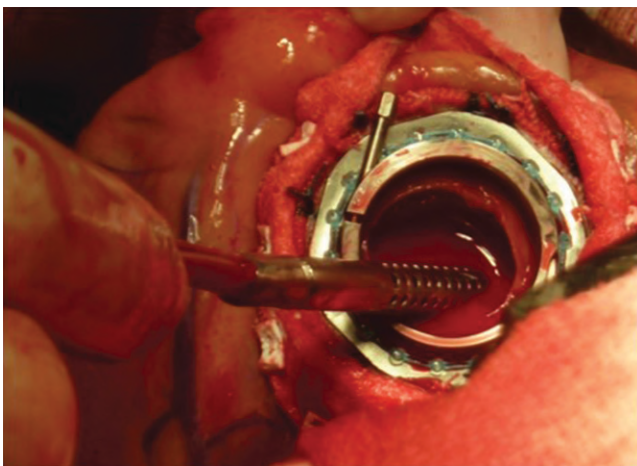
Reprinted with permission from Medtronic, Inc.





**Figure 13.6.** The HVAD is implanted entirely in the pericardium with LV apex to ascending aorta cannulation. Reprinted with permission from Medtronic, Inc.

allows pump settings to be adjusted, monitors and reports system errors and alarm conditions, and is used to update controller software. When the system is on, the monitor receives continuous pump information from the controller



**Figure 13.7.** View into the left ventricle through the sewing ring and apical core before placing the inflow cannula. Reprinted with permission from Medtronic, Inc.



**Figure 13.8.** The HVAD monitor (a touch-screen tablet) connected to a controller (a wearable, water-resistant microprocessor that controls and manages Pump operation) and two batteries. Reprinted with permission from Medtronic, Inc.

and displays it in real time as a waveform. Historical pump information, stored in the controller, is accessed through the monitor in the form of logfiles. Flow is calculated by an algorithm that includes power output, fluid viscosity (derived from the patient's hematocrit), and pump speed. Understanding how the waveform is generated helps interpret changes to the waveform (Table 13.2).<sup>8</sup> The waveforms themselves are not diagnostic, but they do provide vital information for assessing patients.

**Logfiles** are generated by plotting the historical pump settings stored in the controller. Every 15 minutes, the controller stores a snapshot of pump- and battery-related information. This information is sent to Medtronic for analysis, and a report is then sent back to the physician. Logfiles have been useful for detecting early stages of HVAD thrombosis, linking volume changes and arrhythmias to suction events, detecting battery issues, or for simply ensuring normal HVAD function in outpatients (Figure 13.9).<sup>9</sup>

The **HVAD Controller** (Figure 13.10) is a wearable, water-resistant microprocessor unit that controls and manages pump operation. The percutaneous driveline connects the pump to the controller. The controller sends and regulates power and operating signals to the pump and collects information from the pump. An LED screen displays real-time pump settings for power (in watts), speed (revolutions per minute), and flow (L/min), along with alarm conditions. Additional pump and patient information is available in the settings screen. Alarms (low, medium, and high priority) are accompanied by specific LED colors, sounds, and a digital readout on the controller screen.

The controller is set up, and its settings changed, through the monitor, which is connected to the controller through a data port. Users cannot change pump settings

**Table 13.2 • Common Changes in Cardiac Hemodynamics and HVAD Pump Characteristics, by Adverse Event**

Event	Dynamic Changes					Echocardiographic finding	HVAD Pump	
	CVP	PAP	PAOP	MAP	SVO <sub>2</sub>		Power	Pulsatility
Hypovolemia	↓	↓	↓	↓	↓	Underfilled	↓	↓
Tamponade	↑	↓ or no change	↓ or no change	↓	↓	RV compression	↓	↓
RHF	↑	↑ or no change	↓ or no change	↔	↓	Dilated RA/RV	↓	↓ or no change
Hypertension	↔	↑ or no change	↑ or no change	↑	↔	Dilated LA/LV, aorta opening	↓	↑
Occlusion	↑	↑	↑	↓	↓	Dilated LA/LV, aorta opening	↓ less than expected	↓
Hypervolemia	↑	↑	↑	↑	↑	Normal	↑	↑
Vasodilation	↔	↔	↔	↓	↑	Normal aorta opening	↑	↓
Aortic insufficiency	↔	↑	↑	↓	↓	AI, MR, Inc LVEDD	↑	↓
Thrombus	↑	↑	↑	↓	↓	Dilated LA/LV, aorta opening, MR	↑	↓

Abbreviations: HVAD = HeartWare ventricular assist device; CVP = central venous pressure; PAP = pulmonary arterial pressure; PAOP = pulmonary artery occlusion pressure; MAP = mean arterial pressure; SVO<sub>2</sub> = mixed venous oxygen saturation; RV = right ventricle; RHF, = right heart failure; RA = right atrium; LA = left atrium; LV = left ventricle; AI = aortic insufficiency; MR = mitral regurgitation; LVEDD = left ventricular end diastolic dimension.

Redrawn with permission from Medtronic, Inc.

through the controller itself. There are two connections for power sources, one for the driveline and one for the monitor. A non-replaceable, rechargeable battery inside the controller powers an audible “no power” alarm. This internal battery will not run the pump in the event of a double power disconnect.

The HVAD controller requires two **power sources** for safe operation: either two lithium-ion batteries, or one battery and a standard AC or DC connection. If only one is connected, the controller will function, but an alarm will sound after 20 seconds. While the pump is on, patients will typically use the two batteries, which drain sequentially and provide 4–7 hours of support each, allowing 8–14 hours between battery changes. When relaxing or sleeping, most patients power the HVAD system from an electric outlet through the AC adapter because it provides power for an unlimited amount of time. The controller notifies the patients when the batteries need to be changed.

The **battery charger** can simultaneously recharge up to four batteries at a time. Depleted batteries require 5–6 hours to fully charge.

The batteries and controller are carried in proprietary **packs** worn by the patient to provide mobility. A shower

bag also allows safe operation in the shower. The entire weight of this assembly is 2.85 lb (1.13 kg).

## Clinical Trials

The HeartWare™ HVAD™ System received a CE (Conformité Européenne) Mark in Europe in January 2009 for standards in the European Economic Area and US Food and Drug Administration (FDA) approval for use as a bridge to transplant (BTT) in November 2012 and for destination therapy in September 2017.

The CE Mark trial enrolled 50 patients in five centers in Europe and Australia. The primary end point was survival to heart transplant or to 180 days on the original device, whichever came first. Actuarial survival after 180 days was 91%.<sup>10</sup>

The ADVANCE Trial, conducted under a continued access protocol, was a prospective, multicenter clinical trial to evaluate the HVAD system for BTT in the United States (Figure 13.11; Table 13.3). The ADVANCE trial enrolled 140 patients beginning in August 2008. These patients were compared with a contemporaneous control group of

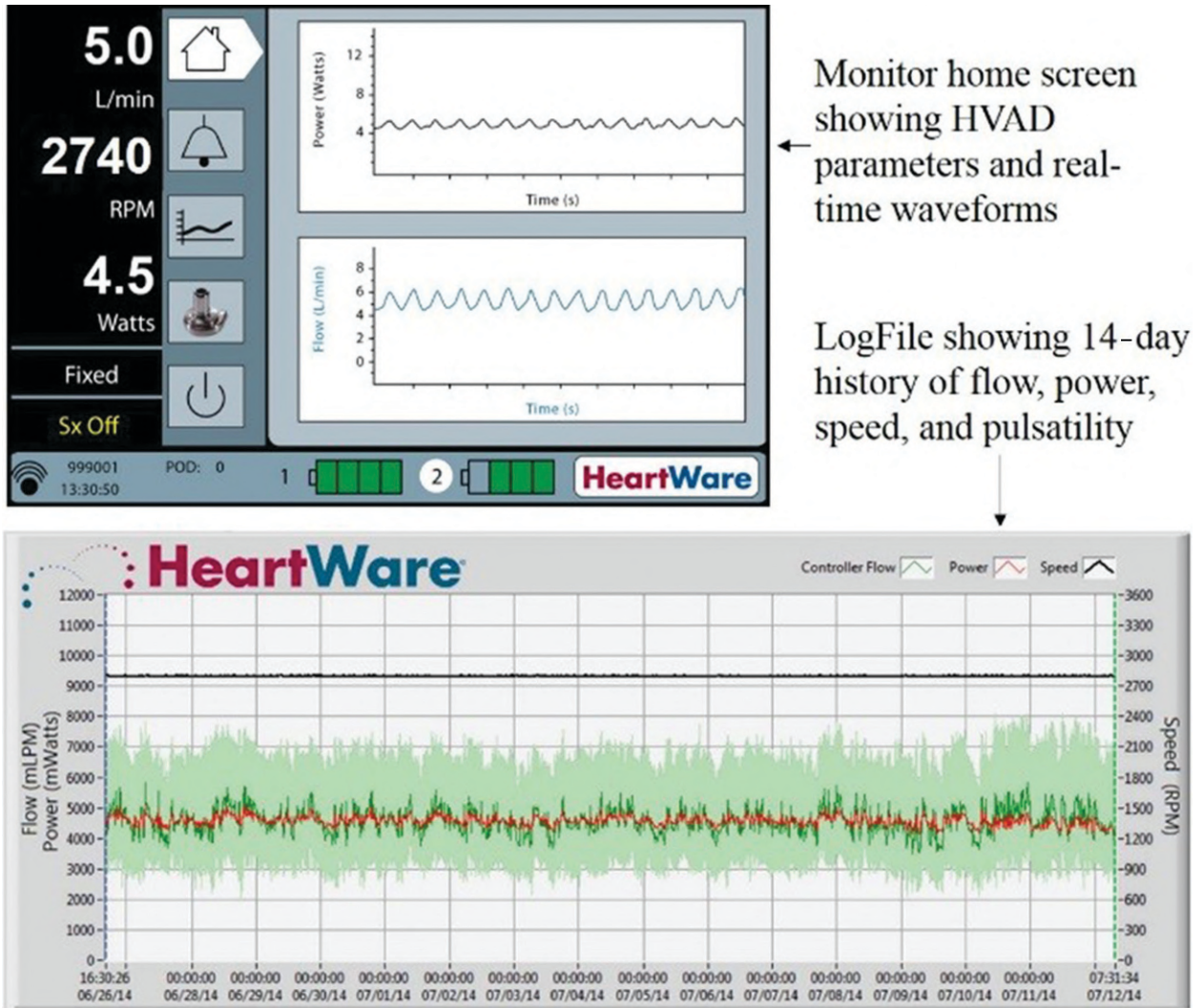
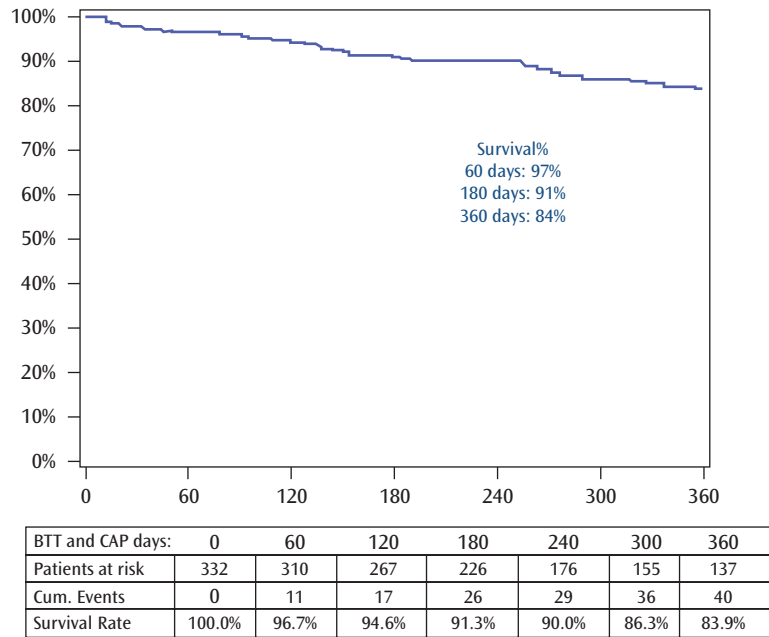


Figure 13.9. Examples of HVAD waveforms and logfiles. Reprinted with permission from Medtronic, Inc.



Figure 13.10. HVAD controller connected to one battery and AC power. Reprinted with permission from Medtronic, Inc.



**Figure 13.11.** Survival in the combined ADVANCED trial of the HVAD in 332 patients as bridge to transplant (BTT) and in the continued access protocol (CAP).

Reprinted with permission from Medtronic, Inc.

**Table 13.3 • Adverse Events in the ADVANCE Trial on the Continued Access Protocol<sup>a</sup> among 332 Patients Receiving the HeartWare HVAD Pump as a Bridge to Transplant**

Adverse Event	Events, <i>n</i>	Patients Affected, %	Event Rate per Person-Years
<b>Bleeding</b>			
Requiring reoperation	57	14.8	0.19
Gastrointestinal	82	12.7	0.27
<b>Infection</b>			
Sepsis	70	17.2	0.23
Driveline	75	16.9	0.25
<b>Renal dysfunction</b>	39	9.6	0.13
<b>Respiratory dysfunction</b>	96	22.0	0.31
<b>Right heart failure requiring RVAD</b>	11	3.3	0.04
<b>Stroke</b>			
Ischemic	28	7.5	0.09
Hemorrhagic	28	7.8	0.09
Transient ischemic attack	17	4.8	0.06
Device exchange after pump thrombosis	15	4.2	0.05

RVAD = right ventricular assist device.

<sup>a</sup> The CAP designation allows patients to continue to be treated at selected investigational sites while the marketing application is under review.

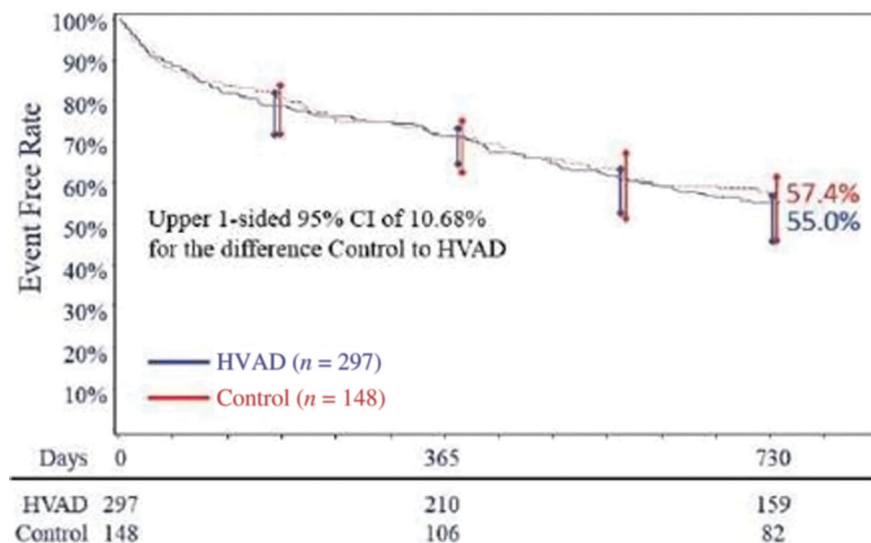
Reprinted with permission from Medtronic, Inc.

499 patients enrolled in the INTERMACS Registry (a North American registry for the clinical outcomes of patients who receive an FDA-approved mechanical circulatory support device to treat advanced HF) who received a commercially approved LVAD as BTT. The study met its primary end point, survival to 180 days or transplant, showing non-inferiority to the INTERMACS control group, 91% vs. 88% (non-inferiority,  $P < 0.001$ ). The FDA approved a continued-access protocol for the BTT indication for an additional 242 patients under the same enrollment criteria.<sup>11</sup> The HVAD was approved for BTT in the United States on November 20, 2012.

The ENDURANCE trial was a randomized trial that compared the safety and effectiveness of the HVAD system to an FDA-approved LVAD in patients with end-stage HF who did not qualify for heart transplantation. The trial enrolled 445 patients (as treated) beginning in August 2010; 296 patients received the HVAD system. The study met its primary end point, survival at 2 years without a disabling stroke and alive on the original device or transplanted or explanted secondary to patient recovery (Figure 13.12).<sup>12</sup> Despite meeting the primary end point, the rate of neurological injury was unacceptably high in the HVAD arm. Multivariate analysis revealed an association between blood pressure management and the rate of neurological complications. For the patients receiving an HVAD, mean arterial blood pressure measurements of 90 mmHg or lower were associated with a lower frequency of strokes, particularly hemorrhagic strokes. Blood pressure management was

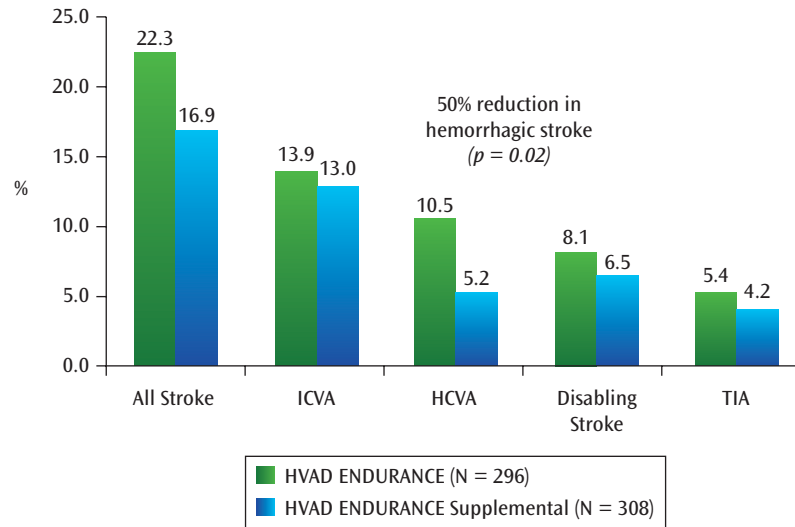
not mandated in the ENDURANCE trial. Based on these observations, a second trial was designed to examine the effect of blood pressure management on reducing neurological events.

The ENDURANCE Supplemental trial was a randomized, controlled, unblinded, multicenter trial that evaluated the effectiveness of a blood pressure management strategy on the rate of neurological injury in patients receiving the HVAD system and that helped qualify it for FDA approval as destination therapy. The blood pressure management protocol required the study subjects to check their blood pressure twice per day for at least the first 3 months following discharge until the mean arterial blood pressure remained in the recommended range of  $\leq 85$  mmHg for automated cuff or  $\leq 90$  mmHg for the Doppler cuff method. The trial enrolled 465 patients beginning in October 2013; 308 patients received the HVAD system. The trial did not meet its primary end point, non-inferiority of the HVAD system to limit the incidence of transient ischemic attack or stroke over 12 months. The upper confidence bound for the non-inferior margin (10.7%) exceeded the prespecified margin (6%), despite only a 2.6% absolute risk difference in neurological event rates. The overall incidence of neurological injury was lower than it had been in the original ENDURANCE trial, including a 50% reduction in hemorrhagic strokes (31/296 patients in the main trial vs. 16/308 in the supplemental trial (Figure 13.13).<sup>13</sup> Additionally, the composite secondary end point of freedom from death, disabling stroke, device exchange, and urgent transplant at 12 months with the HVAD was statistically superior to



**Figure 13.12.** Time-to-event for any of the components of the primary composite endpoint in the ENDURANCE trial. The endpoints were 2 years without a disabling stroke and alive on the original device or transplanted or explanted secondary to patient recovery.

Reprinted with permission from Medtronic, Inc.



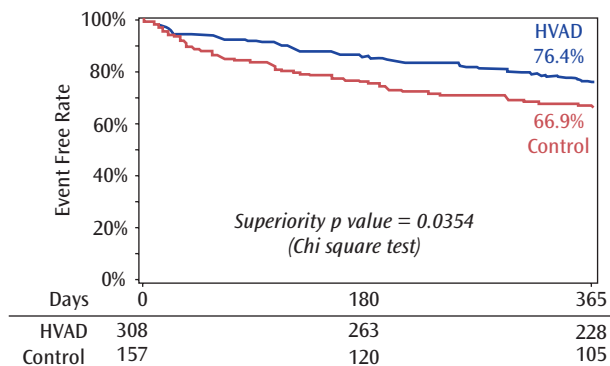
**Figure 13.13.** Incidence of all neurological events in the ENDURANCE and ENDURANCE Supplemental trials. ICVA = ischemic cardiovascular accident; HCVA = hemorrhagic cardiovascular accident; TIA = transient ischemic attack. Reprinted with permission from Medtronic, Inc.

that in the control group (Figure 13.14; Table 13.4). On the basis of these results, the FDA approved the HVAD System for DT on September 27, 2017.

The trials discussed thus far were undertaken with the HVAD pump implanted through a standard median sternotomy. However, given the small size of the pump and the diameter of the outflow graft, implanting the pump through a lateral thoracotomy, although off-label, was becoming increasingly common (Figure 13.15). Presumed benefits of this surgical approach include preserving the sternum for heart transplantation, reducing surgical trauma, and improving recovery time.

#### ENDURANCE SUPPLEMENTAL TRIAL

FREEDOM FROM DEATH, DISABLING STROKE (MRS  $\geq 4$ ), DEVICE EXCHANGE, AND URGENT TRANSPLANT AT 12 MONTHS



**Figure 13.14.** Freedom from death, disabling stroke (a modified Rankin score  $< 4$ ), device exchange, and urgent transplant between HVAD and Control in the ENDURANCE Supplemental trial.

Reprinted with permission from Medtronic, Inc.

The LATERAL trial was a prospective, controlled, unblinded trial that evaluated the thoracotomy implant technique of the HVAD system in patients with advanced HF. Between January 15, 2015, and April 26, 2016, 144 patients were enrolled at 26 sites in the United States and Canada. The study met its primary end point, with 89.5% of patients alive on the original device at 6 months, free from disabling stroke or device malfunction, by exceeding the performance goal of 77.5%. The target success estimate was based on the primary end point observed in the ADVANCE BTT + CAP Trial, post-approval outcomes in HVAD patients from the INTERMACS registry, and the INTERMACS report from Q1 2014. Adverse events included failure of the primary end point in 15 patients, death on the original end point in 11, stroke in 2, device exchange in 1, and explantation (not for recovery) in 1. The FDA approved the thoracotomy implant technique in 2018.

## Summary

The HeartWare™ HVAD™ System is a second-generation, continuous flow, centrifugal pump with both European CE mark and FDA approval for use in patients as a bridge to transplant or destination therapy. Its small size, integrated inflow cannula, and small-diameter outflow graft permit less invasive options for surgical implantation while still providing full cardiac support of up to 10 L/min. The only moving part, the impeller, makes no contact with the pump housing because of a combination of magnetic and hydrodynamic forces, resulting in a durable strategy for long-term support. Pump function can be evaluated under various clinical conditions by monitoring waveforms and logfiles, which can also assist in managing patients in a complex

**Table 13.4 • Adverse Events in the ENDURANCE Supplemental Trial among 308 Patients Receiving the HeartWare HVAD as Destination Therapy**

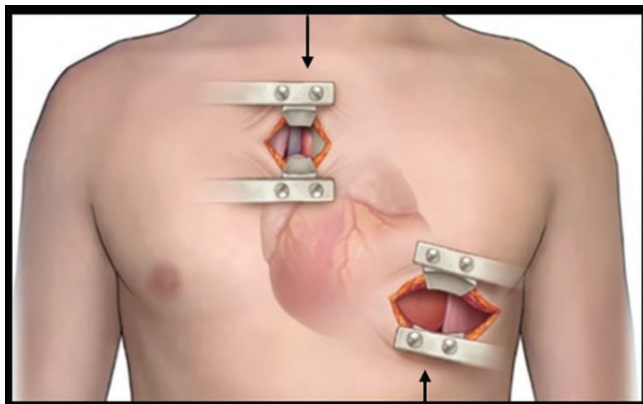
Adverse Event	Events, <i>n</i>	Patients Affected, %	Event Rate per Person-Years
<b>Bleeding</b>			
Requiring reoperation <sup>a</sup>	52	15.2	0.13
Gastrointestinal <sup>a</sup>	230	35.1	0.56
<b>Infection</b>			
Sepsis	84	23.6	0.2
Driveline	59	16.2	NA
<b>Renal dysfunction</b>	35	10.4	NA
<b>Respiratory dysfunction</b>	77	19.8	NA
<b>Right heart failure requiring RVAD <sup>a</sup></b>	8	2.7	0.02
<b>Stroke</b>			
Ischemic	58	13.0	NA
Hemorrhagic	17	5.2	NA
Transient ischemic attack	13	4.2	NA
Device exchange after pump thrombosis	NA	4.5	NA

NA = not available; RVAD = right ventricular assist device.

<sup>a</sup> Data are from the original ENDURANCE trial.

Reprinted with permission from Medtronic, Inc.

care environment. More than 1,000 patients have been enrolled in various HVAD clinical trials in Europe and the United States, including the first clinical trial to prospectively examine the effects of blood pressure management on neurological events in patients with LVADs. The HeartWare HVAD System is an important advance in mechanical circulatory support for patients with end-stage heart failure.



**Figure 13.15.** The HeartWare HVAD can be implanted through an anterior thoracotomy, and the ascending aortic artery can be accessed through an upper hemi sternotomy.

Reprinted with permission from Medtronic, Inc.

## REFERENCES

1. Benjamin EJ, Blaha MJ, Chiuve SE, et al. Heart disease and stroke statistics—2017 update: a report from the American Heart Association. *Circulation*. 2017;136(10):e196. doi: 10.1161/CIR.0000000000000530.
2. Colvin-Adams M, Smith JM, Heubner BM, et al. Optn/srtr 2013 annual data report: heart. *Am J Transplant*. 2015;15(Suppl 2):1–28.
3. Kirklin JK, Pagani FD, Kormos RL, et al. Eighth annual INTERMACS annual report: special focus on framing adverse events. *J Heart Lung Transplant*. 2017;36(10):1080–1086.
4. Tuzun E, Roberts K, Cohn WE, et al. In vivo evaluation of the HeartWare centrifugal ventricular assist device. *Tex Heart Inst J*. 2007;34(4):406–411.
5. Zimpfer D, Strueber M, Aigner P, et al. Evaluation of the HeartWare ventricular assist device Lavare cycle in a particle image velocimetry model and in clinical practice. *Eur J Cardiothorac Surg*. 2016;50:839–848.
6. Cheung A, Lamarche Y, Kaan A, et al. Off-pump implantation of the HeartWare HVAD left ventricular assist device through minimally invasive incisions. *Ann Thorac Surg*. 2011;91(4):1294–1296.
7. Slaughter MS. Implantation of the HeartWare left ventricular assist device. *Semin Thorac Cardiovasc Surg*. 2011;23:245–247.
8. Rich JD, Burkhoff D. HVAD flow waveform morphologies: theoretical foundation and implications for clinical practice. *ASAIO J*. 2017;63:526–535.

9. Chorpenning K, Brown MC, Voskobynikov N, et al. HeartWare controller logs a diagnostic tool and clinical management aid for the HVAD pump. *ASAIO J*. 2014;60(1):115–118.
10. Strueber M, O'Driscoll G, Jansz P, et al.; HeartWare Investigators. Multicenter evaluation of an intrapericardial left ventricular assist system. *J Am Coll Cardiol*. 2011;57:1375–1382.
11. Slaughter MS, Pagani FD, Mcgee EC, et al. HeartWare ventricular assist system for bridge to transplant and continued access protocol. *J Heart Lung Transplant*. 2013;32(7):675–683.
12. Rogers JG, Pagani FD, Tatroles AJ, et al. Intrapericardial left ventricular assist devices for advanced heart failure. *N Engl J Med*. 2017;376(5):451–460.
13. Milano CA, Rogers JG, Tatroles AJ, et al. The treatment of patients with advanced heart failure ineligible for cardiac transplantation with the HeartWare Ventricular Assist Device: results of the ENDURANCE Supplement Trial. *J Heart Lung Transplant*. 2017;36(4):S10.



# 14

## The Medtronic Miniature Left Ventricular Assist Device (MVAD)<sup>TM</sup> System

NICHOLAS HIIVALA AND THOMAS VASSILIADES

### Introduction

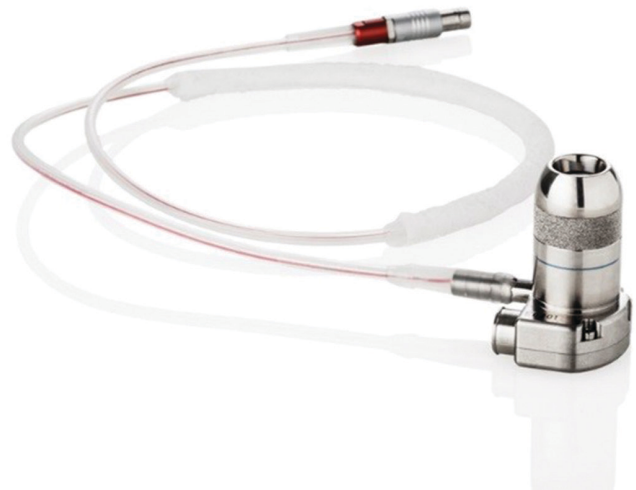
The Medtronic miniature intraventricular, continuous-flow, left ventricular assist device (MVAD)<sup>TM</sup> system is an axial pump capable of providing cardiac support in patients with end-stage systolic heart failure.

### The Medtronic Miniature Ventricular Assist Device

The MVAD pump can be implanted according to the surgeon's preference (e.g., sternotomy or thoracotomy). The inflow to the pump is inserted into the left ventricular apex and moves blood to the ascending aorta through a 10-mm outflow graft. The system is controlled by an external microprocessor connected transcutaneously through a thin, flexible driveline and is powered by lithium-ion batteries or AC/DC power.

The pump consists of one moving part: a platinum alloy impeller suspended in a ceramic tube (Figure 14.1). The pump weighs 67 g and displaces 20 cc of volume. The impeller incorporates wide helical flow channels and is kept suspended in the housing by a hybrid system of passive magnetic and hydrodynamic forces, reducing wear and minimizing shear stress on the circulating blood (Figure 14.2).

A 10-mm Gelweave<sup>TM</sup> gel-impregnated outflow graft is connected at 90 degrees from the pump by a quick-connect metal ring. A ringed strain relief secures the outflow graft to the pump and prevents kinking. The pump is attached to the left ventricle (LV) with a gimbaled sewing ring that allows adjusting both the inflow depth into the LV and the inflow angle to optimize inflow positioning, once the pump is implanted. Connecting the MVAD pump to the external

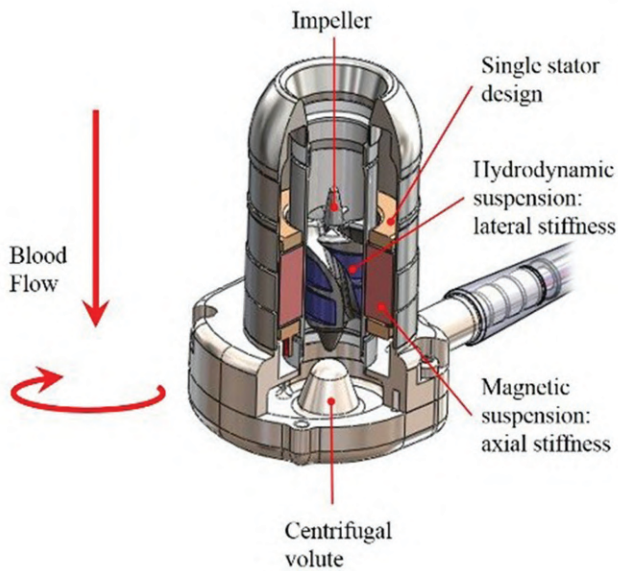


**Figure 14.1.** The Medtronic miniature left ventricular assist device (MVAD)<sup>TM</sup> pump with driveline. Reprinted with permission from Medtronic, Inc.

controller is a 3.5-mm-diameter driveline. A portion of the driveline is encased in woven polyester velour to promote tissue ingrowth and intracorporeal driveline fixation. In the event of pump explant for recovery, a titanium HeartWare<sup>TM</sup> plug is inserted through the metal sewing ring once the pump has been removed (Table 14.1).

### Theory of Operation

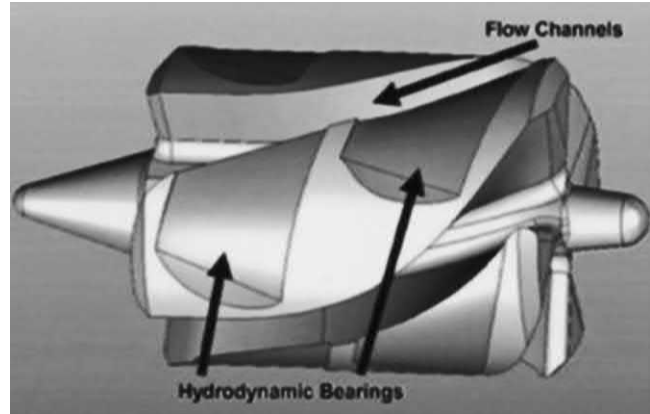
The MVAD impeller is part of a wear-less, hybrid suspension system that employs both magnetic and hydrodynamic forces (Figure 14.3). The magnetic interaction between the stator and impeller provides axial stiffness, and eight hydrodynamic thrust bearings on the impeller



**Figure 14.2.** The impeller, stator, and hybrid impeller suspension system.

Reproduced with permission from Medtronic, Inc.

surface produce the radial forces required to hydraulically suspend the impeller inside the titanium tube. The motor stator geometry has been matched to the magnetic signatures of the impeller to achieve optimal motor efficiency while maintaining the desired axial stiffness. A sensorless, brushless motor, consisting of three coils in the pump housing, are sequentially activated, generating the necessary force to rotate the impeller. One coil is driven high to push the impeller, a second coil is driven low to pull the



**Figure 14.3.** The wide helical flow channels and hydrodynamic bearings on the impeller.

Reprinted with permission from Medtronic, Inc.

impeller, and the third coil is placed in a high-impedance state to measure back electromagnetic force. Back electromagnetic force is a key feature in several motor and physiological control algorithms because it helps run the motor at a constant speed. The rotating impeller generates a static pressure head, providing the necessary energy to move blood from the LV to the arterial system under physiologic conditions. MVAD pump speeds range between 8,000 to 18,000 rpm and can generate 1–7 L/min of blood flow at a mean arterial pressure of 75 mm Hg.<sup>1,2</sup>

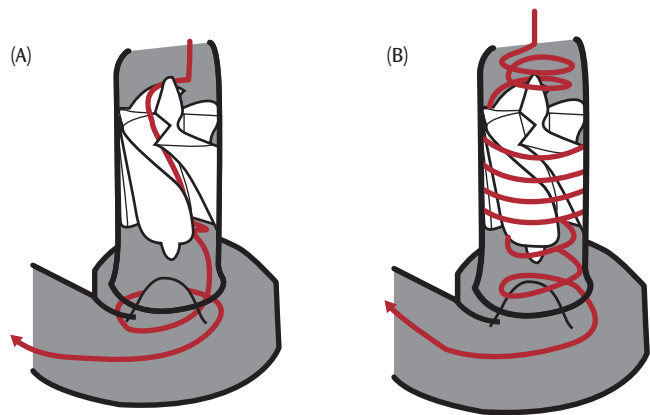
In the MVAD pump, blood flows through two flow paths. In the primary path, blood enters the pump, moves through the impeller, and exits the pump through the outflow port into the outflow graft. In the secondary flow path, blood flows across the gap between the impeller and the ceramic tube, creating radial thrust bearings (Figure 14.4).

Despite running at a fixed speed, three pump algorithms, when enabled, allow for automatic speed changes. Suction

**Table 14.1 • MVAD System Technical Specifications**

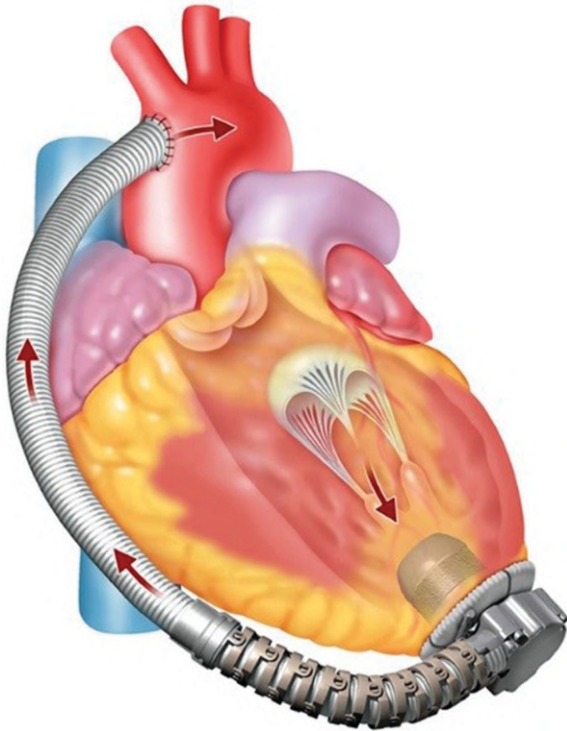
Pump technology	Axial, continuous-flow
Maximum flow, L/min	7
Pump weight, grams	67
Pump volume, cm <sup>3</sup>	20
Wear-less, no mechanical bearings	Yes
Impeller suspension	Hydrodynamic, passive magnetic
Pump speed, rpm	8,000–18,000
Operating speed, rpm	13,000–16,000
Inflow cannula length, mm	35
Inflow cannula OD, mm	21
Outflow graft ID, mm	10
Driveline OD, mm	3.5

Reprinted with permission from Medtronic, Inc.



**Figure 14.4.** The (A) primary and (B) secondary blood flow paths through the pump.

Reprinted with permission from Medtronic, Inc.



**Figure 14.5.** The pump in place in the left ventricle and the outflow graft anastomosed to the ascending aorta. Reprinted with permission from Medtronic, Inc.

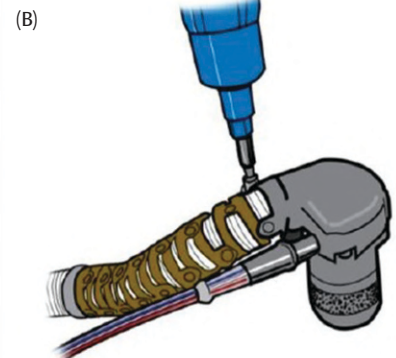
is detected by an algorithm that responds to a sudden decrease in baseline flow, which is often caused by LV collapse or inflow obstruction. When activated, the suspected suction condition first slows the pump and then slowly increases it back to the set speed in an attempt to clear the conditions leading to suction. The qPulse cycle enables periodic, controlled variation in pump speed to provide some degree of pulsatile flow and aortic valve opening. The Pump Pressure algorithm responds to high pressure and automatically decreases the speed when a high-pressure

condition is detected. For instance, if the pump is running at high speeds during low-flow conditions, high pump head pressures may destabilize the impeller, causing it to contact the mechanical stop in the pump housing. This default feature should not be turned off.

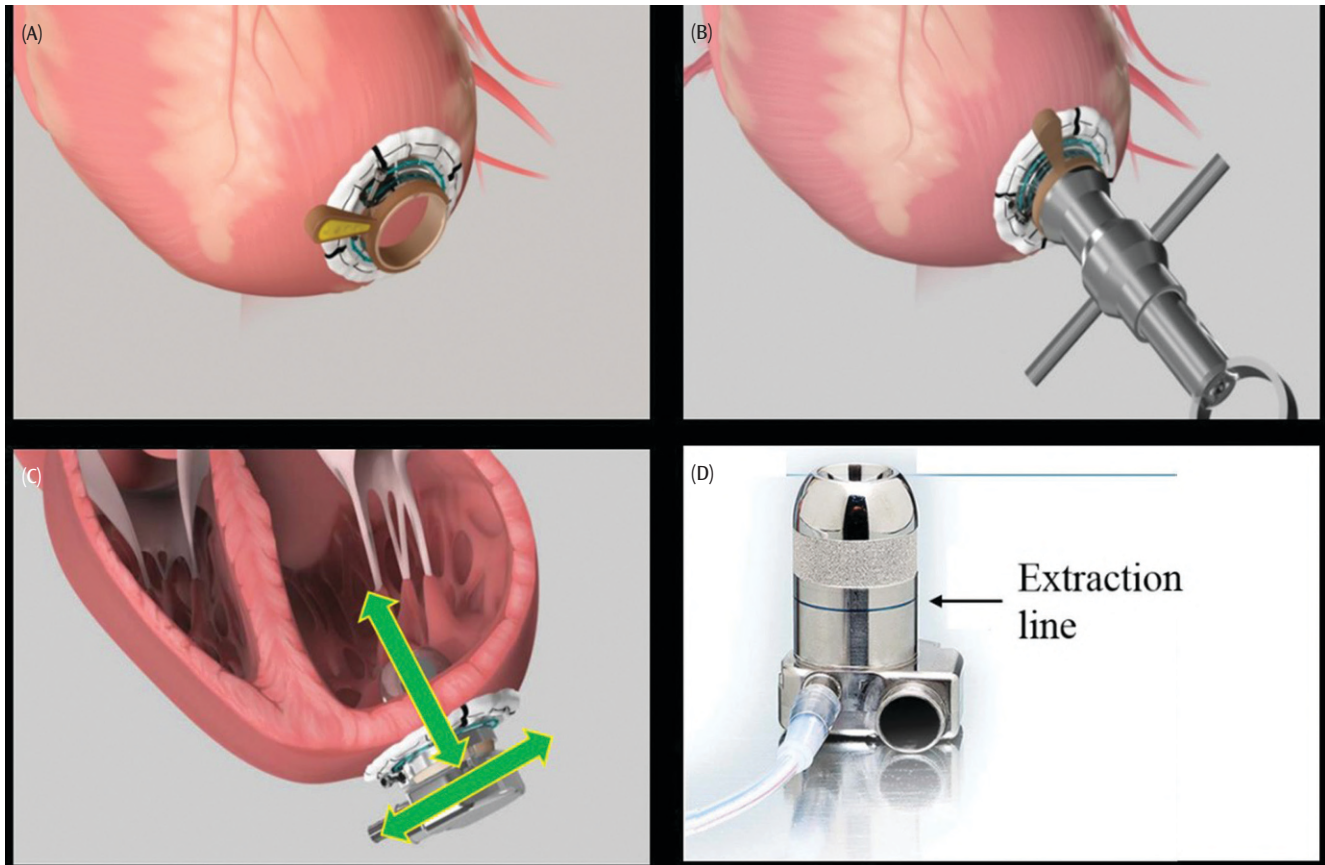
## Surgical Implantation

The MVAD was designed to be implanted entirely in the pericardial space above the diaphragm, without the need for an abdominal pocket or sub-diaphragmatic dissection (Figure 14.5). Before implant, the pump is tested, and the outflow graft with the strain relief is attached (Figure 14.6). The pump can be implanted through a median sternotomy or left thoracotomy under cardiopulmonary bypass. Once the heart and LV apex have been exposed, the gimbaled sewing ring is attached to the apex with pledgeted sutures. The gimbal features a ball-and-socket design and is fixed with a C-clamp zero-positioning tool for LV coring. A left apical core is removed using a proprietary coring tool (Figure 14.7). The inside of the LV must be thoroughly inspected for preexisting thrombi, debris from the coring, and any intraventricular structures that may impede blood flow or affect inflow position within the ventricle.

The optimal inflow cannula position is toward the mitral valve, parallel to the intraventricular septum, and can be adjusted with the gimbaled sewing ring under echocardiographic guidance. The gimbal allows angular adjustment for up to 10° and depth adjustment for about 11 mm. The inflow is marked with an extraction indicator line that marks the outer limit of inflow withdrawal from the LV (Figure 14.7). Once the correct orientation has been established by echocardiography, the sewing ring is tightened, securing the pump to the heart. Next, the outflow graft is cut to the appropriate length and anastomosed to the ascending aorta. The driveline is tunneled subcutaneously to a percutaneous exit site in either the right or left-upper abdominal quadrant using a proprietary driveline-tunneling tool.



**Figure 14.6.** The outflow graft (A) with ringed strain relief and (B) being attached to the pump. Reprinted with permission from Medtronic, Inc.



**Figure 14.7.** (A) The gimballed sewing ring with the zero-position tool attached to the apex of the left ventricle. (B) The coring tool attached to the sewing ring. (C) The gimbal allows the insertion depth and angle of the pump to be adjusted. (D) The extraction indicator line indicating the limit of inflow withdrawal limit.

Reprinted with permission from Medtronic, Inc.

When the driveline is connected to the external system controller, the pump can be turned on. The MVAD is started at 8,000 rpm and initially run at low speeds until the system has been fully de-aired. Once de-airing is complete, the MVAD speed is increased as cardiopulmonary bypass (CPB) support is decreased. The surgical incisions are then closed in the usual manner.

## External Components

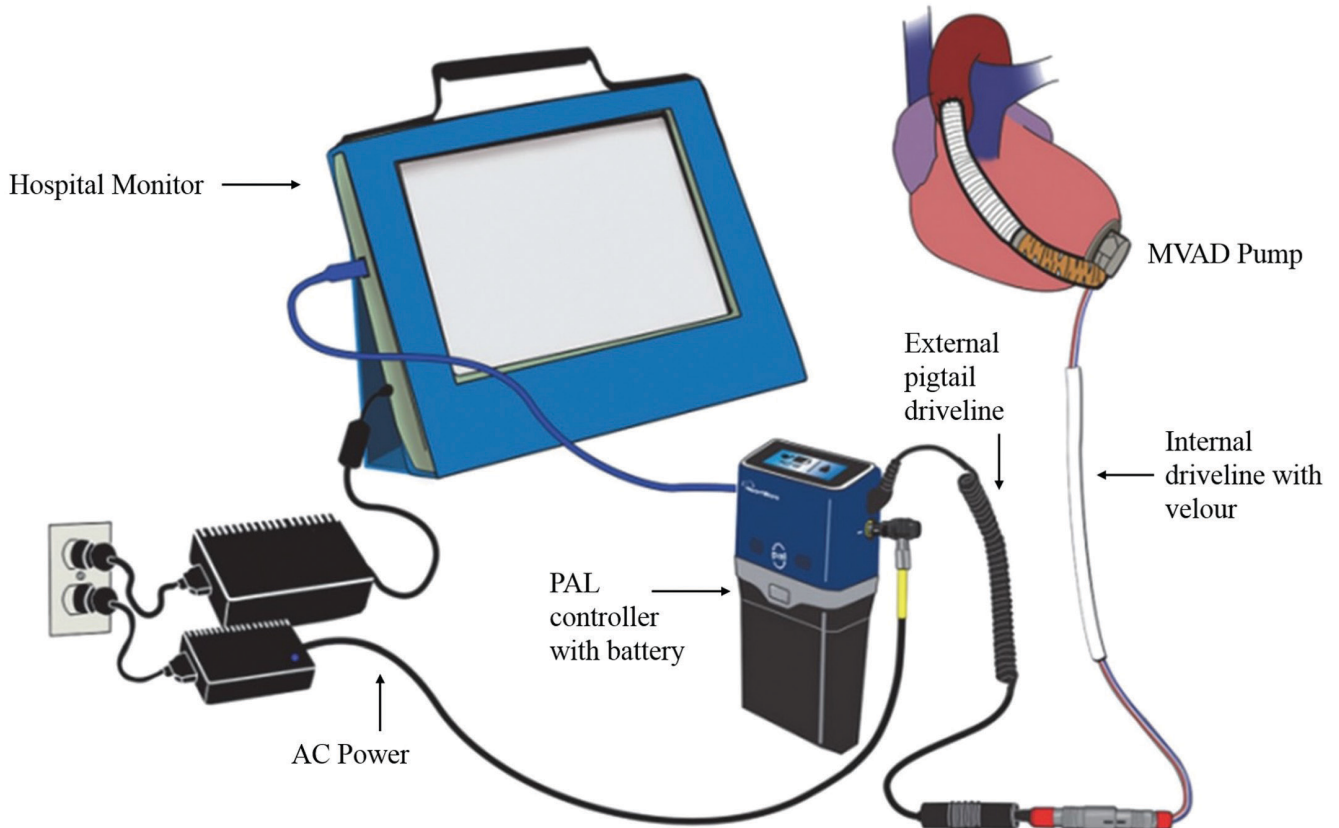
The MVAD System includes several external components (Figure 14.8).

The **HeartWare Monitor** is a touch-screen tablet PC computer that displays pump information, allows users to adjust pump settings, monitors and reports system errors and alarm conditions, and is used to update controller software (Figure 14.9). When connected to a controller, the monitor receives continuous pump information from the controller.

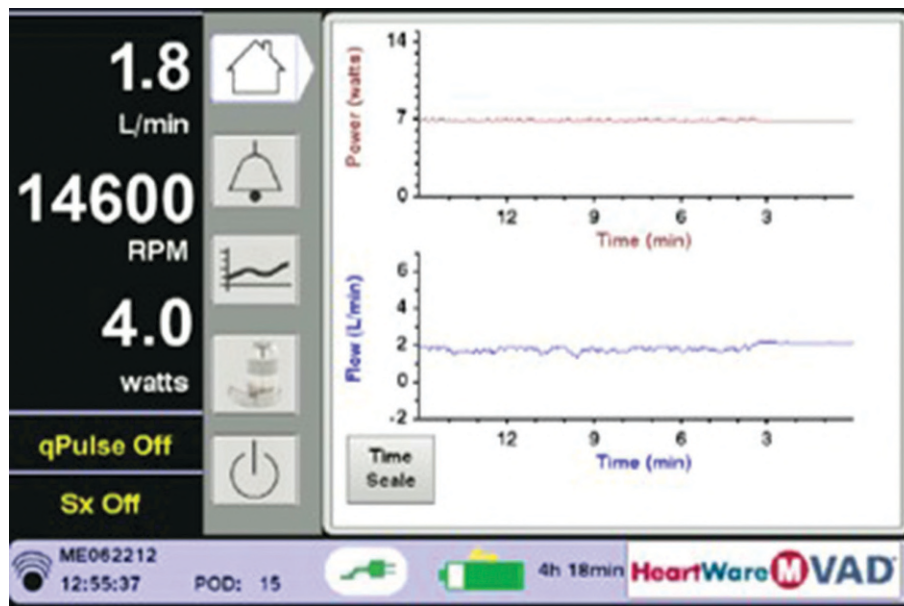
Real-time information about pump function is displayed on the monitor as waveforms. Historical pump information,

stored in the controller, is accessed through the monitor as logfiles. Flow is a calculated value and is only available at speeds above 11,000 rpm. Logfiles are generated by plotting the historical pump settings stored in the controller. Every 10 minutes, the controller stores a snapshot of pump- and battery-related information. This information is sent to Medtronic for analysis, and a report can be sent back to the physician.

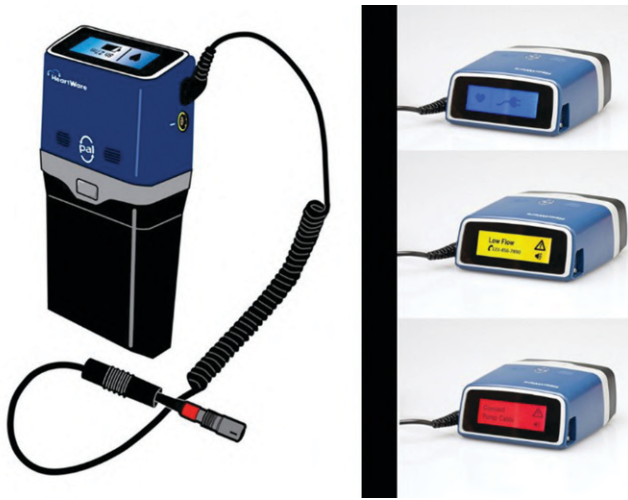
The **Pal controller** is a wearable, water-resistant micro-processor unit that regulates pump function and monitors the overall system. Once the driveline has been tunneled percutaneously, it connects to the Pal controller through an integrated, pigtail driveline cable (Figure 14.10). The pigtail feature was designed to absorb the stresses and strains placed on the driveline exit site and to mitigate damage to system components. The user interface is a monochrome touchscreen LCD that provides auditory, visual, and vibratory alerts. The monochrome screen reflects system status, with blue being normal function, yellow being a non-critical alarm, and red being a critical alarm (Figure 14.10).



**Figure 14.8.** The components of the MVAD system.  
Reprinted with permission from Medtronic, Inc.



**Figure 14.9.** The LCD monitor home screen showing the pump settings and the power (red) and flow (blue) waveforms.  
Reproduced with permission from Medtronic, Inc.



**Figure 14.10.** Pal controller with the integrated pigtail driveline (left) and Pal controller with system status colors (right).

Reprinted with permission from Medtronic, Inc.

The home screen on the Pal controller displays pump and power status, with battery runtime displayed in hours and minutes. Additional screens provide information regarding pump settings, active and inactive alarms, battery and controller status, battery charging status, and action required by the patient, if any. The Pal controller also has an internal lithium ion battery that can power the system for up to 45 minutes. This battery is not meant to be the primary power source for the system; rather, it allows continuous pump function while power sources are being changed. This battery is recharged when the controller is attached to an external power source.

The **power source** for the Pal controller can be either a lithium-ion battery for portable use or standard AC or DC power for when patients are not ambulatory. The external

lithium-ion battery clips into the bottom of the controller to form an integrated unit. A single battery lasts for 5 hours and the dual battery lasts for 10 hours. Additionally, the system can be powered through an AC or DC adapter. The Pal controller recharges both the internal and external batteries when powered through either the AC or DC adapter.

The **battery charger** simultaneously recharges up to four batteries at a time. Depleted batteries require 3 to 5 hours to fully charge.

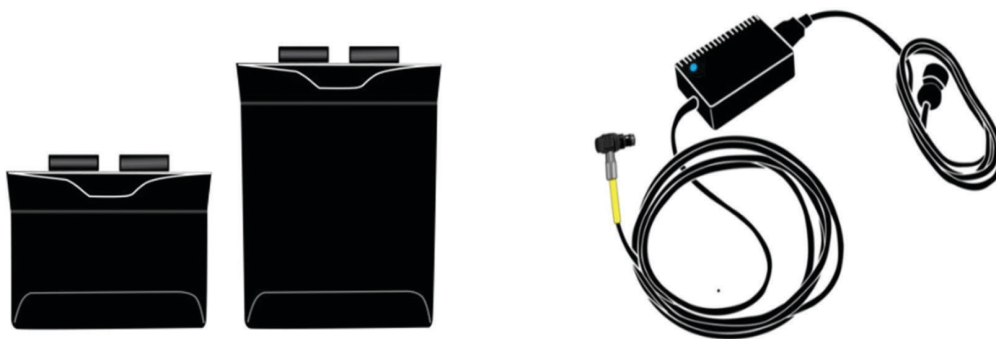
The batteries and controller are carried in proprietary **carrying bags** worn by the patient to provide mobility. A **shower bag** also allows safe operation in the shower, and an **accessories bag** is available for backup equipment. The entire weight of this assembly is approximately 0.73 kg (single battery) or 1.03 kg (dual battery). (Figure 14.11)

## The Conformité Européene Mark Clinical Trial

The MVAD Conformité Européene (CE) Mark trial was a multicenter, prospective, non-randomized, single-arm trial evaluating the safety and short- and long-term use of the HeartWare MVAD System for treating advanced heart failure. The trial was designed to enroll 60 patients in Europe and Australia. Several pump thrombus events ended the trial after 11 patients had been enrolled.

## Conclusion

The MVAD is the first left ventricular assist device designed with a wear-less, hybrid suspension system for an axial pump that is small enough to be placed in the intraventricular cavity. This unique design allows for full cardiac support and provides multiple implant strategies for a wide variety of patients.



**Figure 14.11.** Schematic of external batteries (single and dual) and AC adaptor.

Reprinted with permission from Medtronic, Inc.

## REFERENCES

1. Cheung A, Chorpenning K, Tamez D, et al. Design concepts and preclinical results of a miniaturized HeartWare platform: the MVAD system. *Innovations*. 2015; 36(3):151–156.
2. Slaughter MS, Sobieski MA, Tamez D, et al. HeartWare miniature axial-flow ventricular assist device: design and initial feasibility test. *Tex Heart Inst J*. 2009; 36(1):12–16.

# 15

## The ReliantHeart aVAD<sup>®</sup>

BRYAN E. LYNCH

### Introduction

The ReliantHeart aVAD<sup>®</sup> is an axial flow pump with pumping components that fit within the inflow cannula of a ventricular assist device (VAD) inserted into the ventricle (Figure 15.1). The ReliantHeart aVAD<sup>®</sup> is an improvement over its predecessor, the extra-ventricular HeartAssist5 (HA5)<sup>™</sup>. The pumping components, inflow guide vane, impeller, and diffuser of the aVAD<sup>®</sup> are identical to those in the HA5 and were in turn derived from the original collaboration between NASA and Drs. Michael DeBakey and George Noon at Baylor College of Medicine in Houston, Texas. The aVAD<sup>®</sup> meets the safety standards of the European Union and is sold in the Europe. The aVAD is not yet available in the United States but is being tested

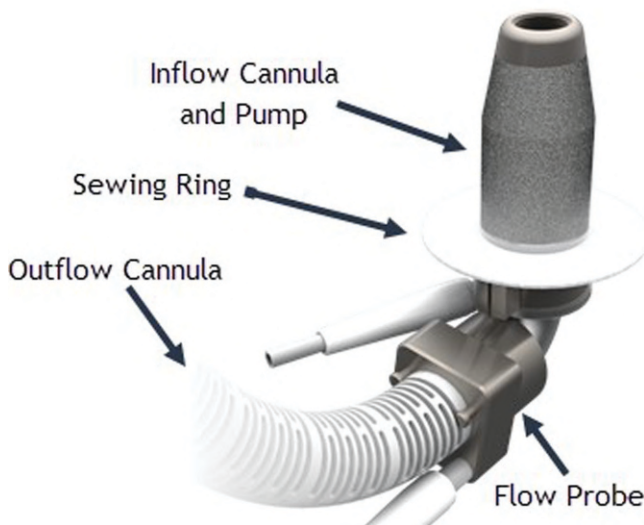
under a US Food and Drug Administration (FDA) investigational device exemption.

### The Design

The aVAD shares many features of the DeBakey VAD<sup>®</sup>, including the general impeller shape and the ultrasonic flow probe. However, improvements in the current generation of the technology differ greatly from earlier generations. The goal of the original DeBakey VAD was to support a patient with acute heart failure long enough for the patient to recover strength and survive a heart transplant. The support durations considered adequate at that time ranged between 60 and 90 days, with an average bridge-to-transplant duration of about 60 days. Over a relatively short period, this bridge-to-transplant goal was extended to more than 6 months and then to several years (Figure 15.2).

The DeBakey VAD was modified to meet the demands of longer support durations and to improve outcomes. First, the long inflow cannula that initially extended from inside the apex of the ventricle to below the diaphragm was shortened, such that the entire device could remain above the diaphragm and within the pericardium. This modification greatly reduced the amount of pre-peritoneal dissection required for implantation, which reduced bleeding complications and surgical time.







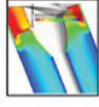



The cannula that connected the inflow of the pump to the apex of the ventricle was originally a cylinder, .5 inch in internal diameter, with an external polyester fabric liner (Dacron) that encouraged tissue ingrowth and integration within the ventricle. This cylinder was changed to a trumpet-shape designed to reduce the likelihood of inflow occlusion by the ventricular free wall or septum. In 2005, the inflow cannula was returned to a cylinder shape, but the Dacron liner was shortened and was eventually replaced by sintered titanium beads to further improve tissue integration. Also, in 2012, a “ringed graft” design was adopted, in which a titanium ring was sewn to the end of the Dacron



**Figure 15.1.** The ReliantHeart aVAD<sup>®</sup> axial flow pump. The pump fits inside the inflow cannula of a ventricular assist device.

Reproduced with permission of ReliantHeart Inc., © 2019. All rights reserved.



Original	1	2	3	4	5	6	7	8
1998 First Axial Flow LVAD	2001 1. Short Cannula 2. Carmeda Coating 3. True Flow Measurement	2003 2x Rear Hub Gap	2005 Cannula Attachment	2008 Reverse Bearing	2010 1. Ball in Cup Bearing 2. Blade Pitch 3. Flow Straightener 4. Heart Attendant	2011/14 1. Change Cup Material 2. Sintered Inflow Cannula 3. Integrate Remote Monitoring into Controller	2015/17 1. aVAD 2. INRTacker 3. TrueCore 4. FastConnect	2018/19 1. aVAD-XS 2. New4GController 3. VAD Maintenance System 4. TET
Original DeBakey VAD weighed 92 grams and the device history record (DHR) weighed 4 Kilos, or 4,000 Grams	1. Move pump above diaphragm to pericardial space 2. Reduce initial inflammatory response 3. Provide true flow measurement for better pump management and patient interface	Improve washing of rear axial and collar bearing	Improve interface of cannula attachment to pump	Improve washing of front axle and collar bearing	1. Improve bearing washing and heat exchange to impeller 2. Less radial shear per bolus of blood expressed as 1 rev per bolus from 1.3 revs per bolus 3. Less turbulence at inlet to impeller 4. Introduce HeartAttendant as pump manager, remote interrogator and battery charger	1. Change bearing cup not ball. Introduce dry start tolerant cup and retain heat transfer ball 2. Sintered cannula to provide improved pump interface at apex of LV to endothelium 3. Radio in controller to provide true 24/7 remote monitoring of accurate flow, speed & power. Alert notifications directed to clinicians via: <a href="http://vadlink.com">vadlink.com</a>	1. Introduce intraventricular implant version of HAS. Called aVAD-XS. The smallest smallest 10L/m pump 2. INRTacker (patient diary), INR, Weight, BloodPressure to Post to VADLink.com. 3. Surgical improvement with TrueCore Ventricular Coring System 4. Surgical improvement FastConnect	1. Introduce even smaller intraventricular implant version of HAS. Called aVAD-XS. The smallest smallest 10L/m pump, 4 volts 2. New4GController will also have BT and new motor controller and single chip flow meter. 3. Introduce VAD Maintenance System to service instead of replace an occluded VAD 4. TET with implantable disconnectable cable, implantable battery and controller will offer wound free power and communication.
	 							

**Figure 15.2.** Design changes in the DeBakey ventricular assist device over the past 20 years. The ReliantHeart aVAD is the current iteration of the DeBakey device.

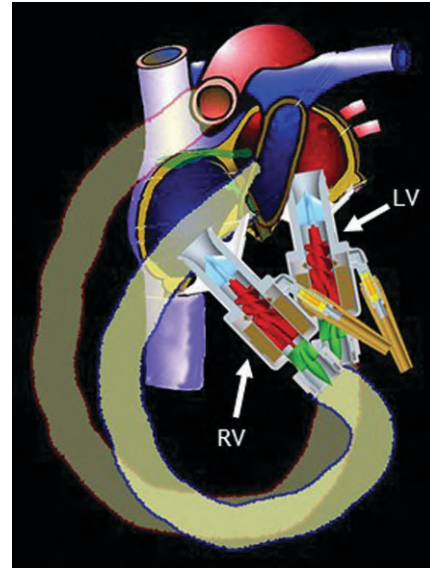
Reproduced with permission of ReliantHeart Inc., © 2019. All rights reserved.

graft to allow a much easier and equally secure connection to the pump. Following these modifications, there has not been a single report of this connection failing.

The original shaft-and-ring bearing design of the DeBakey VAD performed well for short durations but was subject to thrombogenicity with increasing durations. In 2010, the ring and shaft bearings were replaced with a silicon carbide ball-and-cup design to improve washout around the bearings. This improved washout was discovered by computational analysis of fluid dynamics and particle image velocimetry studies and was confirmed in long-term bovine studies. In this new design, both ends of the titanium impeller were tipped with a silicon carbide hemispherical bearing (“the ball”), and both the inflow guide vane and the diffuser held the concave-shaped silicon carbide “cup” bearings. This design was intended to minimize wear, given that silicon carbide is used in tough industrial bearings. Indeed, our tests found almost no wear after years of use. Also, silicon carbide provides excellent thermal conductivity, permitting any temperature increases in the bearing to be diffused into the surrounding metal mount, where the heat is dispersed by the blood. With proper hydration, these bearings functioned as expected. Unfortunately, if the pump ingested air during improper implant preparation, the unlubricated galling created by an instantaneous dry run could quickly destroy the cup bearing. However, despite training and education, the possibility of an inadvertent dry run could not be eliminated, so the silicon carbide of the cup bearings was replaced with a much tougher hot isostatic-pressed Zirconia ceramic in 2012. Silicon carbide remains in the ball portion of the bearings to draw heat away from the bearing and into the impeller and blood. Some of the first patients receiving devices with this design survived more than 5 years, and this bearing configuration is used in the current aVAD.

In 2011 and 2012, the pump was used successfully in calf studies as an artificial heart, with each ventricle being replaced by a modified HA5 VAD.<sup>1</sup> Each device was implanted with an extended fabric cone on the inflow cannula attached to the remnants of the atria. The two LVADs were placed vertically, side by side (Figure 15.3). This placement provided a more compact total artificial heart with formable outflow graft protectors directed to the aorta and pulmonary artery. The vertical configuration of the aVAD evolved from this placement.

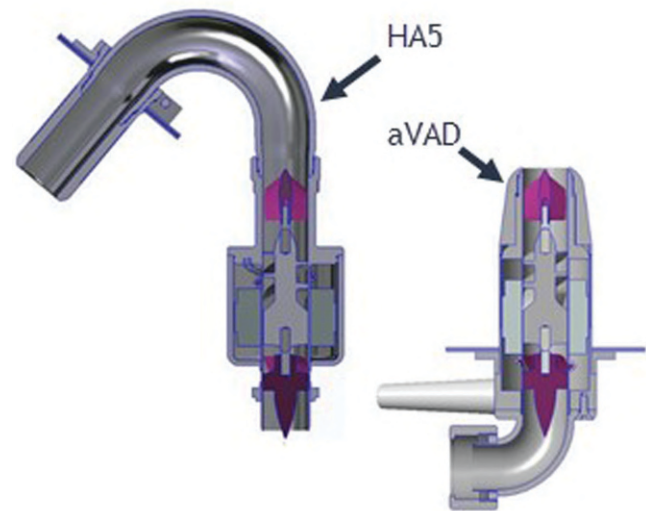
To improve flow compliance for the pressure-sensitive lungs, the pitch of the inducer section of the RVAD impeller was decreased. This decrease effectively flattened the flow-pressure curve, increasing pump hysteresis (slip-page with reduced amplitude) and reducing the likelihood of fluid overload in the lungs when the RVAD is implanted in the total artificial heart configuration. This impeller change further improved flow compliance, so these changes were made to the HA5<sup>™</sup> and subsequently



**Figure 15.3.** Two modified HeartAssist5 pumps can be implanted together to create a total artificial heart.

Reproduced with permission of ReliantHeart Inc., © 2019. All rights reserved.

to the aVAD<sup>™</sup> in its current configuration. This impeller design allows the pump to rapidly add kinetic energy to the blood at a lower pump pressure differential, effectively magnifying any native pulsatility by increasing blood flow during systole, when the pressure drop across the pump is the lowest, and reducing flow during diastole (Figure 15.4).



**Figure 15.4.** The HeartAssist5<sup>™</sup> and aVAD<sup>™</sup> have identical pump component designs that vary only in the location within the cannula.

Reproduced with permission of ReliantHeart Inc., © 2019. All rights reserved.

## The Flow Probe

From the beginning, the designers of the DeBakey VAD understood the value of accurately measuring the output of the device, as well as the net interaction between the VAD and the native heart. For this reason, a flow algorithm was developed that incorporated impeller speed, power consumption, and the pressure-flow relationship. The algorithm was accurate only if the ideal relationship among these variables did not vary. However, if any of these variables did vary beyond the ideal range, because of internal friction, an occlusion, or a drastic change in viscosity, the algorithm could render a dangerously inaccurate flow value. To overcome this hazard, an ultrasonic flow probe that could continuously provide accurate measurements was consequently incorporated into the design of the device (Figure 15.5). The existing ultrasonic flow probe was developed jointly by ReliantHeart and Transonic Systems of Ithaca, New York. Flow measurements remain accurate under all flow conditions, even in implants in place for years. The ultrasonic probe indicates flow in the range of  $-4$  to  $+10$  L/min with  $>95\%$  accuracy (Figure 15.6).

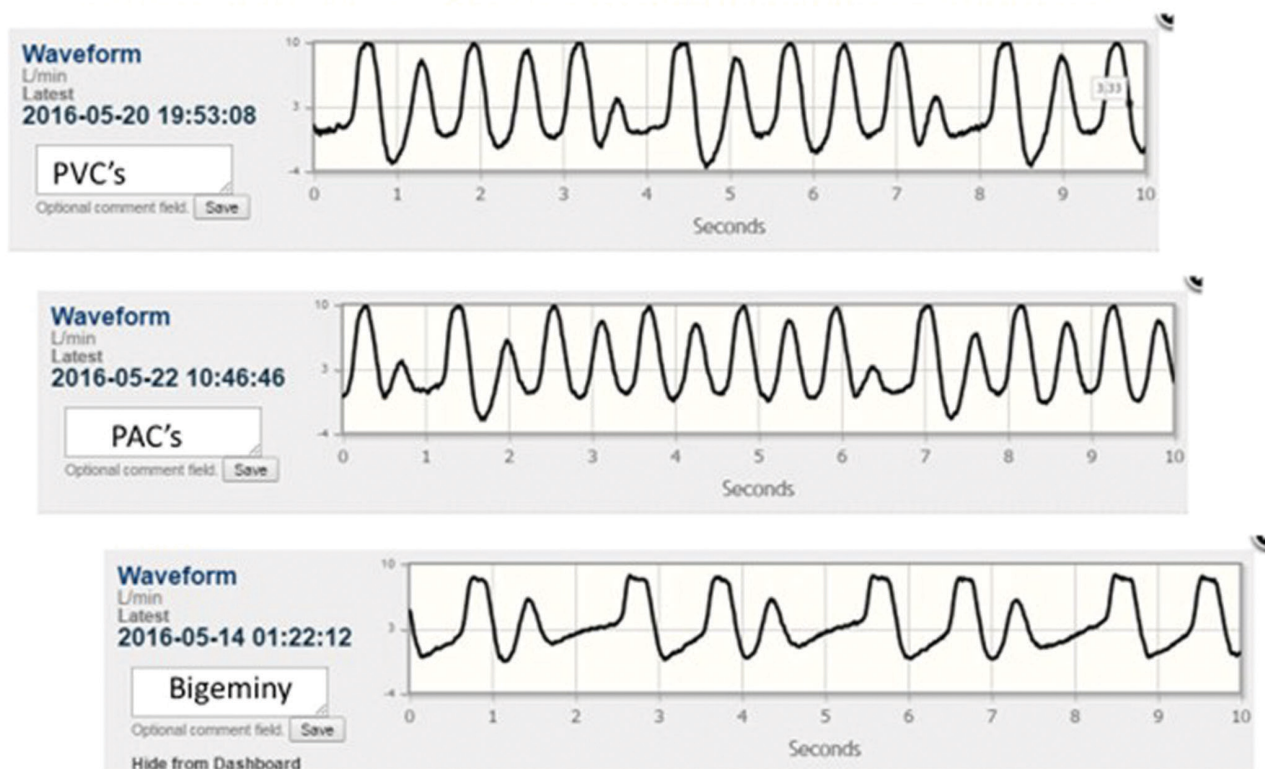
The flow probe can also generate waveforms for assessing the relationship between the VAD and the native ventricle, allowing the clinician to adjust pump speed or

pharmacologic therapy to optimize the pressure across the pump and the ventricle. Flow data can also help interpret the arterial pressure effects on flow, the frequency of aortic valve opening, and rhythm issues, such as premature ventricular contractions, that can cause low-flow conditions, even under normal VAD settings. Likewise, trends in flow can easily be seen, allowing pump performance to be compared over long periods. Managing patients with VADs can be greatly enhanced by accurately assessing changes in pump performance in response to medical therapies.

Although echocardiography can visualize and estimate hemodynamic performance, it is an indirect and unreliable assessment and can be obtained only in the hospital or clinic. In contrast, the calibrated ultrasonic flow probe provides accurate long-term results that can be interpreted from any location to track and manage long-term LVAD function.

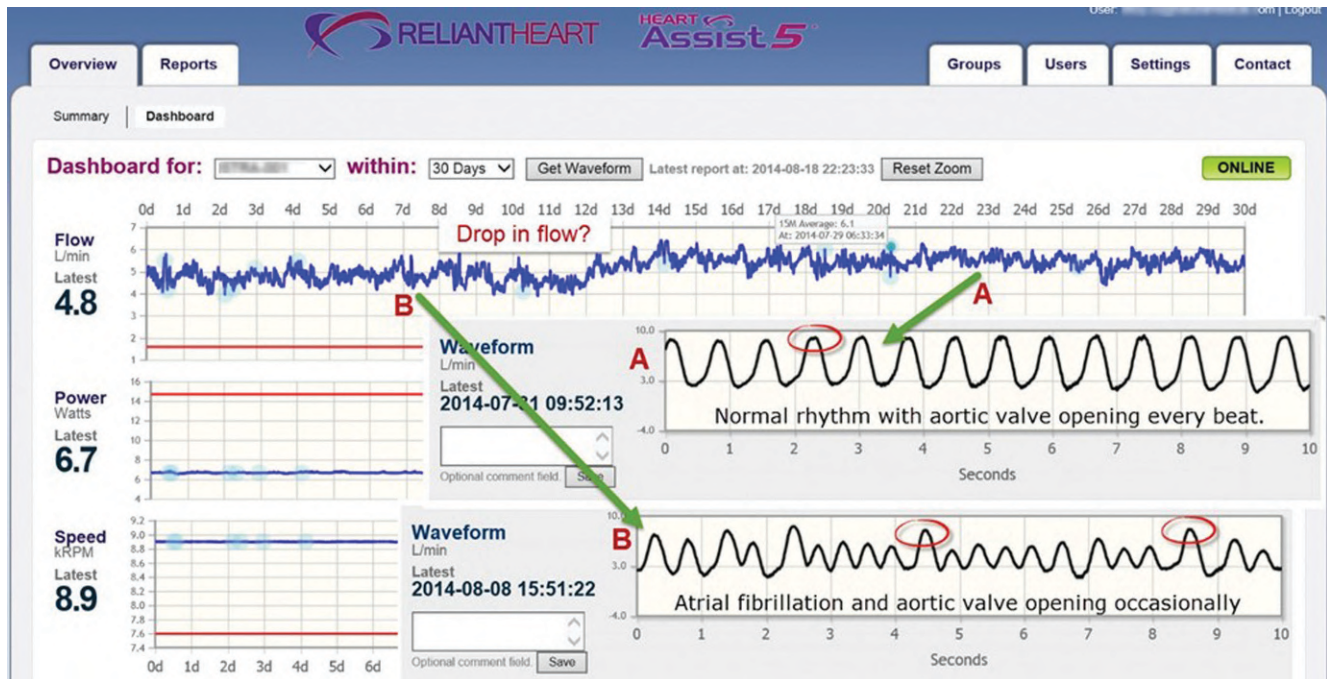
## The Effects of Changes in Pump Speed: The Ramp Study

Long-term support with an LVAD requires optimizing the relationship between the LVAD and the native ventricle. Although several clinician-driven methods can optimize pump speed and support levels, they all center on



**Figure 15.5.** Flow waveforms measured by a flow probe in the aVAD are generated automatically by an alarm or can be requested by the clinician. This flow is measured by ultrasound and is the net output of the pump and the LV.

Reproduced with permission of ReliantHeart Inc., © 2019. All rights reserved.



**Figure 15.6.** Atrial fibrillation in a 61-year-old woman caused a 2-L/min-drop in blood flow. The drop was identified by the flow waveform and communicated remotely through VADLink™.

Reproduced with permission of ReliantHeart Inc., © 2019. All rights reserved.

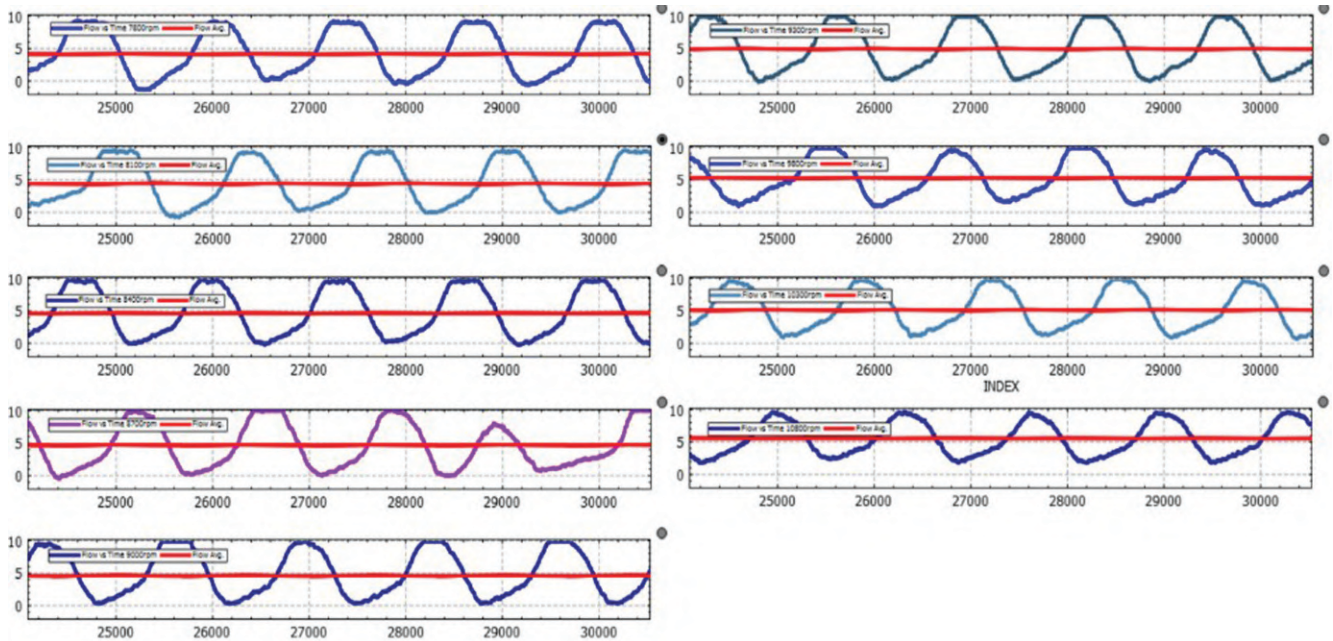
adjusting pump settings to allow reasonable cardiac output while minimizing stress on the cardiac tissues and blood. The amount of support the pump must provide varies with the recovery of the native ventricle and the overall physiology of the patient. A ramp study is a simple strategy for measuring the relative contributions of the LVAD and the native heart to adequate blood flow by assessing net flow as you slowly “ramp” up the pump speed. Aided by the flow probe, evaluating the net flow through the device, as well as the status of the aortic valve, is straightforward. If the top of the flow waveform is a smooth sinusoidal curve, the aortic valve is likely not opening, all blood flow is passing through the pump, and the flow probe is likely measuring total cardiac output. If the top of the flow waveform is flattened, some blood is likely being forced through the aortic valve during systole, with a portion of the cardiac output being contributed by the native ventricle (Figure 15.7).

Graphing flow vs. pump speed shows the contribution of the LVAD flow and the diminishing return on pump speed. This information can help optimize pump speeds to allow the aortic valve to open and close, at least intermittently. Preserving blood flow across the valve to keep the aortic root washed is increasingly appreciated because it can open and close the valve and can keep the valve tissue nourished with blood flow in the leaflets. A pump speed of 8,000 or 9,000 rpm with the aortic valve opening provides about 90% of the flow that the patient would receive if the pump were running at 10,000 or 11,000 rpm (Figure 15.7).

The extra 2,000 or 3,000 rpm translate into up to 2 watts of additional power, causing high pumping stress and little flow benefit. Although there are often good clinical reasons to run the pump at a higher speeds, for long-term support, reducing the speed and consequently the shear stress and degree of hemolysis in the blood over time can be beneficial (Figure 15.8).

### Remote Monitoring

Patients receiving mechanical circulatory support are exposed to a unique variety of risks that can be difficult to manage without external support. As LVADs become more widely available and the number of implants increases, minimizing adverse events through early detection and action becomes more important. Also important is that LVAD systems be designed to reduce the resources required to support the patients receiving them. Wireless remote monitoring systems can provide this early detection. The aVAD uses cellular phone technology to transmit a patient’s VAD performance data in real time to a web portal, allowing the clinician to monitor aVAD performance. This system and the web portal, developed by ReliantHeart, is called VADLink®. Through VADLink, the clinician can view and monitor current VAD performance and alarms, which provide an accurate visualization of the daily variations in flow and support. Determining the conditions that set off alarms might help resolve the problem without a hospital readmission, given that

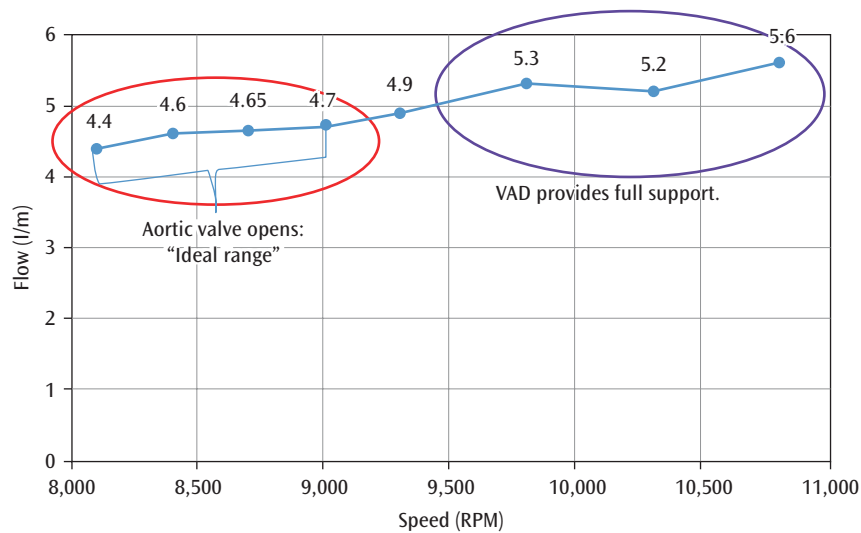


**Figure 15.7.** The flow probe helps evaluate the net flow through the device and the status of the aortic valve. If the top of the flow waveform is a smooth sinusoidal curve (right side), the aortic valve is likely not opening. If the top of the flow waveform is flattened (left side), some blood is likely being forced through the aortic valve during systole, with a portion of the cardiac output being contributed by the native ventricle.

Reproduced with permission of ReliantHeart Inc., © 2019. All rights reserved.

troubleshooting for most minor events during LVAD support (such as hypovolemia) can be resolved over the phone. At the same time, alarms suggesting more serious conditions can be identified early, possibly preventing dire consequences (Figure 15.9).

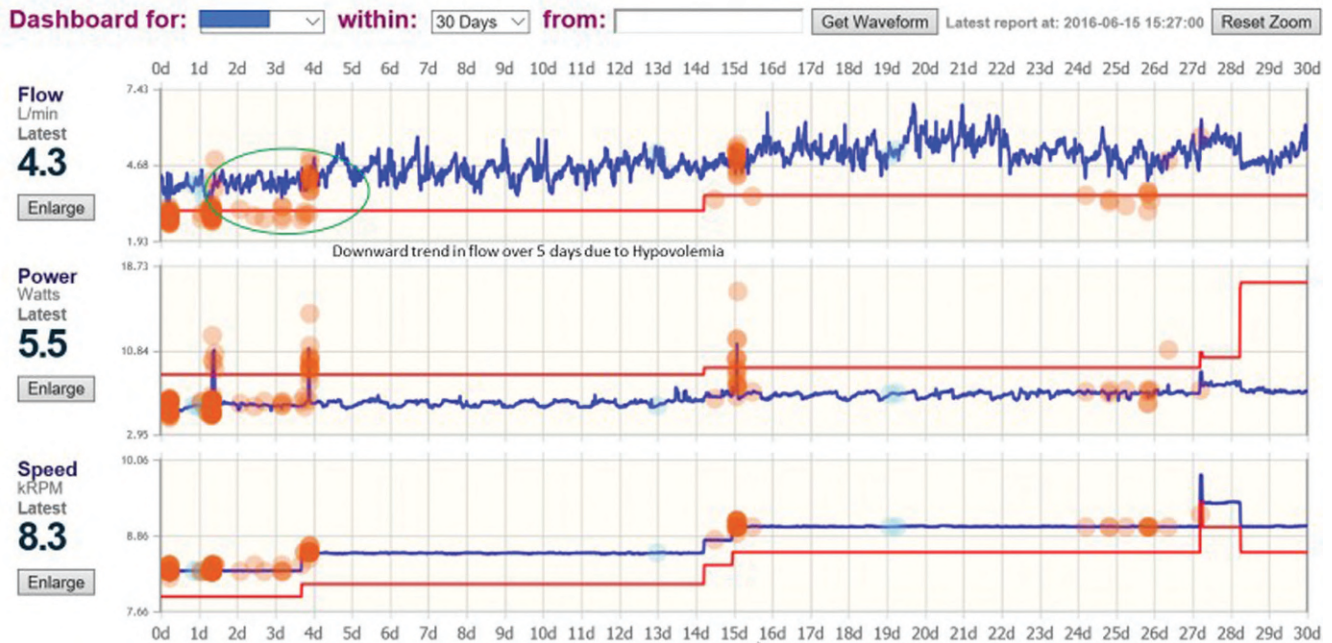
The aVAD has only recently been introduced, but early performance data indicate that it provides excellent circulatory support, a low adverse event rate, and effective remote patient management. As of this printing, 20 patients have received aVADS at several sites in Germany,



**Figure 15.8.** A simple ramp study is useful in setting pump speed. For long-term support, lower pump speeds reduce the shear stress and degree of hemolysis in the blood over time.

Reproduced with permission of ReliantHeart Inc., © 2019. All rights reserved.

## Low Flow Events – Hypovolemia – Reduced Speed



**Figure 15.9.** Waveforms indicating hypovolemia. Through the VADLink™ web portal, the clinician can monitor current VAD performance from an accurate visualization of the daily variations in flow and support.

Reproduced with permission of ReliantHeart Inc., © 2019. All rights reserved.

the United Kingdom, Turkey, and Croatia. Implant durations exceed 24 months, and no cases of gastrointestinal bleeding, stroke, or thrombus have been attributed to the device.

### REFERENCE

1. Cohn WE, Winkler J, Parnis S, et al. Ninety-day survival of a calf implanted with a continuous-flow total artificial heart. *Asaio J.* 2014;60:15–18.

## Introduction

**T**he pneumatically actuated total artificial heart (TAH) (SynCardia Systems, LLC Tucson, AZ) is the latest design stemming from the original Jarvik-7-70 TAH developed by William Kolff at the University of Utah in the 1970s (Figure 16.1). The SynCardia heart can provide long-term support, with documented support times of over

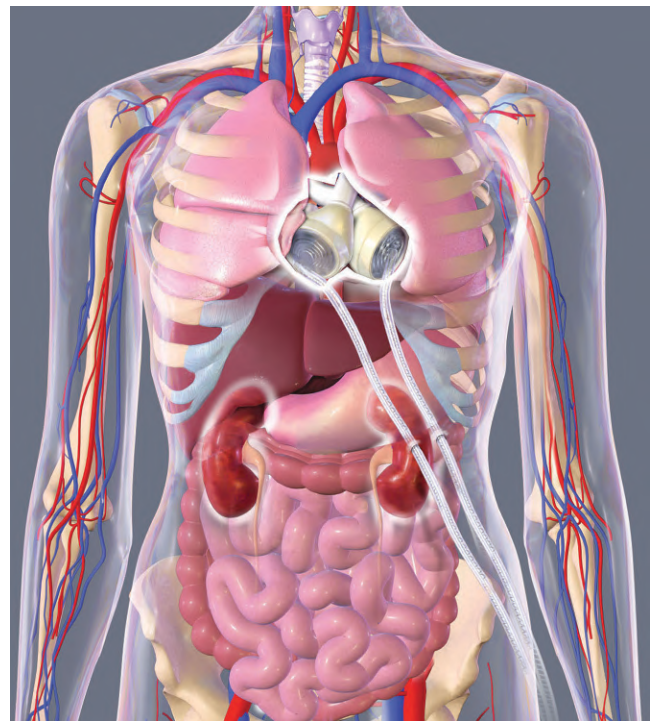


**Figure 16.1.** The SynCardia total artificial heart, a direct descendant of the original Jarvik-7-70 total artificial heart. Courtesy of Syncardia.com.

4 years as a bridge to transplant. Support is immediate, and controlling the device is simple and fast. Here, we describe the applications and operation of the SynCardia TAH.

## The SynCardia Total Artificial Heart

The 70-cc SynCardia TAH is a pneumatic diaphragm pump that is implanted orthotopically in the chest (Figure 16.2). The diseased ventricles and the valves are removed and



**Figure 16.2.** Orthotopic placement of the SynCardia 70-cc total artificial heart.

Courtesy of Syncardia.com.

replaced by right and left artificial ventricles. These ventricles have a total displacement volume of approximately 400 cm<sup>3</sup> and weigh about 160 g. The pump is constructed of a biocompatible polyurethane. The Syncardia TAH is unique among other designs in that the diseased ventricles are excised. The 70-cc pump is generally used in patients who have a body surface area (BSA) of at least 1.6 m<sup>2</sup>. A similar 50-cc TAH is undergoing clinical trials in the United States and is approved for use in the European Economic Area.

The drivelines from the implanted pump attach to an external drive system. Two types of drive systems are available: mobile hospital-based drive systems and portable drive systems. Hospital-based drive systems allow operators to optimize performance by changing the pump settings. The smaller portable drive systems allow patients to leave the hospital and optimize patient mobility. Currently, there are two hospital drive configurations: the Companion 2 Driver, which is docked into a Hospital Cart or a Caddy (Figures 16.3 and 16.4) and the Freedom Driver, which is a patient-portable system (Figure 16.5).



**Figure 16.3.** The Companion 2 Driver on a hospital cart; the first of two hospital-drive configurations. Courtesy of Syncardia.com.



**Figure 16.4.** The Companion 2 Driver on a caddy; the second of two other hospital-drive configurations. Courtesy of Syncardia.com.



**Figure 16.5.** The Freedom driver, a portable drive system for the total artificial heart. Courtesy of Syncardia.com.



## Benefits and Indications of the Total Artificial Heart

Total artificial heart technology is the most aggressive of all mechanical circulatory support devices in that the diseased ventricles are removed from the patient.<sup>1</sup> Removing the diseased heart immediately ends the underlying cardiac dysfunction, allowing clinicians to exercise total control over the failing circulatory system once the pump is implanted. Physiologic pressures and cardiac output can quickly be restored to normal. Cardiac output may be greater than 9 L/min with normal right and left atrial pressures. Lower central venous pressure (CVP) with normal systemic pressure provides a greater perfusion differential pressure across the end organs.

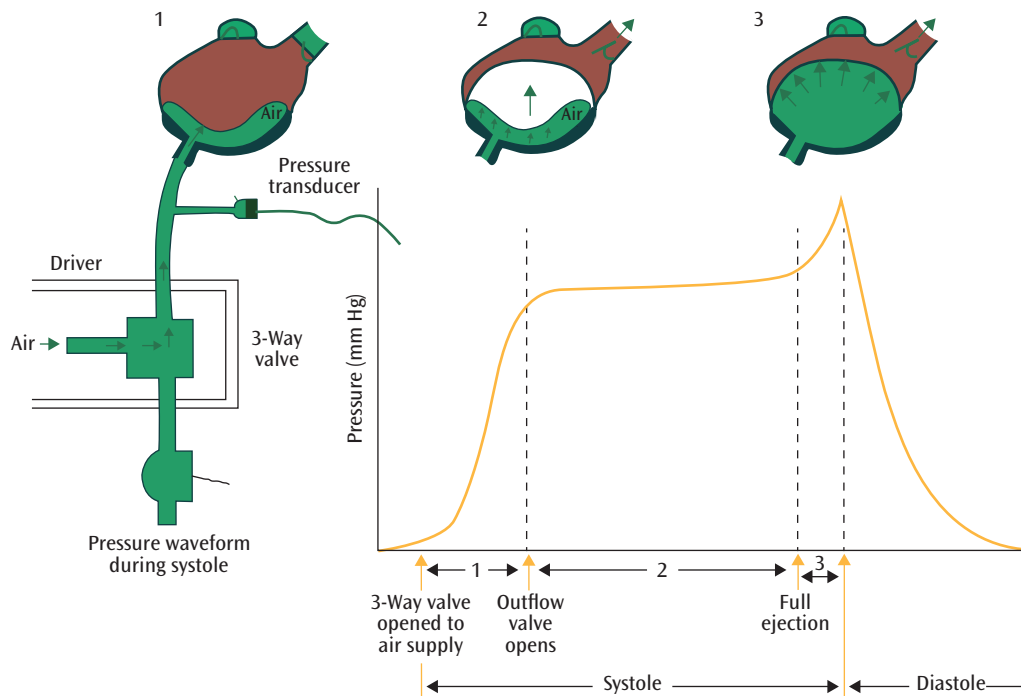
The TAH is indicated for refractory causes of severe biventricular failure. The most common diagnoses have traditionally been dilated and ischemic cardiomyopathies. Over the past few years, indications have expanded to include replacement of a failing allograft after heart transplant (acute or chronic), restrictive and infiltrative cardiomyopathies, congenital abnormalities, malignant arrhythmias refractory to other interventions, large post-infarction ventricular septal defects, partial ventricular thrombosis, cardiac malignancies, and Chagas disease. Re-bridging with a TAH has been successful in some patients who experience right-ventricular (RV) failure after receiving a left-ventricular assist device (LVAD).<sup>2</sup>

## The Companion 2 Drive System

The Companion 2 drive system has a touch-screen interface that allows the operator to control the device. Redundant compressors provide an internal backup for compressed air. The system continually monitors its performance and alerts the operator if the specified limits are exceeded. Operators may assess the waveforms and make driver changes from the touch screens.

## The Freedom Portable Drive System

When a patient is stable, the hospital drive system may be switched to a portable external driver, the Freedom Driver, that allows the patient greater mobility in the hospital and permits discharge to home while awaiting heart transplant. In 2010, the Freedom drive system (Figure 16.5) was introduced in the United States and in Europe. It is the lightest drive system available. The system is intended for stable patients and accordingly offers maximum portability with no adjustments required by the patient. Although drive pressure and vacuum are preset, the clinician can adjust the pump to meet various patient needs. Pressing a button on the top of the driver allows the clinician to see the rate and calculated fill volume, as well as LV cardiac output.



**Figure 16.6.** Full ejection of blood from the pump (full eject) is indicated by the second rise in the pressure waveform. The movement of the diaphragm is apparent.

Courtesy of Syncardia.com.

The Freedom portable driver and the two batteries weigh 6.12 kg. Replaceable external batteries provide about 3 hours of power. The batteries may be exchanged by the patient or caregiver, or the driver can be connected to wall power to recharge the batteries. A car charger can also run the driver and recharge the batteries. The driver can be worn in a specialized backpack or shoulder bag.

## Driver Management

The drive system is controlled by two settings. First, the pressures are adjusted to empty the ventricles during each cycle, a process called a full ejection or a complete eject. Second, the pump rate is adjusted to provide cyclical filling volumes of 50–60 mL in the 70-cc model and of 30–40 mL in the 50-cc model, which is known as partial fill. These two settings are adjusted to optimize device performance.

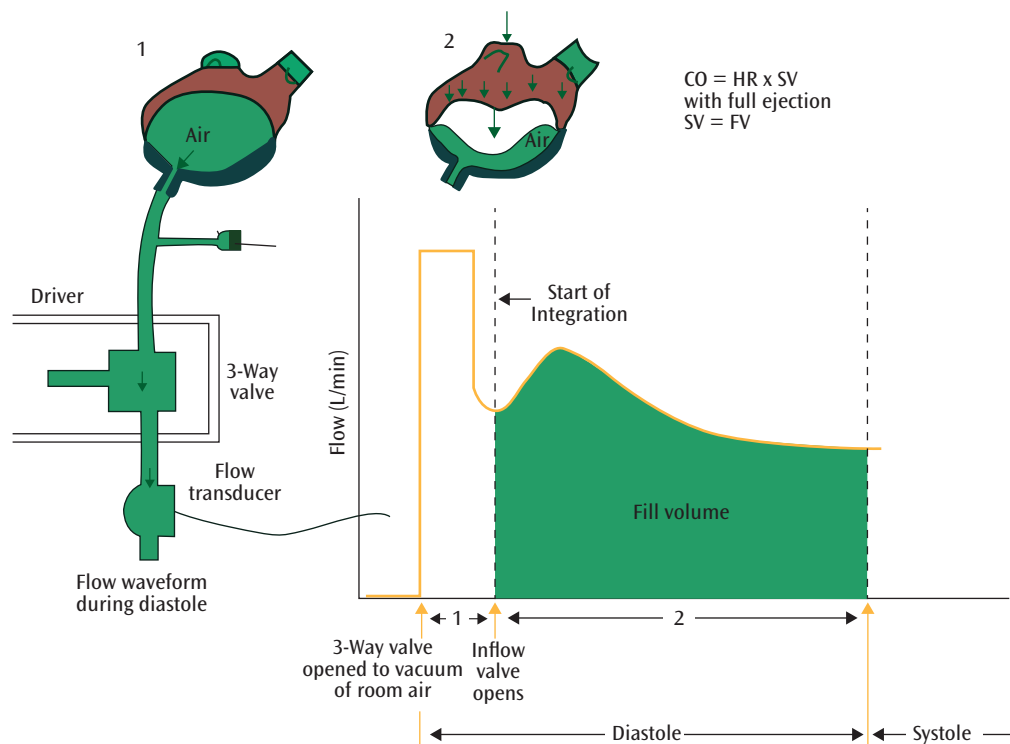
There are no electronics or sensors in the artificial ventricles. The device is managed by assessing the pneumatic drive pressure waveforms and the flow volume of air through the driveline. Optimizing the performance of the pump produces a Frank-Starling effect, allowing increased cardiac output during periods of increased activity.

## The Full Eject

Full ejection from the ventricle is assessed by the shape of the air pressure waveform. At the start of systole, air pressure is increased to the ventricle through the driveline and rapidly increases until it opens the outflow valve. When the outflow valve opens, the diaphragms begin to move forward. As the blood moves out of the device, the diaphragms move into the ventricle, and the air pressure waveform flattens. When the diaphragms are fully extended into the ventricle, the pressure increases rapidly to the pressure that was set by the operator. This second rapid rise in pressure is known as the full eject of the pressure waveform (Figure 16.6) and indicates that the ventricle has fully ejected all of the blood from the device.

## The Partial Fill

Operators can also regulate filling volumes of between 50 and 60 mL per beat (30–40 mL in the 50-cc version of the pump). Filling volumes are assessed through the attached external drive system. The drive system calculates the filling volume by measuring the volume of air exhausted during device diastole. Partial filling of the device is thus assessed from this volume (Figure 16.7). At the end of systole, the diaphragms in the ventricles



**Figure 16.7.** Partial filling of the device is assessed by observing the airflow exhausted from the ventricle during diastole and is indicated by open-ended filling during diastole. The movement of the diaphragm is again apparent.

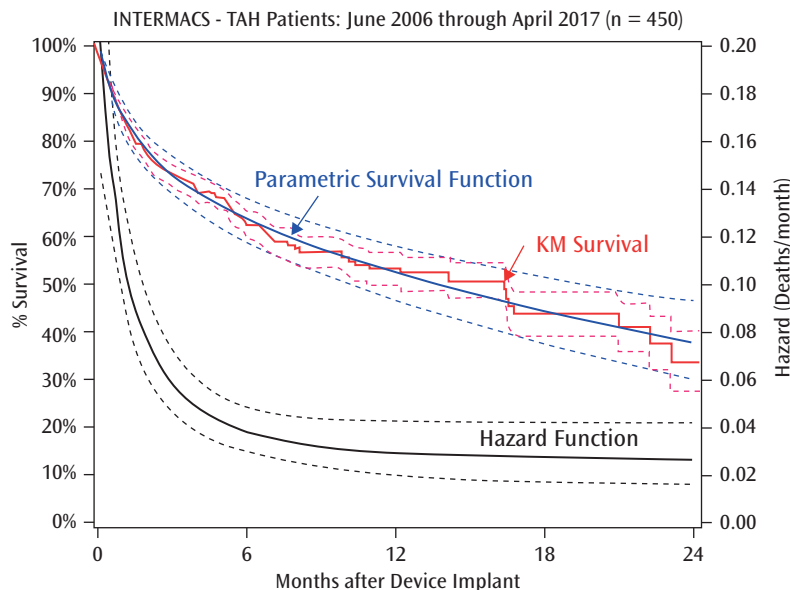
Courtesy of Syncardia.com.

are fully distended. The external driver opens a valve and releases the pressure in the drivelines. As the pressure decreases, the outflow valve in the ventricle closes, the inflow valve opens, and atrial pressure begins to push the diaphragm into the ventricle. The air is pushed out of the driveline as the blood enters the ventricle. Flow transducers in the external drive system measure the flow of air and calculate the volume of air that has exited the ventricle. The volume of air forced out of the ventricle is roughly equal to that of the blood that enters the ventricle during each beat. This volume is the filling volume of the ventricle and is displayed on the external driver. The pump rate of the device is adjusted to allow the ventricle to fill to about 80% of its capacity. The target is 50–60 mL per beat for the ventricle in the 70-cc model and 30–40 mL per beat in the 50-cc model. Each cardiac filling cycle varies depending on the atrial inflow pressure to the ventricle. There is the ability to add vacuum to the system during this phase of the cycle, which will allow for more flow at a lower atrial pressure. Having a variable stroke volume allows variable cardiac output, creating a Frank-Starling-type effect on cardiac output. When the rate and pressure are properly adjusted, the ventricle will empty completely and fill to volumes of 50–60 mL each cardiac cycle. A typical pumping rate for the TAH is 125 beats per minutes, yielding a cardiac output of 6.3–7.5 L/min for the 70-cc TAH and 3.8–5.1 L/min for the 50-cc TAH.

## Clinical Outcomes

An analysis of INTERMACS data found that the 1- and 2-year survival rates after TAH implantation were 53.2% and 33.9%, respectively (Figure 16.8).<sup>3</sup> In competing-risks analysis of 450 patients, 53% of patients underwent transplantation, 34% died, and 13% were alive on a device at 12 months (Figure 16.9). Survival rates correlated with pre-operative clinical status, with the best outcomes reported in patients with INTERMACS profile 3. The most common cause of death was multisystem organ failure (36% of deaths), followed by neurologic injury (18%) and elective withdrawal of support (12%). Outcomes were the most favorable in younger patients, especially those less than 40 years old. Experience also influenced outcomes, with centers performing 10 or fewer implants being associated with a significant risk (Figure 16.10). The 12-month survival was 64.8% for centers implanting more than 10 pumps and 36.7% for those implanting 10 or fewer ( $P = 0.001$ ). The relationship between age and center volume (Figure 16.11) indicates the better outcomes in younger patients treated at high-volume centers.

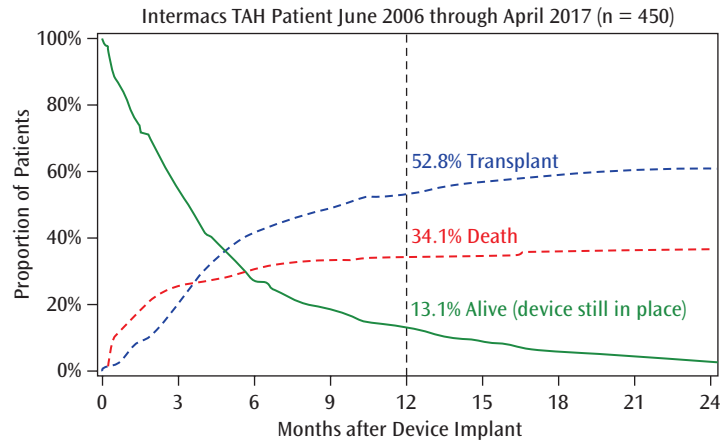
As with all mechanical circulatory support devices, adverse events (AE) remain a challenge in managing patients. The most common early AEs (within 3 months after implantation) are bleeding and infection. After 3 months, minor device malfunction and infection predominate (Table 16.1). Based on INTERMACS registry data, early AE rates



**Figure 16.8.** Two-year survival and the associated hazard function for patients receiving a total artificial heart. The event modeled is death on a device, with data censored at transplant. The Kaplan-Meier survival estimates show the agreement with the fitted parametric model.

Dashed lines are 70% confidence bounds.

Reprinted from Arabia FA et al., Interagency registry for mechanical assisted circulatory support report on the total artificial heart, *Journal of Heart and Lung Transplantation* 2018;37:1304–1312, Copyright (2018), with permission from Elsevier.



**Figure 16.9.** Competing-risks outcomes for 450 patients with total artificial hearts implanted between June 2006 and April 2017. At any given time, the sum of the proportions of each outcome equals 1.

Reprinted from Arabia FA et al., Interagency registry for mechanical assisted circulatory support report on the total artificial heart, *Journal of Heart and Lung Transplantation* 2018;37:1304–1312, Copyright (2018), with permission from Elsevier.

for bleeding, infection, and neurologic dysfunction on the TAH were higher than on LVADs.

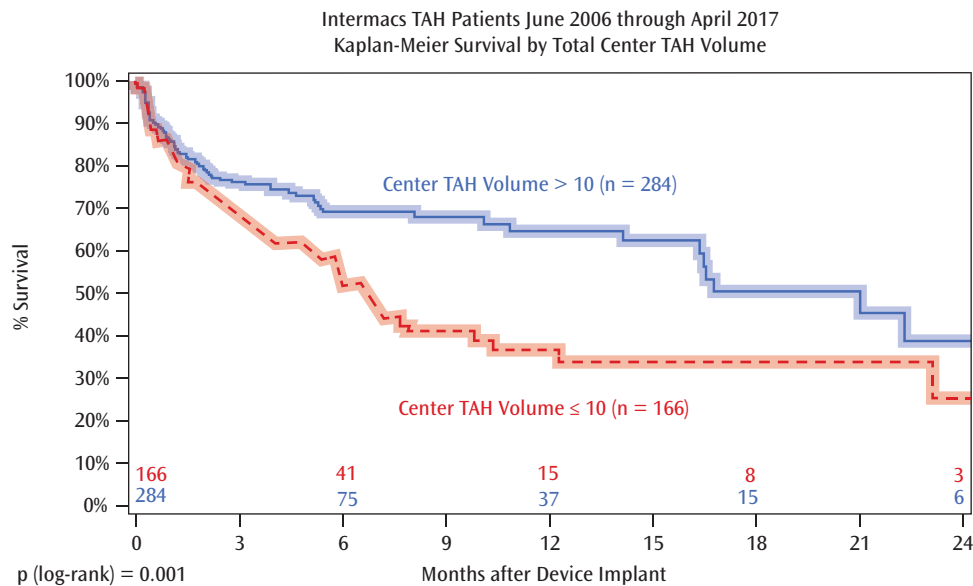
The likelihood of major infection approached 70% within 6 months (Figure 16.12), with 556 infections observed in 450 patients. Pulmonary infections were the most common, and bacteria were the most common pathogens.

Of the 370 patients in the INTERMACS database receiving the TAH after 2010, 99 (27%) were discharged to home on a device. The median (IQR) time from implantation to discharge home was 1.6 (1.1 to 2.3) months. Of the 99 patients discharged, 91% were discharged to home and 4%

were discharged to a rehabilitation unit. During the study period, within 12 months, 58.4% of patients received a heart transplant at 284 centers implanting more than 10 pumps, and 43% received a heart transplant in 166 lower-volume centers (Figure 16.13).

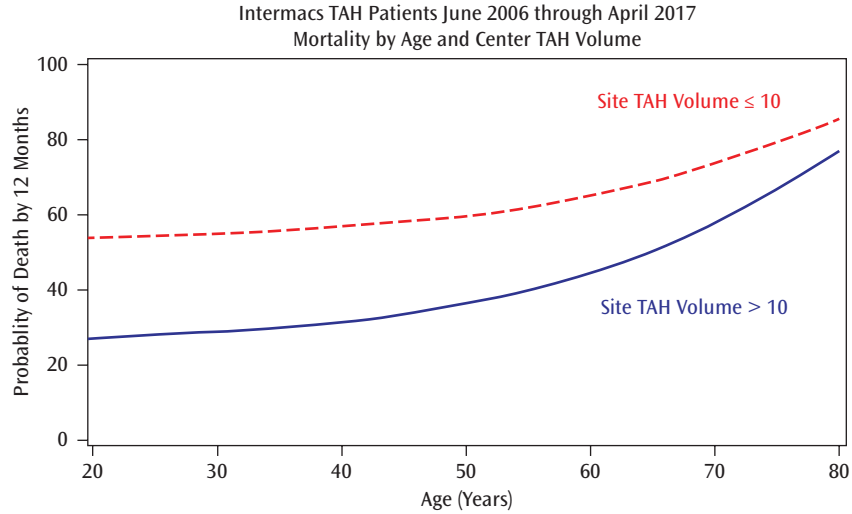
## Discussion

As with other forms of mechanical circulatory support, the tendency to delay referral until the later stages of disease markedly limits the benefits provided by a TAH. The



**Figure 16.10.** Kaplan-Meier survival estimates for 450 patients with total artificial hearts stratified by centers with high (>10) and low ( $\leq 10$ ) TAH implant volumes.

Reprinted from Arabia FA et al., Interagency registry for mechanical assisted circulatory support report on the total artificial heart, *Journal of Heart and Lung Transplantation* 2018;37:1304–1312, Copyright (2018), with permission from Elsevier.



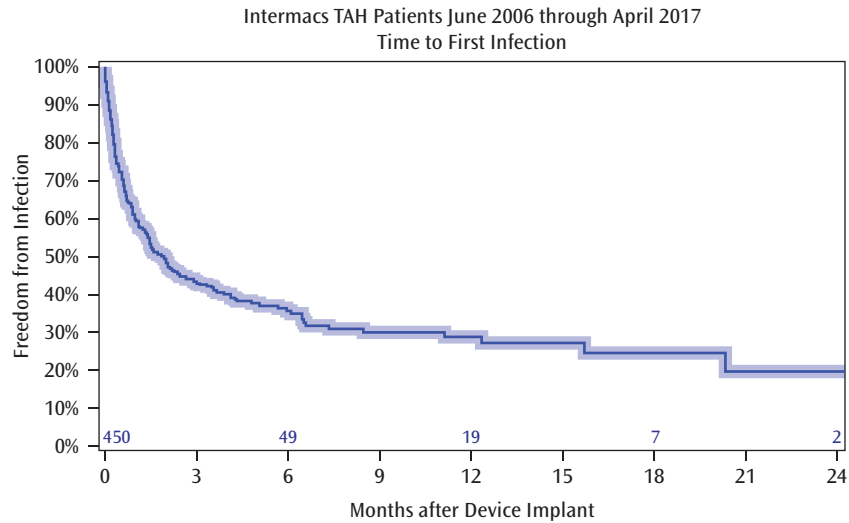
**Figure 16.11.** Predicted probability of death by 12 months in centers with high (>10) and low (≤10) TAH implant volumes. One-year survival is predicted from a multivariate parametric hazard model using the average of patient characteristics. Reprinted from Arabia FA et al., Interagency registry for mechanical assisted circulatory support report on the total artificial heart, *Journal of Heart and Lung Transplantation* 2018;37:1304–1312, Copyright (2018), with permission from Elsevier.

**Table 16.1 • Interagency Registry for Mechanically Assisted Circulatory Support Total Artificial Heart Patients: Adverse Events (June 2006–April 2017, n = 450)**

Event	Early		Late		p-Value
	Events	Rate	Events	Rate	
Thromboembolism					
Venous	17	1.7	3	0.2	0.0001
Arterial non-CNS	20	2.0	2	0.1	<0.0001
Bleeding	414	41.3	96	7.1	<0.0001
Device malfunction					
Major	13	1.3	34	2.5	0.04
Minor	50	5.0	203	14.9	<0.0001
Pump thrombus	4	0.4	3	0.2	0.4
Hepatic dysfunction	52	5.2	11	0.8	<0.0001
Infection	389	38.8	167	12.3	<0.0001
Neurologic dysfunction	148	14.7	40	2.9	<0.0001
Pericardial drainage	63	6.3	1	0.1	<0.0001
Renal dysfunction	162	16.1	21	1.5	<0.0001
Respiratory failure	219	21.8	38	2.8	<0.0001

CNS, central nervous system  
 Early indicates ≤3 months of device implant. Late indicates >3 months after device implant.  
 Rates are reported per 100 patient-months.  
 The p values compare early and late rates.

Reprinted from Arabia FA et al., Interagency registry for mechanical assisted circulatory support report on the total artificial heart, *Journal of Heart and Lung Transplantation* 2018;37:1304–1312, Copyright (2018), with permission from Elsevier.



**Figure 16.12.** Kaplan-Meier estimates of time to first infection among the 251 patients that developed infections after receiving a total artificial heart. Data were censored at transplant or death.

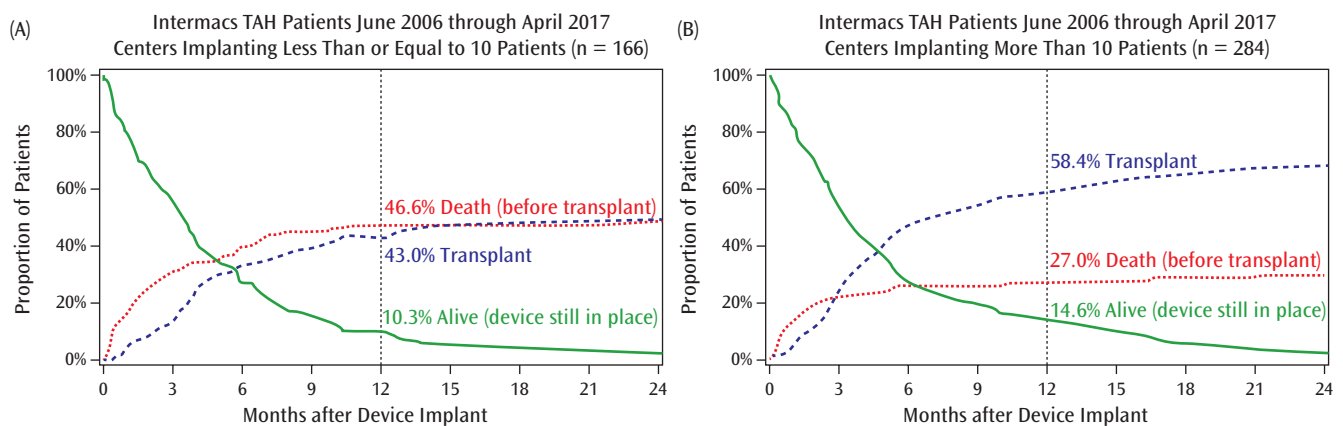
challenges related to early referral are complex and multifactorial. Nonetheless, despite the continued technological advances and increased adoption in LVAD therapy, a group of patients remains whose diagnoses are best treated with heart replacement. In these cases, the TAH offers the potential for home discharge and outpatient follow-up until transplantation.<sup>4</sup>

Late referrals have limited the widespread adoption of TAH, as have decisions to withhold therapy from the sickest of patients. A new group of potential candidates for the TAH are patients in cardiogenic shock with severe RV dysfunction after resuscitation on short-term mechanical circulatory support therapies. Although the increased mortality with transitioning to LVAD therapy in these patients is an important deterrent to single-ventricle support strategies, implanted

TAHs have provided encouraging results.<sup>5</sup> For transplant candidates, pre-implant dialysis (typically viewed as an independent risk factor for mortality) is not a contraindication for a TAH. Bridging to heart-kidney transplantation has been successful.<sup>6</sup> As with renal failure, advanced age is often viewed as a contraindication to TAH therapy. However, the fact that a small number of patients remain on support after 5 years has led to an ongoing destination-therapy trial of TAH in the United States and Europe.

## Conclusions

The TAH benefits the sickest of patients with complex cardiac conditions. After more than 35 years of experience with this evolving technology, we can now select and manage



**Figure 16.13.** Competing-risk outcomes for (A) 166 centers implanting up to 10 pumps and (B) 284 centers implanting more than 10 pumps. At any given time, the sum of the proportions of each outcome equals 1.

Reprinted from Arabia FA et al., Interagency registry for mechanical assisted circulatory support report on the total artificial heart, *Journal of Heart and Lung Transplantation* 2018;37:1304–1312, Copyright (2018), with permission from Elsevier.

patients with the TAH better than ever before. This experience will continue to inform the management of patients receiving the TAH and the biventricular support technologies yet to come. Heart replacement continues to have value in patients with otherwise fatal biventricular failure.

## REFERENCES

1. Copeland JG, Smith RG, Arabia FA, et al. Cardiac replacement with a total artificial heart as a bridge to transplantation. *N Engl J Med*. 2004;351(9):859–867.
2. Arabia FA, Moriguchi JD. Machines versus medication for biventricular heart failure: focus on the total artificial heart. *Future Cardiol*. 2014;10(5):593–609.
3. Arabia FA, Cantor RS, Koehl DA, et al. Interagency registry for mechanical assisted circulatory support report on the total artificial heart. *J Heart Lung Transplant*. 2018;37(11):1304–1312.
4. Shah NR, Jaroszewski, Ashfaq A, et al. SynCardia Portable Freedom Driver: a single-center experience with 11 patients. *Innovations*. 2015;10:188–194.
5. Yoshioka D, Takayama H, Garan AR, et al. Bridge to durable left ventricular assist device for the refractory cardiogenic shock. *J Thorac Cardiovasc Surg*. 2017;153:752–762.
6. Ruzza A, Czer LSC, Ihnken KA, et al. Combined heart-kidney transplantation after total artificial heart insertion. *Transplant Proc*. 2015;47:210–212.

# 17

## Counterpulsation Circulatory Assist Devices

REZA SALABAT AND VALLUVAN JEEVANANDAM

### Background

**T**he number of Americans more than 20 years old with heart failure (HF) increased to 6.5 million by 2014, and this number is projected to exceed 8 million by 2030.<sup>1</sup> Current treatments include medications, cardiac resynchronization therapy, mechanical circulatory support (MCS), and transplantation. Despite these advances, the prognosis of these patients remains poor.<sup>2,3</sup> Heart transplantation offers the best long-term survival. However, each year, more than 100,000 patients with congestive HF are estimated to be eligible for transplantation,<sup>4</sup> but only about 3,000 receive donor hearts.<sup>5</sup> The main restriction to heart transplantation is the shortage of donor organs. This shortage has led to the development of MCS devices, including total artificial hearts (TAH), continuous-flow ventricular assist devices (cfVAD), percutaneous catheter-based pumps, and counterpulsation devices.

Mechanical support devices can be categorized by their mechanism of action; they either pump blood directly (e.g., TAH and cfVAD), or they enhance diastolic function by counterpulsation (e.g., the intra-aortic balloon pump [IABP]).<sup>6–9</sup> Despite several randomized trials documenting improved survival rates and quality of life, only about 4,000 continuous-flow VADs are implanted annually in the United States.<sup>5</sup> The limited adoption of VAD technology can be partially explained by the risk of major complications (including thrombosis, hemolysis, bleeding, infection, and stroke), which may be as high as 70% at 1 year.<sup>5</sup> Adverse event rates have improved with the newer, fully magnetically levitated centrifugal VADs,<sup>9,10</sup> but the invasiveness of implantation continues to limit the widespread adoption of VAD therapy in patients who are less ill.

Counterpulsation has the potential to address some of these concerns, and it has evolved over the past five decades to become the most common approach for supporting

patients in cardiogenic shock. Newer counterpulsation technologies may increasingly be important in the long-term management of advanced heart failure.

### The Principle of Counterpulsation

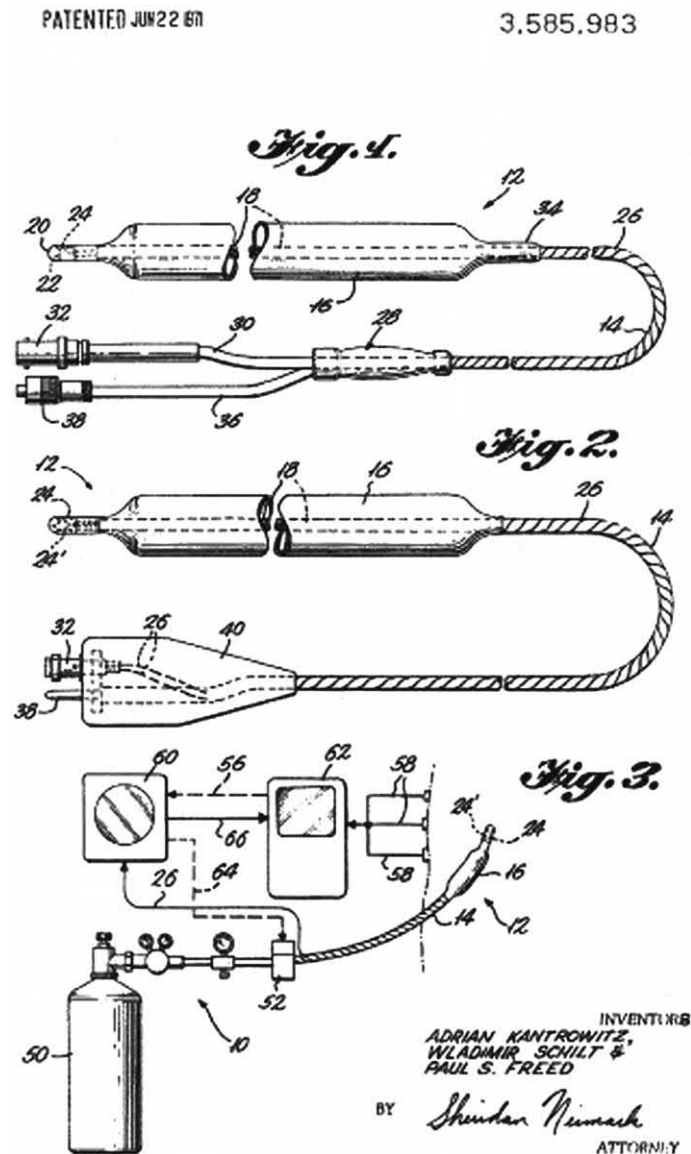
In 1953, Kantrowitz et al. introduced the concept of counterpulsation in a canine model and found an increase in coronary blood flow after delaying the arterial pressure peak until it occurred during diastole.<sup>11</sup> He later showed that compressing the distal thoracic aorta by wrapping it with the diaphragmatic muscles produced the same effect and decreased left ventricular stress.<sup>12</sup>

In earlier experiments, diastolic action was augmented when blood was aspirated from the arterial reservoir during systole and returned during diastole.<sup>13</sup> Sorrof et al. found that counterpulsation decreased left ventricular (LV) workload and myocardial oxygen consumption but had no effect on cardiac output.<sup>14</sup> The active withdrawal phase is important in reducing cardiac workload by diminishing aortic systolic pressure.<sup>15</sup> Counterpulsation can increase coronary blood flow, as well as myocardial collateral revascularization.<sup>16</sup>

### The Intra-Aortic Balloon Pump

In 1961, Mouloupoulos and Kolff introduced the first phase-shifting, intra-aortic balloon pump (IABP), a polyurethane balloon mounted on a catheter to which a latex tube was connected. The balloon was positioned within the descending aorta. A solenoid valve and a delay circuit, triggered by the R-wave of the ECG, inflated the balloon during diastole and deflated it just before systole.<sup>17</sup> In the first clinical use of IABP in 1968, terminal cardiogenic shock was reduced in all 16 patients while the IABP was running, and 7 patients survived to hospital discharge (Figure 17.1).<sup>18</sup>





**Figure 17.1.** U.S. Patent 3585983. Inventors: Adrian Kantrowitz; Wladimir Schilt; Paul S. Freed, all of c/o Maimonides Medical Center 4802 Tenth St., Brooklyn, NY 11219. Filed Mar. 5, 1968, Patented June 22, 1971.

Republished with permission of CCC Republication, from Kantrowitz J, The intra-aortic balloon pump: an early chapter in translational medicine. *Artif Organs*. 2015;39(6):457–472; permission conveyed through Copyright Clearance Center, Inc.

Sintek et al. found that the cardiac power index ( $[\text{cardiac index} \times \text{mean arterial pressure}]/451$ ), a measure of ventricular work based on flow and pressure,<sup>19,20</sup> predicted which patients with heart failure would be stabilized with an IABP.<sup>18</sup> Today, IABP is the most commonly used MCS device, benefiting more than 100,000 patients annually (Table 17.1).

### Insertion through the Subclavian Artery

The IABP was initially inserted through the common femoral artery, with the attachment of a vascular graft or other prosthesis followed by oversewing or removing the

prosthesis when the balloon was removed. With the continued evolution of transcatheter technology, percutaneous insertion through the common femoral artery became possible, either by direct access or with a 7F or 8F sheath.<sup>21,22,23</sup>

Despite these non-invasive features, femoral insertion of the IABP immobilizes the patient and increases the risk of deconditioning, infection, and limb ischemia.<sup>23</sup> Inserting the IABP through the subclavian artery and a subperiosteal clavicular resection in patients with aortoiliac atherosclerosis added little morbidity or functional compromise and allowed the patient to not be bedridden.<sup>24</sup> We modified the approach by anastomosing a graft with a

**Table 17.1 • Uses and Implications of the Intra-Aortic Balloon Pump**

Indication	Contraindications	Complications
After cardiotomy	Aortic valve insufficiency (absolute)	Vascular access injury (femoral or subclavian arteries)
Myocardial infarction	Aortic dissection (absolute)	Aortic dissection
Ventricular arrhythmia	Severe atherosclerosis	Embolism
Acute ischemic mitral incompetence	Aortic aneurysm	Thrombosis
Ischemic rupture of the ventricular septum	Blood dyscrasias	Ischemia (extremity or bowel)
Support during percutaneous coronary intervention	(thrombocytopenia)	Infection
Bridge to transplant	Access limitations	
High-risk patients undergoing other surgeries		

one-way valve to the subclavian artery through an infraclavicular transverse incision.<sup>25</sup> We then placed a guide wire into the graft and inserted a balloon, which was positioned under fluoroscopic or echocardiographic guidance. The size of the balloon (34/40/50 cc) was determined from the patient's height. After insertion, the device can be secured to the chest wall. This method provided excellent hemodynamic support and permitted extensive rehabilitation activities.<sup>34</sup>

### Percutaneous Insertion through the Subclavian or Axillary Arteries

Intra-aortic balloon pumps can be placed percutaneously as a bridge to transplantation.<sup>26</sup> We have used percutaneous subclavian access for almost all of our patients with the following method. The left or right supraclavicular subclavian or infraclavicular axillary artery is accessed under ultrasound guidance with a 5F-micropuncture kit, after the size of the artery is deemed to be greater than 4 mm. A 0.018-inch guidewire is advanced and followed by a 5F sheath. The entry site into the artery and the sheath is visualized with 10 cc of 50% water-soluble contrast to determine whether there are branches which might be occluded when the IABP is removed with an AngioSeal device. Using a 0.035-inch guidewire, the micropuncture sheath is exchanged for a 7F or an 8F sheath, which can be used to advance the 0.025-inch IABP guidewire into the descending aorta under fluoroscopy. The sheath is then removed, and the fiberoptic balloon is advanced and positioned at the level of the left mainstem bronchus. Finally, we always confirm the position of the distal marker in the abdomen to avoid placement in a mesenteric vessel and to avoid bowel ischemia. Hemostasis during removal is accomplished either with direct pressure or an AngioSeal vascular closure device.

## Other Counterpulsation Devices

### Extracorporeal Devices

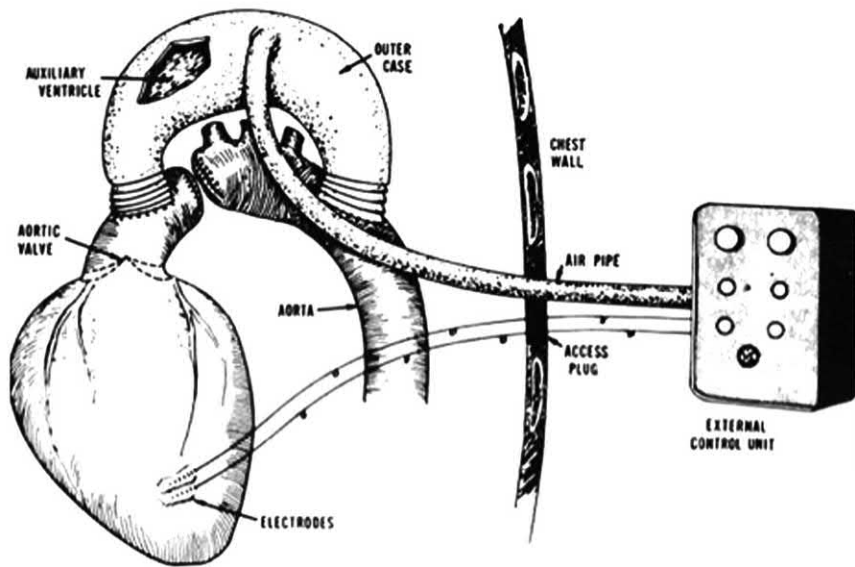
Extracorporeal counterpulsation was first reported as a non-invasive, intermittent counterpulsation strategy.<sup>27,28,29</sup> This method uses three inflatable cuffs placed on the upper thigh, lower thigh, and the calf. During diastole, each cuff is inflated to a pressure of 300 mm Hg, first at the calf, then the lower thigh, and finally the upper thigh. The cuffs are deflated in reverse order during systole in a synchronized fashion, triggered off the patient's ECG.<sup>30</sup> The patient is treated 1–2 hours a day, 5–7 days a week, for 6–7 weeks. This method has been used primarily for patients with chronic stable angina and is based on the hypothesis that it promotes collateral circulation through vascular endothelial growth factor- and nitric-oxide-mediated vasodilation and angiogenesis.<sup>31</sup> The method is contraindicated in patients with peripheral vascular disease, hypertension, deep vein thrombosis, atrial fibrillation, or leg ulcers.

### Implantable Devices

#### The Kantrowitz CardioVAD

##### Left-Ventricular Device

In 1966, Kantrowitz et al. used a U-shaped mechanical auxiliary ventricle that bridged the aortic arch.<sup>32</sup> The pump was extremely effective, given that the pump inlet was close to the aortic valve, creating a stroke volume greater than that of the left ventricle (Figure 17.2). However, high complication rates led to its abandonment. The auxiliary ventricle was later redesigned by replacing a portion of the descending aorta with an inflatable patch. This aortic-wall LVAD was first used successfully in humans in 1971, when it was implanted in a 64-year-old man who survived 96 days after discharge.<sup>33</sup> He was able to ambulate at home with the LVAD. Despite its early success, the device



**Figure 17.2.** The U-shaped, first-generation mechanical auxiliary ventricle and its power supply.

Republished with permission of CCC Republication, from Kantrowicz J, The intra-aortic balloon pump: an early chapter in translational medicine. *Artif Organs*. 2015 Jun;39(6):457–472; permission conveyed through Copyright Clearance Center, Inc.

ultimately failed from an unacceptably high rate of driveline infections. Further research and development resulted in the introduction of a modified device, the Kantrowitz CardioVAD.

The Kantrowitz CardioVAD (LVAD technology, Detroit, MI) consists of three components: (1) the pumping chamber, which is sewn into the aortic wall, (2) a percutaneous access device, and (3) an external driver.<sup>34</sup> The pump is composed of a polyurethane diaphragm mounted on a rigid plastic shell that replaces the lateral wall of the descending aorta. The access device is a Dacron-covered disk seeded with autologous fibroblasts that is placed on the abdominal fascia and connected to the external controller through a driveline (Figure 17.3). The driver supplies compressed air to the pump, providing 50 cc of stroke volume during inflation, which approximates that of a normal heart. The device is triggered by the electrical activity of the native heart and is designed to inflate during diastole and deflate just before systole (Figure 17.4). The device can be implanted through a thoracotomy with cardiopulmonary bypass support and, once implanted, does not require anticoagulation. Contraindications for this device include biventricular dysfunction and uncontrolled tachyarrhythmia. However, complications related to membrane leaks and limited options for device exchange ended further development, and it is no longer used.

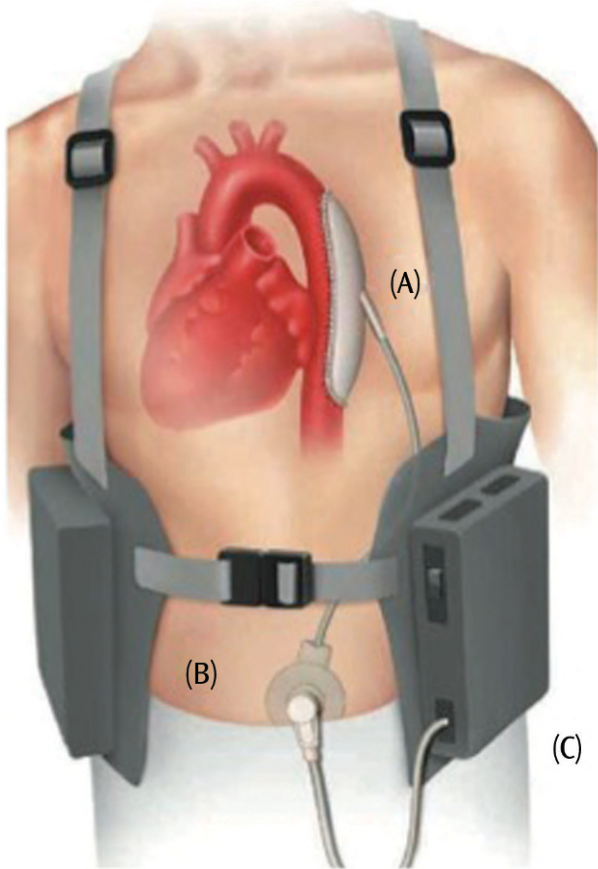
#### Subcutaneous Counterpulsation Devices

The Symphony Device System (ClinicalTrials.gov identifier: NCT01543022) has been introduced as a 30-cc pump with a single conduit that acts as both the inlet and outlet. The device is implanted by anastomosing a conduit

to the subclavian artery. The device itself is placed under the pectoralis muscle in a small pocket, and the driveline is tunneled through the skin and attached to the console. During systole, the driver, which is synchronized to the patient's ECG, evacuates air from the pump, which draws blood away from the systemic circulation, reducing afterload. The device then returns the blood back to the circulation during diastole to increase coronary blood flow. Several studies of the Symphony have documented hemodynamic benefits.<sup>35,36</sup> Indications for this device include NYHA class IIIB and IV heart failure (HF) and myocardial infarction. It is contraindicated in patients with severe vascular disease and small or obstructed axillary arteries. Cerebrovascular accidents are an additional risk of this technology because the device is positioned near the carotid artery. Although early data showed promise for this device, it is no longer being studied in clinical trials.

#### Extra-Aortic Balloon Counterpulsation Devices

The non-blood-containing Sunshine Heart C-Pulse device system (Sunshine Heart, Inc., Eden Prairie, MN) is designed for long-term use in patients with heart failure.<sup>37</sup> The C-Pulse is an extra-aortic balloon pump counterpulsation device that is wrapped around the ascending aorta and pneumatically driven by an external system controller after receiving electrical signals from a bipolar epicardial ECG-sensing lead.<sup>38</sup> Implantation requires a median sternotomy and mobilization of the aorta to the level of the innominate artery. Because the C-Pulse contains no blood, it does not require anticoagulation. It is also a non-obligatory system, meaning that it can be turned off without deleterious effect on the native



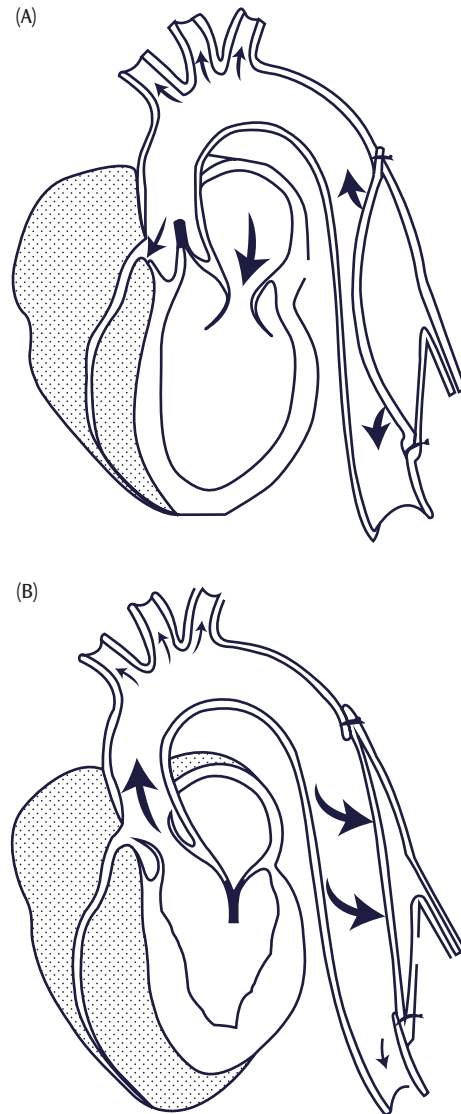
**Figure 17.3.** (A) The Kantrowitz CardioVAD left-ventricular device sewn to the descending aorta. (B) The percutaneous access device. (C) The drive console.

Reprinted with permission from Jeevanandam V et al., Circulatory assistance with a permanent implantable IABP: initial human experience. *Circulation*. 2002;106(12 Suppl 1):I-183–I-188, <https://www.ahajournals.org/journal/circ> © American Heart Association, Inc. All rights reserved.

circulatory pathway. The duration of time on or off is determined by the native cardiac reserve and the degree of heart failure. The device is contraindicated in patients with atherosclerosis of the ascending aorta, aortic insufficiency, and prior heart surgery, and the driveline infection rate is substantial.<sup>39</sup> The pivotal trial was closed for lack of enrollment and insufficient characterization of suitable candidates.

#### The Intravascular Ventricular Assist System

The NuPulseCV intravascular ventricular assist system (iVAS; NuPulseCV, Inc., Raleigh, NC) is a new, minimally invasive, counterpulsation, ambulatory heart assist system.<sup>40</sup> Like the IABP, iVAS provides counterpulsation using a 50-cc pump. Longer-term use and use outside the hospital are facilitated by a skin interface device (Figure 17.5), which is an electromechanical and pneumatic conduit with



**Figure 17.4.** The Kantrowitz CardioVAD (A) inflates during diastole to push blood out of aorta and (B) deflates just before systole, which reduces the workload of the heart.

Reprinted with permission from Jeevanandam V et al., Circulatory assistance with a permanent implantable IABP: initial human experience. *Circulation*. 2002;106(12 Suppl 1):I-183–I-188, <https://www.ahajournals.org/journal/circ> © American Heart Association, Inc. All rights reserved.

a chimney that allows air to be shuttled between the pump and an external driver. Captured ECG signals are transmitted to the driver through subcutaneous electrodes. An external and wearable drive unit provides compressed ambient air to inflate and deflate the pump (Figure 17.6). The NuPulse is inserted through a graft anastomosed to either the right or left subclavian artery using a guide wire inserted into the descending aorta. A snare is inserted through the femoral artery and engages the guidewire. The guidewire is then



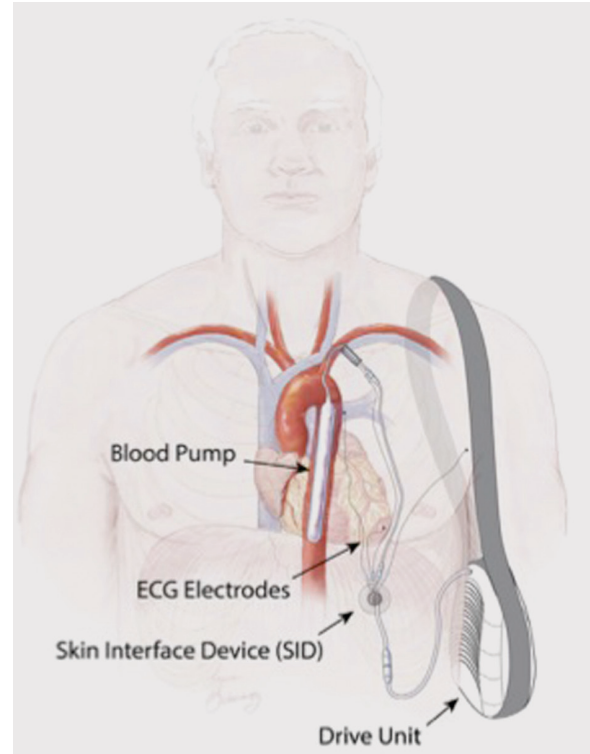
**Figure 17.5.** The NuPulseCV iVAS skin interface device (or SID). It has a wide base to adhere to the subcutaneous tissue for stability and a textured titanium neck for interfacing with the skin. The device has a microprocessor that digitizes the EKG and sends the signal to the driver. The SID acts as an electro-mechanical conduit for the EKG trigger and air. The cap can be rotated. The external driveline is attached to the patient with a connector.

Reprinted with permission from Jeevanandam V et al., Circulatory assistance with a permanent implantable IABP: initial human experience. *Circulation*. 2002;106(12 Suppl 1):I-183–I-188, <https://www.ahajournals.org/journal/circ> © American Heart Association, Inc. All rights reserved.

used as a rail to push the snare out the subclavian artery access port, where it is used to grab the iVAS balloon and guide it to the descending aorta under fluoroscopy.

The Food and Drug Administration (FDA)–approved, first-in-human study reported excellent safety results and marked improvement in hemodynamic characteristics.<sup>40</sup> This study was conducted in 20 patients who were to be listed as IA or IB for transplantation, all of whom received transplants within about a month after iVAS implantation.

The iVAS was developed to prevent the adverse events accompanying the cLVAD and to facilitate forward compatibility because implantation does not violate the pericardial cavity, making the device easy to remove or exchange. The iVAS allows patients to ambulate early, which promotes a shorter recovery. Although designed for prolonged support, iVAS is non-obligatory and can be interrupted for variable periods, depending on the patient's HF status. Unlike a conventional IABP, the iVAS has no seams, which likely enhances stability (up to 2.5 years based on in-vitro studies). Clinically, it is associated with low complication rates. It does require mild anticoagulation with INR goals of 1.5 to 2. The ideal candidate is a patient in whom cardiac resynchronization therapy has failed but who is not yet willing to accept the risks associated with a durable LVAD. Device indications include bridge to (1) recovery, (2) prolongation



**Figure 17.6.** The intravascular ventricular assist system in situ.

Reprinted from Jeevanandam V et al., The first-in-human experience with a minimally invasive, ambulatory, counterpulsation heart assist system for advanced congestive heart failure. *Journal of Heart and Lung Transplantation*. 2018;37:1–6, Copyright (2018), with permission from Elsevier.

of medical therapy, (3) transplantation, and (4) optimization for subsequent LVAD insertion.

## Summary

The ideal MCS device should be easy to implant and remove with minimal complications, allow patient mobility and rehabilitation, and provide enough mechanical unloading to restore quality of life to the patient. Counterpulsation augments aortic pressure during early diastole, which increases coronary blood flow and myocardial performance by increasing myocardial oxygen supply. In addition, it reduces aortic pressure during systole, which reduces myocardial oxygen consumption and ventricular stress by decreasing afterload.<sup>41</sup> As a result, cardiac output and stroke volume increase, which increases end-organ perfusion.<sup>30</sup> Devices based on counterpulsation may prove to be effective in supporting patients with decompensated heart failure; for use as a bridge to prolong medical therapy, recovery, and transplant; or to optimize patients to receive a long-term MCS device.

## REFERENCES

- Benjamin EJ, Blaha MJ, Chiuve SE, et al. Heart disease and stroke statistics-2017 update: a report from the American Heart Association. *Circulation*. 2017;135(10):e146–e603.
- Muntwyler J, Abetel G, Gruner C, Follath F. One-year mortality among unselected outpatients with heart failure. *Eur Heart J*. 2002;23(23):1861–1866.
- Pitt B, Zannad F, Remme WJ, et al. The effect of spironolactone on morbidity and mortality in patients with severe heart failure: Randomized Aldactone Evaluation Study Investigators. *N Engl J Med*. 1999;341(10):709–717.
- Mozaffarian D, Benjamin EJ, Go AS, et al. Heart disease and stroke statistics—2015 update: a report from the American Heart Association. *Circulation*. 2015;131(4):e29–322.
- Kirklin JK, Naftel DC, Pagani FD, et al. Seventh INTERMACS annual report: 15,000 patients and counting. *J Heart Lung Transplant*. 2015;34(12):1495–1504.
- Kantrowitz A. Moments in history: introduction of left ventricular assistance. *ASAIO Trans*. 1987;33(1):39–48.
- Rose EA, Gelijns AC, Moskowitz AJ, et al. Randomized Evaluation of Mechanical Assistance for the Treatment of Congestive Heart Failure (RE-MATCH) Study Group. Long-term use of a left ventricular assist device for end-stage heart failure. *N Engl J Med*. 2001;345:1435–1443.
- Rogers JG, Pagani FD, Tatooles AJ, et al. Intrapericardial left ventricular assist device for advanced heart failure. *N Engl J Med*. 2017;376:451–460.
- Mehra MR, Goldstein DJ, Uriel N, et al. Two-year outcomes with a magnetically levitated cardiac pump in heart failure. *N Engl J Med*. 2018;378(15):1386–1395.
- Mehra MR, Naka Y, Uriel N, et al. A fully magnetically levitated circulatory pump for advanced heart failure. *N Engl J Med*. 2017;376(5):440–450.
- Kantrowitz A. Experimental augmentation of coronary flow by retardation of the arterial pressure pulse. *Surgery*. 1953;34(4):678–687.
- Kantrowitz A, McKinnon WM. The experimental use of the diaphragm as an auxiliary myocardium. *Surg Forum*. 1958;9:266–268.
- Clauss RH, Birtwell WC, Albertal G, et al. Assisted circulation. I. The arterial counterpulsator. *J Thorac Cardiovasc Surg*. 1961;41:447–458.
- Soroff HS, Birtwell WC, Levine HJ, Bellas AE, Deterling RA Jr. Effect of counterpulsation upon the myocardial oxygen consumption and heart work. *Surg Forum*. 1962;13:174–176.
- Sarnoff SJ, Braunwald E, Welch GH, Jr, Case RB, Stainsby WN, Macruz R. Hemodynamic determinants of oxygen consumption of the heart with special reference to the tension-time index. *Am J Physiol*. 1958;192(1):148–156.
- Jacobey JA, Taylor WJ, Smith GT, Gorlin R, Harken DE. A new therapeutic approach to acute coronary occlusion. *Surg Forum*. 1961;12:225–227.
- Moulopoulos SD, Topaz S, Kolff WJ. Diastolic balloon pumping (with carbon dioxide) in the aorta: a mechanical assistance to the failing circulation. *Am Heart J*. 1962;63:669–675.
- Kantrowitz A, Tjonneland S, Krakauer JS, Phillips SJ, Freed PS, Butner AN. Mechanical intraaortic cardiac assistance in cardiogenic shock: hemodynamic effects. *Arch Surg*. 1968;97(6):1000–1004.
- Fincke R, Hochman JS, Lowe AM, et al. Cardiac power is the strongest hemodynamic correlate of mortality in cardiogenic shock: a report from the SHOCK trial registry. *J Am Coll Cardiol*. 2004;44(2):340–348.
- Sintek MA, Gdowski M, Lindman BR, et al. Intra-aortic balloon counterpulsation in patients with chronic heart failure and cardiogenic shock: clinical response and predictors of stabilization. *J Card Fail*. 2015;21(11):868–876.
- Bregman D, Casarella WJ. Percutaneous intraaortic balloon pumping: initial clinical experience. *Ann Thorac Surg*. 1980;29(2):153–155.
- Subramanian VA, Goldstein JE, Sos TA, McCabe JC, Hoover EA, Gay WA Jr. Preliminary clinical experience with percutaneous intraaortic balloon pumping. *Circulation*. 1980;62(2 Pt 2):I-123–I-129.
- Dick P, Mlekusch W, Delle-Karth G, Nikfardjam M, Schillinger M, Heinz G. Decreasing incidence of critical limb ischemia after intra-aortic balloon pump counterpulsation. *Angiology*. 2009;60(2):235–241.
- Mayer JH. Subclavian artery approach for insertion of intra-aortic balloon. *J Thorac Cardiovasc Surg*. 1978;76(1):61–63.
- Tanaka A, Tuladhar SM, Onsager D, et al. The subclavian intraaortic balloon pump: a compelling bridge device for advanced heart failure. *Ann Thorac Surg*. 2015;100(6):2151–2157; discussion 2157–2158.
- Estep JD, Cordero-Reyes AM, Bhimaraj A, et al. Percutaneous placement of an intra-aortic balloon pump in the left axillary/subclavian position provides safe, ambulatory long-term support as bridge to heart transplantation. *JACC Heart Fail*. 2013;1(5):382–388.
- Birtwell W, Giron F, Soroff H, Ruiz U, Collins J, Deterling R. Support of the systemic circulation and left ventricular assist by synchronous pulsation of extramural pressure. *Trans Am Soc Artif Intern Organs*. 1965;11:43–51.
- Dennis C, Moreno JR, Hall DP, et al. Studies external counterpulsation as a potential measure for acute left heart failure. *Trans Am Soc Artif Intern Organs*. 1963;9:186–191.
- Osborn JJ, Russi M, Salel A, Bramson ML, Gerbode F. Circulatory assistance by external pulsed pressures. *Am J Med Electron*. 1964;3:87–90.
- Solanki P. Aortic counterpulsation: C-pulse and other devices for cardiac support. *J Cardiovasc Transl Res*. 2014;7(3):292–300.
- Sharma U, Ramsey HK, Tak T. The role of enhanced external counter pulsation therapy in clinical practice. *Clin Med Res*. 2013;11(4):226–232.
- Kantrowitz A, Akutsu T, Chaptal PA, Krakauer J, Kantrowitz AR, Jones RT. A clinical experience with an implanted mechanical auxiliary ventricle. *JAMA*. 1966;197(7):525–529.
- Kantrowitz A, Krakauer J, Rubenfire M, et al. Initial clinical experience with a new permanent mechanical auxiliary ventricle: the dynamic aortic patch. *Trans Am Soc Artif Intern Organs*. 1972;18(0):159–167, 179.
- Jeevanandam V, Jayakar D, Anderson AS, et al. Circulatory assistance with a permanent implantable IABP: initial human experience. *Circulation*. 2002;106(12 Suppl 1):I-183–I-188.
- Giridharan GA, Pantalos GM, Litwak KN, Spence PA, Koenig SC. Predicted hemodynamic benefits of

- counterpulsation therapy using a superficial surgical approach. *ASAIO J.* 2006;52(1):39–46.
36. Koenig SC, Spence PA, Pantalos GM, Dowling RD, Litwak KN. Development and early testing of a simple subcutaneous counterpulsation device. *ASAIO J.* 2006;52(4):362–367.
  37. Davies AN, Peters WS, Su T, et al. Extra-ascending aortic versus intra-descending aortic balloon counterpulsation-effect on coronary artery blood flow. *Heart Lung Circ.* 2005;14(3):178–186.
  38. Sales VL, McCarthy PM. Understanding the C-pulse device and its potential to treat heart failure. *Curr Heart Fail Rep.* 2010;7(1):27–34.
  39. Hayward CS, Peters WS, Merry AF, et al. Chronic extra-aortic balloon counterpulsation: first-in-human pilot study in end-stage heart failure. *J Heart Lung Transplant.* 2010;29(12):1427–1432.
  40. Jeevanandam V, Song T, Onsager D, et al. The first-in-human experience with a minimally invasive, ambulatory, counterpulsation heart assist system for advanced congestive heart failure. *J Heart Lung Transplant.* 2018;37(1):1–6.
  41. Cheung AT, Savino JS, Weiss SJ. Beat-to-beat augmentation of left ventricular function by intraaortic counterpulsation. *Anesthesiology.* 1996;84(3):545–554.

SHIVA K. ANNAMALAI, ADITYA CHENNOJWALA, SINA FOROUTANJAZI,  
SAMUEL J. KARMIY, ALLEN A. RAZAVI, AND NAVIN K. KAPUR

## Introduction

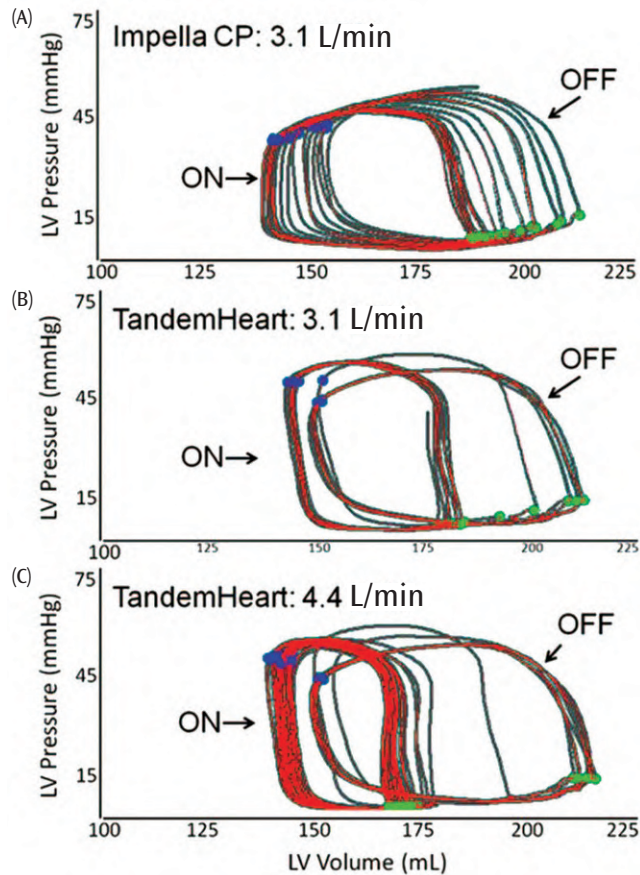
**A**cute mechanical circulatory support pumps can be categorized as either pulsatile or non-pulsatile (continuous) flow systems, which are commonly grouped as either axial or centrifugal flow pumps. In both cases, continuous-flow pumps require an inflow and outflow segment. If the inflow cannula resides outside the left ventricle (LV), as in the case of the TandemHeart device where the inflow cannula is positioned in the left atrium, then they are described as “indirect” LV unloading systems. If the inflow segment resides in the LV, then these devices can be described as “direct” LV unloading systems. At present, all percutaneously delivered, direct LV unloading systems are trans-valvular, meaning the inflow segment is in the LV and the outflow segment is in the ascending aorta. Based on the original description of the Archimedes screw, trans-valvular pumps employ micro-axial impellers within a tube to transfer rotational kinetic energy to blood and thereby generate flow. When activated, trans-valvular pumps reduce both LV pressure and volume, thereby reducing myocardial workload and pressure-volume area, which is a direct correlate of myocardial oxygen consumption (Figure 18.1).

One of the earliest trans-valvular pumps was the Hemopump (Nimbus, Inc.), which featured a micro-axial impeller attached by a driveline to an *extracorporeal* motor. Initial preclinical testing in a canine model of surgical LAD (left anterior descending coronary artery) ischemia and reperfusion showed reduced cardiac workload due to systolic and diastolic unloading with a concomitant increase in perfusion to ischemic myocardium.<sup>2</sup> Clinical translation of these early studies was limited by the need for surgical vascular access for delivery of the Hemopump and potential adverse effects including vascular complications, hemolysis, and the need for a driveline and externalized motor.

In parallel to the development of the Hemopump, another trans-valvular pump known as the Impella (Abiomed, Inc.) was introduced into clinical practice in the first decade of the 2000s. In contrast to the Hemopump, the Impella micro-axial impellers were connected to an *intracorporeal* motor without the need for an externalized driveline. In 2003, Meyns and colleagues employed a sheep model of surgical LAD ischemia and reperfusion injury to test whether full or partial trans-valvular support with a surgically implanted Impella pump reduced infarct size.<sup>3</sup> These investigators observed that initiation of full support at the time of reperfusion with flow rates of over 4 liters per minute had a greater reduction in infarct size compared to partial support (2.5 L/min). Using aortic and coronary sinus blood samples, they further reported that reduced myocardial oxygen consumption during Impella support correlated directly with reduced myocardial infarct size.

The Impella series of trans-valvular pumps include several percutaneous and surgically delivered models for left or right ventricular support (Figure 18.2). The Impella 2.5 left percutaneous pump was first introduced into clinical practice in 2005 in Europe, followed by the United States in 2008. The Impella 2.5 achieves flow rates up to 2.5 L/min and is delivered through a 13 Fr sheath. The Impella 5.0 left direct (LD) and left percutaneous (LP) pump was approved for use in the United States in 2005 and achieves flow rates of 5 L/min. The 5.0 LP pump is most commonly used and is delivered into the LV via a 10-mm chimney graft placed on either the axillary or femoral arteries. In 2012, the Impella CP device was approved for use in the United States and achieves 3.5 L/min of flow. The CP is delivered via a 14 Fr sheath and is commonly deployed via the femoral or axillary arteries. In 2015, the Impella RP was approved for right heart support and is delivered via a 23 Fr sheath in the femoral vein. The RP device displaces blood from the right atrium to the pulmonary artery and can achieve up to 5 L/min of flow (Table 18.1).





**Figure 18.1.** Representative pressure-volume loops during device activation. (A) CP activation at P8 achieved  $3.1 \pm 0.2$  L/min of flow; (B) TH activation at 5,500 rpm achieved  $3.1 \pm 0.4$  L/min of flow; (C) TH activation at 7,500 rpm achieved  $4.4 \pm 0.3$  L/min of flow.

L/min = liter per minute; TH = TandemHeart; rpm = rotations per minute.

Reprinted with permission from Kapur NK et al., Hemodynamic effects of left atrial or left ventricular cannulation for acute circulatory support in a bovine model of left heart injury, *ASAIO Journal* 2015;61(3):301–306, <https://journals.lww.com/asaiojournal/pages/default.aspx> Copyright © 2019 by the ASAIO. All rights reserved.

## Flow Mechanics for the Impella Platform

The fundamental principle governing device flow through a continuous flow pump can be explained using the pressure head-flow (H-Q) curve where flow is directly related to rotations per minute (rpm) of the impeller and indirectly related to pressure at the inlet and outlet of the impeller (Figure 18.3).<sup>4</sup> This pressure gradient ( $P_{in} - P_{out}$ ) varies during systole and diastole. The relationship between pressure and flow is best described using an H-Q curve

where H is defined as the pressure head ( $P_{in} - P_{out}$ ) and Q is defined as device flow. Each device has a specific H-Q curve signature. Axial-flow pumps tend to have a steeper H-Q slope, while centrifugal flow pumps have a flatter H-Q slope.<sup>4</sup> For the left ventricular Impella support devices, the pressure head (H) includes LV pressure and aortic pressure. For patients without decompensated heart failure or aortic valve disease (i.e., undergoing high-risk PCI), peak aortic and LV systolic pressures are matched and at peak systole (i.e.,  $AoSP - LVESP = 120 \text{ mmHg} - 120 \text{ mmHg}$ ) and the estimated H is zero. Throughout diastole, aortic diastolic pressure ranges between 60–80 mmHg (AoDP) and LV diastolic pressure (LVEDP) is often below 20 mmHg. Therefore, the estimated H ranges between 40–60 mmHg ( $AoDP - LVEDP$ ) and 0 ( $AoSP - LVESP$ ). Based on this principle, for a given rpm, continuous flow devices will provide higher flow at peak systole ( $H = 0$ ) and lower flow in diastole ( $H = 40\text{--}60$ ). In contrast, the patient with cardiogenic shock may have a substantially lower H during diastole with high LVEDP and low AoDP. For this reason, for a given rpm, continuous-flow devices will provide higher flow at both peak systole and end-diastole compared to a patient without decompensated heart failure or shock. Based on this principle, the more dysfunctional the LV, the more functional the trans-valvular axial flow pump.

## Left Ventricular Support Cardiogenic Shock

In 2016, the Impella 2.5 LP, CP, 5.0 LP, and LD received Pre Market Approval (PMA) approval from the Food and Drug Administration (FDA) for use in cardiogenic shock. These Impella devices are currently the only acute mechanical circulatory support devices with regulatory approval for cardiogenic shock. The safety of the Impella 2.5 LP device was well established by two large registries.<sup>5,6</sup> The clinical utility of the Impella 2.5 LP was first studied in the ISAR-Shock (Efficacy Study of LV Assist Device to Treat Patients with Cardiogenic Shock) study, which randomized a small number of patients ( $n = 13/\text{group}$ ) presenting with acute myocardial infarction (AMI) and cardiogenic shock to the Impella 2.5 LP or intra-aortic balloon pump (IABP). Acute improvement in cardiac index was greater with the Impella 2.5 LP device compared with IABP ( $0.49 \pm 0.46$  L/min/m<sup>2</sup> compared with a change of  $0.11 \pm 0.31$  L/min/m<sup>2</sup>, Impella 2.5 LP vs. IABP;  $P < .01$ ), but in-hospital mortality and 2-year follow-up data showed no significant difference between the two arms.<sup>7</sup>

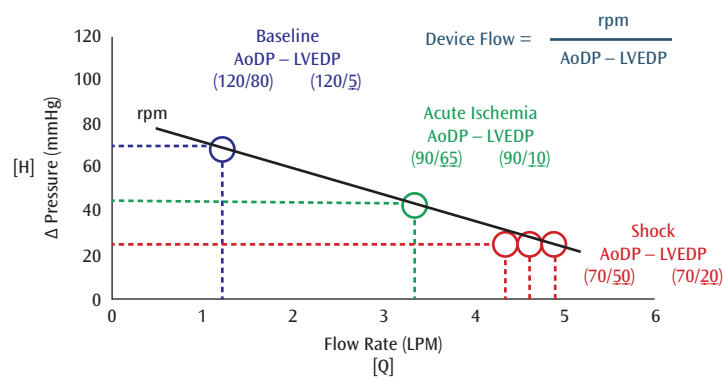
In a study using the USpella Registry, patients ( $n = 154$ ) were evaluated for Impella 2.5 support prior to percutaneous coronary intervention (pre-PCI) versus post-PCI in the setting of cardiogenic shock complicated by acute myocardial infarction.<sup>8</sup> Patients in the pre-PCI arm had better survival rates at discharge compared to post-PCI (65.1% vs.



**Figure 18.2.** The Impella series of pumps. The Impella 2.5, CP, and RP are delivered without the need for a surgical cut-down. The Impella 5.0 requires surgical cut-down of either an axillary or femoral artery. Reproduced with permission from Abiomed® 2019.

**Table 18.1 • Technical Details about Each Impella Device**

	Sheath Size	Motor Size	Catheter Size	Flow (L/min)	Surgical Access
Impella 2.5	13 Fr	12 Fr	9 Fr	2.5	N
Impella CP	14 Fr	14 Fr	9 Fr	3.7	N
Impella 5.0	10mm graft	21 Fr	9 Fr	5	Y
Impella RP	23 Fr	22 Fr	11 Fr	4.5	N



**Figure 18.3.** The H-Q curve: a fundamental principle of continuous-flow pumps. Primary determinants of device flow (Q) for rotary pumps include rotations per minute (rpm) and the pressure gradient between the inlet and outlet of the impeller, referred to as the pressure head (H). In the case of LV acute mechanical circulatory support devices, H is determined by aortic pressure and left ventricular pressure.

AoDP = aortic diastolic pressure, LVEDP = left ventricular end diastolic pressure.

Original figure from the authors.

40.7%,  $p = 0.003$ ) after adjusting for confounding variables. These rates were similar to the results in the SHOCK registry and the EUROSHOCK Impella Registry.<sup>9,10</sup>

More recently, a retrospective analysis of 287 patients with acute myocardial infarction and cardiogenic shock (AMI-CS) from the catheter-based Ventricular Assist Device (CVAD) registry identified that implantation of an Impella 2.5 or CP pump prior to PCI and prior to vasoactive agent use (inotrope or vasopressor) were associated with increased survival to hospital discharge (68% versus 26% when patient was receiving 0 versus >4 vasoactive agents,  $p < 0.001$ ). Furthermore, improved survival was associated with earlier device activation after initial presentation with AMI-CS (66% vs. 26%, Impella support within <1.25 hours versus >4.25 hours from shock onset,  $p = 0.017$ ).<sup>11</sup> The National Cardiogenic Shock Initiative is a prospective registry exploring whether early activation of an Impella CP improves survival in AMI-CS (A in Figure 18.4).<sup>12</sup>

In addition to acute myocardial infarction complicated by cardiogenic shock, several studies have examined the clinical utility of the Impella 5.0 in patients with cardiogenic shock after cardiac surgery or due to advanced heart failure. The RECOVER-I study was a prospective, single-arm feasibility study of the Impella 5.0 device for post-cardiotomy cardiogenic shock. In this study, the Impella 5.0 significantly improved cardiac index from  $1.6 \pm 0.4$  to  $2.5 \pm 0.4$  L/min/m<sup>2</sup> ( $p = 0.0001$ ) and mean arterial pressure ( $71 \pm 13$  to  $83 \pm 8$  mmHg ( $p = 0.01$ ) while reducing pulmonary artery diastolic pressure ( $28 \pm 4$  vs.  $20 \pm 3$  mmHg;  $p < 0.0001$ ); 93% of patients survived to hospital discharge.<sup>13</sup> A larger retrospective analysis of Impella use in cardiogenic shock included 37 of 47 total patients receiving an Impella 5.0 pump. In this study, 1-year survival was 71.8% for post-cardiotomy cardiogenic shock and 42.9% for patients with shock complicating AMI or dilated cardiomyopathy.<sup>14</sup>

Among patients with advanced heart failure, a retrospective multicenter analysis evaluated 58 patients who received the Impella 5.0 as part of bridge strategy to evaluate candidacy for advanced therapies such as durable ventricular assist device or orthotopic heart transplantation. Patients included in the analysis had 100% inotrope dependency and a mean LV ejection fraction of 13%. Mean duration of support was 7 days, 39 (67%) patients survived to next therapy (durable MCS,  $n = 20$ ; heart transplantation,  $n = 15$ ; weaned off support,  $n = 4$ ). Patients who survived to next therapy had a 30-day survival of 87% (B in Figure 18.4).<sup>15</sup>

More recently, a retrospective, single-center series analysis reported the clinical feasibility of ambulating patients with INTERMACS 1 heart failure who received the Impella 5.0 pump via an axillary cut-down approach.<sup>16</sup> Collectively, these studies identify the Impella 5.0 as an intermediate option to first stabilize advanced heart failure patients with cardiogenic shock so that time is available to evaluate patients for advanced heart failure therapies. Furthermore,

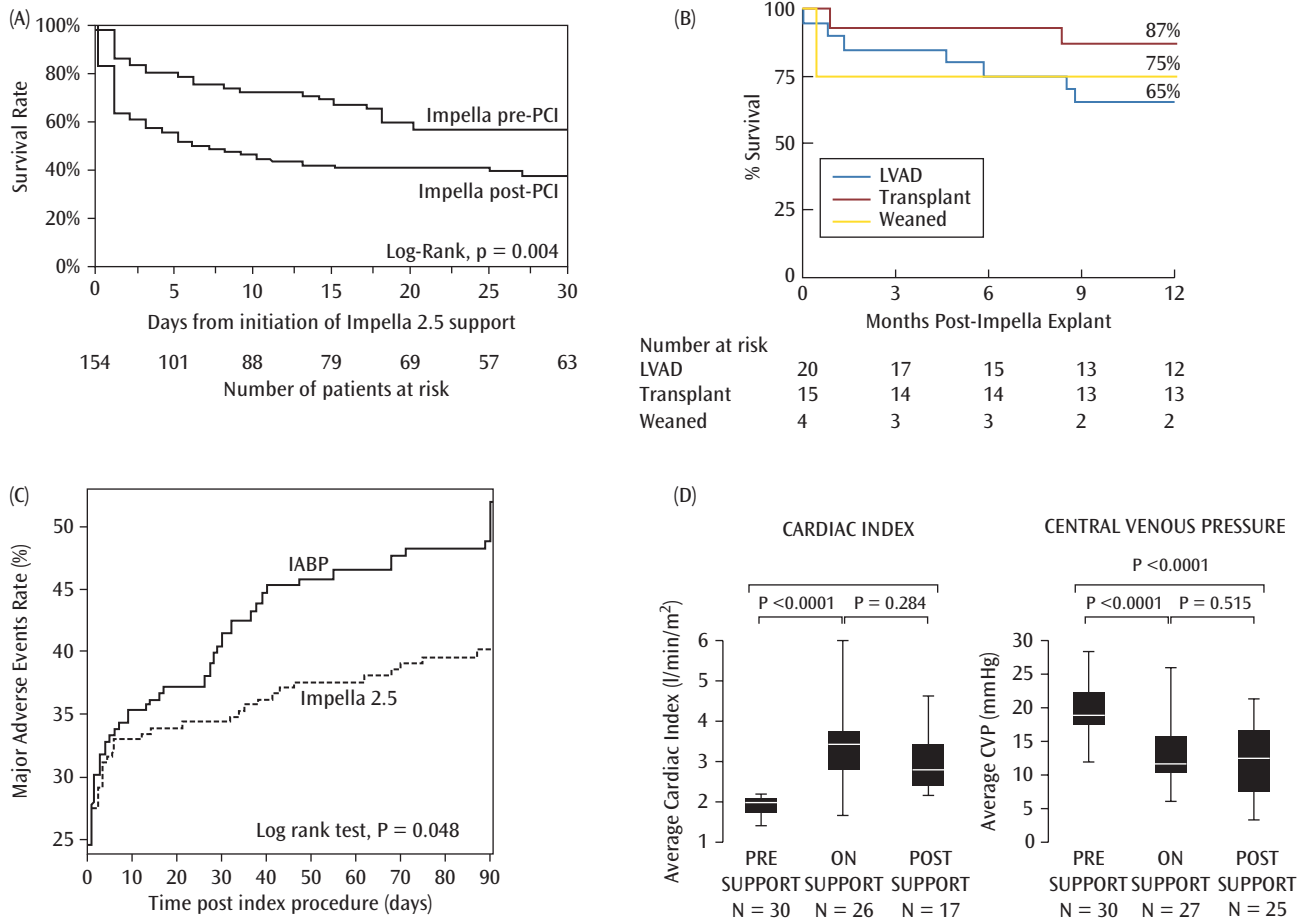
the ability to support patients with a high-flow, non-surgical device while allowing the patient to engage in physical therapy is a major step forward toward optimizing patients before cardiac surgery and as a mechanism to bridge patients to recovery as opposed to cardiac replacement therapy.

### Protected PCI

One of the most common applications of the Impella devices is for high-risk PCI.<sup>17</sup> Most commonly, high-risk PCI patients are defined as having reduced left ventricular ejection fraction, single or multi-vessel coronary artery disease with a large area of myocardium at risk, or complex coronary disease involving either bifurcation anatomy, severe calcification requiring rotational atherectomy, or chronic total occlusions. The PROTECT II trial randomized 452 patients with complex 3-vessel disease (3-VD) with left ventricular ejection fraction (LVEF) <30% or unprotected left main coronary artery disease with LVEF <35% to IABP ( $n = 226$ ) or Impella 2.5 ( $n = 226$ ) support. The trial demonstrated favorable 90-day outcomes in patients with hemodynamic support using Impella 2.5 with a strong trend toward decreased major adverse events (MAE) in Impella-supported patients compared to IABP in the intent-to-treat population (40.6% vs. 49.3%,  $p = 0.066$ ) and in the per-protocol population (40% vs. 51%,  $p = 0.02$ ).<sup>18</sup> In a subsequent sub-study, the patients of the PROTECT II trial were stratified, looking only at patients with the 3VD.<sup>19</sup> Results showed favorable 90- and 30-day outcomes in patients with 3VD using Impella 2.5 ( $n = 167$ ) versus IABP ( $n = 158$ ) (C in Figure 18.4). Additionally, there was a decreasing trend in MAE incidence after 30 days (32.9% vs. 42.4%,  $p = 0.078$ ) and a significant decrease at 90 days (39.5% vs. 51.0%,  $p = 0.039$ ). These findings were consistent when groups were stratified by age, gender, race, LVEF, clinical risk factors, and prior coronary artery bypass grafting (CABG). There was not a significant difference between diabetic and non-diabetic patients with 3VD. Importantly, the duration of the hemodynamic support was significantly less in the Impella arm compared to IABP (1.9 hours vs. 7.4 hours,  $p < 0.001$ ), indicating a possible decrease in MAEs.

### Right Ventricular Support

A major limitation in the field of acute mechanical circulatory support has been the ability to provide non-surgical support for the right ventricle (RV). Historically, veno-arterial extracorporeal membrane oxygenation (VA-ECMO) or right atrial to pulmonary artery bypass with either a TandemHeart or other centrifugal flow pump were the only non-surgical options for the failing RV.<sup>20,21</sup> The Impella RP is the first micro-axial flow pump specifically designed for RV support without the need for surgical access. The Impella RP employs a 22 Fr impeller mounted onto a 11 Fr catheter and delivers blood from the right atrium (RA) into



**Figure 18.4.** Key figures reviewing efficacy of the Impella platform. (A) Kaplan-Meier survival curve for 154 patients receiving Impella 2.5 support pre- and post-PCI in the setting of cardiogenic shock complicating an acute myocardial infarction (AMI).

Reprinted from O'Neill WW et al., The current use of Impella 2.5 in acute myocardial infarction complicated by cardiogenic shock: results from the USpella Registry, *Journal of Interventional Cardiology* 2014;27(1):1–11. <https://onlinelibrary.wiley.com/journal/15408183> Copyright © 1999–2019 John Wiley & Sons, Inc. All rights reserved.

(B) Intermediate outcomes of patients surviving acute support with Impella 5.0 for bridge to decision in decompensated advanced heart failure patients.

Reprinted from Hall SA et al., Use of a percutaneous temporary circulatory support device as a bridge to decision during acute decompensation of advanced heart failure, *Journal of Heart and Lung Transplantation* 208;37:100–106. Copyright (2018), with permission from Elsevier.

(C) Kaplan-Meier curves of major adverse events to 90 days in 452 total patients undergoing high-risk PCI randomized to either IABP or Impella 2.5 support.

Reprinted with permission from O'Neill WW et al., A prospective, randomized clinical trial of hemodynamic support with Impella 2.5 versus intra-aortic balloon pump in patients undergoing high-risk percutaneous coronary intervention: the PROTECT II study, *Circulation* 2012;126(14):1717–1727, <https://www.ahajournals.org/journal/circ> © American Heart Association, Inc. All rights reserved.

(D) Sustained hemodynamic improvement in (left) cardiac index and (right) central venous pressure after Impella RP explant in 30 patients receiving support for RV failure following left ventricular assist device (LVAD) implantation, post-cardiotomy, or AMI.

Reprinted from Anderson MB et al., Benefits of a novel percutaneous ventricular assist device for right heart failure: the prospective RECOVER RIGHT study of the Impella RP device, *Journal of Heart and Lung Transplantation* 2015;34:1549–1560. Copyright (2015), with permission from Elsevier.

the pulmonary artery (PA). The device is delivered via a 23 Fr venous peel-away sheath into the PA using a 0.018 wire as a monorail system and requires one venous access site (most commonly the right femoral vein). Once in position, the 23 Fr sheath is replaced with a staged 11 to 23 Fr repositioning sheath. After removal, the venous access site is commonly closed with manual compression and a purse-string or deep mattress suture. The Impella RP cannot currently be delivered through the internal jugular veins and cannot be used to oxygenate blood.

The RECOVER RIGHT study evaluated the safety and efficacy of the Impella RP in 30 patients with life-threatening right ventricular failure (RVF). These patients were split into two cohorts: RVF after LVAD implantation versus RVF after cardiectomy or myocardial infarction. Both cohorts showed immediate and improved hemodynamic support, increases in cardiac index from  $1.8 \pm 0.2$  to  $3.3 \pm 0.23$  L/min/m<sup>2</sup> ( $p < 0.001$ ), and a decrease in central venous pressure from  $19.2 \pm 4$  to  $12.6 \pm 1$  mmHg ( $p < 0.001$ ) (D in Figure 18.4). The overall survival at 30 days was 73.3% and patients were supported for an average of  $3.0 \pm 1.5$  days.<sup>22</sup> Based on this trial and registry data, the Impella RP is approved by the FDA for acute right heart failure or RV decompensation following LVAD implantation, myocardial infarction, heart transplantation, and open-heart surgery.

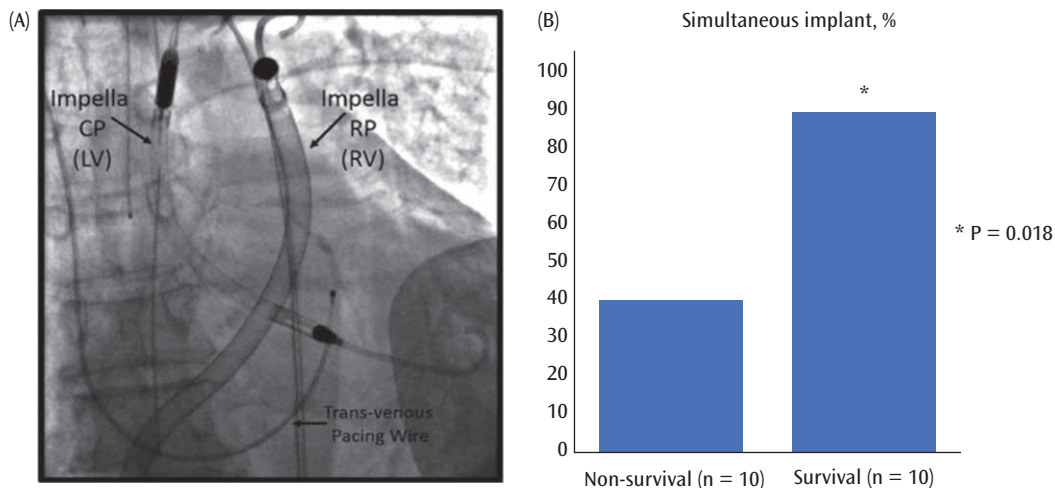
Case reports have demonstrated the use of Impella RP for RV failure due to pulmonary embolism (PE).<sup>23</sup> Hemodynamic instability occurs in roughly 5% of patients of PE, with an associated mortality as high as 20%–50%. A recently published single center experience of 5 patients receiving Impella RP support for massive or submassive

PE demonstrated an improvement in mean cardiac index from 1.69 L/min/m<sup>2</sup> (0.88–2.15 L/min/m<sup>2</sup>) to 2.5 L/min/m<sup>2</sup> (1.88–3.4 L/min/m<sup>2</sup>) after 24 hours of mechanical support.<sup>24</sup> Additionally, mean heart rate and systolic blood pressure improved after Impella RP support. Following insertion and activation of Impella RP, patients received treatment with catheter-directed ultrasound accelerated thrombolysis. Additionally, all patients received standard of care with anticoagulation, volume expansion, and inotropic support. Mean time for Impella RP support was 3.2 days. Echocardiogram at 3 days following Impella RP support showed improvement in RV function, fractional area change, and tricuspid annular plane systolic excursion. Ultimately, all 5 patients survived to discharge. These findings support the utility of Impella RP for patients presenting with PE with RV-mediated hemodynamic compromise.

## Biventricular Support

Biventricular failure in the setting of cardiogenic shock is associated with high in-hospital mortality.<sup>25–27</sup> Multiple single-patient case reports have described the use of two concurrent Impella catheters for biventricular support (BiPella) (Figure 18.5).<sup>28–31</sup>

A multi-center retrospective analysis of 20 patients with biventricular failure demonstrated hemodynamic efficacy of biventricular Impella support with either Impella 5.0 ( $n = 8$ ), Impella CP ( $n = 11$ ), or Impella 2.5 ( $n = 1$ ) for LV support and Impella RP ( $n = 20$ ) for RV support.<sup>32</sup> Etiologies of biventricular failure included acute myocardial infarction



**Figure 18.5.** (A) Fluoroscopic image showing biventricular micro-axial flow Impella catheters for biventricular support (BiPella). (B) Survivors receiving BiPella for biventricular failure were more likely to have had simultaneous implant.

LV = left ventricular; RV = right ventricular.

Reproduced from Kuchibhotla S et al., Acute biventricular mechanical circulatory support for cardiogenic shock, *Journal of the American Heart Association* 2017;6(10):e006670. <https://www.ahajournals.org/journal/jaha> © 2017 The Authors. Published on behalf of the American Heart Association, Inc., by Wiley.

( $n = 11$ ), advanced heart failure ( $n = 7$ ), and myocarditis ( $n = 2$ ). Mean flows achieved were  $3.4 \pm 1.2$  L/min and  $3.5 \pm 0.5$  L/min for LV and RV devices, respectively. BiPella strategies reduced cardiac filling pressures and increased cardiac index (1.8; 95% CI, 1.6–1.9 versus 2.3; 95% CI, 1.9–2.7 L/min/m<sup>2</sup>;  $p = 0.03$ ). Total in-hospital mortality was 50%. No intraprocedural mortality was observed. Major complications included limb ischemia ( $n = 1$ ), hemolysis ( $n = 6$ ) and thrombolysis in myocardial infarction–related major bleeding ( $n = 7$ ). This report suggests that non-surgical, rapid deployment of LV and RV catheters for biventricular circulatory support is clinically feasible and hemodynamically efficacious.

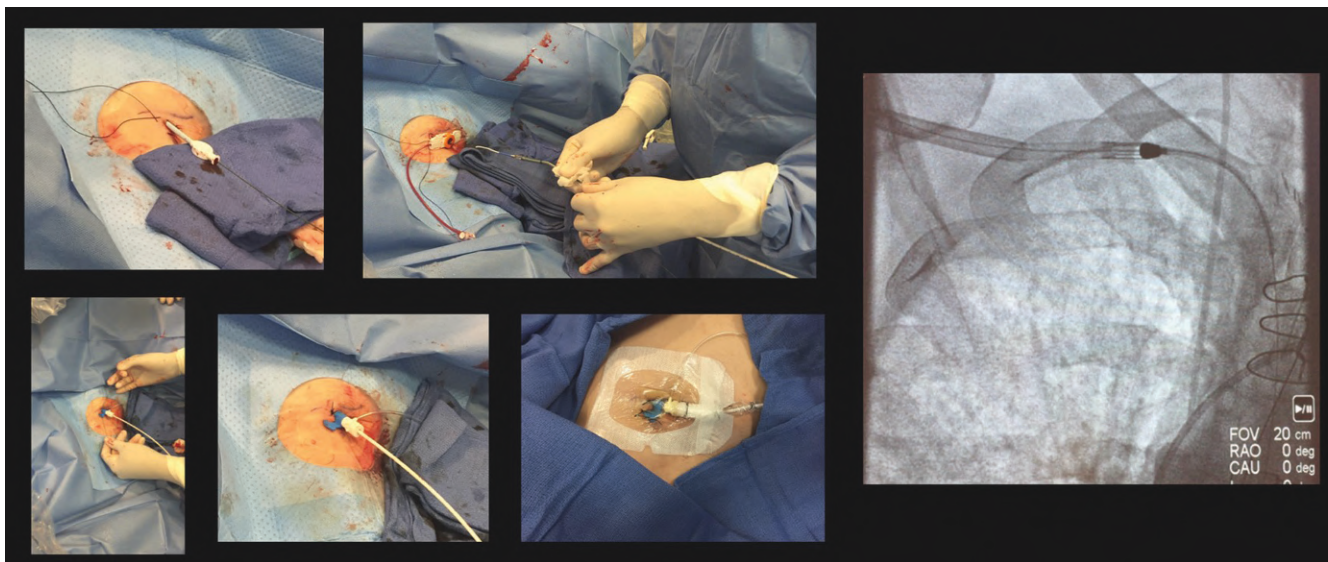
## Contraindications and Potential Complications

Absolute contraindications for Impella 2.5, CP, and 5.0 support include the presence of moderate or severe aortic insufficiency, mechanical aortic valve, and echocardiographic evidence of a recent LV thrombus. Relative contraindications include severe peripheral vascular disease or small vessel caliber <7 mm (in the case of Impella 5.0 insertion). In cases where iliofemoral vascular disease is present, several approaches are commonly employed, including the following: (1) angioplasty and/or stenting of a iliofemoral stenosis to facilitate Impella delivery; (2) delivery of the Impella pump and use of the peel-away sheath side-arm for antegrade perfusion using either

ipsilateral or contralateral arterial bypass; (3) conversion to a percutaneous axillary approach (or surgical cut-down of the axillary artery) (Figure 18.6); (4) trans-caval access for delivery of a long-sheath extending from the inferior vena cava to the abdominal aorta; and (5) insertion via anastomosis of a 10-mm graft to the ascending aorta through a mini-sternotomy approach.<sup>33,34</sup>

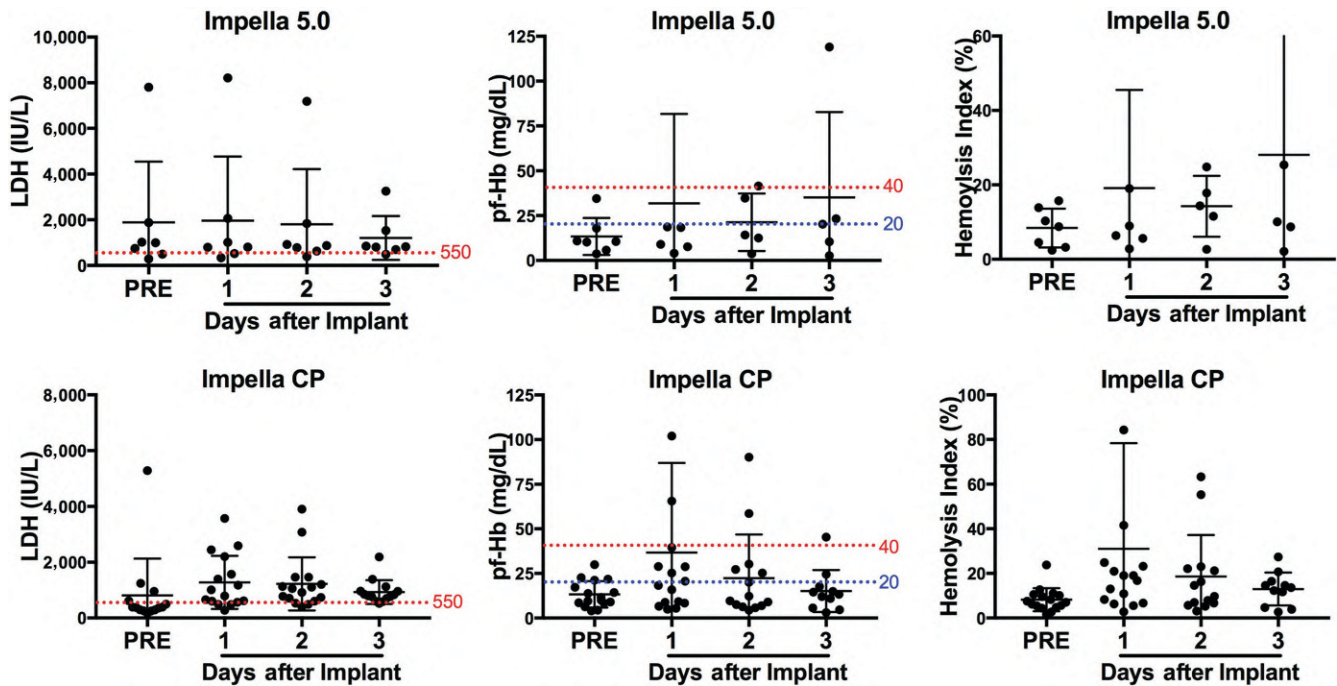
Hemolysis represents a potential limitation associated with all acute mechanical circulatory support (AMCS) devices. Trans-valvular micro-axial flow pumps (TVPs) such as the Impella devices (Abiomed, Inc; Danvers, MA) are among the most commonly used AMCS devices for CS and may be prone to hemolysis given the small impeller size for percutaneous delivery and high level of rotations per minute required to achieve flow rates ranging from 2.5 to 5.0 L/min. Hemolysis among micro-axial flow pumps may be related to improper device position, hemodynamic loading conditions, device speed, and prolonged duration of support. Hemolysis is uncommon with the Impella 5.0 and RP systems due to large caliber impellers and is more common among the Impella 2.5 and CP systems, with reported hemolysis rates between 15% and 50%.<sup>35,36</sup>

Compared to lactate dehydrogenase (LDH) levels, a change in plasma free-hemoglobin (pf-Hb) levels within 72 hours of pump deployment is a sensitive and specific indicator of hemolysis in patients treated with a Impella for cardiogenic shock. A recent analysis identified that pre-implant LDH levels are often significantly elevated in the setting of cardiogenic shock before device implantation, thereby limiting the clinical utility of this biomarker for



**Figure 18.6.** Axillary deployment of an Impella CP using micropuncture access of the axillary artery, followed by delivery of the Impella through a 14 Fr peel-away sheath (orange hub) into the LV. Note that a purse-string suture is placed around the dilator to facilitate hemostasis when the peel-away sheath is removed and the repositioning sheath (blue hub) is delivered and dressed.

Original figure from the authors.



**Figure 18.7.** Identifying hemolysis with plasma-free hemoglobin, not lactate dehydrogenase, levels. LDH is commonly elevated among patients with cardiogenic shock at the time of Impella insertion. Plasma free-hemoglobin elevation is uncommon among Impella 5.0 recipients.

Reprinted from Esposito M et al., Increased plasma free hemoglobin levels identify hemolysis in patients with cardiogenic shock and a trans-valvular microaxial flow pump. *Artificial Organs* 2019;43(2):125–131. <https://onlinelibrary.wiley.com/journal/15251594> © International Center for Artificial Organs and Transplantation and Wiley Periodicals, Inc. All rights reserved.

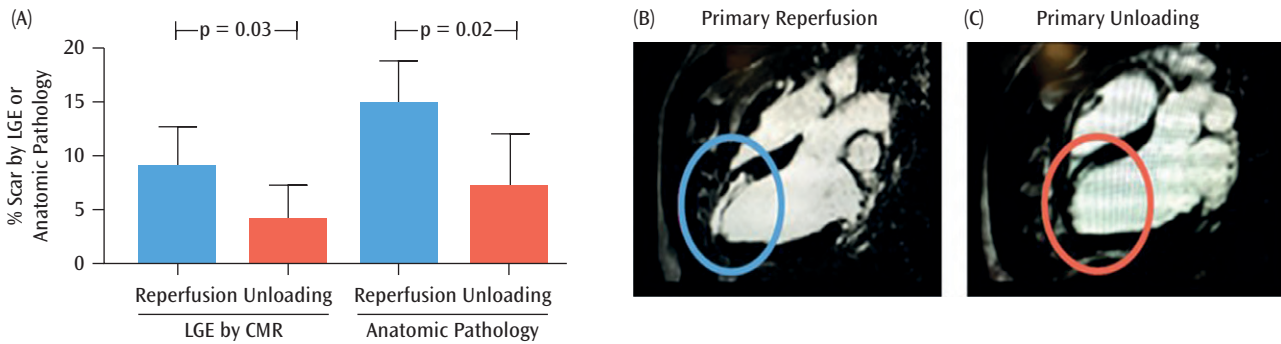
identifying hemolysis.<sup>36</sup> Furthermore, among patients with clinically relevant hemolysis, pf-Hb levels increased within 48 hours after device activation, whereas no change in LDH levels was observed (Figure 18.7). Clinically relevant hemolysis was uncommon in this analysis and may be associated with higher flow rates, prolonged duration of support, and improper positioning of the Impella. These findings suggest that close monitoring of pf-Hb, not LDH, is required for detection and appropriate management of hemolysis in patients receiving Impella therapy for the treatment of cardiogenic shock. Additionally, early recognition of rising pf-Hb levels may allow clinicians to adjust the performance level or position of the device, thereby preventing the development of clinically significant hemolysis.

## Emerging Studies of the Impella Platform for Myocardial Recovery after AMI

The effects of unloading the LV prior to reperfusion in an acute MI, due to implications of improvement

of myocardial oxygen supply/demand matching, have been studied in multiple pre-clinical models since the late 1970s. Regardless of pump type, unloading prior to reperfusion has been repeatedly shown to reduce infarct size.<sup>1,37–40</sup> More recently, this concept was demonstrated using the Impella CP in a pre-clinical model of acute MI. Compared to primary reperfusion, primary unloading with the Impella CP for 30 minutes before reperfusion in swine triggers a cardioprotective shift in myocardial gene expression, preserves mitochondrial integrity, and leads to a durable reduction in LV scar size as quantified by cardiac magnetic resonance imaging 28 days after the initial ischemic injury<sup>38</sup> (Figure 18.8).

Collectively, these preclinical studies led to a clinical first-in-human study known as the Door to Unloading with Impella CP System in Acute Myocardial Infarction to Reduce Infarct Size (DTU): A Prospective Feasibility Study (NIH CLINICAL TRIAL: NCT03000270). This is a multi-center, prospective, randomized, two-arm feasibility trial to assess the potential role of unloading with the Impella CP prior to revascularization in reducing infarct size. The study design includes 1:1 randomization between: (1) 30



**Figure 18.8.** Effects of unloading primary unloading on infarct size in a swine model of AMI. (A) Quantification of LV scar size 28 days after either primary reperfusion or primary unloading using late gadolinium enhancement (LGE) by cardiac magnetic resonance imaging (CMR) or according to anatomic pathology ( $n = 6$  per group). (B) and (C) Representative CMR images showing LV scar within the blue or red circles.

Reprinted from the Esposito M et al., Primary LV unloading with a trans-valvular axial flow pump reduces infarct size by increasing myocardial levels of stromal derived factor one alpha (SDF-1A) in acute myocardial infarction and limits the development of ischemic heart failure, *Journal of the American College of Cardiology* 2018;71:A2660. © 2018 Elsevier and JACC: Journal of the American College of Cardiology.

minutes of unloading with Impella CP prior to primary percutaneous coronary intervention (PPCI); and (2) initiation of Impella CP unloading followed immediately by PPCI. In addition to evaluating safety, infarct size at 3–5 days and 30 days will be evaluated using cardiac magnetic resonance imaging. This study is actively underway in the United States.

## Conclusions

The Abiomed Impella platform is a group of percutaneous or surgically delivered trans-valvular micro axial-flow AMCS devices that provide either left or right hemodynamic support for indications of high-risk coronary intervention or cardiogenic shock. Operating under the pressure head-flow (H-Q) curve, these devices work to reduce pressures and volumes within the left or right ventricle, decreasing ventricular wall stress, unloading the heart, and increasing circulatory support. Severe peripheral vascular disease presents a contraindication to device implant; however, in isolated iliofemoral vascular disease, there are several other commonly employed approaches to delivery. Potential complications of the Impella platform include hemolysis. There are multiple ongoing studies evaluating the utilization of the Impella platform for LV unloading and ultimately myocardial recovery after AMI.

Disclosures: Dr. Kapur has received research funding from Abiomed, Inc. (Danvers, Massachusetts), CardiacAssist, Inc. (Pittsburgh, Pennsylvania), and Maquet Cardiovascular, Inc. (Rastatt, Germany).

## REFERENCES

1. Kapur NK, Paruchuri V, Pham DT, et al. Hemodynamic effects of left atrial or left ventricular cannulation for acute circulatory support in a bovine model of left heart injury. *ASAIO J.* 2015;61(3):301–306.
2. Merhige ME, Smalling RW, Cassidy D, et al. Effect of the hemopump left ventricular assist device on regional myocardial perfusion and function: reduction of ischemia during coronary occlusion. *Circulation.* 1989;80(5 Pt 2):III-158–166.
3. Meyns B, Stolinski J, Leunens V, Verbeke E, Flameng W. Left ventricular support by catheter-mounted axial flow pump reduces infarct size. *J Am Coll Cardiol.* 2003;41(7):1087–1095.
4. Moazami N, Fukamachi K, Kobayashi M, et al. Axial and centrifugal continuous-flow rotary pumps: a translation from pump mechanics to clinical practice. *J Heart Lung Transplant.* 2013;32(1):1–11.
5. Sjauw KD, Konorza T, Erbel R, et al. Supported high-risk percutaneous coronary intervention with the Impella 2.5 device the Europella registry. *J Am Coll Cardiol.* 2009;54(25):2430–2434.
6. Maini B, Naidu SS, Mulukutla S, et al. Real-world use of the Impella 2.5 circulatory support system in complex high-risk percutaneous coronary intervention: the USpella Registry. *Catheter Cardiovasc Interv.* 2012;80(5):717–725.
7. Seyfarth M, Sibbing D, Bauer I, et al. A randomized clinical trial to evaluate the safety and efficacy of a percutaneous left ventricular assist device versus intra-aortic balloon pumping for treatment of cardiogenic shock caused by myocardial infarction. *J Am Coll Cardiol.* 2008;52(19):1584–1588.
8. O'Neill WW, Schreiber T, Wohns DH, et al. The current use of Impella 2.5 in acute myocardial infarction complicated by cardiogenic shock: results from the USpella Registry. *J Interv Cardiol.* 2014;27(1):1–11.



9. Webb JG, Sleeper LA, Buller CE, et al. Implications of the timing of onset of cardiogenic shock after acute myocardial infarction: a report from the SHOCK Trial Registry. SHould we emergently revascularize Occluded Coronaries for cardiogenic shock? *J Am Coll Cardiol.* 2000;36(3 Suppl A):1084–1090.
10. Lauten A, Engstrom AE, Jung C, et al. Percutaneous left-ventricular support with the Impella-2.5-assist device in acute cardiogenic shock: results of the Impella-EUROSHOCK-registry. *Circ Heart Fail.* 2013;6(1):23–30.
11. Basir MB, Schreiber TL, Grines CL, et al. Effect of early initiation of mechanical circulatory support on survival in cardiogenic shock. *Am J Cardiol.* 2017;119(6):845–851.
12. Basir MB, Schreiber T, Dixon S, et al. Feasibility of early mechanical circulatory support in acute myocardial infarction complicated by cardiogenic shock: the Detroit cardiogenic shock initiative. *Catheter Cardiovasc Interv.* 2018;91(3):454–461.
13. Griffith BP, Anderson MB, Samuels LE, Pae WE, Jr., Naka Y, Frazier OH. The RECOVER I: a multicenter prospective study of Impella 5.0/LD for postcardiotomy circulatory support. *J Thorac Cardiovasc Surg.* 2013;145(2):548–554.
14. Lemaire A, Anderson MB, Lee LY, et al. The Impella device for acute mechanical circulatory support in patients in cardiogenic shock. *Ann Thorac Surg.* 2014;97(1):133–138.
15. Hall SA, Uriel N, Carey SA, et al. Use of a percutaneous temporary circulatory support device as a bridge to decision during acute decompensation of advanced heart failure. *J Heart Lung Transplant.* 2018;37(1):100–106.
16. Esposito ML, Jablonski J, Kras A, Krasney S, Kapur NK. Maximum level of mobility with axillary deployment of the Impella 5.0 is associated with improved survival. *The International Journal of Artificial Organs.* 2017;41(4):236–239.
17. Nalluri N, Patel N, Saouma S, et al. Utilization of the Impella for hemodynamic support during percutaneous intervention and cardiogenic shock: an insight. *Expert Rev Med Devices.* 2017;14(10):789–804.
18. O'Neill WW, Kleiman NS, Moses J, et al. A prospective, randomized clinical trial of hemodynamic support with Impella 2.5 versus intra-aortic balloon pump in patients undergoing high-risk percutaneous coronary intervention: the PROTECT II study. *Circulation.* 2012;126(14):1717–1727.
19. Kovacic JC, Kini A, Banerjee S, et al. Patients with 3-vessel coronary artery disease and impaired ventricular function undergoing PCI with Impella 2.5 hemodynamic support have improved 90-day outcomes compared to intra-aortic balloon pump: a sub-study of the PROTECT II trial. *J Interv Cardiol.* 2015;28(1):32–40.
20. Kapur NK, Esposito ML, Bader Y, et al. Mechanical circulatory support devices for acute right ventricular failure. *Circulation.* 2017;136(3):314–326.
21. Kapur NK, Paruchuri V, Jagannathan A, et al. Mechanical circulatory support for right ventricular failure. *JACC Heart Fail.* 2013;1(2):127–134.
22. Anderson MB, Goldstein J, Milano C, et al. Benefits of a novel percutaneous ventricular assist device for right heart failure: the prospective RECOVER RIGHT study of the Impella RP device. *J Heart Lung Transplant.* 2015;34(12):1549–1560.
23. Kumar Bhatia N, Dickert NW, Samady H, Babaliaros V. The use of hemodynamic support in massive pulmonary embolism. *Catheter Cardiovasc Interv.* 2017;90(3):516–520.
24. Elder M, Blank N, Kaki A, et al. Mechanical circulatory support for acute right ventricular failure in the setting of pulmonary embolism. *J Interv Cardiol.* 2018.
25. Mehta SR, Eikelboom JW, Natarajan MK, et al. Impact of right ventricular involvement on mortality and morbidity in patients with inferior myocardial infarction. *J Am Coll Cardiol.* 2001;37(1):37–43.
26. Voelkel NF, Quaipe RA, Leinwand LA, et al. Right ventricular function and failure: report of a National Heart, Lung, and Blood Institute working group on cellular and molecular mechanisms of right heart failure. *Circulation.* 2006;114(17):1883–1891.
27. Zehender M, Kasper W, Kauder E, et al. Right ventricular infarction as an independent predictor of prognosis after acute inferior myocardial infarction. *N Engl J Med.* 1993;328(14):981–988.
28. Hunziker P, Hunziker L. Percutaneous biventricular cardiac assist device in cardiogenic shock. *Eur Heart J.* 2013;34(22):1620.
29. Kapur NK, Jumean M, Ghuloom A, et al. First successful use of 2 axial flow catheters for percutaneous biventricular circulatory support as a bridge to a durable left ventricular assist device. *Circ Heart Fail.* 2015;8(5):1006–1008.
30. Aghili N, Bader Y, Vest AR, et al. Biventricular circulatory support using 2 axial flow catheters for cardiogenic shock without the need for surgical vascular access. *Circ Cardiovasc Interv.* 2016;9(6):1–3.
31. Pappalardo F, Scandroglio AM, Latib A. Full percutaneous biventricular support with two Impella pumps: the Bi-Pella approach. *ESC Heart Fail.* 2018;5(3):368–371.
32. Kuchibhotla S, Esposito ML, Breton C, et al. Acute biventricular mechanical circulatory support for cardiogenic shock. *J Am Heart Assoc.* 2017;6(10).
33. Truong HTD, Hunter G, Lotun K, et al. Insertion of the Impella via the axillary artery for high-risk percutaneous coronary intervention. *Cardiovasc Revasc Med.* 2018;19(5 Pt A):540–544.
34. Greenbaum AB, Babaliaros VC, Chen MY, et al. Transcaval access and closure for transcatheter aortic valve replacement: a prospective investigation. *J Am Coll Cardiol.* 2017;69(5):511–521.
35. Badiye AP, Hernandez GA, Novoa I, Chaparro SV. Incidence of hemolysis in patients with cardiogenic shock treated with impella percutaneous left ventricular assist device. *ASAIO J.* 2016;62(1):11–14.
36. Esposito M, Morine K, Annamalai S, et al. Increased plasma free hemoglobin levels identify hemolysis in patients with cardiogenic shock and a transvalvular microaxial flow pump. *Artif Organs.* 2019;43(2):125–131.
37. LeDoux JF, Tamareille S, Felli PR, Amirian J, Smalling RW. Left ventricular unloading with intra-aortic counter pulsation prior to reperfusion reduces myocardial release of endothelin-1 and decreases infarction size in a porcine ischemia-reperfusion model. *Catheter Cardiovasc Interv.* 2008;72(4):513–521.

38. Esposito M, Zhang Y, Qiao X, et al. Primary LV unloading with a trans-valvular axial flow pump reduces infarct size by increasing myocardial levels of stromal derived factor one alpha (SDF-1a) in acute myocardial infarction and limits the development of ischemic heart failure. *J Am Coll Cardiol*. 2018;71:A2660.
39. Kapur NK, Paruchuri V, Urbano-Morales JA, et al. Mechanically unloading the left ventricle before coronary reperfusion reduces left ventricular wall stress and myocardial infarct size. *Circulation*. 2013;128(4):328–336.
40. Achour H, Boccalandro F, Felli P, et al. Mechanical left ventricular unloading prior to reperfusion reduces infarct size in a canine infarction model. *Catheter Cardiovasc Interv*. 2005;64(2):182–192.

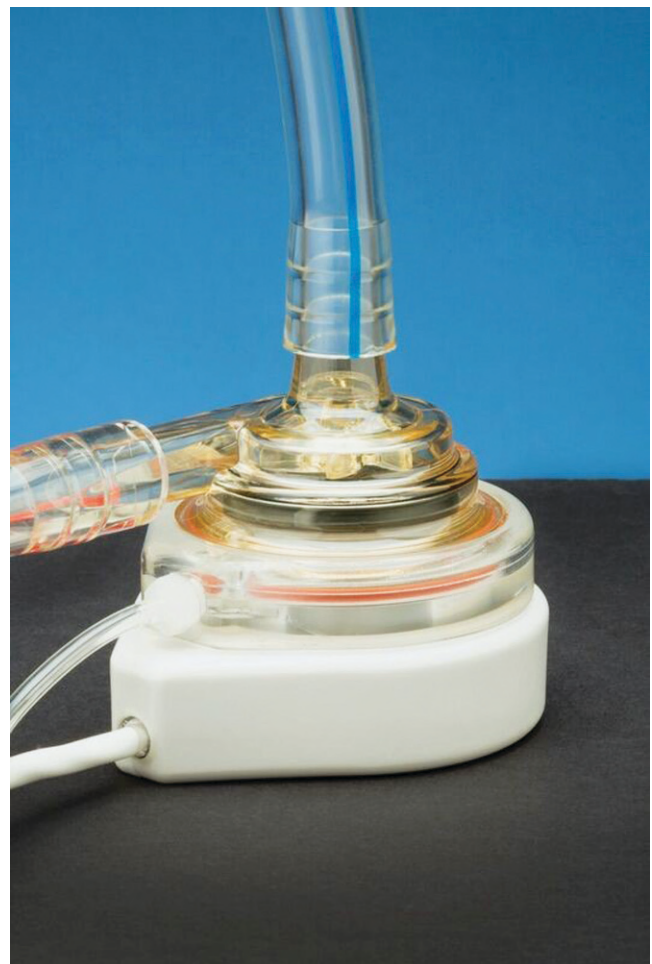
## 19

## The Tandem: Life System Device Description, Implantation, and Clinical Results

DANNY RAMZY AND JOSHUA CHUNG

**T**he TandemLife System, now part of LivaNova, is an extracorporeal circulatory assist device system that was developed to deliver simplified mechanical circulatory support for patients in distress. The system features a variety of different platforms which are powered by the TandemHeart pump along with the Escort Controller. This device can generate up to 5 L/min of blood flow; it is CE (Conformité Européenne) marked for up to 30 days and is approved by the Food and Drug Administration (FDA) for up to 6 hours.<sup>1-3</sup>

The TandemHeart pump is a lightweight (280 grams) continuous-flow centrifugal pump that has a priming volume of 7 mL (Figure 19.1). The pump contains an impeller that is supported by hydrodynamic bearing.<sup>4</sup> It contains a motor chamber and a blood chamber that are separated by a polymeric seal. The brushless direct current motor consists of a laminated stack of stainless-steel plates wound with copper wire embedded in a heat-dissipative epoxy. The rotor, centered in the stator, is spun by the motor through an electromagnetic coupling and is attached directly to the impeller. Saline flows at 10 mL/h through the motor chamber and completely surrounds the rotor during operation.<sup>5</sup> Life pads in the lower housing of the motor chamber provide thrust forces to stabilize the rotor in the axial direction. The saline flows between a journal and the rotor toward the impeller to provide radial stability. The impeller shaft passes through the center of the seal. Heparinized saline (90,000 U/L) flows around the impeller shaft-seal interface to flush the area, preventing thrombus formation. The impeller contains six blades and rotates between 3,000 and 75,000 revolutions per minute (rpm) to provide flow rates from 1 to 8 L/min.<sup>4</sup>



**Figure 19.1.** TandemHeart pump is a lightweight (280 grams) continuous-flow centrifugal pump.

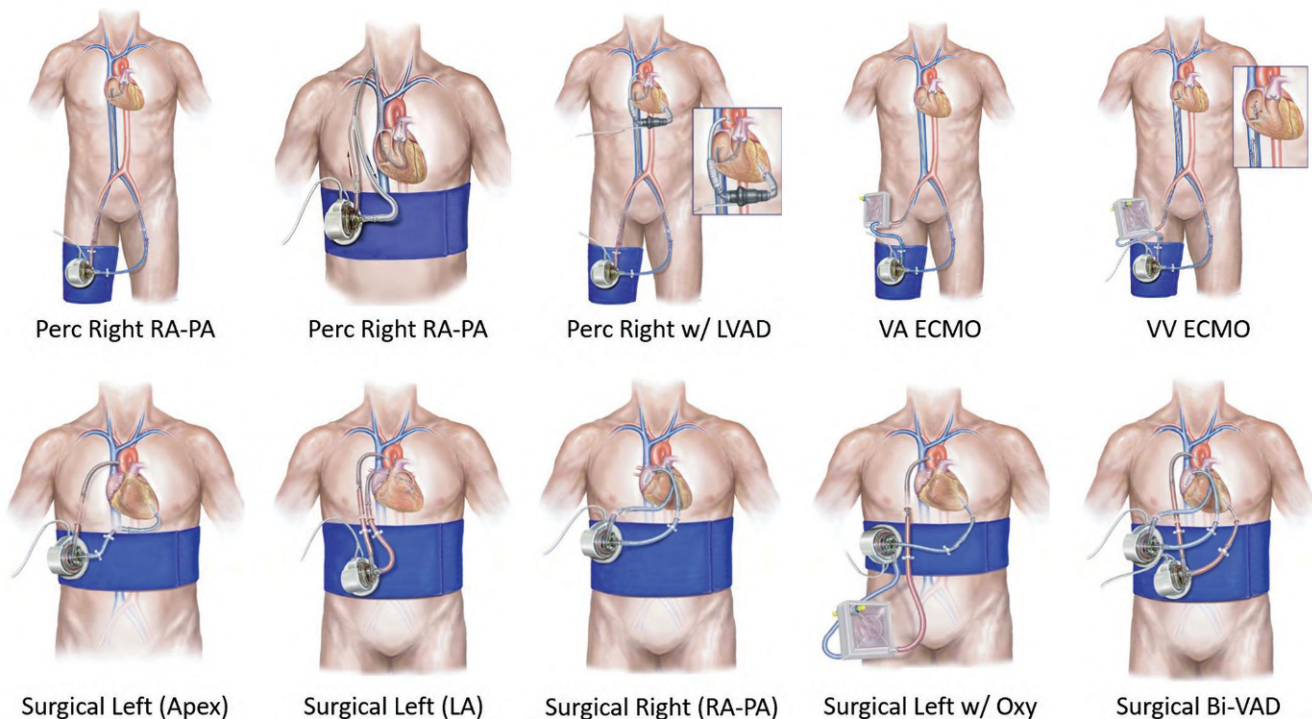
Reproduced with permission of © 2019 CardiacAssist, Inc., All rights reserved.



**Figure 19.2.** TandemHeart Escort is the controller that powers the pump and has built-in alarms and diagnostics. Reproduced with permission of © 2019 CardiacAssist, Inc. All rights reserved.

The Escort is a microprocessor-based controller that drives the pump and supplies saline to the pump (Figure 19.2). It contains self-diagnostics and alarm features, allowing patient support without the need for a constant operator surveillance. The built-in pressure transducer measures the operating pressure of the infusion system. Alarms are linked to changes in the infusion system operating pressure in order to alert the user to a problem with the delivery of saline to the pump. The infusion system also features an air bubble detector that monitors for air. The controller has built-in batteries that allow for 60 minutes of uninterrupted operation during patient transport or in the event of AC power failure. It also contains redundant motor control units so that in the event of hardware failure the controller will automatically switch to an emergency backup mode. Basic pump operation functions, including pump start and pump speed control, will continue to occur in this situation. The Escort can be mounted on an IV pole to facilitate transportation and weighs 21 lbs.

The TandemLife system is a versatile system that allows physicians to provide support tailored to the patient's needs. It is the only system that can provide support for patients with left ventricular failure, right ventricular failure, biventricular failure, pulmonary failure, or cardiopulmonary failure (Figure 19.3). It can be inserted percutaneously or via open methods, and can be used in the catheterization laboratory to assist with high-risk percutaneous coronary intervention (PCI). The system has developed into four



**Figure 19.3.** TandemLife Platform. Very versatile pump capable of LV, RV, and BiV support with or without oxygenation. LV = left ventricle, RV = right ventricle, BiV = left and right ventricle.

Reproduced with permission of © 2019 CardiacAssist, Inc., all rights reserved.

main platforms: TandemLife (veno-arterial extracorporeal membrane oxygenator [VA-ECMO]), TandemHeart (percutaneous left ventricular assist device [LVAD]), Protek Duo (percutaneous right ventricular assist device [RVAD]), and TandemLung (veno-venous extracorporeal membrane oxygenator [VV-ECMO]).

## TandemLife

### Description

TandemLife is a veno-arterial extracorporeal membrane oxygenator (VA-ECMO) system that provides all the necessary components to initiate VA-ECMO. The kit includes the following: (1) TandemHeart Pump; (2) TandemLung oxygenator; (3) sterile priming basin (pump and oxygenator come pre-connected and packaged in a sterile priming basin); (4) Protek Solo arterial cannula and (15 or 17 Fr); (5) Protek Solo venous cannula (24 Fr); and (6) venous dilators (14, 18, and 22 Fr). These components are FDA approved for up to 6 hours. The focus of the TandemLife kit is to provide a simplified approach to initiating a patient on VA-ECMO efficiently.

### Implantation Procedure

The TandemLife VA-ECMO can be inserted percutaneously or open through standard cut-down techniques. The femoral artery and vein are identified ideally under ultrasound guidance or direct visualization, and wire access is gained. A heparin bolus (50–100 units/kg) is then given. Arterial and femoral venous cannulas are inserted using the Seldinger technique. The distal end of the arterial cannula is ideally placed above the bifurcation of the aorta. The venous cannula is ideally inserted into the right atrium. The sterile priming basin is simultaneously used during this time, to prime the TandemHeart pump and TandemLung oxygenator. After this is completed, the venous and arterial cannulas are connected to the pump via a wet-to-wet connection to remove all air from the circuit. The pump is then connected to the Escort controller, and the patient is initiated on VA-ECMO with the speed adjusted to provide the desired level of support.

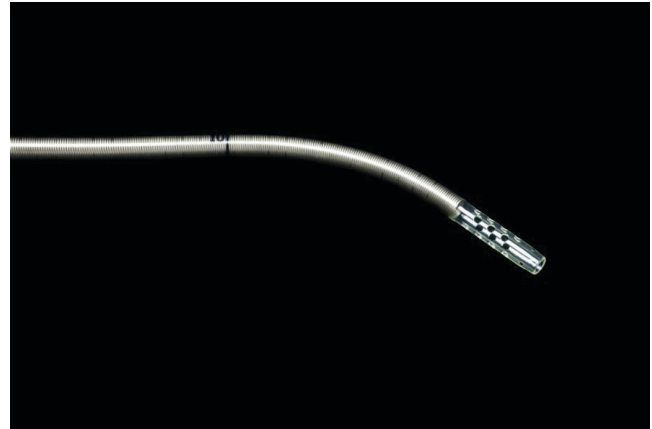
### Clinical Studies

TandemLife recently established the platform for VA-ECMO in March 2016. However, prior to this, the TandemHeart pump and its cannulas have been used for VA-ECMO. Clinical studies are ongoing.

## TandemHeart

### Description

The TandemHeart system is a temporary left ventricular assist device (LVAD). It uses a unique transseptal cannula



**Figure 19.4.** The TandemHeart trans-septal cannula comes in two lengths: 62 cm and 72 cm.

Reproduced with permission of © 2019 CardiacAssist, Inc., all rights reserved.

that draws oxygenated blood from the left atrium and delivers blood to the body via the femoral artery, providing a left atrial-to-femoral bypass. The 21 Fr transseptal cannula is available in two insertable lengths of 62 and 72 cm (Figure 19.4). The TandemHeart system improves hemodynamic performance and increases end-organ perfusion for patients with left ventricular failure.<sup>6</sup> The TandemHeart kit includes the following: (1) TandemHeart pump; (2) Protek Solo transseptal cannula; (3) Protek Solo arterial cannula.

### Implantation

The TandemHeart system can be inserted percutaneously using transesophageal echo (TEE) and fluoroscopic guidance.<sup>7</sup> The femoral vein is accessed, and wire access into the superior vena cava (SVC) is achieved. Under fluoroscopic guidance, transseptal puncture is then achieved by using the Brockenbrough needle and a Mullins sheath, as is done during atrial fibrillation ablations or percutaneous mitral valve procedures.<sup>8</sup> Once the puncture is made in the fossa ovalis, heparin is given to achieve a target-activated clotting time (ACT) of >250 seconds. Once the Mullins sheath has been advanced in the left atrium (LA), a stiff wire is placed into the LA. The Mullins sheath is then removed, and the TandemHeart 14 Fr / 21 Fr two-stage dilator is advanced into the LA. The dilator is then removed, and the tip of the 21 Fr cannula is left in the LA. The cannula tip contains three radiopaque marker disks that can be viewed under fluoroscopy to confirm the position of the cannula tip in the LA. TEE is also used to confirm placement.

The femoral artery is then accessed percutaneously. Using Seldinger technique, a 15 Fr or 17 Fr Protek Solo arterial cannula is inserted. Other arterial cannulas can be used as an alternative. If the artery is greater than 5 mm, Perclose Devices can be deployed to assist in achieving hemostasis following

removal. Once the transeptal and arterial cannulae are in place, the pump and the cannulae are de-aired and are connected via a wet-to-wet connection to remove all air from the circuit. The pump is then connected to the Escort controller, and speed is adjusted according to the patient's needs.

### Clinical Results

Left atrial to femoral bypass was first attempted in 1962 and has been investigated for clinical safety by multiple groups since that time. Thiele et al.<sup>6</sup> reported their clinical experience of 18 patients following acute myocardial infarction (AMI) leading to cardiogenic shock (CS) that underwent TandemHeart insertion. In their study, following insertion of the TandemHeart, patients' hemodynamics improved significantly. The cardiac index (CI) improved from  $1.7 \pm 0.3$  L/min/m<sup>2</sup> at baseline to  $2.4 \pm 0.6$  L/min/m<sup>2</sup> while on support ( $p < 0.001$ ). Mean blood pressure increased from  $63 \pm 8$  to  $80 \pm 9$  mmHg ( $p < 0.001$ ) and pulmonary capillary wedge pressure decreased from  $21 \pm 4$  to  $14 \pm 4$  mmHg ( $p < 0.001$ ). The survival rate was 56%. The study demonstrated that the TandemHeart could help treat patients in CS.

In the United States, the TandemHeart was evaluated for safety in a feasibility study consisting of 13 patients with CS from five centers.<sup>9</sup> The enrollment criteria were broad and included CS secondary to AMI in 8 patients, decompensated idiopathic cardiomyopathy in 1 patient, decompensated ischemic cardiomyopathy in 1 patient, postcardiotomy syndrome in 2 patients, and high-risk intervention in 1 patient. Hemodynamic variables, including CI, mean arterial pressure (MAP), and pulmonary capillary wedge pressure (PCWP), were similarly improved after initiation of the TandemHeart. The survival rate was 54%.

Burkhoff et al.<sup>1</sup> performed a randomized multicenter trial comparing TandemHeart to intra-aortic balloon pump (IABP) for patients presenting within 24 hours of developing CS. The primary objective was to test whether the TandemHeart device provided superior hemodynamic benefits compared with the IABP in patients with medically refractory CS. The secondary objective was to compare survival 30 days after randomization. Patients who had an IABP and still met the criteria for CS were eligible for the trial. Forty-two patients were enrolled at 12 centers. Patients who underwent TandemHeart had significantly greater increases in CI and greater decreases in PCWP compared to patients who underwent IABP insertion. The study, however, demonstrated no statistical difference in mortality between the two groups.

Kar et al.<sup>10</sup> reported their clinical experience with TandemHeart. In their study, they treated 18 patients (11 in CS and 7 undergoing high-risk PCI). The patients in the CS group were supported for a mean of  $88.8 \pm 74.3$  hours. The high-risk PCI group was supported for  $5.5 \pm 8.3$  hours. The overall 30-day survival rate was 61%. Through their experience, they could demonstrate that the TandemHeart System was easy to insert and provided an effective means to support patients in CS or undergoing high-risk PCI.

The TandemHeart system has also been used as a bridge device for patients with heart failure. Tempelhof et al.<sup>11</sup> reported their clinical experience with 25 patients that underwent TandemHeart support. The patients' presenting diagnoses included cardiogenic shock (56%), ST-segment elevation myocardial infarction (STEMI) (20%), post-cardiotomy (16%), and high-risk PCI or ventricular tachycardia ablation (8%). TandemHeart was used for an average of  $4.8 \pm 2.1$  days. Significant hemodynamic improvements were seen. TandemHeart was used as a bridge to LVAD implantation (44%) or recovery (20%); 30-day, 90-day, and long term (>90 days) survival rates were 56%, 52%, and 36%. Bruckner et al.<sup>12</sup> demonstrated that the TandemHeart system can effectively be used as a bridge device to support patients awaiting heart transplantation. In their experience, five heart-failure patients were placed on TandemHeart support with an average support duration of  $7.6 \pm 3.2$  days. All patients were successfully bridged to transplantation and had no follow-up deaths, with an average long-term follow-up of  $8.4 \pm 9.9$  months.

## TandemLung and Protek Duo

### Description

The TandemLung system consists of the Tandem pump, Protek Duo cannula and TandemLung oxygenator, and Voyager Vest (Figure 19.5). The latter component is intended



**Figure 19.5.** The TandemLung system includes the pump, Protek Duo, TandemLung oxygenator, and the Voyager vest. Reproduced with permission of © 2019 CardiacAssist, Inc., all rights reserved.



**Figure 19.6.** The Protek Duo cannula comes in two sizes: a 29 Fr and a 31 Fr. Reproduced with permission of © 2019 CardiacAssist, Inc, all rights reserved.

to provide a secure attachment for the TandemLung components (pump, oxygenator, and tubing). The Tandem pump used with this system is the identical pump described previously. The Protek Duo Venous-Venous Cannula Set is intended for use as a dual-lumen single cannula for right atrium (RA) venous drainage and pulmonary artery (PA) reinfusion of blood. The combination of the Protek Duo and the TandemHeart pump provides right ventricular (RV) support, making the Protek Duo system a temporary RVAD. The TandemLung Oxygenator is intended for use in an extracorporeal circuit, making the TandemLung a VV-ECMO system. In this section we describe the components of the system and its implantation, and provide some clinical data.

The Protek Duo cannula (Figure 19.6) is placed percutaneously via the right internal jugular vein and comes in two different sizes (29 Fr and 31 Fr). The 29 Fr Protek Duo cannula is a wire-reinforced dual lumen with a 29 Fr proximal lumen draining deoxygenated blood from the RA to the pump while the 16 Fr distal lumen returns the deoxygenated blood to the PA to be oxygenated by the lungs. The 31 Fr Protek Duo has a 31 Fr proximal drainage lumen and an 18 Fr distal lumen. Maximum flow across these cannulae are 4.5 L/min and 5 L/min, respectively. The Protek Duo cannula can be used for isolated RV support or as a VV-ECMO platform (if hypoxic respiratory failure is present, the TandemLung oxygenator can be added to the circuit). In the VV-ECMO platform the Protek Duo is typically placed across the pulmonic valve as an RVAD/oxygenator configuration. However, the cannula can be placed such that the outflow is in the RA and the inflow is in the inferior vena cava (IVC), similar to the Avalon Elite cannula for VV-ECMO support.

The TandemLung Oxygenator (Figure 19.7) is used in combination with the Tandem pump for oxygenation of the blood and for carbon dioxide removal. The device consists of a hollow fiber membrane with blood inflow and outflow ports and gas inlet and outlet ports. Blood enters the center of the fiber bundle, where it is distributed radially and uniformly across the fiber bundle by a conical diffuser. The compact nature of the device, the orientation of the inflow/outflow ports, and optimized gap sizes on the inlet and outlet of the bundle simplify the priming process such that only 240 cc of volume is required to prime the oxygenator. This simplified priming process is made even easier with the availability of the Tandem priming tray. This tray allows for quick and easy priming of the oxygenator and

pump without the need of a perfusionist. The tandem priming system is very well suited for non-perfusion-run ECMO centers. The TandemLung oxygenator is intended for (and approved for) use in an extracorporeal circuit requiring cardiopulmonary bypass. The TandemLung oxygenator is also small and compact in design, allowing it to be placed on the patient similar to the tandem pump.

### Implantation

The TandemLung and Protek Duo can be inserted percutaneously in either the catheterization laboratory or in a hybrid operating room. The right internal jugular vein is accessed. Using the Seldinger technique, an 8 Fr sheath is placed. Following the placement of the sheath, a Swan-Ganz-catheter or preferably a 0.035-inch compatible balloon-tipped wedge catheter is advanced into the pulmonary trunk and placed in either the left pulmonary artery (LPA) or right pulmonary artery (RPA) under fluoroscopic guidance. Following catheter placement, a 0.035-inch Lunderquist or Amplatz super-stiff wire is exchanged for the catheter and inserted into the pulmonary artery. Following this, the sheath is removed. After placement of the wires, the patient is heparinized for an activated clotting time (ACT) of greater than 300. The jugular vein is then serially dilated with the Tandem dilator kit until an appropriate size is achieved. When venous dilation is



**Figure 19.7.** The TandemLung Oxygenator, used in combination with the Tandem pump for VV-ECMO and VA-ECMO. Reproduced with permission of © 2019 CardiacAssist, Inc., All rights reserved.

complete, the Protek Duo cannula is advanced under fluoroscopic guidance into the PA, ensuring the distal tip is in the main PA and the proximal drainage holes are in the RA. Placement is confirmed by intraoperative TEE and fluoroscopy, followed by connection of the proximal (inflow-RA) and the distal (outflow-PA) segments to the tubing which is passed from the TandemHeart pump. RVAD support is then initiated and progressively increased (as needed) to a maximum flow of 4.5 or 5 L/min, depending on the Protek Duo cannula used. If oxygenation is required, the TandemLung Oxygenator is spliced into the circuit.

### Unique Insertion/Applications

The TandemLife system and cannulae offer unique insertion procedures and applications. The system is extremely versatile, and can be used as an LVAD, RVAD, and BiVAD (biventricular assist device), with the option of converting to VA-, VV-, VVA- and VAV-ECMO (Figure 19.3). In addition, the system can be used as an oxygenated LVAD or an oxygenated RVAD. Beyond these 10 different configuration options, the system can be placed both percutaneously and via open insertion techniques. In many cases, cannula placement can be arranged to permit ambulation while on support. The following are some examples of strategies that have been used to achieve this important objective.

The TandemHeart system can be placed in the axillary position to facilitate patient ambulation. The axillary artery and vein can be exposed via a right subclavicular approach. An 8-mm graft can be sutured to the axillary artery with 5-0 Prolene. The arterial cannula is then tunneled through the skin and then secured within the graft using a 0 silk tie. The pump inflow cannula is then tunneled through the axillary vein and into the LA, through direct visualization via a minimally invasive thoracotomy approach to facilitate the right atriotomy. The advantage of the axillo-axillary approach is that the patient can tolerate elevation of the bed to 45 degrees, and potentially achieve ambulation. Furthermore, this approach avoids the potential for ischemic complications of the lower extremity. The same axillo-axillary approach described here as an ambulatory LVAD strategy can be utilized for VA-ECMO support if the inflow cannula is placed in the RA and a TandemLung oxygenator is used. This approach would permit ambulation in VA-ECMO patients who would typically be cannulated by groin.

The unique advantages of the Protek Duo result from the design characteristics that permit percutaneous insertion via the right internal jugular vein. In contrast, the CentriMag typically requires an open approach, while the Impella RP, despite being percutaneous, requires femoral insertion. Compared to the standard two-cannula approach to VV-ECMO (neck and groin), the Protek Duo features a single access site in the neck, which allows the patient to ambulate and participate in regular physical therapy. In comparison with the Avalon Elite cannula, the Protek Duo (1) offers RV

support during VV-ECMO support, (2) avoids recirculation and mixing challenges that are frequently seen with the Avalon cannula, and (3) potentially can provide greater stability during ambulation, minimizing even slight position changes that can lead to significant impairment in patient oxygenation.

Additional innovative cannulation strategies have been described. Khalpey et al. recently described a minimally invasive temporary biventricular full-flow support using two Protek Duo cannulae. Left-sided support was provided by using a modified shortened Protek Duo cannula placed transapically and across the aortic valve, draining the LV and pumping into the ascending aorta.<sup>13</sup>

### Clinical Data

The advantages of the TandemLife system have only recently begun to achieve widespread recognition within the MCS community. Consequently, only a small number of publications have described clinical experiences with the device. Ravichandran et al<sup>14</sup> reported on a two-center experience using the TandemLife technology in 17 patients with RV failure, 12 of whom were post-LVAD implantation. In this series, 20% of the patients recovered with a complication rate of 30% and an overall survival rate of 55%.

The TandemHeart Experiences and Methods (THEME) registry is a multi-center, prospective observational registry that was developed to study the use of TandemLife products for cardiac and cardiopulmonary support in a real-world setting. O'Neill and colleagues (SCAI 2018) recently presented the initial findings of percutaneous RV support utilizing the Protek Duo cannula within the THEME registry. In this analysis, 30 patients underwent placement of the Protek Duo cannula for RV failure. The mean patient age was  $54 \pm 18$  years (range, 18–83 years), and 67% of the patients were male. Medical comorbidities included coronary artery disease (43.3%), history of coronary artery bypass grafting (10.0%), congestive heart failure (56.7%), and chronic obstructive pulmonary disease (6.7%). Patients were on 0 (13.3%), 1 (20.0%), 2 (33.3%), 3 (16.7%), or 4 or more (16.7%) vasoactive medications prior to insertion. A total of 40.0% of patients underwent implantation for cardiogenic shock, with an LVAD having been previously placed in 46.7% of patients. Device implantation was successful in 30/30 (100%) of cases. The mean time of support was  $8.7 \pm 6.4$  days (range, 0.9–26.1 days) and 75.9% patients survived to removal (22/29, with one patient still on support). Overall survival at 30 days was 72.4%.

Bermudez et al. (ASAIO 2018) recently examined the initial experience in the THEME registry for RV support in 23 post-surgical patients. RV support was needed after LVAD implantation in 80% (81.3% early; 18.8% late), post-cardiotomy shock (PCS) in 10%, and post-heart-transplant failure in 10%. The Protek Duo was successfully placed in all



patients, and there were no major complications associated with insertion. Mean duration of support was  $10.3 \pm 6.7$  days with a mean flow of  $3.9 \pm 0.8$  L/min. Complications included bleeding (25%), infections (10%), and hemolysis (5%). There was one cardiac arrhythmia 2 days following insertion, requiring amiodarone and cardioversion. Cannula thrombosis occurred after 26 days of support in one patient. Inotropes and vasoconstrictors were rapidly weaned after initiation of RVAD support. The Protek Duo was successfully removed from 17 patients, and 30-day survival was 85% (50% PCS, 87.5% post-LVAD, and 100% post-heart transplantation).

## Conclusion

The TandemLife platform offers a versatile range of options for short-term support in the setting of cardiopulmonary failure. The Tandem pump can be used for left, right, or biventricular support. Cannulation strategies can be achieved via either open or percutaneous methods. The platform can be easily upgraded with an oxygenator for both VA- and VV-ECMO indications. Further innovative strategies to cannula design and insertion may improve the ease with which this technology can be used to increase cardiopulmonary support, reduce potential complications, and further increase the utility of the platform.

## REFERENCES

- Burkhoff D, Cohen H, Brunckhorst C, O'Neill WW; TandemHeart Investigators Group. A randomized multicenter clinical study to evaluate the safety and efficacy of the TandemHeart percutaneous ventricular assist device versus conventional therapy with intra-aortic balloon pumping for treatment of cardiogenic shock. *Am Heart J*. 2006;152(3):469e1–e8
- Kar B, Forrester M, Gemmato C, Civitello A, et al. Use of the TandemHeart percutaneous ventricular assist device to support patients undergoing high-risk percutaneous coronary intervention. *J Invasive Cardiol*. 2006;18(3):93–96
- Vranckx P, Foley DP, de Feijter PJ, Vos J, et al. Clinical introduction of the TandemHeart, a percutaneous left ventricular assist device, for circulatory support during high-risk percutaneous coronary intervention. *Int J Cardiovasc Intervent*. 2003;5(1):35–39
- Magovern JA, Sussman MJ, Goldstein AH, Szydlowski GW, et al. Clinical results with the AB-180 left ventricular assist device. *Ann Thorac Surg*. 2001;71(3 Suppl):S121–S124
- Goldstein Ah, Pacella JJ, Trumble DR, Clark RE. Development of an implantable centrifugal blood pump. *ASAIO J*. 1992;38(3):M362–M365
- Thiele H, Sick P, Boudriot E, Diederich KW, Hambrecht R, Niebauer J, Schuler G. Randomized comparison of intra-aortic balloon support with a percutaneous left ventricular assist device in patients with revascularized acute myocardial infarction complicated by cardiogenic shock. *Eur Heart J*. 2005;26 (13):1276–83.
- Magovern JA, Lasorda DM. Implantation of the TandemHeart percutaneous ventricular assist device. *Oper Tech in Thorac and Cardiovasc Surg*. 2002;7(3):112–119
- Mitchell-Heggs L, Lellouche N, Deal L, Elbaz N, et al. Transseptal puncture using minimally invasive echocardiography during atrial fibrillation ablation. *Europace*. 2010;12(10):1435–1438
- Burkhoff D, O'Neill W, Brunckhorst C, Letts D, et al. Feasibility study of the use of the TandemHeart percutaneous ventricular device for treatment of cardiogenic shock. *Catheter Cardiovasc Interv*. 2006;68(2):211–217
- Kar B, Adkins LE, Civitello A, Loyalka P, et al. Clinical experience with the TandemHeart percutaneous ventricular assist device. *Tex Heart Inst J*. 2006;33(2):111–115
- Tempelhof MW, Klein L, Cotts WG, Benzuly KH, et al. Clinical experience and patient outcomes associated with the TandemHeart Percutaneous transseptal assist device among a heterogeneous patient population. *ASAIO J*. 2011;57(4):254–261.
- Bruckner BA, Jacob LP, Gregoric ID, Loyalka P, et al. Clinical experience with TandemHeart percutaneous ventricular assist device as a bridge to cardiac transplantation. *Tex Heart Inst J*. 2008;35(4):447–450
- Khalpey Z, Smith R, Echeverria A, et al. A novel minimally invasive off-pump biventricular assist device insertion technique. *J Thorac Cardiovasc Surg*. 2016;151(1):e5–e7.
- Ravichandran AK, Baran DA, Stelling K, Cowger JA, Salerno CT. Outcomes with the Tandem Protek Duo dual-lumen percutaneous right ventricular assist device. *ASAIO J*. 2018;64(4):570–572.

# 20

## The Abbott CentriMag™ Acute Circulatory Support System and the HeartMate Percutaneous Heart Pump™

DAVID J. FARRAR

### Introduction

**S**everal clinical conditions, ranging from cardiogenic shock to high-risk coronary interventions, require short-term, mechanical circulatory support systems, placed either surgically or percutaneously.<sup>1-3</sup> In addition to the long-term HeartMate II and HeartMate 3 left ventricular assist systems (LVADs), Abbott currently offers two short-term circulatory support systems. The CentriMag™ Acute Circulatory Support System includes a magnetically levitated centrifugal pump that can provide left, right, or biventricular support. The HeartMate Percutaneous Heart Pump™ (PHP™) is a percutaneously introduced catheter pump expandable to 24 Fr after insertion into the LV across the aortic valve. Here, I briefly review these technologies and their clinical applications.

### The CentriMag Acute Circulatory Support System

The Abbott CentriMag™ Acute Circulatory Support System has a magnetically levitated impeller in a centrifugal blood pump that provides hemocompatible left and/or right ventricular support across a range of clinical conditions. The full MagLev™ flow technology supports the free-floating, magnetically levitated impeller and prevents it from contacting the pump housing, which reduces the shear stress that can cause blood trauma. Wide blood-flow pathways and the absence of seals, bearings, and valves provide hemo-compatibility by minimizing blood turbulence, blood trauma, and stasis, which in combination reduce the potential for hemolysis and thrombus formation. The CentriMag is intended for adults; a smaller version, the PediMag, is

intended for neonates, infants, and small children who require less than 1.5 L/min blood flow (Figure 20.1).

The CentriMag System consists of a disposable single-use polycarbonate centrifugal blood pump, a console, a motor, a monitor, and a flow probe. The system may be used with either the CentriMag Pump or the PediMag Pump. The pumps are placed in a motor (Figure 20.2), which provides the magnetic fields for actuation.

The basic bearingless centrifugal principle involves an impeller that floats and rotates in the magnetic fields of a stator without touching the pump housing (Figure 20.3). A compact digital signal processor system with a servo amplifier allows the impeller location and speed to be precisely regulated. External position sensors actively control the impeller's radial position. Processor-controlled electronics regulate the magnetic fields so that the impeller is always centered.

The CentriMag Console (Figure 20.4) is a microprocessor-based device that generates the primary motor control signal, interfaces with system sensors, generates front display outputs, provides alarms, and communicates with the monitor. The microprocessor acquires sensor data to generate operator displays and alarms. Data, system options, and menus are displayed graphically on a screen. Operator-adjustable alarms and settings are accessible through the system menus.

The CentriMag Console operates the same way for either the CentriMag or PediMag pumps and has the same displays, alarms, and alerts. However, the maximum flow range for the CentriMag Pump is 10.0 L/min (corresponding to a maximum pressure head of 600 mmHg), whereas that for the PediMag Pump is 1.5 L/min (or a maximum pressure head of 540 mmHg). The blood flow depends on the amount of blood entering the pump, the pump speed (in rpm), the



**Figure 20.1.** The CentriMag (left) and PediMag (right) blood pumps for adults and children, respectively. Each pump has a free-floating, magnetically levitated impeller that prevents it from contacting the pump housing, which reduces shear stresses that can cause blood trauma.

Reproduced with permission of Abbott, © 2019. All rights reserved.

extracorporeal circuit resistance, and drainage and return blood pressures (Figure 20.5).

The CentriMag Consoles and Monitor are designed to be used with a System Cart (Figure 20.6), and the CentriMag System transporter is available for patient transport (Figure 20.7).

### Clinical Applications

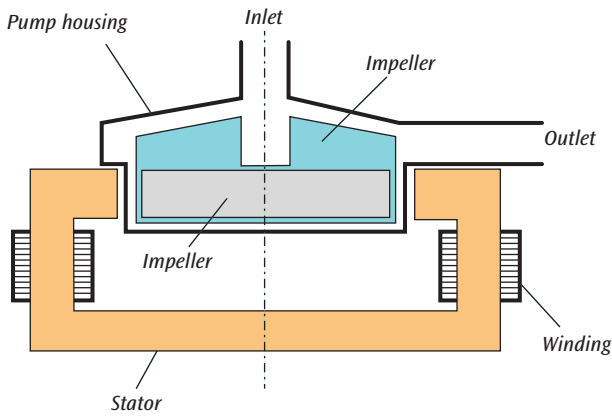
Clinical experience with the CentriMag system<sup>1,2,4-10</sup> is extensive, with more than 40,000 sold and more than 150 articles in the literature. Both the CentriMag Blood Pump and the PediMag™ Blood Pump have a premarket 510(k) clearance from the Food and Drug Administration for up

to 6 hours of use<sup>11</sup> and are indicated for use only with the CentriMag Console and Motor to pump blood through the extracorporeal bypass circuit for extracorporeal circulatory support during cardiopulmonary bypass (up to 6 hours).<sup>11</sup> The Pump is also approved for use in extracorporeal support systems (for up to 6 hours) for procedures not requiring complete cardiopulmonary bypass (e.g., valvuloplasty, mitral valve reoperation, surgery of the vena cava or aorta, liver transplants, etc.). Contraindications include patients who are unable or unwilling to be treated with heparin or an appropriate alternative anticoagulant. Clinical experience indicates that longer periods of support are reasonable, and approval for a 30-day indication is being sought.



**Figure 20.2.** CentriMag pump with the motor, which provides the magnetic fields that levitate the impeller.

Reproduced with permission of Abbott, © 2019. All rights reserved.



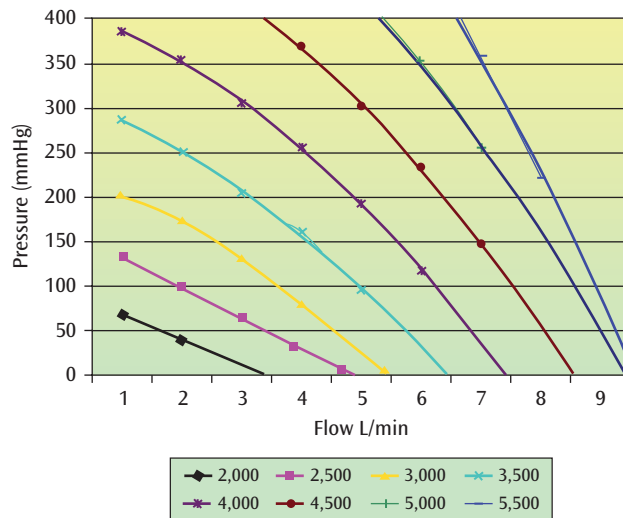
**Figure 20.3.** The design of the CentriMag pump showing the bearingless centrifugal impeller (in blue) and motor (in brown).  
 Reproduced with permission of Abbott, © 2019. All rights reserved.



**Figure 20.6.** The CentriMag system cart with a Mag Monitor, two system consoles, and two motors with CentriMag pumps.  
 Reproduced with permission of Abbott, © 2019. All rights reserved.



**Figure 20.4.** CentriMag Console generates the primary motor control signal, interfaces with system sensors, generates front display outputs, provides alarm functions, and communicates with the monitor.  
 Reproduced with permission of Abbott, © 2019. All rights reserved.



**Figure 20.5.** Pressure-flow curves for the CentriMag VAS circuit (using Edwards Lifesciences TFM032 and Medtronic 77722 cannula and 2 ft of 3/8-inch ID tubing), for selected pump speeds (rpm).  
 Reproduced with permission of Abbott, © 2019. All rights reserved.



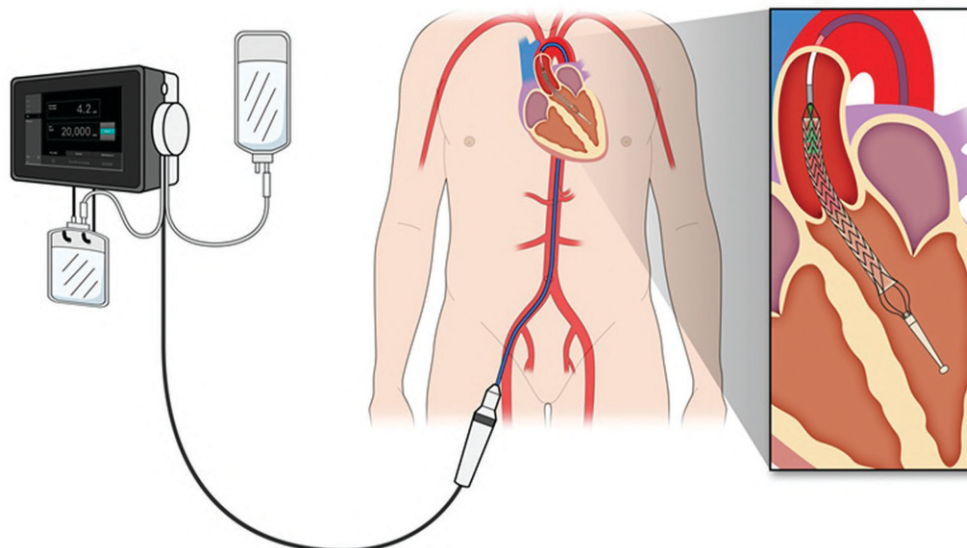
**Figure 20.7.** The CentriMag system transporter (77 x 56 x 19 cm) in the univentricular support configuration. Reproduced with permission of Abbott, © 2019. All rights reserved.

A Humanitarian Device exemption allows the CentriMag™ RVAD to provide temporary circulatory support for up to 30 days for patients in cardiogenic shock from RV failure. However, its effectiveness for this use has not been confirmed in a randomized trial.

## The HeartMate Percutaneous Heart Pump

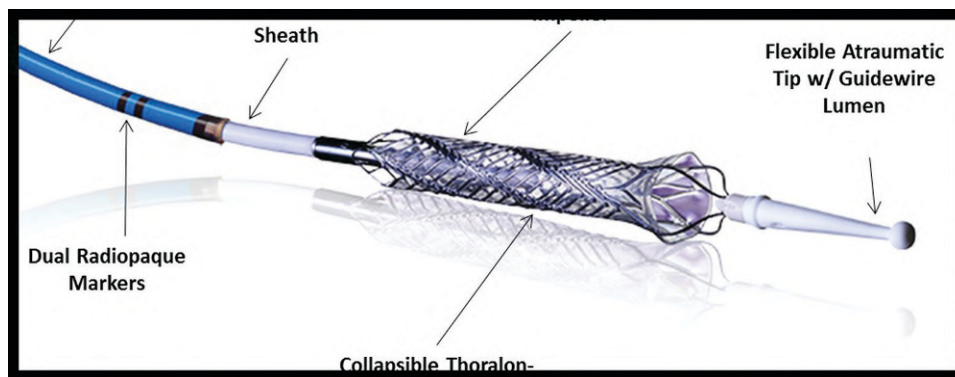
The HeartMate Percutaneous Heart Pump (PHP) System (Figure 20.8) is a catheter-based heart pump and console

designed to provide short-term LV support to rapidly stabilize hemodynamics or to maintain adequate cardiac output.<sup>12</sup> The key feature of the pump (Figure 20.9) is an integrated 14 French arterial sheath that is placed through the femoral artery. The distal portion of the catheter then expands to 24 French after it is inserted into the LV across the aortic valve (Figures 20.10 and 20.11). This feature is made possible by a collapsible elastomeric impeller and cannula that the operator expands during use. The impeller pumps blood from the LV through the collapsible, nitinol-reinforced Thoralon™ polyurethane cannula into the ascending aorta. At the end of the support period, the



**Figure 20.8.** HeartMate Percutaneous Heart Pump System is a catheter-based heart pump and console that can rapidly stabilize hemodynamics or maintain adequate cardiac output.

Reproduced with permission of Abbott, © 2019. All rights reserved.



**Figure 20.9.** The distal end of the HeartMate percutaneous heart pump system, showing the collapsible elastomeric impeller and cannula mechanism. The catheter is placed percutaneously through an integrated 14 French arterial sheath. After insertion into the left ventricle, across the aortic valve, the distal portion of the catheter expands to 24 French. Reproduced with permission of Abbott, © 2019. All rights reserved.

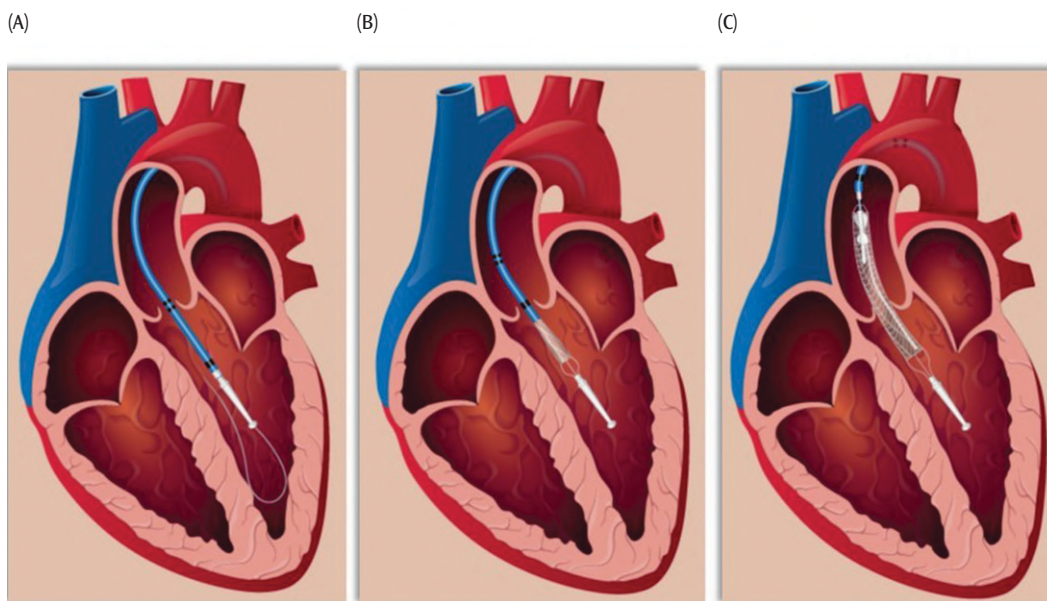
cannula is re-sheathed, and the catheter pump is removed through the initial insertion site. The HeartMate PHP is designed to provide more than 4 L/min flow against a pressure of 60 mmHg (Figure 20.12).

The pump is monitored and controlled through a touchscreen on an external console. The console can be attached to an IV pole in the non-sterile field or can be placed on a flat, non-sterile surface adjacent to the sterile field. During operation, the console supplies power to the electric motor, controls saline lubrication to the catheter, and displays settings and monitoring data. Rechargeable lithium batteries provide short-term backup power to

operate the console for up to 1 hour while not connected to AC power.

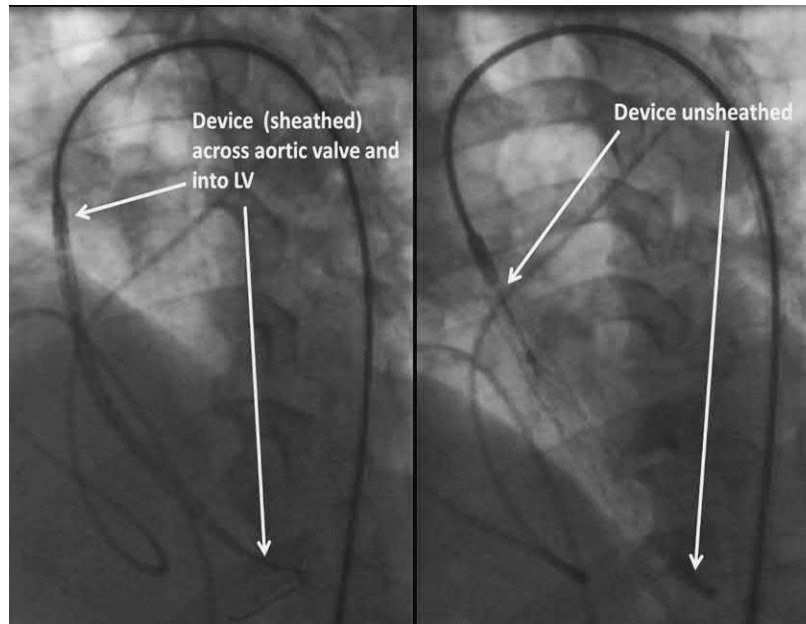
### Clinical Applications

The need for percutaneous mechanical circulatory support during cardiogenic shock and high-risk coronary interventions is well documented.<sup>3,13,14,15</sup> The HeartMate PHP circulatory support system is intended for short-term (approximately 6 hours) use in cardiology and cardiac surgery patients during and after high-risk percutaneous coronary interventions. Other potential clinical applications include rapidly stabilizing the hemodynamics of patients



**Figure 20.10.** Insertion of the HeartMate percutaneous heart pump. (A) In the sheath across the aortic valve, (B) partially unsheathed, and (C) fully unsheathed during operation.

Reproduced with permission of Abbott, © 2019. All rights reserved.



**Figure 20.11.** The HeartMate percutaneous heart pump (left) sheathed for insertion across the aortic valve and into the left ventricle and (right) with the outer sheath withdrawn, showing the cannula in the expanded operational state.

Reproduced with permission of Abbott, © 2019. All rights reserved.

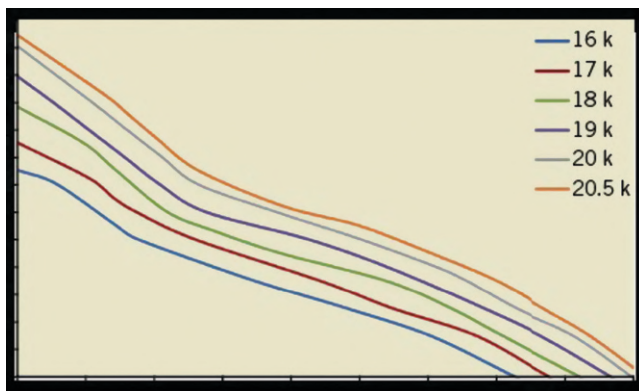
with compromised acute or acute-on-chronic ventricular deterioration from cardiogenic shock, decompensated chronic heart failure, and acute cardiomyopathy/myocarditis. This temporary support could provide sufficient time for patients to recover or to decide whether to implement advanced surgical management, including bridging to long-term LVAD support.

Contraindications for the HeartMate PHP include moderate to severe aortic insufficiency, aortic stenosis, the presence of a mechanical aortic valve, aortic dissection,

and severe aortic or peripheral vascular disease. The system received a CE (Conformité Européenne) Mark in July 2015 for meeting all the European Union's medical device requirements. Registered clinical trials include the Coronary InterventionS in High Risk PatiEnt using a Novel Percutaneous Left Ventricular Support Device Trial (SHIELD-II) for high-risk percutaneous coronary interventions (NCT024468778), and a registry for cardiogenic shock (NCT02279979).

## REFERENCES

- den Uil CA, Akin S, Jewbali LS, et al. Short-term mechanical circulatory support as a bridge to durable left ventricular assist device implantation in refractory cardiogenic shock: a systematic review and meta-analysis. *Eur J Cardiothorac Surg.* 2017 Jul 1;52(1):14–25.
- Saffarzadeh A, Bonde P. Options for temporary mechanical circulatory support. *J Thorac Dis.* 2015 Dec;7(12):2102–2111.
- Briceno N, Kapur NK, Perera D. Percutaneous mechanical circulatory support: current concepts and future directions. *Heart.* 2016;102:1494–1507
- John R, Long JW, Massey HT, et al. Outcomes of a multicenter trial of the Levitronix CentriMag ventricular assist system for short-term circulatory support. *J Thorac Cardiovasc Surg.* 2011;141(4):932–939.
- John R, Liao K, Lietz K, et al. Experience with the Levitronix CentriMag circulatory support system as a bridge to decision in patients with refractory acute cardiogenic shock and multisystem organ failure. *J Thorac Cardiovasc Surg.* 2007;134(2):351–358.
- Borisenko O, Wylie G, Payne J, et al. Thoratec CentriMag for temporary treatment of refractory cardiogenic shock or severe cardiopulmonary insufficiency: a systematic



**Figure 20.12.** Pressure-flow curves for the HeartMate percutaneous heart pump showing differential pressure across the pump for selected pump speeds (rpm).

Reproduced with permission of Abbott, © 2019. All rights reserved.

- literature review and meta-analysis of observational studies. *ASAIO J.* 2014 Sep;60(5):487–497.
7. Aziz TA, Singh G, Popjes E, et al. Initial experience with CentriMag extracorporeal membrane oxygenation for support of critically ill patients with refractory cardiogenic shock. *J Heart Lung Transplant.* 2010;29(1):66–71.
  8. Bhamra JK, Kormos RL, Toyoda Y, et al. Clinical experience using the Levitronix CentriMag system for temporary right ventricular mechanical circulatory support. *J Heart Lung Transplant.* 2009;28(9):971–976.
  9. Zhang J, Gellman B, Koert A, et al. Computational and experimental evaluation of the fluid dynamics and hemocompatibility of the CentriMag blood pump. *Artif Organs.* 2006;30(3):168–177.
  10. De Robertis F, Birks EJ, Rogers P, et al. Clinical performance with the Levitronix CentriMag short-term ventricular assist device. *J Heart Lung Transplant.* 2006;25(2):181–186.
  11. *2nd Generation CentriMag System Operating Manual (US) for use with CentriMag™ and PediMag™ Blood Pumping Systems.* Document No PL-0047, Rev 06, September 2013. Thoratec Corporation, 6035 Stoneridge Drive, Pleasanton, CA.
  12. Van Mieghem NM, Daemen J, den Uil C, et al. Design and principle of operation of the HeartMate PHP (Percutaneous Heart Pump). *Eurointervention.* 2018;13:1662–1666. Published online December 2016. <https://www.pcronline.com/eurointervention/> ahead-of-print/JAA\_EIJ\_EIJ-D-15-00467/design-and-principle-of-operation-of-the-heartmate-phptm-percutaneous-heart-pump.html.
  13. Atkinson TM, Ohman EM, O’Neill WW, Interventional Scientific Council of the American College of Cardiology. A practical approach to mechanical circulatory support in patients undergoing percutaneous coronary intervention: an interventional perspective. *JACC Cardiovasc Interv.* 2016;9:871–883
  14. Rihal CS, Naidu SS, Givertz MM, et al.; Society for Cardiovascular Angiography and Interventions, Heart Failure Society of America, Society of Thoracic Surgeons, American Heart Association, American College of Cardiology. 2015 SCAI/ACC/HFSA/STS clinical expert consensus statement on the use of percutaneous mechanical circulatory support devices in cardiovascular care (endorsed by the American Heart Association, the Cardiological Society of India, and Sociedad Latino Americana de Cardiologia Intervencion; affirmation of value by the Canadian Association of Interventional Cardiology-Association Canadienne de Cardiologie d’intervention). *J Card Fail.* 2015 Jun;21(6):499–518. doi:10.1016/j.cardfail.2015.03.002.
  15. Esposito ML, Kapur NK. Acute mechanical circulatory support for cardiogenic shock: the “door to support” time. *F1000Res.* 2017 May 22;6:737. doi:10.12688/f1000research.11150.1. eCollection 2017.



## Introduction

**M**odern extracorporeal membrane oxygenation (ECMO), also called extracorporeal life support, is a versatile form of temporary support for patients with heart or lung failure. Since its clinical use began in the 1970s, the complications and resource burden associated with ECMO have markedly decreased. Today, this short-term mechanical circulatory support option can sustain a patient without major complications for many months.<sup>1,2</sup>

Improvements in ECMO circuits and patient management have greatly reduced the rate of device-related complications. Just two decades ago, physicians commonly warned families of patients on ECMO that a major complication (typically bleeding or thrombosis) was likely occur in a matter of days. Although major complications continue to pose risks, their frequency is a fraction of what it used to be. Specific advancements in ECMO hardware include the following: the replacement of roller pumps with centrifugal pumps; more efficient oxygenator membranes; biocompatible circuit coating; improved cannula designs (kink resistance, tapering to facilitate percutaneous insertion, improved flow capacity); recognition of the need to limit connectors and irregular thrombus-generating surfaces; and the increased availability of non-invasive monitors (for oxygen saturation, hematocrit, flows, etc.).<sup>3,4</sup> These improvements in turn have stimulated improvements in practice, including refined anticoagulation strategies, reductions in laboratory sampling (and thus transfusions and allo-immunization), sedation moderation, and more routine patient ambulation and physical therapy.

Likely related to the reduced complication rates and improved ECMO devices are the substantial increases in the number of medical centers performing ECMO and in the annual number of ECMO cases reported to the Extracorporeal Life Support Organization (Figure 21.1).<sup>5</sup> The 2009 H1N1

influenza epidemic also likely increased interest in ECMO, and its growth since then has been sustained.<sup>6</sup>

In the arena of mechanical circulatory support devices, ECMO is notable for its versatility and ease of rapid initiation. When used in appropriately selected patients and properly configured, ECMO can fully support end-organ function, allow ambulation and physical rehabilitation, and facilitate heart and heart-lung recovery.

## Indications and Contraindications

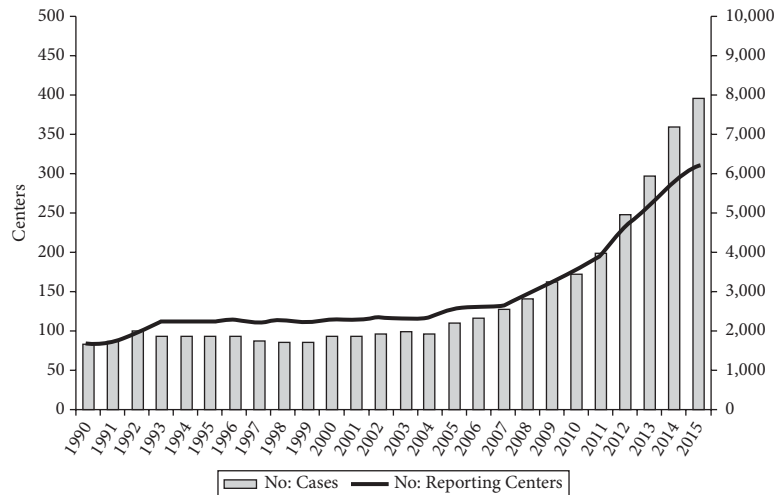
Patient selection in ECMO is critically important. In addition to a few general ECMO selection criteria, each mode of support has its own inclusion and exclusion criteria. The selection guidelines presented here are drawn from those published by the Extracorporeal Life Support Organization and by several established international ECMO programs (Figure 21.2).<sup>7-12</sup>

## Cannulation Strategies

Effective and safe ECMO cannulation requires a thorough understanding of ECMO's effects on physiology and their potential complications. The salient points of physiology, cannulation configurations, and cannula-related complications are discussed in the following. More extensive background information on ECMO physiology has been published elsewhere.<sup>13-15</sup>

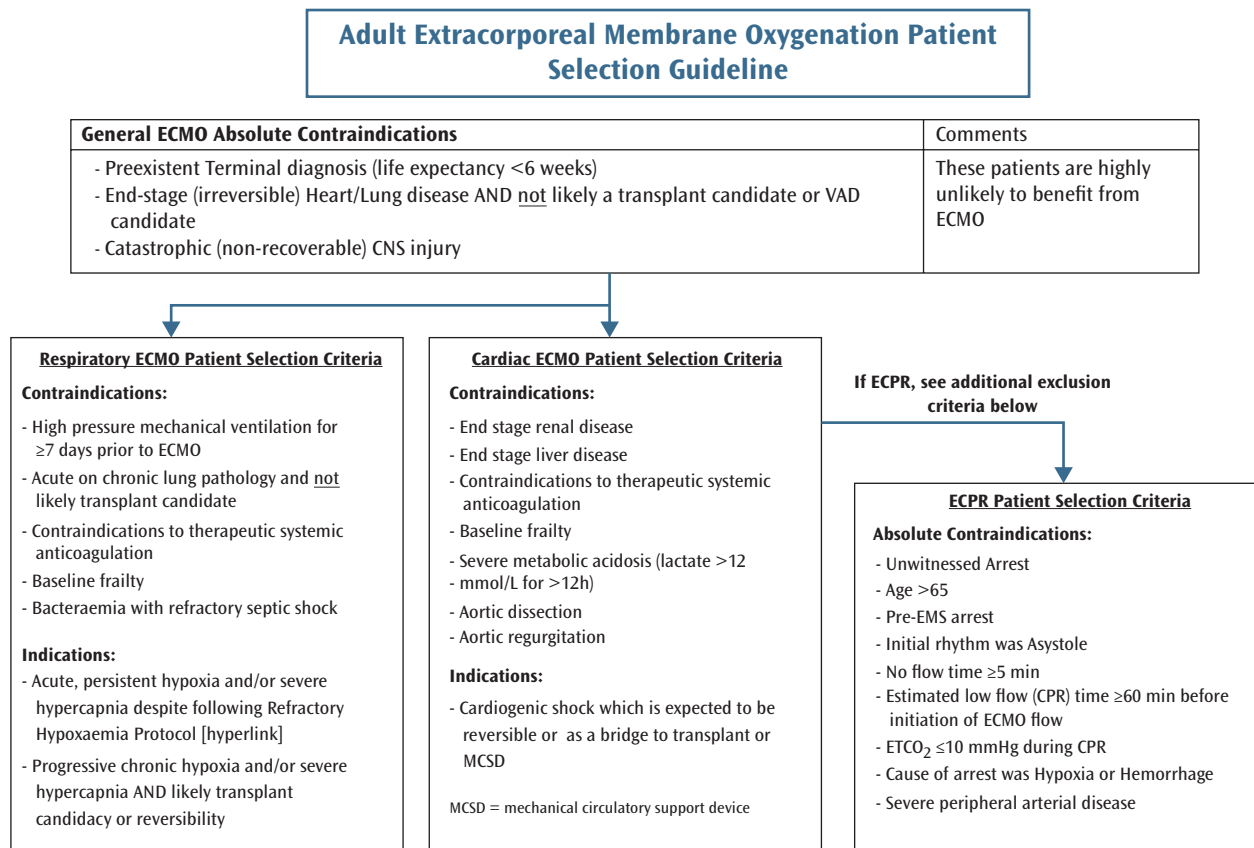
### Veno-Venous Cannulation

In the absence of native lung function, the ECMO circuit needs to drain and oxygenate at least 60% of the total venous return to reliably achieve peripheral oxygen saturations greater than 91%.<sup>16</sup> Therefore, the goal of veno-venous (VV) cannulation is to provide sufficient venous drainage to the oxygenator so that enough of the total venous return can be adequately oxygenated before it enters the right ventricle



**Figure 21.1.** Increase in the use of extracorporeal membrane oxygenation in the United States, 1990–2015.

Reproduced from Thiagarajan RR, Barbaro RP, Rycus PT, et al., Extracorporeal Life Support Organization Registry International Report 2016, *ASAIO Journal* 2019;63(1):60–37, <https://journals.lww.com/asaiojournal/pages/default.aspx> Copyright © 2019 by the ASAIO.



**Figure 21.2.** Patient selection guidelines for adults being considered for treatment with extracorporeal membrane oxygenation.

Reprinted with permission, ©Extracorporeal Life Support Organization (ELSO), *General Guidelines for all ECLS Cases*, August 2017.

(about 60% or more, assuming no native lung function) and is pumped to the systemic vasculature and organs. During VV-ECMO (especially when the patient is awake and ambulating), capillary oxygen saturation can frequently drop to 80%–90%, which is acceptable as long as end-organ perfusion is adequate (e.g., blood gases and lactate concentrations are normal). Cannula manufacturers provide simulated pressure-flow graphs that indicate what type and size of cannula might provide a desired ECMO blood flow.<sup>17</sup>

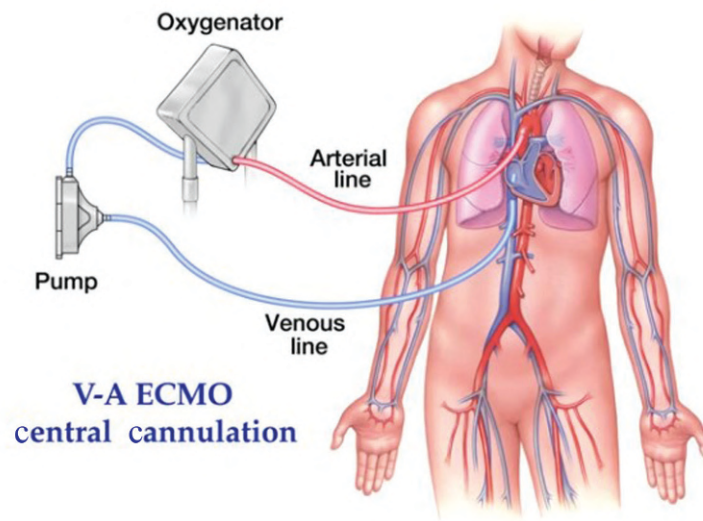
The most common VV-ECMO cannulation configurations are the following: a dual-lumen catheter (Avalon, Crescent), typically inserted through the right internal jugular vein; a femoral vein-internal jugular vein configuration (drainage through a femoral venous cannula with reinfusion through an internal jugular cannula); and a femoral-femoral configuration (the drainage cannula inserted through one femoral vein and return cannula inserted through the contralateral femoral vein).<sup>18</sup>

The theoretical benefits of a dual-lumen veno-venous catheter are less recirculation and greater ease in mobilizing the patient.<sup>19</sup> However, maximum blood flow is at times insufficient because of excessively negative pressures in the drainage cannula (even with large 27 F or 31 F cannulas). Precise positioning (both in depth and rotation) is required to achieve optimal flows with the dual-lumen catheter. The dual-lumen, veno-venous catheter is usually placed with a percutaneous Seldinger technique with serial dilations. We recommend inserting the wire past the right atrium and several centimeters into the inferior vena cava under fluoroscopic guidance and live visualization when advancing the cannula over the guide wire until its tip is 2–3 cm into the vena cava. Without fluoroscopy for this portion of the insertion, the guide wire can get unknowingly displaced

and result in cardiac wall perforation by the dilators or cannula and cause bleeding, resulting in cardiac tamponade.<sup>20</sup> Once the cannula is situated with its tip in the inferior vena cava and ECMO flows are begun, we recommend adjusting and confirming its placement with echocardiography. The outflow jet must be pointed directly at the tricuspid valve to optimize ECMO flows through the cannula. The Medtronic dual-lumen cannula which has been more recently released for use has stronger, thinner walls which appear to improve flows through the same external diameter, as well as improve localization with its inflow/outflow markers. For dual-site, veno-venous cannulation configurations (femoral-internal jugular or femoral-femoral), the cannula tips should be 10–15 cm apart to minimize recirculation. The outflow (oxygenated) cannula tip should be near the inferior vena cava–right atrium junction (for femoral cannulas) or the superior vena cava–right atrium junction (for internal jugular cannulas).

### Veno-Arterial Cannulation

Veno-arterial (VA)-ECMO cannulation can be broadly divided into central versus peripheral, and open versus percutaneous. Open approaches include cut-down for peripheral access and sternotomy or mini-thoracotomy for central access (Figure 21.3). Central cannulation typically allows greater ECMO blood flows, access for left ventricular decompression if necessary, and the option of cannula tunneling to allow chest closure if the ECMO run is expected to be prolonged (e.g., bridge to transplant).<sup>21,22</sup> Peripheral cannulation is generally associated with less hemorrhage, more rapid cannulation, and the ability to cannulate at the bedside. Most non-post-cardiotomy VA-ECMO involves femoral-femoral cannulation.



**Figure 21.3.** Central VA-ECMO cannulation.

Reprinted with permission ©Mayo Foundation for Medical Education and Research.

Practitioners in many different medical and surgical specialties have developed the catheter-based skills needed to perform percutaneous cannulation.<sup>23,24</sup> The foundation of successful and safe percutaneous cannulation is proficiency in acquiring and interpreting ultrasound images. Dynamic ultrasound evaluation is necessary to assess the relevant anatomy and to choose the appropriate cannula sizes. Before vessel dilation, the presence of the guide wire should be confirmed in the intended vessel (i.e., one femoral artery, one femoral vein). The position of the guide wire in either the central venous system or arterial system can be confirmed with either fluoroscopy or echocardiography. For percutaneous insertion, ultrasound guidance is also critical for locating the superficial femoral artery so that the arterial puncture and dilation occur proximal to this point on the common femoral artery.

### Cannulation-Related Complications

Peripheral ECMO cannulation results in limb ischemia requiring intervention in 13% to 33% of cases.<sup>25,26</sup> The most common cause of limb ischemia is obstructed blood flow through the femoral artery to the limb distal to the cannulation site. Because limb ischemia is so common, several interventions have been developed to reduce it (Table 21.1). Marginal perfusion of a limb may be worsened by concomitant venous obstruction, so cannulating both the femoral artery and femoral vein of the same leg should be avoided, if possible. During extracorporeal cardiopulmonary resuscitation, one option to prevent obstruction is to first rapidly cannulate the artery with a relatively small arterial cannula (e.g., 15 F). After resuscitation flows are begun (and coronary catheterization is completed, if indicated), the arterial cannulation can be revised by adding a distal perfusion catheter or semi-elective converting open conversion to a chimney graft.<sup>27,28</sup>

Differential hypoxemia, also referred to as Harlequin syndrome, occurs when poorly oxygenated blood is ejected from the LV, despite the patient being on ECMO.<sup>29</sup> This syndrome is most common during peripheral VA-ECMO, when native cardiac function is preserved but native pulmonary function is diminished. The hypoxemic blood then perfuses part or all the aortic arch (potentially including the vertebral and carotid arteries). Therefore, during all VA-ECMO cases, we recommend monitoring capillary oxygenation and arterial blood gases in the right arm, which is supplied by the most proximal aortic branch. Rarely, VA-ECMO blood flow may perfuse nearly the entire aortic arch, including the right arm, while a small amount of hypoxemic blood perfuses the coronary arteries. This uncommon situation manifests as normal peri-oxygen saturations and arterial blood gases with unexplained acute global cardiac dysfunction.

Differential hypoxemia can be treated by increasing ECMO blood flows (which reduces the venous return that

**Table 21.1 • Interventions for Preventing Limb Ischemia Related to Peripheral Extracorporeal Membrane Oxygenation**

Intervention	Notes
Adding an appropriately sized arterial cannula	Ultrasound is helpful in properly sizing the cannula. Venous cannula size, not the arterial cannula size, is usually the flow-limiting component of the ECM circuit.
Placing a distal perfusion cannula	Commonly, a 5 F to 9 F catheter is placed in the superficial femoral artery or posterior tibial artery. Distal perfusion catheter can be connected to arterial limb of the ECMO circuit.
Replacing a femoral cannula with an end-to-side (“chimney”) graft	No intra-arterial cannula obstructs distal limb perfusion.
Placing contralateral femoral arterial and venous cannulas	Venous obstruction can worsen marginal limb perfusion caused by an arterial cannula.
Distal limb tissue perfusion monitoring	May help detect limb ischemia earlier
Distal limb arterial Doppler ultrasound monitoring	May help detect limb ischemia earlier
Epoprostenol infusion	Improves limb perfusion through vasodilation

the native heart has to eject), connecting another venous catheter to the arterial side of the ECMO circuit (a venous-arterial-venous [VAV] configuration), converting to VV-ECMO (depending on underlying cardiac function), or converting to central VA-ECMO.<sup>22,30</sup> Central VA-ECMO greatly reduces the chances of a proximal arch hypoxemia but does not completely eliminate this risk.

With profound cardiac dysfunction in VA-ECMO, the failing heart may not be able to effectively eject against the systemic afterload imposed by the arterial ECMO flows. This condition results in inadequate LV decompression and increased LV end-diastolic pressure (LVEDP), which can result in left atrial hypertension, pulmonary edema, and increased LV wall tension. Increased LVEDP and LV wall tension decrease coronary perfusion and increase LV oxygen consumption, respectively, and therefore can markedly impede myocardial recovery. Additionally, poor left heart decompression can lead to relative intracardiac blood stagnation, which can result in devastating intracardiac thrombosis.<sup>31</sup> The risk is particularly high in the setting of intracardiac prosthetic material, such as a repaired or replaced valve.

Reported methods for improving LV decompression during VA-ECMO include placing an LV vent (with open surgery, through either the right superior pulmonary vein or the LV apex), percutaneous atrial septostomy, placing an LV assist device (e.g., an Impella), draining the pulmonary arterial catheter, and placing a percutaneous retrograde trans-aortic catheter.<sup>31,32</sup> Increasing VA-ECMO flows may improve LV decompression by reducing venous drainage to the heart, but the reduction is not always sufficient for successful LV decompression, given ongoing bronchial and coronary venous drainage into the heart.

## Outcomes

Because ECMO complications have become less frequent, modern outcomes with ECMO are driven primarily by the underlying indication for ECMO and patient comorbidities. In other words, the disease process that prompted starting ECMO, in the context of the patient's other comorbidities, is the primary determinant of death. If the underlying disease eventually resolves with time (e.g., viral myocarditis), then using ECMO to support the patient until the disease resolves should lead to a favorable outcome. If the underlying disease is progressive and fatal without transplantation or placing a ventricular assist device, then ECMO in itself will result in failure (Table 21.2).<sup>5,11,12,33–40</sup>

Although most outcome data are for survival, data for other important outcomes, such as quality of life and neurologic status, are emerging.<sup>37,41</sup> In the setting of cardiac arrest, neurologic outcomes are more clinically relevant than mere mortality outcomes after Extracorporeal cardiopulmonary resuscitation (ECPR). In their review of 406 patients with in-hospital cardiac arrests treated with ECPR, Shin et al. reported that survival to hospital discharge was 34%, with only 28% of all patients discharged with a Cerebral Performance Category (CPC) score of 2 or lower.<sup>42</sup> The

CHEER trial (mechanical CPR, Hypothermia, ECMO, and Early Reperfusion) reported more favorable outcomes, with 54% (13/24) of their ECPR patients having a CPC score of 2 or less.<sup>11</sup> Similarly, the Minnesota Resuscitation Consortium reported 50% (9 of 18) survival to discharge with a CPC score of 2 or less.<sup>12</sup> The referenced articles outline the differences in the selection criteria used and protocol-driven early interventions used in both the CHEER trial and in Minnesota Resuscitation Consortium study.

A under-appreciated determinant of outcomes in ECMO is the cannulation strategy. The cannulation strategy must provide adequate blood flow to support end-organ function and promote heart or heart-lung recovery without compromising regional perfusion (e.g., resulting in limb ischemia or differential hypoxemia).<sup>43</sup>

Many other comorbidities influence ECMO outcomes, just as they affect mortality outcomes in other critically ill patients. Many of these comorbidities are incorporated into the selection criteria outlined in the earlier section “Indications and Contraindications.” These comorbidities not only increase the risk of mortality and morbidity during ECMO, but also can reduce patients' rehabilitation potential after ECMO treatment.

## Referral Networks

The association between ECMO case volumes and patient outcomes is clear. Although the total annual number of ECMO cases has increased markedly, the number of annual cases at any one ECMO center can be low.<sup>5</sup> The risk of mortality in adults treated with ECMO at high-volume centers ( $\geq 30$  cases per year) is significantly lower (adjusted OR, 0.61; 95% CI, 0.46 to 0.80) than the risk at low-volume centers ( $\leq 5$  cases per year).<sup>44</sup>

Based on case volume and outcome data and the intensity of care required for successful ECMO care, consensus position papers recommend organizing ECMO care into a hub-and-spoke model.<sup>8,9</sup> Local or regional low-volume referral centers that can offer ECMO should work closely with comprehensive, high-volume ECMO centers as soon as possible when considering candidates for ECMO. Key decisions made before and during ECMO treatment—particularly patient selection and cannulation configuration—can greatly affect outcomes. Therefore, the ECMO team at a comprehensive care center can advise on patient selection before treatment and thus minimize the risk of ECMO-related complications.

## Conclusion

As a versatile option for full cardiopulmonary support, ECMO treatment can be delivered for hours to months. The associated cannulation configurations must account for the underlying pathophysiology to support end-organ circulation and to facilitate heart and heart-lung recovery.

**Table 21.2 • Survival to Hospital Discharge in Adults Treated with Extracorporeal Membrane Oxygenation**

Indication for Treatment <sup>5,11,12,33–40</sup>	Survival to Hospital Discharge, %
Post-cardiotomy	25 to 36
Cardiac (Including after cardiotomy)	39 to 41
Viral myocarditis	62 to 67
Acute myocardial infarction	40 to 47
Massive pulmonary embolism	46 to 95
Respiratory	60 to 61
Extracorporeal cardiopulmonary resuscitation	22 to 54

Proper patient selection and preventing, detecting, and treating complications can substantially improve patient outcomes. Although our collective ECMO experience, knowledge, and technological advancements have greatly improved outcomes, the overall intensity of ECMO care requires that it be provided in close coordination with a comprehensive ECMO referral center.

## REFERENCES

- Wiktor AJ, Haft JW, Bartlett RH, Park PK, Raghavendran K, Napolitano LM. Prolonged VV ECMO (265 Days) for ARDS without technical complications. *ASAIO J*. 2015;61(2):205–206.
- Thiara AP, Hoyland V, Norum H, et al. Extracorporeal membrane oxygenation support for 59 days without changing the ECMO circuit: a case of Legionella pneumonia. *Perfusion*. 2009;24(1):45–47.
- MacLaren G, Combes A, Bartlett RH. Contemporary extracorporeal membrane oxygenation for adult respiratory failure: life support in the new era. *Intensive Care Med*. 2012;38(2):210–220.
- Yeager T, Roy S. Evolution of gas permeable membranes for extracorporeal membrane oxygenation. *Artif Organs*. 2017;41(8):700–709.
- Thiagarajan RR, Barbaro RP, Rycus PT, et al. Extracorporeal Life Support Organization Registry International Report 2016. *ASAIO J*. 2017;63(1):60–67.
- Australia and New Zealand Extracorporeal Membrane Oxygenation (ANZ ECHMO) Influenza Investigators; Davies A, Jones B, Bailey M, et al. Extracorporeal membrane oxygenation for 2009 influenza A(H1N1) acute respiratory distress syndrome. *JAMA*. 2009;302(17):1888–1895.
- Extracorporeal Life Support Organization (ELSO) General Guidelines for all ECLS Cases*. August 2017. [www.else.org/Portals/0/ELSO%20Guidelines%20General%20All%20ECLS%20Version%201\\_4.pdf](http://www.else.org/Portals/0/ELSO%20Guidelines%20General%20All%20ECLS%20Version%201_4.pdf) 2017. Accessed October 29, 2018.
- Abrams D, Garan AR, Abdelbary A, et al. Position paper for the organization of ECMO programs for cardiac failure in adults. *Intensive Care Med*. 2018;44(6):717–729.
- Combes A, Brodie D, Bartlett R, et al. Position paper for the organization of extracorporeal membrane oxygenation programs for acute respiratory failure in adult patients. *Am J Respir Crit Care Med*. 2014;190(5):488–496.
- Keebler ME, Haddad EV, Choi CW, et al. Venoarterial extracorporeal membrane oxygenation in cardiogenic shock. *JACC Heart Fail*. 2018;6(6):503–516.
- Stub D, Bernard S, Pellegrino V, et al. Refractory cardiac arrest treated with mechanical CPR, hypothermia, ECMO and early reperfusion (the CHEER trial). *Resuscitation*. 2015;86:88–94.
- Yannopoulos D, Bartos JA, Martin C, et al. Minnesota Resuscitation Consortium's advanced perfusion and reperfusion cardiac life support strategy for out-of-hospital refractory ventricular fibrillation. *J Am Heart Assoc*. 2016;5(6):pii:e003732.
- Sidebotham D, McGeorge A, McGuinness S, Edwards M, Willcox T, Becca J. Extracorporeal membrane oxygenation for treating severe cardiac and respiratory failure in adults: part 2-technical considerations. *J Cardiothorac Vasc Anesth*. 2010;24(1):164–172.
- Fan E, Gattinoni L, Combes A, et al. Venovenous extracorporeal membrane oxygenation for acute respiratory failure: a clinical review from an international group of experts. *Intensive Care Med*. 2016;42(5):712–724.
- Abrams D, Combes A, Brodie D. Extracorporeal membrane oxygenation in cardiopulmonary disease in adults. *J Am Coll Cardiol*. 2014;63(25 Pt A):2769–2778.
- Schmidt M, Tachon G, Devilliers C, et al. Blood oxygenation and decarboxylation determinants during venovenous ECMO for respiratory failure in adults. *Intensive Care Med*. 2013;39(5):838–846.
- Kohler K, Valchanov K, Nias G, Vuylsteke A. ECMO cannula review. *Perfusion*. 2013;28(2):114–124.
- Sidebotham D, Allen SJ, McGeorge A, Ibbott N, Willcox T. Venovenous extracorporeal membrane oxygenation in adults: practical aspects of circuits, cannulae, and procedures. *J Cardiothorac Vasc Anesth*. 2012;26(5):893–909.
- Kuhl T, Michels G, Pfister R, Wendt S, Langebartels G, Wahlers T. Comparison of the Avalon dual-lumen cannula with conventional cannulation technique for venovenous extracorporeal membrane oxygenation. *Thorac Cardiovasc Surg*. 2015;63(8):653–662.
- Banayan JM, Barry A, Chaney MA. Right ventricular rupture during insertion of an Avalon Elite® Catheter. *J Cardiothorac Vasc Anesth*. 2016;30(4):e34–e35.21. Stulak JM, Dearani JA, Burkhart HM, Barnes RD, Scott PD, Schears GJ. ECMO cannulation controversies and complications. *Semin Cardiothorac Vasc Anesth*. 2009;13(3):176–182.
- Jayaraman AL, Cormican D, Shah P, Ramakrishna H. Cannulation strategies in adult veno-arterial and veno-venous extracorporeal membrane oxygenation: Techniques, limitations, and special considerations. *Ann Card Anaesth*. 2017;20(Supplement):S11–S18.
- Lamb KM, Hirose H, Cavarocchi NC. Preparation and technical considerations for percutaneous cannulation for veno-arterial extracorporeal membrane oxygenation. *J Card Surg*. 2013;28(2):190–192.
- Burrell AJ, Pellegrino VA, Sheldrake J, Pilcher DV. Percutaneous cannulation in predominantly venoarterial extracorporeal membrane oxygenation by intensivists. *Crit Care Med*. 2015;43(12):e595.
- Lamb KM, DiMuzio PJ, Johnson A, et al. Arterial protocol including prophylactic distal perfusion catheter decreases limb ischemia complications in patients undergoing extracorporeal membrane oxygenation. *J Vasc Surg*. 2017;65(4):1074–1079.
- Yen CC, Kao CH, Tsai CS, Tsai SH. Identifying the risk factor and prevention of limb ischemia in extracorporeal membrane oxygenation with femoral artery cannulation. *Heart Surg Forum*. 2018;21(1):E018–E022.
- Mohite PN, Fatullayev J, Maunz O, et al. Distal limb perfusion: Achilles' heel in peripheral venoarterial extracorporeal membrane oxygenation. *Artif Organs*. 2014;38(11):940–944.
- Cakici M, Ozcinar E, Baran C, et al. A retrospective cohort analysis of percutaneous versus side-graft perfusion techniques for veno-arterial extracorporeal membrane oxygenation in patients with refractory cardiogenic shock. *Perfusion*. 2017;32(5):363–371.
- Geyer M, Gohrbandt B, Sagoschen I, et al. Pitfalls of cannulation for extracorporeal life support: review of the literature and illustrative case presentation. *J Artif Organs*. 2018;21(1):8–16.

30. Werner NL, Coughlin M, Cooley E, et al. The University of Michigan experience with veno-venoarterial hybrid mode of extracorporeal membrane oxygenation. *ASAIO J.* 2016;62(5):578–583.
31. Rupperecht L, Florchinger B, Schopka S, et al. Cardiac decompression on extracorporeal life support: a review and discussion of the literature. *ASAIO J.* 2013;59(6):547–553.
32. Avalli L, Maggioni E, Sangalli F, Favini G, Formica F, Fumagalli R. Percutaneous left-heart decompression during extracorporeal membrane oxygenation: an alternative to surgical and transeptal venting in adult patients. *ASAIO J.* 2011;57(1):38–40.
33. Khorsandi M, Dougherty S, Bouamra O, et al. Extracorporeal membrane oxygenation for refractory cardiogenic shock after adult cardiac surgery: a systematic review and meta-analysis. *J Cardiothorac Surg.* 2017;12(1):55.
34. Schmidt M, Burrell A, Roberts L, et al. Predicting survival after ECMO for refractory cardiogenic shock: the survival after veno-arterial-ECMO (SAVE)-score. *Eur Heart J.* 2015;36(33):2246–2256.
35. Cheng R, Hachamovitch R, Kittleson M, et al. Clinical outcomes in fulminant myocarditis requiring extracorporeal membrane oxygenation: a weighted meta-analysis of 170 patients. *J Card Fail.* 2014;20(6):400–406.
36. Schmidt M, Zogheib E, Roze H, et al. The PRESERVE mortality risk score and analysis of long-term outcomes after extracorporeal membrane oxygenation for severe acute respiratory distress syndrome. *Intensive Care Med.* 2013;39(10):1704–1713.
37. Muller G, Flecher E, Lebreton G, et al. The ENCOURAGE mortality risk score and analysis of long-term outcomes after VA-ECMO for acute myocardial infarction with cardiogenic shock. *Intensive Care Med.* 2016;42(3):370–378.
38. George B, Parazino M, Omar HR, et al. A retrospective comparison of survivors and non-survivors of massive pulmonary embolism receiving veno-arterial extracorporeal membrane oxygenation support. *Resuscitation.* 2018;122:1–5.
39. Pasrija C, Kronfli A, George P, et al. Utilization of veno-arterial extracorporeal membrane oxygenation for massive pulmonary embolism. *Ann Thorac Surg.* 2018;105(2):498–504.
40. Chen YS, Lin JW, Yu HY, et al. Cardiopulmonary resuscitation with assisted extracorporeal life-support versus conventional cardiopulmonary resuscitation in adults with in-hospital cardiac arrest: an observational study and propensity analysis. *Lancet.* 2008;372(9638):554–561.
41. Rozencwajg S, Pilcher D, Combes A, Schmidt M. Outcomes and survival prediction models for severe adult acute respiratory distress syndrome treated with extracorporeal membrane oxygenation. *Crit Care.* 2016;20(1):392.
42. Shin TG, Choi JH, Jo IJ, et al. Extracorporeal cardiopulmonary resuscitation in patients with inhospital cardiac arrest: a comparison with conventional cardiopulmonary resuscitation. *Crit Care Med.* 2011;39(1):1–7.
43. Sidebotham D. Troubleshooting adult ECMO. *J Extra Corpor Technol.* 2011;43(1):P27–P32.
44. Barbaro RP, Odetola FO, Kidwell KM, et al. Association of hospital-level volume of extracorporeal membrane oxygenation cases and mortality: analysis of the extracorporeal life support organization registry. *Am J Respir Crit Care Med.* 2015;191(8):894–901.

# 22

## The Berlin Heart Ventricular Assist Devices

LUCIAN A. DURHAM III

### Introduction

**O**ptions for support of the failing heart with mechanical circulatory support devices has seen unprecedented growth in the past few years as the technology and increasing experience, both with implantation and management, have led to survival rates rivaling orthotopic cardiac transplantation in adults. However, due to the small market for pediatric support, the DeBakey VAD® Child (MicroMed Technology, Inc., now Reliant Heart, Inc.) was approved by the US Food and Drug Administration (FDA) for use in children with BSA >0.7m<sup>2</sup>. That left veno-arterial extracorporeal membrane oxygenation (VA-ECMO) as the only viable option for short- to intermediate-term support of infants and small children with refractory heart failure, despite substantial risks and complications associated with this strategy.<sup>1-3</sup> Simultaneously, growth of the pediatric heart transplant waiting list resulted in wait times of more than 100 days with an associated 23% wait-list mortality rate.<sup>4,5</sup> The lack of options for caring for this cohort of children led surgeons in the United States to turn to the Berlin Heart EXCOR® (Berlin Heart GmbH, Berlin, Germany), a pulsatile ventricular assist device (VAD) which had been granted CE (Conformité Européenne) Mark in Europe in 1996, requesting compassionate use through the FDA's regulations allowing use of investigational drugs/devices for patients with life-threatening conditions.<sup>6</sup> In the European study, Hetzer et al. were able to demonstrate stable circulatory support in children over 3 kg for greater than 400 days.<sup>7</sup> The first pediatric patient was implanted with the Berlin Heart EXCOR in 2000, and experience and demand finally led to Investigative Device Exemption (IDE) conditional approval in 2007 and final Humanitarian Device Exemption (HDE) approval in late 2011, despite numerous US regulatory hurdles.<sup>8</sup>

### The Berlin EXCOR® Device

The Berlin Heart EXCOR® is a pneumatically driven, extracorporeal ventricular assist device that is suitable for use in left ventricular assist device (LVAD), right ventricular assist device (RVAD), and biventricular assist device (BiVAD) configurations. The system consists of the Blood Pump, inflow and outflow cannulae, and the Ikus® Electropneumatic Drive Unit. The Blood Pumps are polyurethane construction with air and blood chambers divided by a polyurethane membrane; they come in 10, 25, 30, 50, 60, and 80 cc displacements to accommodate neonates >3 kg to adults (Figure 22.1).

The Blood Pump has inflow and outflow arms with trileaflet polyurethane valves to maintain direction of flow in the positive displacement device. All blood interface surfaces, including valves, are bonded with the Carmeda® BioActive Surface (Carmeda, Upplands Väsby, Sweden) thromboresistant surface coating. A nipple on the blood chamber side of the pump facilitates de-airing of the device at implant. The air chamber side of the pump contains the connector for the pneumatic driveline, which connects the device to the Ikus® Drive Unit that provides the pressure to move the triple-layer membrane. Friction is minimized by a layer of graphite powder on the air chamber side. Blood Pump size is dependent upon patient weight and expected output (Figure 22.2).

Three types of cannulae are available, two inflow and one outflow, allowing for various configurations of the device according to the anatomic and physiologic needs of the patient. Atrial and ventricular apical inflow cannulae are available in various sizes, as is the arterial outflow cannula; all are silicone construction with an integrated Dacron cuff at the insertion sites to facilitate suture stabilization of the cannula to the LV apex or atrium (inflow) and aorta (outflow). The cannulae also have a Dacron sleeve distally





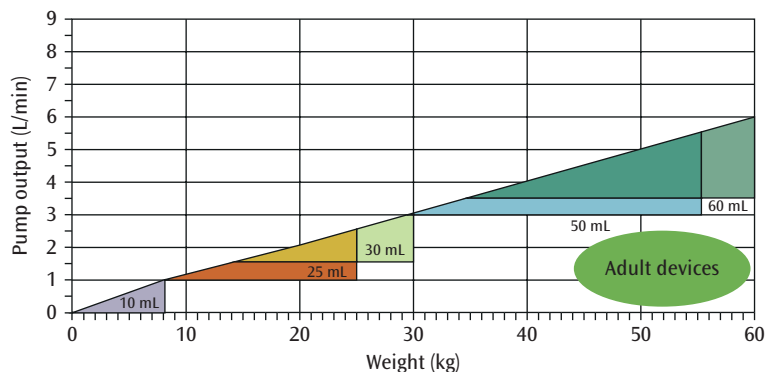
**Figure 22.1.** The Berlin Heart EXCOR device is available in a variety of size ranges to accommodate the pediatric population. Reproduced with permission of © 2019 Berlin Heart, All rights reserved.

that promotes tissue ingrowth in the subcutaneous tunnel, providing a barrier to infection and preventing migration and tension on the cannula as the patient mobilizes postoperatively. Both the atrial and arterial cannulae are angled to reduce tension on the insertion site while the apical ventricular cannula is a straight, open-tipped design (Figure 22.3).

The Ikus® Electropneumatic Drive Unit (Figure 22.4) provides both driving pressure and suction for the blood pumps. Compressed air moves the pump membrane into its end-systolic position, which ejects blood into the arterial circulation under positive pressure. Negative pressure is then created in pump diastole to assist in the filling of the pump. The driving unit contains the compressor and electronic components, as well as a laptop computer that serves as the interface to the operator. The Ikus® has three separate compressor systems that operate independently, providing redundancy for safety. One compressor system is required for each blood pump (right or left heart), with the third serving as an emergency backup. In the case of malfunction of one unit, the backup will take over automatically without delay. If the two units fail simultaneously, the

third unit will take over to operate both pumps with a pump rate of 90 beats/min. The pressure and vacuum cylinders are controlled by two redundant internal computers with an internal battery can provide power for up to 1 hour. In emergency situations, the system is equipped with a manual pump (mounted on the Ikus) which can be used to temporarily drive the blood pump(s).

The maximum positive driving pressure of the system is 350 mmHg with a maximum negative driving pressure of  $-100$  mmHg. Higher pressures are needed to overcome the resistance of the smaller pediatric cannulae. The pump rate can be adjusted between 30 and 150 beats/min and the relative systolic duration from 20% to 70%. The system may be operated in single or biventricular modes. Additionally, the biventricular mode can be set to “synchronous” mode in which both pumps fill and eject simultaneously, or “asynchronous” in which the right and left pumps operate completely independent of one another. Patients supported with the Ikus® stationary driving unit must remain as inpatients. Suggested intraoperative settings for initiation of the pump for LVAD and/or RVAD



**Figure 22.2.** Selection of pump size depends on the required pump output based on the weight of the patient on support. Reproduced with permission of © 2019 Berlin Heart, All rights reserved.



**Figure 22.3** A variety of cannula options are available for implantation of the Berlin Heart EXCOR.

Reproduced with permission of © 2019 Berlin Heart, All rights reserved.

are systole 120 mmHg, diastole  $-2.5$  mmHg, rate 30 beats/min, percentage of systole 40% parameters. Weaning from cardiopulmonary bypass is accomplished while monitoring pump membrane movement. The suggested settings for LVAD are systole 180 to 240 mmHg, and for RVAD are systole 120 to 160 mmHg; diastolic pressure for both right and left devices is  $-30$  to  $-50$  mmHg with percentage of systole 35% to 50%. The final rate is dependent on patient weight and pump size. Movement of the membrane in the blood chamber, as well as the patient's clinical and hemodynamic status, dictates any adjustment of the operating parameters. It is paramount to adequately assess the membrane, ensuring that it is smooth with both filling and ejection. A membrane that appears wrinkled during filling is likely due to hypovolemia; volume replacement should be the primary treatment prior to adjusting settings. Other causes for a wrinkled membrane in filling include inflow cannula obstruction, cardiac tamponade, or severe RV failure with LVAD support only. A wrinkled membrane during ejection requires prompt attention, as incomplete ejection results in blood stasis and thrombus formation. Causes include high afterload, outflow obstruction, or insufficient pump systolic pressures.

The Ikus® stationary unit is constantly monitoring the internal drivers, computer, power supply, and battery. Dysfunction of any of these systems will result in an auditory alarm as well as a message on the laptop computer.



**Figure 22.4.** The IKUS Drive Unit.

Reproduced with permission of © 2019 Berlin Heart, All rights reserved.

The Ikus® monitors the pump membrane movement indirectly through air movement in the driveline. Only acute changes will result in an alarm, such as kinking of cannula, pump thrombosis, or other outflow obstruction, rather than slow gradual changes that may not be detected by the system such as cardiac tamponade or increased afterload. With any major system failure, the Ikus® will automatically switch to its backup systems and alarm accordingly.

The EXCOR® mobile driver is a piston pump that provides full stroke volume for the 60- and 80-cc pumps under normal hemodynamic conditions. This allows some adolescent and adult patients to be managed in an outpatient setting following a suitable period of inpatient management on the Ikus® stationary driver. The mobile driver is not intended to be used for initiating therapy intraoperatively or in the initial postoperative period. Initial criteria for outpatient care include the following: underlying cardiac function that would support perfusion and blood pressure for at least 10 minutes without external assistance if the mobile driver failed; the patient has received adequate training on the use of the mobile driver and is capable of carrying out the operating functions; and the patient is able to maintain adequate hydration.

## Investigational Device Clinical Study (IDE) and Post Market Analysis (PMA)

Conformité Européenne (CE) Mark approval and continued requests for compassionate use of the device led the FDA and Berlin Heart to recognize the need for a clinical trial to assess the safety and efficacy of the system. One of the major hurdles in designing such a study was the lack of comparable devices for the pediatric population. It was commonly felt that randomization of the EXCOR<sup>®</sup> against VA-ECMO was inappropriate due to the time constraints and limitations of ECMO. Therefore, an appropriate historical control group was identified and a clinical protocol was developed under the FDA's Humanitarian Device Exemption (HDE) pathway to allow for a multicenter prospective clinical trial enrolling patients listed for orthotopic cardiac transplantation who required left or biventricular support for survival to transplantation. Four cohorts from 0 to 16 years of age were used in the study; Cohort 1 had BSA <0.7 m<sup>2</sup>, Cohort 2 had BSA ≥0.7 m<sup>2</sup>, Cohort 3 included ongoing compassionate use requests from site not enrolled in the primary study, and Cohort 4 was the historical control group. A total of 204 patients were implanted during the study period (June 2007–December 2010), 48 in the primary cohorts (Cohorts 1 and 2). Both safety and efficacy primary end points favored EXCOR<sup>®</sup> patients over matched ECMO and historic control groups. Of 204 children supported with the EXCOR, the median duration of support was 40 days (range 1 to 435 days). Survival at 12 months was 75%, including 64% who reached transplant, 6% who recovered, and 5% who were alive on the device. Multivariable analysis identified lower weight, BiVAD support, and elevated bilirubin as risk factors for early mortality. The most common adverse events were major infection (62.5%), systemic hypertension (50%), major bleeding episode (41.7%), and neurologic event (29.2%).<sup>8</sup> The FDA Advisory Panel voted unanimously in favor of device approval. The FDA followed the panel's recommendation and granted conditional HDE approval of the EXCOR Pediatric on December 16, 2011. Indications and contraindications are outlined in Table 22.1. Approval was conditional upon Berlin Heart conducting a Post Market Analysis to determine if safety and efficacy of the device in the 17 IDE study sites was similar in the commercial setting. The 2015 Post Approval Study (PAS) demonstrated that clinical results to primary outcome (death, transplant, or successful wean) were met by all patients. Survival was 70% with a reported serious adverse event (SAE) rate of 0.02/pt. days of support (compared to 0.07/pt. days of support in the IDE study ( $p < 0.0001$ )). The stroke rate remained about 30% in both phases of the PAS. Thus, the PAS summarized that survival following transplant or successful wean was high

and that there was a statistically significant improvement in functional outcomes from baseline to 12 months post-transplant or explant. Also, subjects who survived to transplant following cerebral vascular accident (CVA) were improving or doing well according to Pediatric Stroke Outcomes Measure (PSOM).<sup>9</sup> A 2016 Medical Device Report (MDR) noted that the injury and malfunction MDRs related to CVA, membrane defects, and driving tube leaks were similar to reported events in the previous year and the IDE.

## Pump Configuration Strategy

Developing a strategy for pump configuration should start long before entering the operating room. Evaluation of right ventricular function by transthoracic or transesophageal echocardiography and right heart catheterization should take place as part of the pre-implantation evaluation. Ascites, hepatic and renal failure, in addition to other manifestations of systemic venous congestion (CVP >20 mmHg), will also factor into the decision of LVAD versus biventricular support. In the face of mild to moderate RV dysfunction, assessment of the right ventricle may be repeated following implantation of the left-sided device, and implantation of the right-sided device is recommended if the cardiac index remains <2 L/min/m<sup>2</sup> or the central venous pressure (CVP) remains elevated above 15 mmHg following optimal medical management. The single most important predictor of patient mortality on EXCOR<sup>®</sup> support was the degree of end-organ dysfunction, specifically renal and hepatic dysfunction, at the time of VAD implantation.<sup>10</sup> Delay in implanting a device so that hepatorenal or right ventricular function has significantly deteriorated increases the risk of mortality on EXCOR<sup>®</sup> support.

## Pump Exchange

Pump exchange may be required in the event of a leak in the blood pump membrane. This is typically associated with blood on the pneumatic side of the blood pump or development of a significant clot or fibrin burden. This can normally be undertaken in the ICU without the need for moving to the operating room. The chest and abdomen, along with the blood pumps and exteriorized cannulae, are prepped and draped in the normal sterile fashion. Then, with the child sedated, the pumps can be rapidly clamped, disconnected, and new primed pumps connected. Care should be taken when engaging the new blood pump with the cannula as the metal edge on the pump can cut into the cannula, allowing for leakage or air entrainment. Once the new pumps are connected, several test ejections are undertaken to ensure the integrity of the pump/cannula interface prior to recommencing full flow support.

**Table 22.1 • Inclusion/exclusion criteria for the Berlin Heart EXCOR IDE clinical study****Inclusion criteria**

- Severe NYHA functional class IV (or Ross class IV) heart failure refractory to optimal medical therapy and satisfies at least 1 of the following criteria:
  - INTERMACS profile status 1 or 1A (critical cardiogenic shock), ECMO support or unable to separate from cardiopulmonary bypass
  - INTERMACS profile status 2 or 2A (slow progressive decline) as defined by a decline in: renal function (50% reduction in GFR after optimization of volume status), nutritional status (sustained inability ( $\geq 7$  days) to meet 75% of prescribed energies or physical signs of nutritional compromise (e.g. cachexia) despite appropriate intervention), or sustained bed confinement ( $\geq 7$  days) due to heart failure or its treatment
- Listed UNOS status 1A or equivalent for HT
- Two-ventricle circulation (eg, cardiomyopathy or congenital heart disease such as repaired anomalous left coronary from the pulmonary artery)
- Age 0-16 years and weight 3-60 kg
- BSA: cohort 1  $< 0.7$  m<sup>2</sup>, cohort 2 0.7-1.5 m<sup>2</sup>
- Legal guardian able to provide informed consent

**Exclusion criteria**

- Weight  $< 3.0$  kg or  $> 1.5$  m<sup>2</sup>
- Unfavorable cardiac anatomy including
  - Technically challenging anatomy including single-ventricle lesions, restrictive cardiomyopathy, apical VSD or other hemodynamically significant lesion considered technically challenging to repair by the PI
  - Presence of a mechanical aortic valve or moderate or severe aortic or pulmonary valve insufficiency
- Evidence of intrinsic renal disease (serum creatinine  $> 3 \times$  ULN for age) unless caused by acute heart failure in judgment of PI (i.e., reversible)
- Evidence of intrinsic hepatic disease (total bilirubin, AST/ALT  $> 5 \times$  ULN for age) unless caused by acute heart failure (reversible) in judgment of PI
- Evidence of intrinsic pulmonary disease (eg, chronic lung disease or respiratory distress syndrome) requiring chronic ventilation unless caused by acute heart failure and reversible in judgment of PI
- ECMO support  $> 10$  days or CPR for  $> 30$  minutes within 48 hours of VAD implant
- Stroke within the past 30 days or congenital CNS malformation associated with bleeding (eg, AVM *moya moya*)
- Documented coagulopathy (eg, factor VIII deficiency, DIC, factor V Leiden mutation, or HIT) or hematologic disorder causing fragility of blood cells or hemolysis (eg, sickle cell disease)
- Active infection within 48 hours of implantation defined by a positive blood culture or temperature  $> 38^\circ\text{C}$  and WBC  $> 15000$
- Documented HIV infection or life-limiting malignant disease
- Psychiatric or behavioral disease with high likelihood for noncompliance
- Pregnant or breast feeding
- Participating in another investigational device or drug study

Abbreviations: NYHA= New York Heart Association; GFR= glomerular filtration rate; ULN= Upper limit of normal; VSD= ventricular septal defect; AST= aspartate aminotransferase; ALT= alanine aminotransferase; PI= Principal Investigator; CNS= central nervous system; AVM= arteriovenous malformation; DIC= disseminated intravascular coagulation; HIT= heparin-induced thrombocytopenia; CPR= cardiopulmonary resuscitation; WBC= white blood cell. Reprinted from the Almond CS et al., Berlin Heart EXCOR Pediatric ventricular assist device Investigational Device Exemption study: study design and rationale, *American Heart Journal* 2011;162:425–435, Copyright (2011), with permission from Elsevier.

## Anticoagulation Strategies

Bleeding, thrombotic complications, and stroke remain the most challenging and frequent causes of morbidity and mortality in pediatric patients supported with the Berlin Heart

EXCOR®. Morbidity and mortality rates range from 30% to 42%, with infants  $< 5$  kg having worse outcomes.<sup>8,10</sup> Stroke still affects 30% of patients supported with the EXCOR® as bridge to transplantation. An association between inflammation and thrombotic or hemorrhagic complications

**Table 22.2 • Comparison of Anti-Thrombotic Therapy Targets in the Edmonton and Stanford Anti-Thrombotic Guidelines for the Berlin Heart EXCOR Pediatric VAD**

	Edmonton Guideline	Stanford Guideline
Anticoagulant	Enoxaparin (anti Xa 0.6 to 1.0)	Same
Aspirin	Titrate to AA inhibition of >70% by TEG/PM	Titrate to a weight-based dose of 30 mg/kg/day (maximal dose 2,000 mg/day)
Dipyridamole (Persantine)	Titrate to an ADP Net G 4 to 8 or ADP inhibition >70% by TEG/PM	Titrate to a weight-based dose of 15 mg/kg/day
Clopidogrel (Plavix)	No recommendation	0.2 mg/kg/day (starting) titrated to a fixed dose of 1 mg/kg/dose once daily
Prednisone	No recommendation	As needed for fibrinogen >600 mg/dl or other signs of inflammation (fever, rise in CRP)

Abbreviations: AA = arachidonic acid; ADP = adenosine diphosphate; CRP = C-reactive protein; PM = platelet mapping; TEG = thromboelastography; VAD = ventricular assist device.

Net G is calculated by subtracting the percent inhibition of ADP from 100%, dividing by 100, and multiplying the value by the baseline G from the citrated specimen activated with kaolin in the presence of heparinase.

Antiplatelet therapy and steroids titrated primarily to achieve an MA value of between 55 and 65 mm using a citrated specimen activated with kaolin in the presence of heparinase.

Reprinted from the Rosenthal DN et al., Impact of a modified anti-thrombotic guideline on stroke in children supported with a pediatric ventricular assist device, *Journal of Heart and Lung Transplantation* 2017;36:1250–1257, Copyright (2017), with permission from Elsevier.

was studied in the population supported with the Berlin Heart EXCOR® and some survival benefit was established by employing a steroid protocol.<sup>11,12</sup> Current monitoring of anticoagulation/antiplatelet therapy can be performed using activated clotting time (ACT) as is traditionally used for ECMO, as well as anti-factor X<sub>a</sub> for unfractionated heparin level (UFH), international normalized ratio (INR), thromboelastography (TEG), and platelet mapping. While there is considerable variation in antithrombotic protocols, the protocol originally recommended by Berlin Heart has remained frequently employed.<sup>8</sup> Two additional antithrombotic guidelines are the Edmonton and Stanford guidelines for the Berlin Heart EXCOR® which are compared in Table 22.2. The key difference between the two rested on the administration of triple antiplatelet drugs in the Stanford guidelines which appeared, in the initial small cohort trial, to lessen the incidence of stroke.<sup>13</sup> A recent meta-analysis covering a 17-year period found that programs using the Berlin Heart EXCOR® almost universally anticoagulated with heparin postoperatively, then transitioned to low molecular weight heparin and warfarin. Antiplatelet regimens included Dipyridamole and aspirin, though dosage, timing, and monitoring were different.<sup>14</sup>

No anticoagulation is administered in the first 48 hours, then provided the patient is hemodynamically stable and there are no concerns for hemostasis, the antithrombotic protocol of choice is commenced, and when the patient is taking oral feeds, aspirin is started along with additional antiplatelet therapy. TEG with Platelet mapping is usually performed twice weekly thereafter to monitor heparin and aspirin effect. Starting in the postoperative phase

and carrying forward, the blood pump(s) are frequently inspected for thrombus, with particular attention being paid to the polyurethane valves which are subject to thrombus forming behind the valve leaflets where blood tends to stagnate. Enoxaparin is used for long-term anticoagulation while the patient is hospitalized awaiting cardiac transplantation. In the event of significant thrombus or fibrin burden, early consideration must be given to device exchange.

## Bleeding and Cerebrovascular Events

Management of antithrombotic therapy is difficult in the pediatric population, particularly so in pediatric VAD patients. Those supported on the Berlin Heart EXCOR® have a 50% incidence of major bleeding, and 28% experience a cerebrovascular event.<sup>8,10</sup> Bleeding diatheses included GI bleeding, intracranial hemorrhage, and surgical site bleeding necessitating re-exploration. A recent study evaluating the association between hematologic and inflammatory markers with respect to thrombosis or hemorrhage in patients supported with the Berlin Heart EXCOR® concluded that patients presenting with thrombotic events tended to weigh less than those with predominantly hemorrhagic events.<sup>12</sup>

While there is limited neurological outcomes data in pediatric patients supported with the Berlin Heart EXCOR®, some data suggest that the incidence of cerebrovascular events is highest in the immediate postoperative period and lower in programs with significant institutional

experience.<sup>11,15</sup> Neurologic events can be devastating and are the most frequent cause of death in the pediatric VAD population. In many cases these patients no longer qualify for transplantation, with subsequent withdrawal of support. In those who survive, statistically significant improvement in functional outcomes is noted 1 year post-transplant or device explant, though functional assessment remains below baseline.<sup>9,16</sup>

## Infection

Infections with the Berlin Heart EXCOR can involve any aspect of the device, with the surgical site and cannula acting as the most common site. As with all chronically hospitalized patients, infection with antibiotic-resistant organisms (methicillin-resistant *Staphylococcus aureus*, vancomycin-resistant *enterococci*, and *Pseudomonas*) can occur, along with the need for broader antibiotic coverage.<sup>17</sup> This can then lead to a risk of *Clostridium difficile* enteritis and opportunistic fungal infections. A high index of suspicion is required for fungal infections, as the pediatric population can be relatively asymptomatic until the onset of fungal sepsis, which is associated with significant mortality and is difficult to clear despite aggressive therapy.<sup>18</sup> Routine cultures and fastidious attention to hygiene are the mainstays of prevention, along with the use of surveillance transthoracic echocardiography to look for vegetations. Empiric use of broad-spectrum antibiotics and antifungals are frequent considerations dependent upon the index of suspicion. Prophylactic gram-positive coverage is continued in the first postoperative week with daily sterile dressing changes to the cannula sites. Following this, the dressing changes are performed twice weekly concomitant with showering.

## Post-Approval Clinical Experience

Advances in the diagnosis and treatment of heart disease in children, whether cardiomyopathy or structural congenital heart disease, has led to increased survival and the inherent challenges of supporting this difficult cohort of patients over a longer time frame. While many of these patients undergo surgical correction for cure, others may pursue palliation with the potential for transplantation as the ultimate goal. This cohort often requires cardiac support with a VAD as a bridge to transplantation. The Berlin Heart EXCOR® is currently the only durable VAD approved for pediatric use, having been developed and validated in Europe with subsequent approval in the United States in 2011. It was conditionally approved as a bridge-to-transplant device (BTT) in children by the FDA.

A prospective, multi-center, single group Investigational Device Exemption (IDE) trial of the EXCOR® was undertaken in the United States with 48 patients, evenly divided

into two cohorts by body surface area (BSA) (Cohort 1: <0.7 m<sup>2</sup> BSA; Cohort 2: 0.7 to <1.5 m<sup>2</sup> BSA).<sup>8</sup> Patient characteristics are shown in Table 22.3. A 2:1 comparison was made against a historical control group of ECMO patients that were propensity matched to corresponding EXCOR® patients. The IDE study demonstrated a statistically significant increase in survival with the Berlin Heart EXCOR® when compared with ECMO. Serious adverse events (SAE) occurred at a rate of 0.07 and 0.08 per patient day in cohorts 1 and 2, respectively. They included bleeding (42% and 50%), infection (63% and 50%), and stroke (29% in both cohorts). While the SAE rate was concerning, the significant survival advantage led to the qualified approval by the FDA contingent upon annual medical device reports (MDR) and post-approval study (PAS).

A post-approval study reported finding that the diagnostic categories for all-comers were similar between the IDE study and the PAS study. Safety and efficacy were compared to the IDE study using the Berlin Heart EXCOR® Registry (BHER). SAEs were similar between the groups: bleeding was seen in 46% of the IDE cohort and 41% of the PAS, while stroke was unchanged with 29% vs. 33%, respectively. While the rate of transplantation or weaning declined post-approval, the survival benefit was still high.<sup>19</sup>

The majority of patients that have been implanted and supported with the Berlin Heart EXCOR® have been those with cardiomyopathy, either hypertrophic or restrictive, and myocarditis.<sup>20</sup> In this group of patients, earlier implementation of mechanical circulatory support has led to improved outcomes and more successful myocardial recovery or bridge to cardiac transplant. This was particularly evident in infants <1 year of age. Many children with cardiomyopathy have a component of diastolic heart failure that is particularly challenging for pulsatile mechanical circulatory support devices. The incipient right heart failure often leads to biventricular support that has a lower survival than LVAD alone.<sup>21</sup> Cardiomyopathy patients <3 years old had a 38.5% survival to transplantation as opposed to 71.4% survival in those >3 years of age. LVAD versus BiVAD configuration also had a survival advantage (77.8% vs. 27.3%), although the numbers were too small to reach statistical significance ( $p = 0.07$ ). Still, over 50% of these challenging patients were successfully supported.

In patients with congenital heart disease (CHD), there are additional anatomic and physiologic challenges that may limit application of mechanical circulatory support. Survival to weaning or transplantation rates lag behind those for patients without CHD. A recent study demonstrated survival in non-CHD patients that was almost twice that of CHD patients (CHD vs. non-CHD: 48% vs. 80%).<sup>22</sup> The non-CHD patients tended to be evenly divided between INTERMACS profile 1 and 2, whereas the CHD patients were predominantly INTERMACS profile 1. Non-survivors also tended to have more post-implant renal, hepatic, and/or respiratory failure. This is similar to Hertzler's 23-year

Berlin Heart EXCOR® experience in Europe (47% successful bridge in CHD cohort).<sup>20</sup> Despite the unique challenges in found in this difficult group of patients, CHD patients can be successfully supported by the Berlin Heart EXCOR® with careful and early selection.

Eighty-eight percent of the patients in the IDE trial were successfully bridged to orthotopic cardiac transplantation with the Berlin Heart EXCOR® VAD, with much of the success attributable to stringent inclusion criteria. Following the trial, survival to transplantation was 64%, likely due to relaxed selection criteria.<sup>10</sup> Using the UNOS database, a recent retrospective study of patients supported with the Berlin Heart EXCOR® versus those with no mechanical circulatory support (non-MCS) found no statistical difference in post-transplant survival between the cohorts. Overall survival at 30 days, 1 year, and 5 years was 94%, 90%, 72% and 98%, 91%, 77% in the EXCOR® and non-MCS cohorts, respectively.<sup>23</sup> This is comparable to the findings in a similar European study that found 93.6%, 84.6%, 79.1% and 91.9%, 84.6%, 78.8% for 30-day, 1-year, and 5-year post-transplant survival for EXCOR® and primary cardiac transplantation.<sup>24</sup> These studies suggest that patients can be successfully bridged to cardiac transplantation with the Berlin Heart EXCOR® and have similar post-transplant survival expectations of those who are primarily transplanted without MCS.

By the close of 2018, over 2,400 Berlin Heart EXCOR® implantations had taken place at 176 centers in 41 countries with 76% of patients being successfully supported to recovery or transplantation (Berlin Heart unpublished data). Issues with neurologic events, thromboembolism, and anticoagulation persist, but the rates are improving as the pediatric VAD community gains experience with patient selection and management, particularly in areas such as CHD and small children.<sup>25,26</sup> Continued investigation and innovation should see these odds of successful support with the EXCOR® continue to improve in the years to come.

## REFERENCES

- Mehta U, Laks H, Sadeghi A, et al. Extracorporeal membrane oxygenation for cardiac support in pediatric patients. *Am Surg*. 2000 Sep;66(9):879–886.
- Thiagarajan RR, Laussen PC, Rycus PT, Bartlett RH, Bratton SL. Extracorporeal membrane oxygenation to aid cardiopulmonary resuscitation in infants and children. *Circulation*. 2007;116:1693–700.
- Conrad SA, Rycus PT, Dalton H. Extracorporeal life support registry report 2004. *ASAIO J*. 2005;51:4–10.
- Kirk R, Edwards LB, Kucheryavaya AY, et al. The Registry of the International Society for Heart and Lung Transplantation: thirteenth official pediatric heart transplantation report—2010. *J Heart Lung Transplant*. 2010;29:1119–1128.
- Mah D, Singh TP, Thiagarajan RR, et al. Incidence and risk factors for mortality in infants awaiting heart transplantation in the USA. *J Heart Lung Transplant*. 2009;28:1292–1298.
- Arabia FA, Tsau PH, Smith RG, et al. Pediatric bridge to heart transplantation: application of the Berlin Heart, Medos and Thoratec ventricular assist devices. *J Heart Lung Transplant*. 2006;25:16–21.
- Hetzer R, Potapov EV, Stiller B, et al. Improvement in survival after mechanical circulatory support with pneumatic pulsatile ventricular assist devices in pediatric patients. *Ann Thorac Surg*. 2006;82:917–24; discussion 24–5.
- Fraser CD, Jr., Jaquiss RD, Rosenthal DN, et al. Prospective trial of a pediatric ventricular assist device. *N Engl J Med*. 2012;367:532–541.
- U.S. FDA 2016 medical device report (MDR) review, post approval study (PAS) review and literature review. 2016. [fda.gov/media/100048/download](http://fda.gov/media/100048/download)
- Almond CS, Morales DL, Blackstone EH, et al. Berlin Heart EXCOR pediatric ventricular assist device for bridge to heart transplantation in US children. *Circulation*. 2013;127:1702–1711.
- Byrnes JW, Prodhon P, Williams BA, et al. Incremental reduction in the incidence of stroke in children supported with the Berlin EXCOR ventricular assist device. *Ann Thorac Surg*. 2013;96:1727–1733.
- Iyengar A, Hung ML, Asanad K, et al. Association Between Hematologic and Inflammatory Markers and 31 Thrombotic and Hemorrhagic Events in Berlin Heart Excor Patients. *Pediatr Cardiol*. 2017;38:770–777.
- Rosenthal DN, Lancaster CA, McElhinney DB, et al. Impact of a modified anti-thrombotic guideline on stroke in children supported with a pediatric ventricular assist device. *J Heart Lung Transplant*. 2017;36:1250–1257.
- Huang JY, Monagle P, Massicotte MP, VanderPluym CJ. Antithrombotic therapies in children on durable ventricular assist devices: a literature review. *Thromb Res*. 2018;172:194–203.
- Stein ML, Dao DT, Doan LN, et al. Ventricular assist devices in a contemporary pediatric cohort: Morbidity, functional recovery, and survival. *J Heart Lung Transplant*. 2016;35:92–98.
- VanderPluym JH, Robertson CM, Joffe AR, et al. Neurologic, neurocognitive, and functional outcomes in children under 6 years treated with the Berlin Heart EXCOR ventricular assist device. *ASAIO J*. 2017;63:207–215.
- Beiras-Fernandez A, Kur F, Kiefer S, et al. Multidrug-resistant gram-positive infections in patients with ventricular assist devices: the role of daptomycin. *Transplant Proc*. 2009;41:2589–2591.
- Goldstein DJ, el-Amir NG, Ashton RC Jr, et al. Fungal infections in left ventricular assist device recipients. Incidence, prophylaxis, and treatment. *ASAIO J*. 1995;41:873–875.
- Jaquiss RD, Humpl T, Canter CE, Morales DL, Rosenthal DN, Fraser CD Jr. Postapproval outcomes: the Berlin Heart EXCOR Pediatric in North America. *ASAIO J*. 2017;63:193–197.
- Hetzer R, Kaufmann F, Delmo Walter EM. Paediatric mechanical circulatory support with Berlin Heart EXCOR: development and outcome of a 23-year experience. *Eur J Cardiothorac Surg*. 2016;50:203–210.
- Su JA, Menteeer J. Outcomes of Berlin Heart EXCOR(R) pediatric ventricular assist device support in patients with restrictive and hypertrophic cardiomyopathy. *Pediatr Transplant*. 2017;21(8):1-6, e10348.22. Morales DLS, Zafar F, Almond CS, et al. Berlin Heart EXCOR

- use in patients with congenital heart disease. *J Heart Lung Transplant*. 2017;36:1209–1216.
23. Bryant R 3rd, Zafar F, Castleberry C, et al. Transplant survival after Berlin Heart EXCOR support. *ASAIO J*. 2017;63:80–85.
  24. Hetzer R, Javier M, Delmo Walter EM. Role of paediatric assist device in bridge to transplant. *Ann Cardiothorac Surg*. 2018;7:82–98.
  25. Davies RR. Identifying children appropriate for bridge-to-transplantation with the Berlin Heart EXCOR. *J Heart Lung Transplant*. 2017;36:1183–1184.
  26. Miera O, Morales DLS, Thul J, Amodeo A, Menon AK, Humpl T. Improvement of survival in low-weight children on the Berlin Heart EXCOR ventricular assist device support. *Eur J Cardiothorac Surg*. 2019 May 1;55(5):913–919. doi: 10.1093/ejcts/ezy394



## Background of EVAHEART®

**E**VAHEART® is a clinically approved left ventricular assist device (LVAD) system in Japan for bridge to heart transplantation and has been used for supporting over 170 end-stage heart failure patients with an average support time of 900 days (longest case: 10.5 years).<sup>1,2</sup> EVAHEART® is a unique centrifugal LVAD that has high pulse pressure, excellent hemocompatibility, and has demonstrated low pump thrombosis.<sup>3</sup> In this chapter, the basic specifications of the EVAHEART will be summarized. Furthermore, a new version of the system, EVAHEART® 2, has been developed to improve the anatomical fitting and to minimize the risk of inflow malposition, which may help in reducing post-LVAD adverse events such as ischemic cerebrovascular accident (stroke).

## Centrifugal Pump with Hydrodynamic Impeller Suspension

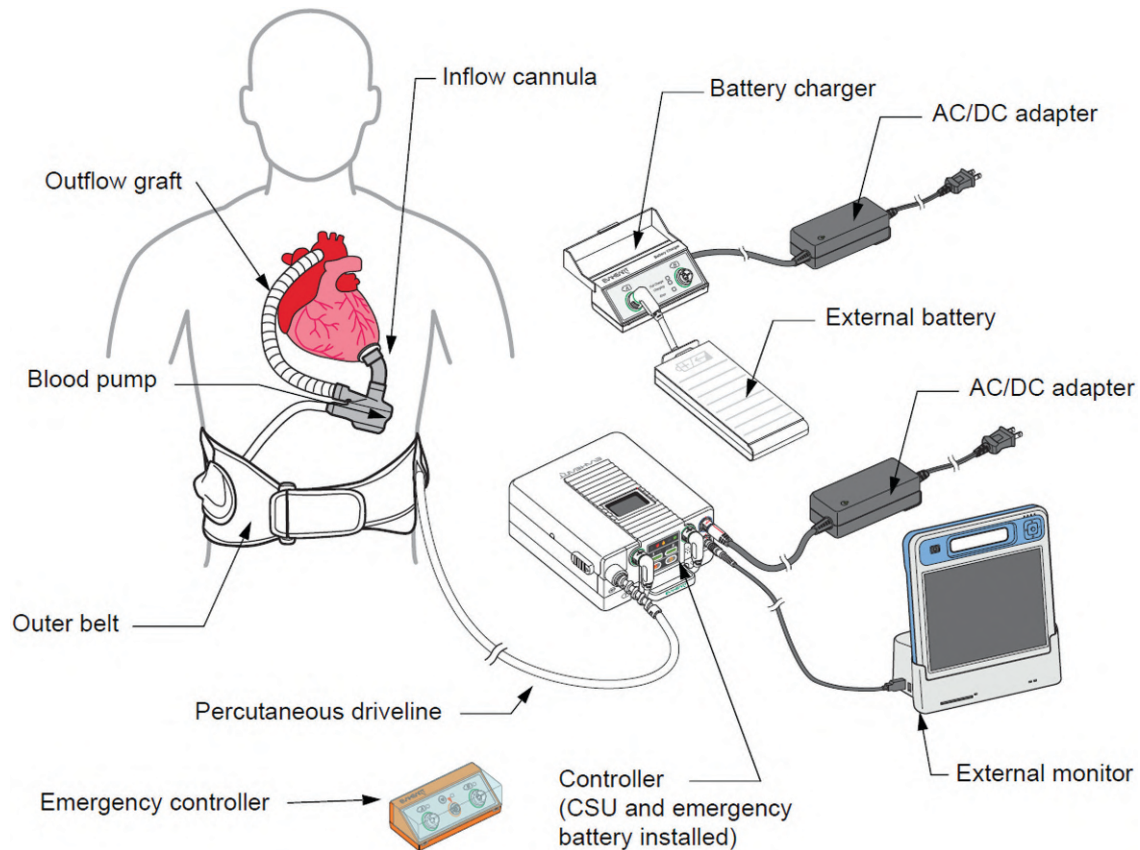
Pump design and the impeller suspension mechanism are key elements of LVAD technology. For recent clinically approved LVADs, there are two main technologies that are used for the impeller suspension, either hydrodynamic or magnetic levitation. EVAHEART® has implemented an open-vane pump design and a unique hydrodynamic impeller levitation system through the use of a continuous water circulation mechanism, a so-called cool seal system (Figure 23.1).<sup>3</sup> Sterile water (WFI: water for injection) is circulated by a separate diaphragm pump through driveline and pooled in the reservoir system (CSU: cool seal unit) inside the external controller. A trained medical professional should replace the CSU every 2–6 months at an out-patient clinic.

## Open-Vane Impeller Design

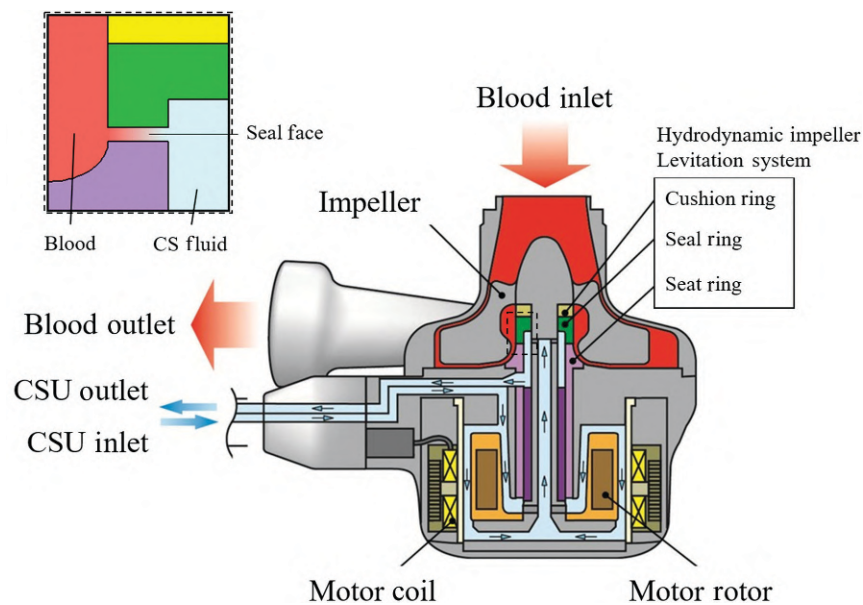
The EVAHEART® open-vane impeller (Figure 23.2) was designed to minimize the shear stress to the blood,<sup>4</sup> which plays a main role in inducing hemolysis, platelet activation, and possibly degradation of the von Willebrand high molecular weight multimer.<sup>5–7</sup> This impeller design can also generate end systolic high peak flow, which contributes to preserving native heart aortic pulsatility (Figure 23.3).<sup>3</sup> The EVAHEART® flow-head pressure curve (HQ curve) is much flatter (more pressure sensitive) as compared to other clinical LVADs (Figure 23.4). In other words, as long as the afterload blood pressure is properly managed (i.e., 65–80 mmHg), the EVAHEART® pump flow can exhibit a self-regulating behavior similar to the “Frank-Sterling” law and have minimal pulse attenuation. The EVAHEART® pump also demonstrates low incidences of pump thrombosis.<sup>1</sup> This is attributed to the open-vane design and high-end systolic peak flow, which help to promote washout of the blood around the hydrodynamic bearing, along with an antithrombogenic 2-methoxyethylphosphoryl choline (MPC) coating<sup>8,9</sup> on the blood-contacting surfaces inside of the pump.

## Secure Power Management and Emergency Controller

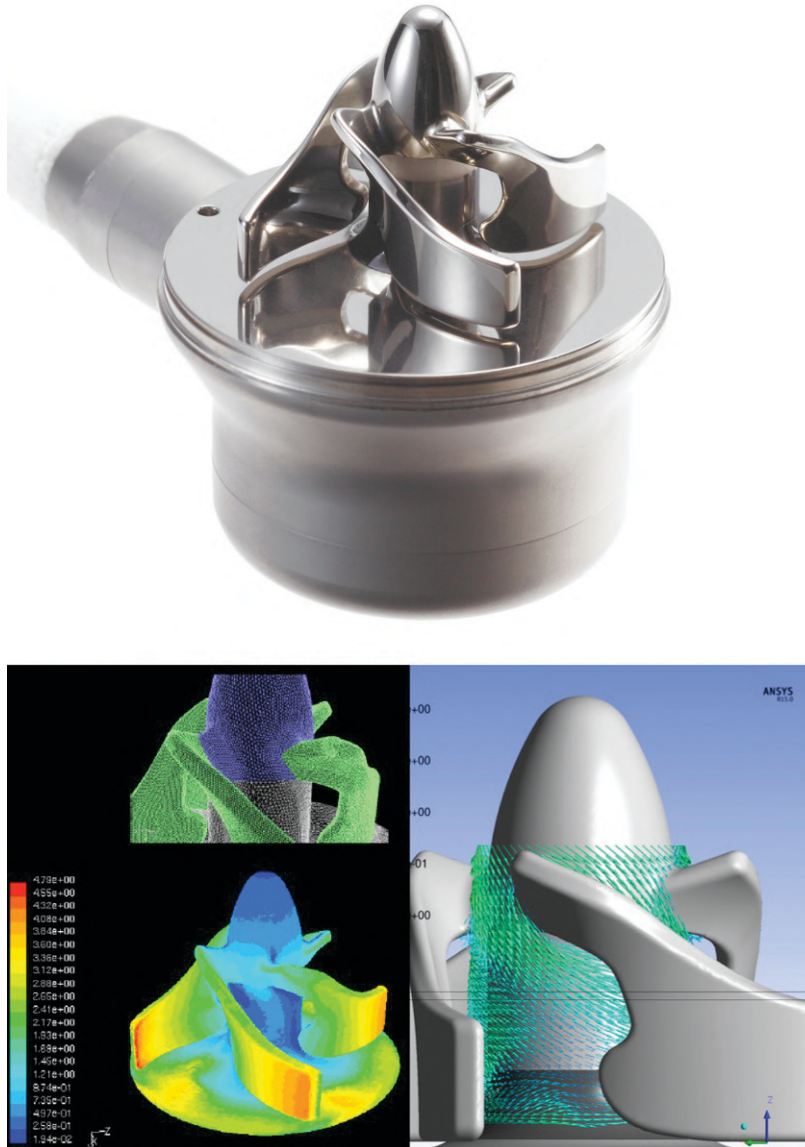
The EVAHEART® system has three power sources: (1) wall outlet through AC/DC adaptor, (2) two external lithium-ion batteries, and (3) an emergency battery inside the controller unit. Under normal operating conditions (approximately 4–5 W power consumption), the two external batteries last 6–8 hours (3–4 hours per one battery). On top of that, the internal emergency battery allows the pump to operate for an additional 30 min when no other power source is



**Figure 23.1.** Schematic of EVAHEART internal and external components.



**Figure 23.2.** Blood Pump Cross Sectional View (Light blue section indicates water circulating pathway for hydrodynamic impeller suspension. Red section indicates blood pathway from inlet to outlet.)



**Figure 23.3.** Computational fluid dynamic analysis of the EVAHEART® open-vane impeller.

available. The emergency controller is separate from the primary controller and is a backup in case the primary controller fails. The emergency controller is powered by one of the external batteries, the same external batteries used for the primary controller. The blood pump power cable connects directly to the emergency controller, which will run the pump at a fixed speed of 2,000 rpm.

### Hemocompatibility

The lower required pump speed and the open-vane impeller of the EVAHEART® blood pump minimize the amount of shear stress that the blood is exposed to. This plays a role in improving the hemocompatibility of the system, such as reducing hemolysis. The adverse event rate due to

hemolysis associated with EVAHEART® LVAD implantation is very low.<sup>1</sup> Another hemocompatibility parameter is von Willebrand factor (vWF) high molecular weight multimers, which may contribute to non-surgical bleeding, clinically represented by gastrointestinal (GI) bleeding.<sup>10–12</sup> Post-LVAD GI bleeding is a common issue for current commercial LVADs and leads to other thromboembolic events due to the temporary discontinuation of anticoagulation.<sup>13</sup> The MOMENTUM 3 trial investigated clinical outcome measures including post-LVAD adverse event profiles in comparing HeartMate II (HMII) and HeartMate 3 (HM3). Pump thrombosis was significantly improved in the HM3 arm, but the incidence of GI bleeding remained the same (27.0% in HMII, 27.3% in HM3).<sup>14</sup> Bartoli et al. compared the EVAHEART® LVAD with another commercially

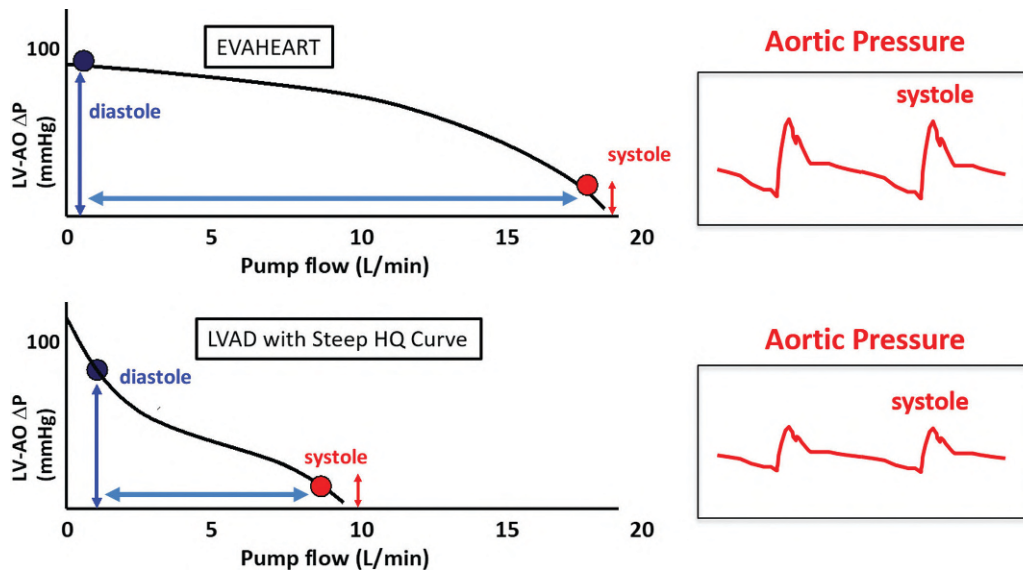


Figure 23.4. Characterization of end systolic peak flow and aortic pulsatility.

available pump using whole human blood in a mock circulatory loop and demonstrated that the EVAHEART® LVAD showed significantly less degradation of vWF high molecular weight multimer than the commercially used axial flow pump. This result can be attributed to the open-vane impeller design and larger flow gaps (700  $\mu\text{m}$  compared to

50  $\mu\text{m}$  in the axial pump), which create lower amounts of shear stress (22 Pa of wall shear stress compared to 55 Pa of wall shear stress in the axial pump).<sup>5</sup> Supraphysiologic shear stress is the driving factor for the adverse events related to blood trauma, so minimizing the levels of shear stress induced on the blood will help to limit the

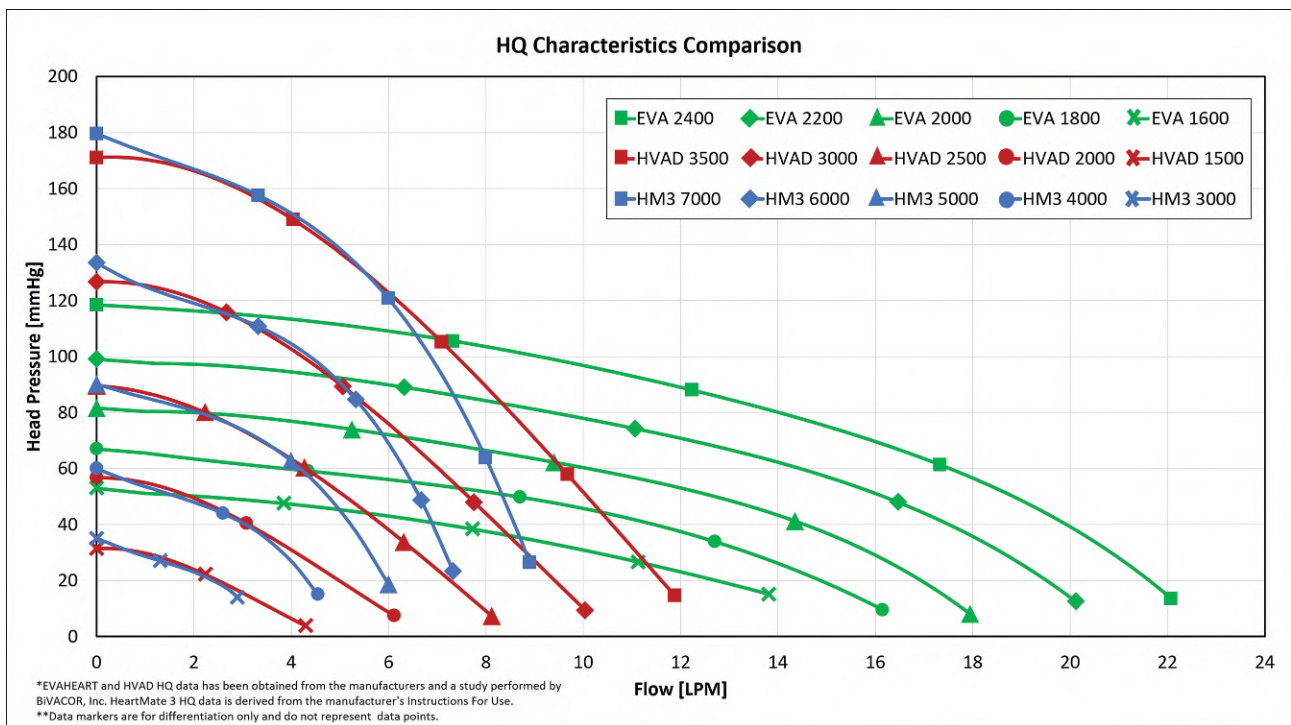


Figure 23.5. HQ curve hemodynamic analysis for clinically used continuous flow LVAD pumps (Eva = EVAHEART LVAS, HMII = HeartMate II, HVD = HVAD).

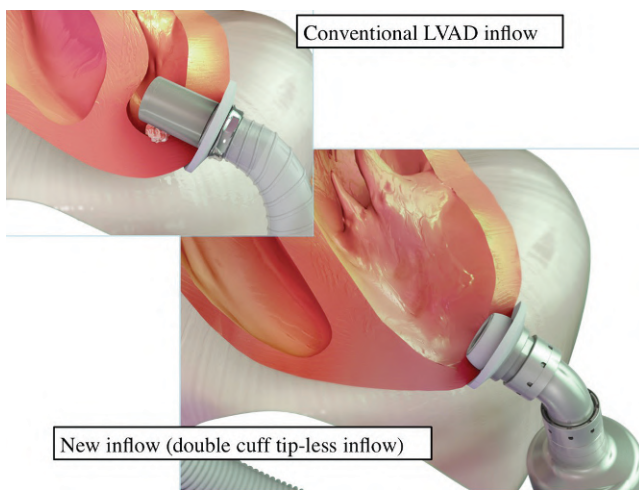


**Figure 23.6.** EVAHEART® 2 LVAS.

number of adverse events seen clinically. According to the Japanese Registry for Mechanically Assisted Circulatory Support (J-MACS), EVAHEART® patients tend to be non-ischemic dilated cardiomyopathy (DCM) dominant, and thus younger compared to US data registry (INTERMACS). Though the patient demographic is different, incidence of GI bleeding with the EVAHEART® LVAD seems markedly low (2.7% at 1-year and 8.9% at 3-year post-LVAD implantation).

## Current Development of EVAHEART® 2

The original EVAHEART® 1 pump was miniaturized to improve anatomical fitting and integrated with a new inflow cannula. This new system, EVAHEART® 2 (smaller pump and new inflow cannula), is shown in Figure 23.5. The EVAHEART® 2 blood pump was miniaturized by 26.3% in displacement volume and 37.6% in weight.

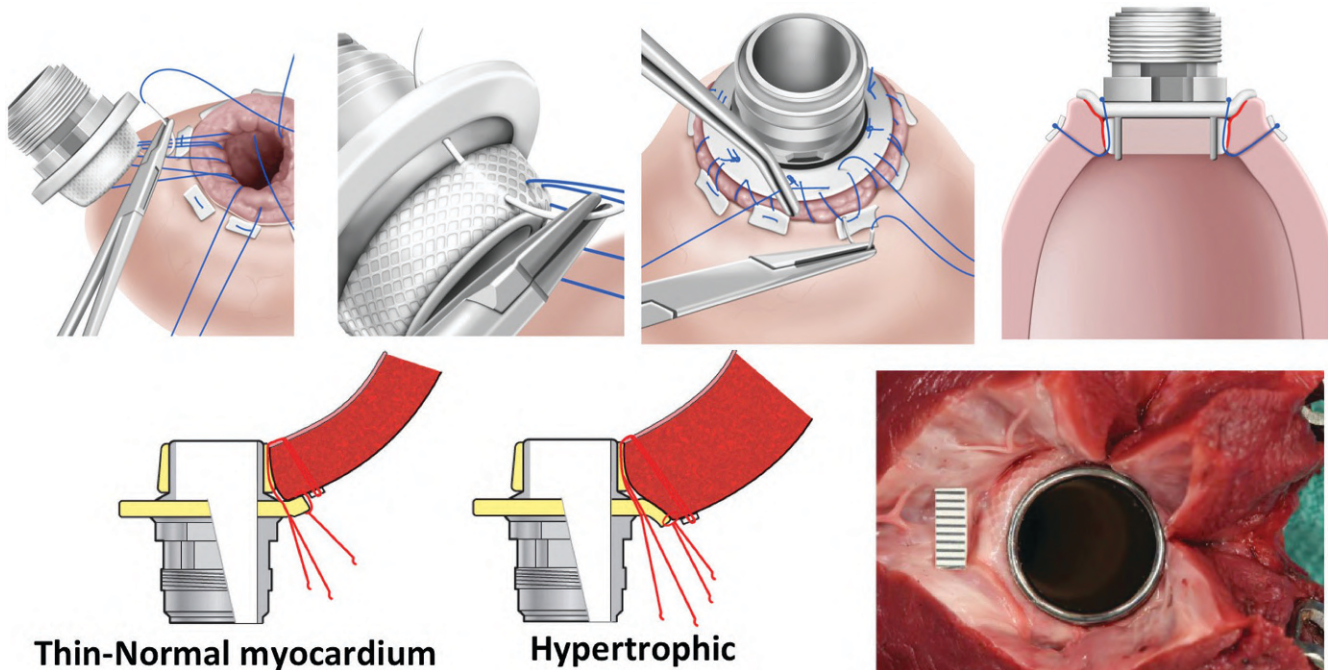


**Figure 23.7.** Conventional inflow malposition (left) and new tip-less inflow fitting (right).

**Table 23.1 • EVAHEART® 2 LVAS Specifications**

Type of pump	Centrifugal
Impeller suspension	Hydrodynamic bearing (with closed-loop water circulation)
Displacement Volume	97.3ml
Priming Volume	25ml
Dimensions (diameter × height)	51mm × 67 mm
Weight	262g
Driveline diameter	7.8mm
Flow range	8LPM @ 2,200 RPM at $\Delta P$ of 90 mmHg
Pump speed range	Clinical range: 1,600–2,400 rpm Average: 1,800 rpm
Power consumption	4–8.5 W
System operation on Batteries	6–8 hours on 2 external batteries, 30 min on emergency battery
Flow Display	Flow estimation
Outflow graft	16 mm inner diameter Reinforced e-PTFE, MPC coated

Also, the driveline diameter was reduced by 36.7%. The pump and key system specifications are summarized in Table 23.1. The EVAHEART® 2 inflow cannula was specifically designed to address inflow malposition inside the left ventricular chamber, which may potentially cause various adverse events such as ventricular wall suction, followed by low pump flow and pump thrombosis, and pose a high risk for right heart failure and ischemic stroke.<sup>15–19</sup> Particularly, wedge thrombus and micro emboli (i.e., fibrin deposition and platelet-driven white thrombus) that are attached to the inflow cannula surface may be aggravated with inflow malposition due to the cannula leaning toward the ventricular free wall or septal wall. Standardization of the LVAD/inflow implantation technique plays a key role in mitigating those risks. Yet in reality, it is difficult to completely adhere to a recommended procedure and thus inflow cannula malposition is practically inevitable with the conventional inflow cannula, which protrudes a few centimeters into the left ventricular chamber (Figure 23.6). In contrast, the new inflow cannula, the Double Cuff Tip-Less (DCT) inflow cannula, eliminates the protruding chimney part and surgically secures endocardium plane to the suture mesh by the inflow ostium. Theoretically, there is no room to generate wedge thrombus between the cannula and myocardial wall. Also, pre-clinical animal studies demonstrated that the DCT inflow cannula was more forgiving against inflow malposition without causing wall suction and low pump flow.



**Figure 23.8.** Surgical technique and fitting to myocardium. Picture on the right lower section shows animal necropsy view after 64-day chronic animal implantation.

## Surgical Technique to Implant the Double Cuff Tip-Less (DCT) Inflow Cannula

The surgical technique and myocardial fitting are illustrated in Figure 23.7. The left ventricular apex is cored using the EVAHEART® coring knife, extra myocardial trabecular is trimmed, and then 12 braided 2-0 mattress sutures are threaded through the myocardial wall from the epicardium to the endocardium (Figure 23.8). The sutures are threaded through the proximal mesh cuff and distal felt cuff, and then the DCT inflow cannula is parachuted downward until the distal cuff resides inside the cored apex and the proximal cuff sits on the epicardial surface. Mattress sutures are then tied off and a running suture is applied circumferentially around the proximal cuff.

## Conclusions

The EVAHEART® 2 with DCT inflow cannula is PMDA approved in Japan, CE Mark approved and under clinical trial in the United States. The DCT inflow cannula is more forgiving against inflow malposition and can enhance fast endothelialization on the suture cuff's interface with the endocardium. With this proprietary inflow cannula design, isolating the wound healing of the cored myocardium from the left ventricle blood flow and inflow cannula, postoperative risk of ischemic stroke is expected to be reduced.

## REFERENCES

1. Saito S, Yamazaki K, Nishinaka T, et al. Post-approval study of a highly pulsed, low-shear-rate, continuous-flow, left ventricular assist device, EVAHEART: a Japanese multicenter study using J-MACS. *J Heart Lung Transplant.* 2014; 33(6):599–608.
2. Takatani S, Matsuda H, Hanatani A, et al. Mechanical circulatory support devices (MCS) in Japan: current status and future directions. *J Artif Organs.* 2005; 8(1):13–27.
3. Yamazaki K, Saito S, Kihara S, Tagusari O, Kurosawa H. Completely pulsatile high flow circulatory support with a constant-speed centrifugal blood pump: mechanisms and early clinical observations. *Gen Thorac Cardiovasc Surg.* 2007;55(4):158–162.
4. Yamane T, Nishida M, Kawamura H, Miyakoshi T, Yamazaki K. Flow visualization for the implantable ventricular assist device EVAHEART(R). *J Artif Organs.* 2013;16(1):42–48.
5. Bartoli CR, Kang J, Zhang D, et al. Left ventricular assist device design reduces von Willebrand factor degradation: a comparative study between the HeartMate II and the EVAHEART left ventricular assist system. *Ann Thorac Surg.* 2016;103(4):1239–1244.
6. Kang J, Zhang DM, Restle DJ, et al. Reduced continuous-flow left ventricular assist device speed does not decrease von Willebrand factor degradation. *J Thorac Cardiovasc Surg.* 2016;151(6):1747–1754.
7. Ichihara Y, Nishinaka T, Komagamine M, Yamada Y, Yamazaki K. Preservation of von Willebrand factor multimers and function in patients with an EVAHEART centrifugal-type, continuous-flow left ventricular assist device. *J Heart Lung Transplant.* 2017;36(7):814–817.
8. Snyder TA, Tsukui H, Kihara S, et al. Preclinical biocompatibility assessment of the EVAHEART ventricular

- assist device: coating comparison and platelet activation. *J Biomed Mater Res A*. 2007;81(1):85–92.
9. Kihara S, Yamazaki K, Litwak KN, et al. In vivo evaluation of a MPC polymer coated continuous flow left ventricular assist system. *Artif Organs*. 2003;27(2):188–192.
  10. Aggarwal A, Pant R, Kumar S, et al. Incidence and management of gastrointestinal bleeding with continuous flow assist devices. *Ann Thorac Surg*. 2012;93(5):1534–1540.
  11. Uriel N, Pak SW, Jorde UP, et al. Acquired von Willebrand syndrome after continuous-flow mechanical device support contributes to a high prevalence of bleeding during long-term support and at the time of transplantation. *J Am Coll Cardiol*. 2010;56(15):1207–1213.
  12. Letsou GV, Shah N, Gregoric ID, et al. Gastrointestinal bleeding from arteriovenous malformations in patients supported by the Jarvik 2000 axial-flow left ventricular assist device. *J Heart Lung Transplant*. 2005;24(1):105–109.
  13. Stulak JM, Lee D, Haft JW, et al. Gastrointestinal bleeding and subsequent risk of thromboembolic events during support with a left ventricular assist device. *J Heart Lung Transplant*. 2014;33(1):60–64.
  14. Mehra MR, Goldstein DJ, Uriel N, et al. Two-year outcomes with a magnetically levitated cardiac pump in heart failure. *N Engl J Med*. 2018 Apr 12;378(15):1386–1395.
  15. Maltais S, Kilic A, Nathan S, et al. PREVENTion of HeartMate II pump thrombosis through clinical management: the PREVENT multi-center study. *J Heart Lung Transplant*. 2017;36(1):1–12.
  16. Hanke JS, Krabatsch T, Rojas SV, et al. In vitro evaluation of inflow cannula fixation techniques in left ventricular assist device surgery. *Artif Organs*. 2017;41(3):272–275.
  17. Strickland KC, Watkins JC, Couper GS, Givertz MM, Padera RF. Thrombus around the redesigned HeartWare HVAD inflow cannula: a pathologic case series. *J Heart Lung Transplant*. 2016;35(7):926–930.
  18. Adamson RM, Mangi AA, Kormos RL, Farrar DJ, Dembitsky WP. Principles of HeartMate II implantation to avoid pump malposition and migration. *J Card Surg*. 2015;30(3):296–299.
  19. Taghavi S, Ward C, Jayarajan SN, Gaughan J, Wilson LM, Mangi AA. Surgical technique influences HeartMate II left ventricular assist device thrombosis. *Ann Thorac Surg*. 2013;96(4):1259–1265.

## 24

# Anesthesia

CHRISTOPHER J. PLAMBECK, MICHAEL K. LOUSHIN,  
AND MICHAEL F. SWEENEY

## Preoperative Considerations

**P**atients requiring general anesthesia (GA) for the placement of a left ventricular assist device (LVAD) present unique challenges to the anesthesiologist during the perioperative period. The complexity of these operations presents anesthetic and procedural risks which are not commonly associated with conventional cardiac procedures. Advanced heart failure patients commonly exhibit Interagency Registry for Mechanically Assisted Support (INTERMACS) level 1–4 at time of presentation for LVAD surgery, making their anesthetic management quite challenging. Frequently, these patients are managed preoperatively in an intensive care unit (ICU) for medical optimization. The usual American Society of Anesthesiology (ASA) physical status class is 4 or 4E (indicating an emergency procedure) (Table 24.1).<sup>1</sup> Despite preoperative optimization in the setting of an ICU, many patients have developed some degree of multi-organ dysfunction that must be accounted for at the time of LVAD implantation. Therefore, at the time of reviewing the patient prior to surgery, the anesthesiologist should follow a detailed checklist specific to the unique challenges inherent in LVAD surgery (Table 24.2). In addition to a careful assessment of biventricular function, an evaluation of the patient's pulmonary, renal, and hepatic systems is necessary. A thorough review of all available cardiac studies should be performed. A particular focus on the etiology and the severity of the left ventricular (LV) dysfunction, the presence of right ventricular (RV) dysfunction or pulmonary hypertension, coronary artery disease, valvular disease, an atrial septal defect (ASD), or arrhythmias is necessary to optimally prepare for any challenges associated with coming off cardiopulmonary bypass. In instances where concomitant cardiac lesions such as a right coronary artery stenosis, patent foramen ovale (PFO), left atrial appendage thrombus, or

regurgitant valvular pathologies occur, a discussion with the surgeon to review the operative plan prior to induction is mandatory. The presence of RV dysfunction or pulmonary hypertension will require having resources such as inhaled pulmonary vasodilators or a right ventricular assist device (RVAD) available. The presence of an intracardiac defibrillator (ICD) or a pacemaker should also be ascertained, and arrangements made for device reprogramming, if necessary. The patient requires continuous monitoring on telemetry, and the ability to perform immediate defibrillation must be available once the ICD therapy is disabled. Any previous cardiac interventions should be reviewed, with specific attention to a previous sternotomy as this requires preparation for the possibility of massive bleeding upon reopening the chest. For this reason, it is essential to have adequate intravenous access and an adequate number of cross-matched packed red blood cells at the time of the induction for redo sternotomy cases.

The evaluation and management of RV dysfunction requires special consideration given the high prevalence and severe consequences of this condition at the time of LVAD implantation. Effective left ventricular support depends on the delivery of adequate blood flow from the RV through the pulmonary circulation. The reported incidence of RV failure after LVAD implantation is quite high, ranging from 20.2% to 44%.<sup>2</sup> The INTERMACS definition of RV failure after LVAD implantation requires an elevated central venous pressure (CVP) greater than 16 mmHG in the context of clinical manifestations such as peripheral edema, ascites, hepatomegaly, and laboratory evidence of hepatic or renal dysfunction.<sup>3</sup> Postoperatively, the severity of right heart failure can be graded by the duration in days in which inotropes or inhaled pulmonary vasodilators are required (mild <7 days, moderate 7–14 days, severe >14 days). The need for an RVAD is graded as severe-acute right heart failure in the INTERMACS definitions. Preoperative RV dysfunction is often present in chronic LV failure due to the elevated



**Table 24.1 • American Society of Anesthesiology (ASA) Physical Status Classification**

ASA PS Classification	Definition	Examples (including, but not limited to)
I	A normal healthy patient	Healthy, non-smoking, no or minimal alcohol use
II	A patient with mild systemic disease	Mild diseases only without substantive functional limitations. Examples include (but not limited to): current smoker, social alcohol drinker, pregnancy, obesity (30 < BMI < 40), well-controlled DM/HTN, mild lung disease
III	A patient with severe systemic disease	Substantive functional limitations; one or more moderate to severe diseases. Examples include (but not limited to): poorly controlled DM or HTN, COPD, morbid obesity (BMI ≥ 40), active hepatitis, alcohol dependence or abuse, implanted pacemaker, moderate reduction of ejection fraction, ESRD undergoing regularly scheduled dialysis, premature infant PCA < 60 weeks, history (> 3 months) of MI, CVA, TIA, or CAD/stents.
IV	A patient with severe systemic disease that is a constant threat to life	Recent (< 3 months) MI, CVA, TIA, or CAD/stents, ongoing cardiac ischemia or severe valve dysfunction, severe reduction of ejection fraction, sepsis, DIC, ARD or ESRD not undergoing regularly scheduled dialysis
V	A moribund patient who is not expected to survive without the operation	Ruptured abdominal/thoracic aneurysm, massive trauma, intracranial bleed with mass effect, ischemic bowel in the face of significant cardiac pathology or multiple organ/system dysfunction
VI	A declared brain-dead patient whose organs are being removed for donor purposes	

The addition of “E” denoted emergency surgery; an emergency is defined as existing when delay in treatment of the patient would lead to a significant increase in the threat to life or body part.

Abbreviations: ARDS = acute respiratory distress syndrome; BMI = body mass index; CAD = coronary artery disease; COPD = chronic obstructive pulmonary disease; CVA = cerebrovascular accident; DIC = disseminated intravascular coagulation; DM = diabetes mellitus; ESRD = end-stage renal disease; HTN = hypertension; MI = myocardial infarction; PCA = post conceptual age; TIA = transient ischemic attack.

Reproduced from Hurwitz EE et al, Adding examples to the ASA-Physical Status Classification improves correct assignment to patients, *Anesthesiology* 2019;126(4): 614–622, <http://anesthesiology.pubs.asahq.org/> Copyright © 2019 by Wolters Kluwer Health and the American Society of Anesthesiologists.

left heart filling pressures, which increase RV afterload, as well as elevated right heart filling pressures, which increase RV preload. Laboratory evidence of RV dysfunction-related hepatic congestion, renal dysfunction, and poor systemic perfusion should be carefully assessed, as these markers portend a greater need for aggressive RV support. The preoperative echocardiogram should be reviewed for right heart chamber dilation, tricuspid regurgitation (TR), and diminished RV ejection fraction. Echocardiographic data consistent with RV dysfunction include an RV fractional area change < 35%, a low tricuspid annular plane systolic excursion (TAPSE) < 7.5 mm, severe TR, a low tissue doppler tricuspid annular systolic velocity (S'), and a decreased RV peak longitudinal strain (Table 24.3).<sup>2,4,5</sup> Hemodynamic parameters of RV dysfunction which have been associated with postoperative RV failure include elevated right atrial and RV filling pressures, a right atrial pressure/pulmonary capillary wedge pressure ratio > 0.63, an RV stroke work index of < 600 mmHg X mL/m<sup>2</sup>, and a low cardiac index (CI).<sup>4,5</sup> An elevated right atrial pressure and a narrow pulmonary artery pulse pressure have also been used as a

predictor of RVAD use post-LVAD implantation.<sup>6</sup> Although many RV failure risk-prediction models have been developed using hemodynamic and echocardiogram data with variable results, no consensus on any single parameter exists.<sup>2</sup> The patient must be evaluated using a combination of factors, including physical examination, laboratory data, echocardiographic findings, and hemodynamic parameters, to assess the risk for post-LVAD RV failure.

Pulmonary complications can severely impair a successful transition from cardiopulmonary bypass (CPB) to LVAD support, and a complete review of the patient's pulmonary history, chest X-ray, and any available pulmonary function test, CT scans, or arterial blood gases should be performed in all cases. Any acute respiratory illnesses should be treated to resolution before proceeding with LVAD surgery. Although the utility of pulmonary function testing has been recently called into question in the preoperative assessment of LVAD candidates, patients with chronic obstructive lung disease who demonstrate a forced expiratory volume in 1 second < 1 L or pulmonary hypertension with a pulmonary vascular resistance (PVR) > 3 Woods units should

**Table 24.2 • Pre-LVAD Surgery Checklist**

General:	<input type="checkbox"/> Patient name and MRN
	<input type="checkbox"/> Allergies
	<input type="checkbox"/> Current medications: antihypertensives, anticoagulants, inotropes
	<input type="checkbox"/> NPO status
	<input type="checkbox"/> Antibiotic prophylaxis
	<input type="checkbox"/> Anesthetic history and airway assessment
	<input type="checkbox"/> Access: IV, arterial line, CVL, PAC
	<input type="checkbox"/> Assess for TEE contraindications: esophageal pathology
	<input type="checkbox"/> Surgical consent form
Cardiac:	<input type="checkbox"/> Etiology/severity LV dysfunction: echo and hemodynamic data
	<input type="checkbox"/> Assess for RV dysfunction: echo, right heart catheterization data
	<input type="checkbox"/> Pulmonary hypertension severity
	<input type="checkbox"/> Intracardiac shunts: PFO, ASD
	<input type="checkbox"/> Coronary artery disease: left heart catheterization; prior bypasses or stents
	<input type="checkbox"/> Valvular heart disease: AI, MS; previous mechanical AVR
	<input type="checkbox"/> Intracardiac thrombus: LV apical; left atrial appendage
	<input type="checkbox"/> Arrhythmias; pacemaker; ICD deactivated
	<input type="checkbox"/> Mechanical devices: IABP, Impella
	<input type="checkbox"/> Previous sternotomy
Pulmonary:	<input type="checkbox"/> Chronic pulmonary disease severity: Obstructive or restrictive
	<input type="checkbox"/> Pulmonary edema
	<input type="checkbox"/> Evaluate chest X-ray, CT scan, PFTs
	<input type="checkbox"/> O <sub>2</sub> requirements; mechanical ventilation
Renal:	<input type="checkbox"/> Chronic or acute renal insufficiency severity
	<input type="checkbox"/> Baseline creatinine, blood urea nitrogen, electrolytes; acid/ base balance
	<input type="checkbox"/> Assess for volume overload
	<input type="checkbox"/> Dialysis
Hepatic:	<input type="checkbox"/> Chronic hepatic disease severity
	<input type="checkbox"/> Baseline liver function tests; INR
Hematologic:	<input type="checkbox"/> Baseline hemoglobin, platelet count, coagulation panel
	<input type="checkbox"/> Type and cross for RBCs; antibody screen

Abbreviations: MRN = Medical Record Number, CVL = Central Venous Line, PAC = Pulmonary Artery Catheter, TEE = Transesophageal Echo, LV = Left Ventricle, RV = Right Ventricle, PFO = Patent Foramen Ovale, ASD = Atrial Septal Defect, AI = Aortic Insufficiency, MS = Mitral Stenosis, AVR = Aortic Valve Replacement, ICD = Intracardiac Debrillator, IABP = Intraaortic Balloon Pump, PFT = Pulmonary Function Test, INR = International Normalized Ratio, RBC = Red Blood Cells.

**Table 24.3 • Echocardiographic Data Consistent with RV Dysfunction**

RA and RV chamber dilation
Severe tricuspid regurgitation
Tricuspid annular plane systolic excursion (TAPSE) <7.5 mm
RV fractional area change <35%
Decreased RV peak longitudinal strain <-9.6%
Low tissue doppler imaging tricuspid imaging systolic velocity (S')

be approached with great caution in LVAD.<sup>7,8</sup> Pulmonary edema, a ubiquitous finding in heart failure patients, can compromise systemic oxygen delivery, and therefore adequate diuresis should be attempted in all patients. The level of ventilatory support needs to be considered, as these patients may require high concentrations of oxygen and significant levels of positive end expiratory pressure (PEEP) to maintain adequate oxygenation and ventilation. When transporting ventilated patients to the operating room (OR), the use of a PEEP valve or a transport ventilator should be considered. An assessment of renal function should be performed preoperatively. About two-thirds of hospitalized patients with heart failure have chronic kidney disease. Pre-implant renal dysfunction is associated with a higher mortality after LVAD implantation.<sup>9</sup> Those patients with a creatinine level >3 mg/dL or on long-term dialysis are poor candidates for mechanical support.<sup>7</sup> Patients with volume overload and poor cardiac output in the setting of renal impairment should be considered for preoperative hemodynamic optimization and aggressive diuresis prior to LVAD implantation.<sup>10</sup> The incidence of acute kidney injury after LVAD implantation has ranged in numerous studies between 4% and 38%.<sup>9</sup> However, many patients with reversible renal dysfunction may slowly improve their renal function in the first month after their LVAD surgery.<sup>9</sup> Liver dysfunction caused by chronic heart failure may be due to ischemic hepatocellular necrosis or hepatic venous congestion. An alanine aminotransferase (ALT) or aspartate aminotransferase (AST) level >3 times the upper limit of normal or an international normalized ratio (INR) >1.5 would suggest the presence of concerning liver impairment.<sup>7</sup> An elevated total bilirubin >5 mg/dL has also been shown to be a strong predictor of hepatic impairment associated with increased mortality.<sup>7</sup> Patients with abnormal liver function tests should have an ultrasound to assess for cirrhosis.<sup>10</sup> Patients with cirrhosis or an increased Model for End-stage Liver Disease (MELD) score  $\geq 17$  are poor candidates for mechanical circulatory support.<sup>11,12</sup> Coagulopathy secondary to liver dysfunction needs to be assessed in the preoperative period. Vitamin K administered preoperatively has been demonstrated to decrease blood product utilization in patients with impaired hepatic synthetic function before LVAD surgery.<sup>13</sup> The use of 4-factor prothrombin complex concentrate (PCC) has also been used to reduce an elevated INR before

invasive procedures in patients with liver impairment.<sup>14</sup> If renal or hepatic insufficiency is present, the choice of anesthetic agents should be tailored to account for that organ's dysfunction. Finally, a review of the medication record is a critical part of the perioperative assessment. For example, by definition, INTERMACS levels 1–3 require inotropic support, either with milrinone or dobutamine, in order to stabilize and optimize their hemodynamic status prior to surgery. The presence of anticoagulant or antiplatelet drugs will increase the risk of bleeding and may require the availability of platelets or fresh frozen plasma for transfusion. Additionally, heart failure patients also are treated with angiotensin converting enzyme (ACE) inhibitors, angiotensin receptor blockers, and/or beta-blockers, which may increase the risk for post-bypass vasoplegia.

When transporting an ICU patient to the OR, continuous intravenous (IV) infusions must not be discontinued, as this may result in acute hemodynamic decompensation. Therefore, prior to transport, measures should be taken to ensure that the patient has a reliable form of IV access. Emergency vasoactive medications should be available during transport to the OR. The patient should be transported with hemodynamic monitoring and an available defibrillator.

## Intraoperative Management

Induction of GA varies depending on the presence or absence of an intra-aortic balloon pump (IABP) or temporary mechanical circulatory support (MCS) device such as an Impella. Patients who are managed with MCS at the time of induction tend to demonstrate greater stability than those without. In the absence of a short-term MCS device, the hemodynamic status of the patient can range from relative stability to cardiogenic shock (INTERMACS level 1). Prior to entering the OR, appropriate inotropic and vasoactive medications should be prepared, along with the standard monitoring devices and airway equipment. Our typical pre-LVAD anesthesia preparation includes placement of a radial arterial line, a continuous cardiac output pulmonary artery catheter (PAC), and a transesophageal echocardiography (TEE) probe. In patients who are on axillary Impella support, we typically obtain arterial access in the contralateral arm or a femoral artery. The timing and placement of a central venous line (CVL) and PAC depends on the level of the hemodynamic stability at the time of surgery.<sup>15</sup> If the preoperative assessment of right ventricular dysfunction suggests a high potential for RVAD use, we have typically favored use of the TandemLife Protek Duo cannula, which is likely to be used by the surgeon to help facilitate right heart support, then consider avoiding the right internal jugular vein for the central access site. In hemodynamically unstable patients, an IABP may be placed prior to the operation to provide afterload reduction

and to assist coronary and systemic perfusion.<sup>3</sup> The use of a continuous cardiac output PAC with a mixed venous saturation oximetry may be useful in monitoring post-LVAD implantation. The data obtained from the PAC may be used in estimating the total cardiac output (CO) in those patients with native ejection adding to the CO supplied by the LVAD. A recent study, however, demonstrated that the accuracy of CO measurements obtained by thermodilution techniques have been shown to be discordant to CO measurements obtained by an indirect Fick method.<sup>16</sup> Therefore, monitoring for any decrease in the mixed venous oxygen saturation may assist in detecting any clinically significant decrease in CO or hematocrit. Near-infrared regional spectroscopy should be available for monitoring cerebral oxygenation as pulse oximetry may not function in the setting of continuous, non-pulsatile flow post-LVAD insertion. The ability to transcutaneously pace and perform cardioversion/defibrillation is attained by placing external pads after implanted devices, if present, have been appropriately reprogrammed for the OR setting.

One of the challenges of providing GA in the setting of advanced heart failure involves the balance between achieving an adequate anesthetic effect without inducing acute hemodynamic decompensation. Prior to induction, at least one large-bore IV line and an arterial line should be placed with the assistance of local anesthesia and judicious use of an anxiolytic. The potential for surgical awareness during induction and maintenance of GA can be problematic in these unstable patients. Even low doses of anesthetic agents can contribute to further hemodynamic instability. Administration of an amnestic drug such as midazolam or scopolamine may be considered to decrease the potential of awareness. Scopolamine provides the benefit of achieving an excellent amnestic effect with minimal hemodynamic impairment. After pre-oxygenation, an IV anesthetic induction is performed with careful consideration of the sympathetic and myocardial depressant effects of the anesthetic agent being used. Etomidate is used frequently as the induction agent of choice given its minimal cardiac effects. It is important to remember that these patients have a slow circulation time and it will take longer for the IV anesthetic drugs to take effect. The maintenance GA may consist of a careful balance of narcotics, such as fentanyl, and a volatile anesthetic to minimize myocardial depression while at the same time preventing surgical awareness. Muscle relaxation is dosed with attention to the preoperative renal and hepatic function. In cases of redo surgery and in all LVAD explants, the use of paralytics should be minimized in order to decrease the risk of phrenic nerve injury, given that this nerve can often be difficult to identify in the reoperative, and stimulation by electrocautery may be surgeon's only warning sign of the phrenic nerve's location.

If the surgeon is planning a minimally invasive approach to LVAD placement via a left thoracotomy, the ability to perform lung isolation via a double lumen tube or a bronchial

blocker may be required. Ventilator management will be guided by the patient's pulmonary status, but it would be prudent to avoid excessive airway pressures or a high level of PEEP in those patients with pulmonary hypertension to avoid worsening PVR.

Depending on the hemodynamic response to GA, inotropic/vasoactive agents may be required before the commencement of CPB. Pharmacological support of the failing ventricle is almost always required to maintain an adequate systemic arterial blood pressure (SBP) and CO. The commonly administered vasopressors/inotropes include dopamine, norepinephrine, epinephrine, milrinone, dobutamine, and vasopressin. A single agent or a combination of the preceding may be required to maintain an adequate SBP. It is important to keep in mind the afterload sensitivity of the failing left ventricle, which favors the use of an inotrope primarily as a means of maintaining adequate hemodynamics.

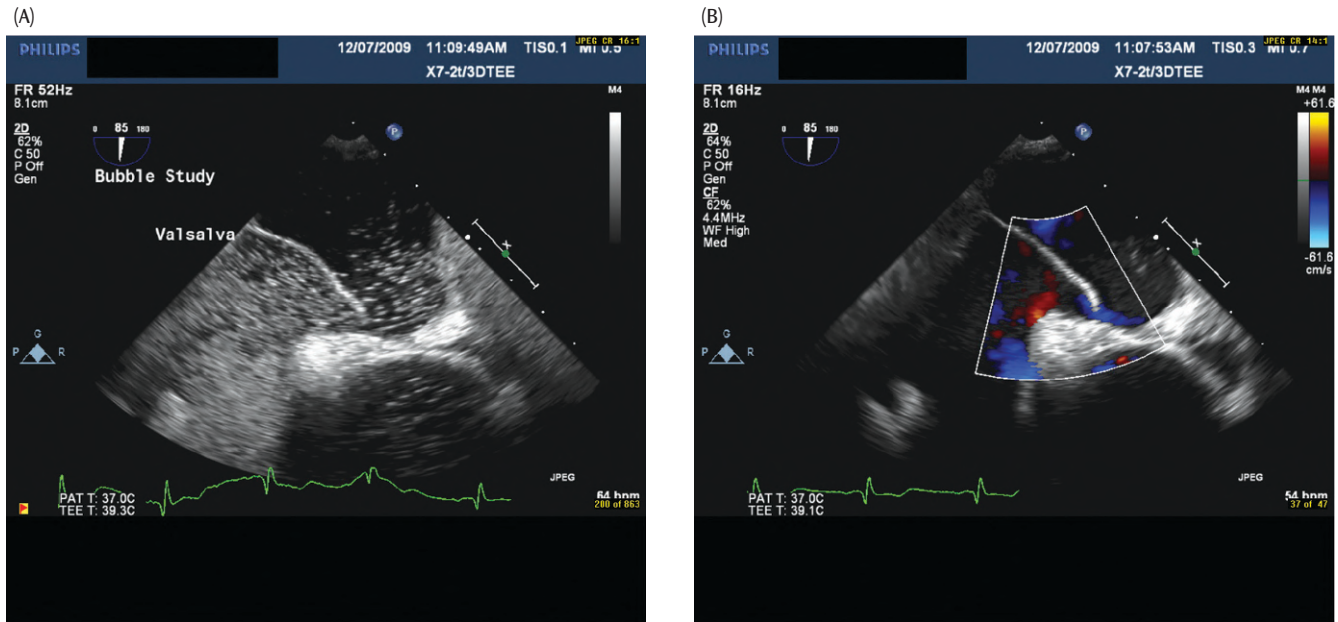
The performance of a comprehensive TEE examination should be performed in the operating room before LVAD implantation to help identify any previously unidentified issues that may need to be addressed by the surgeon (Table 24.4).<sup>17</sup> The aortic valve must be evaluated for the presence of aortic insufficiency (AI). Blood pressure augmentation may be required for patients under general anesthesia during aortic valve assessment to counteract the afterload reduction caused by the anesthetic drugs. Any residual AI after the initiation of the LVAD will contribute to LV volume overload and diminished forward flow as blood recirculates into the LV. If even mild AI is present in the pre-implantation evaluation, the surgeon can either replace or oversee the valve, thereby ensuring LV decompression.<sup>17,18</sup> Those patients who are classified as a bridge-to-transplant or a destination therapy LVAD recipient may have their valve oversewn, but in those patients in which a strategy of LV recovery is anticipated, the aortic valve replacement

with a bioprosthesis is required.<sup>19</sup> A mechanical prosthetic aortic valve, if present, should be replaced or closed with a patch due to the increased risk of thrombosis after LVAD implantation.<sup>20</sup> The aortic valve should be inspected again for AI after institution of CPB when the continuous flow conditions of LV unloading are more analogous to those that will exist after LVAD implantation.<sup>19</sup> The intra-atrial septum should be assessed for the presence of a PFO or an ASD. Any atrial septal communication could result in systemic arterial desaturation by the presence of a right-to-left shunt after initiation of LVAD flow. The decrease in left atrial pressure after LV decompression results in a change in the pressure gradient between the two atria favoring right-to-left flow. The intactness of the atrial septum is best assessed by color flow Doppler and the performance of a "bubble study" using agitated saline as the contrast agent (Figure 24.1). This contrast echocardiogram is performed by rapidly injecting the contrast into a CVL while performing a sustained breath hold to 30 cm H<sub>2</sub>O (Valsalva maneuver). Upon opacification of the right atrium (RA), the breath hold is released and the left atrium is inspected for any contrast crossing the septum.<sup>17</sup> Although rare, the mitral valve should be inspected for mitral stenosis (MS) as any stenosis moderate or greater would restrict filling of the LVAD and diminish pump flow.<sup>10,21</sup> Significant MS could also worsen pulmonary hypertension from the increased left atrial pressures. Our practice has been to disregard mitral regurgitation (MR) under the assumption that the severity of MR will improve once the LV is decompressed. Nevertheless, some centers favor the concomitant surgical correction of significant MR in an effort to enhance the durability of the procedure by lowering the left-sided filling pressures in the postoperative setting. An assessment of RV systolic function, RV and RA dilation, and the severity of any TR is also performed. Previous studies have suggested that a tricuspid valve annuloplasty should be performed when significant TR is present to help decrease its severity and improve RV function post-LVAD insertion.<sup>21</sup> However, more recent data are challenging this recommendation. Although significant preoperative TR is associated with poorer long-term survival, INTERMACS data suggest that tricuspid valve repair at the time of LVAD implantation does not show a survival benefit.<sup>22</sup> Our practice has been to correct moderate or greater TR in patients with a long-term indication for MCS. Finally, the ascending aorta is interrogated for calcifications, and the LV apex is inspected for thrombus, since these are the future LVAD cannulation sites. The left atrial appendage should also be inspected for thrombus. The injection of IV contrast may be required to detect thrombus in certain patients.

Guidelines for antibiotic prophylaxis recommend that the patient receive broad-spectrum gram-positive and gram-negative coverage within 60 minutes of incision.<sup>10</sup> Currently, there is no standardized antibiotic prophylaxis protocol recommended in the literature, but decreased infection rates have been shown in protocols which use vancomycin and

**Table 24.4 • Comprehensive Pre-implantation TEE Checklist**

1. Aortic valve: Aortic insufficiency > mild; prosthetic valves
2. Mitral valve: Mitral stenosis > moderate; severity of mitral insufficiency
3. Tricuspid valve: Tricuspid insufficiency > moderate
4. Intra-atrial septum: assess for PFO or ASD with bubble study
5. Left atrial appendage: assess for thrombus
6. Right ventricle: assess RV size and function
7. Left ventricle: assess LV size and function; assess for apical thrombus
8. Ascending aorta: assess for calcification at outflow graft insertion site



**Figure 24.1.** (A) Bubble study demonstrating a patent foramen ovale. (B) Color flow across a patent foramen ovale. Images courtesy of Dr. Ingela Schnittger, Stanford University Medical Center, Stanford, CA.

fluconazole.<sup>23</sup> Rifampin and nasal mupirocin ointment have also been recommended.<sup>24</sup>

Upon surgical incision, the potential for significant blood loss must be anticipated and appropriate measures should be taken to mitigate this risk. Patients frequently require preoperative anticoagulants as well as antiplatelet drugs, which can potentiate bleeding. Patients with a degree of RV failure may be at risk for liver congestion and hepatic coagulopathy. Finally, many patients receiving an LVAD have had a prior sternotomy and are at increased risk for massive blood loss at the time of repeat sternotomy and mediastinal dissection.

After the LVAD insertion is completed, the appropriate inotropes and typically an inhaled pulmonary vasodilator are started. The left heart and proximal aorta need to be inspected for any residual air after de-airing maneuvers have been performed. The right coronary artery, due to its location anteriorly in the aortic root, is at increased risk of air entrainment which may contribute to RV dysfunction. Once de-airing has been satisfactorily achieved in the LV, the assist device, and the outflow graft, the LVAD may be activated at a low speed per the manufacturer's recommendations. It is important to avoid high pump speeds until the LV is adequately filled to prevent the entrainment of air.<sup>24</sup> Weaning from CPB and advancing the pump speed requires a careful TEE assessment by the anesthesiologist. An ideal pump speed provides unloading of the left ventricle while allowing periodic opening of the aortic valve from LV ejection.<sup>25</sup> Intermittent ejection helps decrease thrombus formation in the aortic root. A midline septum is consistent with adequate filling of the LV post-LVAD insertion.

A non-decompressed LV with shifting of the interventricular septum toward the right could represent cannula obstruction or insufficient pump flow. If the septum shifts toward the left, this could represent hypovolemia, RV dysfunction, or excessive pump flow.

Pump flow is directly proportional to pump speed and inversely proportional to the pressure difference across the LVAD. This differential pressure is defined as the difference between the aortic pressure and the left ventricular pressure. Continuous flow LVADs are therefore afterload sensitive and preload dependent. An increase in afterload will increase the differential pressure and impair flow across the LVAD. A decrease in afterload will increase flow, but an ideal mean arterial pressure (MAP) of 70–90 mmHg has been recommended to balance flow and perfusion pressure.<sup>26</sup> This is to ensure that there is adequate blood flow to certain vital organs, such as the brain and kidneys, in the face of possibly impaired vascular autoregulation. Increased LV preload results in an increased LV pressure which decreases the differential pressure and increases pump flow. Conversely, decreased preload will result in decreased pump flow. The common causes of decreased preload include hypovolemia, position changes, tamponade, and RV failure. Pump speed may be adjusted and the LVAD flow monitored via the system monitor and can be compared to the CO and mixed venous oxygen saturation obtained from the PAC. Pump speed must be carefully adjusted to avoid excessive LV flow that can cause a collapsing of the LV cavity and obstruction of the inflow cannula, which is called a suction event. A suction event may cause an arrhythmia and hemodynamic deterioration. A suction event may be immediately

corrected by decreasing pump speed or manual compression of the outflow graft by the surgeon. The issues that led to the suction event, such as hypovolemia or RV failure, are then addressed. It is important to remember that LVAD flow measured on the system monitor will not represent total left-sided CO when there is native ejection present. Also, the displayed LVAD pump flows are typically not actual measured values, but values extrapolated from the pump speed and pump power. However, trending the pump flows displayed will help in the hemodynamic management of the patient.<sup>26</sup> Intermittent monitoring for the development of metabolic acidosis via an increasing base deficit and rising lactate can provide additional data to assess the degree of adequate perfusion. Note, however, that a rising lactate may occur with epinephrine administration that does not reflect poor tissue oxygenation. Epinephrine may cause a type B lactic acidosis which is not associated with any clinical evidence of poor perfusion or oxygenation.<sup>27</sup> Glycogenolysis is enhanced by epinephrine via a beta<sub>2</sub>-agonist mediated effect causing an increase in pyruvate production. The pyruvate dehydrogenase complex is also inhibited by epinephrine, which then shunts pyruvate toward lactate production by lactate dehydrogenase.<sup>27</sup>

It is essential to interrogate the aortic valve after CPB because the LVAD flow causes a reduction in LV diastolic filling pressures and an increase in aortic blood pressure, which can lead to the appearance of AI that was not detected on the pre-implantation examination.<sup>17</sup> Any AI greater than mild needs to be addressed by the surgeon.<sup>10</sup> The duration of aortic valve opening may be best assessed by using M mode across the valve.<sup>17</sup> It is important to note that the AI flow may be continuous in those patients without aortic valve opening from native LV ejection. The traditional assessments for the severity of AI, such as pressure half-time or diastolic flow reversal in the aorta, will have no validity in these patients, as there is regurgitant flow in the systolic period.<sup>17</sup> It is recommended that a vena contracta width >0.3 cm or an AI jet width/LVOT width ratio of >46% be an indication of at least moderate AI.<sup>17</sup> It is essential to re-examine the intra-atrial septum for any PFO that may have been masked pre-LVAD insertion by the elevated left atrial pressures. An unrecognized atrial septal defect may cause hypoxemia from right-to-left shunting. Excellent hemodynamic conditions following LVAD placement largely depend upon RV performance. The heart should be assessed for any impairment in RV contractility, RV and RA dilation, and worsening TR. RV afterload is minimized with optimization of acid-base balance favoring respiratory alkalosis, avoidance of alveolar hypoxia, and pulmonary vasodilators such as milrinone, nitric oxide (NO), and inhaled epoprostenol. Excessive pump speeds may result in a shifting of the interventricular septum toward the left, which distorts the RV geometry and contributes to RV dysfunction. An assessment of cannula orientation should be performed once the pump has been positioned appropriately,

both before and after closing the sternum. The inflow cannula is positioned in the LV apex and should be directed toward the mitral valve. In the HeartMate II, the flow in an unobstructed cannula should appear laminar and unidirectional by color flow Doppler with a continuous wave Doppler velocity of <1.5 m/s.<sup>17</sup> However, the intrapericardial positioning of the HeartWare HVAD and HeartMate 3 creates a characteristic color and spectral Doppler artifact which precludes a Doppler examination of the inflow cannula.<sup>17</sup> Turbulent flow with a high velocity suggests obstruction from thrombus or impingement of the inflow cannula against the ventricular wall.<sup>28</sup> The outflow graft anastomosis may be visualized in the long axis view of the ascending aorta at the level of the right pulmonary artery and should exhibit laminar flow with a pulsed wave Doppler velocity of less than 2 m/s.<sup>17</sup> Turbulent, high-velocity flow of the outflow graft anastomosis site suggests obstruction.

The transition from CPB to LVAD flows represents the most critical period of the entire procedure, when significant challenges may be encountered related to coagulopathy and bleeding, RV failure, and vasoplegia. Bleeding after CPB is usually multifactorial and may include residual anticoagulation, prior liver dysfunction with resultant cofactor deficiency, CPB and prior renal insufficiency-induced platelet dysfunction, thrombocytopenia, and ongoing surgical blood loss. Bleeding and coagulopathy are managed with scavenged autologous blood, blood bank products (packed red blood cells, fresh frozen plasma, platelets, and cryoprecipitate), and IV desmopressin.<sup>29</sup> In our practice, the judicious administration of blood products to treat coagulopathy is guided by the activated clotting time (ACT), coagulation panels, and the use of thromboelastography (TEG). Studies have been inconsistent on the reported risk of thrombosis after the use of recombinant factor VIIa in treating perioperative bleeding in LVAD recipients.<sup>30</sup> Our practice has been to avoid the use of this drug altogether in the LVAD population. In dire circumstances when no suitable option exists, recombinant factor VIIa probably should only be administered at a lower dose (no greater than 45 mcg/kg) to minimize the risk of thrombosis.<sup>30</sup> PCC appears safe in LVAD patients and has not been shown to increase the risk of thromboembolic events.<sup>31</sup> Heparin should be completely reversed after CPB, and consideration should be given to using an hemostasis management system device to calculate the protamine dose for heparin reversal to prevent excessive protamine administration. Protamine should be administered slowly to minimize exacerbating any systemic vasodilation or pulmonary hypertension. Finally, careful attention must always be made to preserving normothermia in the post-CPB phase by utilizing fluid warmers, patient-warming devices, and increasing the ambient temperature.

RV failure is of utmost concern in the post-CPB period. The echocardiographic findings of the failing RV will include RV and RA dilation, qualitative decreased RV contractility, decreased TAPSE, worsening TR, and a leftward shift of the

intraventricular septum.<sup>4,5</sup> Hemodynamic parameters may include a CVP >16 mmHg, a decreased cardiac index, and low pulmonary arterial pressures and pulmonary artery pulsatility index (Papi).<sup>4,5,32</sup> Direct observation of the anteriorly positioned RV in the open chest is another valuable method of assessing RV contractility. The management of RV failure requires a multifaceted approach. Heart rate and rhythm should be optimized. Normal sinus rhythm at a faster rate is preferred, but epicardial DDD pacing may be required. Maintaining a normal blood pH, potassium and magnesium level, and normothermia will assist in arrhythmia control. Medical therapy with amiodarone may be required in some patients.<sup>33</sup> The RV is preload dependent and may require elevated filling pressures, but avoidance of overdistension is essential to prevent tricuspid annular dilation, TR, and impaired RV contractility.<sup>5</sup> In our practice as well as others, targeting an ideal CVP in the range of 10–16 mmHg has resulted in the best outcomes.<sup>5</sup> Inotropic medications are nearly universally required for right ventricular support. Milrinone, a phosphodiesterase-3-inhibitor, demonstrates the properties of an inodilator and has the advantage of decreasing PVR. It should be used cautiously in the setting of vasoplegia as it also reduces systemic vascular resistance (SVR). Dobutamine and/or epinephrine are also frequently used to enhance inotropy and chronotropy, both of which benefit the failing right ventricle. Dobutamine causes less vasodilation than milrinone and may be preferred when significant vasoplegia is present. Epinephrine should be used as a second-line agent for RV failure as it may also increase PVR in a dose-dependent fashion.<sup>4</sup> The avoidance of systemic hypotension is also a critical management strategy due to the fact that hypoperfusion and ischemia of the RV will further impair RV contractility. In many cases, a timely bolus of a vasopressor may eliminate the need for an RVAD by improving the RV perfusion pressure and reversing hypotension associated ischemia.

A critical strategy in the successful management of RV failure post-LVAD implantation involves the utilization of pulmonary vasodilators for RV afterload reduction. Although the intravenous use of nitroglycerin, sodium nitroprusside, or milrinone may reduce pulmonary arterial pressures, they do so at the expense of systemic vasodilation. Thus, the inhaled vasodilators nitric oxide (NO) or epoprostenol are utilized to treat pulmonary hypertension without systemic hemodynamic effects. Inhaled NO mediates pulmonary vasodilation by increasing cyclic guanosine monophosphate (cGMP) intracellularly. Inhaled epoprostenol is a prostacyclin analog that augments cyclic adenosine monophosphate levels. The result of either pathway is the relaxation of vascular smooth muscle. Both of these therapies have been shown to effectively reduce pulmonary arterial pressures during cardiac surgery.<sup>34</sup> There are several advantages of inhaled epoprostenol compared to NO. First and foremost is the sevenfold reduced cost of epoprostenol over NO. Although epoprostenol may inhibit platelet

aggregation, it does not generate toxic metabolites as does NO. NO may cause methemoglobinemia and generate lung-injuring nitrogen dioxide (NO<sub>2</sub>) in a dose-dependent fashion. Limiting NO to the lowest effective dose may minimize these risks.<sup>35</sup> Also it is important to address the metabolic factors that can impact PVR such as hypoxia, hypercarbia, acidosis, and hypothermia. A ventilator strategy that maintains a tidal volume near the functional reserve capacity and avoids excessive PEEP or airway pressures will minimize the respiratory influences on PVR.<sup>5</sup>

If RV failure persists despite maximal inotropic support and inhaled pulmonary vasodilators, an RVAD may be required. Although a variety of criteria exist for institution of RVAD support, a CVP that exceeds 18–20 mmHg with a CI <2 L/min/m<sup>2</sup>, despite optimal therapy with escalating levels of inotropic support, typically characterizes a patient that will benefit from right-sided MCS. A recent review of INTERMACS data showed about a 4% risk of requiring an RVAD within the first 2 weeks after LVAD implantation.<sup>6</sup> This risk had been previously reported to be between 9.4% and 37%.<sup>2,4</sup> Pre-implantation risk factors for RVAD use have been defined as INTERMACS levels 1 and 2, need for preoperative extracorporeal membrane oxygenation or renal replacement therapy, severe pre-implant TR, and prior history of cardiac surgery.<sup>6</sup> Intraoperative risk factors included prolonged CPB times, excessive blood transfusions, and concomitant surgical procedures during the LVAD surgery.<sup>6</sup> Nevertheless, it has been shown that tricuspid valve repair in and of itself does not increase the risk for the need of an RVAD.<sup>6</sup> A variety of right-sided support strategies exist, including central cannulation connected to an extracorporeal pump (e.g., CentriMag, TandemHeart, or Cardiohelp) or peripherally inserted devices. The peripheral options may include the percutaneous placement of an Impella RP via a femoral vein, or the placement of a Protek Duo cannula via the right internal jugular vein. The Protek Duo cannula must be connected to an extracorporeal pump (e.g., TandemHeart). The use of the Protek Duo has the advantage that an oxygenator may be added to the pump if oxygenation support is required.

Vasoplegia syndrome, characterized as a low SVR state, is common after LVAD implantation. High-dose vasopressors, such as norepinephrine and vasopressin, are often required to maintain a sufficient systemic blood pressure. Risk factors for developing vasoplegia during cardiac surgery include the preoperative use of ACE inhibitors or beta-blockers, higher comorbid disease burden, normothermic CPB, and prolonged CPB times.<sup>36</sup> NO is an intracellular mediator of vasoplegia which increases cGMP intracellularly. The increased cGMP activity contributes to the dephosphorylation of myosin, resulting in vasodilation. Methylene blue may be administered to prevent this NO-mediated vasodilation by the inhibition of NO synthase. Methylene blue does carry the risk of inducing serotonin syndrome, especially in patients taking selective serotonin

receptor inhibitor (SSRI) antidepressant medications.<sup>36,37</sup> Newer therapeutic strategies being investigated to treat refractory vasoplegia include hydroxocobalamin, hydrocortisone, vitamin C, and thiamine.<sup>36,38,39</sup>

Delayed chest closure may be warranted in those patients with uncorrected coagulopathy and bleeding. In addition, those patients with a tenuous RV function status may benefit from delayed closure to avoid compression of the RV.<sup>19</sup> Although this strategy may mitigate the risk of requiring an RVAD, it increases the risk of infection.<sup>5</sup> Although this represents an area of some controversy within the field, our practice has been to correct ongoing coagulopathy in the operating room before attempting chest closure. In the absence of hemodynamic impairment, we have favored returning to the ICU only after hemostasis has been achieved and the chest has been closed. A percutaneously placed RVAD may be an option in this situation to facilitate chest closure in the setting of RV failure.

## Postoperative Considerations

After the LVAD implantation surgery, sedation and analgesia are maintained for transport of the patient to ICU using a combination of narcotics with an infusion of propofol or dexmedetomidine. A complete hand-off report is provided to the ICU physicians and nurses who will be managing the patient. A standardized checklist may help ensure that all critical information is reported (Table 24.5). After transitioning to ICU care, close attention is paid to the chest tube output in the first several hours. A high rate (up to 30%) of exploration for bleeding has been described in many series after LVAD implantation procedures.<sup>40,41</sup> Retained clot may cause tamponade, which typically manifests as hypotension despite escalating vasoactive infusions, increased CVP and pulmonary artery pressures, and decreased LVAD flows.<sup>42</sup> A bedside TEE examination would demonstrate RV and RA compression and an under-filled LV. Tamponade is corrected by immediate surgical decompression. A protocol of active chest clearance using specialized tubes (PleuraFlow ACT) that mechanically remove clot and fibrinous debris from obstructing the chest tube has been demonstrated to decrease the incidence of chest re-exploration after LVAD implantation.<sup>43</sup>

The requirements for extubation include acceptable heart rate and rhythm, stable hemodynamic parameters on low-to-moderate pharmacological support, an adequate level of consciousness and full reversal of pharmacologic neuromuscular blockers, normothermia, absence of significant anemia or ongoing bleeding, and metabolic stability.<sup>44</sup> Ideally, extubation occurs within 6 hours of completion of the operation. Nevertheless, many patients will demonstrate contraindications for this “fast-track” approach due to preoperative risk, procedural duration, and the need for inhaled pulmonary dilators. Despite these potential

challenges, the anesthetic should be tailored so that early extubation is possible. A recent pilot study assessed the feasibility of using ultra-fast track anesthesia for INTERMACS level 3 and 4 patients with a goal of extubation in less than 4 hours.<sup>45</sup> The ultra-fast-track group demonstrated a lower incidence of postoperative complications, better hemodynamics, shorter ICU stays, and less RV failure.<sup>45</sup>

## Anesthetic Considerations in Non-Cardiac Surgery

Anesthesiologists are also frequently involved in the care of patients with an LVAD in arenas outside of the cardiac operating room. The most common type of procedures are gastrointestinal (GI) endoscopies, cardiology procedures, radiology vascular access procedures, and general surgical procedures.<sup>46</sup> GI bleeding resulting from gastrointestinal angiodysplasia may occur in 20%–40% of LVAD patients.<sup>47</sup> The abnormal degradation of von Willebrand factor (vWF) by the shear stress of the axial and centrifugal flow mechanisms contributes to the pathogenesis of intestinal angiodysplasia by triggering abnormal angiogenesis.<sup>47</sup> The combination of anticoagulation with warfarin and the LVAD-related acquired vWF deficiency and platelet dysfunction further contribute to the risk for GI bleeding in LVAD patients who develop angiodysplasia.

In the preoperative assessment for non-cardiac surgical procedures, the type of LVAD device (HeartWare HVAD, HeartMate II, or HeartMate 3) should be determined. The optimal LVAD parameters should be documented, and adequacy of battery life should be assessed. A review of the system monitor or a discussion with the VAD coordinator should be conducted to determine if there have been any recent suction events or concerning alarms. An assessment of the underlying RV function is essential. It is also important to know if the aortic valve had been oversewn to manage AI as the patient will then be completely LVAD dependent.

The preoperative evaluation of the patient requires a careful assessment to determine the degree of pulsatility present. Many patients can generate enough pulsatility for pulse oximetry to be used. In those patients without a suitable pulse, cerebral oximetry may be necessary. For most monitored anesthesia care (MAC) cases or minor surgeries under GA, the use of a non-invasive method to monitor blood pressure is feasible. An initial Doppler-derived blood pressure should be obtained using a handheld Doppler probe and a manual sphygmomanometer. In those patients with significant pulsatility, the Doppler measured pressure correlates more closely with an SBP.<sup>48</sup> However, in the patient with minimal pulsatility, the Doppler measured pressure tends to correspond with the MAP. When pulsatility is present, an automated oscillometric non-invasive blood pressure may be obtained, and if the measured value correlates well with



**Table 24.5 • Intensive Care Unit Handoff Checklist**

Patient name: \_\_\_\_\_

Patient MRN: \_\_\_\_\_

Procedure: \_\_\_\_\_

CPB time \_\_\_\_\_ Clamp time \_\_\_\_\_  Off Pump

Height: \_\_\_\_\_ Weight: \_\_\_\_\_

Allergies: \_\_\_\_\_

Medical History: \_\_\_\_\_

Intubation:  Easy  Difficult

Details: \_\_\_\_\_

ETT: Size \_\_\_\_ Depth \_\_\_\_\_

Vent Settings: \_\_\_\_\_

Monitoring/ Lines: IV \_\_\_\_\_ Arterial \_\_\_\_\_ CVL \_\_\_\_\_ PAC depth (cm) \_\_\_\_\_

Devices:  IABP \_\_\_\_\_  Impella \_\_\_\_\_  LVAD \_\_\_\_\_  RVAD \_\_\_\_\_

Vitals: HR/ Rhythm \_\_\_\_\_ Pacemaker settings \_\_\_\_\_

BP \_\_\_\_\_ CVP \_\_\_\_\_ PA \_\_\_\_\_ CO/CI \_\_\_\_\_ / \_\_\_\_\_ Temp \_\_\_\_\_

Infusions:  Insulin \_\_\_\_\_  Propofol \_\_\_\_\_  Norepi \_\_\_\_\_  Epi \_\_\_\_\_  Milrinone \_\_\_\_\_

Dobutamine \_\_\_\_\_  Vasopressin \_\_\_\_\_  Other \_\_\_\_\_  Other \_\_\_\_\_

Pulmonary Vasodilator: \_\_\_\_\_

Other Pertinent Medications: \_\_\_\_\_

Labs: Hgb \_\_\_\_\_ Platelet Count \_\_\_\_\_ Coags/ TEG: \_\_\_\_\_

Baseline ACT \_\_\_\_\_ Last ACT \_\_\_\_\_ Total Protamine given: \_\_\_\_\_

Blood Products: RBC \_\_\_\_\_ FFP \_\_\_\_\_ PLT \_\_\_\_\_ Cryo \_\_\_\_\_

Urine Output: \_\_\_\_\_ Chest tube output: \_\_\_\_\_

Pertinent Intraoperative Events: \_\_\_\_\_

Postop TEE findings: \_\_\_\_\_

Fast Track Extubation Candidate:  Yes  No Concerns: \_\_\_\_\_

Ongoing Management Concerns: \_\_\_\_\_

\_\_\_\_\_

the Doppler-derived value, it may be used for monitoring. In more involved surgical procedures under GA, an arterial line should be placed for monitoring. The use of ultrasound will help facilitate arterial line insertion in those patients with a non-palpable pulse. The requirement for central venous access or TEE monitoring is dictated by the surgical procedure performed and the hemodynamic condition of the patient. A CVL may be placed if there is an expectation of large fluid shifts or if the use of vasoactive medications is expected. TEE offers the advantage of easily monitoring RV function and assessing LV preload. Also, it is essential to be able to monitor and document the pump speed, flow, and power data from the system controller or system monitor during the anesthetic.

The majority of non-cardiac surgery cases performed on LVAD patients are GI endoscopies or cardiology procedures under MAC. Regional or neuraxial anesthetic techniques are rarely used in non-cardiac surgeries due to anticoagulation concerns. When performing a general anesthetic in these patients it is important to keep in mind the preload dependence and afterload sensitivity of the LVAD. A fluid bolus may be required to compensate for any preoperative fluid deficits or anesthetic-related decreases in preload. Avoidance of extremes in afterload can typically be achieved with judicious use of anesthetics or vasopressors as required. A loss of pulsatility may signal a decrease in myocardial contractility or diminished preload. On the HeartWare HVAD monitor, this often correlates with a decrease in the flow waveform amplitude. An ideal flow pulsatility should be greater than 2 L/min with a waveform trough of greater than 2 L/min. Although waveforms are not represented in the system for the HeartMate devices, the pulsatility index provides a close correlation. If hemodynamic instability persists, TEE or CVP monitoring may be required to help identify problems such as hypovolemia, RV dysfunction, tamponade, or an inappropriate pump speed contributing to a suction event.<sup>25</sup>

The perioperative anticoagulation plan needs to balance the risk of pump thrombosis with the risk of intraoperative bleeding.<sup>26</sup> Warfarin and antiplatelet drugs may be continued if the risk of surgical bleeding is felt to be low. Bridging with heparin may be necessary for those procedures with an elevated risk of bleeding. Emergent surgery may require reversal of anticoagulation with fresh frozen plasma, PCC, and/or vitamin K. Coordination between the surgeon and the heart failure cardiologist is essential for optimal anticoagulation management in these procedures.<sup>10</sup> It is important to monitor for any hemodynamic instability associated with a sudden increase in pump power in the patient in whom anticoagulants have been held as this may be a harbinger of pump thrombosis.<sup>10,25</sup>

According to a recent survey of members of the Society of Cardiovascular Anesthesiologists (SCA), about 79% of the anesthetics for non-cardiac procedures are performed by cardiac anesthesiologists.<sup>21</sup> However, increasing caseloads

have resulted in more LVAD-trained generalist anesthesiologists being involved in care of LVAD patients undergoing minor procedures. The SCA survey also noted that 48% of responders had reported that generalist anesthesiologists occasionally care for the LVAD patients.<sup>21</sup> A cardiac anesthesiologist should manage these patients if they are on pharmacologic support, have significant comorbidities, or are undergoing a major surgical procedure.<sup>49</sup> Connecting the patient to the system monitor should be considered for longer MAC procedures and most general anesthetics. This will facilitate monitoring LVAD parameters, adjustment in pump speed, and avoidance of battery depletion.<sup>50</sup> The assistance of the VAD nurse or coordinator is extremely beneficial in the perioperative care of these patients.<sup>25</sup> The SCA survey reported the presence of VAD support personnel in over 80% of non-cardiac procedures.<sup>21</sup> The patient may be recovered in the post-anesthesia care unit (PACU) or ICU as required by the patient's clinical status or the surgical intervention performed. If the patient is to be recovered in the PACU, it is necessary to have the VAD nurse accompany the patient in the absence of appropriately trained PACU nursing staff.

## Conclusion

The successful anesthetic management of a patient undergoing LVAD implantation depends on a thorough preoperative evaluation to identify and prepare for the intraoperative complexities of the advanced heart failure patient. The anesthesiologist must develop a well-formulated anesthetic management plan, perform a thorough echocardiographic assessment, and anticipate the potential post-CPB challenges which disrupt the successful implantation of an LVAD in order to “cross the bridge” between the progression of advanced heart failure and a renewed quality of life through mechanical circulatory support.

## REFERENCES

1. Hurwitz EE, Simon M, Vinta SR, et al. Adding examples to the ASA-physical status classification improves correct assignment to patients. *Anesthesiology*. 2017;126:614–622.
2. Fida N, Loebe M, Estep JD, Guha A. Predictors and management of right heart failure after left ventricular assist device implantation. *Methodist DeBakey Cardiovasc J*. 2015;11:18–23.
3. *Manual of Operations and Procedures. Version 5.0. Appendix A: Adverse Events Definitions*. Interagency Registry for Mechanically Assisted Circulatory Support website. <http://www.uab.edu/medicine/intermacs/intermacs-documents>. Updated February 4, 2016.
4. Hayek S, Sims DB, Markham DW, Butler J, Kalogeropoulos AP. Assessment of right ventricular function in left ventricular assist device candidates. *Circ Cardiovasc Imaging*. 2014;7:379–389.
5. Marzec LN, Ambardekar AV. Preoperative evaluation and perioperative management of right ventricular

- failure after left ventricular assist device implantation. *Semin Cardiothorac Vasc Anesth.* 2013;17:249–261.
6. Kiernan M, Grandin EW, Brinkley M Jr, et al. Early right ventricular assist device use in patients undergoing continuous-flow left ventricular assist device implantation: incidence and risk factors from the Interagency Registry for Mechanically Assisted Circulatory Support. *Circ Heart Fail.* 2017;10:e003863. doi:10.1161/CIRCHEARTFAILURE.117.003863.
  7. Wilson SR, Mudge GH Jr, Stewart GC, Givertz MM. Evaluation for a ventricular assist device: selecting the appropriate candidate. *Circulation.* 2009;119:2225–2232.
  8. Bedzra EKS, Dardas TF, Cheng JD, et al. Pulmonary function tests do not predict mortality in patients undergoing continuous-flow left ventricular assist device implantation. *J Thorac Cardiovasc Surg.* 2017;154:1959–1970.
  9. Tromp TR, de Jonge N, Joles JA. Left ventricular assist devices: a kidney's perspective. *Heart Fail Rev.* 2015;20:519–532.
  10. Feldman D, Pamboukian SV, Teuteberg JJ, et al. The 2013 International Society for Heart and Lung Transplantation Guidelines for mechanical circulatory support: executive summary. *J Heart Lung Transplant.* 2013;32:157–187.
  11. Melhorn U, Kroner A, de Vivie ER. 30 years clinical intra-aortic balloon pumping: facts and figures. *Thorac Cardiovasc Surg.* 1999;47(Suppl):298–303.
  12. Yang J, Kato TS, Shulman BP, et al. Liver dysfunction as a predictor of outcomes in patients with advanced heart failure requiring ventricular assist device support: use of the Model of End-stage Liver Disease (MELD) and MELD eXcluding INR (MELD-XI) scoring system. *J Heart Lung Transplant.* 2012;31:601–610.
  13. Bansal A, Chan J, Egger A, Desai S, Bhamra JK, Parrino P. Pre operative administration of vitamin K reduces bleeding in continuous flow devices. *J Heart Lung Transplant.* 2015;34:S144–S145.
  14. Lesmana CR, Cahyadinata L, Pakasi LS, Lesmana LA. Efficacy of prothrombin complex concentrate treatment in patients with liver coagulopathy who underwent various invasive hepatobiliary and gastrointestinal procedures. *Case Rep Gastroenterol.* 2016;10:315–322.
  15. Practice guidelines for pulmonary artery catheterization: a report by the ASA Task Force on pulmonary artery catheterization. *Anesthesiology.* 1993;78:380–394.
  16. Tehrani DM, Grinstein J, Kalantari S, et al. Cardiac output assessment in patients supported with left ventricular assist device: discordance between thermodilution and indirect Fick cardiac output measurements. *ASAIO J.* 2017;63:433–437.
  17. Stainback RF, Estep JD, Agler DA, et al. Echocardiography in the management of patients with left ventricular assist devices: recommendations from the American Society of Echocardiography. *J Am Soc Echocardiogr.* 2015;28:853–909.
  18. Tribouilloy CM, Enriquez-Sarano M, Bailey KR, et al. Assessment of severity of aortic regurgitation using the width of the vena contracta: a clinical color Doppler imaging study. *Circulation.* 2000;102:558–564.
  19. Broussard D, Donaldson E, Falterman J, Bates M. Anesthesia for left ventricular assist device insertion: a case series and review. *Ochsner J.* 2011;11:70–77.
  20. Ahn H, Granfeldt H, Hübbert L, Peterzén B. Long-term left ventricular support in patients with a mechanical aortic valve. *Scand Cardiovasc J.* 2013;47:236–239.
  21. Chumnanvej S, Wood MJ, MacGillivray TE, Vidal Melo MF. Perioperative echocardiographic examination for ventricular assist device implantation. *Anesth Analg.* 2007;105:583–601.
  22. Song HK, Gelow JM, Mudd J, et al. Limited utility of tricuspid valve repair at the time of left ventricular assist device implantation. *Ann Thorac Surg.* 2016;101:2168–2175.
  23. Bishawi M, Bell S, Cai L, et al. Antibiotic prophylaxis strategies in LVAD implantation and LVAD infections: a systematic review of the literature. *J Heart Lung Transplant.* 2017;36:S242.
  24. Slaughter MS, Pagani FD, Rogers JG, et al. Clinical management of continuous-flow left ventricular assist devices in advanced heart failure. *J Heart Lung Transplant.* 2010;29:S1–S39.
  25. Dalia AA, Cronin B, Stone ME, et al. Anesthetic management of patients with continuous-flow left ventricular assist devices undergoing noncardiac surgery: an update for anesthesiologists. *J Cardiothorac Vasc Anesth.* 2018;32:1001–1012.
  26. Chung M. Perioperative management of the patient with a left ventricular assist device for noncardiac surgery. *Anesth Analg.* 2018 Jun;126(6):1839–1850. doi:10.1213/ANE.0000000000002669.
  27. Totaro RJ, Raper RF. Epinephrine-induced lactic acidosis following cardiopulmonary bypass. *Crit Care Med.* 1997;25:1693–1699.
  28. Ferns J, Dowling R, Bhat G. Evaluation of a patient with left ventricular assist device dysfunction. *ASAIO J.* 2001;47:696–698.
  29. Despotis GJ, Levine V, Saleem R, et al. Use of point-of-care test in identification of patients who can benefit from desmopressin during cardiac surgery: a randomized controlled trial. *Lancet.* 1999;354:106–110.
  30. Karimi A, Daigle SS, Smith WB, Janelle GM, Klodell CT. Efficacy and safety of recombinant factor VII as rescue for severe perioperative bleeding in HeartMate II recipients. *J Card Surg.* 2015;30:500–505.
  31. Bradford CD, Stahovich MJ, Dembitsky WP, Adamson RM, Engelbert JJ, Perreiter AS. Safety of prothrombin complex concentrate to control excess bleeding during continuous flow LVAD insertion. *ASAIO J.* 2015;61:509–513.
  32. Gudejko MD, Gebhardt BR, et al. Intraoperative hemodynamic and echocardiographic measurements associated with severe right ventricular failure after left ventricular assist device implantation. *Anesth Analg.* 2019;128:25–32.
  33. Daoud EG, Strickberger A, Man C, et al. Preoperative amiodarone as prophylaxis against atrial fibrillation after heart surgery. *N Engl J Med.* 1997;337:1785–1791.
  34. McGinn K, Reichert M. A comparison of inhaled nitric oxide versus inhaled epoprostenol for acute pulmonary hypertension following cardiac surgery. *Ann Pharmacother.* 2016;50:22–26.
  35. Petit PC, Fine DH, Vasquez GB, Gamero L, Slaughter MS, Dasse KA. The pathophysiology of nitrogen dioxide during inhaled nitric oxide therapy. *ASAIO J.* 2017;63:7–13.
  36. Shaefi S, Mittel A, Klick J, et al. Vasoplegia after cardiovascular procedures: pathophysiology and

- targeted therapy. *J Cardiothorac Vasc Anesth.* 2018;32:1013–1022.
37. Schumacher LD, Blumer V, Chaparro SV. Methylene blue-induced serotonin syndrome after left ventricular assist device implantation: a case report and literature review. *J Thorac Cardiovasc Surg.* 2017;154:e39–e43.
  38. Cai Y, Mack A, Ladlie BL, Martin AK. The use of intravenous hydroxocobalamin as a rescue in methylene blue-resistant vasoplegic syndrome in cardiac surgery. *Ann Card Anaesth.* 2017;20:462–464.
  39. Marik PE, Khangoora V, Rivera R, Hooper MH, Catravas J. Hydrocortisone, vitamin C, and thiamine for the treatment of severe sepsis and septic shock: a retrospective before-after study. *Chest.* 2017;151:1229–1238.
  40. Harris P, Kuppurao L. Ventricular assist devices. *Contin Educ Anaesth Crit Care Pain.* 2012;12:145–51.
  41. Mehra MR, Naka Y, Uriel N, Goldstein DJ, Cleveland JC, Colombo PC, et al. A fully magnetically levitated circulatory pump for advanced heart failure. *N Engl J Med.* 2017;376(5):440–450.
  42. Miller LW, Pagani FD, Russell SD, et al. Use of a continuous-flow device in patients awaiting heart transplantation. *N Engl J Med.* 2007;357:885–896.
  43. Maltais S, Davis ME, Haglund NA, et al. Active clearance of chest tubes reduces re-exploration for bleeding after ventricular assist device implantation. *ASAIO J.* 2016;62:704–709.
  44. Yang KL, Tobin MJ. A prospective study of indices predicting the outcome of trials of weaning from mechanical ventilation. *N Engl J Med.* 1991;324:1445–1450.
  45. Zayat R, Menon AK, Goetzenich A, et al. Benefits of ultra-fast-track anesthesia in left ventricular assist device implantation: a retrospective, propensity score matched cohort study of a four-year single center experience. *J Cardiothorac Surg.* 2017;12:10. doi:10.1186/s13019-017-0573-9.
  46. Nelson EW, Heinke T, Finley A, et al. Management of LVAD patients for noncardiac surgery: a single-institution study. *J Cardiothorac Vasc Anesth.* 2015;29:898–900.
  47. Kang J, Hennessy-Strahs S, Kwiatkowski P, et al. Continuous-flow LVAD support causes a distinct form of intestinal angiodysplasia. *Circ Res.* 2017;121:963–969.
  48. Lanier GM, Orlanes KO, Hayashi Y, et al. Validity and reliability of a novel slow cuff-deflation system for noninvasive blood pressure monitoring in patients with continuous-flow left ventricular assist device. *Circ Heart Fail.* 2013;6:1005–1012.
  49. Evans AS, Stone ME. A patient safety model for patients with ventricular assist devices undergoing noncardiac procedures. *Am J Med Qual.* 2014;29:173–174.
  50. Roberts SM, Hovord DG, Kodavatiganti R, Sathishkumar S. Ventricular assist devices and non-cardiac surgery. *BMC Anesthesiol.* 2015;15:185. doi:10.1186/s12871-015-0157-y.

## Introduction

**I**t is well known that events occurring during the operative period can dramatically affect the management of patients into the immediate postoperative setting. Perfusionists harbor much responsibility in the management of these complicated patients and make many decisions in the operating room which may drastically alter the patient's immediate course of care. They often participate in critical decision-making affecting hemodilution, coagulation, and hemodynamics. This chapter will primarily focus upon these three processes relative to cardiopulmonary bypass (CPB), as well as complex scenarios experienced in the transition from CPB onto mechanical circulatory support (MCS) devices. Special circumstances specific to management of mechanical support in the immediate postoperative setting will be reviewed.

## Procedural Sequence

Patients requiring CPB experience identical stages of care. For purposes of simplicity, this section will categorize perfusion considerations for care management of CPB into four stages: pre-bypass, on bypass, post-bypass, and postoperative periods. Three specific foci of care exist for these patients within all four stages: hemodilution, coagulation, and hemodynamics. While many pathophysiological states may affect hemodynamics and coagulation prior to the operative period, chronic anemia is known to enhance transfusion related acute kidney injury (AKI), and interventions that reduce perioperative transfusions should be performed to protect anemic patients.<sup>1</sup> Renal dysfunction is an important predictor of outcome for in-hospital mortality, morbidity, and midterm survival.<sup>2</sup> Because actions of the surgical team frequently induce clinical hemodilution during CPB, it can be considered a controllable process, whereas hemodynamics and

coagulation may be thought of as responsive or secondary processes.

## Pre-Bypass Considerations

The adverse effects of hemodilution from CPB are many and are likely the most detrimental insults imposed by a surgical team on its patients. Perfusionists are the gatekeepers of fluid balance and are habitually keen to tracking the volume administrations and losses occurring within the surgical arena. Nadir hematocrit below mid-20% on CPB is associated with worse renal function, more myocardial injury, longer postoperative ventilator support, longer hospital stay, and higher mortality.<sup>3,4</sup> This may be attributed to lower oxygen delivery (DO<sub>2</sub>) levels yielding ischemic and/or inflammatory vital organ injury.<sup>5</sup> Hemodilution is also an independent risk factor for postoperative hyperlactatemia.<sup>6</sup> Steps deliberated within the perfusion care plan and during the preop briefing to purposefully maintain an elevated nadir hematocrit on CPB prove wholly beneficial.

Several hemodilution reduction techniques exist and ought to be considered early in the operative planning process. Efforts to minimize the CPB circuit prime volume by "right sizing" oxygenators and minimizing tubing lengths and diameters have proven to reduce hemodilution.<sup>7</sup> Tubing length harbors the greatest influence on static prime volume followed by tubing diameter. Perfusionists will often employ excessive blood flow rates for obese patients on CPB by utilizing actual body height and weight for flow calculation instead of implementing body mass index (BMI) correction. Adjusting body weight for high BMI can provide a more accurate estimate of a patient's lean body mass (LBM), creating a better representation of the patient's true metabolic needs and required blood flow, therefore avoiding lower nadir hematocrits.<sup>8</sup> Blood flow calculations for women have often been generated the same as men, despite different physiological needs. Because of a lower nadir

hematocrit on CPB, women have higher rates of stage 2–3 AKI and mortality.<sup>9</sup> Using LBM via BMI correction further enables right-sizing to smaller circuits, resulting in less blood transfusions.<sup>10</sup> Hemodilution can also induce bleeding via dilutional coagulopathy.

Hemodilution is known to cause hemostatic alterations to both red cells and platelets, and 30% dilution levels of circulating blood volume (CBV) in healthy study participants demonstrate significant reduction of platelet adhesion.<sup>11</sup> More notable is that at 30% dilution of CBV the addition of coagulation factor concentrates does not improve platelet reactivity. Hence, ideally the combined volumes of the CPB circuit, as well as the fluids administered to the patient pre-bypass via anesthesia, should be less than 30% of the patient's CBV. It is only through implementation of contemporary prime reduction techniques and team communication stemming from the preop briefing that this goal becomes enabled.

## On Bypass Considerations

While there is some debate within the perfusion community regarding the application of vacuum to an oxygenator reservoir, it is well known through the aged domains of autotransfusion, extracorporeal membrane oxygenation (ECMO), and the use of negative pressure relief valves in CPB circuits that whole blood can safely handle pressures of  $-150$  mmHg even with an air-to-blood interface. Vacuum assist is safe and should be used to minimize venous tubing diameter.<sup>12,13</sup> As of 2014 the use of vacuum assisted venous drainage (VAVD) was nearly universal throughout the perfusion society.<sup>14</sup> Guidelines of the Extracorporeal Life Support Organization (ELSO) limit ECMO inlet pressures to  $-300$  mmHg and outlet pressures to  $+400$  mmHg.<sup>15</sup>

VAVD also enables CPB initiation with an empty venous line permitting prime removal prior to initiation. Because of mixing at the blood/fluid interface within a primed venous line during CPB initiation, a dry venous line proves most effective at prime removal. With either method, however, displacing the prime from the venous tubing remains valuable. Noteworthy of mention is that higher arterial line pressures better enable a membrane oxygenator to remove gaseous micro-emboli (GME). A combined anesthesia and perfusion dilution goal  $<30\%$  cannot be achieved without VAVD and smaller diameter venous tubing. Additional prime reduction techniques exist.

Prime in the arterial tubing between the oxygenator and the arterial cannula may be removed via RAP techniques. Patients with tight left main disease, aortic valve stenosis, and hypertrophic obstructive cardiomyopathy may not tolerate pre-bypass CBV reduction. Displacement of cardioplegia circuit prime and antegrade displacement of prime

between the reservoir outlet and the oxygenator outlet can be quickly done upon CPB initiation. For any given CBV, reducing the static prime of a CPB circuit further enables higher levels in the oxygenator reservoir, permitting additional ultrafiltration (UF). The use of a hemoconcentrator while on CPB is an established technique for both volume management and reducing inflammatory mediators.<sup>16</sup> Using prime reduction techniques reduces the demand for UF on CPB via lesser hemodilution, which in turn lessens associated inflammatory mediator production, thus lowering the odds of inducing cardiac surgery-associated AKI.<sup>17</sup> Diuretics aide in maintaining a higher colloidal osmotic pressure (COP).

The use of mannitol as an osmotic diuretic is often used in the perioperative setting with the belief that it exerts renal protective properties and is recommended as treatment for early AKI because it results in both vascular endothelial and tubular epithelial de-swelling, ultimately improving both renal perfusion and filtration.<sup>18</sup> Mannitol aids in offsetting the effects of the crystalloid load on the interstitial space.<sup>19</sup> Maintaining elevated plasma protein concentrations on CPB not only reduces interstitial edema, but also maintains more normal physiological coagulation profiles.

Hemodilution, not consumption, is the primary cause for the drop in coagulation and fibrinolytic proteins during CPB. While activation does indeed occur on bypass, its impact on coagulation proteins is far less than the effects stemming from hemodilution. Reducing circuit sizes to minimize hemodilution improves postoperative coagulation factor levels.<sup>20</sup> Profound antithrombin III (ATIII) deficiency may be acquired from sepsis prior to CPB<sup>21</sup>, or may occur intraoperatively through significant gross blood losses resulting in large volumes of replacement fluids. Neither crystalloids, platelets, allogenic nor autologous red blood cells (RBCs) contain ATIII, and large volume depletions in the perioperative setting diminish ATIII to dangerously low levels. It sometimes proves beneficial to administer fresh frozen plasma (FFP) into the heart-lung machine and continue UF to manage the dilutional effects from doing so. This can prove especially beneficial when a patient with an elevated international ratio (INR) urgently enters the operative suite. Oftentimes two units of FFP are insufficient to restore heparin responsiveness. ATIII administration is known to decrease hemostatic system activation during CPB.<sup>22</sup> Post-bypass intracardiac thrombosis risks are lowered when appropriate ATIII levels are maintained during CPB on long pump runs.<sup>23</sup>

The prime reduction techniques discussed in the preceding may also be applied to ECMO circuits and short-term MCS devices. By first connecting the circuit inflow tubing to the venous cannula, the patient's blood can be used to displace prime from the circuit into a basin prior to arterial cannulation. Doing so prevents further diluting an already fluid overloaded patient.

## Post-Bypass Considerations

Lower pulmonary compliance, higher pulmonary resistance, and poor alveolar gas exchange is witnessed post-bypass because hemodilution causes serum albumin concentration and COP to drop and the effective capillary filtration pressure to increase.<sup>24</sup> Gross deficiencies in COP and albumin levels are directly attributed to fulminant non-cardiogenic pulmonary edema, a condition which may require time on ECMO to resolve. Maintaining appropriate COP subsequently prevents the development of pulmonary interstitial edema and improves postoperative lung function.<sup>25</sup> Total COP pressure averages 28 mmHg in the capillary, with albumin providing approximately 80% of it. Preserving the integrity of the endothelial vasculature proves critical but difficult during complicated surgical procedures.

Proteins, notably albumin, exert an osmotic pressure in the blood which is designed to pull water into the vasculature from interstitial spaces with the opposing force being hydrostatic. Hypervolemic dynamics resulting from fluid overloading can stretch the endothelial lining in a Starlings Law manner. The endothelial glycocalyx has been labeled as the gateway to the interstitial space, and it appears to serve as a molecular filter which generates an oncotic gradient within a very small space specifically for preserving vascular integrity.<sup>26</sup> Hypervolemic conditions destroy the vascular barrier by increasing the release of atrial natriuretic peptide, which appears to cause delamination of the endothelial glycocalyx.<sup>27</sup>

Hemodilution during CPB has also been directly linked to weaker clot strength and higher blood loss during the post-bypass period.<sup>28</sup> Patients placed on CPB experience significantly increased activated partial thromboplastin time (APTT), platelet activation, and adenosine diphosphate (ADP)-induced platelet aggregation compared to those patients receiving off-pump surgery.<sup>29</sup> Minimizing post-bypass coagulopathic blood loss begins with protamine reversal.

Protamine demonstrates negative effects not only on physiological hemodynamics, but also on coagulation.<sup>30</sup> Protamine is a platelet agonist, and administering allogenic platelets or giving excess protamine amidst activated native platelets remains a recipe for massive thrombosis, particularly in the absence of sufficient ATIII levels. Minimizing the administration of protamine by accurately assessing the amount of heparin to be reversed reduces post-bypass platelet dysfunction,<sup>31</sup> bleeding, and blood transfusion administration.<sup>32</sup> While excess protamine exhibits mild anticoagulant properties, minimal protamine administration enhances risks for heparin rebound. While there are several tests that detect heparin, some are more specific to heparin quantification than others. The Hemostasis Management System (HMS, Medtronic Inc.) uses a protamine titration assay to detect heparin levels as low as 0.2

u/ml, but levels as high as 0.19 u/ml round down to a 0.0 u/ml result, presenting the false perception of no residual heparin. An extended R-time of kaolin Thromboelastograph (TEG) with a simultaneous HMS heparin concentration of 0.0 u/ml amid the presence of substantial bleeding and a normal heparinase/kaolin TEG is not uncommon and makes obvious that additional protamine is required. The effects of these dilutional coagulopathies in the operating suite carry over into the intensive care unit.

## Postoperative ICU Considerations

The concerns to minimize blood products for patients being placed on MCS are usually less than that for typical elective CPB patients due to the complexity of the surgery and higher blood losses. What become more important in the management of these patients are proportional volume replacement principles. While laboratory tests are readily available for platelets and RBCs, plasma quantification proves more difficult. Being deficient in plasma protein factors can result from a state of dilutional coagulopathy where the administration of an imbalanced non-physiologic ratio of platelets, RBCs, and plasma has occurred. It is recommended that hemorrhaging trauma patients receive red cells and FFP in a 1:1 ratio.<sup>33</sup> Recent studies suggest a survivor benefit when higher FFP/platelet to RBC ratio is used.<sup>34</sup> Unfortunately, many institutions wait until the INR is elevated before infusing FFP when bleeding from a dilutional coagulopathy is already being witnessed. Post-CPB patients usually exhibit elevated coagulation tests results in the postoperative setting.

Patients demonstrate an elevated APTT and INR immediately after surgery.<sup>35</sup> After long pump runs, patients often appear edematous and benefit from diuresis. Heparin rebound is a well-documented phenomenon in many of these patients within the first 6–18 hours of arrival to the ICU.<sup>36</sup> Drawing simultaneous samples of a heparinase/kaolin and kaolin TEG will validate if heparin is circulating from heparin rebound, a phenomenon more prevalent in patients with a high BMI. Depending on liver function, anticoagulation may be started after 3–6 hours of normal kaolin TEGs. Patients with chronic liver failure demonstrate a diminished heparin consumption rate and a higher sensitivity to heparin. The detrimental effects of heparin are numerous, and direct thrombin inhibitors (DTIs) are becoming increasingly more popular for patients on MCS devices in the ICU.<sup>37</sup>

## Complex Scenarios

The past decade has witnessed a tremendous increase in the utilization of MCS devices. Longevity ECMO patients now await transplantation for several months while talking, eating, and walking the hallways. This new world of

extended MCS has caused new approaches for cannulation. Occasionally multiple MCS devices are utilized on a single patient for the use of weaning or ventricular unloading. While technology has brought better devices to the forefront, it is the new frontier of anticoagulation management that has enabled such forward progression.

## Mechanical Circulatory Support Longevity

Polymethylpentene (PMP) membrane oxygenators have made possible weeks and months of ECMO via a single oxygenator without exchange. Higher cardiac index flows on ECMO should be anticipated in the new domain of patient mobility owed to extubated patients exercising without ventilator support. Central cannulation through the chest, as opposed to femoral or axillary cannulation, should be considered due to the risk of inducing compartment syndrome. Tunneled cannulation techniques during central cannulation permit both enhanced patient mobility as well as superior aseptic technique. ECMO circuits have demonstrated that circuit pressures of  $-150$  mmHg to  $+350$  mmHg do not damage blood, and it can be argued that it is better to use smaller A/V femoral cannulae with higher/lower line pressures during resuscitation efforts than to induce compartment syndrome in a patient. However, patient mobility is restrictive with femoral-femoral cannulation strategy, and mobile patients indeed require higher blood flows.

Long-term ECMO patients awaiting transplant will benefit from an 8-mm graft onto the aorta fed by a 28 French (Fr) open-ended venous cannula into the graft from the ECMO circuit outflow. Tunneling the cannula below the xiphoid and closing the skin around the cannulae maintains aseptic technique, permits the chest to be closed, and avoids potential aorta degradation at the cannulation site. Upsizing cannulae for central infant/pediatric ECMO will delay re-cannulation to larger sizes as the patient grows while awaiting organ donation. Patient mobility remains a top consideration in today's cannulation strategies for transplant patients, and perhaps the greatest limiting factor against exercising on ECMO is that oxygenator surface sizes are too small, having been designed for patients under anesthesia in the operating room.

## Contemporary Cannulation

When femoral cannulation is desired for ECMO, an 8-mm graft for patient inflow fed by an open-ended 28 Fr venous cannula may be used, and tunneling the cannula subcutaneously through the upper thigh permits closing the skin around the cannula. This technique will allow flexing of the leg for improved mobility. Femoral cannulation strategies can facilitate hypoxia to the upper body, requiring the addition of a third cannula for inflow, also known as

veno-arterial-venous (VAV)-ECMO.<sup>38</sup> This provides a possible solution to the Harlequin phenomenon associated with femoral cannulation, and pre-procedural briefings should include this discussion prior to cannulation.<sup>39</sup>

Patient outflow may occur through a bicaval dual lumen ECMO catheter such as the Maquet Avalon Elite (MAQUET GETINGE GROUP) designed for the neck. Note that by design of the cannula, both ports of a veno-venous (VV) cannula may be used for patient outflow, but both ports cannot be used for patient inflow as the designated cannula inflow port will become obstructed when the larger outflow lumen becomes pressurized. Using a tunneled femoral cannula for patient inflow and a dual lumen neck cannula for patient outflow delays chest entry and further reserves converting to VV-ECMO as an option when cardiovascular hemodynamics improve. Noteworthy of mentioning is that GORE-TEX grafts (Gore Medical) breathe and will entrain foam if exposed to the negative pressures of an ECMO circuit while exposed to atmosphere.

## Combined Mechanical Circulatory Support Therapies

There are numerous applications for combined device uses. A postoperative LVAD patient may succumb to right heart failure (RHF) and demonstrate the inability for the pulmonary circulation to fill the LVAD despite maximal medical therapy. Use of a centrifugal RVAD will permit sufficient filling pressures for the LVAD while providing oxygenation.<sup>40</sup> Occasionally a postoperative LVAD patient will require ECMO due to poor lung function, and using a centrifugal RVAD with an oxygenator cut into the circuit should be considered as pulmonary pressures permit. Caution must be taken to not overflow the right side, possibly inducing pulmonary edema, and lowering the revolutions per minute (rpm) of the LVAD may prove necessary to prevent such an episode. Using this biventricular device conceptually permits staging the ECMO removal; if the oxygenator is close to the centrifugal pump outlet it can be removed from the centrifugal RVAD circuit, allowing the RVAD to remain for further weaning.

## Ventricular Decompression While on Support

Similar staged concepts may be applied if a vent is needed to decompress the left ventricle while on veno-arterial (VA)-ECMO. Stagnation of blood in left heart cavities is a concern while on ECMO due to potential thrombus formation, and the use of a vent requires partial ejection and appropriate anticoagulation. An Impella (Abiomed) catheter inserted from an axillary approach and placed across the aortic valve prevents ventricular distension



while prompting antegrade flow across the aortic valve. This approach also enables ECMO removal while continuing cardiovascular hemodynamic support via the Impella device.<sup>41</sup> This technique, albeit expensive, demonstrates benefit over a vent spliced into the negative inflow side of the ECMO circuit in which excessive vent flow may occur unless restriction is placed on it. Negative pressures of an ECMO circuit can become great and too much flow from a vent spliced into it may induce retrograde flow across the aortic valve.

## Coagulation Issues

Several facets regarding contemporary anticoagulation management bear attention. Any patient on an MCS device with prior or extended heparin exposure is at risk for acquiring heparin-induced thrombocytopenia (HIT). Noteworthy is that the heparin used in covalently bonded heparin-treated circuits such as Cortiva™ BioActive Surface (Medtronic) does not leach off the tubing. An ECMO circuit does not need to be changed if a patient acquires HIT on ECMO, but immediate removal of the antibodies via plasma aphaeresis could prove beneficial. One must be reminded that 50%–70% of the circulating anticoagulant is removed during apheresis and a loading dose should be considered, especially if FFP was chased through at the end of the apheresis run. While the use of DTIs has reduced some of the concerns regarding HIT, monitoring for an appropriate DTI maintenance dosage has proven difficult.

Because DTIs are excreted through both the liver and the kidney, patient-to-patient variability regarding organ function makes use of the TEG unreliable, and an APTT of twice normal reference range has become preferable methodology. However, non-whole blood APTT tests do not account for either platelet or red cell coagulation contributions, but focus primarily on the intrinsic coagulation cascade. Also be advised that upon initiation of continuous renal replacement therapy (CRRT) into an MCS circuit, approximately 40%–60% of Bivalirudin is lost through the effluent and its dose rate will need to be increased accordingly.<sup>42</sup> Present-day anticoagulation strategies have become more effective because the internal and external coagulation cascades are starting to be managed separately.

Low-dose unfractionated heparin does little to suppress the external cascade, as is evidenced by a normal range INR. An elevated APTT reflects a suppressed intrinsic cascade yet does nothing to suppress platelet activation or ATIII consumption while the extrinsic cascade is physiologically normal. One cannot claim a patient is sufficiently anticoagulated when one arm of the coagulation cascade is extended while the other is not. Warfarin has long been clinically proven effective for VADs yet is just now being considered for ECMO. The use of DTIs with antiplatelet therapy use, however, is quickly becoming standard.<sup>43</sup>

Contemporary anticoagulation strategies via Berlin Heart and Syncardia total artificial heart patient management modalities continue to be applied and developed as technology enables and patients demand. Focus placed on the suppression of both platelet activation and function has earned much merit. Arachidonic acid, adenosine diphosphate, and glycoprotein IIb/IIIa receptors each exhibit different traits and should be treated individually. Platelet function, activation, and aggregation are not the same, and technologies such as platelet mapping and thromboelastometry can now safely guide practitioners through the difficulties of sepsis, disseminated intravascular clotting, or fibrinolysis. Worth noting is that fibrinolytic therapy while on MCS requires a sufficient level of anticoagulation to prevent massive sudden thrombosis. This script barely scratches the surface for anticoagulation management of MCS patients, yet it reflects the hope and promise of progress recently being made. The successes in the past decade for MCS devices must be intensely attributed to modern diversity for using multiple anticoagulation strategies and treating each MCS patient as a separate individual.

## Summary

This chapter has focused on perfusion considerations for the procedural sequence of cardiac surgical events related to CPB and complex scenarios involved when converting to MCS devices. Regarding procedural sequence, the surgical team should:

1. Tailor the size of the extracorporeal circuit to the patient's lean body mass, target blood flow rate, and circuit contact surface in order to minimize hemodilution and maximize nadir hematocrit and DO<sub>2</sub> during CPB;
2. Minimize hemodilution of plasma proteins to preserve coagulation factors, colloidal osmotic pressure, and the integrity of the glycocalyx of the endothelial vessel wall and platelet surface;
3. Monitor heparin concentration, viscoelastic platelet function, and proportional volume replacement (a1:1 FFP to RBC unit transfusion ratio) to avoid dilutional coagulopathy;
4. Avoid simultaneous platelet and protamine infusions amid critical low ATIII levels potentially causing intracardiac thrombosis.

When managing MCS devices in complex scenarios, the surgical team should:

1. Consider alternative strategies for longevity of ECMO cannulation and tunnel the cannulae to facilitate patient mobility and asepsis;

2. Optimize intraventricular decompression to avoid stagnant blood and potential thrombus formation from DTIs with a shorter half life;
3. Monitor antithrombin activity and consider the use of direct thrombin inhibitors as well as multi-targeted antithrombotic therapies including antiplatelet agents.

## REFERENCES

1. Karkouti K, Wijeyesundera DN, Yau TM, et al. Influence of erythrocyte transfusion on the risk of acute kidney injury after cardiac surgery differs in anemic and non-anemic patients. *Anesthesiology*. 2011;115(3):523–530.
2. Zakeri R, Freemantle N, Barnett V, et al. Relation between mild renal dysfunction and outcomes after coronary artery bypass grafting. *Circulation*. 2005;112[suppl 1]:I-270–I-275.
3. DeFoe GR, Ross CS, Olmstead EM, et al. Lowest hematocrit on bypass and adverse outcomes associated with coronary artery bypass grafting. *Ann Thorac Surg*. 2001;71(3):769–776.
4. Loor G, Li L, Sabik III J, Rajeswaran J, Blackstone EH, Koch CG. Nadir hematocrit during cardiopulmonary bypass: end-organ dysfunction and mortality. *J Thorac Cardiovasc Surg*. 2012;144:654–662.
5. Habib RH, Zacharias A, Schwann TA, Riordan CJ, Durham SJ, Shah A. Adverse effects of low hematocrit during cardiopulmonary bypass in the adult: Should current practice be changed? *J Thorac Cardiovasc Surg*. 2003;125:1438–1450.
6. Ranucci M, Carboni G, Cotza M, et al. Hemodilution on cardiopulmonary bypass as a determinant of early postoperative hyperlactatemia. *PLoS ONE*. 2015;10(5):e0126939. doi:10.1371/journal.pone.0126939.
7. Bronson, SL, Riley JB, Blessing JP, Ereth MH, Dearani JA. Prescriptive patient extracorporeal circuit and oxygenator sizing reduces hemodilution and allogeneic blood product transfusion during adult cardiac surgery. *J Extra Corpor Technol*. 2013; 45:167–172.
8. Santambrogio L, Leva C, Musazzi G, et al. Determination of pump flow rate during cardiopulmonary bypass in obese patients avoiding hemodilution. *J Card Surg*. 2009;24:245–249.
9. Mehta R, Castelveccchio S, Ballotta A, Frigiola A, Bossone E, Ranucci M. Association of gender and lowest hematocrit on cardiopulmonary bypass with acute kidney injury and operative mortality in patients undergoing cardiac surgery. *Ann Thorac Surg*. 2013;96:133–140.
10. Blessing JM, Riley JB. Lean flow: optimizing cardiopulmonary bypass equipment and flow for obese patients—a technique article. *J Extra Corpor Technol*. 2017;49:30–35.
11. Caballo C, Escolar G, Diaz-Ricart M, et al. Impact of experimental haemodilution on platelet function, thrombin generation and clot firmness: effects of different coagulation factor concentrates. *Blood Transfus*. 2013;11:391–399.
12. Wang S, Ündar A. Vacuum-assisted venous drainage and gaseous microemboli in cardiopulmonary bypass. *J Extra Corpor Technol*. 2008;40:249–256.
13. Durandy Y. Vacuum-assisted venous drainage, angel or demon: pro? *J Extra Corpor Technol*. 2013;45:122–127.
14. Gambino R, Searles B, Darling EM. Vacuum-assisted venous drainage: a 2014 safety survey. *J Extra Corpor Technol*. 2015;47:160–166.
15. *ELSO Guidelines for Cardiopulmonary Extracorporeal Life Support*. Extracorporeal Life Support Organization, Version 1.3, November 2013. Ann Arbor, MI. www.elsonet.org.
16. Searles B. Ultrafiltration techniques and CPB: what we know and what we think we know. *J Extra Corpor Technol*. 2006;38:64–65.
17. Mao H, Katz N, Ariyanon W, et al. Cardiac surgery-associated acute kidney injury. *Cardiorenal Med*. 2013;3:178–199.
18. Bragadottir G, Redfors B, Ricksten SE. Mannitol increases renal blood flow and maintains filtration fraction and oxygenation in postoperative acute kidney injury: a prospective interventional study. *Crit Care*. 2012;16(4):R159.
19. Young R. Perioperative fluid and electrolyte management in cardiac surgery: a review. *J Extra Corpor Technol*. 2012;44:20–26.
20. Chandler W. Effects of hemodilution, blood loss, and consumption on hemostatic factor levels during cardiopulmonary bypass. *J Cardiothorac Vasc Anesth*. 2005;19:459–467.
21. White B, Perry D. Acquired antithrombin deficiency in sepsis. *Br J Haematol*. 2001;112:26–31.
22. Avidan M, Levy J, Van Aken H, et al. Recombinant human antithrombin III restores heparin responsiveness and decreases activation of coagulation in heparin-resistant patients during cardiopulmonary bypass. *J Thorac Cardiovasc Surg*. 2005;130:107–113.
23. Sniecinski R, Szlam F, Chen EP, Bader SO, Levy JH, Tanaka KA. Antithrombin deficiency increases thrombin activity after prolonged cardiopulmonary bypass. *Anesth Analg*. 2008;106:713–718.
24. Huang H, Yao T, Wang W, Zhu D, Zhang W, Chen H, Fu W. Continuous ultrafiltration attenuates the pulmonary injury that follows open heart surgery with cardiopulmonary bypass. *Ann Thorac Surg*. 2003;76:136–140.
25. Apostolakis EE, Koletsis EN, Baikoussis NG, Siminelakis SN, Papadopoulos GS. Strategies to prevent intraoperative lung injury during cardiopulmonary bypass. *J Thorac Cardiovasc Surg*. 2010; 5:1doi: 10.1186/1749-8090-5-1.
26. Chappell D, Jacob M, Hofmann-Kiefer K, Conzen P, Rehm M. A rational approach to perioperative fluid management. *Anesthesiology*. 2008;109:723–40.
27. Chappell D, Bruegger D, Potzel J, et al. Hypervolemia increases release of atrial natriuretic peptide and shedding of the endothelial glycocalyx. *Crit Care*. 2014;18:538. <http://ccforum.com/content/18/5/538>
28. Ranucci M, Baryshnikova E, Ciotti E, Ranucci M, Silvetti S. Hemodilution on cardiopulmonary bypass: thromboelastography patterns and coagulation-related outcomes. *J Cardiothorac Vasc Anesth*. 2017;3:1588–1594.
29. Ballotta A, Saleh H, El Baghdady H, Gomaa M, Belloli F, Kandil H, Balbaa Y, Bettini F, Bossone E, Menicanti L, Frigiola A, Bellucci C, Mehta R. Comparison of early platelet activation in patients undergoing on-pump versus off-pump coronary artery bypass surgery. *J Thorac Cardiovasc Surg*. 2007;134:132–138.
30. Warkentin TE, Crowther MA. Reversing anticoagulants both old and new. *Can J Anaesth*. 2002;49(6):S11–S25.

31. Shigeta O, Kojima H, Hiramatsu Y, et al. Low-dose protamine based on heparin-protamine titration method reduces platelet dysfunction after cardiopulmonary bypass. *J Thorac Cardiovasc Surg.* 1999;118:354–360.
32. Runge M, Møller C, Steinbrüchel D. Increased accuracy in heparin and protamine administration decreases bleeding: a pilot study. *J Extra Corpor Technol.* 2009;41:10–14.
33. Nascimento B, Callum J, Rubenfeld G, Neto JBR, Lin Y, Rizoli S. Clinical review: Fresh frozen plasma in massive bleedings - more questions than answers. *Crit Care.* 2010;14:202. doi:10.1186/cc8205.
34. Holcomb JB, Tilley BC, Baraniuk S, et al. Transfusion of plasma, platelets, and red blood cells in a 1:1:1 vs a 1:1:2 ratio and mortality in patients with severe trauma: the PROPPR randomized clinical trial. *JAMA.* 2015;313(5):471–482.
35. Čeke LS, Imamović S, Ljuca F, et al. Changes in activated partial thromboplastin time and international normalised ratio after on-pump and off-pump surgical revascularization of the heart. *Bosn J Basic Med Sci.* 2014;14(2):70–74.
36. Purandare SV, Parulkar GB, Panday SR, Bhattacharya S, Bhatt MM. Heparin rebound: a cause of bleeding following open heart surgery. *J Postgrad Med.* 1979;25:70–74.
37. Ranucci M, Baryshnikova E, Isgrò G, et al. Heparin-like effect in postcardiotomy extracorporeal membrane oxygenation patients. *Crit Care.* 2014;18(5):504. doi:10.1186/s13054-014-0504-2.
38. Banfi C, Pozzi M, Siegenthaler N, et al. *J Thorac Dis.* 2016;8:3762–3773.
39. Alwardt CM, Patel BM, Lowell A, Dobberpuhl J, Riley JB, DeValeria PA. Regional perfusion during venoarterial extracorporeal membrane oxygenation: a case report and educational modules on the concept of dual circulations. *J Extra Corpor Technol.* 2013;45(3):187–194.
40. Kormos RL, Teuteberg JJ, Pagani FD, et al. Right ventricular failure in patients with the HeartMate II continuous-flow left ventricular assist device: incidence, risk factors, and effect on outcomes. *J Thorac Cardiovasc Surg.* 2010;139:1316–1324.
41. Cheng A, Swartz MF, Massey HT. Impella to unload the left ventricle during peripheral extracorporeal membrane oxygenation. *ASAIO J.* 2013;59:533–536.
42. Koster A, Chew D, Gründel M, et al. An assessment of different filter systems for extracorporeal elimination of bivalirudin: an in vitro study. *Anesth Analg.* 2003;96:1316–1319.
43. Ramirez A, Riley JB, Joyce LD. Multi-targeted anti-thrombotic therapy for total artificial heart device patients. *J Extra Corpor Technol.* 2016;48:27–34.

## 26

# Echocardiography in Left Ventricular Assist Device Recipients

YAN TOPILSKY AND OFER HAVAKUK

## Introduction

**L**eft ventricular assist devices (LVADs) are systems for mechanical support in patients with end-stage heart failure.<sup>1-3</sup> Currently, there are several types of pumps, mostly continuous-flow, positioned in parallel to the left ventricle (LV), consisting of a centrifugal or rotor axial pump, an inflow cannula, and an outflow cannula. The inflow cannula is inserted into the apex of the LV, and the outflow cannula is usually anastomosed to the right anterior aspect of the ascending aorta (Figure 26.1).

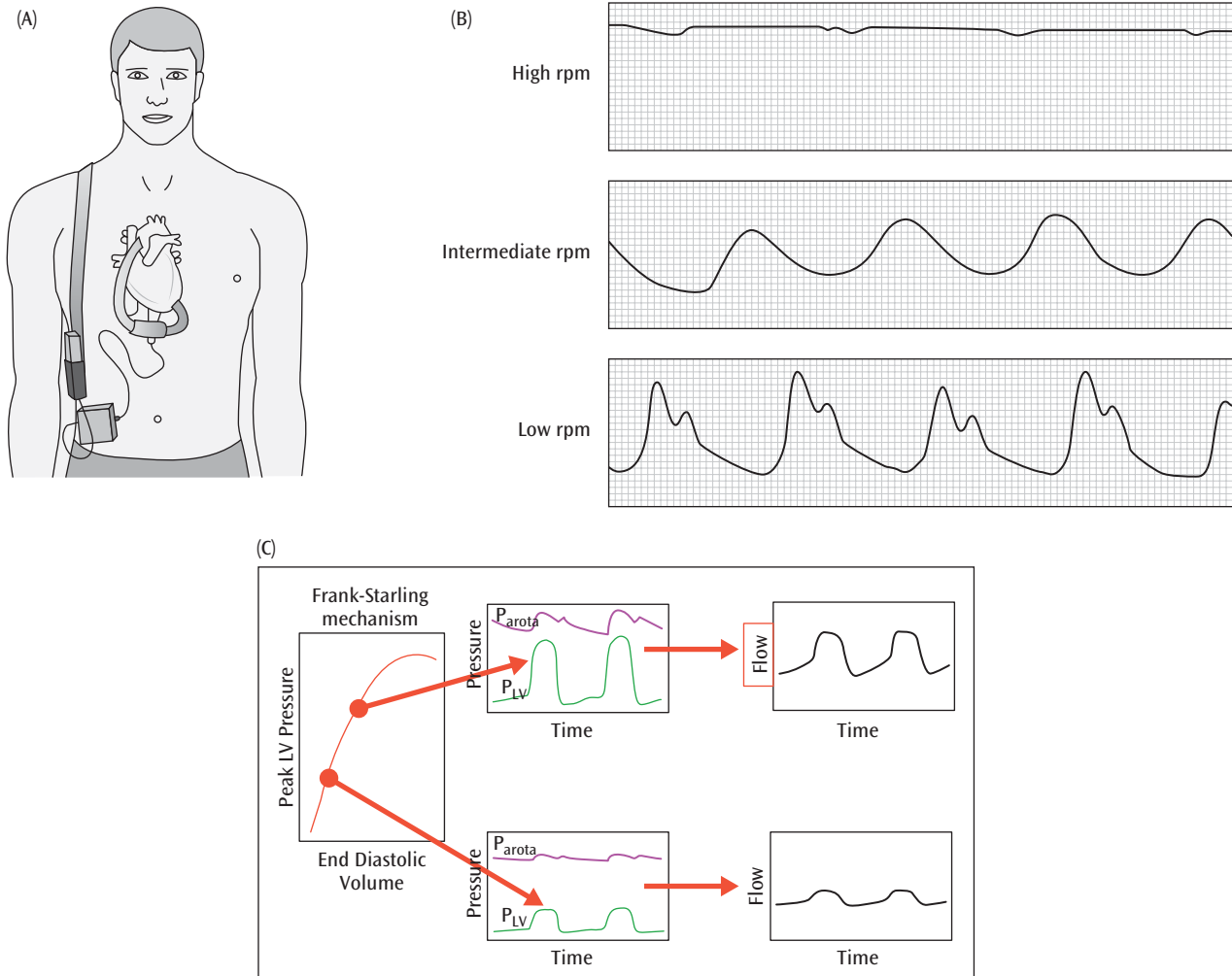
The combined functions of the LVAD, native LV, and native RV result in unique hemodynamic conditions resembling a “cardiac chimera.” Comprehensive echo assessment of patients undergoing VAD insertion requires knowledge of these conditions. For purposes of simplicity, we will divide the following section (“Continuous LVAD Hemodynamics”) into three distinct parts: “The Trade-off between Pump Output and Flow Pulsatility”; “LV and LA Unloading”; and “Hemodynamic Impact of the LVAD on Right-Sided Chambers.”

## Continuous LVAD Hemodynamics

### The Trade-off between Pump Output and Flow Pulsatility

The goals of LVAD are to increase total cardiac output, unload left ventricular and left atrial pressure, and maintain some natural pulsatility of flow to end organs. Continuous-flow pumps are connected in parallel to the LV by the inflow cannula, with the LV being the direct source of preload essential for LVAD output. Although considered to be continuous-flow assist devices, the volume of flow generated by them are determined by the native LV residual contractility, the speed of the rotation of the pump

(rpm), and by the differential pressure that exists across the device.<sup>4,5</sup> The LVAD is connected to the circulation by the inflow conduit in the LV apex, while the outflow graft is secured to the aorta (Figure 26.1). For a specified speed, flow varies inversely with the pressure difference between the outflow (LVAD afterload) and inflow (LVAD preload) cannula. In other words, the flow increases with increasing LVAD preload (LV pressure), or decreasing LVAD afterload (aortic pressure), just like the native heart. The dynamic parameter that determines the pump’s differential pressure is the LV pressure, which in turn is dependent on the cardiac cycle (systole vs. diastole), pump speed, pump proper function, and LV contractile reserve (Figure 26.1). At low pump speed, the flow created by the pump will be low, and even a severely depressed LV will have the possibility to generate some systolic contraction that will increase LV systolic pressure above the pressure in the aorta, allowing the aortic valve to open every cycle. The increase in LVAD preload during native LV systole decreases the pump differential pressure, which in turn increases systolic pump flow and maintains flow pulsatility (Figures 26.1 and 26.2). At high rpm, pump flow increases to maximum, at the expense of decrease in the LV end-diastolic volume, comparable to a state of hypovolemia. The already failing native LV exposed to reduced preload decreases its contractility according to Starling’s response. This minimizes the increase in LV systolic pressure, resulting in a non-significant systolic increase in LVAD preload and output and loss of pulsatility of flow to end organs. The sub-physiological LV systolic pressure never increases above aortic pressure and is insufficient to allow aortic valve opening and ejection (Figures 26.1 and 26.2). Under mid-range LVAD speed, the flow created by the pump is sufficient to maintain proper end-organ perfusion and the systolic LV pressure increases above aortic pressure every several cycles, resulting in intermittent or variable



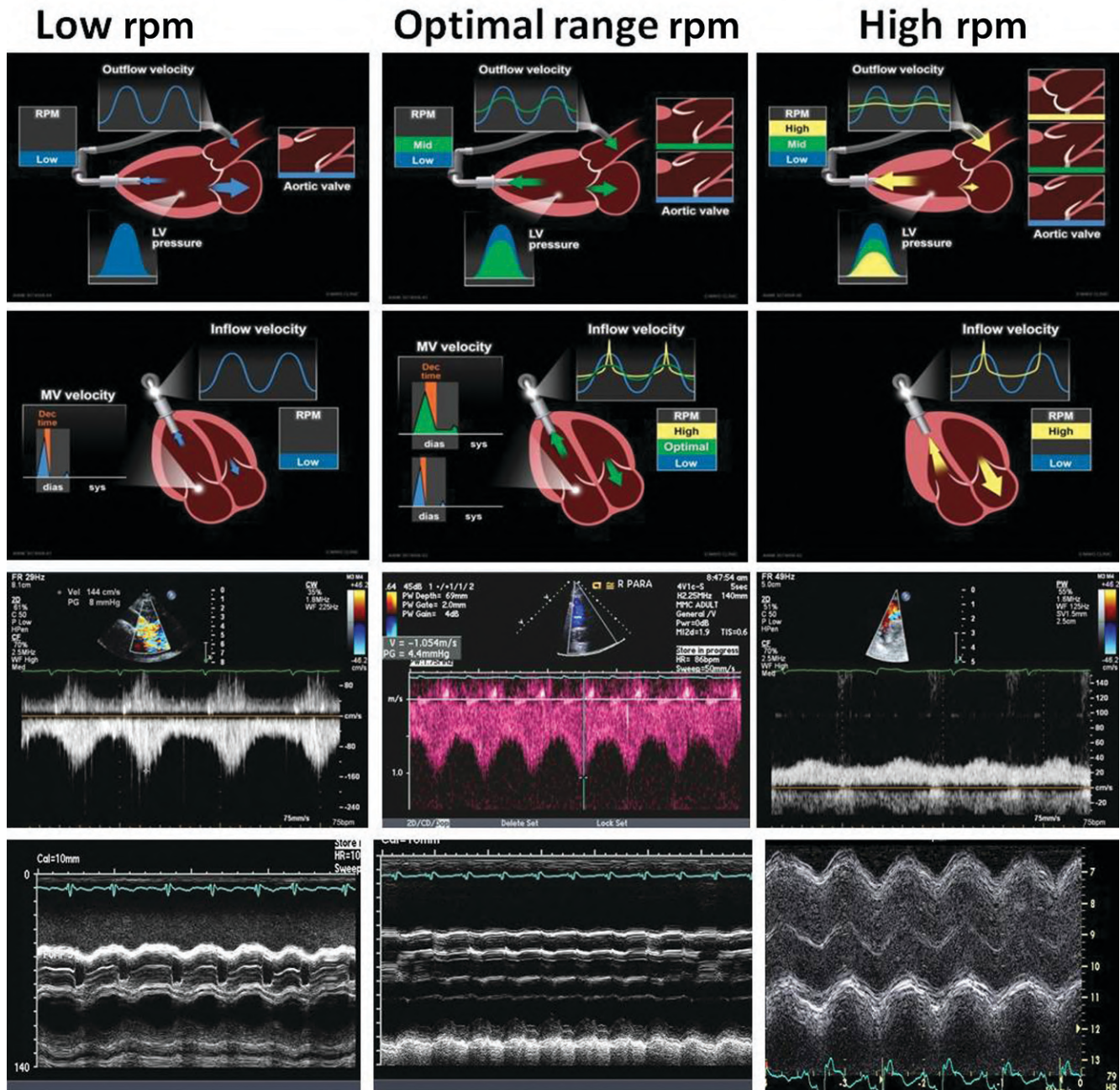
**Figure 26.1.** (A) An example of continuous LVAD consisting of the pump, the inflow cannula connected to the left ventricular apex, the outflow graft connected to the anterior aspect of the ascending aorta, a per-cutaneous power cable, a speed controller, and a battery. The controller and battery are worn on a belt or are carried in a bag.

(B) Arterial pressure tracing at standard pump speed settings. The pulse pressure decreases gradually from 25 mmHg at low rpm to 12 mmHg at intermediate rpm and 6 mmHg at high rpm. Note that at low rpm the dicrotic notch is present every cycle, proving that the aortic valve is opening every cycle. At intermediate rpm the dicrotic notch is absent, suggesting that the aortic valve remains closed. Nevertheless, although the pulse pressure decreases compared to low rpm, the pulse remains pulsatile, proving that pulsatility is maintained through the pump by the changing the preload and pressure difference between the outflow (LVAD afterload) and inflow (LVAD preload) cannulae, irrespective of the flow through the LV outflow tract.

Reprinted from Frazier OH et al., *Circulation* 2002;105:2855–2860, with permission, ©Lippincott Williams & Wilkins.

(C) The trade-off between LV unloading and pulsatility of flow. On the left panel the Frank-Starling volume-pressure curve for a patient with LVAD shows that with increasing rpm (right lower arrow) end-diastolic volume decreases, resulting in decrease in peak LV pressure, while with lower rpm (right upper arrow) end-diastolic volume increases, resulting with higher peak LV systolic pressure.

In the middle panels we can see the aortic (purple) and LV (green) pressure curves with lower rpm (upper mid panel) and higher rpm (lower mid panel). In the right panels we can see the flow pattern in the outflow cannula with low (upper panel) and high (lower panel) rpm. With low rpm LV systolic pressure increases significantly (based on the Frank-Starling mechanism) but systolic aortic pressure increases only in a mild manner. Thus, with low rpm systolic LV (preload) to aortic (afterload) pressure difference is markedly reduced during systole, resulting in markedly increased systolic flow (right upper panel) and pulsatile flow pattern. With high rpm, systolic increase in LV pressure is attenuated, and the difference between LV pressure (LVAD preload) and aortic pressure (LVAD afterload) does not change significantly between systole and diastole. This results in a continuous flow pattern in the outflow cannula (right lower panel).



**Figure 26.2.** Parasternal and apical view in different rates of rpm. The upper figures show in long parasternal view the LV size, LV pressure, amount of functional MR, aortic valve opening status and pulsatility, and amount of flow in the outflow cannula at low (left figure), middle range (middle figure) and high (right figure) rpm. The middle figures show in apical view the LV size, RV size, position of inter ventricular and inter atrial septa, amount of functional TR, pulsatility of flow in the inflow cannula, and mitral inflow pattern at low (left figure), middle range (middle figure) and high (right figure) rpm. The middle lower figures show the flow pulsatility in the outflow cannula at low (left figure), middle range (middle figure), and high (right figure) rpm. The lower figures show the aortic valve opening status in M-mode at low (left figure), middle range (middle figure) and high (right figure) rpm.

AV opening due to variable left-sided stroke volumes. Nevertheless, the amount of blood left in the ventricle increases the native LV contractility through the Starling's response, and the LV is able to generate enough systolic

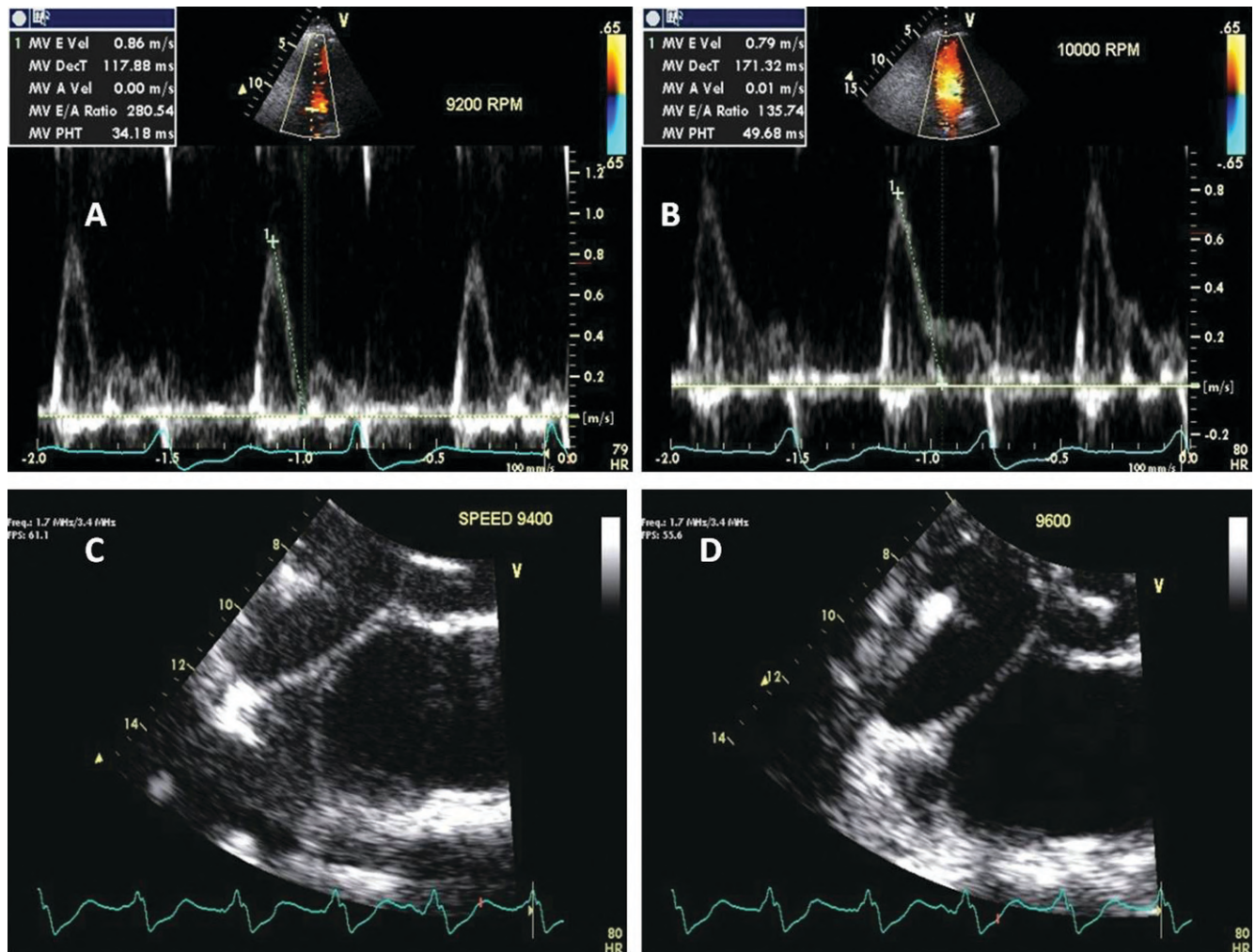
pressure to increase LVAD preload during systole, decrease the pump differential pressure, which in turn increases systolic pump flow even if the aortic valve remains closed, creating pulsatile systemic flow (Figures 26.1 and 26.2).

### LV and LA Unloading

Before surgery, LAVD patients have elevated LA and LV end-diastolic pressure, represented by short deceleration time (restrictive mitral inflow pattern).<sup>6,7</sup> In patients with systolic dysfunction, LV stiffness is load dependent and non-linear. It changes in relation to filling volume, analogous to the stiffness of a balloon in which the amount of pressure required to cause a given increase in volume increases as the volume of the balloon is increased. Once the LVAD is in place, LV volume decreases, stiffness declines, E/A ratio comes down (from restrictive to pseudo-normal to delayed relaxation pattern,<sup>8</sup> and deceleration time prolongs to the normal range (Figures 26.2 and 26.3).<sup>6</sup> Persistence of restrictive pattern (E/A >2 and deceleration time <150 msec) suggests insufficient LV unloading irrespective of aortic valve opening status (Figure 26.3).<sup>5,6,8</sup>

Several other variables have been evaluated for the assessment of optimal unloading of left-sided chambers. These include the change in LV dimension in end diastole (LVEDD), or end systole (LVESD) after LVAD implantation,<sup>9</sup> amount of functional mitral regurgitation,<sup>10</sup> or the position of the inter-atrial septum (IAS).<sup>6</sup> In patients with proper LV unloading, LV end-diastolic and end-systolic diameters are expected to decrease by 15%–20%.<sup>7</sup> Persistence of significant functional mitral regurgitation or diminished changes in LV size are usually associated with LVAD dysfunction or too low pump speed.<sup>10</sup>

Because the IAS is a thin membranous structure, its configuration is altered by minor changes in the inter-atrial pressure gradient. When LVAD function is suboptimal, LA pressure remains higher than the right, and the IAS configuration is convex toward the right atrium. Proper



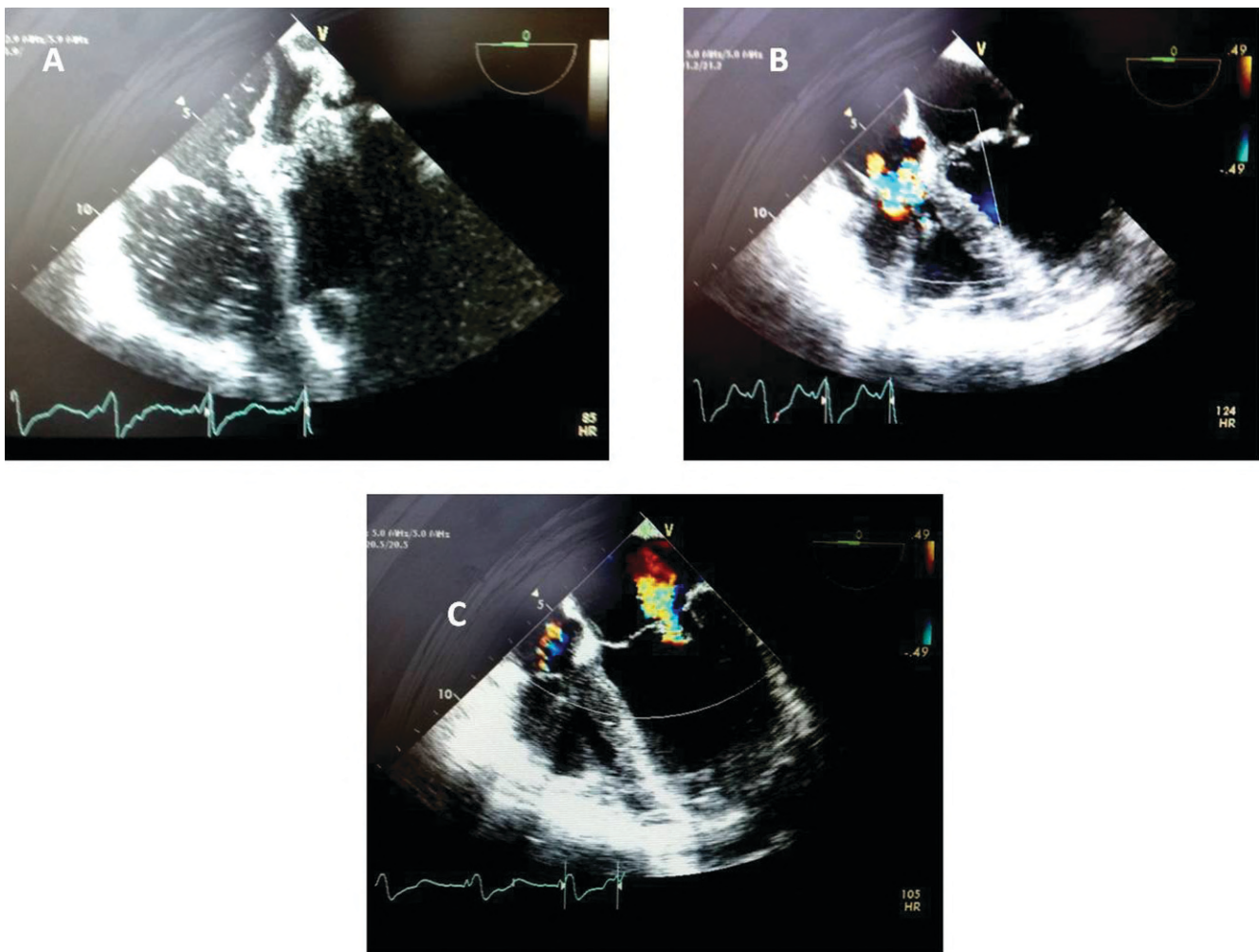
**Figure 26.3.** LV and LA unloading. The E deceleration time increases (from 117 to 171 msec) with increasing left ventricular assist device pump speed from 9,200 to 10,000 rpm (A to B) suggesting decrease in LV end-diastolic pressure and improved LV compliance. The inter-atrial septum changes position from deviated to right to deviated to left with increasing left ventricular assist device pump speed from 9,400 to 9,600 rpm (C to D), suggesting decrease in LA pressure.

unloading of LA pressure should result in neutralization of IAS position (if RA pressure is below 10 mmHg), or displacement of the IAS toward the left (if RA pressure is elevated)<sup>6,9</sup> (Figures 26.2 and 26.3).

### Hemodynamic Impact of the LVAD on Right-Sided Chambers

Right heart dysfunction (RHD) occurs in  $\approx 30\%$  of LVAD recipients, and contributes significantly to postoperative morbidity and mortality.<sup>11</sup> Continuous-flow pumps are directly connected to the LV. The LV, in turn, receives preload from the right ventricle (RV) through the pulmonary circulation. Thus, the output created by LVAD is limited

by RV output. Unloading of left heart chambers may result in a complex effect on RV function. Optimal unloading will decrease mean left atrial and mean pulmonary pressures, resulting in reduced RV afterload. Furthermore, it will increase the return of blood to the RV and optimize its preload, resulting in improved function and total output according to Starling's response.<sup>12</sup> However, excessive unloading will result in bowing of the inter-ventricular septum away from the right ventricle into the decompressed LV, and will reduce the efficiency of RV contraction by destabilizing the hinge upon which the RV contracts.<sup>5</sup> Moreover, the RV may receive excessive venous return, which in an RV working on the flat portion of Starling's



**Figure 26.4.** pRV dysfunction after LAVD: the “suction cascade.”

(A) Excessive LV unloading maintained the inter-ventricle septum in the leftward position. A sudden decrease in preload caused bowing of the inter-ventricular septum away from the right ventricle into the decompressed LV, reducing the efficiency of RV contraction by destabilizing the hinge upon which the RV contracts.

(B) RV dilatation results in tricuspid annular dilatation and tethering of tricuspid leaflets, culminating in severe acute tricuspid regurgitation.

(C) Adjustments in RPM lead to the reduction of the TR, improve RV function, and neutralization of inter-ventricular septal position but increase in functional mitral regurgitation.



curve will result in RV dilatation and severe functional tricuspid regurgitation, exacerbating RV dysfunction even further (Figure 26.4). Thus, maintaining the inter-ventricle septum in the midline position is essential and requires maintenance of adequate or appropriate LV volume. If cardiac output decreases because of lack of LV filling due to RV failure, high pulmonary resistance, or significant tricuspid regurgitation (TR), it is hazardous to attempt to improve the patient's condition by increasing pump speed. Without improvement in left ventricular inflow, increasing the speed will cause a further decrease in LV pressure and size, compounding the leftward septal shift. This further impairs RV function and increases TR severity, decreasing the already compromised LV size, which may result in ventricular arrhythmia.<sup>13</sup> This worsening spiral, sometimes referred to as the "suction cascade," may cause the septum to encroach upon the inflow cannula, increasing inflow velocities, but decreasing the LVAD preload even further. This requires immediate intervention to avoid a vicious cycle that can eventually lead to a fatal outcome (Figure 26.4).

## Role of Echocardiography in LVAD Patients

For purposes of simplicity, we will divide this section in three distinct parts: "Preoperative Assessment"; "Operative Assessment"; and "Postoperative Instability."

### Preoperative Assessment

#### Right Ventricular Function and TR

The central role of RV function has already been discussed, emphasizing the importance of RV evaluation before LVAD implantation. This evaluation allows for proper selection of patients and for planned RV support immediately after surgery in marginal patients.

Several methods are commonly used to evaluate RV function before LVAD implantation. The first is semi-quantitative assessment of RV function and dilatation, using the four chamber and inflow views. This assessment is based on visual appreciation of RV contraction.<sup>14</sup> Another method involves the calculation of RV fractional area change based on the following formula:  $\text{RV fractional area change} = (\text{RV diastolic area} - \text{RV systolic area}) / \text{RV diastolic area}$ , with RV diastolic and systolic areas traced in the four chamber views (Figure 26.5). An RV fractional area change (RVFAC) of <30% has a sensitivity of 82%, and specificity of 52% in predicting RV failure after LVAD implantation.<sup>14</sup> Recently we have shown that a short duration of TR time (corrected for heart rate) before LVAD implantation is associated with RV failure after surgery (Figure 26.5).<sup>15</sup> In patients with extreme RV failure, RV peak systolic, RV end systolic, and pulmonary artery end-diastolic pressures decrease secondary to the markedly diminished stroke

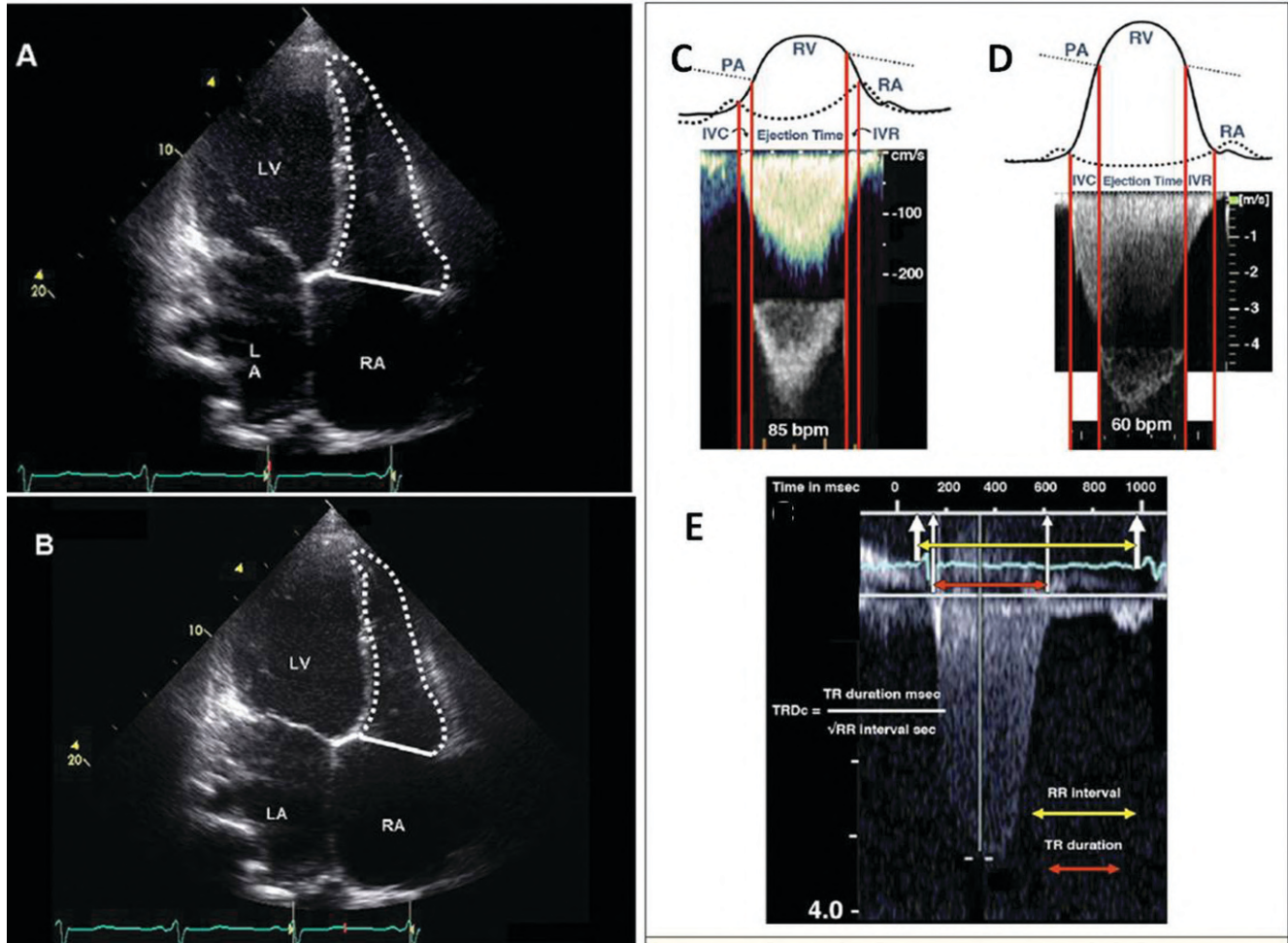
volume. On the other hand, end-diastolic RV pressure and end-systolic RA pressure (V wave) increase, due to RV diastolic dysfunction, decreasing the pressure differences from the time of tricuspid valve closure (RV end-diastolic pressure) to pulmonary valve opening (pulmonary artery end-diastolic pressure), and the time from pulmonary valve closure (RV end systolic pressure) to tricuspid valve opening (RA end systolic pressure), respectively. In other words, with severe RV dysfunction, the main determinant of TR time are the end-diastolic RV pressure, and end-systolic RA pressure, causing the tricuspid valve to close later and open earlier, thereby shortening TR period (Figure 26.5). Finally, the literature reporting on RV function using speckle tracking is growing. RV free-wall longitudinal strain predicted RV failure at a cutoff of less than  $-10\%$ .<sup>14</sup> For estimation of TR, a combination of qualitative and quantitative methods is used, as described previously.<sup>16</sup>

#### Aortic Regurgitation

Diagnosis and quantification of preoperative aortic regurgitation (AR) is crucial in patients receiving an LVAD. The LVAD draws blood from the LV and ejects it into the aorta, creating sub-physiologic LV systolic and diastolic pressures. The retrograde aorta to LV gradient increases and continues throughout the cardiac cycle, including most of the systolic phase (Figure 26.6). The combination of increased pressure gradient and exposure time results in high regurgitant volume after LVAD insertion. This in turn increases LVAD preload and causes secondary pump flow volume up-regulation. Pump output spirals up to very high levels, while actual systemic forward blood flow falls. The end result is a "futile cycle" consisting of high pump flow, low forward cardiac output, and high LV and LA pressures (Figure 26.6). Importantly, the degree of aortic regurgitation may be underestimated before LVAD implantation because of a decreased diastolic trans-valvular gradient secondary to the increased left ventricular diastolic pressure and low aortic diastolic pressure.

#### Patent Foramen Ovale (PFO)

Investigation of a patent foramen ovale (PFO) should always be performed before implantation of an LVAD. Pre-LVAD implantation LA pressure usually surpasses the RA pressure. After insertion of an LVAD, there is LV unloading with decrease of the LA pressure. This hemodynamic change, in association with maintained or increased right heart pressures, may uncover the existence of the PFO, usually with the use of intraoperative TEE. Those hemodynamic conditions can also favor a paradoxical embolism, which may result in stroke or even pump thrombosis. One of the serious and more common consequences of this sequence of events is the development of severe hypoxemia due to the significant right-to-left shunt, stressing the need to evaluate for PFO before and after LVAD implantation in the operating room.



**Figure 26.5.** Pre-surgical right ventricular function assessment. RV end diastolic area (A) and end systolic are (B) are traced in the 4-chamber view. RV fractional area change (RVFAC) is calculated by the formula:  $RVFAC\% = [(RVEDA - RVESA) / RVEDA] \times 100$ . RV efficiency can be assessed by Doppler using the RIMP ratio or tricuspid regurgitation time corrected for heart rate. (C) A patient with short tricuspid regurgitation (TR) duration. The increased right atrial (RA) pressure causes the tricuspid valve to open earlier, on the steeper curve of the ventricular relaxation curve, thereby shortening the isovolumic relaxation (IVR) interval and TR flow duration. Furthermore, a reduction in diastolic pulmonary artery (PA) to end-diastolic right ventricular (RV) pressure difference shortens the “isovolumic contraction (IVC) time.”

(D) Prolonged TR duration in another patient with end-stage dilated cardiomyopathy. The TR signal has a higher peak velocity and systolic RV pressure. The pressure in the right ventricle at the time of pulmonary valve closure must fall from a higher point to reach the pressure of the right atrium, lengthening the IVR period. Furthermore, the increase in diastolic pulmonary pressure to end-diastolic RV pressure difference lengthens the IVC period. Note that the TR signal ends with a concave, prolonged contour, consistent with a markedly delayed relaxation of the right ventricle.

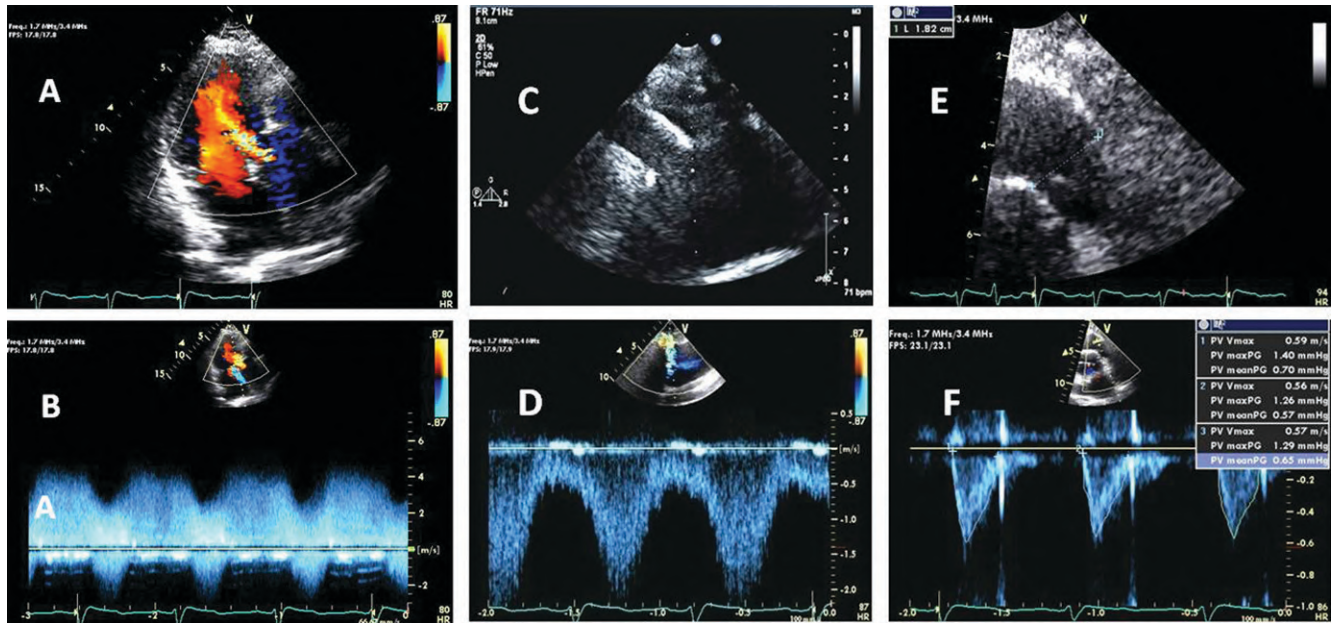
(E) Calculation of TR duration corrected for heart rate (TRDc). We first measure the time interval of the duration of the TR signal in milliseconds (red arrow, 450 ms). We then measure the RR interval in seconds using the electrocardiographic tracing (yellow arrow, 0.9 seconds). We then use the formula  $TRDc = TR \text{ duration} / \sqrt{RR \text{ interval}}$  ( $450 / \sqrt{0.9} = 473\text{ms}$ ).

Reprinted from Topilsky Y, Oh JK, Shah DK, et al., Echocardiographic predictors of adverse outcomes after continuous left ventricular assist device implantation, *JACC Cardiovasc Imaging*. 2011;4:211–222, with permission from Elsevier © American College of Cardiology Foundation.

### Operative Assessment

Operative echo evaluation is performed for two main purposes: (1) to evaluate the surgical results of the LVAD implantation; (2) to determine reasons for postoperative

hemodynamic compromises. Specifically, important routine postoperative imaging concerns include the following: (1) overall structure and function of left heart chambers; (2) quantification of RV function and TR; (3) mitral and



**Figure 26.6.** Aortic regurgitation. (A) Blood is pumped from the LV into the aorta, creating sub-physiological LV pressures and increasing aortic regurgitation. (B) The retrograde aorta to LV gradient continues throughout the cardiac cycle, including most of the systolic phase. (C, D) Pump flow is estimated by measuring the outflow cannula diameter in the parasternal view, calculating its surface area (C). Second, we measure the outflow cannula flow integral by pulsed-wave Doppler 1 cm proximal to its anastomosis to the aorta (D). We then calculate the pump flow using the equation  $LVAD\ output = (cannula\ diameter/2)^2 \times \pi \times cannula\ flow\ time-velocity\ integral\ (TVI) \times heart\ rate\ (HR)$ . (E, F) For total cardiac output estimation, we measure the RVOT diameter in the short-axis view on the level of large vessels (E) and calculate its surface area. (F) Second, we measure the RVOT flow integral by pulsed-wave Doppler in the same view. We then calculate the total cardiac output by multiplying these measurements by the heart rate. The difference between the pump flow and forward flow is the regurgitant volume, representing a futile cycle consisting of high pump flow, low forward cardiac output.

aortic regurgitation; (4) pump flow and total cardiac output; (5) inflow cannula; and (6) outflow cannula.

#### Postoperative Evaluation of Left Heart Chambers

After LVAD insertion, the LV and the LA are unloaded with a reduction in their size.<sup>5,7</sup> Neutral inter-ventricular and neutral or slight leftward inter-atrial septa position indicates adequate LV and LA decompression<sup>7</sup> (Figures 26.3 and 26.4). If the LV and LA are not decompressed after LVAD implantation, suspicion of insufficient device ejection or cannula obstruction should be immediately raised. In contrast, extreme inter-ventricular leftward septal shift may indicate excessive decompression due to high pump rpm, significant tricuspid regurgitation, or RV dysfunction<sup>6</sup> (Figure 26.4).

#### Right Ventricular Function and TR

Up to one-third of patients will present with variable degrees of RV dysfunction following surgery.<sup>11</sup> This stresses the importance of a thorough re-examination of RV function and TR severity after LVAD insertion. The postoperative examination should follow the same protocol described in the pre-LVAD examination section. Once identified, TR severity should be assessed during pump

flow adjustments. Such adjustments not only lead to the reduction of the TR, but can also improve RV function.

#### Assessment of Aortic and Mitral Regurgitation

Estimation of AR severity should be part of every echo evaluation as it may deteriorate secondary to the closed aortic valve encountering high retrograde pressure gradient, continued throughout the cardiac cycle. The most commonly used methods are visual estimation by color Doppler, the ratio of AR jet area to the short axis area of the LVOT at the level of the aortic annulus, and the width of the regurgitant jet at its origin relative to the dimension of the LVOT in the parasternal long-axis view.<sup>5,16</sup>

For mitral regurgitation (MR), in a normally functioning LVAD system, functional MR is expected to decrease significantly.<sup>10</sup> When MR persists, a thorough evaluation of its cause should be performed. Whenever significant functional MR is encountered, a trial of increasing rpm under echo guidance can be tried.<sup>10</sup>

#### Inflow Cannula Evaluation

The inflow cannula and its orientation within the left ventricular apex should be imaged on the four- and

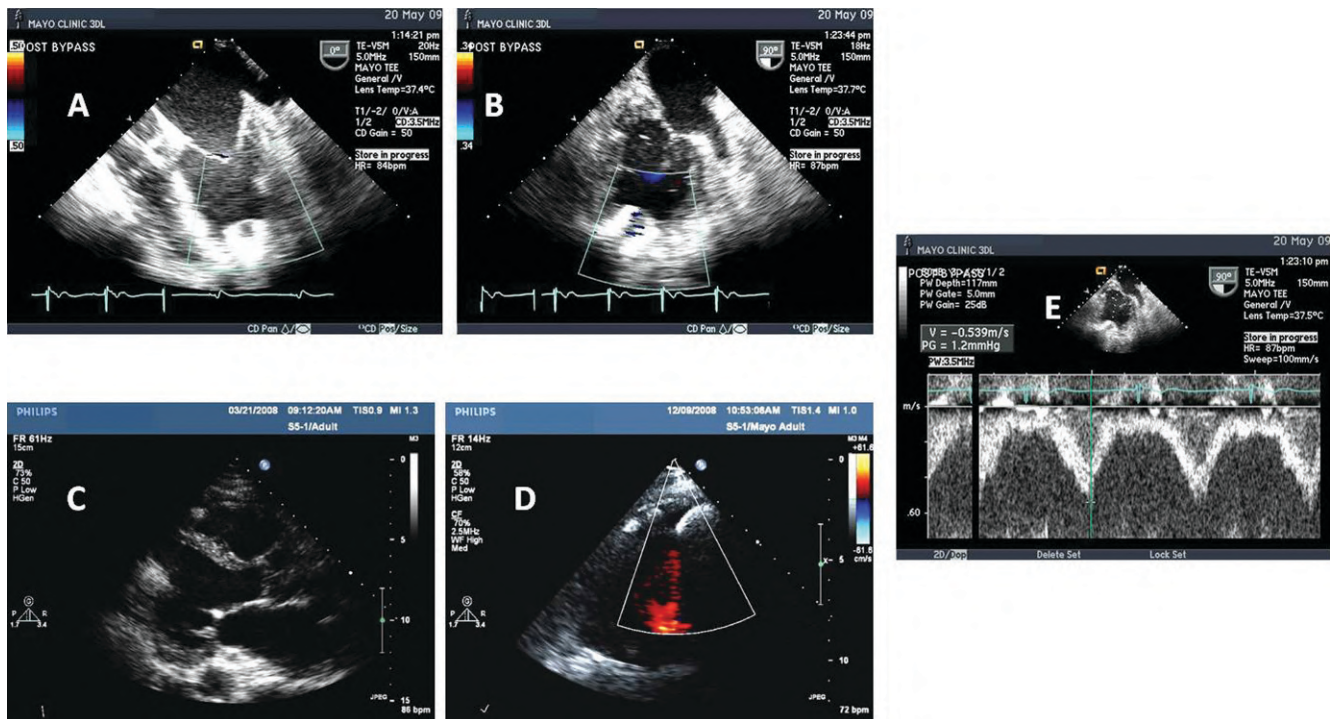
two-chamber views, parasternal; it sometimes requires off-axis imaging as well. The cannula should be aligned with the LV inflow tract. A properly aligned inflow cannula should have a laminar and unidirectional flow from the ventricle to the device. Continuous-wave Doppler is used for measurement of the maximal velocity along the inflow pathway from the ventricle to the LVAD. Maximal systolic and diastolic velocities should be recorded using Doppler, and the ratio of systolic to diastolic inflow velocities is calculated. Peak inflow velocities should be  $<2.0$  m/sec and typically are  $<1.5$  m/sec<sup>7</sup> (Figure 26.7). High velocity or turbulent flow suggests obstruction of the inflow cannula.

As discussed previously, the flow pattern in the inflow cannula will normally be pulsatile because the pump inflow originates from the beating LV, resulting in periodic changes

in flow throughout the cardiac cycle, reaching a maximum during systole, and minimum during diastole.<sup>17</sup>

### Outflow Cannula

Interrogation of the outflow cannula is technically challenging. In TTE we advocate the use of (1) high left parasternal long-axis view, which shows the end-to-side anastomosis of the outflow cannula to the mid ascending aorta; (2) right parasternal view, with the patient lying on his/her right side, which shows the long axis of the outflow cannula traversing from the pump toward the right aspect of the ascending aorta. Color flow, pulsed wave (PW), and continuous wave (CW) Doppler are used to evaluate flow patterns of the outflow cannula. To measure flow velocity in the outflow graft, the PW sample volume should be at least 1 cm proximal



**Figure 26.7.** Inflow cannula.

(A) Proper inflow cannula orientation within the left ventricular apex in the trans-esophageal, mid-esophageal four-chamber view. The cannula is aligned with the LV inflow tract.

(B) Proper inflow cannula orientation within the left ventricular apex in the trans-esophageal, mid-esophageal two-chamber view. The cannula is aligned with the LV inflow tract in this orthogonal view. Color Doppler shows a laminar and unidirectional flow from the ventricle to the device.

(C) Proper inflow cannula orientation within the left ventricular apex in the trans-thoracic parasternal long axis view. The cannula is aligned with the LV inflow tract, and LV diameter is small suggestive of proper LV evacuation through the inflow cannula.

(D) Proper inflow cannula orientation within the left ventricular apex in the trans-thoracic four-chamber view. The cannula is aligned with the LV inflow tract, and color Doppler shows a laminar and unidirectional flow from the ventricle to the device.

(E) Pulsed-wave Doppler is used for measurement of the maximal velocity along the inflow pathway from the ventricle to the LVAD, and the ratio of systolic to diastolic inflow velocities is calculated. Peak inflow velocities should be  $<2.0$  m/sec and typically are  $<1.5$  m/sec. Pulsed Doppler signal is laminar, with no regurgitation.

to the aortic anastomosis. The peak velocity in the outflow graft in continuous flow pumps usually ranges from 0.5 to 2.0 m/s, with unidirectional and slightly pulsatile flow,<sup>7,18</sup> dependent on LVAD output and speed. This pattern is present even when the aortic valve does not open (Figure 26.8).

### Pump Flow and Total Cardiac Output

Pump flow, although it can be extracted from the device controller, must be directly evaluated during echo. Measuring the outflow cannula diameter in the right parasternal view, calculating its surface area (diameter<sup>2</sup> × 0.785), and multiplying it times the outflow cannula time-flow velocity-integral and heart rate is the most reproducible method<sup>7</sup> (Figure 26.6). For total cardiac output we should measure the right ventricular outflow tract (RVOT) diameter in the

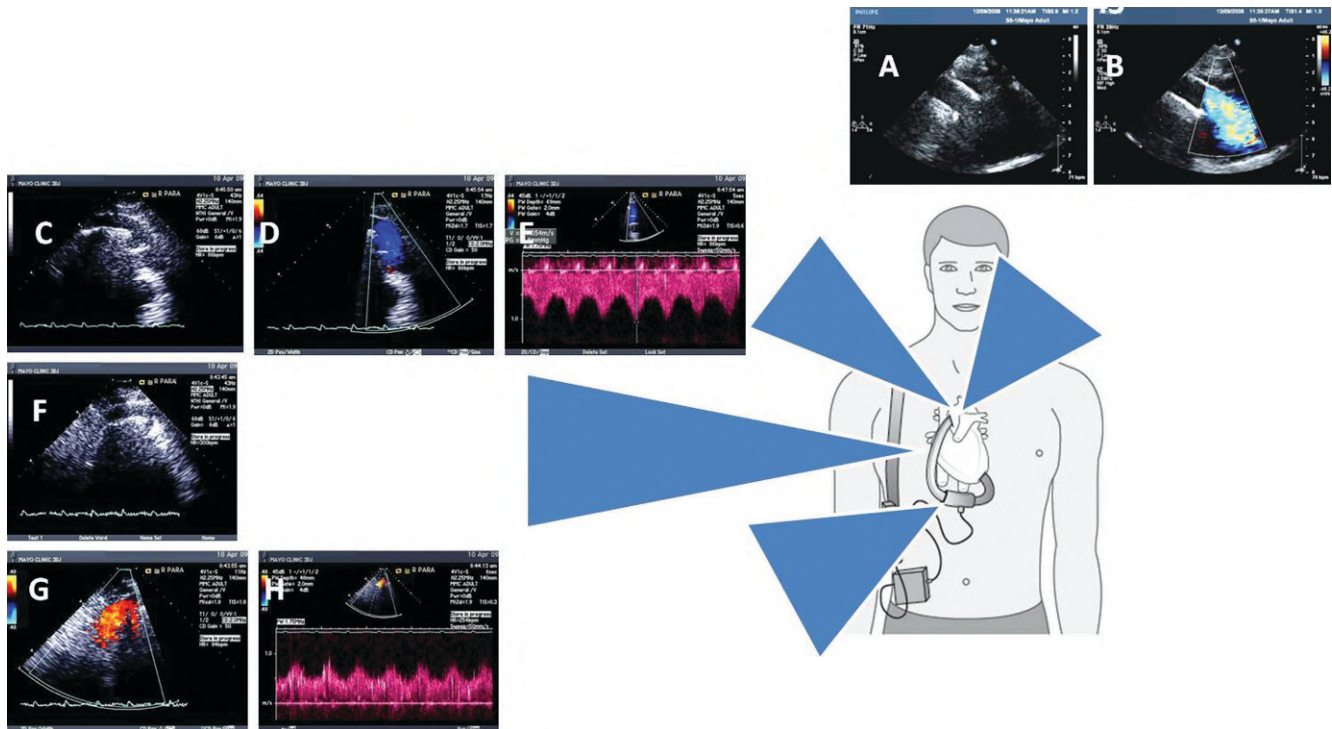
short-axis view on the level of aortic valve and calculate its surface area. The result is multiplied by the integral of flow in the RVOT (on the same view) and the heart rate.<sup>8</sup>

### Postoperative Instability

The most common reasons for hemodynamic instability during the first postoperative days are hypovolemia, acute RV dysfunction, cardiac tamponade, and LVAD dysfunction, most commonly secondary to impeller thrombosis or cannula kinking.<sup>19, 20</sup>

### Hypovolemia

In patients with LVAD, evidence of hypovolemia will be similar to that in patients without LVAD. The inferior vena

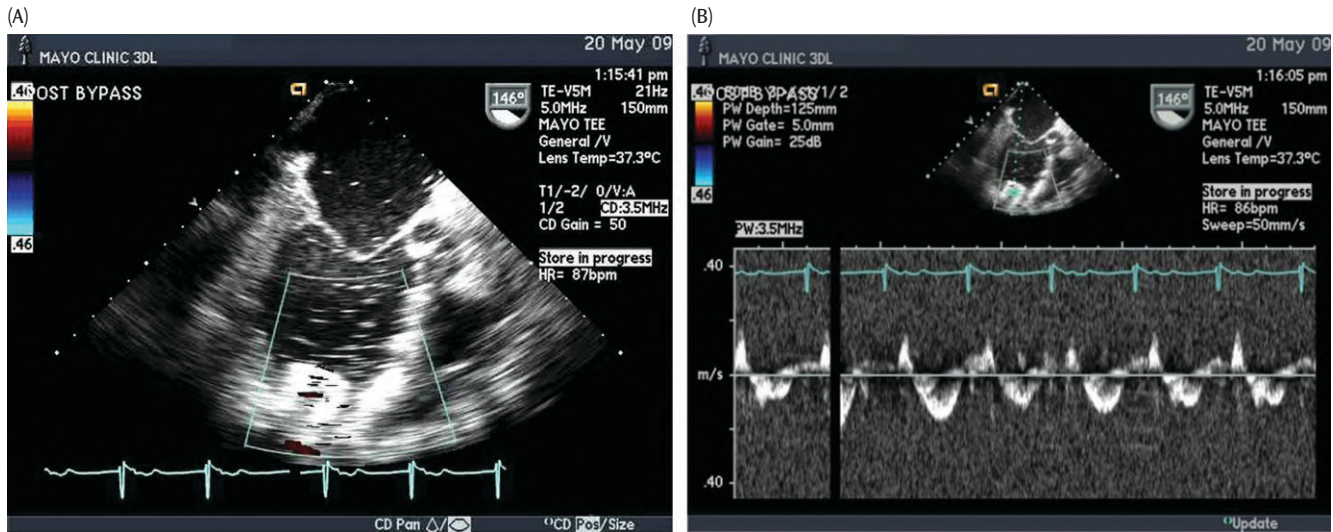


**Figure 26.8.** Outflow cannula. Interrogation of the outflow cannula in the high left parasternal long-axis view showing the end-to-side anastomosis of the cannula to the mid ascending aorta with and without color Doppler (A, B). Note that the color Doppler shows the typical continuous color flow pattern away from the transducer (blue) coming from the pump toward the distal outflow cannula.

Interrogation of the outflow cannula in the high right parasternal view (positioned in the second inter costal space), with and without color Doppler (C, D). Note that the color Doppler shows the typical continuous color flow pattern away from the transducer (blue) when the outflow cannula is bending toward the ascending aorta. (E) This is usually the best view to measure flow velocity, with the pulsed-wave sample (the angle of interrogation will be optimal) positioned 1 cm proximal to the aortic anastomosis and the flow moving away from the transducer.

We then continue to follow the outflow cannula along the right side of the sternum as it transverses toward the ascending aorta (F). In the mid-sternum, the cannula is parallel to the transducer.

We continue to follow the outflow cannula to the low parasternal area (G) so that the color Doppler shows the typical continuous color flow pattern toward the transducer (red) coming from the pump toward the proximal outflow cannula. (H) Sometimes this is the best view to measure flow velocity, with the flow moving toward the transducer.



**Figure 26.9.** Postoperative instability LVAD thrombosis.

(A) A patient with a remote history of left atrial thrombus developed shock in the operating room immediately after LVAD was started. Mid trans-esophageal view shows rightward deviation of the inter-ventricular septum and apical tethering of the mitral leaflets. With acute catastrophic impeller thrombosis the pump's impeller does not rotate; the LVAD system operates as a conduit connecting the ascending aorta to the left ventricular apex. Because diastolic aortic pressure is higher than left ventricular diastolic pressure, the pressure difference reverses the flow from the ascending aorta through the outflow and inflow cannula and into the LV apex (red instead of the normal blue in TEE).

(B) Doppler of the inflow cannula in the same patient as in (A), showing reversal of flow during end diastole.

cava will be collapsed, LV and RV sizes will be small, and mitral inflow will resemble the delayed relaxation pattern with low E wave velocity and prolonged deceleration time.

#### Acute RV Dysfunction

Acute RV dysfunction will manifest itself in the previously described “suction cascade,” including a dilated hypo-contractile RV, worsening TR, small LV size, and intermittent inflow cannula obstruction by the collapsed LV (Figure 26.4).

#### Postoperative Tamponade

This is a common complication after implantation of LVAD and may be difficult to diagnose. Contrary to classic tamponade, in which reciprocal respiratory changes in the RV and LV relationship are common, these hemodynamic characteristics may be masked by LVAD action.<sup>20</sup> In patients with LVAD, tamponade should be suspected whenever pump flows are decreased and right filling pressures are increased, especially if not responsive to a fluid challenge. Blood collections may be confined to a small area, compressing a particular chamber. Right or left atrial tamponade can occur with very small collections of blood.<sup>20</sup>

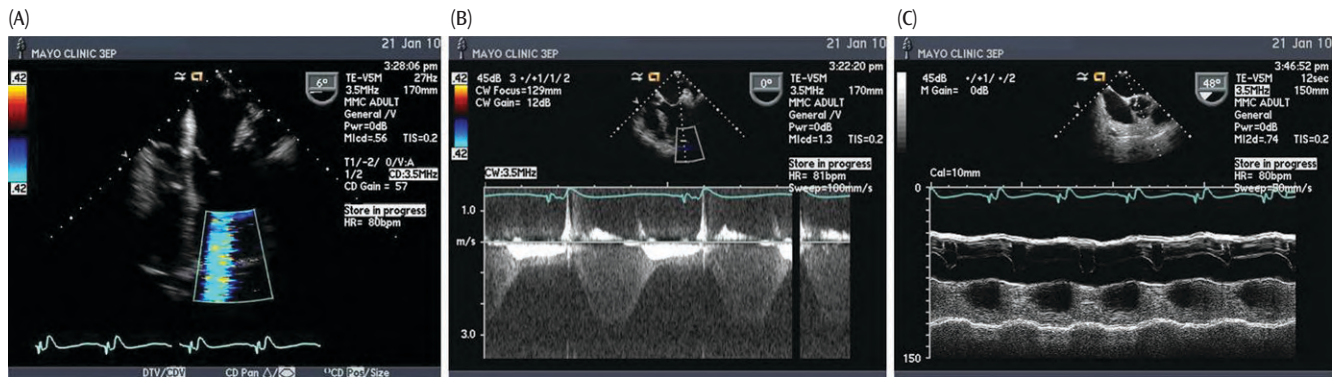
#### Impeller Thrombosis

LVAD thrombosis should be suspected with the following combination of findings: (1) rightward deviation of the

inter-ventricular and inter-atrial septum due to deficient unloading of the LV and left atrium; (2) significant functional MR; (3) aortic valve opening every cardiac cycle; (4) decreased LVAD flow; (5) increased systolic/diastolic (S/D) flow velocity ratio in the inflow and outflow cannula because with inefficient unloading even a severely depressed LV will generate some systolic contraction that will decrease the pump differential pressure, which in turn increases inflow and outflow cannula pulsatility; (6) laboratory clues suggesting intravascular hemolysis (elevated LDH, plasma hemoglobin, and bilirubin and decreased haptoglobin levels).<sup>9,17</sup> In extreme cases the flow through the inflow cannula may reverse in diastole when aortic pressure exceeds LV pressure (Figure 26.9).

#### Cannula Kinking or Obstruction

Inflow or outflow cannula obstruction or kinking (Figure 26.10) should be suspected with the following combination of findings: (1) rightward deviation of the inter-ventricular and inter-atrial septum due to deficient unloading of the LV and left atrium; (2) significant functional MR; (3) aortic valve opening every cardiac cycle; (4) decreased LVAD flow; (5) color Doppler profile demonstrating a turbulent flow in the inflow/outflow cannula; (6) increase in inflow/outflow cannula systolic velocity (above 2 m/s) with partial occlusion or low flow with total occlusion.<sup>5</sup>



**Figure 26.10.** Inflow cannula kinking. A patient developed shock with a palpable radial pulse immediately after LVAD implantation. He was hurried back to the operating room and trans-esophageal echo was performed showing rightward deviation of the inter-ventricular septum, apical tethering of the mitral leaflets, and aortic valve opening every cardiac cycle.

(A) Color Doppler demonstrates a turbulent flow in the inflow cannula.

(B) Doppler interrogation of the inflow cannula shows an increase in inflow cannula systolic velocity (reaching 3 m/s). (C) M mode of the aortic valve shows wide opening of the valve every cycle. The patient performed cardiac CT showing intermittent obstruction of the cannula by adjacent myocardial trabeculations.

## Summary

Precise echo monitoring is mandatory to evaluate the performance of continuous-flow LVADs. This evaluation is essential for surgical planning and interventional success. Standard echo techniques allow optimal LVAD settings during routine follow-up visits and rapid and accurate evaluation of mechanical or systemic malfunctions.

## REFERENCES

- Aaronson KD, Slaughter MS, Miller LW, et al. Use of an intrapericardial, continuous-flow, centrifugal pump in patients awaiting heart transplantation. *Circulation*. 2012;125(25):3191–3200.
- Miller LW, Pagani FD, Russell SD, et al. Use of a continuous-flow device in patients awaiting heart transplantation. *N Engl J Med*. 2007;357(9):885–896.
- Slaughter MS, Rogers JG, Milano CA, Russell SD, Conte JV, Feldman D, et al. Advanced heart failure treated with continuous-flow left ventricular assist device. *N Engl J Med*. 2009;361(23):2241–2251.
- Topilsky Y, Maltais S, Oh JK, et al. Focused review on transthoracic echocardiographic assessment of patients with continuous axial left ventricular assist devices. *Cardiol Res Pract*. 2011;2011:187434.
- Estep JD, Chang SM, Bhimaraj A, Torre-Amione G, Zoghbi WA, Nagueh SF. Imaging for ventricular function and myocardial recovery on nonpulsatile ventricular assist devices. *Circulation*. 2012;125(18):2265–2277.
- Topilsky Y, Hasin T, Oh JK, et al. Echocardiographic variables after left ventricular assist device implantation associated with adverse outcome. *Circ Cardiovasc Imaging*. 2011;4(6):648–661.
- Topilsky Y, Oh JK, Atchison FW, et al. Echocardiographic findings in stable outpatients with properly functioning HeartMate II left ventricular assist devices. *J Am Soc Echocardiogr*. 2011;24(2):157–169.
- Estep JD, Vivo RP, Krim SR, et al. Echocardiographic evaluation of hemodynamics in patients with systolic heart failure supported by a continuous-flow LVAD. *J Am Coll Cardiol*. 2014;64(12):1231–1241.
- Uriel N, Han J, Morrison KA, et al. Device thrombosis in HeartMate II continuous-flow left ventricular assist devices: a multifactorial phenomenon. *J Heart Lung Transplant*. 2014;33(1):51–59.
- Topilsky Y, Hasin T, McGregor CG, Park SJ. Mitral valve regurgitation in patients supported on continuous flow pumps. *Echocardiography*. 2011;28(10):E202–E204.
- Dang NC, Topkara VK, Mercado M, et al. Right heart failure after left ventricular assist device implantation in patients with chronic congestive heart failure. *J Heart Lung Transplant*. 2006;25(1):1–6.
- Lam KM, Ennis S, O'Driscoll G, Solis JM, Macgillivray T, Picard MH. Observations from non-invasive measures of right heart hemodynamics in left ventricular assist device patients. *J Am Soc Echocardiogr*. 2009;22(9):1055–1062.
- Vollkron M, Voitl P, Ta J, Wieselthaler G, Schima H. Suction events during left ventricular support and ventricular arrhythmias. *J Heart Lung Transplant*. 2007;26(8):819–825.
- Hayek S, Sims DB, Markham DW, Butler J, Kalogeropoulos AP. Assessment of right ventricular function in left ventricular assist device candidates. *Circ Cardiovasc Imaging*. 2014;7(2):379–389.
- Topilsky Y, Oh JK, Shah DK, et al. Echocardiographic predictors of adverse outcomes after continuous left ventricular assist device implantation. *JACC Cardiovasc Imaging*. 2011;4(3):211–222.
- Zoghbi WA, Enriquez-Sarano M, Foster E, et al. Recommendations for evaluation of the severity of native valvular regurgitation with two-dimensional and Doppler echocardiography. *J Am Soc Echocardiogr*. 2003;16(7):777–802.

17. Fine NM, Topilsky Y, Oh JK, et al. Role of echocardiography in patients with intravascular hemolysis due to suspected continuous-flow LVAD thrombosis. *JACC Cardiovasc Imaging*. 2013;6(11):1129–1140.
18. Catena E, Milazzo F, Merli M, et al. Echocardiographic evaluation of patients receiving a new left ventricular assist device: the Impella recover 100. *Eur J Echocardiogr*. 2004;5(6):430–437.
19. Catena E, Milazzo F, Montorsi E, et al. Left ventricular support by axial flow pump: the echocardiographic approach to device malfunction. *J Am Soc Echocardiogr*. 2005;18(12):1422.
20. Topilsky Y, Price TN, Atchison FW, Joyce LD. Atypical tamponade hemodynamic in a patient with temporary left ventricular assist device. *Interact Cardiovasc Thorac Surg*. 2011;12(5):832–834.



# Implantation of Continuous-Flow Left Ventricular Assist Devices via Sternotomy Technical Considerations

ANDREW SHAFFER AND RANJIT JOHN

## Preoperative Testing

**P**reoperative assessment of LVAD candidates should include a thorough history and physical. Comprehensive laboratory studies including complete blood count, comprehensive metabolic panel, coagulation studies, urinalysis, type and cross for blood components, and baseline lactate dehydrogenase are necessary. Imaging studies including posterior-anterior (PA) and lateral chest X-ray, as well as a computed tomography (CT) scan of the chest, abdomen, and pelvis, provide an important baseline imaging assessment and assist in the preparation for redo surgical procedures. Diagnostic imaging studies including a recent coronary angiogram and transthoracic (or transesophageal) echocardiogram are important. Right heart catheterization provides a baseline assessment of right heart function, pulmonary vascular resistance, and cardiac index. Patients should have a physiologic assessment that includes pulmonary function testing, cardiopulmonary exercise testing, and a 6-minute walk test performed to assess for degree of limitation due to cardiac disease as opposed to other confounding diagnoses.

Preventative health examinations should be up to date for any patient undergoing LVAD implantation. Routine dental care and an assessment for dental carries/abscesses should be performed. Patients older than 50 years should have a current screening colonoscopy. Men should have prostate specific antigen checked (or prostate exam). Women over 40 years old should have current mammography and PAP smears performed. Pre-menopausal women should have beta-HCG (human chorionic gonadotropin) checked.

A psychosocial evaluation by a clinically specialized psychiatrist should be performed, along with an

evaluation by a social worker familiar with the demands on the patient after LVAD implantation. Insurance assessment and prior authorization for reimbursement are necessary to maintain financial viability as a program, and to prevent placing an onerous financial burden on the patient.

A visit with a specialized LVAD coordinator is important to begin educating the patient on the basics of LVAD management, and to assess for appropriate power supply in the patient's home.

Finally, a decision regarding intended aim of therapy (i.e., bridge to transplant vs. destination therapy vs. recovery) is necessary for reimbursement purposes, and to frame appropriate expectations of therapy.<sup>1</sup>

## Preoperative Preparation and Planning

After preoperative assessment and approval by a multidisciplinary selection committee, a concise operative plan should be developed before proceeding to the operating room.<sup>2,3,4</sup> Encountering patients with a history of prior sternotomy is quite common when preparing for LVAD surgery. Reviewing the prior operative report is always well advised, and these patients should typically have a contrast-enhanced CT scan performed of the chest and abdomen. The surgeon should evaluate the images with careful consideration of the key structures which may be prone to injury, including the innominate vein, aorta, right ventricle, and prior bypass grafts, as well as an evaluation of the number and location of sternal wires. Patients with a previously placed mechanical aortic valve will require oversewing with a pericardial patch or bioprosthetic replacement of the valve.

The surgeon should then plan an appropriate cannulation strategy. Patients without previous sternotomy can be cannulated centrally with ease. When undertaking LVAD implant for patients with a prior sternotomy, the surgeon can frequently cannulate centrally. Depending on expected difficulty and potential of inadvertent vascular injury, the surgeon can prepare for femoral cannulation. This can vary from having the groins marked, preemptive placement of an arterial and venous angiocatheter, planned exposure of the femoral vessels, or cannulation with initiation of cardiopulmonary bypass (CPB) prior to opening the chest.

Standard LVAD placement can be accomplished with a single venous cannula for drainage and a central aortic cannula of surgeon preference. Patients with right-sided cardiac lesions (i.e., patent foramen ovale [PFO] or severe tricuspid regurgitation) should have these lesions repaired during the index procedure. This will require bicaval venous cannulation with snaring of the superior vena cava (SVC) and inferior vena cava (IVC) to permit full CPB.

LVAD implantation is ideally performed on a non-arrested beating heart. However, patients with moderate or greater aortic insufficiency should have this lesion repaired to prevent formation of a circulatory loop. These patients

will require a brief period of aortic cross-clamp, cardioplegic arrest, and standard LV decompression (LV vent placement).

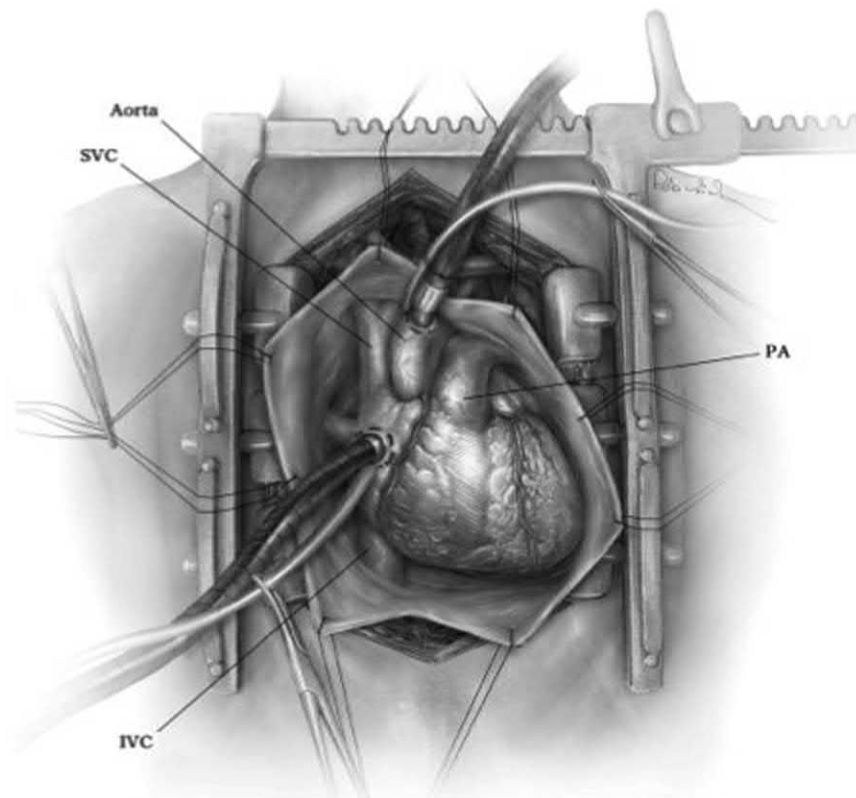
Our standard CBP setup is diagramed in Figure 27.1. We routinely use a three-stage venous cannula for drainage and a 18-22 Fr EOPA aortic cannula. Visualization of the surgical field is aided by three cardiotomy suction lines.<sup>1</sup>

## Anesthesia Considerations

The majority of patients will transfer from the intensive care unit with central IV access, swan ganz catheter, and an arterial line in place. If there are any concerns related to adequate vascular access, these will be addressed prior to starting the case. Patients undergo standard general anesthetic induction with endotracheal intubation using a single lumen endotracheal tube.

LVAD recipients are given a significant regimen of preoperative antibiotics that typically includes vancomycin, zosyn, and rifampin.

Maintaining adequate perfusion pressure during induction is important to prevent hemodynamic collapse. The majority of our patients will present to the OR with an intra-aortic balloon pump in place, and inotropic or vasopressor supplementation may be necessary in many cases.



**Figure 27.1.** Median sternotomy, operative setup, and cannulation strategy for LVAD implant.

Reprinted from John RJ et al., Implantation of continuous-flow ventricular assist devices: technical considerations, *Operative Techniques in Thoracic and Cardiovascular Surgery* 2012;17:143–153, Copyright (2012), with permission from Elsevier.

Transesophageal echocardiography (TEE) is routinely performed during LVAD procedures in order to evaluate for cardiac pathology that will require repair at time of the LVAD implant (i.e., PFO, tricuspid regurgitation, or aortic regurgitation). TEE is mandatory for assessment of right ventricular function, left ventricular volume load, inflow cannula position, tricuspid regurgitation, and final bubble study at separation from CPB.

## Positioning, Sterile Prep, and Draping

Patients are positioned supine on the operating table with a shoulder roll placed to optimize exposure. We routinely place external defibrillator pads, especially on patients who have undergone prior sternotomy. The patient is prepped from chin to toes in sterile fashion using chlorhexadine-based surgical scrub. Draping should be performed to allow access to the lower neck (helpful in redo sternotomies) and access to the lateral aspect of the upper abdomen (which aids in driveline placement). Additionally, access to both groins should be available.

## Cardiopulmonary Bypass Configuration

Our standard practice during LVAD surgery is to use CPB assistance and a non-arrested beating heart. CPB time can be minimized by creation of the LVAD pump pocket, sewing of the outflow graft, and tunneling of the driveline prior to institution of CPB.

### Off-Pump LVAD Implant

We routinely perform all LVAD implants using CPB, due to the stable hemodynamic picture it avails with minimal adverse effects throughout the course of implant. Off-pump LVAD implant has been reported and is performed selectively at certain centers. The benefits of off-pump LVAD implant include minimization of adverse effects associated with CPB, less manipulation of vascular structures, and shorter operative times.

## Choice of Incision

### Sternotomy

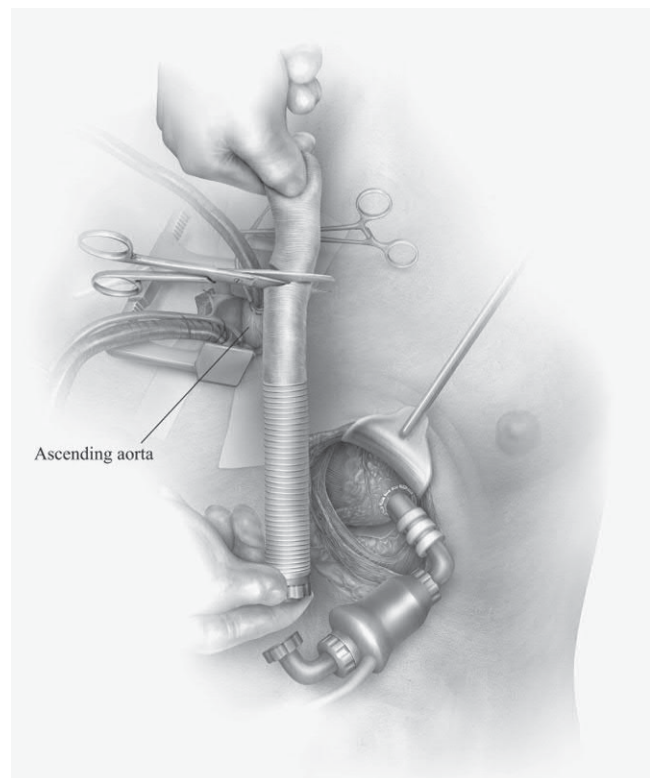
We routinely perform all LVAD implants using full median sternotomy. For first-time sternotomy implants, this allows quick access and excellent exposure to all cardiac structures. For redo surgeries, median sternotomy is the only safe option available for implant. Recovery after median sternotomy is tolerated quite well, despite a common misperception of cardiologists and patients.<sup>1</sup>

## Minimally Invasive LVAD Implant

Minimally invasive LVAD implant (Figure 27.2) is gaining in popularity.<sup>6</sup> This is performed using femoral cannulation for CPB. The apex of the heart is accessed by making a small anterolateral left thoracotomy, or subcostal incision. The apical core and inflow cannula placement are performed through this incision. A small right anterior thoracotomy, or partial upper hemisternotomy, is used to gain access to the ascending aorta or right axillary artery. The outflow graft is anastomosed to the ascending aorta in the standard fashion. The outflow graft is passed anterior to the heart, using care to not twist the graft while passing. Initiation of CPB will decompress the heart and aid in passing the graft within the pericardium (Figure 27.3).<sup>2</sup>

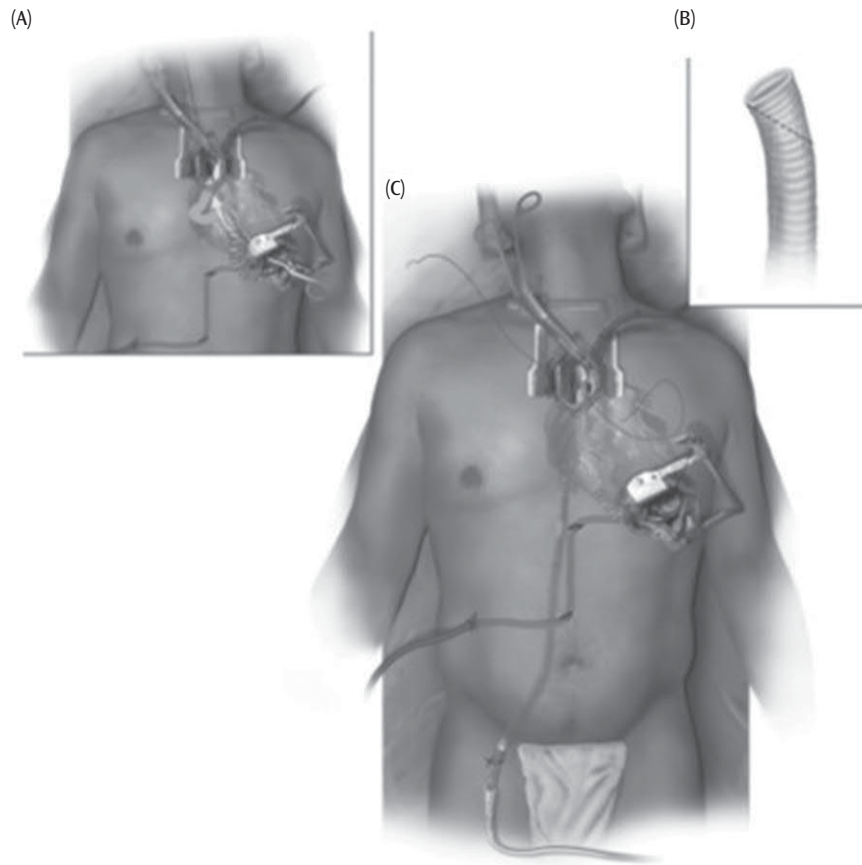
## Creation of LVAD Pump Pocket

For the HeartMate II (HMII) LVAD, the exposed part of the diaphragm is cauterized as far lateral into the left chest as possible, along the line created by the pericardial



**Figure 27.2.** Minimally invasive HeartMate 2 LVAD implant.

Reprinted from Anyanwu AC, Nonsternotomy approaches to left ventricular assist device placement: combined left subcostal-right minithoracotomy technique, *Operative Techniques in Thoracic and Cardiovascular Surgery* 2014;19:254–275, Copyright (2014), with permission from Elsevier.



**Figure 27.3.** Non-sternotomy LVAD implant. The outflow vascular graft is distally tied and tunneled extrapericardially and retrosternally toward the ascending aorta. A partial cross clamp is placed on the ascending aorta. (A) The graft is measured, cut obliquely. (B) The anastomosis with the ascending aorta is performed using a continuous 4-0 prolene (C).

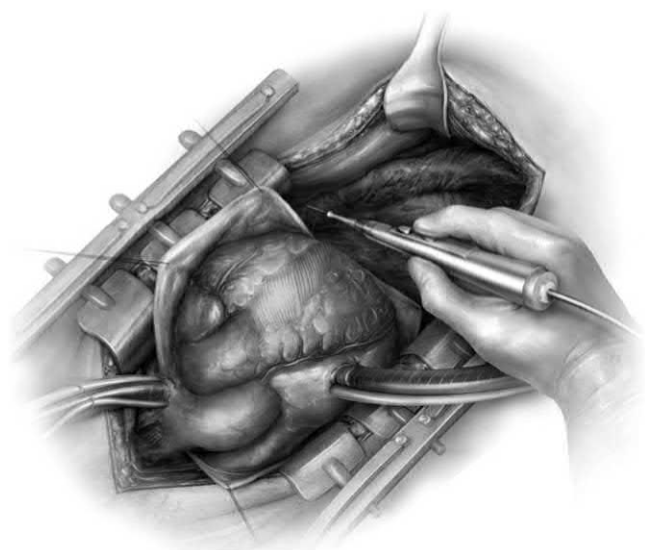
Reprinted from Schmitto JD et al., Minimally invasive implantation: the procedure of choice, *Operative Techniques in Thoracic and Cardiovascular Surgery* 2016;21:65–78, Copyright (2016), with permission from Elsevier.

reflection. Care should be taken to not create a defect in the peritoneum just deep to this muscle layer. The rectus fibers can be divided medially in order to allow the HMII device to sit in a preperitoneal position. Creation of this pocket as inferior as possible will allow for the best orientation of the inflow and outflow cannulas after pump placement. Additionally, it is often helpful to incise the pericardium laterally to create a window into the left chest.

The HeartMate 3 and HVAD devices can be placed intra-pericardially without the need for pump pocket dissection. For these devices, pump position can be optimized by extension of the pericardial opening along the pericardial reflection laterally. At the lateral aspect of the pericardium a 8–10-cm notch is created posteriorly. This notch provides room for the pump to sit and creates a hammock for the pump to sit in (Figure 27.4).<sup>1</sup>

### Inflow Cannula Placement

Inflow cannula positioning is perhaps the most crucial step in LVAD implantation technique. Correct positioning of the inflow cannula provides the best chance for ideal



**Figure 27.4.** Creation of LVAD pump pocket.

Reprinted from John RJ et al., Implantation of continuous-flow ventricular assist devices: technical considerations, *Operative Techniques in Thoracic and Cardiovascular Surgery* 2012;17:143–153, Copyright (2012), with permission from Elsevier.

performance of the pump by minimizing the risk of septal contact, thrombus formation, or ventricular wall contact. Ideal positioning will orient the inflow cannula toward the mitral valve and parallel to the ventricular septum.

The LV apex is exposed by elevating the heart. The heart can be kept in position by placing several laparotomy pads in the pericardial well. Ideal positioning of the heart will result in the LV apex directly in the middle of the sternal incision. One additional maneuver that can improve exposure is placement of a long 0 silk suture in the posterior pericardium and retracting this laterally and securing this to the drape. Laparotomy pads should be positioned between this stitch and the heart to prevent injury to the myocardium.

### Positioning at LV Apex

The ideal position for apical coring is usually 1–2 cm anterolateral to the apical dimple. The apical dimple is usually easily palpable. For centrifugal flow devices, optimal pump positioning can often be accomplished by placing the inflow cannula at the location of the true apex around the dimple. When choosing the site of coring, it is important to be mindful of the proximity to the distal left anterior descending artery (LAD). The sewing cuff for the different types of pumps can protrude medially and come in close proximity to the LAD. Being aware of this location will allow appropriate position of the apical core stitches so that impingement of the LAD is prevented. Our common practice is to position the stitches so they pass under or over the LAD, but never across, although some surgeons intentionally ligate the LAD at the time of inflow cannula placement.

### Apical Core Technique

Coring occurs prior to placement of the inflow cannula adapter in HeartMate II insertion and after placement in HVAD insertion. For the HeartMate 3, the apical core can be made before sewing cuff placement (**cut and sew**) (Figure 27.5) or after sewing cuff placement (**sew then cut**) (Figure 27.6). The ventricular apex can occasionally be friable and easily tear. Tearing of the LV apex can be problematic, especially in patients with recent myocardial infarction. It is our perception that decompression of the ventricle through initial coring or with an LV vent placed through the apex allows for placement of the stitches with less tension on the muscle. The cut and sew technique allows complete decompression of the ventricle with straightforward placement of the sutures in a way that minimizes the risk of tearing of the ventricular muscle.

It is important to have the pump suckers ready prior to cutting. Patients with a competent aortic valve will still have a moderate amount of pressurized blood in the ventricle. Lifting the heart can cause aortic valve incompetence and increase the amount of blood in the LV. Patients with aortic insufficiency will require placement of the cardiomy suction to maintain a clear view.

To perform the **cut and sew** technique, the apical dimple is located as described in the preceding. A 2-0 Tevdek

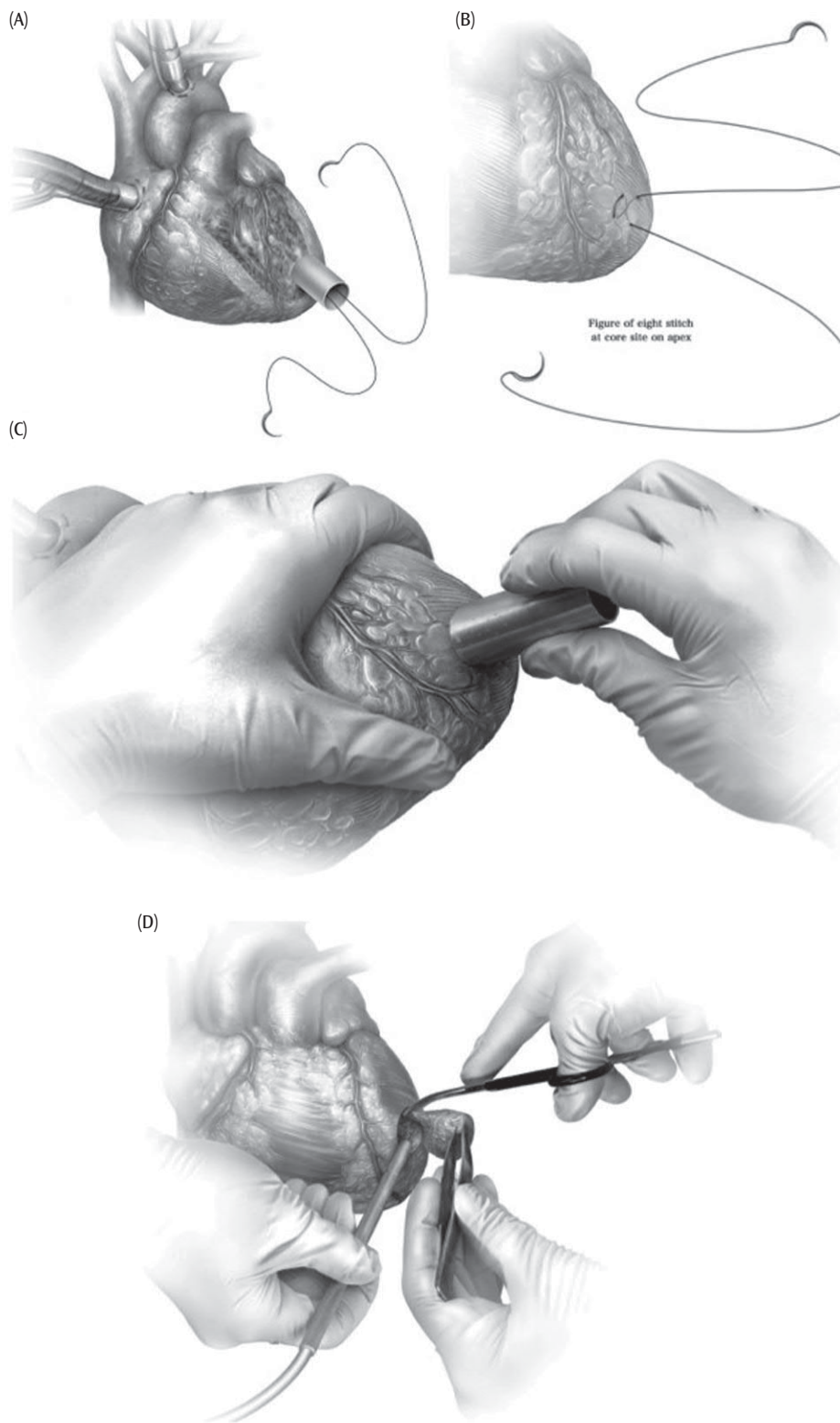
suture is placed here in a figure-eight fashion. The tails of the suture are then passed through the coring knife and grasped by the assistant to prevent the apical core from falling into the LV. The heart is grasped with the surgeon's left hand, and the coring knife in the other. The knife is oriented toward the mitral valve as it passes through the myocardium. A gentle corkscrew motion back and forth with the right hand will create a nice clean cut. The cardiomy suction can then be placed within the LV. The core can be completed at this point with metzenbaum scissors or an 11-blade scalpel. It is important to use extra caution to prevent any debris from falling into the LV. Once the core has been completed we routinely examine the LV apex. Any thrombus or trabeculated muscle present that will obstruct the inflow cannula should be removed.<sup>1</sup>

The sewing cuff is secured by placing 2-0 Tevdek sutures through the myocardium in a circumferential rosette. When using the **cut and sew technique**, the sutures can be placed in a full thickness fashion (Figure 27.7). The suture can be passed from outside the myocardium and retrieved on the inside of the ventricle through the open core. The same stitch can then be passed through the inner edge of the cut myocardium. We typically place a hemostat on each stitch as they are passed through the myocardium. Alternatively, a suture organizer can be used. Once all the stitches are in place they are passed through the sewing cuff.<sup>3</sup>

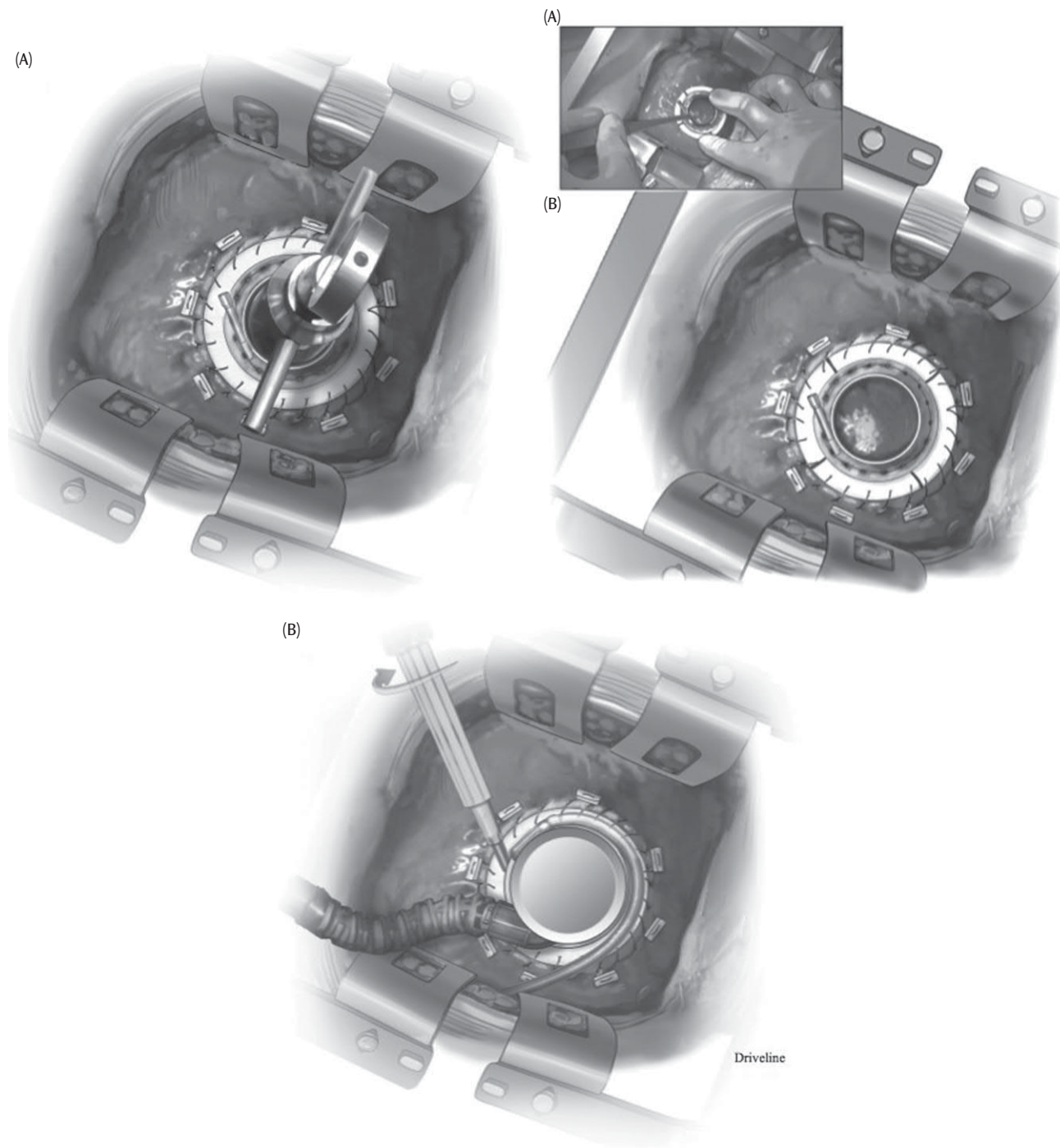
**Sew then cut technique**, the stitches are placed in a partial thickness fashion and immediately through the sewing cuff. The stitches are tied down by the surgeon while the assistant holds the cuff in place gently. The tails of the stitches are then cut to approximately 3 mm in length. Alternatively, a running 3-0 Prolene suture on an SH needle can be used to secure the inflow cannula adapter to the LV apex. Once the sewing cuff is secure, the coring knife can be passed inside the opening of the cuff to make an apical core as described earlier. The pump can then be placed as described in the following.

For the HMII (Figure 27.8) the plastic obturator that comes with the sewing cuff should be pushed in slightly (Figure 27.9). Next, the tails of suture attached to the sewing cuff are looped around the cuff in opposite directions. These can be snared with a romelle tourniquet. We typically mark the felt cuff with a blue marker to designate the separate quadrants. We then routinely place three stitches into each quadrant. The sewing cuff is then parachuted down and held gently in place by the assistant while the surgeon ties the stitches at each of the four quadrants. Next the remaining stitches are tied down by the surgeon and assistant. The tails of the stitches are then cut to approximately 3 mm long. This technique works for either the **cut and sew** or **sew then cut** technique.<sup>4</sup>

For the HM3 (Figure 27.10), the sewing cuff is designed with a rigid metal frame that is secured to a large felt cuff (Figure 27.11). There is debate about the ideal order of sewing cuff placement (i.e., **sew then cut** vs. **cut and sew** technique). It is our general impression, however,



**Figure 27.5.** Inflow cannula placement, apical core technique; cut and sew. Although there are specific tools available for each of the currently used continuous-flow LVADs, certain common principles are essential. During CPB, either a circular coring device or an 11 blade is used for creating the LV apical core (A, B, and C). A 2-0 Tevdek (Johnson & Johnson, Somerville, NJ) suture placed at this location and brought through the coring knife facilitates traction on the apical portion being cored (C). The ideal position is usually 1–2 cm anterolateral to the apical dimple, which is an easily palpable location. A full-thickness piece of myocardial core is removed and the opening is inspected closely for thrombi or adjacent trabeculae, both of which are carefully removed (chronic thrombus, that is well embedded and adherent to the ventricular wall, can be left alone; D). Reprinted from John RJ et al., Implantation of continuous-flow ventricular assist devices: technical considerations, *Operative Techniques in Thoracic and Cardiovascular Surgery* 2012;17:143–153, Copyright (2012), with permission from Elsevier.

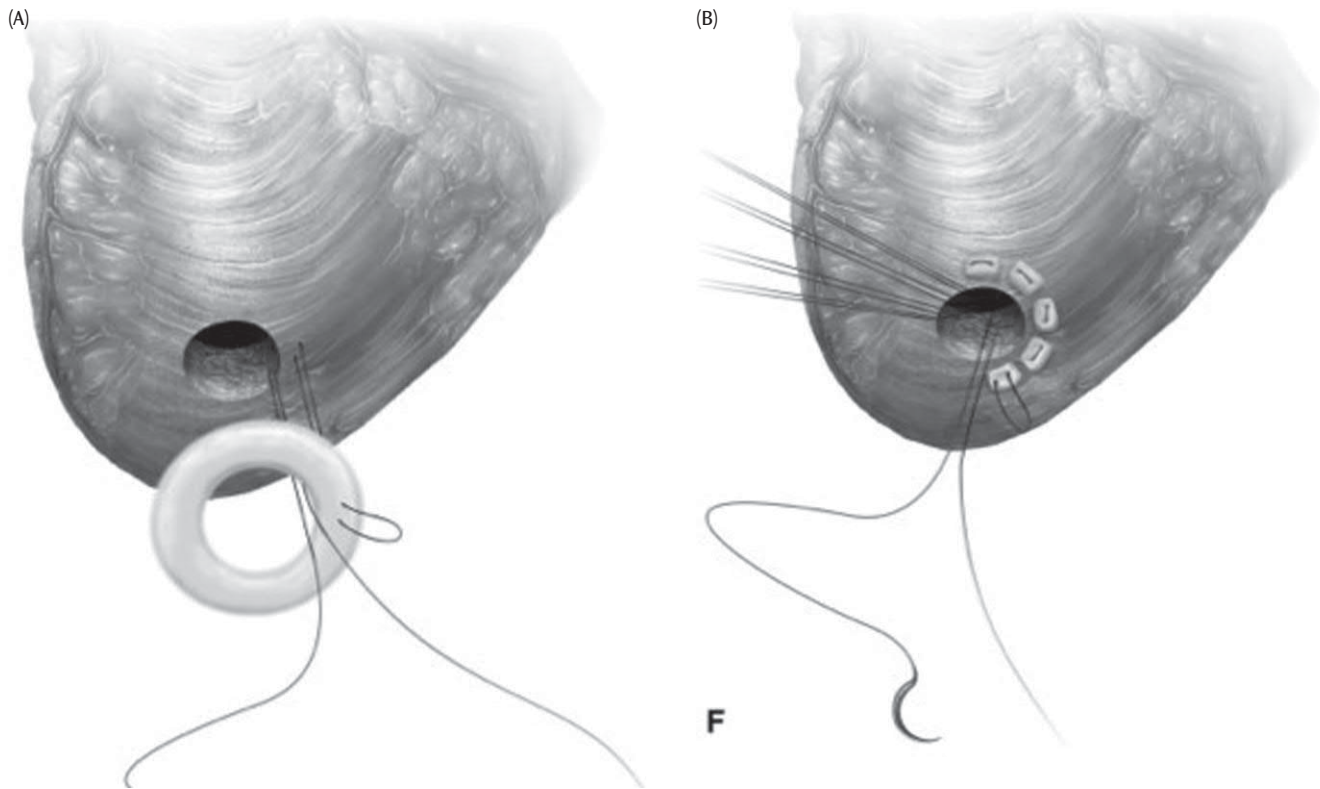


**Figure 27.6.** Inflow cannula placement: sew then cut technique. The HVAD sewing ring is placed on the apex and secured using teflon-pledged sutures and a 4-0 running prolene suture reinforced with BioGlue or PuraStat. A coring knife is used to remove the apical plug (A). The inflow cannula is inserted into the ventricle and secured by tightening an integrated screw in the titanium sewing ring (B).

Reprinted from Schmitto JD et al., Minimally invasive implantation: the procedure of choice, *Operative Techniques in Thoracic and Cardiovascular Surgery* 2016;21:65–78, Copyright (2016), with permission from Elsevier.

that placing stitches through friable myocardium and then tying to a rigid cuff tends to increase the amount of bleeding present after securing the cuff. Because of this we have adopted a modified **cut and sew** technique. To

perform our modified cut and sew technique, first the apical dimple is identified. The sewing cuff is then held in place by the assistant while the surgeon places four partial thickness stitches at the four quadrants of the cuff.



**Figure 27.7.** Apical suture placement: cut and sew technique. 2-0 Tevdek sutures are placed in a full-thickness fashion through the myocardial core. These sutures are either placed through a large circular Teflon donut piece as shown in (A) or one can use a series of pledgetted sutures (B).

Reprinted from John RJ et al., Implantation of continuous-flow ventricular assist devices: technical considerations, *Operative Techniques in Thoracic and Cardiovascular Surgery* 2012;17:143–153, Copyright (2012), with permission from Elsevier.

We use pledgetted 2-0 Tevdek suture on MH needles. These are then tied down and the sutures cut to 2–3 mm in length (if the tails are left longer than this, there is the potential for interference with connection of the pump to the cuff). Next the apical core is created as described earlier by passing the coring knife through the opening for the inflow cannula. The remaining stitches are placed circumferentially to create a rosette at the ventricular apex. The sutures are tied and cut. It is important to be mindful of the LAD when placing this cuff. The felt strip is wider than others and will lie in closer proximity. If the LAD is close it is optimal to make sure the needles for each particular stitch enter the myocardium on the same side of the LAD (i.e., do not cross the LAD with the stitch). Additionally, it is important to be mindful of the metal cross members on the frame of the cuff. When passing stitches through the sewing cuff, one must avoid having the tails of the stitches on opposite sides of the frame members and tying down. Doing so will interfere with attachment of the pump to the frame. If a stitch is placed on opposite sides, then one needle should be passed under the cross member and then tied.<sup>5</sup>

For the HeartWare HVAD (Figure 27.12), sewing cuff placement is performed using either **cut and sew** or **sew then**

**cut** technique (Figure 27.13). This cuff has a smaller diameter than the HM3 cuff, but larger than HMII. Additionally, this cuff is made with a softer felt and does not have a rigid frame attached. These attributes make it less problematic to place this cuff using the **sew then cut** technique. The cuff is positioned at the ventricular apex. Sutures are passed using either technique. The stitches are again cut to 2–3 mm in length (too long and the tails will interfere with pump attachment).<sup>7,8</sup>

### Securing the Inflow Cannula

After the sewing cuff is adequately secured, the pump can be connected and positioned. The pump is wet tested in saline prior to starting the surgery. The pump should then be delivered to the surgeon wetted with the cut finger of a surgical glove covering the inflow cannula. For the HMII LVAD, the pump should be delivered to the surgeon with a specialized plastic cap covering the bend relief of the outflow graft connection. There is a small luer lock connection that accommodates a cardiomy suction line well. For the HM3 and HVAD pumps, the outflow graft should be connected to the pump at this point, prior to positioning the pump in the pericardial well. The surgical glove tip is removed and the pump is drained. The laparotomy pads,

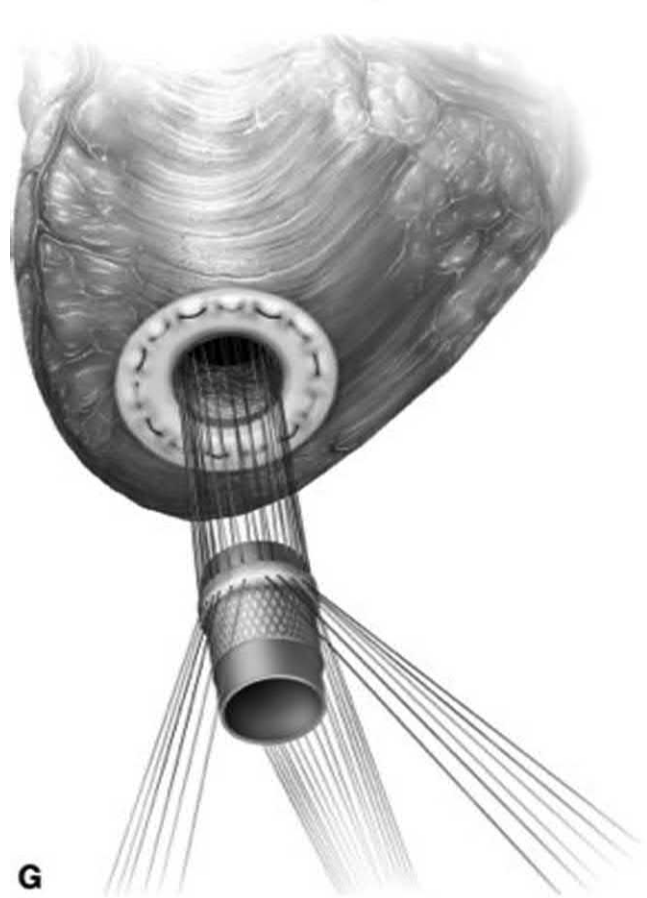




**Figure 27.8.** HeartMate II LVAD pump.

Reprinted with permission from *HeartMate II LVAS; Left Ventricular Assist System Operating Manual*. Thoratec Corporation. Document No. 103538 Rev. B, November 2007, downloaded June 27, 2018, <http://www.thoratec.com/medical-professionals/resource-library/ifus-manuals/heartmate-ll-lvad.aspx>. Reproduced with permission of Abbott, © 2019. All rights reserved.

along with any other positioning aids, should be removed from the pericardial well. The driveline and outflow cannula should be oriented to travel from the ventricular apex toward the patient's right side with a gentle anterior direction. We typically envision the lie of a coronary graft to the posterior descending artery when trimming the outflow graft. Next the pump is held in the surgeon's right hand while the heart is steadied with the left hand. The pump is inserted into the sewing cuff. This provides an excellent opportunity to check for hemostasis around the sewing cuff. We typically check by having the assistant irrigate the connection with a warm saline squirt. Any problematic areas should be addressed prior to positioning the heart in the pericardial well, as lifting the heart and pump back up can exacerbate problematic bleeding. Each pump is attached to the sewing cuff in a particular way as designated by the manufacturer: For the HMII LVAD we routinely gently place the heart and pump into position in the



**Figure 27.9.** HeartMate II sewing cuff.

Reprinted from John RJ et al., Implantation of continuous-flow ventricular assist devices: technical considerations, *Operative Techniques in Thoracic and Cardiovascular Surgery* 2012;17:143–153, Copyright (2012), with permission from Elsevier.

pericardial well. The suture around the silastic portion of the cuff is tied. An additional zip tie is placed around the silastic and secured.

The HM3 LVAD is designed with a special metal tab on the pump that slides into position and attaches to the metal frame of the sewing cuff. There is a yellow line visible when this tab is in open position. The pump is positioned with the inflow cannula into the apical core. The metal frame of the sewing cuff and pump should fit flush together. Next the securing tab is pressed towards the body of the pump. When properly positioned there is a satisfying click of the tab, and the yellow line is no longer visible. The heart and pump are then gently positioned in the pericardial well.

The HeartWare HVAD has a screw incorporated into the sewing cuff. The pump is positioned in an identical fashion to the HM3 with the body of the

pump and metal frame of the sewing cuff flush to each other. Next, a special wrench is used to tighten the screw of the sewing cuff. The wrench is set to a specific torque and will ratchet once that torque is achieved. We routinely tighten until the wrench clicks three times. The heart and pump are then gently positioned in the pericardial well.

## Driveline Placement and Tunneling

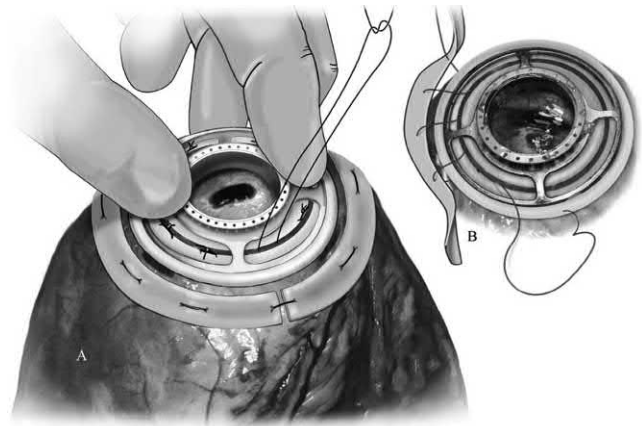
The driveline exit wound can be performed prior to heparinization and institution of CPB to minimize bleeding at the driveline track. However, our preference is to perform the LVAD pump placement first and then decide the exact track of the driveline wound. The exit site is typically 3–4 fingerbreadths below the right costal margin in the mid-clavicular line. All patients are marked preoperatively to avoid placement of the driveline inferior to their usual beltline.

All currently available LVADs come with a specialized tunneling device. The tunneling device is passed from the open sternotomy site. The tip of the tunneling device is used to penetrate the posterior rectus sheath on the right side, just at the inferior edge of the sternotomy. The tunneler is traversed through the rectus muscle until it reaches the intended exit site. The tip is then penetrated through the anterior rectus sheath. A skin incision is made over the tip of the tunneler with a knife, or specialized coring tool, by palpating the tip of the tunneler.



**Figure 27.10.** HeartMate3 LVAD pump.

Reprinted with permission from *HeartMate 3 Left Ventricular Assist System: Instructions for Use*. Thoratec Corporation. Document No. 10006135.B. Publication date: August 2017. Downloaded June 27, 2018, <http://www.thoratec.com/medical-professionals/resource-library/ifus-manuals/heartmate-3-lvad.aspx>. Reproduced with permission of Abbott, © 2019. All rights reserved.



**Figure 27.11.** HeartMate3 apical sewing cuff.<sup>6</sup>

Reprinted from Beyersdorf F et al., Implantation of the HeartMate 3: description of the surgical technique, *Operative Techniques in Thoracic and Cardiovascular Surgery* 2017;22:173–185, Copyright (2017), with permission from Elsevier.

Next, all available pumps come with a specialized connector to attach the driveline to the tunneling device. The driveline is attached to the sternal end of the tunneler. The tunneler is then pulled to deliver the driveline through this track and out the skin incision (Figure 27.14).

All currently available drivelines have been coated with a polyester velour covering that allows for subcutaneous tissue ingrowth. Our preference is to leave the end of the polyester-covered portion of the driveline completely within the subcutaneous wound (leaving the junction of the polyester and smooth portion at least 1–2 cm from the exit site).

Technical factors that will reduce the risk of driveline infections include making the driveline tunnel as long as possible within the abdomen, as well as maneuvers to stabilize the driveline even in the immediate postoperative period. We typically place a skin suture at the driveline exit wound site that is removed 4–6 weeks postoperatively when the wound is well healed. This stitch should be made with a large purchase on the skin to facilitate removal. Additionally, it should be tied gently to the driveline, as there have been reports of driveline fracture from overzealous force when tying.

## Outflow Graft Placement

### Positioning and Measurement of Outflow Graft

The outflow graft is anastomosed to the anterolateral portion of the mid-ascending aorta (Figure 27.15). This portion can be performed prior to institution of CPB; however, determining the exact length of the outflow graft is ideally done after positioning the LVAD pump. We routinely



**Figure 27.12.** HeartWare LVAD pump.

Reprinted with permission from: HeartWare Image & Video Library. <https://www.heartware.com/resources> Reproduced with permission of Medtronic Inc, © 2019. All rights reserved.

position the pump as discussed earlier. The outflow graft is then positioned along the inferior wall of the right ventricle and the lateral aspect of the right atrium, again very similar to the orientation of a distal posterior descending coronary artery (PDA) graft. The graft is best anastomosed to the right side of the mid-ascending aorta. To accurately measure the graft length, the heart should be filled by leaving volume behind on CPB. The graft can then be gently stretched to the perfect comfortable length. Avoidance of excess graft length is important to avoid kinking of the outflow graft. Grafts that are too short may cause tension on the anastomosis, leading to anastomotic site bleeding

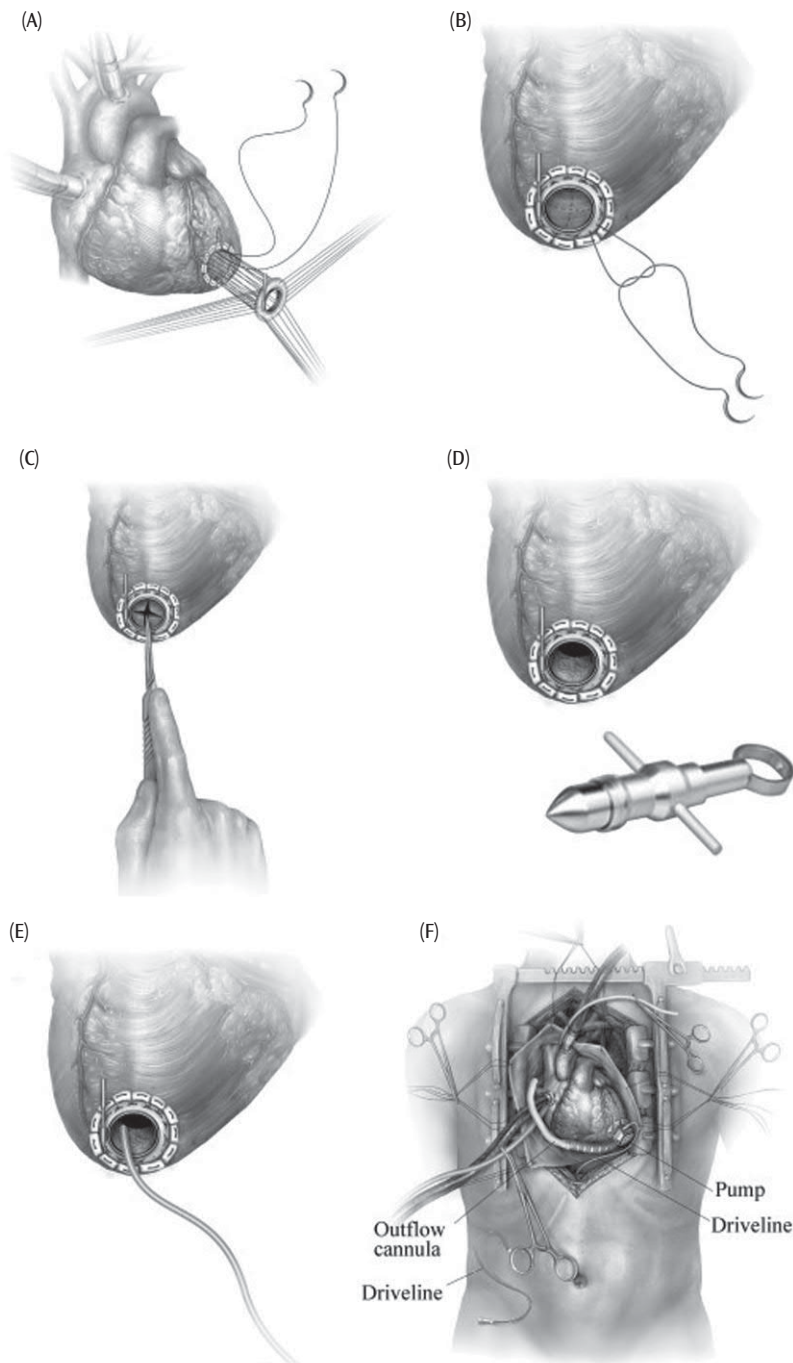
or even possible stricture at the anastomosis, resulting in increased afterload on the LVAD. Grafts that are too short will impinge on the right atrium and right ventricle, potentially causing poor filling of the right heart and right heart dysfunction. In addition, grafts that are too short may cause them to lie closer to the midline, thus increasing the risk of graft injury during sternal re-entry. The graft is cut at a gentle bevel of approximately 60–70 degrees.

### Aortic Outflow Graft Anastomosis

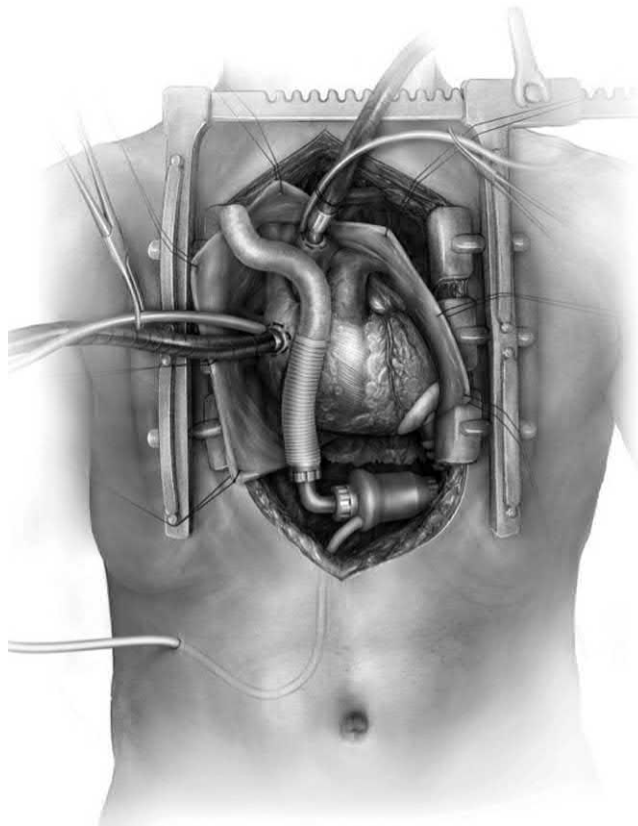
Once the graft is cut to length, a small area of adventitial is cleared from the aorta. Hemostasis will be improved by incorporating the aortic adventitia into the anastomosis. Next, a partially occlusive side-biting aortic cross-clamp is applied. An aortotomy is started with an 11-blade knife and extended with Potts scissors. The ends of the aortotomy can be punched with a 5-mm punch to make the edge smooth and open the anastomosis more. We routinely perform the anastomosis using a running 4-0 or 5-0 polypropylene suture. Typically, pledgets are not used for this anastomosis. The anastomosis is best completed by the surgeon on the left side of the table sewing a forehand stitch from the heel of the graft, along the left side, and stopping just short of the apex. The stitch can then be continued around the toe and down the right side of the anastomosis by the surgeon on the right in a forehand fashion. Performing the anastomosis in this manner allows for one continuous suture line without irregularities. Hemostasis can be improved by the addition of tisseal glue prior to releasing the aortic clamp. Once completed, patency and hemostasis can be ascertained by removal of the partial occluding clamp. A straight vascular clamp should always be placed on the outflow graft with a continuous flow LVAD to avoid backflow into the left ventricle (Figure 27.16).

### Special Considerations for Bridge to Heart Transplant Patients

Strategies instituted at the time of LVAD placement can facilitate a safer/easier LVAD explant at the time of heart transplantation. The LVAD outflow graft should be directed toward the right atrial gutter so as to avoid injury during sternal re-entry. The outflow graft can be wrapped with GoreTex sheet at the time of implant. This protects the outflow graft and allows an easier plane of dissection. Additionally, the outflow graft anastomosis should be placed on the lateral aspect of the aorta as proximal as possible to leave adequate room for aortic cannulation as well as the aortic anastomosis during the subsequent transplant. Minimization of dissection of the plane between the aorta and the pulmonary artery is also preferable to allow easier dissection around the aorta at the time of subsequent transplant. The use of Teflon pledgets at cannulation sites at the time of LVAD placement should be avoided, as this will



**Figure 27.13.** HeartWare LVAD apical sewing cuff.<sup>9</sup> Placement of the inflow cannula. The procedure is performed on full cardiopulmonary bypass on the beating heart. The heart is elevated and supported with moist laparotomy pads to expose the left ventricle (LV) and apex. Correct positioning of the inflow cannula is essential. It should be parallel to the interventricular septum and directed toward the mitral valve. To achieve this, the sewing ring is attached to the distal anterior surface of the LV, approximately 2 cm lateral to the left anterior descending artery. (A) We place 12, 2-0 ETHIBOND pledgeted sutures deep in the myocardium and then through the Dacron sewing ring. It is recommended that the integrated screw of the sewing ring be oriented parallel to the LAD and pointing toward the base of the heart to facilitate tightening. (B) Once the sewing ring is seated, all sutures are tied down. (C) A full-thickness cruciate incision is made in the myocardium within the middle of the sewing ring. (D) The myocardium within the ring is then excised with the punch device supplied by HeartWare. The LV is then inspected for thrombus and crossing trabeculae, which are excised as necessary. Continued (E) At this point, it is our practice to infuse CO<sub>2</sub> into the LV cavity to facilitate deairing of the LV. (F) The inflow cannula is then inserted into the sewing ring and the device is positioned with the outflow graft and driveline parallel to the diaphragm, and the screw on the sewing ring is tightened. Additional deairing is accomplished by passively filling the heart and pump and elevating the apex and gently shaking the ventricle. (G) The outflow graft is then distended, clamped, and trimmed to proper length. Reprinted from Romano M et al., HeartWare HVAD: principles and techniques for implantation, *Operative Techniques in Thoracic and Cardiovascular Surgery* 2013;18:230–238, Copyright (2013), with permission from Elsevier.



**Figure 27.14.** Driveline placement and tunneling.

Reprinted from John RJ et al., Implantation of continuous-flow ventricular assist devices: technical considerations, *Operative Techniques in Thoracic and Cardiovascular Surgery* 2012;17:143–153, Copyright (2012), with permission from Elsevier.

reduce the burden of scarring and facilitate easier aortic dissection at the time of transplant.

## Transitioning from Cardiopulmonary Bypass to LVAD Support

### De-Airing the LV and LVAD Outflow Graft

The outflow graft must be connected to the pump at this point for the HMII LVAD. The HM3 and HeartWare devices are usually connected to the pump prior to positioning in the pericardial well. Once the partially occlusive clamp is removed from the aorta, it is important to place a cross-clamp on the outflow graft with the continuous-flow devices until the LVAD flow is initiated. This maneuver prevents retrograde flow of blood through the LVAD causing distension of the left ventricle. The left ventricle and LVAD need to be de-aired prior to initiation of flows (Figure 27.17). Typical de-airing maneuvers, including Trendelenburg position, addition of volume to the heart, and resuming ventilation, are performed. Next a large-bore

needle is used to make a small hole in the outflow graft between the LVAD and cross-clamp. An aortic root vent can also be placed in the ascending aorta. De-airing is confirmed by TEE.

### Weaning from Cardiopulmonary Bypass and Initiation of LVAD Flows

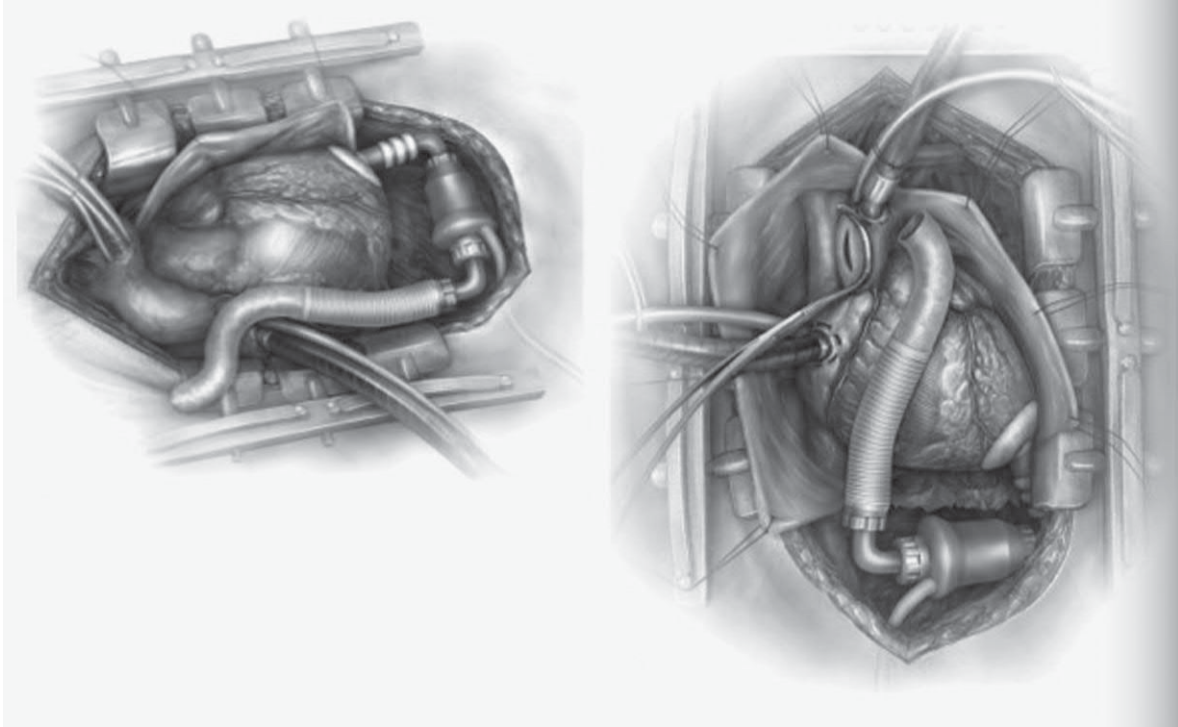
Separation from CPB to LVAD support must involve close communication between the surgeon, anesthesiologist, perfusionist, and surgical team. All members of the team must be alert, vocal, and active participants during the transition.

Our standard process is as follows. First, low- to moderate-dose inotropic and vasopressor support is initiated by anesthesia. A general dose range can be anticipated based upon requirements required by perfusion during CPB. We typically target a mean arterial pressure (MAP) of 90 mmHg, this provides good coronary perfusion (especially for the right heart). If an intra-aortic balloon pump is present, we generally resume use at this point. The patient is then gradually weaned to <1 L/min CPB flow and the LVAD pump is started. The speed of the LVAD is gradually increased to allow for increased LVAD output as CPB is discontinued. Initial targeted pump parameters for each pump (shown in Table 27.1) include the following:

- HMII—flow 4–5 L/min, RPM 8,800–9,400, power 3–7W, and pulsatility index (PI) of 4–6.
- HM3 – flow 4–5 L/min, RPM 5,000–6,000, power 6–7W, and PI 2.5–5.
- HeartWare HVAD flows 4–5 L/min, RPM 2,400–2,800, power 3–7W, and flow variability less than delta of 3 L.

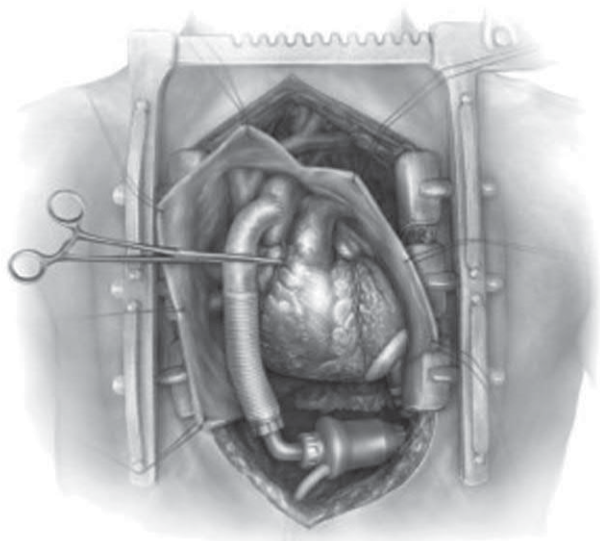
Next, inotropic and vasopressor support is titrated to target a MAP of 65–80 mmHg. A low pulse pressure is normal at this stage of the operation.

A thorough assessment of the transesophageal echocardiogram should be performed next. Close attention should be paid to the presence of air, right ventricular (RV) function, septal wall motion, LV decompression, tricuspid, aortic and mitral valve competence (Figure 27.18). If moderate or greater tricuspid or aortic insufficiency is present, this should be fixed before separating completely from CPB. Tricuspid insufficiency, if left untreated, can lead to persistent volume overload and significant right ventricular dysfunction. Aortic insufficiency will typically worsen over time and can lead to formation of a circular flow loop from LVAD to aorta to LV to LVAD. We generally do not treat mitral insufficiency as the LVAD should decompress the left side of the heart. A bubble test is performed to assess for PFO. If present, a PFO should be closed to prevent development of right-to-left shunt. Inflow cannula position and flow should be assessed for orientation directly toward the mitral valve. The most common positioning problem involves



**Figure 27.15.** Outflow graft placement; positioning and measurement of outflow graft.

Reprinted from John RJ et al., Implantation of continuous-flow ventricular assist devices: technical considerations, *Operative Techniques in Thoracic and Cardiovascular Surgery* 2012;17:143–153, Copyright (2012), with permission from Elsevier.



**Figure 27.16.** Outflow graft placement; aortic outflow graft anastomosis.

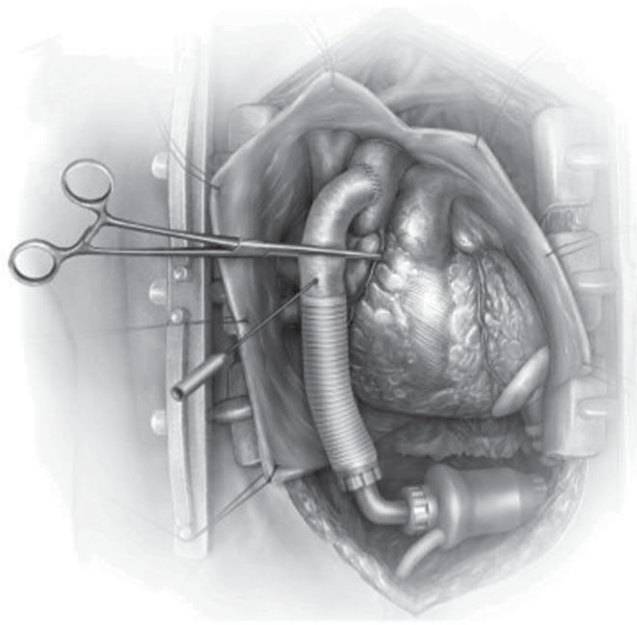
Reprinted from John RJ et al., Implantation of continuous-flow ventricular assist devices: technical considerations, *Operative Techniques in Thoracic and Cardiovascular Surgery* 2012;17:143–153, Copyright (2012), with permission from Elsevier.

orientation toward the ventricular septum with limited flows through the LVAD. Left alone this can predispose to cannula suction events against the septum, and prolonged issues with pump performance. Maneuvers to address inflow cannula position at this point will be discussed in the following.

## LVAD Pump Positioning and Final Steps

### Assessment of LVAD Position

Transesophageal echocardiography assessment of inflow cannula position, degree of LV filling, and number of times the aortic valve opens are additional maneuvers that can be performed in the operating room to optimize LVAD function. As stated earlier, the inflow cannula should ideally be directed in line with the mitral valve. This is affected primarily by selecting the ideal spot on the cardiac apex, and development of an appropriate pump pocket at the start of the operation. Once the pump is in place, maneuvers that can be performed to position the pump vary by the type of pump. One should first relax the sternal retractor to get the most realistic assessment of pump position. Fixing the body of the HMII pump to the posterior rectus fascia can permit the pump to move inferior and rightward. This motion will cause the inflow cannula to angle away from the septum and toward the left shoulder. An additional



**Figure 27.17.** Transitioning from cardiopulmonary bypass to LVAD support; de-airing the LV and LVAD outflow graft.

Reprinted from John RJ et al., Implantation of continuous-flow ventricular assist devices: technical considerations, *Operative Techniques in Thoracic and Cardiovascular Surgery* 2012;17:143–153, Copyright (2012), with permission from Elsevier.

maneuver performed by some surgeons is to create a cantilever stitch that is attached to the rubberized angled connection of the inflow cannula. By looping a long 0 silk suture around this connection twice, and then placing an anchoring stitch on the diaphragm, one can create a cantilever that will change the angle of the inflow cannula when tied down. For the HM3 and HVAD devices, inflow cannula orientation is most affected by the initial apical placement, and placement of the pump within the pericardium. A cantilever stitch can be attempted for these devices, although we do not routinely perform this maneuver.

### Optimization of Initial LVAD Settings

Optimal initial LVAD settings can be guided by TEE assessment of hemodynamics, LV filling, and opening of the aortic valve. We routinely target a MAP of 65–80 mmHg. There is usually 10 mmHg pulsatility, or less, after initial placement of the LVAD.

The relative filling of the LV is an additional guide to pump parameter adjustment. We do not routinely perform a RAMP study (testing the function at varying pump speeds) in the operating room. However, a brief assessment of LV fullness and adjustment of LVAD RPM under echocardiographic guidance can be performed to optimize the initial settings. Ideally the aortic valve will open intermittently, on the order of once every 5th cardiac cycle. This will allow for intermittent washing of the aortic root, and aid in preventing thrombus formation in the aortic root.

### Final Steps

After ensuring adequate de-airing of the LV and LVAD we place a pledgeted 5-0 or 6-0 prolene suture to close the defect made in the outflow graft. Meticulous hemostasis of this site should be ensured.

Next the bend protector should be checked on the outflow graft. This is a crucial step to perform and not skip. For the HMII the bend protector connection should be tested and then the bend protector should be secured with two 2-0 Tevdek sutures placed through the eyeholes. The HM3 and HeartWare HVAD bend protector is attached prior to positioning of the pump in the pericardial space.

Bridge-to-transplant designated patients should be treated with the expectation of redo sternotomy in the future. We routinely wrap the outflow graft and medial portion of the driveline with Gor-Tex (W. L. Gore Co., Newark, DE) or CorMatrix (CorMatrix Cardiovascular, Inc., Alpharetta, GA). This allows easier re-entry and minimizes the risk of outflow graft or driveline injury. This should be well documented in the operative report for the future surgeons.

## Troubleshooting

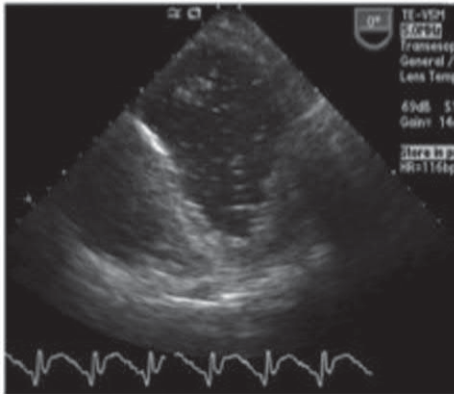
### Failure to Separate from Bypass

Failure to separate from bypass usually is due to poor coronary perfusion or right ventricular failure.<sup>7</sup> This problem can be minimized by ensuring the MAP is at least 80 prior to weaning from CPB. We typically achieve this by running inotropic and vasopressor support prior to weaning. Doing so will optimize coronary perfusion and usually obviates RV failure. This approach will allow most patients to smoothly transition from CPB to LVAD support. After achieving stability on LVAD support, the inotropic and vasopressor support can be titrated down.

**Table 27.1 • Typical Parameters for Commonly Used LVADs**

Device	Flow (L/min)	Rpm (typical range)	Rpm (static flow)	Power (W)	Pulsatility Index
HMII	4–5	8,800–9,400	6,000	3–7	4–6
HM3	4–5	5,000–6,000	3,000	6–7	2.5–5
HVAD	4–5	2,400–2,800	2,800	3–7	N/A

▪ Ensure the LV and aortic root is free of air



**Figure 27.18.** Transitioning from cardiopulmonary bypass to LVAD support; weaning from cardiopulmonary bypass and initiation of LVAD flows.

Reprinted from John RJ et al., Implantation of continuous-flow ventricular assist devices: technical considerations, *Operative Techniques in Thoracic and Cardiovascular Surgery* 2012;17:143–153, Copyright (2012), with permission from Elsevier.

RV failure that is recalcitrant to this approach will require resumption of full CPB. After stability is ensured on CPB, we will typically attempt to optimize the patient's hemodynamics, and attempt a second wean from CPB to LVAD support. We will reassess the inotropic and vasopressor regimen and make adjustments where needed. Assessment of RV function, LV filling, and pump position can be useful to ensure that nothing consequential was missed on first assessment. The addition of flolan or nitric oxide can decrease the pulmonary vascular resistance and reduce RV strain. After a thorough reassessment and optimization of hemodynamics, we will attempt a second transition from CPB to LVAD support. If not successful, we will typically place an intra-aortic balloon pump, if not already present. If the addition of pulmonary vasodilators and IABP support fails to achieve adequate separation from CPB, we will generally proceed to institution of right-sided temporary mechanical circulatory support.

Temporary right-sided support entails drainage from the right atrium, and reinfusion via the pulmonary artery. We most often will use an ECMO circuit for support initially. If the patient's lung function/gas exchange is adequate, we can easily remove the oxygenator from the circuit and convert to right-sided temporary VAD support with a short-term centrifugal flow pump.

### Moderate or Greater Aortic Valve Insufficiency

Significant aortic insufficiency will generally progress if left untreated during LVAD implantation. It is important

to treat this aggressively, as the patient will ultimately develop recalcitrant heart failure from the continuous loop generated with flow from the LVAD to aorta to LV to LVAD. If moderate or greater aortic insufficiency is detected, then the surgical technique is usually altered. Ideally the surgeon is aware of this prior to proceeding to the operating room. The most commonly used technique for aortic valve closure is either with a single multi-pledgeted 4-0 prolene suture or with the use of a felt strip along each leaflet. Aortic valve replacement with a bioprosthetic valve is also used. This technique does require longer ischemic time. Additionally, the cusps of the valve will ultimately fuse. Fusion of the cusps makes the patient 100% dependent upon LVAD function. If the LVAD should stop working, the patient will quickly expire.

Treatment of aortic incompetence during LVAD implantation should proceed in similar fashion to standard aortic valve replacement.<sup>5</sup> The repair of the aortic valve should be performed at the beginning of the operation. Cannulation strategy is similar, with an aortic infusion cannula and venous drainage cannula. An aortic cross-clamp will be applied, and the heart can be arrested with retrograde cardioplegia or with cardioplegia given via handheld catheters directly down the coronary ostia. The aortotomy should be made at the usual site of aortic valve replacement. The valve can be repaired or replaced according to surgeon preference. The aortotomy is closed and the conduct of LVAD implant should proceed as outlined previously. The aortic anastomosis for the outflow graft should be made distal to the aortotomy site. Some have described repairing the aortic valve through the aortotomy for the outflow graft; however, this is usually challenging due to the small opening and distance from the aortic valve. After the repair is complete, the heart is resuscitated with a warm shot of cardioplegia. The LVAD implant is then performed as outlined earlier.

### Patent Foramen Ovale

Patent foramen ovale is another cardiac defect that should be treated aggressively. If left untreated after unloading the LV, a right-to-left atrial level shunt will develop. Depending on size of the PFO, this will result in moderate to severe hypoxia and poor unloading of the LV.

Repair of PFO should entail bicaval venous cannulation. We routinely snare the cavae for a brief period of total CPB. Some surgeons elect to leave the cavae without snares to make the dissection during a redo sternotomy for transplant less risky for injury. A small right atriotomy is made and the PFO defect is closed with a running 4-0 prolene suture. The right atriotomy is closed with a running 4-0 prolene suture, and the caval tapes are removed. Implant of the LVAD should then proceed in routine fashion.



### Tricuspid Regurgitation

Moderate or greater tricuspid regurgitation is an indication for repair. Studies have shown a lower rate of RV dysfunction in patients after LVAD who undergo repair.

Bicaval venous cannulation and caval tapes are placed. A right atriotomy is made. Non-pledged 2-0 Tevdek sutures are placed circumferentially around the tricuspid annulus. The AV node and conduction system are vulnerable to injury near the commissure of the septal and posterior leaflets. Injury here can be avoided by use of a partial ring, the avoidance of suture placement here, and performing the repair with the heart beating. A size 30 or 32 partial Edwards MC3 tricuspid annuloplasty ring (Edwards Lifesciences Corp., Irvine, CA) is our usual choice. We use the CoreKnot device (Innovative Solutions, Victor, NY) regularly to secure the annuloplasty ring in place. The right atriotomy is closed with a running 4-0 prolene suture, and the caval tapes are removed. Implant of the LVAD should then proceed in routine fashion.

### IABP Use and Issues

We regularly implement IABP support in patients prior to LVAD placement. Reduction in afterload and improved coronary perfusion will typically improve patients' physiologic status (liver function, renal function, RV function) prior to proceeding to the operating room. We routinely pause the balloon after heparinization. The case is performed as outlined earlier, and IABP function is resumed prior to separation from CPB. We have found this to decrease the need for extremely high doses of inotropes and vasopressors. Additionally, use of IABP as a measure to improve hemodynamics can help when there is difficulty transitioning from CPB to LVAD support.

IABP use can cause spurious readings of flows and PIs on the HM3 pump. We regularly use IABP to transition from CPB to LVAD support, and for the first 3–4 hours postoperatively. After this we will routinely remove the IABP once the patient is settled in the ICU.

### Conclusion

Implantation of LVAD via sternotomy approach remains a widely accepted technique. Advantages include excellent

visualization and the ability to perform concurrent procedures with ease. Disadvantages include increased blood utilization and bleeding related to surgery. While minimally invasive thoracotomy techniques are increasing in popularity, sternotomy remains the standard approach in the current era.

### REFERENCES

1. John, R. Implantation of Continuous-Flow Ventricular Assist Devices: Technical Considerations. *Operative Techniques in Thoracic and Cardiovascular Surgery*. 2012;17(2):143–153.
2. Anyanwu, AC. Nonsternotomy approaches to left ventricular assist device placement: combined left subcostal-right minithoracotomy technique. *Operative Techniques in Thoracic and Cardiovascular Surgery*. 2014;19:254–275.
3. Schmitto JD, Deniz E, Rojas SV, Maltais S, Khalpey Z, Hanke JS, Egger C, Haverich A. Minimally Invasive Implantation: The Procedure of Choice! *Operative Techniques in Thoracic and Cardiovascular Surgery*. 2016;21:65–78.
4. *HeartMate II LVAS; Left Ventricular Assist System Operating Manual*. Thoratec Corporation. Document No. 103538 Rev. B, November 2007, Downloaded 6/27/18: <http://www.thoratec.com/medical-professionals/resource-library/ifus-manuals/heartmate-ii-lvad.aspx>.
5. *HeartMate III Left Ventricular Assist System: Instructions for Use*. Thoratec Corporation. Document No. 10006135.B. Publication Date: 8/2017. Downloaded 6/27/18: <http://www.thoratec.com/medical-professionals/resource-library/ifus-manuals/heartmate-3-lvad.aspx>.
6. Beyersdorf F, Scheumann J, Siepe M. Implantation of the HeartMate 3 – Description of the Surgical Technique. *Operative Techniques in Thoracic and Cardiovascular Surgery*. 2017;22(3):173–185.
7. *HeartWare Image and Video Library*. Accessed 6/27/18: <https://www.heartware.com/resources>.
8. *HeartWare Left Ventricular Assist System: Instructions for Use*. Medtronic Corporation. Downloaded 6/27/18: [http://www.heartware.com/sites/default/files/uploads/docs/ifu00001\\_rev\\_15.pdf](http://www.heartware.com/sites/default/files/uploads/docs/ifu00001_rev_15.pdf).
9. Romano M, Haft J, Pagani FD. HeartWare HVAD: Principles and Techniques for Implantation. *Operative Techniques in Thoracic and Cardiovascular Surgery*. 2013;18(3):230–238.

# The Less-Invasive (Lateral) Approach to Left Ventricular Device Implantation

EDWIN C. MCGEE, JR.

## Introduction

**I**mplanting left ventricular assist devices (LVADs) in the modern era of continuous-flow devices is still associated with substantial rates of morbidity, despite improvements in survival. Surgical bleeding and severe right heart failure are particularly problematic.<sup>1</sup> Perioperative bleeding and subsequent blood product administration contribute to right heart failure secondary to volume expansion and the increase in pulmonary vascular resistance seen with blood product administration. Additionally, blood product administration can lead to allosensitization, which decreases the probability of finding an acceptable donor and increases the risk of vascular rejection.

To address these pitfalls and improve the acceptability of this technology to both patients and referring physicians, and with the advent of smaller devices, less-invasive implant techniques have been developed for LVADs (Figure 28.1).

A description of every implant strategy in the modern era is beyond the scope of this chapter. Rather, we focus on the refinement and widespread adoption of less-invasive implant techniques and highlight the evolution of this aspect of mechanical circulatory from a series of “one-offs” to evidence-based practice.

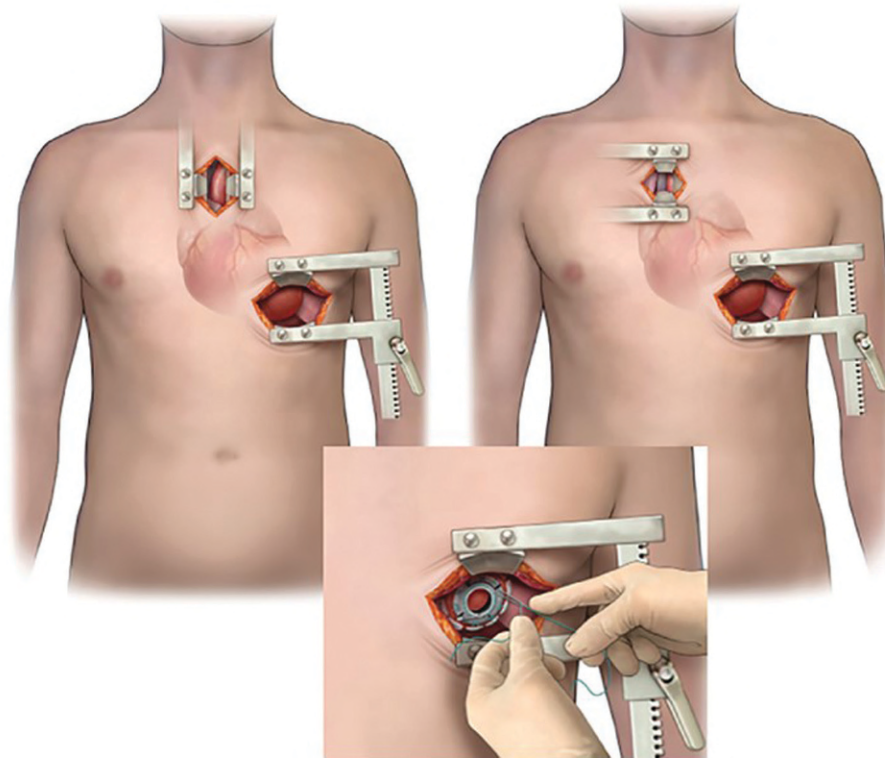
## A History of Implant Strategies

Frazier and Gregoric were the first to describe a less-invasive implant of a continuous-flow pump. In 2006, they implanted a Jarvik 2000 flowmaker with an outflow anastomosis to the supra celiac aorta using a subcostal incision to access the LV apex and the supra celiac aorta in patients with a history of heart surgery.<sup>2</sup> They did not use cardiopulmonary bypass and reported lower rates of bleeding

and earlier patient recovery.<sup>3</sup> Lack of access to intramyocardial pumps and a lack of familiarity with the anatomy of the supra celiac aorta among cardiac surgeons hampered widespread adoption of this approach. The same authors also described a subcostal approach with the HeartMate II (Abbott labs), but they anastomosed the outlet graft to the ascending aorta. Anyanwu reported that an off-pump subcostal approach with the HeartMate II was reproducible and associated with less blood use.<sup>4</sup> Despite these efforts, less-invasive approaches with the HeartMate II were not widely adopted.

The HeartWare HVAD (Medtronic, Inc.), a third-generation centrifugal pump, is the smallest full-support pump approved for both bridge to transplantation and long-term destination therapy. Its small size and relatively low-profile inflow canula led to extensive experience with less-invasive and alternative implant techniques. Single-center retrospective studies by both European and North American groups have found lower rates of bleeding, shorter or no time on cardiopulmonary bypass, and lower rates of right ventricle (RV) failure.<sup>5,6</sup> A multicenter, retrospective series in the United States confirmed this as well.<sup>7</sup>

Given the promising results in single- and multicenter retrospective studies, the HeartWare LATERAL trial was undertaken to study the less-invasive implant technique. It was the first trial approved by the US Food and Drug Administration to study a non-sternotomy mode of LVAD implantation. The trial was a single-arm multi-center, prospective trial of 144 patients undergoing HVAD implant through a left anterior thoracotomy and either an upper hemi-sternotomy or a right anterior thoracotomy. Results were compared with data from contemporaneous matched patients (controls) in the Society of Thoracic Surgeons' INTERMACS (Interagency Registry for Mechanically Assisted Circulatory Support) database undergoing implantation with full sternotomy. Enrollment lasted from 2014 to



**Figure 28.1.** A schematic demonstrating the various surgical approaches used for LATERAL implantation techniques.

2016. All implants were required to be performed on cardiopulmonary bypass.

Success was a composite endpoint defined as follows:

1. Alive on the originally implanted device at 180 days and without a stroke (modified Rankin scale  $>3$  or more months after the stroke (Table 28.1);
- 2) Transplanted by 180 days and without a stroke  $>3$  on a modified Rankin Scale when assessed 3 or more months after the stroke; or
- 3) Explanted for recovery by month 6 and without a stroke  $>3$  or greater on modified Rankin Scale assessed 3 or more months after the stroke.

The primary composite endpoint was non-inferiority to the historical control patients undergoing traditional sternotomy; 88.1% (126/143) patients met the primary endpoint (Figure 28.2). No adverse safety signals were identified, and improvements in quality of life and in NYHA heart failure class were sustained. Bleeding requiring reoperation occurred in 5 (3.4%) patients, and bleeding requiring transfusion occurred in 13 (9%) patients. Two-year survival was 87% (Figure 28.3). The lateral mode of implant was approved by the FDA in 2018.

The HeartMate 3 has recently been approved for bridge to transplantation and destination therapy in the United States. A lateral implant has been reported with this device,

**Table 28.1 • Modified Rankin Scale Criteria**

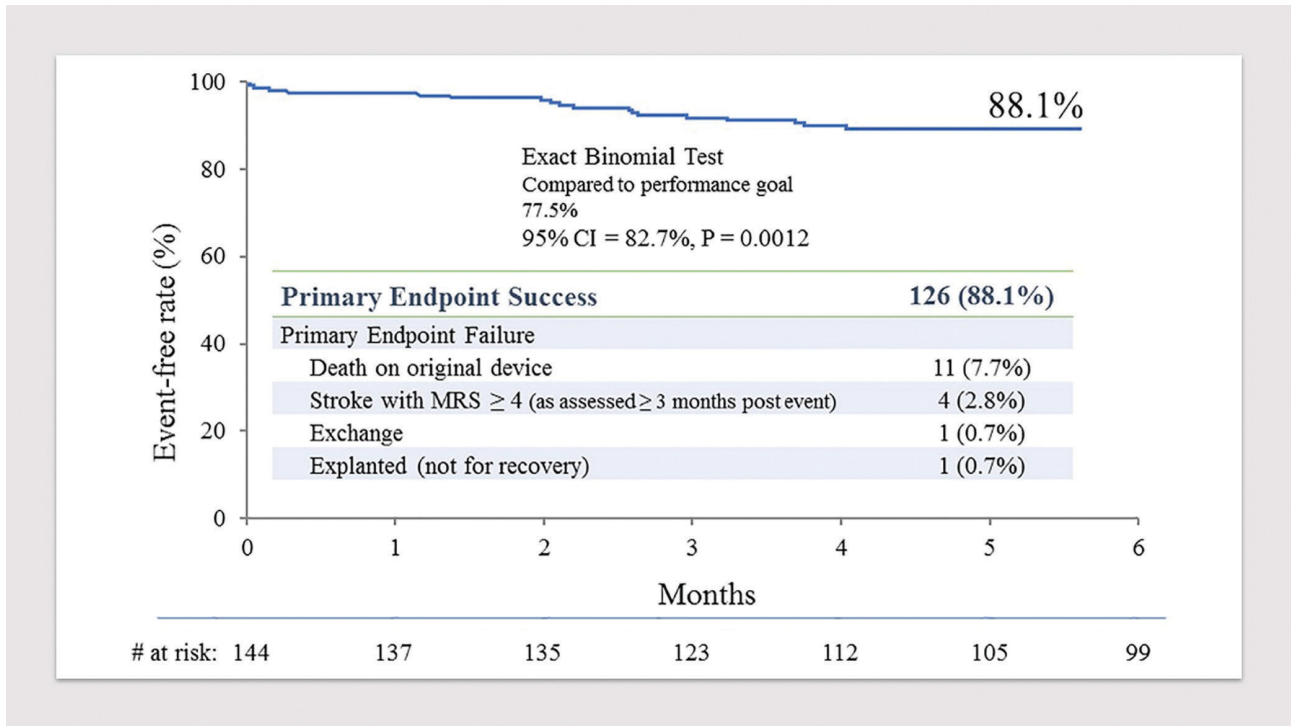
**Modified Rankin Scale (MRS)**

0	No symptoms
1	No significant disability, despite symptoms; able to perform all usual duties and activities
2	Slight disability; unable to perform all previous activities but able to look after own affairs without assistance
3	Moderate disability; requires some help, but able to walk without assistance
4	Moderate severe disability; unable to walk without assistance and unable to attend to own bodily needs without assistance
5	Severe disability; bedridden, incontinent, and requires constant nursing care and attention
6	Death

but the procedure has not been formally studied.<sup>8</sup> Because this device is larger than the HVAD, whether non-sternotomy approaches will be widely accepted is unknown.<sup>9</sup>

### Patient Selection

As with most operations, proper patient selection is critical, especially early in a surgeon's experience. The lateral

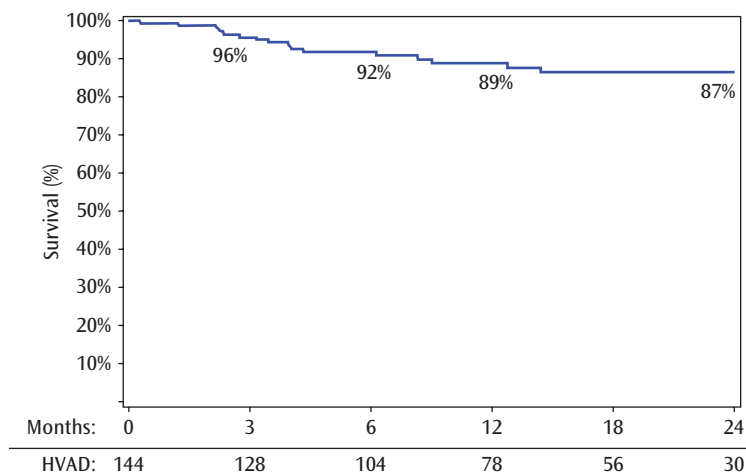


**Figure 28.2.** Primary endpoint success was achieved in 88.1% of patients enrolled in the LATERAL trial.

HVAD implant has a substantial learning curve, but the procedure is quite reproducible with experience. The ideal patient on which to start should be relatively thin with a large heart and no history of heart surgery. With experience, carefully selected reoperative cases can be considered for the LATERAL technique.

Implantation in patients with a history of valve surgery, especially those with mitral valve repair or replacement, is straightforward because adhesions tend not to be dense. Adhesions over the apex are typically filmy and are easy

to lyse. Usually, we choose to secure the sewing ring to the apex without going on bypass. However, if the left ventricle (LV) is tense and fragile, or if hemodynamic instability ensues, cardiopulmonary bypass should be instituted without hesitation. When approaching the apex during a reoperative full sternotomy, cardiopulmonary bypass is typically required so that the apex and lateral wall can be dissected enough to dislocate the apex medially enough to place a sewing ring. If the epicardium is particularly fragile, cardioplegic arrest may be required.

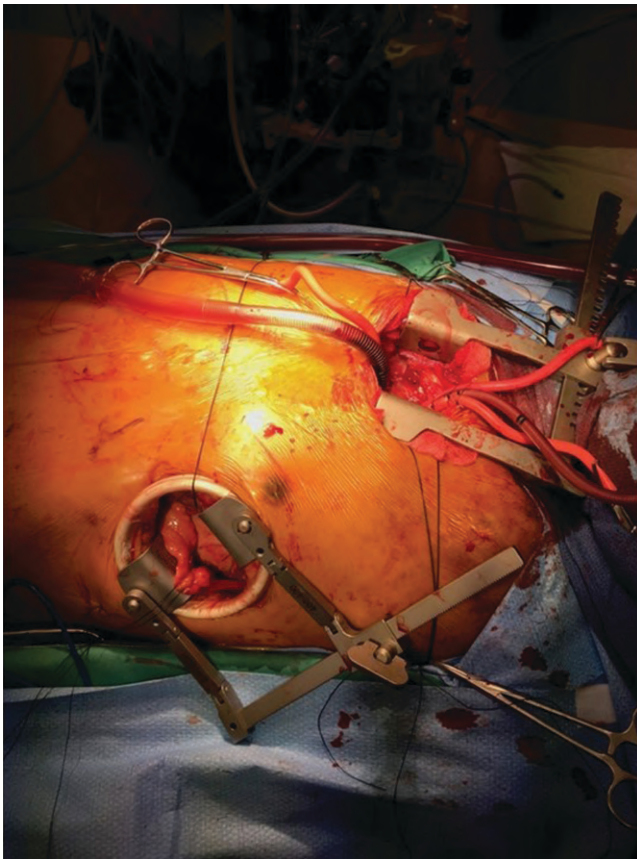


**Figure 28.3.** Survival at 24 months was 87% in the LATERAL trial.

Most LVAD implants in most centers are undertaken as bridge to transplantation. Therefore, the LVAD should be implanted with a strategic focus on improving the ease of a subsequent explant and heart transplantation.

Central aortic and venous cannulation for lateral implant spares the groin or axillary artery for the transplant operation, if needed. Standard aortic cannulation can reliably be accomplished with an upper hemi-sternotomy, and many cases will permit central venous cannulation as well (Figure 28.4). A two-stage cannula introduced through the right atrial appendage facilitates exposure of the outlet graft-to-aorta anastomosis when the cannula is retracted inferiorly.

The sewing ring is sewn to the apical dimple in the standard fashion. My current mode of securing the ring consists of 4, 2-0 Ethibond sutures supported with pledgets of Teflon felt. I then run a 4-0 PROLENE suture on an SH needle joining the LV myocardium to the sewing ring. Depending on the quality of the epicardium, I may



**Figure 28.4.** Operative setup for a lateral LVAD implant. The left ventricular apex is accessed through a left 5th or 6th anterior thoracotomy. The ascending aorta is accessed through an upper hemi-sternotomy that extends through the right 4th intercostal space. An Alexis wound protector facilitates exposure. Central cannulation is typically possible.

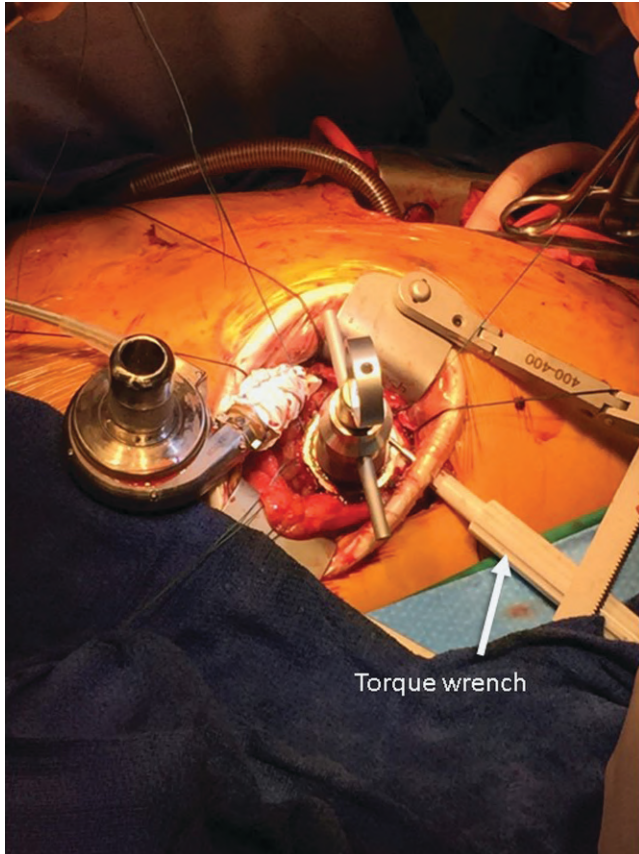
support this suture line with a strip of bovine pericardium. I keep two of the Ethibond sutures on hemostats to facilitate coring and pump placement because seating the pump becomes a one-handed operation with the lateral implant technique. If the sutures are not placed on traction, the left ventricle will be pushed into the pericardium, which makes seating and securing the pump difficult if not impossible (Figure 28.5).

I orient the sewing ring to make the securing screw easily accessible for the fastening wrench. Typically, the ring is oriented so that the screw is pointed toward the right shoulder. Orienting the screw toward the left shoulder may be necessary in obese patients. The screw should never be oriented inferiorly because it likely will be covered by some portion of the bend relief (Figure 28.6).

I always begin cardiopulmonary bypass before coring the ventricle and seating the pump. Off-pump LVAD insertion has been described, but in my opinion, the few minutes



**Figure 28.5.** A patient on cardiopulmonary bypass using standard central cannulation. A cruciate ventriculostomy has been made within the opening of the sewing ring, which is being elevated into the wound by uncut sewing ring sutures placed on traction. The pump has been placed in the operative field and the outlet graft has been routed through the hemi-sternotomy. The bend relief is covered with gortex.

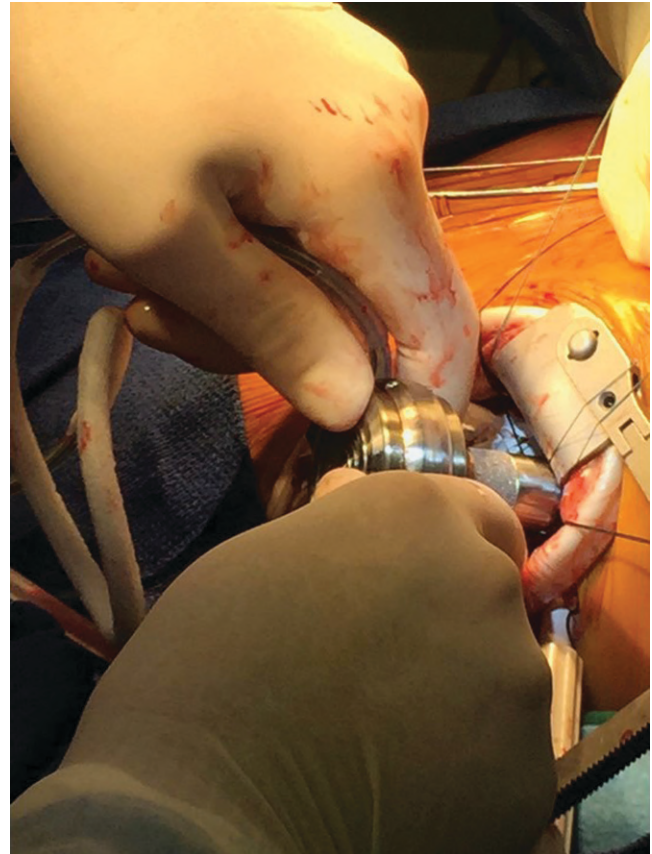


**Figure 28.6.** The ventricle being cored. The torque wrench has been introduced through the lateral aspect of the thoracotomy, and the set screw has been accessed. Sometimes, a counter incision is required to allow the wrench and set screw to be properly oriented.

on bypass to core the LV, remove any bridging trabeculae, and safely secure the pump are a small price to pay for the substantial benefits that accrue by having the ability to visualize the inside of the ventricle. In addition, long-term success with this procedure requires placing the inlet cannula perfectly, and in my opinion, cardiopulmonary bypass is the only way that ideal inlet placement can be assured. Off-pump insertion of LVADs certainly can be mastered, but I am concerned that the excellent results described by some surgeons may not be reproducible when this approach is applied more broadly.

After removing any trabeculae, the heart is filled, and ventilation is begun by the anesthesia team to evacuate any air from the left side. An index finger inserted into the ventriculotomy can confirm hemostasis of the sewing ring (Figure 28.7).

To seat the pump properly into the pericardial space, several links of the bend relief must be removed or the pump outlet graft will be too bulky to fit between the ribs. An optional technique is to keep most of the bend relief but

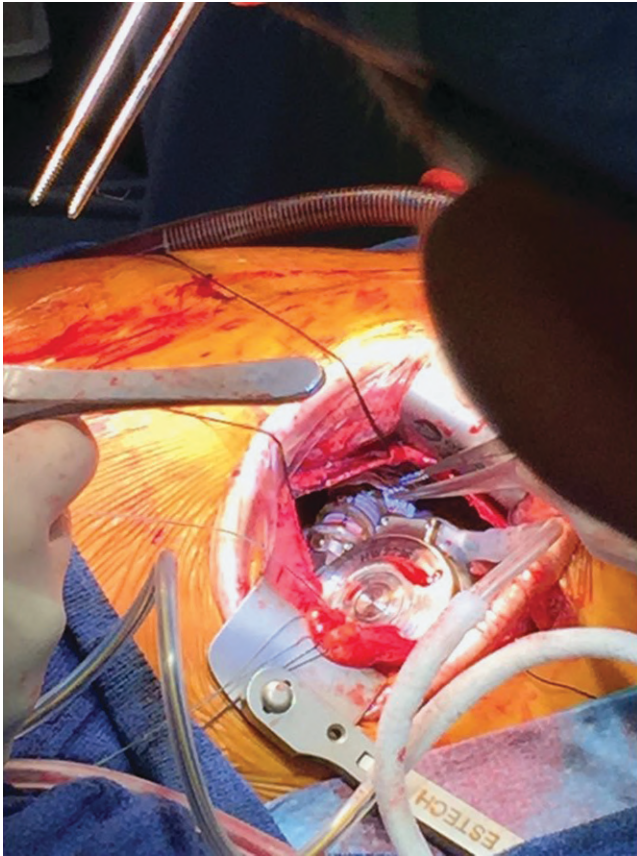


**Figure 28.7.** A pump being seated. The traction sutures and the torque wrench are providing counter-traction to the sewing ring/ventricle, which allows the pump to be introduced through the ventriculotomy.

to unhook the second link from the pump. After the outlet graft is routed through the mediastinum, the bend relief can be reconnected manually without too much difficulty (Figure 28.8).

The outlet graft is clamped after it is de-aired. The heart is filled, and the correct graft length is determined after the graft has had a chance to distend. The Vascutek graft is more expansive than the Hemashield graft, so allowing the graft to distend and stretch is an important nuance in placing the graft correctly. I typically route the graft along the mid-portion of the diaphragm and then along the right atrioventricular groove, similar to the strategy used for a vein graft to a posterior descending artery during coronary artery bypass grafting.

After orienting the outlet graft and trimming to the right length, it is anastomosed to the ascending aorta (Figure 28.9). Gelweave Vascutek is fairly expansible, so I clamp the end of the graft with heart full in order to determine the optimal length of the graft. Depending on the degree of ventricular dysfunction, this step can possibly be completed after the patient is weaned from cardiopulmonary bypass. The



**Figure 28.8.** The pump seated and well positioned in the pericardium. Before closure, the pericardium and mediastinal fat will be reapproximated over the pump or a polytetrafluoroethylene (PTFE) pericardial membrane will be placed to span the pericardial defect. The driveline will be tunneled through the interspace or below the costal margin.

anastomosis can be completed and then the LVAD started. Typically, we just complete implant on bypass. With the patient in Trendelenburg position, the heart is completely de-aired using standard maneuvers and an aortic root vent. The outlet graft (which has been clamped just proximal to the aortic anastomosis) is then vented with a needle as the pump is filled and started. Typically, we increase the speed to around 2,200 rpm during pump de-airing. The outlet graft clamp is temporarily released as the ascending aorta is visualized on transesophageal echocardiography. Once cardiopulmonary bypass has been weaned to a low level and de-airing is complete, the graft clamp is released, and pump flow is increased as appropriate. Typical speeds after bypass range from 2,400 to 2,600 rpm. The de-airing site is closed with a fine PROLENE suture, the cannulae are removed, and the incision is closed after heparin reversal with protamine. Pleural and mediastinal drains are placed, and the pericardium and mediastinal fat are closed over the pump and aorta. If there is not enough tissue to cover the pump, a



**Figure 28.9.** A view from the head of the bed of the completed outlet graft to the ascending aorta. The standard two-stage venous cannula in the right atrium and the aortic cannula are in the foreground.

gortex membrane can be used to prohibit lung adhesions to the pump during time of removal for the heart transplant.

One pitfall of the less-invasive lateral approach is an outlet graft of the wrong length. A kink can constrict the graft if it is too long, or can compress it if the graft is too short. Graft obstruction manifests as low flows and low power, which are easily diagnosed from the waveform on the display screen. In this case, the flow will be low, and the waveform will be flat. Additionally, the patient's aortic valve will continue to open, and phasic blood pressure will be normal. Loosening the setscrew and rotating the pump counterclockwise will compensate for a graft that is too long; rotating it clockwise will alleviate issues if it is too short. These maneuvers must be done carefully to avoid damaging the silicon O-ring on the inlet cannula. If the ring is not fully seated, or if it buckles or breaks, the resulting bleeding from the ring and pump interface will not be controllable. If the O-ring is fractured during seating, the pump must be replaced.

Although some authors have described routing the out-flow graft into the preperitoneal or pleural space to avoid mediastinal adhesions,<sup>10</sup> my success with doing so has

been mixed. The potential for graft impingement with preperitoneal or subcutaneous tunneling is a concern, even with the use of reinforced grafts that some have described. Although tunneling through the pleura is certainly feasible from a technical standpoint, adhesions to the lung present a formidable challenge during LVAD explantation and transplantation.

Outflow to the axillary artery using the HeartWare device has been reported.<sup>11</sup> My experience has been limited to a few patients with a hostile ascending aorta. The same anterior thoracotomy is used for placement of the inflow cannula and pump as described earlier, but the outflow graft is routed through the pleural space and is delivered throughout the second intercostal space to the left axillary artery, which has been previously isolated. Typically, an 8-mm Vascutek graft is anastomosed end-to-side to the axillary artery and this is anastomosed to the 10-mm outflow graft from the pump with a beveled end-to-end anastomosis to allow unobstructed egress from the pleural space through the second interspace.

Despite the attractiveness of this technique in providing mechanical support in patients with a hostile aorta, in my experience the outflow to the left axillary artery does not provide full support. One reported complication of this technique is swelling of the left arm due to over-circulation. Pressure in the arm should be kept relatively normal, with mean arterial pressures less than 100–110 mmHg. More experience is required before this technique can be recommended without reservation.

## Conclusion

Implanting LVADs is now standardized and reproducible. However, bleeding and RV failure may still occasionally occur. We need to find ways to lessen the morbidity associated with these implants. Increasing evidence indicates that a less-invasive approach with an upper hemisternotomy and left anterior thoracotomy can be safe and associated with lower rates of bleeding than those associated with conventional approaches. With experience, the lateral implantation can be mastered, and all surgeons with

expertise in implanting LVADs should have this approach in their armamentarium.

## REFERENCES

1. Kirklin JK, Pagani FD, Kormos RL, et al. Special focus on framing the impact of adverse events. *J Heart Lung Transplant*. 2007 Oct;36(10):1080–1086.
2. Frazier OH, Gregoric ID, Cohn WE. Initial experience with non-thoracic, extraperitoneal, off-pump insertion of the Jarvik 2000 heart in patients with previous median sternotomy. *J Heart Lung Transplant*. 2006 May;25(5):499–503.
3. Gregoric ID, LaFrancesca S, Myers T, et al. A less invasive approach to axial flow pump insertion. *J Heart Lung Transplant* 2008 Apr;27(4):423–4206.
4. Anyanwy AC. Nonsternotomy approaches to left ventricular assist device placement: combined left subcostal-right minithoracotomy technique. *Operat Techniq Thorac Cardiovasc Surg*. 2014;19:254–275.
5. Strueber M, Meyer AL, Feussner M, et al. A minimally invasive off-pump implantation technique for continuous-flow left ventricular assist device early experience. *J Heart Lung Transplant*. 2014 Aug;33(8):851–856.
6. Schmitto JD, Molitoris U, Haverich A, Strueber. Implantation of centrifugal pump as a left ventricular assist device through a novel minimized approach: upper hemi-sternotomy combined with anterolateral thoracotomy. *J Thorac Cardiovasc Surg*. 2012 Feb;143(2):511–513.
7. Sileshi B, Haglund NA, David ME, et al. In-hospital outcomes of a minimally invasive off-pump left thoracotomy approach using a centrifugal continuous-flow left ventricular assist device. *J Heart Lung Transplant*. 2015;34:107–112.
8. Schmitto JD, Krabatsch T, Damme L, et al. Less invasive HeartMate 3 left ventricular assist device implantation *J Thorac Dis*. 2018 Jun;(Suppl 15):S1692–S1695.
9. Riebandt J, Wiedemann D, Laufer G, Zimpfer D. Sternotomy sparing Thoratec HeartMate 3 implantation via bilateral minithoracotomy. *Innovations (Phila)*. 2018 Jan–Feb;13(1):74–76.
10. Cheung A, Lamarche Y, Kaan A et al. Off-pump implantation of the Heartware HVAD left ventricular assist device through minimally invasive incisions. *Ann Thorac Surg*. 2011; 91(4): 1294–1296.
11. Riebandt J, Haberl T, Mahr S, et al. Off pump HeartWare ventricular assist device implantation with outflow graft anastomosis to the left subclavian artery. *Ann Thorac Surg*. 2014;97:2214–2216.



# Concomitant Cardiac Valve Procedures with Circulatory Support Device Implantation

WALT DEMBITSKY, ROBERT ADAMSON, KARL LIMMER,  
AND CRAIG LARSON

## Introduction

**T**he use of left ventricular assist devices (LVADs) to support patients with acute and chronic left heart failure has increased exponentially over the past two decades. Globally, more than 30,000 LVADs have been implanted. In 2005, less than 10 countries were implanting LVADs; today, more than 40 countries do. The expansion can be attributed to improved clinical results, as well as to the limited number of donor hearts available to treat the growing pandemic of heart failure. Furthermore, the increasing number of older patients in developed countries may be better served by LVAD support than by cardiac transplantation.

Historically, survival has been the dominant metric used to assess VAD therapy. Currently, more than 5,000 patients have been supported with LVADs for more than 4 years and some for more than 15 years. With more patients being supported for longer periods, both the length and quality of life will be the new metrics for success. Because only the LV is supported, right ventricular (RV) heart failure can become a progressive problem, especially in recipients who have elevated pulmonary vascular resistance. Persistent or acquired valvular insufficiencies can escalate the development of RV failure. In addition, a small subset of supported patients can be weaned from their devices. Competent native heart valves become important for sustaining these three populations.

The higher hydraulic outputs required during exercise can only be achieved by the combined output of the left ventricle and the LVAD, in what we have labeled the LV-LVAD complex. Competent valves in the retained heart have the potential to augment and optimize this

complementary systemic flow. For these reasons, we have always emphasized first repairing the native heart and then adding an LVAD. To that end, we currently repair 55% of the mitral valves, 20% of the tricuspid valves, and close to 20% of the aortic valves at the time of LVAD implantation. In more than 300 HeartMate implants, our operative mortality has been 1%, and our RVAD use has been 2%. Randomized trials validating clinical recommendations for valvular repair during LVAD implantation do not yet exist. The value of mitral valve repair remains disputed, but aortic valve closure and tricuspid valve repair are less controversial. In this chapter, we present our reasoning as well as our strategies to correct these three valves during LVAD implantation.

## Repairing the Mitral Valve

The function of the mitral valve during LVAD support is to maintain both forward blood flow and the volume in the LV. In the LVAD-supported patient, mitral chordal mechanics are less important for distributing force to the ventricular walls, and the systolic anterior leaflet tension is less important for expanding the aortic annulus because the LV pressures are usually lower. This reduced importance is especially true with the current continuous-flow LVADs, but it was not universally true with the volume-displacement LVADs, especially when they were periodically in a systolic synchronous LV-LVAD relationship. Future iterations of continuous-flow pumps with the ability to generate episodic flows may recreate that adverse relationship. However, even with current continuous-flow LVADs, intra-ventricular pressures can become elevated.

Mitral insufficiency under elevated pressures can produce high left atrial pressures, and eventually, right heart failure.

The right-sided pumping complex is most vulnerable during the early post-implant period, when pulmonary vascular resistance may be elevated, and RV function diminished. Systemic blood pressure (right coronary artery perfusion pressure), volume status, pulmonary vascular resistance, RV contractility, and tricuspid valve function are all in a state of flux, creating the conditions for RV failure. Despite this state, RVAD use can usually be avoided, although that option requires attending to many details, all aimed at maximizing right-sided pumping efficiency. The function of the mitral valve during this crucial state can be pivotal. Left ventricular volumes are usually kept high to prevent suction events. Any transmitted pulsatility (pulsatility index) can be referred back through an incompetent mitral valve and increase RV afterload.

### First Case Example: Immediate Postoperative Right Ventricular Failure in a Patient with a HeartMate II

A patient with a HeartMate II LVAD and postoperative RV failure was returned to the operating room for possible RVAD insertion. An intraoperative transesophageal echocardiogram (TEE) revealed persistent mitral regurgitation and RV dysfunction, despite the use of inotropics and pulmonary artery vasodilatation (A in Figure 29.1). We were unable to re-repair the mitral valve. However, the hemodynamics improved when the mitral valve was replaced, and an RVAD was not needed (B in Figure 29.1).

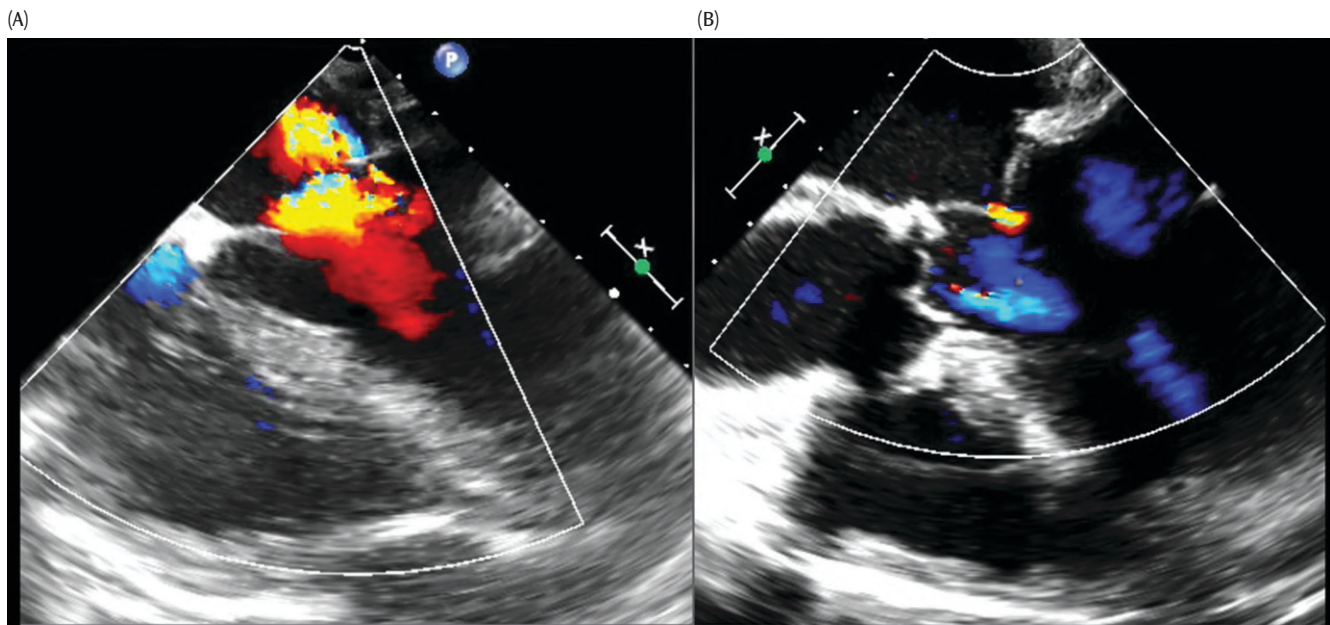
In a mock circulatory loop, we found that mitral regurgitation decreased the augmentation of forward flow by native cardiac function at lower LVAD speeds.<sup>1</sup> During exercise, flow demand exceeds the flow capacity of the volume displacement pumps in the pulsatile HeartMate I (Figure 29.2). The higher flow demands rely on the combined pumping capacity of what we have labeled the LV-LVAD complex.<sup>2</sup>

During exercise in patients with recovered native LV function, the LV-LVAD complex augments systemic flow by adding a parallel flow through the aortic valve (AV). Others have reported the same augmentation with continuous-flow HeartMate II pumps (Figures 29.3 and 29.4)<sup>2</sup>.

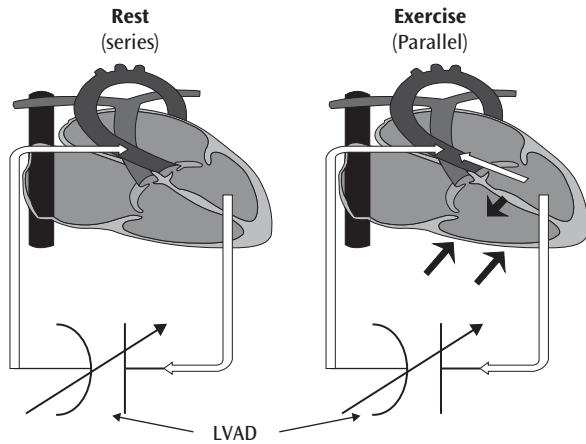
When pulmonary vascular resistance is low, the hydraulic component of maximum exercise capacity is limited by the combined pumping capacity of the LV-LVAD complex and not by RV function (Figure 29.5)<sup>2</sup>. Under these conditions, a competent mitral valve can improve that complementary ventricular contribution and, at the same time, prevent RV afterload from increasing.

### Second Case Example: Aortic Valve Regurgitation with Mitral Regurgitation in Chronic Circulatory Support

During chronic circulatory support, the AV can become progressively incompetent and can increase LV pressures. In that situation, an incompetent mitral valve can produce high right-sided pressures and present as RV failure in the LVAD-supported patient. These high right-sided pressures were greatly and easily reversed in four cases by placing a



**Figure 29.1.** First case example, transesophageal echo: (A) mitral valve with RV failure; (B) bio-prosthetic mitral valve without RV failure.

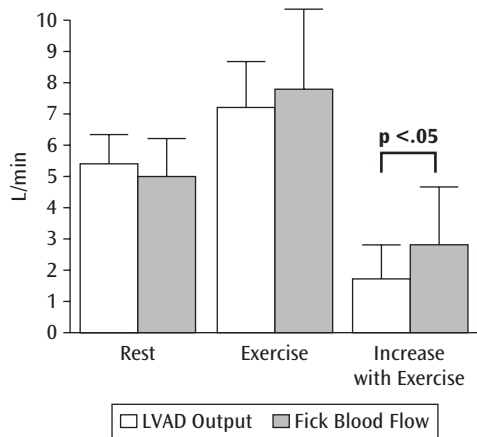


**Figure 29.2.** Diagram of blood flow at rest and with exercise as documented in the mock circulatory loop.

Reproduced from Jaski B et al., Effects of exercise during long-term support with a left ventricular assist device: results of the experience with left ventricular assist device with exercise (EVADE) pilot trial, *Circulation* 1997;95(10):2401–2406, <https://www.ahajournals.org/journal/circ>, Copyright © 2019 by Wolters Kluwer Health and the American Heart Association and American Stroke Association.

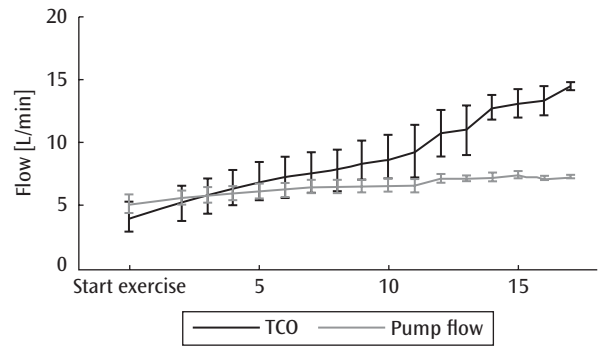
mitral clip, which created a competent mitral valve (Figure 29.6).<sup>5</sup>

In the rare instances when the LV has sufficiently recovered after LVAD implantation., some patients can be weaned



**Figure 29.3.** LV-LVAD complex: LVAD Output and Fick systemic blood flow at rest and with exercise (n = 10).

Reproduced from Jaski B et al., Effects of exercise during long-term support with a left ventricular assist device: results of the experience with left ventricular assist device with exercise (EVADE) pilot trial, *Circulation* 1997;95(10):2401–2406, <https://www.ahajournals.org/journal/circ>, Copyright © 2019 by Wolters Kluwer Health and the American Heart Association and American Stroke Association.



**Figure 29.4.** LV-LVAD complex: impact of exercise on cardiac output with LVAD.

Reproduced from Martina J et al., Exercise hemodynamics during extended continuous flow left ventricular assist device support: the response of systemic cardiovascular parameters and pump performance, *Artificial Organs* 2013;37(9):754–760, <https://onlinelibrary.wiley.com/journal/15251594>, Copyright © 1999–2019 John Wiley & Sons, Inc. All rights reserved.

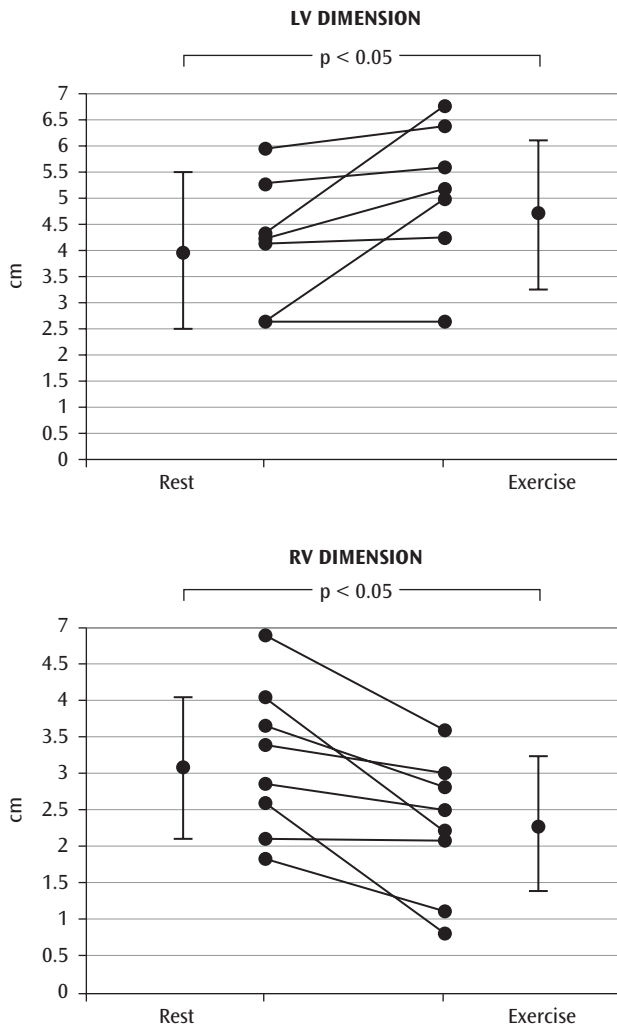
from support. In those patients, a competent mitral valve can permit LVAD removal without concurrent mitral valve repair.

### Third Case Example: A 16-Year-Old Boy with an Occluded Aortic Valve and Mitral Regurgitation

In a 16-year-old boy with acute heart failure, aortic insufficiency, and dilated cardiomyopathy (secondary to cryptic systemic vasculitis), the aortic root was replaced with a mechanical prosthesis. The valve became occluded during LVAD insertion. Systolic ventricular function appeared to recover, but we were unable to test LV function, given both the closed LV outflow tract and the presence of acquired mitral regurgitation. We re-replaced the AV conduit and repaired the mitral valve. When the LVAD was explanted 5 years later, ejection fraction was low, but the valves were competent.

Robertson’s<sup>6</sup> analysis of the INTERMACS database, published as “Concomitant Mitral Valve Procedures in Patients Undergoing Implantation of Continuous-Flow Left Ventricular Assist Devices,” found no statistically significant survival advantage for concomitant mitral valve procedures 3 months, 1 year, or 2 years after surgery (Figure 29.7). However, there was a trend toward increased survival among patients with moderate-to-severe mitral regurgitation who underwent a mitral valve procedure when receiving LVADs as destination therapy.

The effect of mitral valve repair on quality of life has not been extensively studied. Patients treated for mitral valve prolapse reported a statistically significant increase in quality of life 1 year later as measured on the EuroQol Questionnaire, despite being sicker preoperatively than patients whose valves were not treated. Patients with mitral



**Figure 29.5.** Top change in LV dimension from rest to exercise reflects a significant ( $P > .05$ ) increase in LV size ( $n = 8$ ). Reproduced from Jaski B et al., Effects of exercise during long-term support with a left ventricular assist device: results of the experience with left ventricular assist device with exercise (EVADE) pilot trial, *Circulation* 1997;95(10):2401–2406, <https://www.ahajournals.org/journal/circ>, Copyright © 2019 by Wolters Kluwer Health and the American Heart Association and American Stroke Association.

valve procedures also improved their 6-minute walk distances more than did patients with unrepaired valves, but there were no other statistical differences between groups. However, concomitant mitral valve repairs were associated with significantly fewer hospital readmissions 1 and 2 years later (Figure 29.8). The reason for this reduction is unclear because mitral valve repair did not seem to reduce the risk of readmission for right heart failure. Collectively, however, these data corroborate a benefit for select patients.<sup>6</sup>

Six-minute walk distances were significantly increased at 1 year post-operatively for all groups, and no differences

were noted at this point between the groups. The greatest changes in 6-minute walk distances were noted for patients who underwent mitral valve repair. There was no increase in early mortality for patients who underwent a concomitant mitral valve procedure (MVP), which suggests that repairing the valve during LVAD implantation is a safe option to consider (Table 29.1).

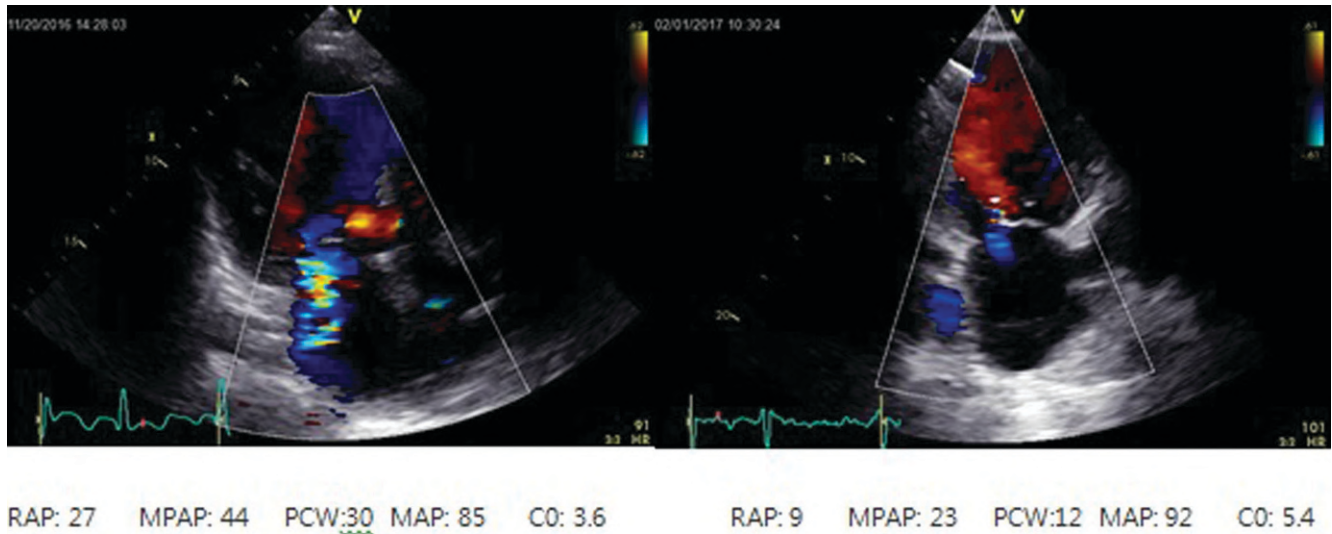
The primary goal of mitral repair is to minimize regurgitant flow. Systolic anterior motion of a large anterior leaflet is unimportant in LVAD-supported patients. Mitral regurgitation is usually managed by inserting an undersized annuloplasty ring. Edge-to-edge suture repair through a transapical approach has been reported, but experience is limited.<sup>7</sup> Existing mitral prostheses have been successfully left in place.<sup>8</sup> Strokes were not more common in patients with mechanical mitral prostheses left in place, although the retrospective INTERMACS data are inconclusive on this point.<sup>6</sup>

When mitral valve replacement is necessary, we prefer a bio-prosthesis. In many cases, late failure of the valve can be addressed using percutaneous techniques. Reducing anticoagulation in patients with LVADs (who often have an increased risk of bleeding complications) may increase the risk of thrombosis for those with a mechanical prosthesis, especially because the leaflet motion necessary to wash the hinge points in most mechanical prostheses is reduced by continuous-flow LVADs.

Our current policy is to correct mitral regurgitation greater than 2+ at any time during the patient's hospitalization. We have gradually increased our mitral valve procedures from 17% during our HeartMate I era from 1991 to 2008, to 42% with our early HeartMate II experience between 2005 and 2011, to our current rate of 55% for our HeartMate II and HeartMate 3 recipients.

#### Aortic Valve Problems Related to Device Implantation

Because blood may not be moving through the AV during LVAD support, aortic stenosis need not be corrected. Existing aortic insufficiency (AI) and progressive deterioration of the native AV, however, do require special attention. Aortic insufficiency in LVAD recipients produces central recirculation with diminishing systemic output and increases the shear stress on the blood components. Increased LV volume loading usually increases LV pressure and volume, depending on native ventricular function. This increased LV pressure can be transmitted back through the pulmonary circulation and can contribute to RV failure. As discussed, this phenomenon can be influenced by the competency of the mitral valve. Increasing LV volume can create functional mitral regurgitation and can exacerbate existing untreated mitral regurgitation. Clinically, this complex interaction gradually reduces exercise tolerance through falling systemic flows; eventually, high left-heart-filling pressures cause pulmonary congestion and dyspnea.<sup>9</sup> Finally, progressive symptoms of



**Figure 29.6.** Left, pre-clip; right, 30 days from clip.

right heart failure (including renal and hepatic failure) and peripheral edema will ensue. Peripheral organ failure produced by systemic elevated venous pressures is worsened by falling systemic cardiac output.

As AI progresses, the shear stress experienced by circulating blood elements increases because the insufficiency is constant rather than episodic (as it is in the unsupported circulation) and because (as described by Bluestein<sup>10</sup>), the circulation history of the blood elements is markedly increased. Clinically, this shear stress can manifest as progressive hemolysis with increasing concentrations of lactate dehydrogenase and hyperbilirubinemia (hepatic congestion).

The incidence of AI in LVAD patients is greater than in the general population. Aortic insufficiency can occur with both pulsatile and non-pulsatile LV assist devices. A recent meta-analysis found that the incidence of AI was 37% in 548 pooled patients with LVADs (Table 29.2).<sup>11</sup>

Variables associated with the development of de novo aortic regurgitation (AR) in patients with LVADs include increasing age, female sex, increased duration of support, and continuous closure of the AV. A tailored LVAD management strategy has been proposed to reduce the incidence of AR by allowing the LV to intermittently open the valve, impeding the evolution of morphologic valvular remodeling.<sup>16</sup> The authors concluded that further investigation was warranted to evaluate the clinical impact of AR and, consequently, less-efficient LVAD flows.

Interestingly, a Japanese study reported the 1-year incidence of de novo AV insufficiency to be 18% in the Jarvik 2000 device, which periodically opens the AV every 8 seconds.<sup>11</sup> In contrast, recent studies<sup>12</sup> from European centers where the HeartWare VAD (HVAD) was programmed with an intermittent low-speed-like effect known as the Lavare

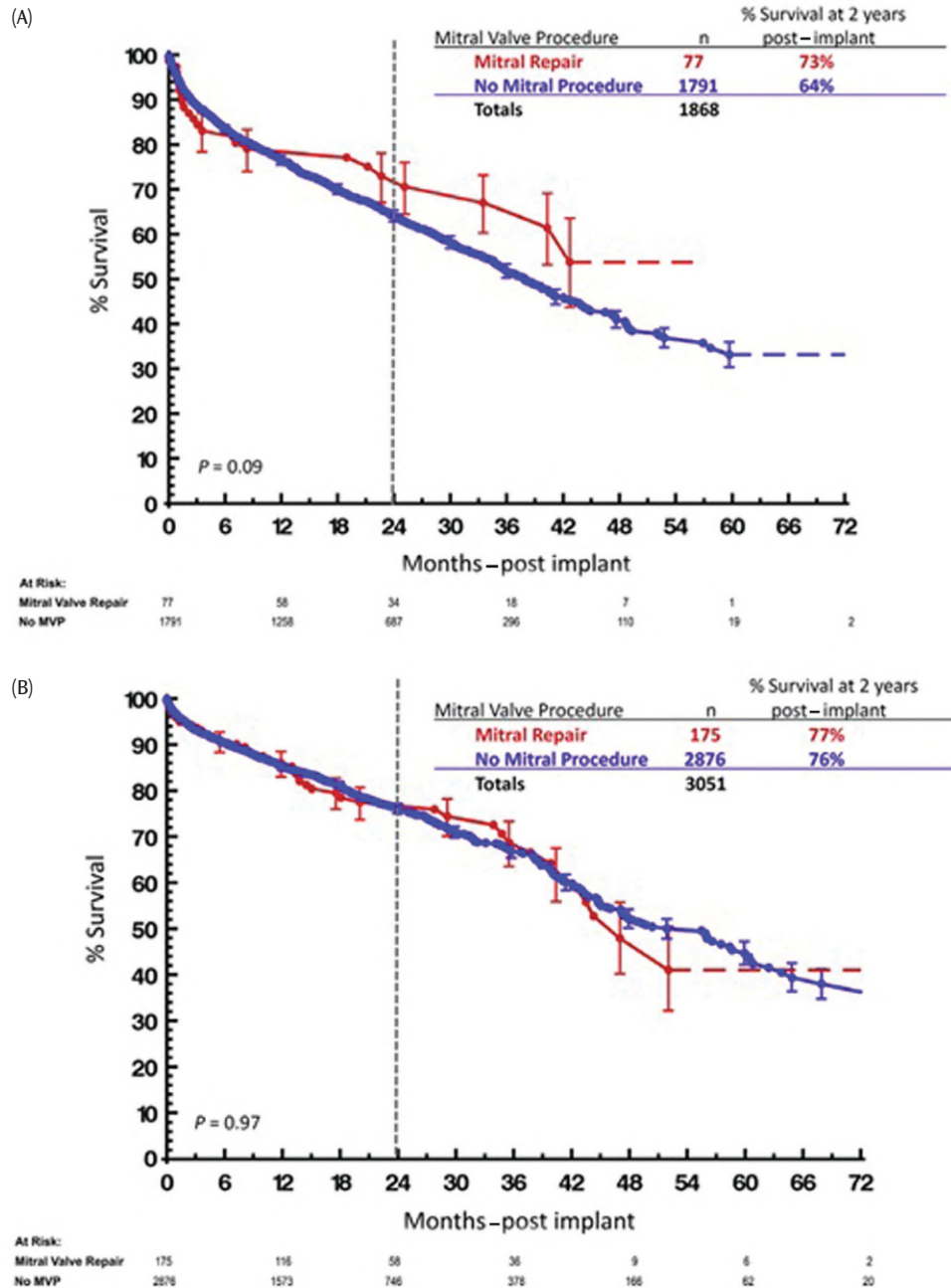
cycle, showed that marked AR was rare in HVAD recipients; the 1-year incidence was only 1.9%.<sup>13</sup> Those studies also revealed that AV opening was frequent in most of the recipients and that atrial AR was common with a closed AV.

Histochemical changes in AVs analyzed from LVAD-supported patients have also been well documented by numerous authors.<sup>14</sup> Aortic valves in patients with LVADs showed increased stiffness with increased valve cell activation, immune and oxidative stress, and transforming growth factor  $\beta$ -related proteins. In patients with LVADs, the AV responds to altered hemodynamics by increasing signaling pathways related to injury and valve cell activation, ultimately leading to valve stiffening. Further study is required to identify the mechanisms resulting in the changes in these mechanical properties.

#### Predicting Aortic Insufficiency after Device Implantation

Patients with preoperative enlargement of the aortic root may have progressive root dilatation, which may be associated with aortic insufficiency.<sup>15</sup> However, in the previously mentioned meta-analysis of eight trials,<sup>16</sup> the diameter of the aortic root did not predict the occurrence of insufficiency. Interestingly, patients whose AVs opened during support experienced less aortic insufficiency.<sup>17</sup> Practice guidelines currently suggest that more-than-mild AV insufficiency at the time of LVAD implantation should be corrected.<sup>18</sup>

Numerous concomitant surgical procedures to treat or prevent AI at the time of LVAD implantation have been proposed. During the current era of continuous-flow LVADs, the fatal threat of pump thrombosis with an occluded LV outflow tract has prompted strategies to keep the outflow



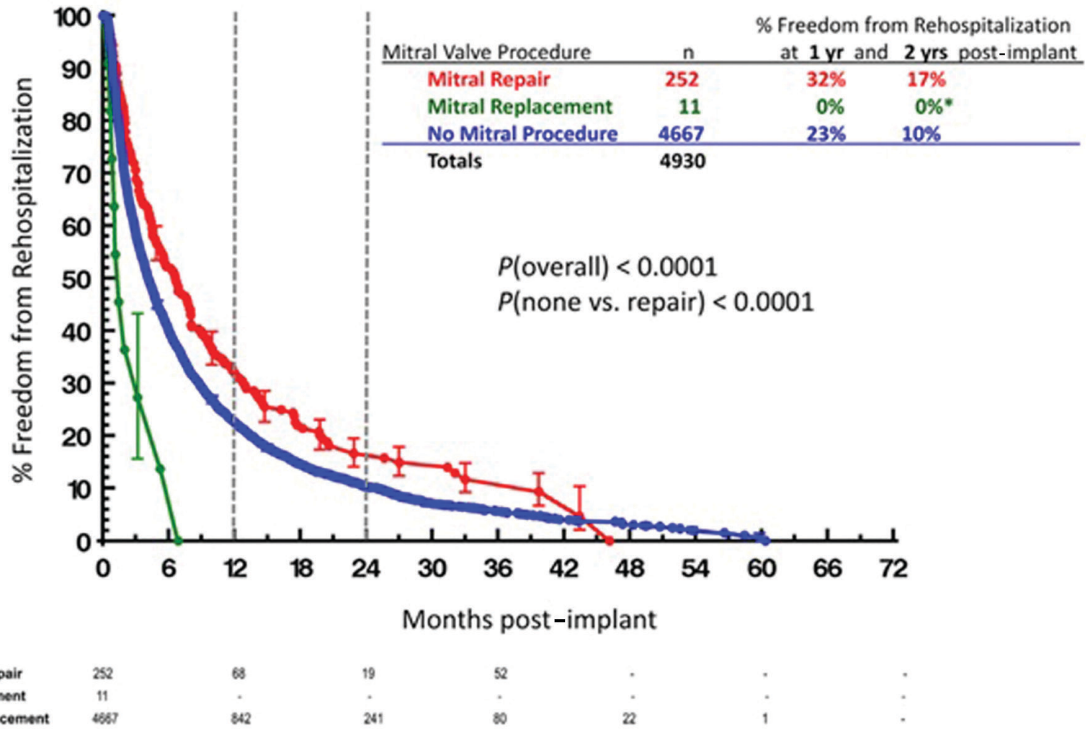
**Figure 29.7.** (A) Patients receiving destination therapy; (B) patients not receiving destination therapy.

Reprinted from Robertson J et al., Concomitant mitral valve procedures in patients undergoing implantation of continuous-flow left ventricular assist devices, *Journal of Heart and Lung Transplantation* 2018;37:79–88, Copyright (2018), with permission from Elsevier.

tract open while eliminating AI. Although long-term, event-free survival of patients with occluded outflow tracts has been reported, AV annuloplasty, bio-prosthetic replacement, and partial valve closure have all been used to maintain an open outflow tract. Because the primary pathology in acquired insufficiency is leaflet failure, experience with annuloplasty is limited and is not widely accepted.<sup>19</sup>

Bio-prosthetic replacement is appealing, but these valves tend to thrombose and can also begin to leak

themselves. Partial native valve leaflet closure with a central felt-reinforced suture can be effective. Unfortunately, this repair can fail when AI progresses in the unclosed portion of the valve or when the closure is disrupted, presumably during occasional native systolic ventricular ejections. Additionally, extension of the fibrotic process initiated by the central felt suture can progress and close the LV outflow tract. For these reasons, Adamson has advocated completely closing the AV using felt strips



**Figure 29.8.** Time to first re-hospitalization by mitral valve procedure group.

Reprinted from Robertson J et al., Concomitant mitral valve procedures in patients undergoing implantation of continuous-flow left ventricular assist devices, *Journal of Heart and Lung Transplantation* 2018;37:79–88, Copyright (2018), with permission from Elsevier.

suspended from the annulus. The outflow tract can be securely closed with occlusive outflow patches in the aortic annulus.

### Existing Aortic Valve Prostheses

Existing mechanical and bio-prosthetic valves have both successfully been left in place during VAD implantation. Most authorities advocate closing the mechanical AVs with the technique described by Cohen<sup>20</sup> to minimize thrombotic risks. Insufficient bio-prosthetic valves over the short term have been closed surgically.

### Long-Term Outcomes with Aortic Valve Closure

Robertson<sup>7</sup> analyzed 5,344 patients enrolled in the INTERMACS database between June 2006 to December 2012 to assess the impact of AV procedures in LVAD recipients. Of these, 125 underwent AV closure, 95 repairs, and 85 replacements. Postoperative aortic insufficiency increased over time in patients undergoing an AV procedure. Despite the procedure, early recurrence of moderate-to-severe AV insufficiency still occurs. After 6–12 months, moderate-to-severe AI has developed in 18% of patients with AV repairs, 10% of those with no

**Table 29.1 • Changes in exercise function post-operatively**

Exercise Function	No Mitral Valve Procedure (N = 4,667)	Mitral Valve Repair (N = 252)	p-value
6-minute walk (feet), pre-implant	800.3 ± 14.2 (n = 839)	662.6 ± 85.5 (n = 29)	0.08
6-minute walk (feet), 1 year post-implant	1158.4 ± 20.1 (n = 988)	1131.7 ± 51.1 (n = 63)	0.74
Difference between pre-implant and 1 year post-implant (feet)	385.3 ± 46.4 (n = 283)	597.4 ± 127.4 (n = 11)	NA
p-value	0.0009	<0.0001	

Data expressed as mean ± standard error. NA, Not applicable.

**Table 29.2 • Summaries of Eight Observational Studies Included in a Meta-Analysis (548 Pooled Patients) of the Factors Influencing de novo Aortic Regurgitation in Patients Receiving Continuous-Flow Left Ventricular Assist Device**

Author, Year of Publication	Study Period	Country	Sample Size	Device Type (n)	Severity of AR	Incidence of de novo AR, %
Aggarwal, 2013	2005–2011	United States	79	HM2 (79)	Mild or more	52
Bhagra, 2016	2009–2013	United Kingdom	48	HVAD (48)	Mild or more	27
Da Rocha, 2016	2009–2013	Germany	102	HM2 (25), HVAD (77)	More than mild	31
Hiraoka, 2015	2005–2012	United States; Japan	82	HM2 (69), HVAD (11), VentrAssist (2)	More than mild	52
Imamura, 2014	2006–2013	Japan	52	HM2 (11), Jarvik 2000 (3), EvaHeart (24), DuraHeart (14)	Mild or more	21
Patil, 2015	2006–2012	United Kingdom	90	HM2 (56), HVAD (34)	Mild or more	53
Saeed, 2016	2013–2015	Germany	32	HVAD (32)	Mild or more	28
Soleimani, 2012	2008–2010	United States	63	HM2 (55), HVAD (8)	Mild or more	10

AR = atrial regurgitation; HM2 = HeartMate II; HVAD = HeartWare ventricular assist device.

Robertson J et al., Concomitant mitral valve procedures in patients undergoing implantation of continuous-flow left ventricular assist devices: an INTERMACS database analysis. *J Heart Lung Transplant.* 2018;37(1):79–88.

AV repair, 9% of those with AV replacements, and 5% of those with AV closures ( $P < 0.001$ ). The best approach for dealing with AI at the time of continuous-flow LVAD implantation has been debated, with no consensus on whether to perform AV repair, replacement, or closure. Robertson's<sup>20</sup> primary finding is that AV closure markedly increases mortality, whereas short- and long-term survival in patients undergoing AV repair is like that of patients with continuous-flow LVADs who did not undergo an AV procedure. The limitation to AV repair is a higher incidence of postoperative AI.

The difficulty in assessing AI in patients with continuous-flow LVADs is that the flow is usually pancyclical and eccentric.<sup>21</sup> Traditional transthoracic echocardiography (TTE) measurements for grading AI severity, including vena contracta, jet width/LV outflow tract diameter, and proximal isovelocity surface area, are less accurate in a continuous-flow system and tend to be less reliable with eccentric regurgitant flow. The clinical importance of AI in patients with continuous-flow LVADs remains unclear. The increased regurgitant flow caused by AI elevates cardiac filling pressures and produces signs or symptoms of congestion. However, studies evaluating outcomes after the development of de-novo AI are mixed with respect to morbidity and mortality.

Grinstein et al.<sup>21</sup> have introduced two new transthoracic echocardiographic measurements for grading AI severity in patients with continuous-flow LVADs. The peak systolic-to-diastolic (S/D) velocity ratio of the LVAD outflow cannula and diastolic acceleration of the LVAD outflow cannula correlate better with clinical filling pressures and regurgitant fraction than do

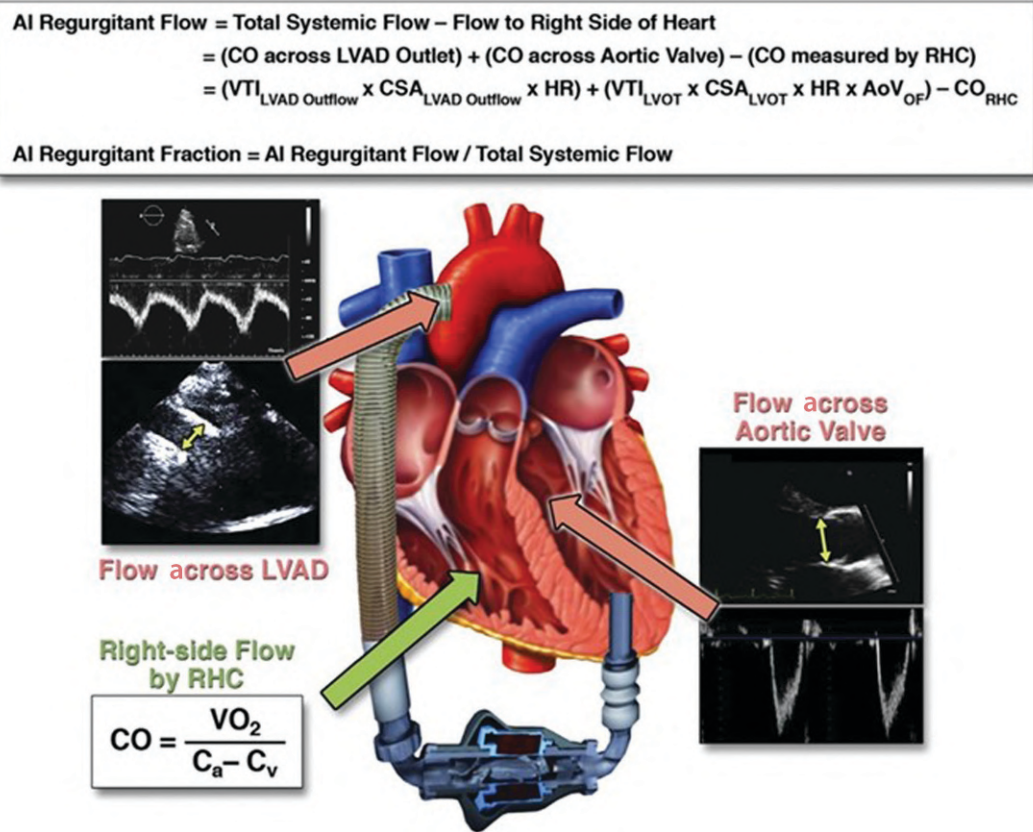
traditional transthoracic echocardiographic measures, including vena contracta measurements (Figure 29.9). Furthermore, the authors found that traditional measures tend to underestimate AI severity.<sup>22</sup> The new AI transthoracic echocardiographic measures better discriminate AI severity and predict clinically meaningful outcomes (Figure 29.10)<sup>22</sup>.

## Managing Late-Onset Aortic Insufficiency

The initial management of symptomatic heart failure in patients with moderate or severe AI should involve diuresis, afterload reduction, and inotropic support, if needed. If symptoms fail to improve, a ramp study to optimize LVAD pump speed should be considered. If symptoms persist despite speed optimization, definitive therapy with surgical or percutaneous correction may be required. Percutaneous treatment of LVAD-acquired and clinically important moderate-to-severe AI that is not amenable to medical management (use of optimal LVAD speed and lower goals for mean arterial pressure) has been documented and reviewed extensively.<sup>23–25</sup>

Percutaneous interventional therapies are important options for patients who are not surgical candidates or who have high surgical risk. Both the percutaneous implantation of an AV and the placement of an Amplatzer Cribiform Septal Occluder to completely occlude the native aortic outflow have been successful. These therapies should be approached with caution because the associated outcomes are not ideal and long-term data are lacking. Reports of Amplatzer occluders





**Figure 29.9.** Derivation of regurgitant fraction by flow measurements using echocardiography and right-sided heart catheterization (RHC) through the LVAD outflow cannula, across the AV, and the right side of the heart.

AI = aortic insufficiency; AoVof = fraction of AV opening; Ca = arterial oxygen content; CO = cardiac output; CSA = cross-sectional area; CV = venous oxygen content; HR = heart rate; LVAD = left ventricular assist device; LVOT = left ventricular outflow tract; VTI = velocity time integral.

Reprinted from Grinstein J et al., Accurate quantification methods for aortic insufficiency severity in patients with LVAD: role of diastolic flow acceleration and systolic-to-diastolic peak velocity ratio of outflow cannula, *JACC: Cardiovascular Imaging* 2016;9:641–651, Copyright (2016), with permission from Elsevier.

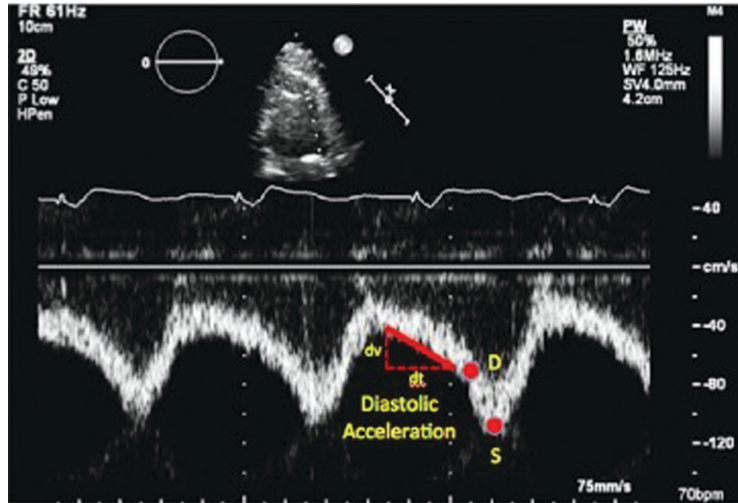
are limited, as are data about the “off-label” use of transcatheter AV replacement to treat pure severe AR.

A recent review of 146 patients enrolled in a large database from 18 centers identified 78 with native aortic valve regurgitation (NAVR) and 68 with failing bioprosthetic surgical heart valves (SHVs).<sup>26</sup> The authors concluded that TAVR for pure NAVR remains a challenging condition, with old-generation transcatheter heart valves (THVs) associated with embolization, migration, and significant paravalvular regurgitation. Newer-generation devices show more promising outcomes. However, further study of this patient subset, with likely new device technology, is required before transcatheter valve replacement can be routinely recommended as a state-of-the-art treatment option for pure NAVR. For those patients with severe AR caused by failing surgical heart valves, transcatheter replacement is a valuable therapeutic option.

## Tricuspid Valve

Moderate-to-severe tricuspid regurgitation (TR) affects up to 1.6 million patients in the United States. Usually associated with concomitant valvular disease, it independently predicts long-term survival among patients with multivalvular disease undergoing surgical or transcatheter aortic or mitral valve procedures, patients with heart failure treated medically, and patients with severe isolated TR who are treated medically. Despite these indicators, surgical treatment of TR is underused in contemporary practice. Isolated TR is associated with high operative morbidity and mortality, prolonged hospitalizations, and considerable cost.<sup>27</sup>

A large observational analysis of cardiac surgical patients revealed a robust relationship between the preoperative grade of TR as assessed by intraoperative TEE and long-term mortality.<sup>28</sup> Even moderately severe TR was



**Figure 29.10.** Measurement of the LVAD outflow cannula S/D ratio and diastolic acceleration by pulsed-wave Doppler echocardiography.

Reprinted from Grinstein J et al., Accurate quantification methods for aortic insufficiency severity in patients with LVAD: role of diastolic flow acceleration and systolic-to-diastolic peak velocity ratio of outflow cannula, *JACC: Cardiovascular Imaging* 2016;9:641–651, Copyright (2016), with permission from Elsevier.

associated with substantially increased long-term mortality. Survival in patients who underwent tricuspid valve surgery for all grades of TR was better than that in those who did not. Randomized controlled trials are needed to assess the long-term survival benefit after surgical repair of less-than-severe TR.

The European Society of Cardiology<sup>29</sup> recommends that patients who have severe TR undergo surgical repair at the time of left-sided valve surgery (class I) and that such surgery should be considered in patients undergoing left-sided heart valve surgery with at least mild TR and a dilated tricuspid annulus (class IIa; Table 29.3). However, similar guidelines do not exist for patients undergoing LVAD implantation, although the prevalence of at least moderate TR has recently been estimated to be nearly 50%.<sup>19</sup>

To provide guidance for treating LVAD recipients with TR, Robertson analyzed patients enrolled in the Society of Thoracic Surgeons' National Database between January 2006 and September 2012.<sup>30</sup> Of 2,196 patients with moderate-to-severe preoperative TR who received continuous-flow LVADs at 115 institutions, 588 (27%) underwent a concomitant tricuspid valve procedure. Concomitant procedures did not reduce early death or the requirement for RVAD placement and were associated with worse early postoperative outcomes. These data caution against routine concomitant tricuspid valve procedures based solely on the degree of preoperative TR and suggest that additional selection criteria are needed to identify patients in whom concomitant tricuspid valve procedures may prevent postoperative RV failure.

The first meta-analysis to evaluate the outcomes of tricuspid valve surgery performed at the time of LVAD

implantation, published in 2014,<sup>30</sup> concluded that tricuspid valve surgery prolongs cardiopulmonary bypass times, but that the evidence was insufficient to conclude that performing tricuspid valve surgery at the time of LVAD implantation affected early postoperative outcomes. Concomitant tricuspid valve procedures did not affect the need for RVADs (6 studies, HR 1.42, 95% CI 0.54 to 3.76), the prevalence of acute renal failure (4 studies, HR 1.07, 95% CI 0.55 to 2.10), or early mortality (6 studies, HR 1.28, 95% CI 0.78 to 2.08). However, most studies were inadequately powered and did not adjust for potential confounders. The two largest studies (which analyzed data from the HeartMate II trials<sup>31</sup> and STS database<sup>30</sup>) found no difference in early mortality in patients undergoing concomitant tricuspid valve procedures, although one<sup>30</sup> found a higher risk for RVAD placement and the other<sup>31</sup> for postoperative renal failure and prolonged length of stay. Both studies noted that observational data on this topic were limited. Although cardiopulmonary bypass times appear to be longer in patients undergoing concomitant tricuspid valve procedures, definitive conclusions on the effect of tricuspid valve surgery on early postoperative outcomes could not be drawn. Data, especially on long-term outcomes, are needed to establish the best practice for these patients.

Anwer et al.<sup>32</sup> have suggested that atrial fibrillation is associated with early progression of TR after LVAD implantation. In patients with preoperative atrial fibrillation and less-than-severe TR, a concomitant tricuspid valve procedure may be considered. The authors acknowledged that the possible relationship between atrial fibrillation and TR on RV failure or remodeling remains to be established.

**Table 29.3 • Summary of Existing Society Guidelines for Tricuspid Valve Surgery for Tricuspid Regurgitation**

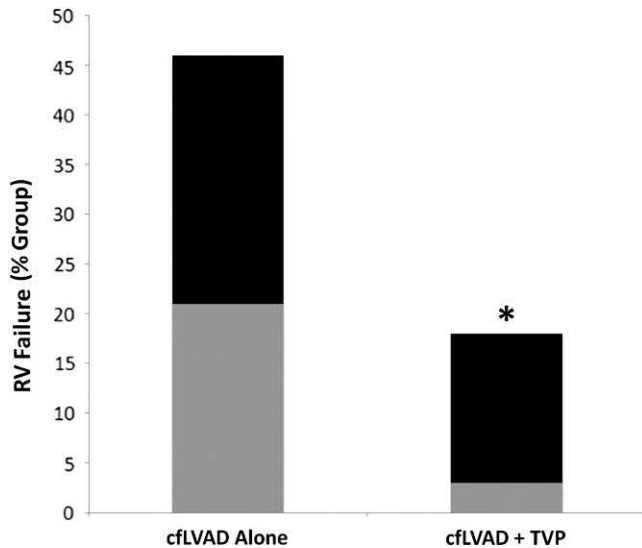
2012 European Society of Cardiology Recommendations	2014 American Heart Association/American College of Cardiology Recommendations
<b>Class I</b>	
Severe primary or secondary TR at the time of left-sided valve surgery (level of evidence C)	Severe primary or secondary TR at the time of left-sided valve surgery (level of evidence C)
Symptomatic isolated severe primary TR without evidence of right ventricular dysfunction (level of evidence C)	
<b>Class IIA</b>	
Surgery may be appropriate for moderate primary TR in patients at the time of left-sided valve surgery (level of evidence C).	Surgery may be appropriate for severe primary TR in patients unresponsive to medical therapy (level of evidence C).
Surgery may be appropriate for mild or moderate secondary TR in patients with annular dilation ( $\geq 40$ mm or $> 21$ mm/m <sup>2</sup> ) at the time of left-sided valve surgery (level of evidence C).	Surgery may be appropriate for mild or moderate secondary TR at the time of left-sided valve surgery if there is (A) dilation of the tricuspid annulus or (B) the patient has a history of right heart failure (level of evidence B).
Surgery may be appropriate for asymptomatic or mildly symptomatic patients with severe isolated primary TR and evidence of progressive RV dilation or decreased RV function (level of evidence C).	
In patients with previous left-sided valve surgery; stand-alone tricuspid surgery may be appropriate for patients with severe secondary TR and either symptoms or evidence of right ventricular dilation or dysfunction, <i>in the absence of left-sided valve dysfunction, severe RV or LV dysfunction and severe pulmonary hypertension</i> (level of evidence C).	
<b>Class IIB</b>	
	Surgical tricuspid valve repair may be appropriate in patients with mild or moderate secondary TR and pulmonary hypertension at the time of left-sided valve surgery (level of evidence C).
	In patients with previous left-sided valve surgery; surgical repair or replacement may be appropriate in patients with symptomatic severe TR <i>in the absence of severe RV dysfunction or severe pulmonary hypertension</i> (level of evidence C).
	Surgery may be appropriate for patients with asymptomatic or minimally symptomatic severe primary who have evidence of at least moderate right ventricular dilation or dysfunction (level of evidence C).

Abbreviations: LV = left ventricle; RV = right ventricle; TR = tricuspid regurgitation.

In one study of patients with preoperative RV failure and marked TR receiving continuous-flow LVADs, about half also underwent concomitant tricuspid valve procedures.<sup>33</sup> These concomitant procedures prolonged cardiopulmonary bypass times, but surgical experience reduced the rate of post-implant RV failure, as evidenced by a reduced need for RVAD and inotropic support (Figure 29.11). Furthermore, prolonged hospitalizations were less frequent in patients undergoing concomitant tricuspid valve procedures. The authors concluded that patients receiving continuous-flow LVADs with

moderate or severe TR should be considered for concomitant tricuspid valve procedures to reduce post-implant RV dysfunction.

Recently, a more focused single-center study<sup>34</sup> examined the effects of residual TR on long-term outcomes in patients with LVADs. The assist devices improved RV and LV function, as well as TR resulting from chordal tethering. The authors noted the benefit of a competent tricuspid valve. Marked TR was observed in about 25% of patients supported for 1 year. Recipients with residual TR had a higher mortality than those without (Figure 29.12). Regurgitation



**Figure 29.11.** Impact on need for RVAD with or without tricuspid valve repair at time of implantation of continuous-flow LVAD. Abbreviations: cf LVAD = continuous flow left ventricular assist device, TVP = tricuspid valve procedure. Reprinted from Piacentino V 3rd et al., Utility of concomitant tricuspid valve procedures for patients undergoing implantation of a continuous-flow left ventricular device, *Journal of Thoracic and Cardiovascular Surgery* 2012;144:1217–1221, Copyright (2012), with permission from Elsevier.

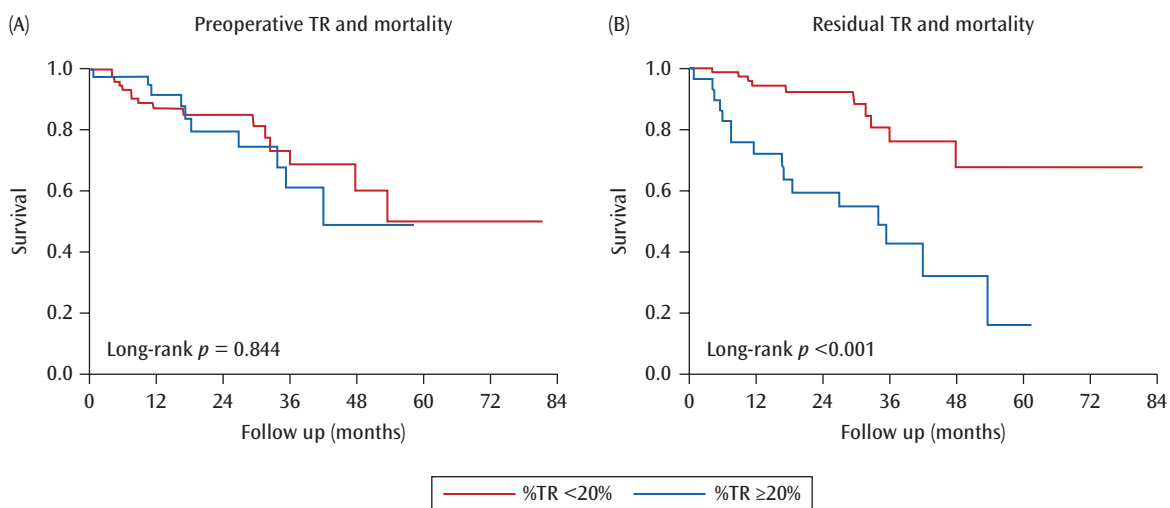
was associated with increasing age, preoperative annular diameter, and mitral regurgitation. The authors concluded that enlarged annuli greater than 41 mm should be considered for correction at the time of LVAD implantation and

that patients with residual regurgitation require closer surveillance (Figure 29.13).<sup>35</sup>

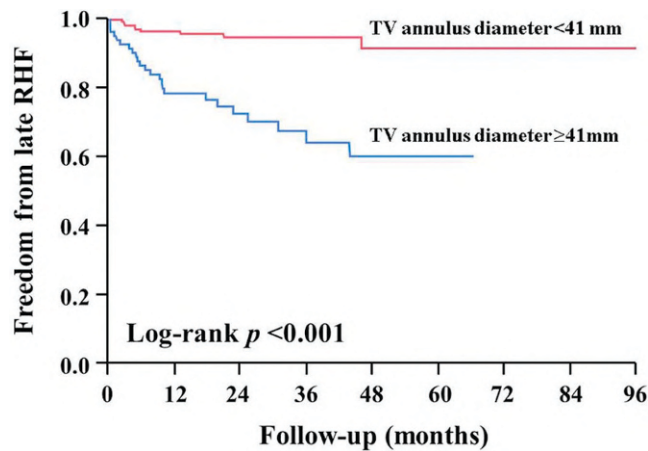
Our current policy is to correct tricuspid regurgitation if more than moderately severe at any time during the patient's preoperative course, especially in the presence of atrial fibrillation and a dilated annulus greater than 42 mm.

## Surgical Correction of Tricuspid Regurgitation

Tricuspid regurgitation caused by annular dilatation and leaflet tethering is best corrected with annuloplasty rings. Implantable cardioverter defibrillators and pacemakers are widely used in patients with poor ventricular function who undergo LVAD implantation. Traumatic damage to the valve is usually caused by lead adherence and restrictive impingement, but perforation and entanglement are also causes. Repairing these tricuspid valves can be difficult. Several corrective valvuloplasty techniques can be used, especially in valves with normal, pliable leaflets. Severe leaflet and subvalvular fibrosis may prevent repair. If a prosthetic valve is needed, a bio-prosthesis may be best because late malfunctions can be corrected using catheter-based techniques, and non-essential anticoagulation can be discontinued if necessary. Epicardial pacer and defibrillator electrode leads can be placed if needed. Additionally, retained defibrillator and pacer electrodes can be relocated through the prosthesis to permit late removal in cases of infection or malfunction<sup>36,37</sup>



**Figure 29.12.** Impact of tricuspid regurgitation on mortality. (A) Mortality related to patients with or without tricuspid regurgitation prior to device implant. (B) Mortality related to the degree of residual tricuspid regurgitation after the device implant. From Nakanishi K, Homma S, Han J, et al. Prevalence, predictors, and prognostic value of residual tricuspid regurgitation in patients with left ventricular assist device. *J Am Heart Assoc.* 2018;7:e008813. Copyright © 2018 The Authors. Published on behalf of the American Heart Association, Inc., by Wiley Blackwell.



**Figure 29.13.** Kaplan-Meier curve for late right-sided heart failure after LVAD implantation according to TV annulus enlargement.

Reprinted from Nakanishi K et al., Usefulness of tricuspid annular diameter to predict late right sided heart failure in patients with left ventricular assist device, *American Journal of Cardiology* 2018;122:115–120, Copyright (2018), with permission from Elsevier.

## Summary

Concomitant procedures at the time of LVAD implantation often have durable benefits to patients, especially those treated with destination therapy. Identifying risk factors that favor less-complex approaches will require further research in large multicenter studies.

## REFERENCES

- May-Newman K. Mitral valve regurgitation in the LVAD-assisted heart studied in a mock circulatory loop. *Cardiovasc Eng Technol*. 2016;7(2):139–147.
- Jaski B, Kim J, Maly RS, et al. Effects of exercise during long-term support with a left ventricular assist device: results of the experience with left ventricular assist device with exercise (EVADE) pilot trial. *Circulation*. 1997;95(10):2401–2406.
- Martina J. Exercise hemodynamics during extended continuous flow left ventricular assist device support: the response of systemic cardiovascular parameters and pump performance. *Artif Organs*. 2013;37:754–762.
- Noor M, Bowles C, Banner N. Relationship between pump speed and exercise capacity during HeartMate II left ventricular assist device support: influence of residual left ventricular function. *Eur J Heart Fail*. 2012;14:613–620.
- Jaski B et al. Effects of exercise during long-term support with a left ventricular assist device: results of the experience with left ventricular assist device with exercise (EVADE) pilot trial. *Circulation*. 1997; 95(10): 2401–2406
- Robertson J et al., Concomitant mitral valve procedures in patients undergoing implantation of continuous-flow left ventricular assist devices: an INTERMACS database analysis. *J Heart Lung Transplant*. 2018;37(1):79–88.
- Russo M, Merlo A, Johnson EM, et al. Transapical approach for mitral valve repair during insertion of a left ventricular assist device. *Scientific World Journal*. 2013;925310:4.
- Schweiger M, Stepanenko A, Vierecke J, et al. Preexisting mitral valve prosthesis in patients undergoing left ventricular assist device implantation. *Artif Organs*. 2012;36:49–53.
- Cowger J, Rao V, Massey T, et al. Comprehensive review and suggested strategies for the detection and management of aortic insufficiency in patients with a continuous-flow left ventricular assist device. *J Heart Lung Transplant*. 2015;34:149–157.
- Bluestein D, Einav S. Techniques in the analysis of stability of pulsatile flow through heart valves. In: Leondes C., ed. *Biomechanics Systems Techniques and Applications: Cardiovascular Techniques*, Volume II, Chapter 4. Boca Raton, FL: CRC Press; 2001:4-1–4-39.
- Gasparovic H, Kopjar T, Saeed D, et al. De novo aortic regurgitation after continuous-flow left ventricular assist device implantation. *Ann Thorac Surg*. 2017;104:704–711.
- Kohno H, Matsumiya G, Sawa Y, et al. The Jarvik 2000 left ventricular assist device as a bridge to transplantation: Japanese Registry for Mechanically Assisted Circulatory Support. *J Heart Lung Transplant*. 2018;37(1):71–78.
- Saeed D, Westenfeld R, Maxhera B, et al. Prevalence of de novo aortic valve insufficiency in patients after HeartWare VAD implantation with an intermittent low-speed algorithm. *ASAIO J*. 2016;62:565–570.
- Bhagra S, Bhagra C, Ozalp F, et al. Development of de novo aortic valve incompetence in patients with the continuous-flow HeartWare ventricular assist device. *J Heart Lung Transplant*. 2016;35:312–319.
- Stephens E. Left-ventricular assist device impact on aortic valve mechanics, proteomics and ultrastructure. *Ann Thorac Surg*. 2018;105:572–580.
- Fine NM, Park SJ, Stulak JM, et al. Proximal thoracic aorta dimensions after continuous-flow left ventricular assist device implantation: longitudinal changes and relation to aortic valve insufficiency. *J Heart Lung Transplant*. 2016;35(4):423–432.
- Imamura T, Kinugawa K. Preoperative prediction of aortic insufficiency during ventricular assist device treatment. *Int Heart J*. 2016;57(1):3–10.
- Feldman D, Pamboukian SV, Teuteberg JJ, et al. The 2013 International Society for Heart and Lung Transplantation guidelines for mechanical circulatory support: executive summary. *J Heart Lung Transplant*. 2013;32:157–187.
- Kurihara C, Cohn WE, Kawabori M, et al. Long-term continuous-flow left ventricular assist device support after left ventricular outflow tract closure. *ASAIO J*. 2019 Aug; 65(6):558–564.
- Cohn WE, Demirozu ZT, Frazier OH. Surgical closure of left ventricular outflow tract after left ventricular assist device implantation in patients with aortic valve pathology. *J Heart Lung Transplant* 2011 Jan;30(1): 59–63.
- Grinstein J, Kruse E, Sayer G, et al. Novel echocardiographic parameters of aortic insufficiency in continuous-flow left ventricular assist devices and clinical outcome. *J Heart Lung Transplant*. 2016;35(8):976–985.

22. Grinstein J, Kruse E, Sayer G, et al. Accurate quantification methods for aortic insufficiency severity in patients with LVAD: role of diastolic flow acceleration and systolic-to-diastolic peak velocity ratio of outflow cannula. *JACC Cardiovasc Imaging*. 2016;9(6):641–651.
23. Kalathiya R. Percutaneous transcatheter therapies for the management of left ventricular assist device complications. *J Invasive Cardiol*. 2017;29(5):151–162.
24. van der Werf HW, Schurer RA, Vonck TE, et al. Emergency transcatheter aortic valve implantation in patients with severe aortic regurgitation and a left ventricle assist device: a case report and systematic review. *Eur Heart J Acute Cardiovasc Care*. 2017;6(8):719–727.
25. Retzer EM, Sayer GT, Fedson SE, et al. Predictors of survival following trans-catheter aortic valve closure for left ventricular assist device associated aortic insufficiency. *Catheter Cardiovasc Interv*. 2016; 87(5):971–979.
26. Sawaya, Deutsch MA, Seiffert M, et al. Safety and efficacy of TAVR for pure aortic regurgitation. *J Am Coll Cardiol Interv*. 2017;10:1048–1056.
27. Alqahtani F. Contemporary trends in the use and outcomes of surgical treatment of tricuspid regurgitation. *J Am Heart Assoc*. 2017;6:e007597.
28. Kelly BJ, Ho Luxford JM, Butler CG, et al. Severity of tricuspid regurgitation is associated with long-term mortality. *J Thorac Cardiovasc Surg*. 2018;155:1032–1038.
29. Vahanian A, Alfieri O, Andreotti F, et al. Guidelines on the management of valvular heart disease (version 2012). *Eur Heart J*. 2012;33:2451–2496.
30. Robertson J, Grau-Sepulveda MV, Okada S, et al. Concomitant tricuspid valve surgery during implantation of continuous-flow left ventricular assist devices: a Society of Thoracic Surgeons database analysis. *J Heart Lung Transplant*. 2014;33(6):609–617.
31. Dunlay S, Deo S, Park S. Impact of tricuspid valve surgery at the time of left ventricular assist device insertion on postoperative outcomes. *ASAIO J*. 2015;61(1):15–20.
32. Anwer L, Tchantchaleishvili V, Poddi S, et al. Atrial fibrillation should guide prophylactic tricuspid procedures during left ventricular assist device implantation. *ASAIO J*. 2018 Sep–Oct;64(5):586–593.
33. Piacentino V 3rd, Ganapathi AM, Stafford-Smith M, et al. Utility of concomitant tricuspid valve procedures for patients undergoing implantation of a continuous-flow left ventricular device. *J Thoracic and Cardiovasc Surg*. 2012;144:1217–1221.
34. Nakanishi K, Homma S, Han J, et al. Prevalence, predictors, and prognostic value of residual tricuspid regurgitation in patients with left ventricular assist device. *J Am Heart Assoc*. 2018;7:e008813.
35. Nakanishi K, Homma S, Han J, et al. Usefulness of tricuspid annular diameter to predict late right sided heart failure in patients with left ventricular assist device. *Am J Cardiol*. 2018;122:115–120.
36. Raman R, Sugeng L, Lai DT, Jeevanandam V. Complex tricuspid valve repair in patients with pacer defibrillator-related tricuspid regurgitation. *Ann Thorac Surg*. 2016;101:1599–1601.
37. Shaikhrezai K, Bartnik A, Khorsandi M, Hunter S. Lead-sparing tricuspid valve repair damaged by pacemaker lead. *Ann Thorac Surg*. 2017;103:e207–e208.

# Providing Mechanical Support to Children Size and Anatomical Considerations

KYLE W. RIGGS AND DAVID L. S. MORALES

## Introduction

**M**echanical circulatory support (MCS) in children has changed greatly during the past 2 decades. Before the 2000s in the United States, less than 4% of eligible children received a ventricular assist device (VAD) as a bridge to transplant. Now, many large pediatric hospitals are experiencing substantial growth in this area, as documented in the Second Annual Pediatric Interagency Registry for Mechanical Circulatory Support (PediMacs) report (Figure 30.1).<sup>1</sup> More than 700 devices have been implanted in more than 500 patients since this National Heart, Lung, and Blood Institute–sponsored North American database was begun (personal communication from PediMacs executive board, December 17, 2018). This has resulted in more than 40% of children undergoing heart transplantation being bridged with a device.

Historically, extracorporeal membranous oxygenation (ECMO) was the only mechanical support option for children. In many programs, this option is restricted to emergent indications for MCS or for concurrent pulmonary dysfunction. The transition from ECMO to VAD as a default option began with the introduction and widespread use of the Berlin Heart EXCOR (Berlin Heart, AG, Berlin, Germany), a pulsatile, pneumatic compression device still commonly used in small children.<sup>2</sup> Recently, we have pushed the limits considering implantable continuous-flow (CF) devices in children weighing at least 13 kg, discharging children with intracorporeal CF VADs in a Fontan circulation, successfully bridging to transplant a neonate weighing less than 3 kg with a single ventricle, and implanting total artificial hearts in children with transposition of the great arteries.<sup>3,4</sup> Here, we review the implications of size and anatomy when

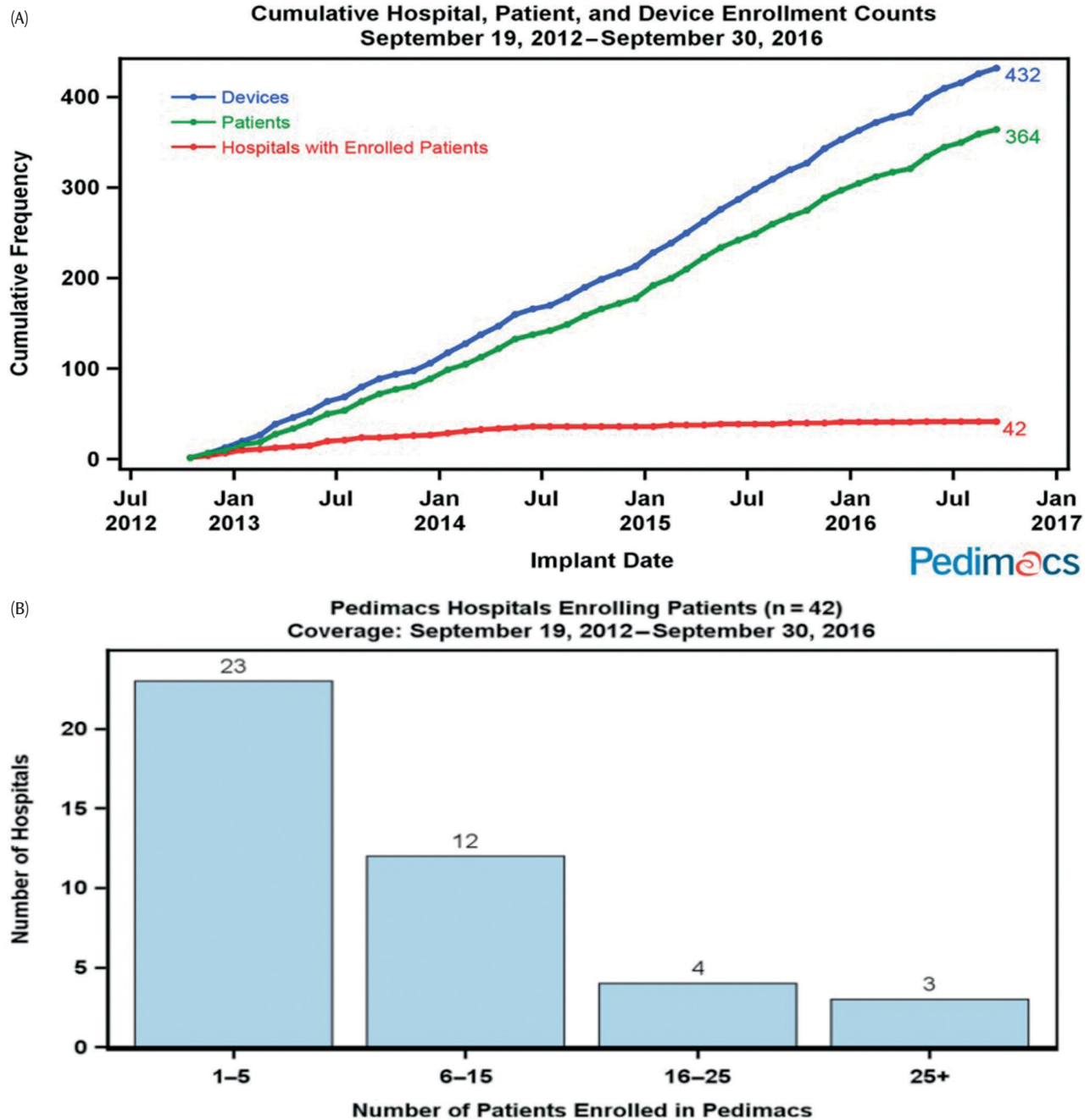
selecting and implanting VADs, as well as advances in imaging technology that can expand the eligibility for VAD.

## Device Selection

The first question when selecting a device is, “Does the patient need either emergent or pulmonary support?” If so, ECMO should be started immediately and continued until the patient is stabilized and the lungs have recovered. Next, one must consider the indication for MCS and thus, the anticipated duration of support. The pathology will dictate whether a short- (less than 2 weeks) or long-term VAD strategy should be considered. Finally, the patient’s weight and anatomic and physiologic considerations will help determine which device is best.

## Choosing the Right Device for the Right Patient

**Temporary or short-term support** can be provided with a host of devices that are typically extracorporeal centrifugal pumps, such as the ROTAFLOW (Maquet Cardiovascular, Wayne, NH) and the Centri/PediMag (Abbott, Lake Bluff, IL). The phrase “short-term VADs” is now out of date because these devices, as discussed in the following, are no longer used exclusively for short-term support. Temporary support is typically used to resuscitate patients from cardiogenic shock secondary to acute heart failure from inflammatory causes (i.e., myocarditis or acute graft rejection) to improve their candidacy for long-term support. These devices are also used in patients in whom neurologic status, transplant status, or the cause of heart



**Figure 30.1.** Second Annual PediMacs report.

Reprinted from Blume ED et al., Second annual Pediatric Interagency Registry for Mechanical Circulatory Support (Pedimacs) report: pre-implant characteristics and outcomes, *Journal of Heart and Lung Transplantation* 2018;37:38–45, Copyright (2018), with permission from Elsevier.

failure is uncertain. This strategy is generally effective for less than 2 weeks and can serve as a bridge to recovery or a bridge to decision. Implantation should involve expeditiously cannulating the left atrium and ascending aorta without cardiopulmonary bypass or blood products. This short-term cannulation strategy can be used in children of any size.

Other options less commonly used in children include the TandemHeart (CardiaAssist, Pittsburgh, PA) and the Impella (Abiomed, Danvers, MA), although their use is limited, given access requirements, which include large percutaneous catheters that typically necessitate a body-surface area (BSA) of at least 1.3 m<sup>2</sup>. The TandemHeart is particularly difficult to maintain in the small left atrium of a child



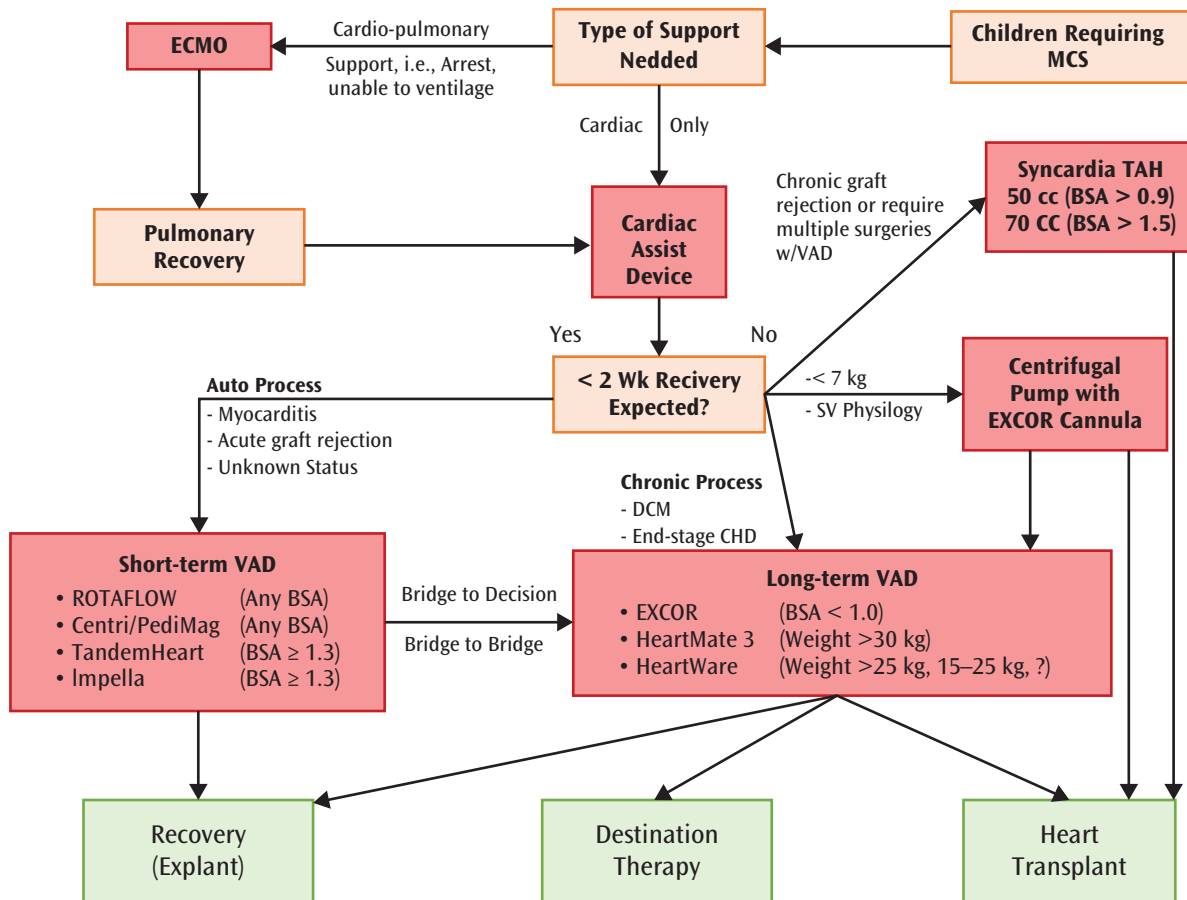
because even small movements may dislodge it back across the atrial septostomy, leading to cyanosis.

**Long-term support** is preferable in patients expected to need MCS for longer than 2 weeks. Indications for long-term support most commonly involve dilated cardiomyopathy or end-stage congenital heart disease (Figure 30.2). Historically, the Berlin Heart EXCOR has been the device of choice for long-term support in children. EXCOR can support children of any size because it features pumps with 10-, 15-, 25-, 30-, 50-, and 60-mL chambers, as well as numerous cannula options. More than 2,000 EXCOR devices have been implanted in children worldwide, making it by far the most studied pump and currently the only U.S. Food and Drug Administration (FDA)-approved pediatric VAD. The EXCOR was brought to the United States in 2000 and was used sparingly until about 2004. By 2012, the North American Investigation Device Exemption trial conclusively established EXCOR’s superiority over ECMO as bridge to transplantation in 48 children.<sup>5</sup> During the same period, among 204 children receiving the EXCOR in North America, 75% survived to transplant or recovery.<sup>6</sup> Notably, end-organ dysfunction,

the use of biventricular assist devices, and low weight predicted early mortality and associated neurologic injury.<sup>7</sup> At this time, EXCOR remains the de facto VAD of choice in children weighing less than 25 kg (~BSA<1.0 m<sup>2</sup>) in the absence of specific features that mandate an alternative strategy.

Despite the success of the Berlin Heart EXCOR, its use in children weighing less than 10 kg, especially those with single-ventricle physiology, has not been as successful. The weight issue (4–10 kg) seems to correlate with poor patient selection, such as the use of the EXCOR as a “salvage VAD” (i.e., a failed congenital palliation then bridged with ECMO to EXCOR). Therefore, EXCOR technology may not always be suitable for small children and those with single-ventricle physiology.

Recently, placing EXCOR cannulas connected to extracorporeal CF pumps as a bridge to transplant has been increasingly successful in smaller children, especially those with congenital heart disease. This long-term strategy is more involved because the EXCOR cannulas are placed during cardiopulmonary bypass. For this reason, the phrase “short-term VADs” is no longer accurate for



**Figure 30.2.** Indications for long-term mechanical support most commonly involve dilated cardiomyopathy or end-stage congenital heart disease.

these types of extracorporeal CF pumps. The advantages of this strategy include easier postoperative management of anticoagulation and less-expensive and simpler replacement in the event of pump thrombosis. In addition, a centrifugal pump can compensate for frequent changes in perioperative preload without adjustments by the provider. This ability is important in patients with congenital heart disease when the  $Q_p:Q_s$  ratio is constantly changing and is rarely 1:1 because of intracardiac shunting, an operative shunt, or collateral aorto-pulmonary arteries. In fact, a 2018 study of the PediMacs database identified 63 devices used in first-time implantations as “temporary” or “short-term VADs.”<sup>8</sup> Nonetheless, 40% of devices were placed as a bridge to transplant with a median (IQR) duration of support of 47 (10–227) days before transplant. Incredibly, 5 patients with a “temporary” VAD lived longer than 5 months on device support. In all, 71% reached the composite endpoint of transplanted, still on the device, or recovered with the extracorporeal CF devices.

Other long-term VAD options in larger children include those approved for use in adults, such as the intracorporeal CF HeartWare® HVAD® (Medtronic, Minneapolis, MN), HeartMate II® (Abbott, Chicago, IL), and HeartMate 3® (Abbott, Chicago, IL), as well as the biventricular, pulsatile total artificial heart (SynCardia, Tucson, AZ). Despite generally being more suitable for larger patients, these devices provide lower morbidity, better mobility, and the ability to be discharged to home with the VAD.

The HVAD, an intracorporeal centrifugal VAD, is now the most common device implanted in patients younger than 18 years. It can consistently be placed in children weighing as little as 25 kg with excellent outcomes. There have been reports of placement in several children less than 20 kg, with the smallest reported in a patient of 13 kg.<sup>4,9</sup> However, implantation below 20 kg is still an area where it remains unclear if the device will consistently work well because of the lower flows required at times. A study of 205 children undergoing HVAD implantation found that more than 50% were discharged to home and 89% had a positive outcome at 1 year.<sup>10</sup> As expected, the discharged patients were typically older and larger than those remaining in the hospital. A more recent report from PediMacs with 192 HVAD patients showed that survival in children was similar to propensity-matched young adults (<30 years old) with no increased mortality in patients weighing less than 20 kg.<sup>11</sup>

The HeartMate II (HMII) is a rotary, axial-flow pump amenable for use in children with a BSA of greater than 1.3 m<sup>2</sup>, given its larger pump and inlet and outlet ports. Implanted in more than 25,000 adults, the device has also provided an excellent positive outcome rate of 95% at 6 months in the pediatric population.<sup>12</sup> In one large study, the device had favorable outcomes that included a bleeding rate of 21%, a stroke rate of 7%, and a sepsis rate of 11%. In late 2017, the HeartMate 3 (HM3), a smaller centrifugal

VAD similar to the HVAD, was approved for use in adults. Because of outstanding survival and low adverse event rates in adults, this device is being implanted in children in several institutions. One important difference in its use in adults and children is the extracardiac portion of the device, which is larger and heavier than that of the HVAD. Nevertheless, the intraventricular shaft is shorter, which can be advantageous in children. This device also appears to decompress the ventricle to a lesser degree than does the HMII but more than what is typically seen with the HVAD,<sup>24</sup> which may be important in certain populations, such as patients with Fontan circulation. The lowest size limit of eligibility for this device remains unclear, but based on virtual implantation techniques, we believe it is about 25 kg.

Finally, the total artificial heart replaces both ventricles in a strategy that delivers pulsatile cardiac output. Current FDA approval is limited to the SynCardia 70-cc cardiac chamber device, which can be used in patients with a BSA greater than 1.7 m<sup>2</sup>. An ongoing trial with the 50-cc chamber version is intended for children with a BSA between 1.2 and 1.85 m<sup>2</sup> or to those in whom virtual implantation can confirm the fit. This smaller chamber could potentially extend the indication down to a BSA as low as 0.9 m<sup>2</sup>. This smaller device has been implanted 70 times worldwide and is increasingly used in patients with congenital defects not easily served by other devices (where it has increased from 4% to 9% of total artificial heart implantations), in children (increased from 4% to 13% of total artificial hearts), and in young females (increased from 12% to 70% of total artificial hearts). This device is not an alternative to long-term VAD support, but it is ideal for patients with pathophysiologic features that preclude the use of a VAD alone. Such patients include those with chronic rejection after orthotopic heart transplant (to stop immune suppression), intractable arrhythmias, cancer, large ventricular clot burdens, biventricular failure, and restrictive cardiomyopathy, among other indications.<sup>13</sup> Discharge from the hospital is possible with the Freedom Portable Driver, which can be carried in a 6-kg backpack. More than 1,800 total artificial hearts have been implanted in 23 countries since 1982, with 40% in just the past 7 years. Outcomes after total artificial heart implantation approximate those of single VAD therapy and are superior to those with biventricular assist therapy, despite the fact that these hearts are more often placed in patients with cardiogenic shock and higher acuity INTERMACS status. The ability of these devices to resuscitate the sickest patients may help increase the rate of end-organ recovery in cases previously believed to be unrecoverable (i.e., congestive cirrhosis; renal insufficiency). This success may in part result from the ability of these devices to produce a cardiac index of at least 4 L/min/m<sup>2</sup> in the setting of low central venous pressure, something neither a new transplanted heart nor a VAD can offer.

## Technical Modifications to Fit a Device

Extracorporeal CF VADs and cannulas will generally fit in all patients because the device itself remains outside the body (Figure 30.3). However, when placing intracorporeal devices in children, spatial considerations can interfere with maintaining unobstructed device inflow. Several innovative techniques to accommodate an intracorporeal CF VAD in children below the recommended BSA guidelines have been described.<sup>4,14–17</sup> Before 2012, these techniques were primarily focused on the HeartMate II, but for the past several years, the HVAD has drawn the most interest, given that it is smaller than other CF VADs. Recently, the HeartMate 3 has emerged as another option.

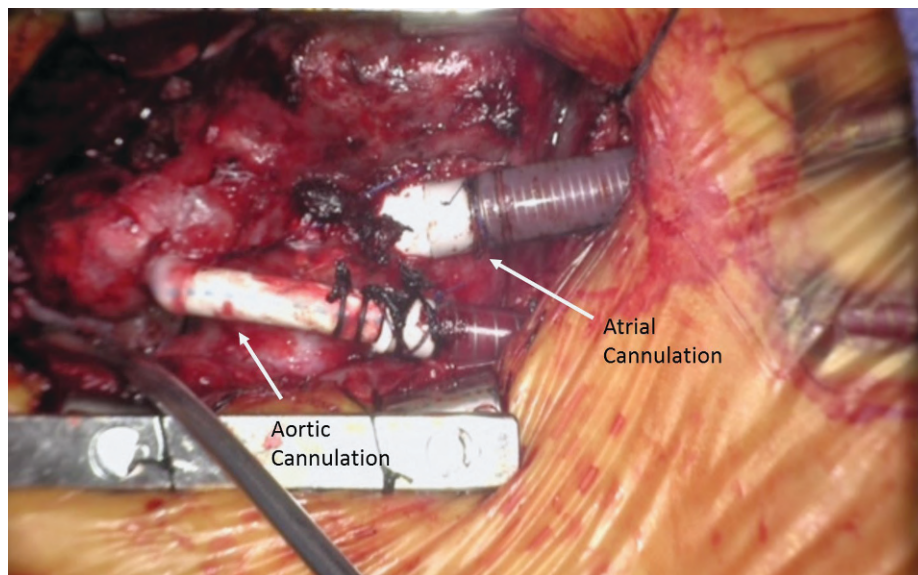
One technique for providing more extracardiac space for the device involves opening the left pleural space. In this technique, covering the device with Gore-Tex may prevent adhesions to the lung, facilitate VAD removal if heart transplantation is anticipated, and avoid erosion into the chest wall arteries (devices abutting the chest wall can cause massive hemorrhage). Furthermore, the left diaphragmatic attachments can be taken down to create a sub-rectus pocket where the device can sit or be anchored by a stay stitch.<sup>4</sup> To provide better inflow in smaller ventricles, felt buttresses can be stacked externally to minimize cannula protrusion into the ventricle.<sup>4</sup> In addition, a papillary muscle sling can create space for unobstructed inflow, or the atrioventricular valve can be excised if necessary, although excision may cause problems if chronic support is anticipated because such support has been associated with late right-heart

failure. In other situations, the atria can be cannulated directly with the VAD.<sup>18</sup> Further creative techniques have been used in patients with more complex anatomy.<sup>14–16,19</sup>

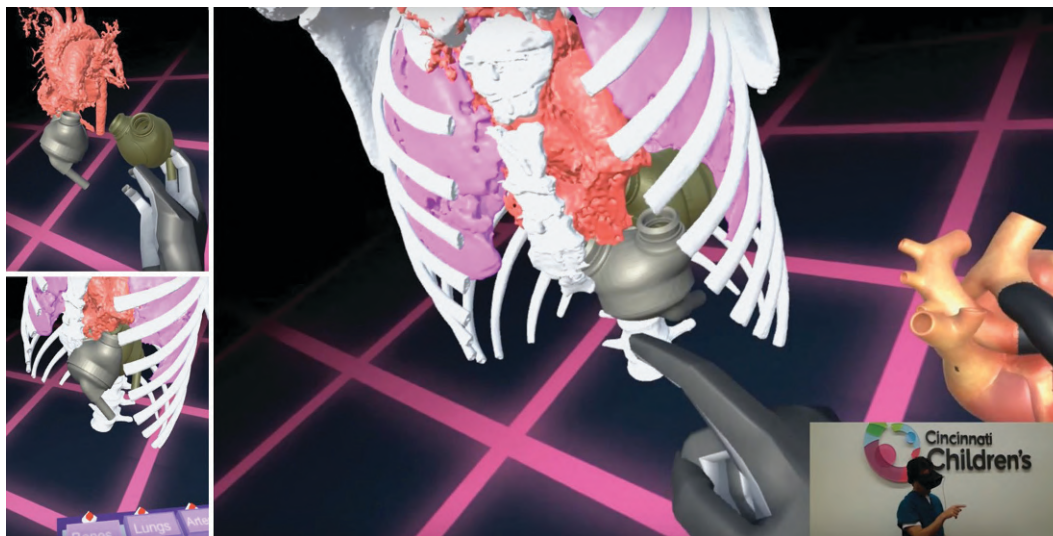
## Expanding Patient Eligibility through Advanced Imaging

Advanced, 3-dimensional imaging has revolutionized the way patients can be selected for VAD implantation and has the potential to greatly expand the use of VADs, especially in children (Figure 30.4). The SynCardia 50-cc trial was the first in which the FDA permitted “virtual evidence of fit” as an acceptable eligibility criterion for device implantation.<sup>20</sup> This permission was based in part on studies showing that virtual fit may increase the eligibility of patients to receive artificial hearts by a third and allow implantation in infants with a BSA as small as 0.9 m<sup>2</sup>.<sup>21</sup> Similarly, this technology has been used to fit HVADs in patients below the recommended BSA of 1.5 m<sup>2</sup> to as small as a 7-year-old with a BSA of 0.86 m<sup>2</sup>.<sup>17</sup> Although body imaging is required, this method will supplant the antiquated use of weight and BSA criteria with much greater accuracy and the ability to plan complicated implantations in the growing number of patients with congenital heart disease presenting with advanced heart failure.

Early in our experience, the surgeon and imaging cardiologist would sit down at a monitor and perform the virtual fit. Now, however, a patient’s CT scan or MRI image can be put into a virtual space with three-dimensional images of all the devices we place (HVAD, HeartMate3, total artificial



**Figure 30.3.** A 2.5-kg infant bridged-to-heart transplant with a Thoratec CentriMag Ventricular Assist System. Extracorporeal continuous-flow, ventricular assist devices, and cannulas will generally fit in all patients because the device itself remains extracorporeal.



**Figure 30.4.** Advanced, 3-dimensional imaging allowing “virtual fitting” of devices has revolutionized the way patients can be selected for VAD implantation and has the potential to greatly expand the use of ventricular assist devices, especially in children.

hearts 50-cc and 70-cc). The surgeon can then manipulate the virtual device to determine the optimal dimensions for a particular patient. The utility of this technology for orthotopic heart transplant sizing and complex implantation planning is being explored as well.<sup>22</sup>

### Anatomical Considerations: Single-Ventricle Pathologies

In general, a single-ventricle heart refers to any patient on the single-ventricle pathway, before or after any stage of palliation. However, patients are best grouped as being either before or after bidirectional Glenn (BDG) shunting or after Fontan procedures when considering how their physiology affects VAD function. Regardless of palliation stage, precise timing and careful patient selection are critical to a successful outcome when contemplating VAD support in patients with single-ventricle pathology.

A review of the North American experience with the EXCOR VAD identified 26 patients with single-ventricle hearts. Of 9 patients undergoing stage I palliation (before BDG), 8 died.<sup>23</sup> The lone survivor was unique: a 19-month-old who survived to undergo a Damus-Kaye-Stansel procedure with a modified Blalock-Taussig shunt.

The literature has not documented, nor are we aware, of any neonate undergoing a Norwood procedure who has been successfully bridged to transplantation and discharged home after EXCOR VAD support. Therefore, the survival benefit of EXCOR VAD therapy remains unclear for these patients. Some of the challenges in these patients involve candidate selection with a constantly changing  $Q_p:Q_s$  ratio (especially in patients with shunts) and the frequent

requirement for a cardiac index of 4 L/min/m<sup>2</sup> or more—a demand the EXCOR VAD was not designed to provide. However, the EXCOR atrial and aortic cannula connected to an extracorporeal CF VAD can meet these requirements, and several patients with single-ventricle pathology and shunts have been successfully bridged to transplant with this strategy.<sup>15</sup> Nevertheless, in very small patients (<3 kg), the EXCOR cannulas are limited, and shunts and bypass cannula are likely better options.

### Providing VAD Support after Bidirectional Glenn Shunting

In the EXCOR review cited previously, 7 of 12 patients did considerably better after BDG shunting and were successfully bridged to transplant after EXCOR support, with results similar to those with ECMO. Patients after BDG shunting benefit from the fact that their heart failure is typically not post-cardiotomy but experienced over an extended period between the Glenn and Fontan procedures. These patients are less commonly placed on a VAD as a salvage maneuver after a failed operation, as is common in patients with Stage 1 palliation. Because patients undergoing Glenn shunting rarely present with chronic heart failure without a substantial aorto-pulmonary collateral burden, in many ways, these patients continue to manifest a “shunted” physiology with a changing  $Q_p:Q_s$  ratio and a greater-than-normal cardiac index requirement. Hence, the aforementioned technique of combining EXCOR cannulas with centrifugal pumps is effective in managing these patients and is gaining popularity. As opposed to pre-BDG, post-BDG circulation is not well supported by

peripheral ECMO, given the inadequate decompression of the heart secondary to inferior vena cava inflow and the high rate of neurological complications with Glenn cannulation. Therefore, after stabilization, peripheral ECMO should swiftly be converted to central ECMO or temporary support with an extracorporeal CF pump.

## Providing VAD Support after a Fontan Procedure

The challenge with the failing Fontan circulation is identifying the cause, which is usually multifactorial, and then targeting interventions with the potential for correcting the cause. Therefore, mechanical circulatory support may not be the best primary strategy for these patients. However, in appropriately selected Fontan patients, VAD support can be consistently successful. Such support is complex and beyond the scope of this chapter, but in short, VADs are most successfully placed in patients with late failure of their Fontan circulation with systolic dysfunction and rising end-diastolic pressures greater than 12–14 mm Hg. If end-diastolic pressure is not high, heart failure is dominated by right-sided issues, and VAD placement will not improve circulation and may even worsen it. Additionally, VAD therapy in these patients should be considered before end-stage morbidities (i.e., liver cirrhosis, protein losing enteropathy, plastic bronchitis, etc.) produce marked frailty and increased surgical risk. Fontan patients have been discharged home with VAD support.<sup>3,24</sup> Overall, VAD therapy in Fontan circulation has been associated with positive outcomes in about two-thirds of several case studies and case series, with many of these patients living to transplantation.<sup>23–36</sup> However, with proper patient selection, success could be improved further.

Some Fontan patients present with a variety of late comorbidities and end-organ dysfunction that make them poor heart transplant candidates. In these cases, heart transplantation may be best avoided and the patients offered a device that can provide both a supra-physiologic cardiac output, as well as a central venous pressure of 3–5 mmHg. This type of support can only be supplied by a total artificial heart. The resultant perfusion and decreased venous congestion surpasses that of a fresh transplant or VAD and potentially allows end organs, such as the liver and kidneys, to recover. Although only five artificial hearts have been placed in Fontan patients, as the technology improves and smaller versions become available, artificial hearts may become an increasingly attractive option, with the potential to resuscitate these frail patients and mitigate the risk of subsequent transplantation. Because the Fontan circulation fails at multiple levels, supporting these patients requires a well-thought-out, staged, and multidisciplinary approach.

## Conclusion

The use of mechanical circulatory support in children has substantially increased over the past two decades; consequently, the indications for implanting these devices are expanding. Both size, physiology, and the unusual anatomy of complex congenital heart disease are challenges to surgeons attempting to provide mechanical circulatory support in these children. Despite these challenges, creative implantation strategies, mixing of cannulas and devices, enhanced imaging techniques, and the development of smaller devices have all combined to offer this lifesaving therapy successfully to more and more children. New devices should allow implantation in ever-smaller patients, and industry and clinicians are focused on the increasing number of adolescents and adults with congenital heart disease who present with advanced heart failure. As the experience with VADs in children continues to accumulate, we expect an increasing number of children to receive them with excellent results as bridge to transplant and as long-term therapy.

## REFERENCES

1. Blume ED, VanderPluym C, Lorts A, et al. Second annual Pediatric Interagency Registry for Mechanical Circulatory Support (Pedimacs) report: pre-implant characteristics and outcomes. *J Heart Lung Transplant Off Publ Int Soc Heart Transplant*. 2018;37(1):38–45. doi:10.1016/j.healun.2017.06.017.
2. Blume ED, Naftel DC, Bastardi HJ, et al. Outcomes of children bridged to heart transplantation with ventricular assist devices: a multi-institutional study. *Circulation*. 2006;113(19):2313–2319. doi:10.1161/CIRCULATIONAHA.105.577601.
3. Morales DLS, Adachi I, Heinle JS, Fraser CD. A new era: use of an intracorporeal systemic ventricular assist device to support a patient with a failing Fontan circulation. *J Thorac Cardiovasc Surg*. 2011;142(3):e138–e140. doi:10.1016/j.jtcvs.2011.05.018.
4. Woods RK, Neibler RA, Kindel SJ, Mitchell ME, Tweddell JS, Hraska V. Multiple mechanical support modalities and cardiac transplantation in a young child with corrected transposition. *J Thorac Cardiovasc Surg*. December 2017. doi:10.1016/j.jtcvs.2017.11.080.
5. Fraser CDJ, Jaquiss RDB, Rosenthal DN, et al. Prospective trial of a pediatric ventricular assist device. *N Engl J Med*. 2012;367(6):532–541. doi:10.1056/NEJMoa1014164.
6. Almond CS, Morales DL, Blackstone EH, et al. Berlin Heart EXCOR pediatric ventricular assist device for bridge to heart transplantation in US children: clinical perspective. *Circulation*. 2013;127(16):1702–1711. doi:10.1161/CIRCULATIONAHA.112.000685.
7. Polito A, Netto R, Soldati M, et al. Neurological complications during pulsatile ventricular assistance with the Berlin Heart EXCOR in children: incidence and risk factors. *Artif Organs*. 2013;37(10):851–856. doi:10.1111/aor.12075.
8. Lorts A, Eghtesady P, Mehegan M, et al. Outcomes of children supported with devices labeled as “temporary” or short-term: a report from the Pediatric Interagency Registry

- for Mechanical Circulatory Support (Pedimacs). *J Heart Lung Transplant*. doi:10.1016/j.healun.2017.10.023.
9. Conway J, Miera O, Henderson HT, et al. Global experience with the HeartWare HVAD® in pediatric patients: a preliminary analysis. *J Heart Lung Transplant*. 2016;35(4):S45. doi:10.1016/j.healun.2016.01.121.
  10. Conway J, Miera O, Adachi I, et al. Worldwide experience of a durable centrifugal flow pump in pediatric patients. *Semin Thorac Cardiovasc Surg*. Autumn 2018;30(3):327–335.
  11. VanderPluym CJ, Adachi I, Niebler R, et al. Outcomes of children supported with an intracorporeal continuous-flow left ventricular assist system. *J Heart Lung Transplant Off Publ Int Soc Heart Transplant*. 2018 Sept. doi:10.1016/j.healun.2018.09.015.
  12. Cabrera AG, Sundareswaran KS, Samayoa AX, et al. Outcomes of pediatric patients supported by the HeartMate II left ventricular assist device in the United States. *J Heart Lung Transplant Off Publ Int Soc Heart Transplant*. 2013;32(11):1107–1113. doi:10.1016/j.healun.2013.07.012.
  13. Villa CR, Morales DLS. The total artificial heart in end-stage congenital heart disease. *Front Physiol*. 2017; 8:131.
  14. Adachi I, Guzmán-Pruneda FA, Jeewa A, Fraser CD, Dean McKenzie E. A modified implantation technique of the HeartWare ventricular assist device for pediatric patients. *J Heart Lung Transplant*. 2015;34(1):134–136. doi:10.1016/j.healun.2014.09.014.
  15. Gazit AZ, Petrucci O, Manning P, et al. A novel surgical approach to mechanical circulatory support in univentricular infants. *Ann Thorac Surg*. 2017;104(5):1630–1636. doi:10.1016/j.athoracsur.2017.04.023.
  16. Mongé MC, Kulat BT, Eltayeb O, et al. Novel modifications of a ventricular assist device for infants and children. *Ann Thorac Surg*. 2016;102(1):147–153. doi:10.1016/j.athoracsur.2016.04.043.
  17. Moore RA, D'Souza GA, Villa C, Taylor MD, Morales DLS, Lorts A. Optimizing surgical placement of the HeartWare ventricular assist device in children and adolescents by virtual implantation. *Prog Pediatr Cardiol*. 2017;47:11–13. doi:10.1016/j.ppedcard.2017.10.002.
  18. Nandi D, Miller KD, Bober CM, et al. Systemic atrioventricular valve excision and ventricular assist devices in pediatric patients. *Ann Thorac Surg*. 2018 Jan; 105(1):170–174.
  19. Griselli M, Sinha R, Jang S, Perri G, Adachi I. Mechanical circulatory support for single ventricle failure. *Front Cardiovasc Med*. 2018;5:115.
  20. *Syncardia 50cc TAH-t as a Bridge to Transplant*. ClinicalTrials.gov. <https://clinicaltrials.gov/ct2/show/NCT02459054>. Published June 1, 2015. Accessed December 7, 2018.
  21. Moore RA, Lorts A, Madueme PC, Taylor MD, Morales DLS. Virtual implantation of the 50cc SynCardia total artificial heart. *J Heart Lung Transplant*. 2016;35(6):824–827. doi:10.1016/j.healun.2015.12.026.
  22. Szugye N, Lorts A, Taylor M, et al. The use of virtual heart transplantation will allow for a broader donor pool in pediatric heart transplantation for dilated cardiomyopathy. *J Heart Lung Transplant*. 2018; 37(4, Suppl):S399. doi:10.1016/j.healun.2018.01.1029.
  23. Weinstein S, Bello R, Pizarro C, et al. The use of the Berlin Heart EXCOR in patients with functional single ventricle. *J Thorac Cardiovasc Surg*. 2014;147(2):697–705. doi:10.1016/j.jtcvs.2013.10.030.
  24. Lorts A, Villa C, Riggs KW, Broderick J, Morales DL. First use of HeartMate 3 TM in a failing Fontan circulation. *Ann Thorac Surg*. 2018 Nov. 106(5): e233–e234.
  25. Arnaoutakis GJ, Blitzer D, Fuller S, et al. Mechanical circulatory support as bridge to transplantation for the failing single ventricle. *Ann Thorac Surg*. 2017;103(1):193–197. doi:10.1016/j.athoracsur.2016.05.015.
  26. Woods RK, Ghanayem NS, Mitchell ME, Kindel S, Niebler RA. Mechanical circulatory support of the Fontan patient. *Semin Thorac Cardiovasc Surg Pediatr Card Surg Annu*. 2017;20(Suppl C):20–27. doi:10.1053/j.pcsu.2016.09.009.
  27. Hoganson DM, Boston US, Gazit AZ, Canter CE, Eghtesady P. Successful bridge through transplantation with Berlin Heart ventricular assist device in a child with failing Fontan. *Ann Thorac Surg*. 2015;99(2):707–709. doi:10.1016/j.athoracsur.2014.04.064.
  28. Poh CL, Chiletto R, Zannino D, et al. Ventricular assist device support in patients with single ventricles: the Melbourne experience. *Interact Cardiovasc Thorac Surg*. 2017;25(2):310–316. doi:10.1093/icvts/ivx066.
  29. Halaweish I, Ohye RG, Si MS. Berlin heart ventricular assist device as a long-term bridge to transplantation in a Fontan patient with failing single ventricle. *Pediatr Transplant*. 2015;19(8):E193–E195. doi:10.1111/petr.12607.
  30. Jabbar AA, Franklin WJ, Simpson L, Civitello AB, Delgado RM, Frazier OH. Improved systemic saturation after ventricular assist device implantation in a patient with decompensated dextro-transposition of the great arteries after the Fontan procedure. *Tex Heart Inst J*. 2015;42(1):40–43. doi:10.14503/THIJ-13-3374.
  31. Valeske K, Yerebakan C, Mueller M, Akintuerk H. Urgent implantation of the Berlin Heart Excor biventricular assist device as a total artificial heart in a patient with single ventricle circulation. *J Thorac Cardiovasc Surg*. 2014;147(5):1712–1714. doi:10.1016/j.jtcvs.2014.01.012.
  32. Mackling T, Shah T, Dimas V, et al. Management of single-ventricle patients with Berlin Heart EXCOR ventricular assist device: single-center experience. *Artif Organs*. 2012;36(6):555–559. doi:10.1111/j.1525-1594.2011.01403.x.
  33. Cardarelli MG, Salim M, Love J, et al. Berlin Heart as a bridge to recovery for a failing Fontan. *Ann Thorac Surg*. 2009;87(3):943–946. doi:10.1016/j.athoracsur.2008.07.086.
  34. Russo P, Wheeler A, Russo J, Tobias JD. Use of a ventricular assist device as a bridge to transplantation in a patient with single ventricle physiology and total cavopulmonary anastomosis. *Paediatr Anaesth*. 2008;18(4):320–324. doi:10.1111/j.1460-9592.2008.02435.x.

35. Ricci M, Gaughan CB, Rossi M, et al. Initial experience with the TandemHeart circulatory support system in children. *ASAIO J.* 2008;54(5):542–545. doi:10.1097/MAT.0b013e31818312f1.
36. Prêtre R, Häussler A, Bettex D, Genoni M. Right-sided univentricular cardiac assistance in a failing Fontan circulation. *Ann Thorac Surg.* 2008;86(3):1018–1020. doi:10.1016/j.athoracsur.2008.03.003.

# 31

## Postoperative Management after Assist Device Implantation

CHRISTOPH E. BREHM

**A**fter the patient has arrived in the intensive care unit, an in-depth sign-out from the surgical/anaesthesia team to the critical care team is invaluable for the patient's further management in the ICU. This discussion should include details related to surgical challenges, complications, degree of coagulopathy, right ventricular (RV) function, optimal filling pressures, hemodynamic measurements and pump flows (both with the chest open and after chest closure), as well as information about inotropic and vasopressor requirements (Table 31.1). It is important to know not only what medication is currently running, but why this medication was started and if the desired effect was achieved. This information is paramount in the subsequent decision making related to weaning strategies.

At the completion of an in-depth sign-out, a thorough assessment by the ICU team itself is still an imperative. Significant clinical changes may have taken place during the time the patient was transported from the operating table to an ICU bed. Optimal timing for this assessment occurs after the patient is completely settled in, with all drips transferred, pressure lines appropriately zeroed, ventilator support transitioned to the ICU ventilator with performance of any necessary adjustments, and (ideally) with the patient remaining on a level of sedation that minimizes any agitation or pain. Also some laboratory analysis should be completed at this time, if not already done at the end of surgery, to assess the most recent coagulation status, hematocrit, and acid base status (including lactate and mixed venous oxygen saturation).

Hemodynamic parameters such as systemic blood pressure (SBP), mean arterial pressure (MAP), central venous pressure (CVP), pulmonary artery pressure (PAP), pulmonary capillary wedge pressure (PCWP), cardiac output (CO), and cardiac index (CI) should be obtained and a goal minimum for pump output according to the patient's

weight should be identified. This goal minimum is calculated as the pump flow in liter per minute (L/min) that will be necessary to achieve a cardiac index of at least 2.2 L/min/m<sup>2</sup>. Depending on the underlying left ventricular (LV) function and assuming the aortic valve is not oversewn, most patients can typically generate additional cardiac output via the normal physiological route, which will augment the output of the LVAD. In the event that the patient manifests a wide pulse pressure with opening of the aortic valve on every beat, an increase in left ventricular assist device (LVAD) revolutions per minute (rpm) should be considered to achieve the best ventricular unloading and optimal flow through the pump. Ideally, the aortic valve should not open with every beat.<sup>1</sup> In order to achieve the optimal rpm settings, a transthoracic echocardiogram (TTE) can be helpful for the assessment of LV unloading, aortic valve opening, position of the septum, and inflow-cannula peak velocity (ideally maintained at <1.5 m/s<sup>2</sup>). In the event that direct postoperative TTE is limited by postsurgical intrathoracic changes, dressings,

**Table 31.1 • A Sample Checklist for Providing Sign-Out to the ICU upon Arrival Post-MCS Surgery**

### ICU Sign-Out Checklist

- Surgical challenges
- Degree of coagulopathy
- RV function
- Optimal filling pressures
- Hemodynamic measurements
- Pump flows (before and after chest closure)
- Inotrope/pressor requirements



and chest tubes, a transesophageal echocardiogram (TEE) may be preferred—particularly in the event that the patient remains intubated.

Since the current generation of LVAD devices that comprise the majority of mechanical circulatory support (MCS) implants feature a laminar flow design, pulse pressure may be substantially blunted, and monitoring of the mean arterial pressure typically offers the best approach to hemodynamic assessment. Due to the enhanced sensitivity to afterload with these devices, the mean arterial pressure should be maintained below 90 mmHg with an optimal range between 70 mmHg and 80 mmHg.<sup>3</sup> These devices are also pre-load dependent and therefore careful attention must be paid to venous filling and RV function. Postoperative assessment of venous filling is performed via CVP or right atrial pressure (RAP) monitoring, but these data can be confirmed with echo measurement of the IVC diameter. There may be significant variability in defining the optimal right-sided filling pressure for a patient, but maintaining the RAP between 10 and 16 mmHg has been described as a reasonable goal.<sup>1</sup> However, caution should be exercised to avoid overloading the RV, which can lead to RV distension with increasing insufficiency of the tricuspid valve, resulting in worsening RV function.

The heart rate will also affect RV output and by extension LVAD preload. Under typical demand, a heart rate between 80 and 100 bpm appears to be sufficient to support optimal RV output.<sup>1</sup> Intraoperative placement of temporary atrial and ventricular pacing wires may provide some benefit in that regard. However, excessive increase of the heart rate will likely not yield a significant increase in pump output.<sup>4</sup>

Severe electrolyte imbalance is common in heart failure (HF) patients and may continue throughout the early postoperative period. Frequent laboratory checks and electrolyte replacement may be indicated to avoid complications in that regard, such as arrhythmias.

In the early postoperative period, the patient will be monitored with an arterial catheter to measure blood pressure. Depending on left ventricular pre-load, underlying LV function, LVAD speed settings, and inotropic support, the arterial waveform can vary significantly within short periods of time. While some degree of pulse pressure is to be expected and typically corresponds with a waveform consistent with intermittent aortic valve opening, a completely flat arterial waveform can be concerning for reduced ventricular filling, and regardless of the underlying cause this should be further investigated.

Once the patient is more stable the intra-arterial blood pressure measurement can be discontinued, and pressures can be obtained by cuff if the patient has an adequate pulse pressure, recognizing that cuff pressures can often be lower than those obtained from an intra-arterial measurement.<sup>5</sup> In patients whose pulse pressure is not high enough for accurate automated cuff measurements, blood pressure can be measured by manual sphygmomanometry combined with Doppler or pulse oximetry.<sup>6</sup> It is important to understand that

in this setting the measured pressure is an estimate of the patient's mean arterial pressure.

In patients with minimal or no pulsatility in the arterial waveform, pulse oximetry may prove to be unreliable. This complicates the monitoring of changes in oxygenation, and in some cases cerebral near infrared spectroscopy (NIRS) can provide a useful adjunct to standard pulse oximetry.<sup>7</sup>

## Ventilator Management

The postoperative ventilator management after LVAD implant should not significantly differ from the ventilator management of patients recovering from other types of open heart surgery. To date, there is no specific ventilation strategy identified to be superior over other approaches in this patient population. However, some ventilation modes like Airway Pressure Release Ventilation (APRV) should be used with caution due to their potential to cause RV dysfunction. Ventilation strategies using high tidal volumes (VT) and significantly increased positive end-expiratory pressure (PEEP) should also be avoided for the same reasons.

Inspiratory oxygen concentration and ventilator support should be weaned carefully and under close monitoring of the patient's blood gas. Hypoxemia (as well as hypercapnia) should be avoided due to the potential for an increase in pulmonary vascular resistance and PAP, which will increase RV afterload and further impair RV function.<sup>8</sup>

When feasible, early extubation (ideally within 6 hours of arrival to the ICU) is a laudable goal. Standard early extubation criteria include hemodynamic stability, achievement of sufficient pump flows, and acceptably low levels of chest tube drainage. By taking away the positive intrathoracic pressure from the ventilator, some stress will be taken off the RV, which in turn may enhance RV function.

## Bleeding

Patients who underwent placement of a mechanical circulatory support devices are often prone to increased postoperative blood loss. Preoperative medications such as platelet inhibitors or Warfarin, disease-related liver dysfunction, redo surgery, and prolonged pump-runs with subsequent coagulopathy are only some of the potential factors that can contribute to ongoing blood loss after surgery. In the era of continuous-flow LVADs, about 30% of patients require reoperation, and 50%–80%<sup>9</sup> of patients require a blood transfusion.

Correction of coagulopathy is started in the operating room and continued in the ICU. This typically involves administration of an appropriate dose of protamine to adequately reverse systemic heparin, blood product administration, and in some cases the use of Aminocaproic acid as an anti-fibrinolytic agent. If not already performed in the operating room, a complete laboratory assessment of the

patient's most recent coagulation status including partial thromboplastin time (PTT), international normalized ratio (INR), hemoglobin (HGB), platelet count, and fibrinogen levels should be performed as soon as the patient arrives in the ICU. In the presence of active bleeding, transfusion of blood products should not be delayed while awaiting the results from the laboratory. Once the results are available, therapy can then be modified in a goal-directed fashion. Attention to detail with respect to monitoring the appropriate laboratory parameters and staying ahead of the situation is paramount in the control of bleeding.

Typically, PRBCs (packed red blood cells), FFPs (fresh frozen plasma), and platelet concentrates are used initially for substitution. In cases with severe bleeding, recombinant Factor VII has been used to control the situation, but caution is advised here since these aggressive types of agents may promote thrombus formation in the implanted device either acutely or as a foundation for subsequent device thrombosis.<sup>10</sup>

Ongoing bleeding at an hourly rate of >200 ml/h despite normalization of the coagulation profile typically points toward surgical sources of bleeding<sup>9</sup> and is typically best managed with timely reoperation. The presence of continuous blood loss will likely impair the establishment of stable device flows, which when combined with the ongoing need for transfusion may lead to RV volume overload with subsequent deterioration in RV function. In bleeding situations where the CVP is already high, cryoprecipitate and prothrombin complex concentrate (PCC)<sup>11</sup> can be used to normalize coagulation while reducing the amount of transfused volume.

## Inotropes and Pulmonary Vasodilators

Patients that have been implanted with biventricular support devices (e.g., Berlin Heart or Syncardia total artificial heart) do not require inotropic support since the cardiac output is achieved entirely through mechanical circulatory support in these instances. However, these patients frequently require the use of vasopressors in order to achieve adequate blood pressure due to the relatively high prevalence of hypotension in these types of cases. Alternatively, vasodilators may be necessary in order to treat episodes of hypertension.

After implantation of an LVAD the situation is different. Here only the left ventricle is mechanically supported, and consequently the RV function must be sufficient to ensure adequate transpulmonary blood flow and LV filling, without which the LVAD will be ineffective in generating appropriate systemic blood flow.

Often patients with end-stage HF will have some degree of RV dysfunction, but ideally in the thoughtful decision-making around LVAD candidacy, patients with severe RV failure are considered for biventricular support strategies. In most other cases, preoperative hemodynamic optimization

of RV support will be sufficient to provide adequate circulation after LVAD implantation. Nevertheless, there are several intra- and postoperative factors which can negatively influence RV function. These include volume overload, prolonged clamp time, massive transfusion due to bleeding, hypoxemia, and hypercapnia. For this reason, pharmacologic forms of RV support are commonly instituted during LVAD implant and are titrated appropriately during weaning from cardiopulmonary bypass and later during recovery in the ICU. Inotropes such as dobutamine and epinephrine provide the mainstay of RV-directed therapy in conjunction with phosphodiesterase 3 inhibitors.<sup>12</sup> The use of inodilators such as levosimendan has been described for preconditioning of the RV prior to LVAD implant,<sup>13,14</sup> but the role for these agents in the post-LVAD implant setting has not been elucidated. Once adequate inotropic support for the RV has been established, vasopressors such as vasopressin and norepinephrine can be used to maintain an appropriate mean arterial pressure. Inhaled pulmonary vasodilators such as nitric oxide (NO) or prostaglandins can be used to reduce RV workload by lowering pulmonary vascular resistance.<sup>15</sup>

Typically these medications are initiated in the operating room and are continued on transfer to the ICU, where an ongoing assessment of the patient's hemodynamic data will guide decision-making related to weaning and escalation of drips. The parameters routinely monitored in this context include LVAD pump flow (and the resulting pulsatility index), MAP, CVP, PCWP, CO (CI) obtained by pulmonary artery catheter, echocardiographic data, and laboratory parameters such as mixed venous saturation and lactic acid. Most patients can be gently weaned from inotropic support after LVAD implantation without difficulty, but some will present challenges in this capacity that will require a careful approach to weaning strategies. Although the duration of inotropic support has been recognized as a predictor for poor outcomes,<sup>16</sup> weaning inotropes too aggressively can potentially have more damaging effects. In our practice the down-titration of inotropic support is deferred until the patient has demonstrated hemodynamic stability over a sufficient period of time without significant ongoing bleeding. Titration of vasopressors may be required in order to keep the patient's blood pressure within the targeted range.

Increases in right atrial pressure, decreases in systemic blood pressure, decreases in pump flow, and a drop in venous saturation suggest that supportive medication has been weaned too aggressively. These findings can also point in the direction of cardiac tamponade as a potential cause of hemodynamic impairment.

Despite the short half-lives of most inotropes, sufficient time should be allowed between weaning steps to observe the hemodynamic impact of any changes that have been made. In the weaning of phosphodiesterase inhibitors, even more time between weaning steps is necessary since the half-life of these drugs is significantly longer.

Inhaled NO or prostacyclin can be safely continued after extubation via nasal cannula or face mask,<sup>17,18</sup> and therefore

the use of these agents should not be viewed as a reason to delay extubation.

If a patient has demonstrated a significant response to NO, weaning should be carefully performed in that even a low dose of around 5 ppm could still be very effective. In most cases the NO concentration is halved until 5–10 ppm is reached, and then it can be discontinued. However, in some patients an abrupt weaning of NO can have a significant effect on oxygenation and RV afterload, and therefore slower weaning below 5 ppm is often necessary prior to discontinuation of the therapy.

While NO has been associated with significant costs, prostacyclin has the potential to adversely impact on platelet function, and its use may lead to increased postoperative bleeding.<sup>19</sup>

## Right Ventricular Failure

Even in the context of improvements in technology and patient selection that characterize the current era of continuous -flow LVADs, right ventricular failure remains a significant complication in up to 40%<sup>20</sup> of the patients, with implications for both short- and long-term outcomes that likely persist beyond heart transplantation. Despite numerous publications related to the prediction of RV failure, the ability to accurately identify this problem preoperatively remains elusive.<sup>21</sup> Perhaps this can be accounted for in part due to the fact that there are a number of intraoperative factors which can contribute to RV failure even in patients where baseline risks are absent. For this reason, it is imperative to watch carefully for signs and symptoms of RV failure during postoperative ICU management, avoiding any treatments that may precipitate this condition.

Generally defined as inotrope or vasodilator dependence for more than 2 weeks after LVAD implant or the requirement of mechanical RV support,<sup>22</sup> RV failure is characterized by high RAP combined with relatively low PAP and consequent low pump output. In this clinical context, cardiac tamponade must be excluded as a cause of hemodynamic impairment. If a PA catheter is in place, low PA pressures can be observed along with a low PCWP, demonstrating a well unloaded LV that is not likely the result of a malfunctioning pump.

If RV failure occurs in the early postoperative period it is imperative to optimize medical management, using volume removal to offload the right ventricle in order to maintain a CVP of less than 15 mmHg. If the CVP rises above 20 mmHg, inotropic and pulmonary vasodilator support should be initiated or intensified. In the clinical context of rising CVP accompanied by a low pulmonary artery pulsatility index (PaPi) and insufficient volume removal with aggressive diuresis, initiation of a percutaneous RV support device should be strongly considered. In some cases in which sufficient fluid removal cannot be accomplished, renal

replacement therapy (CRRT) can be considered as an alternative strategy.<sup>1</sup> Aggressive ventilator settings that promote hypercapnia and hypoxemia should be avoided, NO should be initiated, and sources of acidosis should be corrected.

If RV failure proves to be irreversible despite significant escalation of inotropes, vasopressors, and inodilators, mechanical RV support should be initiated without delay. Early initiation of mechanical circulatory support of the RV has traditionally been resisted due to the invasive nature of reopening the patient's chest to insert cannulae in the right atrium and pulmonary artery. However, with the current percutaneous device options, patients can avoid a reoperation and undergo device removal at the bedside following end-organ recovery.<sup>23</sup> Cannula-based RV support options<sup>24</sup> offer the additional opportunity to integrate an oxygenator which provides the same functionality as venovenous extracorporeal membrane oxygenation (VV-ECMO), allowing for improved oxygenation, low carbon dioxide levels, and gentler ventilator settings, all of which facilitate RV recovery. In institutions where these new devices are not available, RV support can also be achieved with a two-cannula approach whereby one cannula is inserted through the right internal jugular vein with the cannula tip resting in the right main pulmonary artery, and the second cannula is inserted through a femoral vein with the cannula tip terminating in the right atrium.

Immediately after initiation of mechanical RV support, inotropes can typically be weaned aggressively and end-organ function can usually be preserved. Once the patient's volume status is optimized, RV function should be regularly assessed by echo. This assessment can be quite challenging, and each of the parameters for RV assessment discussed previously should be considered in making the decision to separate from mechanical support. During weaning trials the RVAD should be briefly discontinued, which requires higher levels of heparin in order to be performed safely. Ideally the LVAD flow should be adjusted to within the normal range for the patient. Transthoracic echo should be used to assess the position of the septum, the amount of tricuspid regurgitation (TR), tricuspid annular plane systolic excursion (TAPSE), and aortic valve opening during the RVAD wean. If all parameters are in an acceptable range and the patient only requires minimal amounts of inotropic support, separation from RVAD support will likely be successful.

## Arrhythmias

Ventricular arrhythmias remain a common problem in the postoperative setting after LVAD implantation. Patients with preexisting ventricular arrhythmias generally experience a higher incidence of postoperative ventricular arrhythmias.<sup>25</sup> Other risk factors that have been identified include mechanical irritation from the LVAD inflow cannula, electrolyte shifts, and myocardial scarring.

Ventricular arrhythmias typically occur early in the postoperative phase, and can be severe and prolonged at times, requiring multiple cardioversions in addition to maximal medical management with amiodarone or lidocaine.<sup>26</sup>

LVAD patients frequently appear to be relatively stable even during episodes of prolonged ventricular arrhythmias. It is not uncommon for ventricular fibrillation to initially only cause a slight drop in blood pressure and pump flow. Nevertheless, treatment should not be delayed due to the potential for negative effects on RV function with prolonged rhythm abnormalities. Should electric termination be required, there is almost always sufficient time to organize appropriate sedation.

Medical treatment includes normalizing any electrolyte imbalance or volume overload with adjustment of the pump speed under ultrasound guidance to minimize LV distention. Care must be taken to rule out suction events as a possible cause, and appropriate antiarrhythmic medication should be initiated immediately, ideally in close communication with the electrophysiology (EP) service.<sup>26</sup>

Unfortunately, nearly all antiarrhythmic medications carry negative side effects on cardiac function that do not pose a problem for the supported LV, but can be highly problematic for the RV if high doses of antiarrhythmic medications are necessary. This in turn may result in a vicious cycle of lower pump flows requiring escalation of inotropes and aggravation of any ongoing ventricular arrhythmias. In these situations, mechanical RV support may be effective in bridging through the acute phase of this condition, providing appropriate end-organ perfusion.

Atrial arrhythmias with higher heart rates are generally well tolerated, but if the onset is acute, resulting in impaired filling of the right ventricle, they may have the potential to worsen RV dysfunction.<sup>27</sup> If an acute drop in hemodynamic parameters and LVAD flow is observed in this clinical setting, cardioversion may be indicated. Amiodarone is typically initiated as first-line medical therapy given that it has only a minimal negative inotropic effect.<sup>28</sup>

## Cardiopulmonary Resuscitation (CPR)

During prolonged episodes of ventricular fibrillation, LVAD patients will typically achieve some level of perfusion which prevents them from losing consciousness immediately.<sup>29</sup> These compensatory mechanisms may ultimately fail, however, and resuscitation measures are then required. Severe bleeding causing hypovolemia, accidental power disconnection, ischemic stroke, and a variety of less common conditions can also precipitate a loss of consciousness in the LVAD patient. A prompt identification of the cause is mandatory in these situations, even prior to the initiation of chest compressions, since resuscitation efforts can potentially lead to inflow cannula dislocation or injury to the RV.

An arterial line can significantly enhance resuscitation efforts by removing the uncertainty of blood pressure measurement by cuff in the setting of continuous flow. An immediate review of the patient's equipment and power connections should be performed, in addition to troubleshooting any specific alarms which may be present. Also, a Doppler assessment of carotid flow,<sup>30</sup> along with auscultation over the LVAD, can establish whether or not the pump is running. After a prompt assessment of the patient's status, CPR should be initiated in accordance with the existing algorithms that have been published specific to the unconscious LVAD patient.<sup>29</sup>

Venous-arterial extracorporeal membrane oxygenation (VA-ECMO) support in patients with a malfunctioning assist device may be considered, but is not without problems. The currently available continuous-flow LVADs permit free retrograde blood flow in the case of pump stoppage, resulting in a significant increase in LV filling pressure, causing severe pulmonary edema. Therefore, VA-ECMO support for instances of LVAD malfunction should be viewed as a short-term solution, until the underlying problem can be corrected.

In summary, the postoperative ICU course of the MCS patient can often influence the long-term trajectory of a patient's survival. Meticulous attention to detail in the management of each organ system is essential to achieve successful results.

## REFERENCES

1. Slaughter MS, Pagani FD, Rogers JG, et al. Clinical management of continuous-flow left ventricular assist devices in advanced heart failure. *J Heart Lung Transplant.* 2010;29(4 Suppl):S1–S39.
2. Stainback RF, Estep JD, Agler DA, et al. Echocardiography in the management of patients with left ventricular assist devices: recommendations from the American Society of Echocardiography. *J Am Soc Echocardiogr.* 2015;28(8):853–909.
3. Birati EY, Rame JE. Left ventricular assist device management and complications. *Crit Care Clin.* 2014;30(3):607–627.
4. Muthiah K, Gupta S, Otton J, et al. Body position and activity, but not heart rate, affect pump flows in patients with continuous-flow left ventricular assist devices. *JACC Heart Fail.* 2014;2(4):323–330.
5. Myers TJ, Bolmers M, Gregoric ID, Kar B, Frazier OH. Assessment of arterial blood pressure during support with an axial flow left ventricular assist device. *J Heart Lung Transplant.* 2009;28(5):423–427.
6. Woldendorp K, Gupta S, Lai J, Dhital K, Hayward CS. A novel method of blood pressure measurement in patients with continuous-flow left ventricular assist devices. *J Heart Lung Transplant.* 2014;33(11):1183–1186.
7. Maldonado Y, Singh S, Taylor MA. Cerebral near-infrared spectroscopy in perioperative management of left ventricular assist device and extracorporeal membrane oxygenation patients. *Curr Opin Anaesthesiol.* 2014;27(1):81–88.

8. Lahm T, McCaslin CA, Wozniak TC, et al. Medical and surgical treatment of acute right ventricular failure. *J Am Coll Cardiol*. 2010;56(18):1435–1446.
9. Kilic A, Acker MA, Atluri P. Dealing with surgical left ventricular assist device complications. *J Thorac Dis*. 2015;7(12):2158–2164.
10. Bruckner BA, DiBardino DJ, Ning Q, et al. High incidence of thromboembolic events in left ventricular assist device patients treated with recombinant activated factor VII. *J Heart Lung Transplant*. 2009;28(8):785–790.
11. Bradford CD, Stahovich MJ, Dembitsky WP, Adamson RM, Engelbert JJ, Perreiter AS. Safety of prothombin complex concentrate to control excess bleeding during continuous flow LVAD insertion. *ASAIO J*. 2015;61(5):509–513.
12. Wever-Pinzon O, Stehlik J, Kfoury AG, et al. Ventricular assist devices: pharmacological aspects of a mechanical therapy. *Pharmacol Ther*. 2012;134(2):189–199.
13. Sponga S, Ivanitskaia E, Potapov E, Krabatsch T, Hetzer R, Lehmkuhl H. Preoperative treatment with levosimendan in candidates for mechanical circulatory support. *ASAIO J*. 2012;58(1):6–11.
14. Theiss HD, Grabmaier U, Kreissl N, et al. Preconditioning with levosimendan before implantation of left ventricular assist devices. *Artif Organs*. 2014;38(3):231–234.
15. Rao V, Ghadimi K, Keeyapaj W, Parsons CA, Cheung AT. Inhaled nitric oxide (iNO) and inhaled epoprostenol (iPGI2) use in cardiothoracic surgical patients: is there sufficient evidence for evidence-based recommendations? *J Cardiothorac Vasc Anesth*. 2018;32(3):1452–1457.
16. Schenk S, McCarthy PM, Blackstone EH, et al. Duration of inotropic support after left ventricular assist device implantation: risk factors and impact on outcome. *J Thorac Cardiovasc Surg*. 2006;131(2):447–454.
17. Ashutosh K, Phadke K, Jackson JF, Steele D. Use of nitric oxide inhalation in chronic obstructive pulmonary disease. *Thorax*. 2000;55(2):109–113.
18. Thunberg CA, Morozowich ST, Ramakrishna H. Inhaled therapy for the management of perioperative pulmonary hypertension. *Ann Card Anaesth*. 2015;18(3):394–402.
19. Groves DS, Blum FE, Huffmyer JL, et al. Effects of early inhaled epoprostenol therapy on pulmonary artery pressure and blood loss during LVAD placement. *J Cardiothorac Vasc Anesth*. 2014;28(3):652–660.
20. Loforte A, Grigioni F, Marinelli G. The risk of right ventricular failure with current continuous-flow left ventricular assist devices. *Expert Rev Med Devices*. 2017;14(12):969–983.
21. Bellavia D, Iacovoni A, Scardulla C, et al. Prediction of right ventricular failure after ventricular assist device implant: systematic review and meta-analysis of observational studies. *Eur J Heart Fail*. 2017;19(7):926–946.
22. Kormos RL, Teuteberg JJ, Pagani FD, et al. Right ventricular failure in patients with the HeartMate II continuous-flow left ventricular assist device: incidence, risk factors, and effect on outcomes. *J Thorac Cardiovasc Surg*. 2010;139(5):1316–1324.
23. Kapur NK, Esposito ML, Bader Y, et al. Mechanical circulatory support devices for acute right ventricular failure. *Circulation*. 2017;136(3):314–326.
24. Aggarwal V, Einhorn BN, Cohen HA. Current status of percutaneous right ventricular assist devices: first-in-man use of a novel dual lumen cannula. *Catheter Cardiovasc Interv*. 2016;88(3):390–396.
25. Raasch H, Jensen BC, Chang PP, et al. Epidemiology, management, and outcomes of sustained ventricular arrhythmias after continuous-flow left ventricular assist device implantation. *Am Heart J*. 2012;164(3):373–378.
26. Ziv O, Dizon J, Thosani A, Naka Y, Magnano AR, Garan H. Effects of left ventricular assist device therapy on ventricular arrhythmias. *J Am Coll Cardiol*. 2005;45(9):1428–1434.
27. Hottigoudar RU, Deam AG, Birks EJ, McCants KC, Slaughter MS, Gopinathannair R. Catheter ablation of atrial flutter in patients with left ventricular assist device improves symptoms of right heart failure. *Congest Heart Fail*. 2013;19(4):165–171.
28. van Erven L, Schalij MJ. Amiodarone: an effective antiarrhythmic drug with unusual side effects. *Heart*. 2010;96(19):1593–1600.
29. Peberdy MA, Gluck JA, Ornato JP, et al. Cardiopulmonary resuscitation in adults and children with mechanical circulatory support: a scientific statement from the American Heart Association. *Circulation*. 2017;135(24):e1115–e1134.
30. Yuzefpolskaya M, Uriel N, Flannery M, et al. Advanced cardiovascular life support algorithm for the management of the hospitalized unresponsive patient on continuous flow left ventricular assist device support outside the intensive care unit. *Eur Heart J Acute Cardiovasc Care*. 2016;5(8):522–526.

## Introduction

**M**echanical circulatory support devices (MCS) have improved care for patients who have exhausted medical therapies and still require additional cardiac support.<sup>1</sup> One major clinical challenge involves balancing the need for anticoagulation to keep the device functioning with the need to prevent bleeding events.<sup>1–3</sup> Patients on MCS support fit the typical Virchow triad of having stasis of blood flow, endothelial injury, and occasional hypercoagulability. Patients may have stasis because of low cardiac contractility or immobility from the severity of their illness. The device itself is a foreign object, and patients with MCSs are at risk for complications related to infection, hypertension, and shear stress, which can contribute to endothelial dysfunction. Finally, a higher rate of antithrombin III (ATIII) deficiencies in many patients can contribute to a hypercoagulable state.<sup>2,4,5</sup>

In addition to the thrombotic risks associated with MCS, bleeding complications occur at an even greater frequency, in part because of the need for anticoagulation.<sup>6</sup> Balancing the increased mortality from thrombotic complications with the increased morbidity from bleeding complications is the crux of providing optimal care for these patients. The goals of this chapter are to describe current practice standards for anticoagulation management, to address some challenging and common clinical situations, and to discuss some successful anticoagulation strategies for patients requiring MCSs.

## Current Guidelines

### Ventricular Assist Devices

Anticoagulation goals for VADs have changed because of increased clinical experience with a rapidly evolving

technology. Initially, higher anticoagulation goals were targeted to protect the device from failure and to reduce the high mortality associated with pump thrombosis. Anticoagulation regimens were aggressive, such as dual antiplatelet therapy and warfarin to provide an INR (international normalized ratio) between 2.5 and 3.5 for some devices.<sup>7</sup> The initial rate of pump thrombosis was low, around 2%–4%, but this rate came at the expense of a higher rate of bleeding, most commonly gastrointestinal (GI) bleeding.<sup>5,7</sup> In response to high bleeding rates, the pendulum began to swing in the other direction, with warfarin INR goals as low as 1.5–2.0 and potentially without an antiplatelet agent. The consequences of this approach (as well as variability in surgical and medical management strategies across an expanding number of new VAD programs) became apparent with the subsequent rapid rise of acute pump thrombosis, reported in 2013 to be 8.4% at 3 months.<sup>5</sup> This alarmingly high increase in acute device thrombosis resulted in adapting a strategy that falls between the two historical swings in anticoagulation practices.

The most recent guidelines from the International Society for Heart and Lung Transplantation (ISHLT) in 2013 recommend starting heparin on postoperative day 1 or 2 after VAD implantation, with a lower goal of partial thromboplastin time (PTT) of 40–60 seconds and increasing the goal on day 2 or 3 to 60–80 seconds if there is no evidence of bleeding (Table 32.1). Additionally, on day 2 or 3, aspirin 81–325 mg, and warfarin should be started if chest tubes are removed.<sup>1</sup> The recommended INR goal for continuous-flow devices is 2.0–3.0 and 2.5–3.5 for pulsatile devices. These recommendations are sound and should be considered by providers when starting anticoagulation treatment in patients with VADs.<sup>1</sup>

Recent prospective data evaluating adherence to a multisite protocol for reducing pump thrombosis offers additional insight into initial anticoagulation practices.

**Table 32.1 • The 2013 International Society for Heart and Lung Transplantation Recommendations for Beginning Anticoagulation in Patients with Ventricular Assist Devices**

Starting	Intervention	Continuous-Flow Pump Goal	Pulsatile-Flow Pump Goal
<b>Postoperative day 1 to 2</b>	Start heparin if no evidence of bleeding	A PTT of 40–60 s	A PTT of 40–60 s
<b>Postoperative day 2 to 3</b>	Increase heparin goal, start warfarin and aspirin	<ul style="list-style-type: none"> <li>• A PTT of 60–80s</li> <li>• Aspirin 81–325 mg</li> <li>• An INR of 2.0–3.0</li> </ul>	<ul style="list-style-type: none"> <li>• A PTT goal 60–80 s</li> <li>• Aspirin 81–325 mg</li> <li>• AN INR of 2.5–3.5</li> </ul>

PTT = partial thromboplastin time; INR = international normalized ratio.

Adapted from Feldman D et al, The 2013 International Society for Heart and Lung Transplantation Guidelines for mechanical circulatory support: executive summary, *Journal of Heart and Lung Transplantation* 2018;32:157–187. Copyright (2018), with permission from Elsevier.

The Pump Thrombosis Through Clinical Management (PREVENT) trial, which included starting anticoagulation soon after VAD implantation as recommended by the ISHLT guidelines, found that adherence to the protocol reduced early pump thrombosis (Table 32.2).<sup>8</sup> Some notable differences between the trial and the ISHLT guidelines were that warfarin and aspirin could be administered before the chest tube was removed if there was no evidence of bleeding. Aspirin was started slightly later on day 2 to 5 in this protocol, and the dose could be 81–325 mg.<sup>8</sup> The trial's INR goal was narrow, between 2.0 and 2.5.<sup>8</sup> Some practices even after this study have tended to begin anticoagulation after VAD implantation even earlier. Some institutions have begun administering aspirin, warfarin, and heparin all on postoperative day 1, as long as there is no evidence of bleeding, in an effort to prevent early pump thrombosis.

### Extracorporeal Membrane Oxygenation

The use of ECMO has increased markedly over the past decade in response to increased demand for acute

pulmonary and cardiovascular support.<sup>9</sup> The expanding use and longer duration of ECMO support has improved our current understanding of the anticoagulation needs for these devices, but many questions remain. The current guidelines for ECMO management are from the Extracorporeal Life Support Organization (ELSO).<sup>2</sup>

The most recent ELSO guidelines (published in 2014; Table 32.3) give general recommendations for anticoagulation strategies with a preference for heparin anticoagulation as first-line therapy. However, anticoagulation practices have changed since these guidelines were published, given new research on the use of direct thrombin inhibitors as first-line therapy.<sup>4,10</sup>

The 2014 ELSO guidelines recommend that heparin anticoagulation be started as soon as clinical bleeding has been ruled out. Historically, anticoagulation with heparin has been the preferred agent for cardiopulmonary bypass circuits, which resulted in a natural progression to its use as a first-line agent for anticoagulation with ECMO. Nevertheless, the appropriate method for monitoring heparin and the desired degree of anticoagulation during ECMO support are highly controversial.<sup>2,11</sup> Bleeding continues to be a common clinical challenge associated with ECMO, and patients continue to be at high risk for severe bleeding complications, including hemorrhagic stroke.<sup>2</sup>

**Table 32.2 • Anticoagulation Recommendations from the PREVENT Trial (PREVENTion of HeartMate II Pump Thrombosis Through Clinical Management)**

Medication	Starting	Goal
<b>Heparin</b>	Within first 48 hours in patients without persistent bleeding	<ul style="list-style-type: none"> <li>• A PTT goal 45_50 s for the first 48 h</li> <li>• Increase to goal of 50_60 s by 96 h</li> <li>• Stop when INR is between 2.0 and 2.5</li> </ul>
<b>Warfarin</b>	Within first 48 hours	An INR goal of 2.0_2.5 by day 5 to 7
<b>Aspirin</b>	Between day 2 and 5	Aspirin 81_325 mg

PTT = partial thromboplastin time; INR = international normalized ratio

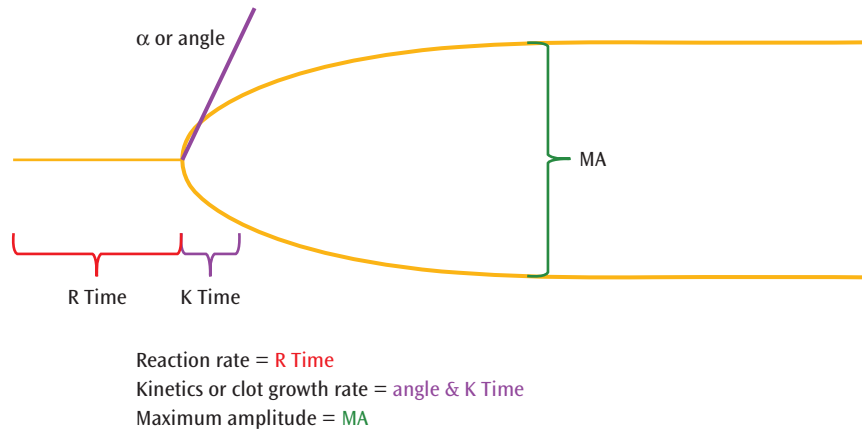
Reprinted from Maltais S, Kilic A, Nathan S, et al., PREVENTion of HeartMate II pump thrombosis through clinical management: the PREVENT multi-center study, *Journal of Heart and Lung Transplantation* 2017;36:1–12, Copyright (2017), with permission from Elsevier.

**Table 32.3 • Anticoagulation Monitoring for Patients Receiving Extracorporeal Membrane Oxygenation Support**

Anticoagulation Lab	Initial Starting Goal
Activated clotting time	180–220 s
Partial prothrombin time	60–80 s
Anti-Xa	0.3–0.7 IU/mL
Thromboelastography R-time	2x to 3x baseline or heparinase reaction time

Anti-Xa = anti-factor Xa assay for plasma heparin;  
IU = international units

Reprinted with permission, ©Extracorporeal Life Support Organization (ELSO)



**Figure 32.1.** Thromboelastography for monitoring heparin anticoagulation. Thromboelastography (TEG) is a visual.

The ELSO guidelines provide general recommendations for using activated clotting time (ACT), partial thromboplastin time (PTT), the anti-factor Xa (anti-Xa) assay for monitoring plasma heparin concentrations, or thromboelastography (TEG) (Figure 32.1) as appropriate for monitoring heparin anticoagulation. Some studies have found that changes in anticoagulation values are poorly correlated with increasing doses of heparin in ECMO.<sup>11</sup> To best capture the overall anticoagulation picture, ELSO recommends monitoring more than one laboratory measure (e.g., ACT and PTT, or PTT and TEG, or PTT and anti-Xa) and to associate these values with the patient's status and circuit patency.<sup>2</sup> There are no specific guideline-directed anticoagulation monitoring goals, but some general recommendations are included in Table 32.1.

Finally, ATIII deficiencies have occurred in these patients. ATIII is a co-factor that is crucial for heparin efficacy, so a possible complication of low ATIII concentrations is subtherapeutic anticoagulation values, despite increasing doses of heparin.<sup>12</sup> ATIII deficiencies can lead to heparin resistance and potential thrombotic complications in the ECMO circuit.<sup>13,14</sup> Different centers target varying ATIII goals (e.g., >80%, >50%, >30%; neonate goals are often 80%–100%), but the minimum amount of ATIII needed for adequate heparin response remains unknown.<sup>14</sup> ATIII supplementation will likely reduce the heparin dose, but whether it reduces device complications is unknown. The literature indicates that an ATIII value between 40% and 60% is a reasonable standard for evaluating potential ATIII supplementation when concentrations of heparin are subtherapeutic.<sup>13,15–17</sup> If anticoagulation is therapeutic, supplementation may not be necessary. For ATIII concentrations lower than 40%, supplementation should be considered. With the high cost of ATIII supplementation, more centers are moving toward administering only one to two

vials at a time instead of using dosing equations to calculate the number of units to reach an ATIII concentration of 100%.

### Total Artificial Heart

Early use of the total artificial heart (TAH) in the 1980s was associated with a high rate of stroke. The high rate led to anticoagulation strategies that included more intense antiplatelet therapy.<sup>3,18</sup> Beginning in the mid-1990s, the anticoagulation regimens in most centers had changed to aspirin, dipyridamole, and heparin bridge to warfarin. Some centers also added pentoxifylline to prevent platelet aggregation by another mechanism of action and potentially to reduce blood viscosity.<sup>18</sup>

Different manufacturers have slightly different recommendations, but some are the same (Table 32.4). Early antiplatelet inhibition with dipyridamole and aspirin is recommended. Aspirin can be started at a lower dose and increased a few days after surgery to a goal of 325 mg. Dipyridamole administration ranges from 100 mg every 8 hours to 250 mg every 6 hours. Platelet aggregation studies are recommended to reduce platelet response by at least 50% for ADP, arachidonic acid, and epinephrine pathways. Finally, centers that add pentoxifylline typically start a dose of 400 mg every 8 hours.<sup>3,18</sup>

Anticoagulation with heparin is recommended once chest tube drainage is stable, without evidence of major bleeding. Initial heparin anticoagulation goals include a PTT greater than 50 seconds for about 2 weeks, until warfarin therapy reaches an INR goal of 2.5–3.5.<sup>18</sup> This anticoagulation strategy reduces stroke rates and bleeding episodes for patients with TAH. One proposed reason for lower bleeding despite intense anticoagulation is the inherent pulsatility of the TAH. Until advances in technology allow lower concentrations of anticoagulants, this strategy is likely to yield the best outcomes.



**Table 32.4 • Example Anticoagulation Regimen for Patients with Total Artificial Hearts**

Medication	Dosing	Starting	Monitoring and Goal
<b>Heparin</b>	Start 2–5 units/kg/h	Postoperative day 1 to 3 when chest tube output < 30 mL/h x 4 h	<ul style="list-style-type: none"> <li>• Monitoring: PTT and TEG</li> <li>• Goals: PTT &gt;50 s; TEG reaction time &gt;12 s</li> </ul>
<b>Warfarin</b>	Adjusted for INR	Postoperative day 1 or when chest tube output <30 mL/hr x 4 h	<ul style="list-style-type: none"> <li>• Monitoring: INR</li> <li>• Goal: 2.5–3.5</li> </ul>
<b>Aspirin</b>	81–325 mg	Postoperative day 1 or when platelet counts >50,000	<ul style="list-style-type: none"> <li>• Monitor: light transmittance aggregometry</li> <li>• Goals: arachidonic acid 20%–40%; ADP 20%–40%; epinephrine 20%–40%</li> </ul>
<b>Dipyridamole</b>	75–100 mg every 6–8 h	Postoperative day 1 or when platelets >50,000	<ul style="list-style-type: none"> <li>• Monitor: light transmittance aggregometry</li> <li>• Goals: arachidonic acid 20%–40%; ADP: 20%–40%; epinephrine: 20%–40%</li> </ul>
<b>Pentoxifylline</b>	200–800 mg every 8 h	Postoperative if additional felt to be needed	<ul style="list-style-type: none"> <li>• Monitor: total plasma hemoglobin</li> <li>• Goal: &lt;50 mg/dL</li> </ul>

Abbreviations: PTT = partial thromboplastin time; TEG = thromboelastography; INR = international normalized ratio; ADP = adenosine diphosphate.

## Challenging Situations

### Ventricular Assist Devices: Adjusting Anticoagulation for Gastrointestinal Bleeding

Post-implantation bleeding remains a substantial problem in patients with continuous-flow VADs, which often necessitates changing anticoagulation goals. For patients with no thrombotic or bleeding complications, following the ISHLT guidelines of aspirin plus warfarin for an INR goal 2.0–3.0 is recommended. However, thrombotic or hemorrhagic complications require modifying that recommendation. The incidence of GI bleeding complications is greater than 30%, in part because of the propensity for arteriovenous malformations to develop.<sup>19</sup> Therefore, many patients will require lower degrees of anticoagulation.<sup>6,20–22</sup>

After an initial GI bleeding event, treating the acute bleeding and continuing the previous management with increased monitoring for future bleeding are reasonable. This recommendation is based on the premise that the risk of mortality associated with a pump thrombosis is higher than that of GI bleeding for patients with VADs. However, this general recommendation may need to be modified in certain situations.

No current guidelines recommend an exact protocol for how to alter anticoagulation goals with recurrent GI bleeding, but the following general approach can be used. The first consideration for adjusting the degree of anticoagulation is to determine whether the INR was supratherapeutic and contributed to the bleeding. If so, consider adjusting the dosage of warfarin to keep the INR in a target range rather than resetting the INR goal. For recurrent GI bleeding that is not the result of supratherapeutic INRs, decreasing the dose of aspirin may be the first step.<sup>23</sup> Patients with VADs acquire von Willebrand deficiencies from the shear stresses inherent in the VAD, and reducing antiplatelet therapy may help reduce future bleeding.<sup>23,24</sup> For subsequent GI bleeding, a stepwise reduction in the INR goal, first to between 2.0 and 2.5 and then to between 1.8 and 2.3, may be necessary, and discontinuing antiplatelet therapy altogether may

be appropriate. A select few patients will be able to stop all anticoagulation therapy, but the resulting increased risk of thrombosis means that stopping should be reserved only for patients with higher VAD flows.

In some case reports and case series, arteriovenous malformations have been treated successfully with agents such as danazol, thalidomide, and doxycycline.<sup>16–18,21</sup> For patients with known arteriovenous malformations, these agents can be tried during anticoagulation therapy to reduce GI bleeding, but these agents can have adverse effects. Overall, GI bleeding events in patients with VADs often lead to difficult anticoagulation decisions.

### Warfarin Time-in-Therapeutic Range for Ventricular Assist Devices

Currently, predicting which patients will have GI bleeding and which will have thrombosis is difficult. One modifiable risk factor is the “time-in-therapeutic range” (TTR). In patients without LVADs, a TTR greater than 65% has been associated with fewer thrombotic complications.<sup>26</sup> The same reduction in complications for patients with LVADs has been reported in smaller retrospective trials, in which a TTR less than 50% was associated with an increased risk of pump thrombosis.<sup>27</sup> Unfortunately, obtaining a high TTR (>65%) is difficult in patients with LVADs.<sup>28</sup> In a meta-analysis of five studies comparing TTRs for patients with continuous-flow LVADs, the weighted mean TTR was 46.6%.<sup>28</sup> Although these patients have inherent reasons for labile warfarin dosing (heart failure, advanced age, right heart failure, and poor nutrition), a goal for all programs should be to maintain a high TTR to avoid complications.

### Chromogenic Factor X or Chromogenic Factor II Monitoring

The increased monitoring of patients without MCSDs and unreliable INRs with alternative laboratory measures raises the question of how to apply this concept to patients with MCSDs.<sup>29–32</sup> Laboratory tests for chromogenic factor X or

factor II may be used in patients with conditions that falsely alter INR laboratory tests, such as antiphospholipid syndrome and direct thrombin inhibitor use.<sup>29,30</sup> The rationale for these alternative tests is that warfarin inhibits vitamin-K-dependent clotting factor, which includes factor X and factor II. As the vitamin-K-dependent factors decrease in the body from warfarin inhibition, the INR increases. Each lab has slight differences in its validated goals. For example, the goal of a chromogenic factor X concentration of 20%–40% reflects an INR of 2.0–3.0. Chromogenic factor II has similar laboratory-specific goals validated to INR goal ranges.<sup>32</sup>

The INR is not specific solely to the factors that warfarin inhibits. In fact, it assesses only three vitamin-K-dependent clotting factors and two non-vitamin-K-dependent clotting factors. Consequently, the INR can be affected by several other clinical conditions. Measuring specific factor concentrations shows the true extent of anticoagulation from warfarin therapy.<sup>32</sup> This information may be helpful to assess the effectiveness of anticoagulation in patients who experience thrombosis while on therapeutic INRs to determine whether their INR truly reflects an appropriate factor reduction from warfarin. The long half-lives of factor X and factor II make using them challenging during acute titration of warfarin because it reflects dosing 2 to 3 days before the day of monitoring. Clinicians should consider monitoring chromogenic factor X or factor II concentrations in outpatients with VADs to verify that they are receiving appropriate concentrations of factor inhibition from warfarin.

#### **Direct Thrombin Inhibitors and Extracorporeal Membrane Oxygenation**

The increasing use of direct thrombin inhibitors (DTIs) in patients on ECMO raises new opportunities and new questions. For several reasons, bivalirudin, a DTI, is an attractive alternative for ECMO anticoagulation. Recent studies of bivalirudin have shown that it decreases bleeding on ECMO without a notable compromise of the circuit.<sup>10</sup> Additionally, the use of direct thrombin inhibitors does not require ATIII to have an anticoagulant effect, thereby reducing potential anticoagulation resistance.<sup>10</sup> Finally, the pharmacokinetics of bivalirudin are such that drug elimination is 80% organ-independent, with the remaining 20% eliminated through the kidneys.

These presumed benefits come with some risk. Most notable is that bivalirudin's effects are not reversible in cases of life-threatening bleeding. Blood product supplementation and waiting for drug clearance are the only management options in this situation. Although bivalirudin had lower bleeding rates than those of heparin in ECMO in certain studies,<sup>10</sup> these studies are limited by different definitions of bleeding and by small samples. Bivalirudin increases the risk of thrombosis with static blood, notably in the ventricles of patients with low contractility on ECMO.<sup>33</sup> This risk is caused by a reduction in circulating blood in the areas of stasis, combined with an 80% organ-independent

drug degradation, which results in a focal region of sub-therapeutic anticoagulation in those areas.<sup>33</sup> For this reason, patients with a propensity for these types of flow variations, as well as those who are being prepared for weaning from ECMO, should be managed with heparin unless contraindicated.

Another issue with direct thrombin inhibitors has been a PTT response curve that plateaus at higher drug concentrations.<sup>34</sup> At some point, dose increases will no longer change PTT, making anticoagulation titration difficult and putting the patient at a potential risk for bleeding.<sup>34,35</sup> In these situations, alternative monitoring procedures, such as ACT or dilute thrombin time, can be used.<sup>35</sup> A more specific and readily available laboratory assessment of a direct thrombin inhibitor effect is needed, given the increasing use of these drugs in these critically ill patients.

Despite the proposed benefits and expanding use of bivalirudin in patients with ECMO, unanswered questions related to the translation of small center data to multi-center use limit more widespread implementation. The ELSO guidelines currently recommend bivalirudin as an alternative to heparin, but as more evidence is accumulated and monitoring becomes more advanced, this recommendation could evolve.

## **Future Directions**

### **Direct Oral Anticoagulant Use and Ventricular Assist Devices**

Although warfarin anticoagulation continues to be the reference standard for long-term VAD therapy, it continues to be limited by a narrow therapeutic range, several drug-drug and drug-food interactions, and a delayed INR response to its administration. These limitations have contributed to the evolution of direct oral anticoagulants (DOACs) as an alternative to warfarin for non-VAD indications. The expanded use of DOACs as an anticoagulation strategy for patients with VADs is intriguing and is a topic for future research.

The three DOACs that have been described most widely in the literature are dabigatran, rivaroxaban, and apixaban. A DTI anticoagulant, dabigatran was the first DOAC on the market. It is effective in treating atrial fibrillation and venous thromboembolism, but it is currently contraindicated in patients with VADs.<sup>36–38</sup> The drug itself requires an acidic environment for appropriate absorption and has tartaric acid in the capsules to improve drug absorption. This requirement is problematic for patients with VADs because of the high rate of GI bleeding that accompanies the use of antacids, which can lead to sub-therapeutic anticoagulation concentrations. A prospective trial evaluating the use of dabigatran in VADs was stopped early because the rate of thrombosis in the dabigatran group was greater than that in the warfarin group.<sup>39</sup> For these reasons, dabigatran should not be used for patients with VADs.

Rivaroxaban is a direct Xa inhibitor and was the second DOAC on the market. Despite its short half-life, only a single daily dose is needed to treat atrial fibrillation.<sup>40,41</sup> To achieve adequate anticoagulation with once-daily dosing in the setting of pharmacokinetic limitations, the degree of anticoagulation is highest soon after administration and decreases over the day. This decrease is problematic for patients with VADs because a missed dose may increase the risk of thrombosis. Data collected after approval for its use in treating atrial fibrillation showed that the risk of intracranial bleeding for rivaroxaban is also greater than it is for other DOACs and warfarin.<sup>42–44</sup> Although data from patients with VADs are limited, the potential risks of rivaroxaban may outweigh the potential benefits.

Apixaban, another direct Xa inhibitor and the third DOAC on the market, has the most promising data. Post-approval data on atrial fibrillation showed that apixaban is safer than warfarin and other DOACs.<sup>42,43,45,46</sup> The rate of GI bleeding is significantly less and could be optimal for patients with VADs. Case reports of apixaban used in patients with VADs are promising, but more data are needed before routine use should be considered.<sup>47,48</sup> The patients in these case reports had VADs with recurrent GI bleeding, and apixaban was used as an alternative to warfarin. Apixaban has fewer drug-drug interactions than does warfarin, but preventing sub-therapeutic anticoagulation still requires a diligent review of potential drug interactions. Two other issues need to be addressed: the risk of thrombosis compared to that of warfarin, and experience with a reversal agent specifically for a factor-Xa inhibitor. Andexanet alfa is a reversal agent recently approved by the Food and Drug Administration (FDA), but its use in patients with LVADs has not been reported.<sup>49</sup> For these reasons, among the various DOAC agents, apixaban offers the most promise for future use in treating patients with VADs.

### Lower Anticoagulation Intensity with Advanced Ventricular Assist Devices

Engineering advancements with new centrifugal continuous-flow devices can markedly reduce thrombosis rates up to 2 years after implant.<sup>50</sup> This reduction may again raise the question about reducing the degree of anticoagulation to reduce bleeding complications. Despite the failure of axial-flow designs to reduce the degree of anticoagulation, the low thrombotic rates associated with newer technologies have re-energized interest in anticoagulation-reduction strategies. Although stroke continues to be a major complication even with newer devices, reducing the warfarin INR goal or using apixaban may be appropriate, even if antiplatelet therapies remain unchanged.<sup>50</sup> Ideally, early efforts at slowly reducing anticoagulant intensity will lead to head-to-head comparisons in the near future.

### Direct Thrombin Inhibitor Drug-Level Monitoring

Advances in laboratory medicine have begun to allow drug-specific anticoagulant monitoring. More specific monitoring is effective, as evident by the use of anti-Xa concentrations for heparin monitoring instead of PTT. For ECMO and the increased use of DTI, validating drug-specific concentrations would be a great step forward in monitoring anticoagulation concentrations, given that the lack of such validation is one of the biggest limitations in balancing the risk-benefit in patients with ECMO.

### Conclusions

Over the past few decades, thinking about anticoagulation in patients with MCS has been innovative. Evolving practices have helped to reduce bleeding complications for these patients while protecting the device that is supporting their circulation. As these devices continue to improve, so will the strategies for managing anticoagulation, until the ultimate goal of preventing both bleeding and thrombosis is achieved.

### REFERENCES

1. Feldman D, Pamboukian S V., Teuteberg JJ, et al. The 2013 International Society for Heart and Lung Transplantation Guidelines for mechanical circulatory support: executive summary. *J Heart Lung Transplant.* 2013 Feb;32(2):157–187. doi:10.1016/j.healun.2012.09.013
2. ELSO. *ELSO Anticoagulation Guideline.* 2014. <https://www.else.org/Portals/0/Files/elseanticoagulationguideline8-2014-table-contents.pdf>
3. Antithrombotic therapy for the CardioWest temporary total artificial heart. *Texas Heart Inst J Antithrombotic Ther Tempor TAH.* 2010;37(2):149–158.
4. Pieri M, Agracheva N, Bonaveglio E, et al. Bivalirudin versus heparin as an anticoagulant during extracorporeal membrane oxygenation: a case-control study. *J Cardiothorac Vasc Anesth.* 2013 Feb;27(1):30–34. doi:10.1053/j.jvca.2012.07.019. Epub 2012 Oct 1.
5. Starling RC, Moazami N, Silvestry SC, et al. Unexpected abrupt increase in left ventricular assist device thrombosis. *N Engl J Med.* 2014;370(1):33–40. doi:10.1056/NEJMoa1313385.
6. Singh G, Albeldawi M, Kalra SS, Mehta PP, Lopez R, Vargo JJ. Features of patients with gastrointestinal bleeding after implantation of ventricular assist devices. *Clin Gastroenterol Hepatol.* 2015 Jan;13(1):107–14.e1. doi:10.1016/j.cgh.2014.05.012. Epub 2014 May 21.
7. Jennings DL, Weeks PA. Thrombosis in continuous-flow left ventricular assist devices: pathophysiology, prevention, and pharmacologic management. *Pharmacotherapy.* 2015;35(1):79–98. doi:10.1002/phar.1501.
8. Maltais S, Kilic A, Nathan S, et al. PREVENTion of HeartMate II pump thrombosis through clinical management: the PREVENT multi-center study. *J Heart Lung Transplant.* 2017;36(1):1–12. doi:10.1016/J.HEALUN.2016.10.001.

9. ELSO. *ELSO International Summary January 2018*. <https://www.else.org/Portals/0/Files/Reports/2018/International%20Summary%20January%202018%20First%20Page.pdf>
10. Ranucci M, Ballotta A, Kandil H, et al. Bivalirudin-based versus conventional heparin anticoagulation for postcardiotomy extracorporeal membrane oxygenation. *Crit Care*. 2011;15(6):R275. doi:10.1186/cc10556. Epub 2011 Nov 20.
11. Yie K, Chon SHD, Na CY. Activated clotting time test alone is inadequate to optimize therapeutic heparin dosage adjustment during post-cardiopulmonary resuscitatory extracorporeal membrane oxygenation (e-CPR). *Perfusion*. 2016 May;31(4):307–315. doi:10.1177/0267659115604710. Epub 2015 Sep 9.
12. Hirsh J, Anand SS, Halperin JL, Fuster V. Guide to anticoagulant therapy: heparin: a statement for healthcare professionals from the American Heart Association. *Circulation*. 2001;103(24):2994–3018. doi:10.1161/01.CIR.103.24.2994.
13. Byrnes JW, Swearingen CJ, Proadhan P, Fiser R, Dyamenahalli U. Antithrombin III supplementation on extracorporeal membrane oxygenation: impact on heparin dose and circuit life. *ASAIO J*. 2014;60(1):57–62. doi:10.1097/MAT.0000000000000010.
14. Gordon S, Heath T, Bourguet-Vincent A, Ozment C. Evaluation of antithrombin supplementation on heparin anticoagulation in pediatric ECMO patients. *Crit Care Med*. 2015;43(12):153. doi:10.1097/01.ccm.0000474434.55997.75.
15. Wong TE, Huang YS, Weiser J, Brogan T V, Shah SS, Witmer CM. Antithrombin concentrate use in children: a multicenter cohort study. *J Pediatr*. 2013 Nov;163(5):1329–1334.e1. doi:10.1016/j.jpeds.2013.06.036. Epub 2013 Aug 6.
16. Ciolek A, Lindsley J, Crow J, Nelson-McMillan K, Procaccini D. Identification of cost-saving opportunities for the use of antithrombin III in adult and pediatric patients. *Clin Appl Thromb*. 2017;24(1):186–191. doi:10.1177/1076029617693941.
17. Beyer JT, Schoeppler KE, Zanotti G, et al. Antithrombin administration during intravenous heparin anticoagulation in the intensive care unit: a single-center matched retrospective cohort study. *Clin Appl Thromb*. 2016;24(1):145–150. doi:10.1177/1076029616668407.
18. Copeland J, Copeland H, Nolan P, Gustafson M, Slepian M, Smith R. Results with an anticoagulation protocol in 99 syncardia total artificial heart recipients. *ASAIO J*. 2013 May-Jun;59(3):216–220. doi:10.1097/MAT.0b013e318288a390
19. Houston BA, Schneider ALC, Vaishnav J, et al. Angiotensin II antagonism is associated with reduced risk for gastrointestinal bleeding caused by arteriovenous malformations in patients with left ventricular assist devices. *J Heart Lung Transplant*. 2017 Apr;36(4):380–385. doi:10.1016/j.healun.2016.12.016. Epub 2016 Dec 30.
20. Sieg AC, Moretz JD, Horn E, Jennings DL. Pharmacotherapeutic management of gastrointestinal bleeding in patients with continuous-flow left ventricular assist devices. *Pharmacotherapy*. 2017 Nov;37(11):1432–1448. doi: 10.1002/phar.2016. Epub 2017 Oct 10.
21. Schettle SD, Pruthi RK, Pereira NL. Continuous-flow left ventricular assist devices and gastrointestinal bleeding: Potential role of danazol. *J Heart Lung Transplant*. 2014. doi:10.1016/j.healun.2014.01.922.
22. Engelen ET, van Galen KPM, Schutgens REG. Thalidomide for treatment of gastrointestinal bleedings due to angiodysplasia: a case report in acquired von Willebrand syndrome and review of the literature. *Haemophilia*. 2015 Jul;21(4):419–429. doi:10.1111/hae.12701. Epub 2015 Apr 30.
23. Uriel N, Pak S-W, Jorde UP, et al. Acquired von Willebrand syndrome after continuous-flow mechanical device support contributes to a high prevalence of bleeding during long-term support and at the time of transplantation. *J Am Coll Cardiol*. 2010;56(15):1207–1213. doi:10.1016/j.jacc.2010.05.016.
24. Saeed O, Shah A, Kargoli F, et al. Antiplatelet therapy and adverse hematologic events during Heart Mate II support. *Circ Heart Fail*. 2016 Jan;9(1):e002296. doi:10.1161/CIRCHEARTFAILURE.115.002296
25. Draper K, Kale P, Martin B, Kelly Cordero R, Ha R, Banerjee D. Thalidomide for treatment of gastrointestinal angiodysplasia in patients with left ventricular assist devices: case series and treatment protocol. *J Heart Lung Transplant*. 2015 Jan;34(1):132–134. doi:10.1016/j.healun.2014.09.013. Epub 2014 Nov 4.
26. Hachamovitch R, Hachamovitch R, Menon V. Current trial-associated outcomes with warfarin in prevention of stroke in patients with nonvalvular atrial fibrillation. *Arch Intern Med*. 2012;172(8):623. doi:10.1001/archinternmed.2012.121.
27. Halder LC, Richardson LB, Garberich RF, Zimbwa P, Bennett MK. Time in therapeutic range for left ventricular assist device patients anticoagulated with warfarin. *ASAIO J*. 2017;63(1):37–40. doi:10.1097/MAT.0000000000000449.
28. Martinez BK, Yik B, Tran R, et al. Meta-analysis of time in therapeutic range in continuous-flow left ventricular assist device patients receiving warfarin. *Artif Organs*. 2018 Jul;42(7):700–704. doi:10.1111/aor.13116. Epub 2018 Mar 6.
29. Sanfelippo MJ, Zinsmaster W, Scherr DL, Shaw GR. Use of chromogenic assay of factor X to accept or reject INR results in warfarin treated patients. *Clin Med Res*. 2009;7(3):103–105. doi:10.3121/cm.2009.836.
30. Austin JH, Stearns CR, Winkler AM, Paciullo CA. Use of the chromogenic factor X assay in patients transitioning from argatroban to warfarin therapy. *Pharmacotherapy*. 2012;32(6):493–501. doi:10.1002/j.1875-9114.2012.01050.x.
31. McGlasson DL, Romick BG, Rubal BJ. Comparison of a chromogenic factor X assay with international normalized ratio for monitoring oral anticoagulation therapy. *Blood Coagul Fibrinolysis*. 2008;19(6):513–517. doi:10.1097/MBC.0b013e328304e066.
32. Baumann Kreuziger LM, Datta YH, Johnson AD, Zantek ND, Shanley R, Reding MT. Monitoring anticoagulation in patients with an unreliable prothrombin time/international normalized ratio: factor II versus chromogenic factor X testing. *Blood Coagul Fibrinolysis*. 2014;25(3):232–236. doi:10.1097/MBC.0000000000000030.
33. Ranucci M. Bivalirudin and post-cardiotomy ECMO: a word of caution. *Crit Care*. 2012 May 9;16(3):427. doi:10.1186/cc11314
34. Cardinale M, Ha M, Liu MH, Reardon DP. Direct thrombin inhibitor resistance and possible mechanisms.

- Hosp Pharm.* 2016;51(11):922–927. doi:10.1310/hpj5111-922.
35. Van Cott EM, Roberts AJ, Dager WE. Laboratory monitoring of parenteral direct thrombin inhibitors. *Semin Thromb Hemost.* 2017;43(3):270–276. doi:10.1055/s-0036-1597297.
  36. Connolly SJ, Ezekowitz MD, Yusuf S, et al. Dabigatran versus warfarin in patients with atrial fibrillation. *N Engl J Med.* 2009;361(12):1139–1151. doi:10.1056/NEJMoa0905561.
  37. Eriksson BI, Dahl OE, Rosencher N, et al. Oral dabigatran etexilate vs. subcutaneous enoxaparin for the prevention of venous thromboembolism after total knee replacement: the RE-MODEL randomized trial. *J Thromb Haemost.* 2007;5(11):2178–2185. doi:10.1111/j.1538-7836.2007.02748.x.
  38. Schulman S, Kearon C, Kakkar AK, et al. Dabigatran versus warfarin in the treatment of acute venous thromboembolism. *N Engl J Med.* 2009;361(24):2342–2352. doi:10.1056/NEJMoa0906598.
  39. Andreas M, Moayedifar R, Wieselthaler G, et al. Increased thromboembolic events with dabigatran compared with vitamin K antagonism in left ventricular assist device patients: a randomized controlled pilot trial. *Circ Heart Fail.* 2017;10(5):e003709. doi:10.1161/CIRCHEARTFAILURE.116.003709.
  40. Patel MR, Mahaffey KW, Garg J, et al. Rivaroxaban versus warfarin in nonvalvular atrial fibrillation. *N Engl J Med.* 2011;365(10):883–891. doi:10.1056/NEJMoa1009638.
  41. Vanassche T, Verhamme P. Rivaroxaban for the treatment of pulmonary embolism. *Adv Ther.* 2013;30(6):589–606. doi:10.1007/s12325-013-0041-4.
  42. Yao X, Abraham NS, Sangaralingham LR, et al. Effectiveness and safety of dabigatran, rivaroxaban, and apixaban versus warfarin in nonvalvular atrial fibrillation. *J Am Heart Assoc.* 2016 Jun 13;5(6). pii: e003725. doi:10.1161/JAHA.116.003725
  43. Abraham NS, Noseworthy PA, Yao X, Sangaralingham LR, Shah ND. Gastrointestinal safety of direct oral anticoagulants: a large population-based study. *Gastroenterology.* 2017 Apr;152(5):1014–1022.e1. doi:10.1053/j.gastro.2016.12.018. Epub 2016 Dec 30.
  44. Noseworthy PA, Yao X, Gersh BJ, Hargraves I, Shah ND, Montori VM. Long-term stroke and bleeding risk in patients with atrial fibrillation treated with oral anticoagulants in contemporary practice: providing evidence for shared decision-making. *Int J Cardiol.* 2017 Oct 15;245:174–177. doi:10.1016/j.ijcard.2017.07.043. Epub 2017 Jul 14.
  45. Granger CB, Alexander JH, McMurray JJ V, et al. Apixaban versus warfarin in patients with atrial fibrillation. *N Engl J Med.* 2011;365(11):339–354. doi:10.1056/NEJMoa1411087.
  46. Agnelli G, Buller HR, Cohen A, et al. Apixaban for extended treatment of venous thromboembolism. *N Engl J Med.* 2013;368(8):699–708. doi:10.1056/NEJMoa1207541.
  47. Pollari F, Fischlein T, Fittkau M, Santarpino G. Anticoagulation with apixaban in a patient with a left ventricular assist device and gastrointestinal bleeding: a viable alternative to warfarin? *J Thorac Cardiovasc Surg.* 2016;151(4):e79–e81. doi:10.1016/j.jtcvs.2015.10.059.
  48. Curran L, Cosgrove A, Clegg A, et al. Apixaban use in LVAD patient with recurrent GI bleeding and recent embolic stroke. *J Card Fail.* 2016;22(8 Supplement):S60–S61.
  49. Connolly SJ, Milling TJ, Eikelboom JW, et al. Andexanet alfa for acute major bleeding associated with factor Xa inhibitors. *N Engl J Med.* 2016;375(12):1131–1141. doi:10.1056/NEJMoa1607887.
  50. Mehra MR, Naka Y, Uriel N, et al. A fully magnetically levitated circulatory pump for advanced heart failure. *N Engl J Med.* 2017;376(5):440–450. doi:10.1056/NEJMoa1610426.

## 33

# Acquired von Willebrand Syndrome with Mechanical Circulatory Support

EVAN C. KLEIN AND LISA BAUMANN KREUZIGER

## Introduction

**T**he increased mechanical shear stress generated by mechanical circulatory support (MCS) devices can cause the large von Willebrand factor multimer to become deformed, leading to cleavage of the protein. The cleaved lower molecular weight multimers have a decreased ability to promote platelet plug formation, leading a disease phenotype known as acquired von Willebrand syndrome. In this chapter we discuss the physiology of von Willebrand factor, the pathophysiology of acquired von Willebrand syndrome, the effect of MCS device choice, and limited data for treatment options in those with recurrent bleeding.

## Physiology of von Willebrand Factor

Von Willebrand factor (vWF) is a large, multimeric glycoprotein that is synthesized in endothelial cells and megakaryocytes (Figure 33.1).<sup>1</sup> After synthesis of the polypeptide monomer, vWF is processed in the endoplasmic reticulum, where it dimerizes. Larger vWF multimers are then assembled in the Golgi apparatus before undergoing glycosylation, followed by packaging into a helical structure or tubules and incorporating factor VIII (FVIII). The assembled vWF multimer complex is then stored in the alpha-granules of platelets or the Weibel-Palade bodies of endothelial cells and secreted at a basal rate by the endothelial cells. Large vWF multimers are released from activated endothelial cells or platelets.<sup>2</sup>

In the bloodstream, vWF circulates with FVIII. The vWF-FVIII complex protects FVIII from degradation by activated protein C, markedly increasing the half-life of circulating

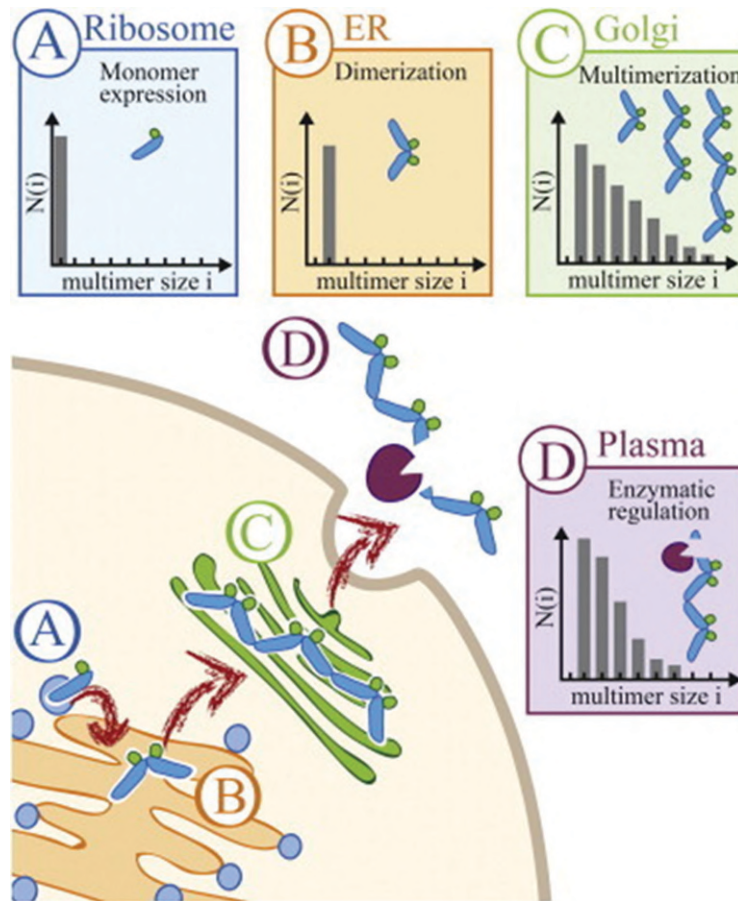
FVIII. Additionally, vWF brings FVIII to the site of blood vessel injury to participate in coagulation.<sup>3</sup>

The vascular endothelium is lined with antithrombotic proteins that inhibit platelet activation and activate fibrinolysis. However, the subendothelial layer contains proteins, such as collagen, that can activate hemostasis when exposed to the bloodstream. After endothelial injury, vWF multimers are rapidly expelled from Weibel-Palade bodies. Shear stress associated with flow through the injured vasculature leads to unfolding of plasma vWF. The exposed vWF then facilitates platelet binding to subendothelial collagen. Platelet aggregation forms a platelet plug and serves as the phospholipid membrane required to activate the coagulation system.<sup>3,4</sup>

The size and clearance of vWF is regulated through two distinct mechanisms. ADAMTS-13 is a metalloprotease that cleaves vWF multimers at a site in the A2 domain that is only exposed after binding to platelets, collagen, or shear-stress-induced vWF unfolding. Deficiencies of ADAMTS-13 lead to ultra-large vWF multimers and to a prothrombotic disorder, thrombotic thrombocytopenic purpura.<sup>3</sup> Plasma vWF is cleared from the circulation through endocytosis by macrophages in the liver and spleen.<sup>2</sup>

## Pathophysiology of Acquired von Willebrand Syndrome in Mechanical Circulatory Support

The American internist Edward Heyde first proposed the development of acquired von Willebrand syndrome (AvWS) in the setting of severe aortic stenosis. Severe aortic stenosis increases the turbulence and velocity of blood



**Figure 33.1.** Schematic representation of plasma VWF synthesis. (A) VWF originates as a 360 kDa monomer in the endothelial cells and megakaryocytes. (B) vWF is dimerized through intermonomer disulfide bonds in the endoplasmic reticulum. (C) Multimerization occurs in the Golgi apparatus, with formation of multimers between 500 and 40,000 kDa, which are secreted into the plasma. (D) Enzymatic regulation by ADAMTS13 occurs in the plasma.

Reprinted from Lippok S et al., Exponential size distribution of von Willebrand factor, *Biophysical Journal* 2013;105:1208–1216, Copyright (2013), with permission from Elsevier.

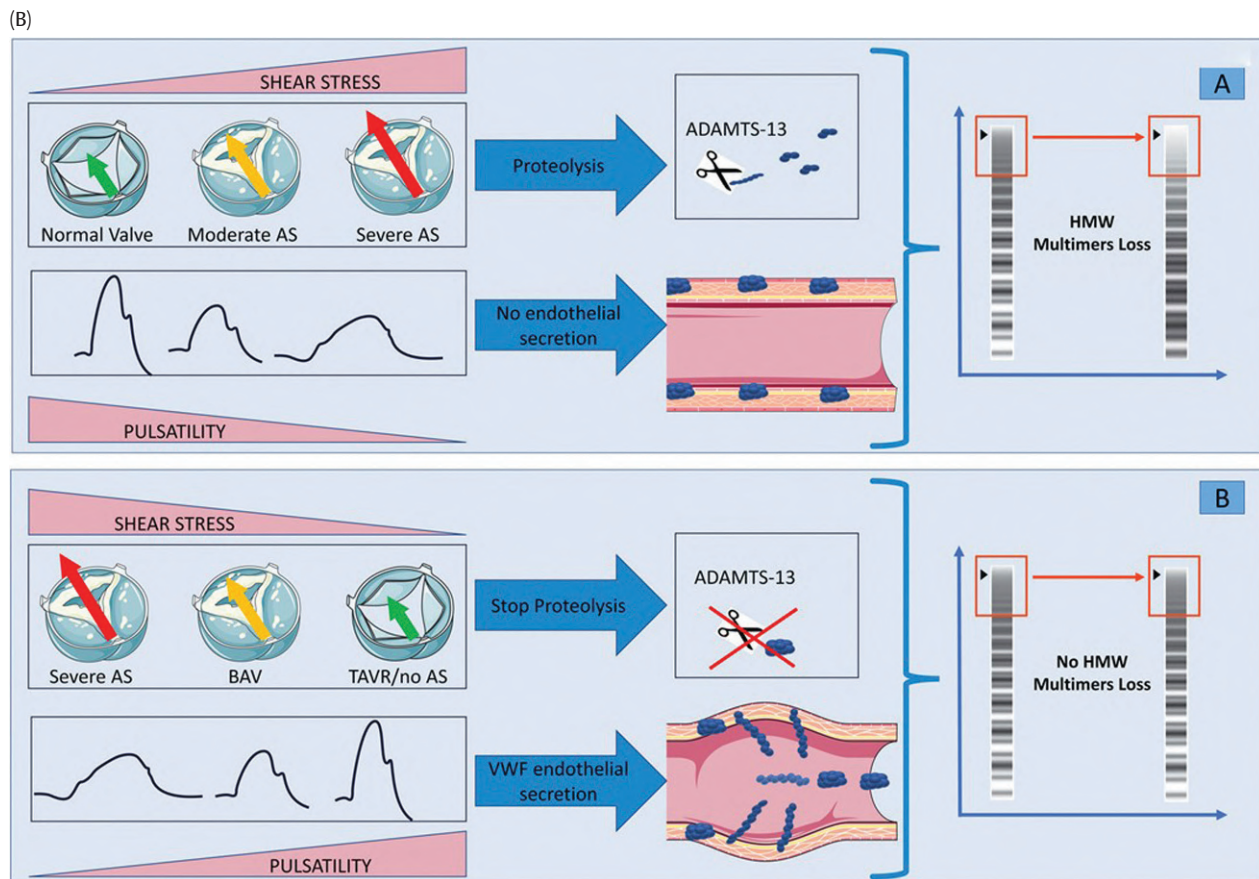
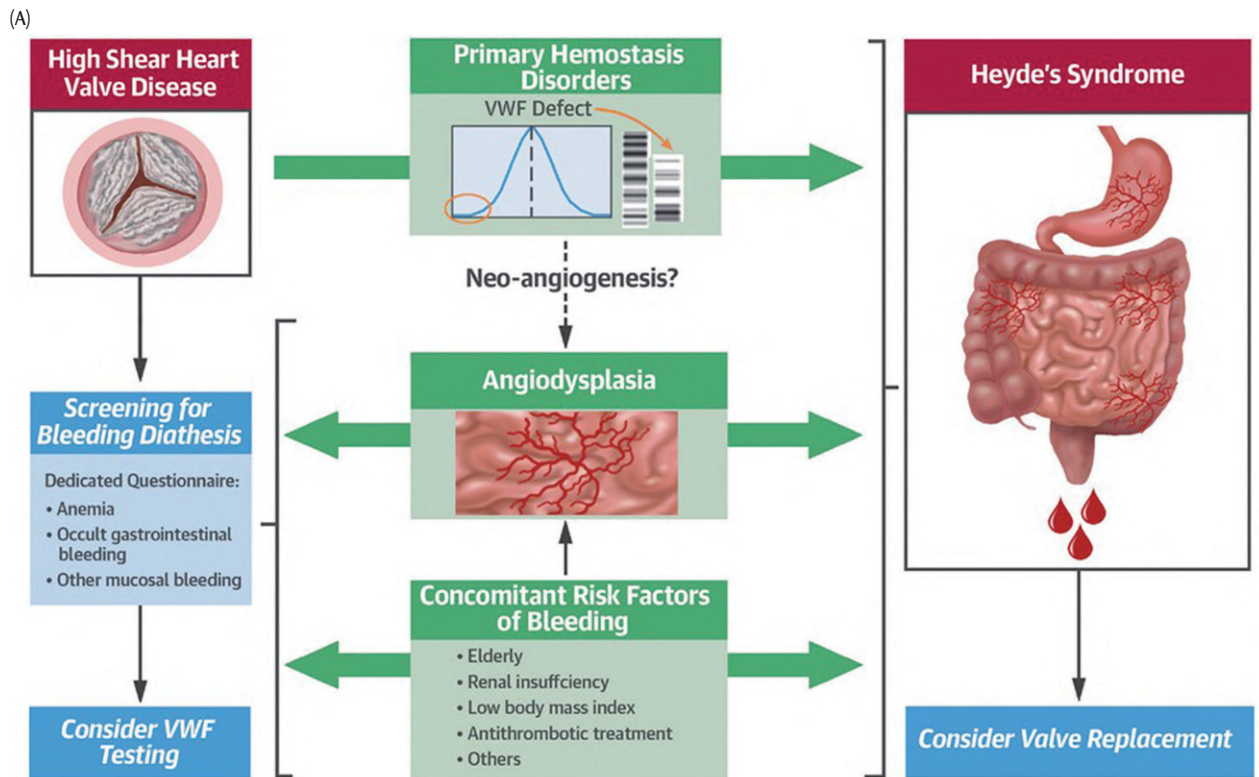
flow through the narrowed valve orifice. This turbulence increases shear stress on the proteins and cells passing through the valve, leading to unfolding of circulating vWF multimers, exposing them to cleavage by ADAMTS-13 (Figure 33.2).<sup>5,6</sup> Loss of the high-molecular-weight vWF multimers is suggested by decreased vWF:collagen binding (vWF:CB) to vWF antigen (vWF:Ag) ratios, which is detected by gel electrophoresis and measured with densitometry, a technique that measures the optical density of each band.<sup>7</sup> A vWF:CB/vWF:Ag ratio of less than 0.8 with an abnormal multimer analysis is diagnostic of AvWS.

Current durable left ventricular assist devices (LVADs) used in adults rely on continuous flow provided by axial or centrifugal mechanisms that pull in blood through an inflow cannula inserted in the left ventricular apex and pump blood into the aorta through an outflow cannula. As blood cells and plasma proteins pass through the pump, they are exposed to increased velocity and shear

stress. Plasma vWF circulates in a globular quaternary structure that unfolds when exposed to the supraphysiologic shear stress associated with LVAD support, exposing the A2 domain and allowing for multimer cleavage by ADAMTS-13.

In vitro studies suggest that supraphysiologic shear stress alone may lead to some multimer degradation, but the pattern of AvWS seen in vivo requires the activity of ADAMTS13.<sup>8</sup> Unfolding of vWF also allows for the binding of platelets, leading to thrombus formation and a consumption of high-molecular-weight multimers.

Acquired von Willebrand syndrome occurs within 4–6 hours of LVAD implantation and resolves within 4 hours after explantation.<sup>9–11</sup> The time course for resolution of AvWS is shorter than the time required to synthesize vWF multimers, and is believed to be explained by a stress-related release of vWF from Weibel-Palade bodies in combination with a lack of shear-stress-induced vWF unfolding.



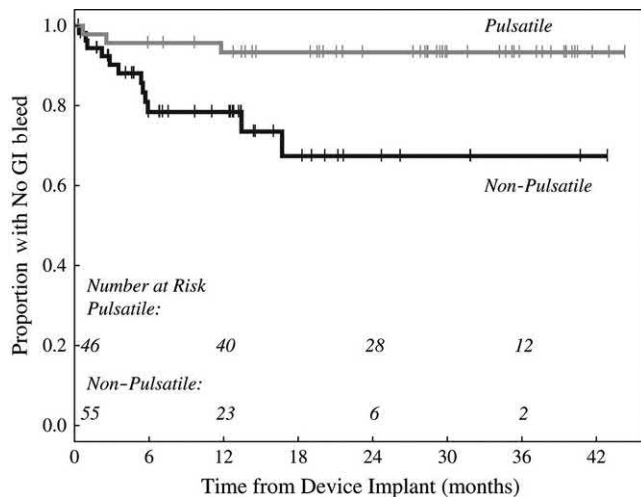
**Figure 33.2.** AVWS in the setting of AS can lead to angiodysplasia and Heyde's syndrome (A). Von Willebrand protein circulates as a coiled protein that unfolds in response to the shear stress created by the narrowed valve (B). The A2 domain of von Willebrand protein is exposed and cleaved by ADAMTS13, resulting in loss of high-molecular weight multimers of von Willebrand protein.

Reprinted from Van Belle E et al., von Willebrand factor and management of heart valve disease: JACC Review Topic of the Week, *Journal of the American College of Cardiology* 2019;73:1078–1088, Copyright (2019), with permission from Elsevier.



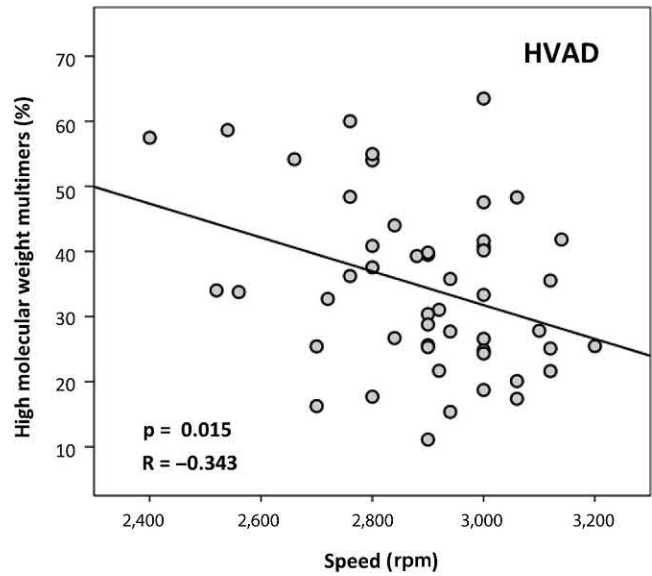
### Device Differences in Acquired von Willebrand Syndrome

Early studies comparing pulsatile- with continuous-flow devices revealed differences in gastrointestinal bleeding,<sup>12,13</sup> which were postulated to result from differences in shear stress and AvWS (Figure 33.3).<sup>12</sup> However, as the technology evolved, most devices adopted a continuous-flow mechanism. Consequently, most MCS devices used today provide continuous flow through either an axial or centrifugal flow mechanism. Axial-flow devices create flow through the rotation of impeller blades at 7,000–12,000 rpm, oriented parallel to the direction of flow. Fluid dynamic modeling suggests that axial devices create mean shear stress levels about 100 times larger than those occurring in normal arterioles.<sup>14,15</sup> Centrifugal-flow devices create flow through revolutions of a rotor at 2,000–6,000 rpm, oriented perpendicular to the direction of flow. The lower rotational speed associated with centrifugal pumps creates one-third to one-quarter of the shear stress associated with axial pumps (Figure 33.4).<sup>14–16</sup> The decreased shear stress is hypothesized to prevent AvWS from developing. However, nearly all patients with implanted MCS devices have moderate-to-severe high molecular weight vWF degradation within 30 days of support (Figure 33.5; Table 33.1).<sup>9–11,16–21</sup>



**Figure 33.3.** Proportion of patients without a gastrointestinal hemorrhage in patients implanted with pulsatile and non-pulsatile devices.

Reprinted from Crow S et al., Gastrointestinal bleeding rates in recipients of nonpulsatile and pulsatile left ventricular assist devices, *Journal of Cardiovascular Surgery* 2009;137:208–215, Copyright (2009), with permission from Elsevier.



**Figure 33.4.** Correlation between percentage of high molecular weight von Willebrand protein multimers and HVAD pump speed.

Reprinted from Meyer AL et al., Acquired von Willebrand syndrome in patients with a centrifugal or axial continuous flow left ventricular assist device, *JACC Heart Failure* 2014;141–145, Copyright (2014), with permission from Elsevier.

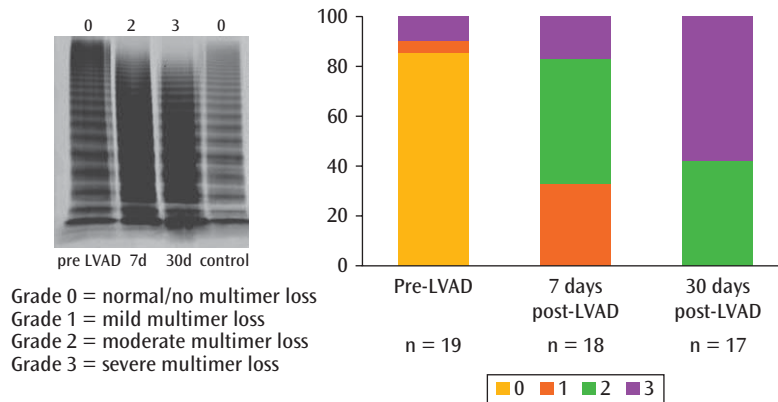
### Temporary Mechanical Circulatory Support Devices

#### The Impella Heart Pump

The Impella® Heart Pump is an axial-flow device that can provide between 2.5 and 5.0 L of flow. A case report and case series have reported vWF multimer profiles in Impella-supported patients. A patient bridged with an Impella® 5.0 to a HeartWare VAD (HVAD) had clinical and biomechanical evidence of AvWS when the Impella was run at 30,000 rpm (4.4 liters per minute). Increased vWF multimer sizes were detected after transition to HVAD support; however, an altered vWF profile persisted.<sup>20</sup> In a case series of 21 patients with the Impella® CP, 20 experienced AvWS after an average of 10 hours of support.<sup>22</sup>

#### Temporary Extracorporeal Centrifugal Pumps

Several external centrifugal pumps are on the market, including the CentriMag magnetically levitated pump, the TandemLife pump, the Rotaflo pump, and the Biomedicus pump. Each of these devices can provide left, right, or biventricular support, depending on inflow and outflow cannula positioning. These pumps can also provide extracorporeal membrane oxygenation (ECMO) support if an oxygenator is spliced into the circuit.



**Figure 33.5.** von Willebrand multimer gel electrophoresis showing loss of high molecular weight multimers after LVAD implantation.

Reprinted from Crow S et al., Acquired von Willebrand syndrome in continuous-flow ventricular assist device recipients, *Ann Thorac Surg.* 2010;90(4):7. Copyright (2010), with permission from Elsevier.

Several studies have found altered vWF multimer profiles in patients supported with extracorporeal centrifugal pumps.<sup>11,21,23</sup> A retrospective study found that 12 of 13 patients with clinical bleeding while on CentriMag support had evidence of AvWS, with an absence of high-molecular-weight vWF multimers.<sup>21</sup> Additionally, a prospective cohort of 38 patients started on ECMO support showed transient reductions in vWF multimer weights in all patients and persistent reductions in vWF multimer size that resolved only after stopping MCS in 37 patients.<sup>11</sup> This study found no important differences in vWF profiles related to pump type or cannulation strategy (e.g., veno-veno vs. veno-arterial ECMO).<sup>11</sup>

(HVAD, HeartMate 3) flow design. Data suggest that all patients supported with a continuous-flow device show some degree of AvWS, with reductions in high-molecular-weight vWF multimer concentrations.<sup>9,10,16,17,24</sup> Although the HeartMate II is associated with higher baseline levels of hemolysis than the centrifugal flow LVADs,<sup>25</sup> the degree of AvWS<sup>16</sup> and bleeding<sup>26</sup> between the HeartMate II and HVAD devices appears to be similar. The severity of AvWS remains stable over time.<sup>27</sup> Although patients treated with the HeartMate 3 left ventricular assist system showed less loss of high molecular weight vWF multimers compared to HeartMate II patients, differences in vWF:RCo/vWF:Ag ratios were not seen.<sup>28</sup>

## Durable Left Ventricular Assist Devices

### Axial and Centrifugal LVADs

Although LVADs were originally pulsatile, the current generation of implantable MCS devices provide continuous flow through either an axial (HeartMate II) or a centrifugal

### Total Artificial Heart

The Syncardia total artificial heart provides biventricular support powered by pneumatically driven membranes that actively retract and then passively relax to pump up to 9.5 liters of blood per minute. This pulsatile method of pumping exposes blood cells and plasma to lower velocities and

**Table 33.1 • Degree of Acquired von Willebrand Syndrome Commonly Associated with Selected Mechanical Circulatory Devices**

Device	vWF:CB, mean (SD), %	vWF:Ag, mean (SD), %	vWF:RCo, mean (SD), %	vWF:CB/vWF:Ag, mean (SD) ratio	vWF:RCo/vWF:Ag, mean (SD) ratio
Impella <sup>22</sup>	213 (82)	265 (106)	183 (56)	0.82 (0.1)	0.71 (0.2)
ECMO <sup>11</sup>	NC	261 (138)	157 (103)	NC	0.61 (0.17)
HeartMate II <sup>17</sup>	NC	372 (28)	186 (18)	NC	0.66 (0.04)
HVAD <sup>16</sup>	113 (57)	160 (58)	NC	0.7 (0.2)	NC
HeartMate 3 <sup>28</sup>	NC	~350	~200	NC	~0.65

Abbreviations: vWF:CB = von Willebrand factor: collagen binding; vWF:Ag = von Willebrand factor: Antigen; vWF:RCo = von Willebrand: Ristocetin cofactor activity; NC = testing not completed.

degrees of shear stress, which may correlate with a lower incidence of AvWS. In support of this possibility, Heilmann et al. found no significant change in vWF multimer profiles up to 3 weeks after implanting three total artificial hearts.<sup>9</sup>

## Association of Acquired von Willebrand Syndrome with Bleeding

The causes of increased bleeding in patients with AvWS are multifactorial. Loss of the high-molecular-weight multimers removes the proteins that most effectively bind platelets. Additionally, a function for vWF in angiogenesis has recently been discovered. In vitro models suggest that vWF regulates angiogenesis through  $\alpha v\beta 3$  inhibition of vascular endothelial growth factor receptor 2 (VEGFR2). Loss of vWF can also increase VEGFR2 concentrations through increases in angiopoietin-2.<sup>29</sup> Abnormal VEGFR2 signaling in turn results in abnormal vascular proliferation and endothelial cell migration. One hypothesis contends that the abnormal angiogenesis secondary to a lack of high-molecular-weight vWF multimers promotes the formation of arterial venous malformations, which are often found in the gastrointestinal tract of patients with AvWS.

Several cohort studies have evaluated risk factors associated with bleeding to predict the risk of bleeding in patients on mechanical circulatory support. Thus far, the presence and severity of AvWS have not been consistently associated with risk for gastrointestinal bleeding in patients supported by MCS.<sup>16,17,24</sup> Additionally, direct measurement of vWF concentration has not been independently associated with increased bleeding risk.<sup>30–33</sup> Given the growing cohort of patients on MCS living with AvWS and the persistently elevated rates of bleeding complications associated with these devices, a validated predictive risk model for bleeding in these patients could potentially improve clinical outcomes through customized anticoagulation strategies.

## Pharmacologic Treatment Options

Chapter 34 provides an in-depth discussion of the management for gastrointestinal bleeding, but several therapies merit discussion in the treatment of AvWS (Table 33.2).

### Octreotide

Although not a targeted therapy for AvWS, octreotide reduces splanchnic blood flow by binding to somatostatin receptors. Case reports of octreotide therapy in patients with LVADs and recurrent gastrointestinal bleeding have reported decreased admissions, re-bleeding episodes, blood product use, and the need for endoscopic procedures.<sup>34–37</sup> A study of 10 patients suggested that prophylactic use of depot octreotide may also decrease the incidence

**Table 33.2 • Drug Therapies for Acquired von Willebrand Syndrome**

Drug	Dose and Regimen
Octreotide acetate <sup>37</sup>	50 $\mu$ g subcutaneous, twice per day
Octreotide LAR depot <sup>37,38,49</sup>	20 mg subcutaneous, monthly
Doxycycline (no effect) <sup>41</sup>	100 mg, twice per day
Humate-P <sup>44</sup>	Slow taper starting at 60 units/kg every 8 hours with down-titration steps of <ul style="list-style-type: none"> <li>• 60 units/kg every 12 hours</li> <li>• 40 units/kg every 24 hours</li> <li>• 40 units/kg every 48 hours</li> <li>• 20 units/kg every 24 hours</li> <li>• 20 units/kg every 48 hours</li> </ul>
Desmopressin acetate <sup>45,49,50</sup>	0.3–4 $\mu$ g/kg IV infusion
Tranexamic Acid <sup>51</sup>	20–25 mg/kg, every 8 hours; adjunctive therapy

LAR = long-acting release.

of gastrointestinal bleeding.<sup>38</sup> Data suggests that octreotide is most beneficial to patients with AvWS and gastrointestinal bleeding from arteriovenous malformations<sup>35</sup> and is less effective in patients presenting with gastrointestinal bleeding from gastric erosions.<sup>39</sup>

### Doxycycline

In vitro studies have shown that doxycycline decreases degradation of vWF multimers and restores vWF:CB activity, even though ADAMTS-13 activity was decreased by only 18%.<sup>40</sup> However, whether doxycycline is effective in treating patients with LVADs remains unclear because in a cohort of six patients, ADAMTS-13 activity did not change significantly after receiving doxycycline therapy to prevent driveline infection.<sup>41</sup>

### Humate-P

Humate-P is a concentrate of intermediate purity vWF and factor VIII. The vWF multimer band pattern is similar to normal human plasma, except for a mild decrease in the highest-molecular-weight multimers.<sup>42</sup> The effectiveness of Humate-P in treating patients with AvWS caused by immune mechanisms has been well validated.<sup>43</sup> One case report has examined Humate-P as adjunct therapy to treat bleeding events in a patient with an LVAD. Pump-related thrombosis occurred during Humate-P supplementation, but the patient was successfully bridged to heart transplant.<sup>44</sup> The immediate degradation of high-molecular-weight vWF multimers that occurs during LVAD therapy is an additional challenge when administering IV therapeutic agents to treat or prevent bleeding complications.

### Desmopressin Acetate

Desmopressin acetate (trade name, DDAVP) releases vWF from Weibel-Palade bodies of endothelial cells and may therefore be an option for treating AvWS-associated bleeding.<sup>45,46</sup> However, the response to DDAVP can be variable, and there are no studies that demonstrate a clear benefit of DDAVP in patients with mechanical circulatory support.

Limitations to DDAVP therapy include tachyphylaxis, hyponatremia, and increased fluid retention.<sup>47</sup> Also, any additional vWF multimers released from the Weibel-Palade bodies will experience the same shear-mediated changes in quaternary structure discussed earlier, exposing these molecules to degradation by ADAMTS-13.

### Tranexamic Acid

Tranexamic acid is an anti-fibrinolytic that inhibits clot degradation by reversibly blocking the lysine binding sites of plasminogen. Tranexamic acid is used in patients with menorrhagia and inherited bleeding disorders, including von Willebrand disease. Ten randomized control trials have shown that administering tranexamic acid before cardiopulmonary bypass for coronary artery bypass surgery reduces postoperative blood loss and transfusion requirements.<sup>48</sup> The use of tranexamic acid to treat bleeding complications during LVAD support has not been studied.

### REFERENCES

- Leebeek FW, Eikenboom JC. Von Willebrand's disease. *N Engl J Med*. 2016;375(21):2067–2080.
- Lenting PJ, Christophe OD, Denis CV. von Willebrand factor biosynthesis, secretion, and clearance: connecting the far ends. *Blood*. 2015;125(13):2019–2028.
- Peyvandi F, Garagiola I, Baronciani L. Role of Von Willebrand factor in the hemostasis. *Blood Transf*. 2011;9(Suppl 2):6.
- Palta S, Saroa r, Palta A. Overview of the coagulation system. *Indian J Anaesth*. 2014;58(5):9.
- Shetty S, Kasatkar P, Ghosh K. Pathophysiology of acquired von Willebrand disease: a concise review. *Eur J Haematol*. 2011;87(2):99–106.
- Loscalzo J. From clinical observation to mechanism: Heyde's syndrome. *N Engl J Med*. 2012;367(20):1954–1956.
- Sharma R, Flood VH. Advances in the diagnosis and treatment of von Willebrand disease. *Blood*. 2017;130(22):2386–2391.
- Bartoli CR, Restle DJ, Zhang DM, Acker MA, Atluri P. Pathologic von Willebrand factor degradation with a left ventricular assist device occurs via two distinct mechanisms: Mechanical demolition and enzymatic cleavage. *J Thorac Cardiovasc Surg*. 2015;149(1):281–289.
- Heilmann C, Geisen U, Beyersdorf F, et al. Acquired von Willebrand syndrome in patients with ventricular assist device or total artificial heart. *Thromb Haemost*. 2010;103(5):962–967.
- Meyer AL, Malehsa D, Bara C, et al. Acquired von Willebrand syndrome in patients with an axial flow left ventricular assist device. *Circ Heart Fail*. 2010;3(6):141–145.
- Tauber H, Ott H, Streif W, et al. Extracorporeal membrane oxygenation induces short-term loss of high-molecular-weight von Willebrand factor multimers. *Anesth Analg*. 2015;120(4):730–736.
- Crow S, John R, Boyle A, et al. Gastrointestinal bleeding rates in recipients of nonpulsatile and pulsatile left ventricular assist devices. *J Thorac Cardiovasc Surg*. 2009;137(1):208–215.
- Jessup ML, Goldstein D, Ascheim DD, et al. 5 Risk for Bleeding after MCSD Implant: An Analysis of 2358 Patients in INTERMACS. *J Heart Lung Transplant*. 2011;30(4):S9.
- Fraser KH, Zhang T, Taskin ME, Griffith BP, Wu ZJ. A quantitative comparison of mechanical blood damage parameters in rotary ventricular assist devices: shear stress, exposure time and hemolysis index. *J Biomech Eng*. 2012;134(8):081002.
- Nascimbene A, Neelamegham S, Frazier OH, Moake JL, Dong JF. Acquired von Willebrand syndrome associated with left ventricular assist device. *Blood*. 2016;127(25):3133–3141.
- Meyer AL, Malehsa D, Budde U, Bara C, Haverich A, Strueber M. Acquired von Willebrand syndrome in patients with a centrifugal or axial continuous flow left ventricular assist device. *JACC Heart Fail*. 2014;2(2):141–145.
- Crow S, Chen D, Milano C, et al. Acquired von Willebrand syndrome in continuous-flow ventricular assist device recipients. *Ann Thorac Surg*. 2010;90(4):7.
- Coutance G, Repesse Y, Belin A, Massetti M. Acquired von Willebrand disease in Jarvik 2000 recipients: a single center experience. *Int J Cardiol*. 2012;159(1):57–58.
- Klovaite J, Gustafsson F, Mortensen SA, Sander K, Nielsen LB. Severely impaired von Willebrand factor-dependent platelet aggregation in patients with a continuous-flow left ventricular assist device (HeartMate II). *J Am Coll Cardiol*. 2009;53(23):2162–2167.
- Davis ME, Haglund NA, Tricarico NM, Keebler ME, Maltais S. Development of acquired von Willebrand syndrome during short-term micro axial pump support: implications for bleeding in a patient bridged to a long-term continuous-flow left ventricular assist device. *ASAIO J*. 2014;60(3):355–357.
- Morrison KA, Jorde UP, Garan AR, Takayama H, Naka Y, Uriel N. Acquired von Willebrand disease during CentriMag support is associated with high prevalence of bleeding during support and after transition to heart replacement therapy. *ASAIO J*. 2014;60(2):241–242.
- Flierl U, Tongers J, Berliner D, et al. Acquired von Willebrand syndrome in cardiogenic shock patients on mechanical circulatory microaxial pump support. *PLoS ONE*. 2017;12(8):e0183193.
- Heilmann C, Geisen U, Beyersdorf F, et al. Acquired von Willebrand syndrome in patients with extracorporeal life support (ECLS). *Intensive Care Med*. 2012;38(1):62–68.
- Uriel N, Pak SW, Jorde UP, et al. Acquired von Willebrand syndrome after continuous-flow mechanical device support contributes to a high prevalence of bleeding during long-term support and at the time of transplantation. *J Am Coll Cardiol*. 2010;56(15):1207–1213.
- Birschmann I, Dittrich M, Eller T, et al. Ambient hemolysis and activation of coagulation is different between HeartMate II and HeartWare left ventricular assist devices. *J Heart Lung Transplant*. 2014;33(1):80–87.

26. Gaffey AC, Chen CW, Chung JJ, et al. Is there a difference in bleeding after left ventricular assist device implant: centrifugal versus axial? *J Cardiothorac Surg.* 2018;13(1):22.
27. Heilmann C, Trummer G, Beyersdorf F, et al. Acquired von Willebrand syndrome in patients on long-term support with HeartMate II. *Eur J Cardiothorac Surg.* 2017;51(3):587–590.
28. Netuka I, Kvasnicka T, Kvasnicka J, et al. Evaluation of von Willebrand factor with a fully magnetically levitated centrifugal continuous-flow left ventricular assist device in advanced heart failure. *J Heart Lung Transplant.* 2016;35(7):860–867.
29. Randi AM, Laffan MA. Von Willebrand factor and angiogenesis: basic and applied issues. *JTH.* 2017;15(1):13–20.
30. Wever-Pinzon J, Wever-Pinzon O, McKellar S, et al. A novel model to predict the risk of non-surgical bleeding among patients receiving continuous flow left ventricular assist devices. *J Heart Lung Transplant.* 2014;33(4):S22.
31. Sparrow CT, Nassif ME, Raymer DS, et al. Development of a preoperative risk model that predicts gastrointestinal bleeding after implantation of continuous-flow LVADs. *J Cardiac Fail.* 2015;21(8):S99–S100.
32. Balcioglu O, Kemal HS, Ertugay S, et al. Risk factors of gastrointestinal bleeding after continuous flow left ventricular assist device. *ASAIO J.* 2018;64(4):458–461.
33. Joy PS, Kumar G, Guddati AK, Bhama JK, Cadaret LM. Risk factors and outcomes of gastrointestinal bleeding in left ventricular assist device recipients. *Am J Cardiol.* 2016;117(2):240–244.
34. Smallfield GB, Gunda S, Emani S, et al. A multi-center evaluation of octreotide for ventricular assist device related gastrointestinal bleeding. *J Heart Lung Transplant.* 2016;35(4):S245.
35. Shah KB, Sampath G, Emani S, et al. Octreotide reduces the reoccurrence of ventricular assist device related gastrointestinal bleeding. *J Heart Lung Transplant.* 2017;36(4):S124.
36. Dias PS, Hayes H, Baumwol J. The use of octreotide to treat refractory gastrointestinal bleeding in patients supported with a continuous-flow left ventricular assist device. *J Heart Lung Transplant.* 2015;34(4):S211–S212.
37. Loyaga-Rendon RY, Hashim T, TallajJA, et al. Octreotide in the management of recurrent gastrointestinal bleed in patients supported by continuous flow left ventricular assist devices. *ASAIO J.* 2015;61(1):107–109.
38. Malhotra R, Shah KB, Chawla R, et al. Tolerability and biological effects of long-acting octreotide in patients with continuous flow left ventricular assist devices. *ASAIO J.* 2017;63(3):367–370.
39. Aggarwal A, Pant R, Kumar S, et al. Incidence and management of gastrointestinal bleeding with continuous flow assist devices. *Ann Thorac Surg.* 2012;93(5):1534–1540.
40. Bartoli CR, Kang J, Restle DJ, et al. Inhibition of ADAMTS-13 by doxycycline reduces von Willebrand factor degradation during supraphysiological shear stress: therapeutic implications for left ventricular assist device-associated bleeding. *JACC Heart Fail.* 2015;3(11):860–869.
41. Keebler ME, Haglund N, Zalawadiya S, et al. Standard dose doxycycline does not alter von Willebrand factor degradation in patients with CF LVAD. *J Heart Lung Transplant.* 2017;36(4):S11.
42. Metzner HJ, Hermentin P, Cuesta-Linker T, Langner S, Muller HG, Friedebold J. Characterization of factor VIII/von Willebrand factor concentrates using a modified method of von Willebrand factor multimer analysis. *Haemophilia.* 1998;4(Suppl 3):25–32.
43. Charlebois J, Rivard GE, St-Louis J. Management of acquired von Willebrand syndrome. *Transfus Apher Sci.* 2018;57(6):721–723.
44. Cushing M, Kawaguchi K, Friedman KD, Mark T. Factor VIII/von Willebrand factor concentrate therapy for ventricular assist device-associated acquired von Willebrand disease. *Transfusion.* 2012;52(7):1535–1541.
45. Castaman G, Rodeghiero F, Di Bona E, Ruggeri M. Clinical effectiveness of desmopressin in a case of acquired von Willebrand's syndrome associated with benign monoclonal gammopathy. *Blut.* 1989;58(4):211–213.
46. Biguzzi E, Siboni SM, Peyvandi F. Acquired Von Willebrand syndrome and response to desmopressin. *Haemophilia.* 2018;24(1):e25–e28.
47. Mannucci PM, Bettega D, Cattaneo M. Patterns of development of tachyphylaxis in patients with haemophilia and von Willebrand disease after repeated doses of desmopressin (DDAVP). *Br J Haematol.* 1992; 82(1):87–93.
48. McCormack PL. Tranexamic acid: a review of its use in the treatment of hyperfibrinolysis. *Drugs.* 2012;72(5):585–617.
49. Juricek C, Kagan V, Ruedlinger H, Lee W. Use of long acting octreotide in an outpatient clinic reduces the rate of gastro-intestinal bleeding in continuous flow LVAD patients. *J Heart Lung Transplant.* 2016;35(4): S82–S83.
50. Federici AB, Stabile F, Castaman G, Canciani MT, Mannucci PM. Treatment of acquired von Willebrand syndrome in patients with monoclonal gammopathy of uncertain significance: comparison of three different therapeutic approaches. *Blood.* 1998;92(8):2707–2711.
51. Tiede A, Rand JH, Budde U, Ganser A, Federici AB. How I treat the acquired von Willebrand syndrome. *Blood.* 2011;117(25):6777–6785.

## 34

# Gastrointestinal Bleeding in Patients with Left Ventricular Assist Devices

SHIVTEJ KAUSHAL AND NUNZIO GAGLIANELLO

## Introduction

**N**ewer-generation, continuous-flow left ventricular assist devices (CF-LVADs) offer multiple advantages over the older, pulsatile left ventricular assist devices (PF-LVADs). Continuous-flow LVADs are smaller and less prone to malfunction than are their pulsatile counterparts.<sup>1</sup> However, the rate of gastrointestinal bleeding (GIB) in CF-LVADs is two to four times higher than the GIB rate in PF-LVADs. Gastrointestinal bleeding in patients with these devices is a common complication with high morbidity, even if not associated increased mortality.<sup>2</sup> In the first 3 months after LVAD implantation, surgical bleeding is the major cause of bleeding. However, after 3 months, GIB is the major cause.<sup>3</sup> Concerns for device thrombosis (particularly in axial-flow devices) mean that most patients with CF-LVADs require anticoagulation with an INR (international normalized ratio) in the range of 2 to 3, as well as an antiplatelet agent, usually aspirin at a daily oral dose of between 81 and 325 mg.

## The Incidence of Gastrointestinal Bleeding

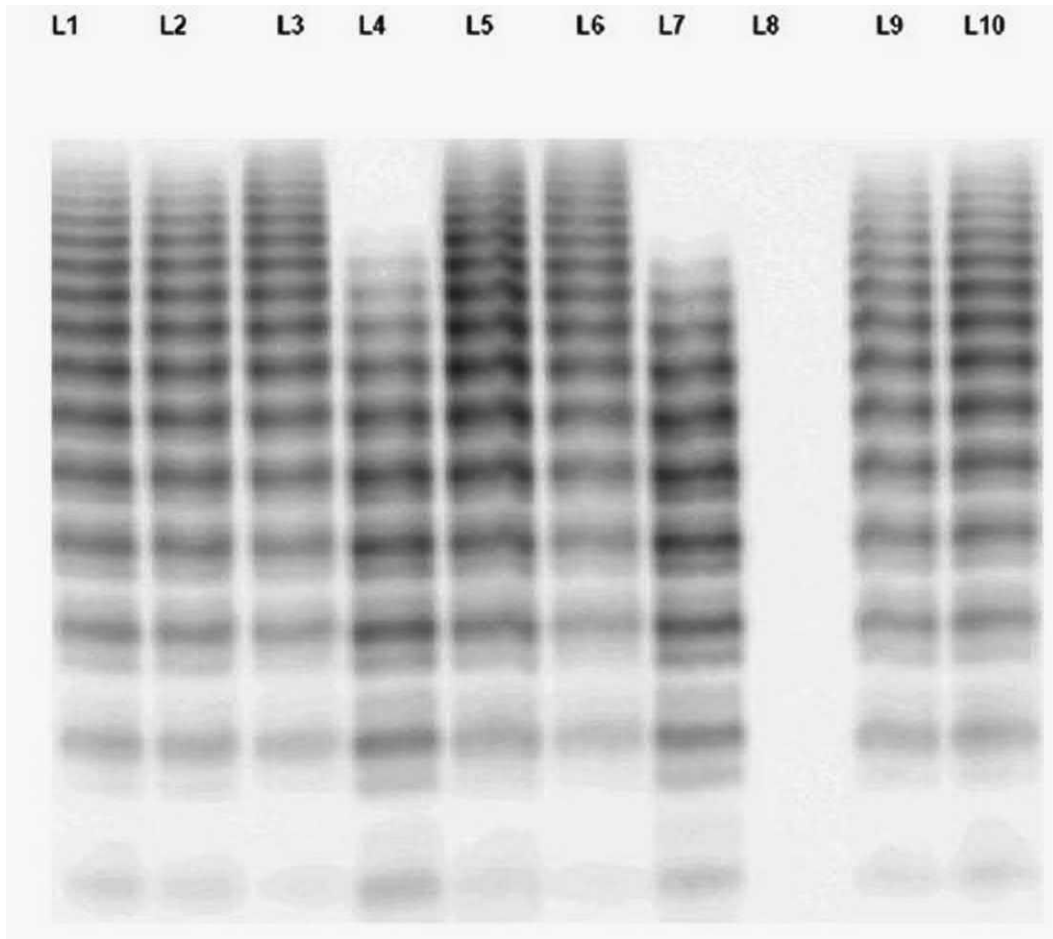
Although the risk of readmission is lower with CF-LVADs than with PF-LVADs (primarily because of the lower incidence of device malfunction), readmissions for GIB occur at a rate of nearly 10%.<sup>4</sup> The overall incidence of GIB in patients with CF-LVADs ranges from 18% to 40%, with recurrent GIB ranging from 30% to 40%.<sup>5</sup> The most common location for GIB is the upper GI tract, followed by the colon, obscure sources of bleeding, and the small bowel.<sup>5</sup> Most culprit bleeds occur as angiodysplasias, followed by peptic ulcer disease.<sup>5</sup>

Gastrointestinal bleeding is not only more prevalent in patients with LVADs, it is associated with a higher morbidity than that in the general public,<sup>6</sup> as evidenced by the need for more blood products, longer hospital stays, and multiple endoscopic procedures. In addition, nearly 80% of these patients are admitted to an intensive care unit.<sup>7</sup> Several studies have tried to identify the risk factors for this bleeding, but the only factor that consistently increases risk is older age.<sup>5</sup>

## The Pathophysiology of Gastrointestinal Bleeding

Gastrointestinal bleeding in patients with CF-LVADs appears to be multifactorial. Proposed mechanisms include the mechanics of continuous flow, abnormal platelet aggregation, and the need for therapeutic anticoagulation.<sup>8</sup>

Continuous-flow mechanics can lead to acquired von Willebrand syndrome and angiodysplasias. Von Willebrand factor is an integral protein in the plasma that allows adequate hemostasis. To be effective in recruiting platelets, the factor has to maintain its three-dimensional configuration in large multimers. Degradation into smaller fragments leads to the catabolism and eventual clearance of this protein.<sup>9</sup> The shear stress produced by continuous-flow devices cleaves these multimers and renders them ineffective. Several studies have documented the loss of these multimers into smaller fragments in patients with CF-LVADs (Figure 34.1). Some studies have even found that the lysis of these multimers depends on the speed of the CF-LVAD pump. Moreover, the loss of these large multimers is reversed after transplantation, when normal thrombotic mechanisms are restored.<sup>6</sup> Angiodysplasia formation is also believed to be a direct consequence of continuous-flow pumps. As in Heyde's syndrome in aortic stenosis, the



**Figure 34.1.** Gel electrophoresis of von Willenbrand factor multimers showing the effect on blood from healthy volunteers after it circulates through a left ventricular assist device. Lanes 4 and 7 show the effects of 2 hours of extracorporeal circulation on plasma from the same healthy volunteer. The size of the von Willenbrand factor multimers is markedly reduced, which increases the susceptibility to bleeding. Lanes 1, 2, 5, 9, and 10 represent commercial plasma controls. Lanes 3 and 6 represent plasma from the same healthy volunteer before extracorporeal circulation.

Reprinted from Jilma-Stohlawetz P et al., Acquired von Willebrand factor deficiency caused by LVAD is ADAMTS-13 and platelet dependent, *Thrombosis Research* 2016;137:196–201, Copyright (2016), with permission from Elsevier.<sup>12</sup>

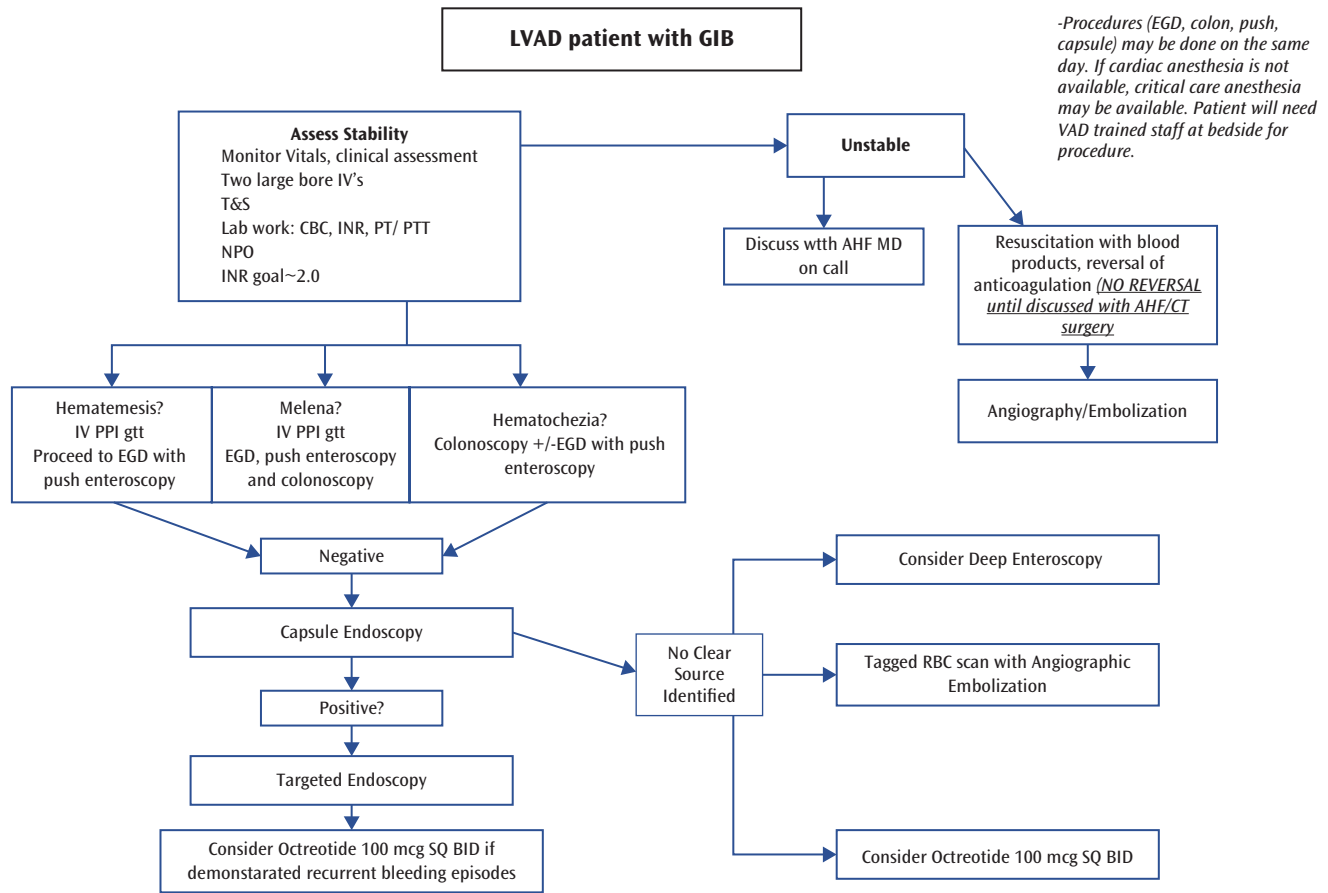
chronically narrow pulse pressure resulting from continuous flow alters the physiology of the endovasculture, which ultimately dilates smooth muscle. This dilatation leads to angioectasias and the resultant bleeding.<sup>6</sup>

Continuous flow also alters platelet aggregation. These alterations appear to be independent of aspirin use and are reversed after transplantation.<sup>7</sup>

Anticoagulation and antiplatelet therapy have long been considered to contribute to the increased incidence of GIB in LVAD recipients. However, patients who receive these therapies for other medical conditions, such as mechanical valves, have a much lower incidence of bleeding. This lower incidence is true, even for those on triple therapy with aspirin, warfarin, and a P2y12 inhibitor. Moreover, GI bleeds often occur in patients with CF-LVADs when their INR is either subtherapeutic or therapeutic.<sup>8</sup>

## Treating Gastrointestinal Bleeding

Treating GI bleeds in patients with LVADs follows the same basic principles as managing any patient with a GI bleed. The initial assessment involves hemodynamic monitoring, a focused physical exam, placing two large-bore intravenous lines, and obtaining basic blood values. However, given the complexity of these patients, a treatment algorithm incorporating a multidisciplinary team should be employed (Figure 34.2). The algorithm provides an organized method of diagnosis and management that improves clinical outcomes.<sup>7</sup> The initial objective of this approach should be to identify and eliminate the source of bleeding. If the patient has recurrent bleeding, new approaches can be employed, aspirin should be withheld, and the INR goal should be closer to 2.



**Figure 34.2.** The algorithm for treating gastrointestinal bleeding in patients with LVAD patients used at Froedtert Hospital and the Medical College of Wisconsin.

Endoscopy can localize the source of bleeding in up to 80% of patients. Upper endoscopy offers the highest yield, given that most of these lesions represent angiodysplasias with a predilection for the small bowel.<sup>5</sup> However, traditional esophagogastroduodenoscopy does not visualize most of the small bowel anatomy. For this reason, studies have found that visualizing the small bowel within 24 hours of hospitalization has been associated with fewer transfusions, procedures, and days of appropriate treatment.<sup>5</sup> Despite appropriate endoscopic therapies to stop bleeding, recurrence of bleeding has been reported in up to half of these patients.<sup>5</sup> In patients for whom the source of bleeding is not identified, video capsule endoscopy can be used.<sup>5</sup>

Patients with recurrent bleeding have been treated medically with drugs, including octreotide, danazol, and thalidomide. Octreotide is a somatostatin analogue reported to be effective in case reports and case series.<sup>10</sup> The starting dose of 100 µg subcutaneously twice per day is increased to 20 mg intramuscular injections monthly.<sup>10</sup> Octreotide works by decreasing blood flow in the arteries supplying the small bowel and can reduce the

recurrence of bleeding. The drug is generally well tolerated, with side effects predominantly limited to nausea and vomiting.<sup>11</sup>

Danzol is another new agent that has been used in a small number of patients. A synthetic androgen and known coagulant, the drug has been reported to decrease bleeding time.<sup>11</sup> However, its use is limited by an increased incidence of thromboembolic events and hepatotoxicity.<sup>5</sup>

Finally, thalidomide has been effective in selected cases. Thalidomide can only be prescribed by certain practitioners, given the known risk of teratogenicity.<sup>5</sup> This medication works directly on the vascular growth factors to inhibit angiogenesis.<sup>11</sup> The typical dose is 50 mg twice daily. Its use is mainly limited by an increased risk of thrombosis and peripheral neuropathy.<sup>5</sup>

Although the medications noted in the preceding have reduced bleeding and the need for transfusions in some institutions, the data are primarily from case reports and case series. Their efficacy has not been tested in randomized clinical trials.



## Conclusion

Gastrointestinal bleeding often complicates CF-LVAD therapy. Although this complication does not typically increase mortality, its associated morbidity can be substantial, leading to recurrent hospitalizations, increased use of resources, and a higher risk of subsequent thrombotic complications, particularly pump thrombosis, if antiplatelets and anticoagulants are de-escalated. New therapies, particularly octreotide, show promise in reducing the recurrence of GIB in cases with persistent bleeding problems.

## REFERENCES

1. Cheng A, Williamitis CA, Slaughter MS. Comparison of continuous-flow and pulsatile-flow left ventricular assist devices: is there an advantage to pulsatility? *Ann Cardiothorac Surg.* 2014;3(6):573–581. doi:10.3978/j.issn.2225-319X.2014.08.24.
2. Crow S, John R, Boyle A, et al. Gastrointestinal bleeding rates in recipients of nonpulsatile and pulsatile left ventricular assist devices. *J Thorac Cardiovasc Surg.* 2009;137(1):208–215.
3. Kushnir VM, Sharma S, Ewald GA, et al. Evaluation of GI bleeding after implantation of left ventricular assist devices. *Gastrointest Endosc.* 2012;75:973–979.
4. Harvey L, Holley CT, John R. Gastrointestinal bleed after left ventricular assist device implantation: incidence, management, and prevention. *Ann Cardiothorac Surg.* 2014;3(5):475–479.
5. Cushing K, Kushnir V. Gastrointestinal bleeding following LVAD placement from top to bottom. *Dig Dis Sci.* 2016;61(6):1440–1447.
6. Gurvits GE, Fradkov E. Bleeding with the artificial heart: gastrointestinal hemorrhage in CF-LVAD patients. *World J Gastroenterol.* 2017;23(22):3945–3953.
7. Marsano J, Desai J, Chang S, Chau M, Pochapin M, Gurvits GE. Characteristics of gastrointestinal bleeding after placement of continuous-flow left ventricular assist device: a case series. *Dig Dis Sci.* 2015;60(6):1859–1867.
8. Guha A, Eshelbrenner CL, Richards DM, Monsour HP. Gastrointestinal bleeding after continuous-flow left ventricular device implantation: review of pathophysiology and management. *Methodist DeBakey Cardiovasc J.* 2015;11(1):24–27.
9. Bharati KP, Prashanth UR. Von Willebrand disease: an overview. *Indian J Pharm Sci.* 2011;73(1):7–16.
10. Dang G, Grayburn R, Lamb G, Umpierrez De Reguero A, Gaglianella N. Octreotide for the management of gastrointestinal bleeding in a patient with a HeartWare left ventricular assist device. *Case Rep Cardiol.* 2014;2014:826453
11. Loyaga-Rendon RY, Jani M, Fermin D, McDermott JK, Vancamp D, Lee S. Prevention and treatment of thrombotic and hemorrhagic complications in patients supported by continuous-flow left ventricular assist devices. *Curr Heart Fail Rep.* 2017;14(6):465–477.
12. Jilma-Stohlawetz P, Quehenberger P, Schima H, et al. Acquired von Willebrand factor deficiency caused by LVAD is ADAMTS-13 and platelet dependent. *Thromb Res.* 2016;137:196–201.

## Introduction

**T**he past two decades have seen significant improvements in left ventricular assist device (LVAD) design. During this period, device design has moved from pulsatile to continuous-flow (CF) pumps, which are smaller and more durable. Simultaneously, implantation techniques have become less invasive. Overall survival and adverse events with contemporary CF devices continues to improve, with >80% survival at 1 year and 70% at 2 years. Despite this, more than 50% of patients have an adverse event in the first 6-months post-implant.<sup>1</sup> Infection, bleeding, stroke, and pump thrombosis continue to be unacceptably high. LVAD thrombosis occurs in up to 13% of all adults with CF LVADs, and differs from axial flow (4%–13%) and centrifugal flow (1%–4.5%) devices.<sup>2–4</sup> Once thrombosis has occurred, it can lead to hemolysis, renal failure, cerebrovascular accident (CVA), and device malfunction. Timely diagnosis and aggressive management, sometimes including pump exchange, are imperative to decrease these subsequent risks.

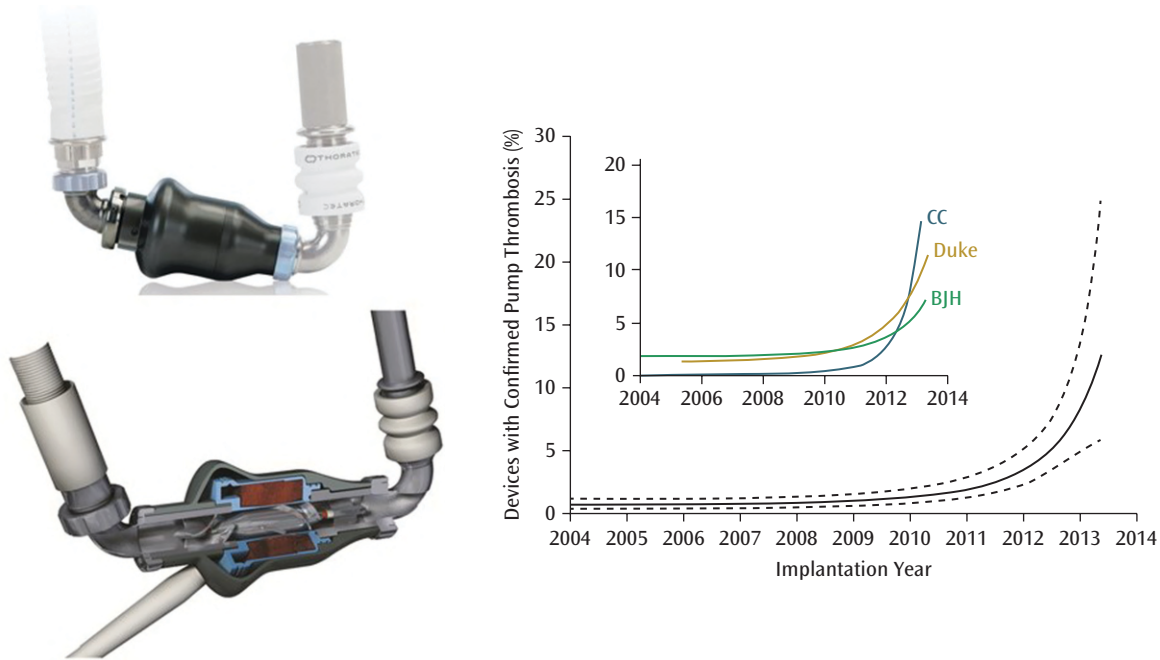
## Mechanisms of Pump Thrombosis

The cause of pump thrombosis is a complex interaction between the patient, pump design, and management strategy. Rudolf Virchow (1821–1902) is credited with describing three categories that contribute to thrombosis: hypercoagulability, stasis, and endothelial injury. The introduction of a prosthetic pump, with variable moving parts, blood contact with artificial surfaces, and differing blood pathway spaces complicate this relationship. Differences in rotor speed, shear stress, internal surface texture, and blood path clearance between the pump housing and the rotor all affect blood cell destruction (hemolysis).<sup>5,6</sup> Although the internal surfaces of all pumps have been designed with hemocompatibility in mind, even the use of inert titanium does not completely eliminate

fibrinogen adsorption and platelet activation, leading to adherence.<sup>7</sup> Continuous shear stress leads to platelet damage and activation, further activating the coagulation cascade.<sup>8,9</sup> Concurrent conditions that affect inflammation and activation, such as ongoing infection, may also affect increase thrombosis risk.

During preoperative patient evaluation, special attention should be paid to patient factors that may contribute to thrombosis. These include a history of or laboratory evidence of hypercoagulable state or contraindications to antithrombotic therapies post-implant. History of hypercoagulability is an important consideration and relative contraindication to LVAD placement. If this is present, alternate therapies, such as transplantation, should be considered. Heparin-induced thrombocytopenia (HIT) is relatively common in all cardiac surgery patients due to repeated heparin exposure and should be considered during patient evaluation.<sup>10</sup> This immune-mediated thrombosis may be more common in LVAD patients, and leads to an increase in risk for thrombo-embolic complications (transient ischemic attacks, CVA, and visceral or extremity thrombo-embolism).<sup>11,12</sup> Although HIT+ patients are higher risk, this is not necessarily a contraindication for surgery. The use of pre-, intra- and postoperative plasmapheresis and alternate postoperative anticoagulation (such as bivalirudin) can be safely done in LVAD placement and heart transplantation.<sup>13</sup>

Current CF LVADs are rotary pumps that propel blood in parallel (axial flow) or perpendicular (centrifugal flow) to the axis of the rotor. Clinical results from current CF LVAD trials reveal that pump design plays a significant role in rates of thrombosis. The HeartMate II (HMII, Abbott Medical, Abbott Park, IL) was the first CF LVAD approved for bridge to transplantation and destination therapy and has been implanted in almost 25,000 patients worldwide. The HMII is an axial flow device centered on a hydrodynamic bearing (Figure 35.1, left panel). The initial experience with this axial flow pump was quite good, with low rates of thrombosis. In fact, trials were being developed to



**Figure 35.1.** Left panel: Photograph and schematic drawing (at bottom) demonstrating the axial flow design of the HeartMate 2 LVAD.

Reproduced with permission of Abbott, © 2019. All rights reserved.

Right panel: From March 2011 the rate of confirmed early (3-month) HeartMate 2 pump thrombosis increased abruptly from 2.2% to 8.4% in January 2013 at three large volume centers.

From Starling RC et al., Unexpected abrupt increase in left ventricular assist device thrombosis, *New England Journal of Medicine* 2014;370:33–40. Copyright © (2014) Massachusetts Medical Society. Reprinted with permission from Massachusetts Medical Society.

test reduced rates of anticoagulation. Unfortunately, a relatively abrupt increase in thrombosis was noted at a few high-volume centers. From March 2011 to January 2013 the rate of confirmed early (3-month) pump thrombosis was noted to increase from 2.2% to 8.4% (Figure 35.1, right panel). This was associated with significant short-term morbidity and mortality. This observation has been confirmed in multiple studies where the rate of thrombosis for this device in patients undergoing short- or long-term support is between 6% and 15%.<sup>14–16</sup> The potential causes for this abrupt rise in thrombosis are not clear but are likely multifactorial, including changes in antithrombotic strategies and drift in patient selection from the pivotal trial for this device.

The HeartWare HVAD (Medtronic, Minneapolis, MN) is another commonly used LVAD with approval for both bridge to transplantation and destination therapy. This pump has a centrifugal design, is truly intra-pericardial and is smaller and more versatile than the HMII (Figure 35.2) Although it is still prone to thrombosis, the rate is lower, with significant thrombosis requiring LVAD exchange in 4.5% of patients (compared to 10.2% in HMII patients)<sup>3</sup> (Table 35.1). This pump has a single moving part and no bearings, so it is thought that HVAD “thrombosis” may be more likely due to ingestion of thrombus or debris rather than de novo

thrombosis within the pump. Unfortunately, the currently published literature does not describe the exact incidence rate of de novo thrombus vs. ingestion, but a pathologic analysis of all submitted pumps is ongoing.

The newest commercially available pump, the HeartMate 3 (HM3, Abbott Medical, Abbott Park, IL), was developed to improve upon the results of the HMII, with a special focus on hemocompatibility. This pump has wider passages for blood flow (approximately 10–20 times that of typical hydrodynamic bearings: 0.5 mm on the sides and 1.0 mm on the top and bottom), is fully magnetically levitated, and utilizes frictionless propulsion and intrinsic pulsation—all design changes intended to reduce shear stress and blood stasis (Figure 35.3). Recently, the 2-year results were published showing only three device exchanges (<1%), with no documented episodes of pump thrombosis<sup>4</sup> (Table 35.2). Although this is very encouraging, the HMII experience is evidence that thrombosis may yet continue to present challenges to the LVAD population.

The current generation of pumps are smaller and significantly easier to implant than their predecessors. Newer designs allow for greater versatility with respect to approaches to minimally invasive insertion and biventricular support. Despite these advances, meticulous surgical



**Figure 35.2.** The HeartWare HVAD, demonstrating its centrifugal flow design.

Reproduced with permission of Abbott, © 2019. All rights reserved.

technique may continue to play a significant role in reducing pump thrombosis. Removal of intraventricular thrombus and debris after left ventricular coring may significantly reduce the risk of early ingestion of thrombus/debris. This may pose different challenges with small pumps and minimally invasive techniques. Inflow cannula malposition/excessive angulation adversely affects the hemodynamic

performance of the pump and may further increase the risk of thrombosis.<sup>17,18</sup> This issue has been described in the HMII, where pump position and cannula angulation can change over time with weight gain or loss. Although there is no comparative data for the HM3 and HVAD, inflow cannulation angle likely has hemodynamic consequences and may affect thrombosis risk, even in the absence of gross malposition. Additionally, technical errors that lead to outflow graft stenosis may lead to turbulent flow with subsequent thrombosis.

## Presentation and Diagnosis

The variable onset of LVAD thrombosis due to different etiologies can make diagnosis difficult. Diagnosis is dependent upon patient history and physical exam, laboratory values, LVAD parameters, and multiple imaging modalities. It must be noted that many patients with subclinical thrombosis have near normal labs and studies, and, thus, a high index of suspicion must remain. Depending on the extent of thrombosis, patients can present along a spectrum from being asymptomatic with no change in their functional status to acute heart failure with cardiogenic shock. The patient's history should be reviewed for compliance with anticoagulation and introduction of any factors that could alter warfarin metabolism, such as dietary changes or concomitant infection. Physical exam should occur, with particular attention to auscultation adjacent to the VAD. Depending on the LVAD type and severity of the thrombus, the LVAD may emit a harsh, grinding noise characteristic of thrombosis. Examination of pump parameters may reveal decreased calculated flows, elevated pump power consumption, and decreased flow variation (pulsatility index for HeartMate devices and flow wave amplitude form for HVAD). A sudden increase in pump power may suggest ingestion of thrombus, rather than de novo formation, where gradual power increase can occur. If the pump is completely thrombosed, the power consumption may paradoxically decrease rather than increase, though this is less common in our experience.

One of the most frequent presentations is with dark urine (due to hemoglobinuria), or even frank hematuria, both from hemolysis. Hemolysis is due to the red blood cells passing through a device with thrombus formation on the rotor or bearing mechanism. If the thrombosis is significant enough to affect pump function, patients may have the signs and symptoms of heart failure or even shock. Admission to an LVAD center should be immediate, and escalation to an intensive care setting should occur if the patient has any signs or symptoms of instability.

The first step in laboratory assessment to diagnose thrombosis involves monitoring plasma levels of hemolysis, such as lactate dehydrogenase (LDH) and plasma-free hemoglobin. An increase in LDH to greater than 1,000

**Table 35.1 • Summary of Adverse Events Occurring Through 1 Year**

	Study Device (n = 308)		Control Device (n = 157)		p Value
	Patients with Events	Number of Events	Patients with Events	Number of Events	
Major bleeding	159 (51.6)	310	89 (56.7)	196	0.33
Cardiac arrhythmia	105 (34.1)	151	49 (31.2)	56	0.60
Hepatic dysfunction	12 (3.9)	12	6 (3.8)	6	>0.99
Hypertension	40 (13.0)	54	20 (12.7)	21	>0.99
Major infection	166 (53.9)	300	93 (59.2)	181	0.28
Driveline exit site infection	50 (16.2)	59	19 (12.1)	22	0.27
Device malfunction/failure	74 (24.0)	107	38 (24.2)	47	>0.99
Hemolysis	4 (1.3)	5	9 (5.7)	9	0.01
Stroke	52 (16.9)	75	23 (14.6)	25	0.60
Ischemic cerebrovascular event	40 (13.0)	58	12 (7.6)	14	0.09
Hemorrhagic cerebrovascular event	16 (5.2)	17	11 (7.0)	11	0.53
TIA	13 (4.2)	13	1 (0.6)	1	0.04
Renal dysfunction	32 (10.4)	35	23 (14.6)	25	0.22
Respiratory failure	61 (19.8)	77	31 (19.7)	37	>0.99
Right heart failure	109 (35.4)	116	60 (38.2)	65	0.61
Pump replacement	16 (5.2)	NA	18 (11.5)	NA	0.02
Exchange for pump thrombosis	14 (4.5)	NA	16 (10.2)	NA	0.03

Values are n (%). The p values compare the percentage of patients with events using the Fisher exact test.  
NA = not applicable; TIA = transient ischemic attack.

Reprinted from Milano CA et al, HVAD: the ENDURANCE supplemental trial, *JACC Heart Failure* 2018;6:792–802, Copyright (2018), with permission from Elsevier.

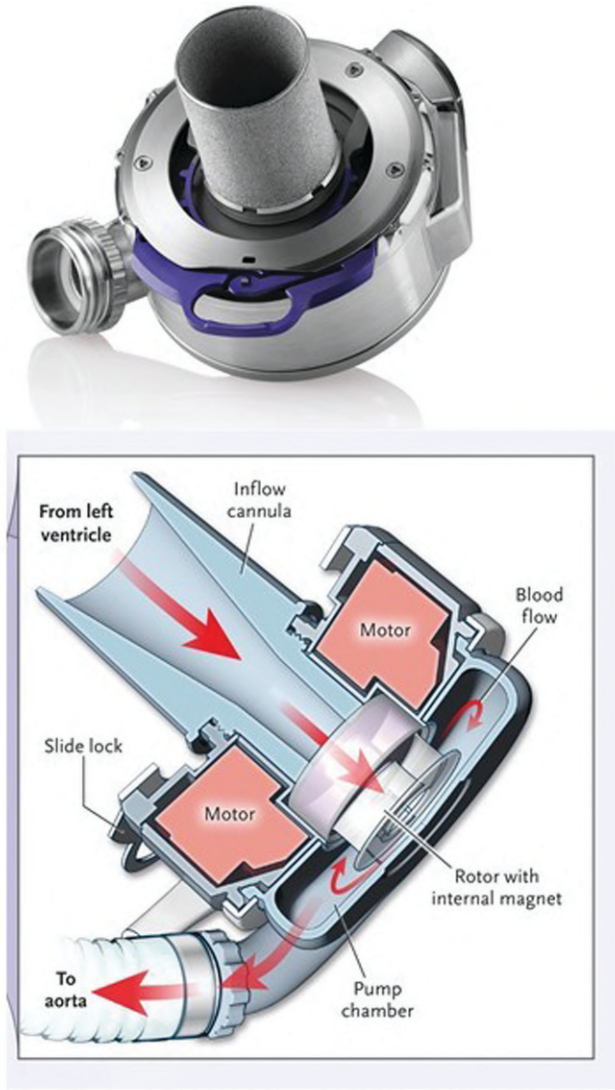
U/L, or 5 times the normal upper limit, demonstrates a sensitivity of 100% and a specificity of 92.5% for LVAD thrombosis.<sup>19</sup> It should be noted that these data are based mainly on HMII patients and that absolute levels for other devices may vary. Plasma-free hemoglobin results can be variable, and have been less frequently studied, but may be used as an adjunct to LDH. An assessment for adequate anticoagulation, typically by measuring international normalized ratio (INR) in patients taking chronic warfarin, can be helpful in both diagnosis and management of this condition.

All patients with suspected pump thrombosis should undergo transthoracic echocardiography (TTE). Although more invasive, transesophageal echocardiography (TEE) may be useful if visualization with TTE is inadequate.

Echocardiography may reveal signs of poor pump performance, including reduced LV unloading, frequent AV opening, and increased MR.<sup>20,21</sup> Although not diagnostic of thrombosis, it supports the diagnosis in the setting

of other suggestive findings. The integrity, location, and velocities of the inflow cannula and out flow graft should be evaluated. Doppler evaluation should reveal laminar flow for both inflow and outflow. Increased turbulence and increased inflow velocity greater than 2.5 m/s suggests inflow obstruction.<sup>22</sup> Additionally, reduced cannula diastolic flow and increased systolic/diastolic flow velocity ratio may suggest thrombosis.<sup>23</sup> Echocardiography can also be useful in identifying LV thrombus. The “Columbia ramp study” was designed, and has been adopted widely, for speed optimization and to analyze for pump malfunction.<sup>17</sup> This standardized approach to pump evaluation is critical—pump malfunction increases the urgency of treatment. It must be noted that the LVAD function of many patients with suspected thrombosis is within normal limits.

Due to location and acoustic artifact, echocardiography is not useful to visualize the inside of the inflow cannula or outflow graft. Gated computed tomography angiography



**Figure 35.3.** Photograph and schematic drawing demonstrating the centrifugal flow design of the HeartMate 3 LVAD.

Photo reproduced with permission of Abbott, © 2019. All rights reserved. Schematic reprinted from Mehra MR et al., Two-year outcomes with a magnetically levitated cardiac pump in heart failure, *New England Journal of Medicine* 2018;378:1386–1395. Copyright © (2018) Massachusetts Medical Society. Reprinted with permission from Massachusetts Medical Society.

(CTA) is a useful adjunct to visualize the LV, inflow cannula, and outflow graft, and is particularly helpful to identify anastomotic strictures or outflow graft compression.<sup>24</sup> Intravascular ultrasound (IVUS) has been used to evaluate the outflow graft and differentiate outflow graft thrombus from external compression from between the bend relief and graft.

## Treatment

The first goal of treatment for pump thrombosis is hemodynamic optimization and preservation of end-organ function. In patients with evidence of LVAD dysfunction, this frequently involves invasive hemodynamic monitoring and inotropic support. When patients present *in extremis*, additional mechanical circulatory support (such as peripheral veno-arterial ECMO) may be required for stabilization and time to evaluate the various treatment options. Historically, the definitive therapy for significant LVAD thrombosis was cardiac transplantation. Due to the severe shortage of suitable donor hearts, this is not a practical option. In some cases, device explantation or exclusion for recovery can be considered, but this is also a relatively uncommon occurrence. Under normal circumstances the treatment of thrombosis can be divided into medical (or pharmacologic) therapies and surgical replacement. Choice of treatment strategy should be dictated by the suspected cause of thrombosis, rate of onset, and the type of LVAD in place. Both strategies are less successful in emergent circumstances, underscoring the importance of early detection and treatment. Despite the historical scope of the problem, there is no consensus statement on optimal treatment.

A recent meta-analysis of 43 studies comparing surgical and medical treatments favored device exchange, with significantly higher initial success rate (81% versus 45%), 30-day survival (83% versus 55%), and decreased recurrence (12% versus 38%) when compared with medical treatments.<sup>25</sup> In the absence of a correctable anatomic issue, the standard surgical approach involves device exchange.<sup>26,27</sup> Nevertheless, the risk of perioperative complications (recurrent thrombosis 25%, infection, stroke, renal failure, and death 1-yr 40%) remain a concern.

Limited data from single institution studies suggests that both the approach and the choice of replacement pump may improve these results. Most of these studies address replacement of HMII pumps, which have a high risk for recurrent thrombosis (up to 31%).<sup>28–30</sup> Although the surgical approach does not appear to affect recurrent thrombosis, it does appear to have other important benefits, such as shorter operative times, lower rate of reoperation for bleeding, decreased blood transfusions, and possibly longer 1-year survival.<sup>31</sup>

Given the hemocompatible design features of the HeartMate 3, there is some thought that it should be the replacement pump of choice in patients who have had pump thrombosis requiring device exchange. Successful exchanges to an HM3 have been performed via sternotomy, subcostal, or combined thoracotomy and midline

**Table 35.2 • Major Adverse Events in the Per-Protocol Population\***

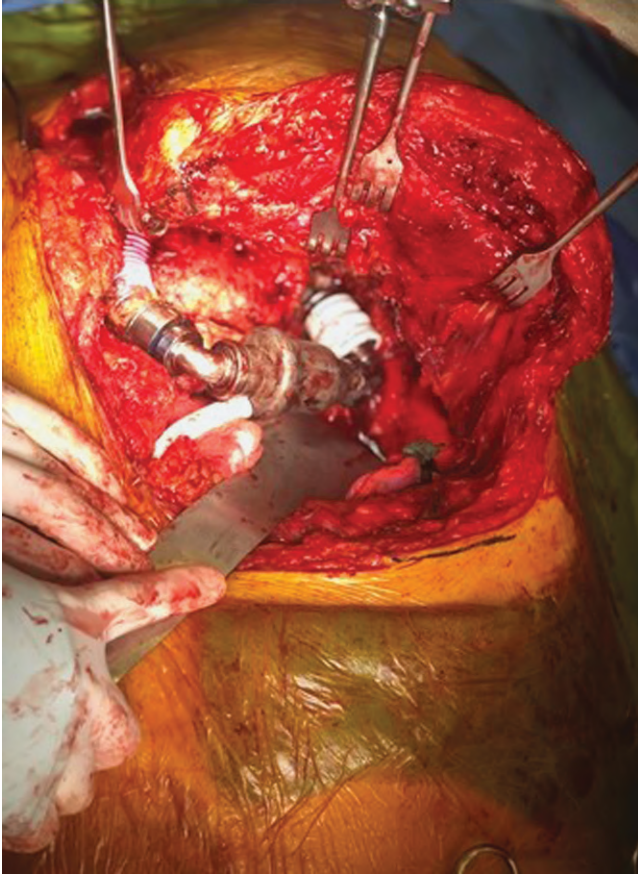
Event	Centrifugal Flow Pump Group (n = 189)		Axial Flow Pump Group (n = 172)		Hazard Ratio (95% CI)	p value <sup>†</sup>
	No. of Patients with Event (%)	No. of Events	No. of Patients with Event (%)	No. of Events		
Suspected or confirmed pump thrombosis	2 (1.1)	2	27 (15.7)	33	0.06 (0.01–0.26)	<0.001
Pump thrombosis resulting in reoperation or removal of device	0	0	21 (12.2)	25	NA	<0.001
Stroke						
Any stroke	19 (10.1)	22	33 (19.2)	43	0.47 (0.27–0.84)	0.02
Hemorrhagic stroke	8 (4.2)	8	16 (9.3)	17	0.42 (0.18–0.98)	0.06
Ischemic stroke	12 (6.3)	14	23 (13.4)	26	0.44 (0.22–0.88)	0.03
Disabling stroke	13 (6.9)	15	9 (5.2)	11	1.25 (.54–2.93)	0.66
Other neurologic event <sup>‡</sup>	22 (11.6)	25	15 (8.7)	16	1.27 (0.66–2.45)	0.39
Bleeding						
Any bleeding	81 (42.9)	187	90 (52.3)	206	0.71 (0.53–0.96)	0.07
Bleeding that led to surgery	23 (12.2)	29	30 (17.4)	34	0.66 (0.38–1.13)	0.18
Gastrointestinal bleeding	51 (27.0)	107	47 (27.3)	100	0.92 (0.62–1.37)	1.00
Sepsis	26 (13.8)	37	24 (14.0)	28	.95 (0.55–1.66)	1.00
LVAS driveline infection	45 (23.8)	68	34 (19.8)	59	1.15 (0.73–1.79)	0.37
Local infection not associated with LVAS	70 (37.0)	108	60 (34.9)	114	1.00 (0.71–1.42)	0.74
Right heart failure						
Any right heart failure	60 (31.7)	73	48 (27.9)	53	1.12 (0.77–1.64)	0.49
Right heart failure managed with RVAS	6 (3.2)	6	8 (4.7)	8	0.67 (0.23–1.94)	0.59
Cardiac arrhythmia						
Any cardiac arrhythmia	71 (17.6)	108	70 (40.7)	105	0.88 (0.63–1.23)	0.59
Ventricular arrhythmia	45 (23.8)	67	39 (22.7)	64	1.04 (0.67–1.59)	0.80
Supraventricular arrhythmia	33 (17.5)	40	36 (20.9)	37	0.79 (0.49–1.26)	0.42
Respiratory failure	45 (23.8)	61	39 (22.7)	46	1.04 (0.68–1.59)	0.80
Renal dysfunction	25 (13.2)	29	18 (10.5)	18	1.23 (0.67–2.25)	0.52
Hepatic dysfunction	8 (4.2)	8	7 (4.1)	7	0.98 (0.36–2.71)	1.00

\*The per-protocol population included only patients who received the assigned device implant. LVAS = left ventricular assist system; NA = not available; RVAS = right ventricular assist system.

<sup>†</sup>P values were calculated with the use of Fisher's exact test. An upper boundary of the 95% confidence interval of the hazard ratio of less than 1.0 was considered to indicate statistical significance.

<sup>‡</sup>Other neurologic events included transient ischemic attack and neurologic events other than stroke.

From Mehra MR et al., Two-year outcomes with a magnetically levitated cardiac pump in heart failure, *New England Journal of Medicine* 2018;378:1386–1395. Copyright © (2018) Massachusetts Medical Society. Reprinted with permission from Massachusetts Medical Society.



**Figure 35.4.** A long left subcostal incision provides excellent exposure of the inflow, outflow, and power cord of the HMII LVAD, avoiding a sternotomy for exchange to a HM3 LVAD.

approaches<sup>32–34</sup> (Figures 35.4, 35.5 and 35.6). Although the cumulative experience is small, to date no recurrent thrombosis events have been reported in patients who have been exchanged to a HM3.

The medical/pharmacologic treatment of LVAD thrombosis has been well described and can be divided into thrombolytic and non-thrombolytic/antiplatelet therapies. Initial reports, all smaller series, showed promising results.<sup>35–39</sup> Although less invasive, the obvious downside to systemic or catheter-directed lytic therapy is bleeding. In a recent meta-analysis, major bleeding occurring in 29% of patients receiving thrombolytics and 12% of those receiving non-thrombolytics. Interestingly, there appeared to be no difference when response to therapy was evaluated based on pump type (HMII versus HVAD).<sup>40</sup> Most of

these data come from case reports or small series; it is likely possible that larger studies of different treatment modalities (such as intra-cavitary administration versus systemic administration) and different pharmacologic agents would help identify the patients in which non-surgical therapy would be most successful.

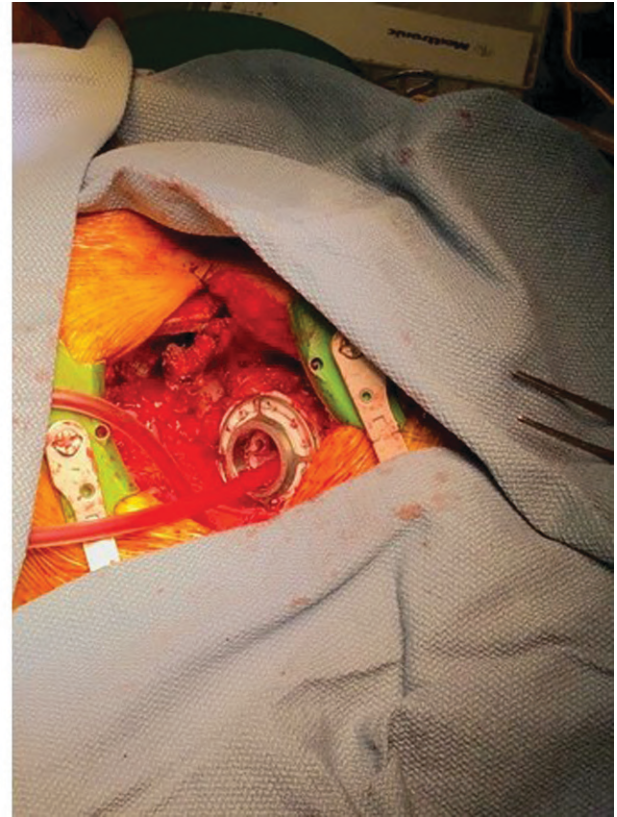
Despite the results from the previously mentioned meta-analysis, the pump type in question, and more specifically design modifications to future LVADs, may impact on the results of both surgical and thrombolytic treatments. When the results of surgery (transplantation or exchange) in the setting of HMII thrombosis are more closely evaluated, the outcomes are favorable with comparable 6-month survival between exchanged/transplanted patients and those who did not develop thrombosis.<sup>14</sup> In contrast, HMII patients treated with medical/pharmacologic therapies had significantly higher rates of thrombosis recurrence and major bleeding events.<sup>41,42</sup>

By comparison, studies in the HVAD population have demonstrated a 50% success rate in managing suspected thrombosis with aggressive antiplatelet/anticoagulant or thrombolytic therapy.<sup>43</sup> Additional research has shown benefits to using HVAD log files in the diagnosis of thrombosis, with some potential to differentiate between etiologies (ingestion versus de novo).<sup>44</sup> This careful examination can be successful in monitoring thrombolytic therapy success (Figure 35.6). These disparate data from two different engineering designs emphasizes the importance of manufacturing techniques in the etiology and treatment of thrombosis.

## Conclusion

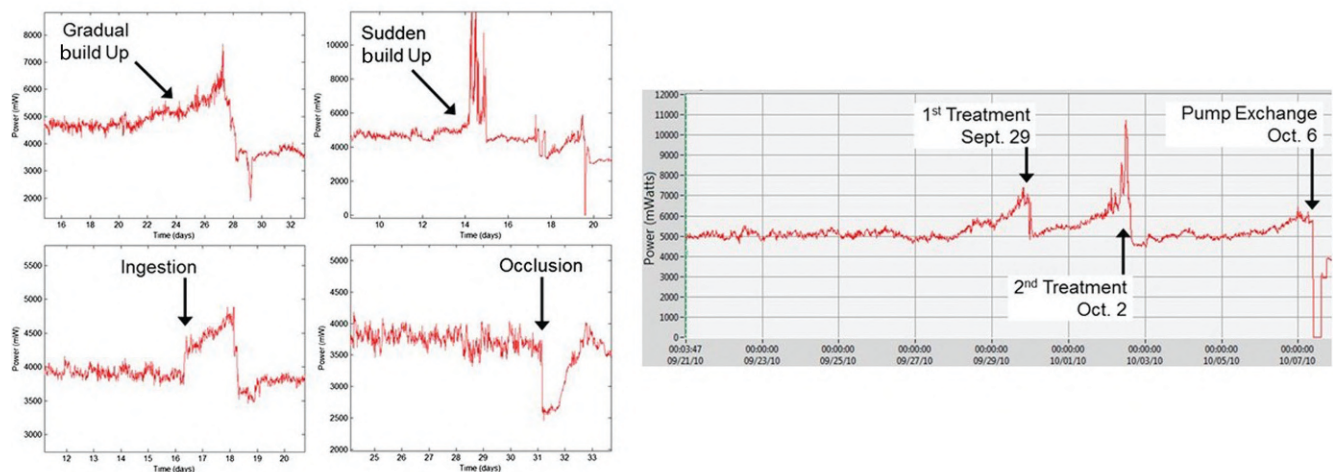
Although rates are decreasing with newer generation pumps, LVAD thrombosis continues to be a concern given the potential for significant downstream complications including death. Device exchange can be performed with acceptable morbidity and mortality, and research into thrombolytic treatment shows promise in select situations. Proper patient selection, good surgical technique, and careful patient management are foundational to achieve optimal results. Despite our increasing ability to diagnose and treat thrombosis, the improvements in device hemocompatibility have yielded the most significant reduction in complication rates. Gaining a better understanding of the interaction between patient, blood, and pump remains the primary challenge for continued improvement in clinical outcomes.





**Figure 35.5.** A left anterolateral thoracotomy and midline incision allows for good exposure of the inflow and outflow of the HMII for exchange to an HM3. The left panel shows the inflow exposure and the small size of the midline incision for outflow with graft exposure. The right panel shows the HM3 sewing ring in place.

Courtesy of Igor Gosev MD, Rochester, New York.



**Figure 35.6.** Left panel: Examination of HVAD waveforms can be useful in predicting the onset and possible causes of pump thrombosis: gradual buildup, sudden buildup, ingestion, and occlusion. Additionally, waveforms can be used to monitor lytic therapy for efficacy and recurrence of thrombosis. The right panel depicts a patient who was treated with thrombolytics, twice, with recurrence, and ultimately underwent LVAD exchange.

Reprinted from Jorde UP et al., Identification and management of pump thrombus in the heartware left ventricular assist device system: a novel approach using log file analysis, *JACC Heart Failure* 2015;3:849–856, Copyright (2015), with permission from Elsevier.

## REFERENCES

- Kirklin JK, Pagani FD, Kormos RL et al. Eighth INTERMACS report: special focus on framing impact of adverse events. *J Heart Lung Transplant*. 2017;36: 1080–1086.
- Slaughter MS, Rogers JG, Milano CA, et al. Advanced heart failure treated with continuous-flow left ventricular assist device. *N Engl J Med*. 2009;361:2241–2251.
- Milano CA, Rogers JG, Tatroles AJ et al. HVAD: the ENDURANCE supplemental trial. *J Am Coll Cardiol HF*. 2018;6:792–802.
- Mehra MR Goldstein DJ, Uriel N et al. Two-year outcomes with a magnetically levitated cardiac pump in heart failure. *N Engl J Med*. 2018;378:1386–1395
- Linneweber J, Dohmen PM, Kertzsch U, et al. The effect of surface roughness on activation of the coagulation system and platelet adhesion in rotary blood pumps. *Artif Organs*. 2007;31:345–351.
- Fraser KH, Zhang T, Taskin ME, et al. A quantitative comparison of mechanical blood damage parameters in rotary ventricular assist devices: shear stress, exposure time and hemolysis index. *J Bioech Eng*. 2012;134(8):081002.
- Mikhailovska LI, Santin M, Denyer SP, et al. Fibrinogen adsorption and platelet adhesion to metal and carbon coatings. *Thromb Haemost*. 2004;92:1032–1039
- Kawahito K, Mohara J, Misawa Y, et al. Platelet damage caused by the centrifugal pump: in vitro evaluation by measuring the release of alpha-granule packing proteins. *Artif Organs*. 1997;21:1105–1109.
- Tamari Y, Aledort L, Puszkin E, et al. Functional changes in platelets during extracorporeal circulation. *Ann Thorac Surg*. 1975;19:639–647.
- Warkentin TE, Greinacher A. Heparin-induced thrombocytopenia and cardiac surgery. *Ann Thorac Surg*. 2003;76:638–648.
- Schenk S, El-Banayosy A, Prohaska W, et al. Heparin-induced thrombocytopenia in patients receiving mechanical circulatory support. *J Thorac Cardiovasc Surg*. 2006;131:1373–1381.
- Schenk S, El-Banayosy A, Morshuis M, et al. IgG classification of anti-pf4/heparin antibodies to identify patients with heparin-induced thrombocytopenia during mechanical circulatory support. *J Thromb Haemost*. 2007;5(2):235–241.
- Schroder JN, Daneshmand MA, Villamizar NR et al. Heparin-induced thrombocytopenia in left ventricular assist device bridge-to-transplantation patients. *Ann Thorac Surg*. 2007;84(3):841–845.
- Starling RC, Moazami N, Silvestry SC et al. Unexpected abrupt increase in left ventricular assist device thrombosis. *N Engl J Med*. 2014;370(1):33–40.
- Stewart GC, Givertz MM, Mehra MR Pump thrombosis redux. *J Heart Lung Transplant*. 2015;34:1511–1514.
- Maltais S Kilic A, Nathan S et al. Prevention of HeartMate II pump thrombosis through clinical management: the PREVENT multi-center study. *J Heart Lung Transplant*. 2017;36:1–12.
- Uriel N, Morrison KA, Garan AR, et al. Development of a novel echocardiographic ramp test for speed optimization and diagnosis of device thrombosis in continuous-flow left ventricular assist devices: the Columbia ramp study. *J Am Coll Cardiol*. 2012;60:1764–1775.
- Estep JD, Stainback RF, Little SH, et al. The role of echocardiography and other imaging modalities in patients with left ventricular assist devices. *J Am Coll Cardiol Cardiovasc Imaging*. 2010;3:1049–1064.
- Catena E, Milazzo F, Montorsi E, et al. Left ventricular support by axial flow pump: the echocardiographic approach to device malfunction. *J Am Soc Echocardiogr*. 2005;18(12):1422.
- Scalia GM, McCarthy PM, Savage RM, et al. Clinical utility of echocardiography in the management of implantable ventricular assist devices. *J Am Soc Echocardiogr*. 2000;13(8):754–763.
- Fine NM, Topilsky Y, Oh JK, et al. Role of echocardiography in patients with intravascular hemolysis due to suspected continuous-flow LVAD thrombosis. *J Am Coll Cardiol Cardiovasc Imaging*. 2013;6(11):1129–1140.
- Acharya D, Singh S, Tallaj JA, et al. Use of gated cardiac computed tomography angiography in the assessment of left ventricular assist device dysfunction. *ASAIO J*. 2011;57(1):32–37.
- Imamura T, Nguyen A, Chung B, et al. Association of inflow cannula position with left ventricular unloading and clinical outcomes in patients with HeartMate II left ventricular assist device. *ASAIO J*. 2019 May/June; 65(4):331–335.
- Chivukula VK, Beckman JA, Prisco et al. Left ventricular assist device inflow cannula angle and thrombosis risk. *Circ Heart Fail*. 2018;11(4):e004325.
- Luc JGY, Tchanchaleishvili V, Phan K, et al. Medical therapy compared with surgical device exchange for left ventricular assist device thrombosis: a systematic review and meta-analysis. *ASAIO J*. 2018 May/June; 65(4):307–317.
- Moazami N, Milano CA, John R, et al. Pump replacement for left ventricular assist device failure can be done safely and is associated with low mortality. *Ann Thorac Surg*. 2013;95(2):500–505.
- Stulak JM, Cowger J, Haft JW, et al. Device exchange after primary left ventricular assist device implantation: indications and outcomes. *Ann Thorac Surg*. 2013;95(4):1262–1267.
- Levin AP, Uriel, N, Takayam, H, et al. Device exchange in HeartMate II recipients: long-term outcomes and risk of thrombosis recurrence. *ASAIO J*. 2015;61(4):144–149.
- Hanke JS, Dogan g, Wert L, et al. Left ventricular assist device exchange for the treatment of HeartMate II pump thrombosis. *J Thorac Dis*. 2018;10(5):S1728–S1736.
- Shaikh AF, Joseph SM, Lima B, et al. HeartMate II left ventricular assist device pump exchange: a single-institution experience. *Thorac Cardiovasc Surg*. 2017;65(5):410–414.
- Soleimani B, Stephenson ER, Price LC, et al. Clinical experience with sternotomy versus subcostal approach for exchange of HeartMate II left ventricular assist device. *Ann Thorac Surg*. 2015;100(5):1577–1580.
- Hanke JS, Haverich A, Schmitto JD. Exchange of a HeartMate II left ventricular assist device with a HeartMate 3 pump. *J Heart Lung Transplant*. 2016;35(7):944–946.
- Hanke JS, Haverich A, Schmitto JD. Exchange of a HeartWare HVAD to a HeartMate 3 left ventricular assist device. *J Heart Lung Transplant*. 2017;36(4): 480–481.
- Hanke, JS, Rojas SV, Dogan G, et al. First series of left ventricular assist device exchanges to HeartMate 3. *Eur J Cardiothorac Surg*. 2017; 51(5): 887–892.
- Kiernan MS, Pham DT, DeNofrio D, et al. Management of HeartWare left ventricular assist device thrombosis

- using intracavitary thrombolytics. *J Thorac Cardiovasc Surg.* 2011;142(3):712–714.
36. Kamouth A, John R, Eckman P. Successful treatment of early thrombosis of HeartWare left ventricular assist device with intraventricular thrombolytics. *Ann Thorac Surg.* 2012;94(1):281–283.
37. Thenappan T, Anderson AS, Jeevandham V, et al. Treatment of left ventricular assist device thrombosis with extended catheter-directed intraventricular thrombolytic therapy. *Circ Heart Fail.* 2013;6(3):e27–e29.
38. Al-Quthami AH, Jumean M, Kociol T, et al. Eptifibatid for the treatment of HeartMate II left ventricular assist device thrombosis. *Circ Heart Failure.* 2012;5(4):e68–e70.
39. Thomas MD, Wood C, Lovett M, et al. Successful treatment of rotary pump thrombosis with the glycoprotein IIb/IIIa inhibitor tirofiban. *J Heart Lung Transplant.* 2008;27(8):925–927.
40. Geetanjali D, Narendranath E, Vijayadershan M, et al. Medical management of pump thrombosis in patients with continuous flow left ventricular assist device: a systematic review and meta-analysis. *ASAIO J.* 2017;63(4):373–385.
41. Hasin T, Deo S, Maleszewski JJ, et al. The role of medical management for acute intravascular hemolysis in patients supported on axial flow LVAD. *ASAIO J.* 2014;60(1):9–14.
42. Schlendorf K, Patel CB, Gehrig T, et al. Thrombolytic therapy for thrombosis of continuous flow ventricular assist devices. *J Card Fail.* 2014;20(2):91–97.
43. Najjar SS, Slaughter MS, Pagani FD, et al. An analysis of pump thrombus events in patients in the HeartWare ADVANCE bridge to transplant and continued access protocol trial. *J Heart Lung Transplant.* 2014;33(1):23–34.
44. Jorde UP, Aaronson KD, Najjar SS, et al. Identification and management of pump thrombus in the HeartWare left ventricular assist device system: a novel approach using log file analysis. *JACC Heart Fail.* 2015;3(11):849–856.

# 36

## Infectious Complications of Mechanical Circulatory Support

JOYCE L. SANCHEZ, TIMOTHY J. BAURES, PATRICK B. MAZI,  
AND SAMUEL L. WINDHAM

### Introduction

**S**ince 2010, the number of patients with mechanical circulatory support (MCS) devices has increased, which has created a corresponding increase in the number of patients at risk for device-related infections.<sup>1</sup> The risks are inherent in any prolonged breach in the skin and constant foreign-body exposure to immune cells. Although the percentage of deaths caused by major infections has decreased, infections contribute to high rates of re-hospitalization and healthcare costs and cerebrovascular events and may delay transplantation.<sup>2-6</sup> Here, we describe the scope and microbiology of left-ventricular assist device (LVAD)-related infections. Data regarding LVAD-related infections can likely be extrapolated to other MCS devices.

### Host Factors of Infection

The incidence of fatal infections in patients receiving MCS decreased by about 6.5% between 2014 and 2017.<sup>1</sup> However, the overall incidence of infectious complications remains high. A constellation of factors predisposes patients to infections resulting from the interactions between a host and microbes within the “damage-response framework.” This framework evaluates host-pathogen interactions across the spectrum, from commensalism (the normal gut microbiome), to colonization (acquiring a potential pathogen as part of the normal microbiome), to disease (invasive infection with inflammatory signs and symptoms). An individual host’s susceptibility to invasive infectious disease results from the interactions of at least 11 identifiable factors: microbiome, inoculum, sex, temperature, environment, age, chance, history, immunity, nutrition, and genetics.<sup>7</sup>

Immune dysregulation begins well before the implantation of an MCS device. Evidence suggests that widespread immune activation occurs in the setting of decompensated heart failure with increased levels of the membrane attack complex (the end result of complement activation), as well as increased concentrations of interleukin-6, tumor necrosis factor- $\alpha$ , and interleukin-1.<sup>8,9</sup> Gene expression related to cellular immune response, antigen presentation, and T-cell activation-survival is down-regulated by 7 days after implantation. These changes appear to reverse, although not back to normal, by 6 months after implantation.<sup>10</sup> Both recent and historical data support the deposition of activated monocytes and T-cells on the LVAD surface, which can be susceptible to apoptosis with further stimulation, resulting in a relative T-cell-directed immune suppression.<sup>11</sup>

Beyond the effects of advanced heart failure and device-related immune suppression, comorbidities, such as advanced age, diabetes mellitus, and obesity, are common in patients with LVADs and can further impair the immune system. The aging immune system undergoes changes favoring overall immune suppression, including both innate (neutrophils, monocytes, macrophages) and adaptive (B-cells, T-cells) immunity.<sup>12</sup> With 46% of LVADs being placed in patients more than 60 years old,<sup>1</sup> and the increasing use of the devices as destination therapy, patients are often immune-suppressed at the time of implantation and for the duration of their life that they spend on the device.

Diabetes mellitus is an established risk factor for infections, a fact that extends to patients who receive MCS devices. In the Mayo Clinic series, about 40% of the patients had diabetes at the time of device implantation. Driveline and pump infections were more frequent in those with diabetes than in those without (16.8% vs. 14.3%). Despite this corresponding increase in device infections overall (HR 2.25 on adjusted analysis), this finding did not correlate

with hemoglobin A1c concentrations.<sup>13</sup> In addition, obesity is common in patients with LVADs, given its association with multiple risk factors for advanced heart failure. Device infections may be more common in patients with class II (moderate risk) obesity or greater, but obesity has not been clearly established as an independent risk factor in the absence of diabetes.<sup>14,15</sup>

Overall, the incidence of infection increases with the duration of MCS device use, immunologic deficiencies, and the number and duration of transcutaneous lines and/or drains.<sup>16</sup> The risk of infection does not differ by sex or race.<sup>17,18</sup>

## Diagnosis

Clinical signs and symptoms vary greatly among patients with VAD-related infections. The most thoroughly investigated study published since the International Society for Heart and Lung Transplantation (ISHLT) definitions were formulated found that when compared to local infections (driveline and pump-pocket infections), endovascular infections (infective endocarditis, bloodstream infections, VAD-related infection) presented earlier and were more often associated with fever, leukocytosis, and anemia.<sup>20</sup> A systemic inflammatory response was also present in substantially more patients with endovascular infections than with local infections (39% vs. 8%), but this inflammatory response was seen in a minority of patients.<sup>20</sup> Nearly three-quarters of localized infections presented with erythema, purulent drainage, and tenderness.<sup>20</sup>

The ISHLT working group recommends that all patients with suspected device-related infections have lab tests for white blood cell count, serial C-reactive protein, and erythrocyte sedimentation rate; microbiology exams for gram stain, potassium hydroxide, blood cultures, and bacterial and fungal cultures on sterile aspirate; and echocardiographic (transesophageal echocardiography if transthoracic echocardiography is negative) and chest radiographic images.<sup>19</sup> Basic imaging modalities are limited to aiding in the diagnosis of VAD infections (VADIs). Computed tomographic scans are hindered by artifacts from the VAD but can assist in identifying rim-enhancing fluid collections, soft-tissue stranding, and gas pockets, with the caveat that postoperative changes can mimic these findings.<sup>21</sup> Ultrasonography is sensitive but non-specific and remains the reference standard for diagnosing endocarditis. For bloodstream infections, transthoracic echocardiography is recommended, with transesophageal echocardiography follow-up (if transesophageal echocardiography is negative) when an endovascular source is suspected.

Although these basic imaging modalities are currently the tests of choice for suspected VADIs, several studies indicate that nuclear imaging may aid in diagnosing infections.<sup>22–25</sup> Fluorine 18-fluorodeoxyglucose (18F-FDG)

positron emission tomography/computed tomography (PET/CT) and Gallium-67 single-photon emission tomography/computed tomography (SPECT/CT) have shown promise in this regard. Both modalities localize the infection more specifically to guide tailored interventions.<sup>22–25</sup> In the largest study to date, among 30 patients who underwent two consecutive whole-body examinations, the sensitivity and specificity of 18F-FDG PET/CT for VADI were 100% and 80%, respectively.<sup>24</sup>

The function of biomarkers (C-reactive protein, erythrocyte sedimentation rate, and procalcitonin) in the diagnosis of VADIs is not well established. Immediately after VAD placement, the systemic inflammatory response from surgery is marked and exacerbated by cardiopulmonary bypass with an expected increase in all inflammatory marker concentrations, limiting specificity and the ability to differentiate an infection from postoperative inflammation. This difficulty was best demonstrated in a prospective study that took serial procalcitonin measurements of 25 patients before surgery and at days 1, 2, 14, and 30 after surgery. As expected, procalcitonin concentrations increased immediately after surgery and did not differ between patients with and without subsequent VADIs during the study.<sup>26</sup>

Biomarker kinetics have not been studied in VAD patients enough to support specific recommendations to guide their use. Proof-of-concept has been established for some new biomarkers, such as circulating microbial RNA and point-of-care imaging tools (real-time auto fluorescence) and may be available in the near future.<sup>27,28</sup>

## Microbiology Tests

As in other intravascular devices (central venous catheters, dialysis catheters, etc.), gram-positive organisms are more often recovered than gram-negative and fungal pathogens in VADIs (Table 36.1). Infections can occur at any site related to the VAD, with the pattern of involvement varying with time from implantation.<sup>29,30</sup> The mean time to onset of percutaneous infections that then place the patient at risk for deeper infections is 3 to 8 months after implantation.<sup>20,31,32</sup>

## Types of Infections

Before 2011, the definitions of infections associated with VADs were not standardized. As a result, how infections are described in different series varies widely. In 2011, the ISHLT Infectious Disease Working Group published definitions that are now the current standard. The definitions classify infections into (1) VAD-specific, (2) VAD-related, and (3) non-VAD infections.<sup>19</sup> Though clinically important infections, such as ventilator-associated pneumonia, postsurgical sternal infections, and urinary tract infections

**Table 36.1 • Causes of Infections Associated with Mechanical Circulatory Support Devices, by Site of Infection**

Infection Site*	Prevalence, %		
	Gram-positive	Gram-negative	Fungal
Bloodstream	<i>S. aureus</i> 19 to 47 MRSA 5.9 to 29 MSSA 5.9 to 16 <i>Enterococcus</i> spp 3 to 25 CoNS 0 to 85 <i>Corynebacterium</i> spp 0 to 9 <i>Bacillus</i> spp 2.9 to 8	<i>P. aeruginosa</i> 2 to 27 Enteric GNRs 4 to 6 <i>Stenotrophomonas</i> 0 to 10	<i>Candida</i> 6 to 30
Driveline	<i>S. aureus</i> 26 to 44 <i>Enterococcus</i> spp 0 to 11 CoNS 0 to 30 <i>Corynebacterium</i> 0 to 2	<i>P. aeruginosa</i> 14 to 28 Enteric GNRs 13 to 29 <i>Stenotrophomonas</i> 0 to 7	<i>Candida</i> 0 to 4
Pump pocket	<i>S. aureus</i> 6 to 25 <i>Enterococcus</i> spp 23 to 25 CoNS 29 to 50 <i>Corynebacterium</i> 0	<i>P. aeruginosa</i> 18 to 25 Enteric GNRs 12 to 25 <i>Stenotrophomonas</i> 0	<i>Candida</i> 0 to 10
Inflow/outflow/endocarditis	<i>S. aureus</i> 20 to 33 <i>Enterococcus</i> spp 0 CoNS 0 to 40 <i>Corynebacterium</i> 0 to 20	<i>P. aeruginosa</i> 20 to 33 Enteric GNRs 0 <i>Stenotrophomonas</i> 0	<i>Candida</i> 0 to 33

\*See references 4, 6, 30, 36, 43–45.

Abbreviations: MRSA = methicillin-resistant *Staphylococcus aureus*; MSSA = methicillin-susceptible *Staphylococcus aureus*; CoNS = coagulase negative *staphylococci*; GNR = gram-negative rod infections

often occur, this chapter addresses only VAD-specific and VAD-related infections.

The VAD-specific infections are defined as infections of the pump and pump pocket, the inflow cannula and outflow graft, anastomoses, and the driveline (superficial or deep; Figures 36.1–36.4). The ISHLT working group proposed diagnostic criteria for each potential site of infection based



**Figure 36.1.** Severe wound infection of the lateral chest wall uncovering the pump chamber and driveline.

Reprinted from Tjan TD et al., Wound complications after left ventricular assist device implantation, *Annals of Thoracic Surgery* 2000;70:538–541, Copyright (2000), with permission from Elsevier.

on the modified Duke criteria used to diagnose infectious endocarditis in patients without VADs.<sup>26</sup> Thus, infections can be categorized as proven, probable, possible, and absent with major and minor criteria at a VAD-specific site.<sup>19</sup>

Device-related infections include infective endocarditis and bloodstream infections. According to the ISHLT definitions, mediastinitis and sternal wound infections are also included in this category. However, because most of these infections are perioperative, they are more likely caused by standard risk factors associated with non-VAD procedures rather than by VAD implantation.

### Driveline Infections

The driveline exit site bridges the external environment and the deeper components of the device, making this interface the likely source of bacterial invasion when VADIs develop. Driveline infections (DLI) are the most common device infections in VAD recipients. These infections have an incidence of about 2% per month and a peak of 11% per month, 7.5 months after implant, which then returns to a baseline risk of 2% per month over the life of the device.<sup>29,33</sup> More than 85% of DLIs are bacterial, about 1% are fungal, and in the remaining 10%–15%, a pathogen is not recovered.<sup>31</sup> Across multiple studies in several countries, *Staphylococcus* species (*S. aureus* and numerous species in the coagulase-negative *Staphylococcus* group [CoNS]) are the most commonly recovered organisms, with



**Figure 36.2.** Severe median wound infection with visible outflow graft conduit.

Reprinted from Tjan TD et al., Wound complications after left ventricular assist device implantation, *Annals of Thoracic Surgery* 2000;70:538–541, Copyright (2000), with permission from Elsevier.<sup>46</sup>

*Staphylococcus aureus*, including methicillin-resistant *Staphylococcus aureus* (MRSA), dominant in many series.<sup>20,29,30,32</sup> Other gram-positive organisms, reflecting cutaneous flora, are seen in varying percentages of DLIs (Viridans-group *Streptococci*, *Corynebacterium* species,

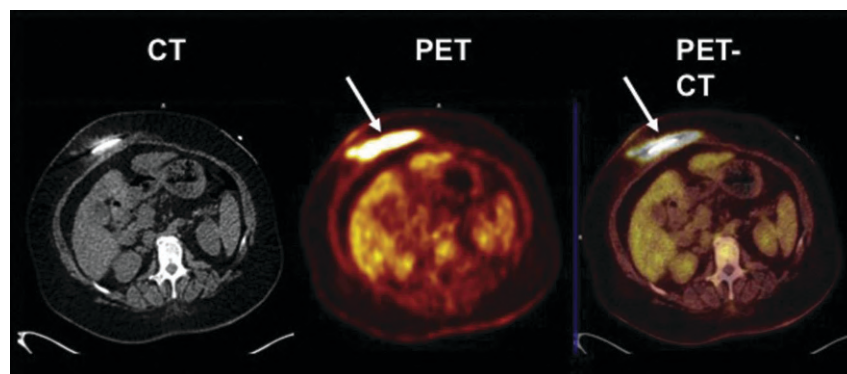
etc.). Although not typical components of the cutaneous microbiome, *Enterococcus faecalis* and *Enterococcus faecium* can be recovered from DLIs in varying percentages and likely represent a shift in microbiome that can occur with gram-negative gastrointestinal organisms. Gram-negative pathogens have been seen in a substantial number of cases of DLIs,<sup>30,32,34</sup> with *Pseudomonas aeruginosa* recovered as the initial pathogen in nearly 30% of DLIs and, increasingly, in patients with multiple DLIs (about 42%).<sup>34</sup> Other often-encountered gram-negative bacteria reflect repeated and prolonged hospital exposure and include *Escherichia coli*, *Klebsiella* species, *Serratia* species, *Enterobacter* species, and *Proteus* species. Most DLIs remain localized without extending to deeper tissues.<sup>34</sup> The cumulative incidence of DLI increases with time from implantation (7% at 1 year, 20% at 2 years, and 29% at 3 years after implantation).<sup>35</sup>

### Pump-Pocket Infections

Infections involving the pump pocket are the least often encountered LVAD-related infections and are evenly distributed from implantation through the life of the device.<sup>30</sup> One study reported an incidence of 15 driveline infections per 100 person-years of LVAD support, compared to an incidence of 2.3 in-pocket infections per 100 person-years over the same period.<sup>20</sup> *Staphylococci* and other gram-positive organisms predominate, with a shift toward more indolent CoNS and *Enterococci* and a similar gram-negative spectrum when compared with DLIs.

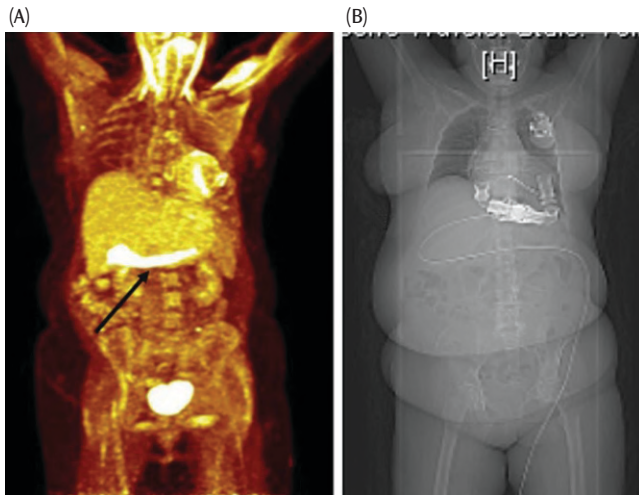
### Bloodstream and Endovascular Infections

Bloodstream infections are of particular concern in patients on MCS, given that the device is in contact with infected blood and at risk for becoming a persistent source of recurrent infections. Although the driveline exit site is



**Figure 36.3.** Three visualizations are shown of a deep driveline infection (arrow): (left) computed tomography (CT), (middle) positron emission tomography (PET), and (right) fusion PET/CT.

Reprinted from Dell'Aquila AM et al., Contributory role of fluorine 18-fluorodeoxyglucose positron emission tomography/computed tomography in the diagnosis and clinical management of infections in patients supported with a continuous-flow left ventricular assist device, *Annals of Thoracic Surgery* 2016;101:87–94, Copyright (2016), with permission from Elsevier.<sup>47</sup>



**Figure 36.4.** Frontal views of after a patient after receiving a left ventricular assist device acquired with (A) positron emission tomography and (B) computed tomography scans. The deep driveline infection (arrow) is localized at the right site of abdomen, whereas the piercing site of driveline is on the left site.

Reprinted from Dell'Aquila AM et al., Contributory role of fluorine 18-fluorodeoxyglucose positron emission tomography/computed tomography in the diagnosis and clinical management of infections in patients supported with a continuous-flow left ventricular assist device, *Annals of Thoracic Surgery* 2016;101:87–94, Copyright (2016), with permission from Elsevier.

often the primary site of infection, the urinary tract, respiratory tract, skin, and other intravascular devices may also precipitate these infections. Across several studies, the incidence of bloodstream infections ranges between 14%

and 30%, with about half of cases attributed to the LVAD.<sup>3–6,20,35</sup> Several groups have described an increased risk of stroke in patients with documented bloodstream infections, particularly in cases of persistent infections. The spectrum of pathogens favors gram-positive bacteria, with *S. aureus* being the most common, followed by CoNS species. *Pseudomonas aeruginosa* is the most common gram-negative pathogen, followed by gastrointestinal pathogens and less commonly by *Acinetobacter*, *Stenotrophomonas*, and other organisms. *Candida* species make up the fungal causes in a minority of cases.<sup>36</sup> *Staphylococcus aureus* and *Pseudomonas* are common causes of persistent bloodstream infections, a finding consistent with their predilection for forming biofilms on prosthetic materials.<sup>4</sup>

## Treatment

Treatment guidelines are lacking for VADIs but are likely to be based on standardized definitions of infections at different sites. Empiric therapy should be directed at the most common bacterial pathogens at the first suspicion of infection and should include an agent with activity against *S. aureus* (including MRSA) and *Pseudomonas aeruginosa* (Table 36.2). Before starting antimicrobials, cultures should be taken from all accessible sites of potential infection. Blood cultures should be drawn routinely because the duration and route of therapy will differ if bacteremia is present. Initial therapy should include intravenous agents unless the suspected infection is limited to the superficial driveline exit site and no systemic signs or symptoms are present. Empiric antifungal therapy is generally not warranted, given the low prevalence of fungal infections, but should be considered with a delayed response to antibacterial medications.

**Table 36.2 • Antibiotics for Treating the Most Common Causes of Infections Associated with Mechanical Circulatory Support Devices**

Route of Administration	<i>S. aureus</i> active MRSA <sup>a</sup> MSSA <sup>b</sup>	<i>Pseudomonas</i> Active	Yeast Active <sup>c</sup>
Intravenous	Vancomycin, <sup>a,b</sup> daptomycin, <sup>a,b</sup> linezolid, <sup>a,b</sup> ceftaroline, <sup>a,b</sup> oritavancin, <sup>a,b</sup> dalbavancin, <sup>a,b</sup> cefazolin, <sup>b</sup> nafcillin, oxacillin <sup>b</sup>	Piperacillin/tazobactam, cefepime, ceftazidime, meropenem, imipenem, ceftolozane/tazobactam, ceftazidime/avibactam, ciprofloxacin, levofloxacin, aminoglycosides, aztreonam	Fluconazole, voriconazole, posaconazole, echinocandins, amphotericin B
Oral	Linezolid, <sup>a,b</sup> trimethoprim/ sulfamethoxazole, <sup>a,b</sup> doxycycline, <sup>a,b</sup> minocycline, <sup>a,b</sup> , clindamycin <sup>a,b</sup>	ciprofloxacin, levofloxacin	Fluconazole, voriconazole, posaconazole, itraconazole

<sup>a</sup> MRSA, methicillin-resistant *Staphylococcus aureus*

<sup>b</sup> MSSA, methicillin-susceptible *Staphylococcus aureus*

<sup>c</sup> *Candida* species susceptibilities to azoles can be predicted by species in many circumstances.



Once an organism has been identified, therapy should be directed to maximize efficacy and minimize side effects. For methicillin-susceptible *S. aureus*, oxacillin-nafcillin or cefazolin should be administered intravenously. There are multiple oral options available for step-down therapy (Table 36.2). Vancomycin has long been used to treat MRSA infections, but it may contribute to kidney injury, particularly if given in combination with piperacillin-tazobactam.<sup>37</sup> Alternatives to vancomycin for treating MRSA include daptomycin, linezolid, or ceftaroline. Treatment for gram-negative pathogens, including *Pseudomonas aeruginosa*, should be directed by susceptibility testing. Antibacterial resistance, particularly among gram-negative pathogens, will likely become an increasing burden that complicates therapy in patients with LVAD infections.

Treatment directed to identified fungal pathogens depends on the species and site of the infection. Susceptibility to fluconazole can often be predicted from the *Candida* species, with *Candida albicans* remaining highly susceptible, but *Candida krusei* and *Candida glabrata* are expected to be resistant. Fluconazole has high oral bioavailability and can treat superficial infections at the driveline exit site. For deeper fungal infections, systemic antifungals in combination with surgical debridement will likely be necessary. Fungemia is particularly challenging because *Candida* species form biofilms on prosthetic material, often require treatment with the more toxic amphotericin B, as is traditionally administered for endocarditis. All invasive fungal infections require consultation with an infectious disease specialist.

### Duration of Treatment

Treatment duration of the index infection depends on site, depth, presence or absence of bacteremia, and the recovered or presumed infecting organism(s). Two weeks of therapy are appropriate for superficial infections with no evidence of deeper extension if initial therapy provides rapid improvement. Deeper infections should be treated for 4–6 weeks, particularly if debridement or source control is not feasible. Bacteremia-associated LVAD infections should be treated for 6 weeks or more and suppressive therapy considered if the recovered organism is prone to deposition or biofilm formation on prosthetic material.

### Chronic Suppression

The decision to employ chronic suppressive therapy after a defined treatment course is complicated and must consider the site of infection, the infecting pathogen, the ability to obtain source control (surgical intervention), the availability of an oral antimicrobial, drug interactions and side effects, and the anticipated duration of device support. The efficacy of suppression is determined by the site of infection and the pathogen, with a higher rate of relapse observed among biofilm-forming organisms (*S. aureus*,

*Pseudomonas*).<sup>20</sup> One study of 101 LVAD infections in 78 patients implemented suppression most often with gram-positive organisms. Of 28 patients treated with suppressive therapy, 8 (29%) relapsed, but of 45 who did receive suppressive therapy, only 5 (11%) relapsed.<sup>20</sup> A similar degree of relapse was seen in a smaller study in which 5 of 16 patients relapsed (after an average of 175 days of treatment).<sup>38</sup> Although further study is needed in this area, it seems likely that the efficacy of suppression will vary considerably by the infecting organism and the type of antimicrobial used.

## Prevention

### Perioperative Antibiotics

In 239 patients treated with continuous-flow LVADs, infection rates 90 days after implantation in those treated with a single drug did not differ from those treated with a multi-drug antimicrobial prophylaxis regimen based on ISHLT diagnostic criteria.<sup>39</sup> The patients receiving a single drug received cefazolin, or vancomycin, and had an infection rate of 1.5% (3 of 199). The multi-drug group received vancomycin, a gram-negative active agent, and fluconazole, with or without rifampin, and had an infection rate of 5% (2 of 40).<sup>39</sup> These findings suggest that a single-agent approach can limit excess exposure to antimicrobials with an efficacy equal to that of multi-drug regimens.<sup>39</sup>

Decisions regarding antimicrobial prophylaxis should also consider factors unique to each institution, such as antimicrobial resistance patterns in the identified infecting organisms.<sup>40–42</sup>

### Dressing Changes

Dressings should be changed using sterile supplies and technique. To minimize exposure and the potential for contamination of the driveline exit site, the dressing should be changed only once a day and then only by a caregiver or by the patient if trained to do so. Educating caregivers on optimal dressing change techniques decreased the infection rate from 0.18 events per person-year to 0.07 events per person-year and, in our practice, is crucial to the successful long-term maintenance of the device.<sup>18</sup> The use of dressing change kits with specific directions and containing all of the necessary components, the use of antibiotic impregnated dressings, and securing the driveline with an anchoring device all decrease the rate of DLIs.<sup>18</sup>

## Summary

As experience in managing patients with LVADs has evolved, the importance of infections in short- and long-term outcomes has become increasingly appreciated. Although our ability to successfully manage these

challenging clinical scenarios has improved greatly in recent years, the design of the currently available devices will likely continue to pose challenges until totally implantable devices are available.

## REFERENCES

- Interagency Registry for Mechanically Assisted Circulatory Support (Intermacs). *Quarterly Statistical Report 2017, Q3*. <https://www.uab.edu/medicine/intermacs/>. Accessed March 5, 2018.
- Akhter SA, Badami A, Murray M, et al. Hospital readmissions after continuous-flow left ventricular assist device implantation: incidence, causes, and cost analysis. *Ann Thorac Surg*. 2015;100:884–889.
- Smedira NG, Hoercher KJ, Lima B, et al. Unplanned hospital readmissions after HeartMateII implantation. *J Am Coll Cardiol HF*. 2013;1:3–39.
- Trachtenberg BH, Cordero-Reyes AM, Aldeiri M, et al. Persistent blood stream infection in patients supported with a continuous-flow left ventricular assist device is associated with an increased risk of cerebrovascular accidents. *J Cardiac Fail*. 2015;21:119–125.
- Aggarwal A, Gupta A, Kumar S, et al. Are blood stream infections associated with an increased risk of hemorrhagic stroke in patients with a left ventricular assist device? *ASAIO J*. 2012;58:509–513.
- Yoshioka D, Sakaniwa R, Toda K, et al. Relationship between bacteremia and hemorrhagic stroke in patients with continuous-flow left ventricular assist device. *Circ J*. 2018;82:448–456.
- Casadevall A, Pirofski L. What is a host? Attributes of individual susceptibility. *Infect Immun*. 2018;86e00636–86e00617.
- Clark DJ, Cleman MW, Pfau SE, et al. Serum complement activation in congestive heart failure. *Am Heart J*. 2001;141:684–690.
- Torre-Amione G. Immune activation in chronic heart failure. *Am J Cardiol*. 2005;95(suppl):3C–8C.
- Mitchell A, Guan W, Staggs R, et al. Identification of differentially expressed transcripts and pathways in blood one week and six months following implant of left ventricular assist devices. *PLoS ONE*. 2013;8:doi:10.1371.
- Itescu S, Ankersmit JH, Kocher AA, et al. Immunobiology of left ventricular assist devices. *Prog Cardiovasc Dis*. 2000;43:67–80.
- Globerson A, Effros RB. Ageing of lymphocytes and lymphocytes in the aged. *Immunol Today*. 2000;21:515–521.
- Asleh R, Briasoulis A, Schettle SD, et al. Impact of diabetes mellitus on outcomes in patients supported with left ventricular assist devices. *Circ Heart Fail*. 2017;10:1–12, e004213. doi:10.1161/CIRCHEARTFAILURE.117.004213.
- Yost G, Coyle L, Gallagher C, et al. The impact of extreme obesity on outcomes after left ventricular assist device implantation. *J Thorac Dis*. 2017;9:4441–4446.
- Clerkin KJ, Naka Y, Mancini DM, et al. The impact of obesity on patients bridged to transplantation with continuous-flow left ventricular assist devices. *J Am Coll Cardiol HF*. 2016;4:761–768.
- Kusne S, Staley L, Arabia F. Prevention and infection management in mechanical circulatory support device recipients. *Clin Infect Dis*. 2017;64(2):222–228.
- Blumer V, Mendirichaga R, Hernandez GA, et al. Sex-specific outcome disparities in patients receiving continuous-flow left ventricular assist devices: A systematic review and meta-analysis. *ASAIO J*. 2017. Jul–Aug;64(4):440–449. doi:10.1097/MAT.0000000000000695.
- Cagliostro B, Levin AP, Fried J, et al. Continuous-flow left ventricular assist devices and usefulness of a standardized strategy to reduce drive-line infection. *J Heart Lung Transplant*. 2016;35:108–114.
- Hannan MM, Husain S, Mather F, et al. Working formulation for the standardization of definitions of infections in patients using ventricular assist devices. *J Heart Lung Transplant*. 2011;30(4):375–384.
- Nienaber JJ, Kusne S, Riaz T, et al. Clinical manifestation and management of left ventricular assist device-associated infections. *Clin Infect Dis*. 2013;57:1438–1448.
- Shroff GS, Ocazionez D, et al. CT Imaging of complications associated with continuous-flow left ventricular assist devices (LVADs). *Semin Ultrasound CT MR*. 2017;38(6):616–628.
- Levy DT, Minamoto GY, Da Silva R, et al. Role of gallium SPECT-CT in the diagnosis of left ventricular assist device infections. *J Clin Imaging Sci*. 2015;61(1):e5–e10.
- Dell'Aquila AM, Mastrobuoni S, Alles S, et al. Contributory role of fluorine 18-fluorodeoxyglucose positron emission tomography/computed tomography in the diagnosis and clinical management of infections in patients supported with a continuous-flow left ventricular assist device. *Ann Thorac Surg*. 2016;101(1):87–94.
- Kanapinn P, Burchert W, Körperich H, et al. F-FDG PET/CT-imaging of left ventricular assist device infection: a retrospective quantitative intrapatient analysis. *J Nucl Cardiol*. 2019 Aug;26(4):1212–1221. doi:10.1007/s12350-017-1161-z. Epub 2018 Jan 16.
- Morris LC, Bradshaw ML. SPECT/CT assessment of infected intracardiac devices with and without infection. *J Nucl Med Technol*. 2016;44(2):94–95.
- Kettner J, Holec M, Franekova J, et al. Procalcitonin dynamics after long-term ventricular assist device implantation. *Heart Lung Circ*. 2017;26(6):599–603.
- Leung RKK, Wu YK. Circulating microbial RNA and health. *Sci Rep*. 2015;18;5:16814.
- Keenan, JB, Rajab TK, Armstrong DG, et al. Real-time autofluorescence imaging to diagnose LVAD driveline infections. *Ann Thorac Surg*. 2017;103(6):e493–e495.
- Koval CE, Rakita R, AST Infectious Disease Community of Practice. Ventricular assist device related infections and solid organ transplantation. *Am J Transplant*. 2013;13:348–354.
- Schaffer JM, Allen JG, Weiss ES, et al. Infectious complications after pulsatile-flow and continuous-flow left ventricular assist device implantation. *J Heart Lung Transplant*. 2011;30:164–174.
- Goldstein DJ, Nftel D, Holman W, et al. Continuous-flow devices and percutaneous site infections: clinical outcomes. *J Heart Lung Transplant*. 2012;31:1151–1157.
- Simeon S, Flecher E, Revest M, et al. Left ventricular assist device-related infections: a multicentric study. *Clin Microbiol Infect*. 2017;23:748–751.
- O'Horo JC, Abu Saleh OM, Stulak JM, et al. Left ventricular assist device infections: A systematic review.

- ASAIO J.* 2018 May/June;64(3):287–294. doi:10.1097/MAT.0000000000000684
34. Koval CE, Thuita L, Moazami N, et al. Evolution and impact of drive-line infection in a large cohort of continuous-flow ventricular assist device recipients. *J Heart Lung Transplant.* 2014;33:1164–1172.
  35. Stulak JM, Davis ME, Haglund N, et al. Adverse events in contemporary continuous-flow left ventricular assist devices: a multi-institutional comparison shows significant differences. *J Thorac Cardiovasc Surg.* 2014;151:177–189.
  36. Toda K, Yonemoto Y, Fujita T, et al. Risk analysis of bloodstream infection during long-term left ventricular assist device support. *Ann Thorac Surg.* 2012;94:1387–1393.
  37. Vavalkele B, Pogue JM, Karino S, et al. Risk of acute kidney injury in patients on concomitant vancomycin and piperacillin-tazobactam compared to those on vancomycin and cefepime. *Clin Infect Dis.* 2017;64:116–123.
  38. Jennings DL, Chopra A, Chambers R, et al. Clinical outcomes associated with chronic antimicrobial suppression therapy in patients with continuous-flow left ventricular assist devices. *Artif Organs.* 2014;10:875–879.
  39. Aburjania N, Ertmer BM, Farid S, et al. Single versus multidrug regimen for surgical infection prophylaxis in left ventricular assist device implantation. *ASAIO J.* 2018 Nov/Dec;64(6):735–740. doi:10.1097/MAT.0000000000000710
  40. Li JS, Sexton DJ, et al. Proposed modifications to the Duke criteria for the diagnosis of infective endocarditis. *Clin Infect Dis.* 2000;30(4):633–638.
  41. O'Horo JC, Abu Saleh OM, Stulak JM, et al. Left ventricular assist device infections: a systematic review. *ASAIO J.* 2018 May–June;64(3):287–294. doi:10.1097/MAT.0000000000000684.
  42. Meeteren JV, Maltais S, Dunlay SM, et al. A multi-institutional outcome analysis of patients undergoing left ventricular assist device implantation stratified by sex and race. *J Heart Lung Transplant.* 2017;36:64–70.
  43. Gordon RJ, Weinberg AD, Pagani FD, et al. Prospective, multicenter study of ventricular assist device infections. *Circulation.* 2013;127(6):691–702.
  44. Topkara VK, Kondareddy S, Malik F, et al. Infectious complications in patients with left ventricular assist device: etiology and outcomes in the continuous-flow era. *Ann Thorac Surg.* 2010;90(4):1270–1277.
  45. Simon D, Fischer S, Grossman A, et al. Left ventricular assist device-related infection: treatment and outcome. *Clin Infect Dis.* 2005;40(8):1108–1115.
  46. Tjan TD, Asfour B, Hammel D, Schmidt C, Scheld HH, Schmid C. Wound complications after left ventricular assist device implantation. *Ann Thorac Surg.* 2000;70(2):538–541.
  47. Dell'Aquila AM, Mastrobuoni S, Alles S, et al. Contributory role of fluorine 18-fluorodeoxyglucose positron emission tomography/computed tomography in the diagnosis and clinical management of infections in patients supported with a continuous-flow left ventricular assist device. *Ann Thorac Surg.* 2016;101(1):87–94; discussion 94.

## 37

# Cerebral Blood Flow and Stroke in Patients with Left Ventricular Assist Devices

MICHAEL EUGENE KIYATKIN AND JOSHUA ZEBADIAH WILLEY

## The Incidence of Device-Related Ischemic and Hemorrhagic Stroke

**W**idespread adoption of continuous-flow (CF) left ventricular assist devices (LVADs) is limited by neurological complications; specifically, by a higher incidence of stroke than that associated with optimal medical management or cardiac transplantation.<sup>1,2,3,4,5</sup> Older pulsatile LVADs were associated with a 1-year incidence of stroke of 20%–30%.<sup>6,14–18</sup> The 2-year incidence in second-generation CF devices, such as the HeartMate II (Abbott; Pleasanton, CA) and HeartWare VAD (Medtronic; Framingham, MA) is between 10% and 30%, with a mean onset of 6–9 months after implantation.<sup>7–11,19–27</sup> Longer follow-up studies have revealed a remarkably high 5-year incidence of stroke of up to 50%.<sup>24,28</sup> Importantly, stroke-related morbidity and mortality are high in these patients, especially after intracerebral hemorrhage.<sup>27,29–31</sup> In several case series, stroke is the leading cause of death in patients with CF-LVADs.<sup>12</sup> Even the latest third-generation CF devices, such as the HeartMate 3 (Abbott), continue to have an unacceptably high 1-year incidence of stroke that ranges between 8% and 18%.<sup>32–34</sup>

Interpreting the literature on stroke is challenging because of disparities in how strokes are categorized. For example, in a reanalysis of radiographic images from the HeartWare VAD clinical trials, a high proportion of primary intracerebral hemorrhage cases were re-adjudicated as secondary hemorrhagic conversion. In the INTERMACS (Interagency Registry for Mechanically Assisted Circulatory Support) reports, subdural hematoma, typically a traumatic non-stroke event, is included in the definition of stroke.<sup>12</sup> Moreover, the IMACS (International Society for Heart and

Lung Transplantation Registry for Mechanically Assisted Circulatory Support) registry includes in its definition of “neurological dysfunction” seizure and headache, in addition to stroke.<sup>13</sup>

## Causes of Device-Related Ischemic Stroke

### Pump Thrombosis

One probable cause of stroke is a thromboembolism secondary to pump thrombosis (PT), a dreaded complication of second-generation LVADs.<sup>12,13</sup> In one study, transcranial Doppler ultrasonography found about an 80% incidence of microemboli months after implantation.<sup>35</sup> Another study in first-generation devices found that most strokes occurred in the left hemisphere and a minority in the vertebrobasilar area.<sup>36</sup> This finding was believed to reflect a more direct path of cardiogenic thromboemboli, especially after the LVAD outflow cannula was directed toward the brachiocephalic trunk. Coincidentally, this finding was consistent with reports of right-hemispheric dominance of cardiogenic emboli after cardiac surgery.<sup>37–39</sup> As a result of this risk, a combined antiplatelet and anticoagulation strategy was implemented with great success.<sup>40</sup>

Surprisingly, PT is not necessarily associated with stroke. For example, LVAD power and elevated plasma lactate dehydrogenase concentrations have only weak associations with stroke.<sup>41</sup> Also, despite an unexpected, well-documented increase in PT several years ago, the rate of stroke did not increase.<sup>42</sup> Importantly, state-of-the-art, third-generation devices have better device-blood interfaces and lower shear forces with new rotor designs<sup>43</sup> that have

made the rates of PT negligible, yet their rate of stroke is nearly equal to that of earlier generations.<sup>32–34</sup> One hypothesis is that the emboli responsible for stroke are too small to cause PT.

### Hypercoagulable State

Another likely contributor to ischemic stroke is the generally pro-thrombotic state of patients with LVADs. Studies of first-generation LVADs found ongoing activation of both pro-coagulant and fibrinolytic pathways, despite normal coagulation laboratory values.<sup>44–46</sup> Additionally, infections, which are common in patients with LVADs, are well-known to alter the clotting cascade in favor of thrombosis.<sup>47</sup> Coincidentally, infection is also a strong risk factor for ischemic stroke in these patients.<sup>48–50</sup> As discussed in the following, loss of blood flow pulsatility has been hypothesized to activate the coagulation cascade through endothelial dysfunction,<sup>51</sup> as well as to promote thrombosis secondary to stagnant blood flow. Stagnant blood flow has been simulated in the carotid artery<sup>52</sup> and may occur in the aortic root.<sup>53</sup> However, thrombi are rarely detected by echocardiography in the aortic root, and setting the pump to allow the valve to open periodically rather than permanently closed does not appear to protect against ischemic stroke, including with the HeartWare VAD Lavare cycle or in the HeartMate 3 or Jarvik devices, which have built-in variable speeds to force the valve to open periodically.<sup>21</sup>

In addition to intrinsic hypercoagulability, subtherapeutic anticoagulation may also contribute to ischemic stroke.<sup>54</sup> For example, gastrointestinal bleeding is associated with subsequent ischemic stroke, perhaps because of undue caution in resuming anticoagulation.<sup>55</sup> However, patients may still have ischemic strokes, despite a therapeutic INR (international normalized ratio), and can be stroke-free, despite subtherapeutic anticoagulation. One explanation for this apparent discrepancy is that an optimal anti-thrombotic regimen has not been well defined because it depends on several factors, including genetic polymorphisms of the individual patient.<sup>56</sup> Nevertheless, a growing literature, including the recently completed PREVENT trial, continues to refine anticoagulation guidelines.<sup>57</sup>

### Large-Artery Atherosclerosis and Surgical Factors

Although atherosclerosis is common in patients with LVADs, and especially in older patients with LVADs, the prevalence of large-artery atherosclerotic stroke (e.g., symptomatic carotid or intracranial arterial stenosis) in these patients is much lower than that in the undifferentiated stroke patient. Similarly, small subcortical strokes (i.e., lacunes), which are primarily caused by hypertension, are rare in patients with LVADs.<sup>58</sup> Although infection is certainly a risk factor for ischemic stroke, septic emboli are not routinely found.<sup>25</sup> The relationship between

the surgical positioning of the LVAD inflow cannula and thrombogenic ventricular trabeculae is also important.<sup>59</sup>

## Causes of Device-Related Hemorrhagic Stroke

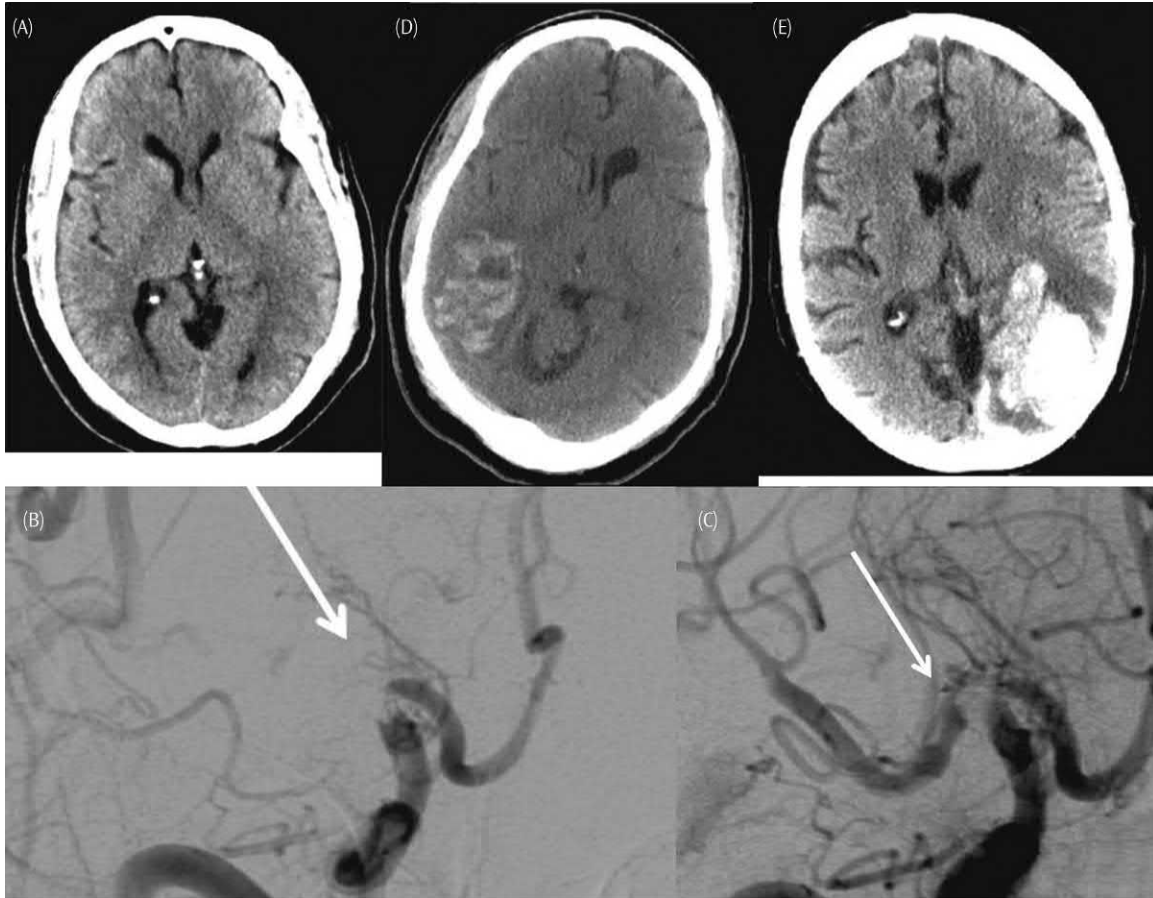
As in ischemic stroke, the cause of hemorrhagic stroke in LVAD patients is unclear and probably multifactorial. Supratherapeutic anticoagulation is always a possibility, given that the degree of coagulation and fibrinolysis are abnormal and difficult to estimate in these patients. For example, the rate of non-surgical bleeding in patients with LVADs is higher than that expected from anticoagulation alone.<sup>60</sup> The artificial materials and high shear forces in the pump, particularly in those with impellers, contribute to the nearly universal development of acquired von Willebrand disease. Possibly reflecting this relationship is the fact that gastrointestinal bleeding is more common at higher pump speeds.<sup>61,62</sup>

However, coagulopathy alone is insufficient to cause hemorrhagic stroke because the blood-brain barrier has to be disrupted.<sup>58</sup> Importantly, intracerebral hemorrhage in patients with LVADs often has a lobar distribution (Figure 37.1), which is typically caused by friable arterioles from the deposition of amyloid protein, similar to that seen in Alzheimer's disease (i.e., cerebral amyloid angiopathy).<sup>63</sup> To what degree continuous-flow pumps contribute to friability is unknown.

Other vascular pathologies thought to contribute to hemorrhagic stroke, particularly subarachnoid hemorrhage, include mycotic aneurysms and septic arteritis.<sup>64,65</sup> One interesting hypothesis from a study of gastrointestinal bleeding with CF pumps is that hypoperfusion from reduced pulse pressure leads to regional hypoxia, vascular dilation, and subsequent angiodysplasias.<sup>60</sup> However, similar pathological changes have not been detected by catheter cerebral angiography.<sup>25,66</sup>

## Low Pulsatility Blood Flow as a Cause of Stroke

The non-physiological, low-pulsatility flow produced by most MCS devices may damage end-organs and may be a major cause of adverse events, such as gastrointestinal bleeding and limited gains in exercise capacity.<sup>62,67–71</sup> Historically, most studies exploring this phenomenon employed completely pulseless circulation achieved with cardioplegia and cardiopulmonary bypass.<sup>72–76</sup> Although informative, these studies are not completely applicable to LVADs because patients with LVADs often have some degree of pulsatility from recovered heart function and variable pump preload.<sup>77</sup> However, how important this mild pulsatility is in causing stroke or, more generally, organ perfusion, is unknown.



**Figure 37.1.** (A) A non-contrast head CT image of a patient with a HeartMate II LVAD. No signs of infarct were present 1 hour after the onset of right hemiparesis, gaze preference, and hemineglect. (B) Digital subtraction angiography performed 2 hours after stroke onset revealed that the distal internal carotid artery was occluded at the origin of the middle cerebral artery (arrow). (C) Successful recanalization of the distal internal carotid artery after endovascular embolectomy (arrow). (D) A head CT image of the same patient 2 days later showed a parenchymal, lobar pattern hematoma (arrow) in the right temporal and parietal lobes with an associated mid-line shift consistent with hemorrhagic transformation. (E) A CT image of the head of a patient with a HeartWare LVAD and new-onset neurologic symptoms showed a primary parenchymal hematoma with probable cerebral amyloid angiopathy.

Adapted from Willey JZ et al, Cerebrovascular disease in the era of left ventricular assist devices with continuous flow: risk factors, diagnosis, and treatment, *Journal of Heart and Lung Transplantation* 2014;33:878–887, Copyright (2014), with permission from Elsevier.

From an arterial, macrocirculatory perspective, an ultrasound examination of the carotid artery in patients with LVADs shows decreased peak systolic velocity, elevated end diastolic velocity, unchanged mean velocity, and decreased pulsatility index (Figure 37.2).<sup>78–80</sup> Moreover, compliance and distensibility progressively decrease as the duration of MCS increases,<sup>81</sup> mimicking aging, atherosclerosis, and other cardiovascular diseases.<sup>82–86</sup> In samples of aortic tissue from patients with CF-LVADs who underwent transplantation, the elastic fibers in the arterial wall showed signs of degradation.<sup>87</sup> Interestingly, these changes in arterial stiffness persist, even after transplantation.<sup>88</sup>

Studies also suggest decreased regional and microcirculatory perfusion after starting CF circulation. For example,

compared with otherwise pulsatile circulation with equal pressure, CF is associated with increased arteriolar resistance and decreased tissue perfusion in renal,<sup>89</sup> gastric,<sup>90</sup> myocardial,<sup>75</sup> and cerebral vasculature.<sup>91</sup> These differences are intriguing but must be interpreted with caution because much of this work was done in non-LVAD CF systems using indirect measures of microcirculation.

As mentioned earlier, a major, direct consequence of CF is endothelial dysfunction. Studies of several in vitro and animal models have established the importance of endothelial mechanotransduction in normal vascular development, repair, and function.<sup>92–94</sup> Accordingly, biomarkers of systemic endothelial disruption have been detected in subjects with non-pulsatile flow.<sup>95–98</sup> These cellular changes have

been implicated in several CF-LVAD complications, including gastrointestinal bleeding.<sup>67</sup> Furthermore, morphological changes have been found in the endothelium of explanted aortic tissues,<sup>87</sup> and one small case series describes retinal vascular dysfunction.<sup>99</sup> Other markers of endothelial dysfunction, such as loss of flow-mediated vasodilation and decreased exercise tolerance despite normal cardiac output, have also been detected in patients with CF-LVADs.<sup>69–71,100</sup>

Although the evidence supporting an association between tissue hypoperfusion and non-pulsatile flow is strong, other evidence supports an association between hyperperfusion and the rapid restoration of cardiac output after LVAD implantation.<sup>101</sup> Cerebral hyperperfusion syndrome is a well-recognized and potentially devastating neurological complication of carotid endarterectomy.<sup>102,103</sup> A major contributing condition is persistently impaired cerebrovascular autoregulation in chronic low-flow states. A similar phenomenon occurs in LVAD recipients, with larger increases in cardiac output associated with more neurological complications soon after surgery.<sup>104</sup> Additionally, animal and human studies have suggested a model of tissue perfusion in which flow through capillary beds is dependent on diastolic time and pressure.<sup>105,106</sup> Given that diastolic times are longer and diastolic pressures are higher in patients with LVADs (Figure 37.2), these conditions may contribute to hyperperfusion and perhaps hemorrhagic stroke.

## Primary Prevention of Stroke in Patients with Left Ventricular Devices

### Preventing Pump Thrombosis

Several strategies have been explored to minimize the risk of PT, including anticoagulation and different pump designs, specifically more thrombogenic-resistant materials and motor design, and computer-controlled artificial pulsatility that better mimics native cardiac function.

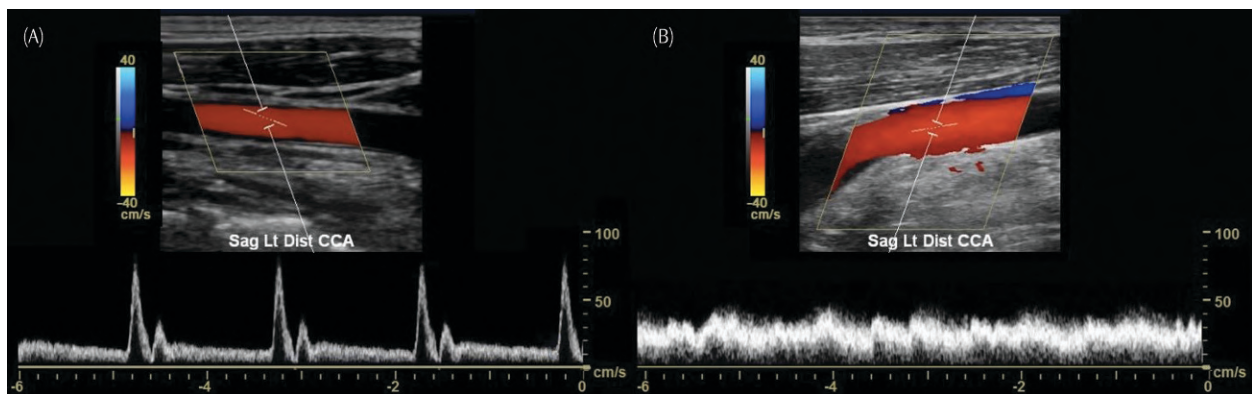
Combined, these strategies have greatly reduced the need for pump exchange or emergent transplant, as documented in the PREVENT and MOMENTUM 3 trials, among others.<sup>32–34,57</sup>

### Managing Hypertension

Hypertension and the risk of stroke are consistently associated with the HeartMate II and HeartWare devices.<sup>107,108</sup> Unfortunately, definitions of hypertension vary between studies. With respect to ischemic stroke, hypertension is thought to increase afterload on the myocardium and in the LVAD, in effect promoting stagnant blood flow and thrombus formation at both sites. The association between hypertension and intracerebral hemorrhage is well recognized in both undifferentiated stroke patients<sup>109</sup> and in patients with LVADs, especially those with HeartWare VAD devices, in which a mean arterial pressure greater than 90 mmHg is one of the strongest predictors of hemorrhagic stroke.<sup>110</sup> Understanding this relationship between high arterial pressure and stroke has stimulated improvements in blood pressure management protocols that have reduced the incidence of intracerebral hemorrhage.<sup>111</sup> However, several questions remain about ideal antihypertensive agents, optimal measures of blood pressure, and the exact pressures to be targeted.

## Diagnosis, Treatment, and Secondary Prevention of Stroke in Patients with Left Ventricular Devices

Overall, in patients with CF-LVADs, stroke is difficult to diagnose, especially when the stroke is small or occurs in the brainstem, given the limitations of computed tomography (CT) and the inability to use magnetic resonance imaging in patients with LVADs.



**Figure 37.2.** A representative carotid artery duplex study of the left distal common carotid artery (CCA) (A) 2 months before and (B) 9 months after implantation of the HeartMate II LVAD. Peak systolic velocity, pulsatility, and the parvus tardus waveform are decreased, and end diastolic velocity is increased while on LVAD.

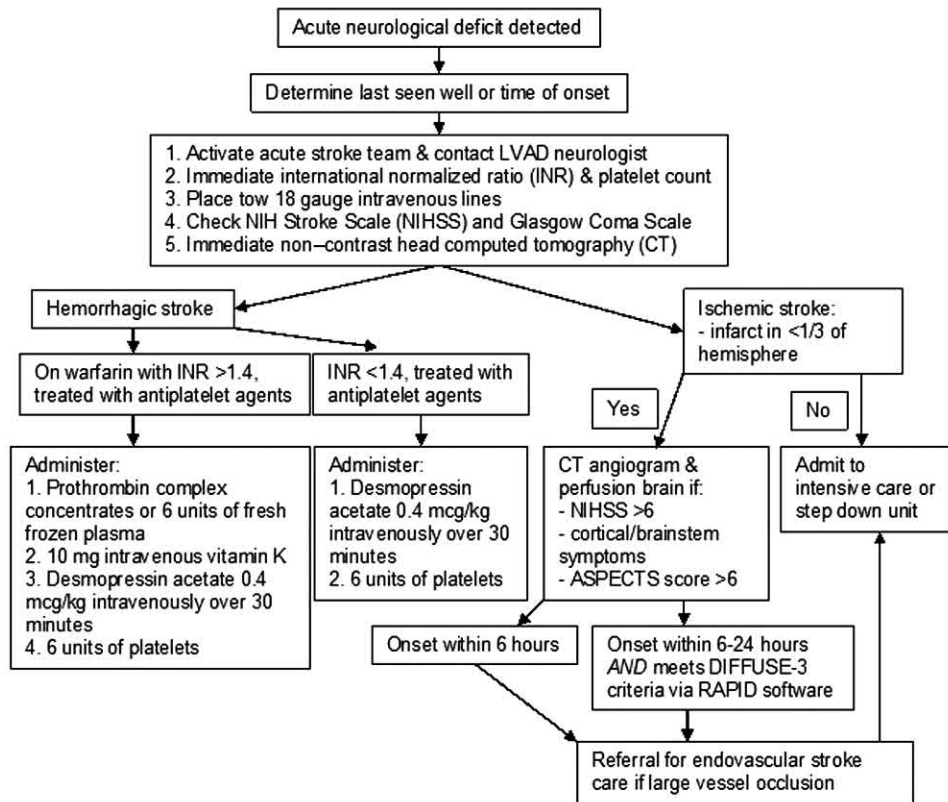
As with the undifferentiated stroke patient, the primary tools for diagnosing stroke in patients with LVADs remain history, physical examination, and CT. In diagnosing ischemic stroke, vessel imaging is mandatory to identify candidates for thrombectomy, particularly within 6 hours of symptom onset and up to 24 hours for select patients. A CT angiogram can be performed rapidly with a low risk of acute kidney injury and has the added benefit of allowing preoperative planning for thrombectomy (Figures 37.1 and 37.3). Carotid and transcranial Doppler ultrasonography can help diagnose large-vessel pathology, but both have poor sensitivity and specificity. Digital subtraction angiography can be considered in support of thrombectomy or on a case-by-case basis for diagnostic purposes. In diagnosing hemorrhagic stroke, CT is highly sensitive. The diagnostic yield of catheter angiography is low, except for isolated subarachnoid hemorrhage.

The presence of an LVAD poses unique challenges for treating acute ischemic stroke. Clinical trials of systemic thrombolysis with recombinant tissue plasminogen activator (0.9 mg/kg given within 3 hours of symptom onset) have specifically excluded patients with MCS, as well as those

with an INR greater than 1.7.<sup>112</sup> The risk of symptomatic intracerebral hemorrhage, among other hemorrhagic complications, is likely to be extremely high because of concurrent anticoagulation and innate platelet dysfunction. The risk of intracerebral hemorrhage is even higher in patients with endocarditis and the large hemispheric infarcts<sup>113</sup> that can occur in these patients.

Whether an LVAD pump thrombus, composed of mixed platelet and denatured protein components, would respond to thrombolysis is unclear.<sup>42</sup> For these reasons, we take a cautious approach and do not include systemic thrombolysis in our treatment algorithm. Instead, we use more targeted endovascular treatment (Figure 37.3). The duration of endovascular intervention continues to expand and is now up to 24 hours after stroke onset, based on selected imaging criteria.<sup>114</sup> We limit endovascular therapy to strokes involving less than one-third of a hemisphere because larger lesions are associated with a substantially increased risk of hemorrhage.<sup>115</sup>

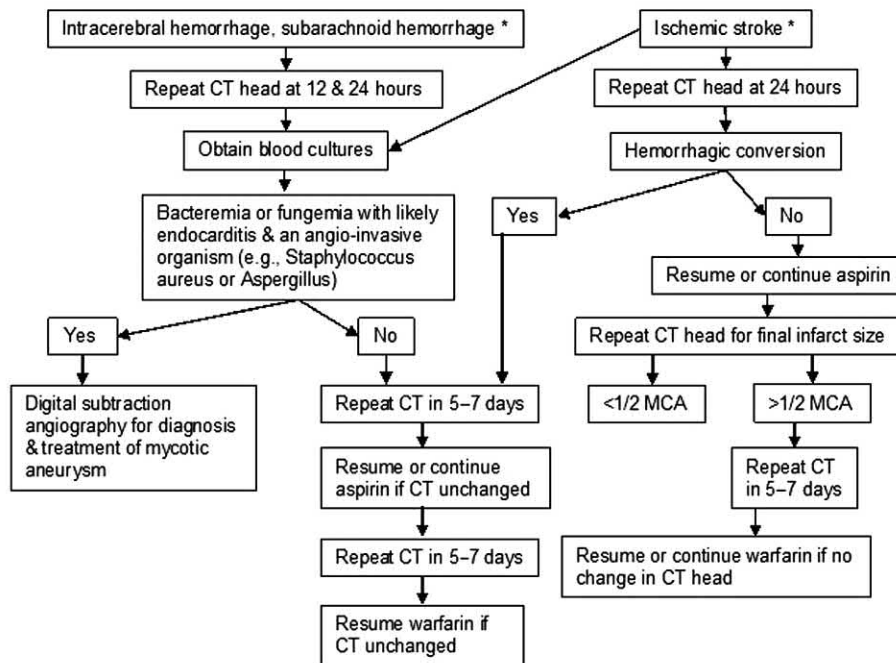
Treating hemorrhagic stroke is likewise considerably different in patients with LVADs. First, primary intracerebral hemorrhage must be distinguished from secondary



**Figure 37.3.** Diagnosis and treatment algorithm for stroke in patients with left ventricular assist devices from the Columbia University Irving Medical Center.

Reprinted from Willey JZ et al., Cerebrovascular disease in the era of left ventricular assist devices with continuous flow: risk factors, diagnosis, and treatment, *Journal of Heart and Lung Transplantation* 2014;33:878–887, Copyright (2014), with permission from Elsevier.





**Figure 37.4.** Secondary prevention and follow-up algorithm for stroke in patients with left ventricular assist devices from the Columbia University Irving Medical Center. Check lactate dehydrogenase concentrations daily.

Reprinted from Willey JZ et al., Cerebrovascular disease in the era of left ventricular assist devices with continuous flow: risk factors, diagnosis, and treatment, *Journal of Heart and Lung Transplantation* 2014;33:878–887, Copyright (2014), with permission from Elsevier.

hemorrhagic conversion because aggressive reversal of anticoagulation in the latter group may result in recurrent thrombosis.<sup>116</sup> Second, we generally reverse anticoagulation only when bleeding is active, when cerebral injury is marked, and we have deemed the risk to PT less than the risk of further neural extension.(Figure 37.3).

In keeping with the latest guidelines for managing intracerebral hemorrhage,<sup>117</sup> we reverse heparinization by discontinuing all heparin and administering protamine. Likewise, we transfuse platelets if blood loss is greater than 430 mL.<sup>117</sup> As noted earlier, we generally perform serial CT scans and monitor lactate dehydrogenase concentrations to evaluate hematoma stability and the risk of PT, respectfully (Figure 37.4).<sup>58</sup>

## Needed Research on Reducing Stroke in Patients with Left Ventricular Devices

Despite numerous advances in LVAD design and tremendous improvement in patient outcomes, the incidence of ischemic and hemorrhagic stroke continues to be unacceptably high. Key areas for research include continuing to improve both pump design and tailoring of anticoagulation for individual patients. Anticoagulation may be improved

with better pharmacogenomics and advanced coagulation testing (e.g., thromboelastography). On the other hand, these developments may be offset by the increased use of new oral anticoagulants.

Another important area of research is clarifying the mechanisms of tissue perfusion with CF and other forms of MCS. A better understanding of the mechanisms may lead to improvements in microcirculatory management, such as the ability to gradually restore pulsatile flow to reduce reperfusion injury while ensuring adequate circulatory flow and physiological macro- and microvascular shear forces. Improved understanding of these and other issues will become more pressing as the use of MCS inevitably expands, particularly for destination therapy.

## Disclosure

Dr. Willey has served as a consultant for Medtronic on causes of stroke in the HeartWare VAD device, and he serves on the clinical endpoint committee for ReliantHeart. Dr. Kiyatkin reports no disclosures.

## REFERENCES

1. Frazier OH, Gemmato C, Myers TJ, et al. Initial clinical experience with the HeartMate II axial-flow left ventricular assist device. *Tex Heart Inst J.* 2007;34(3):275–281.

2. Frazier OH, Delgado RM 3rd, Kar B, Patel V, Gregoric ID, Myers TJ. First clinical use of the redesigned HeartMate II left ventricular assist system in the United States: a case report. *Tex Heart Inst J*. 2004;31(2):157–159.
3. Griffith BP, Kormos RL, Borovetz HS, et al. HeartMate II left ventricular assist system: from concept to first clinical use. *Ann Thorac Surg*. 2001;71(3 Suppl):S116–S120; discussion S114–S116.
4. John R, Kamdar F, Liao K, Colvin-Adams M, Boyle A, Joyce L. Improved survival and decreasing incidence of adverse events with the HeartMate II left ventricular assist device as bridge-to-transplant therapy. *Ann Thorac Surg*. 2008;86(4):1227–1234; discussion 1234–1235.
5. John R, Naka Y, Smedira NG, et al. Continuous flow left ventricular assist device outcomes in commercial use compared with the prior clinical trial. *Ann Thorac Surg*. 2011;92(4):1406–1413; discussion 1413.
6. Slaughter MS, Rogers JG, Milano CA, et al. Advanced heart failure treated with continuous-flow left ventricular assist device. *N Engl J Med*. 2009;361(23):2241–2251.
7. Starling RC, Naka Y, Boyle AJ, et al. Results of the post-U.S. Food and Drug Administration-approval study with a continuous flow left ventricular assist device as a bridge to heart transplantation: a prospective study using the INTERMACS (Interagency Registry for Mechanically Assisted Circulatory Support). *J Am Coll Cardiol*. 2011;57(19):1890–1898.
8. Strueber M, Larbalestier R, Jansz P, et al. Results of the post-market Registry to Evaluate the HeartWare Left Ventricular Assist System (ReVOLVE). *J Heart Lung Transplant*. 2014;33(5):486–491.
9. Slaughter MS, Pagani FD, McGee EC, et al. HeartWare ventricular assist system for bridge to transplant: combined results of the bridge to transplant and continued access protocol trial. *J Heart Lung Transplant*. 2013;32(7):675–683.
10. Pagani FD, Miller LW, Russell SD, et al. Extended mechanical circulatory support with a continuous-flow rotary left ventricular assist device. *J Am Coll Cardiol*. 2009;54(4):312–321.
11. Miller LW, Pagani FD, Russell SD, et al. Use of a continuous-flow device in patients awaiting heart transplantation. *N Engl J Med*. 2007;357(9):885–896.
12. Kirklin JK, Naftel DC, Pagani FD, et al. Seventh INTERMACS annual report: 15,000 patients and counting. *J Heart Lung Transplant*. 2015;34(12):1495–1504.
13. Kirklin JK, Cantor R, Mohacsi P, et al. First annual IMACS report: a global International Society for Heart and Lung Transplantation Registry for Mechanical Circulatory Support. *J Heart Lung Transplant*. 2016;35(4):407–412.
14. Lazar RM, Shapiro PA, Jaski BE, et al. Neurological events during long-term mechanical circulatory support for heart failure: the Randomized Evaluation of Mechanical Assistance for the Treatment of Congestive Heart Failure (REMATCH) experience. *Circulation*. 2004;109(20):2423–2427.
15. Rose EA, Gelijns AC, Moskowitz AJ, et al. Long-term use of a left ventricular assist device for end-stage heart failure. *N Engl J Med*. 2001;345(20):1435–1443.
16. Holman WL, Kormos RL, Naftel DC, et al. Predictors of death and transplant in patients with a mechanical circulatory support device: a multi-institutional study. *J Heart Lung Transplant*. 2009;28(1):44–50.
17. Genovese EA, Dew MA, Teuteberg JJ, et al. Incidence and patterns of adverse event onset during the first 60 days after ventricular assist device implantation. *Ann Thorac Surg*. 2009;88(4):1162–1170.
18. Tsukui H, Abla A, Teuteberg JJ, et al. Cerebrovascular accidents in patients with a ventricular assist device. *J Thorac Cardiovasc Surg*. 2007;134(1):114–123.
19. Parikh NS, Cool J, Karas MG, Boehme AK, Kamel H. Stroke risk and mortality in patients with ventricular assist devices. *Stroke*. 2016;47(11):2702–2706.
20. Schmitto JD, Zimpfer D, Fiane AE, et al. Long-term support of patients receiving a left ventricular assist device for advanced heart failure: a follow-up analysis of the Registry to Evaluate the HeartWare Left Ventricular Assist System. *Eur J Cardiothorac Surg*. 2016;50(5):834–838.
21. Kohno H, Matsumiya G, Sawa Y, et al. The Jarvik 2000 left ventricular assist device as a bridge to transplantation: Japanese Registry for Mechanically Assisted Circulatory Support. *J Heart Lung Transplant*. 2018;37(1):71–78.
22. Rogers JG, Pagani FD, Tatoes AJ, et al. Intrapericardial left ventricular assist device for advanced heart failure. *N Engl J Med*. 2017;376(5):451–460.
23. Haglund NA, Davis ME, Tricarico NM, Keebler ME, Maltas S. Readmissions after continuous flow left ventricular assist device implantation: differences observed between two contemporary device types. *ASAIO J*. 2015;61(4):410–416.
24. Tuncer ON, Kemaloglu C, Erbasan O, Golbasi I, Turkey C, Bayezid O. Outcomes and readmissions after continuous flow left ventricular assist device: Heartmate II versus Heartware ventricular assist device. *Transplant Proc*. 2016;48(6):2157–2161.
25. Frontera JA, Starling R, Cho SM, et al. Risk factors, mortality, and timing of ischemic and hemorrhagic stroke with left ventricular assist devices. *J Heart Lung Transplant*. 2017;36(6):673–683.
26. Tsiouris A, Paone G, Nemeh HW, et al. Lessons learned from 150 continuous-flow left ventricular assist devices: a single institutional 7 year experience. *ASAIO J*. 2015;61(3):266–273.
27. Willey JZ, Gavalas MV, Trinh PN, et al. Outcomes after stroke complicating left ventricular assist device. *J Heart Lung Transplant*. 2016;35(8):1003–1009.
28. Stulak JM, Davis ME, Haglund N, et al. Adverse events in contemporary continuous-flow left ventricular assist devices: a multi-institutional comparison shows significant differences. *J Thorac Cardiovasc Surg*. 2016;151(1):177–189.
29. Harvey L, Holley C, Roy SS, et al. Stroke after left ventricular assist device implantation: outcomes in the continuous-flow era. *Ann Thorac Surg*. 2015;100(2):535–541.
30. Morgan JA, Brewer RJ, Nemeh HW, et al. Stroke while on long-term left ventricular assist device support: incidence, outcome, and predictors. *ASAIO J*. 2014;60(3):284–289.
31. Wilson TJ, Stetler WR, Jr., Al-Holou WN, Sullivan SE, Fletcher JJ. Management of intracranial hemorrhage in patients with left ventricular assist devices. *J Neurosurg*. 2013;118(5):1063–1068.
32. Mehra MR, Naka Y, Uriel N, et al. A fully magnetically levitated circulatory pump for advanced heart failure. *N Engl J Med*. 2017;376(5):440–450.

33. Netuka I, Sood P, Pya Y, et al. Fully magnetically levitated left ventricular assist system for treating advanced HF: a multicenter study. *J Am Coll Cardiol*. 2015;66(23):2579–2589.
34. Krabatsch T, Netuka I, Schmitto JD, et al. Heartmate 3 fully magnetically levitated left ventricular assist device for the treatment of advanced heart failure: 1 year results from the CE mark trial. *J Cardiothorac Surg*. 2017;12(1):23.
35. Nabavi DG, Georgiadis D, Mumme T, et al. Clinical relevance of intracranial microembolic signals in patients with left ventricular assist devices: a prospective study. *Stroke*. 1996;27(5):891–896.
36. Kato TS, Ota T, Schulze PC, et al. Asymmetric pattern of cerebrovascular lesions in patients after left ventricular assist device implantation. *Stroke*. 2012;43(3):872–874.
37. Korn-Lubetzki I, Oren A, Asher E, et al. Strokes after cardiac surgery: mostly right hemispheric ischemic with mild residual damage. *J Neurol*. 2007;254(12):1708–1713.
38. Bokeriia LA, Golukhova EZ, Breskina NY, et al. Asymmetric cerebral embolic load and postoperative cognitive dysfunction in cardiac surgery. *Cerebrovasc Dis*. 2007;23(1):50–56.
39. Kim HJ, Song JM, Kwon SU, et al. Right-left propensity and lesion patterns between cardiogenic and aortogenic cerebral embolisms. *Stroke*. 2011;42(8):2323–2325.
40. Boyle AJ, Russell SD, Teuteberg JJ, et al. Low thromboembolism and pump thrombosis with the HeartMate II left ventricular assist device: analysis of outpatient anti-coagulation. *J Heart Lung Transplant*. 2009;28(9):881–887.
41. Salerno CT, Sundareswaran KS, Schleeter TP, Moanie SL, Farrar DJ, Walsh MN. Early elevations in pump power with the HeartMate II left ventricular assist device do not predict late adverse events. *The J Heart Lung Transplant*. 2014;33(8):809–815.
42. Starling RC, Moazami N, Silvestry SC, et al. Unexpected abrupt increase in left ventricular assist device thrombosis. *N Engl J Med*. 2014;370(1):33–40.
43. Bourque K, Cotter C, Dague C, et al. Design rationale and preclinical evaluation of the heartmate 3 left ventricular assist system for hemocompatibility. *ASAIO J*. 2016;62(4):375–383.
44. Spanier T, Oz M, Levin H, et al. Activation of coagulation and fibrinolytic pathways in patients with left ventricular assist devices. *J Thorac Cardiovasc Surg*. 1996;112(4):1090–1097.
45. Livingston ER, Fisher CA, Bibidakis EJ, et al. Increased activation of the coagulation and fibrinolytic systems leads to hemorrhagic complications during left ventricular assist implantation. *Circulation*. 1996;94(9 Suppl):II227–II234.
46. Himmelreich G, Ullmann H, Riess H, et al. Pathophysiologic role of contact activation in bleeding followed by thromboembolic complications after implantation of a ventricular assist device. *ASAIO J*. 1995;41(3):M790–M794.
47. Elkind MS. Inflammatory mechanisms of stroke. *Stroke*. 2010;41(10 Suppl):S3–S8.
48. Aggarwal A, Gupta A, Kumar S, et al. Are blood stream infections associated with an increased risk of hemorrhagic stroke in patients with a left ventricular assist device? *ASAIO J*. 2012;58(5):509–513.
49. Backes D, van den Bergh WM, van Duijn AL, Lahpor JR, van Dijk D, Slooter AJ. Cerebrovascular complications of left ventricular assist devices. *Eur J Cardiothorac Surg*. 2012;42(4):612–620.
50. Kato TS, Schulze PC, Yang J, et al. Pre-operative and post-operative risk factors associated with neurologic complications in patients with advanced heart failure supported by a left ventricular assist device. *J Heart Lung Transplant*. 2012;31(1):1–8.
51. John R, Panch S, Hrabe J, et al. Activation of endothelial and coagulation systems in left ventricular assist device recipients. *Ann Thorac Surg*. 2009;88(4):1171–1179.
52. Kar B, Delgado RM 3rd, Radovancevic B, et al. Vascular thrombosis during support with continuous flow ventricular assist devices: correlation with computerized flow simulations. *Congest Heart Fail*. 2005;11(4):182–187.
53. Shah S, Mehra MR, Couper GS, Desai AS. Continuous flow left ventricular assist device related aortic root thrombosis complicated by left main coronary artery occlusion. *J Heart Lung Transplant*. 2014;33(1):119–120.
54. Suarez J, Patel CB, Felker GM, Becker R, Hernandez AF, Rogers JG. Mechanisms of bleeding and approach to patients with axial-flow left ventricular assist devices. *Circ Heart Fail*. 2011;4(6):779–784.
55. Stulak JM, Lee D, Haft JW, et al. Gastrointestinal bleeding and subsequent risk of thromboembolic events during support with a left ventricular assist device. *J Heart Lung Transplant*. 2014;33(1):60–64.
56. Potapov EV, Ignatenko S, Nasser BA, et al. Clinical significance of PLA polymorphism of platelet GP IIb/IIIa receptors during long-term VAD support. *Ann Thorac Surg*. 2004;77(3):869–874; discussion 874.
57. Maltais S, Kilic A, Nathan S, et al. PREVENTion of HeartMate II Pump Thrombosis Through Clinical Management: the PREVENT multi-center study. *J Heart Lung Transplant*. 2017;36(1):1–12.
58. Willey JZ, Demmer RT, Takayama H, Colombo PC, Lazar RM. Cerebrovascular disease in the era of left ventricular assist devices with continuous flow: risk factors, diagnosis, and treatment. *J Heart Lung Transplant*. 2014;33(9):878–887.
59. Schmid C, Jurmann M, Birnbaum D, et al. Influence of inflow cannula length in axial-flow pumps on neurologic adverse event rate: results from a multi-center analysis. *J Heart Lung Transplant*. 2008;27(3):253–260.
60. Crow S, John R, Boyle A, et al. Gastrointestinal bleeding rates in recipients of nonpulsatile and pulsatile left ventricular assist devices. *J Thorac Cardiovasc Surg*. 2009;137(1):208–215.
61. Lopilato AC, Doligalski CT, Caldeira C. Incidence and risk factor analysis for gastrointestinal bleeding and pump thrombosis in left ventricular assist device recipients. *Artif Organs*. 2015;39(11):939–944.
62. Letsou GV, Shah N, Gregoric ID, Myers TJ, Delgado R, Frazier OH. Gastrointestinal bleeding from arteriovenous malformations in patients supported by the Jarvik 2000 axial-flow left ventricular assist device. *J Heart Lung Transplant*. 2005;24(1):105–109.
63. Qureshi AI, Mendelow AD, Hanley DF. Intracerebral haemorrhage. *Lancet*. 2009;373(9675):1632–1644.
64. Regelsberger J, Elsayed A, Matschke J, et al. Diagnostic and therapeutic considerations for “mycotic” cerebral

- aneurysms: 2 case reports and review of the literature. *Cent Eur Neurosurg*. 2011;72(3):138–143.
65. Keep RF, Hua Y, Xi G. Intracerebral haemorrhage: mechanisms of injury and therapeutic targets. *Lancet Neurol*. 2012;11(8):720–731.
66. Cho SM, Moazami N, Frontera JA. Stroke and intracranial hemorrhage in HeartMate II and HeartWare left ventricular assist devices: a systematic review. *Neurocrit Care*. 2017;27(1):17–25.
67. Wever-Pinzon O, Selzman CH, Drakos SG, et al. Pulsatility and the risk of nonsurgical bleeding in patients supported with the continuous-flow left ventricular assist device HeartMate II. *Circ Heart Fail*. 2013;6(3):517–526.
68. Goldstein DJ, Aaronson KD, Tatooles AJ, et al. Gastrointestinal bleeding in recipients of the HeartWare Ventricular Assist System. *JACC Heart Fail*. 2015;3(4):303–313.
69. Cornwell WK 3rd, Tarumi T, Stickford A, et al. Restoration of pulsatile flow reduces sympathetic nerve activity among individuals with continuous-flow left ventricular assist devices. *Circulation*. 2015;132(24):2316–2322.
70. Healy AH, McKellar SH, Drakos SG, Koliopoulou A, Stehlik J, Selzman CH. Physiologic effects of continuous-flow left ventricular assist devices. *J Surg Res*. 2016;202(2):363–371.
71. Sansone R, Stanske B, Keymel S, et al. Macrovascular and microvascular function after implantation of left ventricular assist devices in end-stage heart failure: role of microparticles. *J Heart Lung Transplant*. 2015;34(7):921–932.
72. Finlayson DC. Con: nonpulsatile flow is preferable to pulsatile flow during cardiopulmonary bypass. *J Cardiothorac Anesth*. 1987;1(2):169–170.
73. Shevde K, DeBois WJ. Pro: pulsatile flow is preferable to nonpulsatile flow during cardiopulmonary bypass. *J Cardiothorac Anesth*. 1987;1(2):165–168.
74. Taylor KM, Bain WH, Davidson KG, Turner MA. Comparative clinical study of pulsatile and nonpulsatile perfusion in 350 consecutive patients. *Thorax*. 1982;37(5):324–330.
75. Mori F, Ivey TD, Itoh T, Thomas R, Breazeale DG, Misbach G. Effects of pulsatile reperfusion on post-ischemic recovery of myocardial function after global hypothermic cardiac arrest. *J Thorac Cardiovasc Surg*. 1987;93(5):719–727.
76. Canivet JL, Larbuisson R, Damas P, et al. Plasma renin activity and urine beta 2-microglobulin during and after cardiopulmonary bypass: pulsatile vs non-pulsatile perfusion. *Eur Heart J*. 1990;11(12):1079–1082.
77. Potapov EV, Loebe M, Nasser BA, et al. Pulsatile flow in patients with a novel nonpulsatile implantable ventricular assist device. *Circulation*. 2000;102(19 Suppl 3):III183–III187.
78. Cervini P, Park SJ, Shah DK, Penev IE, Lewis BD. Carotid Doppler ultrasound findings in patients with left ventricular assist devices. *Ultrasound Q*. 2010;26(4):255–261.
79. Kabbani LS, Munie S, Lin J, et al. Flow patterns in the carotid arteries of patients with left ventricular assist devices. *Ann Vasc Surg*. 2017;39:182–188.
80. Coutsoumos A, Patel S, Teruya TH, Chiriano J, Bianchi C, Abou-Zamzam AM, Jr. Carotid duplex ultrasound changes associated with left ventricular assist devices. *Ann Vasc Surg*. 2014;28(4):1030 e1037–e1030 e1011.
81. Templeton DL, John R, Painter P, Kelly AS, Dengel DR. Effects of the left ventricular assist device on the compliance and distensibility of the carotid artery. *Heart Vessels*. 2013;28(3):377–384.
82. Olinic D, Olinic M, Laza S, et al. Arterial compliance in hypertension and heart failure. *Rom J Intern Med*. 2003;41(2):113–124.
83. Liao D, Arnett DK, Tyroler HA, et al. Arterial stiffness and the development of hypertension: the ARIC study. *Hypertension*. 1999;34(2):201–206.
84. van Popele NM, Grobbee DE, Bots ML, et al. Association between arterial stiffness and atherosclerosis: the Rotterdam Study. *Stroke*. 2001;32(2):454–460.
85. Lage SG, Kopel L, Monachini MC, et al. Carotid arterial compliance in patients with congestive heart failure secondary to idiopathic dilated cardiomyopathy. *Am J Cardiol*. 1994;74(7):691–695.
86. Badran HM, Mostafa A, Serage A, Fareed W, Abdelfatah E, Fathe A. Arterial mechanics in ischemic versus nonischemic cardiomyopathy: clinical and diagnostic impact. *Echocardiography*. 2009;26(7):785–800.
87. Ambardekar AV, Hunter KS, Babu AN, Tuder RM, Dodson RB, Lindenfeld J. Changes in aortic wall structure, composition, and stiffness with continuous-flow left ventricular assist devices: a pilot study. *Circ Heart Fail*. 2015;8(5):944–952.
88. Stewart AS, Russo MJ, Martens TP, et al. Longer duration of continuous-flow ventricular assist device support predicts greater hemodynamic compromise after return of pulsatility. *J Thorac Cardiovasc Surg*. 2008;136(2):524–525.
89. Fukae K, Tominaga R, Tokunaga S, Kawachi Y, Imaizumi T, Yasui H. The effects of pulsatile and nonpulsatile systemic perfusion on renal sympathetic nerve activity in anesthetized dogs. *J Thorac Cardiovasc Surg*. 1996;111(2):478–484.
90. Gaer JA, Shaw AD, Wild R, et al. Effect of cardiopulmonary bypass on gastrointestinal perfusion and function. *Ann Thorac Surg*. 1994;57(2):371–375.
91. Tranmer BI, Gross CE, Kindt GW, Adey GR. Pulsatile versus nonpulsatile blood flow in the treatment of acute cerebral ischemia. *Neurosurgery*. 1986;19(5):724–731.
92. Bartoli CR, Spence PA, Siess T, Raess DH, Koenig SC, Dowling RD. Nonphysiologic blood flow triggers endothelial and arterial remodeling in vivo: implications for novel left ventricular assist devices with a peripheral anastomosis. *J Thorac Cardiovasc Surg*. 2014;148(1):311–321.
93. Baeyens N, Bandyopadhyay C, Coon BG, Yun S, Schwartz MA. Endothelial fluid shear stress sensing in vascular health and disease. *J Clin Invest*. 2016;126(3):821–828.
94. Baeyens N, Schwartz MA. Biomechanics of vascular mechanosensation and remodeling. *Mol Biol Cell*. 2016;27(1):7–11.
95. Haga JH, Li YS, Chien S. Molecular basis of the effects of mechanical stretch on vascular smooth muscle cells. *J Biomech*. 2007;40(5):947–960.
96. Li YS, Haga JH, Chien S. Molecular basis of the effects of shear stress on vascular endothelial cells. *J Biomech*. 2005;38(10):1949–1971.
97. Liu XM, Peyton KJ, Durante W. Physiological cyclic strain promotes endothelial cell survival via the induction of heme oxygenase-1. *Am J Physiol Heart Circ Physiol*. 2013;304(12):H1634–H1643.

98. Uzarski JS, Scott EW, McFetridge PS. Adaptation of endothelial cells to physiologically-modeled, variable shear stress. *PLoS ONE*. 2013;8(2):e57004.
99. Ozturk T, Nalcaci S, Ozturk P, et al. Fundus fluorescein angiographic findings in patients who underwent ventricular assist device implantation. *Artif Organs*. 2013;37(9):816–820.
100. Witman MA, Garten RS, Gifford JR, et al. Further peripheral vascular dysfunction in heart failure patients with a continuous-flow left ventricular assist device: the role of pulsatility. *JACC Heart Fail*. 2015;3(9):703–711.
101. Saha M, Muppala MR, Castaldo JE, Gee W, Reed JF 3rd, Morris DL. The impact of cardiac index on cerebral hemodynamics. *Stroke*. 1993;24(11):1686–1690.
102. van Mook WN, Rennenberg RJ, Schurink GW, et al. Cerebral hyperperfusion syndrome. *Lancet Neurol*. 2005;4(12):877–888.
103. Gardner CJ, Lee K. Hyperperfusion syndromes: insight into the pathophysiology and treatment of hypertensive encephalopathy. *CNS Spectrums*. 2007;12(1):35–42.
104. Lietz K, Brown K, Ali SS, et al. The role of cerebral hyperperfusion in postoperative neurologic dysfunction after left ventricular assist device implantation for end-stage heart failure. *J Thorac Cardiovasc Surg*. 2009;137(4):1012–1019.
105. Saupe KW, Smith CA, Henderson KS, Dempsey JA. Diastolic time: an important determinant of regional arterial blood flow. *Am J Physiol*. 1995;269(3 Pt 2):H973–H979.
106. Ober D, Kalman J, Weinberger J. Doppler pulse waveform analysis of carotid and middle cerebral artery flow in a patient with an intra-aortic balloon pump. *J Neuroimaging*. 1999;9(2):126–128.
107. Najjar SS, Slaughter MS, Pagani FD, et al. An analysis of pump thrombus events in patients in the HeartWare ADVANCE bridge to transplant and continued access protocol trial. *J Heart Lung Transplant*. 2014;33(1):23–34.
108. Nassif ME, Tibrewala A, Raymer DS, et al. Systolic blood pressure on discharge after left ventricular assist device insertion is associated with subsequent stroke. *J Heart Lung Transplant*. 2015;34(4):503–508.
109. Benjamin EJ, Virani SS, Callaway CW, et al. Heart disease and stroke statistics—2018 update: a report from the American Heart Association. *Circulation*. 2018;137(12):e67–e492.
110. Teuteberg JJ, Slaughter MS, Rogers JG, et al. The HVAD left ventricular assist device: risk factors for neurological events and risk mitigation strategies. *JACC Heart Fail*. 2015;3(10):818–828.
111. Feldman D, Pamboukian SV, Teuteberg JJ, et al. The 2013 International Society for Heart and Lung Transplantation Guidelines for mechanical circulatory support: executive summary. *J Heart Lung Transplant*. 2013;32(2):157–187.
112. National Institute of Neurological Disorders and Stroke rt-PA Stroke Study Group. Tissue plasminogen activator for acute ischemic stroke. *N Engl J Med*. 1995;333(24):1581–1587.
113. Mazya M, Egido JA, Ford GA, et al. Predicting the risk of symptomatic intracerebral hemorrhage in ischemic stroke treated with intravenous alteplase: Safe Implementation of Treatments in Stroke (SITS) symptomatic intracerebral hemorrhage risk score. *Stroke*. 2012;43(6):1524–1531.
114. Jauch EC, Saver JL, Adams HP Jr, et al. Guidelines for the early management of patients with acute ischemic stroke: a guideline for healthcare professionals from the American Heart Association/American Stroke Association. *Stroke*. 2013;44(3):870–947.
115. Vora NA, Gupta R, Thomas AJ, et al. Factors predicting hemorrhagic complications after multimodal reperfusion therapy for acute ischemic stroke. *AJNR Am J Neuroradiol*. 2007;28(7):1391–1394.
116. Jennings DL, Jacob M, Chopra A, Nemerovski CW, Morgan JA, Lanfear DE. Safety of anticoagulation reversal in patients supported with continuous-flow left ventricular assist devices. *ASAIO J*. 2014;60(4):381–384.
117. Morgenstern LB, Hemphill JC 3rd, Anderson C, et al. Guidelines for the management of spontaneous intracerebral hemorrhage: a guideline for healthcare professionals from the American Heart Association/American Stroke Association. *Stroke*. 2010;41(9):2108–2129.

## Introduction

**T**he increasing use of left ventricular assist devices (LVADs) has given new options to patients with end-stage heart failure. They offer improved quality and quantity of life as destination therapy (DT) and bridge to transplantation (BTT).<sup>1,2</sup> Despite the advances in successful treatment of left ventricular failure with continuous-flow (CF) devices, right ventricular failure (RVF) remains a major complication in 10%–40% of LVAD recipients.<sup>3–7</sup> RVF has a significant impact on immediate perioperative mortality and morbidity and is associated with a decreased survival to and after cardiac transplantation.<sup>3,8</sup> RVF can lead to coagulopathy, end-organ dysfunction, altered drug metabolism, worsening nutritional status, diuretic resistance, and poor quality of life. Severe RVF is defined by most clinical investigators and the Interagency Registry for Mechanically Assisted Circulatory Support (INTERMACS) registry as a central venous pressure (CVP) >16 mmHg, plus the need for either (1) prolonged post-implant inotropes, inhaled nitric oxide, or intravenous vasodilators  $\geq 14$  days, or (2) the need for right ventricular assist device (RVAD) support<sup>9</sup> (see Table 38.1). Studies support that early institution of planned biventricular support for patients at high risk for RVF undergoing LVAD implant have significantly improved outcomes when compared to the delayed addition of mechanical support to the RV after isolated LVAD implant.<sup>4,6,10</sup> The complex pathophysiology of the right ventricle, including RV myocardial dysfunction, alterations in geometry, and management of hemodynamics, make identifying LVAD candidates at risk for RVF challenging (Figure 38.1).<sup>11</sup> Multiple risk-assessment calculators have been developed utilizing patient demographics, pre-implant hemodynamics, imaging assessments, and biochemical markers of organ damage, yet no single model has been found to dependably predict RVF when applied to a general cohort.<sup>5–7,12–14</sup>

## Right Heart Physiology

The right ventricle (RV) is the most anteriorly situated cardiac chamber, lying just behind the sternum. It consists of three anatomical components: (1) the inlet, bound by the annulus of the tricuspid valve, including the chordae tendineae and papillary muscles; (2) the apical myocardium; and (3) the outflow region, consisting of the conus region that extends to the pulmonary valve.<sup>15</sup>

The right ventricular function is influenced by multiple factors, including systemic venous return, pulmonary pressures (RV afterload), pericardial compliance, and native RV contractility. The contractility of the RV relies on the contribution of both its free wall and the shared interventricular septum to drive effective forward blood flow. Given that the RV is connected in series with the LV, it is obligated to pump on average the same effective stroke volume as the left ventricle, but is able to do this using only 20% of the LV energy expenditure for an equivalent stroke volume. This is accomplished by utilizing the forward momentum of the venous blood flow while contracting into a highly compliant, low-resistance pulmonary circulation.<sup>15,16</sup>

The right ventricular ejection fraction (RVEF) is inversely proportional to the pulmonary artery (PA) pressure (PAP) or RV afterload.<sup>18</sup> The systolic function of the RV is therefore highly sensitive to changes in the PAP (afterload), with minor increases causing a large decrease in the effective RV stroke volume (SV) (Figure 38.2).<sup>16</sup> In left-sided heart failure, the rising left-sided filling pressures translate to increased pulmonary artery pressures. Over time, elevated PAP reduces the PA compliance and increases PA resistance through reactive pulmonary vasoconstriction and chronic vascular remodeling, the sum of which increases RV afterload and pressure.<sup>19</sup> Elevated afterload can lead to RV remodeling, especially if on a chronic basis, changing the shape of the right ventricle, rendering its function less efficient (Figure 38.3).<sup>20</sup>

**Table 38.1 • INTERMACS Definition of Right Ventricular Failure****INTERMACS Definition of Right Ventricular Failure**

## Definition

Symptoms or findings of persistent right ventricular failure characterized by **both of the following**:

1) **Documentation of elevated central venous pressure (CVP) by:**

- Direct measurement (e.g., right heart catheterization) with evidence of a central venous pressure (CVP) or right atrial pressure (RAP) >16

or

- Findings of significantly dilated inferior vena cava with absence of inspiratory variation by echocardiography,

or

- Clinical findings of elevated jugular venous distension at least half way up the neck in an upright patient.

2) **Manifestations of elevated central venous pressure (CVP) characterized by:**

- Clinical findings of peripheral edema (>2+ either new or unresolved),

or

- Presence of ascites or palpable hepatomegaly on physical examination (unmistakable abdominal contour) or by diagnostic imaging,

or

- Laboratory evidence of worsening hepatic (total bilirubin >2.0 mg/dl) or renal dysfunction (creatinine >2.0 mg/dl).

## Severity

*During VAD Implant Admission*

## Mild

Patient meets **both** criteria for RVF plus:

- 1) Post-implant inotropes inhaled nitric oxide or intravenous vasodilators not continued beyond postop day 7 following VAD implant

**AND**

- 2) No inotropes continued beyond postop day 7 following VAD implant.

## Moderate

Patient meets **both** criteria for RVF plus:

- 1) Post-implant inotropes inhaled nitric oxide or intravenous vasodilators continued beyond postop day 7 and up to postop day 14 following VAD implant.

## Severe

Patient meets **both** criteria for RVF plus:

- 1) Central venous pressure or right atrial pressure greater than 16 mmHg

**AND**

- 2) Prolonged post-implant inotropes inhaled nitric oxide or intravenous vasodilators continued beyond postop day 14 following VAD implant

Severe Acute  
RVF

Patient meets **both** criteria for RVF plus:

- 1) Central venous pressure or right atrial pressure greater than 16 mmHg

**AND**

- 2) Need for right ventricular assist device at any time following VAD implant

**OR**

- 3) Death during the VAD implants hospitalization with RVF as the primary cause.

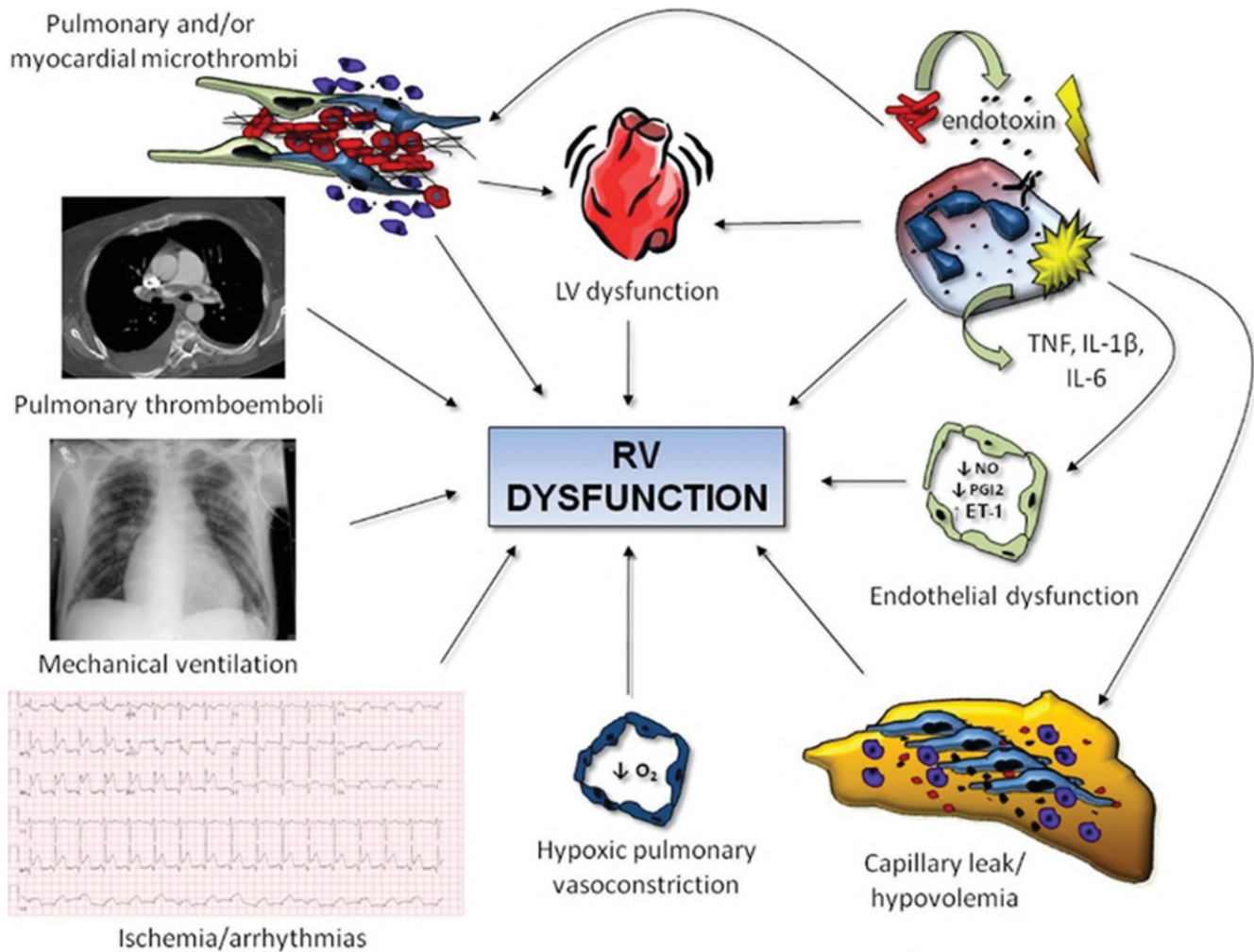
Abbreviations: RVF = right ventricular failure; RV = right ventricle; CVP = central venous pressure; RVAD = right ventricular assist device; LVAD = left ventricular assist device.

Reprinted from Kirklin et al, Eighth annual INTERMACS report: Special focus on framing the impact of adverse events, *Journal of Heart and Lung Transplantation* 2017;36:1080–1086. Copyright (2017), with permission from Elsevier.

Regulation of blood flow to the right ventricle differs significantly from that to the left ventricle. Unlike the LV with predominant diastolic coronary blood flow, the RV relies on blood perfusion during both systole and diastole with less effective pressure-flow autoregulation. During times of acute RV pressure-overload and elevated end-diastolic RV pressure, there is a reduced RV myocardial tissue perfusion gradient and increased risk for development of sub-endocardial ischemia. This effect is magnified during settings of reduced systemic arterial pressure and decreased coronary perfusion.<sup>21</sup> The risk of right ventricular ischemia is also heightened during chronic elevations in right ventricular afterload, due to

microvascular growth failure and inability to match myocyte hypertrophy.

Compared to the LV, the normal RV pressure-volume (PV) relationship lacks isovolumic contraction and relaxation in either systole or diastole. The RV operates at a higher steady-state volume with a lower peak systolic pressure. The normal trapezoidal shaped PV loop reflects the regular high-efficiency/low-impedance state of the RV. When the RV experiences chronically elevated afterload pressures, the RV pressure-volume relation shifts from trapezoidal to rectangular shaped (Figure 38.4.<sup>17</sup> The rectangular shape now has well-defined isovolumic contraction phases, mirroring the normal LV PV loop. Over time, the RV



**Figure 38.1.** Various mechanisms contributing to RV dysfunction.

Reprinted from Lahm T et al., *Medical and surgical treatment of acute right ventricular failure*, Journal of the American College of Cardiology 2010;56:1435–1445, © 2010 Elsevier and JACC: Journal of the American College of Cardiology.

adaptation to elevated pressures will result in ventricular dilation, reduced contractility, and failure of cardiac output due to an inability to maintain adequate preload to support the LV stroke volume.<sup>15,16,17,19</sup>

Right ventricular (RV) pressure-volume (P-V) loops obtained by a conductance catheter. The diagram demonstrates the use of P-V loops. The white solid lines pass tangential to the end-systolic P-V points of a “family” of loops produced by varying the loading conditions. The slope of this line gives the RV end-systolic elastance. A steeper slope depicts higher end-systolic elastance. Loop a depicts a normal RV P-V loop. Loop b represents a compensated, chronically hypertensive RV. Loop c is obtained from a decompensated hypertensive RV. Note the decrease in RV end-systolic elastance from the compensated RV depicted in loop b to the decompensated RV depicted by loop c.

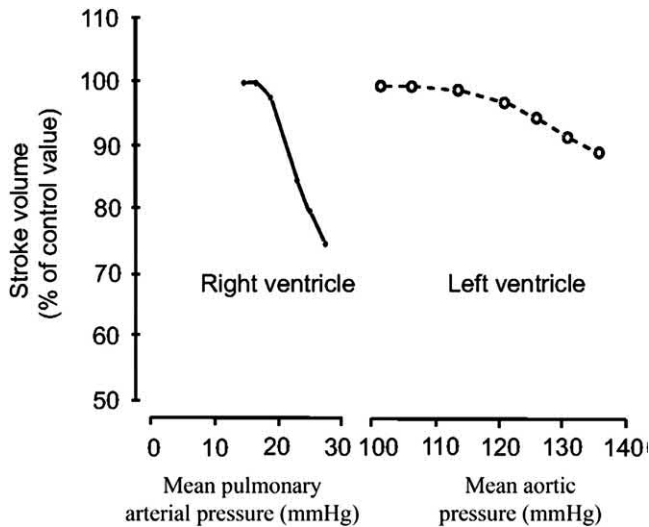
While the RV functions under different hemodynamic parameters compared to the LV, both ventricles are maintained in a closed circuit, mandating that their

stroke volume (SV) be equal. Similar to the LV, the RV’s performance is a reflection of contractility, preload, and afterload, along with influences of heart rhythm, valvular function, and ventricular interdependence.<sup>22</sup> The close anatomic association between the two chambers links their performances together. The RV is dependent on the LV for 20%–40% of its contractile function, and the LV is reliant on the RV for adequate preload. Changes of one ventricle’s size, shape, and function can have a significant deleterious effect on the other’s performance.<sup>3,23,24</sup>

## Influence of LVAD on Right Ventricular Function

The physiology of right ventricular function and failure after LVAD implantation is complex (Figure 38.5).<sup>25</sup> Theoretically, the LVAD should decompress the LV, reducing the LV end-diastolic pressure, lowering the



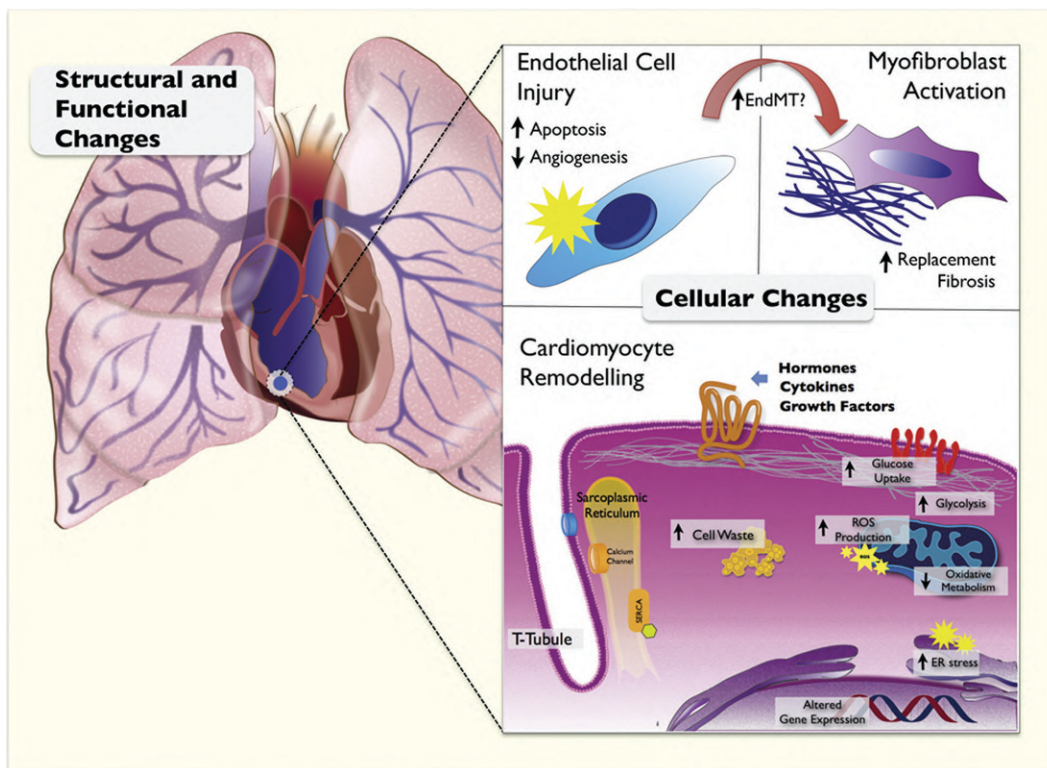


**Figure 38.2.** Relationship of right ventricular (RV) and left ventricular (LV) stroke volumes to increases in afterload.

Reprinted with permission of the American Thoracic Society. Copyright © 2019 American Thoracic Society. MacNee, Pathophysiology of cor pulmonale in chronic obstructive pulmonary disease. Part One, *American Journal of Respiratory and Critical Care Medicine* 1994;150(3):833–852.

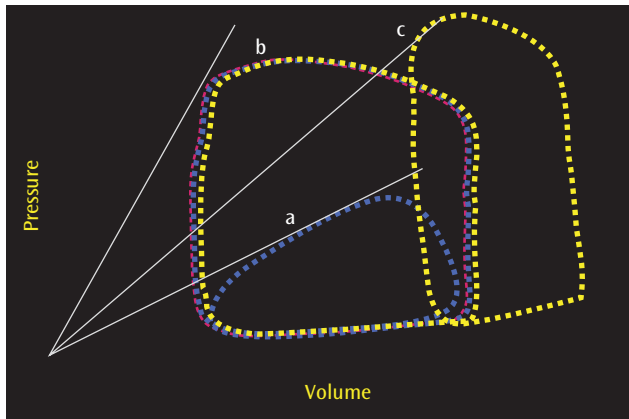
pulmonary artery pressure and subsequent afterload on the RV, resulting in improving contractility.<sup>16</sup> However, in clinical practice, sometimes the mechanics do not work as efficiently as anticipated and can lead to right ventricular failure. The activation of the LVAD increases venous return, potentially overwhelming an already dysfunctional RV, causing RV dilation and alterations in RV geometry. This leads to worsening of tricuspid annulus distortion and functional TR, leftward shift of the intra-ventricular septum and loss of the septal contribution to the RV contraction, and loss of RV stroke volume. As the RV output continues to fall, the septum shifts leftward, reducing the LV preload and LVAD flows.<sup>26,27</sup> The anchoring of the LVAD at the apex may also alter the normal twisting contractile design of the heart rendering it less effective (Figure 38.6).<sup>28</sup>

Tachyarrhythmias also significantly contribute to RVF after LVAD. Atrial arrhythmias double the risk of RVF after LVAD and occur in more than 20% of LVAD patients. Similarly, ventricular tachycardia incidence increases after LVAD implantation, occurring in up to 50% of LVAD implants, and is associated with increased risk for RVF.<sup>29</sup> Ventricular fibrillation can rapidly cause a dramatic drop of over 20% in LVAD flow.<sup>23</sup>



**Figure 38.3.** Structural and functional changes associated with RV failure.

Reprinted from Vonk-Noordegraaf A et al., Right heart adaptation to pulmonary arterial hypertension: physiology and pathobiology, *Journal of the American College of Cardiology* 2013;62:22–33. © 2013 Elsevier and *JACC: Journal of the American College of Cardiology*.



**Figure 38.4.** Right ventricular (RV) pressure-volume (PV) loops.

Reprinted with permission from Friedberg MK et al., Right versus left ventricular failure: differences, similarities, and interactions, *Circulation* 2014;129(9):1033–1044, <https://www.ahajournals.org/journal/circ> © American Heart Association, Inc. All rights reserved.

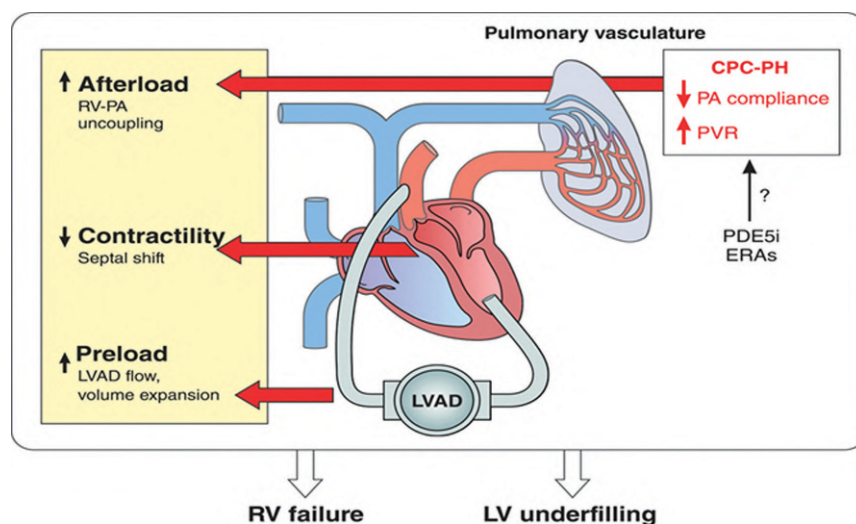
## Predicting RV Failure

Right ventricular failure is a major cause of morbidity and mortality after LVAD implant. Treatment options for RVF are limited to chronic inotropic therapy or mechanical RV support.<sup>5,12,27</sup> While the implications of RVF alone portend worse outcomes, the subsequent implantation of an RVAD bears additional risks, effectively doubling the likelihood of thrombosis, infection, and mechanical failure. While these risks are significant, elective upfront biventricular

support correlates with improved long-term survival and survival to transplant compared to delayed RVAD implantation, even of just a few days after LVAD placement.<sup>16,30,31</sup> Identifying those patients at high risk for RV failure could improve patient selection and facilitate strategies for early RVF management. Importantly, it also allows for more informed clinical decision-making for patients being considered for LVAD therapy. Patients implanted as bridge to transplant (BTT) who develop evidence of severe RV failure have the option for curative treatment measures with transplantation of a new heart. Given that right ventricular failure 6-month associated mortality reaches up to 30%, the risks for RVF have a greater impact for patients considering LVAD as destination therapy, who do not have any other option.<sup>12,23,32</sup>

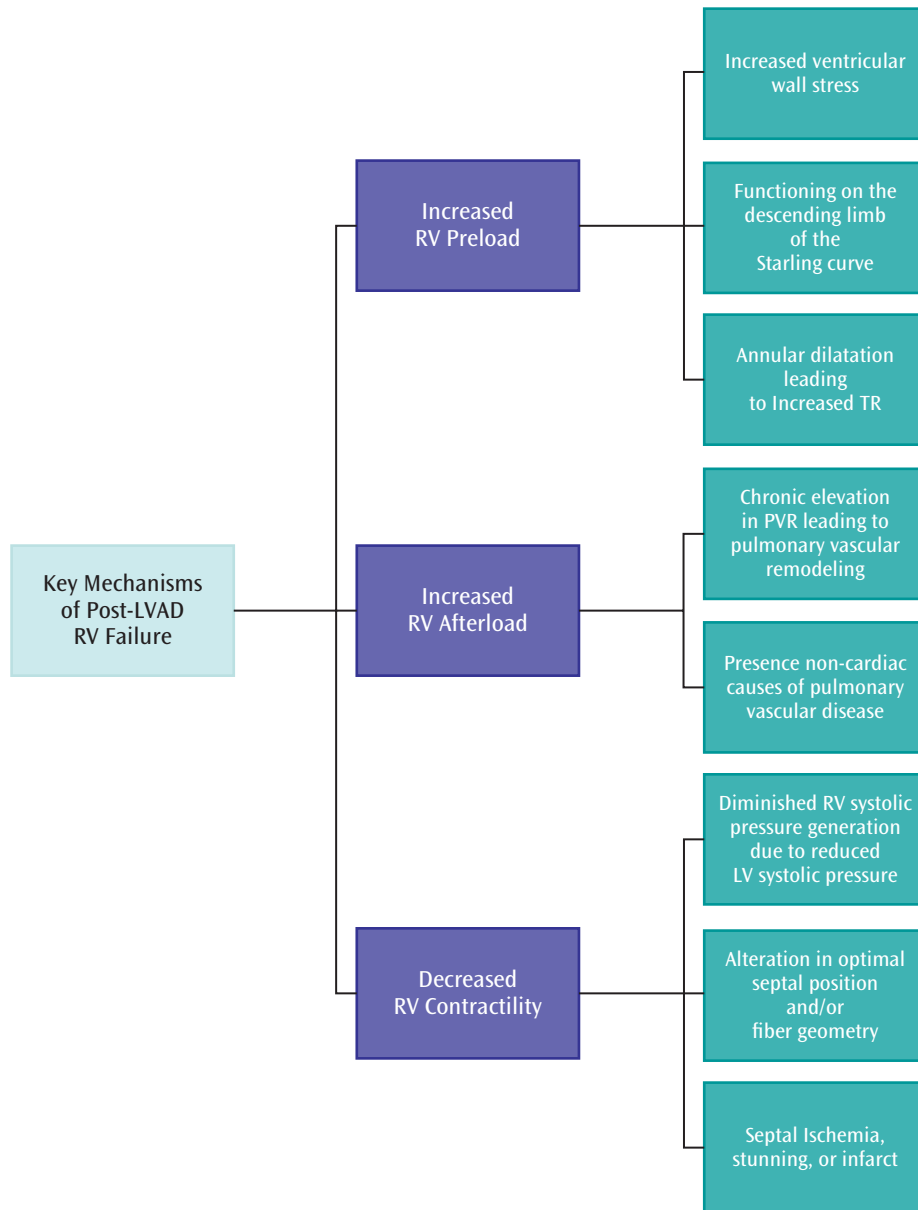
At present, multiple predictors of post-LVAD RVF have been identified; however, available risk scores have been typically derived from single-center cohorts, have used variable definitions of RVF, have identified inconsistent predictors, and have demonstrated, at most, modest predictive value when validated in independent cohorts. Data from these studies recognize a multitude of covariates that influence the risk of RHF, but their individual weighted contribution remains difficult to quantify (Table 38.2).<sup>5,6,12–14,31,33,34</sup>

Patient demographics associated with higher risk include female gender, younger age, and “destination therapy” as indications for LVAD.<sup>35</sup> Global markers of illness severity including end-organ dysfunction and the need for preoperative mechanical support, need for ventilation, extracorporeal membrane oxygenation, or dialysis are associated with the greatest incidence of severe RV failure.<sup>5,13,36</sup> Biomarkers have also been found to aid in



**Figure 38.5.** Impact of LVAD therapy on RV function.

Reprinted with permission from Sparrow CT et al., Intersection of pulmonary hypertension and right ventricular dysfunction in patients on left ventricular assist device support, *Circulation: Heart Failure* 2018;11:e004255, <https://www.ahajournals.org/journal/cirheartfailure> © American Heart Association, Inc. All rights reserved.



**Figure 38.6.** Mechanisms of RV failure after LVAD implantation.

Reprinted from Rich JD et al., Right ventricular failure in patients with left ventricular assist devices, *Cardiology Clinics of North America* 2012;30:291–302, Copyright (2012), with permission from Elsevier.

risk stratification as a marker of clinical illness, including abnormal coagulopathy (elevated INR), elevated N-terminal pro b-type Natriuretic Peptide (NT-BNP), and persistent systemic inflammation (elevated WBC count or C-reactive protein).<sup>31,37,38</sup> Hemodynamic assessment has a central role in understanding RV performance, and several prior studies have identified different hemodynamic metrics as risk factors for RVF after LVAD. Hemodynamic profiles of RVF include elevated CVP ( $\geq 15$  mm Hg), elevated central venous pressure/pulmonary capillary wedge pressure (CVP/PCWP) ( $\geq 0.63$ ), narrow pulmonary artery pulse-pressure (PAPP  $\leq$

21 mm Hg), and reduced cardiac output indexed to body surface area (CI  $\leq 2.0$ – $2.2$  liters/min/m<sup>2</sup>).<sup>10,35,38,39</sup> A calculated right ventricular stroke work index (RVSWI) at a threshold  $\leq 300$  mmHg ml m<sup>2</sup> has previously been shown to be a critical value for RVAD implantation by Kormos et al.<sup>12</sup>

Echocardiographic profiles of RVF include a less-dilated left ventricle, severely reduced RV function, and severe tricuspid regurgitation. Patients with refractory heart failure and a non-dilated left ventricle may be experiencing a restrictive cardiomyopathy which frequently involves the right ventricle and presents with predominantly right-sided

heart failure syndrome. Neither of these is expected to improve with left-sided support alone.<sup>40,41</sup> Quantitative echocardiographic evaluation of the RV-to-LV ratio, longitudinal strain of the RV free wall, and RV fractional area change (RFAC) are all very promising tools, but there is too much variability in measures and too few published studies to reach a definitive conclusion at this time.<sup>42,43</sup>

## Preoperative Medical Management of RV Failure before LVAD Implantation

Preoperative prevention, including selection of appropriate patients, ideal timing of implant, optimization of hemodynamics, and management of comorbid conditions are accepted as crucial foundation in preventing RVF in patients with preexisting right ventricular dysfunction (Figure 38.7). Although no studies to date have been performed to assess the impact of preoperative management on RVF post-LVAD, certain hemodynamic goals have been set across centers as a standard of optimization. An optimal preoperative CVP is undefined, though a value >15 has been correlated with RVF and generally warrants intervention.<sup>12,44</sup> Aggressive preoperative diuresis and the use of inotropes or vasodilators are effective measures to reduce the CVP and relieve RV distension before surgical implant of an LVAD. Preoperative management of elevated PVR is thought to be beneficial, but with conflicting support. Some studies suggest targeting a PA systolic pressure of <65 mmHg ideal before implant.<sup>45</sup>

## Medical Management after LVAD Implantation

Use of pulmonary artery catheters may be useful to allow for continuous assessment of the PAP and CVP, and facilitate careful titration of diuretics, pulmonary vasodilators, and inotropic therapy after LVAD implantation. The Interagency Registry for Mechanically-Assisted Circulatory Support (INTER-MACS) defines RVF specifically after CF-LVAD implantation as an elevation in CVP to >16 mmHg with clinical manifestations of the disease (e.g., ≥2+ pitting edema, ascites/hepatomegaly, or worsening renal/hepatic dysfunction). Similar to preoperative optimization, a goal CVP <15 mmHg ensures reduction of RV workload and hepatic and renal congestion. Use of inotropic therapy, pulmonary vasodilators, diuretics, and ultrafiltration should all be considered for rising CVP >15.

Inotropic therapy such as milrinone and dobutamine support the RV and allow for pulmonary vasodilatation. Milrinone is a PDE-3 inhibitor that is both an inotrope and vasodilator with a longer half-life (2.5 hours). Dobutamine is a β-1 agonist with less vasodilatory effects, but a very

short half-life (2 minutes).<sup>46</sup> Inotropic therapy is used in the immediate postoperative time to support an overwhelmed RV, improve cardiac index, and support pump flow. Mortality has been shown to directly correlate with the duration of inotropic support, and thus the patient should be weaned off as soon as hemodynamics improve. Patients who tolerated early weaning of support have improved 6-month survival compared to those who did not.<sup>47</sup>

## Pulmonary Vasodilators

Preoperative Group II pulmonary artery hypertension (PAH) is common among end-stage heart failure patients, resulting from endothelial dysfunction and vascular remodeling in the setting of chronically elevated left-sided filling pressures.<sup>48</sup> This preexisting PAH can be further exacerbated during the perioperative period by ischemia during cardiopulmonary bypass (CPB), administration of intraoperative protamine, and blood transfusions. Additionally, perioperative hypercarbia and hypoxia during mechanical ventilation are potent stimuli of pulmonary vascular constriction.<sup>49</sup> Given the incredible sensitivity of the RV to even small increases in afterload, PAH is believed to be a significant contributor to postoperative RVF. Milrinone, a phosphodiesterase type 3 inhibitor frequently used after LVAD for both its positive inotropic effects and vasodilatory properties, has been shown to reduce mean pulmonary artery pressure (mPAP) after LVAD.<sup>50</sup> Based on several small studies suggesting safety and efficacy, pulmonary vasodilators are commonly used in the short-term management of patients post-LVAD.

Inhaled nitric oxide (iNO) is considered a selective pulmonary vasodilator with no systemic effect on blood pressure and a very short half-life of only a few seconds. A prospective, randomized, double-blinded, placebo-controlled multi-center study found that iNO reduced mPAP and increased LVAD flow when initiated before weaning from CPB and continued for 48 hours post-LVAD implantation or until patients were extubated.<sup>51,52</sup> The study found trends toward reduced RVF rates in the group that received nitric oxide but did not show statistical significance.

Inhaled prostacyclin analogs (Epoprostenol, Iloprost) are endothelium-derived vasodilators and analogs of endogenous prostacyclin.<sup>53</sup> They provide a similar effect on hemodynamics and oxygenation as nitric oxide, but have a longer half-life of 3–6 minutes and some systemic exposure with potential for platelet inhibition and bleeding and vasodilatory effect of hypotension.<sup>54</sup> Combination therapy of both inhaled nitric oxide and iloprost was retrospectively analyzed in seven patients with severe RV dysfunction post-LVAD.<sup>55</sup> Patients were noted to have a significant decrease in PVR, mPAP, and PCWP, with increase in LVAD flows and RV tricuspid annular velocity, with combined therapy. It is important to note that this therapy also did produce a

**Table 38.2 • Right Ventricular Failure Risk-Prediction Models**

Study (first Author)	Patients	CF-LVAD % (n)	RVF Rate and Definition	Multivariable Predictors	Calculator
<b>Michigan RV failure risk score 2008 (Matthews)</b>	<ul style="list-style-type: none"> <li>• 197 LVADs</li> <li>• 94% BTT</li> <li>• 6% DT</li> </ul>	<ul style="list-style-type: none"> <li>• 14% (28)</li> </ul>	<ul style="list-style-type: none"> <li>• RVF rate 35%</li> <li>• Need for RVAD</li> <li>• Inotrope <math>\geq 14</math> days</li> <li>• Inhaled NO <math>\geq 48</math> hrs</li> </ul>	<ul style="list-style-type: none"> <li>• Preoperative vasopressors (4 points)</li> <li>• AST <math>\geq 80</math> IU/liter (2 points)</li> <li>• Bilirubin <math>\geq 2.0</math> mg/dl (2.5 points)</li> <li>• Creatinine <math>\geq 2.3</math> mg/dl (3 points)</li> </ul>	<ul style="list-style-type: none"> <li>• <math>\geq 5.5</math> –high risk</li> </ul>
<b>Penn RVAD risk score 2008 (Fitzpatrick)</b>	<ul style="list-style-type: none"> <li>• 266 LVADs</li> <li>• BTT vs. DT not reported</li> </ul>	<ul style="list-style-type: none"> <li>• 2% (6)</li> </ul>	<ul style="list-style-type: none"> <li>• RVF rate 37%</li> <li>• Need for RVAD</li> </ul>	<ul style="list-style-type: none"> <li>• Cardiac index <math>\leq 2.2</math> liters/min/m<sup>2</sup> (OR 5.7)</li> <li>• RVSWI <math>\leq 0.25</math> mmHg/liters/m<sup>2</sup> (OR 5.1)</li> <li>• Severe RV dysfunction (OR 5.0)</li> <li>• Creatinine <math>\geq 1.9</math> mg/dl (OR 4.8)</li> <li>• Prior cardiac surgery (OR 4.5)</li> <li>• Systolic BP <math>\leq 96</math> mmHg (OR 2.9)</li> </ul> <p><b>Calculator</b> (score of 1 or 0 if criteria met)</p> $18 \times (\text{Cr}) + 18 \times (\text{RVSWI}) + 17 \times (\text{Cr}) + 16 \times (\text{Prior Cardiac Surgery}) + 16 \times (\text{RV Dysfunction}) + 13 \times (\text{SBP}) = (\text{max score of 98})$	<ul style="list-style-type: none"> <li>• <math>\geq 50</math> –Need for RVAD</li> </ul>
<b>UTAH RV risk score 2010 (Drakos)<sup>6</sup></b>	<ul style="list-style-type: none"> <li>• 175 LVADs</li> <li>• 58% BTT</li> <li>• 42% DT</li> </ul>	<ul style="list-style-type: none"> <li>• 14% (25)</li> </ul>	<ul style="list-style-type: none"> <li>• RVF rate 44%</li> <li>• Need for RVAD</li> <li>• Inotrope <math>\geq 14</math> days</li> <li>• Inhaled NO <math>\geq 48</math> hrs</li> </ul>	<ul style="list-style-type: none"> <li>• DT indication (3.5 points)</li> <li>• IABP (4 points)</li> <li>• PVR (1 to 4 points)</li> <li>• Inotrope dependency (2.5 points)</li> <li>• Obesity (2 points)</li> <li>• ACEI or ARB use (2.5 points)</li> <li>• <math>\beta</math>-blocker use (2 points)</li> </ul>	<ul style="list-style-type: none"> <li>• <math>\geq 12.5</math> – High Risk</li> </ul>
<b>Heartmate II RV risk model 2010 (Kormos)<sup>12</sup></b>	<ul style="list-style-type: none"> <li>• 484 LVADs</li> <li>• 100% BTT</li> </ul>	<ul style="list-style-type: none"> <li>• 100% (484)</li> </ul>	<ul style="list-style-type: none"> <li>• RVF rate 20%</li> <li>• Need for RVAD</li> <li>• Inotrope <math>\geq 14</math> days</li> </ul>	<ul style="list-style-type: none"> <li>• CVP/PCWP <math>\geq 0.63</math> (OR 2.3)</li> <li>• Preoperative intubation (OR 5.5)</li> <li>• BUN <math>\geq 39</math> mg/dl (OR 2.1)</li> </ul>	<ul style="list-style-type: none"> <li>• Multivariate Logistic Regression Analysis/Correlations</li> </ul>
<b>Pittsburgh Decision Tree 2012 (Wang)<sup>31</sup></b>	<ul style="list-style-type: none"> <li>• 183 LVADs</li> <li>• BTT vs. DT not reported</li> </ul>	<ul style="list-style-type: none"> <li>• 22% (40)</li> </ul>	<ul style="list-style-type: none"> <li>• RVF rate 15%</li> <li>• Need for RVAD</li> </ul>	<ul style="list-style-type: none"> <li>• Age, heart rate; Transpulmonary gradient right atrial pressure; INR, white blood cell count, ALT, number of inotropic agents</li> </ul>	<ul style="list-style-type: none"> <li>• Multi-Level decision tree (see Figure 38.7)</li> </ul>
<b>CRITT score 2013 (Atluri)<sup>33</sup></b>	<ul style="list-style-type: none"> <li>• 196 LVADs</li> <li>• BTT vs. DT not reported</li> </ul>	<ul style="list-style-type: none"> <li>• 100% (196)</li> <li>• 26% (51) BiVADs</li> </ul>	<ul style="list-style-type: none"> <li>• RVF rate 23%</li> <li>• Need for RVAD</li> </ul>	<ul style="list-style-type: none"> <li>• CVP <math>\geq 15</math> mmHg (OR 2.0 – 1 point)</li> <li>• Severe RV dysfunction (OR 3.7 – 1 point)</li> <li>• Preoperative intubation (OR 4.3 – 1 point)</li> <li>• Severe TR (OR 4.1 – 1 point)</li> <li>• Heart rate <math>\geq 100</math> (OR 2.0 – 1 point)</li> </ul>	<ul style="list-style-type: none"> <li>• <math>\leq 1</math> – low risk (93% NPV)</li> <li>• <math>\geq 4</math> – high risk</li> </ul>

**INTERMACS RVAD  
risk model  
2017 (Kierman)<sup>10</sup>**

- 9976 LVADS
- 37% DT

- 100% (9976)

- RVF rate 4%
- Need for RVAD

Multivariate Logistic  
Regression Analysis/  
Correlations

- Prior CABG/valve surgery (OR 1.70)
- INTERMACS profile 1 (OR 2.79)
- INTERMACS profile 2 (OR 1.98)
- ECMO within 48 h (OR 2.71)
- HD or UF within 48 h (OR 1.67)
- Creatinine (OR 1.25)
- INR (OR 1.50)
- Total bilirubin (OR 1.13)
- WBC (OR 1.04)
- RA pressure (OR 1.05)
- Stroke volume  $\times 100$  (OR 0.89)
- PA pulse pressure (OR 0.96)
- LVEDD (OR 0.80)
- TR (severe) (OR 1.61)
- Other concomitant procedure (OR 1.47)
- Concomitant TV repair (OR 1.06)

**EUROMACS-RHF  
risk score  
2018 (Soliman)<sup>14</sup>**

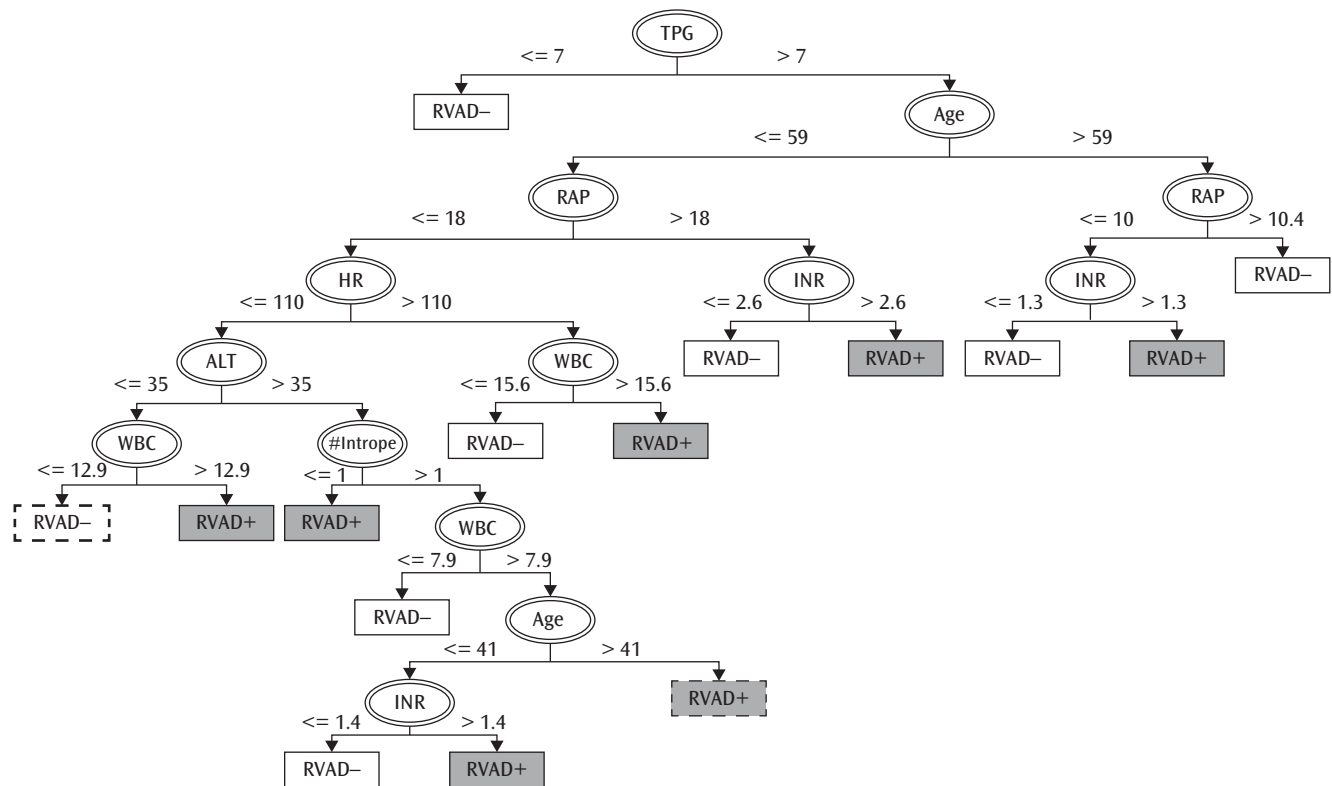
- 2988 LVADS
- 37% BTD
- 24.5% BTT
- 17% DT

- 100% (2978)

- RVF rate 21.7%
- Need for RVAD
- Inotrope  $\geq 14$  days
- Inhaled NO  $\geq 48$  hrs

- $\geq 5$  – high risk

Abbreviations: ACEI = angiotensin-converting enzyme inhibitor; ALT = alanine aminotransferase; ARB = angiotensin receptor blocker; AST = aspartate aminotransferase; BiVAD = biventricular assist device; BP = blood pressure; BTC = bridge to candidacy; BTT = bridge to transplantation; BUN = blood urea nitrogen; CVP = central venous pressure; DT = destination therapy; HD = hemodialysis; IABP = intra-aortic balloon pump; INR = international normalized ratio; ITT = intension-to-treat; LVAD = left ventricular assist device; NO = nitric oxide; PCWP = pulmonary capillary wedge pressure; PVR = pulmonary vascular resistance; RAP = right atrial pressure; RV = right ventricle; RVAD = right ventricular assist device; RVF = right ventricular failure; RVSWI = right ventricular stroke work index; TR = tricuspid regurgitation.



**Figure 38.7.** Pittsburgh decision tree for predicting RV failure.

Reprinted from Wang Y et al., Decision tree for adjuvant right ventricular support in patients receiving a left ventricular assist device, *Journal of Heart and Lung Transplantation* 2012;31:140–149, Copyright (2012), with permission from Elsevier.

significant reduction in systemic vascular resistance. The authors suggest the additive effects of combined treatment of iNO + Iloprost led to improved RV function and avoided the need for RV mechanical support.

Sildenafil is an oral phosphodiesterase-5 (PDE-5) inhibitor used as a selective vasodilator to lower pulmonary vascular resistance (PVR) in persistent pulmonary hypertension post-LVAD. It has been shown to be effective for primary pulmonary hypertension. It has a relatively long half-life of 4 hours, making its duration of action on pulmonary artery pressure an attractive option to facilitate the weaning of iNO and inotropic agents after LVAD implantation.<sup>56</sup>

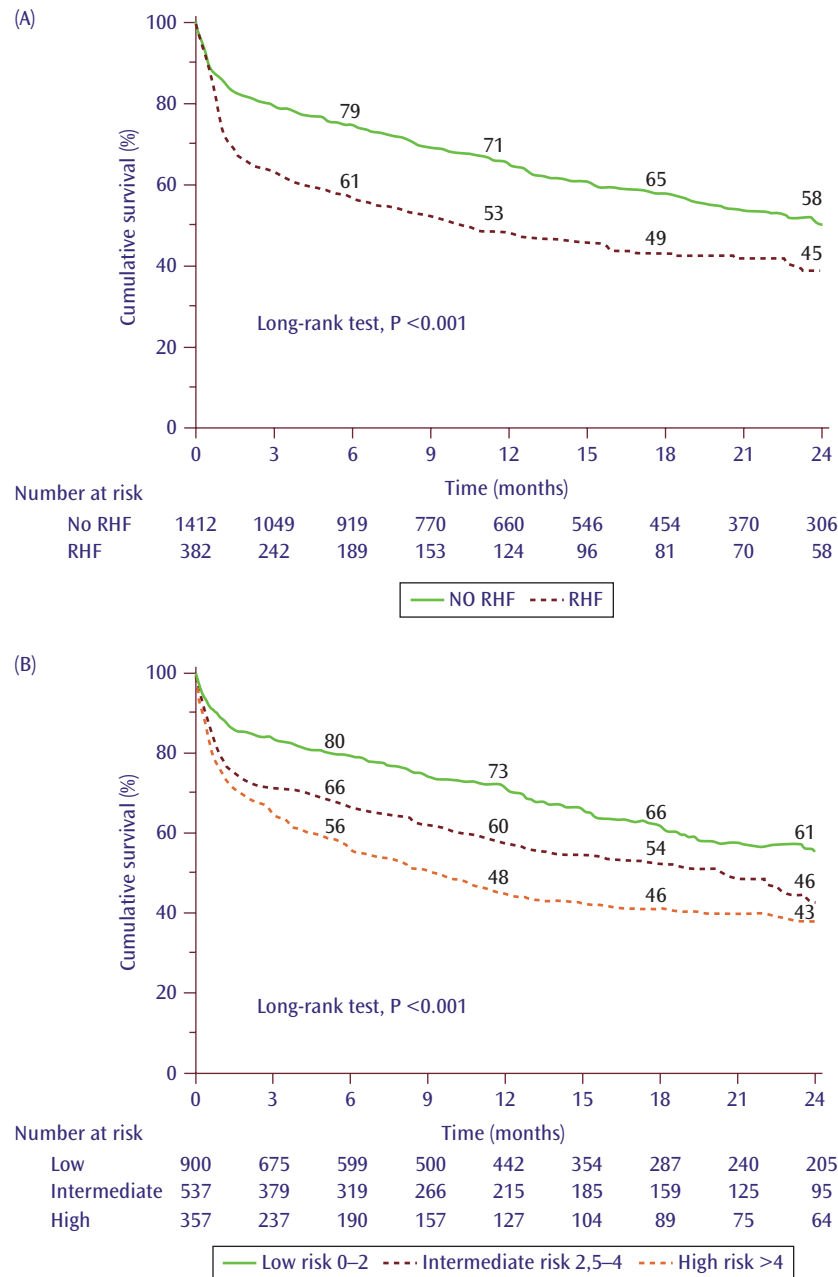
## Surgical Management of RV Failure after LVAD

Based in INTERMACS definition of right ventricular failure after LVAD, mild to severe RVF can generally be managed medically. On the other hand, acute, severe RVF is defined as CVP >16 with need for RVAD (or death occurring during VAD implant admission).<sup>57</sup> Severe acute RVF necessitating a temporary or durable right ventricular assist device occurs in 6%–11% of LVAD implants.<sup>58</sup> No publication to date defines the criteria for RVAD implantation; thus the

characterization of patients with significant RVF requiring biventricular support continues to be center and physician specific. Common indications for RVAD placement include persistent elevation of right atrial pressure despite aggressive diuretic and inotropic support, inability to wean inotrope or vasopressor support after CF-LVAD placement, and ongoing evidence of multi-organ failure, including cardiorenal syndrome or hepatic congestion, despite optimal medical management.<sup>59,60</sup>

Patients with high risk for RVF despite hemodynamic optimization need to be considered for preemptive biventricular support or total artificial heart (TAH). While one of the most significant risk factors for mortality in patients receiving an LVAD is the development of RVF requiring an RVAD (Figure 38.8), those patients with immediate biventricular assist device implantation have significant improvement in survival and ability to bridge to transplant compared to those with delayed implant (>24–48 hours).<sup>27,61</sup> There are several temporary ventricular assist device solutions that allow for a prolonged RV support in anticipation of RV recovery. The lack of a reliable device designed specifically for RV support limits permanent treatment options for patients with biventricular failure or isolated RV support.

A number of options exist for RVAD support at the time of separation from CPB after an LVAD implant. Traditional



**Figure 38.8.** Two-year Kaplan-Meier mortality based on (A) right-sided heart failure (RVF) and (B) European Registry for Patients with Mechanical Circulatory Support (EUROMACS) RVF risk score.

Reprinted with permission from Soliman O II et al., Derivation and validation of a novel right-sided heart failure model after implantation of continuous flow left ventricular assist devices, *Circulation* 2018;137(9):891–906, <https://www.ahajournals.org/journal/circ> © American Heart Association, Inc. All rights reserved.

practice has been to use a Dacron graft attached to the pulmonary artery, passed through a subxiphoid space, where it attaches to the RVAD outflow limb of an extracorporeal circuit. The RVAD inflow cannula can be placed directly in the right atrium, tunneling through the subxiphoid space and connecting to the inflow limb of the same circuit. A number of extracorporeal centrifugal pumps are available for

this purpose, with balancing of flows performed under TEE guidance. When the RVAD is explanted, the outflow graft is ligated, and the insertion site can be secondarily closed. The inflow cannula can be removed with pursestring closure of the right atrium. This technique is beneficial in allowing for early extubation, opportunity for pulmonary support using an oxygenator, and ambulation while on the device.



In cases where RV recovery is felt to be unlikely within a week of RVAD support, durable LVADs have been used successfully when implanted for right ventricular support. In the largest multi-center reported analysis of biventricular support with durable continuous-flow rotary pumps, Shah et al. noted a high rate of suspected right-sided VAD thrombosis (37%), warranting further investigation into its etiology and implications.<sup>58</sup> Durable biventricular assist device (BiVAD) support, when initiated in a concomitant fashion, was associated with reduced intensive care unit length of stay (ICU LOS), higher rates of hospital discharge, and trended toward improved 1-year survival compared with staged BiVADs. Previous studies have suggested that patients receiving a planned BiVAD had a significantly higher survival to hospital discharge than those receiving delayed BiVAD support.<sup>32,61</sup>

The most common temporary RVAD no longer requires direct cannulation of the pulmonary artery and right atrium with the chest open. There are presently two available percutaneous device options for RV mechanical support—the Impella RP (Abiomed, Danvers, MA) and the TandemLife Protek Duo (TPD, TandemLife, Pittsburgh, PA). Initial experience with both devices has been promising but limited.

The Impella RP is a minimally invasive, 22 Fr catheter-based percutaneous pump intended for use up to 14 days. Placement is under fluoroscopic guidance through the femoral vein, with the catheter pump advanced antegrade until positioned across the tricuspid and pulmonary valves. The inflow is placed in the inferior vena cava and pumps blood through the outflow into the pulmonary artery (rate up to 4.0 L/min).<sup>62</sup> Results from the RECOVER RIGHT RP Impella Trial demonstrated the device provided on average 3 L of flow, with improvement in RA pressure, cardiac index, and the need for inotropic support.<sup>63</sup> The main limitation of this device includes mobilization restrictions and risk for pump displacement related to the femoral insertion site.

The Tandem Protek Duo (TPD) is a centrifugal pump that can be placed via the internal jugular vein. The cannulas are either 29 Fr or 31 Fr with dual channels. The cannula has the advantage of full mobilization of the patient and can be removed at bedside in the event of RV recovery. The inflow channel is placed in the superior vena cava (SVC) and the right atrium, from where the blood is drained into the extracorporeal centrifugal pump, such as the CentriMag or TandemHeart (CardiacAssist, Inc). The blood is then pumped back into the outflow channel into the pulmonary artery (rate up to 4.0 L/min).<sup>64</sup>

Given the high risk associated with RV failure requiring RVAD implant, cardiac transplantation still represents the ideal treatment for management of these individuals. Based on the new heart allocation system that was adopted in the United States on October 18, 2018, patients with non-dischargeable RVADs will receive higher prioritization, with the potential for earlier transplantation in cases of failure to wean. Although there is limited literature to evaluate

the criteria and success for RVAD weaning, overall the success rate appears to be around 80%, suggesting that despite its increase in morbidity and mortality, it is a viable option for RVF management given its ever-increasing relevance.

## Conclusion

Despite the dramatic expansion of short- and long-term left ventricular failure mechanical support options over the past two decades, RVF remains the Achilles heel of LVAD therapy. The diagnosis, prevention, and long-term management of RVF remains a significant challenge in the patient with advanced heart failure, making this an imperative opportunity for further thought and research.

## REFERENCES

1. LaRue SJ, Raymer DS, Pierce BR, Nassif ME, Sparrow CT, Vader JM. Clinical outcomes associated with INTERMACS-defined right heart failure after left ventricular assist device implantation. *J Heart Lung Transplant*. 2017;36(4):475–477. doi:10.1016/j.healun.2016.12.017.
2. Drakos SG, Kfoury AG, Long JW, et al. Effect of mechanical circulatory support on outcomes after heart transplantation. *J Heart Lung Transplant*. 2006;25(1):22–28. doi:10.1016/j.healun.2005.07.014.
3. Dang NC, Topkara VK, Mercado M, et al. Right heart failure after left ventricular assist device implantation in patients with chronic congestive heart failure. *J Heart Lung Transplant*. 2006;25(1):1–6. doi:10.1016/j.healun.2005.07.008.
4. Potapov E V., Stepanenko A, Dandel M, et al. Tricuspid incompetence and geometry of the right ventricle as predictors of right ventricular function after implantation of a left ventricular assist device. *J Heart Lung Transplant*. 2008;27(12):1275–1281. doi:10.1016/j.healun.2008.08.012.
5. Matthews JC, Koelling TM, Pagani FD, Aaronson KD. The right ventricular failure risk score: a pre-operative tool for assessing the risk of right ventricular failure in left ventricular assist device candidates. *J Am Coll Cardiol*. 2008;51(22):2163–2172. doi:10.1016/j.jacc.2008.03.009
6. Drakos SG, Janicki L, Horne BD, et al. Risk factors predictive of right ventricular failure after left ventricular assist device implantation. *Am J Cardiol*. 2010;105(7):1030–1035. doi:10.1016/j.amjcard.2009.11.026.
7. Kalogeropoulos AP, Kelkar A, Weinberger JF, et al. Validation of clinical scores for right ventricular failure prediction after implantation of continuous-flow left ventricular assist devices. *J Heart Lung Transplant*. 2015;34(12):1595–1603. doi:10.1016/j.healun.2015.05.005.
8. Kurihara C, Critsinelis AC, Kawabori M, et al. Frequency and consequences of right-sided heart failure after continuous-flow left ventricular assist device implantation. *Am J Cardiol*. 2018;121(3):336–342. doi:10.1016/j.amjcard.2017.10.022.
9. Kirklin JK, Pagani FD, Kormos RL, et al. Eighth annual INTERMACS report: special focus on framing the impact of adverse events. *J Heart Lung Transplant*. 2017;36(10):1080–1086. doi:10.1016/j.healun.2017.07.005.

10. Kiernan MS, Wilson Grandin E, Brinkley M, et al. Early right ventricular assist device use in patients undergoing continuous-flow left ventricular assist device implantation: incidence and risk factors from the inter-agency registry for mechanically assisted circulatory support. *Circ Heart Fail.* 2017;10(10):1–10. doi:10.1161/CIRCHEARTFAILURE.117.003863.
11. Lahm T, Mccaslin CA, Wozniak TC, et al. Medical and surgical treatment of acute right ventricular failure. *JAC.* 2010;56(18):1435–1446. doi:10.1016/j.jacc.2010.05.046.
12. Kormos RL, Teuteberg JJ, Pagani FD, et al. Right ventricular failure in patients with the HeartMate II continuous-flow left ventricular assist device: incidence, risk factors, and effect on outcomes. *J Thorac Cardiovasc Surg.* 2010;139(5):1316–1324. doi:10.1016/j.jtcvs.2009.11.020.
13. Fitzpatrick JR, Frederick JR, Hsu VM, et al. Risk score derived from pre-operative data analysis predicts the need for biventricular mechanical circulatory support. *J Heart Lung Transplant.* 2008;27(12):1286–1292. doi:10.1016/j.healun.2008.09.006.
14. Soliman OII, Akin S, Muslem R, et al. Derivation and validation of a novel right-sided heart failure model after implantation of continuous flow left ventricular assist devices. *Circulation.* 2018;137(9):891–906. doi:10.1161/CIRCULATIONAHA.117.030543.
15. Haddad F, Hunt SA, Rosenthal DN, Murphy DJ. Right ventricular function in cardiovascular disease. Part I. Anatomy, physiology, aging, and functional assessment of the right ventricle. *Circulation.* 2008;117(11):1436–1448. doi:10.1161/CIRCULATIONAHA.107.653576.
16. Konstam MA, Kiernan MS, Bernstein D, et al. *Evaluation and Management of Right-Sided Heart Failure: A Scientific Statement From the American Heart Association*; 2018. doi:10.1161/CIR.0000000000000560.
17. Friedberg MK, Redington AN. Right versus left ventricular failure: differences, similarities, and interactions. *Circulation.* 2014;129(9):1033–1044. doi:10.1161/CIRCULATIONAHA.113.001375.
18. Guazzi M, Naeije R. Pulmonary hypertension in heart failure. *J Am Coll Cardiol.* 2017;69(13):1718–1734. doi:10.1016/j.jacc.2017.01.051.
19. Tedford RJ. Determinants of right ventricular afterload (2013 Grover Conference series). *Pulm Circ.* 2014;4(2):211–219. doi:10.1086/676020.
20. Vonk-Noordegraaf A, Haddad F, Chin KM, et al. Right heart adaptation to pulmonary arterial hypertension: physiology and pathobiology. *J Am Coll Cardiol.* 2013;62(25 SUPPL.):22–33. doi:10.1016/j.jacc.2013.10.027.
21. Wagener G, Bakker J. Physiology and clinical implications. 2015;81(12):1377–1383.
22. Dandel M, Krabatsch T, Falk V. Left ventricular vs. biventricular mechanical support: decision making and strategies for avoidance of right heart failure after left ventricular assist device implantation. *Int J Cardiol.* 2015;198:241–250. doi:10.1016/j.ijcard.2015.06.103.
23. Lampert BC, Teuteberg JJ. Right ventricular failure after left ventricular assist devices. *J Heart Lung Transplant.* 2015;34(9):1123–1130. doi:10.1016/j.healun.2015.06.015.
24. Santamore WP, Dell'Italia LJ. Ventricular interdependence: significant left ventricular contributions to right ventricular systolic function. *Prog Cardiovasc Dis.* 1998;40(4):289–308. doi:10.1016/S0033-0620(98)80049-2.
25. Sparrow CMM, LaRue SJMM, Schilling JDMP. Intersection of pulmonary hypertension and right ventricular dysfunction in patients on left ventricular assist device support. *Circ Heart Fail.* 2018 Jan;11(1):e004255. doi:10.1161/CIRCHEARTFAILURE.117.004255
26. Houston BA, Shah KB, Mehra MR, Tedford RJ. A new “twist” on right heart failure with left ventricular assist systems. *J Heart Lung Transplant.* 2017;36(7):701–707. doi:10.1016/j.healun.2017.03.014.
27. Morgan JA, Paone G, Nemeh HW, et al. Impact of continuous-flow left ventricular assist device support on right ventricular function. *J Heart Lung Transplant.* 2013;32(4):398–403. doi:10.1016/j.healun.2012.12.018.
28. Rich JD. Right ventricular failure in patients with left ventricular assist devices. *Cardiol Clin.* 2012;30(2):291–302. doi:10.1016/j.ccl.2012.03.008.
29. Andersen M, Videbæk R, Boesgaard S, Sander K, Hansen PB, Gustafsson F. Incidence of ventricular arrhythmias in patients on long-term support with a continuous-flow assist device (HeartMate II). *J Heart Lung Transplant.* 2009;28(7):733–735. doi:10.1016/j.healun.2009.03.011.
30. El-Banayosy A, Arusoglu L, Kizner L, et al. *Predictors of Survival in Patients Bridged to Transplantation with the Thoratec VAD Device: A Single-Center Retrospective Study on More Than 100 Patients*; 2000. [https://ac.els-cdn.com/S1053249800001741/1-s2.0-S1053249800001741-main.pdf?\\_tid=43f12126-34b0-40ad-8151-a24d866041d6&acdnat=1544542353\\_fca87da8c527ee447f0cc998a9e7fe01](https://ac.els-cdn.com/S1053249800001741/1-s2.0-S1053249800001741-main.pdf?_tid=43f12126-34b0-40ad-8151-a24d866041d6&acdnat=1544542353_fca87da8c527ee447f0cc998a9e7fe01). Accessed December 11, 2018.
31. Wang Y, Simon MA, Bonde P, et al. Decision tree for adjuvant right ventricular support in patients receiving a left ventricular assist device. *J Heart Lung Transplant.* 2012;31(2):140–149. doi:10.1016/j.healun.2011.11.003.
32. Takeda K, Naka Y, Yang JA, et al. Outcome of unplanned right ventricular assist device support for severe right heart failure after implantable left ventricular assist device insertion. *J Heart Lung Transplant.* 2014;33:141–148. doi:10.1016/j.healun.2013.06.025.
33. Atluri P, Goldstone AB, Fairman AS, et al. Predicting right ventricular failure in the modern, continuous flow left ventricular assist device era. *Ann Thorac Surg.* 2013;96(3):857–864. doi:10.1016/j.athoracsur.2013.03.099.
34. Kiernan MS, Sundareswaran KS, Pham DT, et al. Preoperative determinants of quality of life and functional capacity response to left ventricular assist device therapy. *J Card Fail.* 2016;22(10):797–805. doi:10.1016/j.cardfail.2016.01.006.
35. Bellavia D, Iacovoni A, Scardulla C, et al. Prediction of right ventricular failure after ventricular assist device implant: systematic review and meta-analysis of observational studies. *Eur J Heart Fail.* 2017;19(7):926–946. doi:10.1002/ejhf.733.
36. Boegershausen N, Zayat R, Aljalloud A, et al. Risk factors for the development of right ventricular failure after left ventricular assist device implantation: a single-centre retrospective with focus on deformation imaging. *Eur J Cardiothorac Surg.* 2017;52(6):1069–1076. doi:10.1093/ejcts/ezx123.
37. Meineri M, Van Rensburg AE, Vegas A. Right ventricular failure after LVAD implantation: prevention and treatment. *Best Pract Res Clin Anaesthesiol.* 2012;26(2):217–229. doi:10.1016/j.bpa.2012.03.006.
38. Argiriou M, Kolokotron SM, Sakellaridis T, et al. Right heart failure post left ventricular assist

- device implantation. *J Thorac Dis.* 2014;6(Suppl1). doi:10.3978/j.issn.2072-1439.2013.10.26.
39. Morine KJ, Kiernan MS, Pham DT, Paruchuri V, Denofrio D, Kapur NK. Pulmonary artery pulsatility index is associated with right ventricular failure after left ventricular assist device surgery. *J Card Fail.* 2016;22(2):110–116. doi:10.1016/j.cardfail.2015.10.019.
  40. Topilsky Y, Hasin T, Oh JK, et al. Echocardiographic variables after left ventricular assist device implantation associated with adverse outcome. *Circ Cardiovasc Imaging.* 2011;4(6):648–661. doi:10.1161/CIRCIMAGING.111.965335.
  41. Kato TS, Farr M, Schulze PC, et al. Usefulness of two-dimensional echocardiographic parameters of the left side of the heart to predict right ventricular failure after left ventricular assist device implantation. *Am J Cardiol.* 2012;109(2):246–251. doi:10.1016/j.amjcard.2011.08.040.
  42. Piacentino V, Williams ML, Depp T, et al. Impact of tricuspid valve regurgitation in patients treated with implantable left ventricular assist devices. *Ann Thorac Surg.* 2011;91(5):1342–1347. doi:10.1016/j.athoracsur.2011.01.053.
  43. Vivo RP, Cordero-Reyes AM, Qamar U, et al. Increased right-to-left ventricle diameter ratio is a strong predictor of right ventricular failure after left ventricular assist device. *J Heart Lung Transplant.* 2013;32(8):792–799. doi:10.1016/j.healun.2013.05.016.
  44. Slaughter M, Pagani F, Rogers J, et al. Clinical management of continuous-flow left ventricular assist devices in advanced heart failure. *J Heart Lung Transplant.* 2010;29(4):S1–S39. doi:10.1016/j.healun.2010.01.011.
  45. Van Meter CH. Right heart failure: best treated by avoidance. *Ann Thorac Surg.* 2001;71(3 Suppl):1–3. doi:10.1016/S0003-4975(00)02637-0.
  46. Fida N, Loebe M, Estep JD, Guha A. Predictors and management of right heart failure after left ventricular assist device implantation. *Methodist Debaquey Cardiovasc J.* 2015;11(1):18–23. doi:10.14797/mdcj-11-1-18.
  47. Schenk S, McCarthy PM, Blackstone EH, et al. Duration of inotropic support after left ventricular assist device implantation: risk factors and impact on outcome. *J Thorac Cardiovasc Surg.* 2006;131(2):447–454. doi:10.1016/j.jtcvs.2005.09.031.
  48. Cleland JGF, Swedberg K, Follath F, et al. The EuroHeart Failure survey programme: a survey on the quality of care among patients with heart failure in Europe. Part 1. Patient characteristics and diagnosis. *Eur Heart J.* 2003;24(5):442–463. doi:10.1016/S0195-668X(02)00823-0.
  49. Haddad F, Couture P, Tousignant C, Denault AY. The right ventricle in cardiac surgery, a perioperative perspective. I. Anatomy, physiology, and assessment. *Anesth Analg.* 2009;108(2):407–421. doi:10.1213/ane.0b013e31818f8623.
  50. Haglund NA, Burdorf A, Jones T, et al. Inhaled milrinone after left ventricular assist device implantation. *J Card Fail.* 2015;21(10):792–797. doi:10.1016/j.cardfail.2015.04.011.
  51. Potapov E, Meyer D, Swaminathan M, et al. Inhaled nitric oxide after left ventricular assist device implantation: a prospective, randomized, double-blind, multicenter, placebo-controlled trial. *J Heart Lung Transplant.* 2011;30(8):870–878. doi:10.1016/j.healun.2011.03.005.
  52. Kukucka M, Potapov E, Stepanenko A, et al. Acute impact of left ventricular unloading by left ventricular assist device on the right ventricle geometry and function: effect of nitric oxide inhalation. *J Thorac Cardiovasc Surg.* 2011;141(4):1009–1014. doi:10.1016/j.jtcvs.2010.08.010.
  53. Sabato LA, Salerno DM, Moretz JD, Jennings DL. Inhaled pulmonary vasodilator therapy for management of right ventricular dysfunction after left ventricular assist device placement and cardiac transplantation. *Pharmacotherapy.* 2017;37(8):944–955. doi:10.1002/phar.1959.
  54. Haraldsson a, Kieler-Jensen N, Wadenvik H, Ricksten SE. Inhaled prostacyclin and platelet function after cardiac surgery and cardiopulmonary bypass. *Intensive Care Med.* 2000;26(2):188–194. doi:10.1007/s001340050044.
  55. Antoniou T, Prokakis C, Athanasopoulos G, et al. Inhaled nitric oxide plus iloprost in the setting of post-left assist device right heart dysfunction. *Ann Thorac Surg.* 2012;94(3):792–798. doi:10.1016/j.athoracsur.2012.04.046.
  56. Klodell CT, Morey TE, Lobato EB, et al. Effect of sildenafinil on pulmonary artery pressure, systemic pressure, and nitric oxide utilization in patients with left ventricular assist devices. *Ann Thorac Surg.* 2007;83(1):68–71. doi:10.1016/j.athoracsur.2006.08.051.
  57. N LIU. *INTERMACS Appendix A: Adverse Event Definitions.* 2011.
  58. Shah P, Ha R, Singh R, et al. Multicenter experience with durable biventricular assist devices. *J Heart Lung Transplant.* 2018;37(9):1093–1101. doi:10.1016/j.healun.2018.05.001.
  59. Saito S, Sakaguchi T, Miyagawa S, et al. Recovery of right heart function with temporary right ventricular assist using a centrifugal pump in patients with severe biventricular failure. *HEALUN.* 2012;31(8):858–864. doi:10.1016/j.healun.2012.03.002.
  60. Ravichandran AK, Baran DA, Stelling K, Cowger JA, Salerno CT. Outcomes with the Tandem Protek Duo Dual-Lumen percutaneous right ventricular assist device. *ASAIO J.* 2018 Jul/Aug;64(4):570–572. doi:10.1097/MAT.0000000000000709
  61. Fitzpatrick JR, Frederick JR, Hiesinger W, et al. Early planned institution of biventricular mechanical circulatory support results in improved outcomes compared with delayed conversion of a left ventricular assist device to a biventricular assist device. *J Thorac Cardiovasc Surg.* 2009;137(4):971–977. doi:10.1016/j.jtcvs.2008.09.021.
  62. Pieri M, Pappalardo F. Impella RP in the treatment of right ventricular failure: what we know and where we go. *J Cardiothorac Vasc Anesth.* 2018;32(5):2339–2343. doi:10.1053/j.jvca.2018.06.007.
  63. Anderson MB, Goldstein J, Milano C, et al. Benefits of a novel percutaneous ventricular assist device for right heart failure: the prospective RECOVER RIGHT study of the Impella RP device. *J Heart Lung Transplant.* 2015;34(12):1549–1560. doi:10.1016/j.healun.2015.08.018.
  64. Sultan I, Kilic A. Short-term circulatory and right ventricle support in cardiogenic shock: extracorporeal membrane oxygenation, right ventricular failure heart failure cardiac surgery mechanical circulatory support. *Heart Fail Clin.* 2019;14(4):579–583. doi:10.1016/j.hfc.2018.06.014.

## Introduction

**A**cute kidney injury (AKI) is frequently encountered in the advanced heart failure practice, occurring in greater than 50% of patients with decompensated heart failure and in over 70% patients admitted with cardiogenic shock.<sup>1</sup> It also represents a common complication after cardiac surgery with an incidence that varies between 30% and 90% depending on the type of procedure performed. The institution of cardiopulmonary bypass (CPB) has been associated with AKI in up to 35% of patients,<sup>2-4</sup> while the incidence following left ventricular assist device (LVAD) implantation has been reported between 7% and 56% in various series.<sup>5,6</sup> In one recent retrospective review of 170 patients, 70% developed AKI and 9.5% needed renal replacement therapy (RRT) within 1 week after LVAD surgery.<sup>7</sup>

Even minimal elevations in serum creatinine correlate closely with an increased mortality rate in patients undergoing cardiothoracic surgery.<sup>8</sup> When the renal injury is significant enough to warrant renal replacement therapy, the odds of death increase eightfold.<sup>9</sup> Patients with AKI after LVAD implantation appear to be particularly sensitive to increased 30- and 180-day mortality rates, prolonged ventilator dependence, and longer hospital stays, confirming that AKI is a critical marker of poor outcomes in patients who undergo mechanical circulatory support (MCS) surgeries.<sup>10</sup>

## Renal Dysfunction in Heart Failure

Cardiorenal syndrome is identified in over 60% of patients admitted with heart failure.<sup>11</sup> Heart failure leads to renal hypoperfusion. In addition to this, renal arterial vasoconstriction and activation of renin angiotensin system

(RAAS) leads to further reduction of glomerular filtration. Another important factor that contributes to renal dysfunction is right heart failure. Right ventricular (RV) dysfunction leads to systemic venous congestion, which impairs renal blood flow and oxygenation (Figure 39.1).<sup>12</sup>

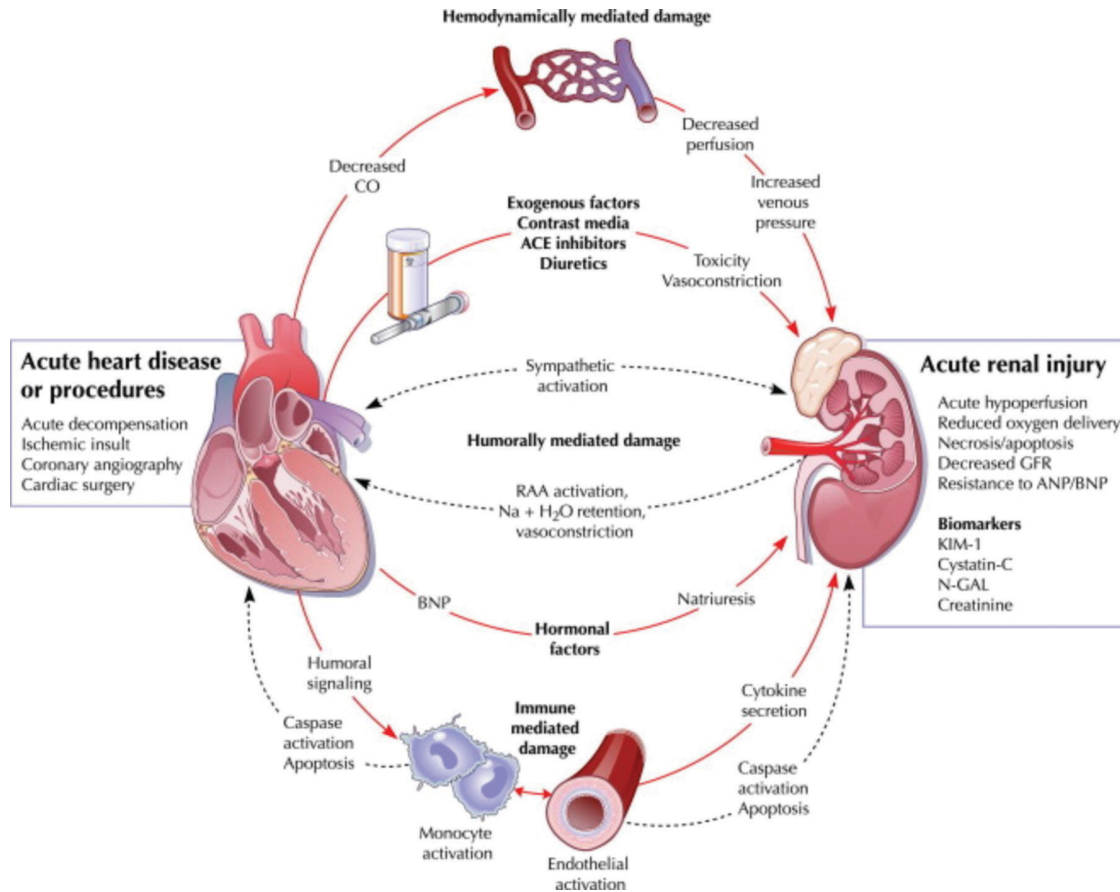
In addition to the preceding factors, iatrogenic exposure to intravenous contrast agents and antibiotics such as aminoglycosides pose a threat to kidney function. Although reno-protective in long term, RAAS blockers can decrease estimated glomerular filtration rate (eGFR) when used in times of hemodynamic instability.<sup>13,14</sup>

Reduced kidney function in heart failure patients has a reversible and irreversible component. The reversible component is due to the hemodynamic changes, and the irreversible component is due to the parenchymal damage accrued due to long-standing hypoperfusion, fibrosis, and systemic hypertension. Also, renal parenchymal disease progresses in these patients due to repeated AKI events, oxidative stress, and inflammatory mediators. Identifying the duration of renal dysfunction is important in predicting the reversibility of renal dysfunction.

## Prevention of Renal Dysfunction in the Perioperative Period

### Preoperative Period

Hypervolemia during the preoperative period has been identified as an independent predictor for dialysis following cardiac surgery.<sup>16</sup> It is our general practice to diurese patients prior to LVAD implantation on the basis that a lower a lower central venous pressure (CVP) decreases the incidence of postoperative right ventricular failure. Although an excessive reliance on arbitrary numerical



**Figure 39.1.** Mechanisms of renal dysfunction in the setting of advanced heart failure.

Reprinted from Ronco C et al., Cardiorenal syndrome, *Journal of the American College of Cardiology* 2016;52:1527–1539, Copyright (2016), with permission from Elsevier.

values should be avoided in favor of observing the entire clinical picture, the International Society of Heart and Lung Transplantation (ISHLT) recommends maintaining CVPs between 4 and 14 mmHg and mean arterial pressures (MAPs) between 65 and 90 mmHg.<sup>17</sup> The incidence of AKI increases when MAPs are below 55 to 60 mmHg.<sup>18</sup>

Avoidance of preoperative intravenous contrast agents and withdrawal of RAAS blockers in the immediate preoperative period is generally advised. RAAS blockers must be restarted once hemodynamics permit as they preserve kidney function in the long run.<sup>19</sup> Based on a multivariate regression model, anemia with hemoglobin <10 g/dl is an independent risk factor for AKI. Hence the management of anemia is important to improve outcomes.

### Intraoperative Period

Judicious intraoperative volume resuscitation should be employed in order to maintain optimal filling pressures for renal perfusion. Other potentially modifiable intraoperative risk factors for AKI include reducing the duration of cardiopulmonary bypass when feasible.<sup>20</sup>

## Post-Implantation Renal Failure Management

Due to the compromised hemodynamics associated with advanced heart failure, it is common to see AKI following LVAD implantation, with an incidence ranging from 7% to 56%.<sup>5,6</sup> The development of AKI in this setting poses a significant mortality risk.<sup>21–23</sup> Despite substantial improvements in MCS technology over the past three decades, there is no strong evidence to support the notion that the use of continuous-flow assist devices has lowered the risk of AKI compared to pulsatile flow devices.<sup>24</sup> Although the factors contributing to AKI after LVAD implantation are complex and have not been fully elucidated, the degree of renal dysfunction prior to the LVAD implantation appears to pose the greatest risk.<sup>5</sup>

Various pharmacological and non-pharmacological strategies have been proposed to lower the incidence of AKI after cardiac surgery. It seems reasonable that the benefits of these approaches may have relevance after LVAD/MCS implantation.

Fenoldopam, a selective dopamine-1 receptor agonist, has renal vasodilatory properties.<sup>25</sup> While there are smaller randomized controlled trials showing the efficacy of fenoldopam infusion as a reno-protective agent, larger randomized trials are needed to definitively establish this relationship.<sup>26,27</sup> Although traditionally viewed as a renal protective agent, dopamine itself does not appear to have any reno-protective effect based on a comprehensive review of the Cochrane database.<sup>28</sup> Hydration with 0.45% saline has been shown to decrease the incidence of AKI in high-risk patients after cardiac surgery.<sup>29</sup> However, there is also concern that chloride-rich fluids in critically ill patients can contribute to increased rates of renal dysfunction and RRT.<sup>30</sup> Although there is some evidence favoring the use of balanced solutions (Hartman solution, Plasma-Lyte) based on prospective studies, larger blinded randomized controlled trials in MCS patients are needed to confirm the superiority of the use of balanced solutions over chloride-rich fluids.<sup>31</sup> There is no evidence in favor of bicarbonate over normal saline in decreasing the incidence of AKI in preoperative period.<sup>32</sup> Similarly, there is no role for the use of osmotic diuretics such as mannitol in reducing the incidence of postoperative AKI.<sup>33</sup>

## Renal Dysfunction Due to Right Heart Failure after LVAD Placement

Incidence of right heart failure (RH failure)<sup>34</sup> after LVAD implantation varies between 5% and 50%. After an LVAD is placed, the increase in cardiac output and venous return often overwhelms the function of an already compromised right ventricle. Reduction in the size of the left ventricle and left atrium causes the ventricular septum to bow into the left ventricle. This altered geometry further decreases the RV output. The resultant RV dysfunction leads to systemic venous congestion, further reducing the renal perfusion. Therefore, early diagnosis of RV dysfunction using right heart catheterization to optimize the LVAD settings to prevent RV septal bowing is an important step in prevention of post-LVAD acute kidney injury. Patients with RV failure may need inotropes, RV mechanical support, or extra corporeal membrane oxygenation. Preoperative hemodynamic indices may be used to predict the need for biventricular support or immediate post-operative RV support (Table 39.1).<sup>35</sup>

## Effect of Continuous-Flow Mechanical Circulation on Kidneys

Compounding the risks of cardiac surgical procedures in the advanced heart failure population are the unique hemodynamic changes that occur with the current generation of continuous-flow devices. Compared to the pulsatile-flow

**Table 39.1 • Preoperative Predictors of RV Support**

1. Cardiac index  $\leq 2.2$  L/min/m<sup>2</sup>
2. RV stroke work index  $\leq 0.25$  mmHg · liter/m<sup>2</sup>
3. Severe preoperative RV failure
4. Creatinine  $\geq 1.9$  mg/dl
5. Prior cardiac surgery
6. Systolic blood pressure  $\leq 96$  mmHg

Reprinted from Fitzpatrick JR, 3rd et al, Risk score derived from preoperative data analysis predicts the need for biventricular mechanical circulatory support, *Journal of Heart and Lung Transplantation* 2008;27(12):1286–1292, Copyright (2008), with permission from Elsevier.

devices that were used historically, continuous-flow left ventricular assist devices (CF-LVADs) typically generate a higher diastolic blood pressure (BP) within the kidney, resulting in a marked reduction in renin levels, an excessive activation of the RAAS system, and the resultant morbidities associated with these changes.<sup>36</sup> Animal studies have demonstrated renal arterial smooth muscle thickening with interstitial leukocyte infiltration and perivascular inflammation after CF-LVAD implantation.<sup>37,38</sup> Despite early improvements in glomerular filtration rates (GFR) after surgery, renal function tends to be only marginally improved from baseline at the end of 1 year, and most patients on MCS continue to have significant ongoing renal dysfunction.<sup>39</sup>

## Renal Replacement Therapy in MCS Patients

Although the causes of AKI in the setting of LVAD support represent a unique combination of factors, the indications for initiating RRT mirror those of a conventional clinical scenario. Volume overload, medically refractory hyperkalemia, acidosis, oligo-anuria, and progressive uremia represent the common indications for RRT in this patient population. While there is no evidence to support the superiority of continuous over intermittent hemodialysis (HD) if the patient can tolerate intermittent HD,<sup>40</sup> the reality of the postoperative hemodynamic conditions after LVAD surgery typically mandates that a continuous modality of RRT, such as continuous veno-venous hemofiltration (CVVH) or continuous veno-venous hemodialysis (CVVHD), be employed as first-line therapy. If a continuous modality is in fact used, a standard dose of replacement fluid (20–30 ml/kg/hr) is generally recommended to address the clearance needs.<sup>41</sup> It should be noted, however, that the data comparing these modalities have been extrapolated from studies involving non-heart-failure patients managed in intensive care units. There are currently no randomized studies comparing the differences

between intermittent and continuous dialysis strategies in a post-cardiac-surgical population, let alone in patients supported on ventricular assist devices.

Systolic and diastolic BP measurements with Korotkoff sounds or automated BP-cuffs are often unreliable in patients with continuous-flow devices due to narrow pulse pressures (PP). Therefore, the current recommendations are to measure MAPs using Doppler ultrasonography and sphygmomanometer. The optimal goals for MAPs while on dialysis are between 70 and 80 mmHg, taking great care to avoid MAPs above 90 mmHg due to the impairment in blood flow associated with elevation in afterload, in addition to the well-documented increase in risk of cerebrovascular accidents with the current generation of devices in the setting of hypertension.<sup>34</sup> Given the inability to obtain reliable BP readings from conventional methods, caution must be exercised in the interpretation of Doppler-based measurements, which may have a greater propensity for inaccuracies. It is important to remember that Doppler opening pressures are closely correlated with arterial measurements of MAP only when the PPs are low. In patients with high PPs, Doppler opening pressures are closer to systolic pressures and therefore tend to overestimate MAPs. A newer device (Terumo Elemano BP monitor) that uses a double oscillometric, slow-deflation technique has been shown to improve correlation with MAPs obtained by an arterial line.<sup>42</sup> Until more data are available, however, Doppler ultrasonography will remain the standard of care for these patients.

## Dialysis Modality: Hemodialysis versus Peritoneal Dialysis

After LVAD implantation, renal function frequently improves in response to improved renal perfusion. However, long-term renal failure can still occur despite the hemodynamic benefits of LVAD therapy.<sup>5</sup> In a large study of over 3,600 LVAD patients, eGFR improved to only 6.7% above pre-implantation value after 1 year.<sup>39</sup> This presents significant challenges to patients with a very low eGFR (<30 ml/min) at the time of implantation. Compounding the challenges of post-implantation renal insufficiency are the previously mentioned changes in non-physiological blood flow patterns, as well as device-specific complications such as bloodstream infections and thromboembolic events, which can further elevate the risk of progression toward renal replacement.

### Hemodialysis

In vast majority of cases, hemodialysis (HD) provides the modality of choice for LVAD patients due to the ease and familiarity with which it can be instituted in a timely fashion. At the inception of HD therapy, ultrafiltration must be

individualized to the patient and the circulatory support device. Aggressive ultrafiltration must be avoided to prevent dramatic changes to flow parameters of the circulatory assist device. Given that LVAD flow is a function of both afterload and preload, aggressive ultrafiltration can severely impair LVAD flows and initiate suction events, which can lead to further hemodynamic compromise. Therefore, developing a strategy for addressing these challenges with a nephrology and dialysis team familiar with MCS devices can play a critical role in both the inpatient and outpatient settings. Current recommendations are to target MAPs between 70–80 mm Hg and avoid MAPs above 90 mmHg to maintain optimal afterload for the circulatory support device.<sup>34</sup>

Despite the hemodynamic stability of most of the chronic MCS patients, outpatient dialysis units might resist to accept patients with MCS devices. This is likely due to the lack of familiarity with the device alarms, ultrafiltration requirements, BP management, and the need for a more careful monitoring. More importantly, the high prevalence of anemia, hypoalbuminemia, and venous catheters lower the quality metrics dictated by the Centers for Medicare and Medicaid Services (CMS), which might result in a lower financial compensation to the dialysis units. However, there is now growing experience with this clinical scenario.<sup>43</sup> Training of the dialysis staff by the advance heart failure staff or dialyzing an LVAD patient in the hospital attached facility where the device expertise is immediately available are some of the ways to counteract issues related to the acceptance of these patients to outpatient dialysis units.

Long-term vascular access can be a challenge in these patients. Although there are very little data on the use of arterio-venous fistulas and grafts in patients on MCS, there is a growing body of anecdotal evidence for this strategy.<sup>44,45</sup> HD access must be individualized to the needs of each patient with the understanding that catheters (both tunneled and non-tunneled) pose a high risk for bloodstream infections.<sup>46</sup> Precautions must be taken during the placement of dialysis catheters in order to minimize the risk of blood stream infections.<sup>38</sup>

### Peritoneal Dialysis

Traditionally, peritoneal dialysis (PD) has been avoided in the context of LVAD support. This is largely a carryover from an earlier era when ventricular assist devices were larger and pulsatile, often requiring sub-diaphragmatic (and frequently intraperitoneal) implantation techniques. Due to concerns about bowel erosion, obstruction, and device infection,<sup>47</sup> PD was generally not considered to be a viable option in the context of pulsatile devices. In contrast, the newest generation of CF-LVADs can be placed intra-pericardially, with care taken to avoid the peritoneal

cavity during driveline tunneling. This configuration presents new opportunities for PD in selected patients.

The advantages of PD over HD include the potential for a sustained and slow ultrafiltration rate that results in a more stable hemodynamic profile,<sup>48</sup> fewer bloodstream infections, and reduced hospitalization rates<sup>49</sup> along with reduction in financial burden.<sup>50</sup> PD is also believed to cause a slower decline in residual kidney function,<sup>51</sup> which has been associated with a reduction in cardiovascular mortality.<sup>52,53</sup> Therefore, PD should be considered as a first-line strategy for RRT for patients on MCS whenever feasible. Although this represents an evolution in clinical management, there are already several case reports describing excellent results with this approach.<sup>54,55</sup> Contraindications for PD in MCS patients are similar to that of a conventional end stage renal disease (ESRD) patient. Conditions that preclude PD include lack of an intact peritoneum due to prior abdominal surgeries, large hernias that might get incarcerated due to the increased pressure, and peritoneal adhesions. Peritoneal dialysis can be a labor-intensive process. Therefore, lack of dexterity in using the PD machine or lack of psycho-social support can result in unsuccessful PD treatments.

## Conclusions

Despite the paucity of data with regard to the use of MCS devices in renal patients, various conclusions can be drawn based on the existing retrospective studies and case series. (a) Even minimal elevation in AKI in the postsurgical period is associated with increased mortality. (b) Currently there is no consensus on the lower limit of glomerular filtration rate below which an MCS device should not be considered. Caution must be exercised in implanting an MCS device in patients with advanced kidney failure or patients already on dialysis due to the preexisting risk for systemic bacteremia and other bloodstream infections. (c) MCS devices appear to improve short-term renal function. However, long-term prognosis and performance of RRT in MCS patients are still an area of poor understanding. Patients with MCS devices who go on to require dialysis can be considered for all the dialysis modalities, including in-center hemodialysis, home hemodialysis, and peritoneal dialysis. (e) Peritoneal dialysis must be considered whenever feasible due to advantages such as reduced hospitalizations, bloodstream infections, and costs, and the preservation of residual kidney function.

## REFERENCES

- Zannad F, Mebazaa A, Juilliere Y, Cohen-Solal A, Guize L, Alla F, Rouge P, Blin P, Barlet MH, Paolozzi L, et al. Clinical profile, contemporary management and one-year mortality in patients with severe acute heart failure syndromes: the EFICA study. *Eur J Heart Fail*. 2006;8(7):697–705.
- Conlon PJ, Stafford-Smith M, White WD, Newman MF, King S, Winn MP, Landolfo K. Acute renal failure following cardiac surgery. *Nephrol Dial Transplant*. 1999;14(5):1158–1162.
- Kim WH, Lee SM, Choi JW, Kim EH, Lee JH, Jung JW, Ahn JH, Sung KI, Kim CS, Cho HS. Simplified clinical risk score to predict acute kidney injury after aortic surgery. *J Cardiothorac Vasc Anesth*. 2013;27(6):1158–1166.
- Ostermann ME, Taube D, Morgan CJ, Evans TW. Acute renal failure following cardiopulmonary bypass: a changing picture. *Intensive Care Med*. 2000;26(5):565–571.
- Frazier OH, Rose EA, Oz MC, Dembitsky W, McCarthy P, Radovancevic B, Poirier VL, Dasse KA, HeartMate LILVAS. Multicenter clinical evaluation of the HeartMate vented electric left ventricular assist system in patients awaiting heart transplantation. *J Thorac Cardiovasc Surg*. 2001;122(6):1186–1195.
- Haddad M, Hendry PJ, Masters RG, Mesana T, Haddad H, Davies RA, Mussivand TV, Struthers C, Keon WJ. Ventricular assist devices as a bridge to cardiac transplantation: the Ottawa experience. *Artif Organs*. 2004;28(2):136–141.
- Muslem R, Caliskan K, Akin S, Sharma K, Gilotra NA, Constantinescu AA, Houston B, Whitman G, Tedford RJ, Hesselink DA, et al. Acute kidney injury and 1-year mortality after left ventricular assist device implantation. *J Heart Lung Transplant*. 2018;37(1):116–123.
- Lassnigg A, Schmidlin D, Mouhieddine M, Bachmann LM, Druml W, Bauer P, Hiesmayr M. Minimal changes of serum creatinine predict prognosis in patients after cardiothoracic surgery: a prospective cohort study. *J Am Soc Nephrol*. 2004;15(6):1597–1605.
- Chertow GM, Levy EM, Hammermeister KE, Grover F, Daley J. Independent association between acute renal failure and mortality following cardiac surgery. *Am J Med*. 1998;104(4):343–348.
- Borgi J, Tsiouris A, Hodari A, Cogan CM, Paone G, Morgan JA. Significance of postoperative acute renal failure after continuous-flow left ventricular assist device implantation. *Ann Thorac Surg*. 2013;95(1):163–169.
- Forman DE, Butler J, Wang Y, Abraham WT, O'Connor CM, Gottlieb SS, Loh E, Massie BM, Rich MW, Stevenson LW, et al. Incidence, predictors at admission, and impact of worsening renal function among patients hospitalized with heart failure. *J Am Coll Cardiol*. 2004;43(1):61–67.
- Mullens W, Abrahams Z, Francis GS, Sokos G, Taylor DO, Starling RC, Young JB, Tang WH. Importance of venous congestion for worsening of renal function in advanced decompensated heart failure. *J Am Coll Cardiol*. 2009;53(7):589–596.
- McCullough PA. Contrast-induced acute kidney injury. *J Am Coll Cardiol*. 2008;51(15):1419–1428.
- Valika AA, Gheorghide M. ACE inhibitor therapy for heart failure in patients with impaired renal function: a review of the literature. *Heart Fail Rev*. 2013;18(2):135–140.
- Ronco C, Haapio M, House AA, Anavekar N, Bellomo R. Cardiorenal syndrome. *J Am Coll Cardiol*. 2008;52(19):1527–1539.
- Xu J, Shen B, Fang Y, Liu Z, Zou J, Liu L, Wang C, Ding X, Teng J. Postoperative fluid overload is a useful



- predictor of the short-term outcome of renal replacement therapy for acute kidney injury after cardiac surgery. *Medicine (Baltimore)*. 2015;94(33):e1360.
17. Feldman D, Pamboukian SV, Teuteberg JJ, Birks E, Lietz K, Moore SA, Morgan JA, Arabia F, Bauman ME, Buchholz HW, et al. The 2013 International Society for Heart and Lung Transplantation guidelines for mechanical circulatory support: executive summary. *J Heart Lung Transplant*. 2013;32(2):157–187.
  18. Sun LY, Wijeyesundera DN, Tait GA, Beattie WS. Association of intraoperative hypotension with acute kidney injury after elective noncardiac surgery. *Anesthesiology*. 2015;123(3):515–523.
  19. Hou FF, Zhang X, Zhang GH, Xie D, Chen PY, Zhang WR, Jiang JP, Liang M, Wang GB, Liu ZR, et al. Efficacy and safety of benazepril for advanced chronic renal insufficiency. *N Engl J Med*. 2006;354(2):131–140.
  20. Karkouti K, Wijeyesundera DN, Yau TM, Callum JL, Cheng DC, Crowther M, Dupuis JY, Fremes SE, Kent B, Laflamme C, et al. Acute kidney injury after cardiac surgery: focus on modifiable risk factors. *Circulation*. 2009;119(4):495–502.
  21. Alba AC, Rao V, Ivanov J, Ross HJ, Delgado DH. Predictors of acute renal dysfunction after ventricular assist device placement. *J Card Fail*. 2009;15(10):874–881.
  22. Genovese EA, Dew MA, Teuteberg JJ, Simon MA, Bhama JK, Bermudez CA, Lockard KL, Winowich S, Kormos RL. Early adverse events as predictors of 1-year mortality during mechanical circulatory support. *J Heart Lung Transplant*. 2010;29(9):981–988.
  23. Topkara VK, Dang NC, Barili F, Cheema FH, Martens TP, George I, Bardakci H, Oz MC, Naka Y. Predictors and outcomes of continuous veno-venous hemodialysis use after implantation of a left ventricular assist device. *J Heart Lung Transplant*. 2006;25(4):404–408.
  24. Sandner SE, Zimpfer D, Zrunek P, Dunkler D, Schima H, Rajek A, Grimm M, Wolner E, Wiesenthaler GM. Renal function after implantation of continuous versus pulsatile flow left ventricular assist devices. *J Heart Lung Transplant*. 2008;27(5):469–473.
  25. Murphy MB, Murray C, Shorten GD. Fenoldopam: a selective peripheral dopamine-receptor agonist for the treatment of severe hypertension. *N Engl J Med*. 2001;345(21):1548–1557.
  26. Cogliati AA, Vellutini R, Nardini A, Urovi S, Hamdan M, Landoni G, Guelfi P. Fenoldopam infusion for renal protection in high-risk cardiac surgery patients: a randomized clinical study. *J Cardiothorac Vasc Anesth*. 2007;21(6):847–850.
  27. Ranucci M, De Benedetti D, Bianchini C, Castelvechio S, Ballotta A, Frigiola A, Menicanti L. Effects of fenoldopam infusion in complex cardiac surgical operations: a prospective, randomized, double-blind, placebo-controlled study. *Minerva Anestesiol*. 2010;76(4):249–259.
  28. Zacharias M, Mugawar M, Herbison GP, Walker RJ, Hovhannisyan K, Sivalingam P, Conlon NP. Interventions for protecting renal function in the perioperative period. *Cochrane Database Syst Rev*. 2013(9):CD003590.
  29. Marathias KP, Vassili M, Robola A, Alivizatos PA, Palatianos GM, Geroulanos S, Vlahakos DV. Preoperative intravenous hydration confers renoprotection in patients with chronic kidney disease undergoing cardiac surgery. *Artif Organs*. 2006;30(8):615–621.
  30. McCluskey SA, Karkouti K, Wijeyesundera D, Minkovich L, Tait G, Beattie WS. Hyperchloremia after noncardiac surgery is independently associated with increased morbidity and mortality: a propensity-matched cohort study. *Anesth Analg*. 2013;117(2):412–421.
  31. Yunos NM, Bellomo R, Hegarty C, Story D, Ho L, Bailey M. Association between a chloride-liberal vs chloride-restrictive intravenous fluid administration strategy and kidney injury in critically ill adults. *JAMA*. 2012;308(15):1566–1572.
  32. Haase M, Haase-Fielitz A, Plass M, Kuppe H, Hetzer R, Hannon C, Murray PT, Bailey MJ, Bellomo R, Bagshaw SM. Prophylactic perioperative sodium bicarbonate to prevent acute kidney injury following open heart surgery: a multicenter double-blinded randomized controlled trial. *PLoS Med*. 2013;10(4):e1001426.
  33. Smith MN, Best D, Sheppard SV, Smith DC. The effect of mannitol on renal function after cardiopulmonary bypass in patients with established renal dysfunction. *Anaesthesia*. 2008;63(7):701–704.
  34. Slaughter MS, Pagani FD, Rogers JG, Miller LW, Sun B, Russell SD, Starling RC, Chen L, Boyle AJ, Chillcott S, et al. Clinical management of continuous-flow left ventricular assist devices in advanced heart failure. *J Heart Lung Transplant*. 2010;29(4 Suppl):S1–S39.
  35. Fitzpatrick JR, 3rd, Frederick JR, Hsu VM, Kozin ED, O'Hara ML, Howell E, Dougherty D, McCormick RC, Laporte CA, Cohen JE, et al. Risk score derived from pre-operative data analysis predicts the need for biventricular mechanical circulatory support. *J Heart Lung Transplant*. 2008;27(12):1286–1292.
  36. Welp H, Rukosujew A, Tjan TD, Hoffmeier A, Kosek V, Scheld HH, Drees G. Effect of pulsatile and non-pulsatile left ventricular assist devices on the renin-angiotensin system in patients with end-stage heart failure. *Thorac Cardiovasc Surg*. 2010;58(Suppl 2):S185–S188.
  37. Kihara S, Litwak KN, Nichols L, Litwak P, Kameneva MV, Wu Z, Kormos RL, Griffith BP. Smooth muscle cell hypertrophy of renal cortex arteries with chronic continuous flow left ventricular assist. *Ann Thorac Surg*. 2003;75(1):178–183; discussion 183.
  38. Ohnishi H, Itoh T, Nishinaka T, Tatsumi E, Fukuda T, Oshikawa M, Shioya K, Tsukiya T, Takewa Y, Homma A, et al. Morphological changes of the arterial systems in the kidney under prolonged continuous flow left heart bypass. *Artif Organs*. 2002;26(11):974–979.
  39. Brisco MA, Kimmel SE, Coca SG, Putt ME, Jessup M, Tang WW, Parikh CR, Testani JM. Prevalence and prognostic importance of changes in renal function after mechanical circulatory support. *Circ Heart Fail*. 2014;7(1):68–75.
  40. Rabindranath K, Adams J, Macleod AM, Muirhead N. Intermittent versus continuous renal replacement therapy for acute renal failure in adults. *Cochrane Database Syst Rev*. 2007(3):CD003773.
  41. Tolwani AJ, Campbell RC, Stofan BS, Lai KR, Oster RA, Wille KM. Standard versus high-dose CVVHDF for ICU-related acute renal failure. *J Am Soc Nephrol*. 2008;19(6):1233–1238.
  42. Lanier GM, Orlandes K, Hayashi Y, Murphy J, Flannery M, Te-Frey R, Uriel N, Yuzefpolskaya M, Mancini DM, Naka Y, et al. Validity and reliability of a novel slow

- cuff-deflation system for noninvasive blood pressure monitoring in patients with continuous-flow left ventricular assist device. *Circ Heart Fail.* 2013;6(5):1005–1012.
43. Quader MA, Kumar D, Shah KB, Fatani YI, Katlaps G, Kasirajan V. Safety analysis of intermittent hemodialysis in patients with continuous flow left ventricular assist devices. *Hemodial Int.* 2014;18(1):205–209.
44. Patel AM, Adeseun GA, Ahmed I, Mitter N, Rame JE, Rudnick MR. Renal failure in patients with left ventricular assist devices. *Clin J Am Soc Nephrol.* 2013;8(3):484–496.
45. Chin AI, Tong K, McVicar JP. Successful hemodialysis arteriovenous fistula creation in a patient with continuous-flow left ventricular assist device support. *Am J Kidney Dis.* 2017;69(2):314–316.
46. Dhingra RK, Young EW, Hulbert-Shearon TE, Leavey SF, Port FK. Type of vascular access and mortality in U.S. hemodialysis patients. *Kidney Int.* 2001;60(4):1443–1451.
47. Icenogle T, Sandler D, Puhlman M, Himley S, Sato DJ, Schaefer S. Intraperitoneal pocket for left ventricular assist device placement. *J Heart Lung Transplant.* 2003, 22(7):818–821.
48. Pego C, Rodrigues A, Ronco C. Role of peritoneal dialysis as a chronic renal replacement therapy in cardiorenal patients. *Contrib Nephrol.* 2012;178:182–188.
49. Cnossen TT, Kooman JP, Krepel HP, Konings CJ, Uszko-Lencer NH, Leunissen KM, van der Sande FM. Prospective study on clinical effects of renal replacement therapy in treatment-resistant congestive heart failure. *Nephrol Dial Transplant.* 2012;27(7):2794–2799.
50. Collins AJ, Foley RN, Chavers B, Gilbertson D, Herzog C, Johansen K, Kasiske B, Kutner N, Liu J, St Peter W, et al. United States Renal Data System 2011 annual data report: atlas of chronic kidney disease & end-stage renal disease in the United States. *Am J Kidney Dis.* 2012;59(1 Suppl 1):A7, e1–e420.
51. Lang SM, Bergner A, Topfer M, Schiff H. Preservation of residual renal function in dialysis patients: effects of dialysis-technique-related factors. *Perit Dial Int.* 2001;21(1):52–57.
52. Liao CT, Chen YM, Shiao CC, Hu FC, Huang JW, Kao TW, Chuang HF, Hung KY, Wu KD, Tsai TJ. Rate of decline of residual renal function is associated with all-cause mortality and technique failure in patients on long-term peritoneal dialysis. *Nephrol Dial Transplant.* 2009;24(9):2909–2914.
53. Shafi T, Jaar BG, Plantinga LC, Fink NE, Sadler JH, Parekh RS, Powe NR, Coresh J. Association of residual urine output with mortality, quality of life, and inflammation in incident hemodialysis patients: the Choices for Healthy Outcomes in Caring for End-Stage Renal Disease (CHOICE) Study. *Am J Kidney Dis.* 2010;56(2):348–358.
54. Guglielmi AA, Guglielmi KE, Bhat G, Siemeck R, Tatoes AJ. Peritoneal dialysis after left ventricular assist device placement. *ASAIO J.* 2014;60(1):127–128.
55. Thomas BA, Logar CM, Anderson AE. Renal replacement therapy in congestive heart failure requiring left ventricular assist device augmentation. *Perit Dial Int.* 2012;32(4):386–392.

## 40

# Arrhythmia/Ventricular Tachycardia Ablation

SURAJ KAPA

**T**reatment of the patient presenting with ventricular tachycardia is often complicated by hemodynamic instability, whether in the pre-, intra-, or post-therapeutic period. The reasons for this are several, including the acute change in rhythm which induces some element of atrio-ventricular and inter-ventricular dyssynchrony, in addition to the rate of ventricular activation which can result in inefficient diastolic filling and resultant insufficient systolic flow. Effects of such hypotension can result in most immediately myocardial, cerebral, and renal ischemia, but can result in injury to nearly any organ. In addition, the inefficiency of blood flow during ventricular tachycardia can result in intracardiac thrombus.

Mechanical circulatory support (MCS) strategies may help improve antegrade flow during ventricular tachycardia, thus limiting the extent of ischemia of systemic organs. In addition, partially offloading the ventricle in this fashion may limit the frequency of ventricular tachycardia that typically results from heart failure decompensation. A number of options can be considered in these challenging cases, including pharmacologic support to augment myocardial function, intra-aortic balloon pump support to offload ventricular contraction, use of percutaneous cardiac support systems such as TandemHeart® or Impella®, surgical left ventricular assist devices (LVADs), and extracorporeal membrane oxygenation (ECMO). Each of these approaches carries potential risks, benefits, and impacts on the therapeutic management of ventricular arrhythmias. A summary of the commonly used short-term MCS options is provided in Figure 40.1.

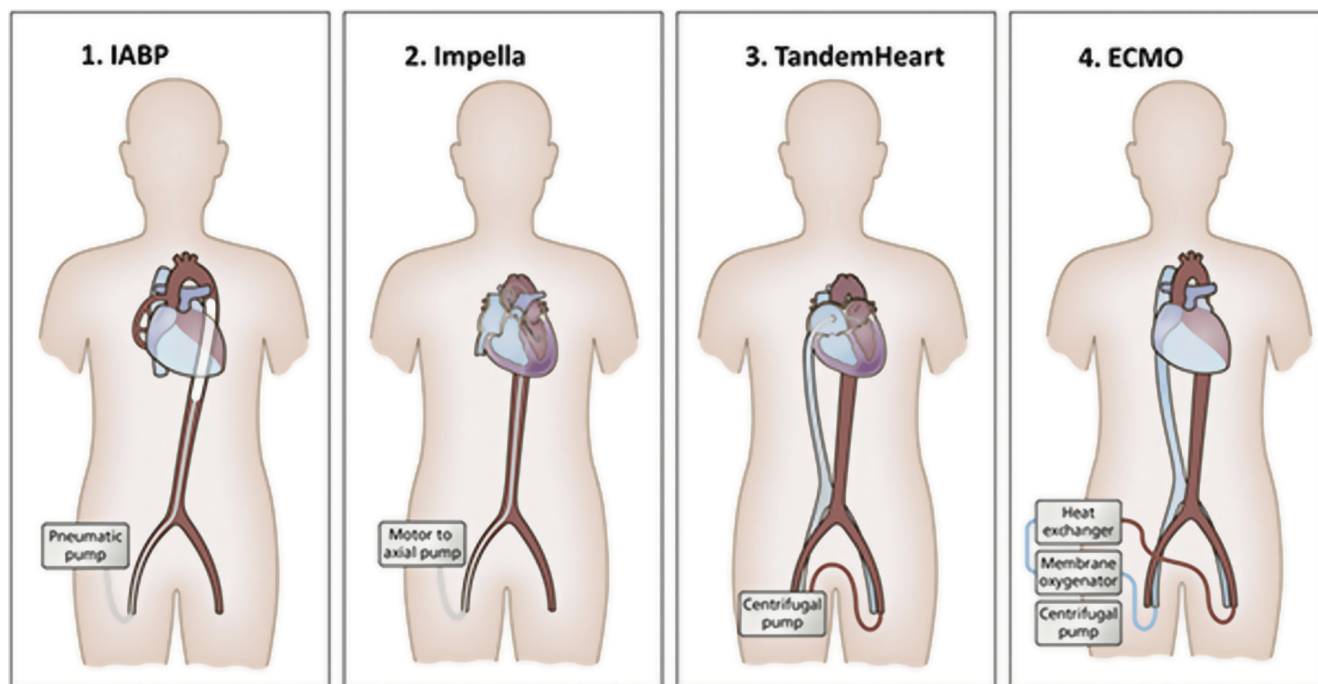
In this chapter, we will review the potential utility of hemodynamic support in treatment of ventricular arrhythmias using both percutaneous catheter and surgical approaches, as well as the benefits and limitations associated with specific therapies. We will also review the

potential use of hemodynamic support in the pre- and post-therapeutic phases and the utility during ablation, which is often used as an approach to disrupt arrhythmogenic tissue and thus prevent recurrent arrhythmia.

## Pre- and Post-Therapeutic Use of Hemodynamic Support

Often, there may be an indication for hemodynamic support in the pre- and post-therapeutic stages. Prior to ablation, it is often necessary to identify an optimal approach to hemodynamic support in order to either optimize patients prior to ablation, maintain them until other reversible factors can be corrected (e.g., coronary artery blockages), or temporize them until ablation can be performed.<sup>1</sup> When deciding on the approach, the following factors should be considered: persistence of the ventricular arrhythmia and whether other preventive approaches have been maximized (e.g., antiarrhythmic drugs, sedation, autonomic blockade using stellate ganglion or spinal block), the risks of the specific approach to support, the amount of time support needs to be provided, and the potential impact on any subsequent surgical approach.

Post-ablation hemodynamic support may be useful to allow the patient time to recover from the procedure or ventricular decompensation induced by preceding arrhythmias. Often, incessant ventricular arrhythmias can result in volume overload, acute renal injury, and cardiac stunning (especially after multiple defibrillations) that may take time to improve. During this time period, even if ventricular arrhythmias have been effectively suppressed, it may be necessary to provide hemodynamic support for some period until the acute organ injury has improved sufficiently. In general, hemodynamic support that has been instituted pre-ablation may be continued post-ablation for both practical



**Figure 40.1.** A summary of the various types of MCS used in conjunction with EP procedures.

From Spiro J, Doshi SN. Use of left ventricular support devices during acute coronary syndrome and percutaneous coronary intervention. Reprinted by permission from Springer Nature, *Current Cardiology Reports*. Use of left ventricular support devices during acute coronary syndrome and percutaneous coronary intervention, Spiro J et al., Copyright 2014.

reasons and to eliminate potential need for reinstatement of therapy. Support instituted during the procedure, however, may or may not be continued post-procedure depending on multiple factors, including patient stability, perceived ongoing needs, and evidence of cardiac stunning or end-organ injury (e.g., poor urine output) during the procedure.

Pre- and post-ablation, use of pharmacologic support agents (e.g., milrinone, dobutamine) can often induce ventricular arrhythmias and thus may result in further decompensation and offset the efficacy of anti-arrhythmic approaches. However, in some cases, arrhythmias may result from acute heart failure decompensation, and offering such pharmacologic support in combination with aggressive anti-arrhythmic interventions may effectively treat the arrhythmia. Other mechanical and invasive approaches to offering circulatory support are summarized in Table 47.1. The choice of a specific therapy will generally be based on availability of the appropriate equipment and clinical support staff, which will be discussed in further detail later.

## Hemodynamic Support during Catheter Ablation

Catheter ablation has become a mainstay of therapy for the treatment of ventricular tachycardia. Both percutaneous

endocardial and epicardial approaches have been established for treatment. The approach to ventricular ablation is generally dependent on the clinical situation and the specific need to maintain ventricular arrhythmia during ablation. Reviews of actual outcomes of hemodynamic support on ventricular tachycardia ablation outcomes has been varied, though there may be utility under specific circumstances. We will first review specific arrhythmia syndromes to understand the rationale for considering hemodynamic support, and then review the reasoning underlying the use or avoidance of specific approaches, before discussing the current data on specific strategies.

### Specific Clinical Situations

The decision to use hemodynamic support preemptively during a cardiac ablation is generally based on the perceived need to map during ventricular tachycardia and the likelihood of cardiac decompensation during the procedure. If a patient is already being maintained on circulatory support due to ventricular tachycardia storm or cardiac decompensation due to incessant arrhythmia, it will generally be continued during the ablation procedure. Otherwise, the decision to support may be made either before beginning the procedure (i.e., instituting support prior to performing cardiac mapping and ablation) or during the procedure, depending on the patient course. The

PAINESD risk score		Low risk	≤8
Variable	Score		
Pulmonary disease (chronic obstructive)	5	Intermediate risk	9–14
Age >60 yr	3		
Ischemic cardiomyopathy	6	High risk	≥15
NYHA class III or IV	6		
Ejection fraction <25%	3		
Storm (VT)	5		
Diabetes mellitus	3		

**Figure 40.2.** A summary of the PAINESD (Pulmonary Disease, Age, Ischemic Cardiomyopathy, NYHA Class III or IV, EF<25%, Storm [VT], Diabetes Mellitus) score for consideration of MCS in the setting of electrical storm.

Reprinted from Muser D, Santangeli P, Liang JJ. Management of ventricular tachycardia storm in patients with structural heart disease, *World Journal of Cardiology* 2017;9(6):521–530. Copyright ©The Author(s) 2017. Published by Baishideng Publishing Group Inc. All rights reserved.

PAINESD risk score has been developed as a tool for guiding these decisions (Figure 40.2).

Not all ventricular arrhythmia syndromes are equivalent in the need to map during ventricular tachycardia and the likelihood of hemodynamic collapse as a result of maintaining ventricular tachycardia. The likelihood of cardiac collapse during catheter ablation may be predicted by how tolerant the patient is of the ventricular tachycardia prior to the procedure. If a patient exhibits immediate syncope or the tachycardia exhibits very high rates (often >200 beats per minute), the likelihood of the patient maintaining adequate cardiac output is low, particularly during use of anesthesia in the procedure. However, younger patients (particularly with arrhythmias due to diseases such as arrhythmogenic right ventricular cardiomyopathy) may be more hemodynamically tolerant of their arrhythmia.

The operator also needs to consider the need to map during ventricular tachycardia (i.e., the need to maintain ventricular tachycardia for long durations during the ablation procedure). Ventricular tachycardia due to structural heart disease (e.g., myocardial infarction) is often treated by specific targeting of the *cardiac substrate* as defined by preoperative imaging (e.g., magnetic resonance imaging) or intraoperative mapping (i.e., voltage mapping). Specific criteria have been established for identifying cardiac regions that may contribute to arrhythmia. Thus, it is often not necessary to map during ventricular tachycardia.

While substrate mapping may be sufficient for ablation in many cases of ventricular tachycardia due to structural heart disease, in some cases a circuit or a specific recurrent ventricular tachycardia may exist that could not be accounted for by extensive substrate ablation. In these cases, it may be optimal to offer hemodynamic support if the ventricular tachycardia is not well tolerated. In addition, it may be that ventricular tachycardia during mapping and

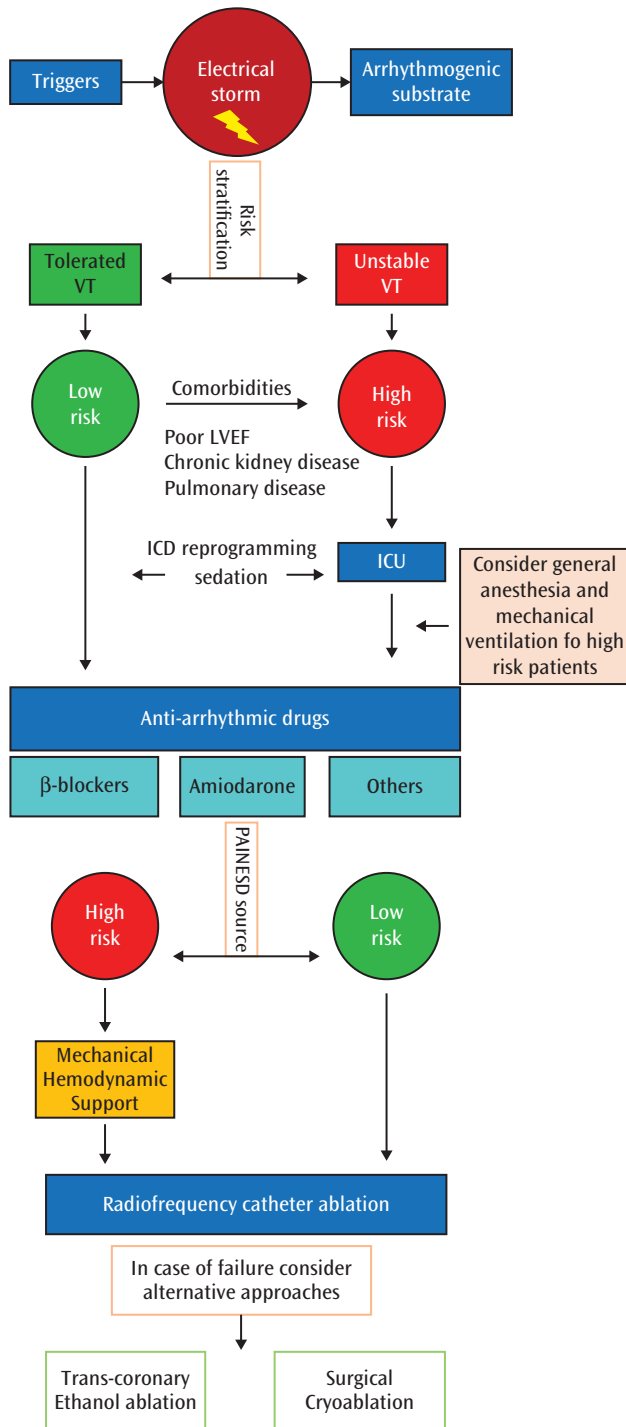
ablation become incessant and thus limit hemodynamic tolerance throughout the procedure, even if a substrate-based approach is chosen.

One specific case in which a low threshold for instituting hemodynamic support may be considered is ablation for premature ventricular contraction (PVC)-triggered ventricular fibrillation. In this particular situation, identifying the inciting PVC is critical to procedural success. During ablation, it is not uncommon for PVCs to initially become more frequent, with repeated episodes of ventricular fibrillation resulting in hemodynamic collapse. In this clinical situation, use of circulatory support may be necessary. A typical flow pathway for the management of electrical storm is shown in Figure 40.3, highlighting the role for MCS in certain circumstances.

### How to Select a Specific Method of Circulatory Support

The choice of a specific method of circulatory support should be based on the patient's comorbidities, the degree of hemodynamic support needed (e.g., left versus biventricular), and the planned approach for ablation (i.e., transseptal, retro-aortic, or epicardial). Table 40.1 again summarizes potential approaches to circulatory support. If a retro-aortic approach is sought, generally an Impella would not be optimal, and vice versa for transseptal and TandemHeart. However, there are reports of attaining a retro-aortic approach with the former, or an additional point of transseptal access with the latter. Other forms of access (ECMO, intra-aortic balloon pump, and implantable LVADs) should not limit the options to access the ventricle, though LVAD may limit options for epicardial access.

In addition to the preceding, the degree of left ventricular (LV) support and whether right ventricular (RV) support is also needed should be considered. The level of cardiac



**Figure 40.3.** A flow diagram for the management of patients with electrical storm, highlighting the role for MCS.

From Muser D, Santangeli P, Liang JJ. Management of ventricular tachycardia storm in patients with structural heart disease, *World Journal of Cardiology* 2017;9(6):521–530. Copyright ©The Author(s) 2017. Published by Baishideng Publishing Group Inc. All rights reserved.

output augmentation offered by intra-aortic balloon pump (in the range of 0.5 L/min) is likely so minimal as to not offer much benefit during ventricular tachycardia ablation. However, the choice of other modalities (e.g., Impella catheters that offer between 2.5 L/min and 5 L/min flow, ECMO, etc.) should be considered in the context of the degree of preceding cardiac impairment (e.g., patients with more severely diminished LV function and more rapid ventricular arrhythmias may require more support).

In addition, full cardiac support (i.e., LV plus RV) versus only LV support should be considered. In patients with significant RV dysfunction, LV support may not be sufficient. In these cases, ECMO may prove to be the optimal approach, offering the potential for oxygenation as well as hemodynamic support. This can be achieved through peripheral or central cannulation strategies, with special consideration given to the potential for impaired forward flow in the ascending aorta to cause sludging and potential thrombus formation in the setting of peripheral cannulation. (Figure 40.4)

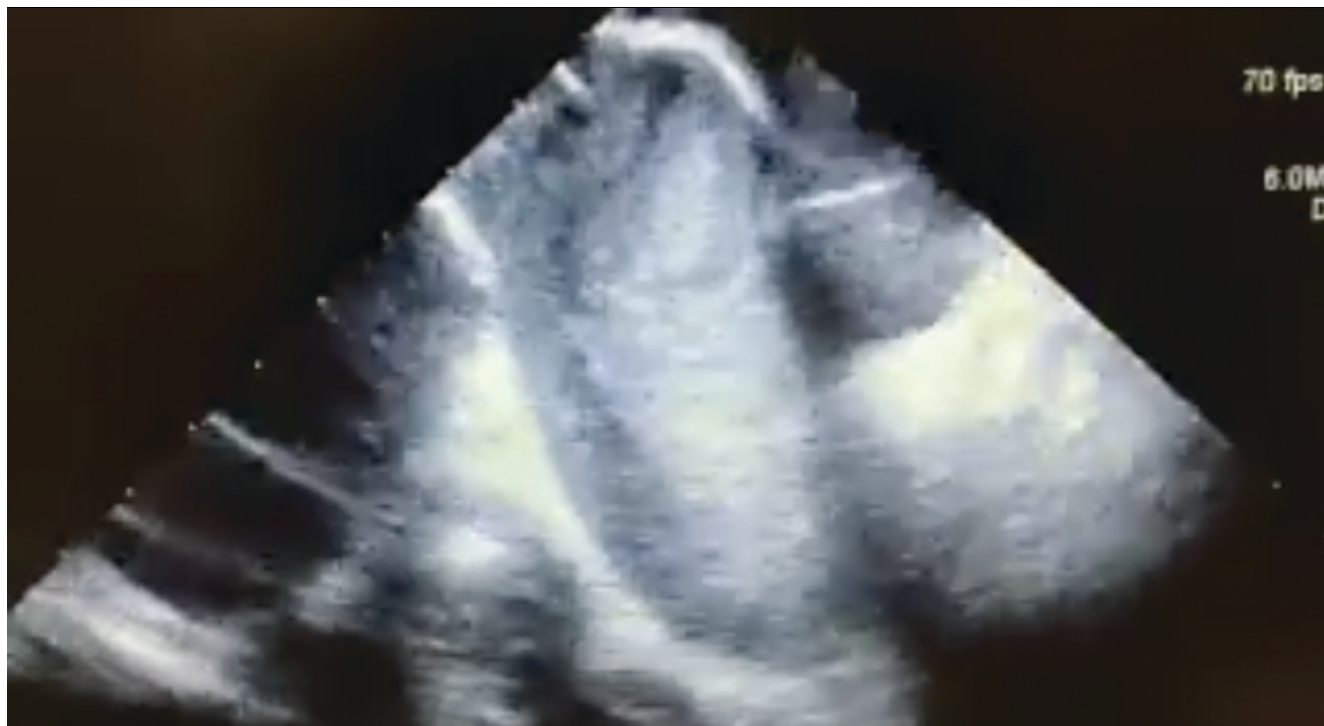
Patient comorbidities may also influence the selection of an MCS strategy. For example, in the setting of severe peripheral arterial disease, the majority of percutaneous support options may be limited. Nevertheless, it should be recognized that axillary access may often permit catheter-based approaches, even in the setting of significant femoral disease. The relevance of significant peripheral vascular disease lies in the large caliber of cannulae required for most hemodynamic support (short of intra-aortic balloon pump, which only requires a 7.5–8 French access). In addition to this, the presence of a mechanical aortic valve may preclude use of devices such as Impella, which require deployment across the valve. During the cardiac ablation procedure, intracardiac echocardiography is often used to rule out intracardiac thrombus, particularly on cardiac devices such as pacemakers or defibrillators, which may preclude trans-septal access for TandemHeart. Thus, careful consideration of comorbidities is critical to the choice of a specific device.

### Current Data on Utility of Hemodynamic Support during Ablation

While several studies have been published on the utility of hemodynamic support during ablation, there is a paucity of prospective randomized data. The largest real-world study, by Turagam et al. (2017), suggested no effect of hemodynamic support on clinical outcomes, although patients in whom hemodynamic support was needed tended to be more ill, with higher expected long-term mortality rates.<sup>2</sup> Table 40.2 summarizes studies to date on the utility of hemodynamic support during catheter ablation. In summary, based on largely retrospective data, there is no significant difference in VT outcomes. However, these studies

**Table 40.1 • Approaches to Circulatory Support**

Device	Technique	Size of Catheter	How Support Provided	Degree of Cardiac Output Increase	Limitations	Contraindications	Potential Complications
Intra-aortic balloon pump (IABP)	Percutaneous vs. surgical via axillary or femoral artery	7.5–8 French	Counterpulsation	0.5 L/min	<ul style="list-style-type: none"> <li>• Uses ECG or pressure triggers that may be limited during VT</li> </ul>	<ul style="list-style-type: none"> <li>• Moderate to severe aortic insufficiency</li> <li>• Aortic disease</li> <li>• Severe peripheral arterial disease</li> </ul>	<ul style="list-style-type: none"> <li>• Limb ischemia</li> <li>• Vascular injury</li> <li>• Stroke</li> </ul>
Impella®	Percutaneous or surgical for 13 or 14 French catheters; surgical for larger	13, 14, or 21 French	Axial pump from left ventricle to aorta	2.5–5 L/min (higher the larger the catheter)	<ul style="list-style-type: none"> <li>• Large arterial cannula</li> <li>• Must be in an intra-cavitary position and may interact with catheters during procedure</li> </ul>	<ul style="list-style-type: none"> <li>• Mechanical aortic valve</li> <li>• Aortic stenosis with valve area <math>\leq 0.6 \text{ cm}^2</math></li> <li>• Aortic disease</li> <li>• Moderate to severe aortic insufficiency</li> <li>• Left ventricular thrombus</li> <li>• Severe peripheral arterial disease</li> <li>• Ventricular septal defect</li> <li>• Right ventricular failure</li> </ul>	<ul style="list-style-type: none"> <li>• Limb ischemia</li> <li>• Vascular injury</li> <li>• Stroke</li> <li>• Cardiac perforation</li> </ul>
TandemHeart®	Percutaneous or surgical	21 French for inflow (Transseptal) 15–17 French for outflow (arterial)	Centrifugal, continuous flow	3.5–5 L/min	<ul style="list-style-type: none"> <li>• Large arterial and venous cannulae</li> <li>• Requires transseptal puncture that may limit approaches to LV access</li> </ul>	<ul style="list-style-type: none"> <li>• Severe peripheral arterial disease</li> <li>• Ventricular septal defect</li> <li>• Right ventricular failure</li> </ul>	<ul style="list-style-type: none"> <li>• Limb ischemic</li> <li>• Vascular injury</li> <li>• Stroke</li> <li>• Cardiac perforation</li> <li>• Persistent iatrogenic atrial septal defect</li> </ul>
ECMO	Percutaneous or surgical	17–22 French venous 15 French arterial	Centrifugal continuous flow with oxygenation provided	>4.5 L/min	<ul style="list-style-type: none"> <li>• Large vascular cannulae</li> <li>• Often complex setup and needs perfusionist support</li> </ul>	<ul style="list-style-type: none"> <li>• Severe peripheral arterial disease</li> <li>• Coagulopathy</li> </ul>	<ul style="list-style-type: none"> <li>• Limb ischemia</li> <li>• Vascular injury</li> <li>• Thrombus and thromboembolism</li> </ul>
LVAD	Surgical	Depends on LVAD device	Either continuous or intermittent flow	>5 L/min	<ul style="list-style-type: none"> <li>• Requires cardiac surgery</li> <li>• May limit epicardial access for percutaneous ablation</li> <li>• Often complex, specialized surgical expertise needed</li> </ul>	<ul style="list-style-type: none"> <li>• Severe right ventricular failure</li> </ul>	<ul style="list-style-type: none"> <li>• Stroke</li> <li>• Thrombus and thromboembolism</li> <li>• Bleeding</li> </ul>
Open surgical bypass	Surgical		Complete cardiac support	>5 L/min	<ul style="list-style-type: none"> <li>• Requires full surgical intervention</li> <li>• May limit ability to map VT due to non-inducibility</li> </ul>	<ul style="list-style-type: none"> <li>• May be increased risk after multiple prior surgeries</li> </ul>	<ul style="list-style-type: none"> <li>• Stroke</li> <li>• Bleeding</li> </ul>



**Figure 40.4.** VT ablation on percutaneous ECMO. Shown is an intracardiac echocardiography image of a patient on ECMO with only femoral venous and arterial cannula. Note that due to lack of a system to offload the ascending aorta, there is significant echogenicity during VT consistent with slow flow and sludging.

are limited by small sample sizes in which patients who were supported hemodynamically tended to be sicker. In general, there was more mapping done during VT, and VTs were more often terminated during ablation as opposed to being “prematurely” terminated due to hemodynamic compromise. Thus, it could be interpreted that while there does not appear to be clear benefit in terms of ablation outcomes, hemodynamic support may still be needed to get certain patients through the procedure itself. Lazkani et al. (2017) offered evidence to support this point in demonstrating improved outcomes for patients with preemptive use of Impella, as opposed to a bailout after hemodynamic compromise.<sup>11,12</sup>

### Use of Hemodynamic Support during Surgical Ventricular Tachycardia Ablation

Surgical ventricular tachycardia ablation is not as commonly used as catheter ablation, but remains a mainstay of therapy in a variety of patients, including those in whom areas of the heart may be inaccessible (e.g., those with prior

cardiac surgery needing epicardial access). One common hybrid strategy involves surgical ablation as a concomitant procedure during LVAD implantation in patients who also have frequent or incessant VT.<sup>13</sup> While some cases of VT in heart failure may be due to the hemodynamic compromise, if substrate is present, LVAD may not eliminate future VT. Surgical ablation at the time of LVAD implantation may be facilitated by intraoperative voltage mapping, preoperative voltage mapping, or preoperative magnetic resonance imaging. There are limited data on the benefit of simultaneous ablation at the time of LVAD implantation in those with known VT, though studies are ongoing.

### Rationale for Choice of Specific Support

Table 40.1 again summarizes specific limitations, benefits, and contraindications for different types of hemodynamic support. The strategy for which (if any) MCS device to use will generally be based on the clinical situation and indication, as discussed previously. Ultimately, a systematic approach, based on the patient’s unique comorbidities and the support available in the hospital setting in which ablation is being performed, needs to be utilized.



**Table 40.2 • Clinical Studies on Utility of Hemodynamic Support during VT Ablation**

Study	Type of Study	Device Studied	Number of Patients	Outcome
Miller, et al. <i>JACC</i> . 2011 <sup>3</sup>	Retrospective	22	Impella 2.5 vs. IABP vs no support	Mapped during VT longer but no difference in hard endpoints (mortality, low cerebral oxygenation, etc.)
Bunch, et al. <i>Europace</i> . 2012 <sup>4</sup>	Retrospective	31	TandemHeart vs. no support	No difference in VT outcomes
Lu, et al. <i>Int J Cardiol</i> . 2013 <sup>5</sup>	Retrospective	16	Impella 2.5 vs. peripheral cardiopulmonary bypass vs. surgical LVAD	No difference in VT outcomes
Miller, et al. <i>Circ Arrhythm Electrophysiol</i> . 2013 <sup>6</sup>	Prospective	20	Impella 2.5	50% procedural success, no comparative group
Reddy, et al. <i>Circ Arrhythm Electrophysiol</i> . <sup>7</sup>	Prospective multi-center registry	66	IABP, Impella 2.5, TandemHeart	No difference in outcomes
Aryana, et al. <i>Heart Rhythm</i> . 2014 <sup>8</sup>	Retrospective	68	Impella 2.5 vs. Impella CP vs. no support	No difference in outcomes
Aryana, et al. <i>J Cardiovasc Electrophysiol</i> . 2017 <sup>9</sup>	Retrospective (Medicare)	345	Percutaneous ventricular assist device (PVAD) vs. IABP	No difference in redo VT ablation but lower hospital stay, renal failure, mortality with PVAD
Kusa, et al. <i>Circ Arrhythm Electrophysiol</i> . 2017 <sup>10</sup>	Retrospective	194	PVAD vs. no support	No difference in outcomes
Turagam, et al. <i>JACC: Clinical EP</i> . 2017 <sup>2</sup>	Retrospective	105	PVAD vs. no support	Worse long-term outcomes with support but no difference in VT

## Conclusion

Mechanical circulatory support may play an important role in selected patients undergoing ablation for ventricular tachycardia. While there is a paucity of data on the benefits of hemodynamic support to optimize procedural outcomes, the degree of hemodynamic compromise in many patients presenting for VT ablation will likely make the use of support devices unavoidable. In these cases, the choice of support will be based on comorbidities, the procedural approach, and other clinical and hospital variables. Surgical ablation at the time of LVAD implantation remains a poorly described area of interest for future thought and study. Ultimately, establishing a systematic approach between critical care providers, invasive electrophysiologists, and cardiac surgeons provides the ideal collaboration for managing these complex and challenging cases.

## REFERENCES

- Enriquez A, Liang J, Gentile J, et al. Outcomes of rescue cardiopulmonary support for periprocedural acute hemodynamic decompensation in patients undergoing catheter ablation of electrical storm. *Heart Rhythm*. 2018;15:75–80.
- Turagam MK, Vuddanda V, Atkins D, et al. Hemodynamic support in ventricular tachycardia ablation: an international VT ablation center collaborative group study. *JACC Clin Electrophysiol*. 2017;3:1534–1543.
- Miller MA, Dukkipati SR, Mittnacht AJ, et al. Activation and entrainment mapping of hemodynamically unstable ventricular tachycardia using a percutaneous left ventricular assist device. *J Am Coll Cardiol*. 2011;58:1363–1371.
- Bunch TJ, Darby A, May HT, et al. Efficacy and safety of ventricular tachycardia ablation with mechanical circulatory support compared with substrate-based ablation techniques. *Europace*. 2012;14:709–714.
- Lu F, Eckman PM, Liao KK, et al. Catheter ablation of hemodynamically unstable ventricular tachycardia with mechanical circulatory support. *Int J Cardiol*. 2013;168:3859–3865.
- Miller MA, Dukkipati SR, Chinitz JS, et al. Percutaneous hemodynamic support with Impella 2.5 during scar-related ventricular tachycardia ablation (PERMIT-I). *Circ Arrhythm Electrophysiol*. 2013;6:151–159.
- Reddy VY, Chinitz L, Mansour M, et al. Percutaneous left ventricular assist devices in ventricular tachycardia

- ablation: multicenter experience. *Circ Arrhythm Electrophysiol.* 2014;7:244–250.
8. Aryana A, Gearoid O'Neill P, Gregory D, et al. Procedural and clinical outcomes after catheter ablation of unstable ventricular tachycardia supported by a percutaneous left ventricular assist device. *Heart Rhythm.* 2014;11:1122–1130.
  9. Aryana A, d'Avila A, Cool CL, et al. Outcomes of catheter ablation of ventricular tachycardia with mechanical hemodynamic support: an analysis of the Medicare database. *J Cardiovasc Electrophysiol.* 2017;28:1295–1302.
  10. Kusa S, Miller MA, Whang W, et al. Outcomes of ventricular tachycardia ablation using percutaneous left ventricular assist devices. *Circ Arrhythm Electrophysiol.* 2017 Jun;10(6). pii: e004717. doi:10.1161/CIRCEP.116.004717.
  11. Lazkani M, Murarka S, Kobayashi A, et al. A retrospective analysis of Impella use in all-comers: 1-year outcomes. *J Interv Cardiol.* 2017;30:577–583.
  12. Spiro J, Doshi SN. Use of left ventricular support devices during acute coronary syndrome and percutaneous coronary intervention. *Curr Cardiol Rep.* 2014;16(12):544.
  13. Muser D, Santangeli P, Liang JJ. Management of ventricular tachycardia storm in patients with structural heart disease. *World J Cardiol.* 2017;9(6):521–530.

# Aortic Regurgitation in Patients with Left Ventricular Assist Devices

MARISA CEVASCO, KOJI TAKEDA, MASAHIKO ANDO,  
AND YOSHIFUMI NAKA

## Introduction

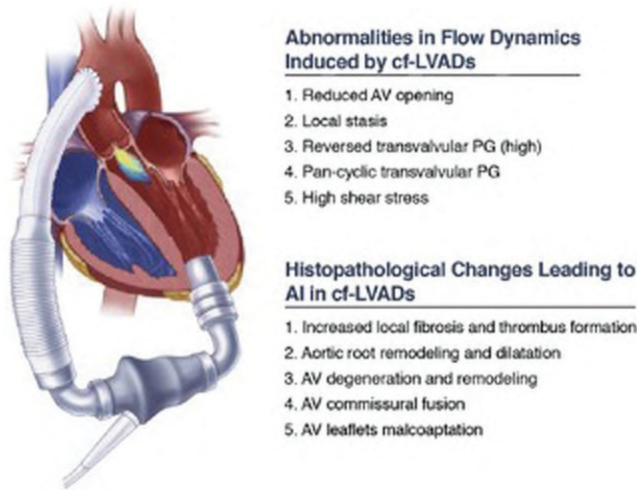
**A**ortic insufficiency (AI), a complication of placing left ventricular assist devices (LVAD), is an increasingly common impediment in the postoperative course of patients on LVAD support. For patients on continuous-flow devices, the overall incidence of AI ranges between 25% and 37%, and the incidence increases by 1% to 6% per month of continued support.<sup>1</sup> Left ventricular assist devices alter the aortic valve's hemodynamic environment, decreasing left ventricular end diastolic pressure and increasing aortic pressure from blood return from the outflow graft. This results in an increased transvalvular gradient, the chance that an aortic valve will not open with every beat or even remain closed (depending on LVAD speed), and the subsequent decline in aortic valve pulsatility. Aortic insufficiency reduces end-organ perfusion because a substantial fraction of the circulating blood leaving the outflow graft regurgitates into the left ventricle through the incompetent valve and then back into the LVAD circuit instead of joining the systemic circulation. Because a portion of the LVAD output immediately returns to the device, forward cardiac output is limited by this circulatory loop (Figure 41.1). Aortic insufficiency slows clinical progress and may increase the risk of congestive heart failure (CHF) symptoms, arrhythmias, and repeat hospital readmissions.<sup>2</sup>

This chapter reviews the literature on aortic insufficiency in patients with LVADs, specifically focusing on mechanisms of AI. The indications for aortic valve procedures in patients with LVAD at the time of implantation are discussed, as are the management strategies for treating postoperative de novo AI.

## Mechanisms of Aortic Insufficiency after Device Placement

Several factors may influence the development of de novo postoperative AI in patients with LVADs. These factors include a closed aortic valve, persistently elevated aortic root pressure, and dilation of the aortic root.<sup>3</sup> Aortic insufficiency was originally noted with the pulsatile-flow (PF) devices, but it is more rapidly progressive and common in the continuous-flow (CF)-LVADs. In a study of AI in patients receiving a PF HeartMate XVE (HMI) LVAD (Thoratec, Pleasanton, CA) or a CF HeartMate II (HMII) device, AI developed earlier and more commonly in patients with the CF HMII device. An enlarged aortic root was also associated with CF-LVAD. Specifically, patients with AI had larger aortic root diameters, both at baseline and at follow-up, than those in patients without AI. In addition, AI occurred more often in patients in whom the aortic valve did not open during LVAD support.<sup>4</sup>

Several other studies mirror these findings. For instance, Imamura and colleagues concluded that patients with CF devices were more susceptible to AI and less likely to undergo LV reverse remodeling than were patients with PF devices. In this study, patients with CF or PF devices were background-matched and followed for 6 months. Patients with CF devices had lower pulse pressures, larger diameters of the aortic root, and more often experienced AI than did patients with PF devices. The authors suggest that aortic root dilation may be a consequence, rather than a cause, of AI and is the result of the altered fluid dynamics and shear forces seen in CF devices, particularly in patients with closed aortic valves.<sup>5</sup> Another study found that the proximal thoracic aorta dimensions (aortic root and ascending



**Figure 41.1.** Mechanisms of aortic insufficiency in patients on continuous-flow, left-ventricular assist devices.

AI = aortic insufficiency; AV = aortic valve; CF-LVAD = continuous-flow, left-ventricular assist device; PG = pressure gradient.

Reprinted from Fang, J et al., Dealing with unintended consequences continuous-flow lvads and aortic insufficiency, *JACC Cardiovascular Imaging* 2016;9:652–654, Copyright (2016), with permission from Elsevier.

aorta diameter) increased modestly after HMII placement and were particularly pronounced in patients with preoperative aortic root dilation. The changes occurred predominantly in the first 6 months after implantation but became more stable at 12 months and at longer-term follow-up.<sup>6</sup>

Valve opening status is also associated with the development of AI; it is well established that patients with closed aortic valves are more likely to experience AI. Several studies have found that AI progressed faster in patients with aortic valves that did not open regularly while on device support than it did in patients with aortic valves that opened on every beat. Cowger and colleagues hypothesize that this faster progression occurs through two mechanisms. Patients without aortic valve opening on LVAD support are generally unable to generate the left ventricular systolic pressures required to open the aortic valve. The root of the aortic valve is thereby subjected to continuous high pressures, and large volumes of retrograde blood from the outflow cannula contact the valve surface. The diameter of the outflow graft is smaller than that of the ascending aorta, and supraphysiologic velocities in the ascending aorta are required to maintain adequate flow. These velocities lead to high luminal pressure on the aortic valve and to the subsequent development of myxomatous granulation tissue on the root aspect of the coronary cusps. The leaflets may then fuse, further reducing the capability for aortic valve opening. Valve thickening also occurs in patients with little or intermittent opening of the aortic valve, with

the associated leaflet pliability and increased degeneration. Valves that remain closed likely fuse and degenerate from disuse.<sup>7</sup>

Pathologic analyses support the preceding findings. Research suggests that the altered mechanical stimulation of aortic valves in patients with LVADs affects the valve's cells, the matrix composition the cells produce, and ultimately, the valve's material properties. Several studies have shown that the abundance of proteins related to actin and myosin increases, especially smooth muscle alpha-actin, suggesting that the valves are stressed. One recent study found that aortic valves in patients with LVADs were stiffer and had more cell activation, immune and oxidative stress, and tumor growth factor beta (TGF- $\beta$ )-related proteins. The authors conclude that aortic valves in these patients respond to altered hemodynamics with increases in signaling pathways related to injury and valve cell activation, ultimately leading to valve stiffening, further contributing to AI.<sup>8</sup> Histologic assessment of the aortic wall also suggests that elastic fibers are depleted, elastic fiber fragmentation is increased, and smooth muscle cells in the medial layer begin to degenerate.<sup>9</sup>

Several other factors associated with post-LVAD implantation AI have been investigated. Older age at time of implantation and longer duration of support are established risk factors for AI. Other factors, such as hypertension, female sex, older age, and smaller body surface area, have also been proposed as risk factors.<sup>7,10</sup> Still, the link between these factors and AI in CF-LVAD patients is uncertain, with some studies showing associations and others not. Most recent studies looking at longer-term LVAD outcomes do not suggest an association between higher mean arterial pressures and an increased risk of developing AI. The results are similarly conflicting for sex and body surface area.<sup>11</sup> Older age and its associated structural deficiency of the aortic tissue may make patients more susceptible to the unique circulatory pattern in the aortic root seen in patients with CF-LVADs.

Thus, the progression of AI after LVAD implantation is multifactorial and includes changes in aortic blood flow dynamics after LVAD support, changes in the aortic wall caused by sheer stress and high diastolic luminal pressures, and aortic valves that remain closed. Fluid dynamics, histology, and aortic valve and aortic geometry are all critical factors in the development of AI. Aortic insufficiency compromises device flow, reduces device output, and can cause end-organ malperfusion.

## Clinical Impact of Aortic Insufficiency after Device Removal

The clinical importance of post-LVAD AI is still being investigated. Most studies of AI in patients with CF-LVAD

are short- to medium-term, and many are in a bridge-to-transplantation cohort with short median durations of LVAD support, in many cases less than 1 year. One longer-term study of late outcomes in patients with an HMII device found that AI did not appear to affect long-term mortality. In this single-institution study, survival among recipients of CF-LVAD devices who experienced marked AI and those who did not differed at 1, 3, and 5 years after implantation.<sup>12</sup> Several smaller studies with mid-term follow-up have had similar results. However, conflicting reports come from Japan, where the average LVAD support period before transplantation exceeds 2 years because of a severe donor shortage. In patients with a median support duration of 773 days, survival was significantly worse in patients who experienced de novo AI within 1 year after LVAD implantation than it was in similar patients without AI. Most patients with de novo AI who died after 2 years of LVAD support died of congestive heart failure.<sup>13</sup>

The degree of AI that develops postoperatively seems to correlate with certain symptoms. For instance, in one study, all LVAD patients with severe postoperative AI experienced clinical symptoms of heart failure and underwent re-operation for aortic valve interventions with subsequent complete resolution of AI and other symptoms.<sup>2</sup> In another study, nearly 40% of patients with at least moderate AI experienced heart failure symptoms, all requiring interventions.<sup>14</sup> At the very least, patients with AI after LVAD implantation may be subject to more frequent testing, monitoring, and imaging compared to those LVAD patients without AI because clinicians may feel compelled to follow these patients more closely. This additional attention increases the burden to patients already coming to the clinic for cardiology follow-up appointments.

Although a link to shorter long-term mortality may not be clear, several studies suggest that higher readmission rates and more heart failure symptoms occur in patients with de novo AI after LVAD implantation, so it is important to study and address this pathology.

## Indications and Surgical Techniques for Aortic Valve Procedures at Time of Device Implantation

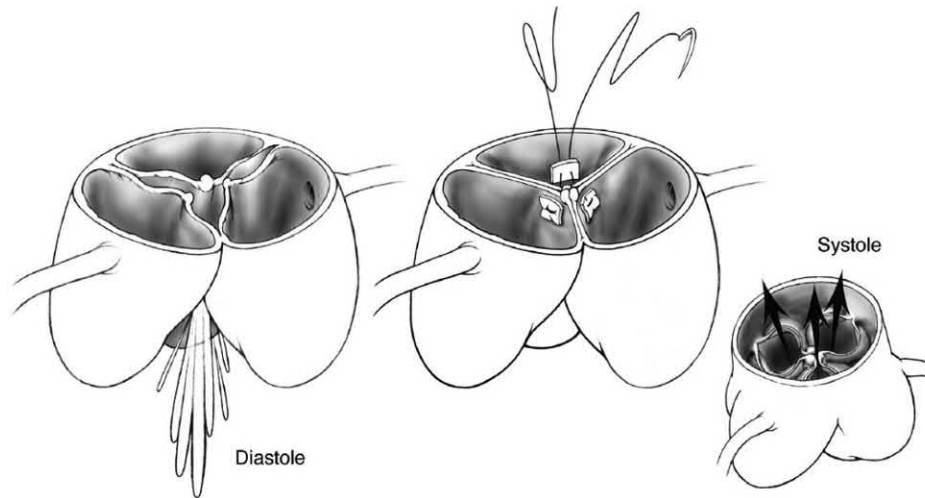
The optimal method to manage AI after LVAD placement remains controversial. The options include no operative intervention and then postoperative medical management with diuretics and afterload reduction, suture repair of the valve, complete closure or central closure of the native valve, replacement with a biological valve, patch closure of the left ventricular outflow tract, and postoperative closure or replacement with a percutaneous device. Even in patients with mild AI, the concern is that AI will progress after LVAD placement. Thus, for patients with mild and greater degrees of AI at the time of LVAD placement, as determined from

intraoperative transthoracic echocardiography, we perform an aortic valve procedure. Patients with large body surface area–indexed aortic roots and with mild or greater AI were at greatest risk for postoperative development of marked AI. In our opinion, these patients are the best candidates for aortic valve procedures.<sup>3</sup> Furthermore, our practice has a high proportion (almost 80%) of bridge-to-transplant patients among LVAD recipients. Long wait-list times and the associated prolonged device support have made us more aggressive about treating AI when placing LVADs. Patients with destination therapy LVADs will also typically be on prolonged support, further motivating us to be aggressive about addressing AI at the time of LVAD placement.

Aortic valve procedures are generally the only instance when we will cross-clamp and arrest the heart during LVAD placement because all other valve procedures, including mitral valve replacements, can be done on beating-heart bypass, if the left ventricle is vented or open through the apex. In general, we are able to perform the aortic valve procedures through the same longitudinal incision in the aorta that will be incorporated into the outflow graft anastomosis.

Central aortic valve closure (CAVC), otherwise known as Park's stitch, is our technique of choice. This technique is a simple, efficient, and durable treatment for AI during LVAD placement, with follow-up that extends to 2 years after device implantation.<sup>3</sup> The valve may be closed with a 4-0 or 5-0 polypropylene monofilament suture to centrally coapt the three aortic leaflets together, at the level of the nodules of Arantius, with a small felt pledget in each cusp (Figure 41.2).<sup>15</sup> This technique eliminates central regurgitation while allowing valve opening through the lateral aspects of the leaflets; thus, it is not a true aortic valve closure, but rather a modified repair. In mid-term outcomes among patients with CF-LVADs who have undergone Park's stitch, AI resolved, recurrent rates of AI were low, and mortality did not differ significantly from that in patients who did not have cross-clamp and aortic valve repair at the time of LVAD placement. Specifically, these patients had a 57% decrease in the odds of marked, post-implant AI progression after adjusting for time and degree of preexisting AI. This decreased rate of postoperative AI may correlate with decreased hospital readmissions for heart failure symptoms, arrhythmias, or generalized monitoring and surveillance.<sup>16</sup> In some cases, CAVC may result in persistent AI during weaning from CPB, which could result in hemodynamically important progression over time. For this reason, many surgeons advocate a running 4-0 or 5-0 Prolene suture to close the leaflets of the valve, either with or without a felt buttress.

Additional options in patients with AI include other methods of valve repair or valve replacement. For patients with AI from a prolapsed leaflet, one option is to suture the prolapsed leaflet to an adjacent leaflet, thereby creating a functionally bicuspid aortic valve. Valve replacement is yet another option for managing AI at the time of LVAD placement, but this combination is associated with higher rates



**Figure 41.2.** A central aortic valve closure (Park's stitch). The valve may be closed with a 4-0 or 5-0 polypropylene monofilament suture to centrally coapt the three aortic leaflets together, at the level of the nodules of Arantius, with a small felt pledget in each cusp.

Reprinted from McKellar SH et al, Durability of central aortic valve closure in patients with continuous flow left ventricular assist devices, *Journal of Thoracic and Cardiovascular Surgery* 2014;147:344–348, Copyright (2014), with permission from Elsevier.

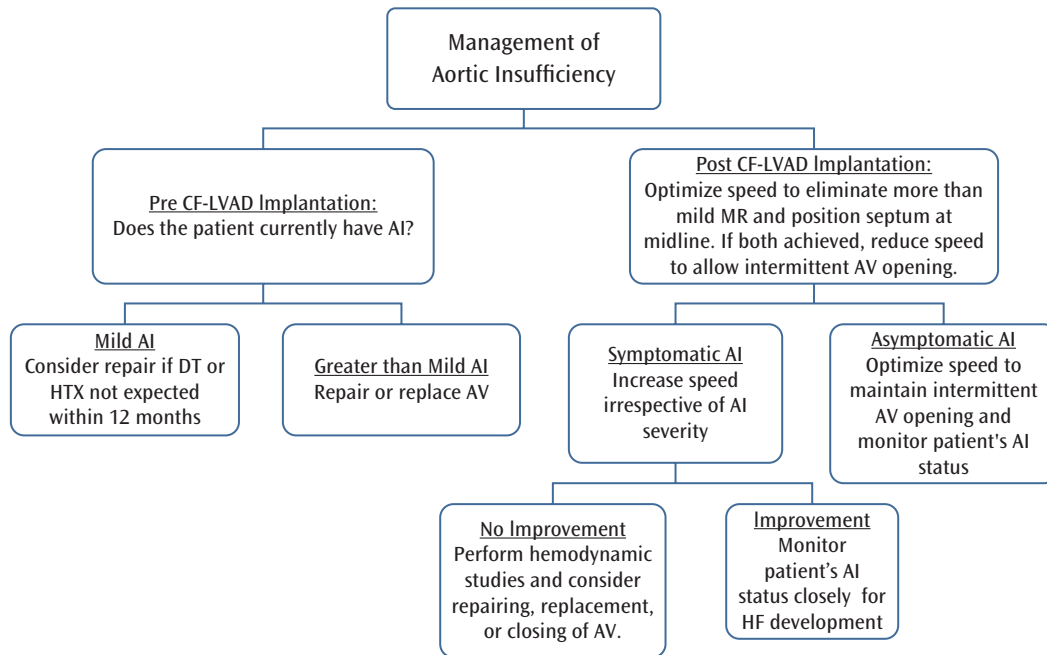
of thrombus and subsequent embolism.<sup>17</sup> Yet, certain valvular characteristics, such as heavily calcified leaflets, might preclude closure or repair techniques, necessitating aortic valve replacement (AVR). Mechanical valves are not indicated in patients with LVADs because of the increased risk of thromboembolism. Blood stasis in and around the prosthetic valve results in thrombus formation with the subsequent potential for embolization. Blood stasis occurs more often in mechanical valves, but it can also occur in biologic valves because they may remain closed after implantation. Thus, our procedure of choice is a CAVC, followed by valve repair, but in the rare case in which the valve cannot be salvaged, we would place a bioprosthetic valve, keeping in mind that these valves are associated with a small but real risk of thrombosis and embolism. Additionally, valve replacement is time-consuming, and minimizing cross-clamp time is important in these patients.

Closing the left ventricular outflow tract is another option, but if the pump stops, there is no option to perform CPR. In this technique, a circular patch of either Dacron (C.R. Bard, Haverhill, PA) or bovine pericardium is sewn circumferentially to the perimeter of the aorta.<sup>18</sup> Postoperative data analyzing various techniques of aortic valve interventions at the time of LVAD placement shows that closing the aortic valve is associated with the highest risk of mortality.<sup>17</sup> We do not close the left ventricular outflow tract, but the technique may be useful in patients with existing mechanical aortic valves requiring LVAD placement. The mechanical aortic prosthesis would be removed at the time of LVAD placement, and the defect in the root would be managed with a patch (Figure 41.3).

## Managing Postoperative de novo Aortic Insufficiency

Echocardiographic evidence of AI does not always indicate clinically important AI, and the clinical importance of AI in patients with CF-LVADs is not clear. Patients with post-LVAD AI require more frequent echocardiographic surveillance and follow-up, but no studies have yet found an increase in mortality from AI progression. In our patients, the surgical reintervention rate was 3.2%, which is consistent with the 2.5%–3.5% range reported by other studies.<sup>16</sup>

Patients with clinically important de novo AI after LVAD implantation can undergo ramp studies to increase LVAD flow in an attempt to overcome AI. Echocardiographic ramp studies are used to assess ventricular loading conditions, AI, and mitral regurgitation over a variety of speeds, and can be used to optimize the setting of the pump speed that provides the best ventricular unloading and cardiac output. However, these tests must be interpreted with caution, and the speed of the LVAD must be adjusted thoughtfully. A recent study found that patients with CF-LVADs and AI have higher pulmonary capillary wedge pressures and lower cardiac indices. Speed increases required to normalize these characteristics sometimes worsen AI, further reducing the unloading capacity of the LVAD. This reduction can translate to upstream effects, including higher wedge pressures, worsening pulmonary hypertension, and higher afterload for the right ventricle. If clinically important AI cannot be reduced with LVAD optimization or if it increases the work of the right ventricle, then surgical or percutaneous interventions may be required.<sup>19</sup>



**Figure 41.3.** A treatment algorithm for managing aortic insufficiency before or after placement of a left-ventricular assist device.

Reprinted from Fukuhara S et al., Concomitant aortic valve repair with continuous-flow left ventricular assist devices: results and implications, *Journal of Thoracic and Cardiovascular Surgery* 2016;151:201–209, 210.e1–2, Copyright (2016), with permission from Elsevier.

Clinically important de novo AI developing after LVAD placement can be treated with CAVC, although reoperation is not insignificant in these patients, especially considering that they may again require chest re-entry for transplantation or device exchange. Many of these patients have already had multiple sternotomies, in which hostile chests and other comorbidities increase the risk for repeat surgery. Repeat sternotomy after LVAD implantation is a major intervention, with risks of right-ventricular damage or postoperative failure, hemorrhage, inadvertent damage to the outflow graft, and other surgical trauma. The obligatory heparinization for cardiopulmonary bypass and cross-clamp time required to surgically repair an aortic valve may both lead to higher overall blood loss and longer recovery times than do other non-surgical options. Yet, in at least one single-institution retrospective study, patients with severe AI who underwent surgical correction had better long-term survival than did patients with uncorrected AI.<sup>20</sup>

Newer percutaneous options, including transcatheter valve closure and valve replacement, have emerged as potential alternatives to surgery. In one retrospective study, 10 patients underwent transcatheter aortic valve closure with an Amplatzer Multi-Fenestrated “Cribiform” Septal Occluder device (St. Jude Medical, St. Paul, MD) to treat LVAD-associated severe de novo AI. Device size was customized based on annulus size. The mortality rate was high, with only 3 patients surviving to hospital discharge.<sup>21</sup> Perhaps this finding is unsurprising, given other studies

reporting that patients undergoing open surgical closure of the aortic valve have a higher risk of postoperative death than that of patients undergoing other aortic valve surgeries.

Transcatheter valve replacements are yet another option for CF-LVAD patients with de novo postoperative AI. The Edwards Sapien valve, the Medtronic CoreValve, and the Medtronic Melody valves have all been placed in patients with CF-LVAD and have successfully treated AI. Complications include device migration and perivalvular leakage. Mid-term follow-up revealed that survival was better in patients undergoing transcatheter valve replacement than transcatheter valve closure. These studies and outcomes data are from small and heterogenous samples, and more data and analysis are required before any conclusions may be reached about this novel approach.<sup>22–24</sup>

## Future Perspectives

Although much is known about AI and its effects on patients with LVADs, several areas of study require investigation. We still cannot predict which patients will experience AI after LVAD implantation or its severity. Additionally, several studies suggest that the optimal management strategy at the time of LVAD implantation is to perform a CAVC in patients with mild or greater AI at the time of implantation, particularly in patients in whom long-term LVAD support is expected. Finally, further

analysis of transcatheter management of post-LVAD AI is a potentially fruitful topic. If the outcomes of percutaneous procedures are as good as or superior to open repair, then these procedures have the potential to spare LVAD patients with de novo AI a re-operative sternotomy and its attendant morbidity.

## Conclusion

We believe that mild and greater AI at the time of LVAD implantation is an indication for intervention. Longer device support times increase the risk of consequences of untreated AI, including heart failure symptoms, arrhythmias, and repeat hospital admissions. Moreover, repeat sternotomies in these patients are undesirable. Our procedure of choice is central aortic valve closure at the time of LVAD placement. This procedure is elegantly designed, easy to reproduce, and quick to perform. The causes of de novo postoperative AI are multifactorial but are well described and include changes in aortic blood flow dynamics after LVAD support, changes in the aortic wall from sheer stress and high diastolic luminal pressures, and aortic valves that remain continuously closed.

Echocardiographically important AI does not always correlate with clinically meaningful AI. Any intervention, be it surgical, percutaneous, or adjusting LVAD speed, must be thoughtfully performed, and patients must be closely monitored after treatment. In the future, de novo AI may be treated with catheters, although current studies are small and at the case report level. We look forward to learning the impact of the newest continuous-flow devices, such as the HeartMate 3 (HM3), with its intermittent pulse generation, on the development of LVAD-associated AI. We hypothesize that patients with this type of device may be slightly less susceptible to de novo AI because the intermittent pulse generated by the device is designed to open the aortic valve and re-establish a small but important degree of pulsatility for these patients.

## REFERENCES

1. Saeed D, Westenfeld R, Maxhera B, et al. Prevalence of de novo aortic valve insufficiency in patients after Heartware VAD implantation with an intermittent low-speed algorithm. *ASAIO J*. 2016;62(5):565–570.
2. Rajagopal K, Daneshmand MA, Patel CB, et al. Natural history and clinical effect of aortic valve regurgitation after left ventricular assist device implantation. *J Thorac Cardiovasc Surg*. 2013;145(5):1373–1379.
3. Fukuhara S, Ikegami H, Polanco AR, et al. Concomitant repair for mild aortic insufficiency and continuous-flow left ventricular assist devices. *Eur J Cardiothorac Surg*. 2017;52(6):1062–1068.
4. Pak SW, Uriel N, Takayama H, et al. Prevalence of de novo aortic insufficiency during long-term support with left ventricular assist devices. *J Heart Lung Transplant*. 2010;29(10):1172–1176.
5. Imamura T, Kinugawa K, Fujino T, et al. Aortic insufficiency in patients with sustained left ventricular systolic dysfunction after axial flow assist device implantation. *Circ J*. 2015;79(1):104–111.
6. Fine NM, Park SJ, Stulak JM, et al. Proximal thoracic aorta dimensions after continuous-flow left ventricular assist device implantation: longitudinal changes and relation to aortic valve insufficiency. *J Heart Lung Transplant*. 2016;35(4):423–432.
7. Cowger J, Pagani FD, Haft JW, Romano MA, Aaronson KD, Koliass TJ. The development of aortic insufficiency in left ventricular assist device-supported patients. *Circ Heart Fail*. 2010;3(6):668–674.
8. Stephens EH, Han J, Trawick EA, et al. Left-ventricular assist device impact on aortic valve mechanics, proteomics and ultrastructure. *Ann Thorac Surg*. 2018;105(2):572–580.
9. Saito T, Wassilew K, Gorodetski B, et al. Aortic valve pathology in patients supported by continuous-flow left ventricular assist device. *Circ J*. 2016;80(6):1371–1377.
10. Patil NP, Mohite PN, Sabashnikov A, et al. Does post-operative blood pressure influence development of aortic regurgitation following continuous-flow left ventricular assist device implantation? *Eur J Cardiothorac Surg*. 2016;49(3):788–794.
11. Lampert BC, Eckert C, Weaver S, et al. Blood pressure control in continuous flow left ventricular assist devices: efficacy and impact on adverse events. *Ann Thorac Surg*. 2014;97(1):139–146.
12. Holley CT, Fitzpatrick M, Roy SS, et al. Aortic insufficiency in continuous-flow left ventricular assist device support patients is common but does not impact long-term mortality. *J Heart Lung Transplant*. 2017;36(1):91–96.
13. Toda K, Fujita T, Domae K, Shimahara Y, Kobayashi J, Nakatani T. Late aortic insufficiency related to poor prognosis during left ventricular assist device support. *Ann Thorac Surg*. 2011;92(3):929–934.
14. Jorde UP, Uriel N, Nahumi N, et al. Prevalence, significance and management of aortic insufficiency in continuous flow left ventricular assist device recipients. *Circ Heart Fail*. 2014;7(2):310–319.
15. McKellar SH, Deo S, Daly RC, et al. Durability of central aortic valve closure in patients with continuous flow left ventricular assist devices. *J Thorac Cardiovasc Surg*. 2014;147(1):344–348.
16. Fukuhara S, Takeda K, Chiuhan C, et al. Concomitant aortic valve repair with continuous-flow left ventricular assist devices: Results and implications. *J Thorac Cardiovasc Surg*. 2016;151(1):201–209. 210.e1–e2.
17. Robertson JO, Naftel DC, Myers SL, et al. Concomitant aortic valve procedures in patients undergoing implantation of continuous-flow left ventricular assist devices: an INTERMACS database analysis. *J Heart Lung Transplant*. 2015;34(6):797–805.
18. Atkins BZ, Hashmi ZA, Ganapathi et al. Surgical correction of aortic valve insufficiency after left ventricular assist device implantation. *J Thorac Cardiovasc Surg*. 2013;146(5):1247–1252.
19. Sayer G, Sarswat N, Kim GH, et al. The hemodynamic effects of aortic insufficiency in patients supported with continuous-flow left ventricular assist devices. *J Card Fail*. 2017;23(7):545–551.
20. Adamson RM, Dembitsky WP, Baradaran S, et al. Aortic valve closure associated with HeartMate left



- ventricular device support: technical considerations and long-term results. *J Heart Lung Transplant*. 2011;30(5):576–582.
21. Retzer EM, Sayer GT, Fedson SE, et al. Predictors of survival following trans-catheter aortic valve closure for left ventricular assist device associated aortic insufficiency. *Catheter Cardiovasc Interv*. 2016;87(5):971–979.
  22. Kornberger A, Beiras-Fernandez A, Fichtlscherer S, Assmus B, Moritz A, Stock UA. Percutaneous SAPIEN S3 transcatheter valve implantation for post-left ventricular assist device aortic regurgitation. *Ann Thorac Surg*. 2015;100(4):e67–e69.
  23. Phan K, Haswell JM, Xu J, et al. Percutaneous transcatheter interventions for aortic insufficiency in continuous-flow left ventricular assist device patients: a systematic review and meta-analysis. *ASAIO J*. 2017;63(2):117–122.
  24. Murashita T, Joyce DL, Pochettino A, Stulak JM, Joyce LD. Concomitant valve-in-valve transcatheter aortic valve replacement and left ventricular assist device implantation. *Innovations (Phila)*. 2017;12(2):147–149.

# 42

## Modalities of Left Ventricular Assist Device Optimization

NIKHIL NARANG, GABRIEL SAYER, AND NIR URIEL

### Introduction

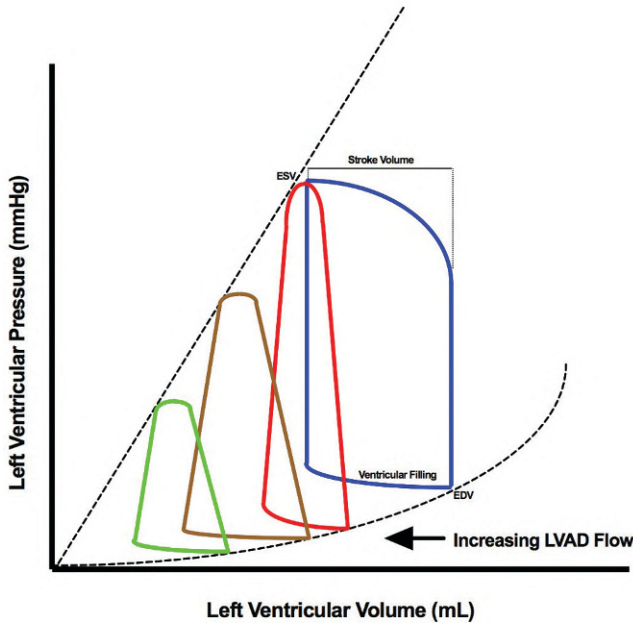
**C**ontinuous-flow left ventricular assist devices (LVADs) offer therapy for patients with advanced heart failure to improve quality of life and survival, either as destination therapy (DT) or bridge to transplantation (BTT).<sup>1,2</sup> With improvements in pump-patient compatibility, 2-year survival of the most contemporary LVADs now rivals heart transplantation.<sup>3</sup> Patients with an LVAD need to be optimized medically with guideline-directed medical therapy and by adjusting device settings. Furthermore, the International Society of Heart and Lung Transplantation recommends that LVAD optimization should be achieved by speed adjustment aimed at left ventricular unloading, while maintaining a midline intraventricular septum. Additionally, speeds should be adjusted to minimize mitral valve regurgitation (MR) to ensure intermittent aortic valve (AV) opening.<sup>4</sup> The use of echocardiography and invasive hemodynamics are essential clinical tools to improve the hemodynamic profile of a patient with an LVAD. This review will cover the following topics: (1) LVAD flow-pressure relationship; (2) echocardiographic and invasive hemodynamic LVAD optimization; and (3) intracardiac pacing in LVADs.

### Hemodynamics of LVADS

LVADs may be classified as either axial pumps such as the HeartMate II (Abbott, Abbott Park, IL) and Jarvik 2000 (Jarvik Heart, New York, NY) or centrifugal pumps, which consist of the HVAD (Medtronic, Minneapolis, MN) and HeartMate 3 (Abbott, Abbott Park, IL). The best way to understand the relationship between the cardiovascular system and LVADs is by using pressure-volume loops (PVLs). Under normal physiologic conditions, the PVL is

characterized by a trapezoidal shape with a rounded top. Following LVAD implantation, the continuous-flow LVAD loses both isovolumic contraction and relaxation, transforming the PVL from a trapezoidal shape to a triangular shape<sup>5</sup> (Figure 42.1). Increasing LVAD speed increases LV unloading by increasing the flow through the pump and progressively shifting the PVL to the left. Higher LVAD flows correlates with decreasing peak LV pressure generation and higher systemic arterial pressures, a phenomenon known as decoupling between LV and aortic pressures. Additionally, lowering ventricular end-diastolic pressure with increased unloading results in a shift in myocardial energetics to a state of minimized demand and maximized supply.<sup>6,7</sup>

An HQ curve is the relationships of blood flow (Q) through a LVAD and pressure differential (H) between the inflow and outflow cannulas (pump pressure; Figure 42.2), and reflects the unique engineering characteristics of the pump and physiologic response to speed changes. As such, the HQ curve appearance in axial and centrifugal pump differs and should be taken into account while setting the device's speed. At a defined pump speed, pump flow decreases as the pressure gradient across the inflow and outflow cannula increases. The converse is true for a static pressure gradient, where pump flow increases as the pump speed increases. However, the underlying contractile reserve of the LV, which can vary drastically between patients, will have a meaningful impact on the pressure differential during systole and diastole, further impacting the degree of flow changes in response pump speed changes. Centrifugal LVADs (HVAD and HeartMate 3) are sensitive to changes in pressure differential and can experience wide ranges of flows for a very small change in pressure gradients (A in Figure 42.2).<sup>8,9</sup> Applying this principle clinically, the flat HQ curve translates to little change in the pressure differential in response to low flows, which



**Figure 42.1.** Flow-dependent changes of the pressure volume loop with leftward shift representing greater LV unloading.

ESV= end-systolic volume; EDV= end-diastolic volume.

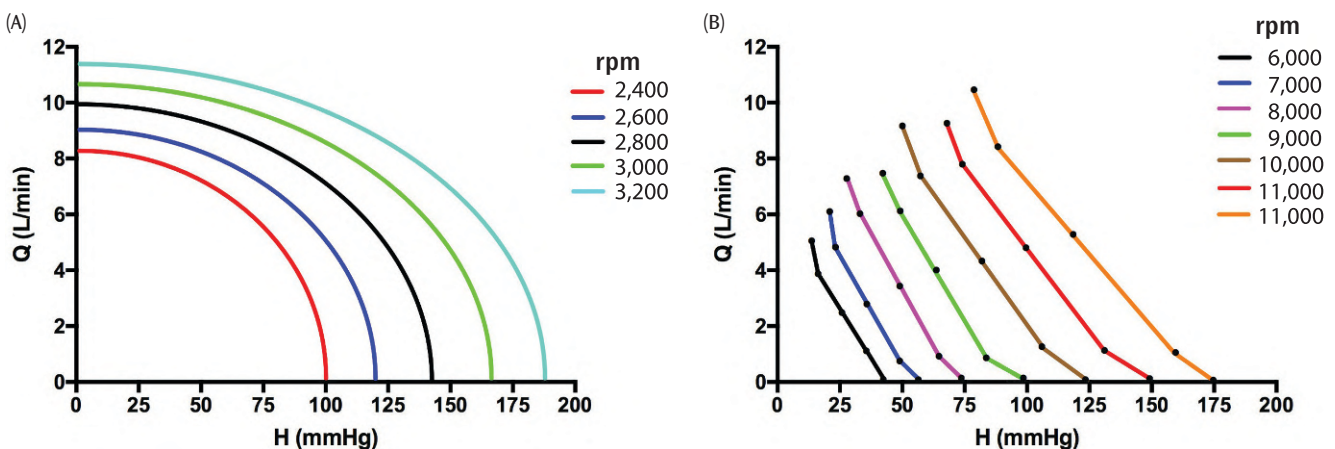
Reprinted from Narang N et al., Hemodynamic pump-patient interactions and left ventricular assist device imaging, *The Cardiology Clinics of North America* 2018;36:561–569, Copyright (2018), with permission from Elsevier.

can occur commonly in hypovolemia or even right heart failure. Static pressure differentials translate to less susceptibility to increased suction during low flow conditions. Conversely, uncontrolled hypertension markedly increases the LV ventricular-aortic pressure gradient and

may cause trough flows to nadir at 0 L/min. Axial flow pumps (HeartMate II) have much steeper HQ curves where there is linear inverse relationship in flow with pump pressure differential (B in Figure 42.2). Narrow pressure differentials will produce less flow pulsatility (3–7 L/min for example) compared to centrifugal pump designs. The steep HQ curves in axial flow LVAD translate to greater pressure differential in the setting of low flows, which may trigger suction events within the LV cavity. Intrinsic myocardial contractility, distinct properties of pump engineering demonstrated in HQ curves, along with dynamic changes in ventricular and aortic loading conditions, govern the complex pump-patient interactions seen in modern-day durable mechanical support.

### LVAD Speed Optimization

A unique pump-patient interaction is present for all subtypes of patients who receive durable mechanical circulatory support. This is due to the several contributing factors which ultimately affect LVAD performance. Device speed adjustment is a common means to achieve medical optimization for patients with LVADs. It is important to consider the other factors which contribute to optimization as governed by the pump-patient interaction, which include patient body size, gender, dynamic loading conditions, neurohormonal blockade, and presence of RV failure. As these factors may only be altered to a finite extent, informed device speed optimization becomes a critical aspect of routine LVAD management. Guidelines suggest that the clinician select a speed where the LV is adequately unloaded, with a midline intraventricular septum, minimal MR, and intermittent AV opening.<sup>10</sup> We will review modes of LVAD speed optimization through both echocardiographic and invasive hemodynamics.



**Figure 42.2.** Flow (Q) compared to pressure differentials (H) between inflow cannula and outflow graft at various pump speeds for (A) centrifugal pump and (B) axial flow pump.

Reprinted from Narang N et al., Hemodynamic pump-patient interactions and left ventricular assist device imaging, *The Cardiology Clinics of North America* 2018;36:561–569, Copyright (2018), with permission from Elsevier.

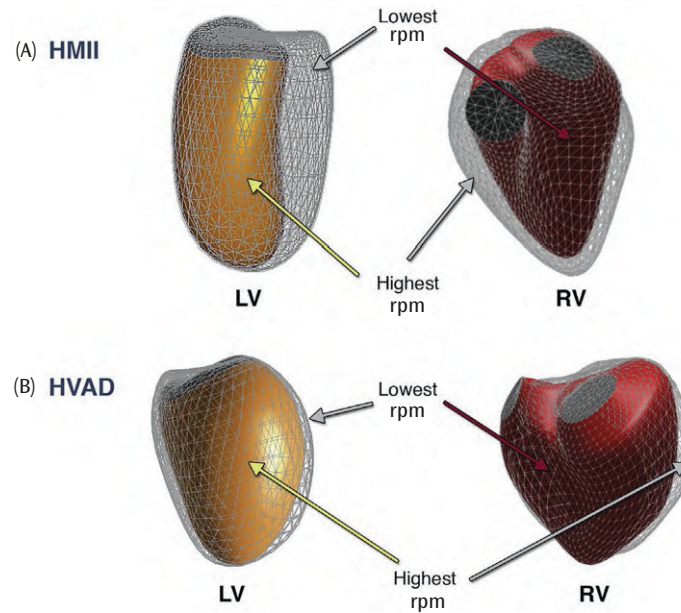
## Two- and Three-Dimensional Echocardiographic Optimization

Echocardiography is an essential tool in choosing an LVAD speed for stable patients, but can be also employed when device-related complications are suspected. Our group was the first to describe a formalized protocol for LVAD speed testing for the purpose of speed optimization and diagnosing device thrombosis.<sup>4</sup> Stepwise LVAD speed titration under echocardiographic guidance or ramp study may be performed once appropriate anticoagulation is confirmed with INR (international normalized ratio) >1.8 or partial thromboplastin time (PTT) >60 seconds. Opening arterial pressure by Doppler should be >65 mmHg at baseline to proceed. The parasternal long-axis view is first acquired to assess left ventricular end-diastolic dimension (LVEDD), left ventricular end-systolic dimension (LVESD), frequency of AV opening (defined as number over 10 beats), degree of aortic insufficiency (AI), MR and heart rate. LVAD parameters including power, pulsatility index (PI), and flow are recorded at each stage. For the HeartMate II devices, the device speed is lowered to 8,000 rpm and 2,300 rpm for the HVAD devices. After 2 minutes of washout time, LVEDD, LVESD, degree of MR, AI, assessment of AV opening, Doppler blood pressure (BP) and heart rate, LVAD power, PI, and flow are all recorded during each stage. Stepwise increase in speed at intervals of 400 rpm for HeartMate II and 100 rpm for HVAD are then made. For the HeartMate 3, the lower speed limit is set to 4,600 rpm and is increased in 100-rpm increments up to 6,200 rpm.<sup>11</sup> The protocol is complete once the upper limit speed is reached, LVEDD reaches <3.0 cm, or either suction events or ventricular ectopic beats occur. Development of premature ventricular contractions, which may indicate contact of the inflow cannula with the septum, should be noted and is considered an indication to no longer increase speed. The comprehensive ramp study will best inform the clinician to choose a device speed that will achieve the goals of device optimization as detailed by echocardiographic criteria.

HVAD and HeartMate II devices may be susceptible to pump thrombosis, and in unclear clinical scenarios, ramp testing can be utilized for device malfunction assessment. Patients with obstruction to flow had minimal change in their LVEDD size in response to speed change leading to an attenuated LVEDD slope when calculated by a linear equation (device speed on x-axis vs. LVEDD on y-axis).<sup>12</sup> Data from our group showed an LVEDD slope of  $>-0.16$  was suggestive of device thrombosis when performing echocardiographic ramp testing. However, performing a ramp test in patients with HVADs was not associated with linear LVEDD reduction in response to speed changes, as seen with the HeartMate II pumps.<sup>13,14</sup> Despite this, the clinician should suspect device thrombosis if other markers are present

(elevated plasma lactate dehydrogenase and plasma free hemoglobin) and the pump is unable to decompress the LV cavity with significant increases in device speed. In regard to HeartMate 3 devices, the low rate of device thrombosis<sup>3</sup> associated with this device make the ramp test irrelevant for this indication.

Recently, our group investigated ventricular structural changes in a patient for whom invasive hemodynamic ramp (simultaneous right heart catheterization with echocardiography) studies were conducted, during which 3D transesophageal echocardiogram (TTE) imaging processing was performed, to better understand the influence of device speed changes and global LV and RV geometry.<sup>15</sup> End-diastolic and systolic volumes using 3D TTE were calculated at each stage during prespecified ramp protocol; 3D endocardial surface analysis was performed to assess for LV conicity and sphericity. Prior studies have detailed how adverse myocardial remodeling leads to a spherical LV due to chronic volume overload in patients with severe mitral regurgitation from MV prolapse, with postsurgical improvements represented by change to more normal, conical shape.<sup>16</sup> To understand better the RV, 3D TTE RV shape analysis was performed. For the HeartMate II cohort, LV volumes decreased by  $127 \pm 78$  mL ( $p < 0.01$ ), becoming more conical with increasing speeds. RV volumes only increased significantly at highest speeds, with RV septal shape on average also becoming more convex (bulging into the LV) at the highest speed when compared to the lowest speed setting. LV volumes in the HVAD cohort similarly decreased when comparing the lowest and highest speeds ( $51 \pm 38$  mL,  $p < 0.01$ ); however, the changes in shape were more global than the longitudinal changes seen with HeartMate II. Schematics depicting 3D ventricular geometry in respect to pump type (HeartMate II and HVAD) are shown in Figure 42.3. In the Heartmate 3, the LV volume changes were in between HeartMate II and HVAD, with global reduction in volumes ( $94 \pm 19$  mL,  $p < 0.01$ ) in a semi-longitudinal fashion<sup>11</sup> (Figure 42.4). There was a non-statistically significant increase in RV volumes in response to the increase in speed in the HVAD cohort. The differential changes in 3D TTE ventricular shape in HVAD and HeartMate II pumps may be attributed to device position. The HeartMate II device is located in the subdiaphragmatic space, resulting in inferior displacement of the LV apex, whereas the intrathoracic placed HVAD resides within the LV apex and consequently has less apical deformation. These advanced imaging modalities allow us to better understand speed optimization than conventional 2D methods. Three-dimensional TTE image processing is especially useful in better quantifying a structural “cross point,” where the LV is adequately unloaded and made more conical without the compromise of increasing RV volume and convexity or bulging into the LV cavity.



**Figure 42.3.** Three-dimensional (3D) endocardial surfaces of the LV (orange) and RV (red) were obtained at the lowest (gray outline) and rpm for both the axial flow pump (A) and centrifugal flow pump (B).

Reprinted from Addetia K et al., 3D morphological changes in LV and RV during LVAD ramp studies, *JACC Cardiovascular Imaging* 2018;11:159–169, Copyright (2018), with permission from Elsevier.

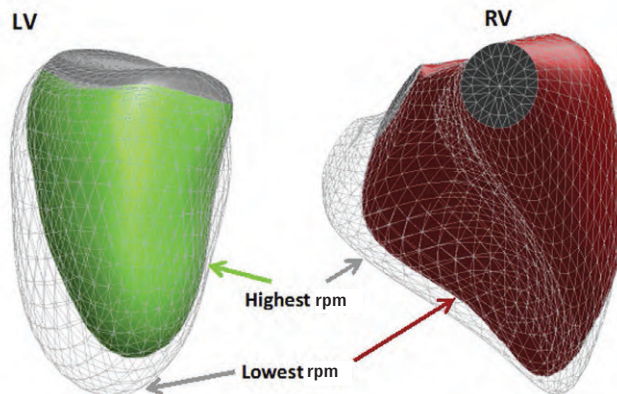
## Invasive Hemodynamic Optimization

Medical optimization of the patient with an LVAD is now able to go beyond echocardiography alone with the combination of invasive hemodynamics to better improve a patient's hemodynamic profile. Our original study of non-invasive ramp testing was followed with a second analysis

of LVAD speed adjustment combined with invasive hemodynamics obtained during a right heart catheterization (RHC).<sup>17</sup>

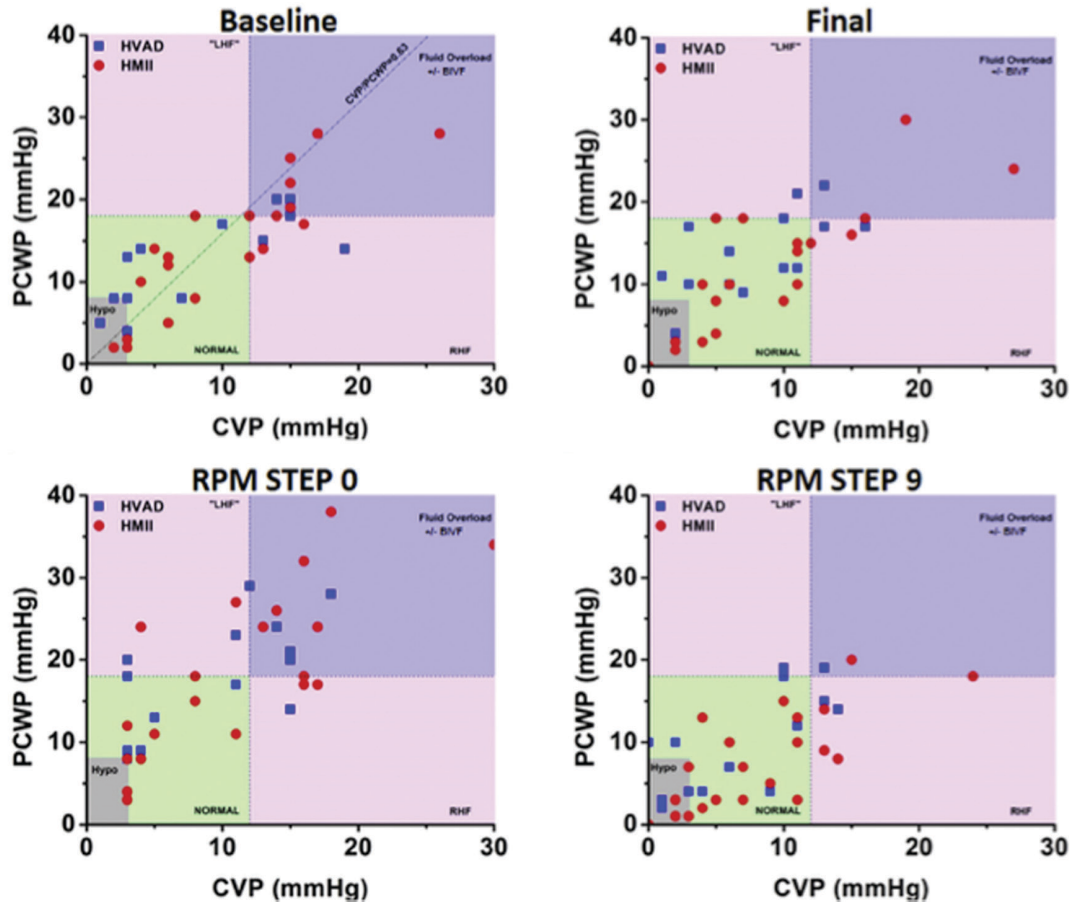
The protocol was similar to echocardiographic testing alone, except the entire study takes place in a cardiac catheterization laboratory. After securement of a Swan-Ganz catheter in the internal jugular vein, baseline central venous pressure (CVP) pressure, pulmonary artery pressure (PAP), pulmonary capillary wedge pressure (PCWP), Fick cardiac output (CO), and index (CI) are measured. The same steps for speed up-titration are made as previously described, with 2-minute washout periods following speed changes, and the same pump parameters and echocardiographic variables collected as previously described. At the conclusion of the assessment, the clinician chooses the speed which best achieves hemodynamic optimization, defined as a PCWP <18 mmHg and CVP <12 mmHg, with the secondary goals of intermittent AV opening and minimal MR.

In ambulatory outpatients with both HVAD and HeartMate II LVADs, baseline hemodynamics surprisingly revealed that only 43% of LVAD patients had a CVP and PCWP within the specified normal range.<sup>17</sup> Following hemodynamic ramp tests, 56% of patients achieved normalization of both CVP and PCWP. The hemodynamic profiles of the overall cohort represented by CVP and PCWP are best characterized in Figure 42.5. The dashed line in baseline panel in Figure 42.5 equates to a CVP to PCWP ratio of 0.63, with ratios greater than this cut point suggestive of right heart failure.<sup>18</sup> No significant differences in baseline



**Figure 42.4.** Three-dimensional endocardial surfaces of the left (LV) and right (RV) ventricles obtained at the lowest (gray outline) and highest rpm.

Reprinted from Uriel N et al., Echocardiographic changes in patients implanted with a fully magnetically levitated left ventricular assist device (HeartMate 3), *Journal of Cardiac Failure* 2019;25:36–43, Copyright (2019), with permission from Elsevier.



**Figure 42.5.** Plot of individual patients' CVP versus PCWP at baseline, highest LVAD speed and final measurement; five zones are described, including normal, left heart failure (LHF), fluid overload, right heart failure (RHF), and hypovolemia (Hypo).

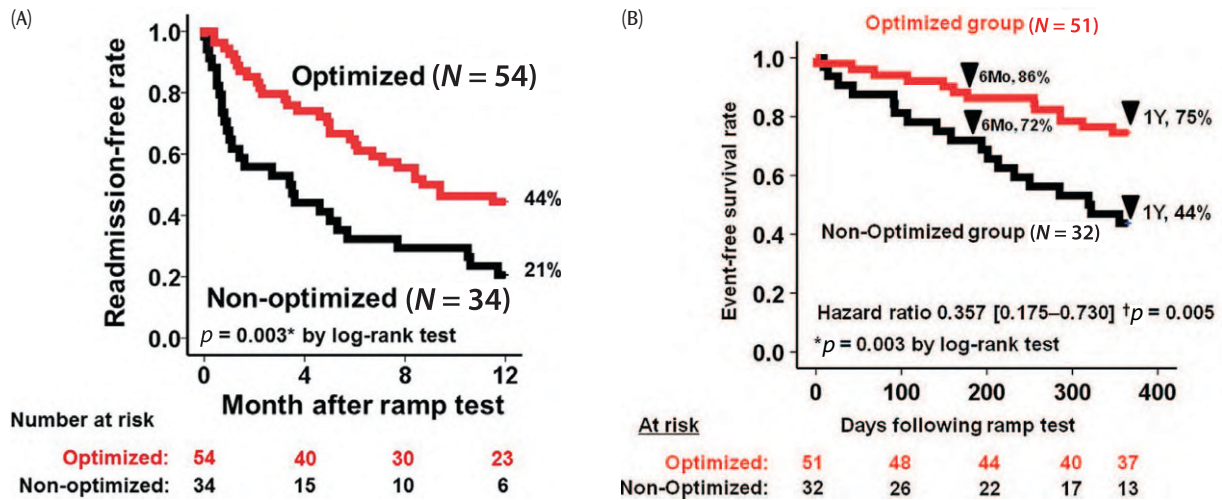
Reprinted from Uriel N et al., Hemodynamic ramp tests in patients with left ventricular assist devices, *JACC Heart Failure* 2016;4:208–217, Copyright (2016), with permission from Elsevier.

hemodynamics were found between pump type; reduction in PCWP was determined to be speed and flow dependent, and not affected by pump type.

A similar hemodynamic ramp protocol was tested by our group in a contemporary HeartMate 3 cohort.<sup>19</sup> Consistent with our prior findings, speed optimization was able to normalize CVP and PCWP in 50% of patients with abnormal hemodynamics at baseline.

The benefits of combined echocardiographic and hemodynamic speed optimization are inherent in LVAD patients given the high prevalence of abnormal hemodynamics encountered at baseline, often going unnoticed and challenging to clinically assess by exam alone. Outcomes data regarding this practice have been unknown until recently. Observational data consisting of 88 patients (both HeartMate II and HVAD) showed a significantly higher hospital admission-free survival rate in the optimized group, defined by speed changes post-ramp, compared to the non-optimized group at one-year post-ramp (HR 0.47, 95% CI 0.28–0.71,

$P = 0.005$ , Figure 42.6A).<sup>20</sup> Half the cohort had at baseline optimized hemodynamics which improved to a rate of 61% post-ramp study (CVP <12 mmHg, PCWP <18 mmHg, and CI > 2.2 L/ min/m<sup>2</sup>). A significant proportion of patients were not able to achieve hemodynamic optimization due to persistently elevated CVP despite speed changes, implying some degree of late RV failure. In addition to the association of reduced heart failure (HF)-related admissions with optimized hemodynamics through ramp studies, a further positive downstream effect may occur in the reduction of pump-related hemocompatibility-related adverse events (HRAEs). HRAEs are defined as non-surgical bleeding and thrombosis through the interaction between the artificial pump interface and blood, collectively increasing the risk of pump-related morbidity and mortality.<sup>21</sup> Events are tiered in order of severity, with non-surgical gastrointestinal bleeding episodes classified as mild events (Tier I), in contrast to disabling stroke, which is considered a severe event and classified as a Tier IIIb event.<sup>22</sup> Data from our LVAD ramp



**Figure 42.6.** (A) Readmission-free survival rates between optimized and non-optimized groups following hemodynamic ramp studies during 1-year observational period.

Reprinted with permission from Imamura T et al., Optimal hemodynamics during left ventricular assist device support are associated with reduced readmission rates, *Circulation: Heart Failure* 2019;12(2):e005094, <https://www.ahajournals.org/journal/circheartfailure> © American Heart Association, Inc. All rights reserved.

(B) Hemocompatibility-related adverse events-free survival rate stratified by optimization of hemodynamics post ramp test. Reproduced from Imamura T et al., Optimal haemodynamics during left ventricular assist device support are associated with reduced haemocompatibility, *European Journal of Heart Failure* 2019;21(2):655–662. <https://onlinelibrary.wiley.com/journal/18790844> Copyright © 1999–2019 John Wiley & Sons, Inc. All rights reserved.

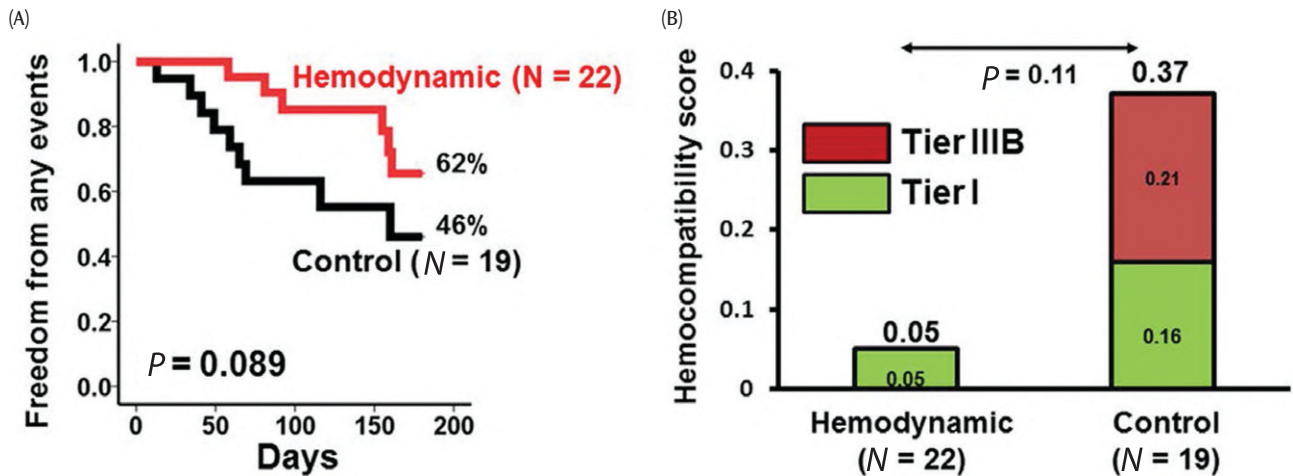
registry revealed a significantly higher rate of survival from HRAEs at 1-year following ramp study in optimized patients compared to non-optimized patients (Figure 42.6B).<sup>23</sup> Non-optimized hemodynamics were an independent risk factor for HRAEs after multivariate modeling, with the most common reason for inability to achieve optimization being persistently high CVP. RV failure, which usually accompanies an elevated CVP in the setting of normal PCWP, may result in reduced LVAD filling, lower LVAD flows, and greater degree of pump stasis and subsequent increased risk for inflow cannula thrombus formation and systemic thrombosis. Right ventricular failure is associated with hepatic congestion, progressive coagulopathy, and lower arterial pulsatility, which may contribute to adverse alterations in angiogenesis and subsequently increased risk for bleeding episodes.<sup>24,25</sup> The cause of HRAEs may be multifactorial, though a contribution from non-optimized hemodynamics is likely. This strengthens the evidence to consider hemodynamic optimization studies as a quality measure in LVAD management to reduce post-implant complications.

The benefit of ramp studies in observational analyses was applied to a multicenter, prospective randomized pilot study (RAMP-IT-UP) recently published.<sup>26</sup> Forty-four patients with HVADs were included and randomized 1 to 3 months post-implant to either hemodynamic ramp or standard care alone. At 6 months post-randomization, patients in the hemodynamic ramp arm had double the number of LVAD speed changes, and twofold greater changes in heart

failure medications. Though not powered for clinical endpoints, a trend toward lower HF-related-admissions and HRAEs was observed (Figure 42.7). This study demonstrated the feasibility in utilizing the hemodynamic ramp study at sites which had not incorporated the practice in the past, along with a road map for future large, randomized trials to better study the clinical effects of hemodynamic ramp studies as part of routine LVAD care.

## Intracardiac Pacing and LVADs

End-stage HF patients who progress to needing LVAD therapy often have preexisting pacemakers equipped for cardiac resynchronization therapy (CRT). Continuous flow physiology from LVAD therapy significantly alters isovolumetric relaxation and contraction and thus may affect the role of resynchronization therapy in this patient population. The concomitant use of both LVAD and CRT devices is growing with the amount of durable MCS implants, though the evidence supporting biventricular pacing post-LVAD implant is limited. Observational data from our cohort of patients who underwent hemodynamic ramp testing showed no difference in echocardiographic or hemodynamic characteristics at baseline or at final set speeds between patients with active CRT pacing and those without.<sup>27</sup> This was further suggested in a small, cross-sectional study where baseline hemodynamics were compared in LVAD patients with



**Figure 42.7.** (A) Kaplan-Meier survival analysis of freedom from any adverse events from the RAMP-IT-UP Multicenter Study in the hemodynamic ramp arm compared to the control arm. (B) Comparison of hemocompatibility score between the hemodynamic ramp arm and the control arm.

Reprinted with permission from Uriel N et al., Impact of hemodynamic ramp test-guided HVAD speed and medication adjustments on clinical outcomes, *Circulation: Heart Failure* 2019;12(4):e006067, <https://www.ahajournals.org/journal/circheartfailure> © American Heart Association, Inc. All rights reserved.

both CRT and RV pacing modes with a 3-minute washout period in between hemodynamic measurement—CRT was not shown to have any acute hemodynamic benefit compared to RV pacing.<sup>28</sup> Furthermore, preliminary prospective data have suggested improved quality of life and exercise capacity by 6-minute walk test and daily step count in RV pacing alone compared to CRT.<sup>29</sup> Our practice given the presumed functional benefit is to turn off the LV lead in patients with a preexisting CRT device who undergo LVAD implantation. This is a clearly a developing area of investigation, with more prospective studies needed.

## Conclusion

The success of durable LVAD support for patients is heavily based on maximizing the “pump-patient” interaction to adequately unload the LV while minimizing device-related adverse events. The combination of both imaging and invasive hemodynamics allows the clinician to apply the best device settings tailored to the individual patient’s needs. Utilizing these methods has demonstrated the importance in device troubleshooting and medical optimization. Further studies, however, are needed to better validate these techniques on a large scale and to determine how they fit in the daily management of patients with LVADs.

## Disclosures

Dr. Uriel receives consultant fees and grant support from Abbott Healthcare and Medtronic. Dr. Sayer receives

consultancy fees from Medtronic. Dr. Narang has no disclosures to report.

## REFERENCES

1. Miller LW, Pagani FD, Russell SD, et al.; HeartMate IICI. Use of a continuous-flow device in patients awaiting heart transplantation. *N Engl J Med*. 2007;357:885–896.
2. Slaughter MS, Rogers JG, Milano CA, et al.; HeartMate III. Advanced heart failure treated with continuous-flow left ventricular assist device. *N Engl J Med*. 2009;361:2241–2251.
3. Mehra MR, Uriel N, Naka Y, et al. A fully magnetically levitated left ventricular assist device: final report. *N Engl J Med*. 2019.
4. Uriel N, Morrison KA, Garan AR, et al. Development of a novel echocardiography ramp test for speed optimization and diagnosis of device thrombosis in continuous-flow left ventricular assist devices: the Columbia ramp study. *J Am Coll Cardiol*. 2012;60:1764–1775.
5. Burkhoff D, Sayer G, Doshi D, Uriel N. Hemodynamics of mechanical circulatory support. *J Am Coll Cardiol*. 2015;66:2663–2674.
6. Narang N, Raikhelkar J, Sayer G, Uriel N. Hemodynamic pump-patient interactions and left ventricular assist device imaging. *Cardiol Clin*. 2018;36(4):561–569.
7. Uriel N, Sayer G, Annamalai S, Kapur NK, Burkhoff D. Mechanical unloading in heart failure. *J Am Coll Cardiol*. 2018;72:569–580.
8. Chung BB, Sayer G, Uriel N. Mechanical circulatory support devices: methods to optimize hemodynamics during use. *Expert Rev Med Devices*. 2017;14:343–353.
9. Moazami N, Fukamachi K, Kobayashi M, et al. Axial and centrifugal continuous-flow rotary pumps: a translation from pump mechanics to clinical practice. *J Heart Lung Transplant*. 2013;32:1–11.
10. Feldman D, Pamboukian SV, Teuteberg JJ, et al. The 2013 International Society for Heart and Lung



- Transplantation guidelines for mechanical circulatory support: executive summary. *J Heart Lung Transplant*. 2013;32:157–187.
11. Uriel N, Medvedofsky D, Imamura T, et al. Echocardiographic changes in patients implanted with a fully magnetically levitated left ventricular assist device (HeartMate 3). *J Card Fail*. 2019;25:36–43.
  12. Nahumi N, Jorde U, Uriel N. Slope calculation for the LVAD ramp test. *J Am Coll Cardiol*. 2013;62:2149–2150.
  13. Uriel N, Levin AP, Sayer GT, et al. Left ventricular decompression during speed optimization ramps in patients supported by continuous-flow left ventricular assist devices: device-specific performance characteristics and impact on diagnostic algorithms. *J Card Fail*. 2015;21:785–791.
  14. Sauer AJ, Meehan K, Gordon R, et al. Echocardiographic markers of left ventricular unloading using a centrifugal-flow rotary pump. *J Heart Lung Transplant*. 2014;33:449–450.
  15. Addetia K, Uriel N, Maffessanti F, et al. 3D morphological changes in LV and RV during LVAD ramp studies. *JACC Cardiovasc Imaging*. 2018;11(2 Pt 1): 159–169.
  16. Maffessanti F, Caiani EG, Tamborini G, et al. Serial changes in left ventricular shape following early mitral valve repair. *Am J Cardiol*. 2010;106:836–842.
  17. Uriel N, Sayer G, Addetia K, et al. Hemodynamic ramp tests in patients with left ventricular assist devices. *JACC Heart Fail*. 2016;4:208–217.
  18. Argiriou M, Kolokotron SM, Sakellaridis T, et al. Right heart failure post left ventricular assist device implantation. *J Thorac Dis*. 2014;6 Suppl 1:S52–S59.
  19. Uriel N, Adatya S, Maly J, et al. Clinical hemodynamic evaluation of patients implanted with a fully magnetically levitated left ventricular assist device (HeartMate 3). *J Heart Lung Transplant*. 2017;36:28–35.
  20. Imamura T, Jeevanandam V, Kim G, et al. Optimal hemodynamics during left ventricular assist device support are associated with reduced readmission rates. *Circ Heart Fail*. 2019;12:e005094.
  21. Forest SJ, Bello R, Friedmann P, et al. Readmissions after ventricular assist device: etiologies, patterns, and days out of hospital. *Ann Thorac Surg*. 2013;95:1276–1281.
  22. Mehra MR. The burden of haemocompatibility with left ventricular assist systems: a complex weave. *Eur Heart J*. 2019;40:673–677.
  23. Imamura T, Nguyen A, Kim G, et al. Optimal haemodynamics during left ventricular assist device support are associated with reduced haemocompatibility-related adverse events. *Eur J Heart Fail*. 2019;21(5):655–662.
  24. Sparrow CT, Nassif ME, Raymer DS, Novak E, LaRue SJ, Schilling JD. Pre-operative right ventricular dysfunction is associated with gastrointestinal bleeding in patients supported with continuous-flow left ventricular assist devices. *JACC Heart Fail*. 2015;3:956–964.
  25. Tomizawa Y, Tanaka A, Kitahara H, et al. Preoperative right-sided cardiac congestion is associated with gastrointestinal bleeding in patients with continuous-flow left ventricular assist devices. *Dig Dis Sci*. 2018;63:1518–1524.
  26. Uriel N, Burkhoff D, Rich JD, et al. Impact of hemodynamic ramp test-guided HVAD speed and medication adjustments on clinical outcomes. *Circ Heart Fail*. 2019;12:e006067.
  27. Tehrani DM, Adatya S, Grinstein J, et al. Impact of cardiac resynchronization therapy on left ventricular unloading in patients with implanted left ventricular assist devices. *ASAIO J*. 2019;65:117–122.
  28. Cotarlan V, Johnson F, Goerbig-Campbell J, et al. Usefulness of cardiac resynchronization therapy in patients with continuous flow left ventricular assist devices. *Am J Cardiol*. 2019;123:93–99.
  29. Chung B, Grinstein J, Sayer G, et al. Improved exercise performance and quality of life with right ventricular pacing over biventricular pacing in LVAD Patients. *J Heart Lung Transplant*. 2018;37:S131.

# 43

## The CardioMEMS Heart Failure Monitoring System

BRENT C. LAMPERT AND WILLIAM T. ABRAHAM

### Introduction

**I**n the United States, 6.5 million adults are living with heart failure, which remains an important cause of morbidity and mortality.<sup>1</sup> With an aging population and improving cardiovascular therapies, the number of patients with heart failure is expected to exceed 8 million by 2030.<sup>1</sup> Each year, about 1 million people are hospitalized for heart failure, which also has the highest readmission rate of any disease.<sup>1,2</sup> Despite advances in monitoring and treatment, the number of hospitalizations for heart failure has remained steady for years.<sup>1</sup> Most importantly, hospitalization for heart failure predicts increased morbidity and mortality.<sup>3,4</sup> The annual financial burden of heart failure in the United States is also substantial: currently \$30 billion, it is expected to rise to nearly \$70 billion by 2030.<sup>1</sup> Improved monitoring and reducing hospitalizations for heart failure are therefore major challenges for the healthcare system.

Despite the aforementioned burden of hospitalizations for heart failure, guideline-directed medical and device therapies have markedly improved survival. Yet, approximately 10% of patients progress to advanced heart failure that is refractory to traditional management strategies.<sup>5</sup> Advanced heart failure is characterized by progressive symptoms, recurrent hospitalizations, an inability to tolerate medical therapy, and a poor prognosis. For appropriately selected patients, durable mechanical circulatory support (MCS) devices provide incredible improvements in survival and quality of life.<sup>6,7</sup> Despite the known benefits, however, the appropriate timing of MCS implantation remains uncertain. Additionally, even with improved cardiac output and left ventricular (LV) unloading from MCS, heart failure complications can persist after implantation because of suboptimal pump speed and incomplete LV unloading, right ventricular (RV) failure, arrhythmias, or

valvular disease. Hospitalizations also remain a considerable burden after implementing MCS, occurring at a rate of 1.5–2.5 per patient-year of support.<sup>8,9</sup> Heart failure is a leading cause of hospitalizations after MCS therapy, which has increased interest in applying successful strategies for managing ambulatory heart failure to patients on MCS.<sup>9</sup>

### Limitations of Traditional Heart Failure Monitoring

Long-term monitoring of patients with heart failure to identify impending decompensations has traditionally focused on non-invasive markers of volume overload. Patients are instructed to monitor symptoms, record their weight daily, regularly check for edema, and remain in close contact with their care team so that medical therapy can be promptly modified when volume overload becomes apparent. Selected patients are also given freedom to self-titrate diuretics to maintain appropriate fluid volume. Although these strategies have some value in getting patients invested in self-management, their impact on reducing hospitalizations is marginal, given challenges with patient adherence and the poor sensitivity of surrogate markers for worsening heart failure. In particular, adherence to daily weight monitoring can be as low as 14%.<sup>10,11</sup> Symptom monitoring presents an even bigger challenge, with adherence rates of only 9%.<sup>10</sup> Even when symptoms are regularly monitored, traditional strategies lack sensitivity to detect an impending heart failure exacerbation. For example, the sensitivity of daily weight monitoring to detect a heart failure decompensation is at best about 20%.<sup>11,12</sup> Even physical exam findings, such as edema, elevated jugular venous pressure, third heart sounds, and pulmonary rales, have sensitivities of less than 50% for determining a patient's hemodynamic status.<sup>13</sup>

Telemonitoring strategies that involve regular communication of non-invasive markers, such as weight, symptoms, and blood pressure, have been used enthusiastically to improve outcomes. Although telemonitoring can improve some adherence challenges, large, randomized controlled trials employing these strategies have not found reductions in hospitalizations. In the National Institutes of Health–sponsored Telemonitoring to Improve Heart Failure Outcomes (TELE-HF) trial, 1,653 patients recently hospitalized for heart failure were randomly assigned to either automated telephone-based monitoring to collect daily symptom and weight information or to usual care of depending on patients to initiate physician communication.<sup>14</sup> After 180 days, neither hospitalization rates for heart failure nor death rates from any cause differed between groups. Even with a longer median follow-up of greater than 2 years in the Telemedical Interventional Monitoring in Heart Failure (TIM-HF) trial, physician-led, remote daily monitoring of blood pressure, weight, electrocardiographic data, and medical telephone support did not reduce all-cause mortality or hospitalizations for heart failure.<sup>15</sup> The Better Effectiveness After Transition–Heart Failure (BEAT-HF) trial was a more recent and aggressive study of telemonitoring in 1,437 patients hospitalized for heart failure.<sup>16</sup> The intervention group received health coaching by telephone and telemonitoring, including daily electronic collection of blood pressure, heart rate, symptoms, and weight. Neither readmission nor mortality rates were reduced after 180 days.

Given the limitations to patient self-monitoring and telemonitoring, interest has increased in using existing cardiac implantable devices for remote monitoring. Indwelling implantable cardioverter defibrillators can monitor factors such as intrathoracic impedance, heart rate, arrhythmias, and patient activity. The sensitivity of these factors to detect a heart failure exacerbation is better than that of changes in daily weight.<sup>12</sup> However, intrathoracic impedance has a high false-positive rate, and randomized trials using these device-based diagnostics have not improved clinical outcomes.<sup>17</sup> Moreover, in the Diagnostic Outcome Trial in Heart Failure (DOT-HF), intrathoracic impedance actually significantly increased hospitalizations for heart failure and outpatient visits.<sup>18</sup>

## Remote Hemodynamic Monitoring

The failure of the aforementioned traditional remote monitoring methods may reflect problems with suboptimal data rather than the failure of the concept of remote management. Markers such as weight gain, edema, impedance changes, and new symptoms occur late in the evolution of heart failure decompensation, which may account for their limited impact in reducing hospitalizations. Conversely,

increases in cardiac filling pressures can precede hospitalization by weeks.<sup>19</sup> Long-term monitoring of cardiac pressures by implantable remote hemodynamic sensors can prevent or delay hospitalizations for heart failure.<sup>21</sup> Of the several approaches to chronic implantable hemodynamic monitoring that have been evaluated, the first approved device was the CardioMEMS HF System.<sup>22</sup>

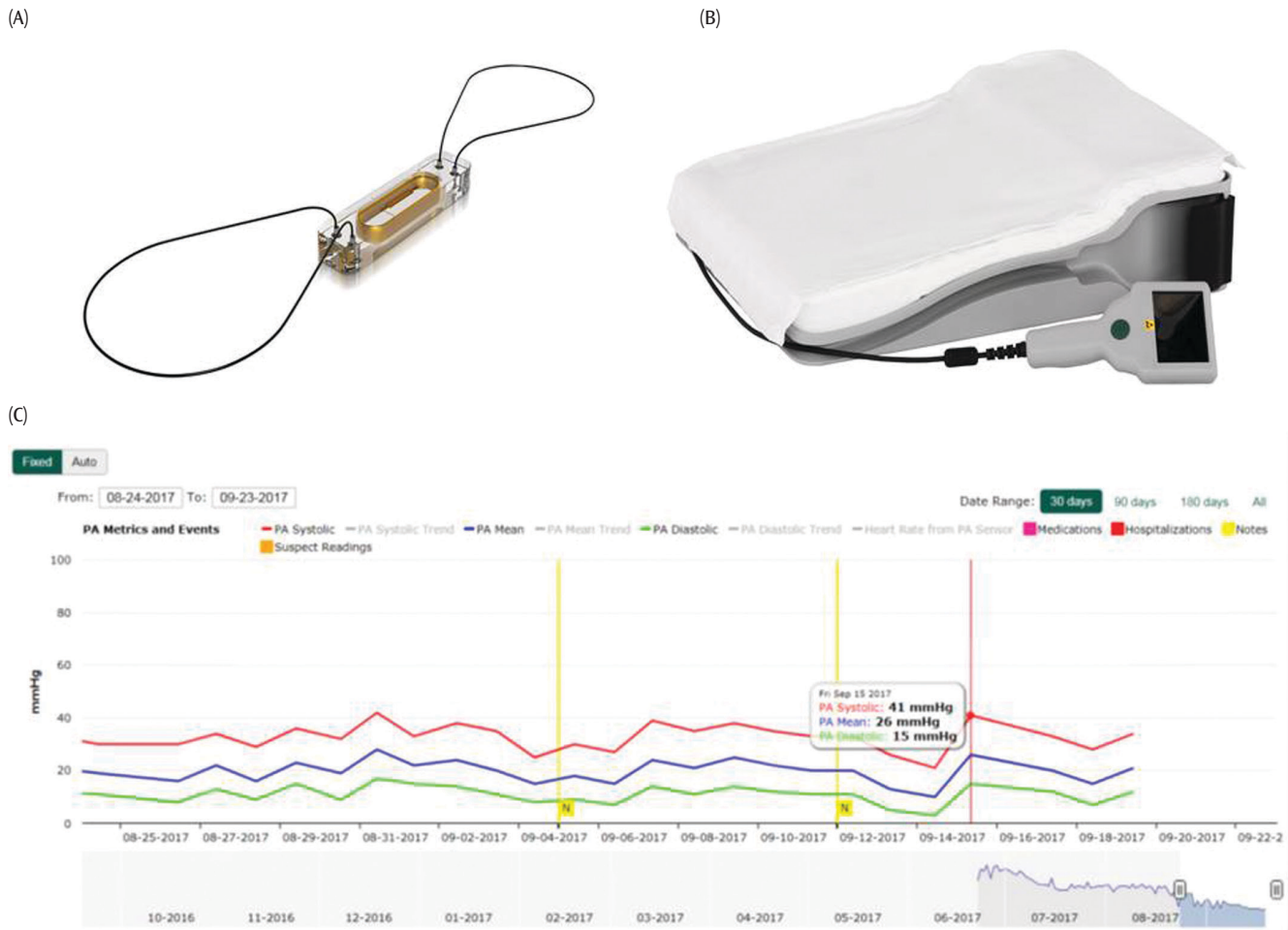
Preceding the CardioMEMS was an RV sensor that continuously monitored pulmonary artery diastolic pressure, heart rate, body temperature, and patient activity. The Chronicle Offers Management to Patients with Advanced Signs and Symptoms of Heart Failure (COMPASS-HF) trial evaluated this sensor and provided important lessons that informed the evaluation of CardioMEMS. In COMPASS-HF, 274 patients with New York Heart Association (NYHA) Class III and ambulatory class IV status were randomly assigned to usual care or to usual care guided by information from the RV monitoring system.<sup>20</sup> Monitoring reduced the combination of heart failure hospitalizations and emergency or urgent care visits requiring intravenous therapy by 21% (0.67 and 0.85 per 6 patient-months, respectively,  $P = 0.33$ ). However, a retrospective analysis found a 36% reduction ( $P = 0.03$ ) in the risk of first hospitalization for heart failure. The benefit was greatest in patients in NYHA Class III, and patients in NYHA Class IV in the treatment group actually had more events.

Several other discoveries shaped investigations of the CardioMEMS device. The primary hemodynamic variable correlating with heart failure events was pulmonary artery diastolic pressure, which generally rose gradually with progression of the disease.<sup>19</sup> However, without prespecified pressure targets, clinicians often allowed pulmonary pressures to remain high, and pressure-guided therapy was only effective if treatment was modified in response to high pressures (even in the absence of symptoms).<sup>20</sup>

## Monitoring Pulmonary Artery Pressure with the CardioMEMS System

The CardioMEMS HF system is a wireless, implantable, pulmonary artery pressure (PAP) monitoring system. It consists of a PAP sensor, an external electronic measuring system, and a secure website where clinicians monitor hemodynamic information (Figure 43.1). The sensor is implanted into a branch of the pulmonary artery during right-heart catheterization and does not require any leads or batteries because it is concurrently powered and interrogated through the external electronic measuring system.

The CardioMEMS Heart Sensor Allows Monitoring of Pressure to Improve Outcomes (CHAMPION) trial evaluated remote PAP-guided heart failure management in patients with NYHA class III heart failure.<sup>21</sup> In CHAMPION, the CardioMEMS HF System was implanted in all 550 patients. Patients were then randomly assigned to a treatment group



**Figure 43.1.** The major components of the CardioMEMS HF System. (A) The MEMS-based pulmonary artery pressure sensor (Abbott, Sylmar, California). (B) The home electronics system that simultaneously powers and interrogates the sensor, relaying pressure data to (C) be displayed on a secure website for clinician review.

Reproduced with permission of Abbott, © 2019. All rights reserved.

for whom daily PAP measurements were available or to a control group without PAP measurements. In contrast to the COMPASS-HF trial, patients in CHAMPION were managed to achieve protocol-specific pressure goals: a systolic PAP between 15 and 35 mmHg, a diastolic PAP between 8 and 20 mmHg, and a mean PAP between 10 and 25 mmHg. Patients not achieving these pressures received new or intensified diuretic or nitrate therapy or were educated about salt and fluid restrictions until their pressures returned to the specified range. The primary endpoint was the rate of hospitalizations for heart failure, and secondary endpoints included changes in PAP, measured as area under the curve of PAP relative to baseline, days alive outside the hospital, and quality of life. At a mean follow-up of 17 months, the risk of hospitalization was 37% lower in the treatment group (158 versus 254 hospitalizations). All prespecified secondary endpoints significantly improved in the treatment group. None of the PAP sensors failed, and

device-related or system-related complications occurred in only 8 patients. The US Food and Drug Administration approved the CardioMEMS HF system on May 28, 2014, for patients in NYHA Class III hospitalized for heart failure at least once in the previous 12 months.<sup>22</sup>

Subgroup analysis of the CHAMPION trial indicated that PAP-guided heart failure therapy is effective in heart failure with preserved ejection fraction (HFpEF)<sup>23</sup> and is effective at reducing hospitalizations in patients with secondary pulmonary hypertension (PH),<sup>24</sup> chronic obstructive pulmonary disease,<sup>25</sup> and chronic kidney disease. After the CHAMPION trial was completed, mean PAP information became available for patients initially placed in the control group. Once this information became available to clinicians, hospitalizations among patients in the former control group were 48% lower than those observed during the trial. (0.36 vs. 0.68, HR 0.52, 95% CI 0.40–0.69,  $p < 0.0001$ ).<sup>26</sup> A detailed account of the medication changes

in CHAMPION suggests that more targeted and aggressive medical therapy guided by direct hemodynamic measures produced more favorable results. Both the treatment and control groups had similar baseline medical therapy, but after 6 months, the doses of diuretics, vasodilators, and neurohormonal antagonists were significantly higher in the treatment group, and renal function was preserved.<sup>27</sup>

De-identified data from the first 2,000 consecutive patients with CardioMEMS implants after FDA approval and at least 6 months of follow-up have also been compared with historic CHAMPION trial data.<sup>28</sup> In real-world clinical practice, baseline PAPs were higher than those in CHAMPION. Also, the reduction in PAP over time during initial commercial utilization was greater than that in the CHAMPION Trial. Importantly, patient and clinician adherence were excellent with the CardioMEMS system, with a median of 1.27 days between transmissions after 6 months.

In the first 3 years after FDA approval, more than 5,500 CardioMEMS were implanted in the United States.<sup>29</sup> Despite this real-world cohort of less-selected, higher-risk patients, the safety profile was similar to that in the CHAMPION Trial. The ongoing CardioMEMS post-approval study (ClinicalTrials.gov Identifier: NCT02279888) will provide more information on the benefits and safety of PAP monitoring.

## Mechanical Circulatory Support

For patients with refractory advanced heart failure, MCS can markedly improve survival and quality of life.<sup>7</sup>

One-year survival after left ventricular assist device (LVAD) implantation now exceeds 80%.<sup>30</sup>

Despite marked improvements in survival and a clear benefit over medical management of advanced heart failure, several adverse events persist and limit more widespread and earlier use. Uncertainty also remains about identifying appropriate candidates and the timing of LVAD implantation. Volume management and recurrent heart failure can occur despite LVAD support. Additionally, how to optimize LVAD speed and medical therapy continue to be challenging.

Because the CardioMEMS is implanted outside the heart, LVAD implantation does not interfere with PAP readings. Hemodynamic monitoring with CardioMEMS may therefore provide better information to guide the timing of LVADs implantation and to improve post-implantation care.

Proper timing and patient optimization before LVAD implantation are currently of intense interest. Identifying patients based on symptoms alone and the limitations of the NYHA classification system in categorizing advanced heart failure led the INTERagency Registry for Mechanically Assisted Circulatory Support (INTERMACS) to develop a nomenclature for stratifying patients with advanced HF more precisely. The seven INTERMACS profiles (Table 43.1) categorize patients across a range from NYHA functional class IIIb (profile 7) to those in refractory cardiogenic shock (profile 1).<sup>31</sup> Not surprisingly, survival is worse in patients in cardiogenic shock at the time of LVAD implant than it is in the “less sick” inotrope-dependent patients.<sup>30</sup> Accordingly, the percentage of LVAD implants in stable, inotrope-dependent patients (INTERMACS Profile 3) has steadily

**Table 43.1 • The Seven Clinical Profiles and Arrhythmia Modifiers of Patients with New York Heart Association Class IV Disease, from the Interagency Registry for Mechanically Assisted Circulatory Support (INTERMACS)**

Profile	Description	Details
1	Critical cardiogenic shock: “Crashing and burning”	Life-threatening hypotension, despite rapidly escalating inotropic support, with critical organ hypoperfusion
2	Progressive decline: “Sliding on inotropes”	Declining function, despite intravenous inotrope support
3	Stable but inotrope-dependent: “Dependent stability”	Stable on continuous intravenous inotrope support
4	Resting symptoms: “Frequent flyer”	Patient experiences daily symptoms of congestion at rest or with activities of daily living
5	Exertion intolerant: “Housebound”	Patient experiences daily symptoms of congestion at rest or with activities of daily living
6	Exertion limited: “Walking wounded”	Patient has fatigue after the first few minutes of any meaningful activity
7	Advanced NYHA Class 3: “NYHA IIIb”	Patients living comfortably with meaningful activity limited to mild physical exertion

NHYA = New York Heart Association.

Reprinted from Stevenson LW et al., INTERMACS profiles of advanced heart failure: the current picture, *Journal of Heart and Lung Transplantation* 2009;28:535–541, Copyright (2009), with permission from Elsevier.

increased since 2008.<sup>30</sup> However, the proportion of patients in cardiogenic shock receiving LVADs (INTERMACS Profile 1) has remained between 14% and 16%.<sup>30</sup> Several variables likely contribute to delaying LVAD implantation, including late recognition of advanced heart failure and delayed referral to a tertiary center.

CardioMEMS monitoring may provide important insights into patient selection and the timing of LVAD implantation. During the primary study period of CHAMPION, 27 patients (5%) met the indications for LVAD implantation.<sup>32</sup> Among the 27, 15 were in the treatment arm and 12 in the control arm. The clinical profiles of patients receiving an LVAD were similar between treatment and control groups at the time of CardioMEMS implant. Interestingly, the LVAD cohort had significantly higher creatinine concentrations, higher PAPs, and lower systemic pressures, but no difference in cardiac output when compared to the rest of the CHAMPION cohort.

From the time of CardioMEMS implant to LVAD implant, renal function tended to worsen in the control group but changed little in the treatment group. Patients in the treatment group also tended to have more heart failure medication changes than did patients in the control group. Notably, in the patients that went on to LVAD implantation, medication changes did not improve PAP in either group. LVAD implantation tended to be earlier in the treatment group. Importantly, in both groups, the most common INTERMACS Profile was 3. Only two patients in each group were INTERMACS Profile 2, and neither group had patients with INTERMACS Profile 1. More patients were bridged to transplant in the treatment group than in the control group (7 vs. 1;  $P = 0.04$ ). The treatment group also spent significantly less time on LVAD support before transplantation.

Because severe pulmonary hypertension is a contraindication to heart transplantation, ambulatory PAP monitoring in patients with LVADs may allow better management and earlier improvements and thus more effective bridging to transplant. Although this analysis is limited by the small sample and post hoc nature, the findings indicate that CardioMEMS monitoring may offer additional insights in selecting patients for LVAD implantation. In particular, knowing that PAP responds poorly to changes in medication may help identify advanced heart failure earlier. With earlier LVAD implantation, ventricular unloading, and the ability to more aggressively titrate medical therapy based on PAP monitoring, progression to fixed pulmonary hypertension may also be slowed, improving success in bridging patients to transplantation.

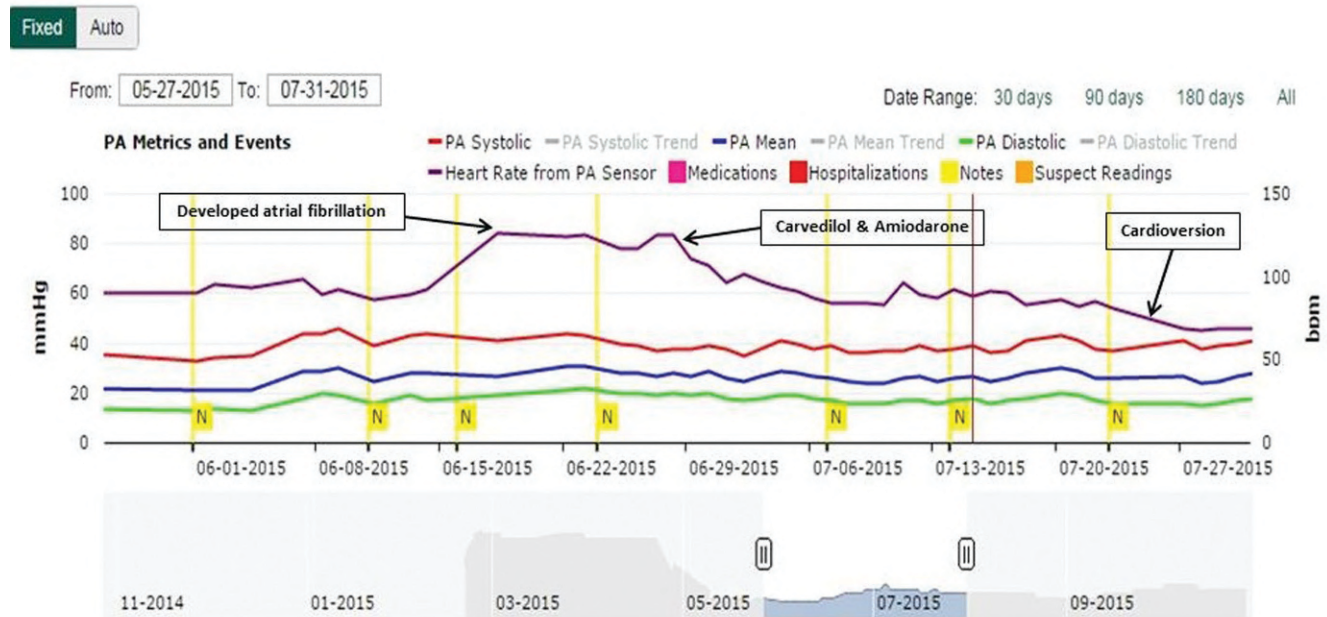
Once an LVAD is implanted, hemodynamic data from CardioMEMS monitoring may help manage the device.<sup>33</sup> The continued risk of recurrent hospitalizations for heart failure after LVAD implantation is small but real, and remote PAP monitoring may reduce the number of such

hospitalizations. In the CHAMPION study, patients who went on to receive an LVAD had mean (SD) decreases in PA systolic pressure ( $-16.5$  [12.4] mm Hg), PA diastolic pressure ( $-9.4$  [7.8] mm Hg), and PA mean pressure ( $-11.6$  [9.1] mm Hg) after LVAD. Pulmonary artery pressures also decreased in the control group, but the decreases were smaller and not statistically significant. Knowing the hemodynamic information allowed physicians to make more medication changes in the treatment group, which reduced PAPs and improved ventricular unloading.

Ambulatory PAP monitoring in these patients offers several other theoretical advantages beyond reducing PAP and hospitalizations for heart failure. Monitoring may allow patient-specific pump speeds to be modified more precisely. Asymptomatic rises in PAP detected by routine monitoring could more quickly identify potential LVAD-related complications, such as device thrombosis. For example, increases in PAP that correlate with increases in lactate dehydrogenase concentrations could lead to timelier intensification of anticoagulation or pump exchange, helping to decrease the risk of stroke or other catastrophic consequences of pump thrombosis. In patients with secondary pulmonary hypertension that prohibits cardiac transplantation, ambulatory PAP monitoring could facilitate more aggressive treatment and decrease the need for repeated right heart catheterizations (and the resulting interruptions of anticoagulation).

In addition to PAP monitoring, the CardioMEMS system monitors heart rate, which may detect tachyarrhythmias that can compromise LVAD function (Figure 43.2). An ongoing observational study, the Investigation to Optimize Hemodynamic Management of Left Ventricular Assist Devices Using the CardioMEMS (Intellect2), will help characterize hemodynamic-guided management of patients with an LVAD (ClinicalTrials.gov Identifier: NCT03247829). Intellect2 plans to enroll up to 100 patients with LVADs and CardioMEMS implanted as standard-of-care. Patients will be followed for 6 months. The objectives are to characterize PAP measurements in these patients under different clinical and physiologic conditions; to characterize the effects of PAP on functional status, quality of life, and hospital readmissions; to evaluate target ranges for PAP; and to assess the impact of medication and pump speed changes on PAP.

In the future, “smart” remote monitoring and mechanical circulatory support technologies that can work together to optimize pump settings and patient symptoms offer some exciting promises. Integrating hemodynamic data from PAP monitoring could allow an LVAD to adjust settings to match a patient’s need, in the same way that a pacemaker does.<sup>33</sup> Although the current understanding of how to synthesize and integrate various data to improve pump performance is limited, improved understanding could provide the next incremental improvement in MCS outcomes and may shape the future of the field.



**Figure 43.2.** An arrhythmia in a 46-year-old man with non-ischemic cardiomyopathy, CardioMEMS, and LVAD. Routine CardioMEMS readings were continued after LVAD implantation. Ten weeks after LVAD placement, his heart rate abruptly increased from 85 to 125 beats bpm. Although he insisted that he had no symptoms, an EKG confirmed atrial fibrillation with rapid ventricular response. Carvedilol and amiodarone were started and returned his heart rate to 85 bpm. He subsequently underwent cardioversion with restoration of sinus rhythm.

Reproduced with permission of Abbott, © 2019. All rights reserved.

## Disclosures

Dr. Lampert is a consultant for Abbott and has received travel grants and honorarium from Medtronic. Dr. Abraham has received consulting fees from Abbott.

## REFERENCES

- Benjamin EJ, Virani SS, Callaway CW, et al. Heart disease and stroke statistics—2018 update: a report from the American Heart Association. *Circulation*. 2018;137(12):e67–e492. doi: 10.1161/CIR.0000000000000558. Epub 2018 Jan 31.
- Jencks SF, Williams MV, Coleman EA. Rehospitalizations among patients in the Medicare fee-for-service program. *N Engl J Med*. 2009;360(14):1418–1428.
- Lee DS, Austin PC, Stukel TA, et al. “Dose-dependent” impact of recurrent cardiac events on mortality in patients with heart failure. *Am J Med*. 2009;122(2):162–169.e1.
- Setoguchi S, Stevenson LW, Schneeweiss S. Repeated hospitalizations predict mortality in the community population with heart failure. *Am Heart J*. 2007;154(2):260–266.
- Metra M, Ponikowski P, Dickstein K, et al. Advanced chronic heart failure: a position statement from the study group on advanced heart failure of the heart failure association of the European Society of Cardiology. *Eur J Heart Fail*. 2007;9(6-7):684–694.
- Rose EA, Gelijns AC, Moskowitz AJ, et al. Long-term use of a left ventricular assist device for end-stage heart failure. *N Engl J Med*. 2001;345(20):1435–1443.
- Rogers JG, Aaronson KD, Boyle AJ, et al. Continuous flow left ventricular assist device improves functional capacity and quality of life of advanced heart failure patients. *J Am Coll Cardiol*. 2010;55(17):1826–1834.
- Forest SJ, Bello R, Friedmann P, et al. Readmissions after ventricular assist device: etiologies, patterns, and days out of hospital. *Ann Thorac Surg*. 2013;95(4):1276–1281.
- Hasin T, Marmor Y, Kremers W, et al. Readmissions after implantation of axial flow left ventricular assist device. *J Am Coll Cardiol*. 2013;61(2):153–163.
- Moser DK, Doering LV, Chung ML. Vulnerabilities of patients recovering from an exacerbation of chronic heart failure. *Am Heart J*. 2005;150(5):984.
- van der Wal MH, Jaarsma T, Moser DK, Veegeer NJ, van Gilst WH, van Veldhuisen DJ. Compliance in heart failure patients: the importance of knowledge and beliefs. *Eur Heart J*. 2006;27(4):434–440.
- Abraham WT, Compton S, Haas G, et al. Intrathoracic impedance vs daily weight monitoring for predicting worsening heart failure events: results of the fluid accumulation status trial (FAST). *Congest Heart Fail*. 2011;17(2):51–55.
- Capomolla S, Ceresa M, Pinna G, et al. Echo-Doppler and clinical evaluations to define hemodynamic profile in patients with chronic heart failure: accuracy and

- influence on therapeutic management. *Eur J Heart Fail*. 2005;7(4):624–630.
14. Chaudhry SI, Mattera JA, Curtis JP, et al. Telemonitoring in patients with heart failure. *N Engl J Med*. 2010;363(24):2301–2309.
  15. Koehler F, Winkler S, Schieber M, et al. Impact of remote telemedical management on mortality and hospitalizations in ambulatory patients with chronic heart failure: the telemedical interventional monitoring in heart failure study. *Circulation*. 2011;123(17):1873–1880.
  16. Ong MK, Romano PS, Edgington S, et al. Effectiveness of remote patient monitoring after discharge of hospitalized patients with heart failure: the Better Effectiveness after Transition–Heart Failure (BEAT-HF) randomized clinical trial. *JAMA Intern Med*. 2016;176(3):310–318.
  17. Morgan JM, Kitt S, Gill J, et al. Remote management of heart failure using implantable electronic devices. *Eur Heart J*. 2017;38(30):2352–2360.
  18. van Veldhuisen DJ, Braunschweig F, Conraads V, et al. Intrathoracic impedance monitoring, audible patient alerts, and outcome in patients with heart failure. *Circulation*. 2011;124(16):1719–1726.
  19. Zile MR, Bennett TD, St John Sutton M, et al. Transition from chronic compensated to acute decompensated heart failure: pathophysiological insights obtained from continuous monitoring of intracardiac pressures. *Circulation*. 2008;118(14):1433–1441.
  20. Bourge RC, Abraham WT, Adamson PB, et al. Randomized controlled trial of an implantable continuous hemodynamic monitor in patients with advanced heart failure: the COMPASS-HF study. *J Am Coll Cardiol*. 2008;51(11):1073–1079.
  21. Abraham WT, Adamson PB, Bourge RC, et al. Wireless pulmonary artery haemodynamic monitoring in chronic heart failure: a randomised controlled trial. *Lancet*. 2011;377(9766):658–666.
  22. U.S. Food and Drug Administration Center for Devices and Radiological Health. CardioMEMS(TM) HF system approval letter. [http://www.accessdata.fda.gov/cdrh\\_docs/pdf10/P100045a.pdf](http://www.accessdata.fda.gov/cdrh_docs/pdf10/P100045a.pdf). Updated 2014. Accessed March 16, 2018.
  23. Adamson PB, Abraham WT, Bourge RC, et al. Wireless pulmonary artery pressure monitoring guides management to reduce decompensation in heart failure with preserved ejection fraction. *Circ Heart Fail*. 2014;7(6):935–944.
  24. Benza RL, Raina A, Abraham WT, et al. Pulmonary hypertension related to left heart disease: insight from a wireless implantable hemodynamic monitor. *J Heart Lung Transplant*. 2015;34(3):329–337.
  25. Krahnke JS, Abraham WT, Adamson PB, et al. Heart failure and respiratory hospitalizations are reduced in patients with heart failure and chronic obstructive pulmonary disease with the use of an implantable pulmonary artery pressure monitoring device. *J Card Fail*. 2015;21(3):240–249.
  26. Abraham WT, Stevenson LW, Bourge RC, et al. Sustained efficacy of pulmonary artery pressure to guide adjustment of chronic heart failure therapy: complete follow-up results from the CHAMPION randomised trial. *Lancet*. 2016;387(10017):453–461.
  27. Costanzo MR, Stevenson LW, Adamson PB, et al. Interventions linked to decreased heart failure hospitalizations during ambulatory pulmonary artery pressure monitoring. *JACC Heart Fail*. 2016;4(5):333–344.
  28. Heywood JT, Jermyn R, Shavelle D, et al. Impact of practice-based management of pulmonary artery pressures in 2000 patients implanted with the CardioMEMS sensor. *Circulation*. 2017;135(16):1509–1517.
  29. Vaduganathan M, DeFilippis EM, Fonarow GC, Butler J, Mehra MR. Postmarketing adverse events related to the CardioMEMS HF system. *JAMA Cardiol*. 2017;2(11):1277–1279.
  30. Kirklin JK, Pagani FD, Kormos RL, et al. Eighth annual INTERMACS report: special focus on framing the impact of adverse events. *J Heart Lung Transplant*. 2017;36(10):1080–1086.
  31. Stevenson LW, Pagani FD, Young JB, et al. INTERMACS profiles of advanced heart failure: the current picture. *J Heart Lung Transplant*. 2009;28(6):535–541.
  32. Feldman DS, Moazami N, Adamson PB, et al. The utility of a wireless implantable hemodynamic monitoring system in patients requiring mechanical circulatory support. *ASAIO J*. 2017;64(3):301–308.
  33. Lampert BC, Emani S. Remote hemodynamic monitoring for ambulatory left ventricular assist device patients. *J Thorac Dis*. 2015;7(12):2165–2171.



# Mechanical Circulatory Support as a Bridge to Recovery

THOMAS C. HANFF, JOYCE WALD, AND J. EDUARDO RAME

## Introduction

**L**eft ventricular assist devices (LVADs) have become an essential component in the care of patients with severe heart failure resistant to medical therapy. In 2001, the Randomized Evaluation of Mechanical Assistance for the Treatment of Congestive Heart Failure trial was published,<sup>1</sup> in which a 20% absolute survival benefit was reported for LVAD therapy compared to medical therapy for patients with end-stage systolic heart failure. Following this, as patients began to live with mechanical support over longer durations, it became increasingly apparent that persistent left ventricular (LV) unloading led to a myriad of beneficial changes in the underlying myocardium that impacted the physiology of the syndrome of heart failure.

With the evolution from first-generation pulsatile LVADs to second- and third-generation continuous-flow LVADs, the nature of left ventricular unloading also shifted. Although the first-generation pulsatile pumps studied in REMATCH and used predominately in the 1990s and 2000s had improved survival and quality of life compared to medical therapies, overall survival was still only 24% at 2 years.<sup>1,2</sup> Device durability was a significant issue, with frequent complications, hospitalizations, and need for device exchange, which limited their use to a small minority of patients for relatively short periods of time.<sup>3</sup> These first-generation pulsatile pumps were replaced by second- and third-generation axial and centrifugal continuous-flow pumps, yielding greater durability, more compact size, and improved duration of survival free from disabling stroke or device failure. The improvements in patient-device compatibility allowed for even greater duration of LVAD therapy in the current era, with hemodynamic effects of continuous unloading that are distinct from those of pulsatile unloading.<sup>4</sup>

As LVADs became more durable and better tolerated, patient selection for implantation and implantation strategies also evolved. Historically, LVADs were primarily used for finite periods to bridge patients to heart transplant (BTT).<sup>5</sup> However, the extreme shortage of donor organs worldwide limits transplant as a solution for the majority of an estimated 300,000 patients in need of advanced heart failure therapies.<sup>6</sup> Instead, many patients are now implanted with LVAD as a destination therapy (DT) following trials where a second-generation LVAD used as DT was shown to improve survival and quality-of-life among patients ineligible for transplant.<sup>4</sup> The BTT and DT strategies make up the vast majority of LVAD implantations,<sup>7</sup> yet there is a growing focus on a third strategy termed bridge to recovery (BTR), wherein the LVAD is used to support the process of reverse remodeling and myocardial recovery, with the ultimate goal of LVAD explantation.

The need for this strategy is clear: patients implanted as DT or as BTT with prolonged wait times suffer a high rate of LVAD-associated complications ranging from gastrointestinal bleeding to hemolysis, infection, right ventricular failure, pump thrombosis, or stroke.<sup>8</sup> Near-complete mechanical unloading with an LVAD has been associated with significant improvements in myocyte structure and function,<sup>9–11</sup> and there are patients that have demonstrated sufficient recovery to allow for explantation of the device with normal or near-normal cardiac function for more than a decade after separation from support.<sup>12</sup> Despite these encouraging findings, the proportion of patients that achieve this outcome has been small—in most trials, only approximately 5% of all LVAD recipients undergo LVAD explantation for recovery.<sup>13–15</sup> Basic questions remain about optimal patient selection for a BTR strategy, the process of predicting durable LV recovery, and how underlying responses to mechanical unloading at the subcellular, cellular, and organ level can be translated into functional myocardial

improvement. In this review, we address the most recent initiative to protocolize the strategy for LV recovery with LVAD and summarize recent developments in our understanding of the pathophysiologic basis for reverse remodeling and cardiac recovery. Ultimately, our aim is to enhance the current understanding of the “responder” versus “non-responder” phenotype as it pertains to myocardial recovery with continuous-flow LVAD support.<sup>16</sup>

## The ReSTAGE-HF Protocol

In all clinical trials with continuous-flow LVADs and in the INTERMACS registry, a very low percentage of LVADs (<5%) have been explanted for myocardial recovery.<sup>7</sup> However, different institutions and providers vary in their assessment of LV recovery post-LVAD, their protocols for staged weaning from LVAD support, and their application of maximal pharmacologic strategies intended to augment reverse remodeling.<sup>15</sup> As a consequence, whether a more aggressive pharmacologic approach post-LVAD would lead to a greater percentage of successfully explanted patients is unknown. During the era of pulsatile LVADs, preliminary data suggested that a strict protocol for oral heart failure therapies and regular assessment of LV recovery could lead to an increase in the percentage of successfully explanted patients. The landmark Harefield Protocol, published in 2006,<sup>17</sup> aimed to augment myocardial recovery among patients with chronic non-ischemic cardiomyopathy via two phases of maximal pharmacologic support concurrent with LVAD therapy (Table 44.1): in phase 1, Lisinopril 40 mg daily, carvedilol 50 mg twice daily, spironolactone 25 mg daily, and losartan 100 mg daily were given early post-operatively after weaning from inotropic therapy. In phase 2, which began after echocardiographic demonstration of a stable reduction in LV size, clenbuterol (a beta2-adrenergic receptor agonist known to induce physiologic hypertrophy in skeletal and cardiac muscle) was given while carvedilol was substituted with a selective beta1-blocker (bisoprolol). This was followed by repeated LVAD “on pump/off pump” turn-down studies aimed to carefully phenotype myocardial recovery sufficient to explant the LVAD with a high

probability of durable survival free of heart failure. Initial results were promising: 11 out of 15 patients were successfully explanted and free of heart failure for at least 2 years, with stable post-explant indices of left ventricular size and function.<sup>17</sup> However, this degree of success with the Harefield protocol was in a highly select group of patients within one center that had yet to be replicated in a larger, multi-center sample of patients in the era of continuous-flow devices.

The ongoing Remission from STAGE D Heart Failure (ReSTAGE-HF) prospective study aims to address the impact of maximal mechanical and pharmacologic unloading on reverse remodeling in the modern era with continuous-flow LVADs. The presence of an LVAD allows for a more aggressive titration of oral heart failure therapies to higher doses than are tolerated before pump implantation; hypotension and renal dysfunction from oral therapies are less potent on an LVAD platform. Moreover, current LVADs are more afterload dependent than were pulsatile-flow devices,<sup>3</sup> so afterload and blood pressure control from heart failure medications may lead to more synergistic unloading in second- and third-generation LVADs compared to first-generation. However, maximal oral heart failure medication doses are not universally achieved in routine clinical practice,<sup>15,18</sup> and many patients evaluated as destination therapy or bridge to transplant are not regularly monitored for evidence of underlying recovery. The hypothesis of the ReSTAGE-HF study is that adherence to a protocol to optimize LVAD speed, maximize high dose oral heart failure therapies early post-LVAD, and perform scheduled echocardiographic assessments of underlying left ventricular function will increase the proportion of patients successfully and durably explanted from LVAD after 18 months to greater than 10%. Table 44.2 lists details of the oral heart failure medication target doses, pump speed optimization, and recovery assessment used in ReSTAGE-HF. A critical secondary aim of the study is to codify predictors of recovery that can extend the generalizability of this platform to routine clinical practice while adding insight into underlying cellular and biochemical mechanisms of reverse remodeling.

## Patient Selection for Bridge to Recovery

The inclusion and exclusion criteria of the ReSTAGE-HF study were designed to increase the pre-test probability of successful LVAD explantation within the boundaries of our current understanding of recovery (Table 44.2). However, predicting which patients are likely to recover to a degree that would permit durable explantation has been a challenge.<sup>19</sup> In general, patients with non-ischemic cardiomyopathy are more successfully weaned to recovery than ischemic patients.<sup>20</sup> As such, only patients with non-ischemic cardiomyopathy confirmed by coronary

**Table 44.1 • The Harefield Protocol**

Phase	Pharmaceutical Agent
Phase 1	Lisinopril 40 mg QD
	Carvedilol 50 mg BID
	Spirinolactone 25 mg QD
	Losartan 100 mg QD
Phase 2	Clenbuterol
	Carvedilol transitioned to bisoprolol

**Table 44.2 • ReSTAGE-HF Protocol****Inclusion Criteria**

- Age 18–59
- NICM
- Heart failure duration <5 years
- LVEF  $\leq$ 25% and cardiomegaly at time of implantation
- <4 weeks since time of HeartMate II implantation

**Exclusion Criteria**

- Active acute myocarditis confirmed by histology
- Restrictive or hypertrophic obstructive cardiomyopathy or sarcoidosis
- Mechanical aortic or mitral valve or aortic valve closure

**Post-Implant and Post-Explant Pharmacological Therapy**

- Lisinopril 40 mg daily
- Carvedilol 25 mg three times daily
- Spirinolactone 25 mg daily
- Digoxin 125 micrograms daily
- Losartan 150 mg daily

**Pump Speed Optimization Criteria (in increments of 200 rpm)**

- LVEDD <6 cm or smaller (if possible)
- Mitral regurgitation <2 (if possible)

**Explant Criteria (measured at 6000 rpm pump speed)**

- LVEDD <60 mm, LVESD <50 mm, LVEF >45%
- LVEDP or PCWP  $\leq$ 15 mm Hg
- Resting cardiac index (CI) >2.4 L/min/m<sup>2</sup>
- $\pm$ mVO<sub>2</sub> >16 ml/kg/min

Left ventricular function after LVAD implantation was assessed by echocardiography during LVAD turn-down at 6 weeks and 4, 6, 9, and 12–18 months post-implant. Cardiopulmonary stress testing and right heart catheterization were performed after echocardiography recovery criteria were met.

Abbreviations: NICM = non-ischemic cardiomyopathy; LVEF = left ventricle ejection fraction; LVEDD = left ventricular end-diastolic dimension; LVESD = left ventricular end-systolic dimension; LVEDP = left ventricular end-diastolic pressure; PCWP = pulmonary capillary wedge pressure; mVO<sub>2</sub> = maximal oxygen consumption on cardiopulmonary stress testing.

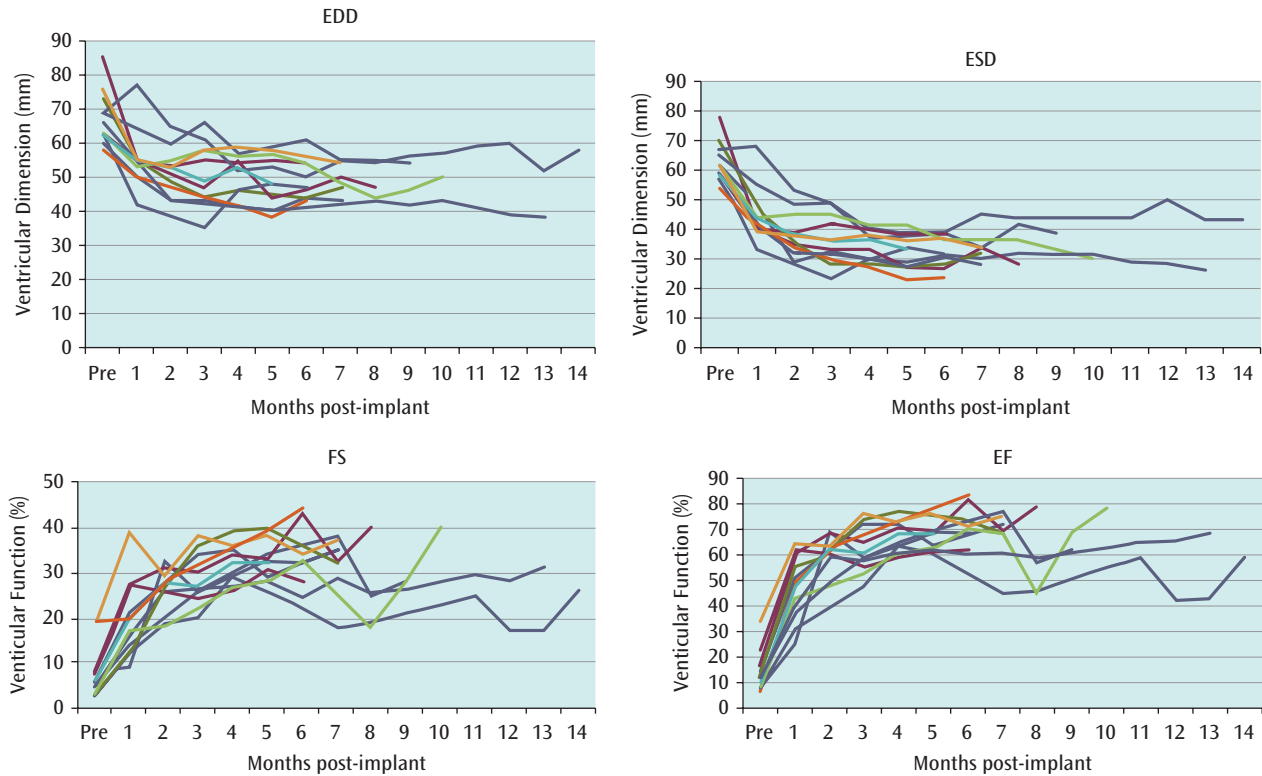
angiography were included in ReSTAGE-HF. Although LVAD implantation occurs primarily in patients with a phenotype of dilated cardiomyopathy, overlapping restrictive or hypertrophic obstructive phenotypes are thought to have a lower likelihood of recovery<sup>21</sup> and were excluded from the study. Given the advantages of younger age and shorter duration of heart failure as predictors of successful recovery,<sup>22–24</sup> patients were included only between age 18 and 59 years at time of implant and with a history of heart

failure for less than 5 years. Outside of this study, several etiologies of non-ischemic cardiomyopathy are thought to have a higher potential for successful recovery with oral heart failure therapies alone or in combination with LVAD. These include cardiomyopathy secondary to alcohol use, tachyarrhythmias, catecholamine exposure, endocrine disturbances, certain drug or toxin exposures, and certain types of myocarditis.<sup>25–27</sup> However, the incidences of these individual etiologies are low in comparison to a phenotype of idiopathic or hereditary dilated cardiomyopathy,<sup>28</sup> so the inclusion of a majority of patients with these phenotypes extends the generalizability of the ReSTAGE-HF study.

A number of protocols have been developed to assess functional myocardial recovery under rest and stress conditions, which is expected to more accurately predict durable remission from heart failure than rest-testing alone. Maybaum et al. performed dobutamine stress echocardiography and hemodynamic monitoring in patients under conditions of partial pulsatile-flow LVAD support. Under this protocol, only a small number of patients who maintained low filling pressures and LVEF >40% with dobutamine challenge were considered for LVAD explantation.<sup>29</sup> Birks et al. analyzed hemodynamic and echocardiographic parameters in patients with a HeartMate II continuous-flow LVAD turned down to an rpm level of 6,000 (the point at which there was no net flow through the LVAD) and considered LVAD explantation only if (1) LV end-diastolic dimension (LVEDD) remained less than 60 mm, the LV end-systolic dimension (LVESD) remained less than 50 mm, and LV ejection fraction (LVEF) remained greater than 45%; (2) pulmonary capillary wedge pressure remained less than 12 mmHg; (3) cardiac index remained above 2.8 L/min/m<sup>2</sup>; and (4) VO<sub>2</sub> max remained above 16 mL/kg/min (Figure 44.1).<sup>30</sup> Based on these parameters, 12 of 20 patients were successfully explanted, 83% of whom remained free from heart failure recurrence at both 1- and 3-year follow-up. Based on these promising results, the Birks criteria were adapted for the ongoing ReSTAGE-HF study with slight modifications (Table 44.2). The most important difference in the ReSTAGE-HF study involved the use of selection criteria derived from retrospective analyses of bridge-to-recovery experiences which identified that younger patients with a shorter duration of heart failure would be more likely to recover.<sup>23,24</sup>

## ReSTAGE-HF OUTCOMES

In total, 40 patients with stage D heart failure were enrolled in the ReSTAGE-HF study from six North American centers. All patients had non-ischemic cardiomyopathy and required HeartMate II LVAD as part of a BTT or DT strategy. Patients in the study were younger (34.9  $\pm$  10.5 years) than the median national age of LVAD implantation. Of the 40 enrolled, 3 died at 14, 63, and 148 days, and 1 was unable to



**Figure 44.1.** Time course of left ventricular end diastolic diameter (EDD), end systolic diameter (ESD), fractional shortening (FS), and ejection fraction (EF) among recovery patients following implantation of a continuous-flow LVAD.

Reprinted with permission from Birks EJ et al., Reversal of severe heart failure with a continuous-flow left ventricular assist device and pharmacological therapy: a prospective study, *Circulation* 2011;123(4):381–390, <https://www.ahajournals.org/journal/circ> © American Heart Association, Inc. All rights reserved.

be evaluated. Of the remaining 36 patients, 13 (36%) to date have been explanted, 2 (6%) were transplanted, 20 (56%) remain on support, and 1 died on support after 763 days with the device. Among the 13 explanted patients, the duration of LVAD support was  $344 \pm 182$  days, LVEF prior to explantation was  $55 \pm 4\%$  at 6,000 rpm for 15 minutes, LVEDD was  $46 \pm 6$  mm, and LVESD was  $34 \pm 3.2$  mm.<sup>31</sup> These preliminary results are promising and demonstrate higher rates of LV recovery leading to LVAD explantation compared to historical averages and the reproducibility of this protocol across multiple centers. Nevertheless, the final proportion of patients who are able to be explanted for recovery is not yet finalized, and durability of LVAD explantation has yet to be published.

## Biologic Basis for Reverse Remodeling over Recovery

Pathologic remodeling refers to a series of cascading maladaptive changes in the myocardium that follow an initial ischemic or non-ischemic cardiac injury, leading to further declines in cardiac function and the development of the

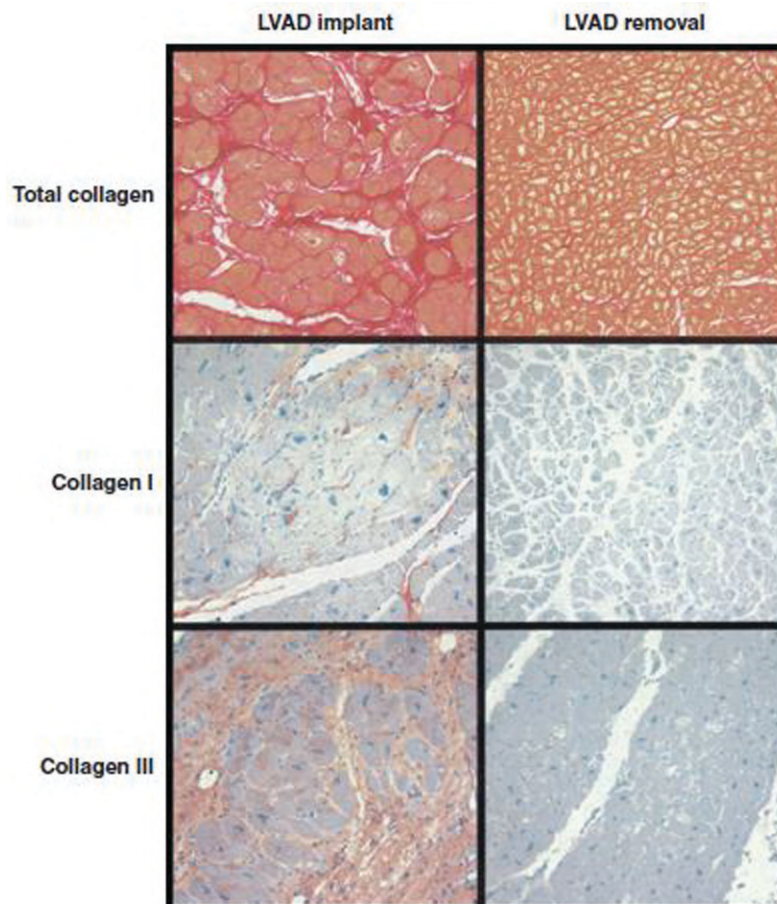
heart failure syndrome.<sup>32</sup> These changes occur at the tissue, cellular, and subcellular levels and have several convergent features independent of the nature of the precipitating myocardial insult. Two fundamental mechanisms drive the process of pathologic remodeling.<sup>33</sup> First, regardless of initial cause, decreased cardiac output, hypotension, and organ malperfusion lead to a number of compensatory neurohormonal responses with downstream toxicity to the myocardium. The best understood of these neurohormonal responses—upregulation of  $\beta$ -adrenergic and renin-angiotensin-aldosterone (RAAS) signaling and suppression of natriuretic peptides—are thought to preserve cardiac output and organ perfusion in the short term at the cost of progressive deterioration of cardiac structure and function in the longer term.<sup>34–37</sup> Second, within the myocardium itself, continued mechanical strain from increased wall stress and increased oxygen supply/demand mismatch leads directly to progressive myocyte damage and pathologic remodeling.<sup>33</sup> Together, neurohormonal signaling and local cardiac mechanical stress result in stereotypic myocardial sequelae that constitute remodeling: myocyte hypertrophy and elongation, increased myocardial mass, chamber dilation, derangements of energy utilization and

excitation-contraction coupling, fibrosis of the extracellular matrix, and numerous underlying changes in myocyte biochemistry, gene expression, and organelle function.<sup>38</sup>

Reverse remodeling refers to the partial or complete regression of pathologic features of a failing heart that occur spontaneously or in response to heart failure therapies. Studies of LVAD-supported hearts subject to mechanical unloading over a sustained period of time have shown improvements in cellular hypertrophy, chamber size and geometry, properties of the extracellular matrix,  $\beta$ -adrenergic signaling, calcium homeostasis, and myocyte metabolism as well as profound effects on the expression of genes and gene products and the kinetics of intra- and extra-cellular signaling pathways (Figures 44.2 and 44.3).<sup>32</sup> Over time, the unloaded heart also begins to demonstrate a leftward shift of the LV end-diastolic pressure-volume relationship, a hemodynamic property of the myocardium that is load-independent and represents the combined effects on diastolic filling of fiber architecture and chamber geometry. The degree of reverse remodeling seen appears to be

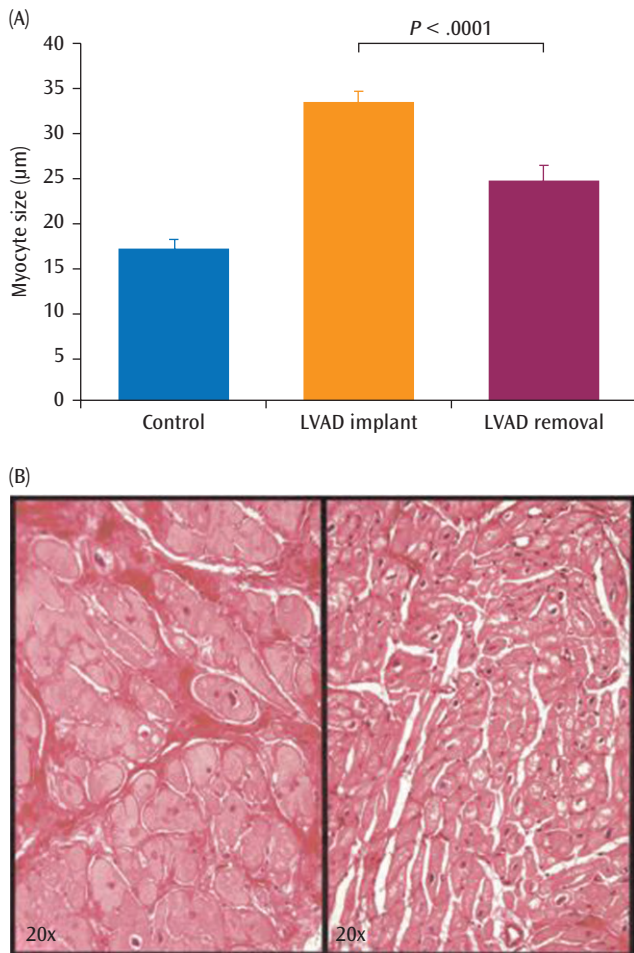
a dose-response relationship dependent on the degree of unloading provided by the device. In fact, a higher rate of reverse remodeling had been seen in pulsatile LVADs compared to continuous-flow devices, most likely explained by the greater degree of LV unloading seen with the pulsatile devices.<sup>23,38</sup>

The LVAD itself has proven to be a very useful human tissue-based experimental model to study the changes of reverse remodeling, with tissue samples from the failing heart collected at the time of implantation that can be compared directly to samples from recovered hearts at time of explantation or from perpetually remodeled hearts at the time of transplantation.<sup>32</sup> What has become increasingly clear from these studies is that, in spite of the recovery of a number of cardiac features at the organ level, significant underlying cardiac pathology remains: for the vast majority of genes implicated in the heart failure phenotype, very few have demonstrated any significant change in expression. Consequently, a many of the disordered subcellular and tissue components fail to normalize with LVAD therapy.



**Figure 44.2.** Regression of fibrosis after LVAD implantation as demonstrated by collagen staining.

Reprinted from Bruckner BA et al., Regression of fibrosis and hypertrophy in failing myocardium following mechanical circulatory support, *Journal of Heart and Lung Transplantation* 2001;20:457–464, Copyright (2001), with permission from Elsevier.



**Figure 44.3.** Reversal of myocyte hypertrophy after LVAD implantation.

Reprinted from Bruckner BA et al., Regression of fibrosis and hypertrophy in failing myocardium following mechanical circulatory support, *Journal of Heart and Lung Transplantation* 2001;20:457–464, Copyright (2001), with permission from Elsevier.

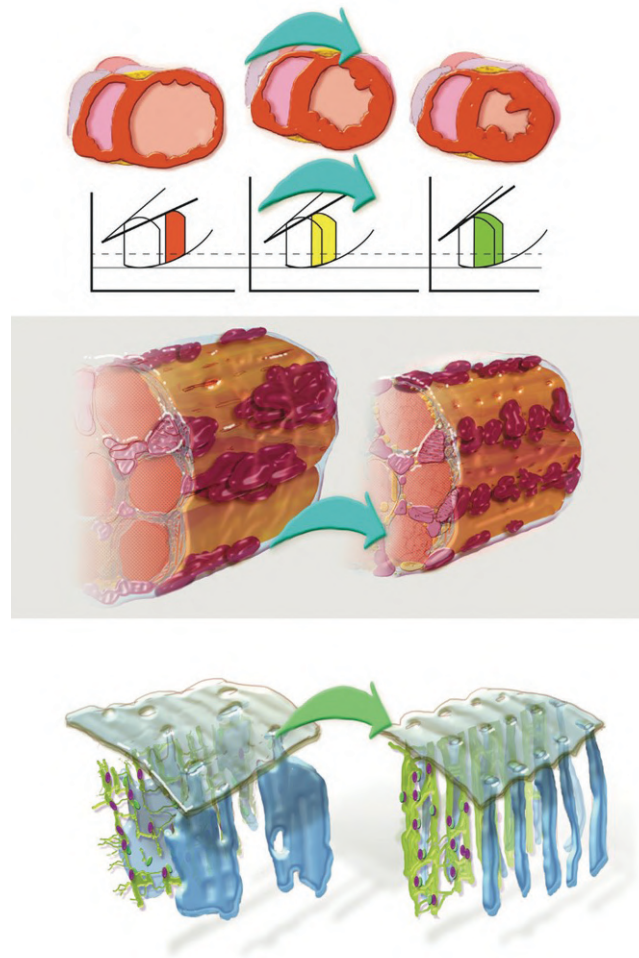
Margulies et al. evaluated 3,088 gene transcripts associated with end-stage cardiomyopathy, of which only 238 demonstrated even a partial response to LVAD therapy.<sup>14</sup> Many genes related to the extracellular matrix, cardiac metabolism, and sarcomeric or cytoskeletal protein families are unresponsive to LVAD therapy in humans or to the withdrawal of cardiac injury in murine models.<sup>39</sup> There also appear to be a new subset of genes that are expressed uniquely in the reverse-remodeled state and not in the normal or failing heart, the clinical implications of which are unclear at this time.<sup>14,38</sup> At an ultrastructural level, there is evidence that misfolding of the t-tubule system (specialized invaginations of the sarcolemma within the myocyte) into sheet-like plates interrupts crucial coupling of calcium channels with the Ryanidine receptor upon which effective calcium

release and myofilament contraction depend (Figure 44.4). Critically, this perturbation of the t-tubule system is highly associated with a long duration of heart failure and predicts a significantly blunted response to mechanical unloading—potentially explaining a large portion of irrecoverable heart failure.<sup>40,41</sup> At the tissue level, several pathologic features of reverse remodeling remain fixed with mechanical unloading but respond to concurrent pharmacologic therapy. Initial reports differed as to whether total collagen content in the extracellular matrix increased or actually decreased to more normal levels following LVAD therapy, until it was shown that the effect stratified by use or non-use of angiotensin-converting enzyme (ACE) inhibitors—only those patients taking an ACE inhibitor after LVAD had normalization of extracellular collagen content.<sup>18</sup>

The heterogeneous and incomplete response of subcellular components, myocyte metabolism, and gene products to mechanical unloading correlate with two important principles in bridge to recovery: (1) patients with clinical similarities at the current level of phenotyping can have a varied clinical responses to mechanical unloading; and (2) even patients demonstrating macroscopic features of myocardial recovery have persistent derangements of underlying myocyte function that render them more susceptible to relapsing heart failure following LVAD explantation. Historically, there has been a high incidence of relapsing heart failure after removal of the LVAD.<sup>42</sup> Thus, a key outcome from the ReSTAGE-HF study is a more detailed phenotyping of clinical markers for *durable* recovery that can be measured before LVAD implantation or while maximally unloaded with LVAD support.

## Explantation

After myocardial recovery occurs, a variety of techniques for explantation have been developed. In the era of pulsatile-flow LVADs, explantation required a median sternotomy and laparotomy, associated with extensive dissection of adhesions and an increased risk for morbidity and mortality. However, in the continuous-flow era, a number of minimally invasive techniques have been developed for the removal of both left<sup>43</sup> and right<sup>44</sup> ventricular assist devices which appear to be safe with a low complication rate. Of the continuous-flow devices that have been explanted for recovery, the Heartmate II (HMII) is the device with the largest experience to date. Current HMII removal strategies center on four distinct approaches: (1) left subcostal approach with complete removal of the inlet cannula and closure with a polytetrafluoroethylene felt plug, which requires brief cardiopulmonary bypass and de-airing due to the risk of arterial gas embolism from the open ventricle; (2) left subcostal approach wherein the enclosed inflow graft material is exposed, cut, and oversewn external to the ventricular apex but the implanted HMII inlet cannula



**Figure 44.4.** Left ventricular remodeling with mechanical unloading: considerations at the organ, cellular (tissue), and ultrastructural level. Myocardial reverse remodeling in human heart failure after left ventricular assist device (LVAD) has been demonstrated with reductions in left ventricular end-diastolic and end-systolic dimension and improved mechanics, resulting in increased slope of the end-systolic pressure volume relation (heavy line) and increased ventricular ejection and stroke volume. At the cellular level, a regression in cardiomyocyte hypertrophy with a reduction cardiomyocyte cross-sectional area after a period of mechanical unloading with both pulsatile and continuous-flow devices has been confirmed by several studies. Electron microscopy of the cardiomyocyte ultrastructure has revealed sheet-like remodeling of the T-tubule membrane system (in blue) in patients with end-stage heart failure, resulting in a disruption of the coupling or dyad distance between the ryanodine receptor type 2 (RyR2, green) of the sarcoplasmic reticulum (also in green) and the L-type calcium channel (purple) of the T-tubular membrane, critical in maintaining calcium-induced calcium release and synchronous excitation-contraction coupling. Patients who have end-stage heart failure with this ultrastructural signature of detubulation into a T-sheet membrane system did not demonstrate myocardial reverse remodeling with a program of LVAD-induced mechanical unloading, raising the possibility that disruption of this membrane system to this degree precludes recovery of ventricular function with mechanical assist device support.

Reprinted with permission from Rame JE et al., Subcellular remodeling of the T-tubule membrane system: the limits of myocardial recovery revealed? *Circulation* 2017;135(17):1646–1650, <https://www.ahajournals.org/journal/circ> © American Heart Association, Inc. All rights reserved.

(coated in non-thrombogenic sintered titanium) is retained (thus mitigating the risk of air embolism and need for cardiopulmonary bypass); (3) subxyphoid approach wherein the outflow graft is encircled and ligated after it leaves the pump, leaving the pump and inflow apparatus intact with separate transection of the driveline; and (4) simple transection of the driveline site while leaving behind the entirety of the intracorporeal portion of the pump.<sup>45</sup> Baldwin et al. compared these four techniques in 27 patients undergoing LVAD explantation for recovery and found no difference among rates of reoperation, stroke, overall survival, or postoperative length of stay, highlighting the tolerance of the human body to retained LVAD material after a period of device support.<sup>45</sup>

## Future Directions

The experience with myocardial recovery and remission from heart failure has been encouraging in select patients, yet the overall percentage of patients who achieve recovery and go on to device explantation remains low. Limiting this strategy is our ability to (1) predict durable recovery and (2) optimize conditions to maximize the recovery of function during LVAD support. Results from the ongoing ReSTAGE-HF trial will shed needed light on the incidence of myocardial recovery when maximal ventricular unloading is combined with optimal oral heart failure therapies in a protocolized fashion. Beyond that, we have increasingly seen that myocardial recovery is incomplete at a tissue, cellular, and subcellular level even when gross structural changes appear to have normalized, and this contributes to the risk of relapsing heart failure in the short or long term after LVAD removal. Some of these factors are likely to be more salient at predicting durable recovery; as they are identified, they should be used both to optimize patient selection for explantation and to develop therapeutic interventions to improve the rates of successful recovery with LVAD therapy.

## REFERENCES

- Rose EA, Gelijns AC, Moskowitz AJ, et al. Long-term use of a left ventricular assist device for end-stage heart failure. *N Engl J Med*. 2001;345(20):1435–1443. doi:10.1056/NEJMoa012175.
- Miller LW. Left ventricular assist devices are underutilized. *Circulation*. 2011;123(14):1552–1558. doi:10.1161/CIRCULATIONAHA.110.958991.
- Cheng A, Williamitis CA, Slaughter MS. Comparison of continuous-flow and pulsatile-flow left ventricular assist devices: is there an advantage to pulsatility? *Ann Cardiothorac Surg*. 2014;3(6):573–581. doi:10.3978/j.issn.2225-319X.2014.08.24.
- Slaughter MS, Rogers JG, Milano CA, et al. Advanced heart failure treated with continuous-flow left ventricular assist device. *N Engl J Med*. 2009;361(23):2241–2251. doi:10.1056/NEJMoa0909938.
- Birks EJ, Yacoub MH, Banner NR, Khaghani A. The role of bridge to transplantation: should LVAD patients be transplanted? *Curr Opin Cardiol*. 2004;19(2):148–153. doi:10.1097/00001573-200403000-00015.
- Birks EJ. The promise of recovery. *JACC Hear Fail*. 2016;4:577–579. doi:10.1016/j.jchf.2016.04.003.
- Kirklin JK, Pagani FD, Kormos RL, et al. Eighth annual INTERMACS report: special focus on framing the impact of adverse events. *J Heart Lung Transplant*. 2017;36(10):1080–1086. doi:10.1016/j.healun.2017.07.005.
- Aissaoui N, Jouan J, Gourjault M, et al. Understanding left ventricular assist devices. *Blood Purif*. 2018;46(4):292–300. doi:10.1159/000491872.
- Dipla K, Mattiello JA, Jeevanandam V, Houser SR, Margulies KB. Myocyte recovery after mechanical circulatory support in humans with end-stage heart failure. *Circulation*. 1998;97(23):2316–2322. doi:10.1161/01.CIR.97.23.2316.
- Terracciano CMN, Harding SE, Adamson D, et al. Changes in sarcolemmal Ca entry and sarcoplasmic reticulum Ca content in ventricular myocytes from patients with end-stage heart failure following myocardial recovery after combined pharmacological and ventricular assist device therapy. *Eur Heart J*. 2003;24(14):1329–1339. doi:10.1016/S0195-668X(03)00242-2.
- Hall JL, Fermin DR, Birks EJ, et al. Clinical, molecular, and genomic changes in response to a left ventricular assist device. *J Am Coll Cardiol*. 2011;57(6):641–652. doi:10.1016/j.jacc.2010.11.010.
- Farrar DJ, Holman WR, McBride LR, et al. Long-term follow-up of thoratec ventricular assist device bridge-to-recovery patients successfully removed from support after recovery of ventricular function. *J Heart Lung Transplant*. 2002;21(5):516–521. doi:10.1016/S1053-2498(01)00408-9.
- Mancini DM, Beniaminovitz A, Levin H, et al. Low incidence of myocardial recovery after left ventricular assist device implantation in patients with chronic heart failure. *Circulation*. 1998;98(22):2383–2389. doi:10.1161/01.CIR.98.22.2383.
- Margulies KB, Matiwala S, Cornejo C, Olsen H, Craven WA, Bednarik D. Mixed messages: transcription patterns in failing and recovering human myocardium. *Circ Res*. 2005;96(5):592–599. doi:10.1161/01.RES.0000159390.03503.c3.
- Drakos SG, Mehra MR. Clinical myocardial recovery during long-term mechanical support in advanced heart failure: insights into moving the field forward. *J Heart Lung Transplant*. 2016;35(4):413–420. doi:10.1016/j.healun.2016.01.001.
- Drakos SG, Pagani FD, Lundberg MS, Baldwin JT. Advancing the science of myocardial recovery with mechanical circulatory support: a working group of the National, Heart, Lung, and Blood Institute. *JACC Basic to Transl Sci*. 2017;2(3):335–340. doi:10.1016/j.jacbs.2016.12.003.
- Birks EJ, Tansley PD, Hardy J, et al. Left ventricular assist device and drug therapy for the reversal of heart failure. *N Engl J Med*. 2006;355(18):1873–1884. doi:10.1056/NEJMoa053063.
- Klotz S, Danser AHJ, Foronjy RF, et al. The impact of angiotensin-converting enzyme inhibitor therapy on the extracellular collagen matrix during left ventricular assist device support in patients with end-stage heart



- failure. *J Am Coll Cardiol*. 2007;49(11):1166–1174. doi:10.1016/j.jacc.2006.10.071.
19. Pan S, Aksut B, Wever-Pinzon OE, et al. Incidence and predictors of myocardial recovery on long-term left ventricular assist device support: results from the United Network for Organ Sharing database. *J Heart Lung Transplant*. 2015;34(12):1624–1629. doi:10.1016/j.healun.2015.08.004.
  20. Wever-Pinzon J, Selzman CH, Stoddard G, et al. Impact of ischemic heart failure etiology on cardiac recovery during mechanical unloading. *J Am Coll Cardiol*. 2016;68(16):1741–1752. doi:10.1016/j.jacc.2016.07.756.
  21. Patel SR, Saeed O, Naftel D, et al. Outcomes of restrictive and hypertrophic cardiomyopathies after LVAD: an INTERMACS analysis. *J Card Fail*. 2017;23(12):859–867. doi:10.1016/j.cardfail.2017.09.011.
  22. Jaiswal A, Le Jemtel TH, Samson R, Mancini D. Sustained cardiac recovery hinges on timing and natural history of underlying condition. *Am J Med Sci*. 2018;356(1):47–55. doi:10.1016/j.amjms.2018.02.008.
  23. Krabatsch T, Schweiger M, Dandel M, et al. Is bridge to recovery more likely with pulsatile left ventricular assist devices than with nonpulsatile-flow systems? *Ann Thorac Surg*. 2011;91(5):1335–1340. doi:10.1016/j.athoracsur.2011.01.027.
  24. Goldstein DJ, Maybaum S, MacGillivray TE, et al. Young patients with nonischemic cardiomyopathy have higher likelihood of left ventricular recovery during left ventricular assist device support. *J Card Fail*. 2012;18(5):392–395. doi:10.1016/j.cardfail.2012.01.020.
  25. Gopinathannair R, Sullivan R, Olshansky B. Tachycardia-mediated cardiomyopathy: recognition and management. *Curr Heart Fail Rep*. 2009;6(4):257–264. <http://www.ncbi.nlm.nih.gov/pubmed/19948094>. Accessed August 17, 2018.
  26. Demakis JG, Proskay A, Rahimtoola SH, et al. The natural course of alcoholic cardiomyopathy. *Ann Intern Med*. 1974;80(3):293–297. <http://www.ncbi.nlm.nih.gov/pubmed/4273902>. Accessed August 17, 2018.
  27. Givertz MM, Mann DL. Epidemiology and natural history of recovery of left ventricular function in recent onset dilated cardiomyopathies. *Curr Heart Fail Rep*. 2013;10(4):321–330. doi:10.1007/s11897-013-0157-5.
  28. Dandel M, Weng Y, Siniawski H, Potapov E, Lehmkühl HB, Hetzer R. Long-term results in patients with idiopathic dilated cardiomyopathy after weaning from left ventricular assist devices. *Circulation*. 2005;112(9 Suppl.). doi:10.1161/CIRCULATIONAHA.104.525352.
  29. Maybaum S, Mancini D, Xydas S, et al. Cardiac improvement during mechanical circulatory support: a prospective multicenter study of the LVAD Working Group. *Circulation*. 2007;115(19):2497–2505. doi:10.1161/CIRCULATIONAHA.106.633180.
  30. Birks EJ, George RS, Hedger M, et al. Reversal of severe heart failure with a continuous-flow left ventricular assist device and pharmacological therapy: a prospective study. *Circulation*. 2011;123(4):381–390. doi:10.1161/CIRCULATIONAHA.109.933960.
  31. Birks EJ, Rame E, Patel S, et al. REmission from Stage D Heart Failure (RESTAGE-HF): interim results and insights from a prospective multi-center non-randomized study of myocardial recovery using LVADs | *Circulation*. *Circulation*. 2018;134:A19838.
  32. Hellowell JL, Margulies KB. Myocardial reverse remodeling. *Cardiovasc Ther*. 2012;30(3):172–181. doi:10.1111/j.1755-5922.2010.00247.x.
  33. Eduardo Rame J, Spragg DD. Device therapy for systolic ventricular failure. In *Muscle* (Vol. 1, pp. 721–737). Elsevier Inc. 2012. <https://doi.org/10.1016/B978-0-12-381510-1.00050-8>
  34. Ogletree-Hughes ML, Stull LB, Sweet WE, Smedira NG, McCarthy PM, Moravec CS. Mechanical unloading restores  $\beta$ -adrenergic responsiveness and reverses receptor downregulation in the failing human heart. *Circulation*. 2001;104(8):881–886. doi:10.1161/hc3301.094911.
  35. SOLVD (Studies of Left Ventricular Dysfunction) investigators. Effect of enalapril on survival in patients with reduced left ventricular ejection fractions and congestive heart failure. *New Engl J Med*. 1991;325(5):293–302. doi:10.1056/NEJM199108013250501.
  36. McMurray JJV, Packer M, Desai AS, et al. Angiotensin-neprilysin inhibition versus enalapril in heart failure. *N Engl J Med*. 2014;371(11):993–1004. doi:10.1056/NEJMoa1409077.
  37. de Groote P, Fertin M, Duva Pentiah A, Goeminne C, Lamblin N, Bauters C. Long-term functional and clinical follow-up of patients with heart failure with recovered left ventricular ejection fraction after beta-blocker therapy. *Circ Heart Fail*. 2014;7(3):434–439. doi:10.1161/CIRCHEARTFAILURE.113.000813.
  38. Marinescu KK, Uriel N, Mann DL, Burkhoff D. Left ventricular assist device-induced reverse remodeling: it's not just about myocardial recovery HHS Public Access. *Expert Rev Med Devices*. 2017;14(1):15–26. doi:10.1080/17434440.2017.1262762.
  39. Topkara VK, Chambers KT, Yang K-C, et al. Functional significance of the discordance between transcriptional profile and left ventricular structure/function during reverse remodeling. *JCI Insight*. 2016;1(4). doi:10.1172/jci.insight.86038.
  40. Seidel T, Navankasattusas S, Ahmad A, et al. Sheet-like remodeling of the transverse tubular system in human heart failure impairs excitation-contraction coupling and functional recovery by mechanical unloading. *Circulation*. 2017;135(17):1632–1645. doi:10.1161/CIRCULATIONAHA.116.024470.
  41. Rame JE, Lavandero S. Subcellular remodeling of the T-tubule membrane system: the limits of myocardial recovery revealed? *Circulation*. 2017;135(17):1646–1650. doi:10.1161/CIRCULATIONAHA.117.025319.
  42. Levin HR, Oz MC, Catanese KA, Rose EA, Burkhoff D. Transient normalization of systolic and diastolic function after support with a left ventricular assist device in a patient with dilated cardiomyopathy. *J Heart Lung Transplant*. 1996;15(8):840–842. doi:10.1161/01.CIR.91.11.2717.
  43. Tansley P, Yacoub M. Minimally invasive explantation of implantable left ventricular assist devices. *J Thorac Cardiovasc Surg*. 2002;124(1):189–191. doi:10.1067/mtc.2002.122786.
  44. Haj-Yahia SM, Birks EJ, Hardy J, Yacoub MH, Khaghani A. Minimally invasive technique for explantation of right ventricular assist devices. *Ann Thorac Surg*. 2006;82(4). doi:10.1016/j.athoracsur.2005.10.010.
  45. Baldwin ACW, Sandoval E, Letsou G V, Mallidi HR, Cohn WE, Frazier OH. Surgical approach to continuous-flow left ventricular assist device explantation: a comparison of outcomes. *J Thorac Cardiovasc Surg*. 2016;151(1):192–198. doi:10.1016/j.jtcvs.2015.08.024.

## Introduction

**M**echanical circulatory support (MCS) with a right, left, or biventricular assist device (VAD) is a cutting-edge therapy providing clear benefits for patients in advanced heart failure (HF).<sup>1-3</sup> Interest in postoperative therapies aimed at aiding recipients with recovery and optimizing response has emerged as a pivotal area for research.<sup>1,2,4-8</sup> Secondary prevention including cardiac and physical rehabilitation featuring exercise training (ET) therapy is an important component of post-implant care resulting in improved prognosis.<sup>9-16</sup>

Modern evidence proves that ET therapy delivered by the cardiac rehabilitation team results in improvements in quality of life, exercise capacity, and prognosis for patients not yet in advanced chronic HF.<sup>17-21</sup> These associations are immediately impactful to VAD recipients since the number of US centers performing implantations for bridge to transplant or destination therapy continues to grow.<sup>1,2</sup> Heightened awareness that ET therapy, even in cases of chronic HF, stimulates integrative whole body adaptations is also important since non-cardio-centric impairments are increasingly recognized as barriers to recovery in patients demonstrating limited responsiveness to MCS.<sup>22-28</sup> Secondary prevention strategies individualized for VAD recipients must consider ET therapy as a key element of the short- and long-term postoperative care plan.

We present in this chapter (1) a contemporary review on the role that cardiac and physical rehabilitation plays in HF and MCS; (2) discussion focused on the importance of understanding exercise physiology as the basis for ET in VAD recipients; (3) evidence-based recommendations for deploying safe and individualized ET therapy in the immediate- to long-term postoperative window; and lastly (4) identification of key research areas focused on MCS and secondary prevention needed to advance the mechanistic understanding of benefits linked to ET, to gain universal support for cardiac and physical rehabilitation, and to

improve patient enrollment and adherence to cardiac and physical rehabilitation.

## Overview of Cardiac and Physical Rehabilitation

The primary goal of cardiac and physical rehabilitation programs designed for advanced HF and MCS implant centers is to take an active role in offering patients the chance to improve postoperative prognosis through secondary prevention and shared medical decision making.<sup>15,17,18,29</sup> Contemporary research based on the proven HF blueprint for delivering cardiac and physical rehabilitation demonstrates that in- and out-patient ET therapy is a fundamental component of secondary prevention, translating to enhanced recovery, response, quality of life, and prognosis for VAD recipients.<sup>3,9,10,13,16,30,31</sup>

### Structure

Patients receive the most benefit from ET therapy when prescribed following a standard operating procedure. This calls for individualized “Phase”-specific program components structured throughout in- and outpatient settings (Box 45.1). Deploying this type of individualized treatment plan is critical for patient success. This is because patients are supervised and progress is monitored from program entry to completion; and over the course of therapy, preemptive care plan and prescription adjustments can be made where necessary. Through additional instruction and education on topics relating to preventive cardiology and secondary prevention beginning as inpatients, patients are able to eventually equip themselves with the necessary skill set to self-manage their ET program on an indefinite basis.

In following a periodized and progressive model (Box 45.1), basic ET therapy should begin during the inpatient stay (i.e., Phase I).<sup>31-36</sup> Shortly following hospital discharge,

### Box 45.1 • Overview of the Main Phases of Cardiac and Physical Rehabilitation Featuring Exercise Training (ET) Therapy

- Phase I: Initiated within the inpatient setting
  - Intensely supervised and guided individualized daily basic physical activity-based programming within the first 10–14 days post-implant (spanning ICU and main hospital setting)
  - Respiratory care also provided as needed (e.g., deep and/or resistive breathing exercises via blow-bottle device)
  - Focused ET aimed at improving patient range-of-motion (ROM), in-bed positioning, ambulation, activities of daily living (ADLs), balance, etc.
  - Pre-discharge, patients should be able to ambulate and climb stairs independently.
- Phase II: Post-discharge and early to intermediate outpatient setting
  - Generally initiated within the first 4–6 weeks post-surgery
    - Must be hemodynamically stable
      - Exercise participation is contraindicated when LVAD flow rate <4 L/min accompanied by symptoms.
    - Depending on the patient, components of advanced ET may be integrated within the inpatient program.
  - Pre-program entry exercise tolerance should be evaluated via cardiopulmonary exercise testing (CPET), stress test, 6-minute walk test (6MWT), etc.
  - Supervised and guided individualized ET programs are designed to last 36 sessions, approximately occurring 3 times/week spanning a 3-month duration (may take upwards of 6–12 months for certain patients).
    - Upper body exercises should be avoided until full sternal healing occurs.
    - Risk for symptomatic hypotension/hypovolemia should be closely monitored.
  - Sessions are expected to be dynamic and include both aerobic and resistance training (where appropriate). Progress made in training intensities should be evaluated mid-program.
  - Improvements in signs and symptoms such as dyspnea, mobility/balance, and exercise tolerance are expected to follow this program.
    - Should be assessed via post-program CPET, stress test, etc., whichever was conducted at program entry for accurate pre-post comparison.
- Phase III (often combined with Phase IV): Long-term outpatient or (home-based) maintenance program. Continuation involving less intense or no supervision of ET.

outpatient assessments should include more advanced benchmark clinical and physiological evaluations upon entry into Phase II cardiac and physical rehabilitation. Assessments should include, at the minimum, exercise stress testing, or preferably, advanced cardiopulmonary exercise testing. Formal assessment of progress towards goals and appropriateness of the initial prescription should occur as a mid-phase review, and again for a final time at Phase II program graduation.<sup>13,17,18,29</sup> Thereafter, self-managed ET should continue indefinitely (i.e., Phase III) with annual follow-up visits including reassessment of Phase II entry clinical tests.<sup>9,10,13,14</sup> Long-term adherence to prescribed ET therapy should yield gradual improvements in hallmark signs and symptoms of HF. Importantly, patients burdened with less severe dyspnea and fatigue and an increased peak exercise oxygen uptake ( $VO_{2\text{peak}}$ ) compared with counterparts demonstrate better prognosis.<sup>9,10,16,17,30,31</sup>

### Safety and Efficacy

During the acute postoperative period, VAD recipients are at increased risk of procedure-related adverse events. This can include infections, bleeding, and/or stroke. Nevertheless, these and other risks seldom prevent patients from safely engaging in physically demanding tasks.<sup>3,9–12,16,24,30,31,35,37</sup> This has been shown to include cardiopulmonary exercise testing as early as 2 weeks after implantation. Various formulations of ET therapy have been encouraged and reported to be safe in implementing as early as 5–14 days post-implantation.<sup>3,9–12,16,24,30,31,35,37</sup>

Most patients should be able to safely participate in basic ET relating to activities of daily living and general mobilization tasks as inpatients (Box 45.1).<sup>3,16,30,31,35</sup> Still, because not all patients can begin ET therapy using the same recovery time frame, cardiac rehabilitation professionals should be aware of standard contraindications to exercise and should closely monitor patients before, during, and after exercise (Box 45.2). Prior to hospital discharge, a standard requirement is that patients should be expected to independently walk and climb stairs as a basic demonstration of functional independence.

The role of inpatient ET therapy is invaluable for physically preparing patients to continue cardiac and physical rehabilitation as outpatients. It can be assumed for patients who receive a VAD at a Centers for Medicare & Medicaid Services (CMS)-approved US center that they are also eligible for, and have access (with co-pay) to Phase II cardiac rehabilitation.<sup>14</sup> With the support and presence of the advanced HF network in place, the overall growth and promise of immediate and long-term, safe, and available outpatient cardiac and physical rehabilitation services are encouraging.<sup>14</sup>

Enhancing our understanding of how ET therapy and secondary prevention tools, such as individualized exercise

### Box 45.2 • Highlighted Contraindications to Engaging in Exercise Training (ET) (or Needing to Stop) in Patients with a Ventricular Assist Device (VAD)

- Symptoms accompanied by physiological signs:
  - Sense of fainting, dizziness, severe dyspnea, sudden fatigue, angina, nausea, pain, paleness, cold-sweating, syncope, orthostatic intolerance, etc.
  - Rapid drop in VAD flow rate 1 L/min persisting <4 L/min.
    - Preload impairment
      - Suckdown
      - Irregular VAD speed and noise/alarms
      - Hypotension (orthostasis)
        - Rapid and persistent drop in blood pressure
        - Hypovolemia (dehydration)
        - Decreased central venous pressure
    - High afterload
      - Hypertension
        - Rapid and persistent increase in blood pressure
  - Arrhythmias (atrial and/or ventricular; may be dependent on device)
    - Tachycardia
    - ECG shifts (ST segment elevation >1 mm)
  - Ataxia
  - Rapid oxygen desaturation (<90%) that persists
  - Rate mediated excessive ventilation
  - Thrombus (bleeding).

prescription and cardiopulmonary exercise testing,<sup>3,13,29,38</sup> can be used to guide patient recovery is a priority. Acquiring additional information on these topics will aid in optimizing delivery of ET therapy for VAD recipients. An improved understanding of the underlying mechanism(s) of benefit linking ET to MCS is also critical for helping to inform and shape other components of the clinical decision-making tree while properly assessing prognosis.

## Exercise Physiology

### Overview

Individualized ET therapy programmed for patients dependent on MCS should follow the principles of exercise physiology, linking goals to unique exercise prescriptions.<sup>39–55</sup> Individualized ET prescriptions must consider in addition to patient medical history and pathophysiology, the principles of (1) specificity, (2) overload and progression,

and (3) temporality and periodicity. By properly applying these constructs, patients who demonstrate close adherence to their prescription can expect the full benefits of ET therapy.<sup>3,17,18,29,56</sup>

### Impact of Mechanical Circulatory Support on Exercise Physiology

Artificial hemodynamic support complicates what is known about classical physiological laws, principles, and redundant pathways.<sup>57–61</sup> In the hybrid model of native and artificial hemodynamics whereby technology is programmed to regularly control irregular hemodynamics, the validity and applicability of assumptions associated with fully intact physiology and, for example, the Frank-Starling law of the heart, principles governing Fick's Laws, autonomic nervous system control, and so on, are still uncertain. Assumptions allowing for discussion of what limits exercise in otherwise healthy individuals have not been comprehensively studied in patients dependent on MCS.

The Fick Principle and general formulation of  $\dot{V}O_2$  ( $Q \times [\text{arterial } O_2 \text{ content (CaO}_2) - \text{mixed venous } O_2 \text{ content (CvO}_2)]$ ) occurs inclusively as a result of innumerable multi-system and interdependent shifts in  $O_2$  flow and extraction. Permanent loss of convective  $O_2$  delivery of any size is detrimental to nearly all aspects of smooth, skeletal, and cardiac muscle function. The inability to properly perform oxidative phosphorylation ( $\text{HPO}_4^{-2} + \text{NADH} + 2 \text{H}^+ + \text{ADP}^{-3} + \frac{1}{2} \text{O}_2 \rightarrow \text{NAD}^+ + 2 \text{H}_2\text{O} + \text{ATP}^{-4}$ ) accompanying delivered  $O_2$  also has massive debilitating effects on muscle and whole-body physiological function.

Together, the complex pathophysiology of redundant and compensatory mechanisms linked to HF (with or without MCS) makes it challenging to decipher what unique feature(s) of the HF syndrome limits exercise as it relates with  $O_2$  “flow” compared with “extraction” (see reviews<sup>21,62,63</sup>). In testing such a question, proper use of the Fick Principle and Fick's First and Second Laws implies that measurements that cannot be made can instead be logically assumed. Two such assumptions that must be maintained when using the Fick Principle include (1) preload hemodynamics that are unaltered by exercise and pathophysiology, and (2) an invariable  $\text{Ca-vO}_2$ .

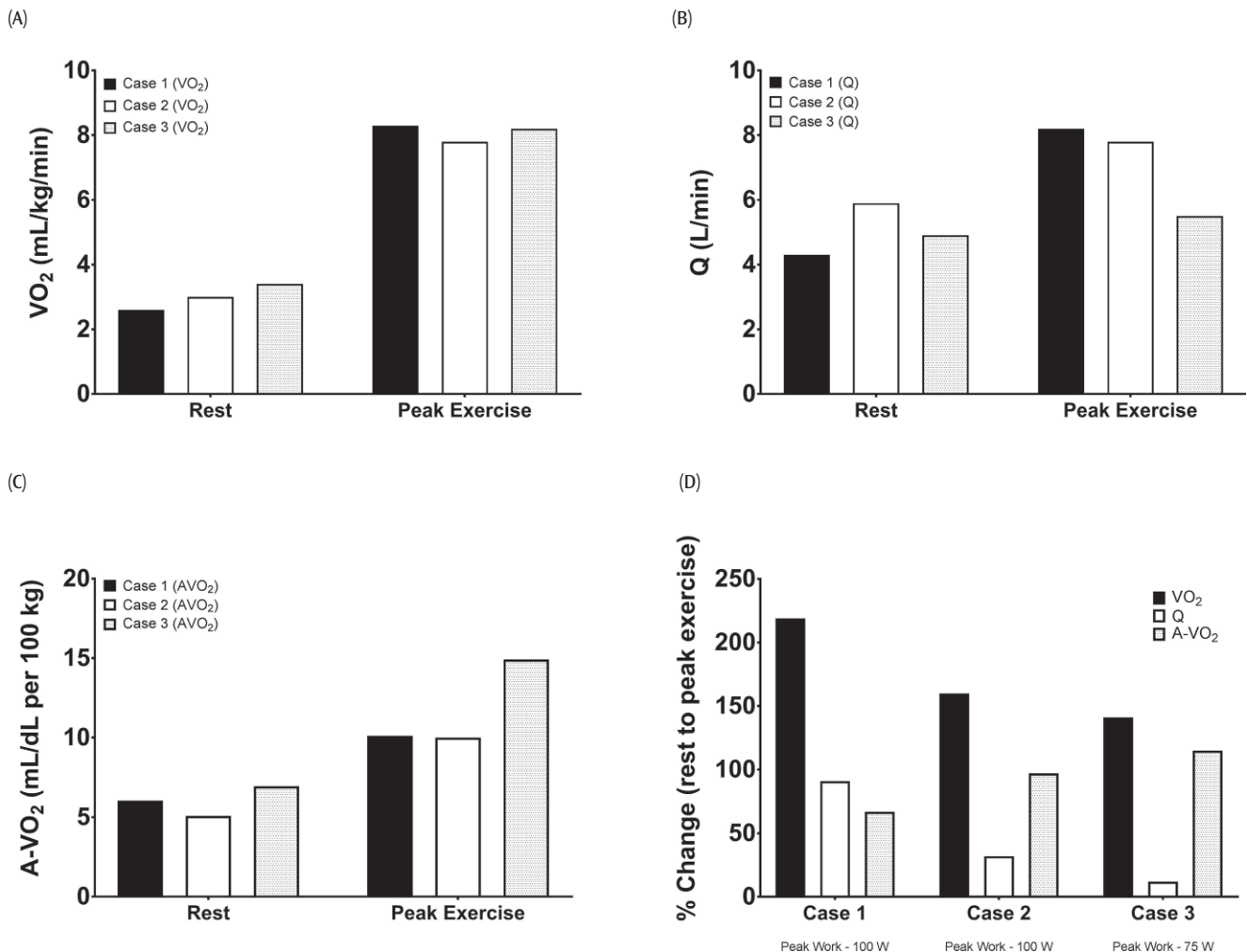
Impaired preload is a known potential risk factor of exercise in VAD recipients. Inadequate venous return precipitates “suckdown” (i.e., ventricular collapse and impaired pump filling) and diminished  $Q$  (of any origin). When present, this unquestionably affects both  $\dot{V}O_2$  and  $\text{Ca-vO}_2$ , although the degree to which each factor is impacted is unknown. Calculating  $Q$ ,  $\dot{V}O_2$ , and  $\text{Ca-vO}_2$  using the Fick Principle is invalid where there is variably impaired preload.

Pre-implant skeletal muscle pathophysiology is also a known burden of advanced HF.<sup>61,64–68</sup> This affects oxidative phosphorylation and what can be inferred about the

contribution of  $\text{Ca-vO}_2$  to  $\text{VO}_{2\text{peak}}$  and exercise capacity. Whether and/or in what manner  $\text{Ca-vO}_2$  function is able to adapt following MCS implantation has not been fully clarified. If in fact the benefits of post-implant participation in ET are related to stimulating skeletal muscle adaptations and at least partially restoring oxidative metabolic capacity, such a cause-effect finding would provide unequivocal support for ET as a Level I recommendation and requirement for VAD recipients.

In patients for whom pump settings are optimized to achieve a given  $Q$  per oxidative metabolic demand, the ability of patients to meet predicted norms for exercise capacity is still unpredictable.<sup>3,27,28,57,58,60,61,69,70</sup> Examples are described in separate case studies from Jaski and

colleagues<sup>57,58</sup> re-illustrated herein (Figure 45.1) to now include assumed  $\text{Ca-vO}_2$  dynamics based on original data published. The critical addition of  $\text{Ca-vO}_2$  responses depicting rest-to-peak exercise differences reaffirms that there are physiological implications if, along with the rise in  $Q$ , peripheral  $\text{O}_2$  extraction and utilization mechanisms fail to meet oxidative metabolic demand.<sup>22–24</sup> Although cases in Figure 45.1 do not implicate impaired  $\text{Ca-vO}_2$  responsiveness to exercise, it is remarkable how much “extraction” is able to make up for inadequate “flow” in meeting oxidative metabolic demand. Indeed, like an effect that a loss of  $Q$  can have on the ability to perform oxidative phosphorylation, incompetent  $\text{Ca-vO}_2$  expansion, coupled with low hemodynamic reserve following a sudden rise in



**Figure 45.1.** Fick determinants of exercise performance in patients with advanced heart failure (HF) implanted with mechanical circulatory support (MCS). Original work reported as separate case studies of Jaski and colleagues<sup>57,58</sup> in patients with HF and left ventricular assist device (LVAD) therapy did not report arteriovenous oxygen content gradients ( $\text{Ca-vO}_2$ ) responses. In using the Fick Principle and native cardiac output ( $Q$ ) and pulmonary oxygen uptake ( $\text{VO}_2$ ) responses from Jaski and colleagues,<sup>57,58</sup> we report herein  $\text{Ca-vO}_2$  as both absolute (per 100 kg body weight) and percent change (rest to peak exercise) responses for respective patient cases. Cases 1 and 2 in our figure correspond with patient numbers 1 and 2, respectively, in Jaski et al.,<sup>57</sup> whereas Case 3 corresponds with patient number 4 in Branch et al.<sup>58</sup>

oxidative metabolic demand, clearly limits exercise capacity (e.g., Cases 2 and 3;<sup>57,58</sup> Figure 45.1).

Preliminary research has demonstrated that, despite no differences in peak exercise Q as a result of modifying VAD pump speed,<sup>27</sup> exercise performed at high pump speeds precipitates larger peak  $\dot{V}O_2$  than that which occurs at low pump speeds.<sup>28</sup> These stand-alone findings suggest that exercise performed at high pump speeds increases  $\dot{V}O_2$  by providing greater Ca- $\dot{v}O_2$  (i.e., a global increase in peripheral  $O_2$  extraction and utilization).<sup>27,28</sup> By contrast, others more recently report that there is a favorable impact of setting a high pump speed on exercise capacity and all components (including Q) essential to calculating  $\dot{V}O_2$  using the traditional Fick Principle.<sup>61</sup> Regrettably, though, the impact of high pump speed also unintentionally led to markedly compromised  $O_2$  transport via impaired lung diffusion and unacceptable risk associated with this transient approach to “optimizing” exercise capacity.<sup>61</sup> The paradoxical associations reported are key findings for this field, as they provide a physiological snapshot as to where future research needs to be focused.

Whether adaptive  $O_2$  flow rate is equally or more important than absolute  $O_2$  flow volume in impacting exercise capacity and prognosis in VAD recipients is an incompletely understood question. Further clarifying this question, followed by testing and finding answers, is a process having great clinical implications for the underappreciated role that whole-body ET plays in secondary prevention following MCS implantation.<sup>3,9,13,16,22–24</sup> Strong support for ET therapy recommended as part of secondary prevention in patients with non-end-stage chronic HF is highly based on knowledge of the impact that linked central and peripheral pathophysiology has on prognosis.<sup>71–76</sup>

## Exercise Training Programming

The speed and size of adaptations developed over the course of structured ET therapy is heterogeneous between and within humans. First, it can be expected that any physical adaptation experienced shortly after beginning ET is heavily influenced by neural mechanisms.<sup>47,48,52–54,77–79</sup> Subsequent aerobic and/or strength improvements observed during a transient period of ET (<12 weeks) can begin to appreciably decline in as little as 1–3 weeks of detraining,<sup>51,54</sup> and adaptations can be completely lost within 4 months of detraining.<sup>55</sup> Therefore, unless ET continues (e.g., >12 weeks) while maintaining training-intensity levels, it cannot be expected that onset and maintenance of physiological adaptations specific to skeletal muscle strength, endurance, and hypertrophy occur.<sup>39–55</sup> This means that participation in ET programs must meet unique length requirements as the basis for allowing physiological adaptation.

In contrast to the aforementioned proven scientific logic, most studies examining VAD recipients have consistently reported ET interventions lasting up to 10 weeks.<sup>9,10,12,16</sup> This is a period falling well within an adaptation window consistent with a high neural influence.<sup>47,48,50,52–54,77–79</sup> Longer-term and individualized ET program recommendations for VAD recipients have yet to be rigorously tested or well-defined.

To date, a single prospective long-term (i.e., >3 months spanning Phases II–III) cardiac and physical rehabilitation study has been conducted in VAD recipients (Table 45.1). Kugler et al.<sup>13</sup> initially observed that patients experienced gains in whole-body physical function as early as 6 months into ET. However, marked improvements in  $\dot{V}O_{2peak}$  did not occur until the end of the intervention 18 months later. Thus, even without considering nuances of the ET prescription (e.g., FITT: frequency, intensity, time, and type), rehabilitation must be of durations appropriate for stimulating lasting integrative physiological adaptations. For the prognostic benefits of cardiac and physical rehabilitation to extend long-term, it is important for aerobic and resistance training to be repeated, progressive, and periodically dynamic.

## Aerobic Exercise Training

Aerobic exercise capacity is important in signaling the overall health of patients with HF across the severity spectra.<sup>3,38,80</sup> Knowledge of the key mechanisms along the oxidative metabolic pathway leading to exercise intolerance is still growing.<sup>62,73,76,81–85</sup> What is understood thus far is that in patients where aerobic exercise capacity improves with ET therapy, this change cannot be exclusively explained by recovered central hemodynamics.<sup>3,9,13,16,22–24</sup>

Despite the complexity of oxidative metabolism for which a detailed discussion is beyond the scope of this chapter, it is known that a high  $\dot{V}O_{2peak}$  reliably indicates a favorable prognosis.<sup>3,24,38,80,86</sup> Regular participation in aerobic ET ( $\geq 3$  days/week;  $\geq 150$  minutes/week) has been shown repeatedly to improve pre- to post-rehab  $\dot{V}O_{2peak}$ , symptoms, and overall prognosis in patients with HF.<sup>3,9,10,13,16–18,86</sup> Therefore, VAD recipients must participate in ET therapy to engage aerobic (oxidative,  $O_2$ -dependent) metabolic pathways through continuous or interval training (Table 45.2).

Individuals should begin ET therapy as inpatients beginning with basic mobility, balance, and ambulatory activities (Box 45.1).<sup>31–35</sup> These introductory exercises are safe and should gradually evolve to include more challenging ET using aerobic exercise machines (both as in- and outpatients), eventually leading to similar types of continuous or interval ET during indefinite outpatient/home-based therapy.<sup>9,10,12,13,17,29,87</sup> Although not yet validated for postoperative use in VAD recipients, objective assessments such as the Functional Independence Measure,<sup>33</sup> Timed-Up-and-Go,<sup>88</sup> 6-minute walk test (6MWT),<sup>89</sup> and others<sup>90–94</sup> can be

**Table 45.1 • Key Outpatient Studies of Physical Rehabilitation and Exercise Training in Patients with Heart Failure Following Ventricular Assist Device Implantation**

Authors (year)	Study Design (VAD sample N)	Program Length	Main Exercise Training Components	Physiological Impact
Marko et al. 2015	Retrospective (N = 41) • cf (axial or centrifugal)-LVAD, designation NA • Duration support at program entry, 48 ± 38 days	32 ± 6 days • Supervised • Sessions per week NA	Aerobic: • Bicycle (interval) • Work to recovery ratio (sec) ~ 20:60 • Work RPE = 13 • Time training NA • Walking (cont.) • 90 min. with Δ grades  Resistance: • Upper and lower body training • 2 sets (12 reps) • RPE = 13 • Time training NA	Pre: VO <sub>2peak</sub> 11.3 ± 4.1 mL/kg/min Post: VO <sub>2peak</sub> 14.5 ± 5.2 mL/kg/min Yes (P < 0.01)
Karapolat et al. 2013	Retrospective (N = 11) • cf (axial) or pulsatile-LVAD BTT • Duration support at program entry, 2.8 ± 2.1 months	2 months • Supervised • 3 x/week	Aerobic: • Treadmill (cont.) • VO <sub>2peak</sub> = 60%–70% • RPE = 12–14 • 30 min.  Resistance: • Upper and lower body training • 0.5–1.0 lb weights • Time training NA	Pre: VO <sub>2peak</sub> 14.7 ± 3.6 mL/kg/min Post: VO <sub>2peak</sub> 15.1 ± 3.4 mL/kg/min Yes (P < 0.05)
Kugler et al. 2012	Prospective non-randomized (N = 34, INT) (N = 36, CTL) • cf (axial or centrifugal)-LVAD BTT • Duration support at program entry, 6 weeks	18 months • Home • Smart-card guided w/phone calls • 3–4 x/week	Aerobic: • Bicycle (cont.) • 10% <AT • HR <sub>peak</sub> <80%–90% • 20 min.	INT Pre: VO <sub>2peak</sub> ~61% pred. Post: VO <sub>2peak</sub> ~69% pred. Yes (P = 0.01; and vs. CTL, P = 0.05)
Hayes et al. 2012	Prospective RCT (N = 7, INT) (N = 7, CTL) • cf (centrifugal)-LVAD BTT • Duration support at program entry, 32 days	2 months • Supervised • 3 x/week	Aerobic: • Treadmill (cont.) • 6MWT = 60% • 15 min. • Bicycle (cont.) • VO <sub>2reserve</sub> = 50% • 15 min.  Resistance: • Upper and lower body training • 2 sets (10 reps) each exercise	INT Pre: VO <sub>2peak</sub> 10.5 ± 2.3 mL/kg/min Post: VO <sub>2peak</sub> 14.8 ± 4.9 mL/kg/min Yes (P < 0.05; No vs. CTL, P = 0.43)
Laoutaris et al. 2011	Prospective RCT (N = 10, INT) (N = 5, CTL) • LVAD or BiVAD (both cf-axial and pulsatile) BTT • Duration support at program entry, 6.6 ± 4.4 months	10 weeks • Exercise, home • 3–5 x/week • IMT, supervised • 2-3 x/week	Aerobic: • Walk daily • 30–45 min. • Treadmill or bicycle (cont.) • RPE = 12–14 • 45 min.  IMT: • 60% of sustained inspiratory muscle strength	INT Pre: VO <sub>2peak</sub> 16.8 ± 3.7 mL/kg/min Post: VO <sub>2peak</sub> 19.3 ± 4.5 mL/kg/min Yes (P < 0.01; No vs. CTL, P = 0.10)

Abbreviations: cf = continuous flow; LVAD = left ventricular assist device; BiVAD = biventricular assist device; BTT = bridge to transplant; RCT = randomized clinical trial; NA = information not available; RPE = rating of perceived exertion (Borg scale, 6–20); cont. = continuous exercise; interval = high intensity interval training; Δ = change; VO<sub>2peak</sub> = peak exercise oxygen uptake; VO<sub>2reserve</sub> = peak exercise oxygen uptake reserve; Pre = testing that occurred prior to entry into physical rehabilitation; Post = testing that occurred at the conclusion of physical rehabilitation; INT = intervention group participating in physical rehabilitation; CTL = control group receiving usual care; HR<sub>peak</sub> = peak exercise heart rate; IMT = inspiratory muscle training.

**Table 45.2 • Key Components and Recommendations for Each Form of Exercise Training (ET) Included in Cardiac Rehabilitation for Postoperative Ventricular Assist Device Heart Failure Patients**

Training Type	Physiological Variables	Main Program Features	Physiological Benefits
<p>Continuous aerobic training (<math>\geq 3</math> x/weekly)</p> <ul style="list-style-type: none"> <li>• Treadmill</li> <li>• Cycle ergometer</li> <li>• Elliptical (no handle use)</li> </ul> <p>As tolerated, maintaining an active lifestyle is recommended on non-ET days.</p> <ul style="list-style-type: none"> <li>• Leisure walks</li> <li>• Household chores</li> </ul>	<ul style="list-style-type: none"> <li>• <math>\text{VO}_{2\text{peak}}</math> (abs./%pred.)</li> <li>• <math>\text{V}_E/\text{VCO}_2</math> slope</li> <li>• <math>\text{VO}_2</math> at AT</li> <li>• peak SBP</li> <li>• peak HR (abs./%pred.)</li> </ul>	<ul style="list-style-type: none"> <li>• Initial (Phase I–II): low intensity</li> <li>• 30%–50% <math>\text{VO}_{2\text{peak}}</math></li> <li>• 20%–40% HRR</li> <li>• 35%–50% peak HR</li> <li>• RPE <math>&lt;12</math></li> <li>• TT, 10–15 min.</li> <li>• Progression (Phase II–III): moderate intensity</li> <li>• 50%–70% <math>\text{VO}_{2\text{peak}}</math></li> <li>• 40%–70% HRR</li> <li>• 50%–70% peak HR</li> <li>• RPE = 12–14</li> <li>• TT, 15–30 min.</li> </ul>	<p>With a comprehensive ET program including both aerobic and resistance components the following integrative physiological improvements in exercise tolerance and functional ability can be expected:</p> <ul style="list-style-type: none"> <li>• <math>\text{VO}_{2\text{peak}}</math> (abs./%pred.)</li> <li>• CPET duration</li> <li>• Peak watts</li> <li>• <math>\text{V}_E/\text{VCO}_2</math> slope</li> <li>• <math>\text{VO}_2</math> at AT</li> <li>• Peak SBP</li> <li>• Peak HR (abs./%pred.)</li> <li>• 6 MWT</li> <li>• Balance</li> <li>• Mobility</li> <li>• Activities of daily living</li> <li>• Decrease fall risk</li> </ul>
<p>Interval (high/low) aerobic training (HIIT) (<math>\geq 3</math> x/weekly)</p> <ul style="list-style-type: none"> <li>• Treadmill</li> <li>• Cycle ergometer</li> <li>• Elliptical (no handle use)</li> </ul> <p>As tolerated, maintaining an active lifestyle is recommended on non-ET days.</p> <ul style="list-style-type: none"> <li>• Leisure walks</li> <li>• Household chores</li> </ul>	<ul style="list-style-type: none"> <li>• <math>\text{VO}_{2\text{peak}}</math> (abs./%pred.)</li> <li>• <math>\text{V}_E/\text{VCO}_2</math> slope</li> <li>• <math>\text{VO}_2</math> at AT</li> <li>• Peak SBP</li> <li>• Peak HR (abs./%pred.)</li> </ul>	<ul style="list-style-type: none"> <li>• Initial (Phase II): low intensity, low to high work ratio <math>&gt;5:1</math></li> <li>• High interval</li> <li>• 30%–50% <math>\text{VO}_{2\text{peak}}</math></li> <li>• 20%–40% HRR</li> <li>• 35%–50% peak HR</li> <li>• RPE = 12–14</li> <li>• 10–20 sec.</li> <li>• Low interval</li> <li>• <math>&lt;25\%</math> <math>\text{VO}_{2\text{peak}}</math></li> <li>• <math>&lt;20\%</math> HRR</li> <li>• <math>&lt;30\%</math> peak HR</li> <li>• RPE <math>&lt;12</math></li> <li>• 50–70 sec.</li> <li>• TT, 5–10 min.</li> <li>• Progression (Phase II–III): moderate intensity, low to high work ratio <math>&gt;3:1</math></li> <li>• High interval</li> <li>• 50%–70% <math>\text{VO}_{2\text{peak}}</math></li> <li>• 40%–70% HRR</li> <li>• 50%–70% peak HR</li> <li>• RPE = 12–14</li> <li>• 30–60 sec.</li> <li>• Low interval</li> <li>• 30%–50% <math>\text{VO}_{2\text{peak}}</math></li> <li>• 20%–40% HRR</li> <li>• 35%–50% peak HR</li> <li>• RPE <math>&lt;12</math></li> <li>• 100–200 sec.</li> <li>• TT, 15–30 min.</li> </ul>	<p>(Same as above)</p>
<p>Resistance (strength) training (<math>\geq 2</math> x/weekly, non-consecutive days)</p> <ul style="list-style-type: none"> <li>• Body weight</li> <li>• Free weights</li> <li>• Weight machines</li> </ul> <p>As tolerated, maintaining an active lifestyle is recommended on non-ET days.</p> <ul style="list-style-type: none"> <li>• Leisure walks</li> <li>• Household chores</li> </ul>	<ul style="list-style-type: none"> <li>• Lower body strength</li> <li>• Press</li> <li>• Extensor/flexor</li> <li>• Balance</li> <li>• Upper body strength</li> <li>• Chest</li> <li>• Shoulders</li> <li>• Back</li> <li>• Arms</li> </ul>	<ul style="list-style-type: none"> <li>• Initial (Phase I–II): low intensity circuit</li> <li>• <math>&lt;40\%</math>, 5 or 10 RM</li> <li>• RPE <math>&lt;12</math></li> <li>• Repetitions, 5–10</li> <li>• Sets, 2</li> <li>• TT, 10–15 min and/or 1–3 circuits</li> <li>• Progression (Phase II–III): moderate intensity</li> <li>• 40%–70%, 5RM</li> <li>• 50%–80%, 10RM</li> <li>• RPE, 12–14</li> <li>• Repetitions, 10–15</li> <li>• Sets, 2</li> <li>• TT, 15–30 min and/or 1–2 circuits.</li> </ul>	<p>(Same as above)</p>

Abbreviations: RPE = rating of perceived exertion (Borg scale, 6–20); HIIT = high intensity interval training;  $\text{VO}_{2\text{peak}}$  = peak exercise oxygen uptake; AT = anaerobic threshold; HR = heart rate; HRR = heart rate reserve ( $=\text{HR}_{\text{rest}} + [\text{HR}_{\text{peak}} - \text{HR}_{\text{rest}}] \cdot X\%$ );  $\text{V}_E/\text{VCO}_2$  slope = ventilatory equivalent for carbon dioxide output slope; TT = total time spent training not including time spent for warm-up and cool-down periods; SBP = systolic blood pressure; CPET = cardiopulmonary exercise testing; 6MWT = 6-minute walk test; abs. = absolute; %pred. = percent of predicted; 5 or 10RM = maximal amount of times a weight can be lifted five or ten times, respectively.



used to evaluate patient “readiness” for more demanding aerobic exercises (Box 45.3).

Modest-to-moderate ET at any stage of basic functional, mobility, or machine-based aerobic training can be prescribed using individual perception of effort (e.g., ~12 to 14 on the Borg Rating of Perceived Exertion [RPE] scale<sup>95–97</sup>).<sup>10,31</sup> The RPE scale is validated for use in patients with cardiovascular disease (including HF) for grading physiological responses to exercise intensity across training modalities commonly used in cardiac rehabilitation centers and home-based programs (Table 45.2).<sup>10,13,17,31,98</sup> Because the RPE scale requires no advanced technical equipment, the measurement scale is standardized across users, and is readily available, this tool can be applied in any cardiac and physical rehabilitation setting. However, for the RPE scale to be effective in guiding ET intensity, patients must be properly educated on the use of this tool before training.

As physical conditioning continues to improve, and as patients become more comfortable with exercise, ET intensity can be based on direct physiological measurements (Table 45.2). Because inpatient cardiopulmonary exercise testing is considered safe for most VAD recipients,<sup>3,11,16,24,30,31,37</sup> the percentage of HR (peak or reserve [HRR]), anaerobic threshold (AT), or percentage of  $VO_{2peak}$  may provide objective thresholds of actual physical capabilities relative to program

entry levels (Table 45.2).<sup>13,17,31,56,86</sup> When used with the RPE scale over the course of ET, fluid adjustments to continuous or interval intensity zones can provide patients with greater training stimuli while maintaining the same perception of exertion as demonstrated at program entry.<sup>17,29,31,56</sup>

Although physiological variables used to establish ET intensities are considered the reference standard across the spectra of patients with cardiac disease,<sup>29,56,86</sup> the validity of such indices is not established for VAD recipients. As part of safety considerations and when deciding on appropriateness of ET therapy, it should be recognized that for both relative and absolute measurements of  $VO_{2peak}$ , HRR, and so on, for some patients these responses may be affected by routine medications.<sup>99–101</sup> These ET and pharmacological interactions may not adequately reflect exertion when solely based on physiological training zones. Thus, when applying scientific research concepts to real-world cardiac and physical rehabilitation, experienced practitioners must be involved at all levels with program conception, oversight, and evaluation to optimize safety and specificity of the ET care plan.

### Strength Training

Strength training complements mainstay aerobic exercise and is an important part of postoperative care (Table 45.2).<sup>9,17,29,31</sup> Cachexia occurring independently or together with sarcopenia is known to contribute to HF syndrome progression and worsened prognosis.<sup>2,22,102,103</sup> For patients with MCS, this pathophysiology is particularly evident as poor locomotor muscle strength and frailty (deficit index based on scoring of physical, psychological, and disease categories) before or after implantation are significant risk factors for hospitalizations and death.<sup>24,25</sup> The importance of skeletal muscle health and function (i.e.,  $O_2$ -independent Type II fibers) specifically in VAD recipients is evident in several studies in which both aerobic and resistance exercise benefited patients in the absence of added risk for adverse events.<sup>9,12,16</sup>

Strength training programs for patients dependent on MCS have not been compared on efficacy. However, in general, a program that incorporates both upper and lower body training is recommended (Table 45.2).<sup>3,17,18,29</sup> As in basic physical activity and more demanding aerobic ET programs, the intensity of strength training may be guided using the RPE scale. Modest-to-moderate training intensity may also be objectively guided by determining the maximum weight a patient is able to lift 5 or 10 times, and thereby setting training intensities at submaximal percentages of either strength test (Table 45.2). Such an approach is effective for making progress toward specific ET goals because unique training weights are determined for each component of an individualized program. Progression of the program can also be carefully monitored using this objective data. Over the course of a strength training program, patients will be

#### Box 45.3 • Tools to Evaluate Physical “Readiness” for Progression from Activity-Based Exercise Training (ET) to Structured Aerobic and Resistance ET

- 6-minute walk test (6MWT) (e.g., poor prognosis, <300 m)
- Daily walking ability (time or distance)
- Timed-Up-and-Go (TUG) test (from a sitting position, time taken to walk 3 m, turn around and sit back down; predictor of falls when test time >16 sec)
- Functional Independence Measure (FIM) (scale consisting of 18 items spanning function and cognitive/psychological abilities)
- Unipedal stance test (UST) (fall risk increases when time for UST <30 sec)
- Berg balance scale (scored on 14 items involving physical ability; 0 = inability and not safe to 4 = able and safe)
- Tinetti test (scored on balance and gait function; score <26 is high fall risk)
- Activities-Specific Balance Confidence (ABC) Scale (scoring based on confidence a patient has in performing activities without losing balance; scores <50 indicate low functional level, whereas >80 indicates high function)

able to lift greater absolute loads while maintaining the same RPE response.<sup>3,9,12,16,17</sup>

Reports of adverse events caused by participating in strength training are rare in VAD recipients.<sup>3,9,12,16,17</sup> This does not mean there are no precautions that should be considered when instituting this type of exercise. All patients, whether experienced with strength training or not, should be initially familiarized with the training environment and educated on the concepts of strength training and how regular participation can improve mobility, functional ability, strength, and endurance. Specific discussions about the types of exercises that will be included in the program, accompanied by proper instruction and demonstration on how to perform movements, are critical for patient safety and program efficacy. For example, patients should be advised on avoiding the Valsalva maneuver during weight lifting, given the potential for hemodynamic and blood pressure complications.

Patients should be expected to make progress and clearly understand what to expect from a long-term strength-training program so they can eventually safely and comfortably train with less oversight from exercise physiologists (Table 45.2). Over the course of a patient's program, performance metrics should be closely documented and monitored to allow for proper timing of progression and periodization of training intensities and, hence, development of adaptations.<sup>17,29,56</sup> As patients near the end of the Phase II program, individuals should be provided with a prescribed transition plan with instructions on how to maintain a strength-training program at home or recreation center.

## Looking to the Future

The proportion of VAD recipients who participate in inpatient cardiac and physical rehabilitation among all who are eligible has been reported to exceed 50%, although exact numbers vary.<sup>32–35</sup> This suggests there are a considerable number of patients who are initially engaged and aware of the benefits associated with this aspect of secondary prevention.

As for outpatient cardiac and physical rehabilitation models currently available to recent VAD recipients, overall patient rate of enrollment and completion suggests under-utilization of the service.<sup>14</sup> Participation in Phase II cardiac and physical rehabilitation (<1 year post-implant) is more likely to be less than 1 out of every 3 who are eligible.<sup>14</sup> Equally concerning is that out of CMS-approved VAD implantation centers, it is estimated that 96% of centers possess the infrastructure capable of offering and deploying Phase II cardiac and physical rehabilitation to patients.<sup>14</sup> Exact reasons for the discrepancy between Phase II cardiac and physical rehabilitation patient eligibility, participation/completion, and service availability remain unclear; but responsibility for suboptimal

utilization of this service is that of both patients and caregivers.

The real-world implementation of cardiac and physical rehabilitation for VAD recipients must continually improve. Stronger awareness and targeted education about the benefits of cardiac and physical rehabilitation following VAD implantation can be expected to encourage patient enrollment, adherence, and completion. By also providing the same effort toward educating clinicians, this can also positively impact referral rate, thereby trickling down to increasing cardiac and physical rehabilitation program initiation and completion.

## Pre-Habilitation

The majority of individuals recommended for VAD therapy are severely deconditioned. This has not been shown to be determined by any single factor.<sup>9,11–13,16,22–25,32,34</sup> Thus, a patient's pre-implant physical condition should be recognized as a central consideration when deciding the appropriateness and how to approach structuring postoperative cardiac and physical rehabilitation.

An early benchmark goal following surgery is for patients to be competent in their ability to readily and safely execute an independent lifestyle (e.g., ambulation, activities of daily living, etc.). Therefore, reasonable collective actions should be taken *prior* to implantation with the goal of better equipping patients for the rigors of postoperative recovery. Just as there is the strong recommendation that extreme obesity (i.e., BMI  $\geq 40$  kg/m<sup>2</sup>) be resolved via intentional weight loss prior to confirmation of eligibility for surgery, those who are identified as profoundly deconditioned (e.g., cachexic, BMI <20 kg/m<sup>2</sup>, VO<sub>2peak</sub> <10 mL/kg/min, etc.) on a trajectory for implantation could be expected to benefit from *pre-operative ET* (pre-habilitation).<sup>2,17,25,104–106</sup>

Predicting the appropriate timing for pre-habilitation is challenging for numerous logistic reasons, all of which are not well-defined. The real-world patient benefit and efficacy of this proposed preemptive model has also yet to be rigorously tested. Testing such questions in the real world is an important next step that must be made in order to identify to what extent pre-habilitation ET translates to improved recovery and prognosis.

## Assessing the Response to Exercise Training

Upon graduating from Phase II cardiac and physical rehabilitation, patients with non-end-stage chronic HF demonstrate improvements in VO<sub>2peak</sub>, symptom severity, quality of life, and prognosis.<sup>17–21,38,107</sup> By contrast, for VAD recipients there is no agreement as to what physiological response(s) occurring as a result of comparable therapy

are directly indicative of benefit gained. For example, it has been questioned as to whether there is a measurable benefit related to changes in  $\text{VO}_{2\text{peak}}$  occurring pre- to post-VAD implantation.<sup>108</sup> Others have gone so far as to suggest that measuring the  $\text{VO}_2$  response bordering the AT should be used as the foundation for ET intensity and prescription.<sup>24,60,109</sup> The incomplete understanding of the value and utility of specific physiological metrics demonstrated by VAD recipients is impactful to patient care since composite clinical decision making is, in part, based on specific cardiopulmonary exercise test results and/or other exercise outcomes (e.g., peak Q,  $\text{VO}_{2\text{peak}}$ , submaximal  $\text{VO}_2$ , 6MWT, etc.).<sup>2,36,105,106,110,111</sup>

## Conclusions

Patients in advanced HF dependent on MCS benefit from cardiac and physical rehabilitation featuring aerobic and resistance ET. Participation in this secondary prevention strategy is safe, can eventually be self-managed, and has the potential to be sustainable long-term. Major next steps for this field are (1) improving gross utilization of outpatient cardiac and physical rehabilitation, (2) advancing the mechanistic understanding of how ET benefits VAD recipients, and (3) universal acceptance and implementation of postoperative (and preoperative) cardiac and physical rehabilitation featuring ET therapy as a hallmark of secondary prevention.

## REFERENCES

- Kirklin JK, Pagani FD, Kormos RL, et al. Eighth annual INTERMACS report: Special focus on framing the impact of adverse events. *J Heart Lung Transplant.* 2017;36(10):1080–1086.
- Mehra MR, Canter CE, Hannan MM, et al. The 2016 International Society for Heart Lung Transplantation listing criteria for heart transplantation: a 10-year update. *J Heart Lung Transplant.* 2016;35(1):1–23.
- Adamopoulos S, Corrà U, Laoutaris ID, et al. Exercise training in patients with ventricular assist devices: a review of the evidence and practical advice. A position paper from the Committee on Exercise Physiology and Training and the Committee of Advanced Heart Failure of the Heart Failure Association of the European Society of Cardiology. *European Journal of Heart Failure.* 2019;21(1):3–13.
- Miller LW, Pagani FD, Russell SD, et al. Use of a continuous-flow device in patients awaiting heart transplantation. *N Engl J Med.* 2007;357(9):885–896.
- Slaughter MS, Rogers JG, Milano CA, et al. Advanced heart failure treated with continuous-flow left ventricular assist device. *N Engl J Med.* 2009;361(23):2241–2251.
- Masetti M, Wilk AR, Grigioni F, et al. Age dependent risk of LVAD used as a bridge to transplant and of comorbidities on post-transplant survival: an analysis of ISHLT registry. *J Heart Lung Transpl.* 2017;36(4):S31–S32.
- Silvestry S, Joseph S, Myers S, Naftel D, Kirklin J, Prasad S. LVAD post-implant length of stay impacts long term survival: an intermacs database analysis. *J Heart Lung Transplant.* 2017;36(4):S174.
- Kaan A, Johansson E, Chiu W, et al. non-adherence to medical advice does not impact survival in a bridge to transplant (BTT) left ventricular assist device (LVAD) program. *J Heart Lung Transplant.* 2016;35(4):S346–S347.
- Hayes K, Leet AS, Bradley SJ, Holland AE. Effects of exercise training on exercise capacity and quality of life in patients with a left ventricular assist device: a preliminary randomized controlled trial. *J Heart Lung Transplant.* 2012;31(7):729–734.
- Laoutaris ID, Dritsas A, Adamopoulos S, et al. Benefits of physical training on exercise capacity, inspiratory muscle function, and quality of life in patients with ventricular assist devices long-term postimplantation. *Eur J Cardiovasc Prev Rehabil.* 2011;18(1):33–40.
- Kennedy MD, Haykowsky M, Humphrey R. Function, eligibility, outcomes, and exercise capacity associated with left ventricular assist devices: exercise rehabilitation and training for patients with ventricular assist devices. *J Cardiopulm Rehabil.* 2003;23(3):208–217.
- Karapolat H, Engin C, Eroglu M, et al. Efficacy of the cardiac rehabilitation program in patients with end-stage heart failure, heart transplant patients, and left ventricular assist device recipients. *Transplant Proc.* 2013;45(9):3381–3385.
- Kugler C, Malehsa D, Schrader E, et al. A multi-modal intervention in management of left ventricular assist device outpatients: dietary counselling, controlled exercise and psychosocial support. *Eur J Cardiothorac Surg.* 2012;42(6):1026–1032.
- Bachmann JM, Duncan MS, Shah AS, et al. Association of cardiac rehabilitation with decreased hospitalizations and mortality after ventricular assist device implantation. *JACC Heart Fail.* 2018;6(2):130–139.
- Ben Gal T, Piepoli MF, Corra U, et al. Exercise programs for LVAD supported patients: a snapshot from the ESC affiliated countries. *Int J Cardiol.* 2015;201:215–219.
- Marko C, Danzinger G, Kaferback M, et al. Safety and efficacy of cardiac rehabilitation for patients with continuous flow left ventricular assist devices. *Eur J Prev Cardiol.* 2015;22(11):1378–1384.
- Piepoli MF, Conraads V, Corra U, et al. Exercise training in heart failure: from theory to practice. A consensus document of the Heart Failure Association and the European Association for Cardiovascular Prevention and Rehabilitation. *Eur J Heart Fail.* 2011;13(4):347–357.
- Piepoli MF, Corra U, Benzer W, et al. Secondary prevention through cardiac rehabilitation: from knowledge to implementation. A position paper from the Cardiac Rehabilitation Section of the European Association of Cardiovascular Prevention and Rehabilitation. *Eur J Cardiovasc Prev Rehabil.* 2010;17(1):1–17.
- Piepoli MF, Guazzi M, Boriani G, et al. Exercise intolerance in chronic heart failure: mechanisms and therapies. Part II. *Eur J Cardiovasc Prev Rehabil.* 2010;17(6):643–648.
- Piepoli MF, Guazzi M, Boriani G, et al. Exercise intolerance in chronic heart failure: mechanisms and therapies. Part I. *Eur J Cardiovasc Prev Rehabil.* 2010;17(6):637–642.
- Hirai DM, Musch TI, Poole DC. Exercise training in chronic heart failure: improving skeletal muscle O<sub>2</sub>

- transport and utilization. *Am J Physiol Heart Circ Physiol*. 2015;309(9):H1419–H1439.
22. George I, Xydas S, Mancini DM, et al. Effect of clenbuterol on cardiac and skeletal muscle function during left ventricular assist device support. *J Heart Lung Transplant*. 2006;25(9):1084–1090.
  23. Feldman CM, Khan SN, Slaughter MS, et al. Improvement in early oxygen uptake kinetics with left ventricular assist device support. *ASAIO J*. 2008;54(4):406–411.
  24. Kerrigan DJ, Williams CT, Ehrman JK, et al. Muscular strength and cardiorespiratory fitness are associated with health status in patients with recently implanted continuous-flow LVADs. *J Cardiopulm Rehabil Prev*. 2013;33(6):396–400.
  25. Dunlay SM, Park SJ, Joyce LD, et al. Frailty and outcomes after implantation of left ventricular assist device as destination therapy. *J Heart Lung Transpl*. 2014;33(4):359–365.
  26. Lietz K, John R, Burke EA, et al. Pretransplant cachexia and morbid obesity are predictors of increased mortality after heart transplantation. *Transplantation*. 2001;72(2):277–283.
  27. Brassard P, Jensen AS, Nordsborg N, et al. Central and peripheral blood flow during exercise with a continuous-flow left ventricular assist device: a pilot study. *Circ Heart Fail*. 2011;4(5):554–560.
  28. Jung MH, Hansen PB, Sander K, et al. Effect of increasing pump speed during exercise on peak oxygen uptake in heart failure patients supported with a continuous-flow left ventricular assist device: a double-blind randomized study. *Eur J Heart Fail*. 2014;16(4):403–408.
  29. American Association of Cardiovascular Pulmonary Rehabilitation. *Guidelines for Cardiac Rehabilitation and Secondary Prevention Programs (with Web Resource)*. Human Kinetics; 2013. <https://us.humankinetics.com/products/guidelines-for-cardiac-rehabilitation-and-secondary-prevention-programs-5th-edition-with-web-resource>
  30. Alsara O, Perez-Terzic C, Squires RW, et al. Is exercise training safe and beneficial in patients receiving left ventricular assist device therapy? *J Cardiopulm Rehabil*. 2014;34(4):233–240.
  31. Scheiderer R, Belden C, Schwab D, Haney C, Paz J. Exercise guidelines for inpatients following ventricular assist device placement: a systematic review of the literature. *Cardiopulm Phys Ther J*. 2013;24(2):35–42.
  32. Alsara O, Reeves RK, Pyfferoen MD, et al. Inpatient rehabilitation outcomes for patients receiving left ventricular assist device. *Am J Phys Med Rehabil*. 2014;93(10):860–868.
  33. Chu SK, McCormick Z, Hwang S, Sliwa JA, Rydberg L. Outcomes of acute inpatient rehabilitation of patients with left ventricular assist devices. *PM R*. 2014;6(11):1008–1012.
  34. Nguyen E, Stein J. Functional outcomes of adults with left ventricular assist devices receiving inpatient rehabilitation. *PM R*. 2013;5(2):99–103.
  35. Yost G, Coyle L, Milkevitch K, Adair R, Tatoes A, Bhat G. Efficacy of inpatient rehabilitation after left ventricular assist device implantation. *PM R*. 2017;9(1):40–45.
  36. Morrone TM, Buck LA, Catanese KA, et al. Early progressive mobilization of patients with left ventricular assist devices is safe and optimizes recovery before heart transplantation. *J Heart Lung Transplant*. 1996;15(4):423–429.
  37. Compostella L, Russo N, Setzu T, Compostella C, Bellotto F. Exercise performance of chronic heart failure patients in the early period of support by an axial-flow left ventricular assist device as destination therapy. *Artific Organs*. 2014;38(5):366–373.
  38. Corra U, Agostoni PG, Anker SD, et al. Role of cardiopulmonary exercise testing in clinical stratification in heart failure. A position paper from the Committee on Exercise Physiology and Training of the Heart Failure Association of the European Society of Cardiology. *Eur J Heart Fail*. 2018;20(1):3–15.
  39. Stratton JR, Levy WC, Cerqueira MD, Schwartz RS, Abrass IB. Cardiovascular responses to exercise: effects of aging and exercise training in healthy men. *Circulation*. 1994;89(4):1648–1655.
  40. McGuire DK, Levine BD, Williamson JW, et al. A 30-year follow-up of the Dallas Bed Rest and Training Study II. Effect of age on cardiovascular adaptation to exercise training. *Circulation*. 2001;104(12):1358–1366.
  41. Beere PA, Russell SD, Morey MC, Kitzman DW, Higginbotham MB. Aerobic exercise training can reverse age-related peripheral circulatory changes in healthy older men. *Circulation*. 1999;100(10):1085–1094.
  42. Seals DR, Hagberg JM, Hurley BF, Ehsani AA, Holloszy JO. Endurance training in older men and women. I. Cardiovascular responses to exercise. *J Appl Physiol Respir Environ Exerc Physiol*. 1984;57(4):1024–1029.
  43. Ogawa T, Spina RJ, Martin WH, 3rd, et al. Effects of aging, sex, and physical training on cardiovascular responses to exercise. *Circulation*. 1992;86(2):494–503.
  44. Ehsani AA, Ogawa T, Miller TR, Spina RJ, Jilka SM. Exercise training improves left ventricular systolic function in older men. *Circulation*. 1991;83(1):96–103.
  45. Kohrt WM, Malley MT, Coggan AR, et al. Effects of gender, age, and fitness level on response of VO<sub>2</sub>max to training in 60–71 yr olds. *J Appl Physiol (1985)*. 1991;71(5):2004–2011.
  46. Levy WC, Cerqueira MD, Abrass IB, Schwartz RS, Stratton JR. Endurance exercise training augments diastolic filling at rest and during exercise in healthy-young and older men. *Circulation*. 1993;88(1):116–126.
  47. Balshaw TG, Massey GJ, Maden-Wilkinson TM, Lanza MB, Folland JP. Neural adaptations after 4 years vs 12 weeks of resistance training vs untrained. *Scand J Med Sci Sports*. 2018.
  48. Balshaw TG, Massey GJ, Maden-Wilkinson TM, et al. Changes in agonist neural drive, hypertrophy and pre-training strength all contribute to the individual strength gains after resistance training. *Eur J Appl Physiol*. 2017;117(4):631–640.
  49. Carter JR, Ray CA. Sympathetic neural adaptations to exercise training in humans. *Auton Neurosci*. 2015;188:36–43.
  50. Mujika I, Padilla S. Detraining: loss of training-induced physiological and performance adaptations. Part II: Long term insufficient training stimulus. *Sports Med*. 2000;30(3):145–154.
  51. Mujika I, Padilla S. Cardiorespiratory and metabolic characteristics of detraining in humans. *Med Sci Sports Exerc*. 2001;33(3):413–421.
  52. Sale DG. Neural adaptation to resistance training. *Med Sci Sports Exerc*. 1988;20(5 Suppl):S135–S145.

53. Saltin B, Henriksson J, Nygaard E, Andersen P, Jansson E. Fiber types and metabolic potentials of skeletal muscles in sedentary man and endurance runners. *Ann N Y Acad Sci.* 1977;301:3–29.
54. Saltin B, Rowell LB. Functional adaptations to physical activity and inactivity. *Fed Proc.* 1980;39(5):1506–1513.
55. Pickering GP, Fellmann N, Morio B, et al. Effects of endurance training on the cardiovascular system and water compartments in elderly subjects. *J Appl Physiol (1985).* 1997;83(4):1300–1306.
56. Moore G, Durstine JL, Painter P, Medicine ACoS. *ACSM's Exercise Management for Persons with Chronic Diseases and Disabilities*, 4th ed. Human Kinetics; 2016. American College of Sports Medicine: 4th Edition ISBN13: 9781450434140.
57. Jaski BE, Branch KR, Adamson R, et al. Exercise hemodynamics during long-term implantation of a left ventricular assist device in patients awaiting heart transplantation. *J Am Coll Cardiol.* 1993;22(6):1574–1580.
58. Branch KR, Dembitsky WP, Peterson KL, et al. Physiology of the native heart and thermocardiostems left-ventricular assist device complex at rest and during exercise: implications for chronic support. *J Heart Lung Transpl.* 1994;13(4):641–651.
59. Simon MA, Kormos RL, Gorcsan J, 3rd, et al. Differential exercise performance on ventricular assist device support. *J Heart Lung Transplant.* 2005;24(10):1506–1512.
60. Vignati C, Apostolo A, Cattadori G, et al. Lvad pump speed increase is associated with increased peak exercise cardiac output and vo(2), postponed anaerobic threshold and improved ventilatory efficiency. *Int J Cardiol.* 2017;230:28–32.
61. Apostolo A, Paolillo S, Contini M, et al. Comprehensive effects of left ventricular assist device speed changes on alveolar gas exchange, sleep ventilatory pattern, and exercise performance. *J Heart Lung Transplant.* 2018;37(11):1361–1371.
62. Van Iterson EH, Olson TP. Therapeutic targets for the multi-system pathophysiology of heart failure: exercise training. *Curr Treat Options Cardiovasc Med.* 2017;19(11):87.
63. Poole DC, Hirai DM, Copp SW, Musch TI. Muscle oxygen transport and utilization in heart failure: implications for exercise (in)tolerance. *Am J Physiol Heart Circ Physiol.* 2012;302(5):H1050–H1063.
64. Kitzman DW, Haykowsky MJ, Tomczak CR. Making the case for skeletal muscle myopathy and its contribution to exercise intolerance in heart failure with preserved ejection fraction. *Circ Heart Fail.* 2017;10:e004281. doi:10.1161/CIRCHEARTFAILURE.117.004281
65. Kitzman DW, Nicklas B, Kraus WE, et al. Skeletal muscle abnormalities and exercise intolerance in older patients with heart failure and preserved ejection fraction. *Am J Physiol Heart Circ Physiol.* 2014;306(9):H1364–H1370.
66. Weiss K, Schär M, Panjath GS, et al. Fatigability, exercise intolerance, and abnormal skeletal muscle energetics in heart failure. *Circ Heart Fail.* 2017;10(7):e004129.
67. Molina AJ, Bharadwaj MS, Van Horn C, et al. Skeletal muscle mitochondrial content, oxidative capacity, and Mfn2 expression are reduced in older patients with heart failure and preserved ejection fraction and are related to exercise intolerance. *JACC: Heart Failure.* 2016;4(8):636–645.
68. Lee JF, Barrett-O'Keefe Z, Nelson AD, et al. Impaired skeletal muscle vasodilation during exercise in heart failure with preserved ejection fraction. *Int J Cardiol.* 2016;211:14–21.
69. Jakovljevic DG, George RS, Donovan G, et al. Comparison of cardiac power output and exercise performance in patients with left ventricular assist devices, explanted (recovered) patients, and those with moderate to severe heart failure. *Am J Cardiol.* 2010;105(12):1780–1785.
70. Benton CR, Sayer G, Nair AP, et al. Left ventricular assist devices improve functional class without normalizing peak oxygen consumption. *ASAIO J.* 2015;61(3):237–243.
71. Olson TP, Joyner MJ, Eisenach JH, Curry TB, Johnson BD. Influence of locomotor muscle afferent inhibition on the ventilatory response to exercise in heart failure. *Exp Physiol.* 2014;99(2):414–426.
72. Olson TP, Joyner MJ, Johnson BD. Influence of locomotor muscle metaboreceptor stimulation on the ventilatory response to exercise in heart failure. *Circ Heart Fail.* 2010;3(2):212–219.
73. Van Iterson EH, Johnson BD, Joyner MJ, Curry TB, Olson TP. Vo2 kinetics associated with moderate-intensity exercise in heart failure: impact of intrathecal fentanyl inhibition of group III/IV locomotor muscle afferents. *Am J Physiol Heart Circ Physiol.* 2017;313(1):H114–H124.
74. Van Iterson EH, Snyder EM, Johnson BD, Olson TP. Influence of the metaboreflex on pulmonary vascular capacitance in heart failure. *Med Sci Sports Exerc.* 2016;48(3):353–362.
75. Van Iterson EH, Snyder EM, Joyner MJ, Johnson BD, Olson TP. Intrathecal fentanyl blockade of afferent neural feedback from skeletal muscle during exercise in heart failure patients: influence on circulatory power and pulmonary vascular capacitance. *Int J Cardiol.* 2015;201:384–393.
76. Van Iterson EH, Smith JR, Olson TP. Exercise on-transition uncoupling of ventilatory, gas exchange and cardiac hemodynamic kinetics accompany pulmonary oxygen stores depletion to impact exercise intolerance in human heart failure. *Acta Physiol (Oxf).* 2018;223(4):e13063.
77. Hakkinen K, Alen M, Kraemer WJ, et al. Neuromuscular adaptations during concurrent strength and endurance training versus strength training. *Eur J Appl Physiol.* 2003;89(1):42–52.
78. Hakkinen K, Alen M, Kallinen M, Newton RU, Kraemer WJ. Neuromuscular adaptation during prolonged strength training, detraining and re-strength-training in middle-aged and elderly people. *Eur J Appl Physiol.* 2000;83(1):51–62.
79. Hakkinen K, Kallinen M, Izquierdo M, et al. Changes in agonist-antagonist EMG, muscle CSA, and force during strength training in middle-aged and older people. *J Appl Physiol (1985).* 1998;84(4):1341–1349.
80. Paolillo S, Veglia F, Salvioni E, et al. Heart failure prognosis over time: how the prognostic role of oxygen consumption and ventilatory efficiency during exercise has changed in the last 20 years. *Eur J Heart Fail.* 2019;0(0).
81. Van Iterson EH, Kim CH, Uithoven K, Olson TP. Obesity and hemoglobin content impact peak oxygen

- uptake in human heart failure. *Eur J Prev Cardiol*. 2018;25(18):1937–1946.
82. Van Iterson EH, Smith JR, Olson TP. Alveolar air and O<sub>2</sub> uptake during exercise in patients with heart failure. *J Card Fail*. 2018;24(10):695–705.
83. Smith JR, Van Iterson EH, Johnson BD, Borlaug BA, Olson TP. Exercise ventilatory inefficiency in heart failure and chronic obstructive pulmonary disease. *Int J Cardiol*. 2018.
84. Van Iterson EH, Johnson BD, Borlaug BA, Olson TP. Physiological dead space and arterial carbon dioxide contributions to exercise ventilatory inefficiency in patients with reduced or preserved ejection fraction heart failure. *Eur J Heart Fail*. 2017;19(12):1675–1685.
85. Van Iterson EH, Olson TP. Use of “ideal” alveolar air equations and corrected end-tidal PCO<sub>2</sub> to estimate arterial PCO<sub>2</sub> and physiological dead space during exercise in patients with heart failure. *Int J Cardiol*. 2018;250(Suppl C):176–182.
86. O'Connor CM, Whellan DJ, Lee KL, et al. Efficacy and safety of exercise training in patients with chronic heart failure HF-ACTION randomized controlled trial. *JAMA*. 2009;301(14):1439–1450.
87. Lee LS, Tsai MC, Oh PI, Brooks D. The effectiveness of progressive aerobic interval training in cardiac rehabilitation. *Med Sci Sports Exerc*. 2018;50(5):881–888.
88. Podsiadlo D, Richardson S. The timed “Up & Go”: a test of basic functional mobility for frail elderly persons. *J Am Geriatr Soc*. 1991;39(2):142–148.
89. Guyatt GH, Sullivan MJ, Thompson PJ, et al. The 6-minute walk: a new measure of exercise capacity in patients with chronic heart failure. *Can Med Assoc J*. 1985;132(8):919–923.
90. Myers AM, Fletcher PC, Myers AH, Sherk W. Discriminative and evaluative properties of the activities-specific balance confidence (ABC) scale. *J Gerontol A Biol Sci Med Sci*. 1998;53(4):M287–M294.
91. Tinetti ME. Performance-oriented assessment of mobility problems in elderly patients. *J Am Geriatr Soc*. 1986;34(2):119–126.
92. Kohli HS, Canada J, Arena R, et al. Exercise blood pressure response during assisted circulatory support: comparison of the total artificial [corrected] heart with a left ventricular assist device during rehabilitation. *J Heart Lung Transplant*. 2011;30(11):1207–1213.
93. Hurvitz EA, Richardson JK, Werner RA, Ruhl AM, Dixon MR. Unipedal stance testing as an indicator of fall risk among older outpatients. *Arch Phys Med Rehabil*. 2000;81(5):587–591.
94. Berg KO, Wood-Dauphinee SL, Williams JL, Maki B. Measuring balance in the elderly: validation of an instrument. *Can J Public Health*. 1992;83(Suppl 2):S7–S11.
95. Dunbar CC, Robertson RJ, Baun R, et al. The validity of regulating exercise intensity by ratings of perceived exertion. *Med Sci Sports Exerc*. 1992;24(1):94–99.
96. Borg GA. Psychophysical bases of perceived exertion. *Med Sci Sports Exerc*. 1982;14(5):377–381.
97. Whaley MH, Brubaker PH, Kaminsky LA, Miller CR. Validity of rating of perceived exertion during graded exercise testing in apparently healthy adults and cardiac patients. *J Cardiopulm Rehabil*. 1997;17(4):261–267.
98. Oka RK, De Marco T, Haskell WL, et al. Impact of a home-based walking and resistance training program on quality of life in patients with heart failure. *Am J Cardiol*. 2000;85(3):365–369.
99. Witte KK, Cleland JG, Clark AL. Chronic heart failure, chronotropic incompetence, and the effects of beta blockade. *Heart*. 2006;92(4):481–486.
100. Colucci WS, Ribeiro JP, Rocco MB, et al. Impaired chronotropic response to exercise in patients with congestive heart failure: role of postsynaptic beta-adrenergic desensitization. *Circulation*. 1989;80(2):314–323.
101. Mezzani A, Corra U, Giordano A, Cafagna M, Adriano EP, Giannuzzi P. Unreliability of the %VO<sub>2</sub> reserve versus %heart rate reserve relationship for aerobic effort relative intensity assessment in chronic heart failure patients on or off beta-blocking therapy. *Eur J Cardiovasc Prev Rehabil*. 2007;14(1):92–98.
102. Mancini DM, Coyle E, Coggan A, et al. Contribution of intrinsic skeletal muscle changes to <sup>31</sup>P NMR skeletal muscle metabolic abnormalities in patients with chronic heart failure. *Circulation*. 1989;80(5):1338–1346.
103. Mancini D, Goldsmith R, Levin H, et al. Comparison of exercise performance in patients with chronic severe heart failure versus left ventricular assist devices. *Circulation*. 1998;98(12):1178–1183.
104. Dang NC, Topkara VK, Kim BT, Lee BJ, Remoli R, Naka Y. Nutritional status in patients on left ventricular assist device support. *J Thorac Cardiovasc Surg*. 2005;130(5):e3–e4.
105. Mancini DM, Eisen H, Kussmaul W, Mull R, Edmunds LH, Jr., Wilson JR. Value of peak exercise oxygen consumption for optimal timing of cardiac transplantation in ambulatory patients with heart failure. *Circulation*. 1991;83(3):778–786.
106. Balady GJ, Arena R, Sietsema K, et al. Clinician’s Guide to cardiopulmonary exercise testing in adults: a scientific statement from the American Heart Association. *Circulation*. 2010;122(2):191–225.
107. Coats AJ, Adamopoulos S, Radaelli A, et al. Controlled trial of physical training in chronic heart failure: exercise performance, hemodynamics, ventilation, and autonomic function. *Circulation*. 1992;85(6):2119–2131.
108. Nahumi N, Morrison KA, Garan AR, Uriel N, Jorde UP. Peak exercise capacity is a poor indicator of functional capacity for patients supported by a continuous-flow left ventricular assist device. *J Heart Lung Transpl*. 2014;33(2):213–215.
109. Jaski BE, Lingle RJ, Kim J, et al. Comparison of functional capacity in patients with end-stage heart failure following implantation of a left ventricular assist device versus heart transplantation: results of the experience with left ventricular assist device with exercise trial. *J Heart Lung Transplant*. 1999;18(11):1031–1040.
110. Hasin T, Topilsky Y, Kremers WK, et al. Usefulness of the six-minute walk test after continuous axial flow left ventricular device implantation to predict survival. *Am J Cardiol*. 2012;110(9):1322–1328.
111. Weber KT, Kinasewitz GT, Janicki JS, Fishman AP. Oxygen utilization and ventilation during exercise in patients with chronic cardiac failure. *Circulation*. 1982;65(6):1213–1223.

# The VAD Coordinator Roles and Responsibilities in Caring for Patients with Ventricular Assist Devices

BRITTANY BUTZLER AND KRISTEN KIEHL

## Introduction

**T**he VAD coordinator is the link between the technical aspects of the ventricular assist device (VAD) and the medical management of the patient and is thus a fundamental part of any mechanical circulatory support (MCS) program. The responsibilities of the VAD coordinator can be many and varied, as well as strictly defined or more open-ended. Coordinators may have specific backgrounds as registered nurses, advanced-practice prescribers, biomedical engineers, or perfusionists, but all are generalists who coordinate a myriad of technical, clinical, and health systems details that make a VAD program possible. Here, we describe both the breadth and depth of this position and detail the many ways in which coordinators contribute to caring for patients with VADs (Table 46.1).

## Primary Roles and Responsibilities of the Coordinator

### Patient Screening and Evaluation

Screening patients for potential VAD implantation is critical in determining candidacy. As such, the coordinator usually evaluates patients for treatment indications and contraindications, such as New York Heart Association class, readmissions for heart failure, reliance on inotropic medications, cardiac function, and exercise capacity.<sup>1</sup>

Once patients have been accepted for advanced therapies, they are evaluated as candidates for VAD placement. Candidacy criteria vary among programs but can greatly affect patient outcomes. As the primary liaison with the

patient, the VAD coordinator is crucial to organizing and completing a thorough multidisciplinary evaluation (Figure 46.1). An evaluation for VAD therapy can include the following:

- Reviewing each device being considered for the patient, informing the patient about the expectations of the evaluation process, probable surgical procedures, and the risk of post-implant complications, including national and center-specific survival benefits<sup>2</sup> and obtaining informed consent.
- Coordinating appointments for financial, dietary, pharmacy, palliative care, social work, and psychological or psychosocial assessments, as well as by heart failure cardiologists and cardiothoracic surgeons.
- Assuring that various laboratory tests and clinical procedures are completed, such as right- or left-heart catheterizations, echocardiographic exams, carotid and lower extremity ultrasound exams, computed-tomography scans, and so on.

After the evaluation is complete, a selection committee determines candidacy, and the implant is scheduled.

### Device Implantation

The implantation process starts with the coordinator participating in or overseeing the assembly of the device according to the manufacturer's guidelines<sup>3-5</sup> and conducting a wet test to ensure proper function before delivering it to the surgical field. The coordinator acts as the clinical representative for the device when a company representative is not in the operating room and so must be thoroughly familiar with the device and implanting procedure.

**Table 46.1 • Resources for Improving or Expanding a VAD Program**

International Society for Heart and Lung Transplantation (ISHLT): <a href="http://www.isHLT.org">www.isHLT.org</a> ; <a href="http://www.jhltonline.org">www.jhltonline.org</a>
International Consortium of Circulatory Assist Clinicians (ICCAC): <a href="http://www.mylvad.com/iccac">www.mylvad.com/iccac</a>
HeartWare (Medtronic): <a href="http://www.heartware.com">www.heartware.com</a>
HeartMate (Abbott): <a href="http://www.heartmate.com">www.heartmate.com</a>
Joint Commission on Accreditation of Healthcare Organizations (JCHO): <a href="https://www.jointcommission.org/certification/ventricular_assist_device.aspx">https://www.jointcommission.org/certification/ventricular_assist_device.aspx</a>
European Society for Artificial Organs (ESAO): <a href="http://www.esao.org">www.esao.org</a>

The coordinator works with the surgeon and anesthesiologist to transition the patient from cardiopulmonary bypass (CPB) to VAD support. When the surgeon has deaired the VAD, the coordinator begins VAD therapy and communicates any setting or waveform abnormalities to the surgeon and anesthesiologist to ensure the seamless discontinuation of CPB.

Once the patient is stabilized, the coordinator accompanies the patient to the ICU and provides the accepting nurse with a thorough report of the implantation procedure and a synopsis of the VAD settings. The coordinator also verifies that all needed VAD equipment is available to the ICU, that the backup equipment is correctly programmed, and that all alarm thresholds and settings are appropriate.

## Postoperative Management

Coordinators may take part in daily rounds of patients with VADs and in interrogating the device. The coordinator facilitates communication about the patient to other members of the team and keeps the attending service apprised of all discharge preparations and the patient's VAD education progress.

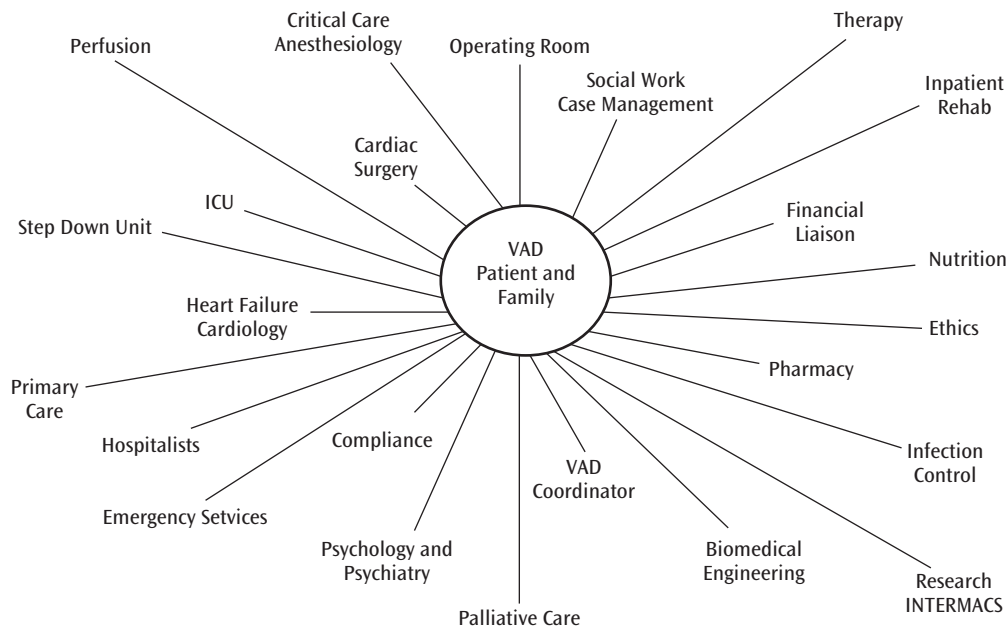
After implantation, the coordinator accompanies patients needing emergent or planned procedures or surgical interventions, such as gastrointestinal endoscopy, right heart catheterization, transesophageal echocardiography, amputations, and craniotomies. The coordinator monitors the VAD so the anesthesia team and proceduralist can focus on the medical management of the sedated patient.

## Patient Education

The cornerstone of the coordinator's tasks is patient education, which includes ensuring that the patient is comfortable managing the VAD at discharge.<sup>6</sup> Patients and family members need to be familiar with topics such as the theory and operation of the VAD, how to manage peripheral equipment, how to respond to emergencies (including how to change to the backup controller and manage power outages), understanding and responding to VAD alarms, anticoagulation issues, managing mean arterial pressure variables, and how to dress the driveline (Figure 46.2).

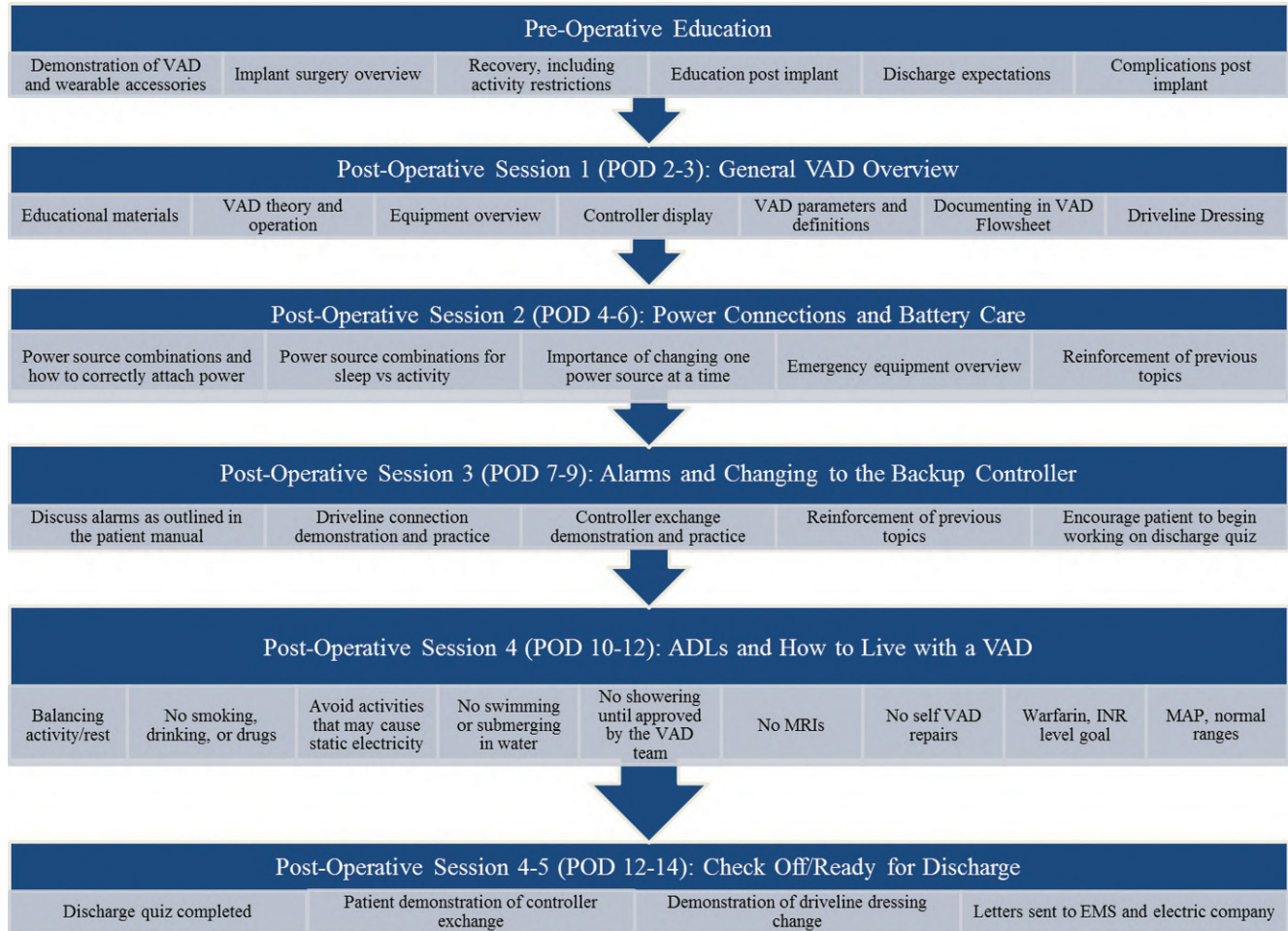
## Outpatient Management

As part of the discharge process and outpatient management, the VAD coordinator may notify the patient's local



**Figure 46.1.** Caring for a patient with a VAD requires a complex, multidisciplinary approach involving many specialists, areas of expertise, and resources.





**Figure 46.2.** An outline of an educational program for patients with VADs before hospital discharge.

emergency medical services about the patient's needs. Community responders should be trained in how to provide safe and effective care to VAD patients in VAD-related medical emergencies. This training may include how to manage a VAD in case of emergencies, including potential ischemic or hemorrhagic stroke; syncopal episodes, related to either volume management or bleeding complications; or any situation that may require acute cardiac life support. The local electric company should also be notified when a VAD recipient has been discharged, in case emergency power outages are prolonged.

Once a patient is discharged into the community, the VAD coordinator is often the most important factor in meeting the long-term goals of therapy. Keeping patients out of the hospital may be just as difficult as managing their transition to home. Depending on each program's post-implantation follow-up guidelines, patients may be seen weekly until they are stable.

The VAD coordinator may be responsible for medication reconciliation to ensure that the patient is medically managed according to therapeutic guidelines. A pharmacist is

sometimes included in these follow-up clinic visits to help the patient understand and manage home medications with techniques ranging from refilling pill boxes to medication reminder applications on a smart phone.

Controlling mean arterial pressure is an essential part of managing patients with VADs to prevent complications, such as hemorrhagic stroke, particularly for centrifugal devices. Afterload reduction is also important in optimizing VAD flow.<sup>7</sup>

The coordinator is often responsible for overseeing typical laboratory tests required at clinic visits, such as a comprehensive metabolic panel to monitor end-organ function and electrolytes, a complete blood count, and lactate dehydrogenase (LDH)/haptoglobin concentrations to detect hemolysis. Markers for hemolysis can include a sudden rise in LDH, a decrease in haptoglobin from the patient's baseline, and a plasma free hemoglobin concentration greater than 40 mg/dL. In axial flow devices, shear stress from propeller blades on red blood cells may cause higher baseline LDH concentrations and undetectable haptoglobin concentrations.<sup>8,9</sup> Anticoagulation may also be managed

by the VAD coordinator alone or with the pharmacy in an anticoagulation clinic.<sup>10</sup> Typically, patients receive both Coumadin and aspirin to meet specific INR (international normalized ratio) goals that are often device-specific.

At each follow-up clinic visit, the coordinator may also help interrogate the VAD to monitor its function and to interview patients, who are typically asked to document VAD performance at home. Speed, flow, power, pulsatility index, and waveform analysis are compared to prior interrogations to determine the functional integrity of the VAD. Technical problems should always be assessed to determine their effects on the patient's condition. If further analysis is warranted, log files or waveforms may be sent to device-specific clinical representatives for technical interrogation.

At each clinic visit, the coordinator may examine the driveline for signs of infection, as well as teach patients how and when to change sterile driveline dressings. These tasks can be program-specific; for example, policies regarding showering may depend on exit site healing, which may affect driveline site integrity.

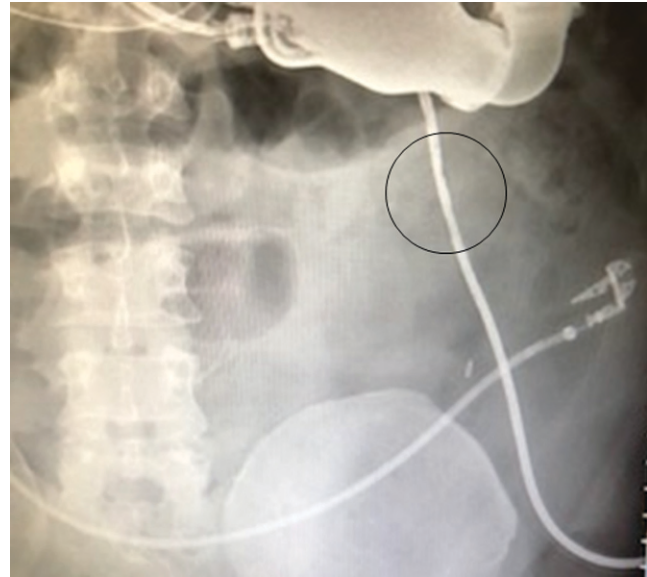
Throughout each phase of the clinic visit, patients need to be educated on a range of topics, including a review of equipment function and maintenance, general guidelines for managing heart failure, and lifestyle modifications. Annual or semiannual competencies may need to be tested with a written exam or hands-on practice. Another important follow-up requirement is an annual equipment safety check.

The VAD coordinator may be responsible for ensuring that patients have round-the-clock coverage for all VAD-related issues. For example, the coordinator may be on call to cover an emergent VAD interrogation or equipment repair or exchange in the event of malfunction or unusual alarms. At times, the coordinator must help first responders triage non-responsive patients by phone. The coordinator may also assist with the arrival of the patient at the emergency department and to coordinate hospital admission.<sup>11,12</sup>

A critical skill for the coordinator is knowing how to troubleshoot VADs, often in emergencies where the patient's health is at stake (Figure 46.3).<sup>13–18</sup> Deviations in performance from baseline can help diagnose a potential or underlying adverse event. Familiarity with VAD performance differentials is useful for diagnosing sudden changes in patient status, especially in outpatients, where clinical data are not available or are limited (Table 46.2).

### Discontinuing Device Support

Life for patients after VAD explantation can extend from transplant to recovery to comfort measures at the end of life. The VAD coordinator may be expected to attend the transplant or explant operation, at which VAD support will be discontinued. The coordinator may also be responsible



**Figure 46.3.** A patient managed with a Heartmate II VAD. The circle marks an internal driveline fracture that led to a driveline fault alarm from a suspected short to shield.

for withdrawing VAD support at the end of life, once comfort measures or hospice care has begun.

### Other Roles and Responsibilities

In addition to the primary responsibilities described in the preceding, coordinators often have other unique responsibilities or responsibilities that complement those of others in the hospital.

The coordinator may order and manage equipment, including dispensing, tracking, and maintaining the inventory for the MCS program and for ensuring correct charging and coding of VAD equipment in compliance with hospital policy. It may be up to the coordinator to visually inspect equipment for defects or abnormalities before use and to document the serial numbers of equipment associated with each patient, to be used in the event of a recall or malfunction and for research studies.

The coordinator may also be responsible for alerting the manufacturer of defective equipment and determining whether the equipment is covered under warranty or if the patient must be charged. In the event of a manufacturer recall, the VAD coordinator will identify the patients affected and inform patients if their equipment is included in the recall. The coordinator may then manage any needed equipment exchange and provide any new education needed by the patient or caregiver. Equipment that needs to be returned to the vendor is often collected by the VAD coordinator.

Finally, the coordinator may be responsible for deciding who is trained to work directly with VADs and who needs to be aware of the function, strengths, and weaknesses of

**Table 46.2 • Clinical Implications of Changes in VAD Performance Characteristics That May Be Useful When Troubleshooting**

Characteristic	Increase or Decrease	Possible Causes	Potential Interventions
Flow, L/min	↑	Hypervolemia, increased activity, vasodilation, thrombus, aortic insufficiency, among other possible causes	Diuresis, right-heart catheterization, imaging studies, and inotrope or pressor support
	↓	Hypovolemia-bleeding, cardiac tamponade, hypertension, right-heart failure, cardiac arrhythmia, among other possible causes	Volume resuscitation, imaging studies, right-heart catheterization, afterload reduction, anti-arrhythmic therapy
Power, Watts	↑	Thrombus	Imaging studies, anti-thrombotics, VAD exchange, transplantation
	↓	Occlusion	Imaging studies, outflow graft angioplasty, volume resuscitation, surgical intervention

VADs. Completing a preceptorship before taking care of a patient with a VAD independently may be required. Topics can include:

- The history, theory, and operation of the VAD
- Peripheral equipment management, such as battery exchange and how to change to the backup controller in an emergency
- Post-implant management, including MAP control, anticoagulation, possible adverse events, and care of a driveline exit site
- Advanced cardiac life support and other emergency procedures.

These topics should be reviewed annually.

Other responsibilities may include organizing and maintaining compliance with regulatory bodies, such as the Joint Commission or DNV GL, the INTERMACS registry, research, and performance improvement or quality assurance project planning.

## Conclusion

Regardless of their educational background, VAD coordinators are clinicians and educators who support patients on MCS and their families, as well as clinical and technical staff. The success of VAD therapy depends heavily on the communication between the patient and the coordinator. Providing continuing education and the ability to troubleshoot VADs are the foundation for the position of VAD coordinator—a position that is variable, challenging, all encompassing, and rewarding.

## REFERENCES

1. Feldman D, Pamboukian SV, Teuteberg JJ, et al. The 2013 International Society for Heart and Lung Transplantation guidelines for mechanical circulatory support: executive summary. *J Heart Lung Transplant.* 2013;32(2):157–187.
2. Kirklin JK, Pagani FD, Kormos RL, et al. Eighth annual INTERMACS report: special focus on framing the impact of adverse events. *J Heart Lung Transplant.* 2017;36(10):1080–1086.
3. *HeartWare Ventricular Assist System Instructions for Use.* Available online: [https://www.heartware.com/sites/default/files/uploads/docs/ifu00375\\_rev06\\_hvad\\_ifu\\_en-electronic.pdf](https://www.heartware.com/sites/default/files/uploads/docs/ifu00375_rev06_hvad_ifu_en-electronic.pdf). Accessed August 29, 2018.
4. *HeartMate II LVAS Operating Manual.* Available online: [http://www.thoratec.com/\\_assets/download-tracker/103884F-HMII-LVS-Operating-Manual.pdf](http://www.thoratec.com/_assets/download-tracker/103884F-HMII-LVS-Operating-Manual.pdf). Accessed August 29, 2018.
5. *HeartMate 3 Instructions for Use.* Available online: [http://www.thoratec.com/\\_assets/download-tracker/HM3/10002832/10002832.F\\_HMIII.BSI.IFU.FinalPDF.2018.0306.pdf](http://www.thoratec.com/_assets/download-tracker/HM3/10002832/10002832.F_HMIII.BSI.IFU.FinalPDF.2018.0306.pdf). Accessed August 29, 2018.
6. Widmar SB, Dietrich MS, Minnick, AF. How self-care education in ventricular assist device programs is organized and provided: a national study. *Heart Lung.* 2014;43(1):25–31.
7. Milano CA, Rogers JG, Tatooles AJ, et al. HVAD: The ENDURANCE Supplemental Trial. *JACC Heart Fail.* 2018;6(9):792–802.
8. Birschmann I, Dittrich M, Eller T, et al. Ambient hemolysis and activation of coagulation is different between HeartMate II and HeartWare left ventricular assist devices. *J Heart Lung Transplant.* 2014;33(1):80–87.
9. Katz JN, Jensen BC, Chang PP, Myers SL, Pagani FD, Kirklin JK. A multicenter analysis of clinical hemolysis in patients supported with durable, long-term left ventricular assist device therapy. *J Heart Lung Transplant.* 2015;34(5):701–709.
10. Bishop MA, Streiff MB, Ensor CR, Tedford RJ, Russell SD, Ross PA. Pharmacist-managed international normalized ratio patient self-testing is associated with increased time in therapeutic range in patients with left ventricular assist devices at an academic medical center. *ASAIO J.* 2014;60(2):193–198.
11. Schweiger M, Vierecke J, Stiegler P, Prenner G, Tscheliessnigg KH, Wasler A. Prehospital care of left ventricular assist device patients by emergency medical services. *Prehosp Emerg Care.* 2012;16(4):560–563.
12. Vierecke J, Schweiger M, Feldman D, et al. Emergency procedures for patients with a continuous flow left ventricular assist device *Emerg Med J.* 2017;34:831–841.

13. Rich JD, Burkhoff D. HVAD flow waveform morphologies: theoretical foundation and implications for clinical practice. *ASAIO J.* 2017;63(5):526–535.
14. Grinstein J, Rodgers D, Kalantari S, et al. HVAD waveform analysis as a noninvasive marker of pulmonary capillary wedge pressure: a first step toward the development of a smart left ventricular assist device. *ASAIO J.* 2017;64(1):10–15.
15. Slaughter MS, Pagani FD, Rogers JG, et al. Clinical management of continuous-flow left ventricular assist devices in advanced heart failure. *J Heart Lung Transplant.* 2010;29(4 Suppl.): S1–S39.
16. Chorpenning K, Brown MC, Voskoboinikov N, Reyes C, Dierlam AE, Tamez D. HeartWare controller logs a diagnostic tool and clinical management aid for the HVAD device. *ASAIO J.* 2014;60(1):115–118.
17. Scandroglio AM, Kaufmann F, Pieri M, et al. Diagnosis and treatment algorithm for blood flow obstructions in patients with left ventricular assist device. *J Am Coll Cardiol.* 2016;67(23):2758–2768.
18. Kalavrouziotis D, Tong MZ, Starling RC, et al. Percutaneous lead dysfunction in the HeartMate II left ventricular assist device. *Ann Thorac Surg.* 2014;97(4):1373–1378.



# Index

Note: Tables, figures and boxes are indicated by *t*, *f* and *b* following the page number

For the benefit of digital users, indexed terms that span two pages (e.g., 52–53) may, on occasion, appear on only one of those pages.

## A

- Abbott CentriMag Acute Circulatory Support System
    - clinical applications, 146–48
    - overview of, 145–46
      - CentriMag and PediMag blood pumps, 146*f*
      - CentriMag console, 147*f*
      - CentriMag pump with motor, 146*f*
      - CentriMag system cart with a Mag Monito, 147*f*
      - CentriMag system transporter, 148*f*
      - design of CentriMag pump, 147*f*
      - pressure-flow curves, 147*f*
  - Abbott HeartMate Percutaneous Heart Pump (PHP) System
    - clinical applications, 149–50
    - overview of, 145, 148–49
      - collapsible elastomeric impeller and cannula mechanism, 149*f*
      - diagram of system, 148*f*
      - insertion of, 149*f*
      - pressure-flow curves, 150*f*
      - sheathed and unsheathed, 150*f*
  - Abiomed Impella platform
    - biventricular support, 132*f*, 132–33
    - contraindications and complications, 133*f*, 133–34, 134*f*
    - flow mechanics for, 128, 129*f*
    - left ventricular support
      - cardiogenic shock, 128–30, 131*f*
      - protected PCI, 130, 131*f*
    - overview of, 127, 128*f*, 129*f*
    - right ventricular support, 130–32, 131*f*
    - studies for myocardial recovery after AMI, 134–35, 135*f*
  - acquired von Willebrand Syndrome
    - association of with bleeding, 274, 277–78
    - device differences in, 272*f*, 272, 273*t*, 273*f*
    - durable left ventricular assist devices
      - axial and centrifugal LVADs, 273
      - total artificial hearts (TAHs), 273–74
    - gel electrophoresis of von Willebrand factor, 278*f*
    - overview of, 269
    - pathophysiology of, 269–70, 271*f*
    - pharmacologic treatment options
      - desmopressin acetate, 275
      - doxycycline, 274
      - Humate-P, 274
      - octreotide therapy, 274
    - overview of, 274*t*
    - tranexamic acid, 275
    - physiology of von Willebrand factor, 269, 270*f*
    - temporary MCS devices
      - Impella Heart Pump, 272
      - temporary extracorporeal centrifugal pumps, 272–73
  - acute MCS
    - contraindications, 13–14
    - indications for, 13*t*, 13
  - acute RV dysfunction, postoperative instability, echocardiography, 205
  - advance directives, 23–25, 25*f*, 26*t*
  - anesthesia
    - intraoperative management, 178–83
      - pre-implantation TEE checklist, 179*t*, 179
    - in non-cardiac surgery, 183–85
    - postoperative considerations, 183
    - ICU handoff checklist, 183, 184*t*
    - preoperative considerations, 175–78
      - ASA physical status classes, 175, 176*t*
    - echocardiograph with RV dysfunction, 175–76, 177*t*
    - pre-LVAD checklist, 175, 177*t*
  - anticoagulation strategies
    - Berlin Heart EXCOR, 163–64
    - therapy target comparison, 164*t*
    - challenging situations
      - chromogenic Factor X or chromogenic Factor II, 264–65
      - direct thrombin inhibitors and ECMO, 265
      - gastrointestinal bleeding, 264
      - warfarin time-in-therapeutic range, 264
  - current guidelines
    - extracorporeal membrane oxygenation, 262*t*, 262–63
    - TEG monitoring for heparin, 263*f*
    - total artificial hearts, 263, 264*t*
    - ventricular assist devices, 261–62, 262*t*
  - future directions
    - direct oral anticoagulant use, 265–66
    - direct thrombin inhibitor drug-level monitoring, 266
    - lower anticoagulation intensity, 266
  - overview of, 261
- aortic insufficiency (AI)
  - clinical impact of AI after device removal, 339–40
  - managing late-onset AI, 239–40
  - managing postoperative de novo AI, 341–42
  - mechanisms of AI after device placement, 338–39, 339*f*
  - predicting AI after device implantation, 236–38
  - sternotomy implantation technique, 223
- aortic regurgitation
  - clinical impact of aortic insufficiency after device removal, 339–40
  - future perspectives, 342–43

- aortic regurgitation (*cont.*)
- indications and surgical techniques for
    - aortic valve procedures at time of device implantation, 340–41
    - central aortic valve closure (Park's stitch), 341*f*
    - treatment algorithm for AI, 342*f*
  - managing postoperative de novo aortic insufficiency, 341–42
  - mechanisms of aortic insufficiency after device placement, 338–39, 339*f*
  - overview of, 340
  - preoperative assessment, 202*f*
- arrhythmia
- hemodynamic support during catheter ablation
    - approaches to circulatory support, 334*t*
    - clinical studies on utility of, 336*t*
    - current data on, 333–35
    - flow diagram for management, 333*f*
    - method selection, 332–33
    - overview of, 331
    - PAINESD risk score, 332*f*
    - specific clinical situations, 331–32
    - VT ablation on percutaneous ECMO, 335*f*
  - hemodynamic support during surgical ventricular tachycardia ablation
    - overview of, 335
    - rationale for choice of specific support, 335
  - overview of, 330
    - commonly used short-term MCS options, 331*f*
    - pre- and post-therapeutic hemodynamic support, 330–31
- axial and centrifugal LVADs, acquired von Willebrand Syndrome with, 273
- B**
- Berlin Heart EXCOR
- anticoagulation strategies, 163–64
    - therapy target comparison, 164*t*
  - bleeding and cerebrovascular events, 164–65
  - clinical studies and post-market analysis, 162
    - criteria for EXCOR IDE study, 163*t*
  - device description, 159–61
    - cannula options available, 161*f*
    - IKUS Drive Unit, 161*f*
    - size ranges for pediatric population, 160*f*
    - weight-based pump selection, 160*f*
  - infection, 165
  - overview of, 159
  - pediatric patient device selection, 58*f*, 58–59
  - post-approval clinical
    - experience, 165–66
  - pump configuration strategy, 162
  - pump exchange, 162
- biventricular assist devices (BiVADs)
- Berlin Heart EXCOR
- anticoagulation strategies, 163–64, 164*t*
  - bleeding and cerebrovascular events, 164–65
  - clinical studies and post-market analysis, 162, 163*t*
  - device description, 159–61, 160*f*, 161*f*
  - infection, 165
  - overview of, 159
  - post-approval clinical
    - experience, 165–66
  - pump configuration strategy, 162
  - pump exchange, 162
- bleeding
- anticoagulation strategies and, 264
  - Berlin Heart EXCOR, 164–65
  - due to acquired von Willebrand Syndrome, 274, 277–78
  - gastrointestinal bleeding
    - incidence of, 277
    - overview of, 277
    - pathophysiology of, 277–78, 278*f*
    - treatment for, 278–79, 279*f*
  - postoperative management of, 256–57
- blood clots
- pulmonary hypertension due to, 49 (*see also* pump thrombosis)
- bridge-to-candidacy (BTC)
- definition of, 9
  - device selection, 66
  - ECMO patient selection, 153*f*
  - MCS used for, 55
  - in pediatric patients, 246–47
- bridge-to-decision (BTD)
- acute MCS, 13
  - Impella platform, 131*f*
  - ionotropic support, 41
  - in pediatric patients, 55, 56, 246–47, 248*f*
- bridge-to-recovery (BTR)
- biologic basis for reverse remodeling over recovery, 363–65
    - LV remodeling with mechanical unloading, 366*f*
    - regression of fibrosis, 364*f*
    - reversal of myocyte hypertrophy, 365*f*
  - case examples, 37
  - device selection, 65*t*, 66
  - explanation, 365–67
  - future directions, 367
  - historical perspective, 4–5
  - long-term MCS, 68
  - LVAD backup for conventional surgery, 39–40, 40*f*
- overview of, 360–61
- patient selection for, 361–62
- time course of EDD, ESD, FS, and EF, 363*f*
- in pediatric patients, 54, 58, 246–47
- ReSTAGE-HF outcomes, 362–63
- exercise training components and recommendations, 360–61
  - key outpatient studies, 374*t*
- ReSTAGE-HF protocol, 361, 362*t*
- Harefield Protocol, 361*t*
- VA-ECMO, 63
- bridge-to-transplantation (BTT)
- anesthesia considerations, 179
  - aortic regurgitation, 339–40
  - Berlin Heart EXCOR, 163–64, 165
  - cardiac and physical rehabilitation and, 369
  - definition of, 9
  - device optimization, 345
  - device selection, 66, 68*t*
  - ECMO patient selection, 153*f*
  - frailty assessment tools, 17, 18*t*, 20
  - HeartMate 3, 81, 226
  - HeartMate II, 70, 76*f*
  - HeartWare HVAD, 89, 90*f*, 91*t*, 225, 282
  - historical perspective, 2–4, 6–7
  - intra-aortic balloon pumps, 120*f*, 121
  - less invasive (lateral) approach, 228
  - optimization strategies, 42–43
  - palliative care and, 23
  - in pediatric patients, 55, 59, 246, 248–49
  - psychological assessment, 29–30
  - pulmonary hypertension and, 51
  - pump thrombosis, 281–82
  - ReliantHeart aVAD, 103
  - ReSTAGE-HF protocol, 361
  - right heart dysfunction, 313, 318
  - sternotomy implantation technique, 222
  - SynCardia TAH, 110
  - VA-ECMO, 154
- C**
- cannula kinking or obstruction, 205, 206*f*
- cardiac and physical rehabilitation
- assessing response to, 377–78
  - exercise physiology
    - impact of MCS on, 371–73, 372*f*
    - overview of, 371
  - exercise training programming
    - aerobic exercise training, 373–76
    - key components and recommendations, 375*t*
    - key outpatient studies, 374*t*
    - overview of, 373
    - strength training, 376–77
    - tools to evaluate readiness, 376*b*

- future perspectives, 377
  - introduction to, 369
  - overview
    - contraindications, 371*b*
    - goal of rehabilitation, 369
    - main phases of, 370*b*
    - safety and efficacy, 370–71
    - structure, 369–70
  - pre-habilitation, 377
  - cardiogenic shock (CS)
    - Abiomed Impella platform, left ventricular support, 128–30, 131*f*
    - acute kidney injury in, 323
    - acute MCS as treatment for, 13
    - Berlin Heart EXCOR IDE study, 163*t*
    - biventricular failure in, 132–33
    - case examples, 35–37
    - CentriMag ACS System, 145–48, 149–50
    - counterpulsation circulatory assist devices, 119–24, 120–24*f*, 121*t*
    - device selection in, 5, 61–66
    - ECMO patient selection, 153*f*
    - flow mechanic for Impella platform, 128
    - Impella platform, complications, 133–34, 134*f*
    - INTERMACS profiles, 355*f*, 356–57
    - INTERMACS study results, 12–13
    - intraoperative management, 178
    - long-term MCS in children, 249
    - patient selection, 246–47
    - preoperative strategies for MCS in, 42–43
    - pump thrombosis, 283
    - TandemLife System, clinical results, 141, 143
    - total artificial heart candidates, 117
  - CardioMEMS HF system
    - limitations of traditional heart failure monitoring, 353–54
    - mechanical circulatory support, 356–57
      - INTERMACS profiles, 356*t*
      - reading in arrhythmia, 358*f*
    - monitoring pulmonary artery pressure with, 354–56
      - major components of CardioMEMS HF system, 355*f*
    - overview of, 353
    - remote hemodynamic monitoring, 354
  - cardiorenal syndrome, preoperative management, 43*t*, 43–44
  - case examples
    - off-pump high-risk CABG, 35–37
    - VAD as bridge-to-recovery post-CABG, 37
  - CentriMag Acute Circulatory Support System
    - clinical applications, 146–48
    - overview of, 145–46, 146*f*
    - CentriMag console, 147*f*
    - CentriMag pump with motor, 146*f*
    - CentriMag system cart with a Mag Monito, 147*f*
    - CentriMag system transporter, 148*f*
    - design of CentriMag pump, 147*f*
    - pressure-flow curves, 147*f*
  - cerebral blood flow and stroke
    - causes of device-related hemorrhagic stroke, 300
      - CT and angiography images, 301*f*
    - causes of device-related ischemic stroke
      - hypercoagulable state, 300
      - large-artery atherosclerosis and surgical factors, 300
      - pump thrombosis, 299–300
    - diagnosis, treatment, and secondary prevention of stroke, 302–4
    - secondary prevention and follow-up algorithm, 304*f*
    - treatment algorithm, 303*f*
  - incidence of device-related ischemic and hemorrhagic stroke, 299
  - low pulsatility blood flow as a cause of stroke, 300–2
    - carotid artery duplex study, 302*f*
    - needed research on reducing stroke, 304
    - primary prevention of stroke
      - managing hypertension, 302
      - preventing pump thrombosis, 302
  - chronic hypoxia, pulmonary hypertension due to, 49
  - chronic thromboembolic pulmonary hypertension (CTEPH), 49
  - concomitant cardiac valve procedures
    - existing aortic valve prostheses, 238
    - long-term outcomes with aortic valve closure, 238–39, 240*f*, 241*f*
    - managing late-onset aortic insufficiency, 239–40
  - mitral valve repair
    - aortic and mitral valve regurgitation, 233–34, 236*f*
    - aortic valve problems related to device implantation, 235–36, 239*t*
    - immediate postoperative right ventricular failure, 233*f*, 233, 234*f*
    - impact of mitral valve procedure on 6-minute walk, 238*t*
    - LV-LVAD complex, 234*f*, 235*f*
    - occluded aortic valve and mitral regurgitation, 234–35, 237*f*, 238*f*
    - overview of, 232–33, 243*f*, 244*f*
    - predicting aortic insufficiency after device implantation, 236–38
  - overview of, 232
  - tricuspid valve procedures
    - guidelines for, 242*t*
    - overview of, 240–43, 243*f*
    - surgical correction of tricuspid regurgitation, 243
  - continuous-flow devices, pediatric patient device selection, 59
  - conventional surgery
    - assessing viability, 38–39
    - case examples, 35–37
    - classifying patients with ischemic cardiomyopathy, 37–38, 38*f*, 38*t*
    - overview of, 35
    - surgical strategies and myocardial injury, 39*f*, 39–40, 40*f*
  - coronary artery bypass graft surgery (CABG)
    - off-pump high-risk CABG, 35–37
    - VAD as bridge-to-recovery post-CABG, 37
  - counterpulsation circulatory assist devices
    - extracorporeal devices, 121
    - implantable devices
      - Kantrowitz CardioVAD LVAD, 121–22, 122*f*, 123*f*
      - NuPulseCV iVAS, 123–24, 124*f*
      - Sunshine Heart C-Pulse device system, 122–23
      - Symphony Device System, 122
    - intra-aortic balloon pump (IABP) insertion through subclavian artery, 120–21
    - overview of, 119–20, 120*f*, 121*t*
    - percutaneous insertion through subclavian or axillary arteries, 121
    - overview of, 119
    - principle of, 119
- ## D
- DeBakey VAD, 103, 105, 106
  - depression, 29–30
  - desmopressin acetate, 275
  - destination therapy (DT)
    - anesthesia considerations, 179
    - aortic regurgitation and, 340
    - cardiac and physical rehabilitation and, 369
    - definition of, 9
    - device optimization, 345–46
    - device selection, 66, 67–68, 68*t*
    - frailty assessment tools, 17, 19*f*, 19, 20*f*
    - HeartMate 3, 78, 81
    - HeartMate II, 70, 281–82
    - HeartWare HVAD, 84, 89, 92–93, 94*t*, 225, 226, 282
    - historical perspective, 6–7
    - increasing use of, 291
    - indications for MCCS, 248*f*
    - needed research on reducing stroke in, 304
    - palliative care and, 23



- destination therapy (DT) (*cont.*)  
 patient selection, 12*f*  
 pediatric case example, 234, 237*f*  
 in pediatric patients, 55, 56  
 psychological assessment, 29–30, 32  
 ReSTAGE-HF study, 361  
 risk score, 11*t*  
 RVF and, 313–14  
 SynCardia TAH, 117
- device optimization  
 hemodynamics of LVADS, 345–46  
 flow (Q) compared to pressure differentials, 346*f*  
 flow-dependent changes of the pressure volume loop, 346*f*
- intracardiac pacing and LVADs, 350–51
- invasive hemodynamic  
 optimization, 348–50  
 Kaplan- Meier survival analysis, 351*f*  
 plot of CVP versus PCWP, 349*f*  
 readmission-free survival rates, 350*f*
- LVAD speed optimization, 346
- optimization of initial LVAD settings, 222
- overview of, 345
- two- and three- dimensional  
 echocardiographic optimization, 347  
 three-dimensional (3D) endocardial surfaces, 348*f*
- device selection  
 long-term MCS  
 bridge-to-recovery (BTR), 68  
 bridge-to-transplantation (BTT), 66  
 destination therapy (DT), 67–68  
 devices available, 68*t*  
 overview of, 65–66  
 UNOS allocation system for heart transplant, 67*t*
- pediatric patients  
 Berlin Heart EXCOR, 58*f*, 58–59  
 bridging to transplant, 58*f*, 58  
 continuous-flow devices, 59  
 devices designed for adults, 59  
 devices suitable for children, 56*t*, 56  
 EMOC in congenital heart disease, 57*f*, 57–58  
 extracorporeal membrane oxygenation, 56*f*, 56–57
- short-term MCS  
 Impella devices, 63  
 intra-aortic balloon pump (IABP), 62–63  
 investigational devices, 64  
 overview of, 61–62  
 recommendations for, 64–65, 65*t*  
 right ventricular MCS, 64  
 surgically implanted, 64  
 TandemHeart, 63
- veno-arterial extracorporeal membrane oxygenation (VA-ECMO), 63–64
- doxycycline, 274
- durable left ventricular assist devices  
 acquired von Willebrand Syndrome with axial and centrifugal LVADs, 273  
 total artificial hearts (TAHs), 273–74
- ## E
- echocardiography  
 continuous LVAD hemodynamics  
 example of, 196*f*  
 hemodynamic impact of LVAD on right-sided chambers, 199*f*, 203*f*  
 LV and LA unloading, 198*f*, 199*f*, 201*f*, 202*f*  
 pump output and flow pulsatility tradeoff, 197*f*, 198*f*
- operative assessment  
 assessment of aortic and mitral regurgitation, 202  
 inflow cannula evaluation, 202–3, 203*f*  
 outflow cannula, 203–4, 204*f*  
 overview of, 201–2  
 postoperative evaluation of left heart chambers, 202  
 pump flow and total cardiac output, 204  
 right ventricular function and TR, 202  
 RV dysfunction after LAVD (suction cascade), 199*f*, 203*f*, 205  
 overview of, 196*f*, 197*f*  
 postoperative instability  
 acute RV dysfunction, 205  
 cannula kinking or obstruction, 205, 206*f*  
 hypovolemia, 204–5  
 impeller thrombosis, 205*f*, 205  
 overview of, 204  
 postoperative tamponade, 205
- preoperative assessment  
 aortic regurgitation, 202*f*  
 patent foramen ovale (PFO), 200  
 right ventricular function and TR, 201*f*, 205*f*, 206*f*
- end-of-life care, 27
- EVAHEART 2 LVAD system  
 background of, 168  
 centrifugal pump with hydrodynamic impeller suspension, 168  
 current development of, 172  
 Double Cuff Tip-Less (DCT) inflow cannula, 172*f*  
 HQ curve comparison, 171*f*  
 description of system, 169*f*
- hemocompatibility, 170–72  
 implantation technique, 173  
 Double Cuff Tip-Less (DCT) inflow cannula, 172*f*  
 normal and hypertrophic myocardium, 173*f*  
 open-vane impeller design, 168  
 196*f*, 170*f*  
 HQ curve comparison, 171*f*  
 secure power management and emergency controller, 168–70
- extracorporeal devices, 121
- extracorporeal membrane oxygenation (ECMO)  
 cannulation strategies  
 complications, 155–56  
 interventions for preventing limb ischemia, 155*t*  
 veno-arterial cannulation, 154*f*, 154–55  
 veno-venous cannulation, 152–54
- in congenital heart failure, 57*f*, 57–58
- indications and contraindications, 152
- outcomes, 156  
 patient selection guidelines for adults, 153*f*  
 survival to discharge in adults, 156*t*
- overview of, 152  
 increase in use of ECMO in U.S., 153*f*  
 pediatric patient device selection, 56*f*, 56–57  
 referral networks, 156
- ## F
- flow pulsatility  
 low pulsatility blood flow as cause of stroke, 300–2, 302*f*  
 pump output and flow pulsatility tradeoff, 197*f*, 198*f*
- frailty  
 assessment, 16–19  
 Frailty Deficit Index, 17  
 other tools, 17–19, 18*t*, 19*f*  
 Physical Frailty Phenotype, 16–17, 17*t*  
 value of, 20–21  
 associations with outcomes, 19–21  
 definition and importance of, 16  
 improving, 21  
 patient survival and, 11–12, 12*f*  
 preoperative management, 44  
 reversibility of, 20*f*, 20
- ## G
- gastrointestinal bleeding  
 anticoagulation strategies and, 264  
 incidence of, 277  
 overview of, 277

- pathophysiology of, 277–78  
 gel electrophoresis of von Willebrand factor, 278f  
 treatment for, 278–79  
 algorithm, 279f
- ## H
- heart failure  
 CardioMEMS HF monitoring system  
 limitations of traditional heart failure monitoring, 353–54  
 mechanical circulatory support, 356t, 356–57, 358f  
 monitoring pulmonary artery pressure with, 354–56, 355f  
 overview of, 353  
 remote hemodynamic monitoring, 354  
 clinical risk predictors, 11t  
 congenital heart failure, extracorporeal membrane oxygenation (ECMO) in, 57f, 57–58  
 indicators of advanced, 10t  
 limitations of traditional monitoring for, 353–54  
 pulmonary hypertension due to, 49, 50f  
 renal dysfunction due to right heart failure after LVAD placement, 325  
 preoperative predictors of RV support, 325t  
 renal dysfunction in heart failure, 323  
 mechanisms of, 324f
- HeartMate 3 (HM3)  
 clinical outcomes of, 80–82, 81f  
 design of, 78–80f, 78–80  
 future technologic enhancements, 82  
 overview of, 78
- HeartMate II (HMII)  
 complications  
 immediate postoperative right ventricular failure, 233f, 233, 234f  
 LV-LVAD complex, 234f, 235f  
 description of pump, 72–73, 73f  
 description of system, 70–72f, 70–72  
 intended use, 70  
 overview of, 70  
 PREVENT surgical  
 recommendations, 74t  
 system controller and monitor  
 post-implantation, 73  
 system controller user interface, 73–75, 74f  
 advisory alarms, 75t  
 average flow estimate, 76f  
 hazard alarms, 75t
- HeartMate Percutaneous Heart Pump (PHP) System  
 clinical applications, 149–50  
 overview of, 145, 148–49  
 collapsible elastomeric impeller and cannula mechanism, 149f  
 diagram of system, 148f  
 insertion of, 149f  
 pressure-flow curves, 150f  
 sheathed and unsheathed, 150f
- heart transplantation  
 pulmonary hypertension and, 51  
 UNOS allocation system for heart transplant, 67t
- HeartWare HVAD  
 clinical trials, 89–93, 90–93f, 91–94t  
 description of system, 84–85f, 84–85, 85t  
 external components, 87–89, 88–90f, 89t  
 overview of, 84  
 surgical implantation, 86–87, 87–88f  
 theory of operation, 85–86, 86–87f
- hematology, preoperative management, 43  
 hemodynamic congestion, treating, 44  
 hemodynamic monitoring, methods, 41
- heparin. *See* anticoagulation strategies
- H-Q curve  
 Abiomed Impella platform, 128, 129f  
 HeartMate II, 73f
- Humate-P, 274
- hypovolemia, postoperative instability, echocardiography, 204–5
- ## I
- Impella devices  
 Abiomed Impella platform  
 biventricular support, 132f, 132–33  
 contraindications and complications, 133f, 133–34, 134f  
 flow mechanics for, 128, 129f  
 left ventricular support, 128–30, 131f  
 overview of, 127, 128f, 129f  
 right ventricular support, 130–32, 131f  
 studies for myocardial recovery after AMI, 134–35, 135f  
 device selection in short-term MCS, 63
- Impella Heart Pump, acquired von Willebrand Syndrome with, 272
- impeller thrombosis, 205f, 205
- implantable devices  
 Kantrowitz CardioVAD LVAD, 121–22, 122f, 123f  
 NuPulseCV iVAS, 123–24, 124f  
 Sunshine Heart C-Pulse device system, 122–23  
 Symphony Device System, 122
- implant strategies  
 history of, 232–34  
 Modified Rankin Scale (MRS), 238t
- less-invasive (lateral) approach  
 completed outlet graft, 230f  
 operative setup and cannulation strategy, 228f  
 patient selection, 226–28  
 pitfalls of, 230–31  
 primary endpoint success in LATERAL trial, 227f  
 procedural sequence, 228–30  
 pump being seated, 229f, 230f  
 survival at 24 months in LATERAL trial, 227f  
 various surgical approaches for, 226f  
 ventricle being cored, 229f
- overview of, 232
- sternotomy implantation technique  
 anesthesia considerations, 209–10  
 cardiopulmonary bypass  
 configuration, 210  
 creation of LVAD pump pocket, 210–11, 211f  
 driveline placement and tunneling, 217, 220f  
 incision choices, 210f, 210  
 inflow cannula placement, 210, 211–17, 213f, 214f, 215f, 216f, 217f, 218f, 219f  
 LVAD pump positioning and final steps, 221–22  
 outflow graft placement, 217–20, 221f  
 positioning, sterile prep, and draping, 210  
 preoperative preparation and planning, 208–9, 209f  
 preoperative testing, 208  
 transitioning from bypass to LVAD support, 220, 222t, 222f, 223f  
 troubleshooting, 222–23, 224
- infectious complications  
 diagnosis, 292  
 host factors of infection, 291–92  
 microbiology tests, 292  
 causes of infections, 293t  
 overview of, 291  
 prevention  
 dressing changes, 296  
 perioperative antibiotics, 296
- treatment  
 antibiotics for, 295t  
 chronic suppressive therapy, 296  
 duration of, 296  
 overview of, 295–96
- types of infections  
 bloodstream and endovascular infections, 294–95  
 deep driveline infection, 294f, 295f  
 driveline infections, 293–94  
 lateral chest wall infection, 293f  
 median wound infection, 294f  
 overview of, 292–93  
 pump-pocket infections, 294

- infectious diseases, preoperative management, 43
- inotropic support  
application of, 41  
titration, 41
- intra-aortic balloon pump (IABP)  
device selection in short-term MCS, 62–63  
insertion through subclavian artery, 120–21  
overview of, 119–20, 120*f*, 121*t*  
percutaneous insertion through subclavian or axillary arteries, 121  
sternotomy implantation technique, 224
- ischemic cardiomyopathy  
assessing viability, 38–39  
classifying patients, 37–38, 38*f*, 38*t*  
surgical strategies and myocardial injury, 39–40
- J**
- Jarvik–7-70 TAH, 110
- K**
- Kantrowitz CardioVAD LVAD, 121–22, 122*f*, 123*f*
- L**
- lateral (less-invasive) approach  
completed outlet graft, 230*f*  
operative setup and cannulation strategy, 228*f*  
patient selection, 226–28  
pitfalls of, 230–31  
primary endpoint success in LATERAL trial, 227*f*  
procedural sequence, 228–30  
pump being seated, 229*f*, 230*f*  
survival at 24 months in LATERAL trial, 227*f*  
various surgical approaches for, 226*f*  
ventricle being cored, 229*f*
- left-heart disease, pulmonary hypertension due to, 47
- left-heart failure, pulmonary hypertension due to, 49, 50*f*
- left ventricular assist devices (LVADs)  
Berlin Heart EXCOR  
anticoagulation strategies, 163–64, 164*t*  
bleeding and cerebrovascular events, 164–65  
clinical studies and post-market analysis, 162, 163*t*  
device description, 159–61, 160*f*, 161*f*  
infection, 165  
overview of, 159  
post-approval clinical experience, 165–66  
pump configuration strategy, 162  
pump exchange, 162
- in conventional surgery  
assessing viability, 38–39  
case examples, 35–37  
classifying patients with ischemic cardiomyopathy, 37–38, 38*f*, 38*t*  
overview of, 35  
surgical strategies and myocardial injury, 39*f*, 39–40, 40*f*
- EVAHEART 2 LVAD system  
background of, 168  
centrifugal pump with hydrodynamic impeller suspension, 168  
current development of, 171*f*, 172*f*, 172  
description of system, 169*f*  
hemocompatibility, 170–72  
implantation technique, 172*f*, 173  
open-vane impeller design, 168, 169*f*, 170*f*, 171*f*  
secure power management and emergency controller, 168–70
- HeartMate 3 (HM3)  
clinical outcomes of, 80–82, 81*f*  
design of, 78–80*f*, 78–80  
future technologic enhancements, 82  
overview of, 78
- HeartMate II (HMII)  
description of pump, 72–73, 73*f*  
description of system, 70–72, 70–72  
intended use, 70  
overview of, 70
- PREVENT surgical recommendations, 74*t*
- system controller and monitor  
post-implantation, 73
- system controller user interface, 73–75, 74*f*, 75*t*, 76*f*
- HeartWare HVAD  
clinical trials, 89–93, 90–93*f*, 91–94*t*  
description of system, 84–85*f*, 84–85, 85*t*  
external components, 87–89, 88–90*f*, 89*t*  
overview of, 84  
surgical implantation, 86–87, 87–88*f*  
theory of operation, 85–86, 86–87*f*
- history of, 2–8
- Kantrowitz CardioVAD LVAD, 121–22, 122*f*, 123*f*
- Medtronic Miniature Left Ventricular Assist Device (MVAD)  
clinical trials, 101
- external components, 99–101, 100–1*f*  
overview of, 96–97*f*, 96, 97*t*  
surgical implantation, 98–99*f*, 98–99  
theory of operation, 96–98, 97*f*
- modalities of device optimization  
hemodynamics of LVADS, 345–46, 346*f*  
intracardiac pacing and LVADs, 350–51  
invasive hemodynamic optimization, 348–50, 349*f*, 350*f*, 351*f*  
LVAD speed optimization, 346  
overview of, 345  
two- and three-dimensional echocardiographic optimization, 347, 348*f*  
patient frailty and, 11–12, 12*f*, 16–21, 17*t*, 18*t*, 19*f*, 20*f*  
preoperative strategies for optimizing, 41–45, 42*f*
- TandemHeart LVAD  
clinical results, 141  
description, 140*f*, 140  
implantation, 140–41
- lung disease, pulmonary hypertension due to, 49
- M**
- mechanical circulatory support (MCS)  
history of, 1–8  
indications for, 9–14  
acute MCS, 13*t*, 13–14  
contraindications, 10  
estimating patient survival, 10–11  
key elements, 9  
QOL, complications, and poor outcomes, 11*t*, 11–12, 12*f*  
referrals for evaluation, 9  
shared decision-making, 13  
standard indications for, 9–10, 10*t*, 11*t*  
timing of implantation, 12–13  
preoperative strategies for optimizing, 41–45, 42*f*
- medical management  
frailty, 44  
hematology, 43  
infectious diseases, 43  
nephrology, 43*t*, 43–44  
pulmonology, 43
- Medtronic Miniature Left Ventricular Assist Device (MVAD)  
clinical trials, 101  
external components, 99–101, 100–1*f*  
overview of, 96–97*f*, 96, 97*t*  
surgical implantation, 98–99*f*, 98–99  
theory of operation, 96–98, 97*f*

## N

nephrology, preoperative management, 43*t*, 43–44

NuPulseCV iVAS, 123–24, 124*f*

## O

octreotide therapy, 274

## P

palliative care

advance directives, 23–25, 25*f*, 26*t*

end-of-life care, 27

key focus of, 23, 25*f*

overview of, 23

preparedness plans, 25–27, 26*t*

summary of guidelines, 24*f*

patent foramen ovale (PFO)

preoperative assessment, 200

sternotomy implantation

technique, 223

patient education, 383, 384*f*

patient survival

frailty and, 11–12, 12*f*, 16–21, 17*t*, 18*t*, 19*f*, 20*f*

mortality risk prediction with

MCS, 10–11

mortality risk prediction without

MCS, 10

pediatric patients

Berlin Heart EXCOR

anticoagulation strategies,

163–64, 164*t*

bleeding and cerebrovascular

events, 164–65

clinical studies and post-market

analysis, 162, 163*t*

device description, 159–61,

160*f*, 161*f*

infection, 165

overview of, 159

post-approval clinical

experience, 165–66

pump configuration strategy, 162

pump exchange, 162

bridging to outcomes

decision or candidacy, 55

destination therapy, 55

recovery and explanation, 55

complications

impact of mitral valve procedure on

6-minute walk, 238*t*

occluded aortic valve and mitral

regurgitation, 234–35

contraindications for MCS in, 55*t*, 55

device selection

Berlin Heart EXCOR, 58*f*, 58–59

bridging to transplant, 58*f*, 58

continuous-flow devices, 59

devices designed for adults, 59

devices suitable for children, 56*t*, 56

EMOC in congenital heart disease,

57*f*, 57–58

extracorporeal membrane

oxygenation, 56*f*, 56–57

indications for MCS in, 54, 55*t*

size and anatomical considerations

advanced imaging for expanded

eligibility, 250–51, 251*f*

device selection, 246

long-term support, 248*f*, 248–49

overview of, 246

PediMacs report, 246, 247*f*

single-ventricle pathologies, 251

technical modifications to fit devices,

250*f*, 250

temporary support, 246–48

VAD support after bidirectional

Glenn shunting, 251–52

VAD support after Fontan

procedures, 252

timing MCS initiation, 56

percutaneous coronary intervention (PCI)

Abiomed Impella platform, protected

PCI, 130, 131*f*

perfusion considerations

on bypass considerations, 189

coagulation issues, 192

combined MCA therapies, 191

complex scenarios, 190–91

contemporary cannulation, 191

MCA longevity, 191

overview of, 188

post-bypass considerations, 190

postoperative ICU considerations, 190

pre-bypass considerations, 188–89

procedural sequence, 188

ventricular decompression while on

support, 191–92

postoperative management

acute RV dysfunction, 205

arrhythmias, 258–59

bleeding, 256–57

cannula kinking or obstruction, 205, 206*f*

cardiopulmonary resuscitation

(CPR), 259

evaluation of left heart chambers, 202

hemodynamic considerations, 190

hypovolemia, 204–5

impeller thrombosis, 205*f*, 205

inotropes and pulmonary

vasodilators, 257–58

mitral valve repair, immediate

postoperative right ventricular

failure, 233*f*, 233, 234*f*

overview, 204

overview of, 255–56

ICU handoff checklists, 183, 184*t*, 255*t*

postoperative tamponade, 205

right ventricular failure, 258

sedation and analgesia, 183

ventilator management, 256

postoperative tamponade, postoperative

instability, echocardiography, 205

preoperative management

algorithm for, 41, 42*f*, 45

hemodynamic congestion, 44

hemodynamic monitoring, 41

ionotropic support, 41

medical management

frailty, 44

hematology, 43

infectious diseases, 43

nephrology, 43*t*, 43–44

pulmonology, 43

overview of, 41

right ventricular assessment and

management, 44–45

temporary mechanical circulatory

support, 41–43

preparedness plans, 25–27, 26*t*

PREVENT surgical recommendations, 74*t*

psychosocial assessment

advantages of dedicated mental health

teams, 32

challenges in multidisciplinary care, 32

factors determining candidacy

cognitive functioning, 30

depression, 29–30

overview of, 29

social support, 30

substance use, 30

overview of, 29

recommendations for practice, 32–33

tools for, 30–32, 31*t*

pulmonary arterial hypertension (PAH),

classification of, 47, 48*t*

pulmonary hypertension (PH)

classification of

PH from blood clots, 49

PH from left-heart disease, 47

PH from lung disease or chronic

hypoxia, 49

pulmonary arterial hypertension, 47

WHO groups, 48*t*

heart failure and, 49, 50*f*

heart transplantation and, 51*t*, 51

MCS as bridge-to-transplant in, 51

overview of, 47

pathophysiology secondary to left-heart

failure, 49, 50*f*

U.S. deaths associated with, 47, 48*f*

pulmonology, preoperative

management, 43

pump thrombosis

causes of device-related ischemic

stroke, 299–300

echocardiography results, 205*f*

pump thrombosis (*cont.*)  
 mechanisms of, 281–83  
 adverse events in per-protocol population, 286*t*  
 adverse events through 1 year, 284*t*  
 HeartMate 3 centrifugal flow design, 285*f*  
 HeartMate II axial flow design, 282*f*  
 HeartWare centrifugal flow design, 283*f*  
 overview of, 281  
 postoperative instability due to, 205  
 presentation and diagnosis, 283–85  
 preventing, 302  
 treatment for, 285–87  
 HVAD waveforms, 288*f*  
 left anterolateral thoracotomy and midline incision, 288*f*  
 subcostal incision approach, 287*f*

## Q

quality of life (QOL)  
 impact on, 11*t*  
 MCS impact on, 11–12  
 shared decision-making and, 13

## R

ReliantHeart aVAD  
 design of, 103–5, 104–5*f*  
 effects of changes in pump speed, 106–7, 108*f*  
 flow probe, 106–7*f*, 106  
 overview of, 103*f*, 103  
 patients receiving, 108–9  
 remote monitoring, 107–8, 109*f*  
 renal failure  
 cardiorenal syndrome, preoperative management, 43*t*, 43–44  
 effect of MCS on kidneys, 325  
 overview of, 323  
 post-implantation management, 324–25  
 prevention of in perioperative period  
 intraoperative period, 324  
 preoperative period, 323–24  
 renal dysfunction due to right heart failure after LVAD placement, 325  
 preoperative predictors of RV support, 325*t*  
 renal dysfunction in heart failure, 323  
 mechanisms of, 324*f*  
 renal replacement therapy  
 hemodialysis, 326  
 in MCS patients, 325–26  
 modality choices, 326  
 peritoneal dialysis, 326–27  
 ReSTAGE-HF protocol  
 Harefield Protocol, 361*t*  
 outcomes, 362–63

exercise training components and recommendations, 375*t*  
 key outpatient studies, 374*t*  
 overview of, 361, 362*t*  
 right heart dysfunction  
 assessment and management, 44–45  
 continuous LVAD hemodynamics, hemodynamic impact of LVAD on right-sided chambers, 199*f*, 203*f*  
 device selection  
 Abiomed Impella platform, 130–32, 131*f*  
 for short-term MCS, 64  
 device selection in short-term MCS, 64  
 influence of LVAD on right ventricular function, 311–12, 313*f*  
 mechanisms of RV failure, 314*f*  
 medical management after implantation, 315  
 medical management before implantation, 315  
 Pittsburgh decision tree, 318*f*  
 operative assessment, right ventricular function and TR, 202  
 overview of, 309  
 INTERMACS definition of right ventricular failure, 310*t*  
 mechanisms contributing to RV dysfunction, 311*f*  
 postoperative management  
 immediate postoperative right ventricular failure, 233*f*, 233, 234*f*  
 right ventricular failure, 258  
 predicting RV failure, 313–15  
 risk-prediction models, 316*t*  
 preoperative assessment, right ventricular function and TR, 201*f*, 205*f*, 206*f*  
 preoperative management, right ventricular assessment and management, 44–45  
 pulmonary vasodilators, 315–18  
 right heart physiology, 309–11  
 right heart physiogy  
 relationship of RV and LV stroke volumes in afterload, 312*f*  
 RV pressure-volume loops, 313*f*  
 structural and functional changes in RV failure, 312*f*  
 surgical management after RV failure, 318–20  
 two-year Kaplan-Meier mortality, 319*f*  
 right ventricular assist devices (RVADs)  
 Berlin Heart EXCOR  
 anticoagulation strategies, 163–64, 164*t*  
 bleeding and cerebrovascular events, 164–65

clinical studies and post-market analysis, 162, 163*t*  
 device description, 159–61, 160*f*, 161*f*  
 infection, 165  
 overview of, 159  
 post-approval clinical experience, 165–66  
 pump configuration strategy, 162  
 pump exchange, 162  
 device selection, 64  
 TandemLung and Protek Duo RVAD description, 141*f*, 141–42, 142*f*  
 implantation, 142–43  
 RV dysfunction after LAVD (suction cascade), 199*f*, 203*f*, 205

## S

shared decision-making (SDM), 13  
 short-term MCS  
 Abbott CentriMag Acute Circulatory Support System, 145–48, 146–48*f*  
 Abbott HeartMate Percutaneous Heart Pump (PHP) System, 145–50, 148–50*f*  
 social support, 30  
 sternotomy implantation technique  
 anesthesia considerations, 209–10  
 cardiopulmonary bypass configuration, 210  
 creation of LVAD pump pocket, 210–11, 211*f*  
 driveline placement and tunneling, 217, 220*f*  
 incision choices  
 minimally invasive LVAD implant, 210*f*, 210  
 sternotomy, 210  
 inflow cannula placement  
 apical core technique, 212, 213*f*, 215*f*  
 HeartMate 3 LVAD pump, 217*f*  
 HeartMate 3 apical sewing cuff, 217*f*  
 HeartMate II LVAD pump, 216*f*  
 HeartMate II sewing cuff, 216*f*  
 HeartWare LVAD apical sewing cuff, 219*f*  
 HeartWare LVAD pump, 218*f*  
 overview of, 211–12  
 positioning at LV apex, 212  
 securing inflow cannula, 215–17  
 sewing cuff placement, 210, 212–15, 214*f*  
 LVAD pump positioning and final steps  
 assessment of LVAD position, 221–22  
 final steps, 222  
 optimization of initial LVAD settings, 222  
 outflow graft placement

aortic outflow graft anastomosis, 218, 221*f*  
 consideration for bridge to transplant patients, 218–20  
 positioning and measurement, 217–18, 221*f*  
 positioning, sterile prep, and draping, 210  
 preoperative preparation and planning, 208–9  
 operative setup and cannulation strategy, 209*f*  
 preoperative testing, 208  
 transitioning from bypass to LVAD support  
 de-airing the LV and LVAD outflow graft, 220, 222*f*  
 typical parameters for commonly used LVADs, 222*t*  
 weaning from bypass and initiation of LVAD flows, 220, 223*f*  
 troubleshooting  
 failure to separate from bypass, 222–23  
 IABP use and issues, 224  
 moderate or greater aortic valve insufficiency, 223  
 patent foramen ovale (PFO), 223  
 tricuspid regurgitation (TR), 224  
 stroke. *See* cerebral blood flow and stroke  
 substance use, 30  
 suction cascade (RV dysfunction after LAVD), 199*f*, 203*f*  
 operative assessment, echocardiography, 205  
 Sunshine Heart C-Pulse device system, 122–23  
 Symphony Device System, 122  
 SynCardia total artificial heart  
 benefits and indications of, 112  
 clinical outcomes, 114–17*f*, 114–15  
 Companion 2 drive system, 112  
 delayed referrals, 115–17  
 driver management  
 full eject, 112*f*, 113  
 overview of, 113  
 partial fill, 113*f*, 113–14  
 Freedom drive system, 112–13  
 overview of, 110–11*f*, 110–11

## T

TandemHeart, device selection in short-term MCS, 63

TandemLife System  
 clinical data, 143–44  
 clinical studies, 140  
 description of system, 140  
 implantation procedure, 140  
 overview of, 138*f*, 138–40, 139*f*  
 TandemHeart LVAD  
 clinical results, 141  
 description, 140*f*, 140  
 implantation, 140–41  
 TandemLung and Protek Duo RVAD  
 description, 141*f*, 141–42, 142*f*  
 implantation, 142–43  
 unique insertion and applications, 143  
 temporary extracorporeal centrifugal pumps, acquired von Willebrand Syndrome with, 272–73  
 temporary MCS devices  
 acquired von Willebrand Syndrome with  
 Impella Heart Pump, 272  
 temporary extracorporeal centrifugal pumps, 272–73  
 temporary mechanical circulatory support (TMCS)  
 conventional surgery, 35–40  
 device selection, 61–65, 65*t*  
 preoperative management, 41–43  
 total artificial hearts (TAHs)  
 acquired von Willebrand Syndrome with, 273–74  
 Jarvik–7-70 TAH, 110  
 SynCardia total artificial heart  
 benefits and indications of, 112  
 clinical outcomes, 114–17*f*, 114–15  
 Companion 2 drive system, 112  
 delayed referrals, 115–17  
 driver management, 112*f*, 113*f*, 113–14  
 Freedom drive system, 112–13  
 overview of, 110–11*f*  
 tranexamic acid, 275  
 tricuspid regurgitation (TR), 201*f*, 205*f*, 206*f*, 224

## V

VAD coordinators  
 other roles and responsibilities, 385–86  
 overview of, 382  
 resources for VAD programs, 383*t*  
 primary roles and responsibilities of

device implantation, 382–83  
 discontinuing device support, 385  
 multidisciplinary approach to care, 383*f*  
 outpatient management, 383–85, 385*f*  
 patient education, 383  
 patient screening and evaluation, 382  
 postoperative management, 383  
 pre-discharge education program, 384*f*  
 troubleshooting changes in VAD performance, 386*t*  
 veno-arterial extracorporeal membrane oxygenation (VA-ECMO)  
 device selection in short-term MCS, 63–64  
 TandemLife System, 138–42*f*, 138–44  
 ventricular tachycardia  
 hemodynamic support during catheter ablation  
 approaches to circulatory support, 334*t*  
 clinical studies on utility of, 336*t*  
 current data on, 333–35  
 flow diagram for management, 333*f*  
 method selection, 332–33  
 overview of, 331  
 PAINESD risk score, 332*f*  
 specific clinical situations, 331–32  
 VT ablation on percutaneous ECMO, 335*f*  
 hemodynamic support during surgical ventricular tachycardia ablation  
 overview of, 335  
 rationale for choice of specific support, 335  
 overview of, 330  
 commonly used short-term MCS options, 331*f*  
 pre- and post-therapeutic hemodynamic support, 330–31  
 von Willebrand Syndrome. *See* acquired von Willebrand Syndrome

## W

warfarin. *See* anticoagulation strategies















