

Symbolic Representation
of the
GENERALIZED

(in Time)

ELECTRIC WAVE

©1985

by Eric Dollard



P.O. BOX 429 ★ GARBERVILLE, CA 95440-0429 ★ U.S.A.

Contents

1 Preface	4
2 Introduction	6
2.1 Electrical Power	6
2.2 Time and j	7
2.3 Examples of Generalized Electric Waves	8
2.4 Types of Current	9
2.5 Continuous Current	9
3 Representation of Alternating Electric Waves	9
3.1 Graphical and Trigonometric Representation	9
3.2 Representation into Two Dimensional Space	10
3.3 Analogous 3-D Representation	11
4 Symbolic Representation of AC Waves	12
4.1 New methodology for extensive calculation	12
4.2 Distinguishing time variance and time invariance	13
4.3 Positive and Negative Quadrature Variations (90°steps)	14
4.4 Characteristics of the Versor Operator - \varkappa_4^n	18
4.5 Trigonometric and Exponential Equivalents for the versor	20
5 Non-Quadrature Operators	21
5.1 D.C. Operator - \varkappa_2^n	21
5.2 Triple Phase Operator - \varkappa_3^n	23
5.3 Octic or Double Quadrature Operator \varkappa_8^n	23
5.4 Examples — Energy Consumption and Energy Production	25
6 Canonic Electric Waves	27
6.1 Generalized Versor Operator Form	27
6.2 Imposition Produces Interference Patterns	27
6.3 Quadrantal Multiplication and Canonic Electric Waves	28
7 Transient Waves	28
7.1 Introduction to Transient Waves	28
7.2 Starting Point Equation for Transients	29
7.3 Algebraic Representation of Generalized Electric Wave	29
7.4 The Wave Equation and Transients	30
7.5 Exponential Representation of the Alternating Electric Wave	32
7.6 Special Cases of the Exponential Form	34
7.7 Polar Representation of Eight Categories of Electric Waves	35
8 Other References	36
9 List of Symbols	37

List of Figures

1	Oscillogram of High-frequency Oscillation Preceding Low-frequency Oscillation of Compound Circuit Caused by Switching 154 miles of 100,000 Volts Transmission Line and Step-down Transformer off another 154 Miles of 100,000 Volts Line; High-tension Switching.	8
2	Oscillogram of Oscillation of Compound Circuit Consisting of 154 miles of 100,000 Volts Line and Step-up Transformer; Connecting and Disconnecting by Low-Tension Switches. High-tension Current and Low-tension Voltage.	8
3	Reproduction of Oscillogram of Propagation of Impulse Over Transmission Line; no Reflection. Voltage.	8
4	Alternating Wave, O.C. Envelope, and Oscillating Wave	8
5	Resistance, Reactance, Impedance relationship	10
6	Resistance, Reactance in 3-d Space	11
7	Normal to X-Plane	11
8	Normal to X-Plane	12
9	\pm Reactance versus Resistance Rotations	12
10	\pm Susceptance versus Conductance Rotations	13
11	Resistance/Acceptance versus Reactance/Susceptance Rotations	13
12	Power Factor a versus Induction Factor $\varkappa b$	14
13	Positive phase quadrature delay (90° lag)	14
14	One half cycle delay (180° lag)	15
15	Three quarter cycle delay (270° lag)	16
16	Full Cycle Delay (360° lag)	16
17	Quarter Cycle Lead (90° lead)	17
18	Versor operator \varkappa_4^n	18
19	Variable Reactance, Reaction Machine	26
20	Hysteric Loss of Reaction Machine	26
21	Reaction Machine	26
22	Variable Reactance, Reaction Machine	26
23	Hysteric Loss of Reaction Machine	26
24	Comparison of Transient and Continuous Waves	32
25	Eight Categories of Electric Waves	35

List of Tables

1	Versor Characteristics	19
2	Rotation Sense	20
3	Quadrature Rotations	20
4	Octic Versors	24

LIST OF TABLES

3

5	Four Characteristics of Alternating Electric Waves	27
6	Quarter-Shifted Quadrantal Properties	28

1 Preface

“Nature has stored up in the universe infinite energy. The eternal recipient and transmitter of this infinite energy is the ether. The recognition of the existence of ether, and of the functions it performs, is one of the most important results of modern scientific research... It has been for the enlightened student of physics what the understanding of the mechanism of the firearm or of the steam engine is for the barbarian...” — Nikola Tesla

The fundamental problem with electricity and electrical engineering is that no one really knows what electricity is. Many theories are bandied about on how electricity works. The understanding of Tesla implies the understanding of what electricity is. The phenomena of electrical waves in Tesla coils is sometimes explained in the terms of theoretical physics and this is a misnomer. Electricity is a property of the ether, “Modern” physics denies the existence of the ether and has virtually denied the existence of electricity.

This publication is a preliminary attempt at a symbolic representation of electrical waves. It serves as a continuation of the works of Charles Proteus Steinmetz, the man hired by General Electric to decipher the Tesla patents. The language taking form here uses simple algebra and avoids advanced math such as calculus. The purpose of this language is to provide a more complete understanding of the phenomenon of electrical waves. The discoveries of Nikola Tesla can now be understood as being practical and applicable to our present situation.

Present electrical theory comprises of two quadrants out of the four quadrants presented by author Eric Dollard in this paper. This four quadrant pattern is a primal glyph of the formative forces of our present experiential reality and can be seen in such ancient patterns as the Mandala and Medicine Wheel. The four quadrant pattern represents the flow of growth and decay. The quadrants of decay are prominent in our presently accepted theories. Consumption without regeneration is the pattern of our present society and this has brought our world off balance.

The quadrants of growth are denied to us by the ‘media event’ that our lives have become. What we are programmed to do is to ‘consume more NOW’ without ever really knowing or caring where everything comes from or where all the waste goes to. We have to pay for everything, electricity being a constantly running bill. Free electricity is contained in the quadrants of growth. Unless people strive for freedom in all matters we will always be held in the thrall of large conglomerates of profiteers.

Austrian scientist Viktor Schauberger has provided us with a basis for the understanding of the unbalanced condition of the earth. His work shows that our whole technology is based on the patterns of decay. Detrimental forces are enveloping us and the media promotes more consumption. Automobiles, power generating plants, jet airplanes, etc. are all based on explosive forces to power them. These forces promote pollution and mechanical wear. Schauberger provided us with the insight to use the natural forces of implosion to provide us with our present energy needs. Implosion technology is non-polluting and powerful. The beneficial technologies presented by Schauberger hold the key to saving our world. He provided us with the other half of the energy equation in his areas of understanding.

Eric Dollard is now providing us with the language for understanding how to use electrical technology in a beneficial manner. As Viktor Schauberger before him he takes a monumental

task in hand. It is the eternal battle of life versus death, in this case it is a matter of the survival of Mother Earth. We need to apply Dollard's work as soon as we can. It is left to you, the reader, to make some noise in this matter and see if you can't wake up a few people along the way.

A handwritten signature in black ink that reads "Tom Brown". The signature is written in a cursive, slightly slanted style.

Tom Brown
Director,
Borderland Sciences
Research Foundation
March 28, 1986

2 Introduction

2.1 Electrical Power

A fundamental quantity of electrical engineering is that of the energy, often known as the work, of the electric system. This quantity is commonly known as the *kilowatt-hour* in practical applications, and as the *watt-second* in theoretical applications. The dimensions of electrical energy is given by

$$\begin{aligned} W &= \psi\phi F_0 \\ &= \frac{\psi\phi}{T_0} \quad \text{watt-sec} \end{aligned} \quad (1)$$

where

W	work or energy in watt-sec.
ψ	total dielectric flux, in lines contained in the electric system
ϕ	total magnetic flux, in lines contained in the electric system
F_0	frequency of energy pulsation, cycles/sec (<i>Hz</i>)
T_0	period of energy pulsation, in secs

The dimension of T_0 is often a complex quantity.

The quantities, ψ and ϕ , represent the basic components of electric energy. The time rate of the production or consumption of these fluxes are represented by the relations

$$E = \phi/t_1 \quad \text{lines per second (volts)} \quad (2)$$

$$I = \psi/t_2 \quad \text{lines per second (amperes)} \quad (3)$$

Equation (2) is the *Law of Electromagnetic Induction*. The complimentary equation (3) is the *Law of Dielectric Induction*. [1, 20]

Combining equation (2) with equation (3) and substituting the time relation

$$2t_1t_2 = T_1^2$$

and

$$T_1^2 = T_0t$$

gives

$$E \cdot I = \frac{\psi\phi}{T_1^2} = P \quad \text{volt-amperes (watts)} \quad (4)$$

This quantity, P , is known as the power of the electric system. Substitution of equation (1) into equation (4) gives

$$P = W/t \quad \text{watt-sec/sec (watts)} \quad (5)$$

Hence, the power of an electric system is the time rate of energy production or consumption.

Taking the ratio of equation (2) and equation (3), and substituting

$$t_1/t_2 = 1 \quad \text{a dimensionless unit}$$

gives

$$\frac{E}{I} = \frac{\phi}{\psi} = Z \quad \text{volts per ampere (Ohm)} \quad (6)$$

This quantity, Z , is known as the *Characteristic Impedance* of the electric system, and expresses the ratio of magnetic flux ϕ to dielectric flux ψ within the system.

2.2 Time and j

Since the dimension Time is a fundamental dimension in the important electric quantities, volts, amperes, watts, it is of interest to investigate its properties in relation to electric phenomena and its representation in electrical engineering calculations.

The variation of an electric quantity, U , with respect to time is usually expressed as

$$\frac{d^n U}{dt^n} = \gamma_t^n \quad \text{units/sec}^n \quad (7)$$

This is known as a differential operation. Since the properties of this type of representation are quite abstract and possess a generality beyond that required for engineering calculations, it is desirable to develop a form of symbolic representation more suited for engineering calculations — one such symbolic expression that has found extensive application in alternating current calculations is [2, 14]

$$\gamma_t = j\omega \quad \text{radians/sec} \quad (8)$$

where

$$\begin{aligned} \pm j &= \pm\sqrt{-1} \\ \omega &= 2\pi F \end{aligned}$$

The factor j is known as the imaginary unit.

The exact nature & origin of this symbol is a mystery to most engineers and explanation as to how an imaginary number represents real phenomena is seldom given. [8] The demystification of this symbol and the extension of such symbolisms to electric phenomena in general is the object of this paper.

2.3 Examples of Generalized Electric Waves

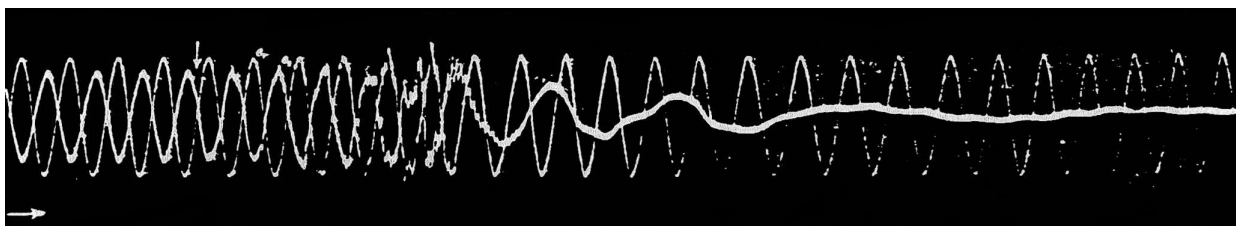

Figure 1: Oscilloscope of High-frequency Oscillation Preceding Low-frequency Oscillation of Compound Circuit Caused by Switching 154 miles of 100,000 Volts Transmission Line and Step-down Transformer off another 154 Miles of 100,000 Volts Line; High-tension Switching.

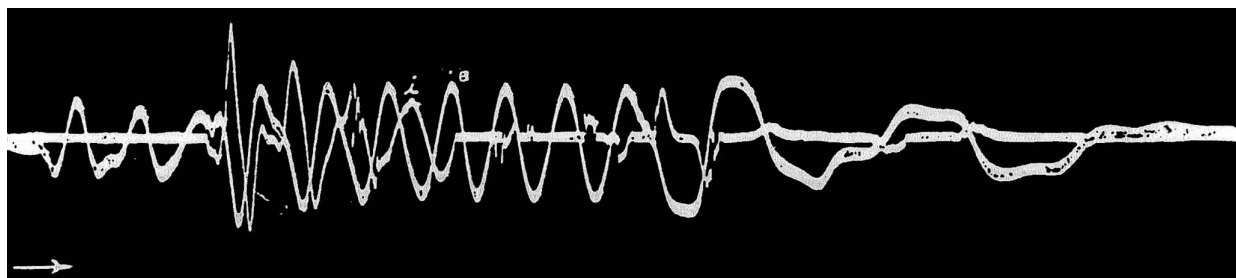

Figure 2: Oscilloscope of Oscillation of Compound Circuit Consisting of 154 miles of 100,000 Volts Line and Step-up Transformer; Connecting and Disconnecting by Low-Tension Switches. High-tension Current and Low-tension Voltage.



Figure 3: Reproduction of Oscilloscope of Propagation of Impulse Over Transmission Line; no Reflection. Voltage.

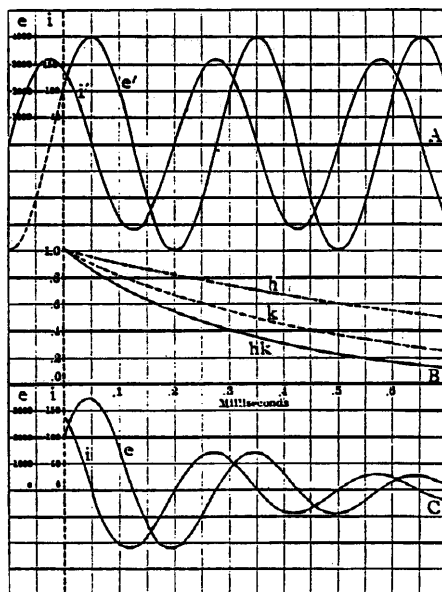

Figure 4: Alternating Wave, O.C. Envelope, and Oscillating Wave

2.4 Types of Current

In the study of electric phenomena, attention is usually focused on only two forms of electric waves, those of *alternating current* (A.C.) and continuous, or *direct current*, (D.C.). While these forms are representative of the commercial application of electric energy, they only represent special steady state cases. It is known that during switching operations, and in the process of modulation, other forms of electric waves appear due to energy readjustment within the electric system. These waves are known as electric transients. Theoretical understanding of these phenomena is usually quite vague. These transients give rise to a new pair of waveforms, the *oscillating currents* (O.C.) and *impulse currents* (I.C.). Thus, in general, the variation of electric quantities with respect to time may be divided into four distinct categories:

1. Continuous Currents (D.C.) Time Function = Zero
2. Alternating Currents (A.C.) Time Function = radians/second
3. Impulse Currents (I.C.) Time Function = nepers/second
4. Oscillating Currents (O.C.) Time Function = neper-radians/second

NOTE: **Neper** is a logarithmic unit for ratios of power, defined as $L_{Np} = \ln \frac{x_1}{x_2} = \ln x_1 - \ln x_2$ where \ln is natural logarithm.

The continuous currents represent the continuous time invariant, or scalar, component of the generalized electric wave. The alternating currents represent the continuous cyclic variation component of the wave. The impulse currents represent the discontinuous or acyclic component of the wave. The oscillating currents represent alternating currents that grow or decay with respect to time, thus being a combination of cyclic and acyclic variation.

2.5 Continuous Current

The continuous current can be resolved into a pair of superimposed impulse currents, one impulse growing in amplitude with respect to time, representing the production of electrical energy, the other impulse decaying in amplitude with respect to time, representing the consumption of electric energy. If the two rates are equal and opposite, and the two amplitudes unequal, the resultant wave is a direct or continuous current. Likewise, an alternating current can be resolved into a pair of superimposed oscillating currents, one oscillation growing in amplitude with respect to time, representing the production of electric energy, the other oscillation decaying in amplitude with respect to time, representing the consumption of electric energy. If the two rates are equal and opposite, and the two amplitudes unequal, the resulting wave is an alternating current.

3 Representation of Alternating Electric Waves

3.1 Graphical and Trigonometric Representation

The method most commonly employed for the representation of alternating electric waves is known as the graphical method of representation. Other names for this method are the

phasor diagram and vector diagram. Despite the apparent simplicity of this form of representation it often becomes too complicated for application to practical situations involving many quantities.

Another common method is the trigonometric form of representation. This method, while being more suited for calculating purposes, is also complex. Additionally, the trigonometric functions possess a somewhat mystical character in the minds of most engineers[9] and require the use of tables or computing apparatus for their solutions.

The trigonometric functions do not completely represent the alternating electric wave since the functions sine and cosine represent horizontal and vertical projections, respectively of the wave. The sine projection is known as the alternating current, however both the sine and cosine functions combined together represent the alternating power, since the alternating electric wave is a quantity of constant amplitude rotating at a constant rate.

The alternating electric wave may be called a rotating direct current. The trigonometric functions thus only represent shadows of the complete wave of electric energy[13], that is, the current or voltage.

3.2 Representation into Two Dimensional Space

The primary drawback of both the graphical and trigonometric methods is that they serve as misrepresentations of the electric waves under investigation. These representations are actually representations of two dimensional space, that is, a plane surface. The concept of a “surface of time” is of little value for the theoretical investigation of electric waves since time is an axial dimension typically given as points on a line.

Consider the addition of electric resistance, R , in Ohms, and magnetic inductive reactance, X , in Henrys per second, $(\gamma_t)L$. The usual representation is given by

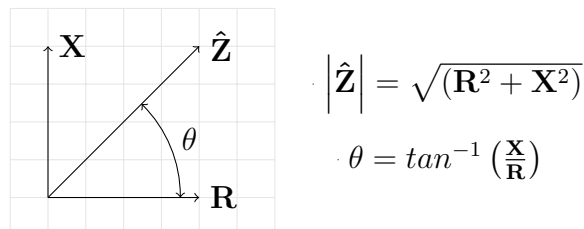

Figure 5: Resistance, Reactance, Impedance relationship

The resistance of an electric system is, however, a property of the system that is frequency, or time, invariant. Thus resistance is a scalar quantity independent of the time rate of variation of the applied electric wave. Resistance then is not a vector quantity as portrayed in figure 5.

The reactance of an electric system is its magnetic inductance, L , multiplied by the time rate of variation of the applied electric wave, (γ_t) , and by equation (8). It is a time dependent quantity associated with a *quadrature versor*. Thus reactance is also not a vector quantity, hence the addition of resistance and reactance is not properly represented by a vector diagram such as figure 5. The graphical method then really serves as a form of computing apparatus for calculating purposes and is incapable of providing the proper representation of the electric wave required for theoretical investigation.

3.3 Analogous 3-D Representation

An analogous representation is two perpendicular planes in space, figure 6, containing the vectors of figure 5.

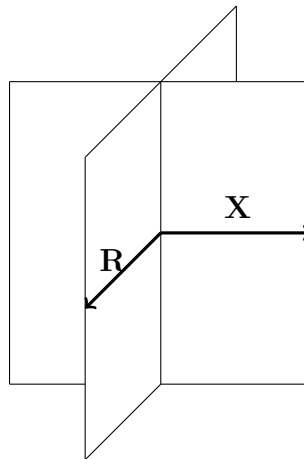

Figure 6: Resistance, Reactance in 3-d Space

If the viewer faces one of the two planes straight on, plane **X** for example, then the quadrature plane, **R**, having no thickness by definition of a plane surface, disappears from view:

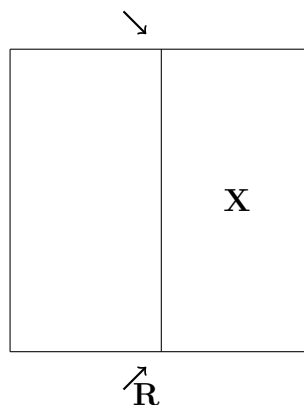

Figure 7: Normal to X-Plane

Going one step further, let the line **R** be reduced to a single point, the point being the thickness of a plane of infinitesimal area, and let the plane **X** be viewed edgewise reducing it to a single line, as shown in figure 8:

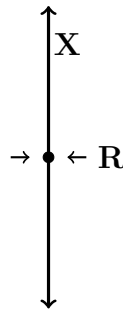

Figure 8: Normal to X-Plane

The result is a single point **R** in the center of a line **X**. Hence, the point **R** represents the resistance of the electric system, and the amount of resistance is given by the “weight” of the point. The line **X** represents the reactance of the electric system, and the amount of reactance is given by the length of this line.

Despite its somewhat contrived nature, the representation of figure 8 is more representative of the electric phenomena than is figure 5.

4 Symbolic Representation of AC Waves

4.1 New methodology for extensive calculation

Since the aforementioned methods are only usable for situations involving few quantities and are mis-representative of the electric relations to which they are applied, a method is therefore desirable that is capable of extensive calculation while retaining a basic simple form representative of the wave.

It is well known that the quadrature angle, 90° or $\pi/2$ radians, represents a fundamental relation in A.C. theory. Since 90° is one fourth of a complete cycle, the complete alternating electric wave is represented in its entirety by four quadrants of rotation.

These rotations are represented[3] by figures 9, 10, & 11:

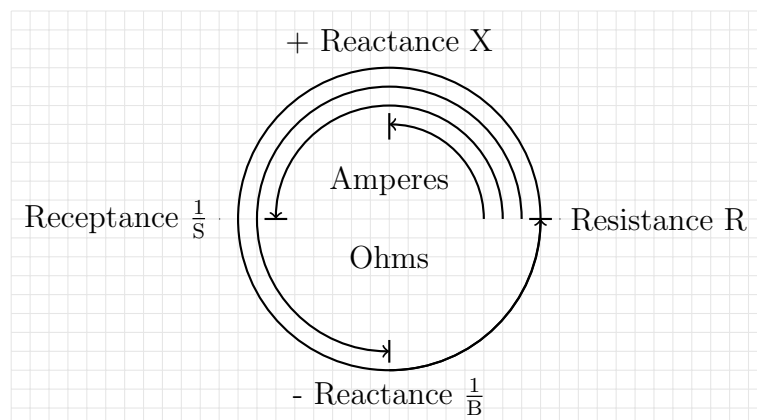

Figure 9: \pm Reactance versus Resistance Rotations

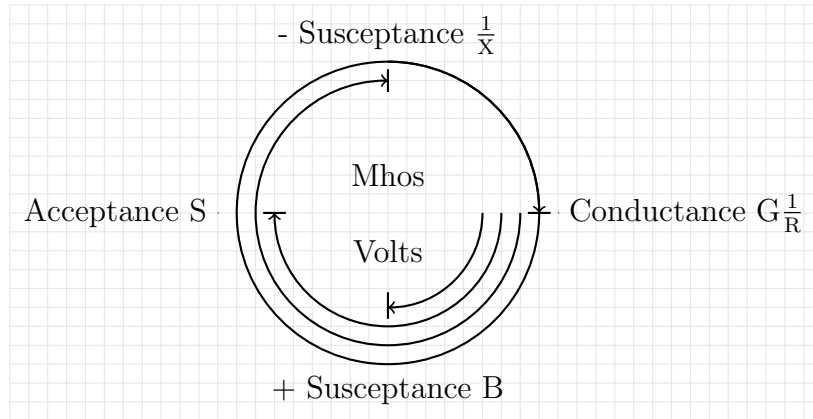

Figure 10: \pm Susceptance versus Conductance Rotations

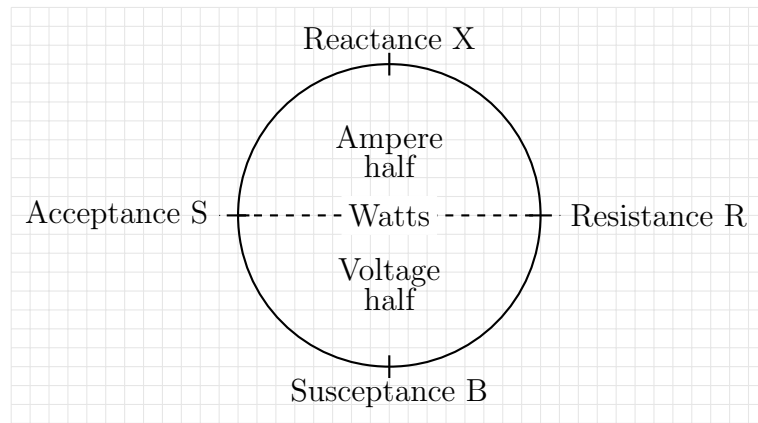

Figure 11: Resistance/Acceptance versus Reactance/Susceptance Rotations

Expressed in rectangular coordinates the *resistance—acceptance axis* is expressed by

$$\pm a = \cos(\theta) = \text{power factor \%}$$

and the *reactance—susceptance axis* is expressed by

$$\pm b = \sin(\theta) = \text{induction factor \%}$$

where θ is the time position of the alternating electric wave.

4.2 Distinguishing time variance and time invariance

To distinguish the time invariant power factor, a , from the time invariant induction factor, b , of the complete alternating electric wave, we may mark, for instance, the inductive time dependent component by a distinguishing index[15], or the addition of an otherwise meaningless symbol, as the letter \varkappa , to indicate the time dependency of this component. Thus the representation of the alternating wave is given by the expression:

$$(\gamma_t^2) = a + \varkappa b \quad \text{numeric} \quad (9)$$

which has the meaning that the wave factor, (γ_t^2) , of the wave is the sum of the time invariant power factor a of the wave, and the time variant induction factor $\varkappa b$ of the wave. Both factors combine into a resultant wave of unit intensity,

$$|(\gamma_t^2)| = \sqrt{a^2 + b^2} = 1 \quad \text{unit radius} \quad (10)$$

and of time position in the cycle of alternation,

$$\theta = \arctan(b/a) \quad \text{radians} \quad (11)$$

These relations in graphical representation[4] are given by —

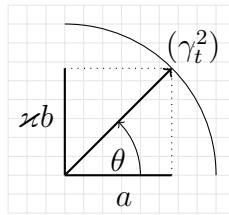

Figure 12: Power Factor a versus Induction Factor $\varkappa b$

Similarly,

$$-(\gamma_t^2) = -a - \varkappa b \quad \text{numeric} \quad (12)$$

represents a wave with the power factor $-a$, and the induction factor, $-\varkappa b$, etc.

Obviously the plus sign in the symbolic expression of equation (9) does not imply simple addition, since it connects heterogeneous quantities — time invariant and variant quantities, but implies combination as a complex quantity.

For the present, \varkappa is nothing but a distinguishing index, and is otherwise free of definition except that it is not an ordinary number.

4.3 Positive and Negative Quadrature Variations (90° steps)

A wave of unit intensity, but delayed by one quarter cycle (positive phase quadrature) lags behind the wave $a + \varkappa b$ by 90°

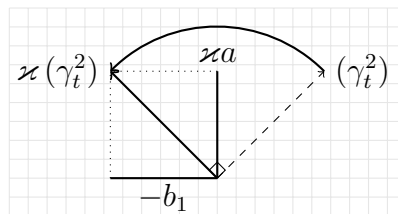

Figure 13: Positive phase quadrature delay (90° lag)

The power factor a is translated into induction factor $\varkappa a$, the induction factor b is translated into power factor $-b_1$.

This wave is represented symbolically as:

$$\varkappa a - b = \varkappa (\gamma_t^2) \quad (13)$$

Explicitly, the algebraic operation is given by

$$\varkappa(a + \varkappa b) = \varkappa^1 a + \varkappa^2 b \quad (14)$$

Hence, it is a property of \varkappa that

$$\begin{aligned} \varkappa^2 &= -1 \\ \varkappa^1 &= \varkappa \end{aligned} \quad (15)$$

Multiplying the symbolic expression $a + \varkappa b$ of an alternating electric wave by \varkappa^1 represents the retarding of the wave through one quadrant, that is one fourth cycle or 90° lag.

A wave of unit intensity, but delayed by one half cycle (phase opposition) lags behind the wave $a + \varkappa b$ by 180° . The power factor a and induction factor b have both become negative,

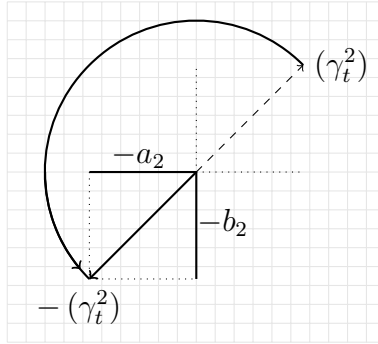

Figure 14: One half cycle delay (180° lag)

that is, reversed their polarity.

This wave is expressed symbolically as

$$-a - \varkappa b = -(\gamma_t^2) \quad (16)$$

Explicitly, the algebraic operation is given by

$$\varkappa^2(a + \varkappa b) = \varkappa^2 a + \varkappa^3 b \quad (17)$$

Hence, it is a property of \varkappa that

$$\varkappa^3 = -\varkappa^1 = -\varkappa \quad (18)$$

Multiplying the symbolic expression $a + \varkappa b$ of an alternating electric wave by \varkappa^2 represents the retarding of the wave through two quadrants, that is, one half cycle or 180° lag.

A wave of unit intensity, but delayed by three quarter cycles (negative phase quadrature) lags behind the wave $a + \varkappa b$ by 270° .

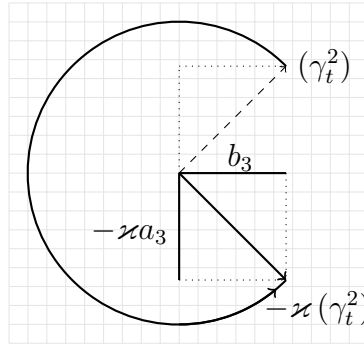

Figure 15: Three quarter cycle delay (270°lag)

The power factor a is translated into induction factor $-\varkappa a^3$. The induction factor b is translated into power factor b_3 .

The wave is expressed symbolically as

$$-\varkappa a + b = -\varkappa(\gamma_t^2) \quad (19)$$

Explicitly the algebraic operation is given by

$$\varkappa^3(a + \varkappa b) = -\varkappa^2 a + \varkappa^4 b \quad (20)$$

Hence, it is a property of \varkappa that

$$\varkappa^4 = +1 = \varkappa^0 \quad (21)$$

Multiplying the symbolic representation $a + \varkappa b$ of an alternating electric wave by \varkappa^3 represents the retarding of the wave through three quadrants, that is, three quarter cycles.

A wave of unit intensity, but delayed by a full cycle (phase conjunction) is in phase with the wave $a + \varkappa b$

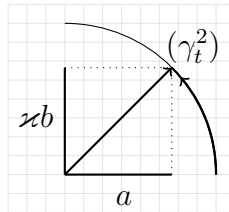

Figure 16: Full Cycle Delay (360°lag)

Thus no translations occur between the power and induction factors.

Explicitly the algebraic operation is given by

$$\varkappa^4(a + \varkappa b) = \varkappa^4 a + \varkappa^5 b \quad (22)$$

Hence it is a property of \varkappa that

$$\varkappa^5 = \varkappa^1 \quad (23)$$

Multiplying the symbolic expressions $a + \varkappa b$ of an alternating electric wave by \varkappa^4 represents the retarding of the wave through one full cycle and thus leaves the wave unaltered.

A wave of unit intensity, but advanced by one quarter cycle (negative phase quadrature) leads ahead of the wave $a + \varkappa b$ by $+90^\circ$.

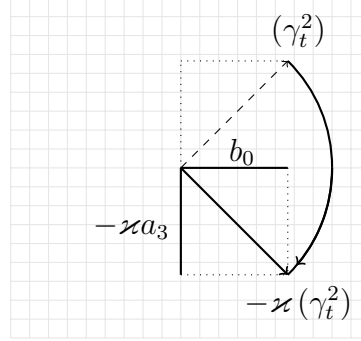

Figure 17: Quarter Cycle Lead (90° lead)

It is seen that this is exactly the same as the wave portrayed by figure 15, and is symbolized by equation (19).

$$-\varkappa a + b = -\varkappa(\gamma_t^2) \quad (19)$$

However the explicit algebraic operation is given by

$$\frac{1}{\varkappa}(a + \varkappa b) = \frac{a}{\varkappa} + b \quad (24)$$

Hence it is a property of \varkappa that

$$\frac{1}{\varkappa} = \varkappa^3 = \varkappa^{-1} = -\varkappa^1 \quad (25)$$

Dividing the symbolic expression $a + \varkappa b$ of an alternating electric wave by \varkappa^1 represents the advancing the wave through one complete quadrant, that is, one quarter cycle, and is directly equivalent to multiplying the symbolic expression $a + \varkappa b$ by \varkappa^3 .

A wave of unit intensity, but advanced by one half cycle (phase opposition) leads ahead of the wave $a + \varkappa b$ by 180° . This produces exactly the wave of figure 14, and is symbolized by equation (16)

$$-a - \varkappa b = -(\gamma_t^2) \quad (16)$$

However, the explicit algebraic operation is given by

$$\frac{1}{\varkappa^2}(a + \varkappa b) = \varkappa^{-2}a + \varkappa^{-1}b \quad (26)$$

Hence it is a property of \varkappa that

$$\frac{1}{\varkappa^2} = \varkappa^2 = \varkappa^{-2} \quad (27)$$

Multiplying or dividing the symbolic expression $a + \varkappa b$ of an alternating electric wave by \varkappa^2 represents the inversion of the wave, that is, either advancing or retarding the wave through one half cycle, or simply reversing its sense.

Therefore if we define the heretofore meaningless symbol, \varkappa , by the condition

$$\varkappa^4 = +1 \quad (21)$$

we arrive at

$$\begin{aligned}\varkappa^n &= \sqrt[4]{+1} = 1^{1/4} \\ n &= 0, 1, 2, 3 \dots\end{aligned}\quad (28)$$

and

$$\begin{aligned}\varkappa^0 &= +1 \\ \varkappa^1 &= \varkappa \\ \varkappa^2 &= -1 \\ \varkappa^3 &= \varkappa^{-1}\end{aligned}\quad (29)$$

The symbol \varkappa^n is a *versor operator* where \varkappa is the axis and n is the amount of turning around the axis \varkappa . Since the rotational unit in this case is $\pi/2$, or a quarter cycle, the symbol is more correctly given as \varkappa_4^n

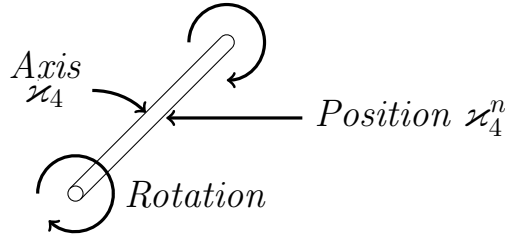

Figure 18: Versor operator \varkappa_4^n

Thus the quadrantal versor operator \varkappa_4^n serves as a fundamental symbolic representation of the alternating current wave:

$$+(\gamma_t^2) = a + \varkappa b \quad (30a)$$

$$-(\gamma_t^2) = -a - \varkappa b \quad (30b)$$

Hence

$$\begin{aligned}\varkappa_4^n &= (\gamma_t^4) = \varkappa^{0,2}a + \varkappa^{1,3}b \\ n &= 0, 1, 2, 3 \dots\end{aligned}\quad (31)$$

4.4 Characteristics of the Versor Operator - \varkappa_4^n

The algebraic operation, $1^{1/4}$, represents a quartic equation and thus has four distinct roots which may be grouped into a pair of quadratics:

$$(+1)^{1/2} = +1 \quad , \quad -1 \quad (32a)$$

$$(-1)^{1/2} = +j \quad , \quad -j \quad (32b)$$

where the unit root $+j$ is often taken as the square root of minus one which is only partially true since $-j$ is also a root.

Hence the four unit roots are:

$$\begin{array}{ll} 0) +1 & 1) +j \\ 2) -1 & 3) -j \end{array} \quad (33)$$

All four roots are imaginary[10] numbers, however the root +1 is usually taken as the reference root, and called a real number. These four roots represent unit versors, that is, unit amounts of change in angular time position around an axis \varkappa .

For a continuing number of cycles, the characteristics of the versor operator \varkappa_4^n are given by

Table 1: Versor Characteristics

\varkappa_4^{4m+0}	=	\varkappa^0	=	+1	+1	=	1	$n = 0, 4, 8, 12, \dots$
\varkappa_4^{4m+1}	=	\varkappa^1	=	+j	+j	=	1	$n = 1, 5, 9, 13, \dots$
\varkappa_4^{4m+2}	=	\varkappa^2	=	-1	+1	=	1	$n = 2, 6, 10, 14, \dots$
\varkappa_4^{4m+3}	=	\varkappa^3	=	-j	-j	=	1	$n = 3, 7, 11, 15, \dots$

m = numbers of complete (360°) cycles of revolution.

These symbols represent the following electric constants

\varkappa^0 coefficient of energy consumption

magnetic part — resistance in Ohms, R

dielectric part — conductance in Mhos, G

\varkappa^1 coefficient of magnetic energy storage

Henrys per second — reactance X

” coefficient of dielectric energy return

Farads per second — susceptance B

\varkappa^2 coefficient of energy production

magnetic part — resistance in negative Ohms, H

dielectric part — acceptance in negative Mhos, S

\varkappa^3 coefficient of dielectric energy storage

Farads per second — susceptance, B

” coefficient of magnetic energy return

Henrys per second — reactance X

The complete expression of the alternating electric wave is thus

$$(\gamma_t^4) = (\varkappa^0 a_i + \varkappa^2 a_{ii}) + (\varkappa^1 b_i + \varkappa^3 b_{ii}) \quad (34)$$

where

a_i is the coefficient of the power factor representing energy consumption

a_{ii} is the component of the power factor representing energy production

b_i is the component of the induction factor representing energy storage and return

b_{ii} is the component of the induction factor representing energy return and storage

There is a rotation sense of versor operations:

Table 2: Rotation Sense

$+x_4^1 = +j$	$+x_4^{-1} = x_4^3 = -j$
$+x_4^2 = -1$	$+x_4^{-2} = x_4^2 = -1$
$+x_4^3 = -j$	$+x_4^{-3} = x_4^1 = +j$
$+x_4^4 = +1$	$+x_4^{-4} = x_4^0 = +1$
$-x_4^1 = -j$	$-x_4^{-1} = x_4^1 = +j$
$-x_4^2 = +1$	$-x_4^{-2} = x_4^0 = +1$
$-x_4^3 = +j$	$-x_4^{-3} = x_4^3 = -j$
$-x_4^4 = -1$	$-x_4^{-4} = x_4^2 = -1$

forward rotation

reverse rotation

Re-summarizing:

Table 3: Quadrature Rotations

$$\begin{aligned}
 (-x)^4 &= +1 & (-x)^3 &= +j \\
 (-x)^2 &= -1 & (-x)^1 &= -j
 \end{aligned}$$

4.5 Trigonometric and Exponential Equivalents for the versor

Trigonometric and exponential (natural) equivalents in trigonometric form for the versor operator x_4^n is given by the following relations.

$$\begin{aligned}
 x_4^n &= 1^{\frac{1}{4}} \\
 &= (+1)^{1/2} = +\cos(n_0), -\cos(n_0) \\
 &\quad \text{and} \\
 &= (-1)^{1/2} = +\sin(n_0), -\sin(n_0)
 \end{aligned} \tag{35}$$

where $n_0 = \frac{\pi}{2}n$;

Hence

$$x_4^n = x^0 \cos(n_0) + x^1 \sin(n_0) + x^2 \cos(n_0) + x^3 \sin(n_0) \tag{36}$$

Substituting equation (34) into (36) gives

$x^0 \cos n_0 = +\cos n_0 = +a_i$	energy consumption
$x^2 \cos n_0 = +\cos n_0 = -a_{ii}$	energy production
$x^1 \sin n_0 = +\sin n_0 = +b_i$	energy storage/return
$x^3 \sin n_0 = -\sin n_0 = -b_{ii}$	energy return/storage

It can be seen that energy consumption and production is represented by the *even function* while energy storage and return by the *odd function*, hence

$$\begin{aligned}
0) \quad +\cos n_0 &= +1 - \frac{n_0^2}{2!} + \frac{n_0^4}{4!} - \frac{n_0^6}{6!} + \dots \\
2) \quad -\cos n_0 &= -1 + \frac{n_0^2}{2!} - \frac{n_0^4}{4!} + \frac{n_0^6}{6!} - \dots \\
1) \quad +\sin n_0 &= +n_0 - \frac{n_0^3}{3!} + \frac{n_0^5}{5!} - \frac{n_0^7}{7!} + \dots \\
3) \quad -\sin n_0 &= -n_0 + \frac{n_0^3}{3!} - \frac{n_0^5}{5!} + \frac{n_0^7}{7!} - \dots
\end{aligned} \tag{37}$$

Substituting into equation (3), the exponential equations:

$$\pm \cos n_0 = \pm \frac{1}{2} [\epsilon^{+jn_0} + \epsilon^{-jn_0}] \tag{38}$$

$$\pm \sin n_0 = \pm \frac{1}{2} [\epsilon^{-jn_0} - \epsilon^{+jn_0}] \tag{39}$$

which gives

$$\varkappa_4^n = \epsilon^{\pm jn_0} = \epsilon^{\sqrt[4]{1}jn_0} \tag{40}$$

Thus the versor operator \varkappa_4^n also serves as the basis of imaginary logarithms and eliminates the necessity of utilizing the square root of minus one in the exponent when expressing an alternating electric wave in exponential form. It is then also possible for n to be of non-integer value, allowing for the expression of heretofore unexplored electric waves.

5 Non-Quadrature Operators

The previously described methods of representing alternating, or cyclic, electric waves which were based on four divisions can be applied to cyclic divisions other than four. One such electric wave is the three-phase wave utilized for power transmission and conversion in common use.

Since extensive analysis is not possible without going beyond the scope of this paper, only an outline of a few important special cases of interest; the non-rotating operator of double division \varkappa_2 which may be called the D.C. operator, the triple phase operator \varkappa_3 associated with conventional polyphase power, and the double quadrature operator \varkappa_8 .

5.1 D.C. Operator - \varkappa_2^n

The operator \varkappa_2^n represents an electric wave possessing no induction factor but only the power factor thereby representing a time invariant wave or a wave in which there is no energy storage and return. The \varkappa_2^n represents a wave that does not vary with respect to time but is continuous, that is, direct current.

Conversely however, \varkappa_2^n can represent an electric wave possessing no power factor but only the induction factor thereby representing continuous energy pulsation between magnetic and dielectric form or a single phase A.C. load into a resistive load.

In algebraic form

$$\varkappa_2^n = \sqrt[2]{+1} = 1^{1/2} \quad \text{for } n = 0, 1 \quad (41)$$

thus two roots

$$\begin{aligned} \varkappa_2^0 &= +1 &= + & \quad | + | = 1 \\ \varkappa_2^1 &= -1 &= - & \quad | - | = 1 \end{aligned} \quad (42)$$

hence the positive and negative of direct current.

For the representation of energy pulsation it is

$$\varkappa_{-2}^n = \sqrt[2]{-1} = (-1)^{1/2} \quad \text{for } n = 0, 1 \quad (43)$$

thus the two roots

$$\begin{aligned} \varkappa_{-2}^0 &= +j && \text{phase A} \\ \varkappa_{-2}^1 &= -j && \text{phase B} \end{aligned} \quad (44)$$

which are positive and negative phases.

Exponentially the operator \varkappa_2^n is expressed as

$$\epsilon^{\pm n_0} = \varkappa_2^n \quad (45)$$

where

$$n_0 = \pi n \quad (46)$$

Expressing the basis of natural logarithms, ϵ as an infinite series gives:

$$\epsilon^1 = 1 + \frac{1}{1!} + \frac{1}{2!} + \frac{1}{3!} + \dots \quad (47)$$

Separating the even terms from the odd terms gives

$$\begin{aligned} \epsilon^1 &= 1 + \frac{1}{2!} + \frac{1}{4!} + \frac{1}{6!} + \dots \\ &+ \frac{1}{1!} + \frac{1}{3!} + \frac{1}{5!} + \frac{1}{7!} + \dots \end{aligned} \quad (48)$$

But it is (the sum of two series)

Even series = $\cosh 1$

Odd series = $\sinh 1$

hence

$$\begin{aligned} \varkappa_2^n &= \epsilon^{\pm n_0} \\ &= \cosh(n_0) + \sinh(n_0) \\ &= \cosh(n_0) - \sinh(n_0) \end{aligned} \quad (49)$$

and the symbolic expression of the electric wave is thereby given by

$$(\gamma_t^2) = (a_i - a_{ii}) \quad (50)$$

or alternately $(\gamma_t^2) = (b_i - b_{ii})$.

5.2 Triple Phase Operator - \varkappa_3^n

The triple phase operator \varkappa_3^n represents an electric wave possessing three factors which are partially induction factors and partially power factors, thus this form of wave produces phenomena of which there exist little to no theoretical understanding, only the most basic relations are given here.

In algebraic form

$$\varkappa_3^n = \sqrt[3]{+1} = 1^{1/3} \quad (51)$$

$$(\gamma + t^3) = \varkappa_3^0 A + \varkappa_3^1 B + \varkappa_3^2 C \quad (51a)$$

$$\begin{aligned} \varkappa_3^0 &= \iota_0 = \varkappa_3^{3m+0} & n = 0, 3, 6, 9, \dots & |\iota_0| = 1 \\ \varkappa_3^1 &= \iota_1 = \varkappa_3^{3m+1} & n = 1, 4, 7, 10, \dots & |\iota_0| = 1 \\ \varkappa_3^2 &= \iota_2 = \varkappa_3^{3m+2} & n = 2, 5, 8, 11, \dots & |\iota_0| = 1 \end{aligned} \quad (52)$$

All three roots are imaginary numbers and if ι_0 is taken as reference, it is

$$\iota_0 = +1 \quad (53)$$

and -1 is no longer a unit amount of variation. Thus the conventional concepts of plus (+) and minus (-) no longer are applicable.

The expression of $\varkappa + 3^n$ in quadrature form gives[16]

$$\begin{aligned} \varkappa_3^0 &= j_0 = +1 \\ \varkappa_3^1 &= j_1 = -\frac{1}{2} \left[1 - j\sqrt[2]{3} \right] \\ \varkappa_3^2 &= j_2 = -\frac{1}{2} \left[1 + j\sqrt[2]{3} \right] \end{aligned} \quad (54)$$

and

$$\varkappa_3^n = \varkappa_4^{0,2} \cos\left(\frac{2}{3}\pi n\right) + \varkappa_4^{1,3} \sin\left(\frac{2}{3}\pi n\right) \quad (55)$$

Unlike the versor operators \varkappa_2^n and \varkappa_4^n , the operator \varkappa_3^n cannot be expressed directly in trigonometric form, but requires three new trigonometric functions. Also this operator cannot be expressed in the basis of natural logarithms but requires a new logarithm base.

5.3 Octic or Double Quadrature Operator \varkappa_8^n

The octic or double quadrature operator \varkappa_8^n is of particular interest in that it is involved in symbolic representation of aperiodic electric waves such as impulse currents, and of non-linear conditions such as the distortion of waves by the skin effect.

Algebraically it is,

$$\varkappa_8^n = \sqrt[8]{+1} = 1^{1/8} \quad (56)$$

The algebraic operation $1^{1/8}$ represents an octic equation and thus has eight roots. These roots may be grouped into a pair of quartic equations

$$(+1)^{1/4} = \left. \begin{array}{l} +1, \quad -1 \\ +j, \quad -j \end{array} \right\} = \varkappa_4^n \quad (57)$$

$$(-1)^{1/4} = \left. \begin{array}{l} +h, \quad -h \\ +jh, \quad -jh \end{array} \right\} = \varkappa_{-4}^n = h_4^n \quad (58)$$

As shown in figure (18) these two quartic systems are displaced by 45° , or $\pi/4$ radian, angle. Equation (57) has \varkappa for an axis of rotation and equation (58) has h for an axis[11], which is co-axial with the axis \varkappa .

The symbol \varkappa_8^n represents unit versors in multiples of one-eighth period, hence

Table 4: Octic Versors

$$\begin{aligned}
 \varkappa_8^1 &= \varkappa_4^{1/2} = h^1 = +h \\
 \varkappa_8^2 &= \varkappa_4^1 = h^2 = +j \\
 \varkappa_8^3 &= \varkappa_4^{3/2} = h^3 = +jh \\
 \varkappa_8^4 &= \varkappa_4^2 = h^4 = -1 \\
 \varkappa_8^5 &= \varkappa_4^{5/2} = h^5 = -h \\
 \varkappa_8^6 &= \varkappa_4^3 = h^6 = -j \\
 \varkappa_8^7 &= \varkappa_4^{7/2} = h^7 = -jh \\
 \varkappa_8^8 &= \varkappa_4^4 = h^8 = +1
 \end{aligned}$$

Thereby, the octic versor may be expressed as

$$\pm h = \sqrt[2]{j} \quad (59)$$

and thus h may be called the doubly imaginary unit.

In Quadrature form $(-1)^{1/4}$ is given by

$$\begin{aligned}
 h^1 &= \frac{1}{\sqrt[2]{2}} [+1 + j] \\
 h^3 &= \frac{1}{\sqrt[2]{2}} [+1 - j] \\
 h^5 &= \frac{1}{\sqrt[2]{2}} [-1 + j] \\
 h^7 &= \frac{1}{\sqrt[2]{2}} [-1 - j]
 \end{aligned} \quad (60)$$

Substituting equation (59) into the value of h^1 given in equation (60)

$$\sqrt[2]{2}h^1 = 1 + j \quad (61)$$

However

$$1 + j = \sqrt[2]{2}\sqrt[2]{j} \quad (62)$$

Hence

$$\pm h = \sqrt[2]{j} \quad (59)$$

As with the operator \varkappa_3^n , it is not possible to express \varkappa_8^n directly in trigonometric form. In terms of equation (60) the quadrature trigonometric form is given by

$$\varkappa_8^n = \varkappa^{0,2} \cos\left(\frac{\pi}{4}n\right) + \varkappa^{1,3} \sin\left(\frac{\pi}{4}n\right) \quad (63)$$

The operator \varkappa_8^n can be expressed in terms of the basis of natural logarithms, ϵ , giving rise to the infinite series expressions of a new set of functions applicable to \varkappa_8^n . Substituting the exponent h into the series for ϵ given in equation (47)

$$\epsilon^h = 1 + h^1 + \frac{h^2}{2!} + \frac{h^3}{3!} + \frac{h^4}{4!} + \dots \quad (64)$$

Substituting the values of table (4) for the powers of h into equation (64), and grouping like terms produces the infinite series expressions for the functions relating to \varkappa_8^n hence

$$\begin{aligned}
+\gamma_0 &= 1 - \frac{n_0^4}{4!} + \frac{n_0^8}{8!} - \frac{n_0^{12}}{12!} + \dots \\
+\gamma_i &= n_0 - \frac{n_0^5}{5!} + \frac{n_0^9}{9!} - \frac{n_0^{13}}{13!} + \dots \\
+\gamma_{ii} &= \frac{n_0^2}{2!} - \frac{n_0^6}{6!} + \frac{n_0^{10}}{10!} - \frac{n_0^{14}}{14!} + \dots \\
+\gamma_{iii} &= \frac{n_0^3}{3!} - \frac{n_0^7}{7!} + \frac{n_0^{11}}{11!} - \frac{n_0^{15}}{15!} + \dots \\
+\gamma_{iv} &= -\gamma_0 \\
+\gamma_v &= -\gamma_i \\
+\gamma_{vi} &= -\gamma_{ii} \\
+\gamma_{vii} &= -\gamma_{iii} \\
+\gamma_{viii} &= -\gamma_{iv}
\end{aligned} \tag{65}$$

thus the symbolic expression of the electric wave is given by

$$(\gamma_t^8) = \pm h^0 \gamma_0 \pm h^1 \gamma_i \pm h^2 \gamma_{ii} \pm h^3 \gamma_{iii} \tag{66}$$

Substituting table (4) and grouping like terms

$$(\gamma_t^8) = \left. \begin{aligned} &+1\gamma_0 + \mathcal{J}\gamma_{ii} + h\gamma_i + jh\gamma_{iii} \\ &-1\gamma_{iv} - \mathcal{J}\gamma_{vi} - h\gamma_v - jh\gamma_{vii} \end{aligned} \right\} \tag{67}$$

$$(\gamma_t^8) = +1(\pm\gamma_0 \pm \mathcal{J}\gamma_{ii}) + h(\pm\gamma_i \pm \mathcal{J}\gamma_{iii}) \tag{68}$$

$$(\gamma_t^8) = \alpha + h\beta, -\alpha - h\beta, \text{ etcetera} \tag{69}$$

It is of interest that this expression is of similar form to

$$(\gamma_t^2) = \alpha + jb, -\alpha - jb \tag{30a, 30b}$$

Therefore the factor α is similar to the power factor a , consisting of even terms, and the factor β is similar to the induction factor b , consisting of the odd terms.

Remembering even and odd terms of the series equations of (65)

$$(+\gamma_0 + \mathcal{J}\gamma_{ii}) = \alpha = 1 + j\frac{n_0^2}{2!} - \frac{n_0^4}{4!} + j\frac{n_0^6}{6!} - \dots \tag{65a}$$

$$(+\gamma_i + \mathcal{J}\gamma_{iii}) = \beta = n_0^1 - j\frac{n_0^3}{3!} + \frac{n_0^5}{5!} - j\frac{n_0^7}{7!} + \dots \tag{65b}$$

It is observed that these are quite similar in form to the conventional trigonometric functions, sine and cosine, excepting that internally the series terms are complex quantities.

5.4 Examples — Energy Consumption and Energy Production

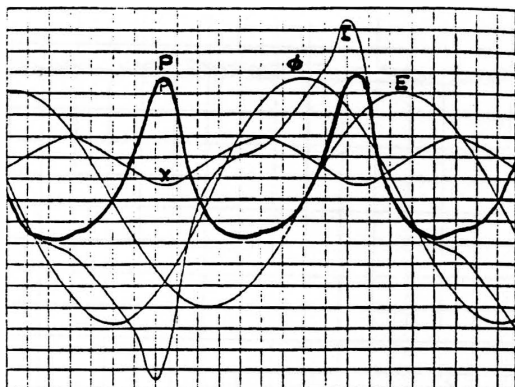

Figure 19: Variable Reactance, Reaction Machine

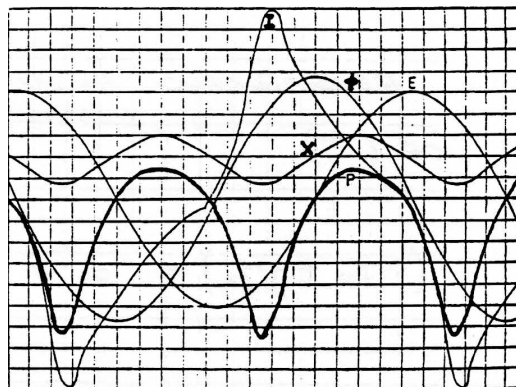

Figure 22: Variable Reactance, Reaction Machine

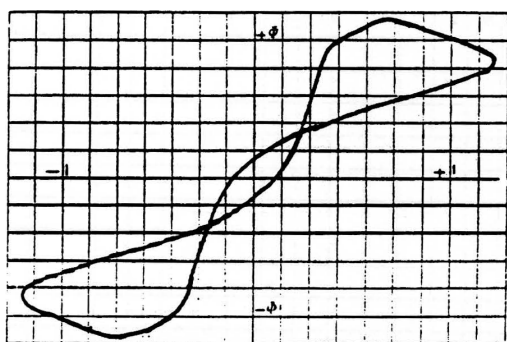

Figure 20: Hysteric Loss of Reaction Machine

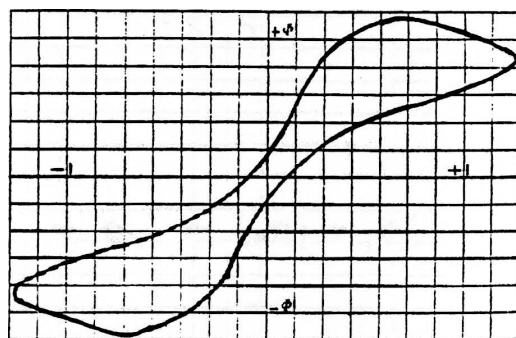

Figure 23: Hysteric Loss of Reaction Machine

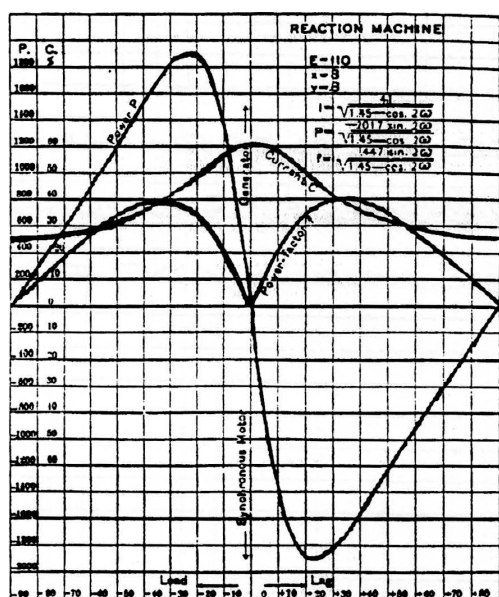

Figure 21: Reaction Machine

Rotating Apparatus exhibiting
Canonic Electric waves —

- Figures (19) and (20):
- Production of Electric Energy
- Figures (22) and (23):
- Consumption of Electric Energy
- Figure (21):
- Composite

6 Canonic Electric Waves

6.1 Generalized Versor Operator Form

From the proceeding sections, it can be concluded that the generalized versor operator is given as

$$\varkappa_N^n = 1^{1/N} \quad (70)$$

where

\varkappa	is the axis of rotation
N	is the number of unit divisions
n	is the specific amount of variation

If the number of divisions N is a power of 2, the wave can be expressed in terms of log base ϵ otherwise a new basis of logarithms is required.

In quadrature trigonometric form the generalized versor operator is of the form

$$\varkappa_N^n = \varkappa_4^{0,2} \cos\left(2\pi \frac{n}{N}\right) + \varkappa_4^{1,3} \sin\left(2\pi \frac{n}{N}\right) \quad (71)$$

The operator \varkappa_N^n represents the division of the alternating wave into N units of variation through the cycle, thus the generalized symbolic expression of the electric wave is divided into N factors,

$$(\gamma_t^N) = A\varkappa_N^0 + B\varkappa_N^1 + C\varkappa_N^2 + \cdots + N\varkappa_N^{N-1} \quad (72)$$

6.2 Imposition Produces Interference Patterns

Since the alternating electric wave is characteristically of quadrantal, or four pole, form, \varkappa_4^n , the four characteristics basically being,

Table 5: Four Characteristics of Alternating Electric Waves

0)	Resistance, Ohms	+1	R
1)	Reactance, Henrys/sec	+j	X
2)	Acceptance, Mhos	-1	S
3)	Susceptance, Farads/sec	-j	B

then establishing electric waves in systems of angular division other than quadrantal, such as triple phase, produces a type of interference pattern between the natural form of the wave and the form imposed on it by the given system. This produces partial interchanges between the four fundamental characteristics of the natural electric wave producing unique products such as non-inductive reactance, that is, the storage of energy with no accompanying electric field; or inductive acceptance, that is, the growth of an electric wave with no apparent supply of energy[17]. This would appear as a violation of the law of energy conservation, however these phenomena do occur in practical situations and are in need of theoretical explanation.

6.3 Quadrantal Multiplication and Canonic Electric Waves

It was seen towards the beginning of the paper that multiplication of the alternating electric wave

$$a + \varkappa b \tag{9}$$

by the quadrantal versor \varkappa resulted in the power factor a becoming an induction factor b , and the induction factor b becoming a power factor a , hence the four characteristics have been shifted by one quarter cycle and assume the form given in table (6)

Table 6: Quarter-Shifted Quadrantal Properties

- 0) Inductive Resistance, (Farads/sec)⁻¹
- 1) Non-Inductive Reactance, Ohms
- 2) Inductive Acceptance, (Henrys/sec)⁻¹
- 3) Non-Inductive Susceptance, Mhos

thus, complete interchange of the four characteristics. This multiplication, or modulation of one wave by another wave of the same number of divisions, produces what may be called *canonic* electric waves, after the process in music where one melody is combined with itself delayed by a given number of divisions of the measure, producing harmony by interference with itself. This process is the underlying principle behind the synchronous condenser, hysteresis motor, and parametric amplifier. The means for producing this phenomena is called *synchronous parameter* variation[18] and is the principle behind what is often called “free energy” which hence is quite possible if not certain. More on this will be given in Part III on Hysteresis.

7 Transient Waves

7.1 Introduction to Transient Waves

In the previous section the electric waves vary in magnitude between constant maximum and minimum values, that is, in equal intervals of elapsed time the wave repeats the same magnitude, thus the waves are continuous waves (C.W.) having constant period and effect (R.M.S.) amplitude and the alternating electric wave is in reality a rotating direct current, with single phase and double phase being a sine or cosine projection thereof.

Transient electric waves however are discontinuous waves having magnitude that grow or decay with respect to time, appearing as intermediate between two continuous conditions. The appearance of transient waves is the result of changes within the electric system requiring a change in the stored energy[21] of the system, the capacitor discharge being an example. In electric systems where cause and effect are in direct proportion, as is generally the case in most systems which possess no magnetic saturation or dielectric saturation (corona, etc.), the magnitude of the transient wave varies in constant geometric progression. Since the constant periodic progression of the alternating electric wave has been reduced to a constant numerical value through the use of the symbolic method of representation it must be possible to express the constant geometric progression of the transient wave in a similar symbolic form. This

introduces the concept of the compound imaginary number, which serves as an expression of the transient wave.

Since the symbolic representation of the transient waves is still under development by the writer, the following material is somewhat incomplete, however it should serve as a suitable starting point for the study of these waves.

7.2 Starting Point Equation for Transients

The symbolic expression of an alternating wave

$$(\gamma_t^2) = a + jb \quad \text{percent} \quad (73)$$

is equivalent to the known equation of Oliver Heaviside (for no spatial variation)[5]

$$(\gamma_t^2) = (RG + XB) + j(XG - RB) \quad (74)$$

$$(\gamma_t^2) = \dot{Z}\dot{Y} \quad \text{percent} \quad (75)$$

hence

$$a = (RG + XB) \quad \text{power factor, percent} \quad (76)$$

$$b = (XG - RB) \quad \text{induction factor, percent} \quad (77)$$

It is however

$$(RG + XB) \quad , \quad \text{continuous wave}$$

$$(XG - RB) \quad , \quad \text{transient wave}$$

where XG and RB are the magnetic and dielectric time constants respectively in nepers per radian. Thus equation (77) serves as a starting point in the study of transient waves.

7.3 Algebraic Representation of Generalized Electric Wave

Since the symbolic expression of equation (73) is but one quadrant of the complete wave, it is of interest to extend equation (74) to cover all four quadrants. The general form is

$$(\gamma_t^4) = \dot{Z}\dot{Y} \quad (75a)$$

where the quantities of \dot{Z} and \dot{Y} now include energy production as energy consumption. Substituting the electric characteristics of figures (9) and (10) into the equations of \dot{Z} and \dot{Y} gives

$$\dot{Z} = \varkappa^0 R + \varkappa^1 X + \varkappa^2 H \quad \text{impedance in complex Ohms} \quad (78)$$

$$\dot{Y} = \varkappa^4 G + \varkappa^3 B + \varkappa^2 S \quad \text{admittance in complex Mhos} \quad (79)$$

where

$$R = \text{Resistance} \quad (\text{amperes})$$

$$G = \text{Conductance} \quad (\text{volts})$$

$$X = \text{Reactance} \quad (\text{amperes})$$

$$B = \text{Susceptance} \quad (\text{volts})$$

$$H = \text{Receptance} \quad (\text{amperes})$$

$$S = \text{Acceptance} \quad (\text{volts})$$

hence

$$\begin{aligned} \dot{Z}\dot{Y} = (\gamma_t^4) = & [(RG + XS) - (RS + HG) + XB] + j[(XG - RB) - (XS - HB)] \\ & = a_0 + jb_0 \quad \text{percent} \quad (80) \end{aligned}$$

This equation serves as an algebraic representation of the generalized electric wave (time) and may be divided into three groups:

- | | | |
|----|-------------------------|----------------|
| 0) | $(RG + HS) - (RS + HG)$ | scalar product |
| 1) | XB | axial product |
| 2) | $(XG - RB) - (XS - HB)$ | cross products |

It is of interest to note that group (0) is similar in form to equation (74) possessing the form of a wave but scalar in that all of its constituent parts are time invariant quantities[19]. This wave thus may be called a D.C. wave or scalar wave. Group (1) represents the continuous pulsation of energy between the two opposite forms of energy storage, the form due to amperes “through” reactance X and the form due to volts “across” susceptance B . Typically this is the magnetic and dielectric fields respectively. Such a pulsation would occur if a capacitor of zero leakage was exchanging energy with a reactance coil of perfect conductivity, the stored energy in the system would endlessly pulsate between the two forms, the magnetic field and the dielectric field.

Group (2) represents the production or consumption of either of the two forms of stored energy;

- | | |
|-------|--|
| XG | consumption of magnetic energy by conductance, G |
| $-RB$ | consumption of dielectric energy by resistance, R
and in phase opposition with XG (-) |
| XS | production of magnetic energy by acceptance, S |
| $-HB$ | production of dielectric energy by receptance, H
and in phase opposition with XS (-) |

7.4 The Wave Equation and Transients

If the arithmetic mean of the generalized electric wave is zero, the wave equation becomes

$$(\gamma_t^4) = X \cdot B \quad (81)$$

$$\begin{aligned} (R \cdot G + X \cdot S) = 0 & \quad (R \cdot S + H \cdot G) = 0 \\ (X \cdot G - R \cdot B) = 0 & \quad (X \cdot S - H \cdot B) = 0 \end{aligned}$$

hence continuous energy pulsation with no gain or loss of energy.

If the arithmetic mean of the wave differs from zero, the wave equation becomes

$$\begin{aligned} (\gamma_t^4) &= [(R \cdot G + X \cdot S) - (R \cdot S + H \cdot G) + X \cdot B] \quad (82) \\ (X \cdot G - R \cdot B) &= (X \cdot S - H \cdot B) \end{aligned}$$

hence the flow of alternating electric energy, where

$$(R \cdot G + H \cdot S) > (R \cdot S + H \cdot G)$$

indicates energy consumption, and

$$(R \cdot G + H \cdot S) > (R \cdot S + H \cdot G)$$

indicates energy production.

An important class of electric wave is one in which the quantity

$$(X \cdot G - R \cdot B) - (X \cdot S - H \cdot B)$$

is non-zero. This condition results from the rate of energy consumption differing from the rate of energy production, distorting the waveform. This produces electric waves that grow or decay with respect to time. Such waves are transient electric waves. These waves are characterized by having a frequency or period that is a complex quantity consisting of real and imaginary components.

$$\dot{\nu} = (\omega - j\nu) \quad \text{neper-radians/sec} \quad (83)$$

The real component of the complex frequency ω in radians per second represents the cyclic period of revolution in which the wave repeats the same minimum value of amplitude in equal time intervals. The imaginary component ν , in nepers per second, represents the acyclic period of evolution in which the maximum value of amplitude increases or decreases at a constant geometric rate.

Transient electric waves may be divided into two categories, those waves which repeat the minimum value of amplitude in equal intervals of time, and those waves which do not repeat any value of amplitude more than once.

The former category of wave is called an *oscillating* electric wave. This wave is characterized by the condition

$$|a_0| > |b_0| \quad (84)$$

The latter category of wave is called an electric impulse and is characterized by the condition

$$|a_0| < |b_0| \quad (85)$$

A particular characteristic of the transient electric wave is the displacement of the maximum value of the wave from the point of maximum of an equivalent alternating wave as shown in figure (24). The angle of displacement is given by

$$\theta_0 = \arctan \left(\frac{b_0}{a_0} \right) \quad (86)$$

with

$$\begin{aligned} \theta_0 > 45^\circ, & \text{ oscillation} \\ \theta_0 < 45^\circ, & \text{ impulse} \end{aligned}$$

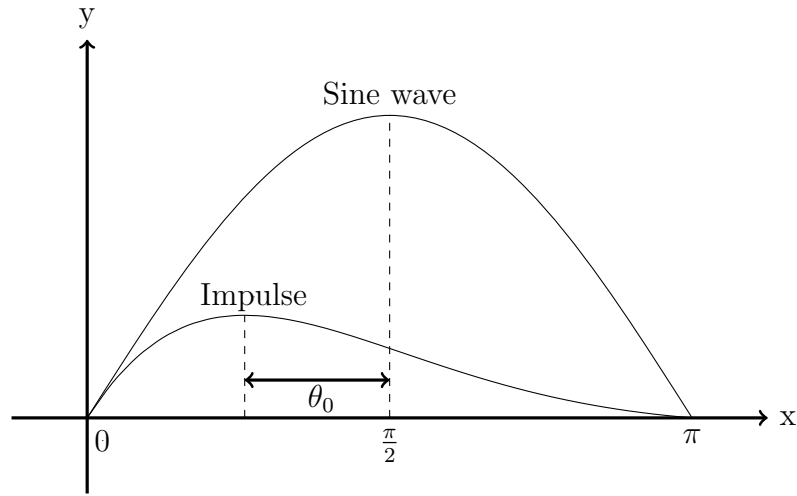

Figure 24: Comparison of Transient and Continuous Waves

7.5 Exponential Representation of the Alternating Electric Wave

The exponential representation of the alternating electric wave is given by

$$\epsilon^{\pm j\beta} = \cos(\beta) \pm j \sin(\beta) \quad (87)$$

where the angle β represents the time position of revolution.

Analogously, the wave of geometric progression is given by

$$\epsilon^{\pm 1\alpha} = \cosh(\alpha) \pm j^2 \sinh(\alpha) \quad (88)$$

where the angle α represents the time position of evolution.

Since the transient wave is the product of the period of revolution and evolution, the exponential representation is given by

$$\epsilon^{\pm 1\alpha} \epsilon^{\pm j\beta} = \epsilon^{\pm 1\alpha \pm j\beta} \quad (89)$$

since the quantity

$$\alpha + j\beta$$

is a complex quantity, it can be expressed in symbolic representation

$$\varkappa_1^{\theta_1} = \pm \alpha \pm j\beta \quad (90)$$

where the subscript 1 in \varkappa_1 does not indicate the base, since base four is assumed, but however distinguishes the axis from that of \varkappa in the previous calculations.

Substituting the relation

$$\epsilon^{j\frac{\pi}{2}} = \varkappa^1$$

and

$$\begin{aligned} n_{10} &= \frac{\pi}{2} n_1 \\ n_0 &= \frac{\pi}{2} n \end{aligned}$$

into equations (89) and (40) gives

$$\epsilon^{(\pm\alpha\pm j\beta)n_0} = \epsilon^{\varkappa_1^{\theta_1} n_0} = \varkappa^{\varkappa_1^{n_1}} \quad (91)$$

where both versors[12] are assumed base four (\varkappa_4).

Equation (91) is called a hyper-complex quantity in that it possesses a complex quantity within a complex quantity. Obviously this could be carried indefinitely

$$\varkappa^{\varkappa_1^{n_1 \varkappa_1^{n_{ii}} \dots}}$$

producing exceedingly complex waveforms.

This equation (91) serves as a basic symbolic expression of the generalized transient electric wave for the condition of direct correlation between cause and effect. This representation indicates variation within variation of the wave.

Substituting

$$\varkappa_1^{n_1} = \varkappa_1^{0,2} \cos(n_{10}) + \varkappa_1^{1,3} \sin(n_{10})$$

into equation (91) gives

$$\varkappa^{n(\varkappa_1^{0,2} \cos(n_{10}) + \varkappa_1^{1,3} \sin(n_{10}))} \quad (92)$$

$$= \varkappa^{n\varkappa_1^{0,2} \cos(n_{10})} \times \varkappa^{n\varkappa_1^{1,3} \sin(n_{10})} \quad (93)$$

and

$$\varkappa^{n\varkappa_1^{0,2} \cos(n_{10})} = \varkappa^{0,2} \cos(n_{10}\varkappa^{0,2} \cos(n_{10})) + \varkappa^{1,3} \sin(n_{10}\varkappa^{0,2} \cos(n_{10})) \quad (94)$$

$$\varkappa^{n\varkappa_1^{1,3} \sin(n_{10})} = \varkappa^{0,2} \cosh(n_{10}\varkappa^{0,2} \sin(n_{10})) + \varkappa^{1,3} \sinh(n_{10}\varkappa^{0,2} \sin(n_{10})) \quad (95)$$

Substituting: $\cos(n_{10}) = a_1$
 $\sin(n_{10}) = b_1$

and combining equations (94) and (95) gives

$$\begin{aligned} &+ 1 [\cos(a_1 n_{10}) \cosh(b_1 n_{10}) - \sin(a_1 n_{10}) \sinh(b_1 n_{10})] \\ &+ j [\cos(a_1 n_{10}) \sinh(b_1 n_{10}) - \sin(a_1 n_{10}) \cosh(b_1 n_{10})] \end{aligned} \quad (96)$$

substituting $a_1 n_{10} = \theta_a$ and $b_1 n_{10} = \theta_b$ gives:

$$[\cosh(\theta_b) (\cos(\theta_a) - j \sin(\theta_a))] + j [\sinh(\theta_b) (\cos(\theta_a) - j \sin(\theta_a))] \quad (97)$$

and substituting

$$\varkappa_0^\theta = \cos(\theta_a) - j \sin(\theta_a)$$

gives

$$\varkappa_0^\theta [\cosh(\theta_b) + j \sinh(\theta_b)] \quad (98)$$

and putting

$$\begin{aligned} \varkappa_0^\theta \cosh(\theta_b) &= A \\ \varkappa_0^\theta \sinh(\theta_b) &= B \end{aligned}$$

Hence

$$(\gamma_t^4) = A + jB \quad (99)$$

and thus the symbolic expression of the generalized electric wave.

$$\varkappa^{n\varkappa_1^{n_1}} \quad \begin{cases} \varkappa^n & \text{primary quadrantal versor} \\ \varkappa_1^{n_1} & \text{secondary quadrantal versor} \end{cases}$$

n time angle (in quadrants) of position along the wave

n_1 time angle (in quadrants) of phase distortion of the wave, a function of θ_α

7.6 Special Cases of the Exponential Form

If the angle n_{10} is zero, then $n_1 = 0$ and

$$\begin{aligned} \varkappa_1^0 &= +1 \\ \varkappa^{+1n} &= \varkappa^{0,2} \cos(n_0) + \varkappa^{1,3} \sin(n_0) \end{aligned} \quad (100)$$

This equation is the representation of a forward rotating alternating electric wave.

If the angle n_{10} is one quadrant ($\frac{\pi}{2}$ radians), then $n_1 = 1$ and

$$\begin{aligned} \varkappa_1^1 &= +j \\ \varkappa^{+jn} &= \varkappa^{0,2} \cosh(n_0) - \varkappa^{1,3} \sinh(n_0) \end{aligned} \quad (101)$$

This equation is the representation of a decaying electric impulse and a direct current.

If the angle n_{10} is two quadrants (π radians), then $n_1 = 2$ and

$$\begin{aligned} \varkappa_1^2 &= -1 \\ \varkappa^{-1n} &= \varkappa^{0,2} \cos(n_0) = \varkappa^{1,3} \sin(n_0) \end{aligned} \quad (102)$$

This equation is the representation of a backward rotating alternating electric wave.

If the angle n_{10} is minus one quadrant ($\frac{3\pi}{2}$ radians), then $n_1 = 3$ and

$$\begin{aligned} \varkappa_1^3 &= -j \\ \varkappa^{-jn} &= \varkappa^{0,2} \cosh(n_0) + \varkappa^{1,3} \sinh(n_0) \end{aligned} \quad (103)$$

This equation is the representation of a growing electric impulse and a direct current.

If the angle n in equation (101) is one quadrant ($\frac{\pi}{2}$), then $n = 1$ and

$$\varkappa^{jn} = \varkappa^{j1} = j^j \quad (101a)$$

since

$$\varkappa^{jn} = \epsilon^{-n_0}$$

it is

$$\varkappa^{jn} \quad \text{for } n = 1 = j^j = \epsilon^{-\frac{\pi}{2}} \approx 0.2078795763 \dots \quad (101a)$$

If the angle n in equation (101) is two quadrants (π), then $n = 2$ and

$$\varkappa^{j^2} = \epsilon^{-\pi} \approx 0.04321391826 \dots \quad (101b)$$

If the angle n in equation (101) is minus one quadrant ($\frac{3\pi}{2}$), then $n = 3 = -1$ and

$$\varkappa^{-j} = j^{-j} = \epsilon^{+\frac{\pi}{2}} \approx 4.8104773809 \dots \quad (101c)$$

If the angle n in equation (101) is zero, then $n = 0$ and

$$\varkappa^{j0} = \varkappa^0 = \epsilon^0 = +1 \quad (101d)$$

Likewise for equation (103), if the angle n is one quadrant ($\frac{\pi}{2}$), then $n = 1$ and

$$\varkappa^{-jn} = \varkappa^{-j} = j^{-j} \approx 4.8104773809 \dots \quad (103a)$$

If the angle n is two quadrants (π), then $n = 2$ and

$$\varkappa^{-j2} = \epsilon^{+\pi} \approx 23.140692632 \dots \quad (103b)$$

If the angle n is minus one quadrant ($\frac{3\pi}{2}$), then $n = 3 = -1$ and

$$\varkappa^j = j^j = \epsilon^{-\frac{\pi}{2}} \approx 0.20787957635 \dots \quad (103c)$$

If the angle n is zero, then $n = 0$ and

$$\varkappa^{-j0} = \varkappa^0 = \epsilon^0 = +1 \quad (103d)$$

7.7 Polar Representation of Eight Categories of Electric Waves

In polar representation, figure (25), the rotation of angle n_1 through one complete cycle of distortion indicates the existence of eight distinct categories of electric waves:

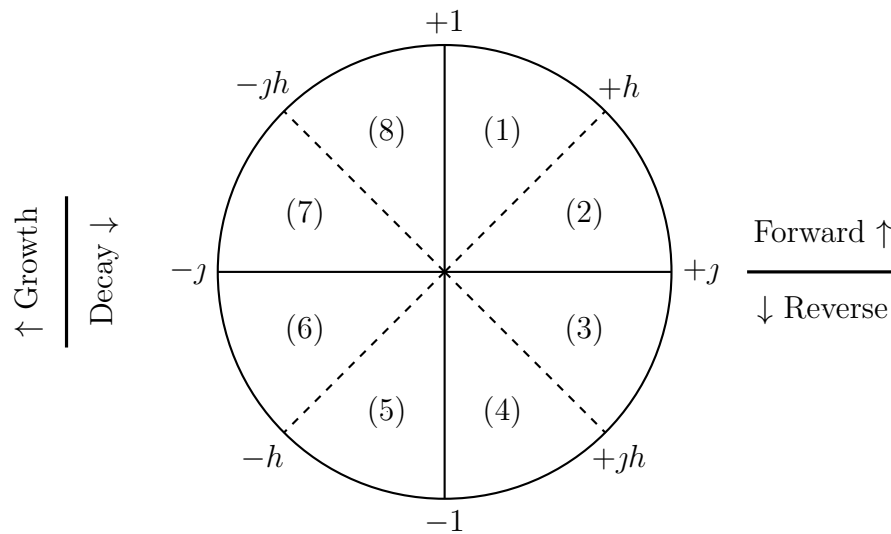

Figure 25: Eight Categories of Electric Waves

1. This wave is an oscillating electric wave, rotating in a forward (clockwise direction) and decaying with respect to time moving forward. Its limits are $+1$, when the wave becomes a forward rotating alternating electric wave, and $+h$, when the wave becomes a critically damped impulse.
2. This wave is an electric impulse, decaying with respect to time moving forward. Its limits are $+h$, the critically damped impulse, and $+j$ when the wave becomes scalar (D.C.) of consumption.
3. This wave is an electric impulse, decaying with respect to time moving backwards, its limits are $+j$, a scalar (D.C.) wave and $+jh$, a critically damped impulse in reverse time.
4. This wave is an oscillating electric wave, rotating in a reverse direction (counterclockwise), decaying with respect to backward time. Its limits are $+jh$, the critical impulse of (3) and -1 , when the wave becomes a reverse rotation alternating electric wave.
5. This wave is an oscillating electric wave, rotating in a reverse (counterclockwise) direction, growing with respect to backward time. Its limits are -1 , the alternating wave of (4), and $-h$, when the rate of growth supersedes the rate of rotation and the wave ceases to spiral. This is analogous to critical damping.
6. This wave is an electric impulse growing with respect to backward time. Its limits are $-h$, the critical wave of (5) and $-j$, a scalar wave of energy production.
7. This wave is an electric impulse growing with respect to time moving forward. Its limits are $-j$, the scalar of (6), and $-jh$ a critical impulse as in (5), but with the opposite time sense.
8. This wave is an oscillating electric wave rotating in a forward direction (clockwise), growing with respect to forward time. Its limits are $-jh$, the critical impulse as in (7) and $+1$, the alternating wave as in (1). This completes the cycle.

8 Other References

Please see “*Impedance, Angular Velocities and Frequencies of Oscillating Current Circuits*”, and “*Vector Power in A.C. Circuits*”, both by A.E. Kennelly [7, 6] for other related information pertaining to the general electric wave.

9 List of Symbols

- A Component of complex quantity, in %
- B Component of complex quantity, in %
- B Electric Susceptance in Mhos or Farads per second
- C Component of complex quantity, in %
- C Dielectric Inductance, in Farads
- E E.M.F. of Magnetic Induction, lines per second
- \dot{E} E.M.F., complex versor quantity, in volts
- F Frequency, in cycles per second (hz)
- G Electric Conductance, in Mhos
- H Electric Receptance in Negative Ohms
- I M.M.F. of Dielectric Induction, lines per second
- \dot{I} M.M.F. complex versor quantity, in amperes
- L Magnetic Inductance, in Henrys
- N Number of divisions of a complete cycle
- P Electric Power, in volt-amperes or Watts
- R Electric Resistance, in Ohms
- S Electric Acceptance, in Negative Mhos
- T Period, in seconds per cycle (1/hz)
- U General Electric quantity
- W Electric Energy
- X Electric Reactance, in Ohms or Henrys per second
- \dot{Y} Electric Admittance, complex versor quantity in Mhos
- \dot{Z} Electric Impedance, complex versor quantity in Ohms
- a* Power factor in % total wave
- b* Induction factor in % total wave
- d* Magnification factor in % total wave

f	Function of ()
h	Negative versor operator
i	Arbitrary imaginary number
j	Scalar or imaginary number
1	Scalar or imaginary number
\varkappa	Positive versor operator
l	Length, in centimeters
m	Mass, in grams
n	Angle of cyclic divisions transversed
t	Time variable, in seconds
v	Imaginary Frequency in nepers per second
α	Component of complex quantity
β	Component of complex quantity
(γ_t)	Function of time, wave factor
ϵ	Basis of natural logarithms ($\epsilon = 2.71828\dots$)
π	Ratio of Circumference to Diameter of a Circle $\pi = 3.1415926535\dots$
θ	Time angle variable, in radians
ϕ	Magnetic flux, in total lines
ψ	Dielectric flux, in total lines

References

- [1] Eric Dollard. Introduction to dielectric and magnetic discharges in electrical windings. (TE-2), 1982.
- [2] Eric Dollard. Symbolic representation of alternating electric waves. (TE-3), 1985.
- [3] Eric Dollard. Symbolic representation of alternating electric waves. (TE-3), 1985.
- [4] Eric Dollard. Symbolic representation of alternating electric waves. (TE-3), 1985.
- [5] Oliver Heaviside. Electromagnetic theory. ?
- [6] A. E. Kennelly. Vector power in a.c. circuits. 29 JUNE 1910.
- [7] A. E. Kennelly. Impedence, angular velocities and frequencies of oscillating current circuits. 8 NOV 1913.
- [8] Alex McFarlane. The imaginary of algebra. XLI:33–35, 1891-1894.
- [9] Alex McFarlane. The imaginary of algebra. XLI:33–35, 1891-1894.
- [10] Alex McFarlane. The imaginary of algebra. XLI:41, 1891-1894.
- [11] Alex McFarlane. The imaginary of algebra. XLI:43–45, 1891-1894.
- [12] Alex McFarlane. The imaginary of algebra. XLI:40,47, 1891-1894.
- [13] Alex McFarlane. Principles of the algebra of physics. XL:77, 1891-1894.
- [14] Charles Proteus Steinmetz. Theory and calculation of alternating current phenomena. 1900.
- [15] Charles Proteus Steinmetz. Theory and calculation of alternating current phenomena. page 36, 1900.
- [16] Charles Proteus Steinmetz. Theory and calculation of alternating current phenomena. page 478, 1900.
- [17] Charles Proteus Steinmetz. Theory and calculation of alternating current phenomena. page 395, 1900.
- [18] Charles Proteus Steinmetz. Theory and calculation of alternating current phenomena. 1900.
- [19] Charles Proteus Steinmetz. Transients in time and space. 1910.
- [20] Charles Proteus Steinmetz. Electrical discharges, waves, and impulses. 1914.
- [21] Charles Proteus Steinmetz. Electrical discharges, waves, and impulses. 1914.

Appendices

A Reactive Energy in Transmission Lines

In the transmission of electrical energy from the substation to the load, the transmission line conveying this energy stores a certain amount in the space surrounding the line conductors, that is, energy is stored in the magnetic and dielectric flow that makes up the electric field of the conductor.

Thus, an interaction exists between this reactive energy of the line and the active and reactive energies of the load, since all must flow through the same space.

As a matter of efficiency, the resistance of the transmission line must be very small, and is approximately zero. Likewise, the insular conductance is also practically zero. In addition, because of relatively low voltages and frequency, the dielectric susceptance is zero.

Hence, the only line coefficient of the line having significant magnitude is the line's magnetic reactance, which is directly proportional to the area enclosed by the total length of the line conductors. These approximations hold only for overhead lines. All four constants, R , G , X and B must be considered for underground cables.

For situations typically encountered in practice, it is permissible to assume the line as pure reactance. The impedance of the line is given by

$$\begin{array}{lll}
 & Z_1 = R_1 + K^1 X_1 & \text{Ohms, complex} \\
 \text{and} & R_1 < 10\% X_1 & \text{Ohms} \\
 \text{hence} & Z_1 \approx K^1 X_1 & \text{Ohms, Reactive}
 \end{array} \tag{104}$$

and represented by the symbol Z_1 .

The impedance of the load is given by the symbolic expression,

$$Z_0 = K^0 R_0 + K^1 X_0 + \frac{1}{K^2 S_0} + \frac{1}{K^3 B_0} \quad \text{Ohms, complex} \tag{105}$$

where

- R_0 = Effective resistance of active energy consumption in Ohms, real.
- X_0 = Effective reactance of reactive energy consumption in Ohms, reactive.
- S_0 = Effective acceptance of active energy production in Mhos, real.
- B_0 = Effective susceptance of reactive energy production in Mhos, reactive.

The algebraic operator is defined as

$$\begin{aligned}
 k^n &= \sqrt[4]{+1} \\
 k^n &= \cos\left(\frac{\pi}{2}\right) + j \sin\left(\frac{\pi}{2}\right)
 \end{aligned}$$

Where

$$\begin{aligned}
 K^1 &= \text{First quarter cycle of lag, } 90^\circ &= +j \\
 K^2 &= \text{Second quarter of cycle of lag, } 180^\circ &= -1 \\
 K^3 &= \text{Third quarter cycle of lag, } 270^\circ &= -j \\
 K^4 &= K^0 = \text{Complete cycle } 360^\circ = 0^\circ &= +1 \\
 K^{-1} &= \text{First quarter of lead, } -90^\circ, +270^\circ = K^3 &= -j \\
 K^{-2} &= \text{Second quarter of lead, } -180^\circ, +180^\circ = K^2 &= -1 \\
 K^{-3} &= \text{Third quarter cycle of lead, } -270^\circ, +90^\circ = K^1 &= +j \\
 K^{-4} &= \text{Complete cycle } 360^\circ = 0^\circ = K^0 &= +1
 \end{aligned}$$

hence

$$\begin{aligned}
 K^{-1} &= \frac{1}{K^1} = -K^1 \\
 K^{-2} &= \frac{1}{K^2} = +K^2 \\
 K^{-3} &= \frac{1}{K^3} = -K^3 \\
 K^{-4} &= \frac{1}{K^4} = +K^4 = K^0
 \end{aligned}$$

Thus:

1. The resistance R_0 has maximum effect at the beginning of the A.C. cycle; (0°)
2. The reactance X_0 has maximum effect at the first quarter of the cycle; (90°)
3. The acceptance S_0 has maximum effect at the second quarter of the A.C. cycle; (180°)
4. The susceptance B_0 has maximum effect at the third quarter of the A.C. cycle; (270°)

And inversely

1. R_0 has maximum cause at the end of the A.C. cycle
2. B_0 has maximum cause at the first quarter of the A.C. cycle
3. S_0 has maximum cause at the second quarter of the A.C. cycle
4. X_0 has maximum cause at the third quarter of the A.C. cycle

Consequently, E.M.F. is the cause and current is the effect and this is known as constant potential system.

Let the constant potential load be represented by the schematic diagram:

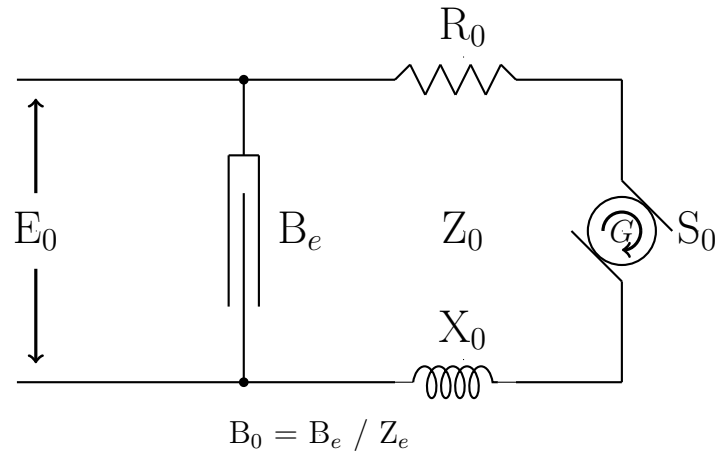

And the equation of the total impedance of this circuit is given by

$$Z_0 = (R_0 - S_0^{-1}) + j(X_0 - B_0^{-1}) \quad \text{Ohms, complex} \quad (106)$$

The power factor is

$$a = \frac{(R_0 - S_0^{-1})}{Z_0} \quad \text{percent} \quad (107)$$

The induction factor is

$$b = \frac{(X_0 - B_0^{-1})}{Z_0} \quad \text{percent} \quad (108)$$

The combined impedance at the substation due to line and load is

$$Z_S = Z_1 + Z_o \quad \text{Ohms, complex} \quad (109)$$

Substituting equations (104) and (106) into (109) gives

$$Z_S = (R_o - S_o^{-1}) + j[(X_o + X_1) - B_o^{-1}] \quad (110)$$

And the schematic representation is

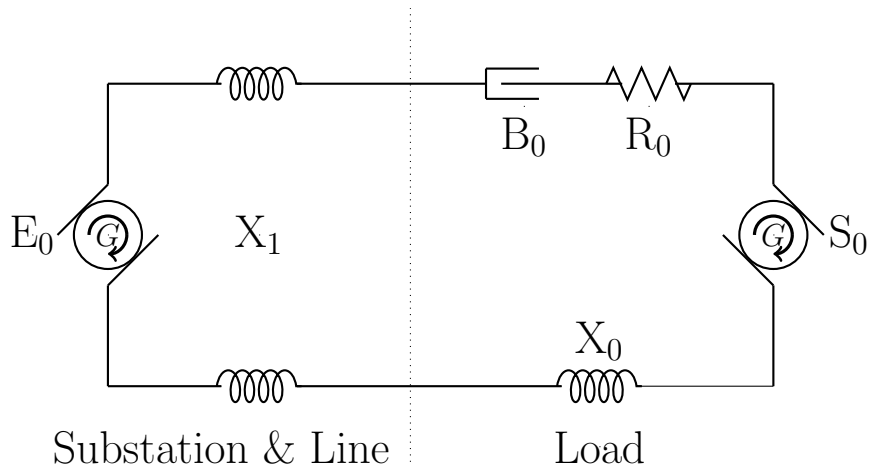

The E.M.F. consumed by the line reactance is,

$$\dot{E}_1 = -\dot{I}jX_1 \quad \text{Volts, reactive} \quad (111)$$

The E.M.F. consumed by the load impedance is,

$$\dot{E}_0 = -\dot{I} [(R_0 - S_0^{-1}) + j(X_0 - B_0^{-1})] \quad \text{Volts, complex} \quad (112)$$

The E.M.F. at the substation is given by

$$\dot{E}_S = 7,200 \text{ volts}$$

By *Kirchoff's Law*, the sum of all the E.M.F's in a circuit must equal zero, thus

$$\begin{aligned} \dot{E}_S + \dot{E}_o + \dot{E}_1 &= 0 \\ \dot{E}_S &= -\dot{E}_o - \dot{E}_1 \\ K^2 \dot{E}_S &= \dot{E}_o + \dot{E}_1 \end{aligned} \quad (113)$$

where K^2 indicates the substation is producing active energy.

Since the voltage is held constant at the substation (7200 volts), this voltage is the reference phase,

$$\left| K^2 \dot{E}_S \right| = \left| \dot{E}_S \right| = E_S = 7200 \text{ volts absolute}$$

Hence

$$E_S = \dot{E}_o + \dot{E}_1$$

The voltage at the load is thereby,

$$\dot{E}_0 = E_S - \dot{E}_1 \quad (114)$$

That is, the load E.M.F. is the substation E.M.F. minus the complex line E.M.F.

Having established the complex voltage relations, it is possible to investigate the effect the power factor of the load has upon the voltage drop of the line.

Since the voltage drop of the line is voltage gain with respect to \dot{E}_o , that is the voltage increase from load to substation if it drops from substation to load equation (111) becomes

$$\dot{E}_1 = +\dot{I}jX_1 \quad \text{Volts, reactive} \quad (115)$$

Taking the load voltage as reference give for equation (112).

$$E_o = \dot{I} [(R_o - S_o^{-1}) + j(X_o - B_o^{-1})] \quad (116)$$

The voltage at the load is thus,

$$E_o = \left| \dot{E}_S - \dot{E}_1 \right| \quad (117)$$

If the load is pure resistance, it has a power factor of +100%, and the load current is given by

$$\dot{I} = \frac{E_o}{R_o} = +i_1 \quad \text{Amperes, real}$$

And substituting into equation (115) gives

$$\dot{E}_1 = j i_1 X_1 = +j e_1 \quad \text{Volts, reactive}$$

Hence

$$\dot{E}_o = E_S - j e_1 \quad \text{Volts, complex}$$

That is, the line E.M.F. indirectly subtracts from the substation E.M.F.

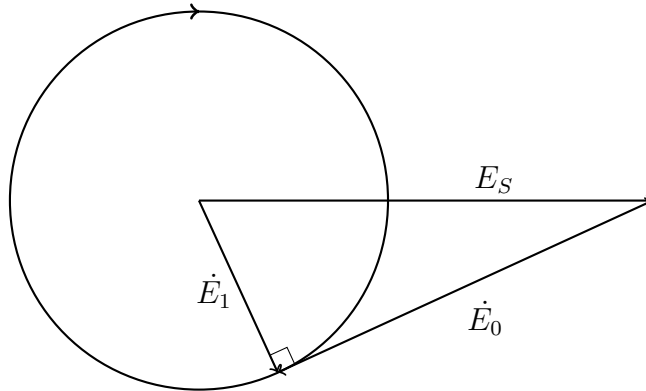

If the load is a pure magnetic reactance, consuming reactive energy, it has a power factor of 0% (Lag), and the load current is given by,

$$i = \frac{E_o}{j X_0} = j i_{11} \quad \text{Amperes, reactive}$$

And substituting into equation (115) gives,

$$\dot{E}_1 = -j j i_{11} X_1 = +e_{11} \quad \text{Volts, real}$$

Hence

$$\dot{E}_o = E_S - e_{11} \quad \text{Volts, complex}$$

That is, the line E.M.F. directly subtracts from the substation E.M.F.

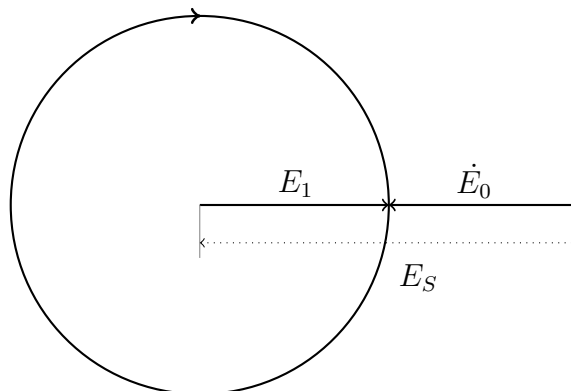

If the load is a pure acceptance, producing active energy, it has a power factor of -100%, and the load current is given by,

$$\dot{I} = -E_o S_o = -i_o \quad \text{Amperes, real}$$

And substituting into equation (115) gives,

$$\dot{E}_1 = -j i_o X_1 = -j e_o \quad \text{Volts, reactive}$$

Hence,

$$\dot{E}_o = E_S + j e_o \quad \text{Volts, complex}$$

That is, the line E.M.F. indirectly adds to the substation voltage, resulting in a higher voltage at the load than at the substation.

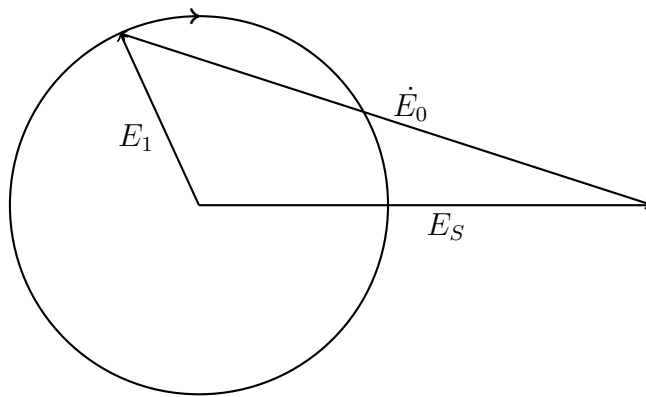

If the load is a pure susceptance, producing reactive energy, it has a power factor of 0% (Lead), and the load current is given by,

$$\dot{I} = j E_o B_o = +j i_\infty \quad \text{Amperes, reactive}$$

And substituting into (115) gives,

$$\dot{E}_1 = (+j)^2 i_\infty = -e_\infty \quad \text{Volts, real}$$

Hence,

$$E_o = E_S + e_\infty \quad \text{Volts, complex}$$

That is, the line E.M.F. directly adds to the substation voltage, resulting in a higher voltage at the load than the substation.

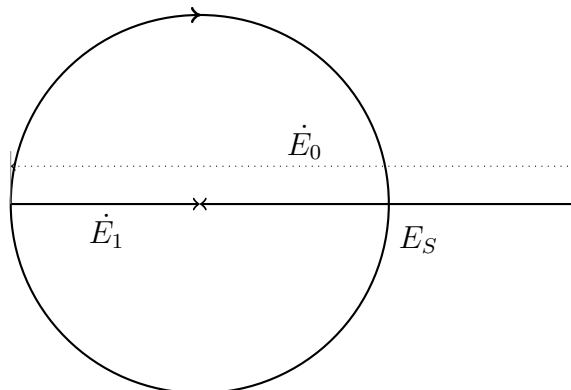

Thus it can be seen that the power factor, or more properly, the wave factor, of the load has a definite effect on the voltage drop of the transmission line. A load of pure reactive energy consumption, such as a magnetic reactor, produces the maximum voltage drop since the E.M.F. consumed by the reactor is in phase conjunction with the E.M.F. consumed by the line reactance. Inversely, a load of pure reactive energy production, such as a synchronous condenser, produces the maximum voltage gain, since the E.M.F. produced by the condenser is in phase opposition with the E.M.F. produced by the line reactance.

It is of interest to note that a reactive load produces a real E.M.F. in the line, and a real load produces a reactive E.M.F. in the line. A reactive load such as a synchronous condenser converts the transmission line into an extension of the substation transformer by inducing a forward E.M.F. in phase conjunction with the E.M.F. produced by the transformer winding.

Thus, it may be said that a load which consumes reactive energy increases the apparent distance to the substation, and a load which produces reactive energy decreases the apparent distance to the substation.