



VISUAL

french english

le petit déjeuner
breakfast

le croissant

croissant

le café

coffee

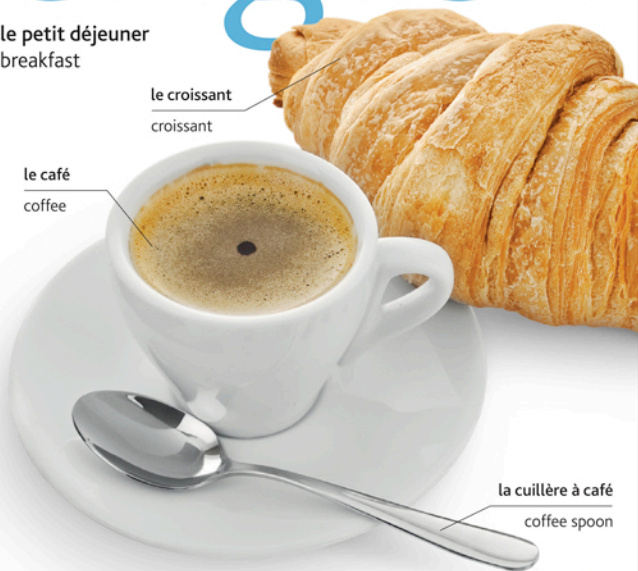

la cuillère à café

coffee spoon

BILINGUAL
DICTIONARY



Bilingual
VISUAL
dictionary

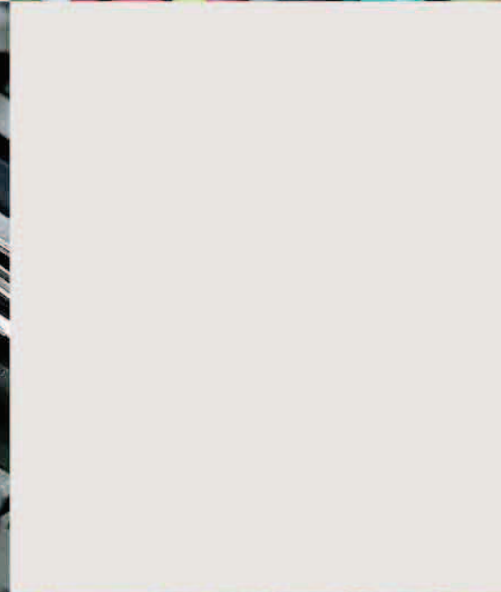

Bilingual **VISUAL** dictionary

Previously published as part of
5-Language Visual Dictionary





Penguin
Random
House

Senior Editor Angeles Gavira

Senior Art Editor Ina Stradins

DTP Designers Sunil Sharma, Balwant Singh,
Harish Aggarwal, John Goldsmid, Ashwani Tyagi

DTP Coordinator Pankaj Sharma

Production Controller Liz Cherry

Picture Researcher Anna Grapes

Managing Editor Liz Wheeler

Managing Art Editor Phil Ormerod

Category Publisher Jonathan Metcalf

Designed for Dorling Kindersley by WaltonCreative.com

Art Editor Colin Walton, assisted by Tracy Musson

Designers Peter Radcliffe, Earl Neish, Ann Cannings

Picture Research Marissa Keating

Language content for Dorling Kindersley by
g-and-w PUBLISHING

Managed by Jane Wightwick, assisted by Ana Bremón

Translation and editing by Christine Arthur

Additional input by Dr. Arturo Pretel, Martin Prill,

Frédéric Monteil, Meinrad Prill, Mari Bremón,

Oscar Bremón, Anunchi Bremón, Leila Gaafar

First American Edition, 2009

This edition published in the United States in 2015

by DK Publishing, 345 Hudson Street, New York,
New York 10014

Copyright © 2015 Dorling Kindersley Limited

A Penguin Random House Company

15 16 17 18 19 10 9 8 7 6 5 4 3 2 1

001 – 283035 – June/15

All rights reserved.

Without limiting the rights under the copyright reserved
above, no part of this publication may be reproduced,
stored in or introduced into a retrieval system, or transmitted,
in any form, or by any means (electronic, mechanical,
photocopying, recording, or otherwise), without the prior
written permission of the copyright owner.

Published in Great Britain by Dorling Kindersley Limited.

A catalog record for this book is available from the
Library of Congress.

ISBN: 978-1-4654-3630-6

DK books are available at special discounts when purchased
in bulk for sales promotions, premiums, fund-raising, or
educational use. For details, contact: DK Publishing Special
Markets, 345 Hudson Street, New York, New York 10014
SpecialSales@dk.com

Printed and bound in China

All images © Dorling Kindersley Limited

For further information see: www.dkimages.com

A WORLD OF IDEAS:
SEE ALL THERE IS TO KNOW

www.dk.com

table des matières contents



la santé
health



sortir manger
eating out



le temps libre
leisure



8

**à propos du
dictionnaire**
about the dictionary



9

**comment utiliser
ce livre**
how to use this book



10

les gens
people



28

l'apparence
appearance



56

la maison
home



92

les services
services



102

les courses
shopping



116

la nourriture
food



160

l'étude
study



170

le travail
work



192

le transport
transportation



218

les sports
sports



278

l'environnement
environment



302

l'information
reference



324

index
index



360

remerciements
acknowledgments

les gens • people

le corps body	12
le visage face	14
la main hand	15
le pied foot	15
les muscles muscles	16
le squelette skeleton	17
les organes internes internal organs	18
les organes de reproduction reproductive organs	20
la famille family	22
les relations relationships	24
les émotions emotions	25
les événements de la vie life events	26

l'apparence • appearance

les vêtements d'enfants children's clothing	30
les vêtements pour hommes men's clothing	32
les vêtements pour femmes women's clothing	34
les accessoires accessories	36
les cheveux hair	38
la beauté beauty	40

la santé • health

la maladie illness	44
le médecin doctor	45
la blessure injury	46
les premiers secours first aid	47
l'hôpital hospital	48
le dentiste dentist	50
l'opticien optometrist	51

la grossesse pregnancy	52
la naissance childbirth	53
les thérapies alternatives complementary therapy	54

la maison • home

la maison house	58
les systèmes domestiques internal systems	60
le salon living room	62
la salle à manger dining room	64
la cuisine kitchen	66
les ustensiles de cuisine kitchenware	68
la chambre bedroom	70
la salle de bain bathroom	72
la chambre d'enfants baby's room	74
la buanderie utility room	76
l'atelier workshop	78
la boîte à outils toolbox	80
la décoration decorating	82
le jardin garden	84
les plantes de jardin garden plants	86
les outils de jardin garden tools	88
le jardinage gardening	90
les services • services	
les services d'urgence emergency services	94
la banque bank	96

les communications communications	98
l'hôtel hotel	100

les courses • shopping

le centre commercial shopping centre	104
le grand magasin department store	105
le supermarché supermarket	106
la pharmacie pharmacy	108
le fleuriste florist	110
le marchand de journaux newsagent	112
le confiseur confectionery	113
les autres magasins other shops	114

la nourriture • food

la viande meat	118
le poisson fish	120
les légumes vegetables	122
le fruit fruit	126
les céréales et les légumes secs grains and legumes	130
les herbes et les épices herbs and spices	132
les aliments en bouteilles bottled foods	134
les produits laitiers dairy produce	136
les pains et la farine breads and flours	138
les gâteaux et les desserts cakes and desserts	140
la charcuterie delicatessen	142
les boissons drinks	144

sortir manger •

eating out

le café café	148
le bar bar	150
le restaurant restaurant	152
la restauration rapide fast food	154
le petit déjeuner breakfast	156
le repas dinner	158

l'étude • study

l'école school	162
les mathématiques maths	164
la science science	166
l'enseignement supérieur college	168

le travail • work

le bureau office	172
l'ordinateur computer	176
les médias media	178
le droit law	180
la ferme farm	182
la construction construction	186
les professions professions	188

**le transport •
transportation**

les routes roads	194
le bus bus	196
la voiture car	198
la moto motorcycle	204
la bicyclette bicycle	206
le train train	208
l'avion aircraft	210
l'aéroport airport	212
le navire ship	214
le port port	216

les sports • sport

le football américain football	220
le rugby rugby	221
le football soccer	222
le hockey hockey	224
le cricket cricket	225
le basket basketball	226
le baseball baseball	228
le tennis tennis	230
le golf golf	232
l'athlétisme track and field	234
les sports de combat combat sports	236
la natation swimming	238
la voile sailing	240
l'équitation horseback riding	242
la pêche fishing	244
le ski skiing	246
les autres sports other sports	248
le conditionnement physique fitness	250

**le temps libre •
leisure**

le théâtre theater	254
l'orchestre orchestra	256
le concert concert	258
le tourisme sightseeing	260
les activités de plein air outdoor activities	262
la plage beach	264
le camping camping	266
les distractions à la maison home entertainment	268
la photographie photography	270
les jeux games	272



les arts et métiers arts and crafts	274
--	-----

**l'environnement •
environment**

l'espace space	280
la terre Earth	282
le paysage landscape	284
le temps weather	286
les roches rocks	288
les minéraux minerals	289
les animaux animals	290
les plantes plants	296
la ville town	298
l'architecture architecture	300

**l'information •
reference**

l'heure time	304
le calendrier calendar	306
les nombres numbers	308
les poids et mesures weights and measures	310
la carte du monde world map	312
particules et antonymes particles and antonyms	320
phrases utiles useful phrases	322

à propos du dictionnaire

Il est bien connu que les illustrations nous aident à comprendre et retenir l'information. Fondé sur ce principe, ce dictionnaire bilingue richement illustré présente un large éventail de vocabulaire courant et utile dans deux langues européennes.

Le dictionnaire est divisé de façon thématique et couvre en détail la plupart des aspects du monde quotidien, du restaurant au gymnase, de la maison au lieu de travail, de l'espace au monde animal. Vous y trouverez également des mots et expressions supplémentaires pour la conversation et pour enrichir votre vocabulaire.

Il s'agit d'un outil de référence essentiel pour tous ceux qui s'intéressent aux langues – pratique, stimulant et d'emploi facile.

Quelques points à noter

Les deux langues sont toujours présentées dans le même ordre – français et anglais.

Les noms sont donnés avec leurs articles définis qui indiquent leur genre (masculin ou féminin) et leur nombre (singulier ou pluriel):

la graine	les amandes
seed	almonds

Les verbes sont indiqués par un (v), par exemple:

récolter • harvest (v)

Chaque langue a également son propre index à la fin du livre. Vous pourrez y vérifier un mot dans n'importe laquelle des deux langues et vous serez renvoyé au(x) numéro(s) de(s) page(s) où il figure. Le genre est indiqué par les abréviations suivantes:

m = masculin
f = féminin

about the dictionary

The use of pictures is proven to aid understanding and the retention of information. Working on this principle, this highly-illustrated bilingual dictionary presents a large range of useful current vocabulary in two European languages.

The dictionary is divided thematically and covers most aspects of the everyday world in detail, from the restaurant to the gym, the home to the workplace, outer space to the animal kingdom. You will also find additional words and phrases for conversational use and for extending your vocabulary.

This is an essential reference tool for anyone interested in languages – practical, stimulating, and easy-to-use.

A few things to note

The two languages are always presented in the same order – French and English.

Nouns are given with their definite articles reflecting the gender (masculine or feminine) and number (singular or plural), for example:

la graine	les amandes
seed	almonds

Verbs are indicated by a (v) after the English—for example:

récolter • harvest (v)

Each language also has its own index at the back of the book. Here you can look up a word in either of the two languages and be referred to the page number(s) where it appears. The gender is shown using the following abbreviations:

m = masculine
f = feminine



comment utiliser ce livre

Que vous appreniez une nouvelle langue pour les affaires, le plaisir ou pour préparer vos vacances, ou encore si vous espérez élargir votre vocabulaire dans une langue qui vous est déjà familière, ce dictionnaire sera pour vous un outil d'apprentissage précieux que vous pourrez utiliser de plusieurs manières.

Lorsque vous apprenez une nouvelle langue, recherchez les mots apparentés (mots qui se ressemblent dans différentes langues) et les faux amis (mots qui se ressemblent mais ont des significations nettement différentes). Par exemple, l'anglais a importé des autres langues européennes de nombreux termes désignant la nourriture mais, en retour, exporté des termes employés dans le domaine de la technologie et de la culture populaire.

Activités pratiques d'apprentissage

- Lorsque vous vous déplacez dans votre maison, au travail ou à l'université, essayez de regarder les pages qui correspondent à ce contexte. Vous pouvez ensuite fermer le livre, regarder autour de vous et voir combien d'objets vous pouvez nommer.
- Forcez-vous à écrire une histoire, une lettre ou un dialogue en employant le plus de termes possibles choisis dans une page. Ceci vous aidera à retenir le vocabulaire et son orthographe. Si vous souhaitez pouvoir écrire un texte plus long, commencez par des phrases qui incorporent 2 à 3 mots.
- Si vous avez une mémoire très visuelle, essayez de dessiner ou de décalquer des objets du livre sur une feuille de papier, puis fermez le livre et inscrivez les mots sous l'image.
- Une fois que vous serez plus sûr de vous, choisissez des mots dans l'index de la langue étrangère et essayez de voir si vous en connaissez le sens avant de vous reporter à la page correspondante pour vérifier.

how to use this book

Whether you are learning a new language for business, pleasure, or in preparation for an overseas vacation, or are hoping to extend your vocabulary in an already familiar language, this dictionary is a valuable learning tool that you can use in a number of different ways.

When learning a new language, look for cognates (words that are alike in different languages) and “false friends” (words that look alike but carry significantly different meanings). You can also see where the languages have influenced each other. For example, English has imported many terms for food from other European languages but, in turn, exported terms used in technology and popular culture.

Practical learning activities

- As you move around your home, workplace, or school, try looking at the pages which cover that setting. You could then close the book, look around you, and see how many of the objects and features you can name.
- Challenge yourself to write a story, letter, or dialogue using as many of the terms on a particular page as possible. This will help you retain the vocabulary and remember the spelling. If you want to build up to writing a longer text, start with sentences incorporating 2–3 words.
- If you have a very visual memory, try drawing or tracing items from the book onto a piece of paper, then closing the book and filling in the words below the picture.
- Once you are more confident, pick out words in a foreign-language index and see if you know what they mean before turning to the relevant page to see if you were right.







les gens
people

le corps • body

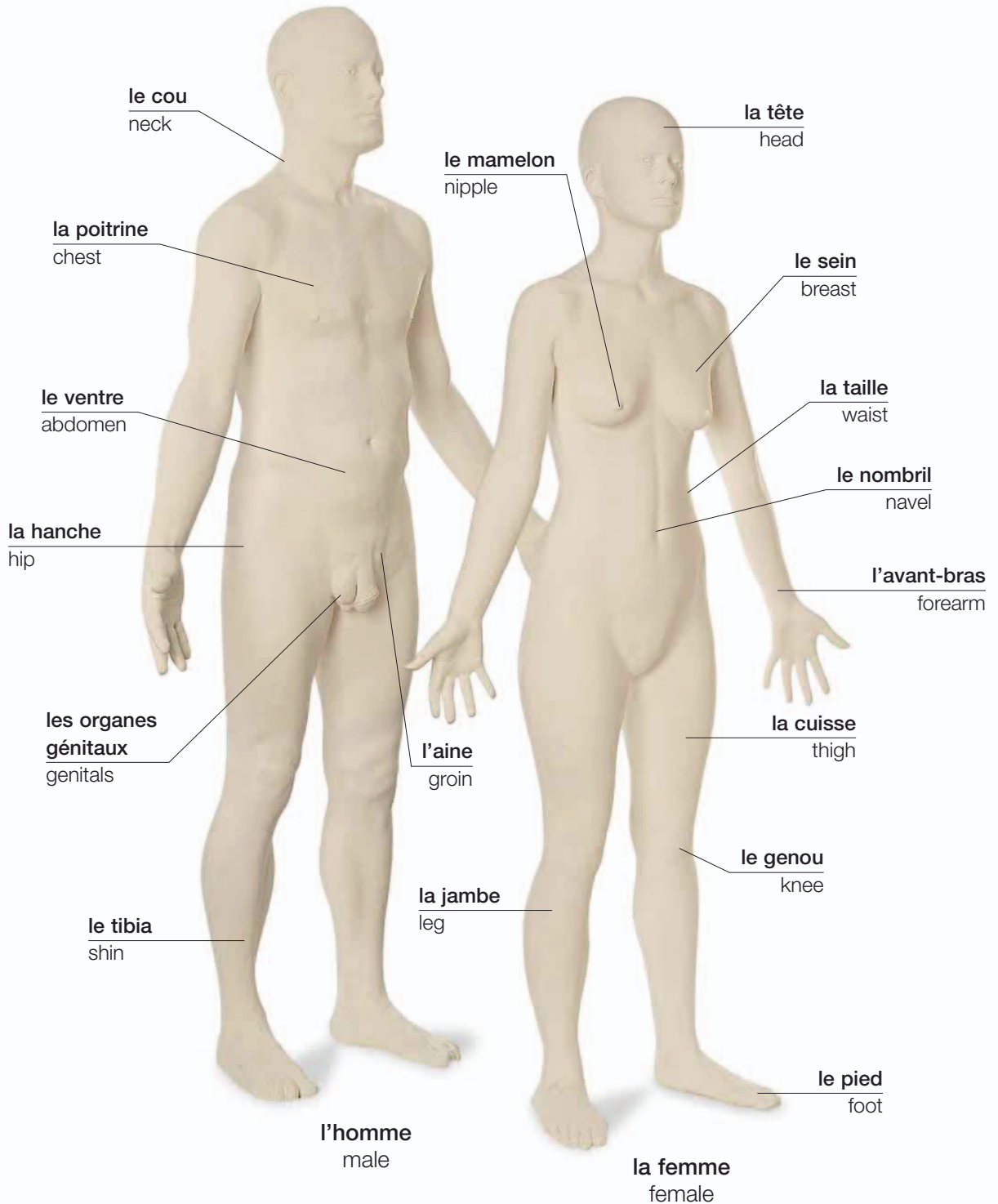

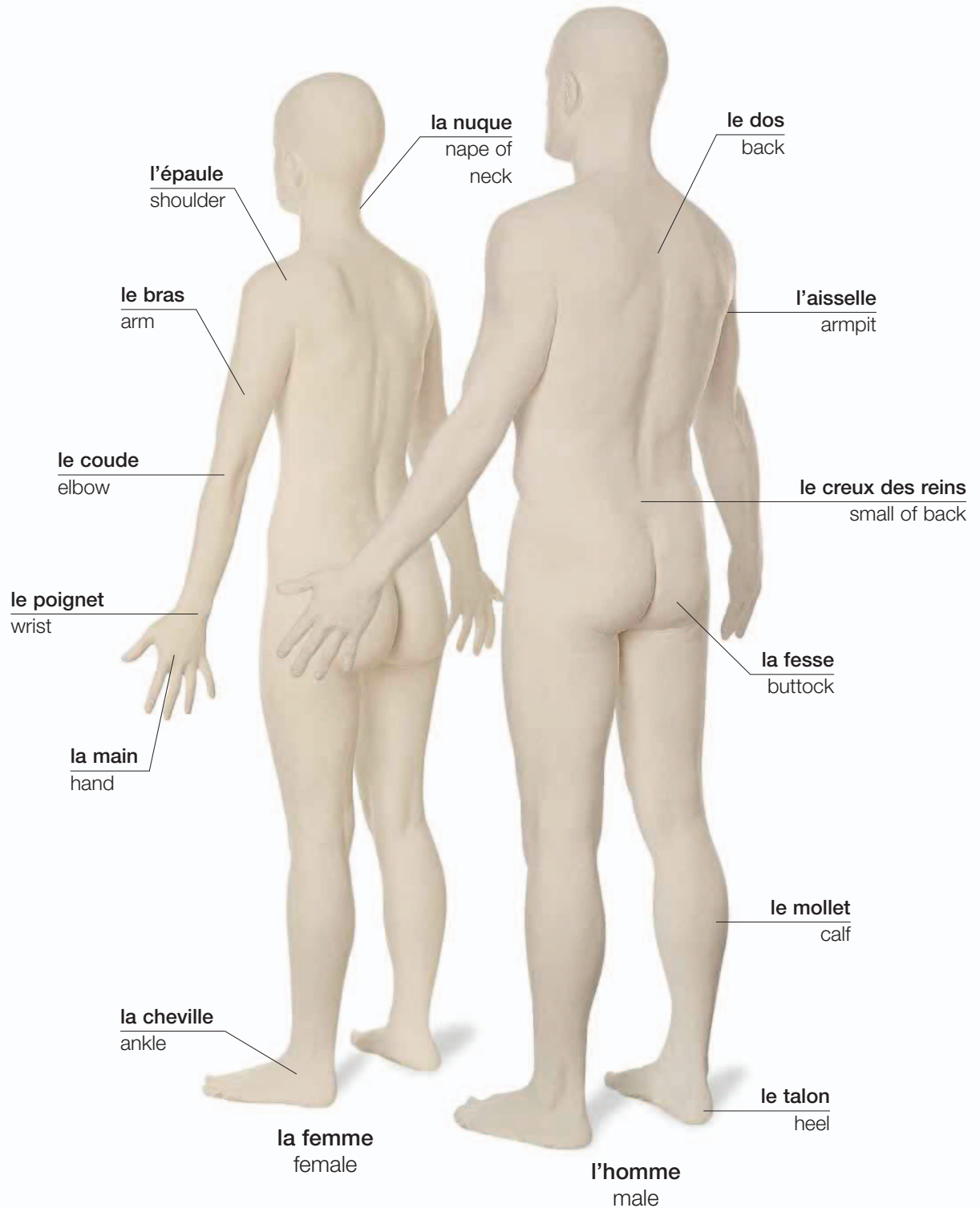

le visage • face

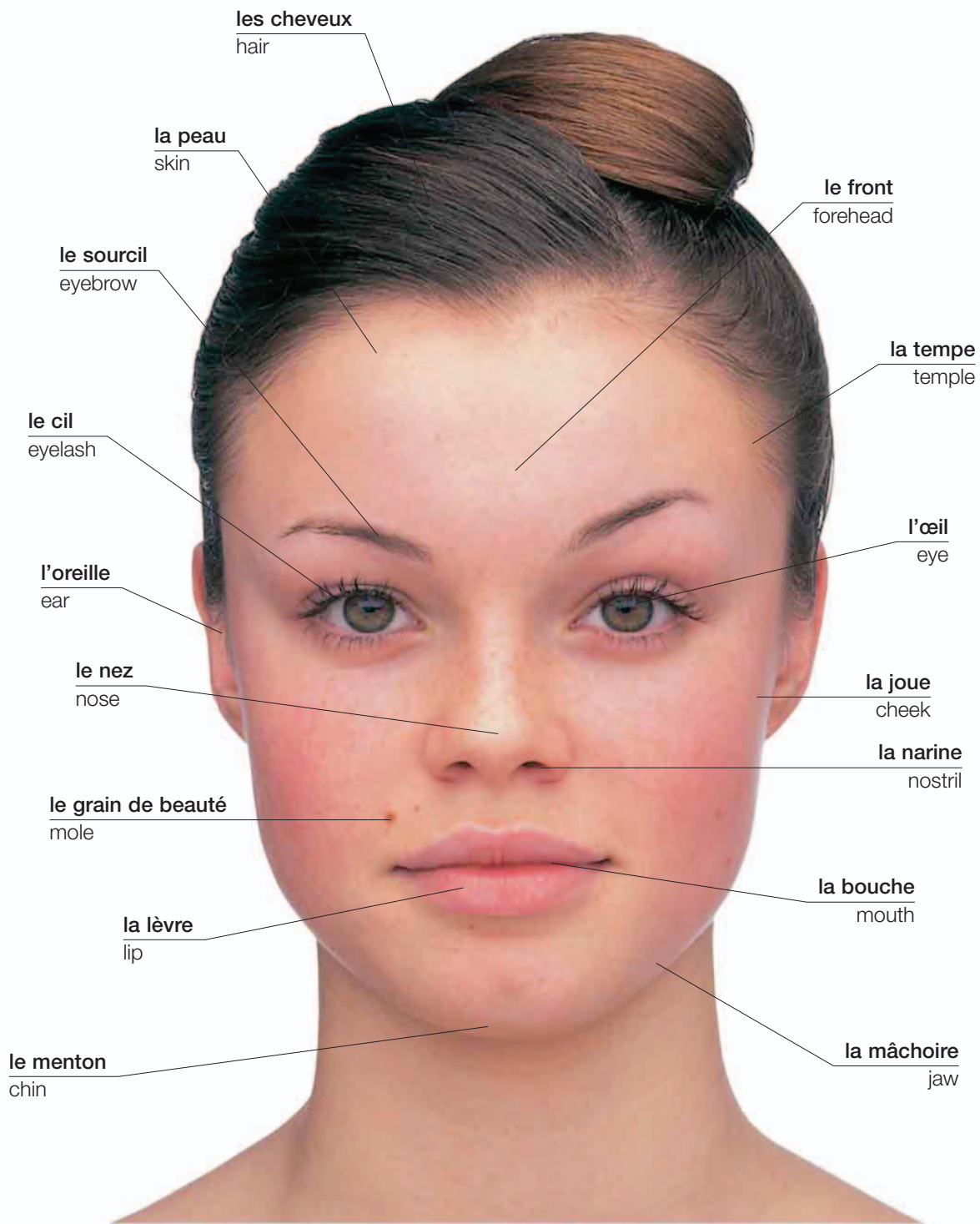



la ride
wrinkle

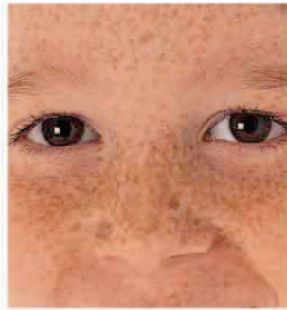

la tache de rousseur
freckle

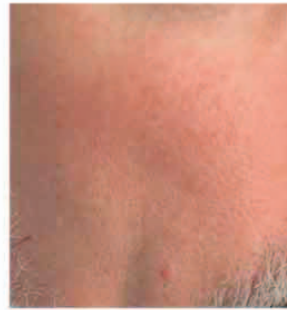

le pore
pore

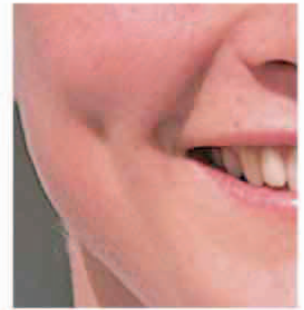

la fossette
dimple

la main • hand

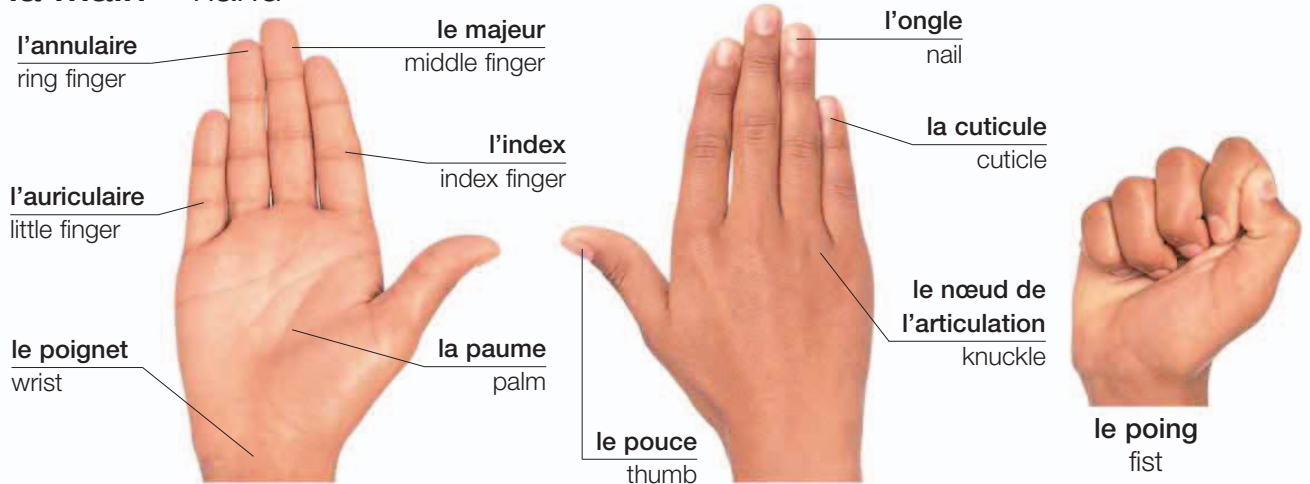

le pied • foot

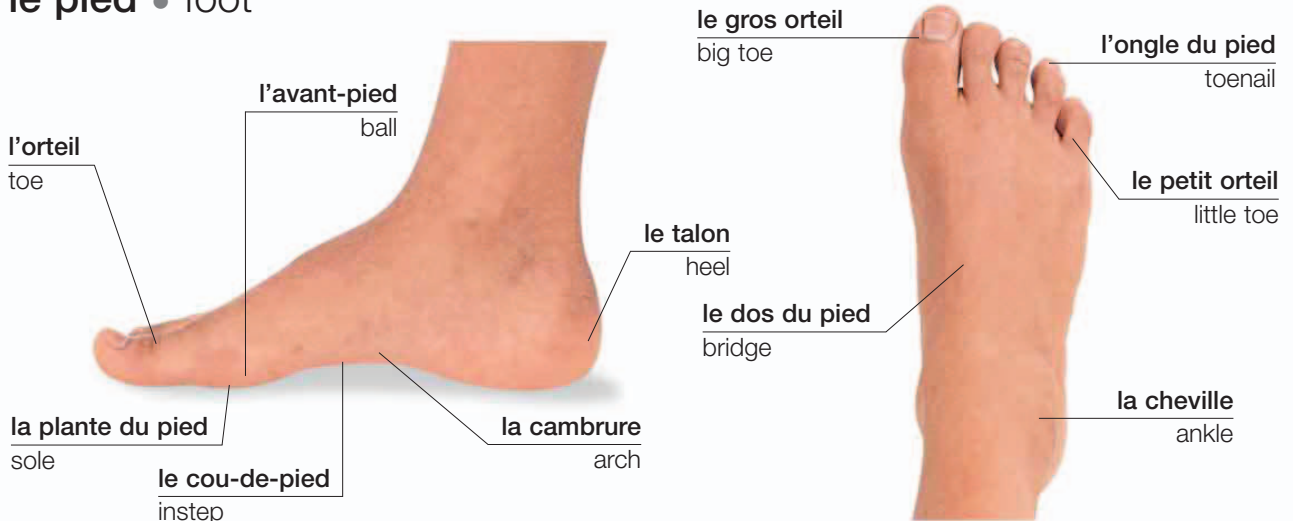

les muscles • muscles

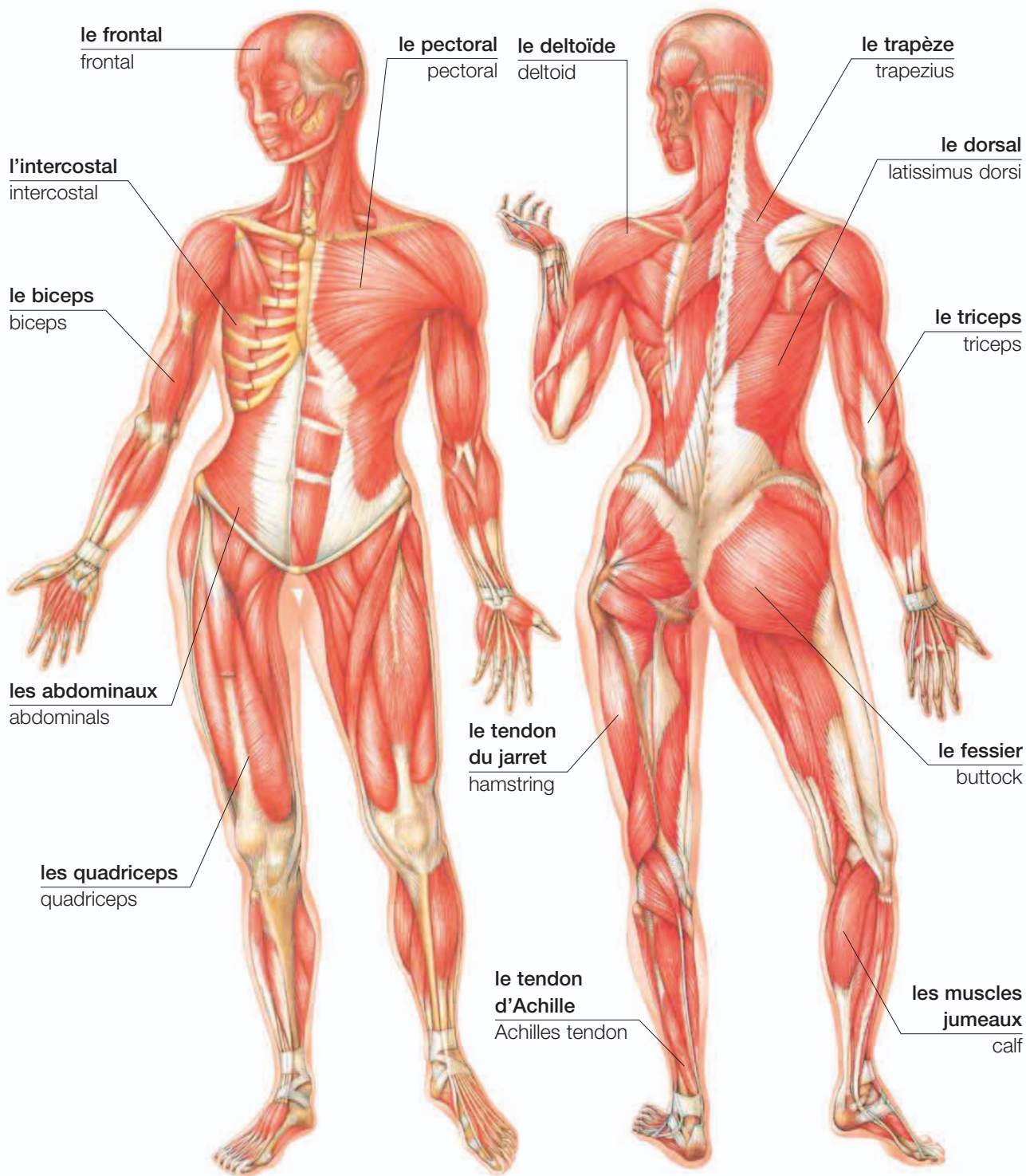

le squelette • skeleton

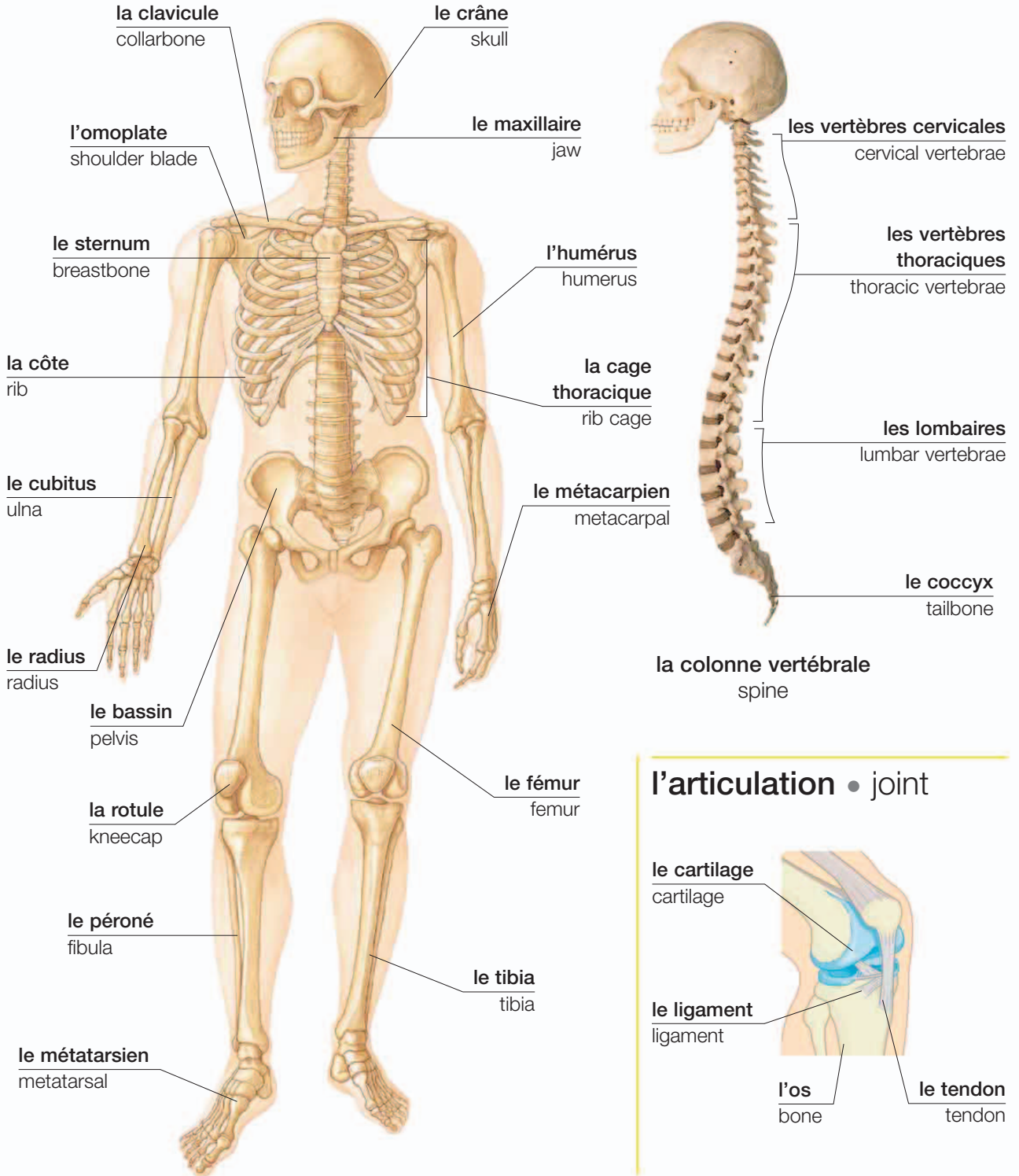

les organes internes • internal organs

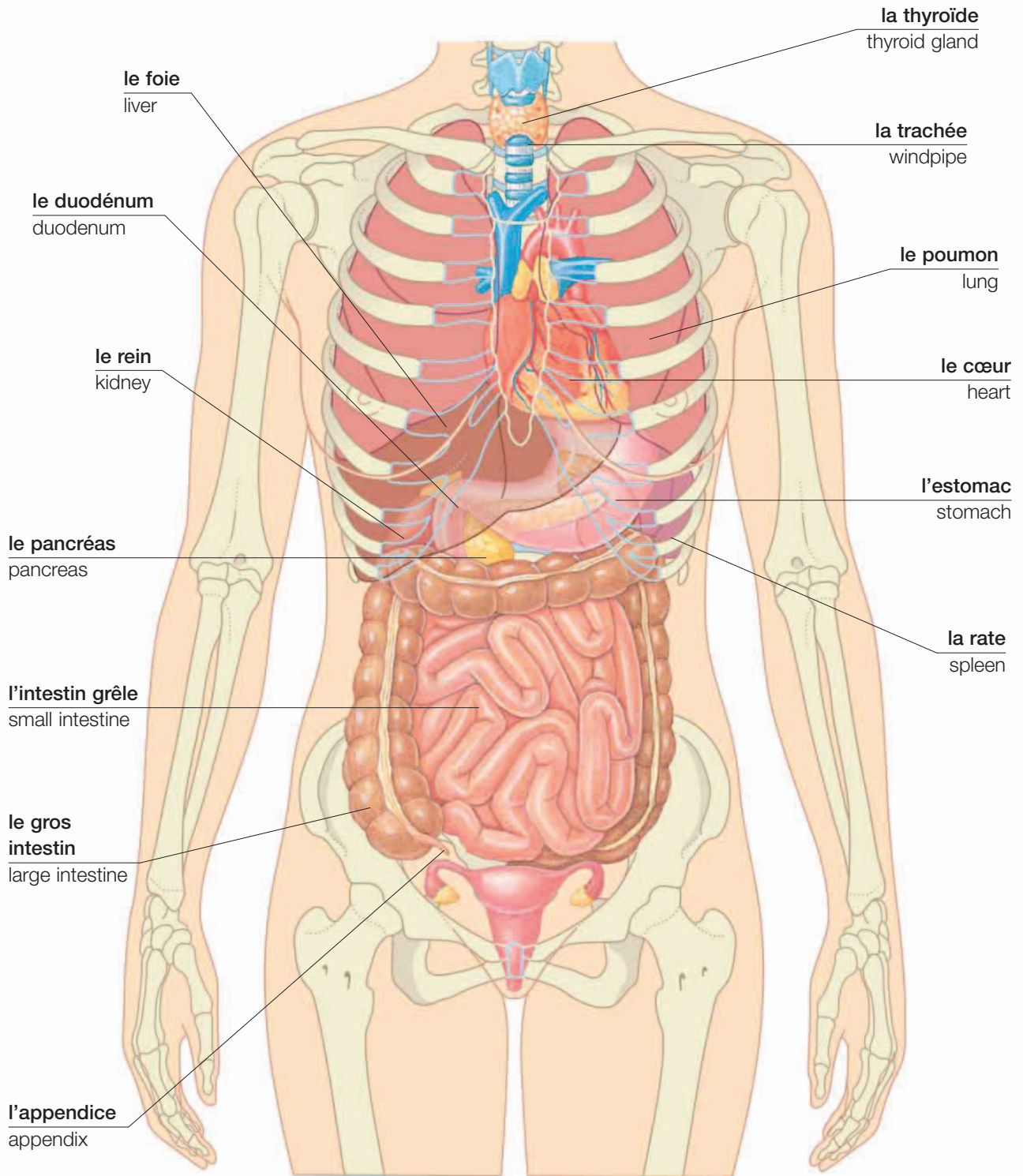

la tête • head

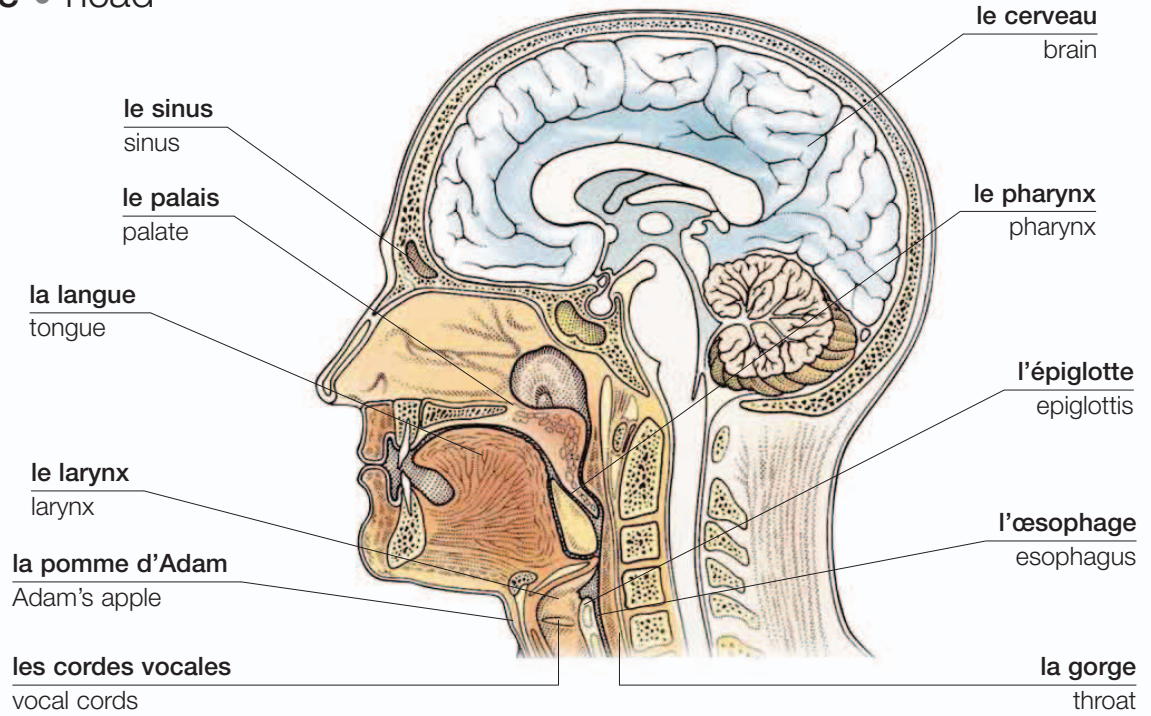

les systèmes du corps • body systems

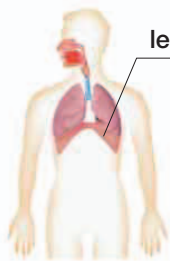

respiratoire
respiratory

le diaphragme
diaphragm

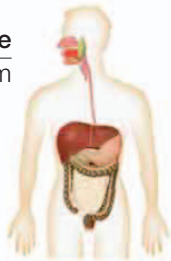

digestif
digestive

la veine
vein



cardio-vasculaire
cardiovascular

l'artère
artery



lymphatique
lymphatic

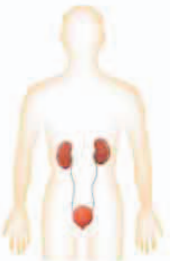

urinaire
urinary

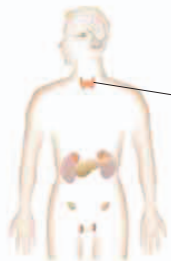

endocrine
endocrine

la glande
gland



nerveux
nervous

le nerf
nerve



reproducteur
reproductive

les organes de reproduction • reproductive organs

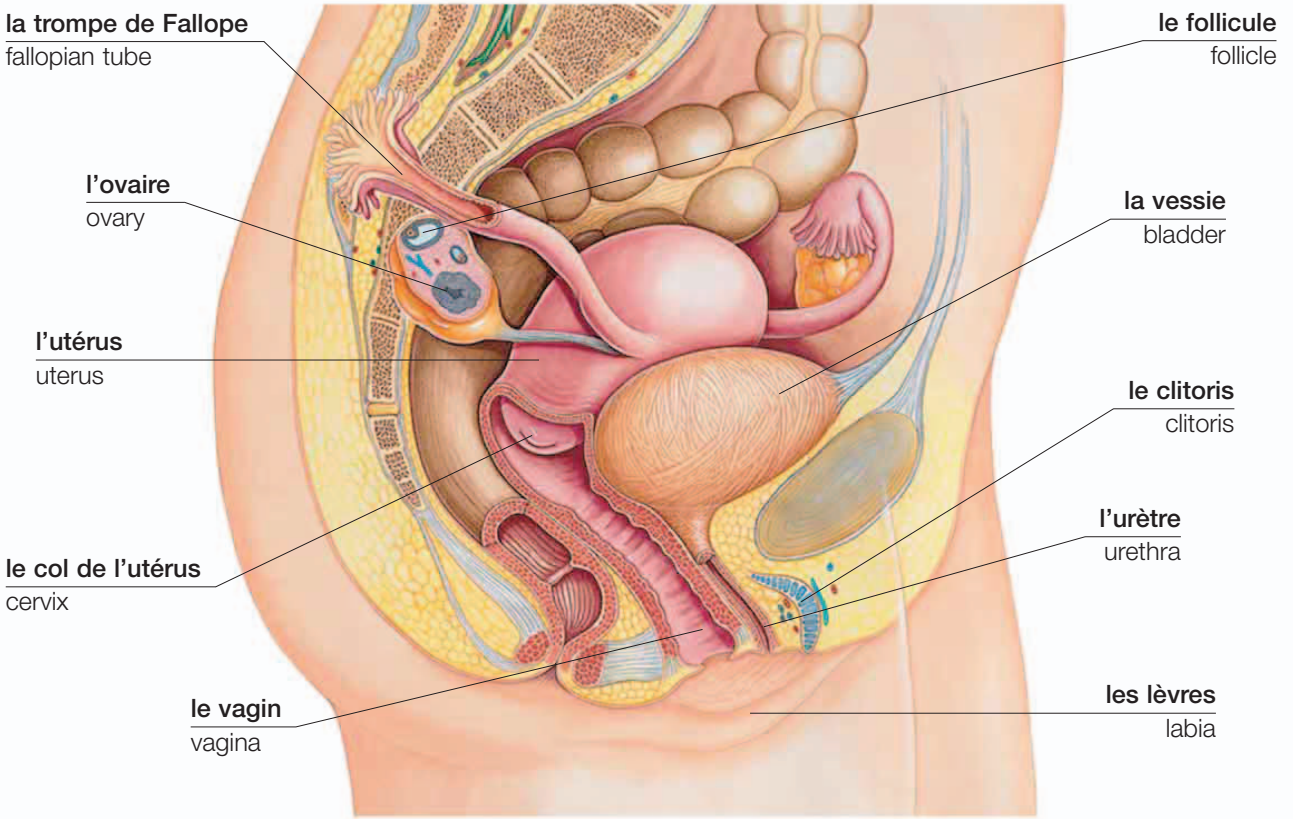

féminin | female

la reproduction • reproduction

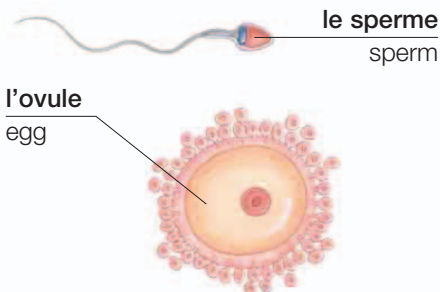

la fécondation | fertilization

vocabulaire • vocabulary

l'hormone
hormone

impuissant
impotent

les règles
menstruation

l'ovulation
ovulation

fécond
fertile

les rapports sexuels
intercourse

stérile
infertile

concevoir
conceive

la maladie sexuellement transmissible
sexually transmitted disease

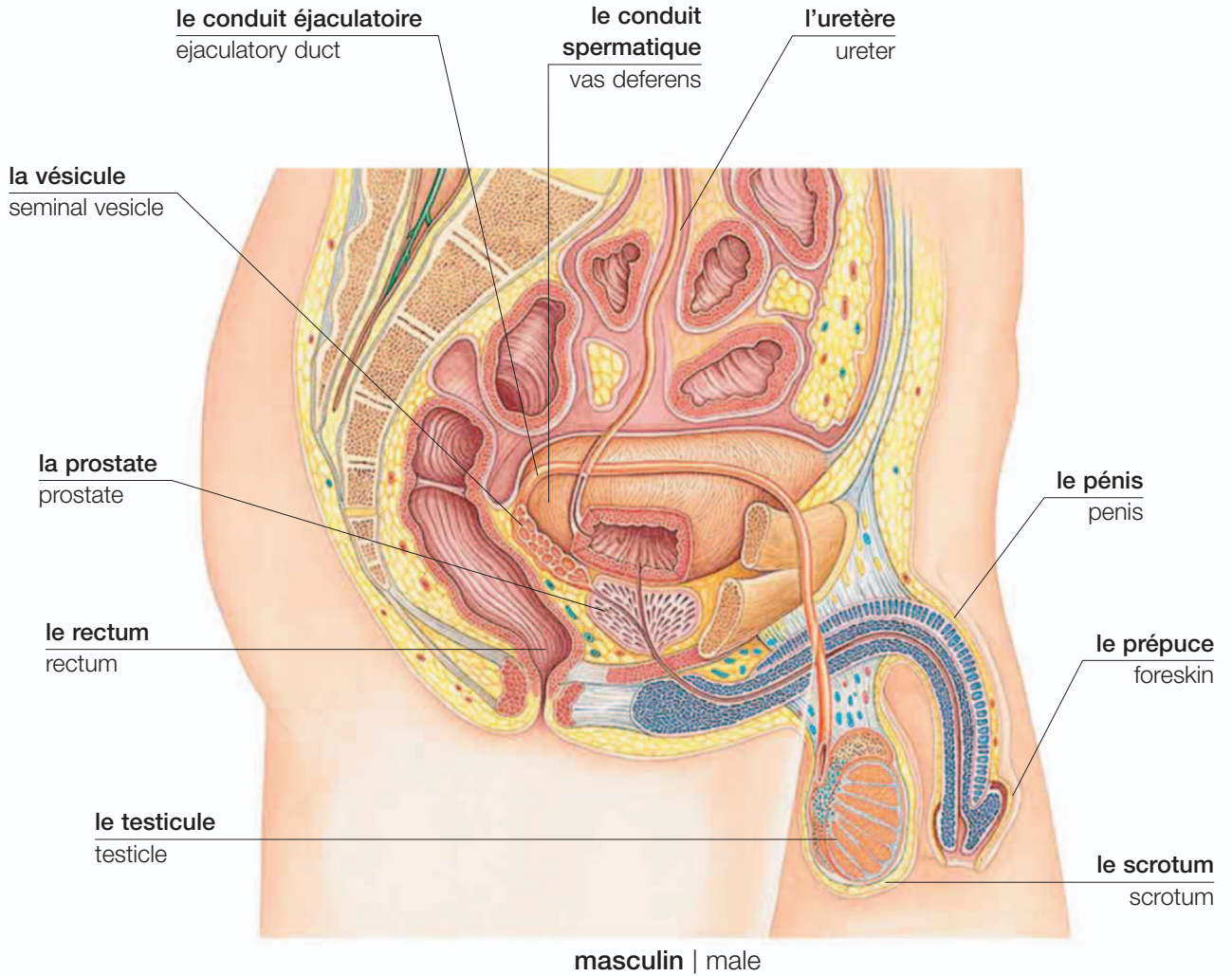

la contraception • contraception

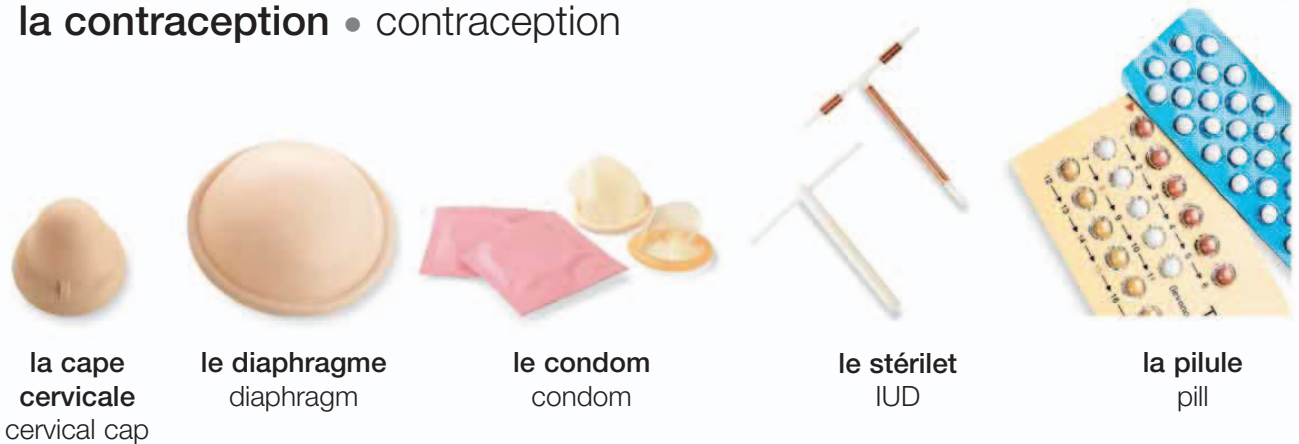

la famille • family

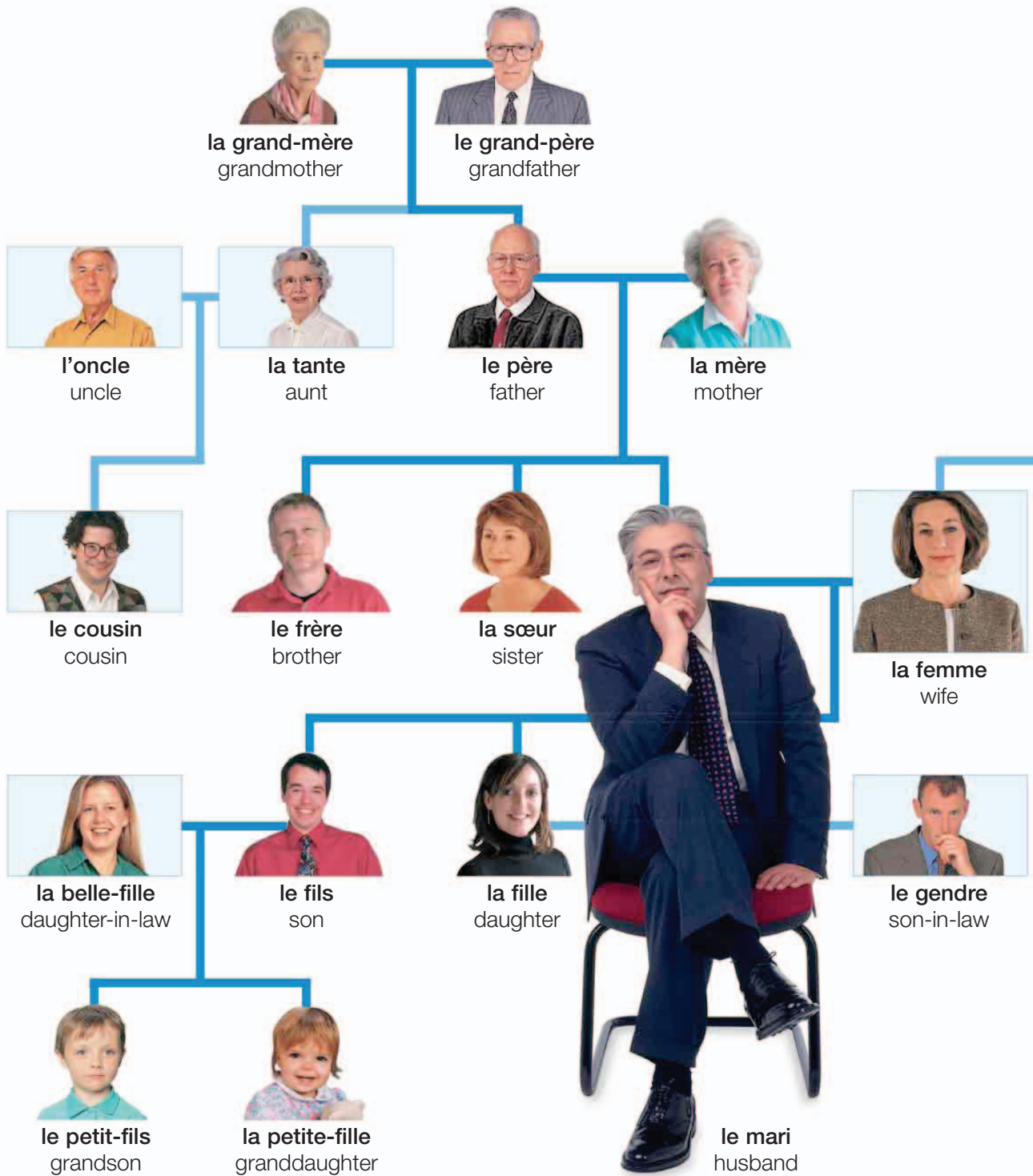

vocabulaire • vocabulary

les parents relatives	les parents parents	les petits-enfants grandchildren	la belle-mère stepmother	le beau-fils stepson	la génération generation
les grands-parents grandparents	les enfants children	le beau-père stepfather	la belle-fille stepdaughter	le/la partenaire partner	les jumeaux twins



la belle-mère
mother-in-law



le beau-père
father-in-law



le beau-frère
brother-in-law



la belle-sœur
sister-in-law



la nièce
niece



le neveu
nephew

Mademoiselle
Miss

les titres • titles

Madame
Mrs.

Monsieur
Mr.



les stades • stages



le bébé
baby



l'enfant
child



le garçon
boy



la fille
girl



l'adolescente
teenager



l'adulte
adult



l'homme
man



la femme
woman

les relations • relationships

l'assistante
assistant

le chef
manager



l'associée
business partner

l'employeur
employer

l'employée
employee

le collègue
colleague



le bureau | office



le voisin
neighbor



l'ami
friend



la connaissance
acquaintance



le correspondant
pen pal

le petit ami
boyfriend



le couple | couple

la petite amie
girlfriend

le fiancé
fiancé



les fiancés | engaged couple

la fiancée
fiancée

les émotions • emotions



le sourire
smile

heureux
happy



triste
sad



excité
excited



ennuyé
bored



surpris
surprised



effrayé
scared



le froncement
de sourcils
frown

fâché
angry

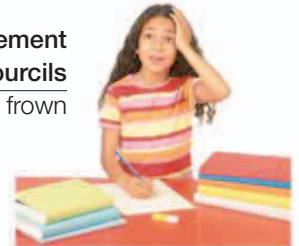

confus
confused



inquiet
worried



nerveux
nervous



fier
proud



confiant
confident



gêné
embarrassed



timide
shy

vocabulaire • vocabulary

consterné upset	rire laugh (v)	soupirer sigh (v)	crier shout (v)
choqué shocked	pleurer cry (v)	s'évanouir faint (v)	bâiller yawn (v)

les événements de la vie • life events



naître
be born (v)



commencer à l'école
start school (v)



se faire des amis
make friends (v)



obtenir sa licence
graduate (v)



trouver un emploi
get a job (v)



tomber amoureux
fall in love (v)



se marier
get married (v)



avoir un bébé
have a baby (v)



le mariage | wedding



le divorce
divorce



l'enterrement
funeral

vocabulaire • vocabulary

le baptême
christening

mourir
die (v)

la bar-mitsvah
bar mitzvah

faire son testament
make a will (v)

l'anniversaire de mariage
anniversary

l'acte de naissance
birth certificate

émigrer
emigrate (v)

le repas de nocés
wedding reception

prendre sa retraite
retire (v)

le voyage de nocés
honeymoon

les fêtes • celebrations

la fête
birthday party



l'anniversaire
birthday

la carte
card



le cadeau
present



le Noël
Christmas

les fêtes • festivals



la Pâque
Passover



le Nouvel An
New Year



le carnaval
carnival

le défilé
procession



le Ramadan
Ramadan

le ruban
ribbon



la fête de Thanksgiving
Thanksgiving



Pâques
Easter



la veille de la Toussaint
Halloween



la Diwali
Diwali





l'apparence
appearance

les vêtements d'enfants • children's clothing

le bébé • baby



le tricot de corps
undershirt

la grenouillère
coverall

le bouton-pression
snap



le pyjama
sleeper



la combinaison de neige
snowsuit



la combinaison-short
romper



le bavoir
bib



les moufles
mittens



les chaussons
booties



la couche éponge
cloth diaper



la couche jetable
disposable diaper



la culotte en plastique
plastic pants

le petit enfant • toddler



le chapeau de soleil
sun hat



le tablier
apron



le bermuda
shorts

la salopette
overalls



le t-shirt
T-shirt



la jupe
skirt

l'enfant • child



la robe
dress

la capuche
hood

les sandales
sandals

l'été
summer



l'imperméable
raincoat



le jean
jeans

l'automne
fall

le sac à dos
backpack

le bouton
toggle



le duffel-coat
duffle coat



l'écharpe
scarf

l'anorak
parka

les bottes de caoutchouc
wellington boots

l'hiver
winter



la robe de chambre
bathrobe

le logo
logo

les baskets
athletic shoes

la chemise de nuit
nightgown

les pantoufles
slippers

les vêtements de nuit
nightwear



la tenue de foot
soccer uniform



le survêtement
jogging suit



les leggings
leggings

vocabulaire • vocabulary

la fibre naturelle
natural fiber

synthétique
synthetic

C'est lavable en machine?
Is it machine washable?

C'est la bonne taille pour deux ans?
Will this fit a two-year-old?

les vêtements pour hommes • men's clothing



le col
collar

la cravate
tie

la ceinture
belt

le revers
lapel

la boutonnière
buttonhole

la manchette
cuff

la poche
pocket

la veste
jacket

le bouton
button

le pantalon
pants

le costume
business suit

l'imperméable
raincoat

la doublure
lining

les
chaussures
en cuir
leather
shoes

vocabulaire • vocabulary

le cardigan
cardigan

les sous-vêtements
underwear

le manteau
coat

court
short

le peignoir
dressing gown

le survêtement
jogging suit

long
long

Avez-vous ça en plus grand/petit?
Do you have this in a larger/smaller size?

Je peux l'essayer?
May I try this on?



le blazer
blazer



la veste de sport
sportcoat



le gilet
waistcoat

l'encolure en V
V-neck

le col rond
round neck



le t-shirt
T-shirt



l'anorak
parka



le sweat-shirt
sweatshirt



la chemise
shirt

le jean
jeans



le pullover
sweater



le pyjama
pajamas



le tricot de corps
vest

les vêtements sport
casual wear



le short
shorts



le slip
briefs



le caleçon
boxer shorts



les chaussettes
socks

les vêtements pour femmes • women's clothing



la lingerie • lingerie



le peignoir
robe



le caraco
slip

la bretelle
strap



la camisole
camisole



la guêpière
bustier

la jarretelle
garter



le bas
stocking



le collant
pantyhose



le soutien-gorge
bra



le slip
panties



la chemise de nuit
nightgown

le mariage • wedding



le voile
veil

la
dentelle
lace

le bouquet
bouquet

la traîne
train

la robe de mariée
wedding dress

vocabulaire • vocabulary

le corset
corset

ajusté
tailored

la jarretière
garter

dos-nu
halter neck

l'épaulette
shoulder pad

à armature
underwired

la ceinture
waistband

le soutien-gorge
sport
sports bra

les accessoires • accessories



la casquette
cap



le chapeau
hat



le foulard
scarf



la ceinture
belt

le manche
handle



la pointe
tip



le mouchoir
handkerchief



le nœud papillon
bow tie



l'épingle de
cravate
tie-pin



les gants
gloves

le parapluie
umbrella

les bijoux • jewellery



le pendentif
pendant



la broche
brooch



le bouton de manchette
cufflink

le rang de perles
string of pearls

le maillon
link



le bracelet
bracelet

le fermoir
clasp



la chaîne
chain

la boucle d'oreille
earring

la bague
ring

la pierre
stone

le collier
necklace

la montre
watch



la boîte à bijoux | jewelry box

les sacs • bags



le portefeuille
wallet



le porte-monnaie
purse



le sac à
bandoulière
shoulder bag

le fermoir
fastening

la bretelle
shoulder strap

les poignées
handles



le fourre-tout
duffle bag



la serviette
briefcase



le sac à main
handbag



le sac à dos
backpack

les chaussures • shoes

le lacet
lace

la languette
tongue

l'œillet
eyelet

la semelle
sole



la chaussure lacée
lace-up

le talon
heel



la botte
boot



le pataugas
walking boot



la basket
athletic shoe



la tong
flip-flop



la chaussure de cuir
leather shoe



la chaussure à
talon
high-heeled shoe



la chaussure
compensée
wedge



la sandale
sandal



le mocassin
slip-on



la ballerine
pump

les cheveux • hair



peigner
comb (v)



brosser | brush (v)



laver | wash (v)



couper
cut (v)



les accessoires • accessories



les coiffures • styles



la queue de cheval
ponytail

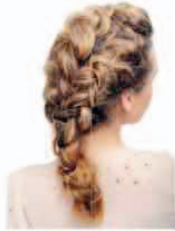

la natte
braid



le rouleau
French braid



le chignon
bun



les couettes
pigtails



au carré
bob



la coupe courte
crop



frisé
curly



la permanente
perm



raide
straight

les racines
roots



les reflets
highlights



chauve
bald



la perruque
wig

les couleurs • colors



blond
blonde



châtain
brunette



auburn
auburn



roux
red



noir
black



gris
gray



blanc
white



teint
dyed

vocabulaire • vocabulary

rafraîchir
trim (v)

gras
greasy

décrêper
straighten (v)

sec
dry

le coiffeur
barber

normal
normal

les pellicules
dandruff

le cuir chevelu
scalp

les fourches
split ends

l'élastique pour
cheveux
hairband

la beauté • beauty



la teinture de cheveux
hair dye

le fard à
paupières
eye shadow

le mascara
mascara

l'eye-liner
eyeliner

le fard à joues
blusher

le fond de teint
foundation

le rouge à lèvres
lipstick

le maquillage • makeup



le crayon à sourcils
eyebrow pencil



la brosse à sourcils
eyebrow brush



la pince à épiler
tweezers



le brillant à lèvres
lip gloss



le pinceau à lèvres
lip brush



le crayon à lèvres
lip liner



le pinceau
brush



le correcteur
concealer

le miroir
mirror

la poudre
face powder

la houppette
powder puff



le poudrier | compact

les soins de beauté • beauty treatments

le masque de beauté
face mask



le soin du visage
facial



le lit U.V.
sunbed



exfolier
exfoliate (v)



l'épilation
wax



la pédicurie
pedicure

la manucure • manicure



la lime à ongles
nail file

le dissolvant
nail polish remover



le vernis à ongles
nail polish

les ciseaux à ongles
nail scissors



le coupe-ongles
nail clippers



les accessoires de toilette • toiletries



le démaquillant
cleanser



le tonique
toner



la crème hydratante
moisturizer



l'autobronzant
self-tanning cream



le parfum
perfume



l'eau de toilette
cologne

vocabulaire • vocabulary

le teint
complexion

gras
oily

le bronzage
tan

clair
fair

sensible
sensitive

le tatouage
tattoo

foncé
dark

hypoallergénique
hypoallergenic

antirides
anti-wrinkle

sec
dry

le ton
shade

les boules de coton
cotton balls





la santé
health



la maladie • illness



la fièvre | fever

l'inhalateur
inhaler



l'asthme
asthma



les crampes
cramps



le mal de tête
headache

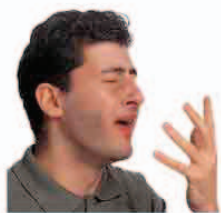

l'éternuement
sneeze



le saignement de
nez
nosebleed



le rhume
cold



la toux
cough



la grippe
flu



la nausée
nausea



la varicelle
chickenpox



l'éruption
rash

vocabulaire • vocabulary

l'attaque
stroke

le diabète
diabetes

l'eczéma
eczema

le refroidissement
chill

vomir
vomit (v)

la diarrhée
diarrhea

la tension
blood pressure

l'allergie
allergy

l'infection
infection

le mal d'estomac
stomachache

l'épilepsie
epilepsy

la rougeole
measles

la crise
cardiaque
heart attack

le rhume
des foins
hayfever

le virus
virus

s'évanouir
faint (v)

la migraine
migraine

les
oreillons
mumps

le médecin • doctor
la consultation • consultation

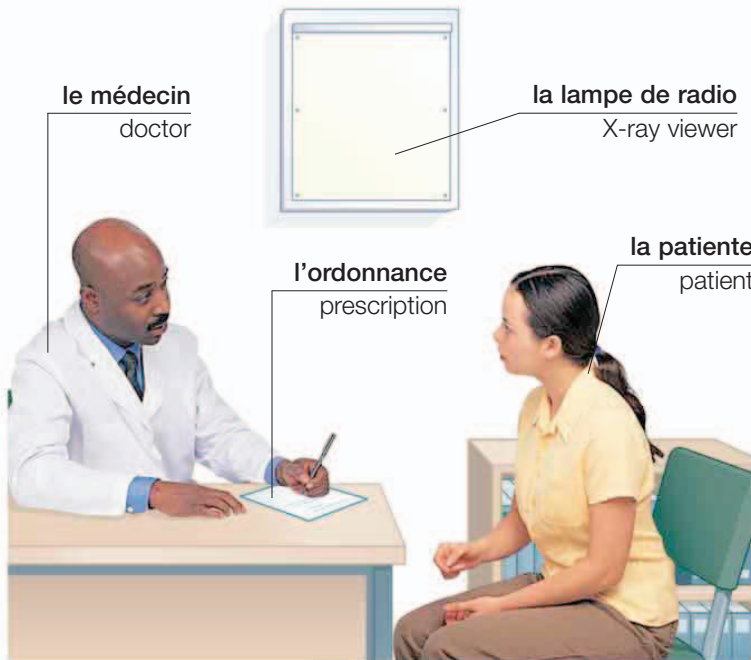

l'infirmière
nurse

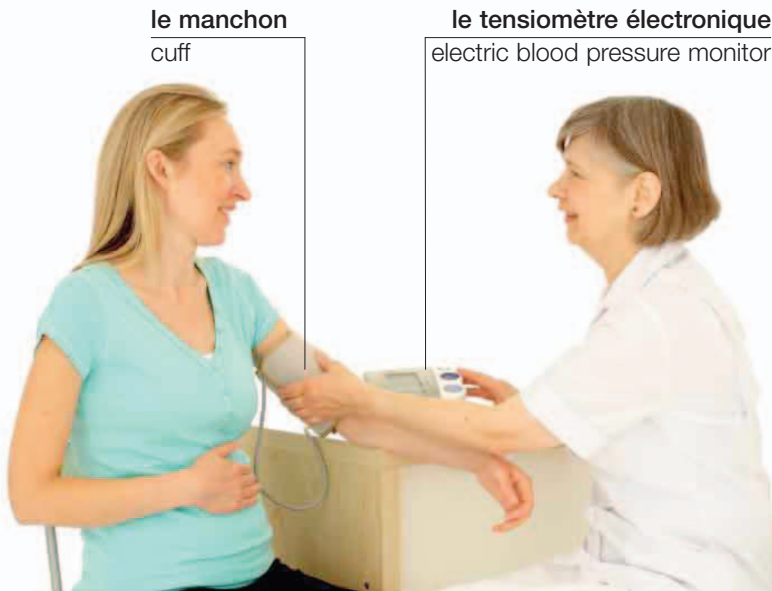

vocabulaire • vocabulary

le rendez-vous
appointment

l'inoculation
vaccination

le cabinet
surgery

le thermomètre
thermometer

**la salle
d'attente**
waiting room

**l'examen
médical**
medical
examination

J'ai besoin de voir un médecin.
I need to see a doctor.

J'ai mal ici.
It hurts here.

la blessure • injury



l'entorse | sprain

l'écharpe
sling



la fracture
fracture

la minerve
neck brace



le coup du lapin
whiplash



la coupure
cut



l'écorchure
graze



la contusion
bruise



l'écharde
splinter



le coup de soleil
sunburn



la brûlure
burn



la morsure
bite



la piqûre
sting

vocabulaire • vocabulary

l'accident
accident

l'hémorragie
hemorrhage

l'empoisonnement
poisoning

Est-ce qu'il/elle va se remettre?
Will he/she be all right?

l'urgence
emergency

l'ampoule
blister

le choc électrique
electric shock

Où avez-vous mal?
Where does it hurt?

la blessure
wound

**la commotion
cérébrale**
concussion

**le traumatisme
crânien**
head injury

**Appelez une ambulance s'il
vous plaît.**
Please call an ambulance.

les premiers secours • first aid

la pommade
ointment

le pansement
bandage

l'épingle de
sûreté
safety pin

le bandage
bandage

les analgésiques
painkillers



la serviette
antiseptique
antiseptic wipe

la pince fine
tweezers

les ciseaux
scissors

l'antiseptique
antiseptic

la trousse de premiers secours | first-aid box

la gaze
gauze



le pansement
dressing



l'attelle
splint



le sparadrap
adhesive tape



la réanimation
resuscitation

vocabulaire • vocabulary

le choc
shock

le pouls
pulse

étouffer
choke (v)

Est-ce que vous pouvez
m'aider?

Can you help?

sans
connaissance
unconscious

la
respiration
breathing

stérile
sterile

Pouvez-vous donner les
soins d'urgence?

Do you know first aid?

l'hôpital • hospital



l'analyse de sang
blood test



l'injection
injection



le chariot
gurney

la salle des urgences
emergency room



le bouton d'appel
call button

la salle
ward



la chaise roulante
wheelchair



la radio
X-ray

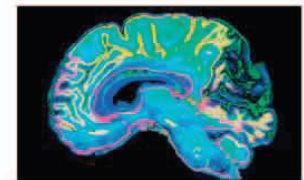

la scanographie
scan

vocabulaire • vocabulary

l'opération
operation

renvoyé
discharged

les heures de visite
visiting hours

la pédiatrie
children's ward

le service de soins intensifs
intensive care unit

admis
admitted

la clinique
clinic

la maternité
maternity ward

la chambre privée
private room

le malade en consultation externe
outpatient

les services • departments



l'O.R.L.
ENT (otolaryngology)



la cardiologie
cardiology



l'orthopédie
orthopedics



la gynécologie
gynecology



la kinésithérapie
physiotherapy



la dermatologie
dermatology



la pédiatrie
pediatrics



la radiologie
radiology



la chirurgie
surgery



la maternité
maternity



la psychiatrie
psychiatry



l'ophtalmologie
ophthalmology

vocabulaire • vocabulary

la neurologie
neurology

l'urologie
urology

l'endocrinologie
endocrinology

la pathologie
pathology

le résultat
result

l'oncologie
oncology

**la chirurgie
esthétique**
plastic surgery

**l'orientation
d'un patient**
referral

l'analyse
test

le spécialiste
consultant

le dentiste • dentist

la dent • tooth

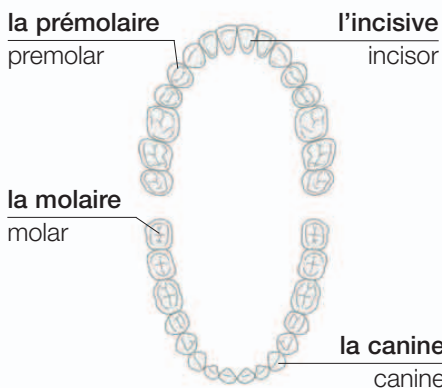
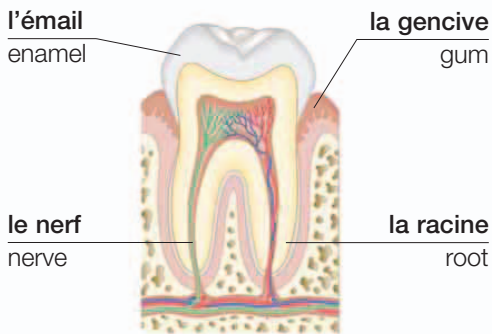

la visite de contrôle • checkup

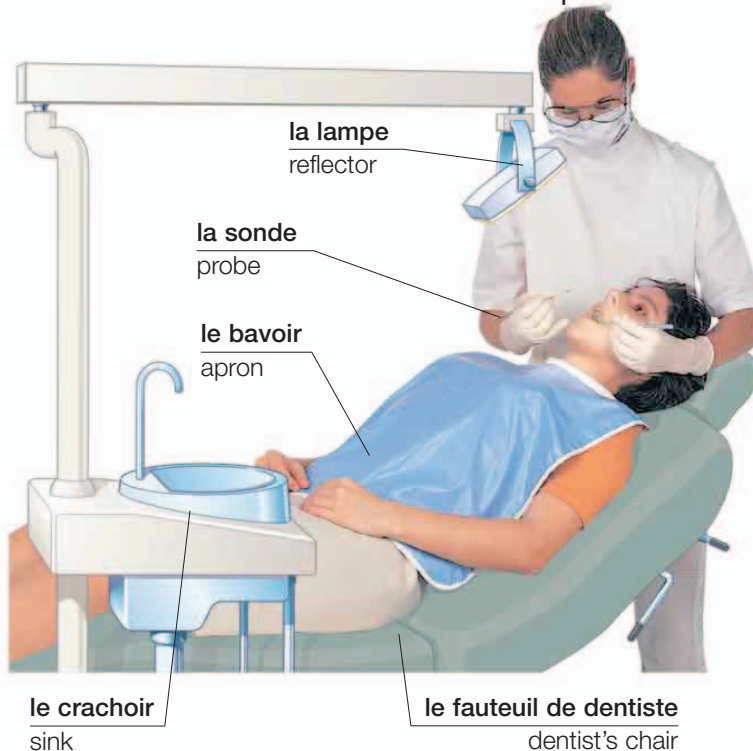

vocabulaire • vocabulary

la rage de dents
toothache

la fraise
drill

la plaque
plaque

le fil dentaire
dental floss

la carie
decay

l'extraction
extraction

le plombage
filling

la couronne
crown



utiliser le fil dentaire
floss (v)



brosser
brush



l'appareil dentaire
braces



la radio dentaire
dental X-ray



la radio
X-ray film



le dentier
dentures

l'opticien • optometrist



l'examen de la vue | eye test

l'étui
case



les lunettes
glasses

le verre
lens



les lunettes de soleil
sunglasses

la monture
frame

la solution nettoyante
cleaning fluid



la solution
désinfectante
disinfectant solution



l'étui à lentilles
lens case

les lentilles de contact | contact lenses

l'œil • eye

le sourcil
eyebrow

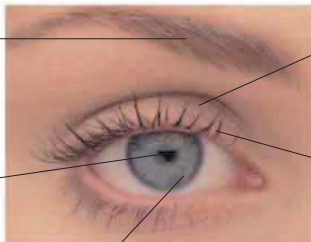

la paupière
eyelid

la pupille
pupil

le cil
eyelash

l'iris
iris

le cristallin
lens

la rétine
retina

la cornée
cornea

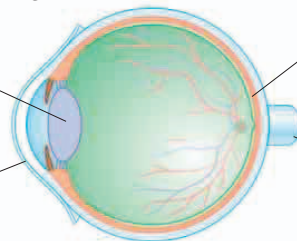

le nerf optique
optic nerve

vocabulaire • vocabulary

la vue
vision

l'astigmatisme
astigmatism

la dioptrie
diopter

la presbytie
farsightedness

la larme
tear

la myopie
nearsightedness

la cataracte
cataract

bifocal
bifocal

la grossesse • pregnancy



le test de grossesse
pregnancy test

l'échographie
scan



les ultrasons | ultrasound

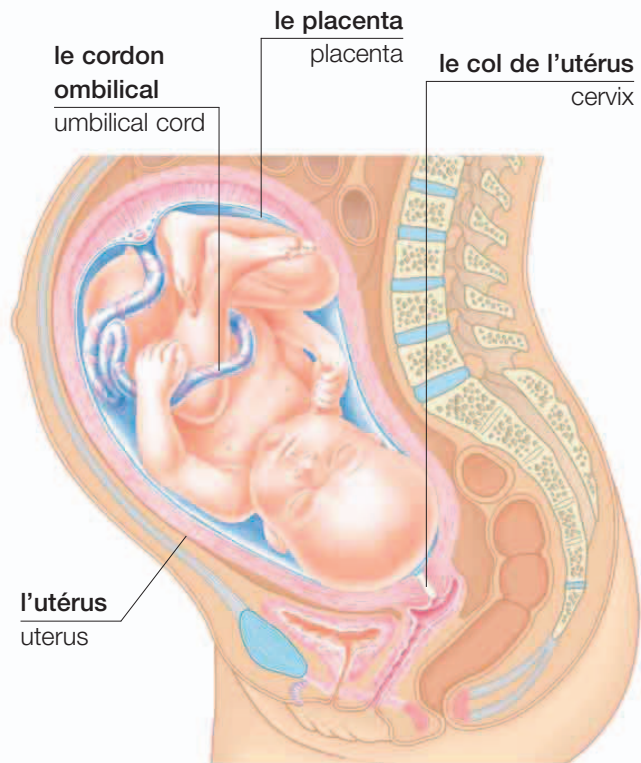

le cordon ombilical
umbilical cord

le placenta
placenta

le col de l'utérus
cervix

l'utérus
uterus

le fœtus | fetus

vocabulaire • vocabulary

l'ovulation ovulation	prénatal prenatal	l'amniocentèse amniocentesis	la dilatation dilation	l'accouchement delivery	par le siège breach
la conception conception	l'embryon embryo	la contraction contraction	la péridurale epidural	la naissance birth	prématuré premature
enceinte pregnant	l'utérus womb	perdre les eaux break water (v)	l'épisiotomie episiotomy	la fausse couche miscarriage	le gynécologue gynecologist
enceinte expecting	le trimestre trimester	le liquide amniotique amniotic fluid	la césarienne cesarean section	les points de suture stitches	l'obstétricien obstetrician

la naissance • childbirth

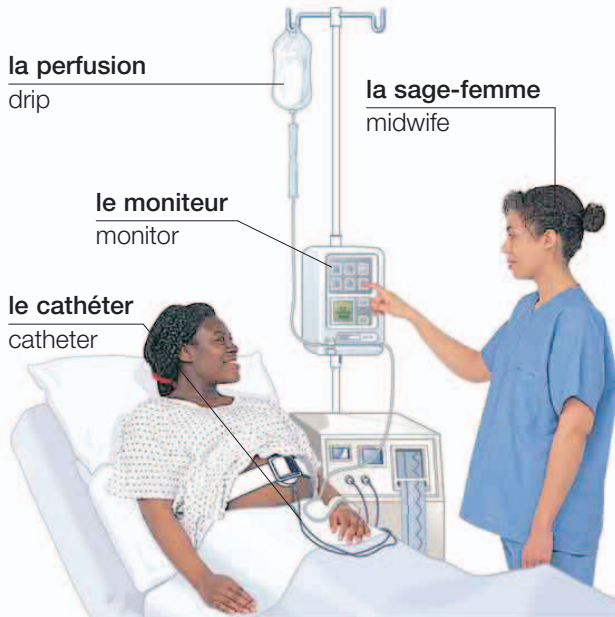

la perfusion
drip

la sage-femme
midwife

le moniteur
monitor

le cathéter
catheter

déclencher l'accouchement
induce labor (v)



la conveuse | incubator



le poids de naissance
birth weight

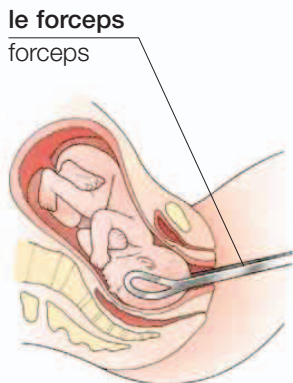

le forceps
forceps

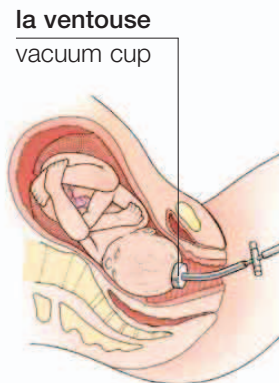

la ventouse
vacuum cup

l'accouchement assisté
assisted delivery

le bracelet d'identité
identity tag



le nouveau-né
newborn baby

l'allaitement • nursing



la pompe à lait
breast pump



le soutien-gorge
d'allaitement
nursing bra



donner le sein
breastfeed (v)



les coussinets
pads

les thérapies alternatives • complementary therapy



le yoga | yoga



le massage
massage



le shiatsu
shiatsu



la chiropractie
chiropractic



l'ostéopathie
osteopathy



la réflexologie
reflexology



la méditation
meditation

le conseiller
counselor



la thérapie de groupe
group therapy



le reiki
reiki



l'acupuncture
acupuncture



la médecine ayurvédique
ayurveda



l'hypnothérapie
hypnotherapy

les huiles essentielles
essential oils



l'herboristerie
herbalism



l'aromathérapie
aromatherapy



l'homéopathie
homeopathy



l'acupression
acupressure

la thérapeute
therapist



la psychothérapie
psychotherapy

vocabulaire • vocabulary

le supplément
supplement

la naturopathie
naturopathy

la relaxation
relaxation

l'herbe
herb

l'hydrothérapie
hydrotherapy

le feng shui
feng shui

le stress
stress

la guérison
par cristaux
crystal healing





la maison
home

la maison • house

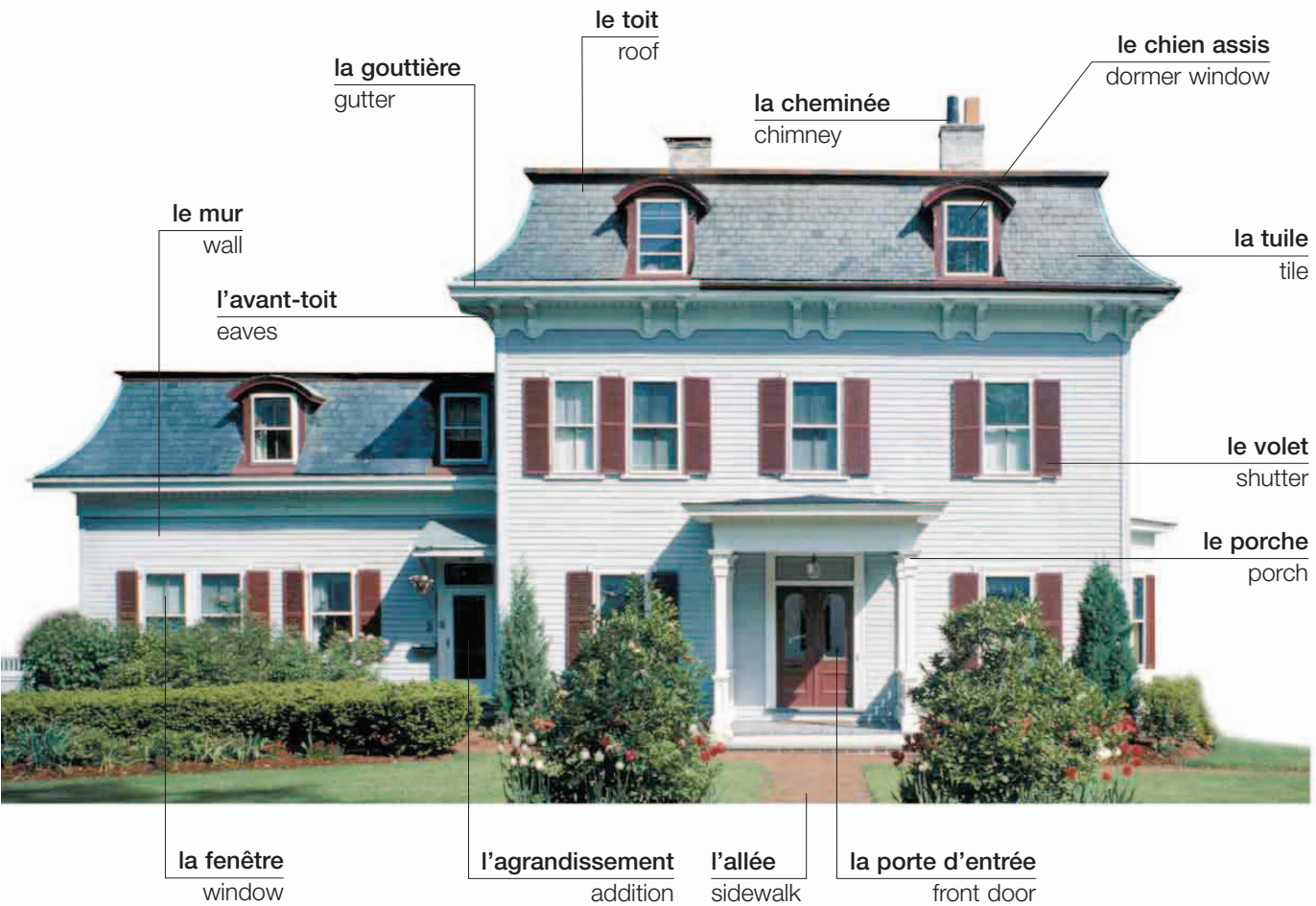

vocabulaire • vocabulary

individuelle single-family	le locataire tenant	le garage garage	la boîte aux lettres mailbox	l'alarme burglar alarm	louer rent (v)
mitoyenne duplex	la pavillon ranch house	le grenier attic	la lampe d'entrée porch light	la cour courtyard	le loyer rent
la maison de deux étages townhouse	le sous-sol basement	la chambre room	le propriétaire landlord	l'étage floor	attenante terraced

l'entrée • entrance



la main courante
hand rail

l'escalier
staircase

le palier
landing

la rampe
banister

le vestibule
foyer



la sonnette
doorbell



le paillason
doormat



le marteau de porte
door knocker



la chaîne de sûreté
door chain

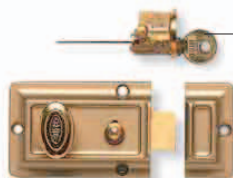

la serrure
lock



le verrou
bolt

la clef
key

l'appartement • apartment



le balcon
balcony

l'immeuble
apartment building



l'interphone
intercom



l'ascenseur
elevator

les systèmes domestiques • internal systems



le radiateur
radiator



l'appareil de chauffage
space heater



l'aile
blade

le ventilateur
fan



le convecteur
convector heater

l'électricité • electricity



le filament
filament

la mise à la terre
ground

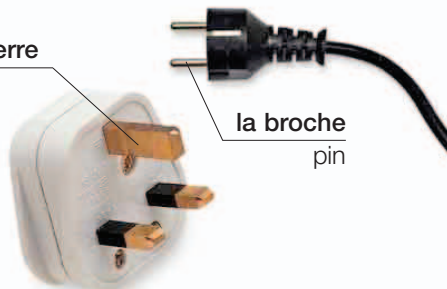

la broche
pin

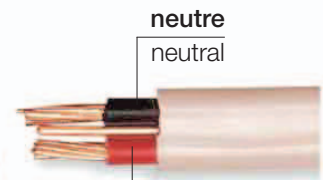

neutre
neutral

sous tension
live

l'ampoule basse consommation
energy-saving bulb

la prise
plug

les fils
wires

vocabulaire • vocabulary

la tension
voltage

le fusible
fuse

la prise de courant
outlet

le courant continu
direct current

la coupure de courant
power outage

l'ampère
amp

la boîte à fusibles
fuse box

l'interrupteur
switch

le transformateur
transformer

le réseau d'électricité
household current

le courant
power

la génératrice
generator

le courant alternatif
alternating current

le compteur d'électricité
electric meter

la plomberie • plumbing

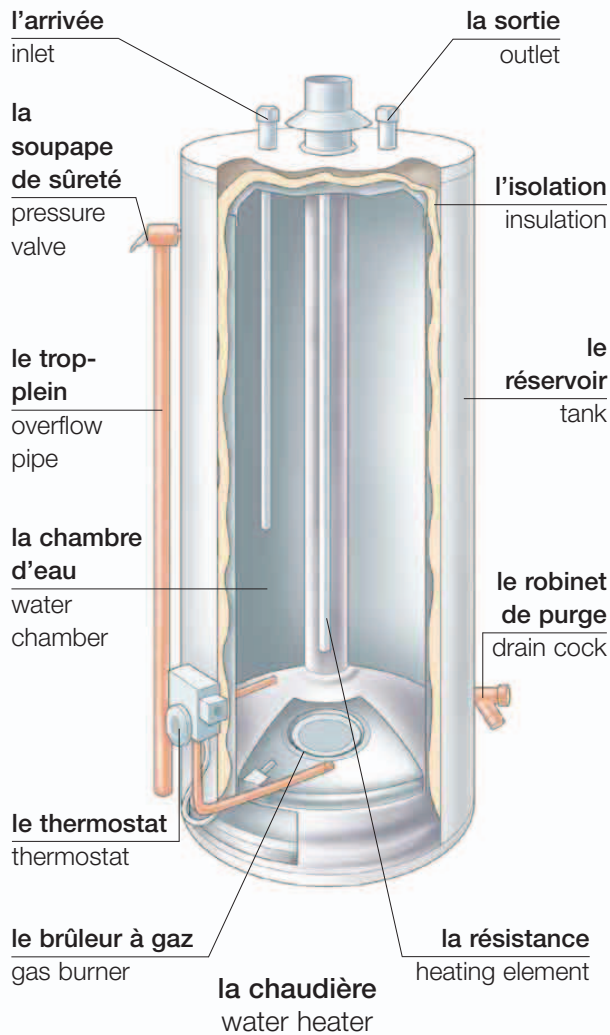

l'évier • sink

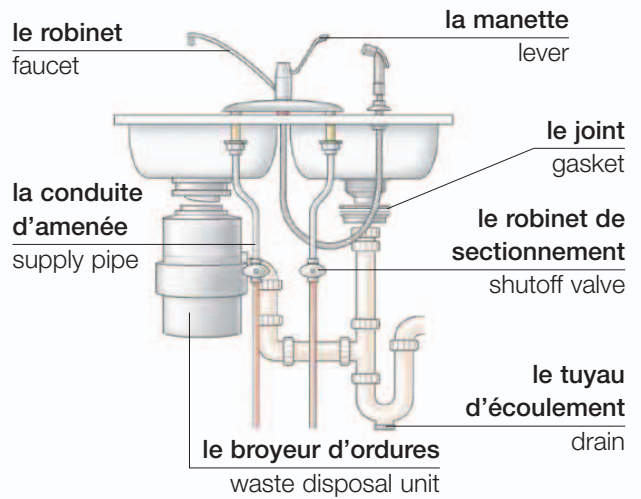

les W.-C. • toilet

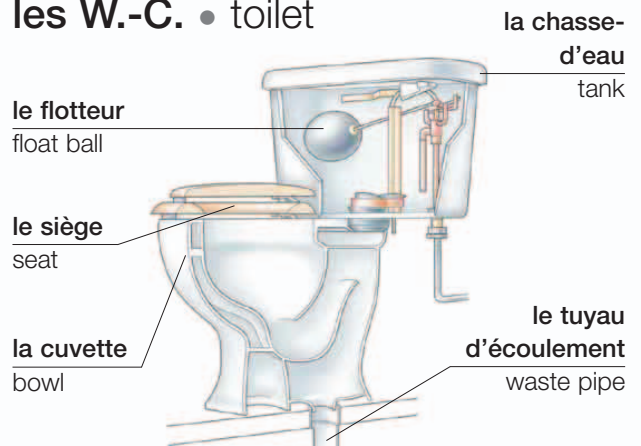

l'enlèvement de déchets • waste disposal



le salon • living room

le plafond
ceiling

le vase
vase

le coussin
cushion

la lampe
lamp

la table basse
coffee table

le canapé
sofa

le sol
floor

l'applique
wall light

la cheminée
fireplace



le cadre
frame



le tableau
painting



le rideau
curtain



le brise-bise
net curtain



le store vénitien
venetian blind



le store
shade

la moulure
molding

le fauteuil
armchair



la bibliothèque
bookshelf

le canapé-lit
sofabed

le tapis
rug

le bureau | study

la salle à manger • dining room



vocabulaire • vocabulary

mettre la table
set the table (v)

(avoir) faim
hungry

le déjeuner
lunch

rassasié
full

l'hôte
host

servir
serve (v)

la nappe
tablecloth

le dîner
dinner

la portion
portion

l'hôtesse
hostess

manger
eat (v)

le petit déjeuner
breakfast

le set de table
placemat

le repas
meal

l'invité
guest

Puis-je en reprendre un peu, s'il vous plaît?

Can I have some more, please?

Non merci, j'en ai eu assez.

I've had enough, thank you.

C'était délicieux.

That was delicious.

la vaisselle et les couverts • crockery and cutlery



la grande tasse
mug



la tasse à thé
teacup



la tasse à café
coffee cup

la cuiller à café
teaspoon



l'assiette
plate



le bol
bowl



la cafetière
cafetière



la théière
teapot



le pot
pitcher



le coquetier
egg cup

le verre à vin
wine glass

le verre
tumbler



la verrerie
glassware

le rond de
serviette
napkin ring

l'assiette à
dessert
side plate

l'assiette
plate
dinner plate

l'assiette à
soupe
soup bowl

la cuiller à soupe
soup spoon



la serviette
napkin



la fourchette
fork



le couvert
place setting



la cuiller
spoon

le couteau
knife

la cuisine • kitchen



les appareils ménagers • appliances

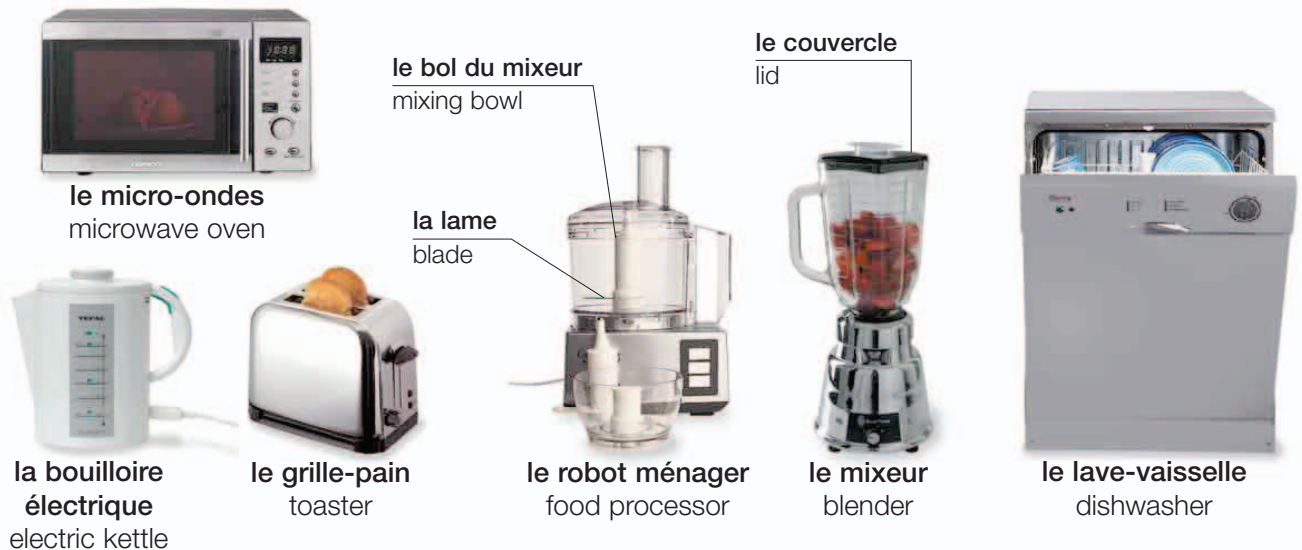

le freezer
ice maker

le congélateur
freezer



la clayette
shelf

le bac à légumes
crisper

le réfrigérateur | refrigerator

vocabulaire • vocabulary

l'égouttoir
draining board

congeler
freeze (v)

le brûleur
burner

décongeler
defrost (v)

la table de cuisson
stovetop

cuire à la vapeur
steam (v)

la poubelle
garbage can

faire sauter
sauté (v)

la cuisine • cooking



éplucher
peel (v)



couper
slice (v)



râper
grate (v)



verser
pour (v)



mélanger
mix (v)



battre
whisk (v)



bouillir
boil (v)



frir
fry (v)



étaler au rouleau
roll (v)



remuer
stir (v)



mijoter
simmer (v)



pocher
poach (v)



cuire au four
bake (v)



rôtir
roast (v)



griller
broil (v)

les ustensiles de cuisine • kitchenware



la planche à hacher
cutting board

le couteau à pain
bread knife



le couteau de cuisine
kitchen knife



le fendoir
cleaver



l'aiguisoir
knife sharpener



l'attendrisseur
meat tenderizer



la broche
skewer



la râpe
grater



le mortier
mortar

le pilon
pestle



le presse-purée
potato masher



l'épluche-légume
vegetable peeler



le vide-pomme
apple corer



l'ouvre-boîte
can opener



l'ouvre-bouteille
bottle opener



le presse-ail
garlic press



la cuiller à servir
serving spoon



la pelle à poisson
slotted spatula



la passoire
colander



la spatule
spatula



la cuiller en bois
wooden spoon



l'écumoire
slotted spoon



la louche
ladle



la fourchette à découper
carving fork



la cuiller à glace
ice-cream scoop



le fouet
whisk



la passoire
sieve



la pâtisserie • baking cakes



la chambre • bedroom

l'armoire

wardrobe

la lampe de chevet

bedside lamp

la tête de lit

headboard

la table de nuit

nightstand

la commode

chest of drawers



le tiroir
drawer

le lit
bed

le matelas
mattress

le couvre-lit
bedspread

l'oreiller
pillow



la bouillotte
hot-water bottle



le radio-réveil
clock radio



le réveil
alarm clock



la boîte de kleenex
box of tissues



le cintre
coathanger

le linge de lit • bed linen



le miroir
mirror

la coiffeuse
dressing
table

le sol
floor



la taie d'oreiller
pillowcase

le drap
sheet

la frange de lit
dust ruffle

la couette
comforter

l'édredon
quilt

la
couverture
blanket



vocabulaire • vocabulary

le lit simple
twin bed

le pied de lit
footboard

l'insomnie
insomnia

se réveiller
wake up (v)

mettre le réveil
set the alarm (v)

le grand lit
full bed

le ressort
spring

se coucher
go to bed (v)

se lever
get up (v)

ronfler
snore (v)

la couverture
chauffante
electric blanket

le tapis
carpet

s'endormir
go to sleep (v)

faire le lit
make the bed (v)

l'armoire
encastrée
built-in wardrobe

la salle de bain • bathroom

le porte-serviettes
towel bar

la porte de douche
shower door

le robinet d'eau froide
cold faucet

le robinet d'eau chaude
hot faucet

le pommeau de douche
shower head

le lavabo
sink

la bonde
plug



la baignoire
bathtub



le bidet | bidet



la douche
shower

le tuyau d'écoulement
drain

le siège des toilettes
toilet seat

les toilettes
toilet

la brosse
toilet brush

vocabulaire • vocabulary

l'armoire à pharmacie
medicine cabinet

le tapis de bain
bath mat

le rouleau de papier hygiénique
toilet paper

le rideau de douche
shower curtain

prendre une douche
take a shower (v)

prendre un bain
take a bath (v)

l'hygiène dentaire • dental hygiene



la brosse à dents
toothbrush



le fil dentaire
dental floss



le dentifrice
toothpaste



l'eau dentifrice
mouthwash

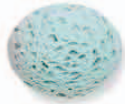

l'éponge
sponge



la pierre ponce
pumice stone



la brosse pour le dos
back brush



le déodorant
deodorant

le porte-savon
soap dish



le savon
soap

le gel douche
shower gel



la crème pour le visage
moisturizer



le bain moussant
bubble bath



le peignoir
bathrobe

la serviette
hand towel



les serviettes
towels

la serviette de bain
bath towel



la lotion pour le corps
body lotion



le talc
talcum powder

le rasage • shaving



le rasoir électrique
electric razor



la mousse à raser
shaving foam



le rasoir jetable
disposable razor



la lame de rasoir
razor blade



l'after-shave
aftershave

la chambre d'enfants • baby's room

les soins de bébé • baby care



l'éponge
sponge

la crème pour
l'érythème
diaper rash cream

la lingette
wet wipe



la baignoire en plastique
baby bath

le pot
potty

le matelas à langer
changing mat

le coucher • sleeping



le mobile
mobile

les barreaux
bars

la couverture laineuse
fleece

le protège-barreaux
bumper

le matelas
mattress

le lit d'enfant | crib

le drap
sheet

la couverture
blanket



la literie
bedding



le hochet
rattle



le moïse
bassinet

le jeu • playing



la sécurité • safety

la serrure de sécurité
child lock

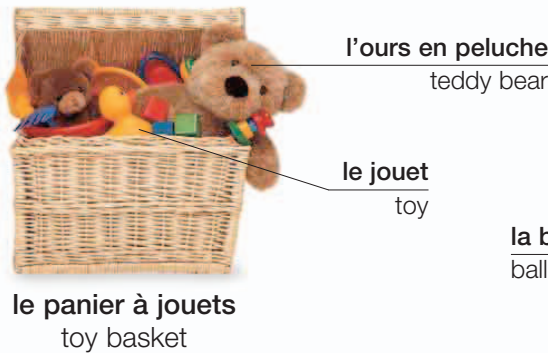

le manger • eating



la sortie • going out



la buanderie • utility room

le linge • laundry

le linge sale
dirty laundry



le panier à linge
laundry basket



le lave-linge
washing machine



le lave-linge séchant
washer-dryer



le sèche-linge
tumble-dryer

le linge propre
clean clothes



le panier à linge
linen basket

la pince à linge
clothespin



sécher
dry (v)

la corde à linge
clothesline



la planche à repasser | ironing board



le fer à repasser
iron

vocabulaire • vocabulary

charger
load (v)

essorer
spin (v)

repasser
iron (v)

Comment fonctionne le lave-linge?
How do I operate the washing machine?

rincer
rinse (v)

l'essoreuse
spin-dryer

l'assouplisseur
fabric softener

Quel est le programme pour les couleurs/le blanc?
What is the setting for colors/whites?

l'équipement d'entretien • cleaning equipment



les activités • activities



l'atelier • workshop



la scie sauteuse
jigsaw



la pile
battery pack

la perceuse rechargeable
cordless drill



le mandrin
chuck

la perceuse électrique
electric drill



la mèche
drill bit



le pistolet à colle
glue gun



l'étau
vise

le serre-joint
clamp



la ponceuse
sander

la lame
blade

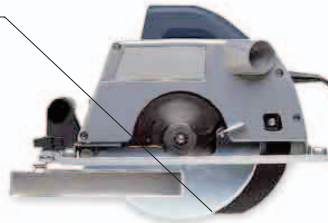

la scie circulaire
circular saw



l'établi
workbench

la colle à bois
wood glue

la guimbarde
router

les copeaux
wood shavings



le porte-outils
tool rack

le vilebrequin
bit brace

la rallonge
extension cord

les techniques • techniques

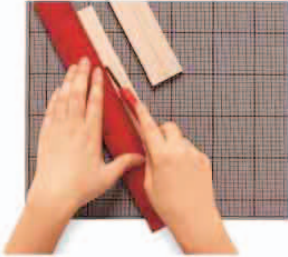

découper
cut (v)



scier
saw (v)



percer
drill (v)



marteler
hammer (v)



raboter
plane (v)

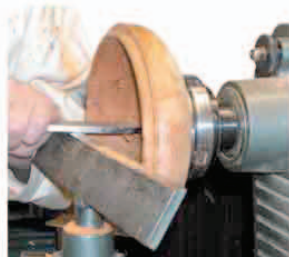

tourner
turn (v)



la soudure
solder

sculpter
carve (v)

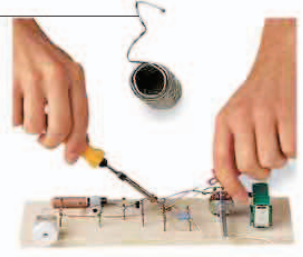

souder
solder (v)

les matériaux • materials

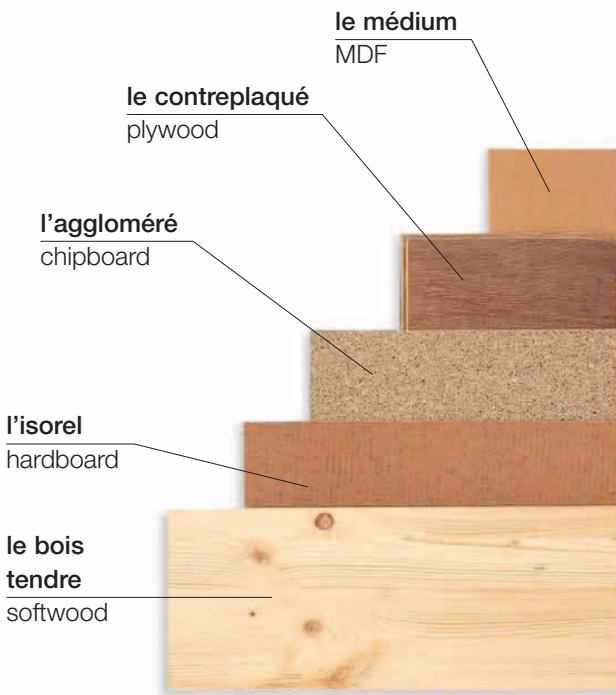

le bois tendre
softwood

l'isorel
hardboard

l'aggloméré
chipboard

le contreplaqué
plywood

le médium
MDF

le bois | wood

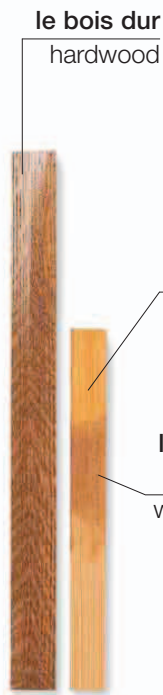

le bois dur
hardwood

la couleur pour bois
wood stain

le vernis
varnish

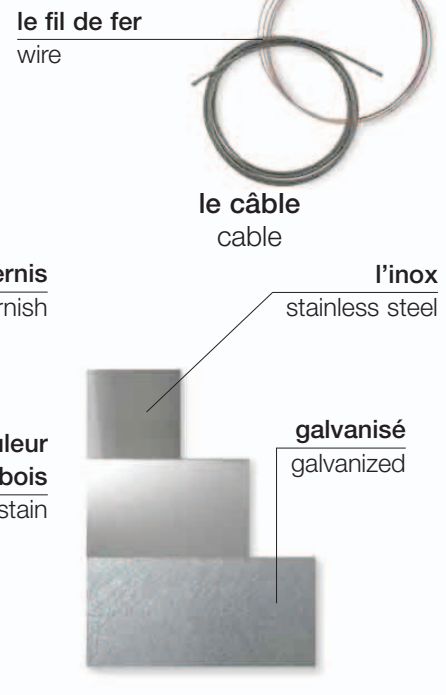

le fil de fer
wire

le câble
cable

l'inox
stainless steel

galvanisé
galvanized

le métal | metal

la boîte à outils • toolbox

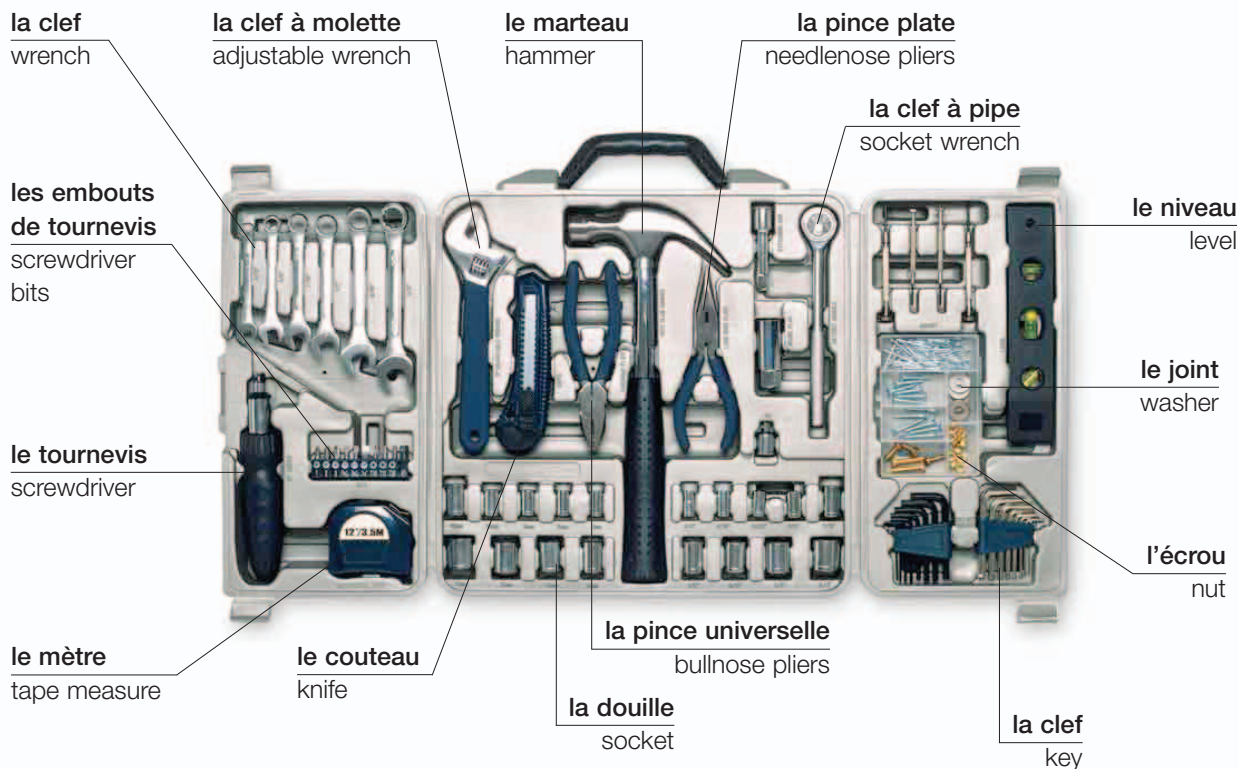

les forets • drill bits

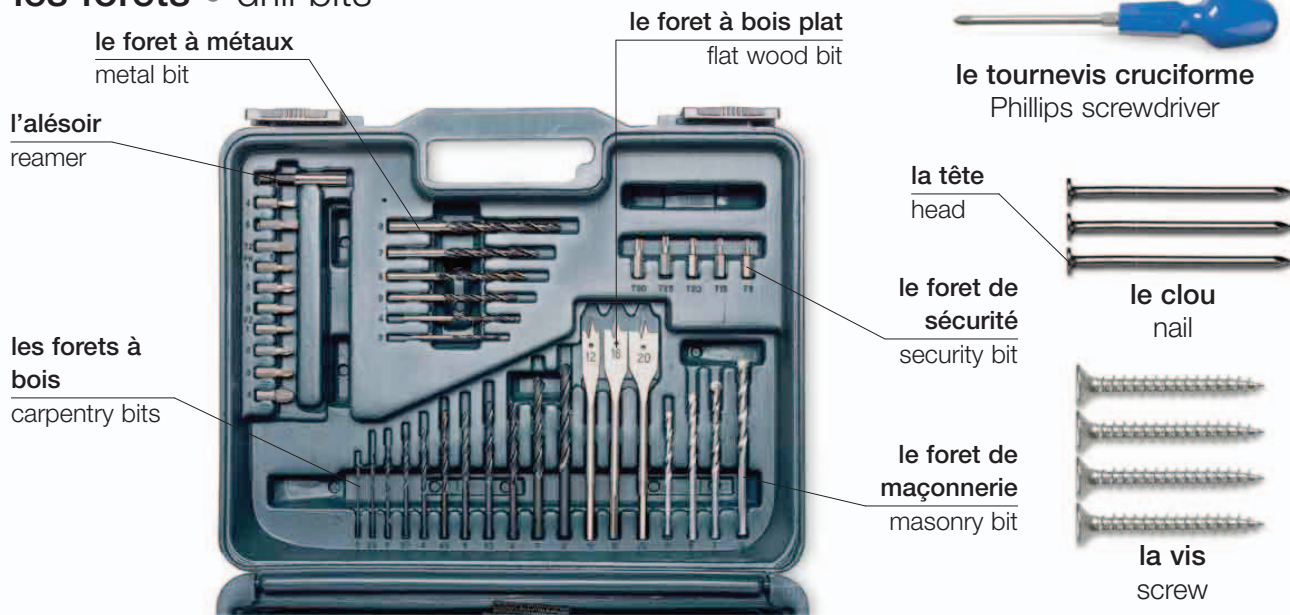

la pince à dénuder
wire strippers

la pince coupante
wire cutters

le fer à souder
soldering iron

le ruban
isolant
insulating
tape



la scie à
chantourner
fret saw

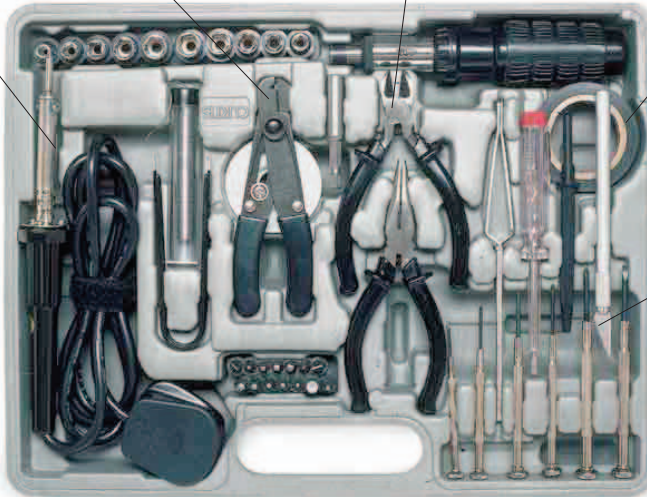

le scalpel
craft knife



la scie à dossieret | tenon saw

la soudure
solder



les lunettes de
sécurité
safety goggles



le rabot
plane



la scie égoïne
hand saw



la boîte à onglets
miter block



la scie à métaux
hacksaw



la perceuse
manuelle
hand drill



la paille de fer
steel wool



la clef serre-tube
wrench



le burin
chisel



le papier de verre
sandpaper



la ventouse
plunger



la lime
file



la pierre à
aiguiser
whetstone



le coupe-tube | pipe cutter



la décoration • decorating



les ciseaux
scissors



le cutter
utility knife



le fil à plomb
plumb line



le grattoir
scraper

**le tapissier
décorateur**
decorator

le papier peint
wallpaper

l'escabeau
stepladder



**la brosse à
tapisser**
wallpaper brush

**la table à
encoller**
pasting table

**la brosse à
encoller**
pasting brush

**la colle à
tapisser**
wallpaper paste

le seau
pail

tapisser | wallpaper (v)



décoller
strip (v)



mastiquer
fill (v)



poncer
sand (v)



plâtrer | plaster (v)



poser | hang (v)



carreler | tile (v)



peindre
paint (v)

le rouleau
roller

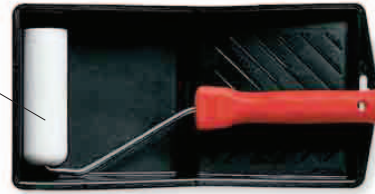

le bac à peinture
paint tray



la peinture
paint

la brosse
brush



l'éponge
sponge



le papier cache
masking tape



le papier de verre
sandpaper

le pot de peinture
paint can

le bleu
overalls

la couverture de protection
dust sheet



le mastic
filler

la térébenthine
turpentine



le white-spirit
mineral spirits

vocabulaire • vocabulary

le plâtre
plaster

brillant
gloss

le papier gaufré
embossed paper

la couche de fond
undercoat

l'enduit
sealant

le vernis
varnish

mat
mat

le papier d'apprêt
lining paper

la dernière couche
topcoat

le solvant
solvent

la peinture mate
latex paint

le pochoir
stencil

l'apprêt
primer

l'agent de conservation
preservative

le mastic
grout

le jardin • garden

les styles de jardin • garden styles



le patio
patio garden



le jardin sur le toit
roof garden



la rocaille
rock garden



la cour
courtyard



le jardin à la française | formal garden



le jardin paysan
cottage garden



**le jardin d'herbes
aromatiques**
herb garden



le jardin d'eau
water garden

les ornements de jardin • garden features



le panier suspendu
hanging basket



le treillis
trellis



la pergola
pergola

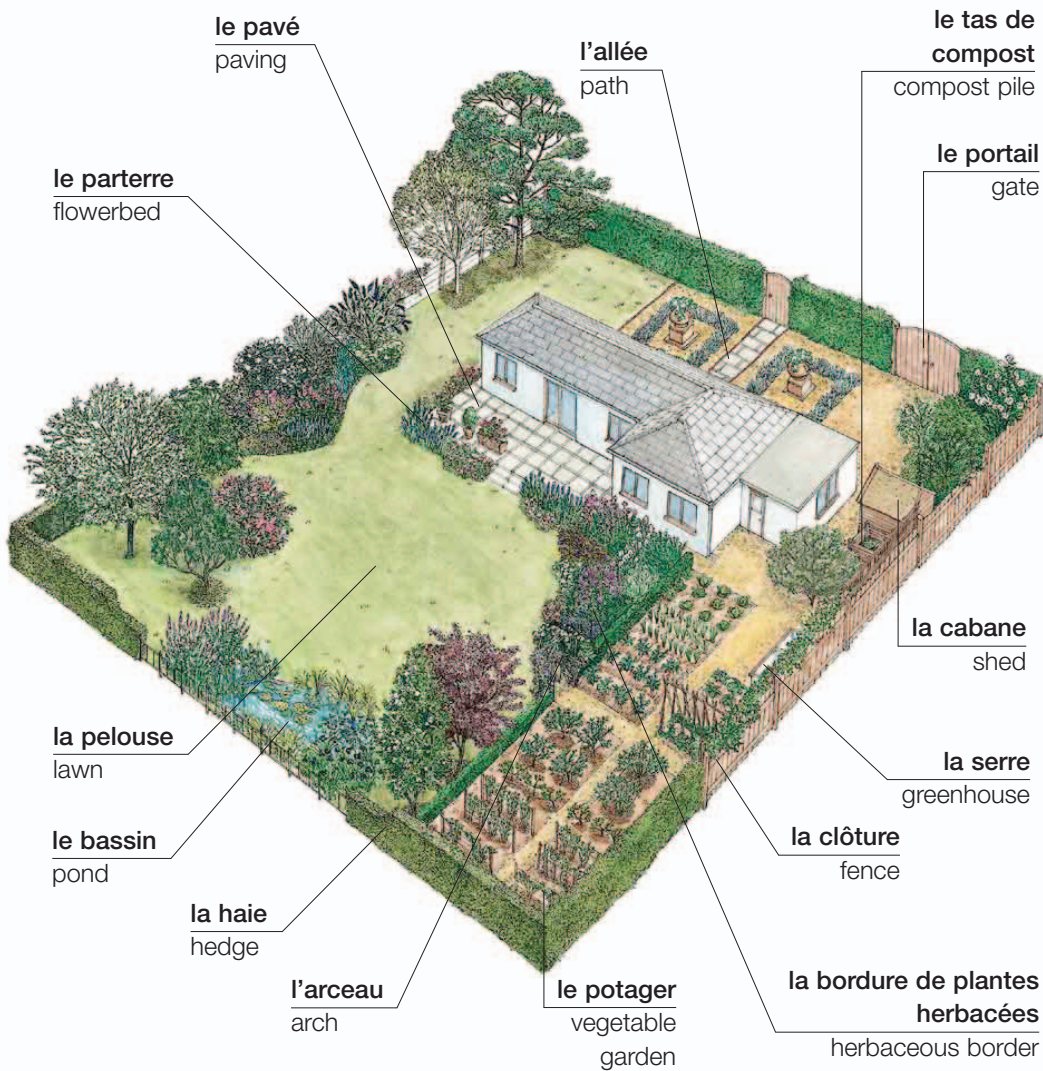

le sol • soil



la terre
topsoil



le sable
sand



la chaux
chalk



la vase
silt



l'argile
clay



les planches
decking



la fontaine | fountain

les plantes de jardin • garden plants

les genres de plantes • types of plants



annuel
annual



bisannuel
biennial



vivace
perennial



le bulbe
bulb



la fougère
fern



le jonc
rush



le bambou
bamboo



les mauvaises herbes
weeds



l'herbe
herb



la plante aquatique
water plant



l'arbre
tree



à feuilles caduques
deciduous



le palmier
palm



le conifère
conifer



à feuilles persistantes
evergreen



la topiaire
topiary



la plante alpestre
alpine



la plante grasse
succulent



le cactus
cactus

la plante en pot
potted plant

la plante d'ombre
shade plant

la plante grimpante
climber

l'arbuste à fleurs
flowering shrub

la couverture du sol
ground cover



la plante rampante
creeper

ornemental
ornamental

l'herbe
grass

les outils de jardin • garden tools



la bêche
spade



la fourche
fork



la grande cisaille
long-handled shears



le balai à gazon
lawn rake



le râtelier
rake



la houe
hoe



le terreau
compost



les graines
seeds

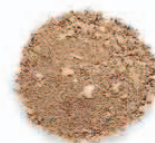

la cendre d'os
bone meal



le gravier
gravel

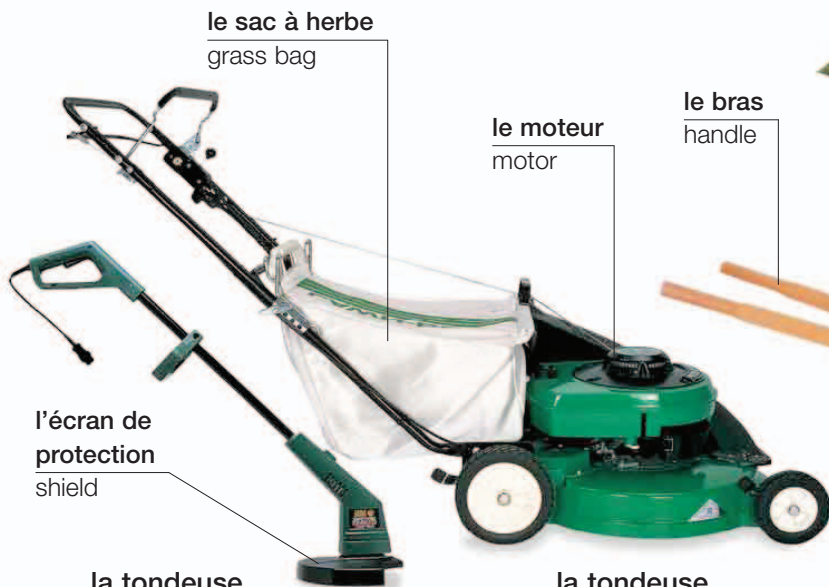

le sac à herbe
grass bag

le moteur
motor

le bras
handle

l'écran de protection
shield

la tondeuse
trimmer

la tondeuse
lawnmower



le panier de jardinier
trug



le support
stand

la brouette
wheelbarrow



l'arrosage • watering



l'arrosoir
watering can

le tuyau d'arrosage
hose

la pomme
rose

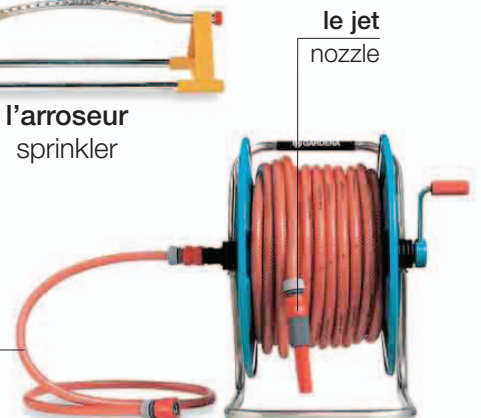

le dévidoir de tuyau | hose reel

le jardinage • gardening



tondre | mow (v)



gazonner
sod (v)



piquer
spike (v)



ratissier
rake (v)



tailler
trim (v)



bêcher
dig (v)



semer
sow (v)



fumer en surface
top-dress (v)



arroser
water (v)



palisser
train (v)



enlever les fleurs fanées
deadhead (v)

asperger
spray (v)



mettre un tuteur
stake (v)



greffer
graft (v)



propager
propagate (v)



élaguer
prune (v)



transplanter
transplant (v)



désherber
weed (v)



pailler
mulch (v)



récolter
harvest (v)

vocabulaire • vocabulary

cultiver
cultivate (v)

dessiner
landscape (v)

fertiliser
fertilize (v)

tamiser
sift (v)

biologique
organic

le semis
seedling

le sous-sol
subsoil

soigner
tend (v)

mettre en pot
pot (v)

cueillir
pick (v)

retourner
aerate (v)

le drainage
drainage

l'engrais
fertilizer

l'herbicide
weedkiller



2

JKL

5

TUV

7

8

SYMBOL

0



les services
services

les services d'urgence • emergency services

l'ambulance • ambulance



l'ambulance
ambulance



le brancard
stretcher

l'infirmier du SAMU
paramedic

la police • police



le badge
badge

l'uniforme
uniform

la sirène
siren

les feux
lights



la voiture de police
police car



le poste de police
police station

la matraque
nightstick

le pistolet
gun



les menottes
handcuffs

le policier
police officer

vocabulaire • vocabulary

l'inspecteur inspector	le suspect suspect	la plainte complaint	l'arrestation arrest
le crime crime	l'agression assault	l'enquête investigation	la cellule cell
l'officier de police detective	les empreintes fingerprint	le cambriolage burglary	l'accusation charge

les pompiers • fire department



l'incendie | fire

la fumée
smoke

le tuyau
hose

la nacelle
basket

le jet d'eau
water jet

la flèche
boom

l'échelle
ladder

la cabine
cab

la casque
helmet

les sapeurs-pompiers
firefighters



le poste d'incendie
fire station



l'escalier de secours
fire escape



la voiture de pompiers
fire engine



le détecteur de
fumée
smoke alarm



l'avertisseur
d'incendie
fire alarm



la hache
ax



l'extincteur
fire extinguisher



la borne
d'incendie
hydrant

La police/les pompiers/une ambulance, s'il vous plaît.
I need the police/fire department/ambulance.

Il y a un incendie à...
There's a fire at...

Il y a eu un accident.
There's been an accident.

Appelez la police!
Call the police!

la banque • bank

le client
customer

le guichet
window

le caissier
teller



les dépliant
brochures

le comptoir
counter

les fiches de versement
deposit slips

la carte bancaire
debit card

le talon
stub

le numéro de compte
account number

la signature
signature

le montant
amount



le directeur d'agence
bank manager



la carte de crédit
credit card



le carnet de chèques
checkbook

le chèque
check

vocabulaire • vocabulary

l'épargne
savings

l'hypothèque
mortgage

le paiement
payment

verser
deposit (v)

le compte courant
checking account

l'impôt
tax

le découvert
overdraft

le prélèvement
automatic payment

les frais bancaires
bank charge

le compte d'épargne
savings account

le prêt
loan

le taux d'intérêt
interest rate

la fiche de retrait
withdrawal slip

le virement bancaire
electronic transfer

le code secret
PIN

la pièce
coin



l'argent
money

le billet
bill

l'écran
screen

le clavier
keypad



le distributeur
ATM

la fente
card slot

les devises étrangères • foreign currency

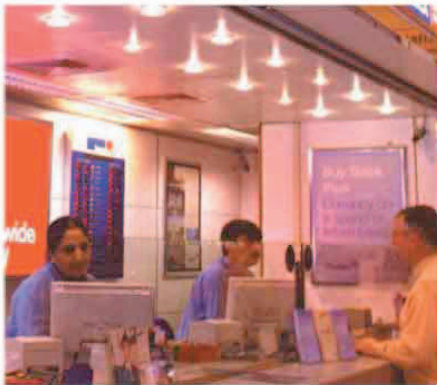

le bureau de change
bureau de change



le traveller
traveler's check



le taux de
change
exchange rate

vocabulaire • vocabulary

encaisser
cash (v)

les actions
shares

la valeur
denomination

les dividendes
dividends

la commission
commission

le comptable
accountant

l'investissement
investment

le portefeuille
portfolio

les titres
stocks

l'action
equity

Est-ce que je peux changer ça, s'il vous plaît?

Can I change this, please?

Quel est le taux de change aujourd'hui?

What's today's exchange rate?

la finance • finance

le prix des actions
share price

l'agent de la
bourse
stockbroker



la conseillère financière
financial advisor



la bourse | stock exchange

les communications • communications

le postier
postal worker

le guichet
window

la balance
scale

le guichet
counter



la poste | post office

le tampon de la poste
postmark

le timbre
stamp

l'adresse
address

le code postal
ZIP code



l'enveloppe | envelope



le facteur
mail carrier

vocabulaire • vocabulary

la lettre
letter

l'expéditeur
return address

la distribution
delivery

fragile
fragile

ne pas plier
do not bend (v)

par avion
by airmail

la signature
signature

le mandat postal
money order

le sac postal
mailbag

dessus
this way up

l'envoi en recommandé
registered mail

la levée
pickup

le tarif d'affranchissement
postage

le télégramme
telegram

le fax
fax



la boîte aux lettres
mailbox



la boîte aux lettres
letter slot



le colis
package



le service de messagerie
courier

le téléphone • telephone

le combiné
handset

la base
base station



le téléphone sans fil
cordless phone

le répondeur
answering machine



le visiophone
video phone



la cabine
téléphonique
telephone booth



le smartphone
smartphone



le portable
mobile phone

le clavier
keypad

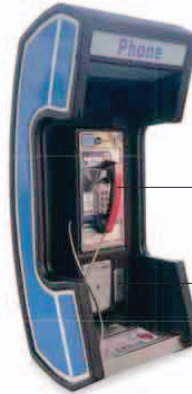

le combiné
receiver

les pièces rendues
coin return

le téléphone public
payphone

vocabulaire • vocabulary

les renseignements
directory assistance

le SMS
text

coupé
disconnected

Pouvez-vous me donner le numéro pour...?

Can you give me the number for...?

le P.C.V.
collect call

le message vocal
voice message

l'appli
app

Quel est l'indicatif pour...?

What is the area code for...?

composer
dial (v)

le téléphoniste
operator

le mot de
passe
passcode

Envoie-moi un SMS!

Text me!

répondre
answer (v)

occupé
busy

l'hôtel • hotel

le hall • lobby



la réception | reception



le porteur
porter

les
bagages
luggage

le diable
cart



l'ascenseur
elevator



le numéro de chambre
room number

les chambres • rooms



la chambre simple
single room



la chambre double
double room



la chambre à deux lits
twin room



la salle de bain privée
private bathroom

les services • services



le service de ménage
maid service



le service de blanchisserie
laundry service

le plateau à petit déjeuner
breakfast tray



le service d'étage | room service



le minibar
mini bar



le restaurant
restaurant



la salle de sport
gym



la piscine
swimming pool

vocabulaire • vocabulary

la chambre avec le petit déjeuner

bed and breakfast

Avez-vous une chambre de libre?

Do you have any vacancies?

Je voudrais une chambre pour trois nuits.

I'd like a room for three nights.

la pension complète

full board

J'ai une réservation.

I have a reservation.

C'est combien par nuit?

What is the charge per night?

la demi-pension

half-board

Je voudrais une chambre simple.

I'd like a single room.

Quand est-ce que je dois quitter la chambre?

When do I have to check out?





les courses
shopping

le centre commercial • shopping center

l'atrium
atrium

l'enseigne
sign

l'ascenseur
elevator



le deuxième étage
third floor

le premier étage
second floor

l'escalier mécanique
escalator

le rez-de-chaussée
ground floor

le client
customer

vocabulaire • vocabulary

le rayon enfants
children's department

le guide
store directory

les cabines d'essayage
changing rooms

C'est combien?
How much is this?

le rayon bagages
luggage department

le vendeur
sales clerk

les soins de bébés
baby changing facilities

Est-ce que je peux changer ça?
May I exchange this?

le rayon chaussures
shoe department

le service après-vente
customer services

les toilettes
restrooms

le grand magasin • department store



les vêtements pour hommes
menswear



les vêtements pour femmes
women's clothing



la lingerie
lingerie



la parfumerie
perfume



la beauté
beauty



le linge de maison
linen



l'ameublement
home furnishings



la mercerie
notions



la vaisselle
kitchenware



la porcelaine
china



l'électroménager
electrical goods



l'éclairage
lighting



les articles de sport
sports



les jouets
toys



la papeterie
stationery



l'alimentation
food

le supermarché • supermarket



l'allée
aisle

l'étagère
shelf

le tapis roulant
conveyor belt

le caissier
checker

les promotions
specials

la caisse | checkout

le client
customer

la caisse
cash register

la sac à provisions
shopping bag



les provisions
groceries

l'anse
handle



le code barres
bar code

le caddie
cart



le panier
basket



le lecteur optique
scanner



la boulangerie
bakery



la cr merie
dairy



les c r ales
cereals



les conserves
canned food



la confiserie
candy



les l gumes
vegetables



les fruits
fruit



la viande et la volaille
meat and poultry



le poisson
fish



la charcuterie
deli



les produits surgel s
frozen food



les plats cuisin s
convenience food



les boissons
drinks



les produits d'entretien
household products



les articles de toilette
toiletries



les articles pour b b s
baby products



l' lectrom nager
electrical goods



la nourriture pour animaux
pet food



les magazines | magazines

la pharmacie • drugstore

les soins
dentaires
dental care

l'hygiène
féminine
feminine
hygiene

les déodorants
deodorants

les vitamines
vitamins

l'officine
pharmacy

le pharmacien
pharmacist

le médicament pour
la toux
cough medicine

l'herboristerie
herbal remedies

les soins de la peau
skin care



l'après-soleil
aftersun

l'écran solaire
sunscreen



l'écran total
sunblock



le produit anti-insecte
insect repellent



la lingette humide
wet wipe



le kleenex
tissue



la serviette hygiénique
sanitary napkin



le tampon
tampon



le protège-slip
panty liner



la gélule
capsule



la pilule
pill

la cuiller pour mesurer
measuring spoon



le sirop
syrup

le mode d'emploi
instructions



l'inhalateur
inhaler



la crème
cream



la pommade
ointment



le gel
gel



le suppositoaire
suppository

le compte-gouttes
dropper



les gouttes
drops



l'aiguille
needle

la seringue
syringe



le spray
spray



la poudre
powder

vocabulaire • vocabulary

le fer
iron

l'insuline
insulin

jetable
disposable

le médicament
medicine

l'analgésique
painkiller

le calcium
calcium

les effets secondaires
side effects

soluble
soluble

le laxatif
laxative

le sédatif
sedative

le magnésium
magnesium

la date d'expiration
expiration date

la posologie
dosage

la diarrhée
diarrhea

le somnifère
sleeping pill

le médicament multivitamine
multivitamins

les cachets antinaupathiques
travel sickness pills

la médication
medication

la pastille pour la gorge
cough drop

l'anti-inflammatoire
anti-inflammatory

le fleuriste • florist

les fleurs
flowers

le lis
lily

l'acacia
acacia

l'œillet
carnation

la plante en pot
potted plant



le glaïeul
gladiolus

l'iris
iris

la marguerite
daisy

le
chrysanthème
chrysanthemum

la gypsophile
gypsophila



la giroflée
stocks



le gerbera
gerbera



le feuillage
foliage



la rose
rose



le freesia
freesia

les compositions florales • arrangements

le vase
vase



l'orchidée
orchid



la pivoine
peony

la botte
bunch

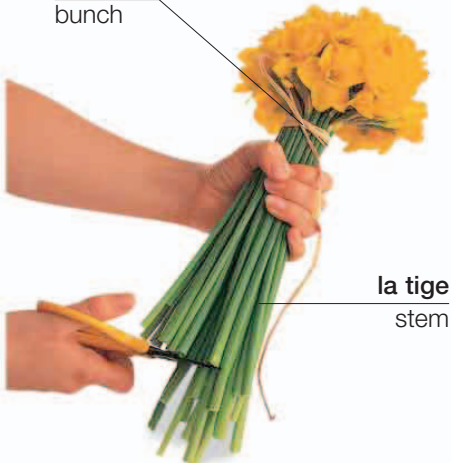

la jonquille
daffodil

la tige
stem

le bourgeon
bud



la tulipe | tulip

l'emballage
wrapping

le ruban
ribbon



le bouquet
bouquet



les fleurs séchées
dried flowers



le pot-pourri | potpourri



la couronne | wreath



la guirlande
de fleurs
garland

Je peux y attacher un message?
Can I attach a message?

Est-ce qu'elles sentent bon?
Are they fragrant?

Pouvez-vous les emballer?
Can I have them wrapped?

Elles tiennent combien de temps?
How long will these last?

Pouvez-vous les envoyer à...?
Can you send them to...?

Je voudrais un bouquet de..., SVP.
Can I have a bunch of..., please.

le marchand de journaux • newsstand



les cigarettes
cigarettes

le paquet de cigarettes
pack of cigarettes

les timbres
stamps



la carte postale
postcard



la bande dessinée
comic book



le magazine
magazine



le journal
newspaper

fumer • smoking



le tabac
tobacco



le briquet
lighter

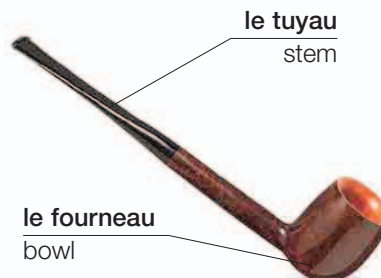

la pipe
pipe



le cigare
cigar

le confiseur • confectionery

la boîte de chocolats
box of chocolates

la friandise
snack bar

les chips
chips



la confiserie | candy store

vocabulaire • vocabulary

le chocolat au lait
milk chocolate

le caramel
caramel

le chocolat noir
semisweet
chocolate

la truffe
truffle

le chocolat blanc
white chocolate

le biscuit
cookie

**les bonbons
assortis**
pick and mix

les bonbons
hard candy

la confiserie • confectionery



le chocolat
chocolate



**la tablette de
chocolat**
chocolate bar



les bonbons
candies



la sucette
lollipop



le caramel
toffee



le nougat
nougat



la guimauve
marshmallow



le bonbon à la menthe
mint



le chewing-gum
chewing gum



la dragée à la gelée
jellybean



le bonbon au fruit
gumdrop



le réglisse
licorice

les autres magasins • other stores



la boulangerie
bread shop



la pâtisserie
bakery



la boucherie
butcher shop



la poissonnerie
fish-seller



le marchand de légumes
produce stand



l'épicerie
grocery store



le magasin de chaussures
shoe store



la quincaillerie
hardware store



le magasin d'antiquités
antique store



la boutique de cadeaux
gift shop



l'agence de voyage
travel agent



la bijouterie
jewelry store



la librairie
bookstore



le magasin de disques
record store



le magasin de vins et spiritueux
liquor store



l'animalerie
pet store



le magasin de meubles
furniture store



la boutique
boutique



le tailleur
tailor shop



le salon de coiffure
beauty salon

vocabulaire • vocabulary

l'agent immobilier realtor	le magasin d'appareils photos camera store
la pépinière garden center	le magasin bio health food store
le pressing dry-cleaner	la boutique d'art art store
la laverie automatique laundromat	le marchand d'occasion second-hand store



le marché | market





la nourriture
food

la viande • meat

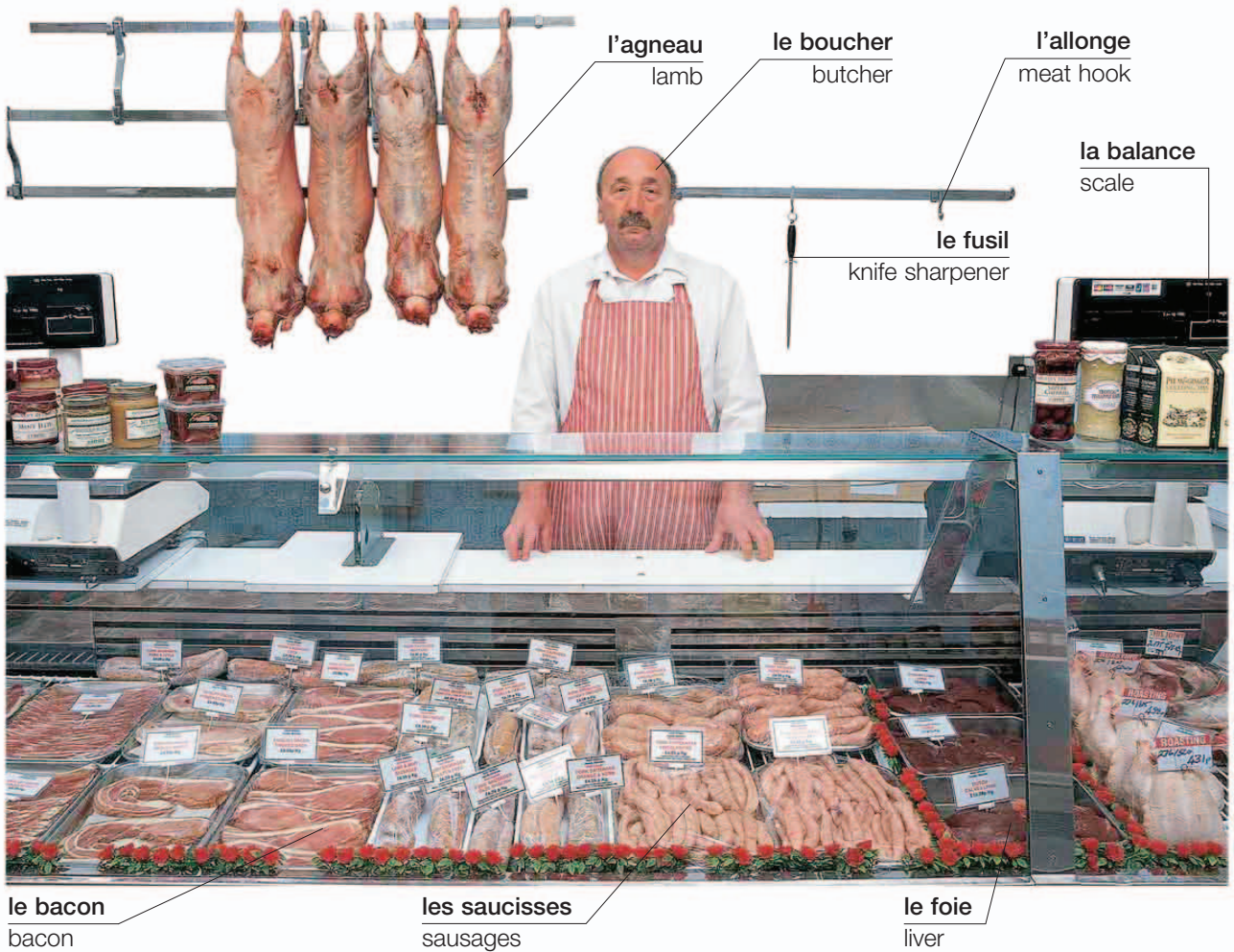

vocabulaire • vocabulary

le porc
pork

la venaison
venison

les abats
offal

de ferme
free range

la viande rouge
red meat

le bœuf
beef

le lapin
rabbit

salé
cured

naturel
organic

la viande maigre
lean meat

le veau
veal

la langue de bœuf
tongue

fumé
smoked

la viande blanche
white meat

la viande cuite
cooked meat

les morceaux de viande • cuts

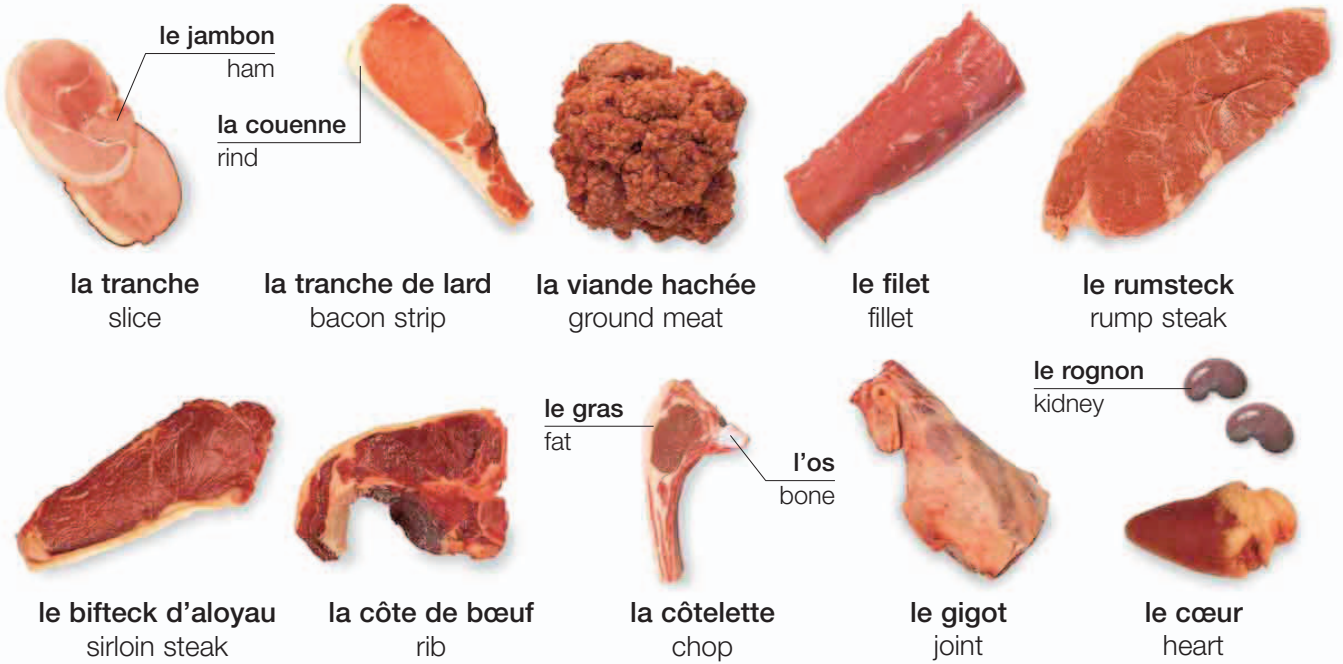

la volaille • poultry

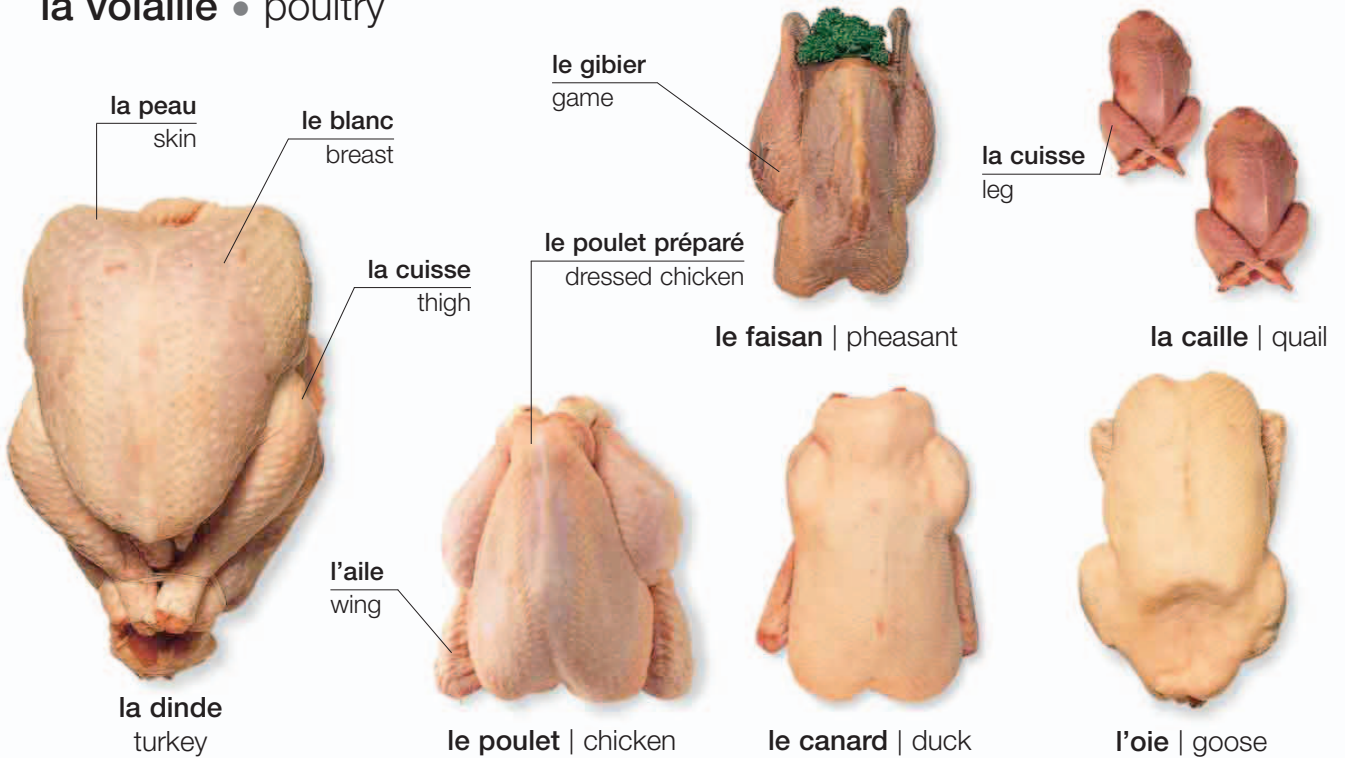

le poisson • fish

les crevettes
décortiquées
peeled shrimp

la glace
ice

le rouget barbet
red mullet

les filets de
flétan
halibut fillets

la truite arc-en-ciel
rainbow trout

les ailes de raie
skate wings

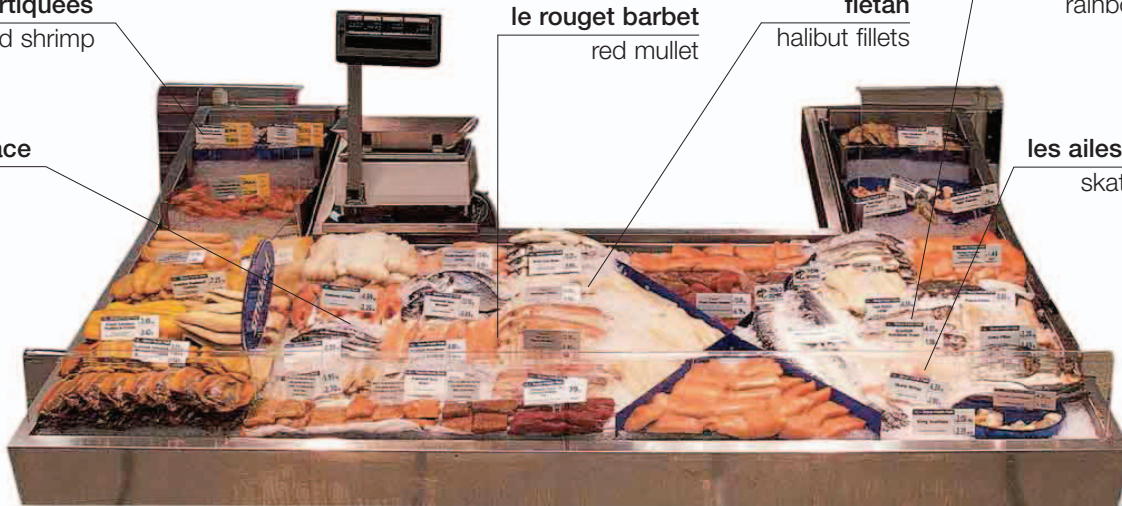

la poissonnerie
fish counter



la lotte
monkfish



le maquereau
mackerel



la truite
trout



l'espadon
swordfish



la sole
Dover sole



la limande-sole
lemon sole



l'aiglefin
haddock



la sardine
sardine



la raie
skate



le merlan
whiting



le bar
sea bass



le saumon | salmon



la morue
cod



la daurade
sea bream



le thon
tuna

les fruits de mer • seafood

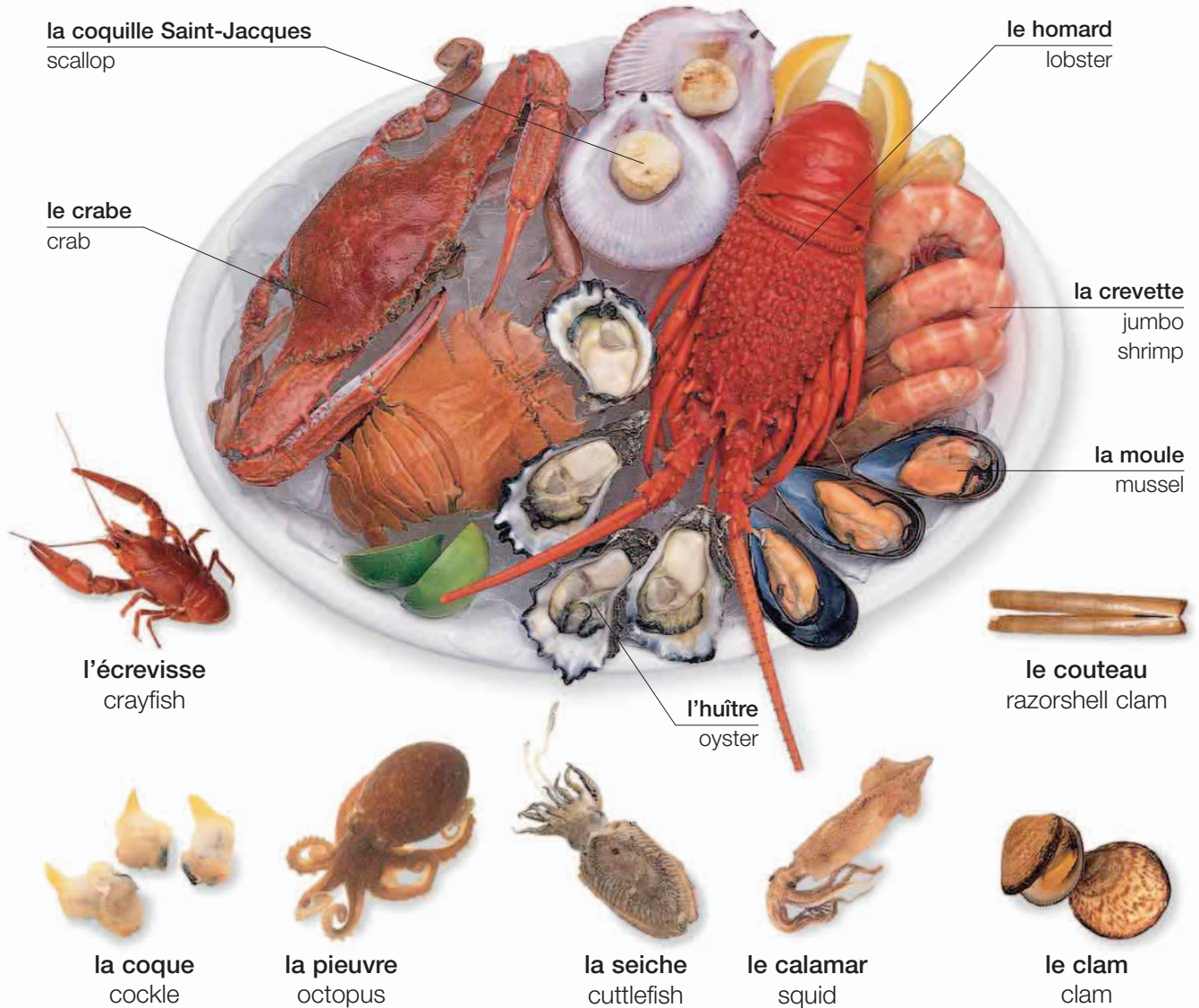

vocabulaire • vocabulary

surgelé frozen	préparé cleaned	fumé smoked	écaillé descaled	le filet fillet	la longe loin	la queue tail	l'arête bone	l'écaille scale
frais fresh	salé salted	sans peau skinned	sans arêtes boned	en filets filleted	la tranche steak	Pouvez-vous le préparer pour moi? Will you clean it for me?		

les légumes 1 • vegetables 1

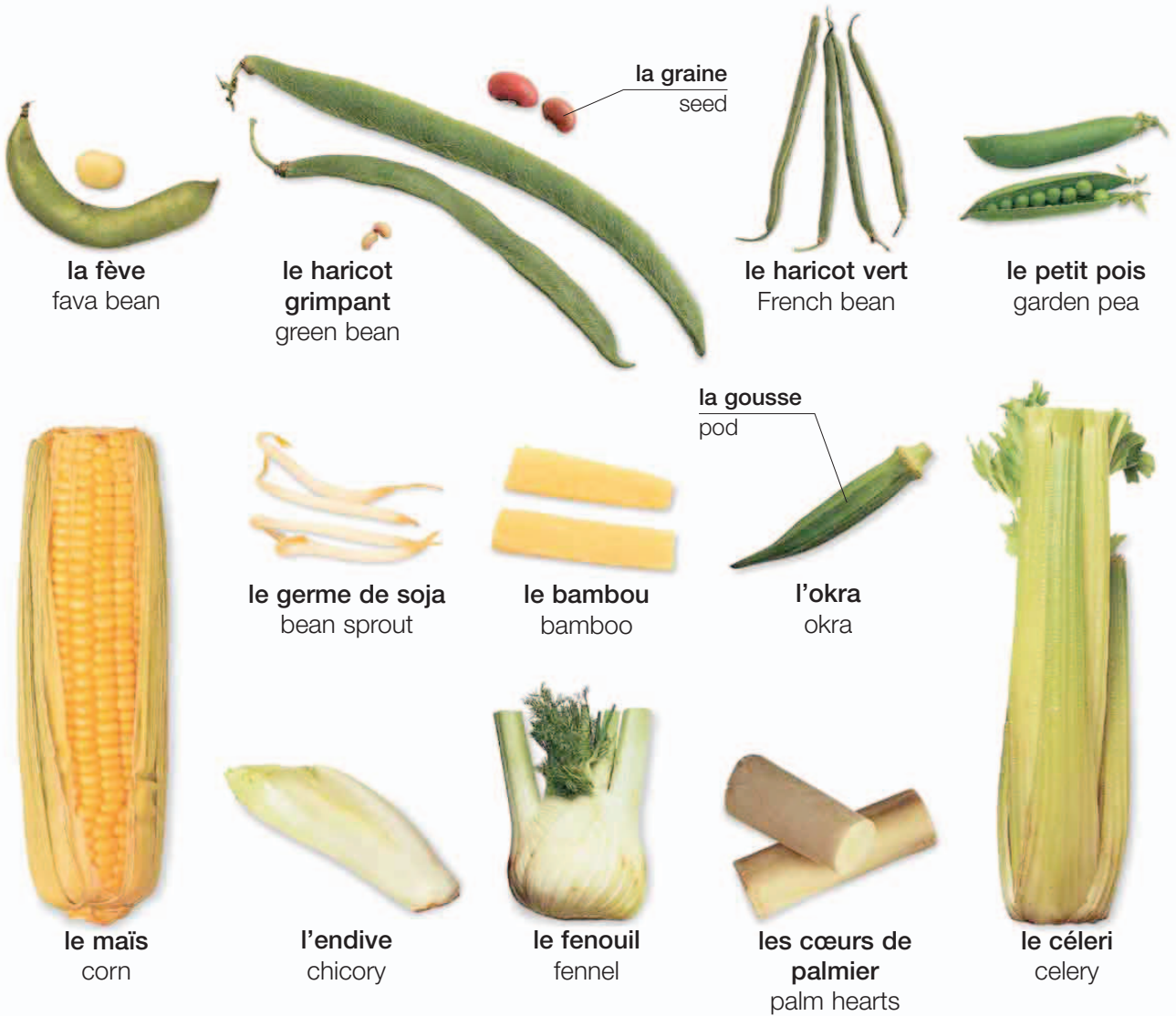

vocabulaire • vocabulary

la feuille
leaf

la fleurette
floret

la pointe
tip

biologique
organic

le trognon
stalk

le grain
kernel

le cœur
heart

le sac en plastique
plastic bag

Est-ce que vous vendez des légumes bios?
Do you sell organic vegetables?

Est-ce qu'ils sont cultivés dans la région?
Are these grown locally?



la roquette
arugula



le cresson
watercress



le radicchio
radicchio



le chou de Bruxelles
Brussels sprout



la bette
Swiss chard



le chou frisé
kale



l'oseille
sorrel



la chicorée
endive



le pissenlit
dandelion



les épinards
spinach



le chou-rave
kohlrabi



le chou chinois
pak-choi



la laitue
lettuce



le brocoli
broccoli



le chou
cabbage



le chou précoce
spring greens

les légumes 2 • vegetables 2

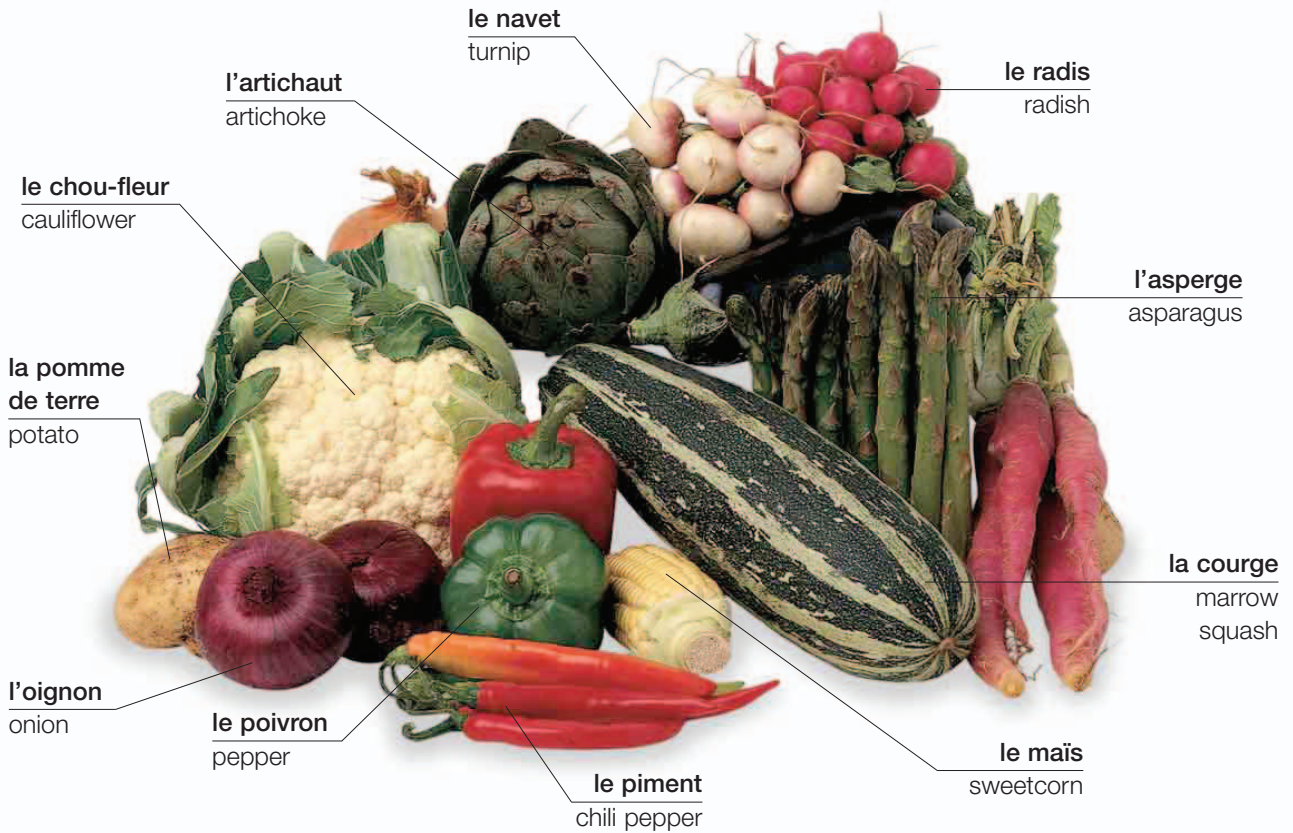

vocabulaire • vocabulary

la tomate cerise
cherry tomato

le céleri
celeriac

surgelé
frozen

amer
bitter

Puis-je avoir un kilo de pommes de terre s'il vous plaît?

la carotte
carrot

le taro
taro root

cru
raw

ferme
firm

Can I have one kilo of potatoes, please?

le fruit de l'arbre à pain
breadfruit

le manioc
cassava

épicé
hot (spicy)

la pulpa
flesh

C'est combien le kilo?
What's the price per kilo?

la pomme de terre nouvelle
new potato

la châtaigne d'eau
water chestnut

sucré
sweet

la racine
root

Ils s'appellent comment?
What are those called?



la patate douce
sweet potato



l'igname
yam



la betterave
beet



le rutabaga
rutabaga



le topinambour
Jerusalem
artichoke



le raifort
horseradish



le panais
parsnip



le gingembre
ginger



l'aubergine
eggplant



la tomate
tomato



la ciboule
green onion

le poireau
leek



l'échalote
shallot



l'ail
garlic

la gousse
clove



le champignon
mushroom

la truffe
truffle



le concombre
cucumber



la courgette
zucchini



**la courge
musquée**
butternut squash



la courge gland
acorn squash



la citrouille
pumpkin

le fruit 1 • fruit 1

les agrumes • citrus fruit

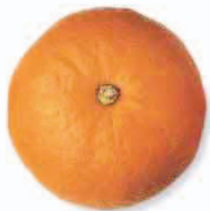

l'orange
orange



la clémentine
clementine

**la peau
blanche**
pith



le tangelo
ugli fruit

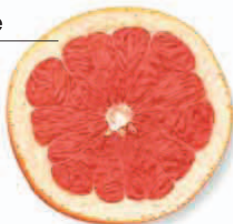

le pamplemousse
grapefruit

le quartier
segment



la mandarine
tangerine

la satsuma
satsuma



le zeste
zest

le citron vert
lime



le citron
lemon



le kumquat
kumquat

les fruits à noyau • stone fruit



la pêche
peach



la nectarine
nectarine



l'abricot
apricot



la prune
plum



la cerise
cherry

la poire
pear

la pomme
apple



la corbeille de fruits | basket of fruit

les fruits rouges et les melons • berries and melons



la fraise
strawberry



la framboise
raspberry



le melon
melon



les raisins
grapes



la mûre
blackberry



la groseille
red currant



le cassis
black currant



la canneberge
cranberry



la myrtille
blueberry



la groseille blanche
white currant

l'écorce
rind

le pépin
seed

la pulpe
flesh

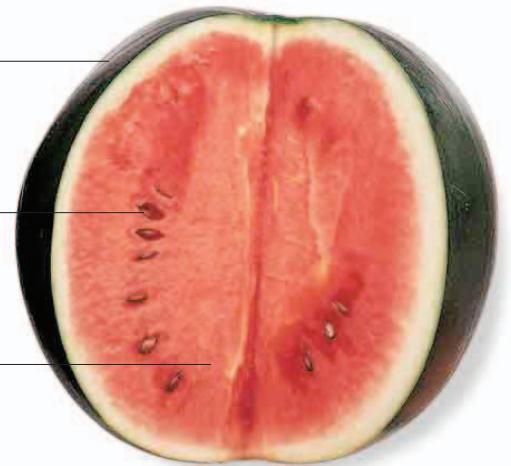

la pastèque
watermelon



la loganberry
loganberry



la groseille à
maquereau
gooseberry

vocabulaire • vocabulary

la rhubarbe
rhubarb

aigre
sour

croquant
crisp

le jus
juice

Est-ce qu'ils sont
mûrs?

Are they ripe?

la fibra
fiber

frais
fresh

pourri
rotten

le trognon
core

Je peux goûter?

Can I try one?

sucré
sweet

juteux
juicy

la pulpe
pulp

sans pépins
seedless

Ils se gardent
combien de temps?

How long will they
keep?

les fruits 2 • fruit 2

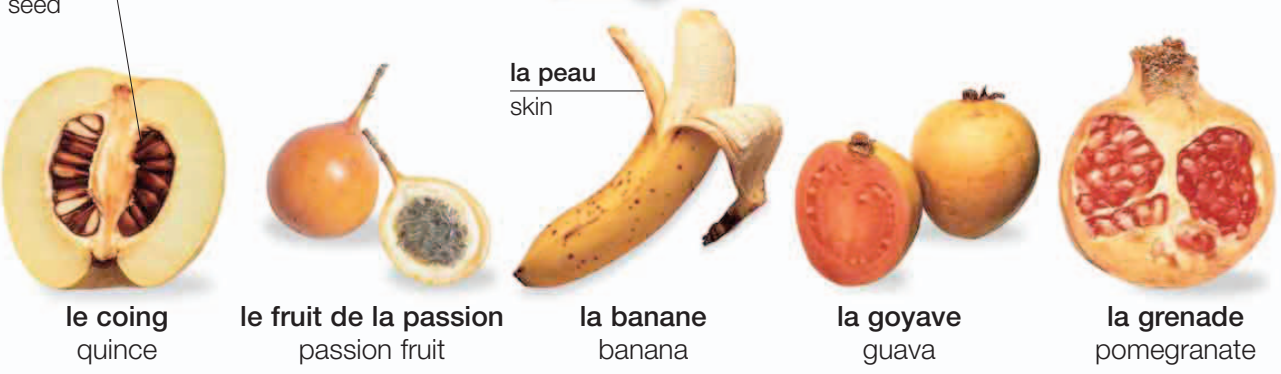
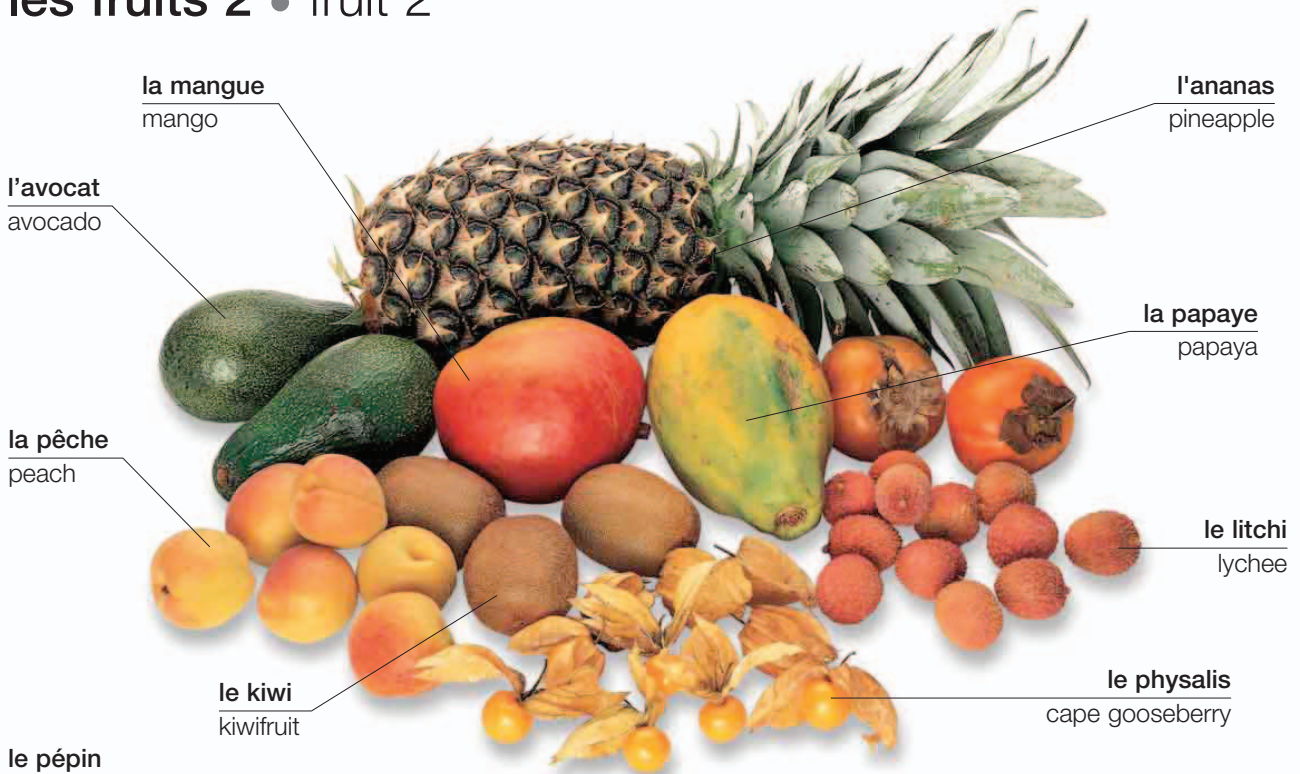

les noix et les fruits secs • nuts and dried fruit



le pignon
pine nut



la pistache
pistachio



la noix de cajou
cashew



la cacahouète
peanut



la noisette
hazelnut



la noix du Brésil
Brazil nut



la noix pacane
pecan



l'amande
almond



la noix
walnut



le marron
chestnut



le macadamia
macadamia



la figue
fig



la datte
date



le pruneau
prune



la coquille
shell

la chair
flesh



le raisin de
Smyrne
sultana raisin



le raisin sec
raisin



le raisin de
Corinthe
currant

la noix de coco
coconut

vocabulaire • vocabulary

vert green	dur hard	l'amande kernel	salé salted	grillé roasted	décortiqué shelled	le fruit confit candied fruit
mûr ripe	mou soft	séché desiccated	cru raw	de saison seasonal	complet whole	les fruits tropicaux tropical fruit

les céréales et les légumes secs • grains and legumes

les céréales • grains



le blé
wheat



l'avoine
oats



l'orge
barley

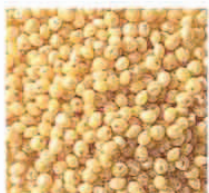

le millet
millet



le maïs
corn

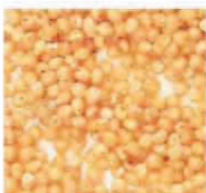

le quinoa
quinoa

vocabulaire • vocabulary

la graine
seed

parfumé
fragranced

facile à cuisiner
easy-cook

la balle
husk

la céréale
cereal

à grains longs
long-grain

le grain
kernel

complet
whole-grain

sec
dry

laisser tremper
soak (v)

à grains ronds
short-grain

frais
fresh

le riz • rice



le riz blanc
white rice



le riz complet
brown rice



le riz sauvage
wild rice



le riz rond
pudding rice

les céréales traitées • processed grains



le couscous
couscous



le blé écrasé
cracked wheat



la semoule
semolina



le son
bran

les haricots et les pois • beans and peas



les gros haricots blancs
butter beans



les haricots blancs
haricot beans



les haricots rouges
red kidney beans



les adzukis
aduki beans



les fèves
fava beans



les graines de soja
soybeans



les haricots à œil noir
black-eyed beans



les haricots pinto
pinto beans



les haricots mung
mung beans



les flageolets
flageolet beans



les lentilles
brown lentils



les lentilles rouges
red lentils



les petits pois
green peas



les pois chiches
garbanzos



les pois cassés
split peas

les graines • seeds



la graine de potiron
pumpkin seed



le grain de moutarde
mustard seed



la graine de carvi
caraway



la graine de sésame
sesame seed

la graine de tournesol
sunflower seed

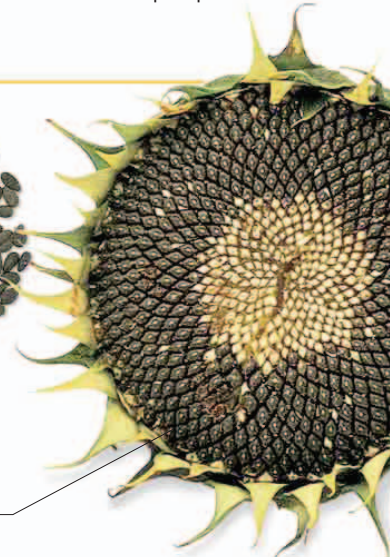

les herbes et les épices • herbs and spices

les épices • spices



la vanille
vanilla



la noix de muscade
nutmeg



le macis
mace



le curcuma
turmeric



le cumin
cumin



le bouquet garni
bouquet garni



le poivre de la Jamaïque
allspice

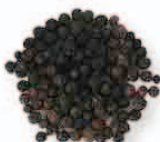

le grain de poivre
peppercorn



le fenugrec
fenugreek



le piment
chili powder

en morceaux
whole

écrasé
crushed

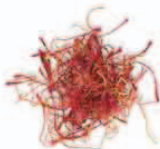

le safran
saffron



la cardamome
cardamom



la poudre de curry
curry powder



en poudre
ground



le paprika
paprika

en flocons
flakes



l'ail
garlic

les herbes • herbs

les bâtons
sticks



la cannelle
cinnamon



la citronnelle
lemon grass



le clou de girofle
cloves



l'anis étoilé
star anise



le gingembre
ginger

les graines de
fenouil
fennel seeds



le fenouil
fennel



la ciboulette
chives



la menthe
mint



la feuille de laurier
bay leaf



le persil
parsley



le thym
thyme



la sauge
sage



l'estragon
tarragon



la marjolaine
marjoram



le basilic
basil



l'origan
oregano



la coriandre
cilantro



l'aneth
dill



le romarin
rosemary

les aliments en bouteilles • bottled foods

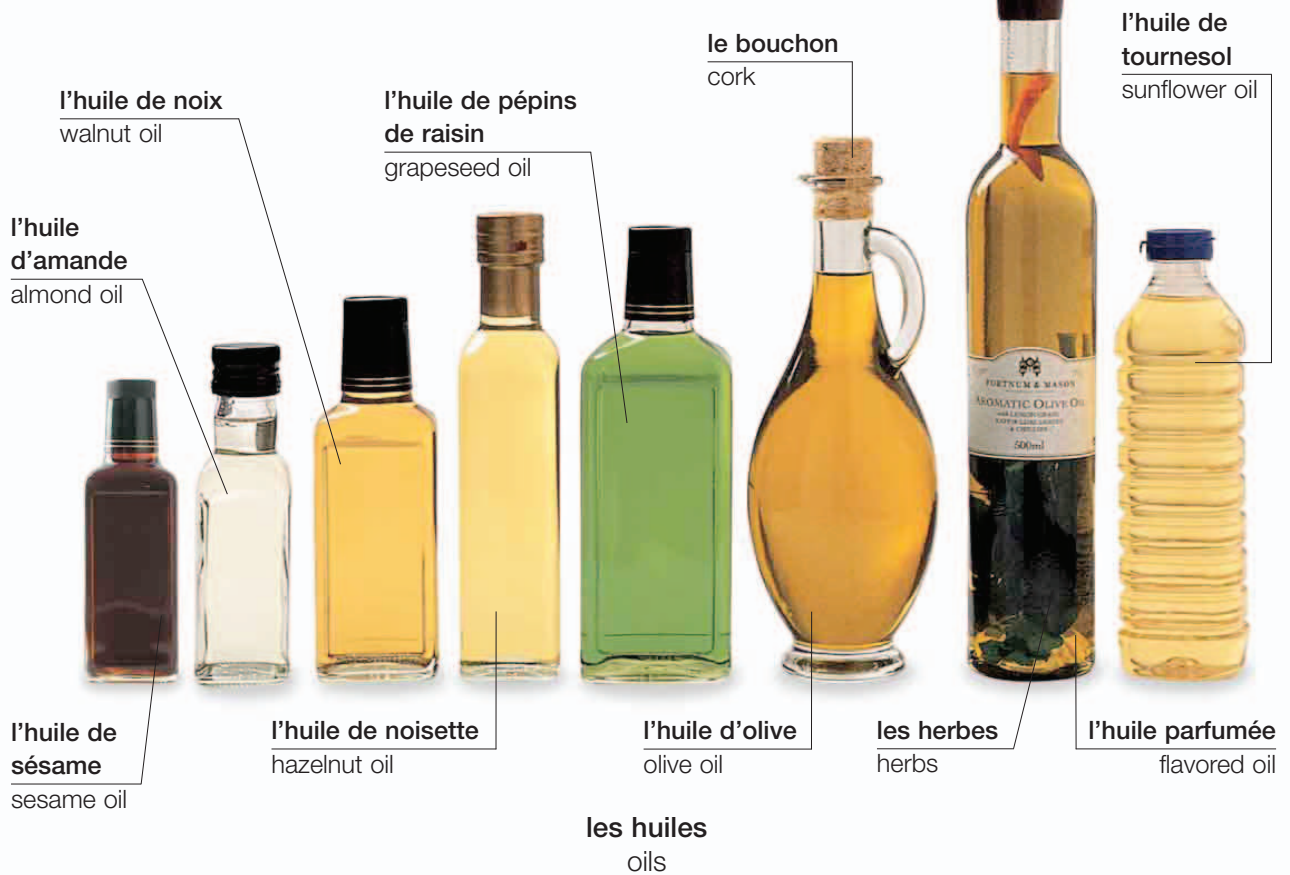

les produits à tartiner • sweet spreads



les condiments • condiments and spreads



la mayonnaise
mayonnaise

le vinaigre de
cidre
cider vinegar



le vinaigre de malt
malt vinegar

le vinaigre
balsamique
balsamic vinegar



le vinaigre de vin
wine vinegar



le vinaigre
vinegar

la bouteille
bottle



le ketchup
ketchup



la sauce
sauce



la moutarde
anglaise
English mustard



la moutarde
française
French mustard



la moutarde
en grains
whole-grain
mustard



le chutney
chutney



le beurre de
cacahouètes
peanut butter



la pâte à tartiner
au chocolat
chocolate spread



les fruits en
bocaux
preserved fruit

le bocal scellé
sealed jar

vocabulaire • vocabulary

l'huile de maïs
corn oil

l'huile de colza
canola oil

l'huile
d'arachide
peanut oil

l'huile pressée
à froid
cold-pressed oil

l'huile végétale
vegetable oil

les produits laitiers • dairy produce

le fromage • cheese

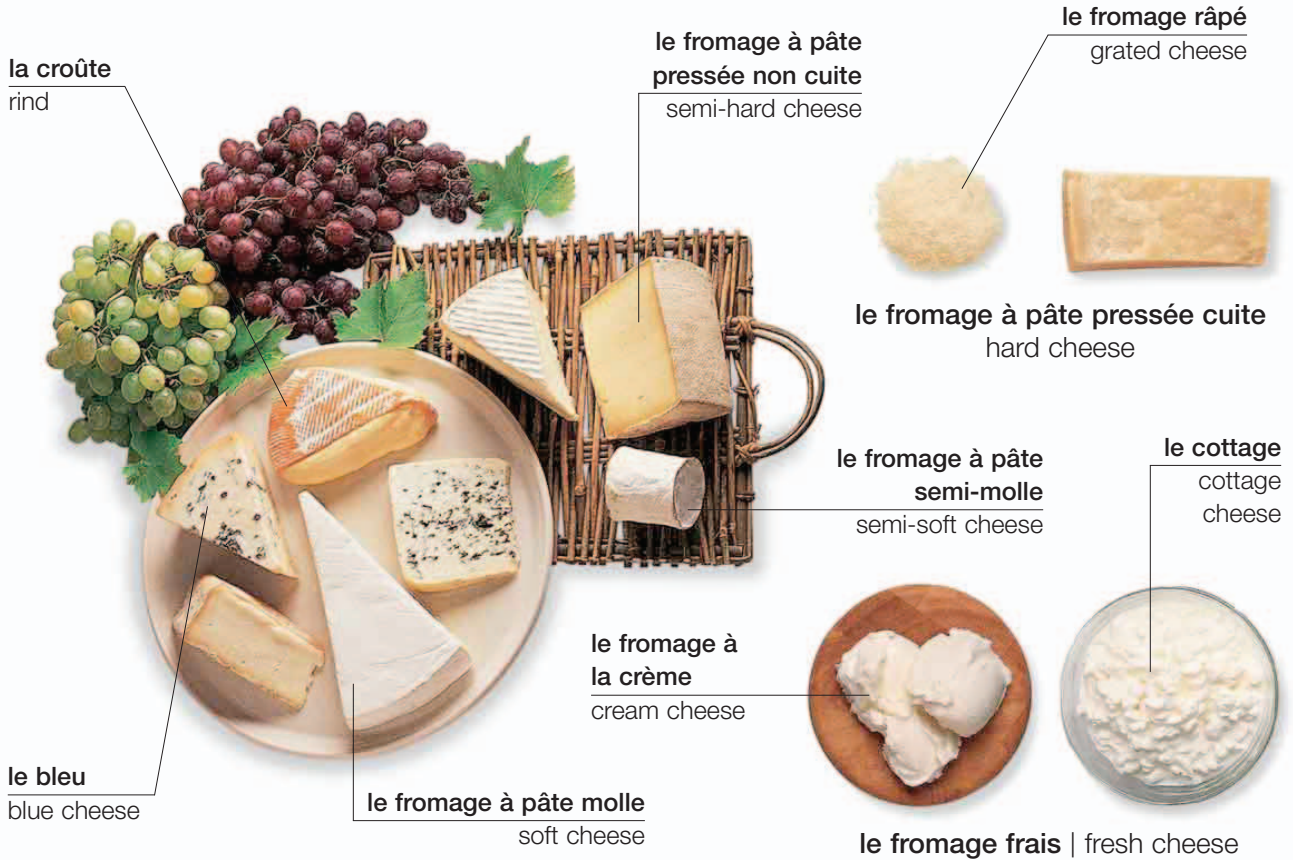

le lait • milk





le beurre
butter



la margarine
margarine



la crème
cream



la crème allégée
light cream



la crème épaisse
heavy cream



la crème fouettée
whipped cream



la crème fraîche
sour cream



le yaourt
yogurt



la glace
ice cream

les œufs • eggs

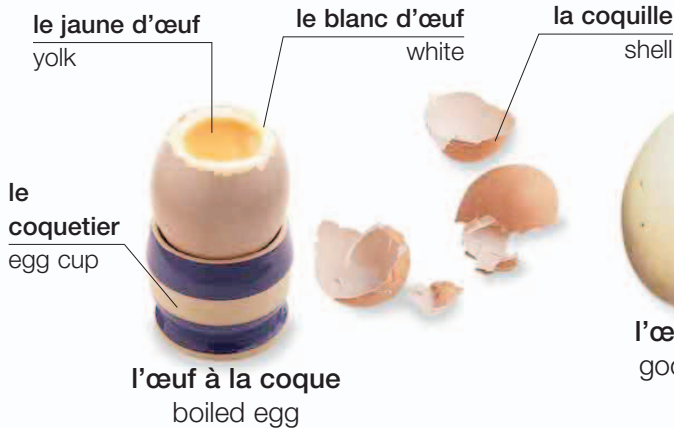

l'œuf de poule
hen's egg



l'œuf de cane
duck egg



l'œuf d'oie
goose egg



l'œuf de caille
quail egg

vocabulaire • vocabulary

pasteurisé pasteurized	le milk-shake milkshake	salé salted	le lait de brebis sheep's milk	le lactose lactose	homogénéisé homogenised
non pasteurisé unpasteurized	le yaourt surgelé frozen yogurt	non salé unsalted	le babeurre buttermilk	sans matières grasses fat-free	le lait en poudre powdered milk

les pains et la farine • breads and flours

le pain tranché
sliced bread

les graines de pavot
poppy seeds

le pain de seigle
rye bread

la baguette
baguette



la boulangerie | bread shop

faire du pain • making bread



la farine blanche
white flour



la farine complète
brown flour



la farine brute
wholemeal flour



la levure
yeast



tamiser | sift (v)



mélanger | mix (v)

la pâte
dough



faire cuire au four | bake (v)





la croûte
crust

le pain blanc
white bread



le pain
loaf

le pain bis
brown bread



le pain de son
whole-wheat bread

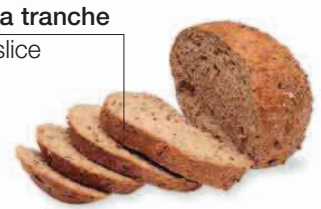

la tranche
slice

le pain complet
multigrain bread



le pain de maïs
corn bread



le pain au bicarbonate
de soude
soda bread



le pain au levain
sourdough bread



le pain plat
flatbread



le petit pain américain
bagel



le petit pain rond
bun



le petit pain
roll



le pain aux raisins secs
fruit bread



le pain aux graines
seeded bread



le naan
naan bread



le pita
pita bread

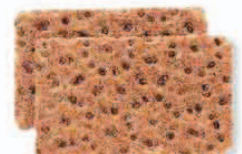

le biscuit scandinave
crispbread

vocabulaire • vocabulary

la farine traitée
bread flour

se lever
rise (v)

lever
prove (v)

la chapelure
breadcrumbs

la machine à couper
slicer

la farine avec la
levure
self-rising flour

la farine sans
levure
all-purpose
flour

glacer
glaze (v)

la flûte
flute

le boulanger
baker

les gâteaux et les desserts • cakes and desserts



les gâteaux | cakes

vocabulaire • vocabulary

la crème pâtissière
crème pâtisserie

le petit gâteau
sweet bun

la pâte
pastry

le riz au lait
rice pudding

**Est-ce que je peux
avoir une tranche s'il
vous plaît?**

le gâteau au chocolat
chocolate cake

la crème anglaise
custard

la tranche
slice

la fête
celebration

May I have a slice,
please?

les pépites de chocolat
chocolate chip



les boudoirs
lady fingers



le florentine
florentine

le diplomate
trifle

les biscuits | cookies



la mousse
mousse



le sorbet
sherbet



la tarte à la crème
cream pie



la crème caramel
crème caramel

les gâteaux de fête • celebration cakes

l'étage supérieur
top tier

le ruban
ribbon

l'étage inférieur
bottom tier

le glaçage
frosting

la pâte d'amandes
marzipan



le gâteau de mariage | wedding cake

la décoration
decoration

les bougies d'anniversaire
birthday candles

souffler
blow out (v)



le gâteau d'anniversaire | birthday cake

la charcuterie • delicatessen

le saucisson piquant
spicy sausage

l'huile
oil



le salami
salami

le pepperoni
pepperoni

le vinaigre
vinegar

la viande non cuite
uncooked meat

le comptoir
counter

la quiche
quiche



le pâté
pâté



la mozzarella
mozzarella



le brie
brie



le fromage de chèvre
goat's cheese



le cheddar
cheddar



le parmesan
parmesan



le camembert
camembert

la croûte
rind



l'édam
edam



le manchego
manchego

les pâtés en croûte
meat pies

l'olive noire
black olive

le piment
chili
pepper

la sauce
sauce



le petit pain
bread roll

la viande cuite
cooked meat



l'olive verte
green olive

le comptoir sandwichs
sandwich counter

le jambon
ham



le poisson fumé
smoked fish



les câpres
capers

vocabulaire • vocabulary

à l'huile
in oil

mariné
marinated

fumé
smoked

en saumure
in brine

salé
salted

séché
cured

Prenez un numéro, s'il vous plaît.
Take a number, please.

Est-ce que je peut goûter un peu de ça, s'il vous plaît?
Can I try some of that, please?

Je voudrais six tranches, s'il vous plaît.
May I have six slices of that, please?



le prosciutto
prosciutto

le chorizo
chorizo



l'olive fourrée
stuffed olive

les boissons • drinks

l'eau • water

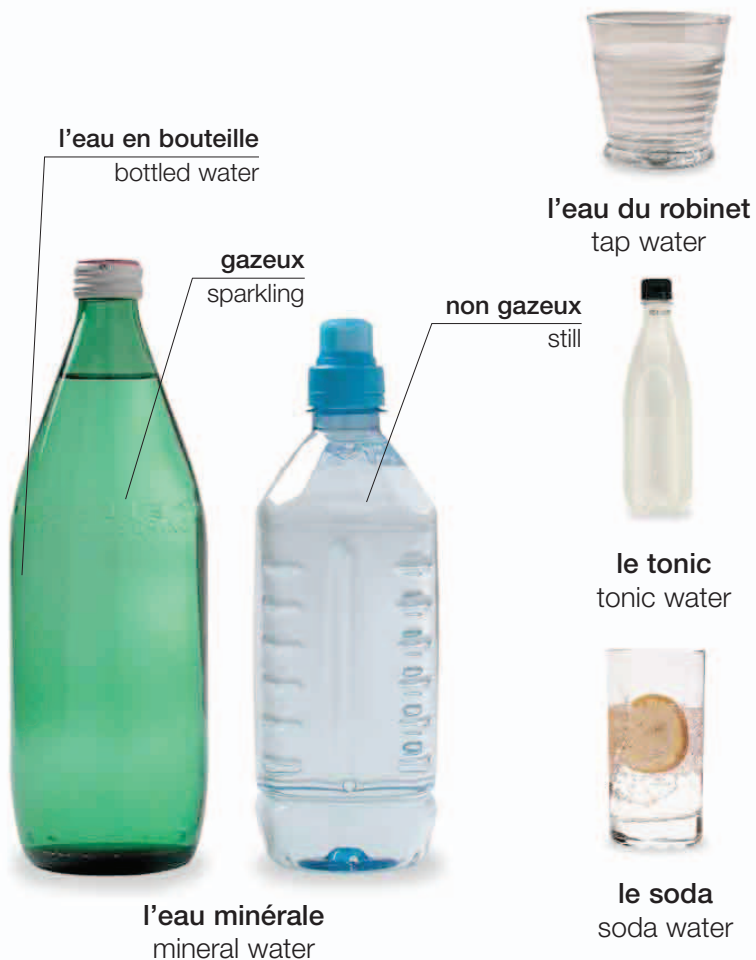

les boissons chaudes • hot drinks



les boissons non alcoolisées • soft drinks



les boissons alcoolisées • alcoholic drinks



le gin
gin



la boîte
can

la bière
beer



le cidre
cider



la bière anglaise
bitter



la bière brune
stout



la vodka
vodka



le whisky
whiskey



le rhum
rum



le brandy
brandy



le porto
port



sec
dry

le sherry
sherry



le campari
campari

rosé
rosé

blanc
white

rouge
red



la liqueur
liqueur



la téquila
tequila



le champagne
champagne



le vin
wine





sortir manger
eating out

le café • café



le menu
menu

le store
awning

la terrasse de café | sidewalk café



le parasol
umbrella

la terrasse de café
terrace café

le serveur
waiter

le percolateur
coffee machine

la table
table



le snack | snack bar

le café • coffee

le crème
coffee with
milk

le noir
black coffee

le chocolat en
poudre
cocoa powder

la mousse
froth



le café filtre
filter coffee



l'expresso
espresso



le cappuccino
cappuccino



le café glacé
iced coffee

le thé • tea

la tisane
herbal tea



le thé au lait
tea with milk

le thé nature
plain tea



la camomille
chamomile tea



le thé au citron
tea with lemon



le thé vert
green tea



l'infusion de menthe
mint tea



le thé glacé
iced tea

les jus et milk-shakes • juices and milkshakes



le jus
d'orange
orange juice



le jus de
pomme
apple juice



le jus
d'ananas
pineapple juice



le jus de
tomate
tomato juice

le milk-shake au chocolat
chocolate milkshake

le milk-shake à la
fraise
strawberry milkshake

le milk-shake au
café
coffee milkshake



la nourriture • food

le pain bis
brown bread

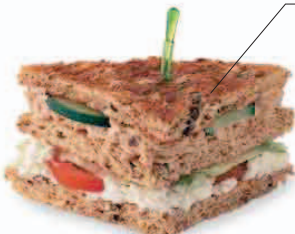

le sandwich grillé
toasted sandwich



la salade
salad



la glace
ice cream

la boule
scoop



la pâtisserie
pastry

le bar • bar

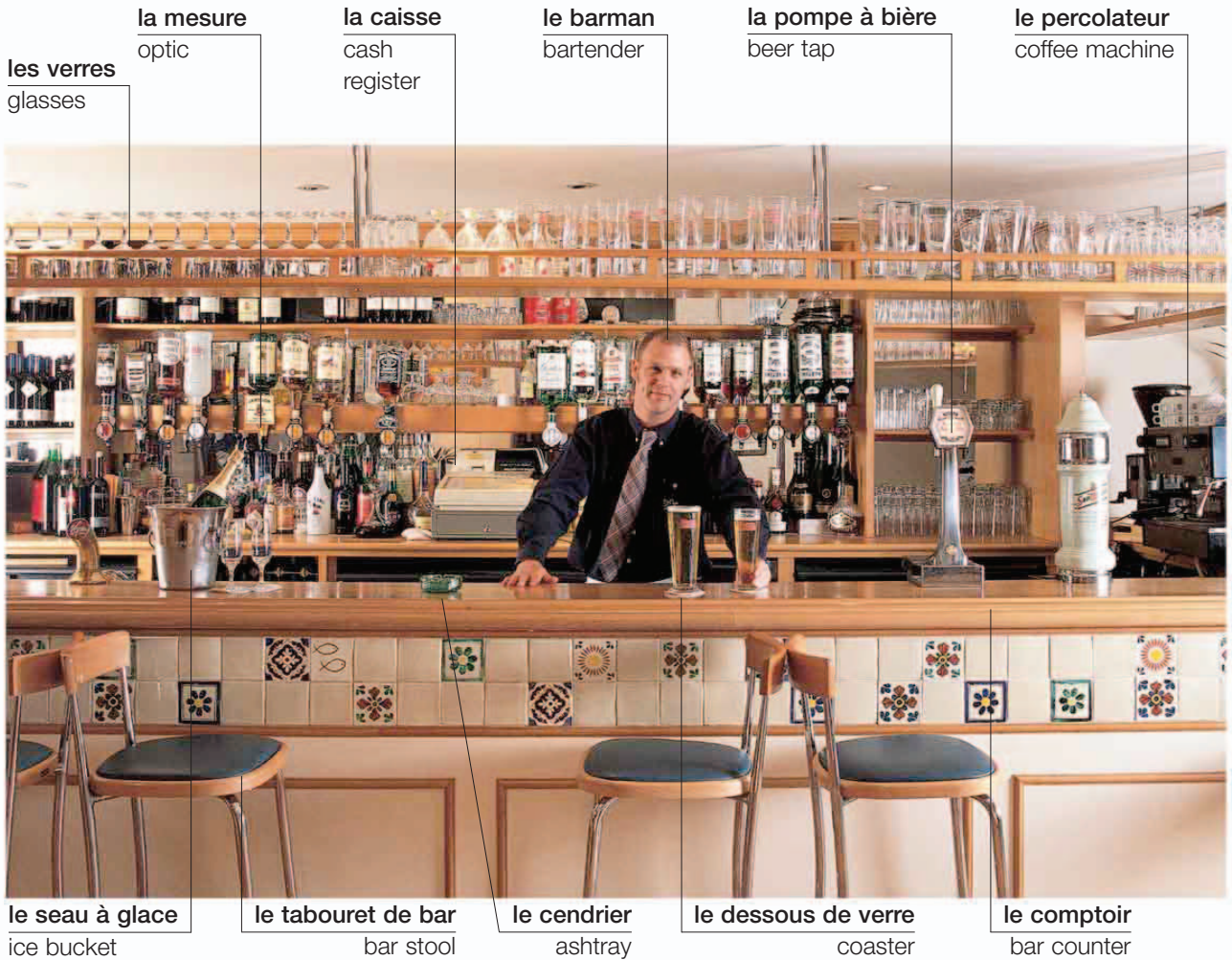

l'ouvre-bouteille
bottle opener



le levier
lever

le tire-bouchon | corkscrew

les pinces
tongs



l'agitateur
stirrer

le verre gradué
mesure

le shaker à cocktails | cocktail shaker



le gin tonic
gin and tonic

le pichet
pitcher



le scotch à l'eau
scotch and water



le glaçon
ice cube

le rhum coca
rum and cola



la vodka à l'orange
screwdriver



le martini
martini



le cocktail
cocktail



le vin
wine



la bière | beer



un coup
shot

simple
single



la mesure
measure

double
double



sans glaçons
without ice

citron et glaçons
ice and lemon



avec des glaçons
with ice

les amuse-gueule • bar snacks



les chips | chips

les noix de cajou
cashews

les amandes
almonds



les noix | nuts

les cacahouètes
peanuts



les olives | olives

le restaurant • restaurant

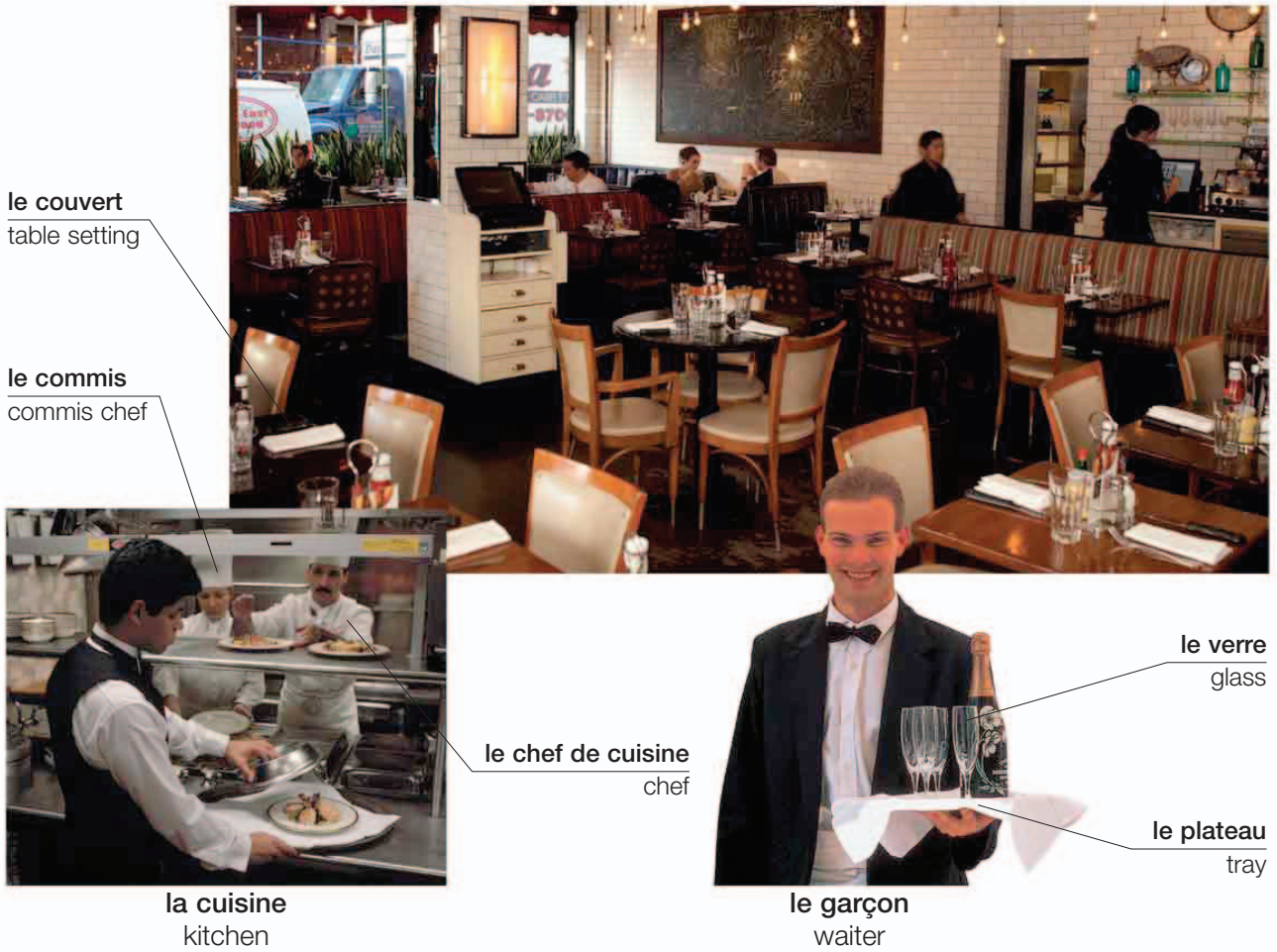

le couvert
table setting

le commis
commis chef

le chef de cuisine
chef

le verre
glass

le plateau
tray

la cuisine
kitchen

le garçon
waiter

vocabulaire • vocabulary

le menu du soir evening menu	les spécialités specials	le prix price	le pourboire tip	le buffet buffet	le client customer
la carte des vins wine list	à la carte à la carte	l'addition check	service compris service included	le bar bar	le poivre pepper
le menu du déjeuner lunch menu	le plateau de desserts dessert cart	le reçu receipt	service non compris service not included	le sel salt	



la carte
menu



le menu d'enfant
children's meal



commander
order (v)



payer
pay (v)

les plats • courses



l'apéritif
apéritif



l'entrée
appetizer



la soupe
soup



le plat principal
entrée



l'accompagnement
side order



le dessert | dessert



le café | coffee

Une table pour deux, s'il vous plaît.

A table for two, please.

La carte/la carte des vins, s'il vous plaît.

Can I see the menu/wine list, please?

Avez-vous un menu à prix fixe?

Is there a fixed-price menu?

Avez vous des plats végétariens?

Do you have any vegetarian dishes?

L'addition/un reçu, s'il vous plaît.

Could I have the check/a receipt, please?

Pouvons-nous payer chacun notre part?

Can we pay separately?

Où sont les toilettes, s'il vous plaît?

Where are the restrooms, please?

la restauration rapide • fast food

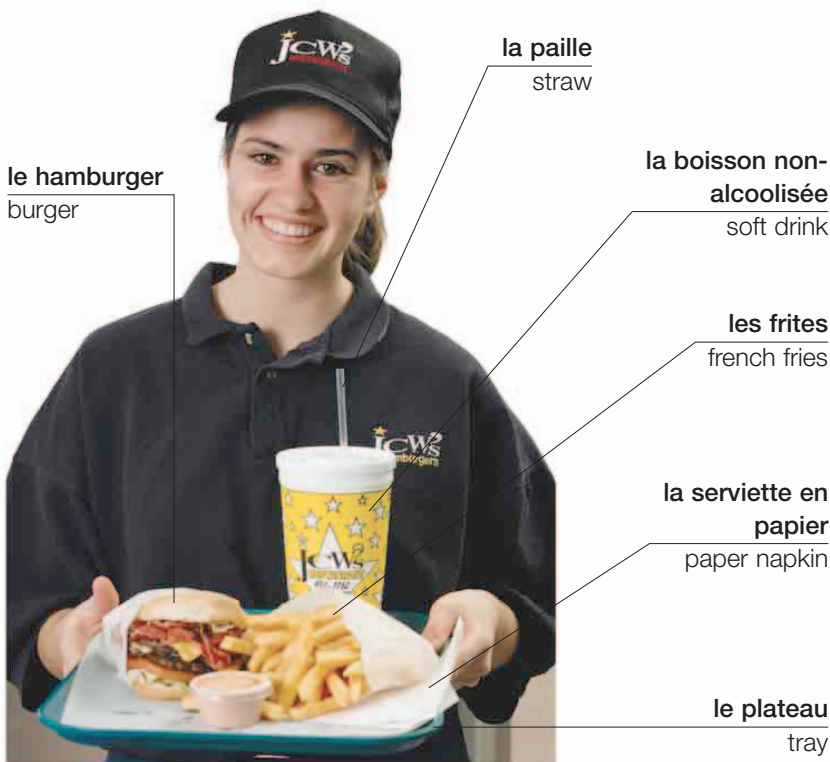

le hamburger
burger

la paille
straw

la boisson non-
alcoolisée
soft drink

les frites
french fries

la serviette en
papier
paper napkin

le plateau
tray

le hamburger avec des frites
burger meal



la pizza
pizza

le tarif
price list

la boisson en boîte
canned drink



le marchand de hot-dogs
hot dog vendor

vocabulaire • vocabulary

la pizzeria
pizzeria

le restaurant rapide
burger bar

la carte
menu

manger sur place
for here

à emporter
to go

réchauffer
reheat (v)

le ketchup
ketchup

À emporter, s'il vous
plaît.
Can I have that to go,
please?

Est-ce que vous livrez à
domicile?
Do you deliver?



le hamburger
hamburger



le hamburger au poulet
chicken burger



le hamburger végétarien
veggie burger

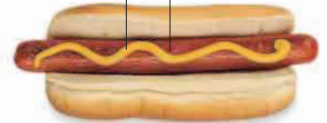

le hot-dog
hot dog

le petit pan
bun

la moutarde
mustard

la saucisse
sausage



le sandwich
sandwich



le sandwich mixte
club sandwich



le canapé
open sandwich

la garniture
filling



le taco
wrap



le kébab
kebab

la sauce
sauce



les beignets de poulet
chicken nuggets

salé
savory



les crêpes | crêpes

sucré
sweet



la garniture
topping



le poisson avec des frites
fish and chips



les côtes
ribs



le poulet frit
fried chicken



la pizza
pizza

le petit déjeuner • breakfast

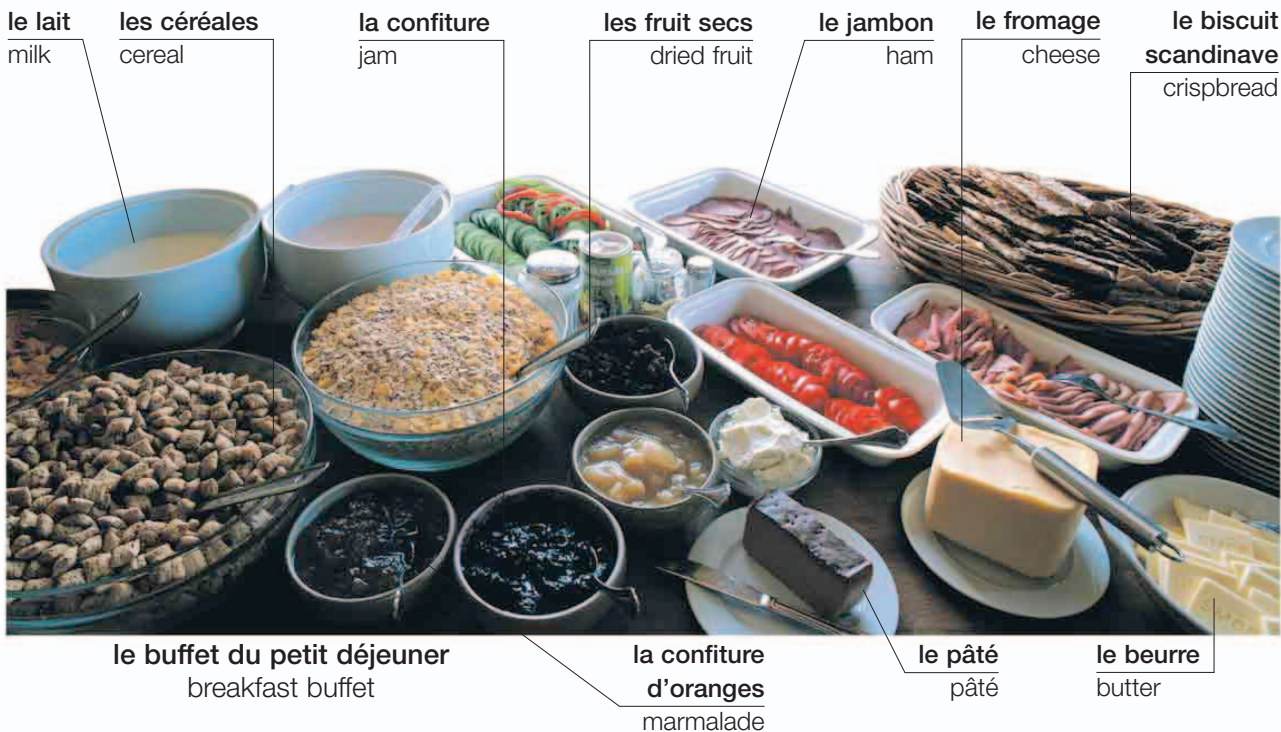

la table du petit déjeuner | breakfast table



les boissons | drinks



la brioche
brioche



le pain
bread

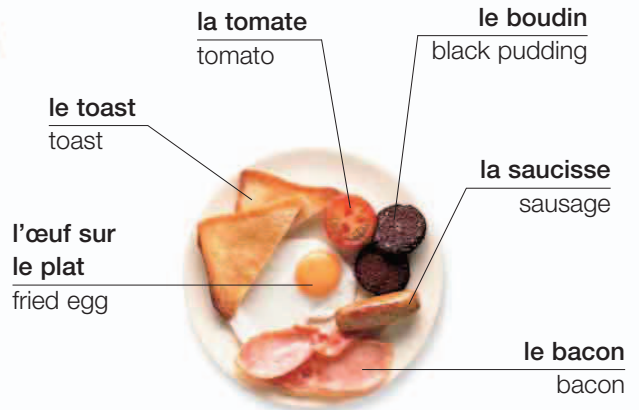

le toast
toast

la tomate
tomato

le boudin
black pudding

la saucisse
sausage

l'œuf sur le plat
fried egg

le bacon
bacon

le petit déjeuner anglais
English breakfast



les kippers
kippers



le pain perdu
French toast

le jaune d'œuf
yolk



l'œuf à la coque
boiled egg



les œufs brouillés
scrambled eggs

la crème
cream



les crêpes
crêpes

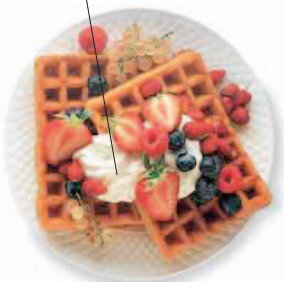

les gaufres
waffles

le yaourt aux fruits
fruit yogurt



le porridge
oatmeal



les fruits
fresh fruit

le repas • dinner



le potage | soup



le bouillon | broth



le ragoût | stew



le curry | curry



le rôti
roast



la tourte
pie



le soufflé
soufflé



le chiche-kébab
kebab



les boulettes de viande
meatballs



l'omelette
omelet



le sauté | stir fry

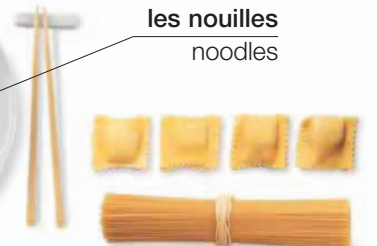

les nouilles
noodles

les pâtes | pasta



le riz
rice



la salade composée
tossed salad



la salade verte
green salad



la vinaigrette
dressing

la préparation • techniques



farc | stuffed



en sauce | in sauce



grillé | grilled



mariné | marinated



poché | poached



en purée | mashed



cuit | baked



sauté | pan-fried



frit
fried



macéré
pickled



fumé
smoked



frit
deep fried



au sirop
in syrup



assaisonné
dressed



cuit à la vapeur
steamed



séché
cured





l'étude
study

l'école • school



le cartable
schoolbag

l'élève
student



vocabulaire • vocabulary

l'histoire
history

les sciences
science

la physique
physics

les langues
languages

l'art/le dessin
art

la chimie
chemistry

la littérature
literature

la musique
music

la biologie
biology

la géographie
geography

les mathématiques
math

l'éducation physique
physical education

les activités • activities



lire | read (v)



écrire | write (v)



épeler
spell (v)



dessiner
draw (v)



le projecteur numérique
digital projector



le stylo
pen



le crayon
pencil

le crayon de couleur
colored pencil



le taille-crayon
pencil sharpener

le cahier
notebook



le livre | textbook



la gomme
eraser



la trousse
pencil case



la règle
ruler



questionner
question (v)



répondre
answer (v)



discuter
discuss (v)



apprendre
learn (v)

vocabulaire • vocabulary

le directeur
principal

la réponse
answer

la note
grade

la leçon
lesson

les devoirs
homework

la classe
year

la question
question

l'examen
test

le dictionnaire
dictionary

prendre des notes
take notes (v)

la rédaction
essay

l'encyclopédie
encyclopedia

les mathématiques • math

les formes • shapes

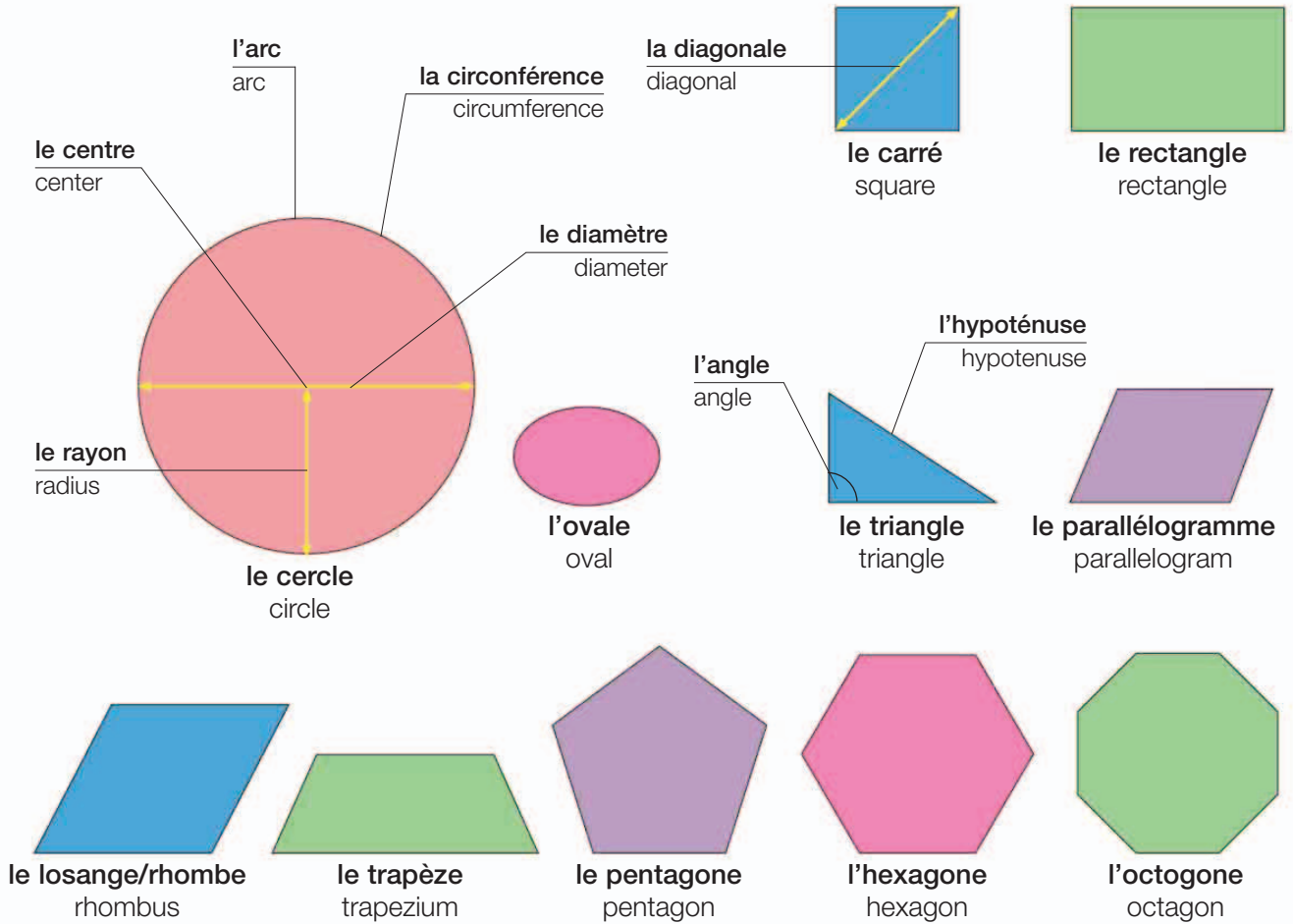

les solides • solids

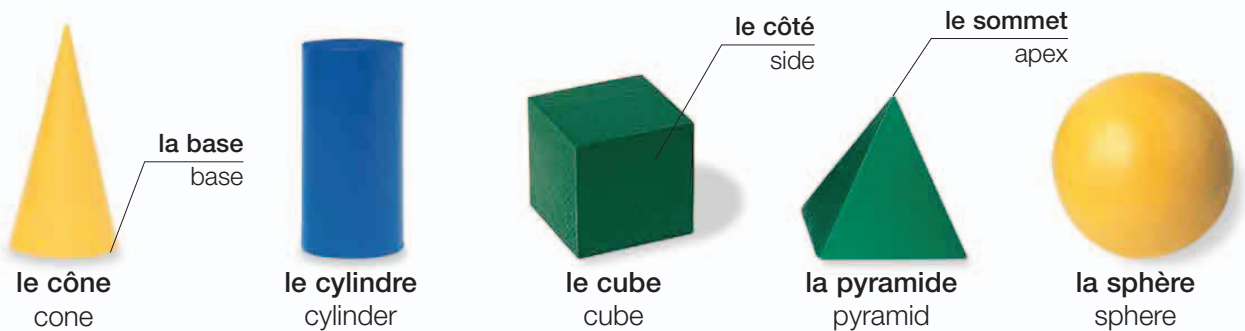

les lignes • lines



les mesures • measurements

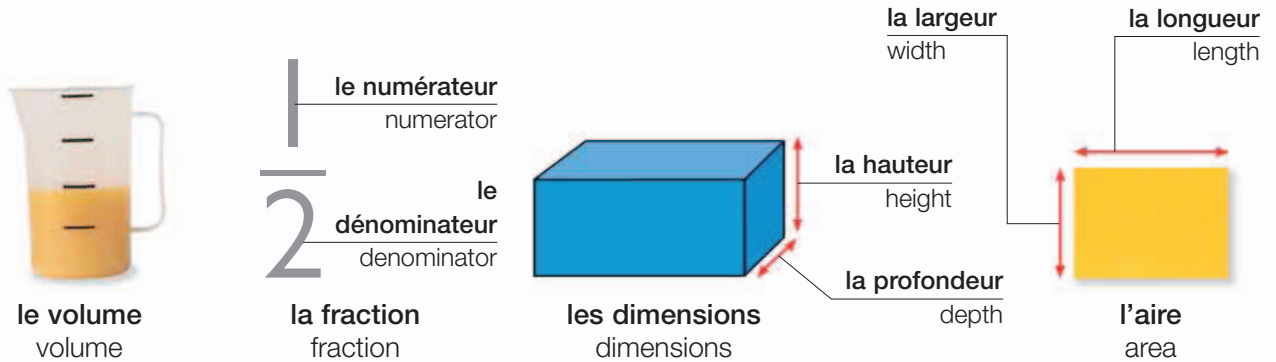

l'équipement • equipment

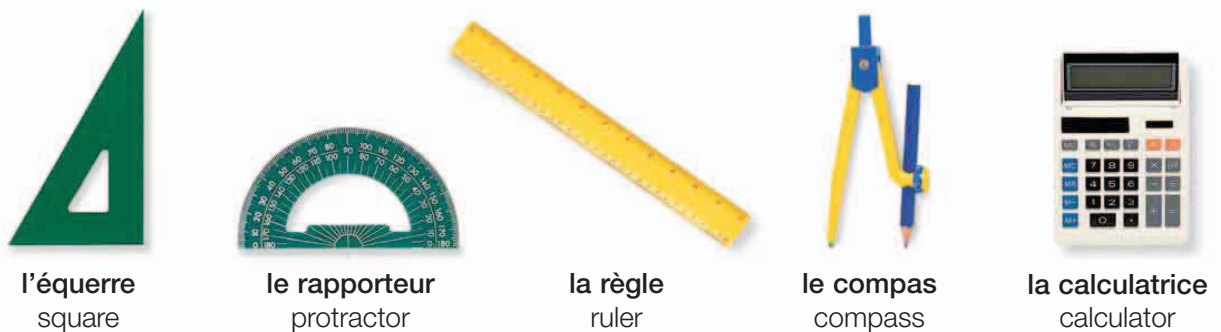

vocabulaire • vocabulary

la géométrie geometry	plus plus	fois times	égale(nt) equals	additionner add (v)	multiplier multiply (v)	l'équation equation
l'arithmétique arithmetic	moins minus	divisé par divided by	compter count (v)	soustraire subtract (v)	diviser divide (v)	le pourcentage percentage

la science • science



le laboratoire
laboratory



la balance
scales

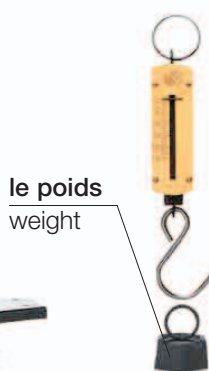

le poids
weight

la balance à ressort
spring balance

le creuset
crucible



le bec Bunsen
bunsen burner

le trépied
tripod



la bouteille
glass bottle

l'entonnoir
funnel

la fiole
flask

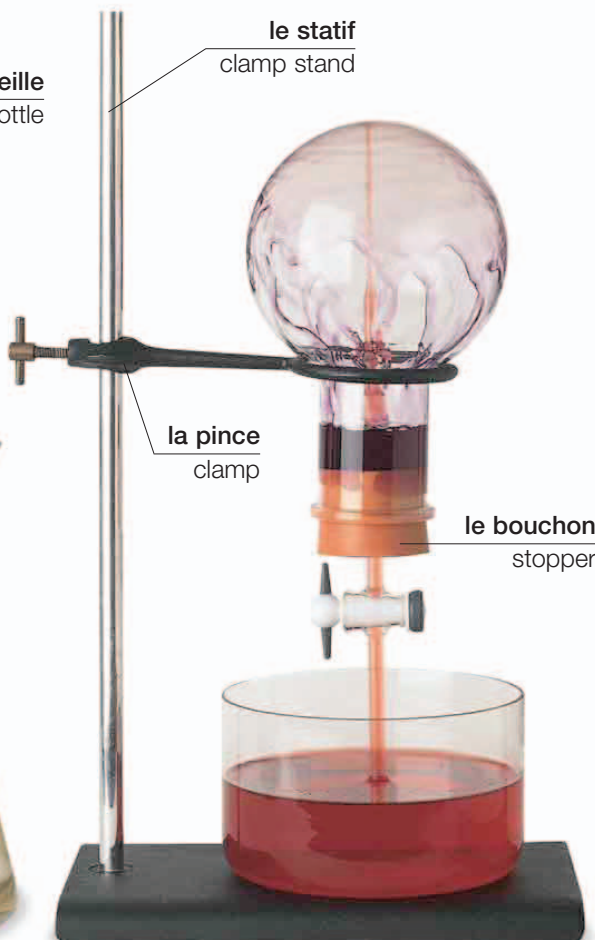

le statif
clamp stand

la pince
clamp

le bouchon
stopper

l'expérience | experiment

l'éprouvette
test tube



le support
rack



le chronomètre
timer



la boîte de Pétri
petri dish



le thermomètre
thermometer



la seringue
syringe



la pince fine
tweezers



le scalpel
scalpel



le compte-gouttes
dropper



le forceps | forceps



la pince
tongs



la spatule
spatula

le pilon
pestle



le mortier
mortar



le papier filtre
filter paper



les lunettes de protection
safety goggles

l'oculaire
eyepiece

le bouton de mise au point
focusing knob

la tige de verre
glass stirrer



la pipette
pipette

le bécher
beaker

la lentille de l'objectif
objective lens

la platine
stage

le porte-objet
slide

le miroir
mirror



l'aimant
magnet



la pince crocodile
alligator clip

l'électrode négative
negative electrode

l'électrode positive
positive electrode



la pile | battery



le microscope | microscope

l'enseignement supérieur • college



le secrétariat
admissions
office

le restaurant universitaire
cafeteria

le service de santé
clinic

le terrain de sport
sports field

la résidence universitaire
residence hall

le campus | campus

vocabulaire • vocabulary

la carte de lecteur
library card

les renseignements
help desk

le prêt
loan

la salle de lecture
reading room

emprunter
borrow (v)

le livre
book

les ouvrages recommandés
reading list

réserver
reserve (v)

le titre
title

la date de retour
due date

renouveler
renew (v)

le couloir
aisle

la bibliothécaire
librarian

le service de prêt
circulation desk

les rayons
bookshelves

le périodique
periodical

la revue
journal



la bibliothèque | library

l'étudiant
undergraduate

l'assistant
professor

la licenciée
graduate

la robe
robe



la salle de cours
lecture hall



la cérémonie de la remise des diplômes
graduation ceremony

les écoles • schools



le modèle
model

l'école des beaux arts
art college



le Conservatoire
music school



l'école de danse
dance academy

vocabulaire • vocabulary

la bourse
scholarship

la recherche
research

la dissertation
dissertation

la médecine
medicine

la philosophie
philosophy

le diplôme
diploma

la maîtrise
master's
degree

l'U.F.R.
department

la zoologie
zoology

la littérature
literature

la licence
degree

le doctorat
doctorate

le droit
law

la physique
physics

l'histoire d'art
art history

**de troisième
cycle**
postgraduate

la thèse
thesis

**les études
d'ingénieur**
engineering

**les sciences
politiques**
politics

**les sciences
économiques**
economics

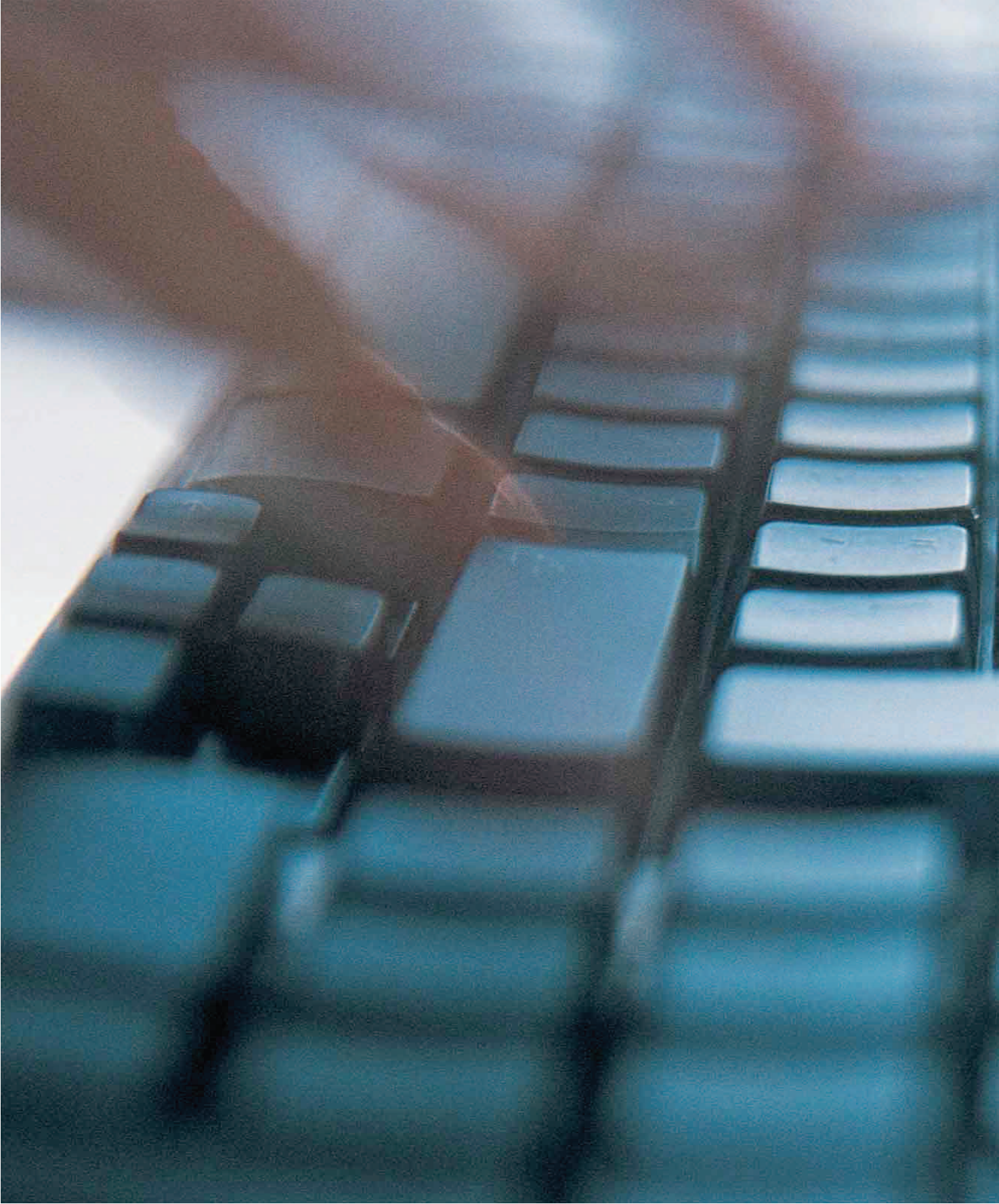



le travail
work

le bureau 1 • office 1



l'équipement de bureau • office equipment

le magasin à papier
paper tray



l'imprimante | printer



le fax | fax machine

vocabulaire • vocabulary

imprimer
print (v)

agrandir
enlarge (v)

photocopier
copy (v)

réduire
reduce (v)

J'ai besoin de faire des photocopies.
I need to make some copies.

les fournitures de bureau • office supplies

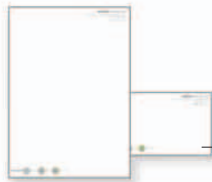

l'en-tête
stationery

la fiche compliments
notecard



l'enveloppe
envelope

le dossier-classeur
box file



le clipboard
clipboard



le bloc-notes
notepad



l'étiquette
tab

le dossier suspendu
hanging file

la fiche intercalaire
divider



le porte-dossiers
expanding file

le classeur à levier
ring binder



l'agenda
personal organizer



les agrafes
staples

l'agrafeuse
stapler

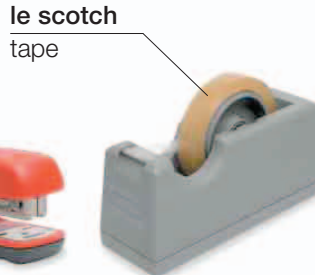

le scotch
tape

le dévidoir de scotch
tape dispenser



le perforateur
hole punch



le tampon encreur
ink pad

le cachet
rubber stamp



l'élastique
rubber band



la pince à dessin
bulldog clip



le trombone
paper clip

la punaise
thumbtack



le panneau d'affichage | notice board

le bureau 2 • office 2

le tableau à feuilles mobiles
flipchart

le compte rendu
minutes

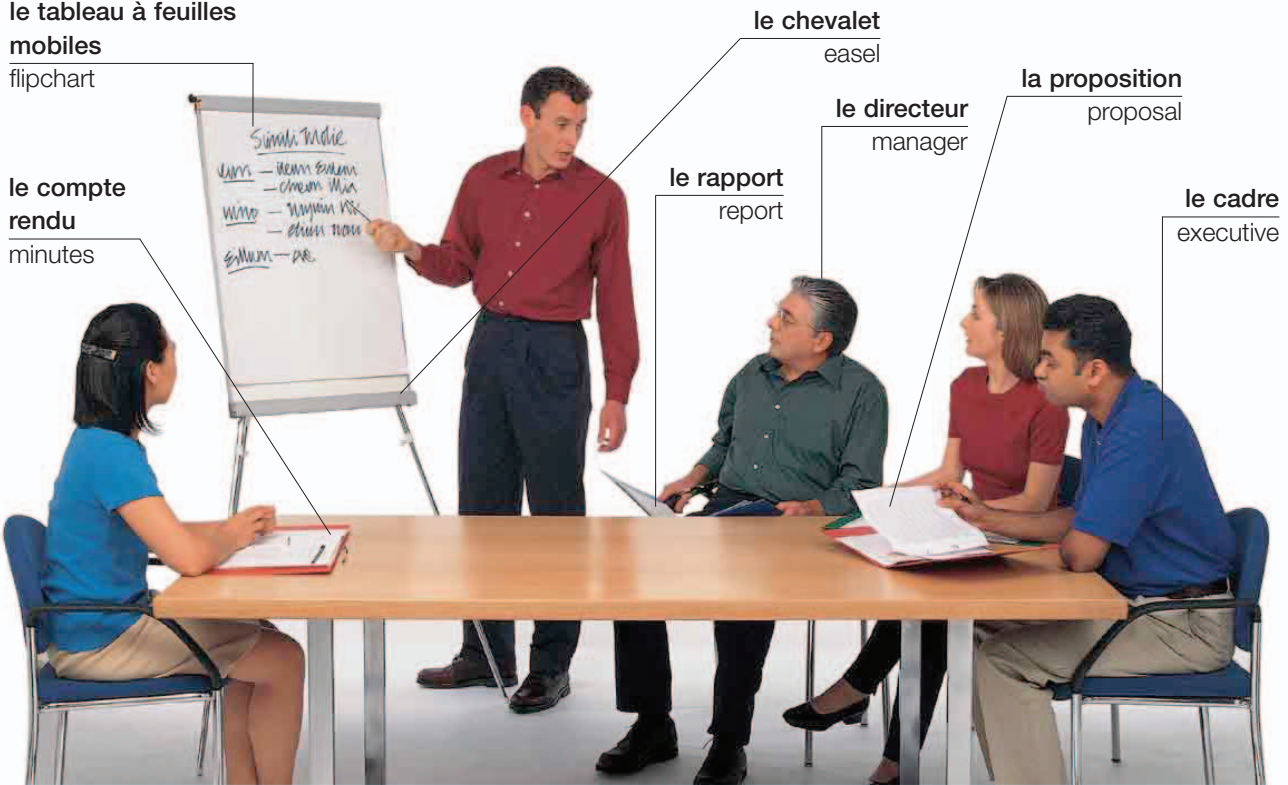

le chevalet
easel

le directeur
manager

la proposition
proposal

le rapport
report

le cadre
executive

le réunion | meeting

vocabulaire • vocabulary

la salle de conférence
meeting room

assister à
attend (v)

l'ordre du jour
agenda

présider
chair (v)

La conférence est à quelle heure?
What time is the meeting?

Quelles sont vos heures de bureau?
What are your office hours?

la conférencière
speaker



la présentation | presentation

les affaires • business

l'homme d'affaires
businessman

la femme d'affaires
businesswoman



le déjeuner d'affaires
business lunch



le voyage d'affaires
business trip

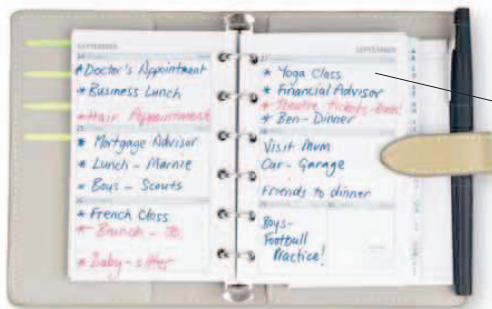

l'agenda | organizer

le rendez-vous
appointment

la cliente
client



le directeur général
CEO

le contrat
business deal

vocabulaire • vocabulary

la société
company

le personnel
staff

la comptabilité
accounts department

le service du contentieux
legal department

le siège social
headquarters

le salaire
salary

le service marketing
marketing department

le service après-vente
customer service department

la succursale
regional office

le livre de paie
payroll

le service des ventes
sales department

le service de ressources humaines
human resources department

l'ordinateur • computer

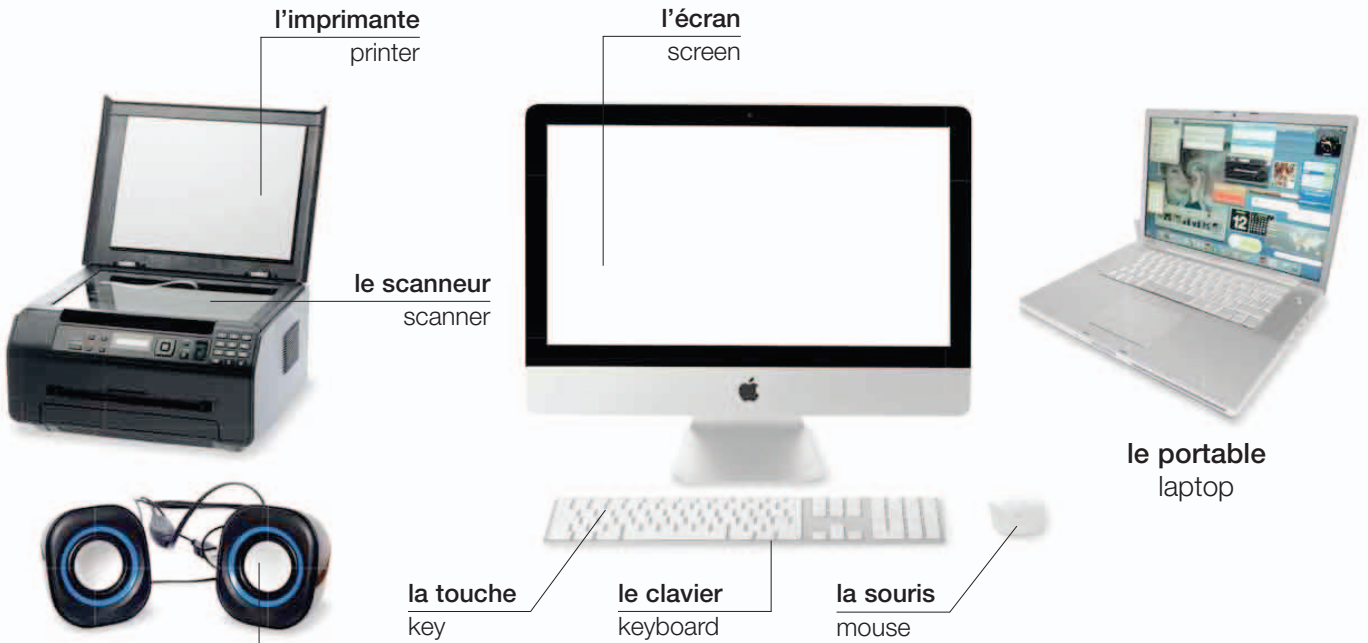

le matériel
hardware



la clé USB
memory stick



le disque dur externe
external hard drive



l'iPad®
iPad



le smartphone
smartphone

vocabulaire • vocabulary

la mémoire memory	le logiciel software	le serveur server
la RAM RAM	l'application application	le port port
les bytes bytes	le programme program	le processeur processor
le système system	le réseau network	le câble électrique power cord

le bureau • desktop

la barre de menus
menu bar

la barre d'outils
toolbar

le papier peint
wallpaper

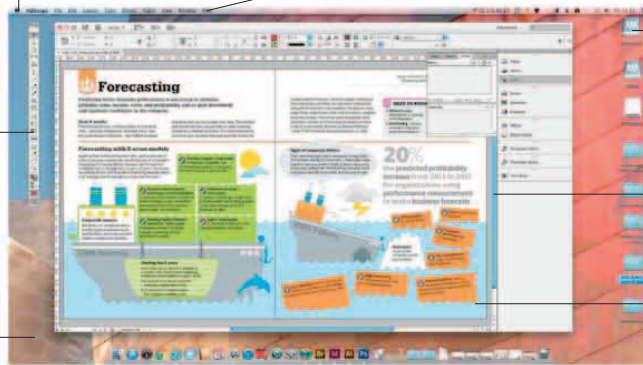

la police
font

l'icône
icon

la barre
de défilement
scrollbar

la fenêtre
window



le fichier
file



le dossier
folder



la poubelle
trash

l'internet • internet

le navigateur
browser



naviguer
browse (v)

la boîte de
réception
inbox

le site web
website

l'e-mail • email

l'adresse e-mail
email address

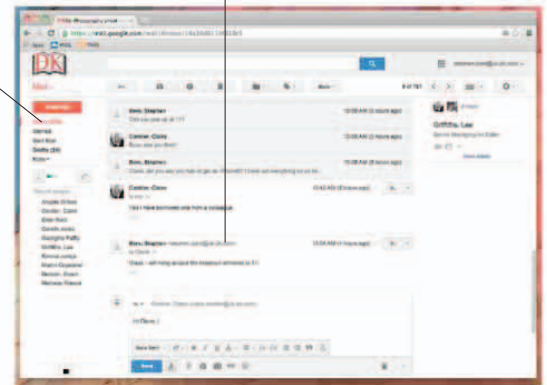

vocabulaire • vocabulary

connecter
connect (v)

le fournisseur d'accès
service provider

entrer
log on (v)

télécharger
download (v)

envoyer
send (v)

sauvegarder
save (v)

installer
install (v)

le compte e-mail
email account

en ligne
on line

la pièce jointe
attachment

recevoir
receive (v)

chercher
search (v)

les médias • media

le studio de télévision • television studio

le plateau
set

le présentateur
presenter

l'éclairage
light



la caméra
camera

la grue de caméra
camera crane

le cameraman
cameraman

vocabulaire • vocabulary

la chaîne
channel

les nouvelles
news

la presse
press

le feuilleton
soap opera

le dessin animé
cartoon

en direct
live

la programmation
programming

le documentaire
documentary

la série télévisée
television series

le jeu télévisé
game show

en différé
prerecorded

émettre
broadcast (v)



l'interviewer
interviewer



la reporter
reporter



le télésoffleur
teleprompter



la présentatrice
newscaster



les acteurs
actors



la perche
sound boom



la claquette
clapper board

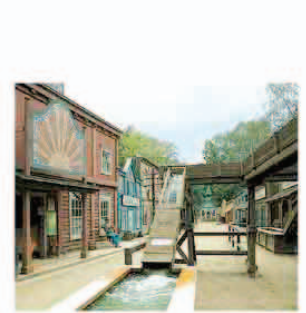

le décor de cinéma
movie set

la radio • radio

l'ingénieur du son
sound technician

le pupitre de mixage
mixing desk

le microphone
microphone



le studio d'enregistrement | recording studio

vocabulaire • vocabulary

la station de radio
radio station

la fréquence
frequency

le D.J.
DJ

le volume
volume

l'émission
broadcast

régler
tune (v)

la longueur d'ondes
wavelength

les ondes courtes
short wave

les grandes ondes
long wave

les ondes moyennes
medium wave

analogique
analog

numérique
digital

le droit • law

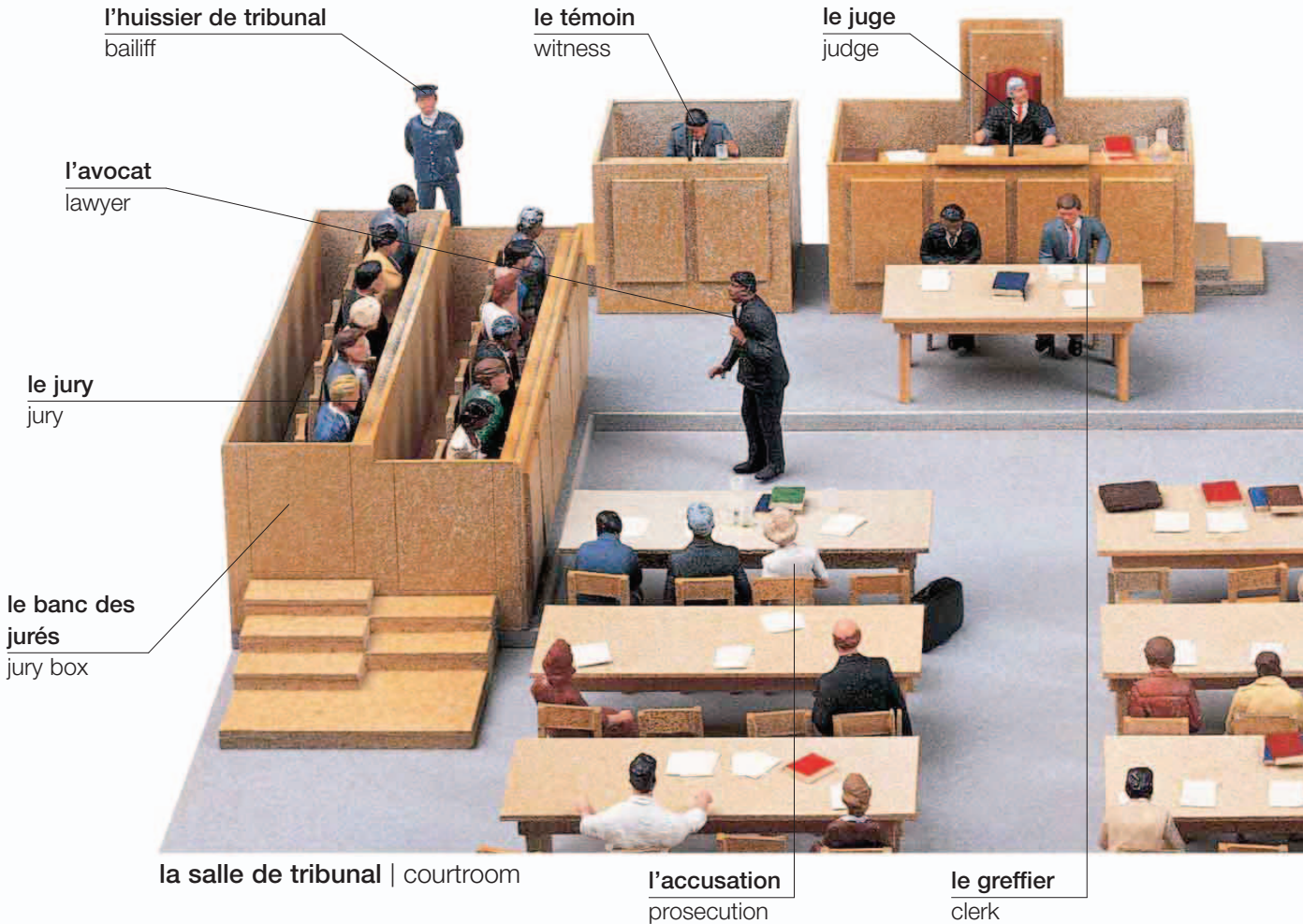

vocabulaire • vocabulary

le cabinet
lawyer's office

l'assignation
summons

l'acte judiciaire
writ

la cause
court case

le conseil juridique
legal advice

la déposition
statement

la date du procès
court date

l'accusation
charge

le client
client

le mandat
warrant

le plaidoyer
plea

l'accusé
accused

le sténographe
stenographer



le suspect
suspect



le criminel
criminal



l'accusé
defendant

la défense
defense

le portrait-robot
composite

le casier judiciaire
criminal record

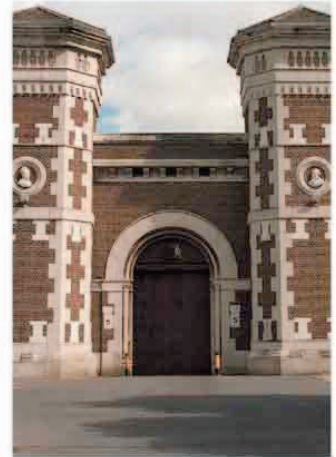
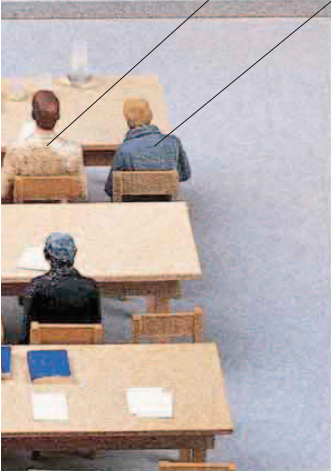

le gardien de prison
prison guard

la cellule
cell

la prison
prison

vocabulaire • vocabulary

la preuve
evidence

coupable
guilty

la caution
bail

Je voudrais voir un avocat.
I want to see a lawyer.

le verdict
verdict

acquitté
acquitted

l'appel
appeal

Où est le palais de justice?
Where is the courthouse?

innocent
innocent

la condamnation
sentence

la liberté conditionnelle
parole

Est-ce que je peux verser la caution?
Can I post bail?

la ferme 1 • farm 1



l'agriculteur/le fermier
farmer

le potager
vegetable garden

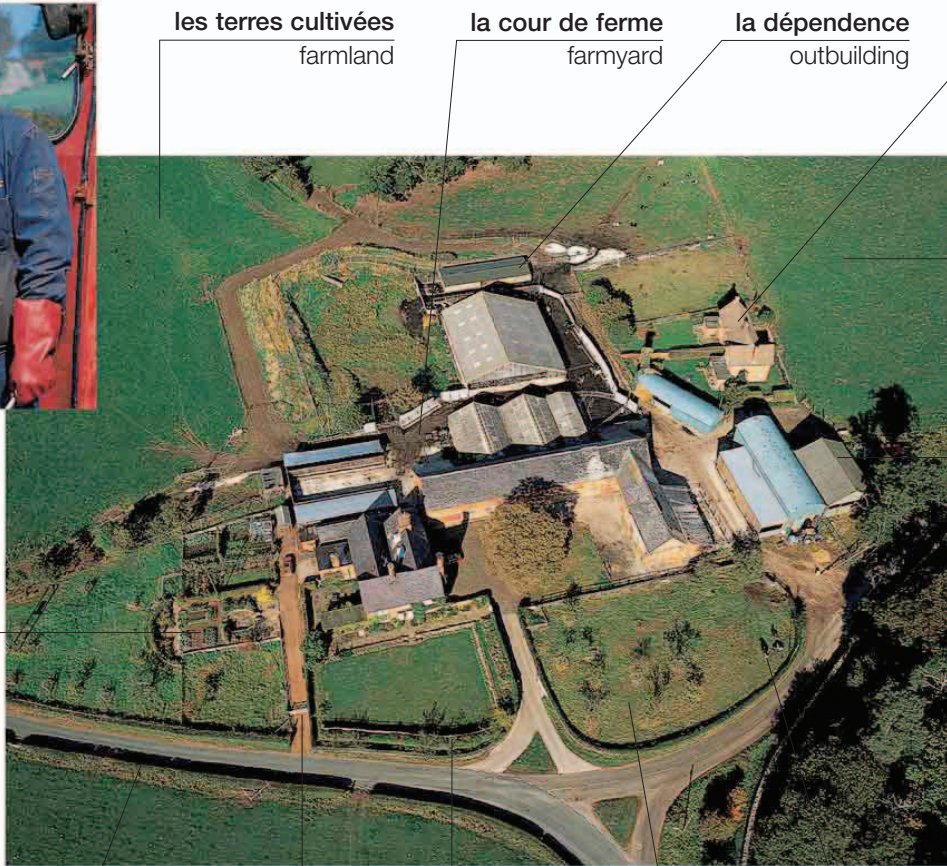

les terres cultivées
farmland

la cour de ferme
farmyard

la dépendance
outbuilding

la maison d'habitation
farmhouse

le champ
field

la grange
barn

la haie
hedge

la barrière
gate

la clôture
fence

le pré
pasture

le bétail
livestock



le tracteur | tractor

le cultivateur
cultivator



la moissonneuse-batteuse | combine

les exploitations agricoles • types of farm

la culture
crop



la ferme de culture
crop farm



la ferme laitière
dairy farm

le troupeau
flock



la ferme d'élevage de
moutons
sheep farm



la ferme d'aviculture
poultry farm



la ferme d'élevage
porcin
pig farm



le centre de
pisciculture
fish farm



l'exploitation fruitière
fruit farm

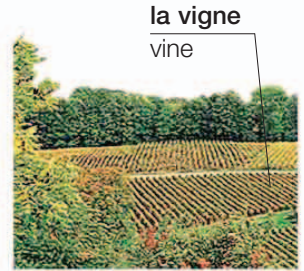

la vigne
vineyard

les activités • actions

le sillon
furrow



labourer
plow (v)



semer
sow (v)



traire
milk (v)

donner à manger
feed (v)



arroser | water (v)



récolter | harvest (v)

vocabulaire • vocabulary

l'herbicide
herbicide

le troupeau
herd

l'auge
trough

le pesticide
pesticide

le silo
silo

planter
plant (v)

la ferme 2 • farm 2

les cultures • crops



le blé
wheat



le maïs
corn



l'orge
barley



le colza
rapeseed



le tournesol
sunflower



la balle
bale

le foin
hay



la luzerne
alfalfa



le tabac
tobacco



le riz
rice



le thé
tea



le café
coffee



l'épouvantail
scarecrow



le lin
flax



la canne à sucre
sugarcane



le coton
cotton

le bétail • livestock

le porcelet
piglet



le cochon
pig

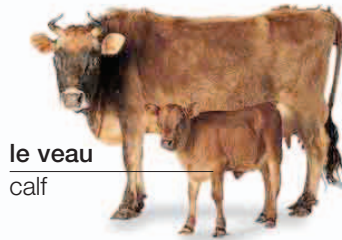

le veau
calf

la vache
cow



le taureau
bull



le mouton
sheep



l'agneau
lamb



le chevreau
kid

la chèvre
goat



le poulain
foal

le cheval
horse



l'âne
donkey

le poussin
chick

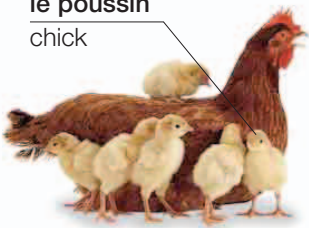

le poulet
chicken



le coq
rooster



le dindon
turkey

le caneton
duckling



le canard
duck



l'écurie
stable



l'enclos
pen



le poulailler
chicken coop



la porcherie
pig sty

la construction • construction

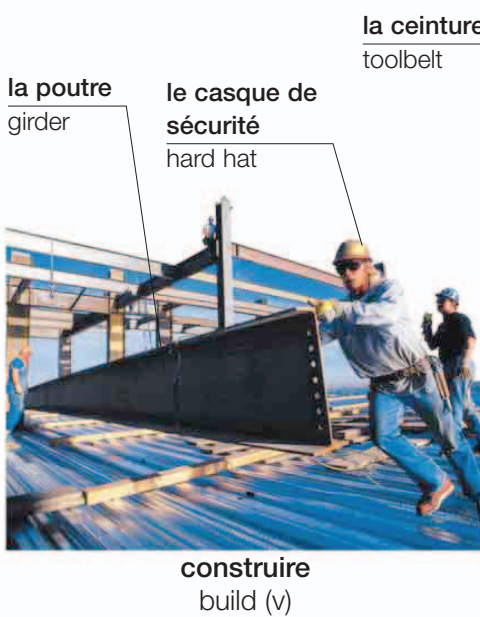
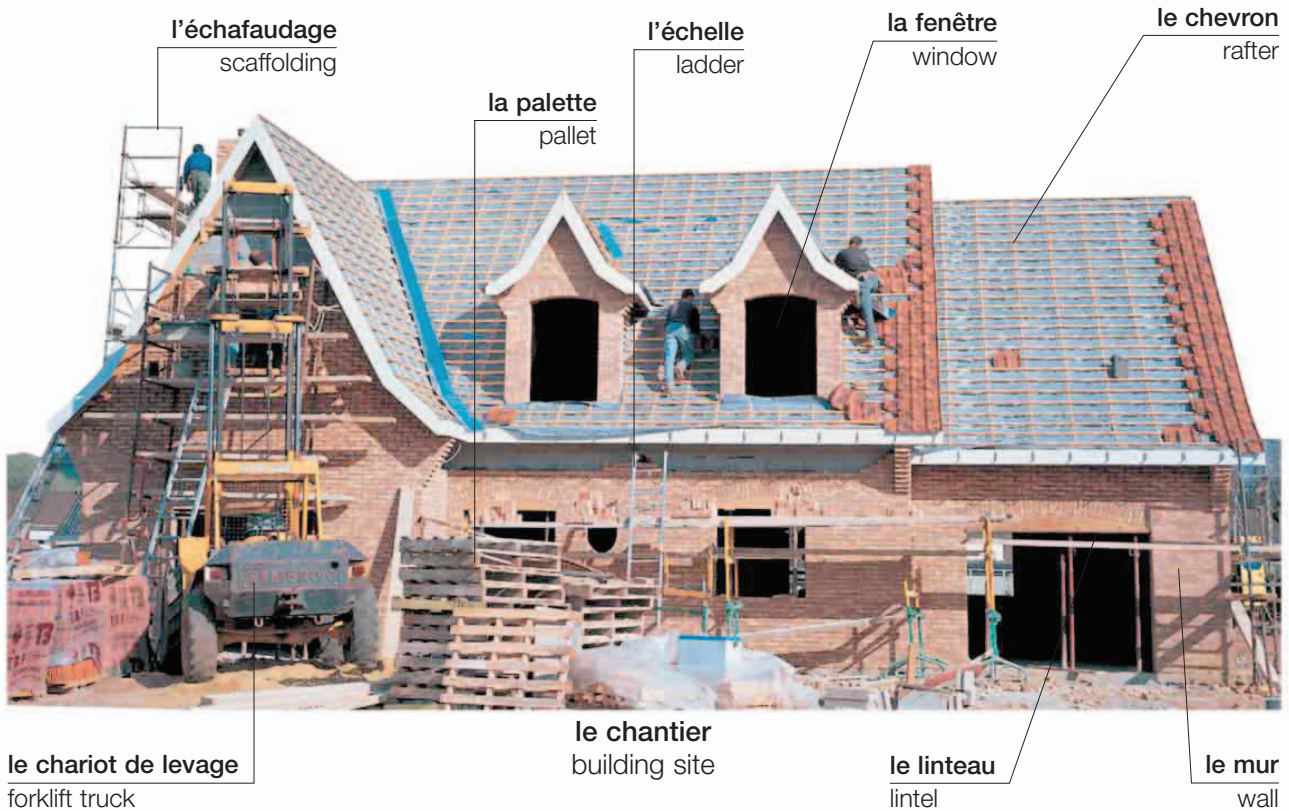

les matériaux • materials



la brique
brick



le bois
lumber



la tuile
roof tile



le bloc de béton
concrete block

les outils • tools

le mortier
mortar

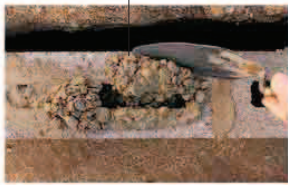

la truelle
trowel



le niveau à bulle
level



le marteau de
forgeron
sledgehammer

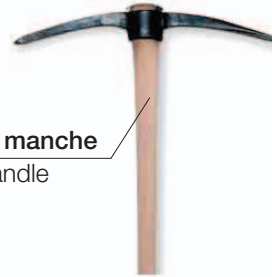

le manche
handle

la pioche
pickax



la pelle
shovel

les machines •

machinery



le rouleau compresseur
roller



le tombereau
dump truck

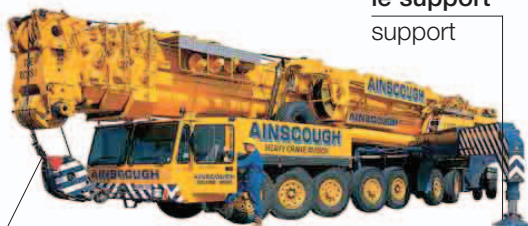

le
crochet
hook

la grue | crane

le support
support

les travaux • roadworks

le macadam
goudronné
asphalt



le marteau-
piqueur
jackhammer

le cône
cone



le
revêtement
resurfacing

la pelle
mécanique
excavator

les professions 1 • occupations 1



le menuisier
carpenter



l'électricien
electrician



le plombier
plumber



le maçon
construction worker



le jardinier
gardener

l'aspirateur
vacuum
cleaner



le nettoyeur
cleaner



le mécanicien
mechanic



le boucher
butcher



le coiffeur
hairdresser



la marchande de poissons
fish-seller



le marchand de légumes
produce-seller



la fleuriste
florist



le coiffeur
barber



le bijoutier
jeweler



l'employée de magasin
sales clerk



l'agent immobilier
realtor



l'opticien
optician



la dentiste
dentist

le masque
mask



le docteur
doctor



la pharmacienne
pharmacist



l'infirmière
nurse



la vétérinaire
veterinarian



le fermier
farmer



le pêcheur
fisherman

la mitrailleuse
machine gun



le soldat
soldier



le policier
police officer

le badge
badge

l'uniforme
uniform



le garde
security guard



le marin
sailor



le pompier
firefighter

les professions 2 • occupations 2



l'avocat
lawyer



le comptable
accountant



la maquette
model

l'architecte
architect



la scientifique
scientist



l'institutrice
teacher



le bibliothécaire
librarian



la réceptionniste
receptionist



le sac postal
mailbag

le facteur
mail carrier



le conducteur de bus
bus driver



le camionneur
truck driver



le chauffeur de taxi
cab driver



le pilote
pilot



l'hôtesse de l'air
flight attendant



l'agent de voyages
travel agent

la toque
chef's hat



le chef
chef



le musicien
musician



le tutu
tutu

la danseuse
dancer



la comédienne
actress



la chanteuse
singer



la serveuse
waitress



le barman
bartender



le sportif
sportsman



le sculpteur
sculptor



la peintre
painter



le photographe
photographer



la présentatrice
newscaster



les notes
notes

le journaliste
journalist



la rédactrice
editor



le dessinateur
designer



la couturière
seamstress

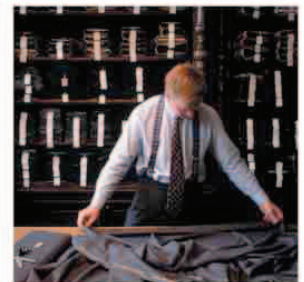

le couturier
tailor



The image features a background of a sunset or sunrise over a body of water. The sky is a mix of soft pinks, oranges, and blues, with a white horizontal band across the middle. The water below is a deep blue, reflecting the colors of the sky. The overall mood is serene and calm.

le transport
transportation

les routes • roads

l'autoroute
freeway

le poste de péage
toll booth

les signalisations
road markings

la bretelle d'accès
frontage road

à sens unique
one-way

l'îlot directionnel
divider

le carrefour
interchange

les feux
traffic light

la file de droite
right lane

la voie centrale
center lane

la voie de dépassement
passing lane

la bretelle de sortie
exit ramp

la circulation
traffic

l'autopont
overpass

l'accotement stabilisé
shoulder

le camion
truck

le terre-plein
median strip

le passage inférieur
underpass





le passage clouté
crosswalk



le téléphone de secours
emergency phone



le parking réservé aux personnes handicapées
disabled parking



l'embouteillage
traffic jam

le GPS
satnav



le parc-mètre
parking meter



l'agent de la circulation
traffic policeman

vocabulaire • vocabulary

le rond-point
roundabout

garer
park (v)

remorquer
tow away (v)

la déviation
detour

doubler
pass (v)

la route à quatre voies
divided highway

les travaux
road work

conduire
drive (v)

C'est la route pour...?
Is this the road to...?

la glissière de sécurité
guard rail

faire marche arrière
back up (v)

Où peut-on se garer?
Where can I park?

les panneaux routiers • road signs



sens interdit
do not enter



la limitation de vitesse
speed limit



danger
hazard



arrêt interdit
no stopping



interdit de tourner à droite
no right turn

le bus • bus

le siège du
conducteur
driver's seat

la poignée
handrail

la porte automatique
automatic door

la roue avant
front wheel

le compartiment à bagages
luggage hold



la porte | door



le car | long-distance bus

les types de bus • types of buses

le numéro de bus
route number

le conducteur
driver



le bus à deux étages
double-decker bus



le tramway
tram



le trolleybus
trolley bus



le bus scolaire | school bus

la roue arrière
rear wheel

la fenêtre
window

le bouton d'arrêt
stop button



le ticket
bus ticket



la sonnette
bell



la gare routière
bus station



l'arrêt de bus
bus stop

vocabulaire • vocabulary

le prix du ticket
fare

l'accès aux handicapés
wheelchair access

l'horaire
schedule

l'abribus
bus stop shelter

Vous stoppez à...?
Do you stop at...?

C'est quel bus pour
aller à...?
Which bus goes to...?



le minibus
minibus



le bus de touristes | tour bus



la navette | shuttle bus

la voiture 1 • car 1

l'extérieur • exterior

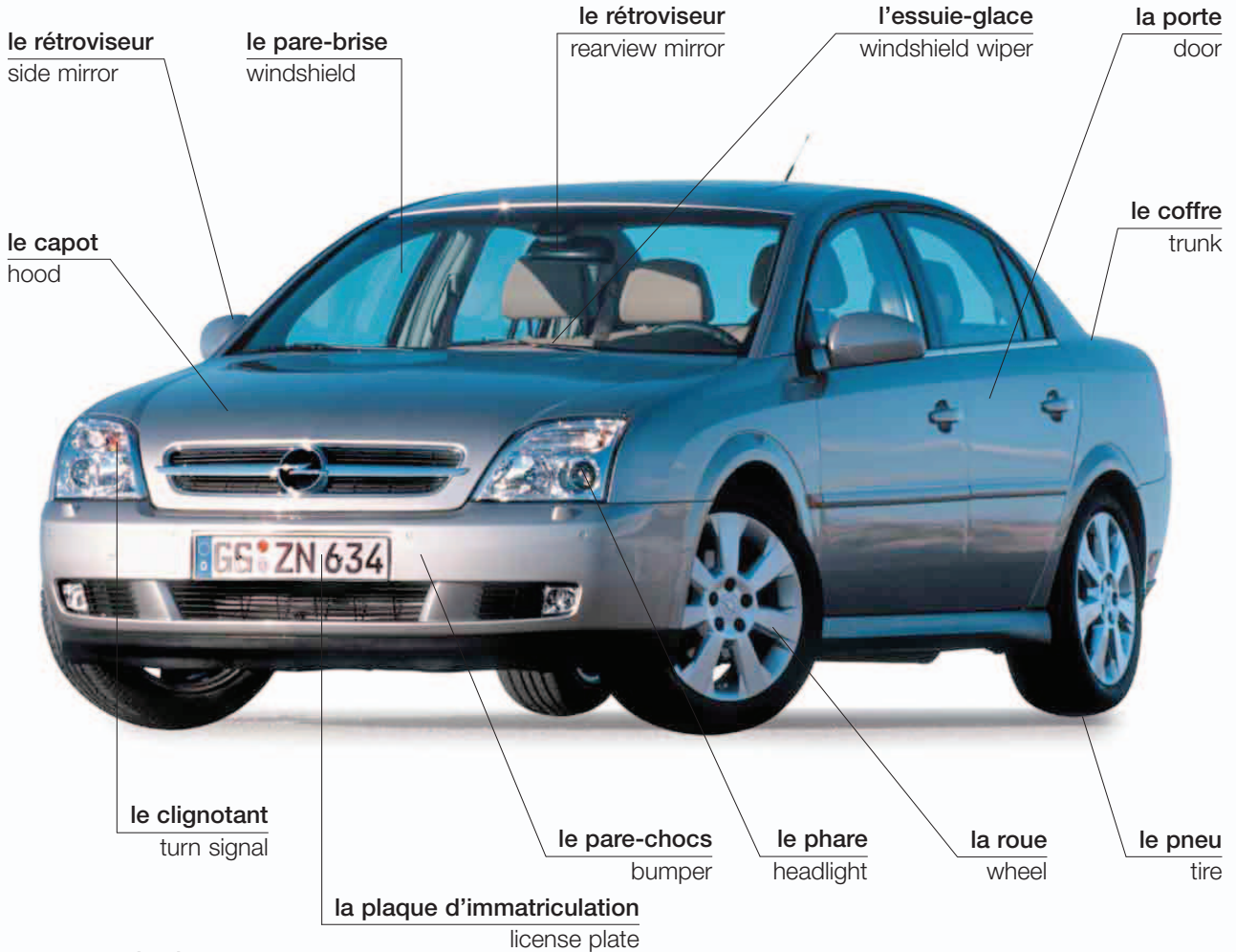

les modèles • types



la voiture électrique
electric car



la berline à hayon
hatchback



la berline
sedan



le break
station wagon



la décapotable
convertible



le cabriolet sport
sports car



la voiture à six places
minivan



la quatre-quatre
four-wheel drive

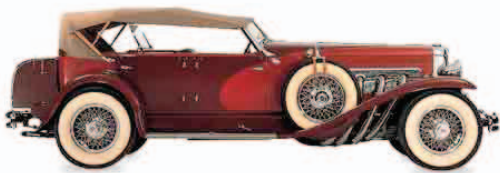

la voiture d'époque
vintage



la limousine
limousine

la station-service • gas station

la pompe
gas pump

le tarif
price



l'aire de stationnement
forecourt

vocabulaire • vocabulary

l'huile oil avec plomb leaded le lave-auto car wash

l'essence gasoline le diesel diesel l'antigel antifreeze

sans plomb unleaded le garage garage le lave-glace washer fluid

Le plein, s'il vous plaît.
Fill it up, please.

la voiture 2 • car 2

l'intérieur • interior

le siège arrière
back seat

l'accoudoir
armrest

le repose-tête
headrest

le verrouillage
door lock

la poignée
handle



vocabulaire • vocabulary

à deux portes
two-door

à quatre portes
four-door

automatique
automatic

le frein
brake

l'accélérateur
accelerator

à trois portes
hatchback

manuel
manual

l'allumage
ignition

l'embrayage
clutch

la climatisation
air conditioning

Pouvez-vous m'indiquer la route pour...?
Can you tell me the way to...?

Où est le parking?
Where is the parking lot?

On peut se garer ici?
Can I park here?

les commandes • controls

le volant
steering
wheel

le klaxon
horn

le tableau de bord
dashboard

les feux de détresse
hazard lights

le navigateur par satellite
satellite navigation



la conduite à gauche | left-hand drive

le thermomètre
temperature gauge

le compte-tours
tachometer

le compteur
speedometer

la jauge d'essence
fuel gauge

la stéréo
car stereo

l'interrupteur feux
light switch

la manette de chauffage
heater controls

l'odomètre
odometer

le levier de vitesses
gearshift

l'airbag
air bag



la conduite à droite | right-hand drive

la voiture 3 • car 3

la mécanique • mechanics

le réservoir de
lave-glace

washer fluid reservoir

la jauge d'huile
dipstick

le filtre à air
air filter

le réservoir de liquide de frein
brake fluid reservoir

la batterie
battery

la
carrosserie
bodywork



le réservoir de liquide de
refroidissement
coolant reservoir

la culasse
cylinder head

le tuyau
pipe

le toit ouvrant
sunroof

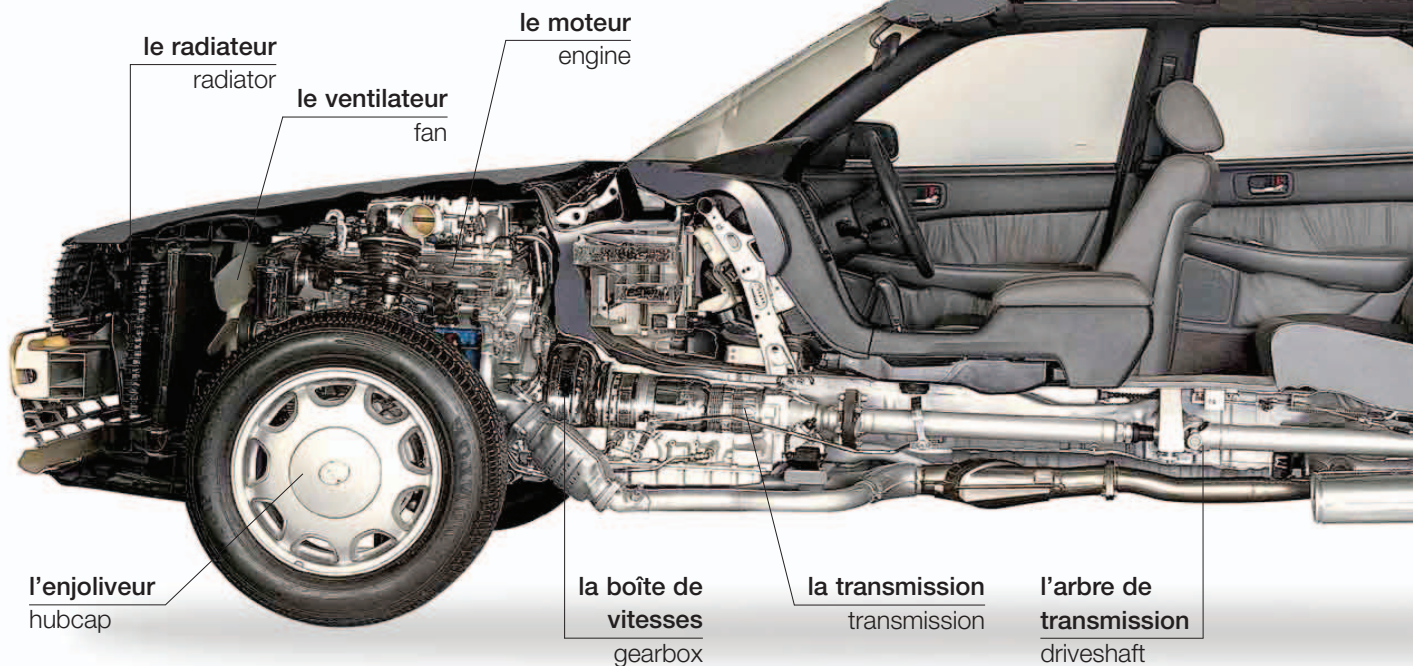

l'enjoliveur
hubcap

la boîte de
vitesses
gearbox

la transmission
transmission

l'arbre de
transmission
driveshaft

la crevaison • flat tire

la roue de secours
spare tire

la manivelle
tire iron

les écrous de roue
wheel nuts

le cric
jack

changer une roue
change a tire (v)

le toit
roof

la suspension
suspension

le silencieux
muffler

le pot d'échappement
exhaust pipe

vocabulaire • vocabulary

l'accident de voiture
car accident

le turbocompresseur
turbocharger

la panne
breakdown

le distributeur
distributor

l'assurance
insurance

le châssis
chassis

la dépanneuse
towtruck

le frein à main
parking brake

le mécanicien
mechanic

l'alternateur
alternator

la pression des
pneus
tire pressure

la courroie de
cames
cam belt

le porte-fusibles
fuse box

Ma voiture est en
panne.
My car has broken
down.

la bougie
sparkplug

la courroie de
ventilateur
fan belt

Ma voiture ne
démarré pas.
My car won't start.

le réservoir
d'essence
gas tank

Faites-vous les
réparations?
Do you do repairs?

le réglage de
l'allumage
timing

Le moteur chauffe
The engine is
overheating

la moto • motorcycle

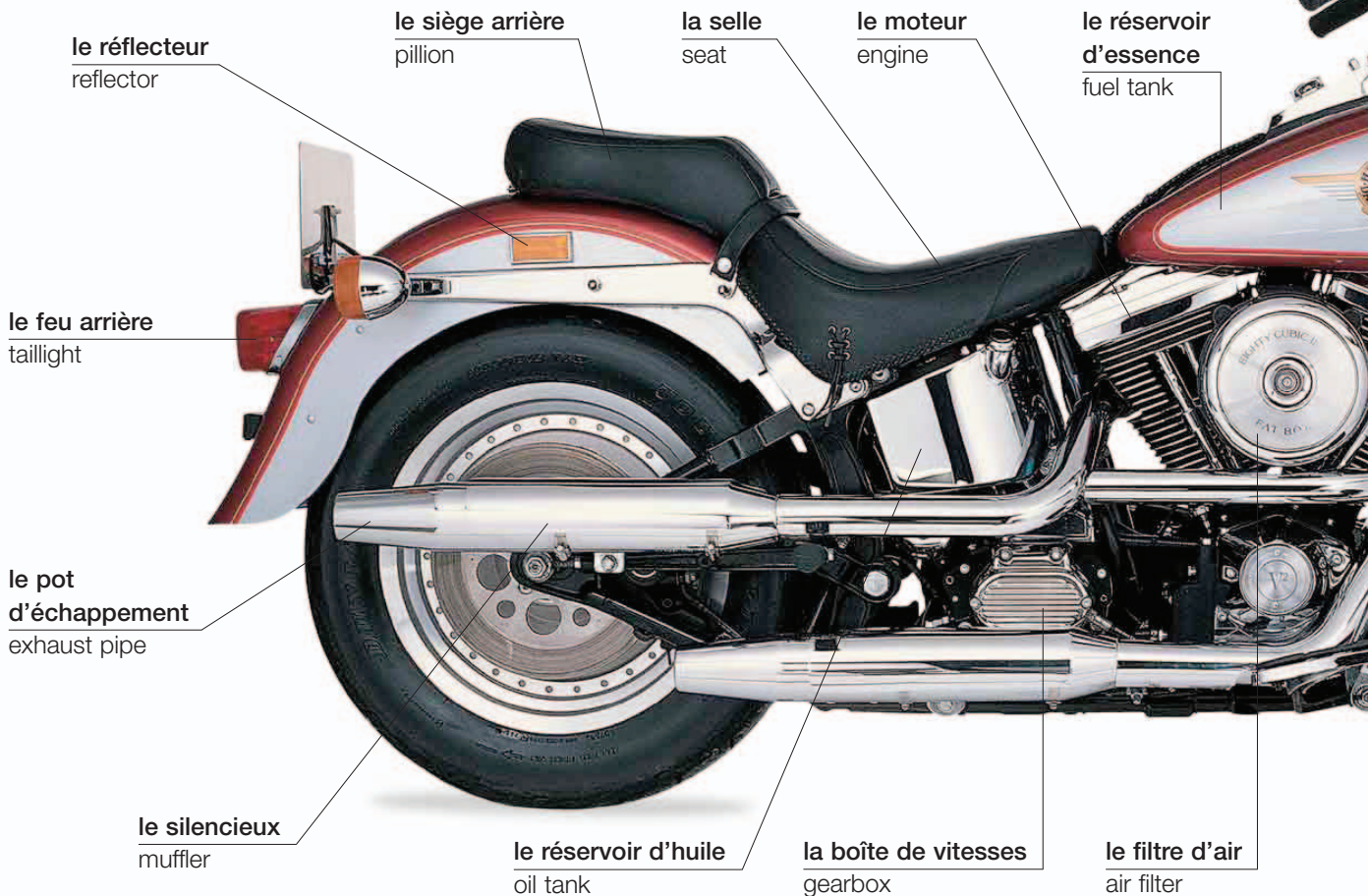
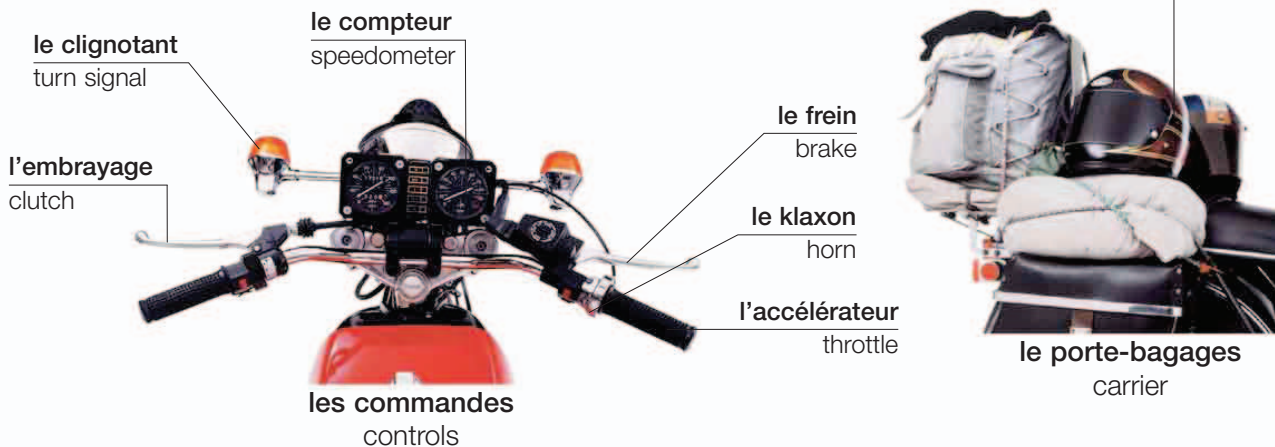



les vêtements | clothing

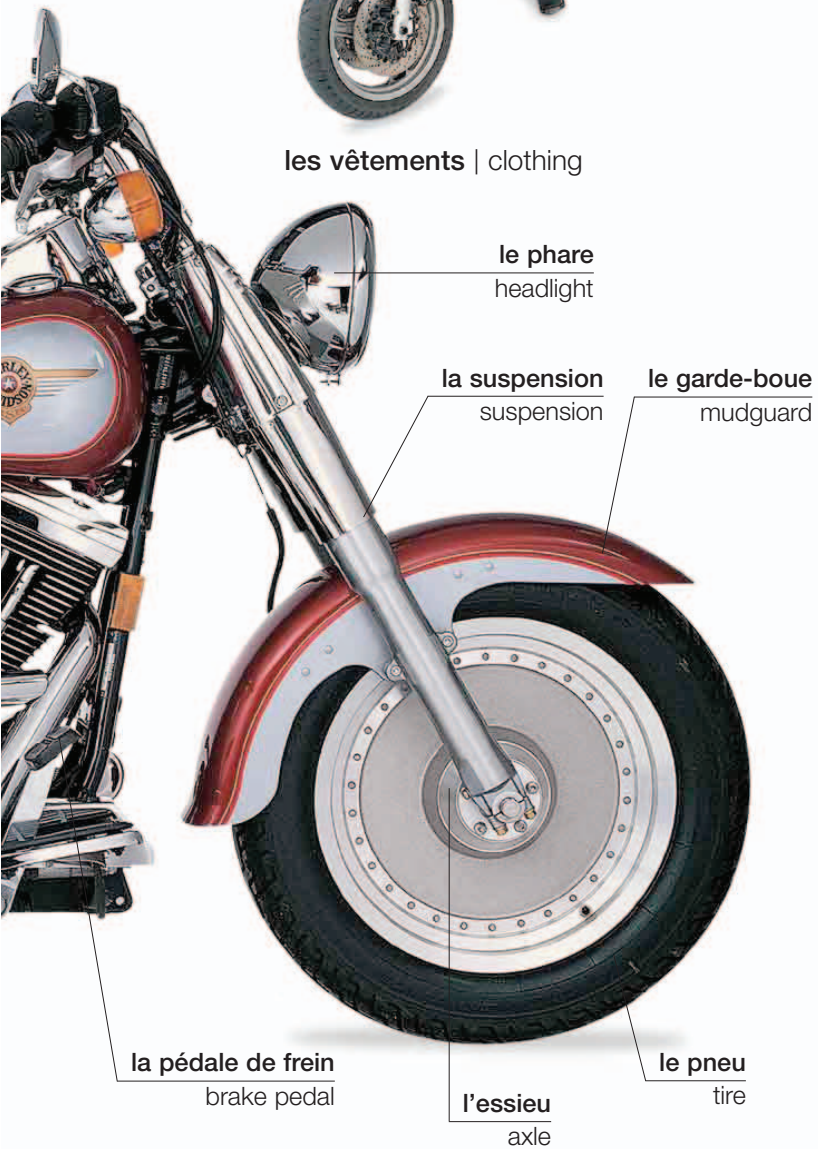

les types • types



la moto de course | racing bike

le pare-brise
windshield



la moto routière | tourer



la moto tout-terrain | dirt bike

la béquille
stand



le scooter | scooter

la bicyclette • bicycle



le tandem
tandem



le vélo de course
racing bike



le vélo tout-terrain
mountain bike



le vélo de randonnée
touring bike



le vélo de ville
road bike

la selle
saddle

le tube porte-selle
seat post

la bouteille d'eau
water bottle

le cadre
frame

le frein
brake

le moyeu
hub

les vitesses
gears

la jante
rim

le pneu
tire

la chaîne
chain

la pédale
pedal

la roue dentée
cog



la piste cyclable | bike lane



vocabulaire • vocabulary

le phare headlight	la béquille kickstand	le patin de frein brake block	le panier basket	le cale-pied toe clip	freiner brake (v)
le feu arrière rear light	la galerie à vélo bike rack	le câble cable	la dynamo dynamo	la lanière toe strap	faire du vélo cycle (v)
le catapote reflector	les roues d'entraînement training wheels	le pignon sprocket	la crevaison flat tire	pédaler pedal (v)	changer de vitesse change gears (v)

le train • train

la voiture
car

le quai
platform

le caddie
cart



le numéro de
voie
platform number

le voyageur
commuter

la gare | train station

les types de trains • types of train



le train à vapeur
steam train

la locomotive
engine



le train diesel | diesel train

la cabine du
conducteur
engineer's
cab

le rail
rail



le train électrique
electric train



le train à grande vitesse
high-speed train



le monorail
monorail



le métro
subway



le tram
tram



le train de marchandises
freight train



le compartiment
compartment

le porte-bagages
luggage rack

la fenêtre
window

la voie ferrée
track

la porte
door

le siège
seat



le portillon
ticket gate

le haut-parleur
public address system

l'horaire
schedule



le billet
ticket



la voiture-restaurant | dining car



le hall de gare | concourse



le compartiment-couchettes
sleeping compartment

vocabulaire • vocabulary

le réseau ferroviaire
rail network

le plan de métro
subway map

le guichet
ticket office

le rail conducteur
live rail

le rapide
express train

le retard
delay

le contrôleur
ticket inspector

le signal
signal

l'heure de pointe
rush hour

le prix
fare

changer
change trains (v)

la manette de secours
emergency lever

l'avion • aircraft

l'avion de ligne • airliner



la cabine • cabin





la montgolfière
hot-air balloon



l'U.L.M.
ultralight



le planeur
glider



le biplan
biplane

l'hélice
propeller



l'avion léger
light aircraft



l'hydravion
sea plane



le jet privé
private jet

le missile
missile



le chasseur
fighter plane

la pale de rotor
rotor blade



l'hélicoptère
helicopter



le bombardier
bomber

vocabulaire • vocabulary

le pilote
pilot

décoller
take off (v)

atterrir
land (v)

la classe économique
economy class

les bagages à main
carry-on luggage

le copilote
co-pilot

voler
fly (v)

l'altitude
altitude

la classe affaires
business class

la ceinture de sécurité
seat belt

l'aéroport • airport



l'aire de stationnement
apron

le porte-bagages
baggage trailer

le terminal
terminal

le véhicule de service
service vehicle

la passerelle
walkway

l'avion de ligne | airliner

vocabulaire • vocabulary

la piste
runway

le numéro de vol
flight number

le tapis roulant
carousel

les vacances
vacation

le vol international
international flight

l'immigration
immigration

la sécurité
security

enregistrer
check in (v)

le vol domestique
domestic flight

la douane
customs

la machine de rayons x
X-ray machine

la tour de contrôle
control tower

la correspondance
connection

l'excédent de bagages
excess baggage

la brochure de vacances
travel brochure

faire une réservation de vol
make a flight reservation (v)

les bagages à main
carry-on
luggage

les bagages
luggage

le chariot
cart



l'enregistrement des bagages
check-in desk



le visa
visa

le passeport | passport



le contrôle de passeports
passport control

la carte d'embarquement
boarding pass



le billet
ticket

le numéro de la porte d'embarquement
gate number



la salle de départ
departure lounge

les départs
departures



l'écran d'information
information screen

la destination
destination

les arrivées
arrivals



la boutique hors taxes
duty-free shop



le retrait des bagages
baggage claim



la station de taxis
taxi stand



la location de voitures
car rental

le navire • ship

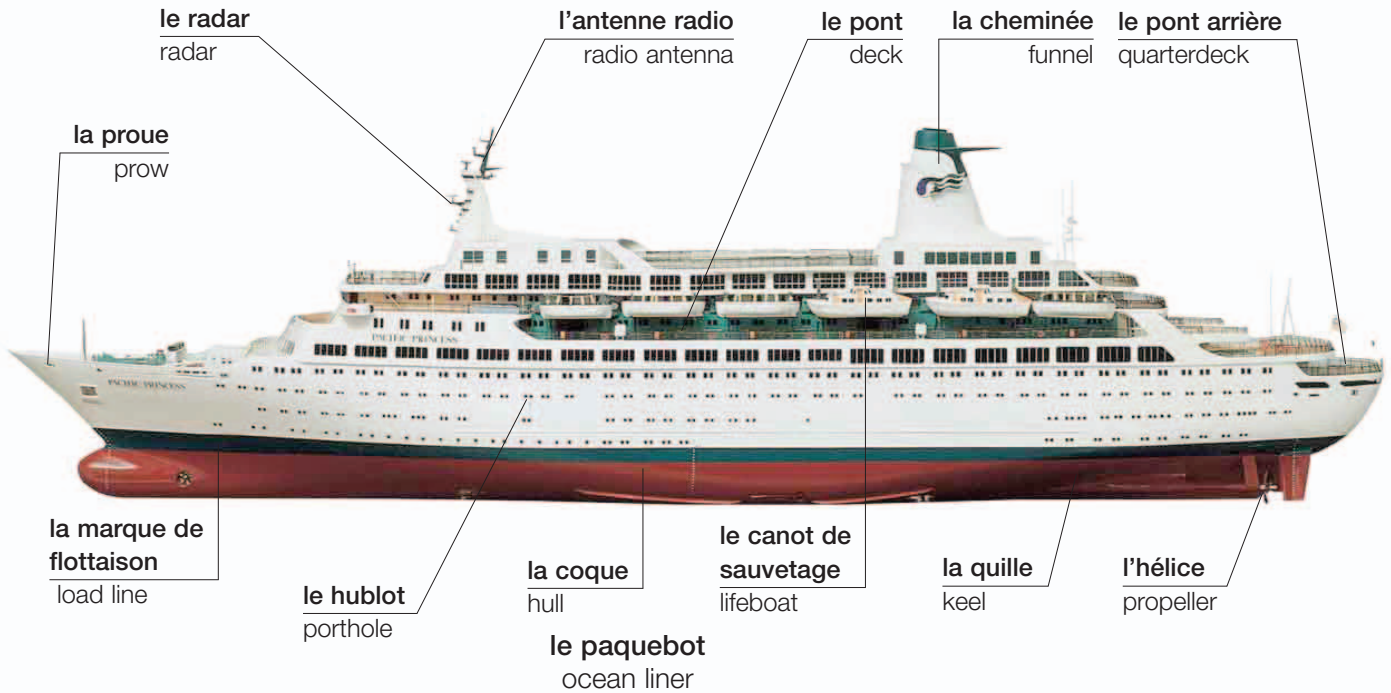

la passerelle de commandement
bridge



la salle des moteurs
engine room



la cabine
cabin



la cuisine
galley

vocabulaire • vocabulary

le dock
dock

le port
port

la passerelle
gangway

l'ancre
anchor

le bollard
bollard

le guindeau
windlass

le capitaine
captain

le runabout
speedboat

la barque
rowboat

le canoë
canoe

autres bateaux • other ships



le ferry
ferry

le hors-bord
outboard motor



le canot pneumatique
inflatable dinghy



l'hydroptère
hydrofoil



le yacht
yacht



le catamaran
catamaran



le remorqueur
tugboat



l'aéroglysieur
hovercraft



le navire porte-conteneurs
container ship

le gréement
rigging



le voilier
sailboat

la cale
hold



le cargo
freighter



le pétrolier
oil tanker



le porte-avions
aircraft carrier



le navire de guerre
battleship

le kiosque
conning tower



le sous-marin
submarine

le port • port

l'entrepôt
warehouse

la grue
crane

le chariot élévateur
forklift truck

la route d'accès
access road

le bureau des douanes
customs house



le dock
dock

le conteneur
container

le quai
quay

la cargaison
cargo



le port de conteneurs | container port

le terminal de ferrys
ferry terminal

le ferry
ferry

le guichet
ticket office

le passager
passenger

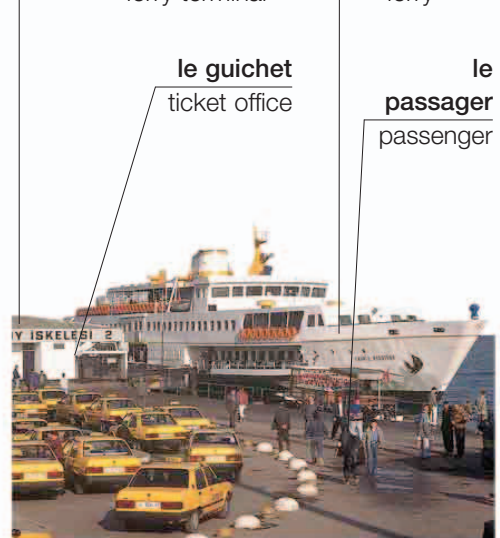

le port de passagers | passenger port

le filet
net

le bateau de pêche
fishing boat

les amarres
mooring



la marina
marina



le port
harbor

le port de pêche
fishing port



l'embarcadère
pier



la jetée
jetty



le chantier naval
shipyard



le phare
lighthouse

le feu
lamp



la bouée
buoy

vocabulaire • vocabulary

le garde-côte
coastguard

la cale sèche
dry dock

embarquer
board (v)

le capitaine de port
harbor master

mouiller
moor (v)

débarquer
disembark (v)

jeter l'ancre
drop anchor (v)

se mettre à quai
dock (v)

prendre la mer
set sail (v)



PRESSION

ULTRA
3

DUNLOP
DDH III
4

TOP-FLITE

DUNLOP

TOUR
EDITION
1

ProStaff
4

SAVING SPRINGS
GOLF CLUB

TOP-FLITE
HOT XL
4

ProStaff
4

RAM TOUR
1

MAXFLI
1

DISTANCE

TOP-FLITE
STRATA
3

ProStaff



les sports
sports

le football américain • football

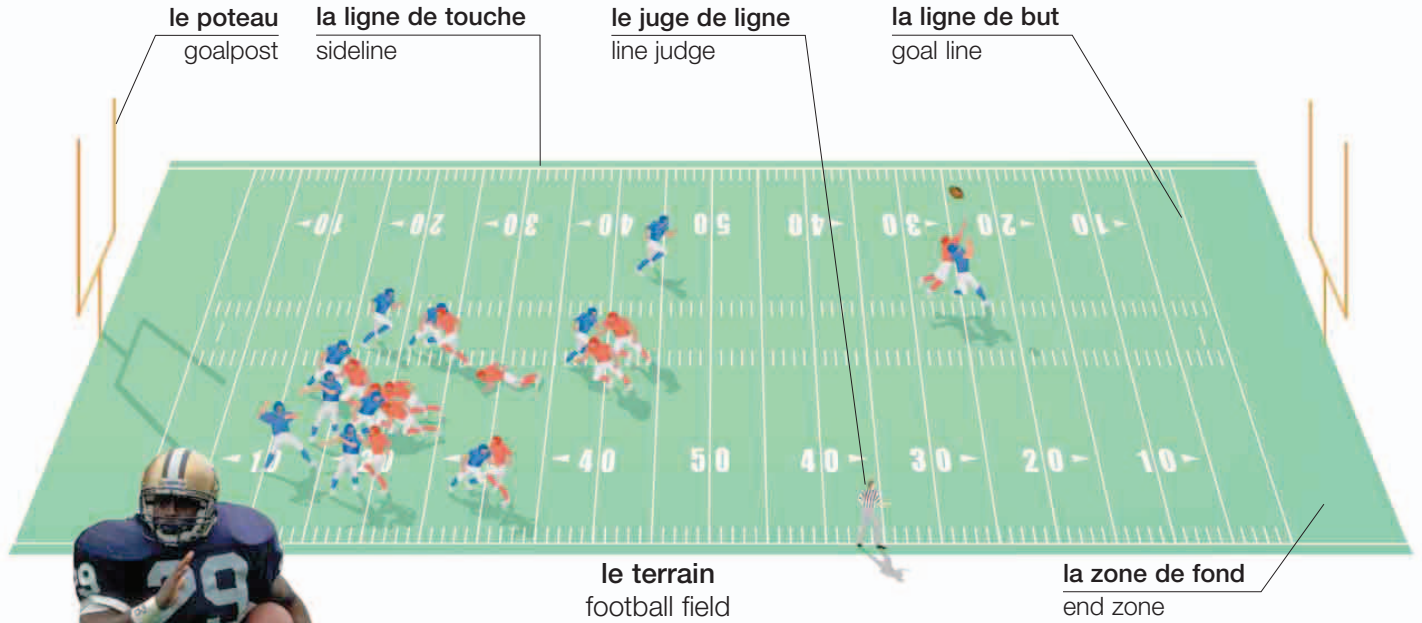

le poteau
goalpost

la ligne de touche
sideline

le juge de ligne
line judge

la ligne de but
goal line

le terrain
football field

la zone de fond
end zone

le ballon
football

les protections
pads

le casque
helmet

la chaussure
shoe



le joueur de football
football player

tacler
tackle (v)

faire une passe
pass (v)

attraper
catch (v)

vocabulaire • vocabulary

le temps mort
time out

l'équipe
team

la défense
defense

la majorette
cheerleader

Où en est le match?
What is the score?

la prise de ballon maladroite
fumble

l'attaque
attack

le score
score

le but
touchdown

Qui est-ce qui gagne?
Who is winning?

le rugby • rugby

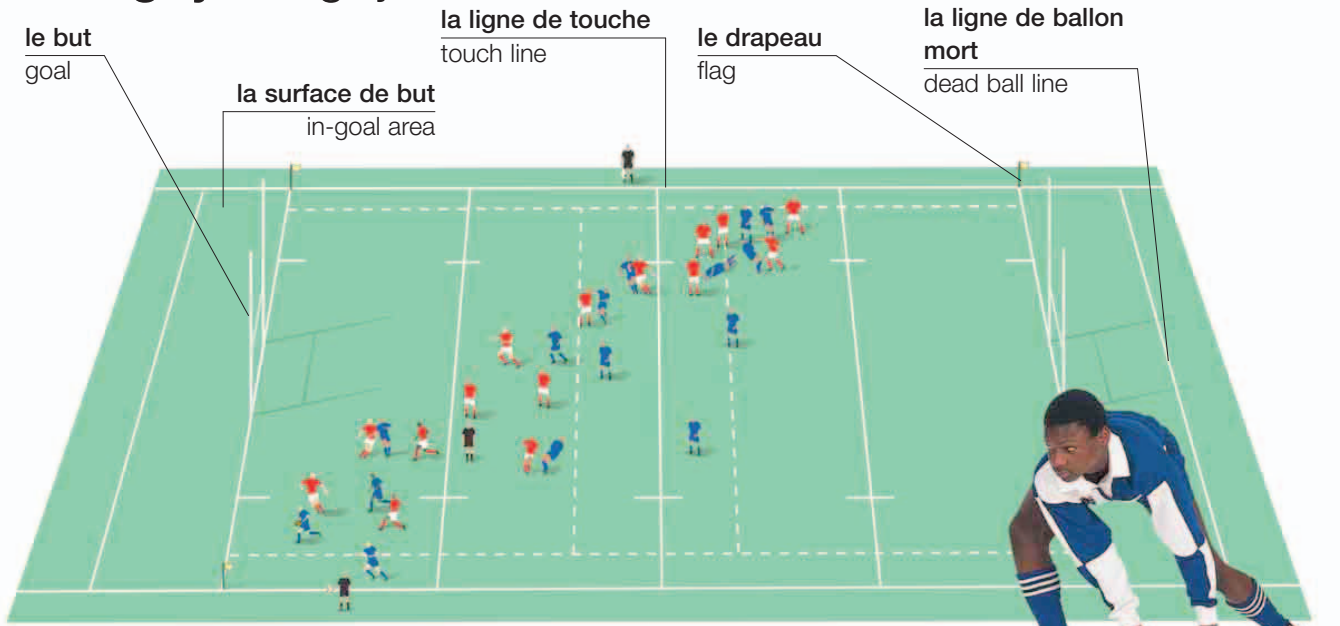

le terrain de rugby | rugby field

le ballon
ball



botter
kick (v)

le maillot de
rugby
rugby uniform



faire une passe
pass (v)



tacler
tackle (v)

lancer
throw (v)



l'essai
try



la mêlée ouverte | ruck

le joueur
player



la mêlée | scrum

le football • soccer



le joueur de foot
soccer player

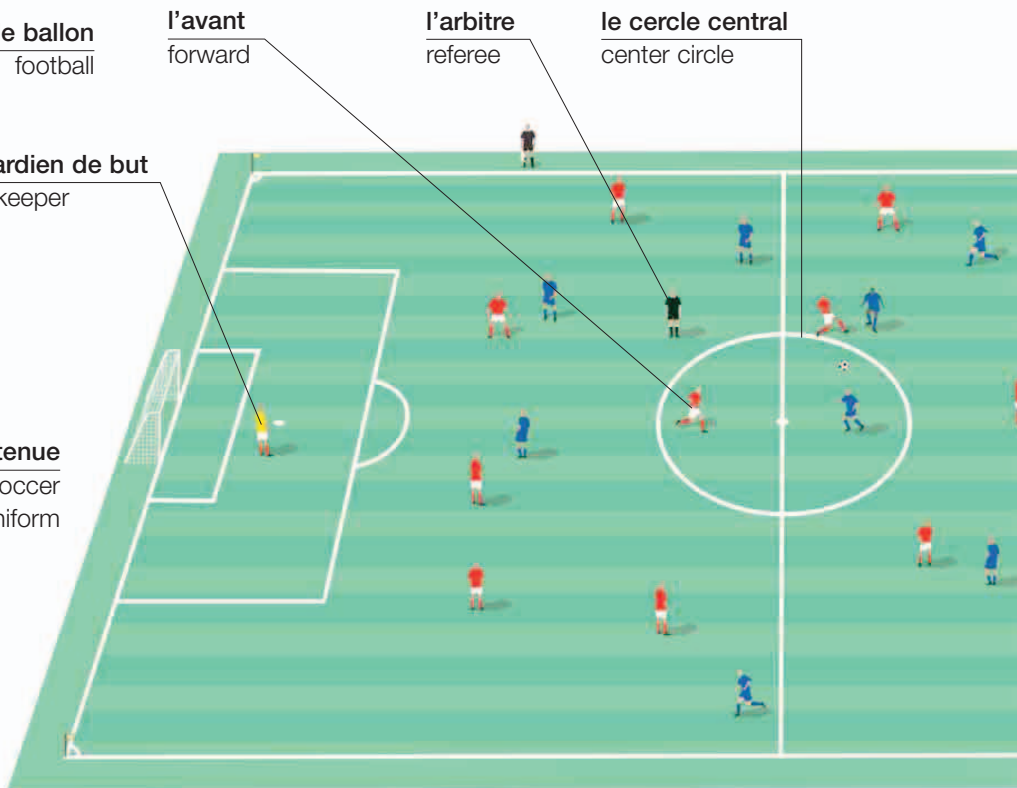

le terrain
football field



le but | goal



dribbler | dribble (v)



faire une tête
head (v)



le coup franc | free kick

le mur
wall

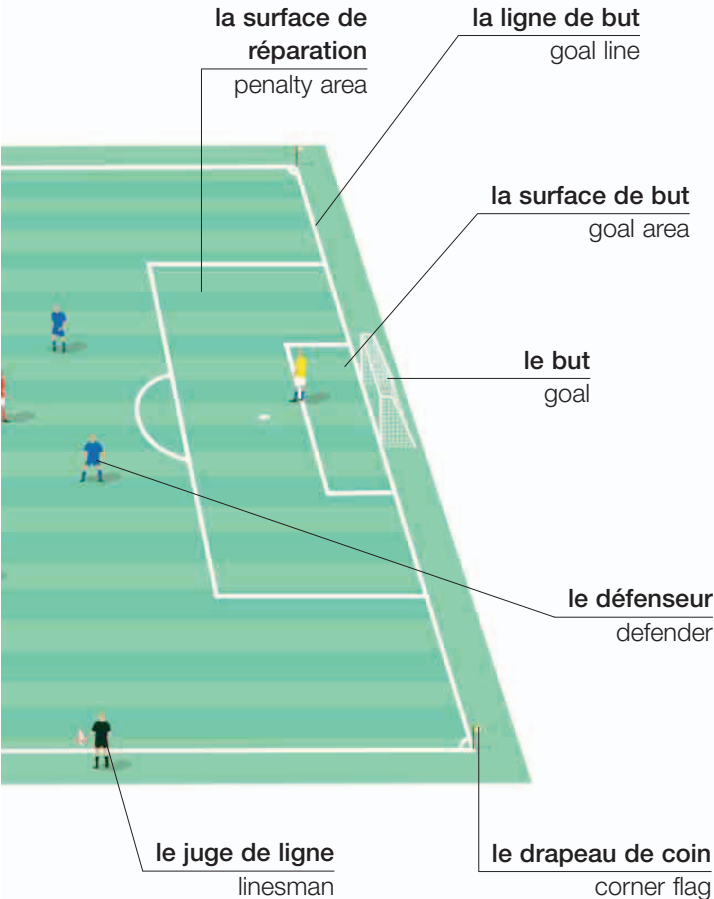

la rentrée en touche
throw-in



botter
kick (v)



faire une passe
pass (v)

la chaussure
shoe



shooter
shoot (v)



sauver
save (v)

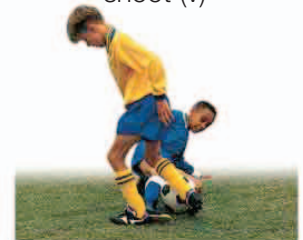

tacler
tackle (v)

vocabulaire • vocabulary

le stade
stadium

la faute
foul

le carton jaune
yellow card

le championnat
league

la prolongation
extra time

marquer un but
score a goal (v)

le corner
corner

l'hors-jeu
off-side

l'égalité
draw

le remplaçant
substitute

le penalty
penalty

le carton rouge
red card

l'expulsion
send off

la mi-temps
half time

le remplacement
substitution

le hockey • hockey

le hockey sur glace • ice hockey



le hockey • field hockey

la crosse de hockey
hockey stick



le palet
puck

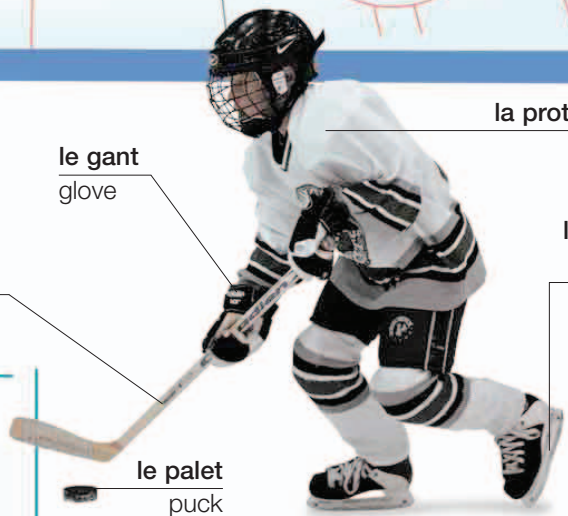

le cricket • cricket

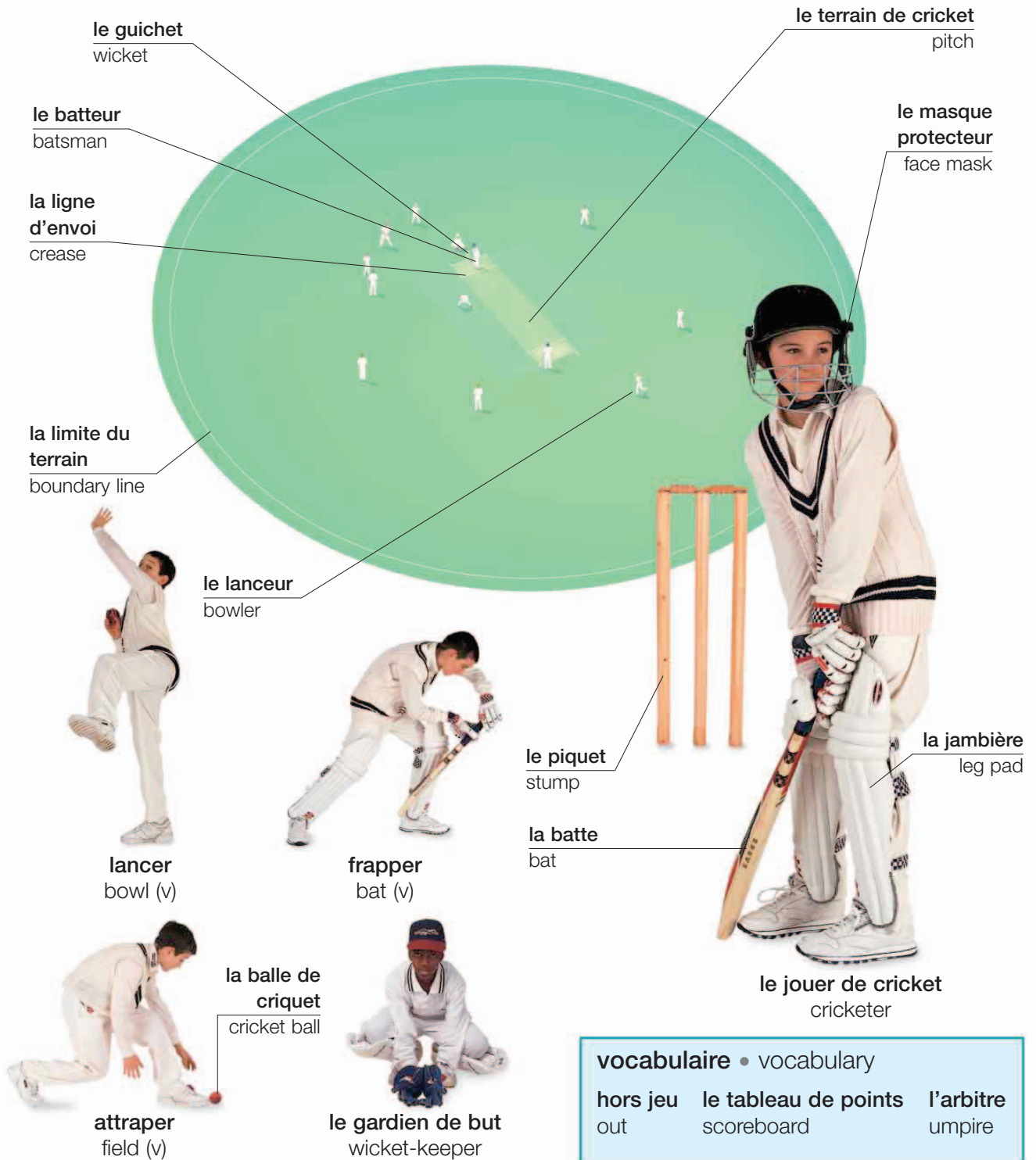

vocabulaire • vocabulary

hors jeu
out

le tableau de points
scoreboard

l'arbitre
umpire

le basket • basketball

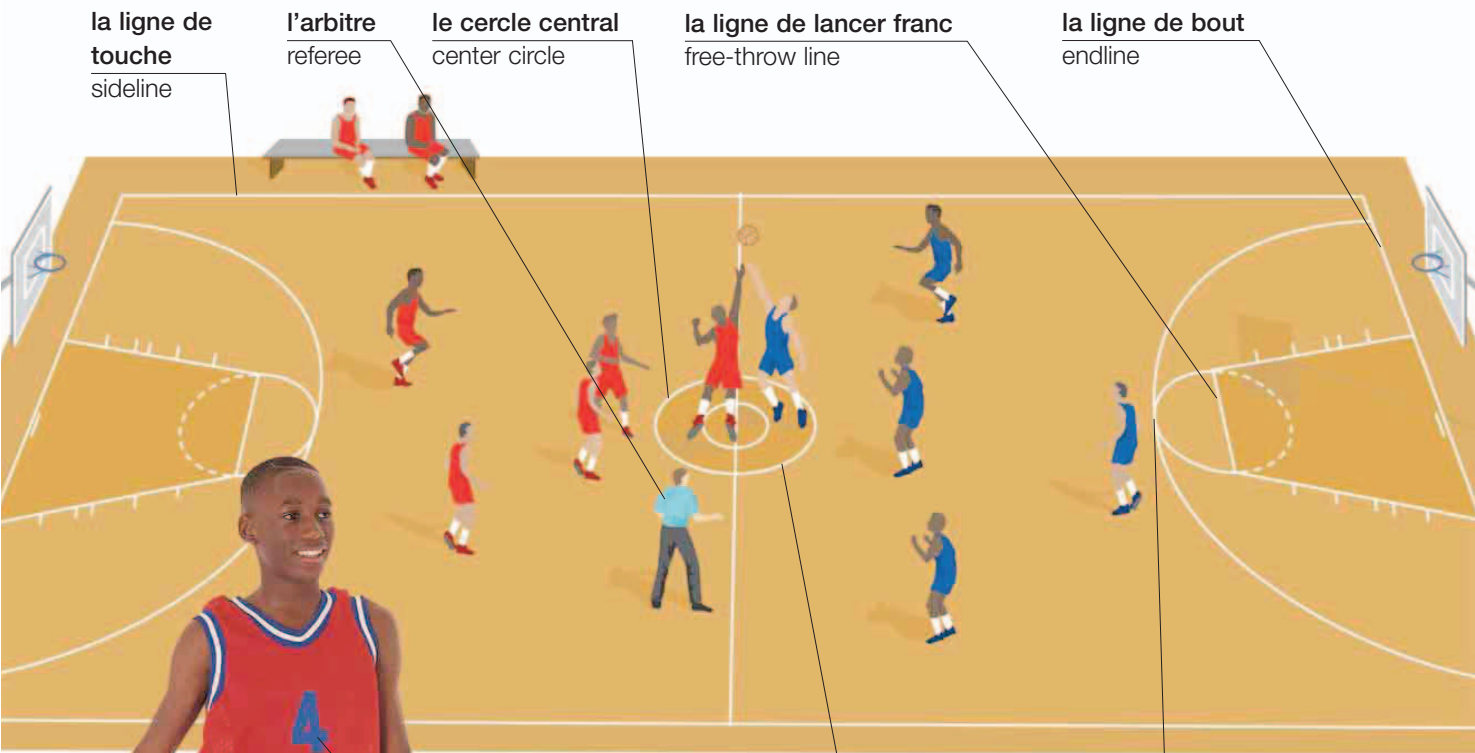

la ligne de touche
sideline

l'arbitre
referee

le cercle central
center circle

la ligne de lancer franc
free-throw line

la ligne de bout
endline

le terrain
court

la ligne de centre
centerline

la ligne de trois points
three-point line

le numéro
number

le panneau
backboard

le ballon
ball

l'anneau
hoop

le filet
net

le panier
basket

le joueur de basket | basketball player

vocabulaire • vocabulary

la passe
pass

la rentrée
throw-in

la faute
foul

l'entre-deux
jump ball

le rebond
rebound

hors jeu
out of bounds

les actions • actions



lancer
throw (v)



attraper
catch (v)



tirer
shoot (v)



sauter
jump (v)



faire un dunk
dunk (v)



marquer
mark (v)



bloquer
block (v)



faire rebondir
dribble (v)



le volley • volleyball

bloquer
block (v)

le filet
net

faire une manchette
dig (v)

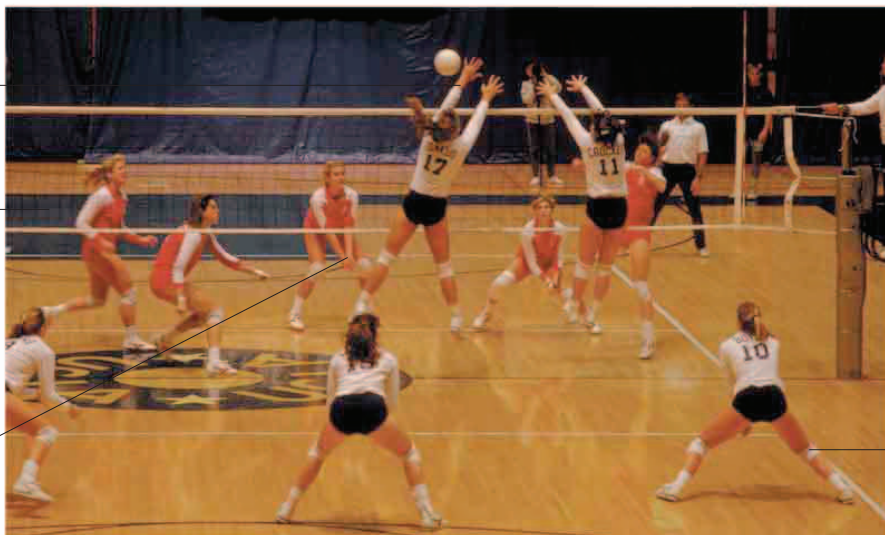

l'arbitre
referee

la genouillère
knee support

le terrain | court

le baseball • baseball

le terrain • field

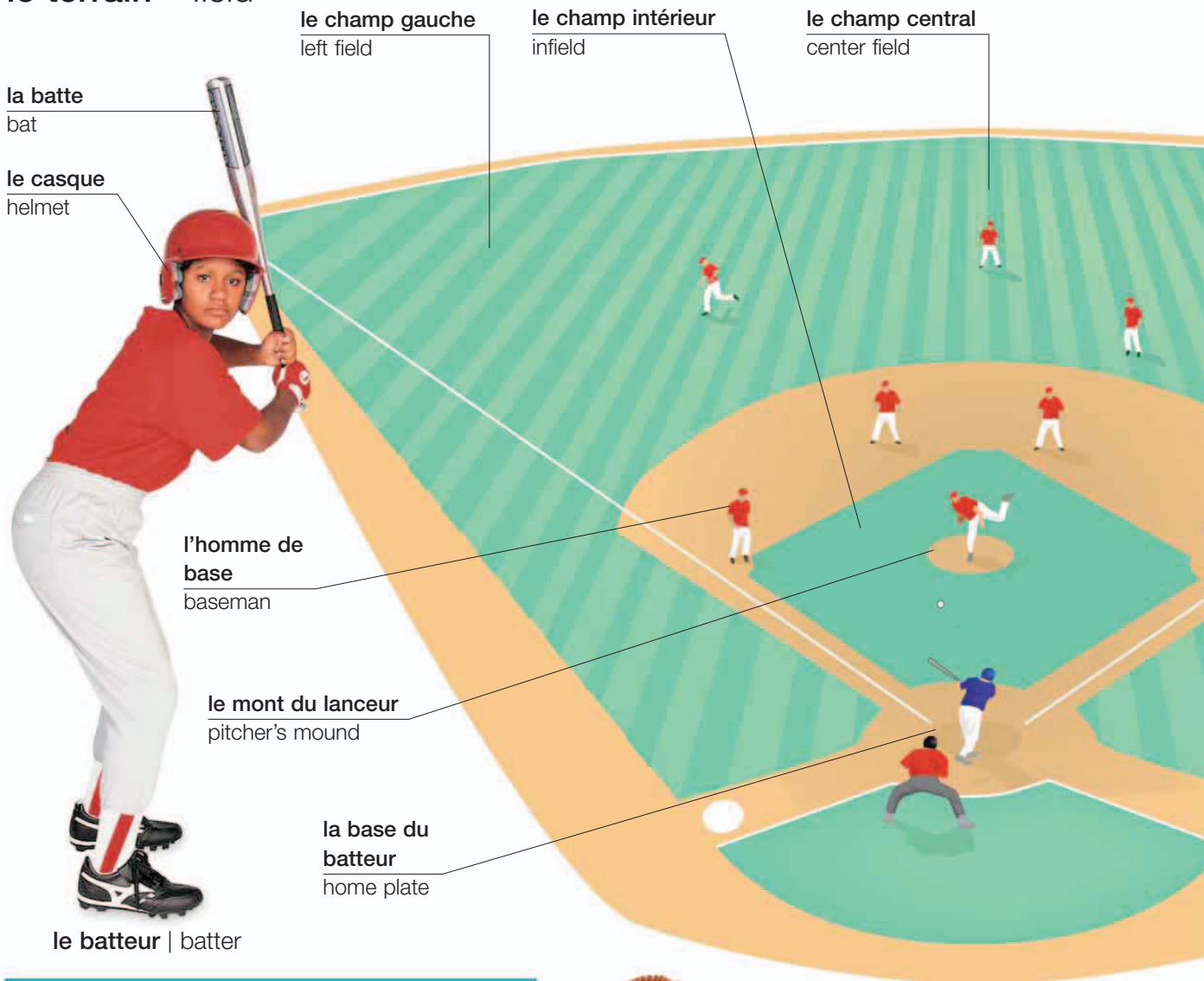

le batteur | batter

vocabulaire • vocabulary

le tour de batte inning	sauf safe	la fausse balle foul ball
le point run	hors jeu out	le coup manqué strike



le gant
mitt

la balle
ball



le masque
mask

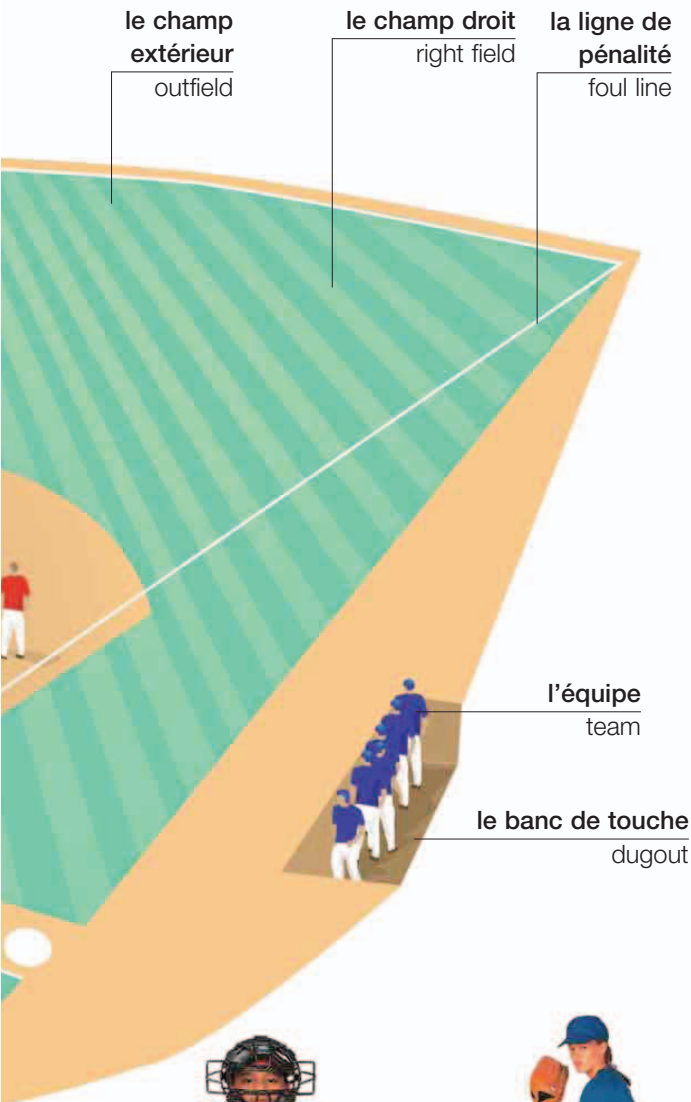

le receveur
catcher



le lanceur
pitcher

les actions • actions



lancer | throw (v)



attraper | catch (v)



courir
run (v)



être en défense
field (v)

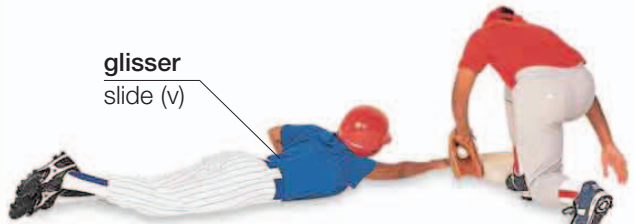

glisser
slide (v)

courser
tag (v)

lancer
pitch (v)

batter
bat (v)

l'arbitre
umpire

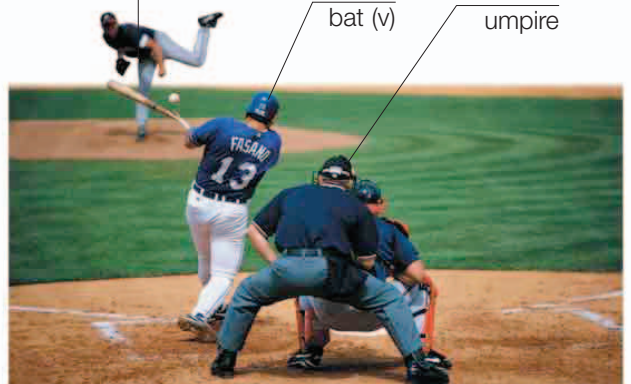

jouer | play (v)

le tennis • tennis

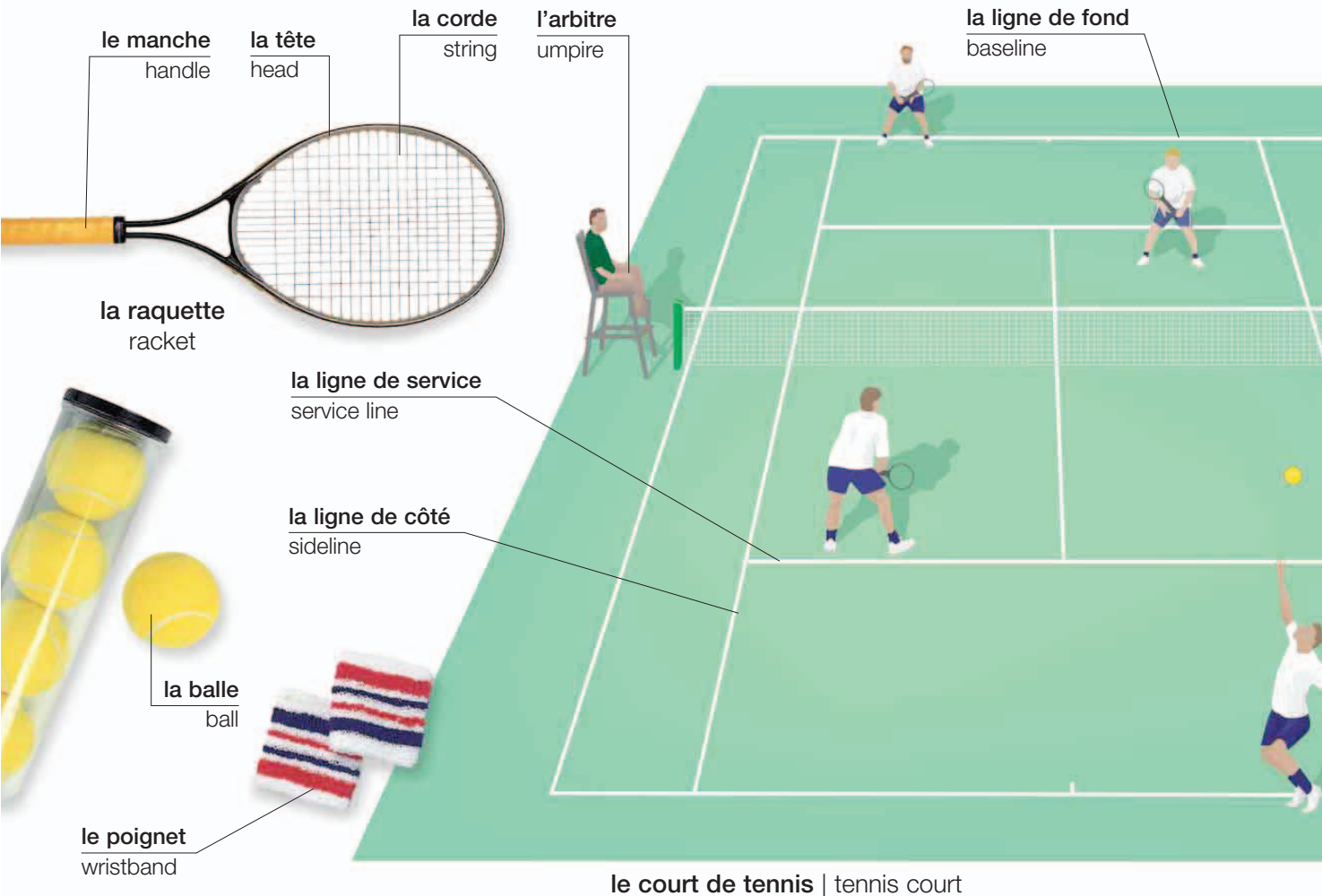

le court de tennis | tennis court

vocabulaire • vocabulary

le simple
singles

le set
set

l'égalité
deuce

la faute
fault

le slice
slice

l'effet
spin

le double
doubles

le match
match

l'avantage
advantage

l'as
ace

l'échange
rally

le juge de ligne
linesman

le jeu
game

le tiebreak
tiebreaker

zéro
love

l'amorti
dropshot

net!
let!

le championnat
championship

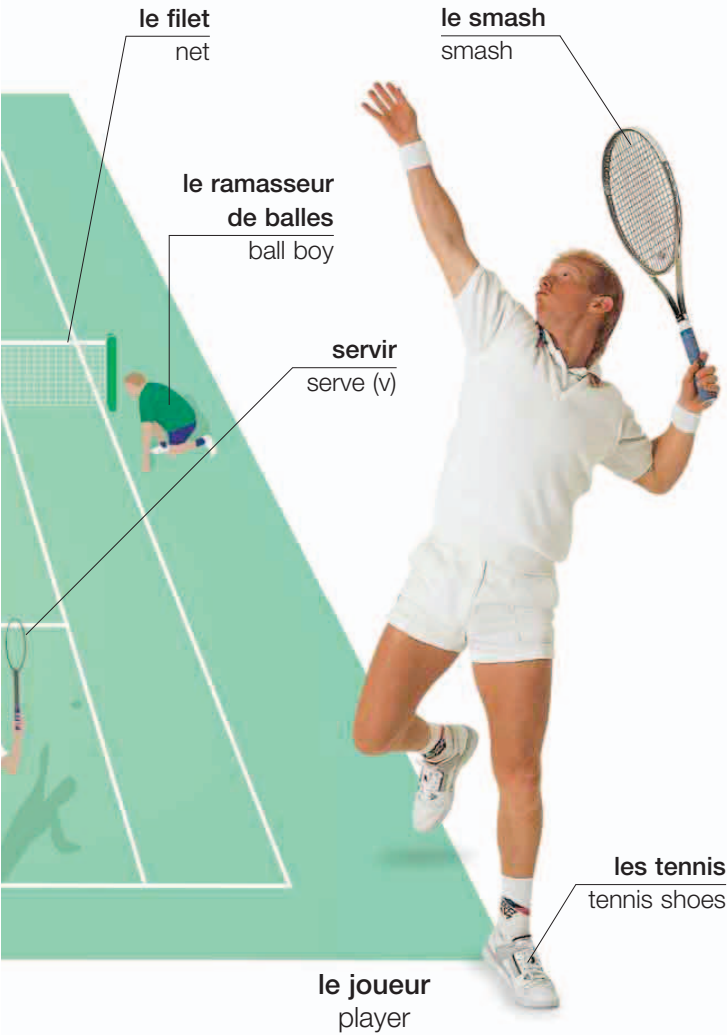

le joueur
player

les coups • strokes



le service
serve



la volée
volley



le retour
return



le lob
lob



le coup droit
forehand



le revers
backhand

les jeux de raquette • racquet games



le badminton
badminton

le volant
shuttlecock



le tennis de table
table tennis

la raquette
paddle



le squash
squash



le racquetball
racquetball

le golf • golf



le trou
hole

le départ
teeing ground

le green
green

le bunker
bunker

le drapeau
flag

exécuter un swing
swing (v)

le fairway
fairway

le rough
rough

l'obstacle d'eau
water hazard

le parcours de golf
golf course

le buggy
golf cart

la position
stance



la joueuse de golf | golfer



le pavillon | clubhouse

l'équipement • equipment



les clubs de golf • golf clubs



le bois
wood



le putter
putter



le fer
iron



la cale
wedge

les actions • actions



partir du tee
tee-off (v)



driver
drive (v)



putter
putt (v)



cocher
chip (v)

vocabulaire • vocabulary

le par
par

le over par
over par

le handicap
handicap

le caddie
caddy

le swing en arrière
backswing

le coup
stroke

le under par
under par

le trou en un
hole in one

le tournoi
tournament

les spectateurs
spectators

le swing d'essai
practice swing

la ligne de
jeu
line of play

l'athlétisme • track and field

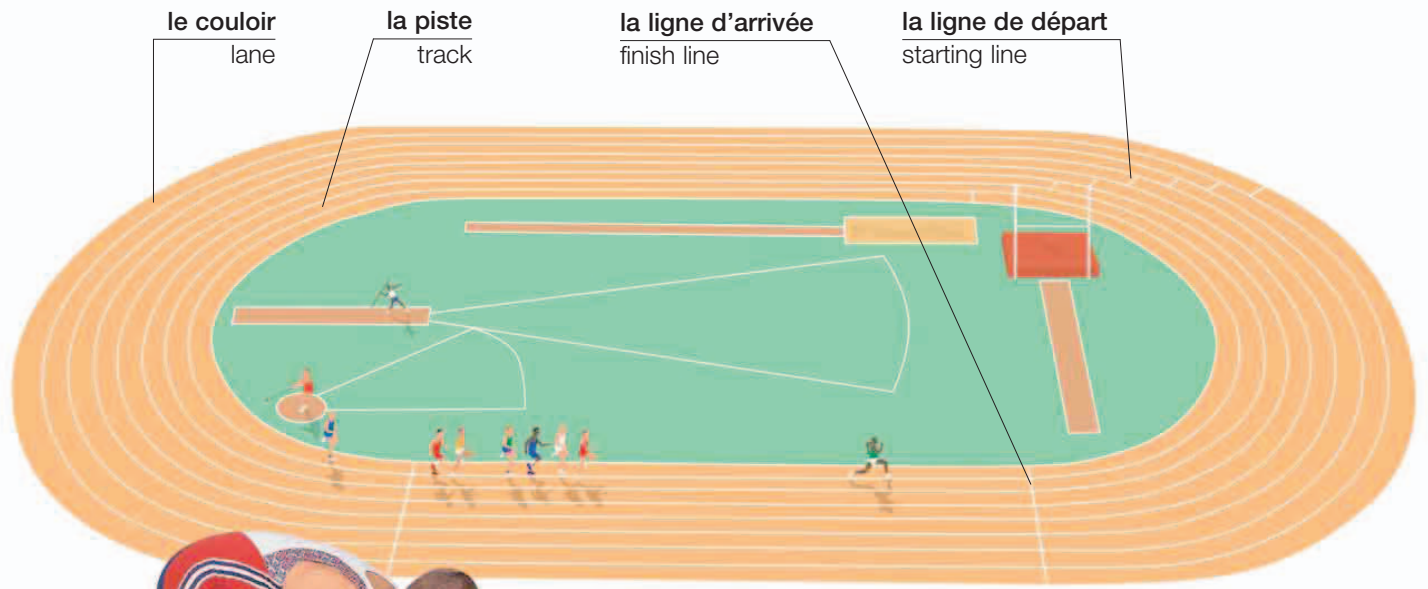

le bloc de départ
starting blocks

le sprinter
sprinter



le disque
discus

le terrain
field

l'athlète
athlete



le lancement du poids
shotput



le javelot
javelin

vocabulaire • vocabulary

la course
race

le record
record

le photo-finish
photo finish

le saut à la perche
pole vault

le temps
time

battre un record
break a record (v)

le marathon
marathon

le record personnel
personal best



le chronomètre
stopwatch

le bâton

baton



le relais
relay race

la barre

crossbar



le saut en hauteur
high jump



le saut en longueur
long jump



les haies
hurdles

la gymnastique • gymnastics



le cheval
horse

le saut
vault

le tremplin
springboard



le salto
somersault

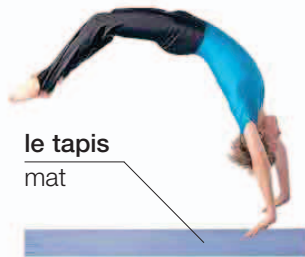

le tapis
mat

les exercices au sol
floor exercises

la gymnaste
gymnast



la poutre
beam

le drapeau
ribbon

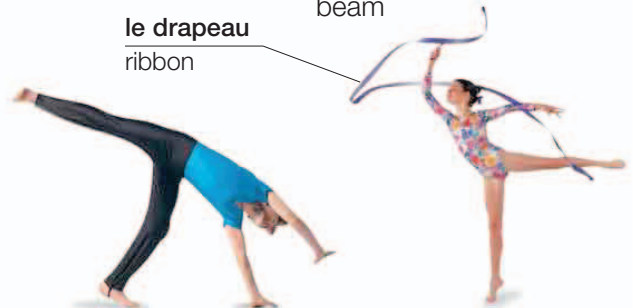

la cabriole
tumble

la gymnastique
rythmique
rhythmic gymnastics

vocabulaire • vocabulary

la barre fixe
horizontal bar

le cheval d'arçons
pommel horse

les anneaux
rings

les médailles
medals

l'argent
silver

les barres
parallèles
parallel bars

les barres
asymétriques
asymmetric bars

le podium
podium

l'or
gold

le bronze
bronze

les sports de combat • combat sports

l'adversaire
opponent

le protège-tête
guard

le gant
glove

la ceinture
belt



le karaté
karate



le judo
judo

le taekwondo
tae kwon do

le masque
mask



l'aïkido
aikido



le sabre
sword

le kendo
kendo



le kung-fu
kung fu



la boxe thaïlandaise
kickboxing

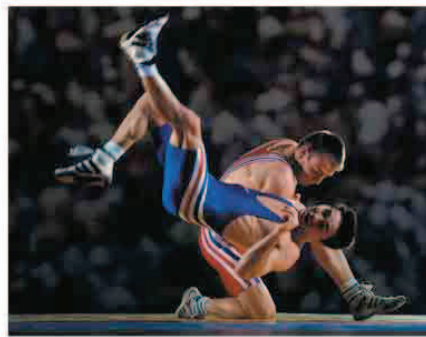

la lutte
wrestling



la boxe
boxing

les actions • actions



la chute
fall



la prise
hold



la projection
throw



l'immobilisation
pin



le coup de pied
kick



le coup de poing
punch



le coup
strike



le coup
chop



le saut
jump



le blocage
block

vocabulaire • vocabulary

le ring
boxing ring

le round
round

le poing
fist

la ceinture noire
black belt

la capoeira
capoeira

les gants de boxe
boxing gloves

le combat
bout

le knock-out
knockout

l'autodéfense
self-defense

le sumo
sumo wrestling

le protège-dents
mouth guard

l'entraînement
sparring

le punching-bag
punching bag

les arts martiaux
martial arts

le tai chi
tai chi

la natation • swimming

l'équipement • equipment



la brassière
armband



les lunettes protectrices
goggles

la pince pour le nez
nose clip



la planche
kickboard



le maillot de bain
swimsuit

le couloir
lane

l'eau
water

le plot de
départ
starting block



la piscine
swimming pool

le bonnet de
natation
cap

le slip de bain
trunks



le nageur | swimmer

le tremplin
springboard

le plongeur
diver



plonger | dive (v)



nager | swim (v)



le tour | turn

les styles • styles



le crawl
front crawl



la brasse
breaststroke



le dos crawlé | backstroke

la nage
stroke

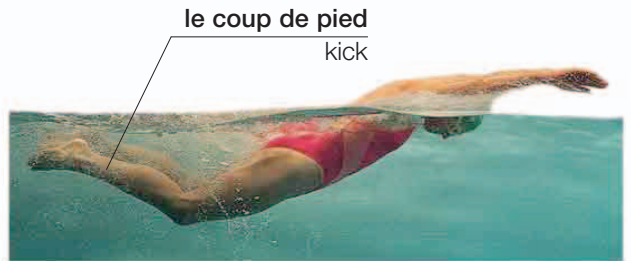

le coup de pied
kick

le papillon | butterfly

la plongée • scuba diving

**la combinaison
de plongée**
wetsuit

la palme
flipper

**la ceinture de
plomb**
weight belt



la bouteille d'air
air cylinder

le masque
mask

le régulateur
regulator

le tuba
snorkel

vocabulaire • vocabulary

le plongeon dive	nager sur place tread water (v)	les casiers lockers	le water-polo water polo	le petit bassin shallow end	la crampe cramp
le plongeon de haut vol high dive	le départ plongé racing dive	le maître nageur lifeguard	le grand bassin deep end	la nage synchronisée synchronized swimming	se noyer drown (v)

la voile • sailing



le compas
compass



l'ancre
anchor

le taquet
cleat



naviguer | navigate (v)

le pont de côté
sidedeck

la voile d'avant
headsail

l'avant
bow

la barre
tiller

la coque
hull

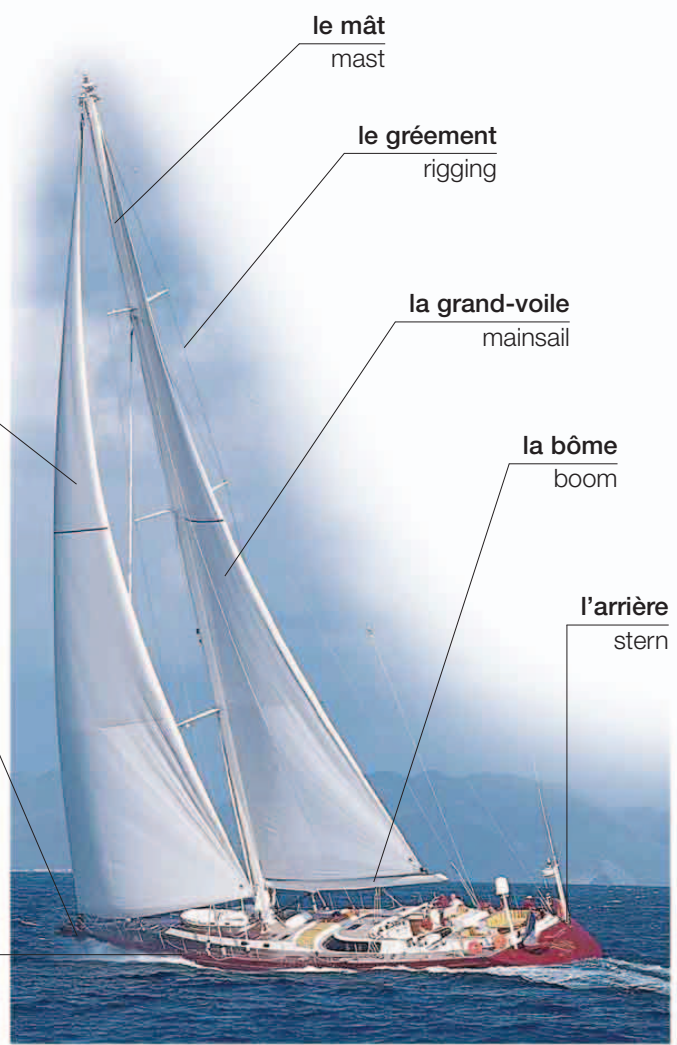

le yacht | yacht

le mât
mast

le gréement
rigging

la grand-voile
mainsail

la bôme
boom

l'arrière
stern

la sécurité • safety



la fusée éclairante
flare



la bouée de sauvetage
life preserver



le gilet de sauvetage
life jacket



le radeau de sauvetage
life raft

les sports aquatiques • watersports



ramer | row (v)



le canoë
canoeing



la planche à voile | windsurfing



le surf
surfing



le ski nautique
waterskiing



le motonautisme
speedboating



le rafting
rafting



le jet-ski
jet-skiing

vocabulaire • vocabulary

le skieur nautique
waterskier

l'équipage
crew

le vent
wind

l'écume
surf

l'écoute
sheet

la dérive
centerboard

le surfeur
surfer

louvoyer
tack (v)

la vague
wave

les rapides
rapids

le gouvernail
rudder

chavirer
capsize (v)

l'équitation • horseback riding



le fer à cheval / horseshoe



la selle de femme / side-saddle

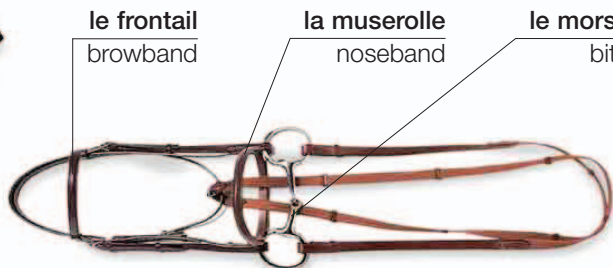

la bride | bridle
la cravache | riding crop

les courses • events

le cheval de course
racehorse



la course de chevaux
horse race

l'obstacle
fence



le steeple
steeplechase



la course de trot
harness race



le rodéo
rodeo



le jumping
showjumping



la course attelée
carriage race



la randonnée
trail-riding



le dressage
dressage



le polo
polo

vocabulaire • vocabulary

le pas
walk

le petit galop
canter

le saut
jump

le licou
halter

l'enclos
paddock

la course de plat
flat race

le trot
trot

le galop
gallop

le valet d'écurie
groom

l'écurie
stable

l'arène
arena

le champs de
courses
racecourse

la pêche • fishing



le plomb | sinker

le barbillon
barb

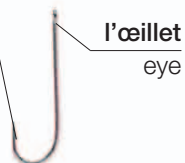

l'œillet
eye



l'amorce | bait



l'épuisette
landing net



le flotteur
float



l'appât
lure



la mouche
fly



la boîte d'équipement
tackle box

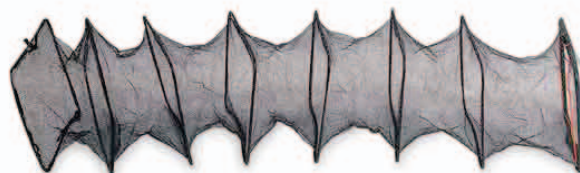

la bourriche
keep net

la canne à pêche
fishing rod

le moulinet
reel

les bottes
de pêche
waders

la ligne
line

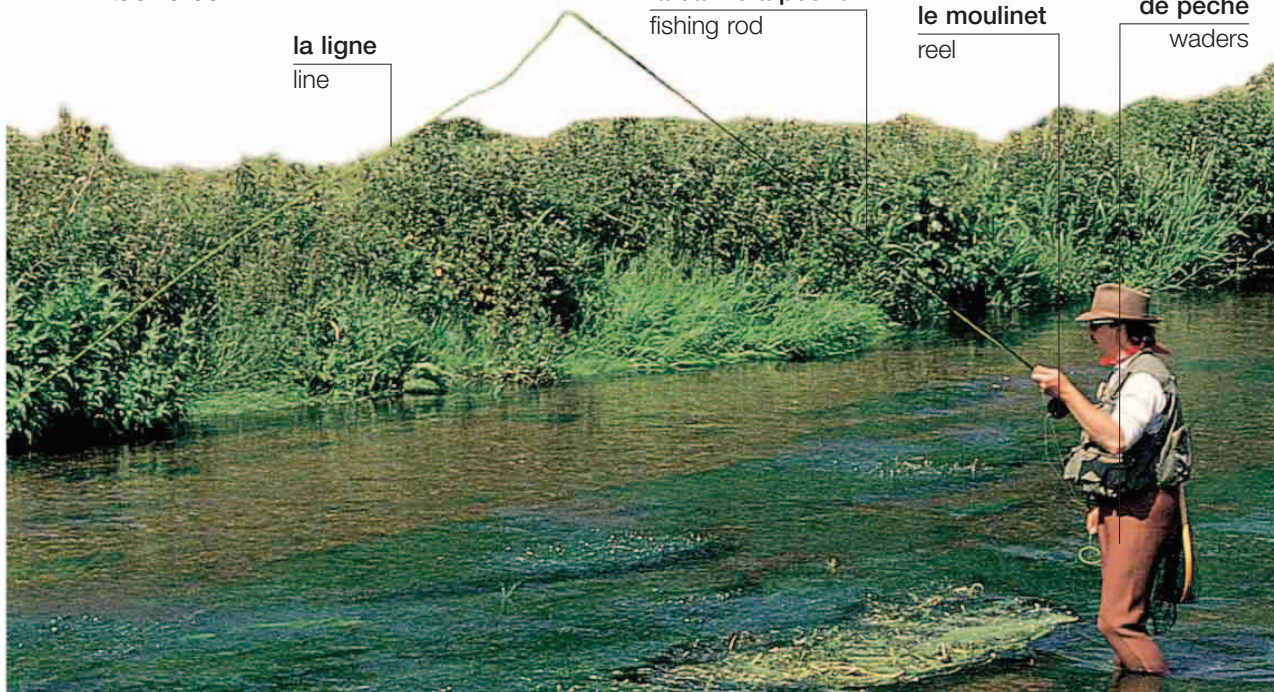

le pêcheur | angler

les genres de pêche • types of fishing



la pêche en eau douce
freshwater fishing



la pêche à la mouche
fly fishing

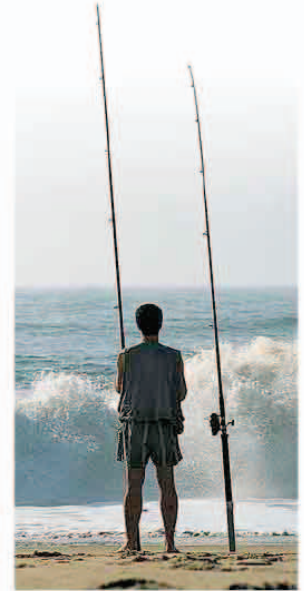

la pêche au lancer
en mer
surfcasting



la pêche sportive
sport fishing



la pêche hauturière
deep sea fishing

les activités • activities

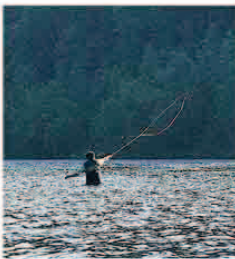

lancer
cast (v)

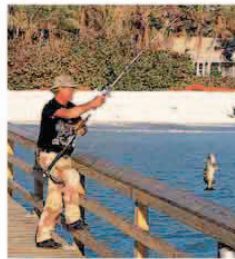

attraper
catch (v)



ramener
reel in (v)



prendre au filet
net (v)



lâcher
release (v)

vocabulaire • vocabulary

amorcer
bait (v)

le matériel de pêche
tackle

l'imperméable
rain gear

le permis de pêche
fishing permit

le panier de pêche
creel

mordre
bite (v)

le tambour
spool

la perche
pole

la pêche maritime
marine fishing

la pêche sous-marine
spearfishing

le ski • skiing

la pente de ski
ski slope

le télésiège
chairlift

la télécabine
cable car

la veste de ski
ski jacket



le bâton de ski
ski pole

le gant
glove

la piste de ski
ski run

la barrière de sécurité
safety barrier

la pointe
tip

la carre
edge

le ski
ski

la veste de ski
ski jacket

la skieuse
skier

la chaussure de ski
ski boot

les épreuves • events



la descente
downhill skiing



la porte
gate

le slalom
slalom



le saut
ski jump



le ski de randonnée
cross-country skiing

les sports d'hiver • winter sports



l'escalade en glace
ice climbing



le patinage
ice-skating



le patinage artistique
figure skating

les lunettes de ski
goggles



le surf des neiges
snowboarding

le patin à glace
skate



le bobsleigh
bobsled



la luge
luge



l'autoneige
snowmobile



la luge
sledding

vocabulaire • vocabulary

le ski alpin
alpine skiing

le traîneau à chiens
dog-sledding

le slalom géant
giant slalom

le patinage de vitesse
speed skating

hors piste
off-piste

le biathlon
biathlon

le curling
curling

l'avalanche
avalanche

les autres sports • other sports

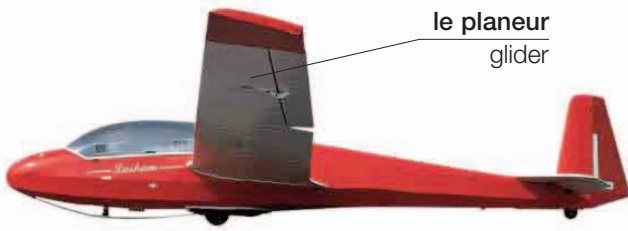

le planeur
glider

le deltaplane
hang-glider



le deltaplane
hang-glider

le vol plané
gliding

le parachute
parachute



la corde
rope

l'escalade
rock-climbing



le parachutisme
parachuting

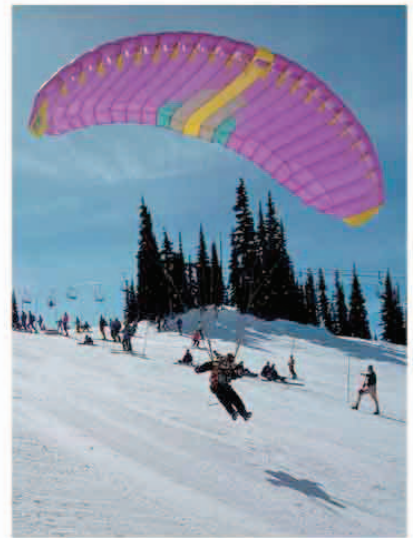

le parapente
paragliding



le saut en chute libre
skydiving



le rappel
rappelling



le saut à l'élastique
bungee jumping



le rallye
rally driving



la course automobile
auto racing

le coureur automobile
race-car driver



le motocross
motocross



la course de moto
motorcycle racing



la planche à roulettes
skateboarding

la planche à roulettes
skateboard



le patin en ligne
inline skating

la crosse
stick



le lacrosse
lacrosse

le masque
mask



l'escrime
fencing

le fleuret
foil

la quille
pin

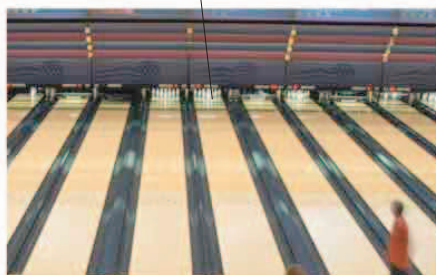

le bowling
bowling

la flèche
arrow

le carquois
quiver



le tir à l'arcx
archery

la cible
target



le tir à cible
target shooting

la boule de bowling
bowling ball



le billard américain
pool



le billard
snooker

le conditionnement physique • fitness

le vélo
d'entraînement
exercise bike

l'appareil de gym
gym machine

le banc
bench

les poids
free weights

la barre
bar



la machine
à ramer
rowing machine

le gymnase
gym



le tapis roulant
treadmill



la machine de
randonnée
cross-trainer



l'entraîneuse
individuelle
personal trainer



l'escalier
d'entraînement
step machine

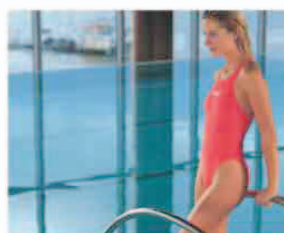

la piscine
swimming pool



le sauna
sauna

les exercices • exercises



l'étirement
stretch



la fente en avant
lunge

le collant
tights



la traction
push-up



la flexion de jambes
squat



le redressement assis
sit-up



l'exercice pour les biceps
biceps curl

l'haltère
dumbbell



la traction pour les jambes
leg press



la barre à poids
weight bar



l'exercice pour la poitrine
chest press

les baskets
athletic shoes

l'entraînement poids et haltères
weight training



le jogging
jogging



le Pilates
Pilates

vocabulaire • vocabulary

s'entraîner
train (v)

jogger sur place
jog in place (v)

étendre
extend (v)

l'aérobixe
boxercise

l'entraînement en circuit
circuit training

s'échauffer
warm up (v)

fléchir
flex (v)

tirer
pull up (v)

le saut à la corde
rope-jumping



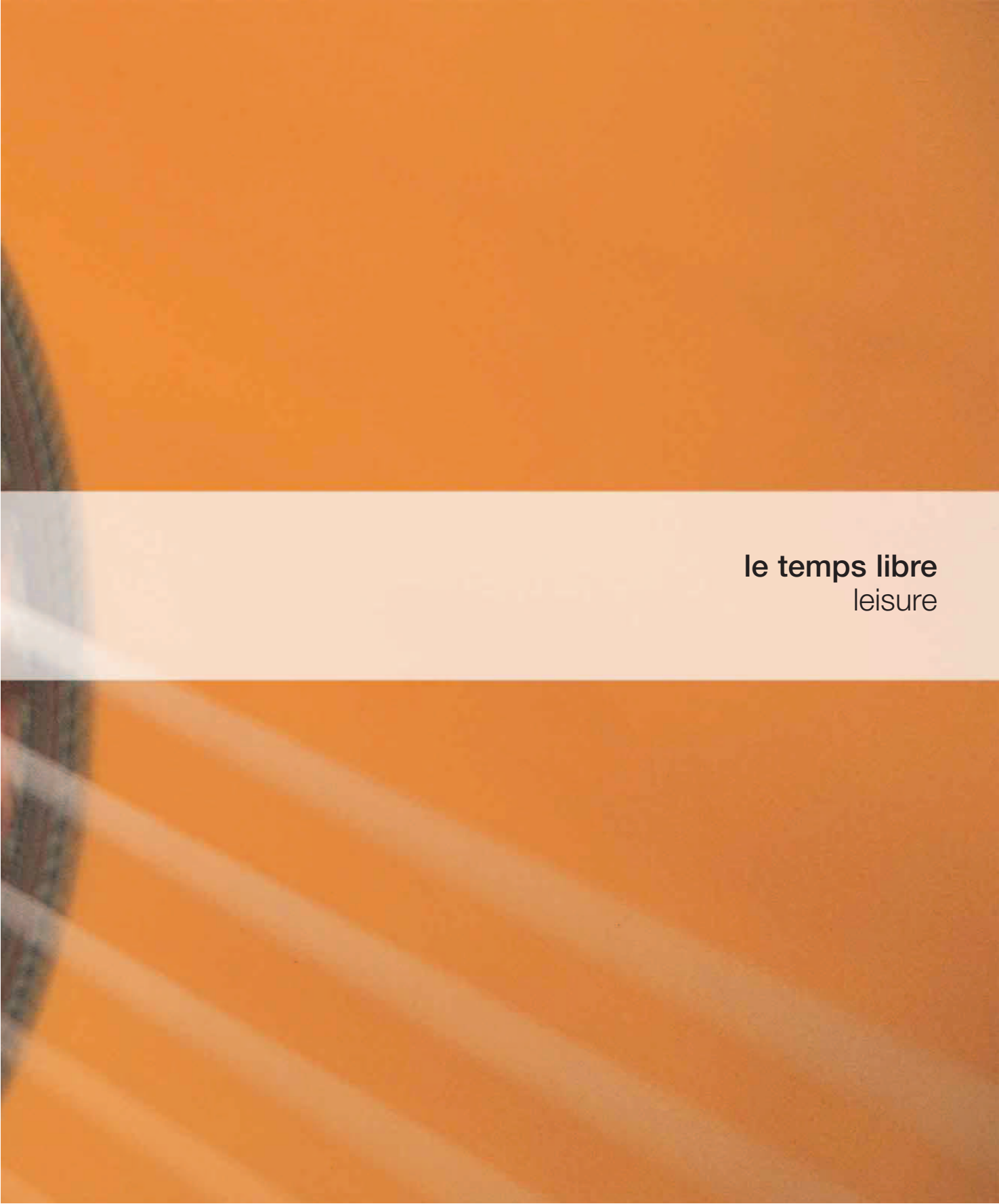

le temps libre
leisure

le théâtre • theater



le rideau
curtain

les coulisses
wings

le décor
set

le public
audience

l'orchestre
orchestra

la scène | stage

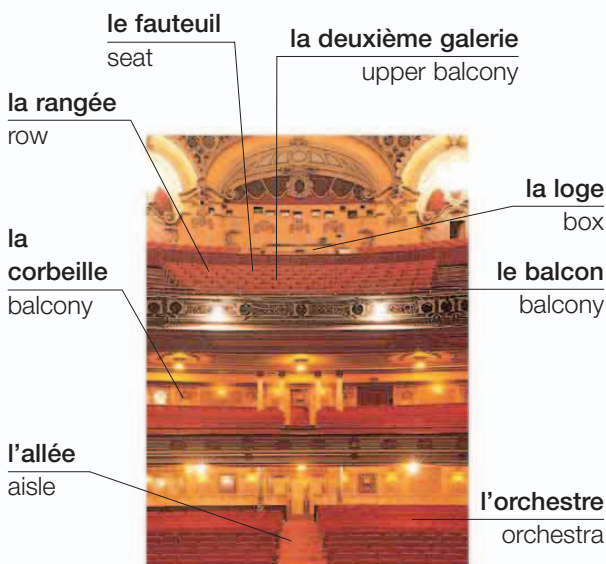

le fauteuil
seat

la deuxième galerie
upper balcony

la rangée
row

la corbeille
balcony

l'allée
aisle

la loge
box

le balcon
balcony

l'orchestre
orchestra

les places | seating

vocabulaire • vocabulary

la distribution
cast

le texte
script

la première
opening night

l'acteur
actor

la toile de fond
backdrop

l'entracte
intermission

l'actrice
actress

le metteur en
scène
director

le programme
program

la pièce de
théâtre
play

le metteur en
scène
producer

la fosse
d'orchestre
orchestra pit



le concert
concert



la comédie musicale
musical

le costume
costume



le ballet
ballet



l'opéra
opera

vocabulaire • vocabulary

le placeur
usher

la bande sonore
soundtrack

Ça commence à quelle heure?
What time does it start?

la musique classique
classical music

applaudir
applaud (v)

Je voudrais deux billets pour la représentation de ce soir.
I'd like two tickets for tonight's performance.

la partition
musical score

le bis
encore

le cinéma • cinema

le pop-corn
popcorn



le foyer
lobby

la caisse
box office

l'affiche
poster



la salle de cinéma
movie theater



l'écran
screen

vocabulaire • vocabulary

la comédie
comedy

la comédie romantique
romance

le thriller
thriller

le film de science-fiction
science fiction movie

le film d'horreur
horror movie

le film d'aventures
adventure

le western
Western

le film d'animation
animated film

l'orchestre • orchestra

les cordes • strings



le piano | piano

la partition
score

la clé de fa
bass clef



la notation | notation

vocabulaire • vocabulary

l'ouverture
overture

la sonate
sonata

le silence
rest

le dièse
sharp

le bémol
natural

la gamme
scale

la symphonie
symphony

les instruments
instruments

le ton
pitch

le bémol
flat

la barre de
mesure
bar

la baguette
baton

les bois • woodwind



le piccolo
piccolo



la flûte traversière
flute



le hautbois
oboe



le cor anglais
cor anglais



le saxophone
saxophone



la clarinette
clarinet



la clarinette
bass clarinet



le basson
bassoon



le contrebasson
double bassoon

la percussion • percussion



la timbale
kettle drum



le gong
gong

le vibraphone
vibraphone



les pédales
foot pedals



les bongos
bongos



la caisse claire
snare drum



les cymbales
cymbals



le tambour
tambourine



le triangle
triangle



les maracas
maracas

les cuivres • brass



la trompette
trumpet



le trombone
trombone



le cor
French horn



le tuba
tuba

le concert • concert



le haut-parleur
speaker

les fans
fans

le chanteur
lead singer

le guitariste
guitarist

le microphone
microphone

le batteur
drummer

le concert de rock | rock concert

les instruments • instruments

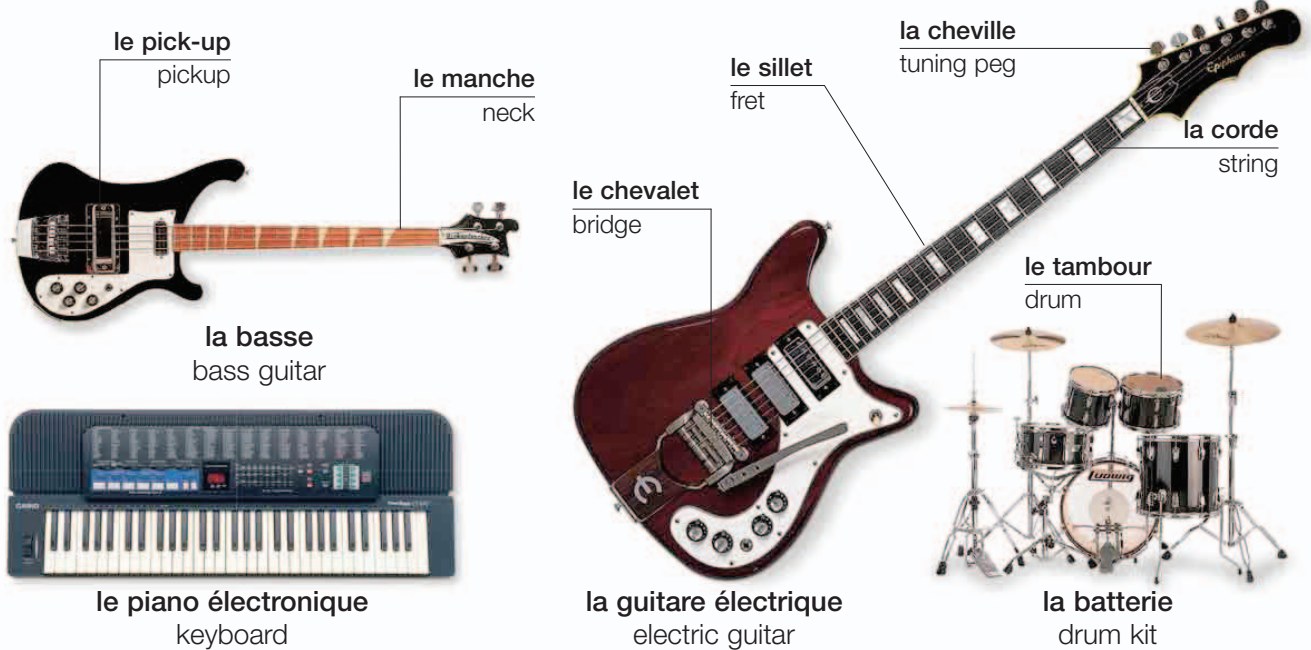

les styles de musique • musical styles



le jazz
jazz



le blues
blues



la musique punk
punk



la musique folk
folk music



la pop
pop



la danse
dance



le rap
rap



la heavy métal
heavy metal



la musique classique
classical music

vocabulaire • vocabulary

la chanson
song

les paroles
lyrics

la mélodie
melody

le beat
beat

le reggae
reggae

la country
country

le projecteur
spotlight

le tourisme • sightseeing



le touriste
tourist

l'attraction touristique | tourist attraction



l'itinéraire
itinerary

à impériale
open-top

le bus touristique | tour bus



la guide
tour guide

la visite guidée
guided tour



la statuette
figurine

les souvenirs
souvenirs

vocabulaire • vocabulary

ouvert
open

le guide
guidebook

le caméscope
camcorder

à gauche
left

Où est...?
Where is...?

fermé
closed

la pellicule
film

l'appareil photo
camera

à droite
right

Je me suis perdu.
I'm lost.

le prix d'entrée
admission
charge

les piles
batteries

les directions
directions

tout droit
straight
ahead

Pour aller à..., s'il vous plaît?
Can you tell me the way to....?

les attractions • attractions

le tableau
painting

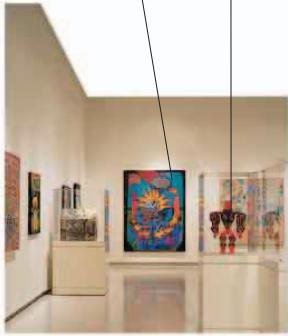

le musée d'art
art gallery

l'objet exposé
exhibit

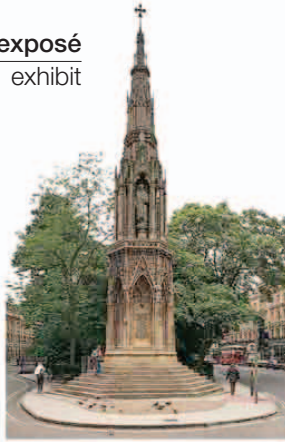

le monument
monument

l'exposition
exhibition

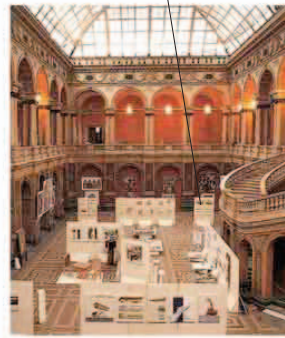

le musée
museum

la ruine célèbre
famous ruin



le monument
historique
historic building



le casino
casino



le parc
gardens



le parc national
national park

l'information • information

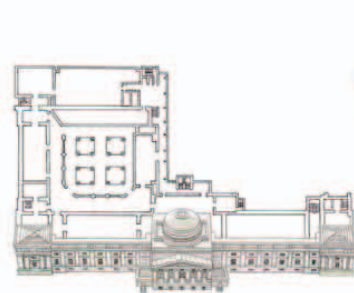

le plan
floor plan



le plan
map

les heures
times



l'horaire
schedule



l'information
touristique
tourist information

les activités de plein air • outdoor activities

le sentier
footpath

le cadran solaire
sundial

le café
café

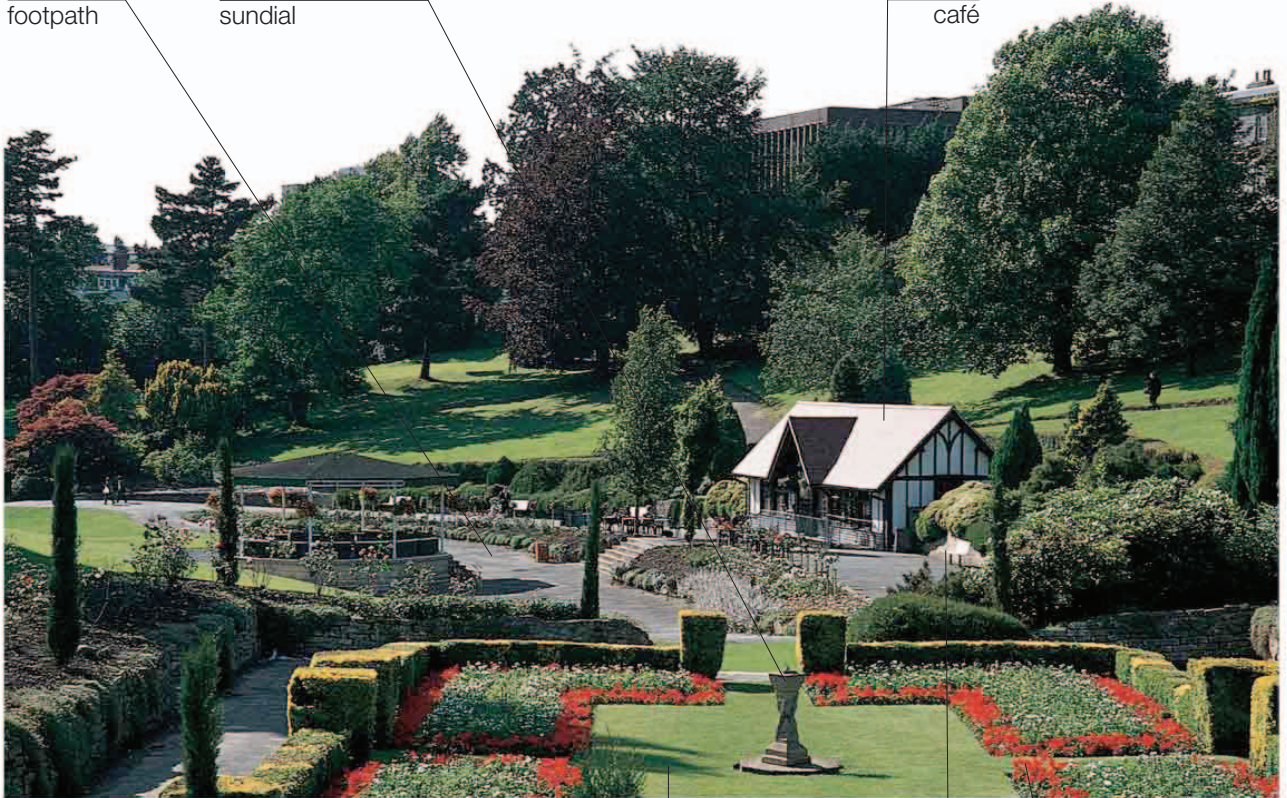

le parc | park

la pelouse
grass

le banc
bench

les jardins à la
française
formal gardens

les montagnes
russes
roller coaster



la foire
fairground



le parc d'attractions
theme park



la réserve
safari park



le zoo
zoo

les activités • activities



le vélo
cycling



le jogging
jogging



la planche à roulette
skateboarding



le roller
rollerblading

la piste cavalière
bridle path



l'observation des
oiseaux
bird-watching



l'équitation
horseback riding



la randonnée
hiking

le panier à
pique-nique
hamper



le pique-nique
picnic

le terrain de jeux • playground



le bac à sable
sandbox



la pataugeoire
wading pool



la balançoire
swing



la bascule | seesaw



le toboggan
slide



la cage à poules
climbing frame

la plage • beach

l'hôtel
hotel

le parasol
beach umbrella

la cabine de plage
beach hut

le sable
sand

la vague
wave

la mer
sea



le sac de plage
beach bag

le bikini
bikini



prendre un bain de soleil | sunbathe (v)



le maître nageur
lifeguard

la tour de surveillance
lifeguard tower



le pare-vent
windbreak

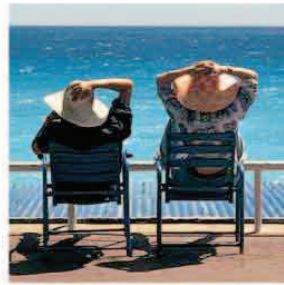

la promenade
boardwalk



le transat
deck chair



les lunettes de soleil
sunglasses



le chapeau de plage
sun hat



la lotion solaire
suntan lotion



l'écran total
sunblock



le ballon de plage
beach ball



la bouée
inflatable ring

le maillot de bain
swimsuit

la pelle
shovel

le seau
pail

le château de sable
sandcastle

le coquillage
shell



la serviette de plage
beach towel

le camping • camping



vocabulaire • vocabulary

camper
camp (v)

l'emplacement
site

le banc à pique-nique
picnic bench

le charbon de bois
charcoal

le bureau du chef
site manager's office

monter une tente
pitch a tent (v)

le hamac
hammock

l'allume-feu
firelighter

les emplacements libres
sites available

le mât
tent pole

le camping-car
camper van

allumer un feu
light a fire (v)

complet
full

le lit de camp
camp bed

la remorque
trailer

le feu de camp
campfire



le spray contre les
insects
insect repellent



la lampe torche
flashlight

la moustiquaire
mosquito net



les sous-vêtements
thermiques
thermal underwear



les chaussures de
marche
walking boots



l'imperméable
rain gear



le sac de couchage
sleeping bag



le réchaud
camping stove



le barbecue
barbecue grill

le tapis de sol
sleeping mat



le matelas pneumatique | air mattress

les distractions à la maison • home entertainment



la radio numérique
digital radio



l'iPod®
iPod



le DVD
DVD disk

le lecteur DVD
DVD player

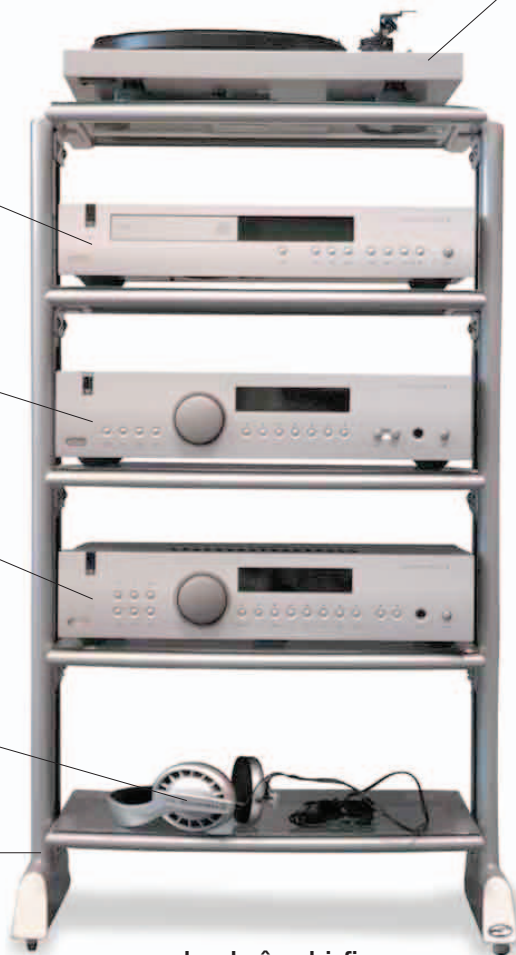

le lecteur CD
CD player

la radio
radio

l'amplificateur
amplifier

les écouteurs
headphones

l'étagère
stand

la chaîne hi-fi
stereo system

le tourne-disque
record player



le baffle
speaker

le support
speaker stand



le box
DTV converter box



l'écran
screen

le caméscope
camcorder

l'ocilleton
eyecup



l'antenne parabolique
satellite dish

la télévision à écran plat
flatscreen TV



la console
console

l'avance rapide
fast-forward

la pause
pause

l'enregistrement
record

la commande
controller



le jeu vidéo | video game

le volume
volume

le retour rapide
rewind

la lecture
play

l'arrêt
stop



la télécommande
remote control

vocabulaire • vocabulary

le CD
CD

la publicité
advertisement

le wifi
wifi

la chaîne à péage
pay-per-view channel

regarder la télévision
watch television (v)

la cassette
cassette tape

numérique
digital

le programme
program

changer de chaîne
change channels (v)

éteindre la télévision
turn off the television (v)

le lecteur cassettes
cassette player

le streaming
streaming

stéréo
stereo

allumer la télévision
turn on the television (v)

régler la radio
tune the radio (v)

le film
feature film

haute définition
high-definition

la télévision par câble
cable television

la photographie • photography

le déclencheur

shutter release

le réglage de l'ouverture

aperture dial

l'objectif

lens



l'appareil réflex mono-objectif | SLR camera



le filtre
filter



le bouchon d'objectif
lens cap



le trépied
tripod



le flash compact
flash gun



le posemètre
light meter



le zoom
zoom lens

les types d'appareils photo • types of camera



le Polaroid®
Polaroid camera



l'appareil photo APS
APS camera

le flash
flash



le photophone
cameraphone



l'appareil jetable
disposable camera

photographe • photographer (v)

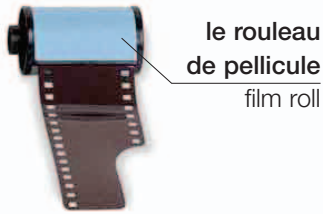

la pellicule
film



mettre au point
focus (v)



développer
develop (v)



le négatif
negative

paysage
landscape



portrait
portrait



la photo | photograph



l'album de photos
photo album



le cadre de photo
picture frame

les problèmes • problems



sous-exposé
underexposed



surexposé
overexposed



flou
out of focus



la tache rouge
red eye

vocabulaire • vocabulary

le viseur
viewfinder

l'épreuve
print

le sac d'appareil photo
camera case

mat
mat

la pose
exposure

brillant
gloss

la chambre noire
darkroom

l'agrandissement
enlargement

Pourriez-vous faire développer cette pellicule?

I'd like this film processed.

les jeux • games

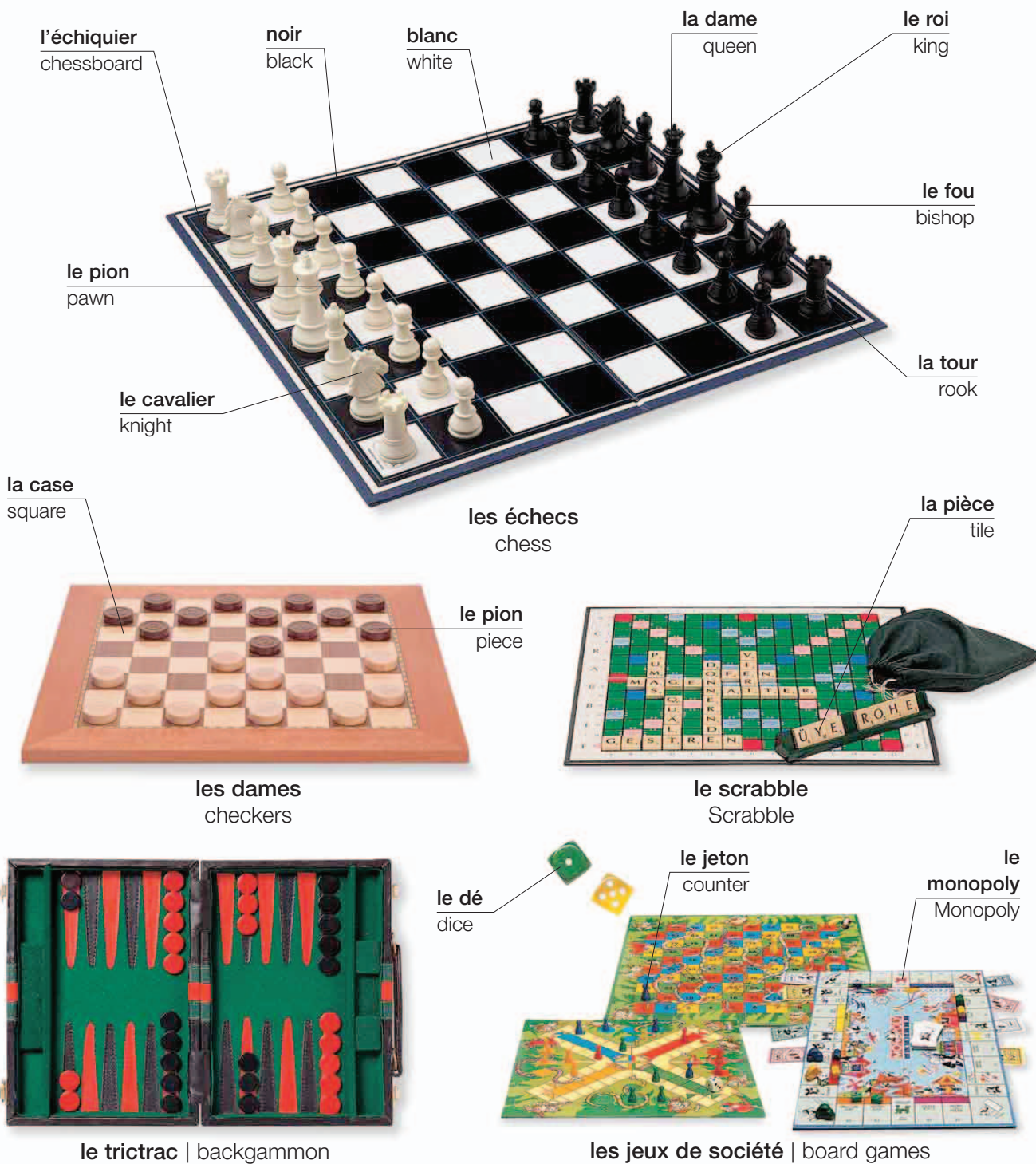



la philatélie
stamp collecting



le puzzle
jigsaw puzzle



les dominos
dominoes

la cible
dartboard

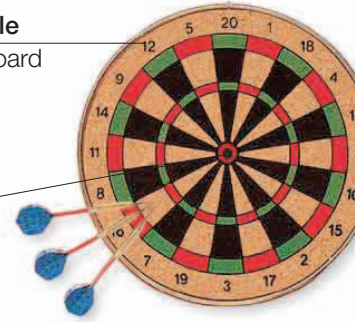

le mille
bullseye

les fléchettes
darts

le joker
joker

le valet
jack

la dame
queen

le roi
king

l'as
ace

les cartes
cards



le carreau
diamond

le pique
spade

le cœur
heart

le trèfle
club



battre | shuffle (v)

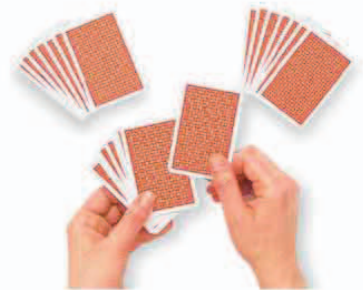

donner | deal (v)

vocabulaire • vocabulary

le coup
move

gagner
win (v)

le perdant
loser

le point
point

le bridge
bridge

Jette le dé.
Roll the dice.

jouer
play (v)

le gagnant
winner

le jeu
game

la marque
score

le jeu de cartes
deck of cards

C'est à qui de jouer?
Whose turn is it?

le joueur
player

perdre
lose (v)

le pari
bet

le poker
poker

la couleur
suit

C'est à toi de jouer.
It's your move.

les arts et métiers 1 • arts and crafts 1

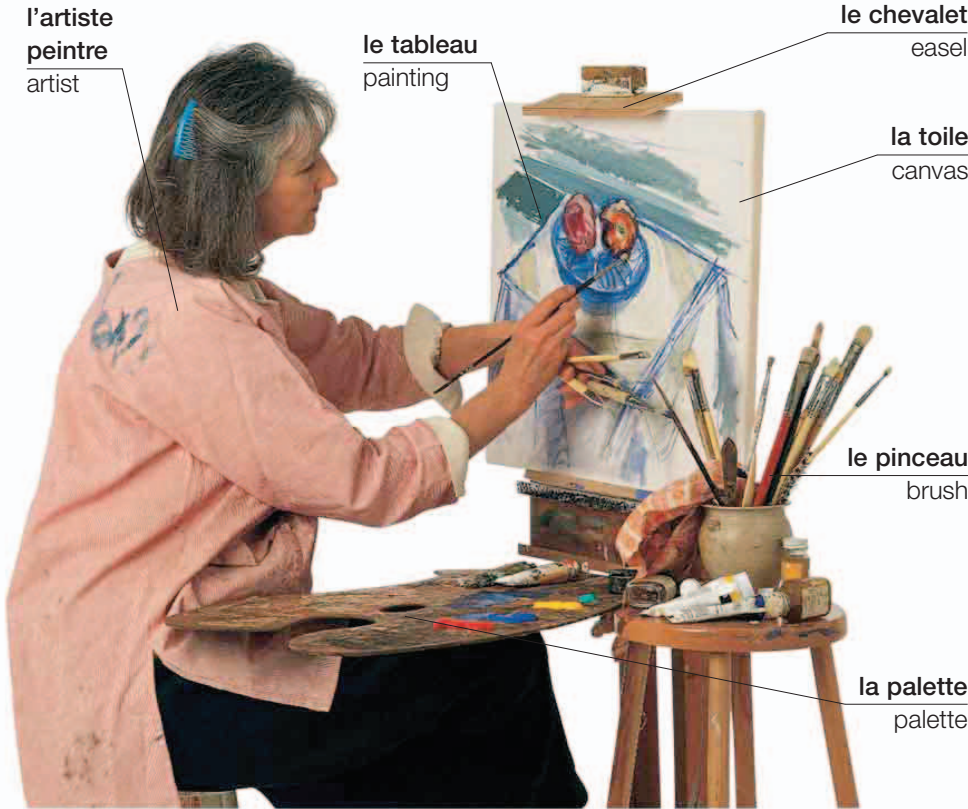

la peinture | painting

les couleurs • paints



les peintures à l'huile
oil paints



l'aquarelle
watercolor paint



les pastels
pastels



l'acrylique
acrylic paint



la gouache
poster paint

les couleurs • colours



rouge
red



bleu
blue



jaune
yellow



vert
green



orange
orange



violet
purple

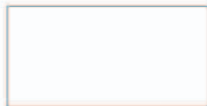

blanc
white



noir
black

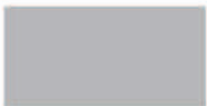

gris
gray



rose
pink



marron
brown



indigo
indigo

les autres arts • other crafts

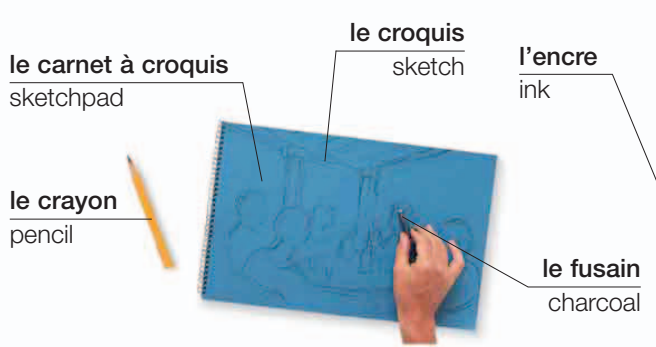

le dessin | drawing



l'imprimerie
printing



la gravure
engraving



la sculpture
sculpting

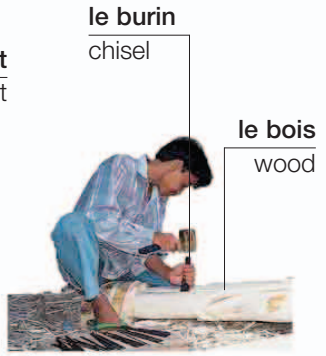

la sculpture sur bois
woodworking



la poterie
pottery



le collage | collage



la joaillerie
jewelry-making



le papier mâché
papier-mâché



l'origami
origami



le modélisme
model-making

les arts et métiers 2 • arts and crafts 2



la machine à coudre | sewing machine



les ciseaux
scissors



le patron
pattern



la pelote à épingles
pincushion



le centimètre
tape measure



le tissu
material

l'épingle
pin

la corbeille à coudre | sewing basket



la bobine
bobbin



le fil
thread



l'œillet
eye



l'agrafe
hook



le dé à coudre
thimble



la craie de tailleur
tailor's chalk



le mannequin
tailor's dummy



enfiler
thread (v)



coudre
sew (v)



repriser
darn (v)



bâtir
tack (v)



couper
cut (v)



la tapisserie
needlepoint



la broderie
embroidery

le crochet
crochet hook



le crochet
crochet



le macramé
macramé

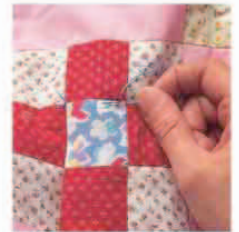

le patchwork
patchwork



le ouatage
quilting

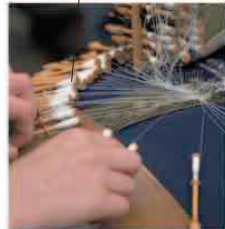

la dentelle
lace-making



le tissage
weaving

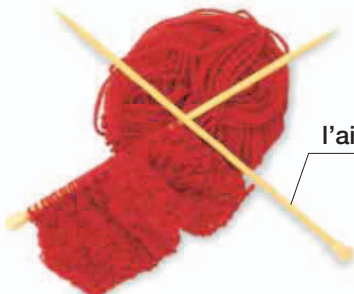

le tricot | knitting

l'aiguille à tricoter
knitting needle



l'écheveau | skein

la laine
wool

vocabulaire • vocabulary

défaire
unpick (v)

le nylon
nylon

le tissu
fabric

la soie
silk

le coton
cotton

le styliste
designer

le lin
linen

la moda
fashion

le polyester
polyester

la fermeture éclair
zip





l'environnement
environnement



l'espace • space

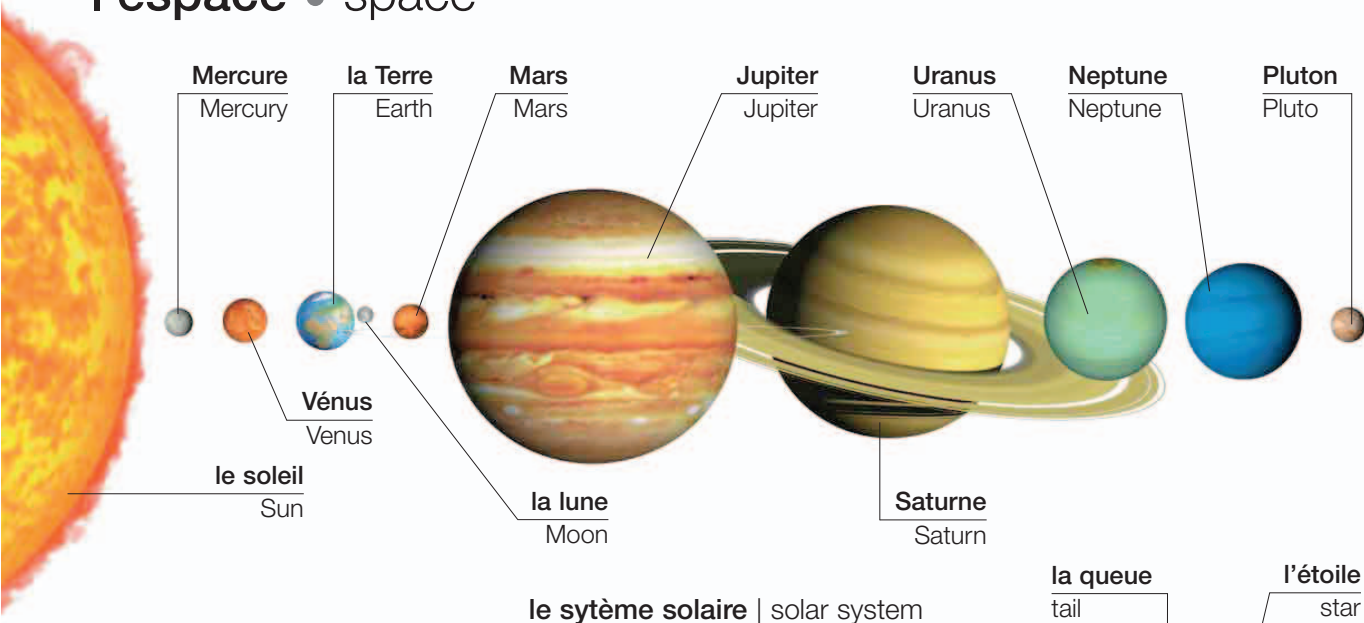

la galaxie / galaxy



la nébuleuse / nebula



l'astéroïde / asteroid



la comète / comet

vocabulaire • vocabulary

l'univers
universe

le trou noir
black hole

la pleine lune
full moon

l'orbite
orbit

la planète
planet

la nouvelle lune
new moon

la pesanteur
gravity

le météore
meteor

le croissant de lune
crescent moon



l'éclipse | eclipse

l'exploration spatiale • space exploration

la navette spatiale
space shuttle

l'accélérateur
booster



le lancement
launch

le scaphandre spatial
space suit



l'astronaute | astronaut

la fusée d'orientation
thruster

la rampe de lancement
launch pad

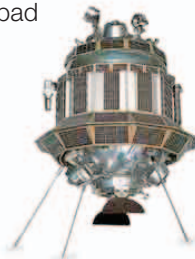

le satellite
satellite

le radar
radar

le sas d'équipage
crew hatch

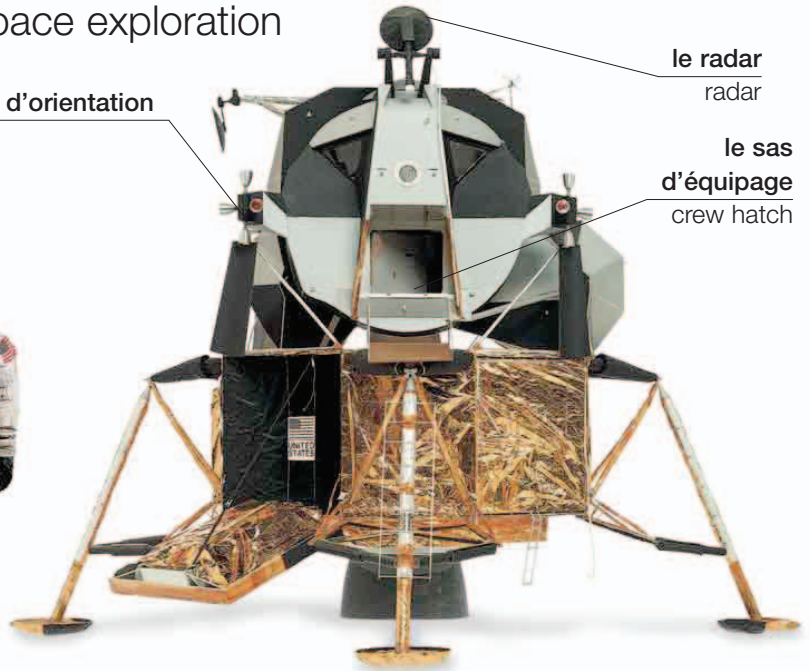

le module lunaire | lunar module



la station spatiale
space station

l'astronomie • astronomy



la constellation
constellation



les jumelles
binoculars

le télescope
telescope

le trépied
tripod



la terre • Earth

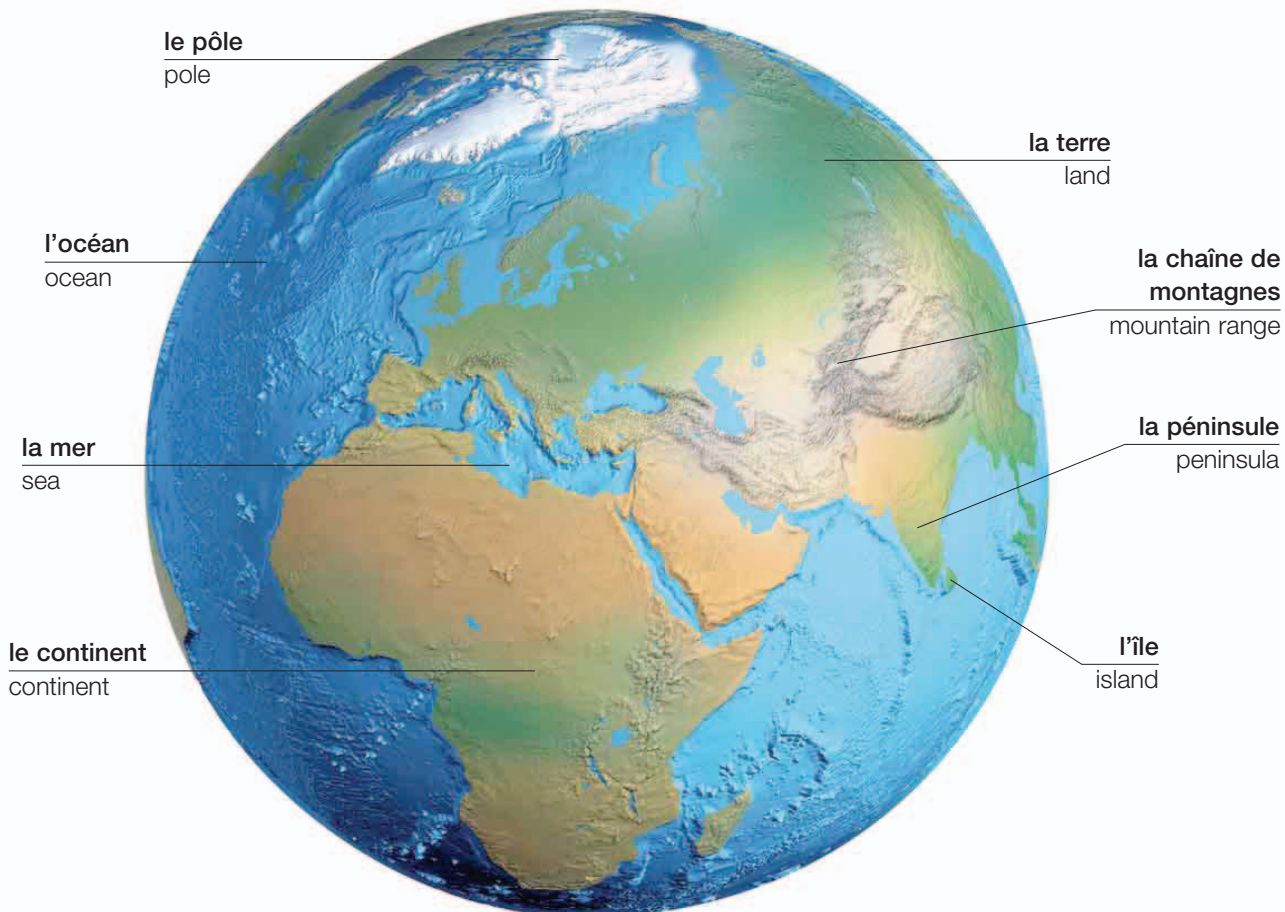

la planète | planet

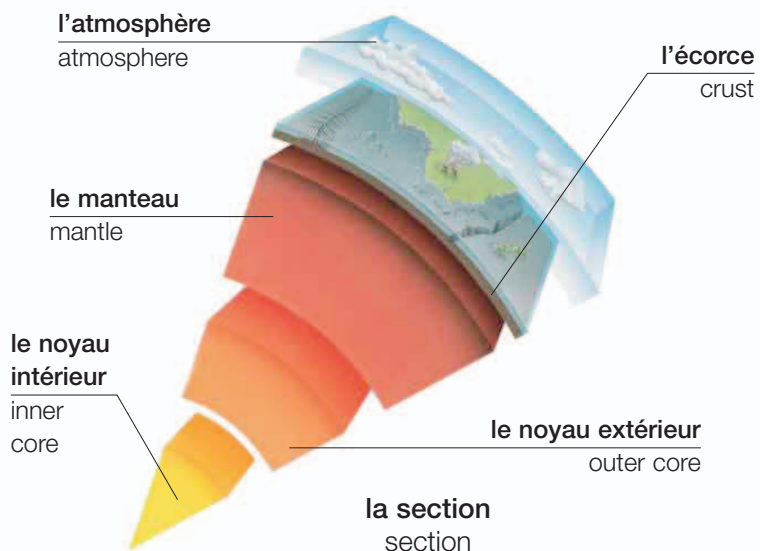

le cercle polaire arctique

Arctic circle

le tropique du cancer

tropic of Cancer

les tropiques
tropics

le tropique du capricorne

tropic of Capricorn

le pôle nord

North Pole

l'hémisphère nord

northern hemisphere

la longitude

longitude

la latitude

latitude

l'hémisphère sud

southern hemisphere

l'équateur

equator

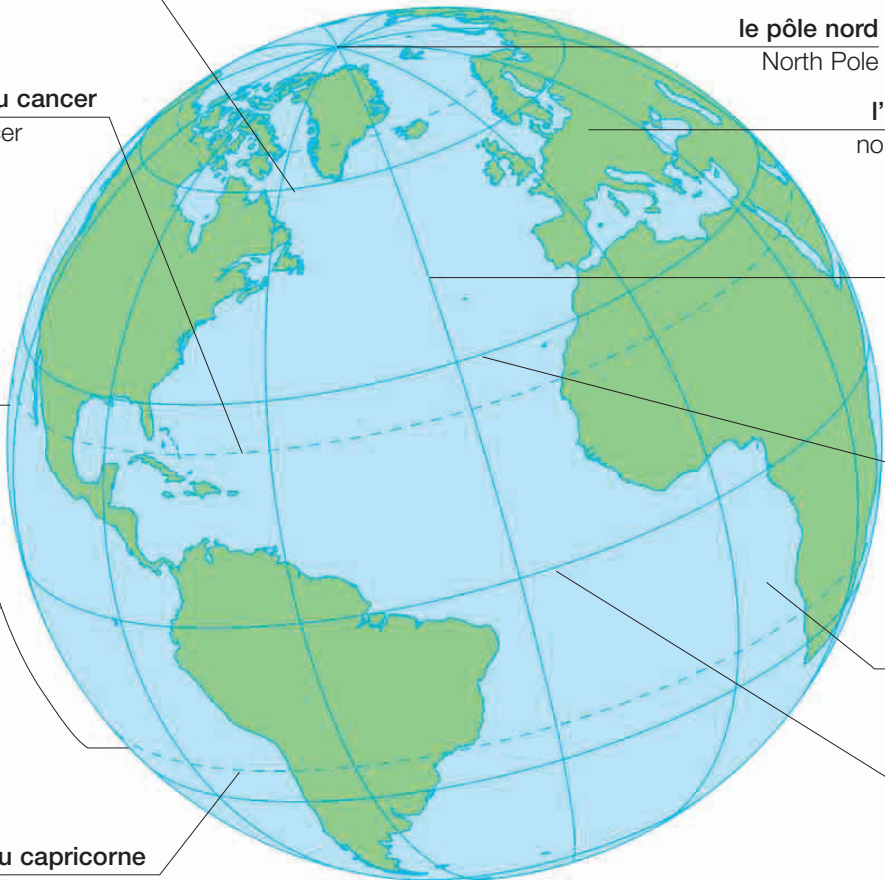

les zones | zones

vocabulaire

• vocabulary

le tremblement de terre

earthquake

la plaque

plate

entrer en éruption

erupt (v)

le tremblement

tremor

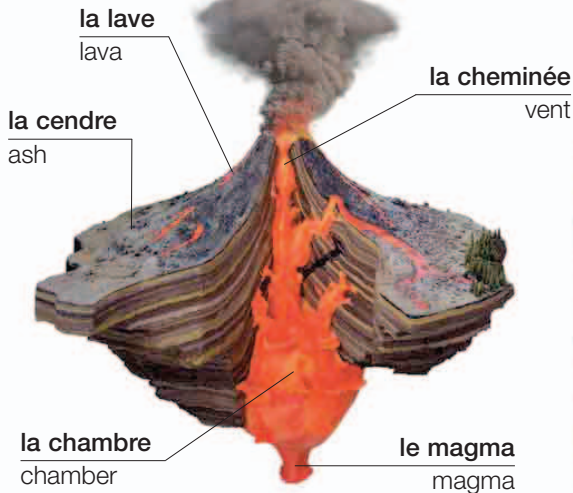

le volcan | volcano



le cratère | crater

le paysage • landscape

la montagne
mountain

la pente
slope

la rive
bank

la rivière
river

les rapides
rapids

les rochers
rocks

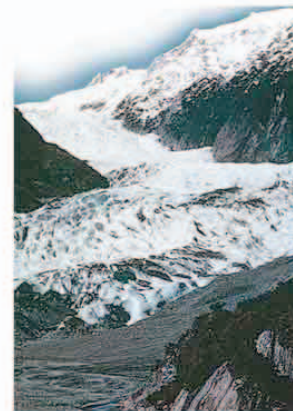
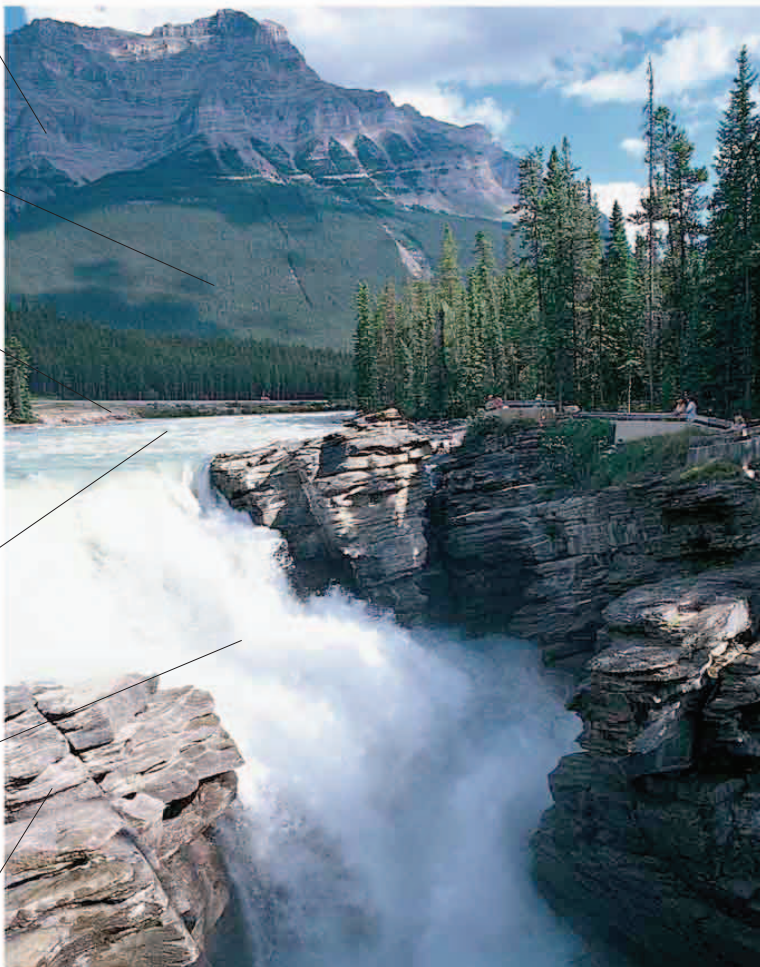

le glacier
glacier

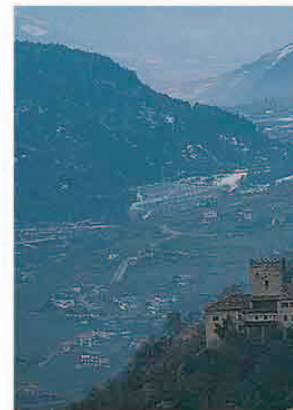

la vallée | valley



la colline
hill



le plateau
plateau



la gorge
gorge



la caverne
cave



la plaine | plain

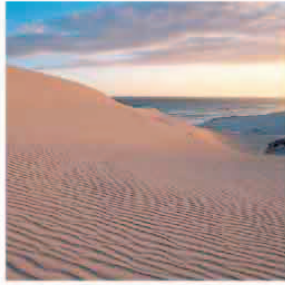

le désert | desert



la forêt | forest



le bois | woods



la forêt tropicale
rainforest



le marais
swamp



le pré
meadow



la prairie
grassland



la cascade
waterfall



le ruisseau
stream



le lac
lake



le geyser
geyser



la côte
coast



la falaise
cliff



le récif de corail
coral reef



l'estuaire
estuary

le temps • weather

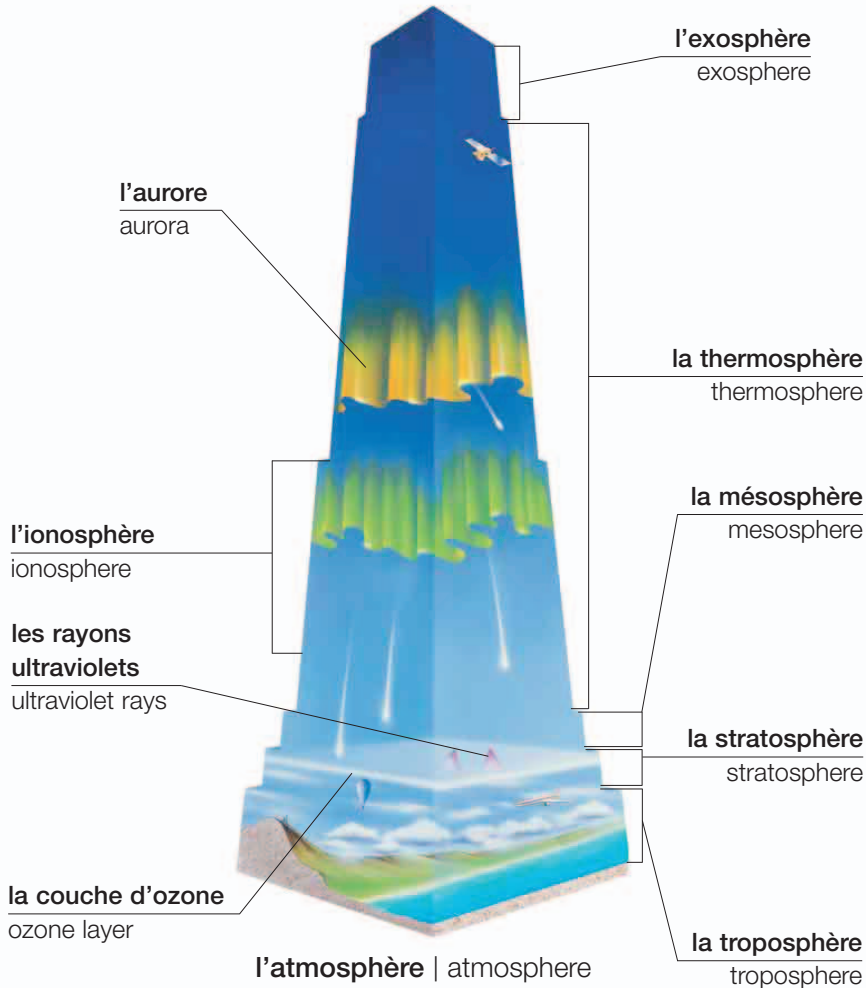

le soleil
sunshine



le vent
wind

vocabulaire • vocabulary

la neige fondue sleet	l'averse shower	(très) chaud hot	sec dry	venteux windy	: J'ai chaud/froid. I'm hot/cold.	
la grêle hail	ensoleillé sunny	froid cold	humide wet	la tempête gale		: Il pleut. It's raining.
le tonnerre thunder	nuageux cloudy	chaud warm	lourd humid	la température temperature		: Il fait ... degrés. It's ... degrees.



le nuage
cloud



la pluie
rain

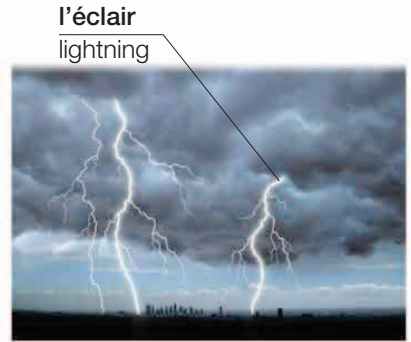

l'éclair
lightning

l'orage
storm



la brume
mist



le brouillard
fog



l'arc-en-ciel
rainbow



la neige
snow



le givre
frost



la glace
ice



le glaçon
icicle

le gel
freeze



l'ouragan
hurricane



la tornade
tornado



la mousson
monsoon



l'inondation
flood

les roches • rocks

igné • igneous



le granit
granite

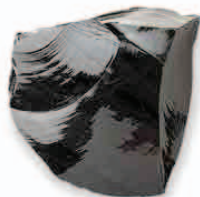

l'obsidienne
obsidian



le basalte
basalt



la pierre ponce
pumice

sédimentaire • sedimentary



le grès
sandstone



le calcaire
limestone



la craie
chalk



le silex
flint



le conglomérat
conglomerate



le charbon
coal

métamorphique •

metamorphic



l'ardoise
slate



le schiste
schist



le gneiss
gneiss

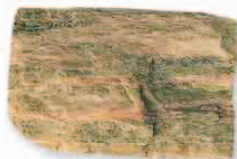

le marbre
marble

les gemmes • gems

le rubis
ruby



l'aigue-marine
aquamarine

l'améthyste
amethyst



le
diamant
diamond



le jade
jade

le jais
jet

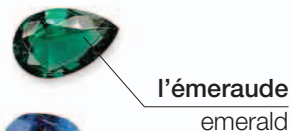

l'émeraude
emerald

l'opale
opal



le saphir
sapphire

la pierre de
lune
moonstone



le grenat
garnet



le topaze
topaz

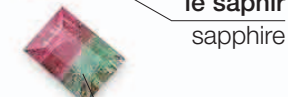

la tourmaline
tourmaline

les minéraux • minerals



le quartz
quartz



le mica
mica



le soufre
sulfur



l'hématite
hematite



la calcite
calcite



la malachite
malachite



la turquoise
turquoise



l'onyx
onyx

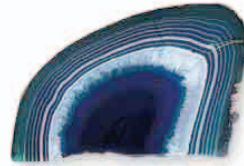

l'agate
agate



le graphite
graphite

les métaux • metals



l'or
gold

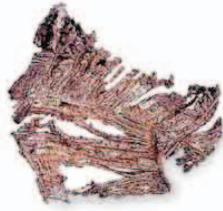

l'argent
silver



le platine
platinum



le nickel
nickel



le fer
iron



le cuivre
copper



l'étain
tin



l'aluminium
aluminum



le mercure
mercury

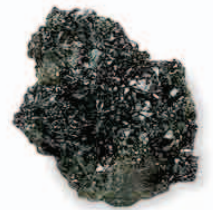

le zinc
zinc

les animaux 1 • animals 1

les mammifères • mammals



le lapin
rabbit



le hamster
hamster

les poils
whiskers



la souris
mouse

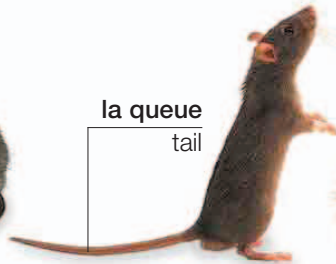

la queue
tail

le rat
rat



le hérisson
hedgehog



l'écureuil
squirrel



la chauve-souris
bat



le raton laveur
raccoon



le renard
fox



le loup
wolf



le chiot
puppy

le chien
dog



le chaton
kitten

le chat
cat



la loutre
otter



le bébé-phoque
pup

le phoque
seal



l'otarie
sea lion

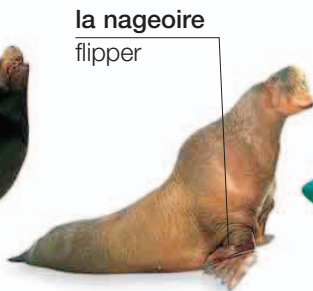

la nageoire
flipper

le morse
walrus

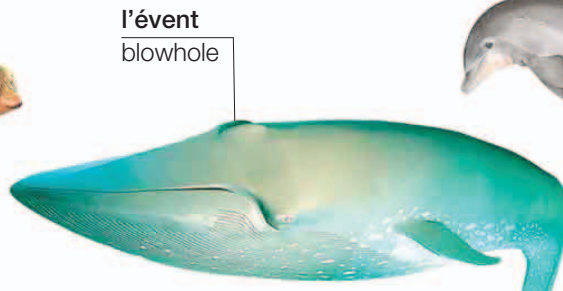

l'évent
blowhole

la baleine
whale



le dauphin
dolphin



la ramure
antler

le cerf
deer

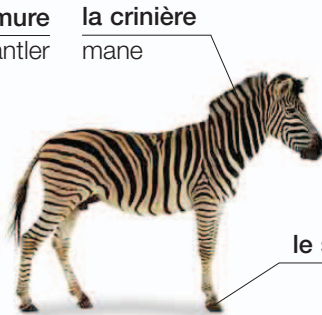

la crinière
mane

le sabot
hoof

le zèbre
zebra



la girafe
giraffe



la bosse
hump

le chameau
camel



la trompe
trunk

l'hippopotame
hippopotamus

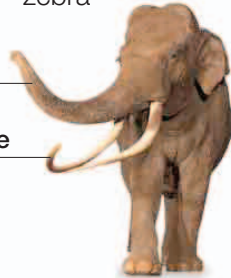

la défense
tusk

l'éléphant
elephant



la corne
horn

le rhinocéros
rhinoceros



le tigre
tiger



la crinière
mane

le lion
lion



le singe
monkey



le gorille
gorilla



le koala
koala



la poche
pouch

le kangourou
kangaroo



l'ours
bear

la griffe
claw



l'ours blanc
polar bear



le panda
panda

les animaux 2 • animals 2

les oiseaux • birds



le canari
canary



le moineau
sparrow



le colibri
hummingbird



l'hirondelle
swallow



le corbeau
crow



le pigeon
pigeon



le pic
woodpecker



le faucon
falcon



la chouette
owl



la mouette
gull



l'aigle
eagle



le pélican
pelican



le flamant
flamingo



la cigogne
stork



la grue
crane



le pingouin
penguin



l'autruche
ostrich



l'oie | goose



le cygne
swan



le paon
peacock



le faisan
pheasant



le dindon
turkey



le cacatoès
cockatoo

le bec
bill



la plume
feather

l'aile
wing

la griffe
claw

le perroquet
parrot

les reptiles • reptiles

les écailles
scales



l'alligator
alligator



le lézard
lizard



l'iguane
iguana



la tortue marine
turtle



la tortue
tortoise

la carapace
shell

le serpent
snake



le museau
snout



le crocodile
crocodile

les animaux 3 • animals 3

les amphibiens • amphibians



la grenouille
frog



le crapaud
toad



le têtard
tadpole



la salamandre
salamander

les poissons • fish

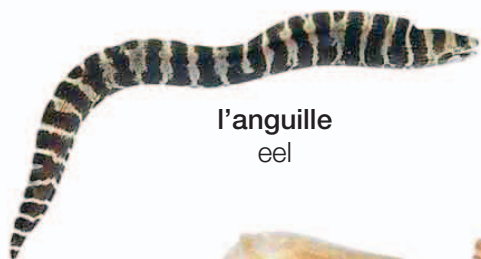

l'anguille
eel

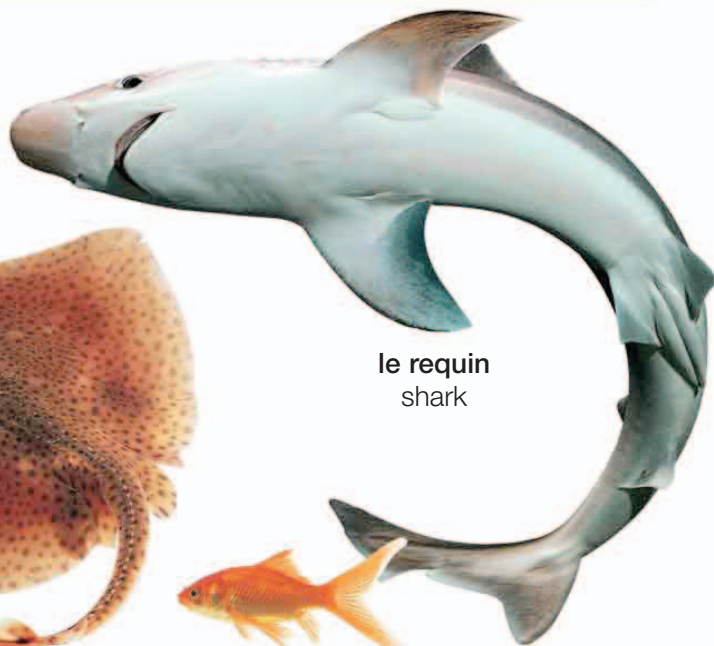

le requin
shark



l'hippocampe
sea horse



la raie
skate



la raie
ray



le poisson rouge
goldfish

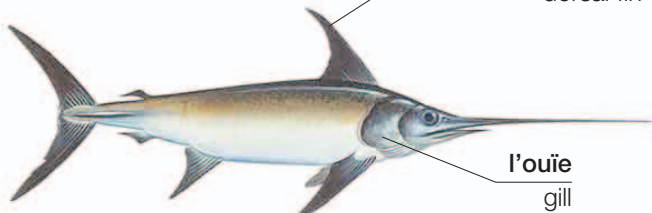

l'espardon
swordfish

la nageoire dorsale
dorsal fin

l'ouïe
gill

la nageoire pectorale
pectoral fin

la queue
tail

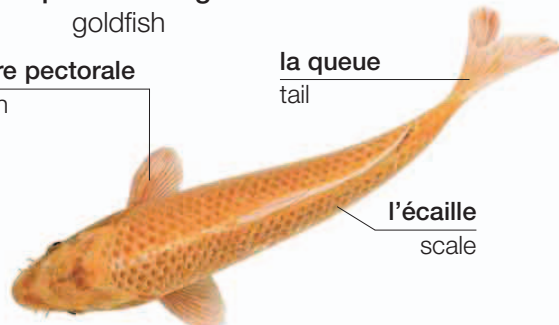

la carpe koi
koi carp

l'écaille
scale

les invertébrés • invertebrates



la fourmi
ant



la termite
termite



l'abeille
bee



la guêpe
wasp



le scarabée
beetle



le cafard
cockroach



le papillon
moth



le papillon
butterfly

l'antenne
antenna



le cocon
cocoon



la chenille
caterpillar



le grillon
cricket



la sauterelle
grasshopper



la mante religieuse
praying mantis



le dard
sting

le scorpion
scorpion



le mille-pattes
centipede



la libellule
dragonfly



la mouche
fly



le moustique
mosquito



la coccinelle
ladybug



l'araignée
spider



la limace
slug



l'escargot
snail



le ver
worm



l'étoile de mer
starfish



la moule
mussel



le crabe
crab



le homard
lobster



la pieuvre
octopus



le calmar
squid



la méduse
jellyfish

les plantes • plants

l'arbre • tree

la branche
branch

la racine
root



le mélèze
larch



l'érable
maple



le chêne
oak



le hêtre
beech



l'orme
elm



le bouleau
birch



le tilleul
lime



la feuille
leaf

la brindille
twig

l'écorce
bark

le tronc
trunk



le peuplier
poplar



le pin
pine



le houx
holly



le saule
willow



l'eucalyptus
eucalyptus



le cèdre
cedar

la baie
berry



le palmier
palm

la plante à fleurs • flowering plant

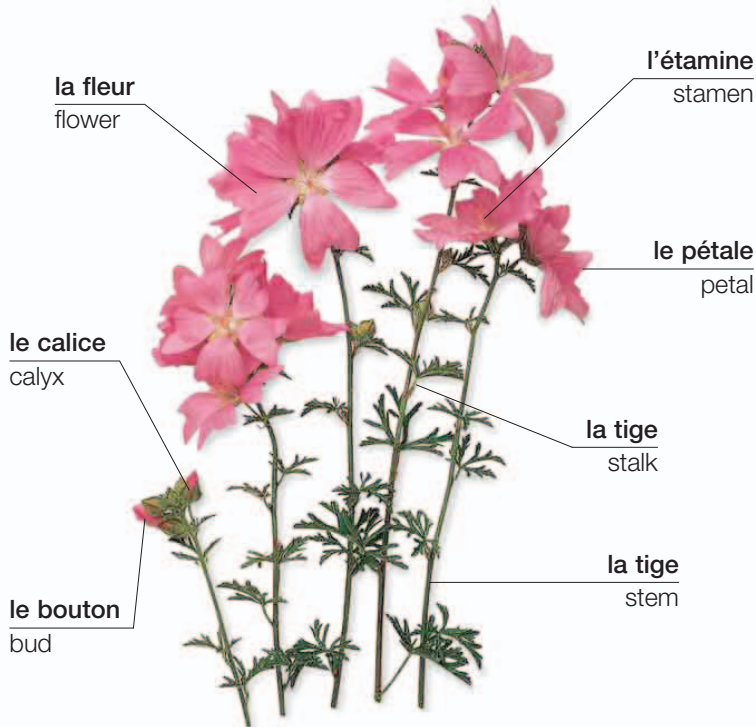

la renoncule
buttercup



la pâquerette
daisy



le chardon
thistle



le pissenlit
dandelion



la bruyère
heather



le coquelicot
poppy



la digitale
foxglove



le chèvrefeuille
honeysuckle



le tournesol
sunflower



le trèfle
clover



**les jacinthes
des bois**
bluebells



la primevère
primrose



les lupins
lupines



l'ortie
nettle

la ville • town



les bâtiments • buildings



la mairie
town hall



la bibliothèque
library



le cinéma
movie theater



le théâtre
theater



l'université
university



le gratte-ciel
skyscraper



l'école
school

les environs • areas



la zone industrielle
industrial park



la ville
city



la banlieue
suburb



le village
village

vocabulaire • vocabulary

la zone piétonnière
pedestrian zone

la rue transversale
side street

la bouche d'égout
manhole

le caniveau
gutter

l'église
church

l'avenue
avenue

la place
square

l'arrêt de bus
bus stop

l'usine
factory

l'égout
drain

l'architecture • architecture

les bâtiments et structures • buildings and structures



le gratte-ciel
skyscraper



le château
castle



l'église
church

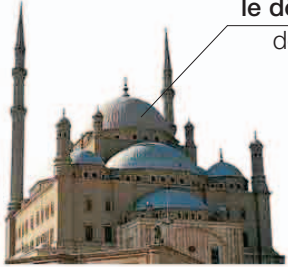

la mosquée
mosque



le temple
temple



la synagogue
synagogue



le barrage
dam



le pont
bridge

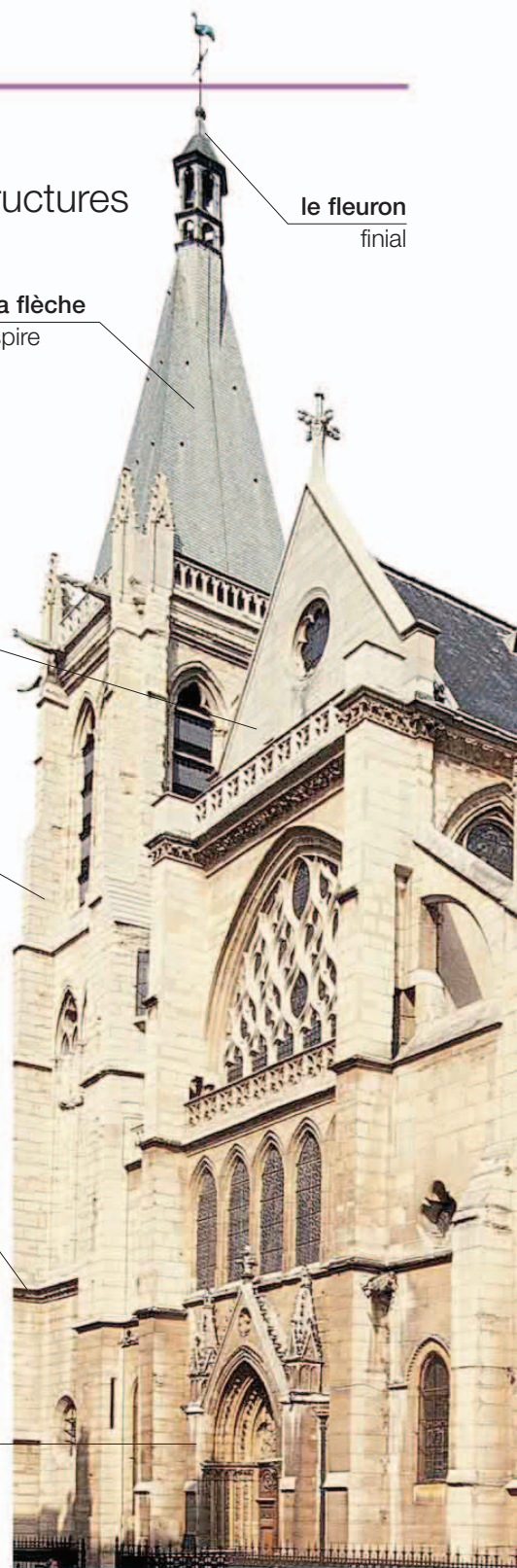

le fleuron
finial

la tourelle
turret

la flèche
spire

la douve
moat

le pignon
gable

le dôme
dome

la tour
tower

la voûte
vault

la corniche
cornice

la colonne
pillar

la cathédrale | cathedral

les styles • styles



gothique
gothic

l'architrave
architrave



Renaissance
Renaissance



baroque
baroque



l'arc
arch

la frise
frieze

le chœur
choir

le fronton
pediment

le contrefort
buttress



rococo
rococo



néoclassique
neoclassical



art nouveau
Art Nouveau



art déco
Art Deco

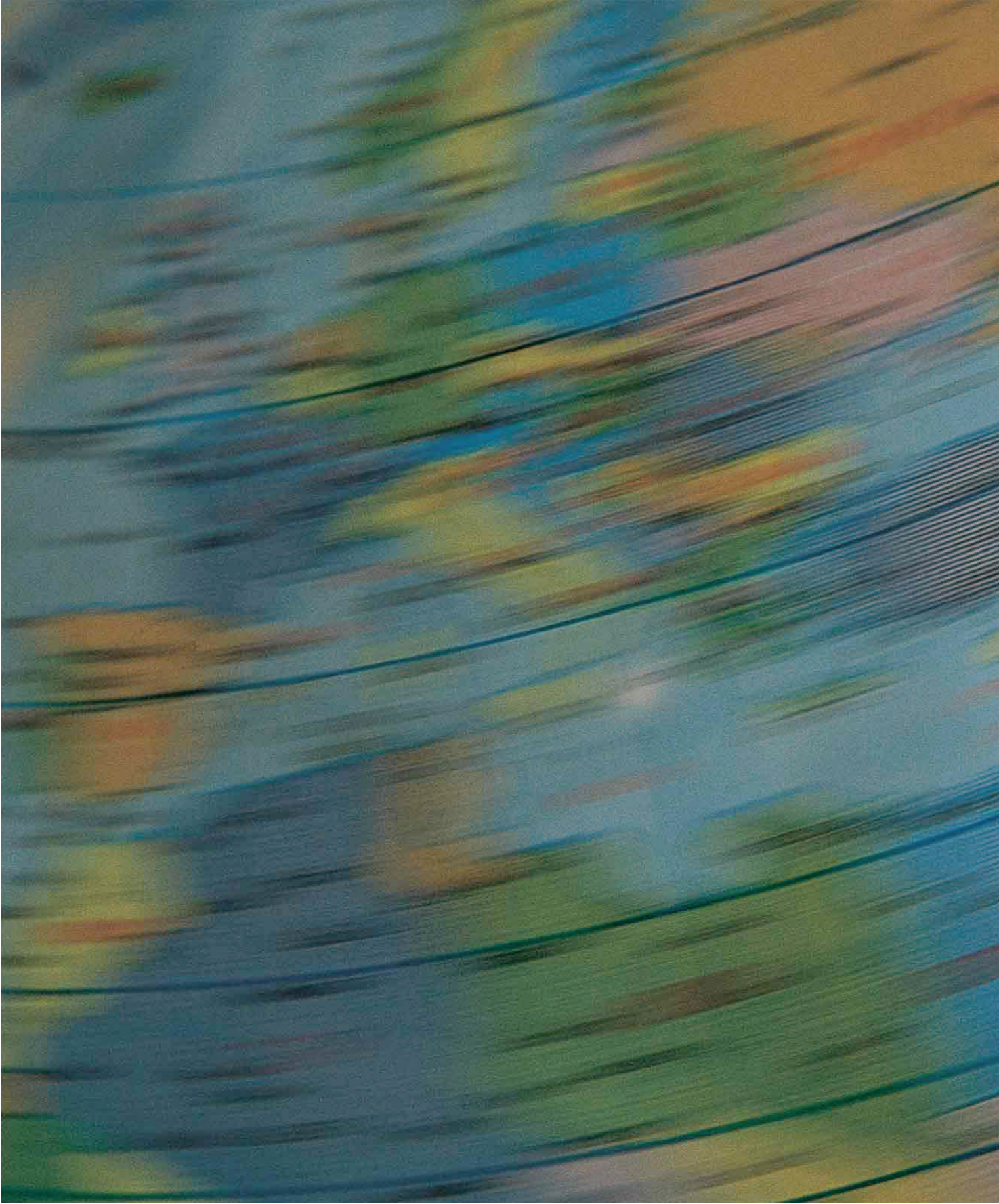

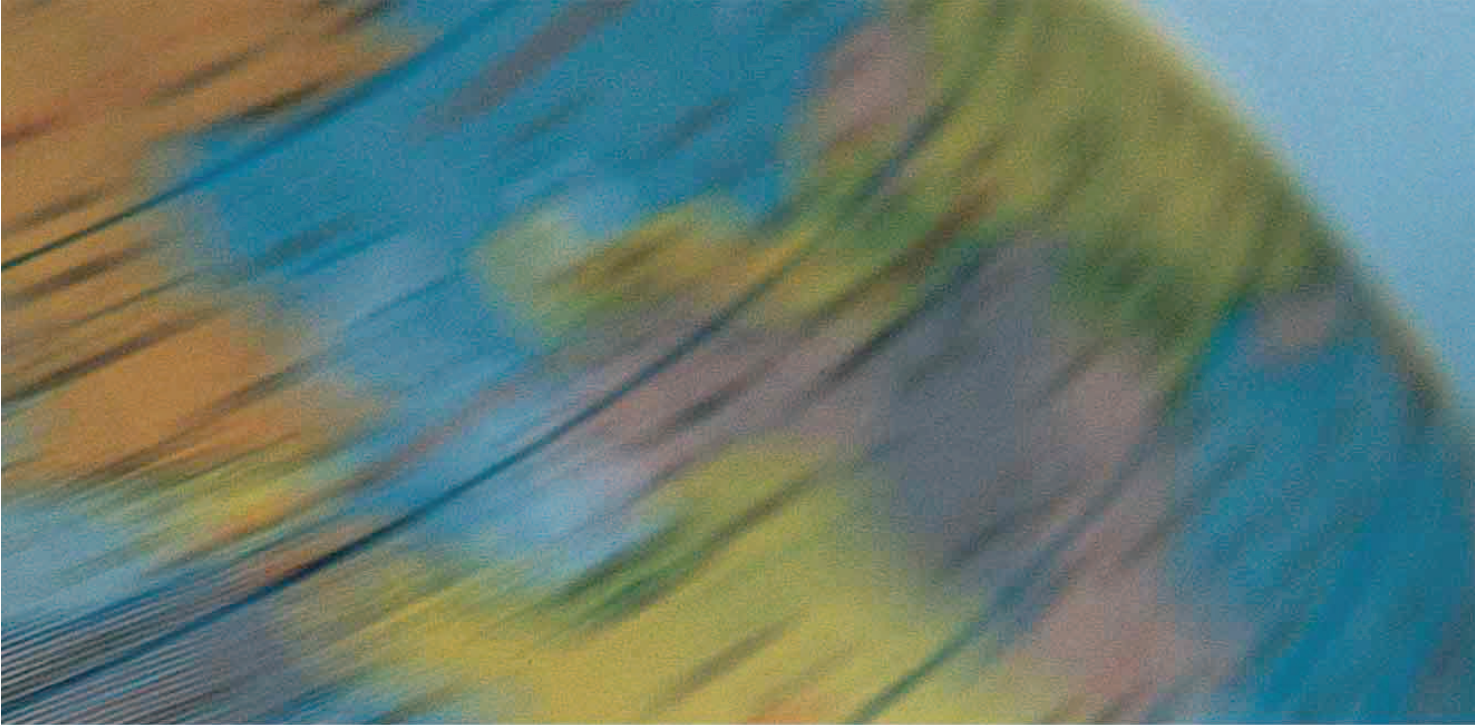

l'information
reference

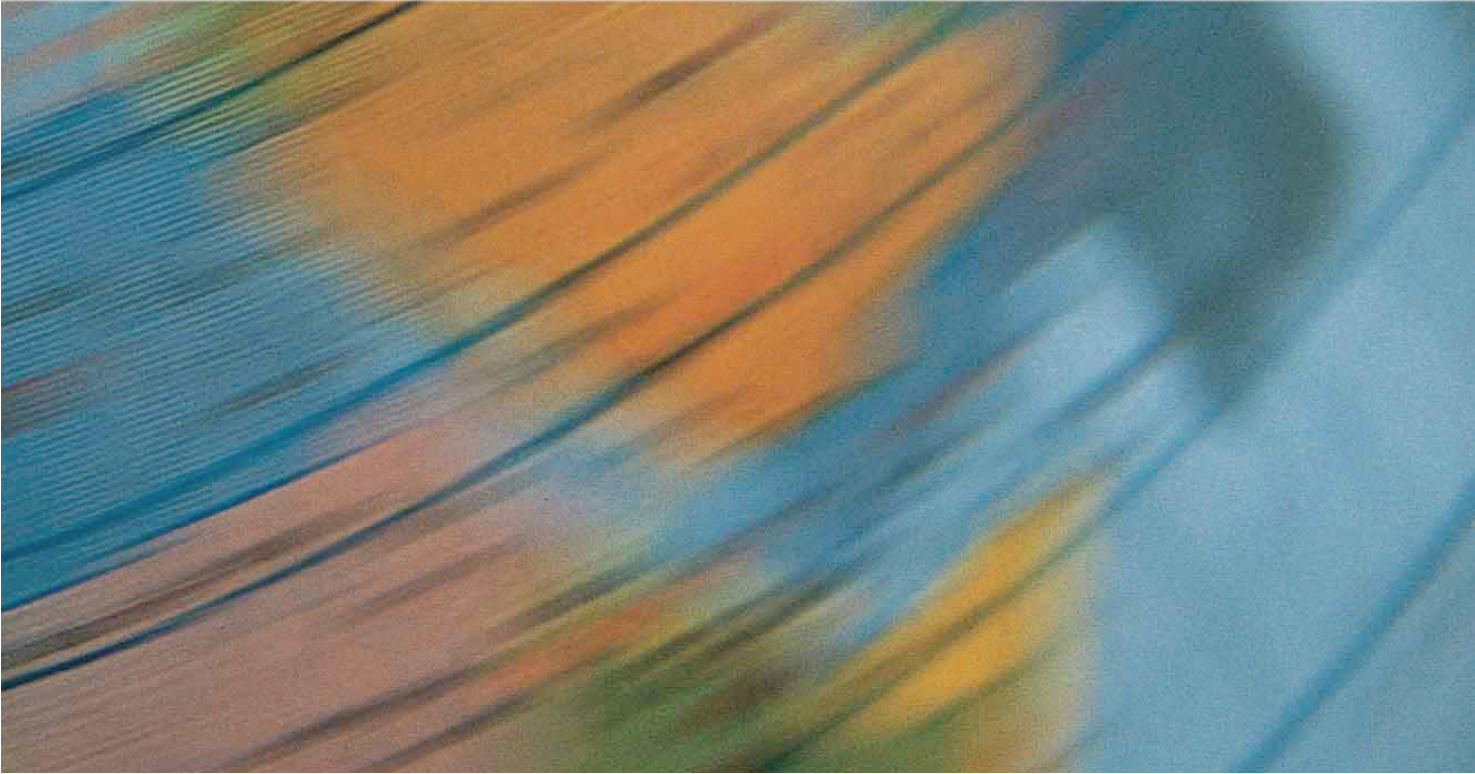

l'heure • time



l'horloge
clock

vocabulaire • vocabulary

la seconde second	maintenant now	un quart d'heure 15 minutes
la minute minute	plus tard later	vingt minutes twenty minutes
l'heure hour	une demi-heure half an hour	quarante minutes forty minutes

Quelle heure est-il?
What time is it?

Il est trois heures.
It's three o'clock.



une heure cinq
five after one



une heure dix
ten after one



une heure et quart
quarter after one



une heure vingt
twenty after one



une heure vingt-cinq
twenty-five after one

la trotteuse
second hand



une heure trente
one-thirty



deux heures moins vingt-cinq
twenty-five to two



deux heures moins vingt
twenty to two



deux heures moins le quart
quarter to two



deux heures moins dix
ten to two



deux heures moins cinq
five to two



deux heures
two o'clock

la nuit et le jour • night and day



minuit
midnight



le lever du soleil
sunrise



l'aube
dawn



le matin
morning



le coucher du soleil
sunset



(le) midi
noon

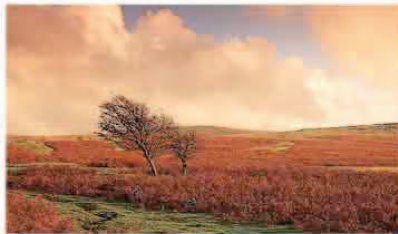

le crépuscule
dusk



le soir
evening



l'après-midi
afternoon

vocabulaire • vocabulary

tôt
early

Tu es en avance.
You're early.

Sois à l'heure, s'il te plaît.
Please be on time.

Ça finit à quelle heure?
What time does it end?

à l'heure
on time

Tu es en retard.
You're late.

À tout à l'heure.
I'll see you later.

Il se fait tard.
It's getting late.

tard
late

J'y arriverai bientôt.
I'll be there soon.

Ça commence à quelle heure?
What time does it start?

Ça dure combien de temps?
How long will it last?

le calendrier • calendar

le mois
month

l'an
year

janvier
January

2010



le jour
day

lundi mardi mercredi jeudi vendredi samedi dimanche
Monday Tuesday Wednesday Thursday Friday Saturday Sunday

le jour ouvrable
work day

1	2	3	4	5	6	7
8	9	10	11	12	13	14
15	16	17	18	19	20	21

la semaine
week

la date
date

hier
yesterday

aujourd'hui
today

demain
tomorrow

le week-end
weekend

vocabulaire • vocabulary

janvier
January

mars
March

mai
May

juillet
July

septembre
September

novembre
November

février
February

avril
April

juin
June

août
August

octobre
October

décembre
December

les ans • years

1900	mille neuf cents • nineteen hundred
1901	mille neuf cent un • nineteen hundred and one
1910	mille neuf cent dix • nineteen ten
2000	deux mille • two thousand
2001	deux mille un • two thousand and one

les saisons • seasons



le printemps
spring



l'été
summer



l'automne
fall



l'hiver
winter

vocabulaire • vocabulary

le siècle
century

la décennie
decade

le millénaire
millennium

cette semaine
this week

la semaine dernière
last week

la semaine prochaine
next week

avant-hier
the day before yesterday

après-demain
the day after tomorrow

hebdomadaire
weekly

mensuel
monthly

annuel
annual

.....
Quelle est la date aujourd'hui?
What's the date today?

C'est le sept février deux mille deux.
It's February seventh, two thousand and two.

les nombres • numbers

0	zéro • zero	20	vingt • twenty
1	un • one	21	vingt et un • twenty-one
2	deux • two	22	vingt-deux • twenty-two
3	trois • three	30	trente • thirty
4	quatre • four	40	quarante • forty
5	cinq • five	50	cinquante • fifty
6	six • six	60	soixante • sixty
7	sept • seven	70	soixante-dix • seventy
8	huit • eight	80	quatre-vingts • eighty
9	neuf • nine	90	quatre-vingt-dix • ninety
10	dix • ten	100	cent • one hundred
11	onze • eleven	110	cent dix • one hundred and ten
12	douze • twelve	200	deux cents • two hundred
13	treize • thirteen	300	trois cents • three hundred
14	quatorze • fourteen	400	quatre cents • four hundred
15	quinze • fifteen	500	cinq cents • five hundred
16	seize • sixteen	600	six cents • six hundred
17	dix-sept • seventeen	700	sept cents • seven hundred
18	dix-huit • eighteen	800	huit cents • eight hundred
19	dix-neuf • nineteen	900	neuf cents • nine hundred

1,000	mille • one thousand
10,000	dix mille • ten thousand
20,000	vingt mille • twenty thousand
50,000	cinquante mille • fifty thousand
55,500	cinquante-cinq mille cinq cents • fifty-five thousand five hundred
100,000	cent mille • one hundred thousand
1,000,000	un million • one million
1,000,000,000	un milliard • one billion

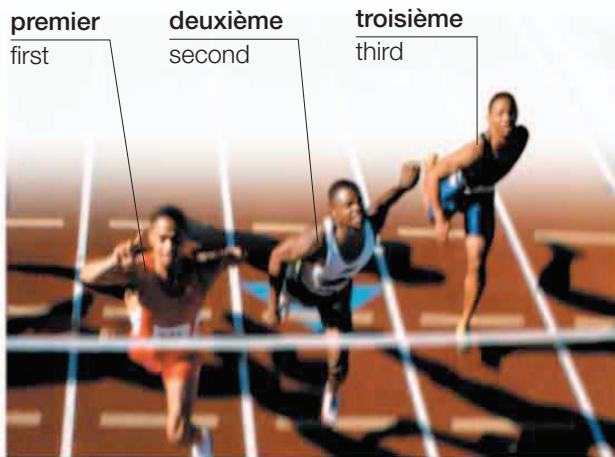

premier
first

deuxième
second

troisième
third

quatrième • fourth

cinquième • fifth

sixième • sixth

septième • seventh

huitième • eighth

neuvième • ninth

dixième • tenth

onzième • eleventh

douzième • twelfth

treizième • thirteenth

quatorzième • fourteenth

quinzième • fifteenth

seizième

• sixteenth

dix-septième

• seventeenth

dix-huitième

• eighteenth

dix-neuvième

• nineteenth

vingtième

• twentieth

vingt et unième

• twenty-first

vingt-deuxième

• twenty-second

vingt-troisième

• twenty-third

trentième • thirtieth

quarantième • fortieth

cinquantième • fiftieth

soixantième • sixtieth

soixante-dixième

• seventieth

quatre-vingtième

• eightieth

quatre-vingt-dixième

• ninetieth

centième

• one hundredth

les poids et mesures • weights and measures

la superficie • area

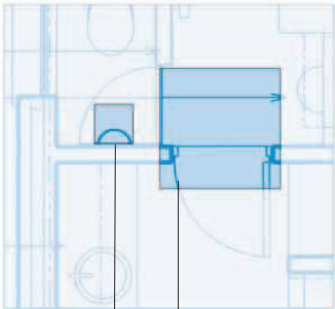

le pied carré
square foot

le mètre carré
square meter

la distance • distance

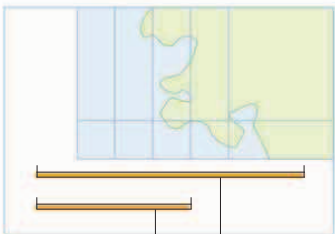

le kilomètre
kilometer

le mile
mile

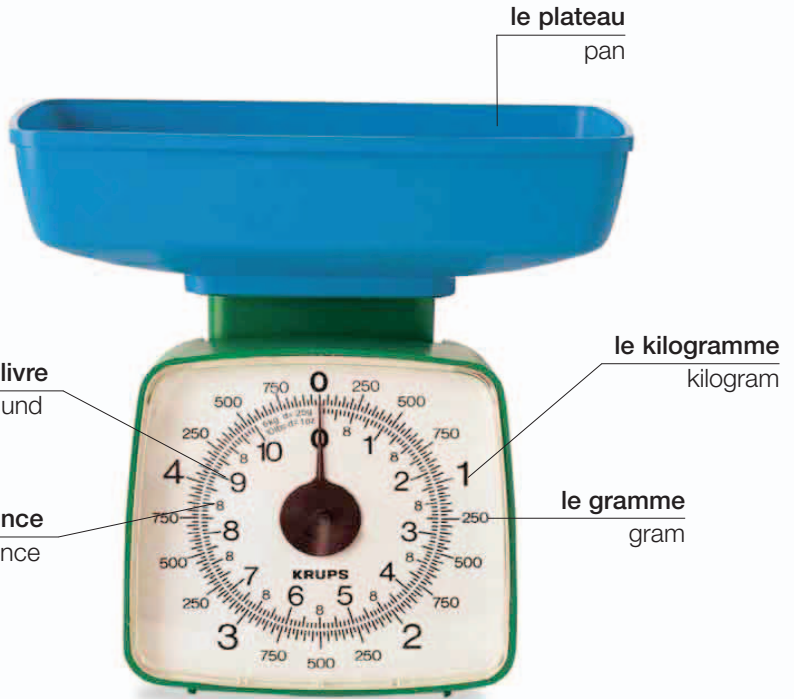

le plateau
pan

la livre
pound

l'once
ounce

le kilogramme
kilogram

le gramme
gram

la balance | scale

vocabulaire • vocabulary

le yard
yard

la tonne
ton

mesurer
measure (v)

le mètre
meter

le milligramme
milligram

peser
weigh (v)

la longueur • length

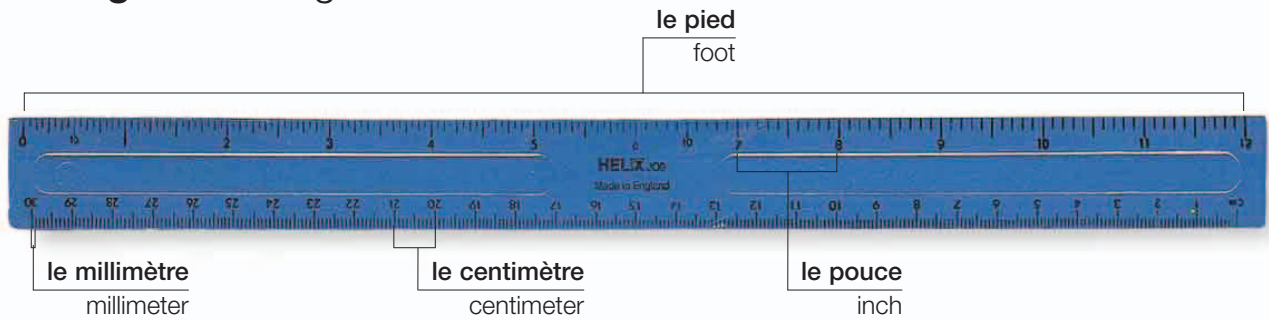

le pied
foot

le millimètre
millimeter

le centimètre
centimeter

le pouce
inch

la capacité • capacity

le demi-litre
half-liter

la pinte
pint

le volume
volume

le millilitre
milliliter



le verre mesureur
measuring cup



la mesure pour les liquides
liquid measure

vocabulaire •
vocabulary

le gallon
gallon

deux pintes
quart

le litre
liter

le récipient • container



la brique
carton



le paquet
packet



la bouteille
bottle



le sac
bag



le pot | tub



le pot | jar

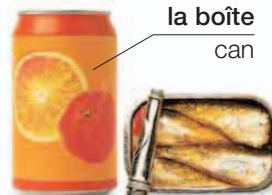

la boîte
can

la boîte | tin



le pulvérisateur
spray bottle



le pain
bar



le tube
tube



le rouleau
roll



le paquet
pack



la bombe
spray can

la carte du monde • world map

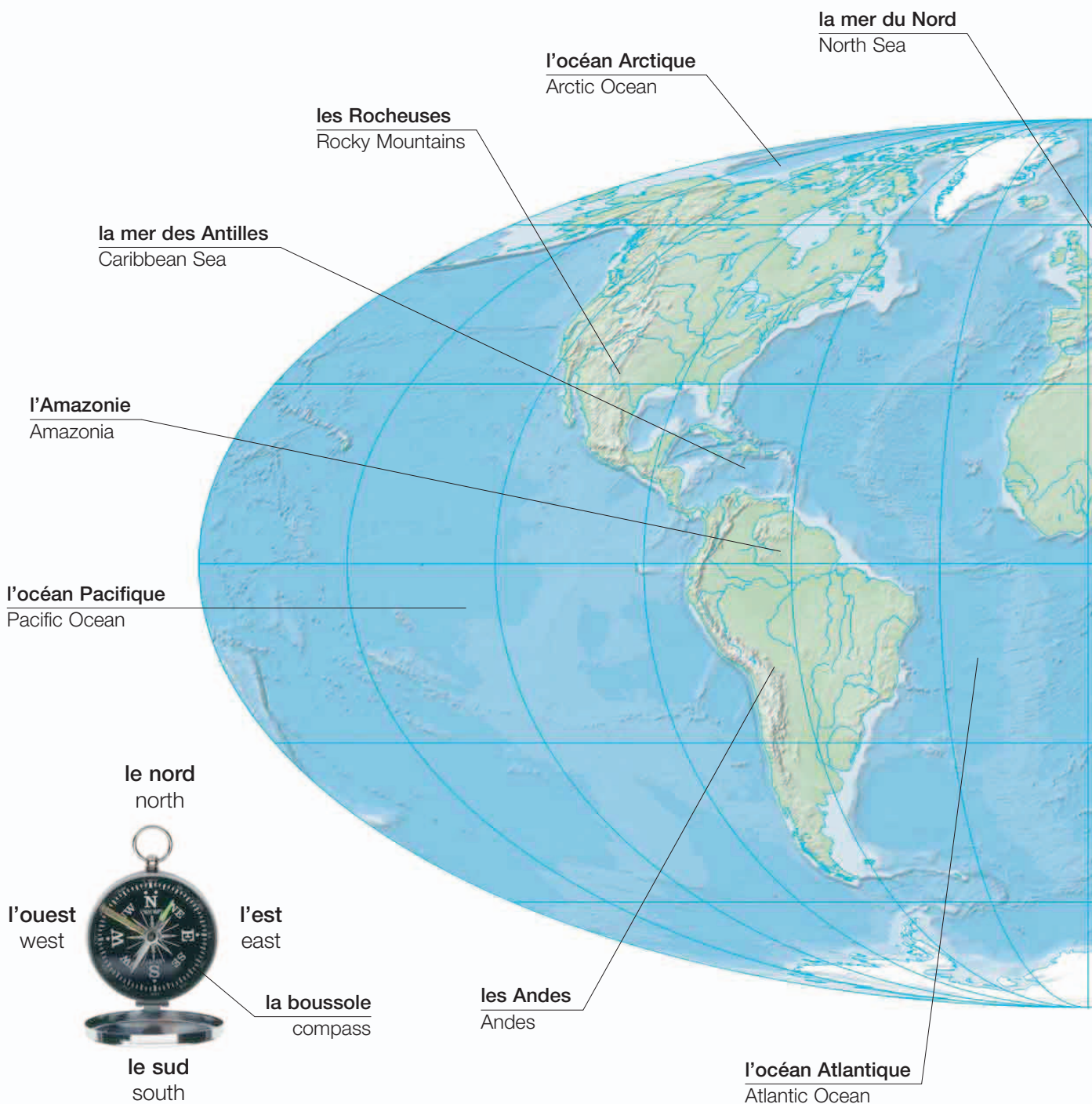

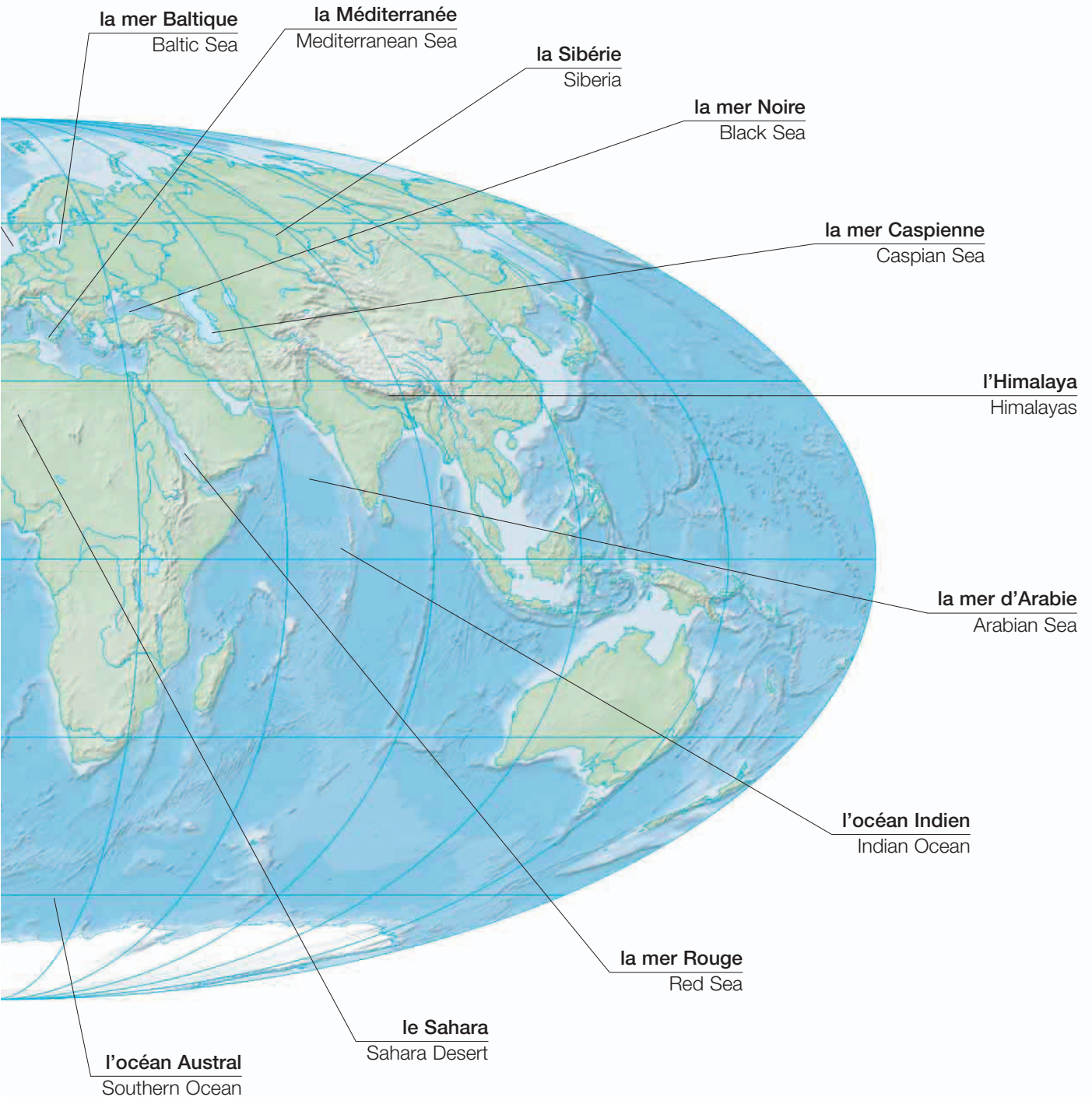

l'Amérique du Nord et centrale • North and Central America



- 1 **l'Alaska** • Alaska
- 2 **le Canada** • Canada
- 3 **le Groenland** • Greenland
- 4 **les États-Unis d'Amérique**
• United States of America
- 5 **le Mexique** • Mexico
- 6 **le Guatemala** • Guatemala
- 7 **(le) BÉLIZE** • Belize
- 8 **Le Salvador** • El Salvador
- 9 **le Honduras** • Honduras
- 10 **le Nicaragua** • Nicaragua
- 11 **le Costa Rica** • Costa Rica
- 12 **le Panama** • Panama
- 13 **Cuba** • Cuba
- 14 **les Bahamas** • Bahamas
- 15 **la Jamaïque** • Jamaica
- 16 **Haïti** • Haiti
- 17 **la République dominicaine**
• Dominican Republic
- 18 **la Porto Rico** • Puerto Rico
- 19 **la Barbade** • Barbados
- 20 **la Trinité-et-Tobago** • Trinidad and Tobago
- 21 **Saint-Kitts-et-Nevis** • St. Kitts and Nevis

- 22 **Antigua-et-Barbuda** • Antigua and Barbuda
- 23 **la Dominique** • Dominica
- 24 **Sainte-Lucie** • St. Lucia
- 25 **Saint-Vincent-et-les-Grenadines**
• St. Vincent and The Grenadines
- 26 **la Grenade** • Grenada

l'Amérique du Sud • South America



- 1 **le Venezuela** • Venezuela
- 2 **la Colombie** • Colombia
- 3 **l'Équateur** • Ecuador
- 4 **le Pérou** • Peru
- 5 **les îles Galapagos**
 - Galapagos Islands
- 6 **la Guyane** • Guyana
- 7 **le Surinam** • Suriname
- 8 **la Guyane française**
 - French Guiana
- 9 **le Brésil** • Brazil
- 10 **la Bolivie** • Bolivia
- 11 **le Chili** • Chile
- 12 **l'Argentine** • Argentina
- 13 **le Paraguay** • Paraguay
- 14 **l'Uruguay** • Uruguay
- 15 **les îles Malouines**
 - Falkland Islands

vocabulaire • vocabulary

le pays country	la province province	la zone zone
la nation nation	le territoire territory	le district district
l'État state	la colonie colony	la région region
le continent continent	la principauté principality	la capitale capital

I'Europe • Europe

- 1 **I'Irlande** • Ireland
- 2 **le Royaume-Uni** • United Kingdom
- 3 **le Portugal** • Portugal
- 4 **l'Espagne** • Spain
- 5 **les Baléares** • Balearic Islands
- 6 **l'Andorre** • Andorra
- 7 **la France** • France
- 8 **la Belgique** • Belgium
- 9 **les Pays-Bas** • Netherlands
- 10 **le Luxembourg**
 - Luxembourg
- 11 **l'Allemagne** • Germany
- 12 **le Danemark** • Denmark
- 13 **la Norvège** • Norway
- 14 **la Suède** • Sweden
- 15 **la Finlande** • Finland
- 16 **l'Estonie** • Estonia
- 17 **la Lettonie** • Latvia
- 18 **la Lituanie** • Lithuania
- 19 **Kaliningrad** • Kaliningrad
- 20 **la Pologne** • Poland
- 21 **la République tchèque**
 - Czech Republic
- 22 **l'Autriche** • Austria
- 23 **le Liechtenstein**
 - Liechtenstein
- 24 **la Suisse**
 - Switzerland
- 25 **l'Italie** • Italy
- 26 **Monaco**
 - Monaco
- 27 **la Corse**
 - Corsica
- 28 **la Sardaigne**
 - Sardinia
- 29 **le Saint-Marin** • San Marino
- 30 **la Cité du Vatican**
 - Vatican City
- 31 **la Sicile** • Sicily
- 32 **Malte** • Malta
- 33 **la Slovénie** • Slovenia
- 34 **la Croatie** • Croatia
- 35 **la Hongrie** • Hungary
- 36 **la Slovaquie** • Slovakia
- 37 **l'Ukraine** • Ukraine
- 38 **la Bélarus** • Belarus
- 39 **la Moldavie** • Moldova
- 40 **la Roumanie** • Romania
- 41 **la Serbie** • Serbia
- 42 **la Bosnie-Herzégovine**
 - Bosnia and Herzegovina
- 43 **l'Albanie** • Albania
- 44 **la Macédonie** • Macedonia
- 45 **la Bulgarie** • Bulgaria
- 46 **la Grèce** • Greece
- 47 **le Kosovo** • Kosovo
- 48 **Montenegro** • Montenegro
- 49 **l'Islande** • Iceland



l'Afrique • Africa

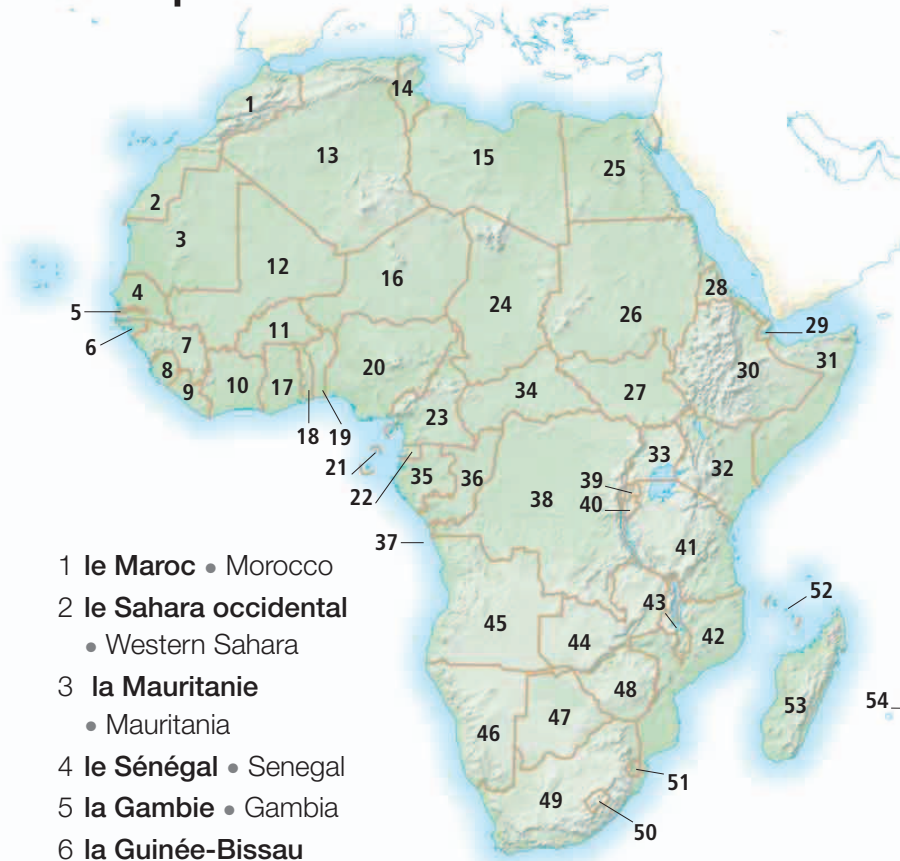

- 1 **le Maroc** • Morocco
 2 **le Sahara occidental**
 • Western Sahara
 3 **la Mauritanie**
 • Mauritania
 4 **le Sénégal** • Senegal
 5 **la Gambie** • Gambia
 6 **la Guinée-Bissau**
 • Guinea-Bissau
 7 **la Guinée** • Guinea
 8 **la Sierra Leone**
 • Sierra Leone
 9 **le Libéria** • Liberia
 10 **la Côte d'Ivoire**
 • Ivory Coast
 11 **le Burkina** • Burkina Faso
 12 **le Mali** • Mali
 13 **l'Algérie** • Algeria
 14 **la Tunisie** • Tunisia
 15 **la Libye** • Libya
 16 **le Niger** • Niger
 17 **le Ghana** • Ghana
 18 **le Togo** • Togo
 19 **le Bénin** • Benin
 20 **le Nigéria** • Nigeria
 21 **Sao Tomé-et-Principe**
 • São Tomé and Príncipe
 22 **la Guinée équatoriale**
 • Equatorial Guinea
 23 **le Cameroun** • Cameroon
 24 **le Tchad** • Chad
 25 **l'Égypte** • Egypt
 26 **le Soudan** • Sudan
 27 **le Soudan du Sud**
 • South Sudan
 28 **l'Érythrée** • Eritrea
 29 **Djibouti** • Djibouti
 30 **l'Éthiopie** • Ethiopia
 31 **la Somalie** • Somalia
 32 **le Kenya** • Kenya
 33 **l'Ouganda** • Uganda
 34 **la République centrafricaine**
 • Central African Republic
 35 **le Gabon** • Gabon
 36 **le Congo** • Congo
 37 **Cabinda** • Cabinda
 38 **la République démocratique du Congo** • Democratic Republic of the Congo
 39 **le Rwanda** • Rwanda
 40 **le Burundi** • Burundi
 41 **la Tanzanie** • Tanzania
 42 **le Mozambique**
 • Mozambique
 43 **le Malawi** • Malawi
 44 **la Zambie** • Zambia
 45 **l'Angola** • Angola
 46 **la Namibie** • Namibia
 47 **le Botswana** • Botswana
 48 **le Zimbabwe** • Zimbabwe
 49 **l'Afrique du Sud**
 • South Africa
 50 **le Lesotho** • Lesotho
 51 **le Swaziland** • Swaziland
 52 **les Comores** • Comoros
 53 **Madagascar** • Madagascar
 54 **l'île Maurice** • Mauritius

l'Asie • Asia

- 1 **la Turquie** • Turkey
- 2 **Chypre** • Cyprus
- 3 **la Fédération de Russie**
• Russian Federation
- 4 **la Géorgie** • Georgia
- 5 **l'Arménie** • Armenia
- 6 **l'Azerbaïdjan** • Azerbaijan
- 7 **l'Iran** • Iran
- 8 **l'Irak** • Iraq
- 9 **la Syrie** • Syria
- 10 **le Liban** • Lebanon
- 11 **Israël** • Israel
- 12 **la Jordanie** • Jordan
- 13 **l'Arabie Saoudite**
• Saudi Arabia
- 14 **le Koweït** • Kuwait
- 15 **Bahreïn** • Bahrain
- 16 **le Qatar** • Qatar
- 17 **les Émirats arabes unis**
• United Arab Emirates
- 18 **l'Oman** • Oman
- 19 **le Yémen** • Yemen
- 20 **le Kazakhstan** • Kazakhstan
- 21 **l'Ouzbékistan** • Uzbekistan
- 22 **le Turkménistan** • Turkmenistan
- 23 **l'Afghanistan** • Afghanistan
- 24 **le Tadjikistan** • Tajikistan
- 25 **le Kirghizistan** • Kyrgyzstan
- 26 **le Pakistan** • Pakistan
- 27 **l'Inde** • India
- 28 **les Maldives** • Maldives
- 29 **Sri Lanka** • Sri Lanka
- 30 **la Chine** • China
- 31 **la Mongolie** • Mongolia
- 32 **la Corée du Nord** • North Korea
- 33 **la Corée du Sud** • South Korea
- 34 **le Japon** • Japan
- 35 **le Népal** • Nepal
- 36 **le Bhoutan** • Bhutan
- 37 **le Bangladesh** • Bangladesh
- 38 **la Birmanie (le Myanmar)**
• Burma (Myanmar)
- 39 **la Thaïlande** • Thailand
- 40 **le Laos** • Laos
- 41 **le Vietnam** • Vietnam



l'Australasie • Australasia



- 1 l'Australie • Australia
- 2 la Tasmanie • Tasmania
- 3 la Nouvelle-Zélande • New Zealand

- 42 le Cambodge • Cambodia
- 43 la Malaisie • Malaysia
- 44 Singapour • Singapore
- 45 l'Indonésie • Indonesia
- 46 le Brunei • Brunei
- 47 les Philippines • Philippines
- 48 le Timor oriental • East Timor
- 49 la Papouasie-Nouvelle-Guinée
• Papua New Guinea
- 50 les îles Salomon • Solomon Islands
- 51 Vanuatu • Vanuatu
- 52 Fidji • Fiji

particules et antonymes • particles and antonyms

à to	de from	pour for	vers toward
au-dessus de over	sous under	le long de along	à travers across
devant in front of	derrière behind	avec with	sans without
sur onto	dans into	avant before	après after
dans in	dehors out	avant by	jusqu'à until
au-dessus de above	au-dessous de below	tôt early	tard late
à l'intérieur de inside	à l'extérieur de outside	maintenant now	plus tard later
en haut up	en bas down	toujours always	jamais never
à at	au-delà de beyond	souvent often	rarement rarely
à travers through	autour de around	hier yesterday	demain tomorrow
sur on top of	à côté de beside	premier first	dernier last
entre between	en face de opposite	chaque every	quelque some
près de near	loin de far	vers about	exactement exactly
ici here	là there	un peu a little	beaucoup a lot

grand large	petit small	chaud hot	froid cold
large wide	étroit narrow	ouvert open	fermé closed
grand tall	court short	plein full	vide empty
haut high	bas low	neuf new	vieux old
épais thick	mince thin	clair light	foncé dark
léger light	lourd heavy	facile easy	difficile difficult
dur hard	mou soft	libre free	occupé occupied
humide wet	sec dry	fort strong	faible weak
bon good	mauvais bad	gros fat	mince thin
rapide fast	lent slow	jeune young	vieux old
juste correct	faux wrong	mieux better	pire worse
propre clean	sale dirty	noir black	blanc white
beau beautiful	laid ugly	intéressant interesting	ennuyeux boring
cher expensive	bon marché cheap	malade sick	bien well
silencieux quiet	bruyant noisy	le début beginning	la fin end

phrases utiles • useful phrases

phrases essentielles

• essential phrases

Oui

Yes

Non

No

Peut-être

Maybe

S'il vous plaît

Please

Merci

Thank you

De rien

You're welcome

Pardon

Excuse me

Je suis désolé

I'm sorry

Ne... pas

Don't

D'accord

OK

Très bien

That's fine

C'est juste

That's correct

C'est faux

That's wrong

salutations

• greetings

Bonjour

Hello

Au revoir

Goodbye

Bonjour

Good morning

Bonjour

Good afternoon

Bonsoir

Good evening

Bonne nuit

Good night

Comment allez-vous?

How are you?

Je m'appelle...

My name is...

Vous vous appelez comment?

What is your name?

Il/Elle s'appelle comment?

What is his/her name?

Je vous présente...

May I introduce...

C'est...

This is...

Enchanté

Pleased to meet you

À tout à l'heure

See you later

panneaux • signs

Office de tourisme

Tourist information

Entrée

Entrance

Sortie

Exit

Sortie de secours

Emergency exit

Poussez

Push

Danger

Danger

Défense de fumer

No smoking

En panne

Out of order

Heures d'ouverture

Opening times

Entrée gratuite

Free admission

Journée continue

Open all day

Prix réduit

Reduced price

Soldes

Sale

Frappez avant d'entrer

Knock before entering

Défense de marcher sur la pelouse

Keep off the grass

assistance • help

Pouvez-vous m'aider?

Can you help me?

Je ne comprends pas

I don't understand

Je ne sais pas

I don't know

Vous parlez anglais, français...?

Do you speak English, French...?

Je parle anglais, espagnol...

I speak English, Spanish...

Parlez moins vite, s'il vous plaît

Please speak more slowly

Écrivez-le pour moi, s'il vous plaît

Please write it down for me

J'ai perdu...

I have lost...

directions

- directions

Je me suis perdu

I am lost

Où est le/la...?

Where is the...?

Où est le/la...le/la plus proche?

Where is the nearest...?

Où sont les toilettes?

Where are the restrooms?

Pour aller à...?

How do I get to...?

À droite

To the right

À gauche

To the left

Tout droit

Straight ahead

C'est loin...?

How far is...?

les panneaux routiers

- road signs

Toutes directions

All directions

Prudence

Caution

Entrée interdite

No entry

Ralentir

Slow down

Déviation

Detour

Serrez à droite

Keep right

Autoroute

Freeway

Stationnement interdit

No parking

Passage interdit

No through road

Sens unique

One-way street

Autres directions

Other directions

Riverains autorisés

Residents only

Travaux

Road construction

Virage dangereux

Dangerous bend

logement •

accommodation

J'ai réservé une chambre

I have a reservation

Où est la salle à manger?

Where is the dining room?

Le numéro de ma chambre est le ...

My room number is ...

Le petit déjeuner est à quelle heure?

What time is breakfast?

Je serai de retour à ... heures

I'll be back at ... o'clock

Je pars demain

I'm leaving tomorrow

nourriture et boissons

- eating and drinking

À la vôtre!

Cheers!

C'est**délicieux/terrible**

It's delicious/awful

Je ne bois/fume pas

I don't drink/smoke

Je ne mange pas de la viande

I don't eat meat

Je n'en veux plus, merci

No more for me, thank you

Encore un peu, s'il vous plaît.

May I have some more?

L'addition, s'il vous plaît.

May we have the bill/check?

Je voudrais un reçu.

Can I have a receipt?

Partie non-fumeurs

No-smoking area

la santé

- health

Je ne me sens pas bien

I don't feel well

J'ai envie de vomir

I feel sick

Pouvez-vous me donner le numéro de téléphone du docteur le plus proche?

What is the telephone number of the nearest doctor?

J'ai mal ici

It hurts here

J'ai de la fièvre

I have a fever

Je suis enceinte de ...mois

I'm ... months pregnant

J'ai besoin d'une ordonnance pour ...

I need a prescription for ...

Je prends habituellement ...

I normally take ...

Je suis allergique à ...

I'm allergic to ...

index français • French index

- A**
à 320
à armature 35
à côté de 320
à deux portes 200
à droite 260
à emporter 154
à feuilles caduques 86
à feuilles persistantes 86
à gauche 260
à genou 34
à grains longs 130
à grains ronds 130
à impériale 260
à l'extérieur de 320
à l'heure 305
à l'intérieur de 320
à la carte 152
à l'huile 143
à quatre portes 200
à sens unique 194
à travers 320
à trois portes 200
abats *m* 118
abdominaux *m* 16
abeille *f* 295
abribus *m* 197
abricot *m* 126
acacia *m* 110
accélérateur *m* 200, 204
accès aux handicapés *m* 197
accessoires *m* 36, 38
accessoires de toilette *m* 41
accident *m* 46
accident de voiture *m* 203
accompagnement *m* 153
accotement stabilisé *m* 194
accouchement *m* 52
accouchement assisté *m* 53
accouder *m* 200, 210
accusation *f* 94, 180
accusé *m* 180, 181
acquitté 181
acrylique *m* 274
acte de naissance *m* 26
acte judiciaire *m* 180
acteur *m* 254
acteurs *m* 179
action *f* 97
actions *f* 97, 233, 227, 229, 237
activités *f* 77, 162, 183, 245, 263
activités de plein air *f* 262
actrice *f* 254
acuponcture *f* 55
acupression *f* 55
addition *f* 152
ajouter 165
admis 48
adolescente *f* 23
adresse e-mail *f* 177
adulte *m* 23
adversaire *f* 236
adzukis *m* 131
aéroboxe *m* 251
aéroglesseur *m* 215
aéroport *m* 212
affaires *f* 175
affiche *f* 255
Afghanistan 318
Afrique 317
Afrique du Sud 317
after-shave *m* 73
agate *f* 289
agence de voyage *f* 114
agenda *m* 173, 175
agenda électronique *m* 175
agent de conservation *m* 83
agent de la bourse *m* 97
agent de la circulation *m* 195
agent de voyage *m* 190
agent immobilier *m* 115, 189
aggloméré *m* 79
agitateur *m* 150
agneau *m* 118, 185
agrafe *f* 276
agrafes *f* 173
agrafeuse *f* 173
agrandir 172
agrandissement *m* 58, 271
agression *f* 94
agriculteur *m* 182
agrumes *m* 126
aigle *m* 292
aiglefin *m* 120
aigre 127
aigue-marine *f* 288
aiguille *f* 109, 276
aiguille à tricoter *f* 277
aiguiseur *m* 68
aikido *m* 236
ail *m* 125, 132
aile *f* 60, 119, 210, 293
aileron *m* 210
ailes de raie *f* 120
aimant *m* 167
aine *f* 12
airbag *m* 201
aire *f* 165
aire de stationnement *f* 199, 212
aisselle *f* 13
ajusté 35
alarme *f* 58
Alaska 314
Albanie 316
album de photos *m* 271
alésoir *m* 80
Algérie 317
alimentation *f* 105
aliments en bouteille *m* 134
allaitement *m* 53
allant au four 69
allée *f* 58, 85, 106, 254
Allemagne 316
allergie *f* 44
alligator *m* 293
allonge *f* 118
allumage *m* 200
allume-feu *m* 266
allumer la télévision 269
allumer un feu 266
alternateur *m* 203
altitude *f* 211
alto *m* 256
aluminium *m* 289
amande *f* 129
amandes *f* 151
amarres *f* 217
Amazonie *f* 312
amer 124
Amérique centrale 314
Amérique du Nord 314
améthyste *f* 288
ameublement *m* 105
ami *m* 24
amniocentèse *f* 52
amorcer *f* 244
amorcer 245
amorti *m* 230
ampère *m* 60
amphibiens *m* 294
amplificateur *m* 268
ampoule *f* 46, 60
ampoule basse consommation *f* 60
amuse-gueule *m* 151
an *m* 306
analgésique *m* 109
analgésiques *m* 47
analogique 179
analyse *f* 49
analyse de sang *f* 48
ananas *m* 128
ancrer *f* 214, 240
Andes *f* 312
Andorre 316
âne *m* 185
anesthésiste *m* 48
aneth *f* 133
angle *m* 164
Angola 317
anguille *f* 294
animalerie *f* 115
animaux *m* 292, 294
anis *m* 133
anneau *m* 226
anneaux *m* 89, 235
anniversaire *m* 27
anniversaire de mariage *m* 26
annuel 86, 307
annulaire *m* 15
anorak *m* 31, 33
anse *f* 106
antenne *f* 295
antenne parabolique *f* 269
antenne radio *f* 214
anti-adhérent 69
antigel *m* 199, 203
Antigua-et-Barbuda 314
anti-inflammatoire *m* 109
antrides 41
antiseptique *m* 47
antivol *m* 207
août *m* 306
apéritif *m* 153
appareil de chauffage *m* 60
appareil de gym *m* 250
appareil dentaire *m* 50
appareil instantané *m* 270
appareil jetable *m* 270
appareil numérique *m* 270
appareil photo *m* 260
appareils électriques *m* 105
appareils ménagers *m* 66
apparence *f* 30
appartement *m* 59
appât *m* 244
appel *m* 181
appendice *m* 18
applaudir 255
appli *m* 99
application *f* 176
applique *f* 62
apprendre 163
apprêt *m* 83
après 320
après-demain 307
après-midi *f* 305
après-shampooing *m* 38
après-soleil *m* 108
aquarelle *f* 274
Arabie Saoudite 318
araignée *f* 295
arbitre *m* 222, 225, 226, 229, 230
arbre *m* 86, 296
arbre de transmission *m* 202
arbuste à fleurs *m* 87
arc *m* 164, 249, 300
arceau *m* 85
arc-en-ciel *m* 287
architecte *m* 190
architecture *f* 300
architrave *f* 301
ardoise *f* 288
arène *f* 243
arête *f* 121
argent *m* 97, 235, 289
Argentine 315
argile *f* 85, 275
arithmétique *f* 165
Arménie 318
armoire *f* 70
armoire à pharmacie *f* 72
armoire encastrée *f* 71
aromathérapie *f* 55
arrestation *f* 94
arrêt *m* 269
arrêt de bus *m* 197, 299
arrêt interdit 195
arrière *m* 240
arrivée *f* 61
arrivées *f* 213
arrosage *m* 89
arroser 90, 183
arroseeur *m* 89
art *m* 162
art déco 301
art nouveau 301
artère *f* 19
artichaut *m* 124
articles de sport *m* 105
articles de toilette *m* 107
articles pour bébés *m* 107
articulation *f* 17
articulation du doigt *f* 15
artiste peintre *f* 274
arts et métiers *m* 274, 276
arts martiaux *m* 237
as *m* 230, 273
ascenseur *m* 59, 100, 104
Asie 318
asperge *f* 124
asperger 91
aspirateur *m* 77, 188
assaisonné 159
assiette *f* 65
assiette à dessert *f* 65
assiette à soupe *f* 65
assiette plate *f* 65
assignation *f* 180
assistant *m* 169
assistante *f* 24
assister à 174
associée *f* 24
assouplisseur *m* 76
astéroïde *m* 280

- asthme *m* 44
 astigmatisme *m* 51
 astronaute *m* 281
 astronomie *f* 281
 atelier *m* 78
 athlète *m* 234
 athlétisme *m* 234
 atmosphère *f* 282, 286
 atrium *m* 104
 attaches *f* 89
 attaque *f* 44, 220
 attelle *f* 47
 attenante 58
 attendrisseur *m* 69
 atterrir 211
 attraction touristique *f* 260
 attractions *f* 261
 attraper 225, 227, 229, 220, 245
 au carré 39
 au revoir 322
 au sirop 159
 aube *f* 305
 aubergine *f* 125
 auburn 39
 au-delà de 320
 au-dessous de 320
 au-dessus de 320
 auge *f* 183
 aujourd'hui 306
 auriculaire *m* 15
 aurore *f* 286
 Australasie 319
 Australie 319
 autobronzant *m* 41
 autodéfense *f* 237
 automatique 200
 automne *m* 31, 307
 autoneige *m* 247
 autopont *m* 194
 autoroute *f* 194
 autour de 320
 autres arts *m* 275
 autres bateaux *m* 215
 autres magasins *m* 114
 autres sports *m* 248
 Autriche 316
 autruche *f* 292
 aux pépites de chocolats 141
 avalanche *f* 247
 avance rapide *f* 269
 avant 320
 avant *m* 240
 avant *m* 222
 avantage *m* 230
 avant-bras *m* 12
 avant-hier 307
 avant-toit *m* 58
 avec 320
 avec plomb 199
 avenue *f* 299
 averse *f* 286
 avertisseur d'incendie *m* 95
- avion *m* 210
 avion de ligne *m* 210, 212
 avion léger *m* 211
 avocat *m* 128, 180, 190
 avoine *f* 130
 avoir faim 64
 avoir un bébé 26
 avril *m* 306
 Azerbaïdjan 318
- B**
 babeurre *m* 137
 bac à légumes *m* 67
 bac à peinture *m* 83
 bac à sable *m* 263
 bacon *m* 118, 157
 badge *m* 94, 189
 badminton *m* 231
 baffle *m* 268
 bagages *m* 100, 198, 213
 bagages à main *m* 211, 213
 bague *f* 36
 baguette *f* 138, 256
 Bahamas 314
 baie *f* 296
 baignoire *f* 72
 baignoire en plastique *f* 74
 bâiller 25
 bain moussant *m* 73
 balai *m* 77
 balai à gazon *m* 88
 balai laveur *m* 77
 balance *f* 45, 69, 98, 118, 166, 212, 310
 balance à ressort *f* 166
 balancier *m* 276
 balançoire *f* 263
 balayer 77
 balayette *f* 77
 balcon *m* 59, 254
 Baléares 316
 baleine *f* 290
 balle *f* 75, 130, 184, 224, 228, 230
 balle de criquet *f* 225
 balle de golf *f* 233
 ballerine *f* 37
 ballet *m* 255
 ballon *m* 221, 220, 222, 226
 ballon de plage *m* 265
 ballon lancé *m* 226
 bambou *m* 86, 122
 banane *f* 128
 banc *m* 250, 262
 banc à pique-nique *m* 266
 banc de touche *m* 229
 banc des jurés *m* 180
 bandage *m* 47
 bande de roulement *f* 207
- bande dessinée *f* 112
 bande fluorescente *f* 205
 bande sonore *f* 255
 Bangladesh 318
 banlieue *f* 299
 banque *f* 96
 baptême *m* 26
 bar *m* 120, 150, 152
 Barbade 314
 barbecue *m* 267
 barbillon *m* 244
 barman *m* 150, 191
 bar-mitsvah *f* 26
 baroque 301
 barque *f* 214
 barrage *m* 300
 barre *f* 207, 235, 240, 250
 barre à poids *f* 251
 barre d'outils *f* 177
 barre de défilement *f* 177
 barre de menus *f* 177
 barre de mesure *f* 256
 barre fixe *f* 235
 barre transversale *f* 222
 barreaux *m* 74
 barres asymétriques *f* 235
 barres parallèles *f* 235
 barrière *f* 182
 barrière d'escalier *f* 75
 barrière de sécurité *f* 246
 bas 321
 bas *m* 35
 basalte *m* 288
 bascule *f* 263
 base *f* 99, 164, 229
 base du batteur *f* 228
 baseball *m* 228
 basilic *m* 133
 basket *m* 226
 basket *f* 37
 baskets *m* 251
 baskets *f* 31
 bassin *m* 17, 85
 bassin *m* 257
 bateau de pêche *m* 217
 bâtiments *m* 299
 bâtir 277
 bâton *m* 235
 bâton de ski *m* 246
 bâtons *m* 133
 batter 229
 batterie *f* 202, 258
 batteur *m* 225, 228
 battre 67, 273
 battre un record 234
 bavoir *m* 30, 50
 beat *m* 259
 beau-fils *m* 23
 beau-frère *m* 23
- beau-père *m* 23
 beauté *f* 40, 105
 bébé *m* 23, 30
 bébé-phoque *m* 290
 bec *m* 293
 bec Bunsen *m* 166
 bécarre *m* 256
 bêche *f* 88
 bécher *m* 167
 bécher 90
 beignets de poulet *m* 155
 Bélarus 316
 Belgique 316
 Bélize 314
 belle-fille *f* 22, 23
 belle-mère *f* 23
 belle-sœur *f* 23
 bémol *m* 256
 Bénin 317
 béquille *f* 205, 207
 berline *f* 199
 berline à hayon *f* 199
 bermuda *m* 30
 bétail *m* 182
 bétonnière *f* 186
 bette *f* 123
 betterave *f* 125
 beurre *m* 137, 156
 beurre de cacahuètes *m* 135
 Bhoutan 318
 biathlon *m* 247
 biberon *m* 75
 bibliothécaire *m* 190
 bibliothécaire *f* 168
 bibliothèque *f* 63, 168, 299
 biceps *m* 16
 bicyclette *f* 206
 bidet *m* 72
 bière *f* 145, 151
 bière anglaise *f* 145
 bière brune *f* 145
 bifocal 51
 bifteck d'aloyau *m* 119
 bijouterie *f* 114
 bijoutier *m* 188
 bijoux *m* 36
 bikini *m* 264
 billard *m* 249
 billard américain *m* 249
 billet *m* 97, 209, 213
 billets de loterie *m* 112
 biologie *f* 162
 biologique 91, 122
 biplan *m* 211
 Birmanie 318
 bis *m* 255
 bisannuel 86
 biscuit *m* 113
 biscuit scandinave *m* 139, 156
 biscuits *m* 141
 blanc 39, 145, 272, 274
 blanc *m* 119
- blanc d'œuf *m* 137
 blazer *m* 33
 blé *m* 130, 184
 blé écrasé *m* 130
 blessure *f* 46
 bleu 274
 bleu *m* 136
 bleu *m* 82
 bloc de béton *m* 187
 blocage *m* 237
 bloc-note 173
 blond 39
 bloquer 227
 blues *m* 259
 bobine *f* 276
 bobine de fil *f* 276
 bobsleigh *m* 247
 bocal scellé *m* 135
 bœuf *m* 118
 bois *m* 79, 187, 233, 257, 275, 285
 bois dur *m* 79
 bois tendre *m* 79
 boisson en boîte *f* 154
 boisson maltée *f* 144
 boisson non alcoolisée *f* 154
 boissons *f* 107, 144, 156
 boissons alcoolisées *f* 145
 boissons chaudes *f* 144
 boissons non alcoolisées *f* 144
 boîte *f* 145, 311
 boîte à bijoux *f* 36
 boîte à déchets recyclables *f* 61
 boîte à fusibles *f* 60
 boîte à onglets *f* 81
 boîte à outils *f* 80
 boîte aux lettres *f* 58, 99
 boîte d'équipement *f* 244
 boîte de chocolats *f* 113
 boîte de kleenex *f* 70
 boîte de réception *f* 177
 boîte de tri *f* 61
 boîte de vitesses *f* 202, 204
 boîte d'outils *f* 207
 bol *m* 65
 bol du mixeur *m* 66
 Bolivie 315
 bollard *m* 214
 bombardier *m* 211
 bombe *f* 242, 311
 bôme *m* 240
 bon 321
 bonbon à la menthe *m* 113
 bonbon au fruit *m* 113
 bonbons *m* 113
 bonbons assortis *m* 113
 bonde *f* 72
 bongos *m* 257

- bonjour 322
 bonne nuit 322
 bonnet de natation *m*
 238
 bonsoir 322
 bord du trottoir *m* 298
 bordure de plantes
 herbacées *f* 85
 bordure de plantes
 mixtes *f* 85
 borne *f* 298
 borne d'incendie *f* 95
 Bosnie-Herzégovine 316
 bosse *f* 291
 Botswana 317
 botte *f* 37, 111, 242
 botter 221, 223
 bottes *f* 89
 bottes de caoutchouc *f*
 31
 bottes de pêche *f* 244
 bouche *f* 14
 bouche d'égout *f* 299
 boucher *m* 118, 188
 boucherie *f* 114
 bouchon *m* 134, 166
 bouchon d'objectif *m* 270
 boucle *f* 36
 boucle d'oreille *f* 36
 boudin *m* 157
 boudoirs *m* 141
 bouée *f* 217, 265
 bouée de sauvetage *f*
 240
 bougie *f* 203
 bougies d'anniversaire *f*
 141
 bouillir 67
 bouilloire électrique *f* 66
 bouillon *m* 158
 bouillotte *f* 70
 boulanger *m* 139
 boulangerie *f* 107, 114,
 138
 boule *f* 149
 boule de bowling *f* 249
 bouleau *m* 296
 boules de coton *f* 41
 boulettes de viande *f*
 158
 bouquet *m* 35, 111
 bouquet garni *m* 132
 bourgeon *m* 111
 bourriche *f* 244
 bourse *f* 97, 169
 boussole *f* 312
 bouteille *f* 61, 135, 166,
 311
 bouteille d'eau *f* 206,
 267
 bouteille d'air *f* 239
 boutique *f* 115
 boutique d'art *f* 115
 boutique de cadeaux *f*
 114
 boutique hors
- taxes *f* 213
 bouton *m* 31, 32, 297
 bouton d'appel *m* 48
 bouton d'arrêt *m* 197
 bouton de manchette *m*
 36
 bouton de mise
 au point *m* 167
 bouton de porte *m* 59
 boutonnière *f* 32
 bouton-pression *m* 30
 bowling *m* 249
 box *m* 269
 boxe *f* 236
 boxe thaïlandaise *f* 236
 bracelet *m* 36
 bracelet d'identité *m* 53
 brancard *m* 94
 branche *f* 296
 brandy *m* 145
 bras *m* 13, 88
 brassard *m* 45
 brasse *f* 239
 brassière *f* 238
 break *m* 199
 Brésil 315
 bretelle *f* 35, 37
 bretelle d'accès *f* 194
 bretelle de sortie *f* 194
 bride *f* 241, 242
 bridge *m* 273
 brie *m* 142
 brillant 83
 brillant à lèvres *m* 40
 brillant 271
 brindille *f* 296
 brioche *f* 157
 brique *f* 136, 187, 311
 briquet *m* 112
 brise-bise *m* 63
 broche *f* 36, 60, 68
 brochure *f* 175
 brochure de vacances *f*
 212
 brocoli *m* 123
 broderie *f* 277
 bronzage *m* 41
 bronze *m* 235
 brosse *f* 38, 72, 83
 brosse à dents *f* 72
 brosse à encoller *f* 82
 brosse à sourcils *f* 40
 brosse à tapisser *f* 82
 brosse pour le dos *f* 73
 brosser 38, 50
 brouette *f* 88
 brouillard *m* 287
 broyeur d'ordures *m* 61
 brûleur *m* 67
 brûleur à gaz *m* 61
 brulure *f* 46
 brume *f* 287
 Brunei 319
 bruyère *f* 297
 buanderie *f* 76
 buffet *m* 152
- buffet du petit déjeuner *m*
 156
 buggy *m* 232
 bulbe *m* 86
 Bulgarie 316
 bunker *m* 232
 bureau 172
 bureau *m* 24, 63, 174,
 177
 bureau de change *m* 97
 bureau des douanes *m*
 216
 bureau du chef *m* 266
 burin *m* 81, 275
 Burkina 317
 Burundi 317
 bus *m* 196
 bus à deux étages *m*
 196
 bus de touristes *m* 197
 bus scolaire *m* 196
 bus touristique *m* 260
 but *m* 221, 223, 224
 bytes *m* 176
- C**
 cabane *f* 84
 cabine d'essayage *f* 104
 Cabinda 317
 cabine *f* 95, 210, 214
 cabine de plage *f* 264
 cabine du conducteur *f*
 208
 cabine téléphonique *f* 99
 cabinet *m* 45, 180
 câble *m* 79, 207
 câble électrique *m* 176,
 209
 cabriolet *f* 235
 cabriolet sport *m* 198
 cacahouète *f* 129
 cacahouètes *f* 151
 cacao *m* 156
 cacatoès *m* 293
 cachet 173
 cachets
 antinaupathiques *m*
 109
 cactus *m* 87
 caddie *m* 106, 208, 233
 cadeau *m* 27
 cadre *m* 62, 174, 206,
 230, 267
 cadre de photo *m* 271
 cafard *m* 295
 café *m* 144, 148, 153,
 156, 184, 262
 café filtre *m* 148
 café glacé *m* 148
 café moulu *m* 144
 cafetière *f* 65
 cage à poules *f* 263
 cage thoracique *f* 17
 cahier *m* 163
 caille *f* 119
 caisse *f* 106, 150, 255
- caisse claire *f* 257
 caissier *m* 96, 106
 cake *m* 140
 calamar *m* 121
 calcaire *m* 288
 calcite *f* 289
 calcium *m* 109
 calculatrice *f* 165
 cale *f* 215, 233
 cale sèche *f* 217
 caleçon *m* 33
 calendrier *m* 306
 cale-pied *m* 207
 calice *m* 297
 calmar *m* 295
 Cambodge 318
 cambriolage *m* 94
 cambure *f* 15
 camembert *m* 142
 caméra *f* 178
 cameraman *m* 178
 Cameroun 317
 caméscope *m* 260, 269
 camion *m* 194
 camionneur *m* 190
 camisole *f* 35
 camomille *f* 149
 Campari *m* 145
 camper 266
 camping *m* 266
 camping-car *m* 266
 campus *m* 168
 Canada 314
 canapé *m* 62, 155
 canapé-lit *m* 63
 canard *m* 119, 185
 canari *m* 292
 caneton *m* 185
 canine *f* 50
 caniveau *m* 299
 canne *f* 91
 canne à pêche *f* 244
 canne à sucre *f* 184
 canneberge *f* 127
 cannelle *f* 133
 Cannes *f* 89
 canoë *m* 214, 241
 canot pneumatique *m*
 215
 canot de sauvetage *m*
 214
 capacité *f* 311
 cape cervicale *f* 21
 capitaine *m* 214
 capitaine de port *m* 217
 capitale *f* 315
 capoeira *m* 237
 capot *m* 198
 capote *f* 75
 cappuccino *m* 148
 câpres *f* 143
 capuche *f* 31
 car *m* 196
 caractéristiques *f* 282
 carambole *f* 128
 caramel *m* 113
- carapace *f* 293
 caravane *f* 266
 cardamome *f* 132
 cardigan *m* 32
 cardiologie *f* 49
 cardio-vasculaire 19
 cargaison *f* 216
 cargo *m* 215
 carie *f* 50
 carnaval *m* 27
 carnet 172
 carnet à croquis *m* 275
 carnet de chèques *m* 96
 carotte *f* 124
 carpe koi *f* 294
 carquois *m* 249
 carre *f* 246
 carré *m* 164
 carreau *m* 273
 carrefour *m* 194, 298
 carreler 82
 carrosserie *f* 202
 cartable *m* 162
 carte *f* 27, 153, 154
 carte bancaire *f* 96
 carte d'embarquement *f*
 213
 carte de crédit *f* 96
 carte de lecteur *f* 168
 carte des vins *f* 152
 carte du monde *f* 312
 carte postale *f* 112
 cartilage *m* 17
 carton *m* 275
 carton jaune *m* 223
 carton rouge *m* 223
 cascade *f* 285
 case *f* 272
 casier *m* 100
 casier à bagages *m* 210
 casier judiciaire *m* 181
 casiers *m* 239
 casino *m* 261
 casque *m* 95, 204, 206,
 220, 224, 228
 casque de sécurité *m*
 186
 casquette *f* 36
 casserole *f* 69
 cassette *f* 269
 cassis *m* 127
 catamaran *m* 215
 cataphote *m* 207
 cataracte *f* 51
 cathédrale *f* 300
 cathéter *m* 53
 cause *f* 180
 caution *f* 181
 cavalier *m* 242, 272
 caverne *f* 284
 CD *m* 269
 cèdre *m* 296
 ceinture *f* 32, 35, 36,
 236
 ceinture à outils *f* 186
 ceinture de plomb *f* 239

- ceinture de sécurité *f*
198
- ceinture de sécurité *f*
211
- ceinture noire *f* 237
- céleri *m* 122, 124
- cellule *f* 94, 181
- cedre *f* 283
- cedres d'os *f* 88
- cedrier *m* 150
- cent 308
- cent dix 308
- cent mille 308
- centième 309
- centimètre *m* 276, 310
- centre *m* 164
- centre commercial *m*
104
- centre de pisciculture *m*
183
- cerceau *m* 277
- cercle *m* 165
- cercle central *m* 222,
224, 226
- cercle de jeu *m* 224
- cercle polaire arctique *m*
283
- céréale *f* 130
- céréales *f* 107, 130, 156
- céréales traitées *f* 130
- cérémonie de la remise
des diplômes *f* 169
- cerf *m* 291
- cerise *f* 126
- cerveau *m* 19
- césarienne *f* 52
- cette semaine 307
- chaîne *f* 36, 178, 206,
269
- chaîne à péage *f* 269
- chaîne de montagnes *f*
282
- chaîne de sûreté *f* 59
- chaîne hi-fi *f* 268
- chair *f* 127, 129
- chaise *f* 64
- chaise haute *f* 75
- chaise roulante *f* 48
- chaise tournante *f* 172
- chambre *f* 58, 70, 283
- chambre à air *f* 207
- chambre à deux lits *f*
100
- chambre d'enfants *f* 74
- chambre d'eau *f* 61
- chambre double *f* 100
- chambre noire *f* 271
- chambre privée *f* 48
- chambre simple *f* 100
- chambres *f* 100
- chameau *m* 291
- champ *m* 182
- champ central *m* 228
- champ droit *m* 229
- champ extérieur *m* 229
- champ gauche *m* 228
- champ intérieur *m* 228
- champagne *m* 145
- champignon *m* 125
- championnat *m* 223, 230
- champs de courses *m*
243
- changer de chaîne 269
- changer de vitesse 207
- changer une roue 203
- chanson *f* 259
- chanteur *m* 258
- chanteuse *f* 191
- chantier *m* 186
- chantier naval *m* 217
- chapeau *m* 36
- chapeau de plage *m*
265
- chapeau de soleil *m* 30
- chapelure *f* 139
- charbon *m* 288
- charbon de bois *m* 266
- charcuterie *f* 107, 142
- chardon *m* 297
- charger 76
- chariot *m* 48, 213
- chariot de levage *m*
186
- chariot élévateur *m* 216
- chasse-d'eau *f* 61
- chasseur *m* 211
- châssis *m* 203
- chat *m* 290
- châtaigne d'eau *f* 124
- châtain 39
- château *m* 300
- château de sable *m* 265
- chaton *m* 290
- chaud 286, 321
- chaudière *f* 61
- chauffeur de taxi *m* 190
- chaussettes *f* 33
- chaussons *m* 30
- chaussure *f* 220, 223,
233
- chaussure à talon *f* 37
- chaussure compensée
f 37
- chaussure de ski *f* 246
- chaussure lacée *f* 37
- chaussures *f* 34, 37
- chaussures de marche
267
- chaussures en cuir *f* 32
- chauve 39
- chauve-souris *f* 290
- chaux *f* 85
- chavirer 241
- cheddar *m* 142
- chef *m* 24, 190
- chef d'orchestre *m* 256
- chef de cuisine *m* 152
- cheminée *f* 58, 63, 214,
283
- chemise *f* 33, 35
- chemise de nuit *f* 31, 35
- chemisier *m* 34
- chêne *m* 296
- chenille *f* 295
- chèque *m* 96
- chercher 177
- cheval *m* 185, 235, 242
- cheval d'arçons *m* 235
- cheval de course *m* 243
- chevalet *m* 174, 258,
274
- cheveux *m* 14, 38
- cheville *f* 13, 15, 259
- chèvre *m* 185
- chevreau *m* 185
- chèvrefeuille *m* 297
- chevron *m* 186
- chewing-gum *m* 113
- chiche-kébab *m* 158
- chicorée *f* 123
- chien *m* 290
- chien assis *m* 58
- chiffon *m* 77
- chignon *m* 39
- Chili 315
- chimie *f* 162
- Chine 318
- chiot *m* 290
- chips *f* 113, 151
- chiropractie *f* 54
- chirurgie *f* 48
- chirurgien *m* 48
- chirurgie esthétique *f* 49
- choc *m* 47
- choc électrique *m* 46
- chocolat *m* 113
- chocolat au lait *m* 113
- chocolat blanc *m* 113
- chocolat chaud *m* 144
- chocolat en poudre *m*
148
- chocolat noir *m* 113
- chœur *m* 301
- choqué 25
- chorizo *m* 143
- chou *m* 123
- chou chinois *m* 123
- chou de Bruxelles *m* 122
- chou frisé *m* 123
- chou précocé *m* 123
- chouette *f* 292
- chou-fleur *m* 124
- chou-rave *m* 123
- chronomètre *m* 166, 234
- chrysanthème *m* 110
- chute *f* 237
- chutney *m* 134
- Chypre 316
- cible *f* 249, 273
- ciboule *f* 125
- ciboulette *f* 133
- cidre *m* 145
- cigare *m* 112
- cigarettes *f* 112
- cigogne *f* 292
- cil *m* 14, 51
- ciment *m* 186
- cinéma *m* 255, 299
- cinq 308
- cinq cents 308
- cinquante-cinq mille cinq
cents 309
- cinquante 308
- cinquante mille 309
- cinquantième 309
- cinquième 309
- cintré *m* 70
- circonférence *f* 164
- circulation *f* 194
- cire *f* 77
- cirer 77
- cisaille *f* 89
- ciseaux *m* 38, 47, 82,
276
- ciseaux à ongles *m* 41
- Cité du Vatican *f* 316
- citron *m* 126
- citron et glaçons 151
- citron vert *m* 126
- citronnelle *f* 133
- citrouille *f* 125
- clair 41, 321
- clam *f* 121
- claquette *f* 179
- clarinette *f* 257
- clarinette basse *f* 257
- classe *f* 163
- classe affaires *f* 211
- classe économique *f* 211
- classeur 172
- classeur à levier 173
- clavicule *f* 17
- clavier 97, 99, 172, 176
- clayette *f* 67
- clé de fa *f* 256
- clé de sol *f* 256
- clé USB *f* 176
- clef *f* 59, 80, 207
- clef à molette *f* 80
- clef à pipe *f* 80
- clef de la chambre *f* 100
- clef serre-tube *f* 81
- clémentine *f* 126
- client *m* 96, 100, 104,
106, 152, 175, 180
- cliente *f* 38
- clignotant *m* 198, 204
- climatisation *f* 200
- clinique *f* 48
- clipboard 173
- clitoris *m* 20
- clôture *f* 85, 182
- clou *m* 80
- clou de girofle *m* 133
- clubs de golf *m* 233
- coccinelle *f* 295
- coccyx *m* 17
- cocher 233
- cochon *m* 185
- cockpit *m* 210
- cocktail *m* 151
- cocon *m* 295
- cocotte *f* 69
- coquille *f* 129
- code barres *m* 106
- code postal *m* 98
- code secret *m* 96
- cœur *m* 18, 119, 122,
273
- cœurs de palmier *m* 122
- coffre *m* 198
- coiffeur *m* 39, 188
- coiffeuse *f* 38, 71
- coiffures *f* 39
- coin de la rue *m* 298
- coing *m* 128
- col *m* 32
- col de l'utérus *m* 20
- col de l'utérus *m* 52
- col rond *m* 33
- cola *m* 144
- colibri *m* 292
- colis *m* 99
- collage *m* 275
- collant *m* 35, 251
- colle *f* 275
- colle à bois *f* 78
- colle à tapisser *f* 82
- collègue *m* 24
- collier *m* 36
- colline *f* 284
- Colombie 315
- colonie 315
- colonne *f* 300
- colonne vertébrale *f* 17
- colza *m* 184
- combat *m* 237
- combinaison *f* 35
- combinaison de neige *f*
30
- combinaison de plongée *f*
239
- combinaison-short *f* 30
- combiné *m* 99
- comédie *f* 255
- comédie musicale *f* 255
- comédie romantique *f*
255
- comédienne *f* 191
- comète *f* 280
- commande *f* 269
- commander 153
- commandes *f* 201, 204
- commencer à l'école 26
- commis *m* 152
- commission *f* 97
- commode *f* 70
- commotion cérébrale *f* 46
- communications *f* 98
- Comores 317
- compartment *m* 209
- compartment à
bagages *m* 196
- compartment-
couchettes *m* 209
- compas *m* 165, 240
- complet 129, 131, 266
- composer 99
- compositions florales
f 111

- comptabilité *f* 175
 comptable *m* 97, 190
 compte courant *m* 96
 compte e-mail *m* 177
 compte d'épargne *m* 97
 compte rendu *m* 174
 compte-gouttes *m* 109, 167
 compter 165
 compte-tours *m* 201
 compte *m* 201, 204
 compteur d'électricité *m* 60
 comptoir *m* 96, 100, 142, 150
 comptoir sandwichs *m* 143
 conception *f* 52
 concert *m* 255, 258
 concert de rock *m* 258
 concevoir 20
 concombre *m* 125
 condamnation *f* 181
 conditionnement
 physique *m* 250
 condom *m* 21
 conducteur *m* 196
 conducteur de bus *m* 190
 conduit éjaculatoire *m* 21
 conduit spermatique *m* 21
 conduite à droite *f* 201
 conduite à gauche *f* 201
 conduite d'amenée *f* 61
 cône *m* 164, 187
 conférencière *f* 174
 confiant 25
 confiserie *f* 107, 113
 confiseur *m* 113
 confiture *f* 134, 156
 confiture de framboises *f* 134
 confiture d'oranges *f* 134, 156
 confus 25
 congélateur *m* 67
 congeler 67
 conglomerat *m* 288
 Congo 317
 conifère *m* 86
 connaissance *m* 24
 connecter 177
 conseil juridique *m* 180
 conseillère *f* 55
 conseillère financière *f* 97
 Conservatoire *m* 169
 conserves *f* 107
 console *f* 269
 constellation *f* 281
 consterné 25
 construction *f* 186
 construire 186
 consultation *f* 45
 conteneur *m* 216
 continent *m* 282, 315
 contraception *f* 21, 52
 contraction *f* 52
 contrat *m* 175
 contrebasse *f* 256
 contrebasson *m* 257
 contrefort *m* 301
 contreplaqué *m* 79
 contrôle de passeports *m* 213
 contrôleur *m* 209
 contusion *f* 46
 convecteur *m* 60
 copeaux *m* 78
 copilote *m* 211
 coq *m* 185
 coque *f* 121, 214, 240
 coquelicot *m* 297
 coquetier *m* 65, 137
 coquillage *m* 265
 coquille *f* 137
 coquille Saint-Jacques *f* 121
 cor *m* 257
 cor anglais *m* 257
 corbeau *m* 292
 corbeille *f* 254
 corbeille à couture *f* 276
 corbeille à papier 172
 corbeille arrivée 172
 corbeille de fruits *f* 126
 corbeille départ 172
 corde *f* 248, 258, 266
 corde à linge *f* 76
 cordes *f* 256
 cordes vocales *f* 19
 cordon ombilical *m* 52
 Corée du Nord 318
 Corée du Sud 318
 coriandre *f* 133
 corne 293
 cornée *f* 51
 corner *m* 223
 corniche *f* 300
 corps *m* 12
 correcteur *m* 40
 correspondance *f* 212
 correspondant *m* 24
 Corse 316
 corset *m* 35
 Costa Rica 314
 costume *m* 32, 255
 côte *f* 17, 285
 côté *m* 164
 côte de bœuf *f* 119
 Côte d'Ivoire 317
 côtelette *f* 119
 côtes *f* 155
 coton *m* 184, 277
 cottage *m* 136
 cou *m* 12
 couche *f* 75
 couche de fond *f* 83
 couche d'ozone *f* 286
 couche éponge *f* 30
 couche jetable *f* 30
 coucher *m* 74
 coucher du soleil *m* 305
 coude *m* 13
 cou-de-pied *m* 15
 coudre 277
 couenne *f* 119
 couette *f* 71
 couettes *f* 39
 couffin *m* 75
 couleur *f* 273
 couleur pour bois *f* 79
 couleurs *f* 39, 274
 coulisses *f* 254
 couloir *m* 168, 210, 234, 238
 country *f* 259
 coup *m* 151, 233, 237, 273
 coup de pied *m* 237, 239
 coup de poing *m* 237
 coup de soleil *m* 46
 coup droit *m* 231
 coup du lapin *m* 46
 coup franc *m* 222
 coup manqué *m* 228
 coupable 181
 coupe *f* 91
 coupé 99
 coupe courte *f* 39
 coupe-ongles *m* 41
 couper 38, 67, 277
 coupe-tube *m* 81
 couple *m* 24
 coups *m* 231
 coupure *f* 46
 coupure de courant *f* 60
 cour *f* 58, 84
 cour de ferme *f* 182
 courant *m* 60
 courant alternatif *m* 60
 courant continu *m* 60
 courbe 165
 courbe *f* 48
 coureur automobile *m* 249
 courge *f* 124, 125
 courge musquée *f* 125
 courgette *f* 125
 courir 228
 couronne *f* 50, 111
 courroie de cames *f* 203
 courroie de ventilateur *f* 203
 course *f* 234
 course attelée *f* 243
 course automobile *f* 249
 course de chevaux *f* 243
 course de moto *f* 249
 course de plat *f* 243
 course de trot *f* 243
 courser 229
 courses *f* 104, 243
 court 321
 court de tennis *m* 230
 couscous *m* 130
 cousin *m* 22
 coussin *m* 62
 coussinets *m* 53
 couteau *m* 65, 80, 121
 couteau à pain *m* 68
 couteau de cuisine *m* 68
 couture *f* 34
 couturier *m* 191
 couturière *f* 191, 277
 couvercle *m* 61, 66
 couvert *m* 65
 couverts *m* 64
 couverture *f* 71, 74
 couverture chauffante *f* 71
 couverture de protection *f* 83
 couverture du sol *f* 87
 couverture laineuse *f* 74
 couveuse *f* 53
 couvre-lit *m* 70
 crabe *m* 121, 295
 crachoir *m* 50
 craie *f* 162, 288
 craie de tailleur *f* 276
 crampe *f* 239
 crampes *f* 44
 crâne *m* 17
 crapaud *m* 294
 cratère *m* 283
 cravache *f* 242
 cravate *f* 32
 crawl *m* 239
 crayon *m* 163, 275
 crayon à lèvres *m* 40
 crayon à sourcils *m* 40
 crayon de couleur *m* 163
 crème *f* 109, 137, 157
 crème *m* 148
 crème allégée *f* 137
 crème anglaise *f* 140
 crème caramel *f* 141
 crème épaisse *f* 137
 crème fouettée *f* 137
 crème fraîche *f* 137
 crème hydratante *f* 41
 crème pâtissière *f* 140
 crème pour le visage *f* 73
 crème pour l'érythème *f* 74
 crémérie *f* 107
 crêpes *f* 155, 157
 crépuscule *m* 305
 cresson *m* 123
 creuset *m* 166
 creux des reins *m* 13
 crevaison *f* 203, 207
 crevette *f* 121
 crevettes décortiquées *f* 120
 cric *m* 203
 cricket *m* 225
 crier 25
 crime *m* 94
 criminel *m* 181
 crinière *f* 242, 291
 crise cardiaque *f* 44
 cristallin *m* 51
 Croatie 316
 crochet *m* 187, 277
 crocodile *m* 293
 croissant *m* 156
 croissant de lune *m* 280
 croquant 127
 croquis *m* 275
 crosse *f* 224, 249
 crosse de hockey *f* 224
 croûte *f* 136, 139, 142
 cru 124, 129
 Cuba 314
 cube *m* 164
 cubitus *m* 17
 cueillir 91
 cuiller *f* 65
 cuiller à café *f* 65, 153
 cuiller à glace *f* 68
 cuiller à servir *f* 68
 cuiller à soupe *f* 65
 cuiller en bois *f* 68
 cuiller pour mesurer *f* 109
 cuir chevelu *m* 39
 cuire à la vapeur 67
 cuire au four 67
 cuisine *f* 66, 67, 152, 214
 cuisse *f* 12, 119
 cuit 159
 cuit à la vapeur 159
 cuivre *m* 289
 cuivres *m* 256
 culasse *f* 202
 culotte en plastique *f* 30
 cultivateur *m* 182
 cultiver 91
 culture *f* 183
 cultures *f* 184
 cumin *m* 132
 curcuma *m* 132
 curling *m* 247
 curry *m* 158
 cutter *m* 82
 cuvette *f* 61
 cygne *m* 293
 cylindre *m* 164
 cymbales *f* 257

D

- d'accord 322
 dame *f* 272, 273
 dames *f* 272
 dance *f* 259
 Danemark 316
 danger *m* 195
 dans 320
 danseuse *f* 191
 dard *m* 295
 date *f* 306
 date d'expiration *f* 109
 date de retour *f* 168

- date du procès *f* 180
 datte *f* 129
 dauphin *m* 290
 daurade *f* 120
 de 320
 dé *m* 272
 dé à coudre *m* 276
 de ferme 118
 de rien 322
 de saison 129
 de troisième cycle 169
 débarquer 217
 début *m* 321
 décapotable *f* 199
 décembre *m* 306
 décennie *f* 307
 déchets bios *m* 61
 déclencher
 l'accouchement 53
 déclencheur *m* 270
 décoller 82, 211
 décongeler 67
 décontracté 34
 décor *m* 254
 décor de cinéma *m* 179
 décoration *f* 82, 141
 décortiqué 129
 découper 79
 découvert *m* 96
 décréter 39
 défaire 277
 défense *f* 181, 220, 291
 défenseur *m* 223
 défilé *m* 27
 dehors 320
 déjeuner *m* 64
 déjeuner d'affaires *m*
 175
 deltaplane *m* 248
 deltoïde *m* 16
 demain 306
 démaquillant *m* 41
 demi-heure 304
 demi-litre *m* 311
 demi-pension *f* 101
 démonte-pneu *m* 207
 dénominateur *m* 165
 dent *f* 50
 dentelle *f* 35, 277
 dentier *m* 50
 dentifrice *m* 72
 dentiste *f* 189
 dentiste *m* 50
 déodorant *m* 73
 déodorants *m* 108
 dépanneuse *f* 203
 départ *m* 232
 départ plongé *m* 239
 départs *m* 213
 dépendance *f* 182
 déplantoir *m* 89
 dépliants *m* 96
 déposition *f* 180
 dérive *f* 210, 241
 dermatologie *f* 49
 dernière couche *f* 83
 derrière 320
 descente *f* 247
 désert *m* 285
 désherber 91
 dessert *m* 153
 desserts *m* 140
 dessin *m* 162, 275
 dessin animé *m* 178
 dessinatrice *f* 191
 dessiner 91, 162
 dessous de verre *m* 150
 dessus 98
 destination *f* 213
 détecteur de fumée *m*
 95
 détergent *m* 77
 deux 308
 deux cents 308
 deux heures 304
 deux mille 307
 deux pintes 311
 deuxième 309
 deuxième étage *m* 104
 deuxième galerie *f* 254
 devant 320
 développer 271
 déviation *f* 195
 dévidoir de scotch 173
 dévidoir de tuyau *m* 89
 devises étrangères *f* 97
 devoirs *m* 163
 diabète *m* 44
 diable *m* 100
 diagonale *f* 164
 diamant *m* 288
 diamètre *m* 164
 diaphragme *m* 21, 19
 diarrhée *f* 44, 109
 dictionnaire *m* 163
 diète *m* 256
 diesel *m* 199
 difficile 321
 digestif 19
 digitale *f* 297
 dilatation *f* 52
 dimanche *m* 306
 dimensions *f* 165
 dinde *f* 119
 dindon *m* 185, 293
 dîner *m* 64
 dioptrie *f* 51
 diplomate *m* 141
 diplôme *m* 169
 directeur *m* 163, 174
 directeur d'agence *m* 96
 directeur général *m* 175
 directions *f* 260
 disc-jockey *m* 179
 discuter 163
 disque *m* 234
 dissertation *f* 169
 dissolvant *m* 41
 distance *f* 310
 distractions à la maison
 f 268
 distributeur *m* 97, 203
 distribution *f* 98, 254
 district *m* 315
 dividendes *f* 97
 divisé par 165
 diviser 165
 divorce *m* 26
 Diwali *f* 27
 dix 308
 dix mille 309
 dix-huit 308
 dix-huitième 309
 dixième 309
 dix-neuf 308
 dix-neuvième 309
 dix-sept 308
 dix-septième 309
 Djibouti 317
 dock *m* 214, 216
 docteur *m* 189
 doctorat *m* 169
 documentaire *m* 178
 dôme *m* 300
 Dominique 314
 dominos *m* 273
 donner 273
 donner à manger 183
 donner le sein 53
 dorsal *m* 16
 dos *m* 13
 dos crawlé *m* 239
 dos du pied *m* 15
 dos-nu 35
 dossier *m* 210
 dossier *m* 177
 dossier suspendu 173
 dossier-classeur 173
 douane *f* 212
 double *m* 230
 double 151
 double toit *m* 266
 doubler 195
 doublure *f* 32
 douche *f* 72
 douches *f* 266
 douille *f* 69, 80
 douve *f* 300
 douze 308
 douzième 309
 dragée à la gelée *f* 113
 drainage *m* 91
 drap *m* 71, 74
 drapeau *m* 221, 232,
 235
 drapeau de coin *m* 223
 dressage *m* 243
 dribbler 223
 driver 233
 droit *m* 169, 180
 droite 165
 drummer *m* 258
 duffel-coat *m* 31
 dumper *m* 187
 duodénum *m* 18
 dur 129, 321
 DVD *m* 269
 dynamo *f* 207
E
 eau *f* 144, 238
 eau de Javel
 eau de toilette *f* 41
 diviser 165
 eau dentifrice *f* 72
 eau du robinet *m* 144
 eau en bouteille *f* 144
 eau minérale *f* 144
 écaille *f* 121, 294
 écaillé 121
 écailles *f* 293
 échafaudage *m* 186
 échalote *f* 125
 échange *m* 230
 écharde *f* 46
 écharpe *f* 31, 46
 échecs *m* 272
 échelle *f* 95, 186
 écheveau *m* 277
 échiquier *m* 272
 échographie *f* 52
 éclair *m* 140, 287
 éclairage *m* 105, 178
 éclipse *f* 280
 école *f* 162, 299
 école de danse *f* 169
 école des beaux arts *f*
 169
 écoles *f* 169
 écolier *m* 162
 écolière *f* 162
 écorce *f* 127, 282, 296
 écorchure *f* 46
 écoute *f* 241
 écouteurs *m* 268
 écran *m* 97, 176, 255,
 269
 écran d'information *m*
 213
 écran de protection *m*
 88
 écran solaire *m* 108
 écran total *m* 108, 265
 écrasé 132
 écrevisse *f* 121
 écrire 162
 écrou *m* 80
 écrous de roue *m* 203
 écume *f* 241
 écumoire *f* 68
 écreuil *m* 290
 écurie *f* 185, 243
 eczéma *m* 44
 édam *m* 142
 édredon *m* 71
 éducation physique *f*
 162
 effet *m* 230
 effets secondaires *m*
 109
 effrayé 25
 égale 165
 égalité *f* 223, 230
 église *f* 298, 300
 égout *m* 299
 égouttoir *m* 67
 Égypte 317
 élaguer 91
 élastique 173
 élastique pour cheveux *m*
 39
 électricien *m* 188
 électricité *f* 60
 électrode négative *f* 167
 électrode positive *f* 167
 électroménager *m* 107
 éléphant *m* 291
 élève *m* 162
 e-mail *m* 177
 email *m* 50
 emballage *m* 111
 embarcadère *f* 217
 embarquer 217
 embouteillage *m* 195
 embouts de tournevis *m*
 80
 embrayage *m* 200, 204
 embryon *m* 52
 émeraude *f* 288
 émettre 178
 émigrer 26
 Émirats arabes unis 318
 émission *f* 179
 émotions *f* 25
 empennage *m* 210
 emplacement *m* 266
 emplacements libres 266
 employé *m* 24
 employée de magasin *f*
 188
 employeuse *f* 24
 empoisonnement *m* 46
 empreintes *f* 94
 emprunter 168
 en bas 320
 en différé 178
 en direct 178
 en face de 320
 en filets 121
 en flocons 132
 en haut 320
 en ligne 177
 en morceaux 132
 en poudre 132
 en purée 159
 en sauce 159
 en saumure 143
 en verre 69
 encaisser 97
 enceinte 52
 enclos *m* 185, 242
 enclore en V *f* 33
 encre *f* 275
 encyclopédie *f* 163
 endive *f* 122
 endocrine 19
 endocrinologie *f* 49
 enduit *m* 83
 enfant *m* 23
 enfant *m* 31
 enfants *m* 23
 enfiler 277

- engrais *m* 91
 enjoliveur *m* 202
 enlèvement de déchets *m* 61
 enlever les fleurs fanées 91
 ennuyé 25
 enquête *f* 94
 enregistrement des bagages *m* 213
 enregistrer 212, 269
 enrobé de chocolat 140
 enseignante *f* 104
 enseignement supérieur *m* 168
 ensoleillé 286
 enterrement *m* 26
 en-tête 173
 entonnoir *m* 166
 entorse *f* 46
 entracte *m* 254
 entraînement *m* 237
 entraînement en circuit *m* 251
 entraînement poids et haltères *m* 251
 entraîneuse *f* 250
 entre 320
 entrée *f* 58, 59, 153
 entrepôt *m* 216
 entrer 177
 entrer en éruption 283
 enveloppe *f* 98, 173
 environnement *m* 280
 environs *m* 299
 envoi en recommandé *m* 98
 envoyer 177
 épais 321
 épargne *f* 96
 épaupe *f* 13
 épauvette *f* 35
 épeler 162
 épiché 124
 épicerie *f* 114
 épices *f* 132
 épiglotte *f* 19
 épilation *f* 41
 épilepsie *f* 44
 épinards *m* 123
 épingle *f* 276
 épingle de cravate *f* 36
 épingle de sûreté *f* 47
 épisiotomie *f* 52
 épiluche-légume *m* 68
 épilucher 67
 éponge *f* 73, 74, 83
 épousseter 77
 épouvantail *m* 184
 épreuve *f* 271
 épreuves *f* 247
 éprouvette *f* 166
 épuisette *f* 244
 Équateur 315
 équateur *m* 283
 équation *f* 165
- équerre *f* 165
 équipage *m* 241
 équipe *f* 220, 229
 équipement *m* 165, 233, 238
 équipement de bureau 172
 équipement d'entretien *m* 77
 équitation *f* 242, 263
 érable *m* 296
 éruption *f* 44
 Érythrée 317
 escabeau *m* 82
 escalade *f* 248
 escalade en glace *f* 247
 escalator *m* 104
 escalier *m* 59
 escalier de secours *m* 95
 escalier d'entraînement 250
 escargot *m* 295
 escrime *f* 249
 espace *m* 280
 espadon *m* 120, 294
 Espagne 316
 essai *m* 221
 essence *f* 199
 essieu *m* 205
 essorer 76
 essoreuse *f* 76
 essuie-glace *m* 198
 essuyer 77
 est *m* 312
 estomac *m* 18
 Estonie 316
 estragon *m* 133
 estuaire *m* 285
 établi *m* 78
 étage inférieur *m* 141
 étage supérieur *m* 141
 étagère *f* 66, 106, 268
 étain *m* 289
 étaler au rouleau 67
 étamine *f* 297
 État *m* 315
 États-Unis d'Amérique 314
 étau *m* 78
 été *m* 31, 307
 éteindre la télévision 269
 étendre 251
 éternuement *m* 44
 Éthiopie 317
 étiquette 173
 étiquettes *f* 89
 étirement *m* 251
 étoile *f* 280
 étoile de mer *f* 295
 étouffer 47
 être en défense 229
 étrier *m* 242
 étroit 321
 étude *f* 162
 études d'ingénieur *f* 169
- étudiant *m* 169
 étui *m* 51
 étui à lentilles *m* 51
 eucalyptus *m* 296
 Europe 316
 événements de la vie *m* 26
 événement *m* 290
 évier *m* 61, 66
 examen *m* 163
 examen de la vue *m* 51
 examen médical *m* 45
 excédent de bagages *m* 212
 excité 25
 exécuter un swing 232
 exercice pour la poitrine *m* 251
 exercice pour les biceps *m* 251
 exercices *m* 251
 exercices au sol *m* 235
 exfolier 41
 exosphère *f* 286
 expéditeur *m* 98
 expérience *f* 166
 exploitation fruitière *f* 183
 exploitations agricoles *f* 183
 exploration spatiale *f* 281
 exposition *f* 261
 expresso *m* 148
 expulsion *f* 223
 extérieur *m* 198
 extincteur *m* 95
 extraction *f* 50
 eye-liner *m* 40
- F**
 fâché 25
 facile 321
 facile à cuisiner 130
 facteur *m* 98, 190
 faible 321
 faire du pain 138
 faire cuire au four 138
 faire du vélo 207
 faire le lit 71
 faire marche arrière 195
 faire rebondir 227
 faire son testament 26
 faire un dunk 227
 faire un vœu 140
 faire une manchette 227
 faire une mise en plis 38
 faire une passe 220, 223
 faire une réservation de vol 212
 faire une tête 222
 fairway *m* 232
 faisane *m* 119, 293
 fait-tout *m* 69
 falaise *f* 285
 famille *f* 22
 fans *m* 258
 farci 159
- fard à joues *m* 40
 fard à paupières *m* 40
 farine *f* 138
 farine avec la levure chimique *f* 139
 farine blanche *f* 138
 farine brute *f* 138
 farine complète *f* 138
 farine sans levure chimique *f* 139
 farine traitée *f* 139
 faucon *m* 292
 fausse couche *f* 52
 faute *f* 222, 226, 230
 fauteuil *m* 63, 254
 fauteuil de dentiste *m* 50
 fax 172
 fax *m* 98
 Fédération de Russie 318
 féminin 20
 femme *f* 12, 22, 23
 femme d'affaires *f* 175
 fémur *m* 17
 fendoir *m* 68
 fenêtre *f* 58, 177, 186, 197, 209
 feng shui *m* 55
 fenouil *m* 122, 133
 fente *f* 97
 fente avant *f* 251
 fenugrec *m* 132
 fer *m* 109, 233, 289
 fer à cheval *m* 242
 fer à friser *m* 38
 fer à lisser *m* 38
 fer à repasser *m* 76
 fer à souder *m* 81
 ferme *f* 182, 184
 ferme 124
 fermé 260, 321
 ferme d'aviculture *f* 183
 ferme de culture *f* 183
 ferme d'élevage de moutons *f* 183
 ferme d'élevage porcin *f* 183
 ferme laitière *f* 183
 fermeture éclair *f* 277
 fermier *m* 182, 189
 fermoir *m* 36
 ferry *m* 215, 216
 fertilisation *f* 20
 fertiliser 91
 fesse *f* 13
 fessier *m* 16
 fête *f* 140
 fête de Thanksgiving *f* 27
 fêtes *f* 27
 feu *m* 217
 feu arrière *m* 204, 207
 feu de camp *m* 266
 feuillage *m* 110
 feuille *f* 122, 296
 feuille de laurier *f* 133
 feuilles de thé *f* 144
- feuilleton *m* 178
 feux *m* 94, 194
 feux de détresse *m* 201
 fève *f* 122
 fèves *f* 131
 février *m* 306
 fiancé *m* 24
 fiancée *f* 24
 fiancés *m* 24
 fibre *f* 127
 fibre naturelle *f* 31
 ficelle *f* 89
 fiche compliments 173
 fiche de retrait *f* 96
 fiche intercalaire 173
 fiches de versement *m* 96
 fichier *m* 177
 Fidji 319
 fier 25
 fièvre *f* 44
 figue *f* 129
 figue de Barbarie *f* 128
 fil *m* 276
 fil à plomb *m* 82
 fil de fer *m* 79
 fil dentaire *m* 50, 72
 filament *m* 60
 file de droite *f* 194
 filet *m* 119, 121, 217, 222, 226, 227, 231
 filets de flétan *m* 120
 fille *f* 22, 23
 film *m* 178, 269
 film d'aventure *m* 255
 film d'horreur *m* 255
 film d'animation *m* 255
 film de science-fiction *m* 255
 fils *m* 22, 60
 filtre *m* 270
 filtre à air *m* 202
 filtre d'air *m* 204
 fin *f* 321
 finance *f* 97
 Finlande 316
 fiole *f* 166
 flageolets *m* 131
 flamant *m* 292
 flanc *m* 284
 flash *m* 270
 flash compact *m* 270
 flèche *f* 95, 249, 300
 fléchettes *f* 273
 fléchir 251
 fleur *f* 297
 fleuret *m* 249
 fleurette *f* 122
 fleuriste *f* 188
 fleuriste *m* 110
 fleuron *m* 300
 fleurs *f* 110
 fleurs séchées *f* 111
 flexion de jambes *f* 251
 florentin *m* 141
 flotteur *m* 61, 244

- flou 271
 flûte *f* 139, 257
 fœtus *m* 52
 foie *m* 18, 118
 foin *m* 184
 foire *f* 262
 fois 165
 follicule *m* 20
 foncé 41, 321
 fond de teint *m* 40
 fontaine *f* 85
 fontaine publique *f* 262
 foot *m* 222
 football américain *m* 220
 forceps *m* 53, 167
 forêt *f* 285
 forêt à bois plat *m* 80
 forêt à métaux *m* 80
 forêt de maçonnerie *m* 80
 forêt de sécurité *m* 80
 forêt tropicale *f* 285
 forêts *m* 80
 forêts à bois *m* 80
 formes *f* 164
 fort 321
 fosse d'orchestre *f* 254
 fossette *f* 15
 fou *m* 272
 fouet *m* 68
 fougère *f* 86
 foulard *m* 36
 four *m* 66
 fourche *f* 88, 207
 fourches *f* 39
 fourchette *f* 65, 153
 fourchette à découper *f* 68
 fourmi *f* 295
 fourneau *m* 112
 fournitures de bureau 173
 fourre-tout *m* 37
 foyer *m* 255
 fraction *f* 165
 fracture *f* 46
 fragile 98
 frais 121, 127, 130
 frais bancaires *m* 96
 fraise *f* 50, 127
 framboise *f* 127
 France 316
 frange de lit *f* 71
 frapper 224, 225
 freesia *m* 110
 freezer *m* 67
 frein *m* 204
 frein *m* 200, 206
 frein à main *m* 203
 freiner 207
 fréquence *f* 179
 frère *m* 22
 friandise *f* 113
 frire 67
 frise *f* 301
 frisé 39
- frit 159
 frites *f* 154
 froid 286, 321
 fromage *m* 136, 156
 fromage à la crème *m* 136
 fromage à pâte molle *m* 136
 fromage à pâte pressée cuite *m* 136
 fromage à pâte pressée non cuite *m* 136
 fromage à pâte semi-molle *m* 136
 fromage de chèvre *m* 142
 fromage frais *m* 136
 fromage râpé *m* 136
 froncement de sourcils *m* 25
 front *m* 14
 frontail *m* 242
 frontal *m* 16
 fronton *m* 301
 fruit confit *m* 129
 fruit de feijoa *m* 128
 fruit de l'arbre à pain *m* 124
 fruit de la passion *m* 128
 fruits *m* 107, 126, 128, 157
 fruits à noyau *m* 126
 fruits de mer *m* 121
 fruits en bocaux *m* 134
 fruits secs *m* 156
 fruits tropicaux *m* 128
 fumé 118, 121, 143, 159
 fumée *f* 95
 fumer 112
 fumer en surface 90
 fusain *m* 275
 fuseau *m* 277
 fusée d'orientation *f* 281
 fusée éclairante *f* 240
 fuselage *m* 210
 fusible *m* 60
 fusil *m* 118
- G**
 Gabon 317
 gagnant *m* 273
 gagner 273
 galaxie *f* 280
 galerie *f* 198
 galerie à vélo *f* 207
 gallon *m* 311
 galop *m* 243
 galvanisé 79
 Gambie 317
 gamme *f* 256
 gant *m* 224, 228, 233, 236, 246
 gant isolant *m* 69
 gants *m* 36
 gants de boxe *m* 237
 gants de jardinage *m* 89
- garage *m* 58, 199, 203
 garçon *m* 23, 152
 garde *m* 189
 garde-boue *m* 205
 garde-côte *m* 217
 gardien de but *m* 222
 gardien de guichet *m* 225
 gardien de prison *f* 181
 gare *f* 208
 gare routière *f* 197
 garer 195
 garniture *f* 140, 155
 gâteau au chocolat *m* 140
 gâteau d'anniversaire *m* 141
 gâteau de mariage *m* 141
 gâteau de miel *m* 135
 gâteaux *m* 140
 gâteaux de fête *m* 141
 gaufres *f* 157
 gaze *f* 47
 gazeux 144
 gazonner 90
 gel *m* 38, 109, 287
 gel douche *m* 73
 gélule *f* 109
 gemmes *f* 288
 gencive *f* 50
 gendre *m* 22
 géné 25
 génération *f* 23
 génératrice *f* 60
 genou *m* 12
 genouillère *f* 227
 genres de pêche *m* 245
 genres de plantes *m* 86
 gens 12, 16
 géographie *f* 162
 géométrie *f* 165
 Géorgie 318
 gerbera *m* 110
 germe de soja *m* 122
 germeoir *m* 89
 geyser *m* 285
 Ghana 317
 gibier *m* 119
 gigot *m* 119
 gilet *m* 33
 gilet de sauvetage *m* 240
 gin *m* 145
 gin tonic *m* 151
 gingembre *m* 125, 133
 girafe *f* 291
 giroflée *f* 110
 givre *m* 287
 glaçage *m* 141
 glace *f* 120, 137, 149, 287
 glacer 139
 glacier *m* 284
 glaçon *m* 151, 287
 glaïeul *m* 110
- glande *f* 19
 glisser 229
 glissière de sécurité *f* 195
 gneiss *m* 288
 golf *m* 232
 gomme *f* 163
 gong *m* 257
 gorge *f* 19, 284
 gorille *m* 291
 gotique 301
 gouache *f* 274
 gourde amère *f* 124
 gousse *f* 122, 125
 gouttes *f* 109
 gouttière *f* 58
 gouvernail *m* 241
 gouverne *f* 210
 goyave *f* 128
 GPS *m* 195
 grain *m* 122, 130
 grain de beauté *m* 14
 grain de moutarde *m* 131
 grain de poivre *m* 132
 graine *f* 122, 130
 graine de carvi *f* 131
 graine de potiron *f* 131
 graine de sésame *f* 131
 graine de tournesol *f* 131
 graines *f* 88, 131
 graines de fenouil *f* 133
 graines de pavot *f* 138
 graines de soja *f* 131
 grains *m* 144
 gramme *m* 310
 grand 321
 grand bassin *m* 239
 grand bol *m* 69
 grand lit *m* 71
 grand magasin *m* 105
 grande aiguille *f* 304
 grande cisaille *f* 88
 grande tasse *f* 65
 grandes ondes *f* 179
 grand-mère *f* 22
 grand-père *m* 22
 grands-parents *m* 23
 grand-voile *f* 240
 grange *f* 182
 granite *m* 288
 graphite *m* 289
 gras *m* 119
 gras 39, 41
 gratte-ciel *m* 299, 300
 grattoir *m* 82
 gravier *m* 88
 gravure *f* 275
 Grèce 316
 grément *m* 215, 240
 green *m* 232
 greffer 91
 greffier *m* 180
 grêle *f* 286
 Grenade 314
- grenade *f* 128
 grenat *m* 288
 grenier *m* 58
 grenouille *f* 294
 grenouillère *f* 30
 grès *m* 288
 griffe *f* 291
 grill *m* 69
 grillé 129, 159
 grille de refroidissement *f* 69
 grille-pain *m* 66
 griller 67
 grillon *m* 295
 grippe *f* 44
 gris 39, 274
 Groenland 314
 gros 321
 gros haricots blancs *m* 131
 gros intestin *m* 18
 gros orteil *m* 15
 groseille à maquereau *f* 127
 groseille blanche *f* 127
 grossesse *f* 52
 grue *f* 187, 216, 292
 grue de caméra *f* 178
 Guatemala 314
 guêpe *f* 295
 guépière *f* 35
 guérison par cristaux *f* 55
 gueule *f* 293
 guichet *m* 96, 98, 209, 216, 225
 guide *m* 104, 260
 guide *m* 260
 guide de fil *m* 276
 guidon *m* 207
 guimauve *f* 113
 guimbarde *f* 78
 guideau *m* 214
 Guinée 317
 Guinée équatoriale 317
 Guinée-Bissau 317
 guirlande de fleurs *f* 111
 guitare basse *f* 258
 guitare électrique *f* 258
 Guyane 315
 Guyane française 315
 gymnase *m* 250
 gymnaste *f* 235
 gymnastique *f* 235
 gymnastique rythmique *f* 235
 gynécologie *f* 49
 gynécologue *m* 52
 gypsophile *f* 110
- H**
 habillé 34
 hache *f* 95
 haie *f* 85, 90, 182
 haies *f* 235
 Haïti 314

- hall *m* 100
 hall de gare *m* 209
 haltère *m* 251
 hamac *m* 266
 hamburger *m* 154
 hamburger au poulet *m* 155
 hamburger avec des frites *m* 154
 hamburger végétarien *m* 155
 hameçon *m* 244
 hamster 290
 hanche *f* 12
 handicap *m* 233
 haricot grim pant *m* 122
 haricot vert *m* 122
 haricots *m* 131
 haricots blancs *m* 131
 haricots mung *m* 131
 haricots pinto *m* 131
 haricots rouges *m* 131
 harpe *f* 256
 haut 321
 haute-définition 269
 haut-parleur *m* 176, 209
 hautbois *m* 257
 hauteur *f* 165
 Hawaï 314
 hayon *m* 198
 heavy métal *f* 259
 hebdomadaire 307
 hélice *f* 211, 214
 hélicoptère *m* 211
 hématite *f* 289
 hémisphère nord *m* 283
 hémisphère sud *m* 283
 hémorragie *f* 46
 herbe *f* 55, 86
 herbes *f* 133, 134
 herbes et les épices *f* 132
 herbicide *m* 91, 183
 herboristerie *f* 55, 108
 hérisson *m* 290
 hêtre *m* 296
 heure *f* 304
 heure de pointe *f* 209
 heures *f* 261
 heures de visite *f* 48
 heureux 25
 hexagone *m* 164
 hier 306
 Himalaya *m* 313
 hippocampe *m* 294
 hippopotame *m* 291
 hirondelle *f* 292
 histoire *f* 162
 histoire de l'art *f* 169
 hiver *m* 31, 307
 hochet *m* 74
 hockey *m* 224
 hockey sur glace *m* 224
 hockeyeur *m* 224
 homard *m* 121, 295
 homéopathie *f* 55
 homme *m* 12, 23
 homme d'affaires *m* 175
 homme de base *m* 228
 homogénéisé 137
 Honduras 314
 Hongrie 316
 hôpital *m* 48
 horaire *m* 197, 209, 261
 horloge *f* 304
 hormone *f* 20
 hors jeu 225, 226, 228
 hors piste 247
 hors-bord *m* 215
 hors-jeu *m* 223
 hot-dog *m* 155
 hôte *m* 64
 hôtel *m* 100, 264
 hôtesse *f* 64
 hôtesse de l'air *f* 190, 210
 hotte *f* 66
 houé *f* 88
 houppette *f* 40
 houx *m* 296
 hublot *m* 210, 214
 huile *f* 142, 199
 huile d'amande *f* 134
 huile d'arachide *f* 135
 huile d'olive *f* 134
 huile de colza *f* 135
 huile de maïs *f* 135
 huile de noisette *f* 134
 huile de noix *f* 134
 huile de pépins de raisin *f* 134
 huile de sésame *f* 134
 huile de tournesol *f* 134
 huile parfumée *f* 134
 huile pressée à froid *f* 135
 huile végétale *f* 135
 huiles *f* 134
 huiles essentielles *f* 55
 huissier *m* 180
 huit 308
 huit cents 308
 huitième 309
 huître *m* 121
 humérus *m* 17
 humide 321, 286
 hydravion *m* 211
 hydroptère *m* 215
 hydrothérapie *f* 55
 hygiène dentaire *f* 72
 hygiène féminine *f* 108
 hypnothérapie *f* 55
 hypoallergénique 41
 hypoténuse *f* 164
 hypothèque *f* 96
- I**
 icône *f* 177
 igname *f* 125
 igné 288
 iguane *m* 293
 île *f* 282
 île Maurice 317
 îles Galapagos 315
 îles Malouines 315
 îles Salomon 319
 immeuble *m* 59, 298
 immeuble de bureaux *m* 298
 immigration *f* 212
 immobilisation *f* 237
 imperméable *m* 31, 32, 245, 267
 impôt *m* 96
 imprimante *f* 172, 176
 imprimer 172
 imprimerie *f* 275
 impuissant 20
 incendie *m* 95
 incisive *f* 50
 Inde 318
 index *m* 15
 individuelle 58
 Indonésie 319
 infection *f* 44
 infirmier du SAMU *m* 94
 infirmière *f* 45, 48, 52, 189
 information *f* 261
 information touristique *f* 261
 infusion de menthe *f* 149
 ingénieur du son *m* 179
 inhalateur *m* 44, 109
 injection *f* 48
 innocent 181
 inoculation *f* 45
 inondation *f* 287
 inox *m* 79
 inquiet 25
 insomnie *f* 71
 inspecteur *m* 94
 installer 177
 institutrice *f* 162, 191
 instruments *m* 256, 258
 insuline *f* 109
 intercostal *m* 16
 interdit de tourner à droite 195
 intérieur *m* 200
 internet *m* 177
 interphone *m* 59
 interrupteur *m* 60
 interrupteur feux *m* 201
 interviewer *m* 179
 intestin grêle *m* 18
 invertébrés *m* 295
 investissement *m* 97
 invité *m* 64
 ionosphère *f* 286
 iPad *m* 176
 iPod *m* 268
 Irak 318
 Iran 318
 iris *m* 51, 110
 Irlande 316
 Islande 316
 isolation *f* 61
 isorel *m* 79
 Israël 318
 Italie 316
 itinéraire *m* 260
- J**
 jacinthes des bois *f* 297
 jade *m* 288
 jais *m* 288
 Jamaïque 314
 jambe *f* 12
 jambière *f* 224, 225
 jambon *m* 119, 143, 156
 jante *f* 206
 janvier *m* 306
 Japon 318
 jardin *m* 84
 jardin à la française *m* 84, 262
 jardin d'eau *m* 84
 jardin d'herbes aromatiques *m* 84
 jardin paysan *m* 84
 jardin sur le toit *m* 84
 jardinage *m* 90
 jardinier *m* 188
 jarretelle *f* 35
 jarretière *f* 35
 jauge d'essence *f* 201
 jauge d'huile *f* 202
 jaune 274
 jaune d'œuf *m* 137, 157
 javelot *m* 234
 jazz *m* 259
 jean *m* 31, 33
 jet *m* 89
 jet d'eau *m* 95
 jet privé *m* 211
 jetable 109
 jetée *f* 217
 jeter l'ancre 217
 jeton *m* 272
 jet-ski *m* 241
 jeu *m* 75, 230, 273
 jeu de cartes *m* 273
 jeu télévisé *m* 178
 jeu vidéo *m* 269
 jeudi *m* 306
 jeux *m* 272
 jeux de raquette *m* 231
 jeux de société *m* 272
 joaillerie *f* 275
 jodhpur *m* 242
 jogger sur place 251
 jogging *m* 251, 263
 joint *m* 61, 80
 jointolement *m* 187
 joker *m* 273
 jonc *m* 86
 jonquille *f* 111
 Jordanie 318
 joue *f* 14
 jouer 229, 273
 jouet *m* 75
 jouet en peluche *m* 75
 jouets *m* 105
 joueur *m* 221, 231, 273
 joueur de basket *m* 226
 joueur de cricket *m* 225
 joueur de foot *m* 222
 joueur de football *m* 220
 joueuse de golf *f* 232
 jour *m* 306
 jour ouvrable *m* 306
 journal *m* 112
 journaliste *m* 190
 judas *m* 59
 judo *m* 236
 juge *m* 180
 juge de ligne *m* 220, 223, 230
 juillet *m* 306
 juin *m* 306
 jumeaux *m* 23
 jumelles *f* 281
 jumping *m* 243
 jupe *f* 30, 34
 Jupiter *f* 280
 jury *m* 180
 jus *m* 127
 jus d'ananas *m* 149
 jus de fruit *m* 156
 jus de pomme *m* 149
 jus de raisin *m* 144
 jus de tomate *m* 144, 149
 jus d'orange *m* 148
 jus et milk-shakes *m* 149
 jusqu'à 320
 juteux 127
- K**
 kaki *m* 128
 Kaliningrad 316
 kangourou *m* 291
 karaté *m* 236
 Kazakhstan 318
 kébab *m* 155
 kendo *m* 236
 Kenya 317
 ketchup *m* 135, 154
 kilomètre *m* 310
 kinésithérapie *f* 49
 kiosque *m* 215
 kippers *m* 157
 Kirghizistan 318
 kiwi *m* 128
 klaxon *m* 201, 204
 kleenex *m* 108
 knock-out *m* 237
 koala *m* 291
 Koweït 318
 kumquat *m* 126
 kung-fu *m* 236
- L**
 laboratoire *m* 166
 labourer 183
 lac *m* 285
 lacet *m* 37
 lâcher 245

- lacrosse *m* 249
 lactose *m* 137
 laine *f* 277
 laisser tremper 130
 lait *m* 136, 156
 lait condensé *m* 136
 lait de brebis *m* 137
 lait de chèvre *m* 136
 lait de vache *m* 136
 lait demi-écrémé *m* 136
 lait écrémé *m* 136
 lait en poudre *m* 137
 lait entier *m* 136
 laitue *f* 123
 lame *f* 66, 78, 89
 lame de rasoir *f* 73
 lampadaire *m* 298
 lampe *f* 50, 62
 lampe de chevet *f* 70
 lampe de radio *f* 45
 lampe d'entrée *f* 58
 lampe torche *f* 267
 lancement *m* 281
 lancement du poids *m* 234
 lancer 221, 225, 227, 229, 245
 lanceur *m* 225, 229, 281
 landau *m* 75
 langue *f* 19
 langue de bœuf *f* 118
 langues *f* 162
 languette *f* 37
 lanière *f* 207
 Laos 318
 lapin *m* 118, 290
 laque *f* 38
 large 321
 largeur *f* 165
 larme *f* 51
 larynx *m* 19
 latitude *f* 283
 lavabo *m* 38, 72
 lave *f* 283
 lave-auto *m* 198
 lave-glace *m* 199
 lave-linge *m* 76
 lave-linge séchant 76
 laver 38, 77
 laver à la brosse 77
 laverie automatique *f* 115
 lave-vaisselle *m* 66
 laxatif *m* 109
 le long de 320
 Le Salvador 314
 leçon *f* 163
 lecteur cassettes *m* 269
 lecteur CD *m* 268
 lecteur DVD *m* 268
 lecteur optique *m* 106
 lecture *f* 269
 léger 321
 leggings 31
 légumes *m* 107, 122, 124
 légumes secs *m* 130
 lent 321
 lentille de l'objectif *f* 167
 lentilles *f* 131
 lentilles de contact *f* 51
 lentilles rouges *f* 131
 Lesotho 317
 Lettonie 316
 lettre *f* 98
 lettre par avion 98
 levée *f* 98
 lever 139
 lever du soleil *m* 305
 levier *m* 150
 levier de frein *m* 207
 levier de vitesse *m* 207
 levier de vitesses *m* 201
 lèvre *f* 14
 lèvres *f* 20
 levure *f* 138
 lézard *m* 293
 Liban 318
 libellule *f* 295
 Libéria 317
 liberté conditionnelle *f* 181
 librairie *f* 115
 libre 321
 Libye 317
 licence *f* 169
 licenciée *f* 169
 licou *m* 243
 Liechtenstein 316
 ligament *m* 17
 ligne *f* 244
 ligne d'arrivée *f* 234
 ligne de bout *f* 226
 ligne de but *f* 220, 223, 224
 ligne de centre *f* 226
 ligne de côté *f* 230
 ligne de départ *f* 234
 ligne de fond *f* 230
 ligne de jeu *f* 233
 ligne de lancer franc *f* 226
 ligne de pénalité *f* 229
 ligne de service *f* 230
 ligne de touche *f* 220, 221, 226
 ligne de trois points *f* 226
 ligne d'envoi *f* 225
 ligne du ballon mort *f* 221
 lignes *f* 165
 limace *f* 295
 limande-sole *f* 120
 lime *f* 81
 lime à ongles *f* 41
 limitation de vitesse *f* 195
 limite du terrain *f* 225
 limonade *f* 144
 limousine *f* 199
 lin *m* 184, 277
 linge *m* 76
 linge de lit *m* 71
 linge de maison *m* 105
 linge propre *m* 76
 linge sale *m* 76
 lingerie *f* 35, 105
 lingette *f* 74, 108
 linteau *m* 186
 lion *m* 291
 liqueur *f* 145
 liquide *m* 77
 liquide amniotique *m* 52
 lire 162
 lis *m* 110
 liseuse *f* 210
 lit *m* 70
 lit d'enfant *m* 74
 lit de camp *m* 266
 lit simple *m* 71
 lit U.V. *m* 41
 litchi *m* 128
 literie *f* 74
 litre *m* 311
 littérature *f* 162, 169
 Lituanie 316
 livraison à domicile *f* 154
 livre *f* 310
 livre *m* 163, 168
 lob *m* 230
 locataire *m* 58
 location de voitures *f* 213
 locomotive *f* 208
 loganberry *f* 127
 loge *f* 254
 logement du film *m* 270
 logiciel *m* 176
 logo *m* 31
 loin de 320
 lombaires *f* 17
 long 34
 longe *f* 121
 longitude *f* 283
 longueur *f* 165, 310
 longueur d'ondes *f* 179
 losange *m* 164
 lotion *f* 109
 lotion pour le corps *f* 73
 lotion solaire *f* 265
 lotte *f* 120
 louche *f* 68
 louer 58
 loup *m* 290
 lourd 286, 321
 loutre *f* 290
 louvoyer 241
 loyer *m* 58
 luffa *m* 73
 luge *f* 247
 lundi *m* 306
 lune *f* 280
 lunettes *f* 51, 247
 lunettes de protection *f* 167
 lunettes de sécurité *f* 81
 lunettes de soleil *f* 51
 lunettes protectrices *f* 238
 lupins *m* 297
 lutte *f* 236
 Luxembourg 316
 luzerne *f* 184
 lymphatique 19
M
 macadam goudronné *m* 187
 macadamia *f* 129
 Macédoine 316
 macéré 159
 machine à coudre *f* 276
 machine à couper *f* 139
 machine à ramer *f* 250
 machine de randonnée *f* 250
 machine de rayons X *f* 212
 machines *f* 187
 mâchoire *f* 14
 macis *m* 132
 maçon *m* 186, 188
 macramé *m* 277
 Madagascar 317
 Madame *f* 23
 madeleine *f* 140
 Mademoiselle *f* 23
 magasin *m* 298
 magasin à papier 172
 magasin bio *m* 115
 magasin d'antiquités *m* 114
 magasin d'appareils photos *m* 115
 magasin de chaussures *m* 114
 magasin de disques *m* 115
 magasin de meubles *m* 115
 magasin de vins et spiritueux *m* 115
 magazine *m* 112
 magazines *m* 107
 magma *m* 283
 magnésium *m* 109
 mai *m* 306
 maillet *m* 275
 maillon *m* 36
 maillot *m* 222, 251
 maillot de bain *m* 238, 265
 maillot de rugby *m* 221
 main *f* 13, 15
 maintenant 304
 mairie *f* 299
 mais *m* 122, 124, 130, 184
 maison *f* 58
 maison de deux étages *f* 58
 maison de poupée *f* 75
 maison d'habitation *f* 182
 maison pliante *f* 75
 maître nageur *m* 239, 265
 maîtrise *f* 169
 majeur *m* 15
 majorette *f* 220
 mal de tête *m* 44
 mal d'estomac *m* 44
 malachite *f* 288
 malade en consultation externe *m* 48
 maladie *f* 44
 maladie sexuellement transmissible *f* 20
 Malaisie 318
 Malawi 317
 Maldives 318
 Mali 317
 Malte 316
 mamelon *m* 12
 mammifères *m* 290
 manche *m* 34, 36, 187, 230, 258
 manchego *m* 142
 manchette *f* 32
 mandarine *f* 126
 mandat *m* 180
 mandat postal *m* 98
 mandrin *m* 78
 manette *f* 61
 manette de chauffage *f* 201
 manette de secours *f* 209
 manger 64
 manger *m* 75
 manger sur place 154
 mangue *f* 128
 manioc *m* 124
 manivelle *f* 203
 mannequin *m* 276
 mante religieuse *f* 295
 manteau *m* 32, 282
 manucure *f* 41
 manuel 200
 maquereau *m* 120
 maquette *f* 190
 maquillage *m* 40
 maracas *m* 257
 marais *m* 285
 marathon *m* 234
 marbre *m* 288
 marchand de hot-dogs *m* 154
 marchand de journaux *m* 112
 marchand de légumes *m* 114, 188
 marchand d'occasion *m* 115
 marchande de poissons *f* 188
 marché *m* 115
 mardi *m* 306
 margarine *f* 137
 marguerite *f* 110
 mari *m* 22
 mariage *m* 26, 35
 marin *m* 189

- marina *f* 217
 mariné 143, 159
 marjolaine *f* 133
 Maroc 317
 marque *f* 273
 marque de flottaison en charge *f* 214
 marquer 227
 marquer un but 223
 marron 274
 marron *m* 129
 mars *m* 306
 Mars *f* 280
 marteau *m* 80
 marteau de forgeron *m* 187
 marteau de porte *m* 59
 marteau-piqueur *m* 187
 marteler 79
 martini *m* 151
 mascara *m* 40
 masculin 21
 masque *m* 189, 228, 236, 239, 249
 masque de beauté *m* 41
 masque protecteur *m* 225
 massage *m* 54
 mastic *m* 83
 mastiquer 82
 mat 83, 271
 mât *m* 240, 266
 match *m* 230
 matelas *m* 70, 74
 matelas à langer *m* 74
 matelas pneumatique *m* 267
 matériaux *m* 79, 187
 matériel *m* 176
 matériel de pêche *m* 245
 maternité *f* 48, 49
 mathématiques *f* 162, 164
 matin *m*
 matraque *f* 94
 Mauritanie 317
 mauvais 321
 mauvais point *m* 228
 mauvaises herbes *f* 86
 maxillaire *m* 17
 mayonnaise *f* 135
 mécanicien *m* 188
 mécanique *f* 202
 mèche *f* 78
 médailles *f* 235
 médecin *m* 45
 médecine *f* 169
 médecine ayurvédique *f* 55
 médias *m* 178
 médicament *m* 109
 médicament
 multivitamine *m* 109
 médicament pour la toux *m* 108
 médication *f* 109
 méditation *f* 54
 Méditerranée *f* 313
 médium *m* 79
 méduse *f* 295
 mélanger 67, 138
 mêlée *f* 221
 mêlée ouverte *f* 221
 mélèze *m* 296
 mélodie *f* 259
 melon *m* 127
 mémoire *f* 176
 mémoire *m* 127
 mémoire *f* 176
 menottes *f* 94
 mensuel 307
 menthe *f* 133
 menton *m* 14
 menu *m* 148
 menu du déjeuner *m* 152
 menu du soir *m* 152
 menu enfant *m* 153
 menuisier *m* 188
 mer *f* 264, 282
 mer Baltique *f* 313
 mer Caspienne *f* 313
 mer d'Arabie *f* 313
 mer des Caraïbes *f* 312
 mer du Nord *f* 312
 mer Noire *f* 313
 mer Rouge *f* 313
 mercerie *f* 105
 merci 322
 mercredi *m* 306
 mercure *m* 289
 Mercure *f* 280
 mère *f* 22
 meringue *f* 140
 merlan *m* 120
 mésosphère *f* 286
 message vocal *m* 99
 messages *m* 100
 mesure *f* 150, 151
 mesure pour les liquides *f* 311
 mesurer 310
 mesures *f* 165
 métacarpien *m* 17
 métal *m* 79
 métamorphique *m* 288
 métatarsien *m* 17
 métaux *m* 289
 météore *m* 280
 métier à tisser *m* 277
 mètre *m* 80, 310
 mètre carré *m* 310
 métro *m* 209
 mettre en scène *m* 254
 mettre en pot 91
 mettre la table 64
 mettre le réveil 71
 mettre un tuteur 91
 meuble-classeur *m* 172
 Mexique 314
 mica *m* 289
 micro *m* 258
 micro-ondes *m* 66
 microphone *m* 179
 microscope *m* 167
 midi *m* 305
 miel liquide *m* 134
 miel solide *m* 134
 migraine *f* 44
 mijoter 67
 mile *m* 310
 milk-shake *m* 137
 milk-shake à la fraise *m* 149
 milk-shake au chocolat *m* 149
 mille 309
 mille *m* 273
 mille neuf cent dix 307
 mille neuf cents 307
 millénaire *m* 307
 mille-pattes *m* 295
 millet *m* 130
 milliard *m* 309
 milligramme *m* 310
 millilitre *m* 311
 millimètre *m* 310
 million *m* 309
 mince 321
 minéraux *m* 289
 minerve *f* 46
 minibar *m* 101
 minibus *m* 197
 minijupe *f* 34
 minuit *m* 305
 minute *f* 304
 miroir *m* 40, 71, 167
 mise à la terre *f* 60
 mise au point *f* 271
 missile *m* 211
 mi-temps *f* 223
 mitoyenne 58
 mitrailleuse *f* 189
 mixeur *m* 66
 mobile *m* 74
 mocassin *m* 37
 mode *f* 277
 mode d'emploi *m* 109
 modèle *m* 169
 modèles *m* 199
 modélisme *m* 275
 module lunaire *m* 281
 moineau *m* 292
 moins 165
 mois *m* 306
 moïse *m* 74
 moissonneuse-batteuse *f* 182
 molaire *f* 50
 Moldavie 316
 mollet *m* 13, 16
 Monaco 316
 Mongolie 318
 moniteur *m* 53, 75, 172,
 Monopoly *m* 272
 monorail *m* 208
 Monsieur *m* 23
 mont du lanceur *m* 228
 montagne *f* 284
 montagnes russes *f* 262
 montant *m* 96
 monter une tente 266
 montgolfière *f* 211
 montre *f* 36
 monture *f* 51
 monument *m* 261
 monument historique *m* 261
 morceaux de viande *m* 119
 mordre 245
 mors *m* 242
 morse *m* 290
 morsure *f* 46
 mortier *m* 68, 167, 187
 morue *f* 120
 mosquée *f* 300
 mot de passe *m* 99
 moteur *m* 88, 202, 204
 moto *f* 204
 moto de course *f* 205
 moto routière *f* 205
 moto tout-terrain *f* 205
 motocross *m* 249
 motonautisme *m* 241
 mou 129, 321
 mouche *f* 244, 295
 mouchoir *m* 36
 mouette *f* 292
 mouflon *f* 30
 mouiller 217
 moule *f* 121, 295
 moule à gâteaux *f* 69
 moule à muffins *m* 69
 moule à soufflé *m* 69
 moule à tarte *m* 69
 moulinet *m* 244
 moulure *f* 63
 mourir 26
 mousse *f* 141, 148
 mousse à raser *f* 73
 mousson *f* 287
 moustiquaire *f* 267
 moustique *m* 295
 moutarde *f* 155
 moutarde anglaise *f* 135
 moutarde en grains *f* 135
 moutarde française *f* 135
 mouton *m* 185
 moyeu *m* 206
 Mozambique 317
 mozzarella *f* 142
 muffin *m* 140
 multiplier 165
 mur *m* 58, 186
 mûr 129
 mûre *f* 127
 muscles *m* 16
 musée *m* 261
 musée d'art *m* 261
 museronne *f* 242
 musicien *m* 191
 musique *f* 162
 musique classique *f* 255, 259
 musique folk *f* 259
 myopie *f* 51
 myrtille *f* 127
N
 naan *m* 139
 nacelle *f* 95
 nage *f* 239
 nage synchronisée *f* 239
 nageoire 290
 nageoire dorsale *f* 294
 nageoire pectorale *f* 294
 nager 238
 nager sur place 239
 nageur *m* 238
 naissance *f* 52, 53
 naître 26
 Namibie 317
 nappe *f* 64
 narine *f* 14
 natation *f* 238
 nation *m* 315
 natte *f* 39
 naturel 118
 naturopathie *f* 55
 nausée *f* 44
 navet *m* 124
 navette *f* 197
 navette spatiale *f* 281
 navigateur *m* 177
 navigateur satellite *m* 201
 naviguer 177, 240
 navire *m* 214
 navire de guerre *m* 215
 navire porte-conteneurs *m* 215
 ne pas plier 98
 nébuleuse *f* 280
 nectarine *f* 126
 négatif *m* 271
 neige *f* 287
 neige fondue *f* 286
 néoclassique 301
 Népal 318
 Neptune *f* 280
 nerf *m* 50, 19
 nerf optique *m* 51
 nerveux 19, 25
 nettoyer 77
 nettoyeur *m* 188
 neuf 308, 321
 neuf cents 308
 neurologie *f* 49
 neutre 60
 neuvième 309
 neveu *m* 23
 nez *m* 14, 210
 Nicaragua 314
 nickel *m* 289
 nièce *f* 23
 Niger 317
 Nigéria 317
 niveau *m* 80

- niveau à bulle *m* 187
 Noël *m* 27
 nœud papillon *m* 36
 noir 39, 272, 274
 noir *m* 148
 noisette *f* 129
 noix *f* 129, 151
 noix de cajou *f* 129, 151
 noix de coco *f* 129
 noix de muscade *f* 132
 noix du Brésil *f* 129
 noix et les fruits secs *f, m* 129
 noix pacane *f* 129
 nombres *m* 308
 nombril *m* 12
 non 322
 non gazeux 144
 non pasteurisé 137
 non salé 137
 nord *m* 312
 normal 39
 Norvège 316
 notation *f* 256
 note *f* 163, 256
 notes *f* 191
 nougat *m* 113
 nouilles *f* 158
 nourriture *f* 118, 130, 149
 nourriture pour animaux *f* 107
 nouveau-né *m* 53
 Nouvel An *m* 27
 nouvelle lune *f* 280
 nouvelles *f* 178
 Nouvelle-Zélande 319
 novembre *m* 306
 noyau extérieur *m* 282
 noyau intérieur *m* 282
 nuage *m* 287
 nuageux 286
 nuit *f* 305
 numérateur *m* 165
 numérique 179, 269
 numéro *m* 226
 numéro de bus *m* 196
 numéro de chambre *m* 100
 numéro de compte *m* 96
 numéro de la porte d'embarquement *m* 213
 numéro de voie *m* 208
 numéro de vol *m* 213
 nuque *f* 13
 nylon *m* 277
- O**
 O.R.L. *f* 49
 objectif *m* 270
 objet exposé *m* 261
 observation des oiseaux *f* 263
 obsidienne *f* 288
 obstacle *m* 243
- obstacle d'eau *m* 232
 obstétricien *m* 52
 obtenir sa licence 26
 occupé 99
 océan *m* 282
 océan Arctique *m* 312
 océan Atlantique *m* 312
 océan Austral *m* 313
 océan Indien *m* 312
 océan Pacifique *m* 312
 octobre *m* 306
 octogone *m* 164
 oculaire *m* 167
 odomètre *m* 201
 œil *m* 14, 51
 œillet *m* 37, 110, 244, 276
 œilleton *m* 269
 œsophage *m* 19
 œuf à la coque *m* 137, 157
 œuf de caille *m* 137
 œuf de cane *m* 137
 œuf de poule *m* 137
 œuf d'oie *m* 137
 œuf sur le plat *m* 157
 œufs *m* 137
 œufs brouillés *m* 157
 officier de police *m* 94
 officine *f* 108
 oie *f* 119, 293
 oignon *m* 124
 oiseaux *m* 292
 okra *m* 122
 olive fourrée *f* 143
 olive noire *f* 143
 olive verte *f* 143
 olives *f* 151
 Oman 318
 omelette *f* 158
 omoplate *f* 17
 once *f* 310
 oncle *m* 22
 oncologie *f* 49
 ondes courtes *f* 179
 ondes moyennes *f* 179
 ongle *m* 15
 ongle du pied *m* 15
 onyx *m* 289
 onze 308
 onzième 309
 opale *f* 288
 opéra *m* 255
 opération *f* 48
 ophtalmologie *f* 49
 opticien *m* 51, 189
 or *m* 235, 289
 orage *m* 287
 orange 274
 orange *f* 126
 orangeade *f* 144
 orbite *f* 280
 orchestre *m* 254, 256
 orchidée *f* 111
 ordinateur *m* 176
 ordonnance *f* 45
- ordre du jour *m* 174
 oreille *f* 14
 oreiller *m* 70
 oreillons *m* 44
 organes de reproduction *m* 20
 organes génitaux 12
 orge *f* 130, 184
 orientation d'un patient *m* 49
 origami *m* 275
 origan *m* 133
 orme *m* 296
 ornemental 87
 ornements de jardin *m* 84
 ortel *m* 15
 orthopédie *f* 49
 ortie *f* 297
 os *m* 17, 119
 oseille *f* 123
 ostéopathie *f* 54
 otarie *f* 290
 ouatage *m* 277
 ouest *m* 312
 Ouganda *m* 317
 oui 322
 ouïe *f* 294
 ouragan *m* 287
 ourlet *m* 34
 ours *m* 291
 ours blanc *m* 291
 ours en peluche *m* 75
 outils *m* 187
 outils de jardin *m* 88
 ouvert 260, 321
 ouverture *f* 256
 ouvrages recommandés *m* 168
 ouvre-boîte *m* 68
 ouvre-bouteille *m* 68, 150
 Ouzbékistan 318
 ovaire *m* 20
 ovale *m* 164
 over par *m* 233
 ovulation *f* 20, 52
 ovule *m* 20
- P**
 P.C.V. *m* 99
 pagaie *f* 241
 paie *f* 175
 paiement *m* 96
 paillason *m* 59
 paille *f* 144, 154
 paille de fer *f* 81
 pailler 91
 pain *m* 139, 157, 311
 pain au bicarbonate de soude *m* 139
 pain au levain *m* 139
 pain aux graines *m* 139
 pain aux raisins secs *m* 139
 pain bis *m* 139, 149
- pain blanc *m* 139
 pain complet *m* 139
 pain de maïs *m* 139
 pain de seigle *m* 138
 pain de son *m* 139
 pain perdu *m* 157
 pain plat *m* 139
 pain tranché *m* 138
 pains *m* 138
 Pakistan 318
 palais *m* 19
 pale de rotor *f* 211
 palet *m* 224
 palette *f* 186, 274
 palier *m* 59
 palisser 91
 palme *f* 239
 palmier *m* 86, 296
 pamplemousse *m* 126
 panais *m* 125
 Panama 314
 pancréas *m* 18
 panda *m* 291
 panier *m* 106, 207, 226
 panier à jouets *m* 75
 panier à linge *m* 76
 panier à pique-nique *m* 263
 panier de jardinier *m* 88
 panier de pêche *m* 245
 panier suspendu *m* 84
 panne *f* 195, 203
 panneau *m* 226
 panneau d'affichage 173
 panneau de signalisation *m* 298
 panneaux routiers *m* 195
 pansement *m* 47
 pantalon *m* 32, 34
 pantalon de jogging *m* 33
 pantoufles *f* 31
 paon *m* 293
 papaye *f* 128
 papeterie *f* 105
 papier cache *m* 83
 papier d'apprêt *m* 83
 papier de verre *m* 81, 83
 papier filtre *m* 167
 papier gaufré *m* 83
 papier mâché *m* 275
 papier peint *m* 82, 177
 papillon *m* 239, 295
 Papouasie-Nouvelle-Guinée 319
 paprika *m* 132
 Pâques *f* 27
 paquebot *m* 215
 pâquerette *f* 297
 Pâques *f* 27
 paquet *m* 311
 paquet de cigarettes *m* 112
 par *m* 233
 par avion 98
 parachute *m* 248
- parachutisme *m* 248
 Paraguay 315
 parallèle 165
 parallélogramme *m* 164
 parapente *m* 248
 parapluie *m* 36, 233
 parasol *m* 264
 parc *m* 75, 261, 262
 parc d'attractions *m* 262
 parc national *m* 261
 parcourmètre *m* 195
 parcours de golf *m* 232
 pare-brise *m* 198, 205
 pare-chocs *m* 198
 parents *m* 23
 pare-vent *m* 265
 pardon 322
 parfum *m* 41
 parfumé 130
 parfumerie *f* 105
 pari *m* 273
 parking *m* 298
 parking réservé aux personnes handicapées *m* 195
 parmesan *m* 142
 paroles *f* 259
 partenaire *m, f* 23
 parterre *m* 85, 90
 partir du tee 233
 partition *f* 255, 256
 pas *m* 243
 passage clouté *m* 195
 passage inférieur *m* 194
 passager *m* 216
 passe *f* 226
 passeport *m* 213
 passerelle *f* 212, 214
 passoire *f* 68
 pastels *m* 274
 pastèque *f* 127
 pasteurisé 137
 pastille pour la gorge *f* 109
 patate douce *f* 125
 pataugas *m* 37
 pataugeoire *f* 263
 patchwork *m* 277
 pâte *f* 138, 140
 pâté *m* 142, 156
 pâte à choux *f* 140
 pâte à tartiner au chocolat *f* 135
 pâte à tartiner au citron *f* 134
 pâte d'amandes *f* 141
 pâte de filo *f* 140
 pâte feuilletée *f* 140
 pâtes *f* 158
 pâtes en croûte *m* 143
 pathologie *f* 49
 patient *m* 45
 patin à glace *m* 224, 247
 patin de frein *m* 207
 patin en ligne *m* 249

- patinage *m* 247
 patinage artistique *m* 247
 patinage de vitesse *m* 247
 patiner 224
 patinoire *f* 224
 patio *m* 85
 pâtisserie *f* 69, 114, 149
 patron *m* 276
 paume *f* 15
 paupière *f* 51
 pause *f* 269
 pavé *m* 85
 pavillon *m* 58, 232
 payer 153
 pays *m* 315
 paysage *m* 284
 paysage 271
 Pays-Bas 316
 peau *f* 14, 119, 128
 peau blanche *f* 126
 pêche *f* 126, 128, 244
 pêche à la mouche *f* 245
 pêche au lancer en mer *f* 245
 pêche en eau douce *f* 245
 pêche hauturière *f* 245
 pêche maritime *f* 245
 pêche sous-marine *f* 245
 pêche sportive *f* 245
 pêcheur *m* 189, 244
 pectoral *m* 16
 pédale *f* 61, 206, 257
 pédale de frein *f* 205
 pédaler 207
 pédiatrie *f* 48, 49
 pédicurie *f* 41
 peigne *m* 38
 peigner 38
 peignoir *m* 32, 35, 38, 73
 peindre 83
 peintre *m* 191
 peinture *f* 83, 274
 peintures à l'huile *f pl* 274
 peinture mate *f* 83
 pélican *m* 292
 pelle *f* 77, 187, 265
 pelle à poisson *f* 68
 pelle mécanique *f* 187
 pellicule *f* 260, 271
 pellicules *f* 39
 pelote à épingles *f* 276
 pelouse *f* 85, 90, 262
 penalty *m* 222
 pendentif *m* 36
 péninsule *f* 282
 pénis *m* 21
 pension complète *f* 101
 pentagone *m* 164
 pente de ski *f* 246
 pépin *m* 128, 127
 pépinière *f* 115
 pepperoni *m* 142
 percer 79
 perceuse électrique *f* 7
 perceuse manuelle *f* 81
 perceuse rechargeable *f* 78
 perche *f* 179, 245
 percolateur *m* 148, 150
 percussion *f* 257
 perdant *m* 273
 perdre 273
 perdre les eaux 52
 père *m* 22
 perforateur 173
 perfusion *f* 53
 pergola *f* 84
 périodique *f* 52
 périodique *m* 168
 permanente *f* 39
 permis de pêche *m* 245
 péroné *f* 17
 Pérou 315
 perpendiculaire 165
 perroquet *m* 293
 perruque *f* 39
 persil *m* 133
 personnel *m* 175
 pesanteur *f* 280
 pèse-bébé *m* 53
 peser 310
 pesticide *m* 89, 183
 pétale *m* 297
 petit 321
 petit ami *m* 24
 petit bassin *m* 239
 petit déjeuner *m* 64, 156
 petit déjeuner anglais *m* 156
 petit enfant *m* 30
 petit galop *m* 243
 petit gâteau *m* 140
 petit orteil *m* 15
 petit pain *m* 139, 143, 155
 petit pain américain *m* 139
 petit pain rond *m* 139
 petit pois *m* 122
 petite aiguille *f* 304
 petite amie *f* 24
 petite fourche *f* 89
 petite-fille *f* 22
 petit-fils *m* 22
 petits pois *m* 131
 petits-enfants *m* 23
 pétrir 138
 pétrolier *m* 215
 peuplier *m* 296
 peut-être 322
 phare *m* 198, 205, 207, 217
 pharmacien *m* 108
 pharmacienne *f* 189
 pharynx *m* 19
 philatélie *f* 273
 Philippines 319
 philosophie *f* 169
 photo *f* 290
 photo *f* 271
 photocopier 172
 photo-finish *m* 234
 photographe *m* 191
 photographie *f* 270
 photographe 271
 photophone *m* 270
 physalis *f* 128
 physique *f* 162, 169
 piano *m* 256
 piano électronique *m* 258
 pic *m* 292
 piccolo *m* 257
 pichet *m* 151
 pick-up *m* 258
 pièce *f* 97, 272
 pièce jointe *f* 177
 pièce de théâtre *f* 254
 pièces rendues *f pl* 99
 pied *m* 12, 15, 310
 pied carré *m* 310
 pied du lit *m* 71
 pierre *f* 36, 275
 pierre à aiguiser *f* 81
 pierre de lune *f* 288
 pierre ponce *f* 73, 288
 pieuvre *f* 121, 295
 pigeon *m* 292
 pignon *m* 129, 207, 300
 Pilates *m* 251
 pile *f* 78, 167
 piles *f* 260
 pillule *f* 109
 pilon *m* 68, 167
 pilote *m* 190, 211
 pilule *f* 21
 piment *m* 124, 132, 143
 pin *m* 296
 pince *f* 166, 167
 pince à cheveux *f* 38
 pince à dénuder *f* 81
 pince à dessin 173
 pince à épiler *f* 40
 pince à linge *f* 76
 pince coupante *f* 80
 pince crocodile *f* 167
 pince fine *f* 47, 167
 pince plate *f* 80
 pince pour le nez *f* 238
 pince universelle *f* 80
 pinceau *m* 40, 274
 pinceau à lèvres *m* 40
 pinceau à pâtisserie *m* 69
 pinces *f* 150
 pingouin *m* 292
 pinte *f* 311
 pioche *f* 187
 pion *m* 272
 pipe *f* 112
 pipette *f* 167
 pique *m* 273
 pique-nique *m* 263
 piquer 90
 piquet *m* 225, 266
 piqûre *f* 46
 piscine *f* 101, 238, 250
 pissenlit *m* 123, 297
 pistache *f* 129
 piste *f* 212, 234
 piste cavalière *f* 263
 piste cyclable *f* 206
 piste de ski *f* 246
 pistolet *m* 94
 pistolet à colle *m* 78
 pita *m* 139
 pivoine *f* 111
 pizza *f* 154
 pizzeria *f* 154
 placard *m* 66
 place *f* 299
 placenta *m* 52
 places *f* 254
 placeur *m* 255
 plafond *m* 62
 plage *f* 264
 plaidoyer *m* 180
 plaine *f* 285
 plainte *f* 94
 plan *m* 261
 plan de métro *m* 209
 plan de travail *m* 66
 planche *f* 238, 241
 planche à hacher *f* 68
 planche à repasser *f* 76
 planche à roulette *f* 249, 263
 planche à voile *f* 241
 planches *f* 85
 planchiste *m* 241
 planète *f* 280, 282
 planeur *m* 211, 248
 plante à fleurs *f* 297
 plante alpestre *f* 87
 plante aquatique *f* 86
 plante d'ombre *f* 87
 plante du pied *f* 15
 plante en pot *f* 87, 110
 plante grasse *f* 87
 plante grimpeuse *f* 87
 plante rampante *f* 87
 planter 183
 plantes *f* 296
 plantes de jardin *f* 86
 plaque *f* 50, 283
 plaque à gâteaux *f* 69
 plaque d'immatriculation *f* 198
 plat à gratin *m* 69
 plat à rôtir *m* 69
 plat principal *m* 153
 plateau *m* 152, 154, 178, 284, 310
 plateau de desserts *m* 152
 plateau à petit déjeuner *m* 101
 platine *m* 289
 platine *f* 167, 276
 platine magnétophone *f* 268
 plâtre *m* 83
 plâtrer 82
 plats *m* 153
 plats cuisinés *m* 107
 plein 321
 pleine lune *f* 280
 pleurer 25
 plomb *m* 244
 plombage *m* 50
 plomberie *f* 61
 plombier *m* 188
 plongée *f* 239
 plongeur *m* 239
 plongeur de haut vol *m* 239
 plonger 238
 plongeur *m* 238
 plot de départ *m* 238
 pluie *f* 287
 plume *f* 163, 293
 plus 165
 plus tard 304
 Pluton *m* 280
 pneu *m* 198, 205, 206
 poche *f* 32, 293
 pocher 67
 pochoir *m* 83
 podium *m* 235, 256
 poêle *f* 69
 poids *m* 166, 250
 poids de naissance *m* 53
 poignée *f* 196, 200
 poignées *f* 37
 poignet *m* 13, 15, 230
 poing *m* 15, 237
 point *m* 228, 273, 277
 pointe *f* 37, 122, 246
 pointes *f* 233
 points de suture *m* 52
 poire *f* 127
 poireau *m* 125
 pois *m* 131
 pois cassés *m* 131
 pois chiches *m* 131
 poisson *m* 107, 120
 poisson avec des frites *m* 155
 poisson fumé 143
 poisson rouge *m* 294
 poissonnerie *f* 114, 120
 poissons *m* 294
 poitrine *f* 12
 poivre *m* 64, 152
 poivre de la Jamaïque *f* 132
 poivron *m* 124
 poker *m* 273
 Polaroid *m* 270
 pôle *m* 282
 pôle nord *m* 283
 police *f* 94, 177
 policier *m* 94, 189
 polo *m* 243
 Pologne 316
 polyester *m* 277

- pommade *f* 47, 109
 pomme *f* 126
 pomme d'Adam *f* 19
 pomme de terre *f* 124
 pomme de terre nouvelle *f* 124
 pommeau *m* 242
 pommeau de douche *m* 72
 pommes *f* 89
 pompe *f* 199, 207
 pompe à bière *f* 150
 pompe à lait *f* 53
 pompier *m* 189
 pompiers *m* 95
 poncer 82
 ponceuse *f* 78
 pont *m* 214, 300
 pont arrière *m* 214
 pont de commandement *m* 214
 pont de côté *m* 240
 pop *f* 259
 pop-corn *m* 255
 porc *m* 118
 porcelaine *f* 105
 porcelet *m* 185
 porche *m* 58
 porcherie *f* 185
 pore *m* 15
 porridge *m* 157
 port *m* 176, 214, 216, 217
 port de conteneurs *m* 216
 port de passagers *m* 216
 port de pêche *m* 217
 portable *m* 172, 175
 portable *m* 99, 176
 portail *m* 85
 porte *f* 196, 198, 209, 247
 porte automatique *f* 196
 porte d'entrée *f* 58
 porte de douche *f* 72
 porte vitrée *f* 59
 porte-avions *m* 215
 porte-bagages *m* 204, 209, 212
 porte-bébé *m* 75
 porte-crayons 172
 porte-dossiers 173
 portée *f* 256
 portefeuille *m* 37, 97
 porte-fusibles *m* 203
 porte-monnaie *m* 37
 porte-objet *m* 167
 porte-outils *m* 78
 porte-parapluies *m* 59
 porte-savon *m* 73
 porte-serviettes *m* 72
 porteur *m* 100
 portillon *m* 209
 portion *f* 64
 porto *m* 145
 Porto Rico 314
 portrait 271
 portrait-robot *m* 181
 Portugal 316
 pose *f* 271
 posemètre *m* 270
 poser 82
 position *f* 232
 posologie *f* 109
 poste *f* 98
 poste de péage *m* 194
 poste de police *m* 94
 postier *m* 98
 pot *m* 65, 74, 134, 311
 pot à fleurs *m* 89
 pot d'échappement *m* 204
 pot de peinture *m* 83
 pot d'échappement *m* 203
 potage *m* 158
 potager *m* 85, 182
 poteau *m* 220, 222
 poterie *f* 275
 pot-pourri *m* 111
 poubelle *f* 61, 67, 177
 pouce *m* 15, 310
 poudre *f* 40, 77, 109
 poudre de curry *f* 132
 poudrif *m* 40
 poulailler *m* 185
 poulain *m* 185
 poulet *m* 119, 185
 poulet frit *m* 155
 poulet préparé *m* 119
 pouls *m* 47
 poumon *m* 18
 poupée *f* 75
 pour 320
 pourcentage *m* 165
 pourri 127
 poussette *f* 75
 poussin *m* 185
 poutre *f* 186, 235
 prairie *f* 285
 pré *m* 182, 285
 prélèvement *m* 96
 prématuré 52
 premier 309
 premier étage *m* 104
 première *f* 254
 premiers secours *m* 47
 prémolaire *f* 50
 prénatal 52
 prendre au filet 245
 prendre des notes 163
 prendre la mer 217
 prendre sa retraite 26
 prendre un bain 72
 prendre un bain de soleil 264
 prendre une douche 72
 préparation *f* 159
 préparé 121
 prépuce *m* 21
 près de 320
 presbytie *f* 51
 présentateur *m* 178
 présentation *f* 174
 présentatrice *f* 179, 191
 présider 174
 presse-ail *m* 68
 presse-pied *m* 276
 presse-purée *m* 68
 pressing *m* 115
 pression des pneus *f* 203
 prêt *m* 96, 168
 preuve *f* 181
 prie 321
 primevère *f* 297
 principauté *f* 315
 printemps *m* 307
 prise *f* 60, 237
 prise de courant *f* 60
 prise maladroite du ballon *f* 220
 prison *f* 181
 prix *m* 152, 209
 prix d'entrée *m* 260
 prix des actions *m* 97
 prix du ticket *m* 197
 problèmes *m* 271
 produit anti-insecte *m* 108
 produits à tartiner *m* 134
 produits d'entretien *m* 107
 produits laitiers *m* 136
 produits surgelés *m* 107
 professions *f* 188, 190
 profondeur *f* 165
 programmation *f* 178
 programme *m* 176, 254
 projecteur *m* 259
 projecteur numérique *m* 163
 projection *f* 237
 prolongation *f* 223
 promenade *f* 265
 promotions *f* 106
 propager 91
 proposition *f* 174
 propriétaire *m* 58
 prosciutto *m* 143
 prostate *f* 21
 protections *f* 220
 protège-barreaux *m* 74
 protège-dents *m* 237
 protège-slip *m* 108
 protège-tête *m* 236
 proue *f* 215
 province *f* 315
 provisions *f* 106
 prune *f* 126
 pruneau *m* 129
 psychiatrie *f* 49
 psychothérapie *f* 55
 public *m* 254
 publicité *f* 269
 pullover *m* 33
 pulpe *f* 124, 127
 pulvérisateur *m* 311
 punaise 173
 punching-bag *m* 237
 pupille *f* 51
 pupitre *m* 162
 pupitre de mixage *m* 179
 putter 233
 putter *m* 233
 puzzle *m* 273
 pyjama *m* 30, 33
 pyramide *f* 164
Q
 Qatar 318
 quadriceps *m* 16
 quai *m* 208, 216
 quarante 308
 quarante minutes 304
 quarantième 309
 quart d'heure 304
 quartier *m* 126
 quartz *m* 289
 quatorze 308
 quatorzième 309
 quatre 308
 quatre cents 308
 quatre-quatre *f* 199
 quatre-vingts 308
 quatre-vingt-dix 308
 quatre-vingt-dixième 309
 quatre-vingtième 309
 quatrième 309
 question *f* 163
 questionner 163
 queue *f* 121, 210, 242, 280, 290, 294
 queue de cheval *f* 39
 quiche *f* 142
 quille *f* 214, 249
 quincaillerie *f* 114
 quinoa *m* 130
 quinze 308
 quinze jours 307
 quinzième 309
R
 rabot *m* 81
 raboter 79
 racine *f* 50, 124, 296
 racines *f* 39
 racler 77
 racquetball *m* 231
 radar *m* 214, 281
 radeau de sauvetage *m* 240
 radiateur *m* 60, 202
 radiccio *m* 123
 radio *f* 48, 50, 179, 268
 radio dentaire *f* 50
 radiologie *f* 49
 radio numérique *m* 268
 radio-réveil *m* 70
 radis *m* 124
 radius *m* 17
 rafraîchir 39
 rafting *m* 241
 rage de dents *f* 50
 ragoût *m* 158
 raide 39
 raie *f* 120, 294
 raifort *m* 125
 rail *m* 208
 rail conducteur *m* 209
 raisin de Corinthe *m* 129
 raisin de Smyrne *m* 129
 raisin sec *m* 129
 rallonge *f* 78
 rallye *m* 249
 RAM *f* 176
 ramadan *m* 26
 ramasseur de balles *m* 231
 rambarde *f* 59
 rame *f* 241
 ramener 245
 ramequin *m* 69
 ramer 241
 rameur *m* 241
 rampe *f* 59
 rampe de lancement *f* 281
 ramure *f* 291
 randonnée *f* 243, 263
 rang de perles *m* 36
 rangée *f* 210, 254
 rap *m* 259
 râpe *f* 68
 râper 67
 rapide 321
 rapide *m* 209
 rapides *m* 240, 284
 rappel *m* 248
 rapport *m* 174
 rapporteur *m* 165
 rapports sexuels *m* 20
 raquette *f* 230, 231
 rasage *m* 73
 rasoir électrique *m* 73
 rasoir jetable *m* 73
 rassasié 64
 rat *m* 290
 rate *f* 18
 râteau *m* 88
 ratisser 90
 raton laveur *m* 290
 rayon *m* 164, 207
 rayon bagages *m* 104
 rayon chaussures *m* 104
 rayon enfants *m* 104
 rayons *m* 168
 rayons ultraviolets *m* 286
 réacteur *m* 210
 réanimation *f* 47
 rebond *m* 227
 réception *f* 100
 réceptionniste *f* 100, 190
 recevoir *m* 229
 recevoir 177
 réchaud *m* 269
 réchauffer 154
 recherche *f* 169
 récif de corail *m* 285

- récipient *m* 311
 récipient Petri *m* 166
 récolter 91, 183
 record *m* 234
 record personnel *m* 234
 rectangle *m* 164
 rectum *m* 21
 reçu *m* 152
 rédaction *f* 163
 rédactrice *f* 191
 redressement assis *m* 251
 réduire 172
 réflecteur *m* 204
 reflets *m* 39
 réflexologie *f* 54
 réfrigérateur *m* 67
 réfrigérateur-congélateur *m* 67
 refroidissement *m* 44
 regarder la télévision 269
 reggae *m* 259
 région *f* 315
 registre *m* 100
 réglage de l'allumage *m* 203
 règle *f* 163, 165
 régler 179
 régler la radio 269
 règles *f* 20
 réglisse *m* 113
 régulateur *m* 239
 reiki *f* 55
 rein *m* 18
 relais *m* 235
 relations *f* 24
 relaxation *f* 55
 remorque *f* 266
 remorquer 195
 remorqueur *m* 215
 remplaçant *m* 223
 remplacement *m* 223
 remuer 67
 Renaissance 301
 renard *m* 290
 rendez-vous *m* 45, 175
 rênes *f* 242
 renoncule *f* 297
 renouveler 168
 renseignements *m* 99, 168
 rentrée en touche *f* 223, 226
 renvoyé 48
 repas *m* 64, 158
 repas de noces *m* 26
 repasser 76
 répondeur *m* 99
 répondre 163
 réponse *f* 163
 reporter *f* 179
 repose-tête *m* 200
 reprendre 277
 reproducteur 19
 reproduction *f* 20
 reptiles *m* 293
 République centrafricaine 317
 République démocratique du Congo 317
 République dominicaine 314
 République tchèque 316
 requin *m* 294
 réseau *m* 176
 réseau d'électricité *m* 60
 réseau ferroviaire *m* 209
 réserve *f* 262
 réserver 168
 réservoir *m* 61
 réservoir d'huile *m* 204
 réservoir de lave-glace *m* 202
 réservoir de liquide de freins *m* 202
 réservoir de liquide de refroidissement *m* 202
 réservoir d'essence *m* 203, 204
 résidence universitaire *f* 168
 résistance *f* 61
 respiration *f* 47
 respiratoire 19
 ressort *m* 71
 restaurant *m* 101, 152
 restaurant rapide *m* 154
 restaurant universitaire *m* 168
 restauration rapide *f* 154
 résultat *m* 49
 retard *m* 309
 rétiné *f* 51
 retour *m* 231
 retour rapide *m* 269
 retourner 91
 retrait des bagages 213
 rétroviseur *m* 198
 réunion *f* 174
 réveil *m* 70
 revers *m* 32, 231
 revêtement *m* 66, 187
 revue *f* 168
 rez-de-chaussée *m* 104
 rhinocéros *m* 291
 rhombe *m* 164
 rhubarbe *f* 127
 rhum *m* 145
 rhum coca *m* 151
 rhume *m* 44
 rhume des foies *m* 44
 richelieu *m* 37
 ride *f* 15
 rideau *m* 63, 254
 rideau de douche *m* 72
 rincer 38, 76
 ring *m* 237
 rire 25
 rive *f* 284
 rivière *f* 284
 riz *m* 130, 158, 184
 riz à grains ronds *m* 130
 riz blanc *m* 130
 riz complet *m* 130
 riz sauvage *m* 130
 robe *f* 31, 34, 169
 robe de chambre *f* 31
 robe de mariée *f* 35
 robe du soir *f* 34
 robinet *m* 61, 66
 robinet d'eau chaude *m* 72
 robinet d'eau froide *m* 72
 robinet de purge *m* 61
 robinet de sectionnement *m* 61
 robot ménager *m* 66
 rocaille *f* 84
 rochers *m* 284
 roches *f* 288
 Rocheuses *f* 312
 rococo 301
 rodéo *m* 243
 rognon *m* 119
 roi *m* 272, 273
 roller *m* 263
 romarin *m* 133
 rond de serviette *m* 65
 rond-point *m* 195
 ronfler 71
 roquette *f* 123
 rose 274
 rose *f* 110
 rosé 145
 rôti *m* 158
 rôti 67
 rotule *f* 17
 roue *f* 198, 207
 roue arrière *f* 197
 roue avant *f* 196
 roue de nez *f* 210
 roue de secours *f* 203
 roue dentée *f* 206
 roues d'entraînement *f* 207
 rouge 145, 274
 rouge à lèvres *m* 40
 rougeole *f* 44
 rouget barbet *m* 120
 rough *m* 232
 rouleau *m* 39, 83, 311
 rouleau compresseur *m* 187
 rouleau de papier hygiénique *m* 72
 rouleau de pellicule *m* 271
 rouleau à pâtisserie *m* 69
 Roumanie 316
 round *m* 237
 route à quatre voies *f* 195
 route d'accès *f* 216
 routes *f* 194
 roux 39
 Royaume-Uni *m* 316
 ruban *m* 27, 39, 111, 141
 ruban isolant *m* 81
 rubis *m* 288
 rue *f* 298
 rue transversale *f* 299
 ruelle *f* 298
 rugby *m* 221
 ruine célèbre *f* 261
 ruisseau *m* 285
 rumsteck *m* 119
 runabout *m* 214
 rustine *f* 207
 rutabaga *m* 125
 Rwanda 317
S
 sable *m* 85, 264
 sabot *m* 291
 sabot *m* 242
 sabre *m* 236
 sac *m* 75, 311
 sac à bandoulière *m* 37
 sac à dos *m* 31, 37, 267
 sac à herbe *m* 88
 sac à main *m* 37
 sac à provisions *m* 106
 sac d'appareil photo *m* 271
 sac de couchage *m* 267
 sac de golf *m* 233
 sac de plage *m* 264
 sac en plastique *m* 122
 sac postal *m* 98, 190
 sachet de thé *m* 144
 sacs *m* 37
 safran *m* 132
 sage-femme *f* 53
 Sahara *m* 313
 Sahara occidental *m* 317
 saignement de nez *m* 44
 Sainte-Lucie 314
 Saint-Kitts-et-Nevis 314
 Saint-Marin 316
 Saint-Vincent-et-les-Grenadines 314
 saisons *f* 306
 salade *f* 149
 salade composée *f* 158
 salade verte *f* 158
 salaire *m* 175
 salamandre *f* 294
 salami *m* 142
 salé 118, 121, 129, 137, 143, 155
 salle *f* 48
 salle à manger *f* 64
 salle d'opération *f* 48
 salle d'attente *f* 45
 salle de bain *f* 72
 salle de bain privée *f* 100
 salle de cinéma *f* 255
 salle de classe *f* 162
 salle de conférence *f* 174
 salle de cours *f* 169
 salle de départ *f* 213
 salle de lecture *f* 168
 salle de sport *f* 101
 salle de tribunal *f* 180
 salle des moteurs *f* 214
 salle des urgences *f* 48
 salon *m* 62
 salon de coiffeur *m* 115
 salopette *f* 30
 salto *m* 235
 samedi *m* 306
 sandale *f* 37
 sandales *f* 31
 sandwich *m* 155
 sandwich grillé *m* 149
 sandwich mixte *m* 155
 sangle *f* 242
 sans 320
 sans arêtes 121
 sans bretelles 34
 sans connaissance 47
 sans manches 34
 sans matières grasses 137
 sans peau 121
 sans pépins 127
 sans plomb 199
 santé *f* 44
 Sao Tomé-et-Principe 317
 sapeurs-pompiers *m* 95
 saphir *m* 288
 Sardaigne 316
 sardine *f* 120
 sas d'équipage *m* 281
 satellite *m* 281
 satsuma *f* 126
 Saturne *f* 280
 sauce *f* 134, 143, 155
 saucisse *f* 155, 157
 saucissons *m* 118
 saucisson piquant *m* 142
 sauf 228
 sauge *f* 133
 saule *m* 296
 saumon *m* 120
 sauna *m* 250
 saut *m* 235, 237, 243, 247
 saut à l'élastique *m* 248
 saut à la corde *m* 251
 saut à la perche *m* 234
 saut en chute libre *m* 248
 saut en hauteur *m* 235
 saut en longueur *m* 235
 sauté 159
 sauté *m* 158
 sauter 67, 227
 sauterelle *f* 295
 sauvegarder 177
 sauver 223
 savon *m* 73
 saxophone *m* 257
 scalpel *m* 81, 167
 scanner *m* 176

- scanographie *f* 48
 scaphandre spatial *m*
 281
 scarabée *m* 295
 scène *f* 254, 258
 schiste *m* 288
 scie à chantourner *f* 81
 scie à dossier *f* 81
 scie à main *f* 89
 scie circulaire *f* 78
 scie égoïne *f* 80
 scie sauteuse *f* 78
 science *f* 166
 sciences *f* 162
 sciences économiques *f*
 169
 sciences politiques *f* 169
 scientifique *f* 190
 scier 79
 scooter *m* 205
 score *m* 220
 scorpion *m* 295
 scotch 173
 scotch à l'eau *m* 151
 Scrabble *m* 272
 scrotum *m* 21
 sculpter 79
 sculpteur *m* 191
 sculpture *f* 275
 sculpture sur bois *f* 275
 se coucher 71
 se faire des amis 26
 se lever 71, 139
 se marier 26
 se mettre à quai 217
 se noyer 239
 se réveiller 71
 seau *m* 77, 82, 265
 seau à glace *m* 150
 sec 39, 41, 130, 145,
 286, 321
 sécateur *m* 89
 s'échauffer 251
 séché 129, 143, 159
 sèche-cheveux *m* 38
 sèche-linge *m* 76
 sécher 38, 76
 seconde *f*
 secrétariat *m* 168
 section *f* 282
 sécurité *f* 75, 212, 240
 sédatif *m* 109
 sédimentaire 288
 seiche *f* 121
 sein *m* 12
 seize 308
 seizième 309
 sel *m* 64, 152
 sélecteur de point *m*
 276
 selle *f* 204, 206, 242
 selle de femme *f* 242
 semaine *f* 306
 semaine dernière 307
 semaine prochaine 306
 semelle *f* 37
 semer 90, 183
 semis *m* 91
 semoule *f* 130
 s'endormir 71
 Sénégal 317
 sens interdit 195
 sensible 41
 sentier *m* 262
 s'entraîner 251
 sept 308
 sept cents 308
 septembre *m* 306
 septième 309
 série télévisée *f* 178, 179
 seringue *f* 109, 167
 serpent *m* 293
 serre *f* 85
 serre-joint *m* 78
 serre-tête *m* 38
 serrure *f* 59
 serrure de sécurité *f* 75
 serveur *m* 148, 176
 serveur d'accès *m* 177
 serveuse *f* 191
 service *m* 231
 service après-vente *m*
 104, 175
 service compris 152
 service de blanchisserie *m*
 101
 service de ménage *m*
 101
 service de messagerie *m*
 99
 service de prêt *m* 168
 service de ressources
 humaines *m* 175
 service de santé *m* 168
 service de
 soins intensifs *m* 48
 service des ventes *m*
 175
 service d'étage *m* 101
 service du contentieux *m*
 175
 service marketing *m* 175
 service non compris
 152
 services *m* 49
 services d'urgence *m*
 94, 99
 serviette *f* 37, 65, 73,
 serviette antiseptique *f*
 47
 serviette de bain *f* 73
 serviette de plage *f* 265
 serviette en papier *f* 154
 serviette hygiénique *f*
 108
 serviettes *f* 73
 servir 64
 set *m* 230
 set de table *m* 64
 s'évanouir 25, 44
 shaker à cocktails
 m 150
 shampoing *m* 38
 sherry *m* 145
 shiatsu *m* 54
 shooter 223
 short *m* 33
 Sibérie *f* 313
 Sicile 316
 siècle *m* 307
 siège *m* 52, 61, 209,
 210, 242
 siège arrière *m* 200, 204
 siège d'enfant *m* 198,
 207
 siège des toilettes *m* 72
 siège du conducteur *m*
 196
 siège social *m* 175
 Sierra Leone 317
 signal *m* 209
 signalisations *f* 194
 signature *f* 96, 98
 s'il vous plaît 322
 silence *m* 256
 silencieux *m* 203, 204
 silex *m* 288
 sillet *m* 258
 sillon *m* 183
 silo *m* 183
 simple *m* 230
 simple 151
 Singapour 319
 singe *m* 291
 sinus *m* 19
 sirène *f* 94
 sirop *m* 109
 sirop d'érable *m* 134
 site web *m* 177
 six 308
 six cents 308
 sixième 309
 ski *m* 241, 246
 ski alpin *m* 247
 ski de randonnée *m* 247
 ski nautique *m* 241
 skieur nautique *m* 241
 skieuse *f* 246
 slalom *m* 247
 slalom géant *m* 247
 slice *m* 230
 slip *m* 33, 35
 slip de bain *m* 238
 Slovaquie 316
 Slovincie 316
 smartphone *m* 99, 176
 smash *m* 231
 SMS *m* 99
 snack *m* 148
 société *f* 175
 soda *m* 144
 cœur *f* 22
 soigner 91
 soin dentaire *m* 108
 soin du visage *m* 41
 soins de beauté *m* 41
 soins de bébé *m* 74,
 104
 soins de la peau *m* 108
 soir *m* 305
 soixante 308
 soixante-dix 308
 soixante-dixième 309
 soixantième 309
 sol *m* 62, 71, 85
 soldat *m* 189
 sole *f* 120
 soleil *m* 280, 286
 solides *m* 164
 soluble 109
 solution désinfectante *f*
 51
 solution nettoyante *f* 51
 solvant *m* 83
 Somalie 317
 sommet *m* 165, 284
 somnifère *m* 109
 son *m* 130
 sonate *f* 256
 sonde *f* 50
 sonnette *f* 59, 197
 sorbet *m* 141
 sortie *f* 61, 75, 210
 sortie de secours *f* 210
 Soudan 317
 Soudan du Sud 317
 souder 79
 soudure *f* 79, 80
 soufflé *m* 158
 souffler 141
 soufre *m* 289
 soupape de sûreté *f* 61
 soupe *f* 153
 soupire 25
 sourcil *m* 14, 51
 sourire *m* 25
 souris *f* 176, 290
 sous 320
 sous tension 60
 sous-exposé 271
 sous-marin *m* 215
 sous-sol *m* 58, 91
 soustraire 165
 sous-vêtements *m* 32
 35, 267
 soutien-gorge *m* 35
 soutien-gorge
 d'allaitement *m* 53
 souvenirs *m* 260
 sparadrap *m* 47
 spatule *f* 68, 167, 275
 spécialiste *m* 49
 spécialités *f* 152
 spectateurs *m* 233
 sperme *m* 20
 sphère *f* 164
 sportif *m* 191
 sports *m* 220, 236
 sports aquatiques *m* 241
 sports d'hiver *m* 247
 sports de combat *m* 236
 spray *m* 109
 spray contre
 les insectes *m* 267
 sprinter *m* 234
 squash *m* 231
 squelette *m* 17
 Sri Lanka 318
 stade *m* 223
 stades *m* 23
 starting block *m* 234
 statif *m* 166
 station de radio *f* 179
 station de taxis *f* 213
 station spatiale *f* 281
 station-service *f* 199
 statuette *f* 260
 steeple *m* 243
 sténographe *m* 181
 stéréo 269
 stéréo *f* 201
 stérile 47, 20
 stérilet *m* 21
 sternum *m* 17
 stéthoscope *m* 45
 store *m* 63, 148
 store vénitien *m* 63
 stratosphère *f* 286
 streaming *m* 269
 stress *m* 55
 studio d'enregistrement *m*
 179
 studio de télévision *m*
 178
 styles *m* 239, 301
 styles de jardin *m* 84
 styles de musique *m*
 259
 styliste *m* 277
 stylo *m* 163
 succursale *f* 175
 sucette *f* 113
 sucré 124, 127, 155
 sud *m* 312
 Suède 316
 Suisse *f* 316
 sumo *m* 237
 superficie *f* 310
 supermarché *m* 106
 supplément *m* 55
 support *m* 88, 166, 187,
 268
 suppositoire *m* 109
 sur 320
 surexposé 271
 surf *m* 241
 surf des neiges *m* 247
 surface de but *f* 221,
 223
 surface de réparation *f*
 223
 surfeur *m* 241
 surgelé 121, 124
 Surinam 315
 surpris 25
 survêtement *m* 31, 32
 suspect *m* 94, 181
 suspension *f* 203, 205
 Swaziland 317
 sweat-shirt *m* 33

swing d'essai *m* 233
 swing en arrière *m* 233
 symphonie *f* 256
 synagogue *f* 300
 synthétique 31
 Syrie 318
 système *m* 176
 système solaire *m* 280
 systèmes domestiques *m*
 60
 systèmes du corps *m* 19

T

tabac *m* 112, 184
 table *f* 64, 148
 table à encoller *f* 82
 table basse *f* 62
 table de cuisson *f* 67
 table de cuisson
 vitrocéramique *f* 66
 table de nuit *f* 70
 table du petit déjeuner *f*
 156
 tableau *m* 62, 162, 261,
 274
 tableau à feuilles
 mobiles *m* 174
 tableau de bord *m* 201
 tableau des points *m*
 225
 tablette *f* 210
 tablette de chocolat *f*
 113
 tablier *m* 30, 69
 tabouret de bar *m* 150
 tache de rousseur *f* 15
 tache rouge *f* 271
 tacler 220, 223
 taco *m* 155
 Tadjikistan 318
 taekwondo *m* 236
 taï chi *m* 236
 taie d'oreiller *f* 71
 taille *f* 12
 taille-crayon *m* 163
 tailler 90
 tailleur *m* 115
 Taiwan 319
 talc *m* 73
 talon *m* 13, 15, 37, 96
 tamarillo *m* 128
 tambour *m* 245, 257
 tamis *m* 89
 tamiser 91, 138
 tampon *m* 108
 tampon de la poste *m* 98
 tampon encreur 173
 tandem *m* 206
 tangelo *m* 126
 tante *f* 22
 Tanzanie *f* 317
 tapis *m* 54, 63, 71, 235
 tapis de bain *m* 72
 tapis de sol *m* 267
 tapis roulant *m* 106,
 212, 250

tapisser 82
 tapisserie *f* 277
 tapissier décorateur *m*
 82
 taquet *m* 240
 tard 305
 tarif *m* 154, 199
 tarif d'affranchissement *m*
 98
 taro *m* 124
 tarte *f* 141
 tarte à la crème *f* 141
 tarte aux fruits *f* 140
 tas de compost *m* 85
 Tasmanie 319
 tasse *f* 75
 tasse à café *f* 65
 tasse à thé *f* 65
 tatouage *m* 41
 taureau *m* 185
 taux d'intérêt *m* 96
 taux de change *m* 97
 Tchad 317
 techniques *f* 79
 tee *m* 233
 teint *m* 41
 teint 39
 teinture de cheveux *f* 40
 télécabine *f* 246
 télécharger 177
 télécommande *f* 269
 télégramme *m* 98
 téléphone *m* 99
 téléphone de secours *m*
 195
 téléphone public *m* 99
 téléphone sans fil *m* 99
 téléphoniste *m* 99
 téléprompateur *m* 179
 télescope *m* 281
 télésiège *m* 246
 télévision *f* 268
 télévision à écran plat *f*
 269
 télévision par câble *f* 269
 témoin *m* 180
 tempe *f* 14
 température *f* 286
 tempête *f* 286
 temple *m* 300
 temps *m* 234, 286
 temps libre *m* 254, 258,
 264
 temps mort *m* 220
 tendon *m* 17
 tendon d'Achille *m* 16
 tendon du jarret *m* 16
 tennis *m* 230, 231
 tennis de table *m* 231
 tensiomètre électronique
m 45
 tension *f* 44, 60
 tente *f* 267
 tenue de foot *f* 31
 téquila *f* 145
 térébenthine *f* 83

terminal *m* 212
 terminal de ferrys *m* 216
 termite *f* 295
 terrain *m* 220, 222, 226,
 228, 234
 terrain de camping *m*
 266
 terrain de cricket *m* 225
 terrain de jeux *m* 263
 terrain de rugby *m* 221
 terrain de sport *m* 168
 terrasse de café *f* 148
 terrasse de café *f* 148
 terre *f* 85, 282
 Terre *f* 280
 terreau *m* 88
 terre-plein *m* 194
 terres cultivées *f* 182
 territoire *m* 315
 test de grossesse *m* 52
 testicule *m* 21
 têtard *m* 294
 tête *f* 12, 19, 81, 230
 tête du lit *f* 70
 tétine *f* 75
 texte *m* 254
 texto *m* 99
 Thaïlande 318
 thé *m* 144, 149, 184
 thé au citron *m* 149
 thé au lait *m* 149
 thé glacé *m* 149
 thé nature *m* 149
 thé vert *m* 149
 théâtre *m* 254, 299
 théière *f* 65
 thénar *m* 15
 thérapeute *f* 55
 thérapie de groupe *f* 55
 thérapies alternatives *f*
 54
 thermomètre *m* 44, 167,
 201
 thermos *m* 267
 thermosphère *f* 286
 thermostat *m* 61
 thèse *f* 169
 thon *m* 120
 thriller *m* 255
 thym *m* 133
 thyroïde *f* 18
 tibia *m* 12, 17
 ticket *m* 197
 tiebrake *m* 230
 tige *f* 111, 297
 tige de verre *f* 167
 tigre *m* 291
 tilleul *m* 296
 timbale *f* 257
 timbre *m* 98
 timbres *m* 112
 timide 25
 Timor oriental 319
 tir à cible *m* 249
 tir à l'arc *m* 249
 tire-bouchon *m* 150

tirer 227, 251
 tiroir *m* 66, 70, 172
 tisane *f* 149
 tissage *m* 277
 tissu *m* 276, 277
 titre *m* 168
 titres *m* 23, 97
 toast *m* 157
 toboggan *m* 263
 Togo *m* 317
 toile *f* 274
 toile de fond *f* 254
 toile métallique *f* 167
 toilettes *f* 72, 104, 266
 toise *f* 45
 toit *m* 58, 203
 toit ouvrant *m* 202
 tomate *f* 125, 157
 tomate cerise *f* 124
 tomber amoureux 26
 ton *m* 41, 256
 tondeuse *f* 88, 90
 tondeuse à gazon *f* 88
 tondre 90
 tong *f* 37
 tonic *m* 144
 tonique *m* 41
 tonne *f* 310
 tonnerre *m* 286
 topaze *m* 288
 topiaire *f* 87
 topinambour *m* 125
 toque *f* 190
 tornade *f* 287
 tortue *f* 293
 tortue marine *f* 293
 tôt 305
 touche *f* 176
 tour *f* 272, 301
 tour *m* 238
 tour de batte *m* 228
 tour de contrôle *f* 212
 tour de potier *m* 275
 tour de surveillance *f*
 265
 tourelle *f* 300
 tourisme *m* 260
 touriste *m* 260
 tourmaline *f* 288
 tourne-disque *m* 268
 tourner 79
 tournesol *m* 184, 297
 tournevis *m* 80
 tournevis cruciforme *m*
 81
 tournois *m* 233
 tourte *f* 158
 tourtière *f* 69
 tout droit 260
 toux *f* 44
 trachée *f* 18
 tracteur *m* 182
 traction *f* 251
 traction pour les jambes *f*
 251
 train *m* 208

train à grande vitesse
m 208
 train à vapeur *m* 208
 train d'atterrissage *m* 210
 train de marchandises *m*
 208
 train diesel *m* 208
 train électrique *m* 208
 traîne *f* 35
 traîneau à chiens *m* 247
 traire 183
 tram *m* 208
 tramway *m* 196
 tranche *f* 119, 121, 139,
 140
 tranche de lard *f* 119
 transat *m* 265
 transfert *m* 223
 transformateur *m* 60
 transmission *f* 202
 transplanter 91
 transport *m* 194
 trapèze *m* 16, 164
 traumatisme crânien *m* 46
 travail 172
 travaux *m* 187, 195
 travailler *m* 97
 trèfle *m* 273, 297
 treillis *m* 84
 treize 308
 treizième 309
 tremblement *m* 283
 tremplin *m* 235, 238
 trente 308
 trentième 309
 trépied *m* 166, 270, 281
 très chaud 286
 triangle *m* 164, 257
 triceps *m* 16
 tricot *m* 277
 tricot de corps *m* 33
 trictrac *m* 272
 trimestre *m* 52
 Trinité-et-Tobago 314
 triste 25
 trognon *m* 122, 127
 trois 308
 trois cents 308
 troisième 309
 trolleybus *m* 196
 trombone *m* 257
 trombone 173
 trompe *f* 291
 trompe de Fallope *f* 20
 trompette *f* 257
 tronç *m* 296
 tropique du cancer *m*
 283
 tropique du capricorne *m*
 283
 tropiques *f* 283
 troposphère *f* 286
 trop-plein *m* 61
 trot *m* 243
 trotteuse *f* 304
 trottoir *m* 298

- trou *m* 232
 trou en un *m* 233
 trou noir *m* 280
 troupeau *m* 183
 trousse *f* 163
 trousse de premiers secours *f* 47
 trouver un emploi 26
 truette *f* 187
 truffe *f* 113, 125
 truite *f* 120
 truite arc-en-ciel *f* 120
 T-shirt *m* 30, 33
 tuba *m* 239, 257
 tube *m* 230, 311
 tube porte-selle *m* 206
 tuile *f* 58, 187
 tulipe *f* 111
 Tunisie *f* 317
 turbocompresseur *m* 203
 Turkmenistan 318
 Turquie *f* 316
 turquoise *f* 289
 tuteur *m* 90
 tutu *m* 191
 tuyau *m* 95, 112, 202
 tuyau d'arrosage *m* 89
 tuyau d'écoulement *m* 61, 72
 tuyau flexible *m* 77
 types *m* 205
 types d'appareils photo *m* 270
 types de bus *m* 196
 types de trains *m* 208
- U**
 U.F.R. *f* 169
 U.L.M. *m* 211
 Ukraine *f* 316
 ultrasons *m* 52
 un 308
 under par *m* 233
 uniforme *m* 94, 189
 univers *m* 280
 université *f* 299
 Uranus *f* 280
 uretère *m* 21
 urètre *m* 20
 urgence *f* 46
 urinaire 19
 urologie *f* 49
 Uruguay 315
 usine *f* 299
 ustensiles de cuisine *m* 68, 105
 utérus *m* 20, 52
 utiliser le fil dentaire 50
- V**
 vacances *f* 212
 vaccination *f* 45
 vache *f* 185
 vagin *m* 20
 vague *f* 241, 264
- vaisselle *f* 64
 vaisselle et les couverts *f* 65
 valet *m* 273
 valet d'écurie *m* 243
 valeur *f* 97
 vallée *f* 284
 valve *f* 207
 vanille *f* 132
 Vanuatu 319
 vaporisateur *m* 89
 varicelle *f* 44
 vase *f* 85
 vase *m* 63, 111
 veau *m* 118, 185
 véhicule de service *m* 212
 veille de la Toussaint *f* 27
 veine *f* 19
 vélo *m* 263
 vélo de course *m* 206
 vélo de randonnée *m* 206
 vélo de ville *m* 206
 vélo d'entraînement *m* 250
 vélo tous terrains *m* 206
 venaison *f* 118
 vendeur *m* 104
 vendredi *m* 306
 Venezuela 315
 vent *m* 241, 286
 venteux 286
 ventilateur *m* 60, 202, 210
 ventouse *f* 53, 81
 ventre *m* 12
 Vénus *f* 280
 ver *m* 295
 verdict *m* 181
 vernis *m* 79, 83
 vernis à ongles *m* 41
 verre *m* 51, 65, 152
 verre à vin *m* 65
 verre gradué *m* 150
 verre mesureur 69, 311
 verrerie *f* 64
 verres *m* 150
 verrou *m* 59
 verrouillage *m* 200
 vers 320
 verser 67, 96
 vert 129, 274
 vertèbres cervicales *f* 17
 vertèbres thoraciques *f* 17
 vésicule *f* 21
 vessie *f* 20
 veste *f* 32, 34
 veste de ski *f* 246
 veste de sport *f* 33
 vestibule *m* 59
 vêtement en cuir *m* 205
 vêtements *m* 205
 vêtements de nuit *m* 31
 vêtements pour enfants *m* 30
- vêtements pour femmes *m* 34, 105
 vêtements pour hommes *m* 32, 105
 vêtements sport *m* 33
 vétérinaire *f* 189
 viande *f* 119
 viande blanche *f* 118
 viande cuite *f* 118, 143
 viande et la volaille *f* 106
 viande hachée *f* 119
 viande maigre *f* 118
 viande non cuite *f* 142
 viande rouge *f* 118
 vibraphone *m* 257
 vide 321
 vide-pomme *m* 68
 Vietnam 318
 vieux 321
 vigne *f* 183
 vilebrequin *m* 78
 village *m* 299
 ville *f* 298, 299
 vin *m* 145, 151
 vinaigre *m* 135, 142
 vinaigre balsamique *m* 135
 vinaigre de cidre *m* 135
 vinaigre de malt *m* 135
 vinaigrette *f* 158
 vingt 308
 vingt et un 308
 vingt et unième 309
 vingt mille 309
 vingt minutes
 vingt-deux 308
 vingt-deuxième 309
 vingtième 309
 vingt-troisième 309
 violet 274
 violon *m* 256
 violoncelle *m* 256
 virement *m* 96
 virus *m* 44
 vis *f* 80
 visa *m* 213
 visage *m* 14
 viseur *m* 271
 visière *f* 205
 visiophone *m* 99
 visite de contrôle *m* 50
 visite guidée *f* 260
 vitamines *f pl* 108
 vitesses *f* 206
 vivace 86
 vodka *f* 145
 vodka à l'orange *f* 151
 voie à sens unique *f* 298
 voie centrale *f* 194
 voie de dépassement *f* 194
 voie ferrée *f* 208
 voile *f* 240, 241
 voile *m* 35
 voile d'avant *f* 240
- voilier *m* 215
 voisin *m* 24
 voiture *f* 198, 200, 208
 voiture à six places *f* 199
 voiture de police *f* 94
 voiture de pompiers *f* 95
 voiture d'époque *f* 199
 voiture électrique *f* 199
 voiture-restaurant *f* 209
 vol domestique *m* 212
 vol international *m* 212
 vol plané *m* 248
 volaille *f* 119
 volant *m* 201, 231
 volcan *m* 283
 voler 211
 volet *m* 58
 vollée *f* 231
 volley *m* 227
 volume *m* 165, 179, 269, 311
 vomir 44
 voûte *f* 300
 voyage d'affaires *m* 175
 voyage de noces *m* 26
 voyageur *m* 208
 vue *f* 51
- W**
 W.-C. *m* 61
 water-polo *m* 239
 week-end *m* 306
 western *m* 255
 whisky *m* 145
 white-spirit *m* 83
 wifi *m* 269
 wok *m* 69
- Y**
 yacht *m* 215, 240
 yaourt *m* 137
 yaourt aux fruits *m* 157
 yaourt surgelé *m* 137
 yard *m* 310
 Yémen 318
 yoga *m* 54
 Yougoslavie 316
- Z**
 Zambie *f* 317
 zèbre *m* 291
 zéro 230, 308
 zeste *m* 126
 Zimbabwe *m* 317
 zinc *m* 289
 zone *f* 315
 zone d'attaque *f* 224
 zone de défense *f* 224
 zone de fond *f* 220
 zone industrielle *f* 299
 zone neutre *f* 224
 zone piétonnière *f* 299
 zones *f* 283
 zoo *m* 262
 zoologie *f* 169
 zoom *m* 270

index anglais • English index

A

- à la carte 152
 abdomen 12
 abdominals 16
 above 320
 acacia 110
 accelerator 200
 accessories 36, 38
 accident 46
 account number 96
 accountant 97, 190
 accounts department 175
 accused 180
 ace 230, 273
 Achilles tendon 16
 acorn squash 125
 acquaintance 24
 acquitted 181
 across 320
 acrylic paints 274
 actions 237, 229, 227, 233, 183
 activities 263, 245, 162, 77
 actor 254, 191
 actors 179
 actress 254
 acupressure 55
 acupuncture 55
 Adam's apple 19
 add v 165
 address 98
 adhesive tape 47
 adjustable wrench 80
 admission charge 260
 admissions office 168
 admitted 48
 aduki beans 131
 adult 23
 advantage 230
 adventure 255
 advertisement 269
 aerate v 91
 Afghanistan 318
 Africa 317
 after 320
 afternoon 305
 aftershave 73
 after-sun 108
 agate 289
 agenda 174
 aikido 236
 aileron 210
 air bag 201
 air conditioning 200
 air cylinder 239
 air filter 202, 204
 air letter 98
 air mattress 267
 air vent 210
 aircraft 210
 aircraft carrier 215
 airliner 210, 212
 airport 212
 aisle 106, 168, 210, 254
 alarm clock 70
 Alaska 314
 Albania 316
 alcoholic drinks 145
 alfalfa 184
 Algeria 317
 all-purpose flour 139
 allergy 44
 alley 298
 alligator 293
 alligator clip 167
 allspice 132
 almond 129
 almond oil 134
 almonds 151
 along 320
 alpine 87
 alpine skiing 247
 alternating current 60
 alternative therapy 54
 alternator 203
 altitude 211
 aluminum 289
 Amazonia 312
 ambulance 94
 amethyst 288
 amniocentesis 52
 amniotic fluid 52
 amount 96
 amp 60
 amphibians 294
 amplifier 268
 analog (radio) 179
 anchor 214, 240
 Andes 312
 Andorra 316
 anesthetist 48
 angle 164
 angler 244
 Angola 317
 angry 25
 animals 292, 294
 animated film 255
 ankle 13, 15
 ankle-length 34
 anniversary 26
 annual 86, 307
 answer 163
 answer v 99, 163
 answering machine 99
 ant 295
 antenna 295
 antifreeze 199, 203
 Antigua and Barbuda 314
 anti-inflammatory 109
 antique shop 114
 antiseptic 47
 antiseptic wipe 47
 anti-wrinkle 41
 antler 291
 apartment building 298
 apéritif 153
 aperture dial 270
 apex 165
 app 99
 appeal 181
 appearance 30
 appendix 18
 applaud v 255
 apple 126
 apple corer 68
 apple juice 149
 appliances 66
 application 176
 appointment 45, 175
 apricot 126
 April 306
 apron 30, 50, 69, 212
 aquamarine 288
 Arabian Sea 313
 arc 164
 arch 15, 85, 301
 archery 249
 architect 190
 architecture 300
 architrave 301
 Arctic Circle 283
 Arctic Ocean 312
 area 165, 310
 areas 299
 arena 243
 Argentina 315
 arithmetic 165
 arm 13
 armband 238
 armchair 63
 Armenia 318
 armpit 13
 armrest 200, 210
 aromatherapy 55
 around 320
 arrangements 111
 arrest 94
 arrivals 213
 arrow 249
 art 162
 art college 169
 Art Deco 301
 art gallery 261
 art history 169
 Art Nouveau 301
 art shop 115
 artery 19
 artichoke 124
 artist 274
 arts and crafts 274, 276
 ash 283
 ashtray 150
 Asia 318
 asparagus 124
 asphalt 187
 assault 94
 assistant 24
 assisted delivery 53
 asteroid 280
 asthma 44
 astigmatism 51
 astronaut 281
 astronomy 281
 asymmetric bars 235
 at 320
 athlete 234
 athletic shoes 31, 251
 Atlantic Ocean 312
 ATM 97
 atmosphere 282, 286
 atrium 104
 attachment 177
 attack 220
 attack zone 224
 attend v 174
 attic 58
 attractions 261
 auburn 39
 audience 254
 August 306
 aunt 22
 aurora 286
 Australasia 319
 Australia 319
 Austria 316
 automatic 200
 automatic door 196
 automatic payment 96
 avalanche 247
 avenue 299
 avocado 128
 awning 148
 ax 95
 axle 205
 ayurveda 55
 Azerbaijan 318

B

- baby 23, 30
 baby bath 74
 baby care 74
 baby changing facilities 104
 baby monitor 75
 baby products 107
 baby sling 75
 back 13
 back brush 73
 back seat 200
 back up v 195
 backboard 226
 backdrop 254
 backgammon 272
 backhand 231
 backpack 31, 37, 267
 backslash 66
 backstroke 239
 backswing 233
 bacon 118, 119, 157
 bad 321
 badge 94, 189
 badminton 231
 bag 311
 bagel 139
 baggage claim 213
 baggage trailer 212
 bags 37
 baguette 138
 Bahamas 314
 bail 181
 bailiff 180
 bait 244
 bait v 245
 bake v 67, 138
 baked 159
 baker 139
 baker's 114
 bakery 107, 114, 138
 baking 69
 baking sheet 69
 balance wheel 276
 balcony 59, 254
 bald 39
 bale 184
 Balearic Islands 316
 ball 15, 75, 221, 224, 226, 228, 230
 ball boy 231
 ballet 255
 balsamic vinegar 135
 Baltic Sea 313
 bamboo 86, 122
 banana 128
 bandage 47
 Bangladesh 318
 banister 59
 bank 96, 284
 bank charge 96
 bank manager 96
 bank transfer 96
 bar 150, 152, 250, 256, 311
 bar code 106
 bar counter 150
 bar mitzvah 26
 bar snacks 151
 bar stool 150
 barb 244
 Barbados 314
 barbecue 267
 barber 39, 188
 bark 296

- barley 130, 184
 barn 182
 baroque 301
 bars 74
 bartender 150, 191
 basalt 288
 base 164, 229
 base station 99
 baseball 228
 baseline 230
 baseman 228
 basement 58
 basil 133
 basket 106, 207, 226
 basket of fruit 126
 basketball 226
 basketball player 226
 basque 35
 bass clarinet 257
 bass clef 256
 bass guitar 258
 bassinet 74
 bassoon 257
 bat 225, 228, 231, 290
 bat v 225, 229
 bath mat 72
 bath towel 73
 bathrobe 31, 32, 73
 bathroom 72
 bathtub 72
 baton 235, 256
 batsman 225
 batter 228
 batteries 260
 battery 167, 202
 battery pack 78
 battleship 215
 bay leaf 133
 be born v 26
 beach 264
 beach bag 264
 beach ball 265
 beach hut 264
 beach towel 265
 beach umbrella 264
 beaker 167
 beam 186, 235
 bean sprout 122
 beans 131, 144
 bear 291
 beat 259
 beauty 40, 105
 beauty treatments 41
 bed 70
 bed and breakfast 101
 bed linen 71
 bedding 74
 bedroom 70
 bedside lamp 70
 bedspread 70
 bee 295
 beech 296
 beef 118
 beer 145, 151
 beer tap 150
 beetle 295
 beet 125
 before 320
 beginning 321
 behind 320
 Belarus 316
 Belgium 316
 Belize 314
 bell 197
 below 320
 belt 32, 36, 236
 bench 250, 262
 Benin 317
 berry 296
 beside 320
 bet 273
 between 320
 beyond 320
 Bhutan 318
 biathlon 247
 bih 30
 biceps curl 251
 biceps 16
 bicycle 206
 bidet 72
 biennial 86
 bifocal 51
 big toe 15
 bike rack 207
 bikini 264
 bill 152, 293
 binoculars 281
 biology 162
 biplane 211
 birch 296
 bird-watching 263
 birds 292
 birth 52
 birth weight 53
 birth certificate 26
 birthday 27
 birthday cake 141
 birthday candles 141
 birthday party 27
 bishop 272
 bit 242
 bit brace 78
 bite 46
 bite v 245
 bitter 124, 145
 black 39, 272, 274
 black belt 237
 black coffee 148
 black currant 127
 black hole 280
 black olive 143
 black pudding 157
 Black Sea 313
 black tea 149
 blackberry 127
 blackboard 162
 black-eyed beans 131
 bladder 20
 blade 60, 66, 78, 89
 blanket 71, 74
 blazer 33
 bleach 77
 blender 66
 blister 46
 block 237
 block v 227
 blonde 39
 blood pressure 44
 blood pressure gauge 45
 blood test 48
 blouse 34
 blow-dry v 38
 blow out v 141
 blowhole 290
 blue 274
 blue cheese 136
 bluebells 297
 blueberry 127
 blues 259
 blusher 40
 board 241
 board v 217
 board games 272
 boarding pass 213
 boardwalk 265
 bob 39
 bobbin 276
 bobsled 247
 body 12
 body lotion 73
 body systems 19
 bodywork 202
 boil v 67
 boiled egg 137, 157
 Bolivia 315
 bollard 214, 298
 bolt 59
 bomber 211
 bone 17, 119, 121
 bone meal 88
 boned 121
 bongos 257
 book 168
 bookstore 115
 bookshelf 63, 168
 boom 95, 240
 booster 281
 boot 37
 booties 30
 bored 25
 borrow v 168
 Bosnia and Herzegovina 316
 Botswana 317
 bottle 61, 75, 135, 311
 bottle opener 68, 150
 bottled foods 134
 bottled water 144
 bottom tier 141
 boundary line 225
 bouquet 35, 111
 bouquet garni 132
 bout 237
 boutique 115
 bow 240, 249
 bow tie 36
 bowl 61, 65, 112
 bowl v 225
 bowler 225
 bowling 249
 bowling ball 249
 box 254
 box file 173
 box of chocolates 113
 box of tissues 70
 box office 255
 boxer shorts 33
 boxercise 251
 boxing 236
 boxing gloves 237
 boxing ring 237
 boy 23
 boyfriend 24
 bra 35
 braces 50
 bracelet 36
 braid 39
 brain 19
 brake 200, 204, 206
 brake v 207
 brake block 207
 brake fluid reservoir 202
 brake lever 207
 brake pedal 205
 bran 130
 branch 296
 brandy 145
 brass 256
 Brazil 315
 Brazil nut 129
 bread 157
 bread flour 139
 bread knife 68
 bread roll 143
 breadcrumbs 139
 breadfruit 124
 breads 138
 break a record v 234
 break water v 52
 breakdown 203
 breakfast 64, 156
 breakfast buffet 156
 breakfast cereals 107
 breakfast table 156
 breakfast tray 101
 breast 12, 119
 breast pump 53
 breastbone 17
 breastfeed v 53
 breaststroke 239
 breathing 47
 breech 52
 brick 187
 bridge 15, 214, 258, 273, 300
 bridle 242
 bridle path 263
 brie 142
 briefcase 37
 briefs 33, 35
 brioche 157
 broadcast 179
 broadcast v 178
 broccoli 123
 brochure 96, 175
 brogue 37
 broil v 67
 bronze 235
 brooch 36
 broom 77
 broth 158
 brother 22
 brother-in-law 23
 browband 242
 brown 274
 brown bread 139, 149
 brown flour 138
 brown lentils 131
 brown rice 130
 browse v 177
 browser 177
 bruise 46
 Brunei 319
 Brunette 39
 brush 38, 40, 77, 83, 274
 brush v 38, 50
 Brussels sprout 122
 bubble bath 73
 buckle 36
 bud 111, 297
 buffet 152
 build v 186
 building site 186
 buildings 299
 built-in wardrobe 71
 bulb 86
 Bulgaria 316
 bull 185
 bulldog clip 173
 bullnose pliers 80
 bullseye 273
 bumper 74, 198
 bun 39, 140, 139, 155
 bunch 111
 bungalow 58
 bungee jumping 248
 bunker 232
 bunsen burner 166
 buoy 217
 bureau de change 97
 burger 154
 burger bar 154
 burger meal 154
 burglar alarm 58
 burglary 94
 Burkina Faso 317
 Burma (Myanmar) 318
 burn 46
 burner 67

- Burundi 317
 bus 196
 bus driver 190
 bus stop 197
 bus station 197
 bus stop 197, 299
 bus ticket 197
 buses 196
 business 175
 business class 211
 business deal 175
 business lunch 175
 business partner 24
 business suit 32
 business trip 175
 businessman 175
 businesswoman 175
 busy 99
 butcher 118, 188
 butcher shop 114
 butter 137, 156
 butter beans 131
 buttercup 297
 butterfly 239, 295
 buttermilk 137
 butternut squash 125
 buttock 13, 16
 button 32
 buttonhole 32
 buttress 301
 by 320
 by airmail 98
 bytes 176
- C**
 cab 95
 cab driver 190
 cabbage 123
 cabin 210, 214
 Cabinda 317
 cable 79, 207
 cable car 246
 cable television 269
 cactus 87
 caddy 233
 cesarean section 52
 café 148, 262
 cafeteria 168
 cafetière 65
 cake pan 69
 cakes 140
 calcite 289
 calcium 109
 calculator 165
 calendar 306
 calf 13, 16, 185
 call button 48
 calyx 297
 cam belt 203
 Cambodia 318
 camcorder 260, 269
 camel 291
 camembert 142
 camera 178, 260, 270
 camera case 271
 camera crane 178
 camera shop 115
 cameraman 178
 cameraphone 270
 Cameroon 317
 camisole 35
 camp v 266
 camp bed 266
 campari 145
 camper van 266
 campfire 266
 camping 266
 camping stove 267
 campground 266
 campus 168
 can 145, 289, 311
 can opener 68
 Canada 314
 canary 292
 candied fruit 129
 candy 113
 candy store 113
 cane 91
 canes 89
 canine 50
 canned drink 154
 canned food 107
 canoe 214
 canoeing 241
 canola oil 135
 canter 243
 canvas 274
 cap 21, 36, 238
 capacity 311
 cape gooseberry 128
 capers 143
 capital 315
 capoeira 237
 cappuccino 148
 capsize v 241
 capsule 109
 captain 214
 car 198, 200
 car accident 203
 car rental 213
 car seat 198, 207
 car stereo 201
 car wash 198
 caramel 113
 caraway 131
 card 27
 card slot 97
 cardamom 132
 cardboard 275
 cardigan 32
 cardiology 49
 cardiovascular 19
 cards 273
 cargo 216
 Caribbean Sea 312
 carnation 110
 carnival 27
 carousel 212
 carpenter 188
 carpentry bits 80
 carpet 71
 carriage race 243
 carrier 75, 204
 carrot 124
 carry-on luggage 211, 213
 cart 48, 100, 106, 208, 213
 cartilage 17
 cartoon 311
 cartoon 178
 carve v 79
 carving fork 68
 case 51
 cash v 97
 cashew 129
 cashews 151
 cashier 96, 106
 casino 261
 Caspian Sea 313
 cassava 124
 casserole dish 69
 cassette player 269
 cassette tape 269
 cast 254
 cast v 245
 castle 300
 casual 34
 casual wear 33
 cat 290
 catamaran 215
 cataract 51
 catch v 220, 227, 229, 245
 catcher 229
 caterpillar 295
 cathedral 300
 catheter 53
 cauliflower 124
 cave 284
 CD 269
 CD player 268
 cedar 296
 ceiling 62
 celebration 140
 celebration cakes 141
 celebrations 27
 celeriac 124
 celery 122
 cell 94, 181
 cell phone 99
 cello 256
 cement 186
 cement mixer 186
 centimeter 310
 centipede 295
 Central African Republic 317
 central reservation 194
 center 164
 center circle 222, 224, 226
 center field 228
 center line 226
 centerboard 241
 century 307
 CEO 175
 ceramic range 66
 cereal 130, 156
 cervical vertebrae 17
 cervix 20, 52
 Chad 317
 chain 36, 206
 chair 64
 chair v 174
 chairlift 246
 chalk 85, 162, 288
 chamber 283
 chamomile tea 149
 champagne 145
 championship 230
 change v 209
 change a tire v 203
 change channels v 269
 change gears v 207
 changing mat 74
 changing room 104
 channel 178
 charcoal 266, 275
 charge 94, 180
 chart 48
 chassis 203
 check 96
 checkbook 96
 checkers 272
 check-in v 212
 check-in desk 213
 checking account 96
 checkout 106
 checkup 50
 cheddar 142
 cheek 14
 cheerleader 220
 cheese 136, 156
 chef 152, 190
 chef's hat 190
 chemistry 162
 cherry 126
 cherry tomato 124
 chess 272
 chessboard 272
 chest 12
 chest of drawers 70
 chest press 251
 chestnut 129
 chicken coop 113
 chick 185
 chicken 119, 185
 chicken burger 155
 chicken coop 185
 chicken nuggets 155
 chicken pox 44
 chicory 122
 child 23, 31
 child lock 75
 childbirth 53
 children 23
 children's clothing 30
 children's department 104
 children's meal 153
 children's ward 48
 Chile 315
 chili pepper 124, 132, 143
 chill 44
 chimney 58
 chin 14
 China 318
 china 105
 chip v 233
 chips 113, 151
 chipboard 79
 chiropractic 54
 chisel 81, 275
 chives 133
 chocolate 113
 chocolate bar 113
 chocolate cake 140
 chocolate chip 141
 chocolate-coated 140
 chocolate milkshake 149
 chocolate spread 135
 choir 301
 choke v 47
 chop 119, 237
 chorizo 143
 choux pastry 140
 christening 26
 Christmas 27
 chrysanthemum 110
 chuck 78
 church 298, 300
 chutney 134
 cider 145
 cider vinegar 135
 cigar 112
 cigarettes 112
 cilantro 133
 cinnamon 133
 circle 165, 254
 circular saw 78
 circuit training 251
 circulation desk 168
 circumference 164
 citrus fruit 126
 city 299
 clam 121
 clamp 78, 166
 clamp stand 166
 clapper board 179
 clarinet 257
 clasp 36
 classical music 255, 259
 classroom 162
 claw 291
 clay 85, 275
 clean v 77
 clean clothes 76

- cleaned 121
 cleaner 188
 cleaning equipment 77
 cleaning fluid 51
 cleanser 41
 clear honey 134
 cleat 240
 cleaver 68
 clementine 126
 client 38, 175, 180
 cliff 285
 climber 87
 climbing frame 263
 clinic 48, 168
 clipboard 173
 clitoris 20
 clock radio 70
 closed 260, 321
 cloth diaper 30
 clothesline 76
 clothespin 76
 clothing 205
 cloud 287
 cloudy 286
 clove 125
 clover 297
 cloves 133
 club 273
 club sandwich 155
 clubhouse 232
 clutch 200, 204
 coach 196
 coal 288
 coast 285
 coaster 150
 coastguard 217
 coat 32
 coat hanger 70
 cockatoo 293
 cockle 121
 cockpit 210
 cockroach 295
 cocktail 151
 cocktail shaker 150
 cocoa powder 148
 coconut 129
 cocoon 295
 cod 120
 coffee 144, 148, 153,
 156, 184
 coffee cup 65
 coffee machine 148, 150
 coffee milkshake 149
 coffee spoon 153
 coffee table 62
 cog 206
 coin 97
 coin phone 99
 coin return 99
 cola 144
 colander 68
 cold 44, 286, 321
 cold faucet 72
 cold-pressed oil 135
 collage 275
 collar 32
 collarbone 17
 colleague 24
 collect call 99
 collection 98
 college 168
 cologne 41
 Colombia 315
 colony 315
 colored pencil 163
 colors 39, 274
 comb 38
 comb v 38
 combat sports 236
 combine 182
 comedy 255
 comforter 71
 comet 280
 comic 112
 commis chef 152
 commission 97
 communications 98
 commuter 208
 Comoros 317
 compact 40
 compact car 199
 company 175
 compartment 209
 compass 165, 312, 240
 complaint 94
 complexion 41
 composite 181
 compost 88
 compost pile 85
 computer 176
 concealer 40
 conceive v 20
 conception 52
 concert 255, 258
 concourse 209
 concrete block 187
 concussion 46
 condensed milk 136
 conditioner 38
 condom 21
 conductor 256
 cone 164, 187
 confectionery 107, 113
 confident 25
 confused 25
 conglomerate 288
 Congo 317
 conifer 86
 connect v 177
 connection 212
 conning tower 215
 console 269
 constellation 281
 construction 186
 construction worker 186,
 188
 consultant 49
 consultation 45
 contact lenses 51
 container 216, 311
 container port 216
 container ship 215
 continent 282, 315
 contraception 21, 52
 contraction 52
 control tower 212
 controller 269
 controls 201, 204
 convenience food 107
 convertible 199
 conveyer belt 106
 cooked meat 118, 143
 cookies 113, 141
 cooking 67
 coolant reservoir 202
 cooling rack 69
 co-pilot 211
 copper 289
 copy v 172
 cor anglais 257
 coral reef 285
 cordless drill 78
 cordless phone 99
 core 127
 cork 134
 corkscrew 150
 corn 122, 130, 184
 corn bread 139
 corn oil 135
 cornea 51
 corner 223
 corner flag 223
 cornice 300
 corset 35
 Corsica 316
 Costa Rica 314
 costume 255
 cottage cheese 136
 cottage garden 84
 cotton 184, 277
 cotton balls 41
 cough 44
 cough drop 109
 cough medicine 108
 counselor 55
 count v 165
 counter 96, 98, 100,
 142, 272
 countertop 66
 country 259, 315
 couple 24
 courier 99
 courses 153
 court 226
 court case 180
 court clerk 180
 court date 180
 courtroom 180
 courtyard 58, 84
 couscous 130
 cousin 22
 coverall 30
 cow 185
 cow's milk 136
 crab 121, 295
 cracked wheat 130
 cradle 95
 craft knife 82
 crafts 275
 cramp 239
 cramps 44
 cranberry 127
 crane 187, 216, 292
 crater 283
 crayfish 121
 cream 109, 137, 140,
 157
 cream cheese 136
 cream pie 141
 crease 225
 credit card 96
 creel 245
 creeper 87
 crème caramel 141
 crème patisserie 140
 crêpe 155, 157
 crescent moon 280
 crew 241
 crew hatch 281
 crib 74
 cricket 225, 295
 cricket ball 225
 cricketer 225
 crime 94
 criminal 181
 criminal record 181
 crisp 127
 crispbread 139, 156
 crisper 67
 Croatia 316
 crochet 277
 crochet hook 277
 crockery 64
 crockery and cutlery 65
 crocodile 293
 croissant 156
 crop 39, 183
 crop farm 183
 crops 184
 crossbar 207, 222, 235
 cross-country skiing 247
 cross-trainer 250
 crosswalk 195
 crow 292
 crown 50
 crucible 166
 crushed 132
 crust 139, 282
 cry v 25
 crystal healing 55
 Cuba 314
 cube 164
 cucumber 125
 cuff 32, 45
 cufflink 36
 cultivate v 91
 cultivator 182
 cumin 132
 curb 298
 cured 118, 159, 143
 curler 38
 curling 247
 curly 39
 currant 129
 curry 158
 curry powder 132
 curtain 63, 254
 curved 165
 cushion 62
 custard 140
 customer 96, 104, 106,
 152
 customer service
 department 175
 customer services 104
 customs 212
 customs house 216
 cut 46
 cut v 38, 79, 277
 cuticle 15
 cutlery 64
 cuts 119
 cutting 91
 cutting board 68
 cuttlefish 121
 cycle v 207
 cycle lane 206
 cycling 263
 cylinder 164
 cylinder head 202
 cymbals 257
 Cyprus 316
 Czech Republic 316

D

- daffodil 111
 dairy 107
 dairy farm 183
 dairy produce 136
 daisy 110, 297
 dam 300
 dance 259
 dance academy 169
 dancer 191
 dandelion 123, 297
 dandruff 39
 dark 41, 321
 darkroom 271
 darn v 277
 dartboard 273
 darts 273
 dashboard 201
 date 129, 306
 daughter 22

- daughter-in-law 22
dawn 305
day 305, 306
day after tomorrow 307
day before yesterday 307
dead ball line 221
deadhead *v* 91
deal *v* 273
debit card 96
decade 307
decay 50
December 306
deciduous 86
decimal 165
deck 214
deck chair 265
deck of cards 273
decking 85
decorating 82
decoration 141
decorator 82
deep end 239
deep-fried 159
deep-sea fishing 245
deer 291
defense 181, 220
defendant 181
defender 223
defending zone 224
defrost *v* 67
degree 169
delay 209
deli 107
delicatessen 142
delivery 52, 98
deltoid 16
Democratic Republic of the Congo 317
Denmark 316
denomination 97
denominator 165
dental care 108
dental floss 50, 72
dental hygiene 72
dental X-ray 50
dentist 50, 189
dentist's chair 50
dentures 50
deodorant 73, 108
department 169
department store 105
departments 49
departure lounge 213
departures 213
deposit *v* 96
deposit slips 96
depth 165
dermatology 49
descaled 121
desert 285
desiccated 129
designer 191, 277
desk 162, 172
desktop 177
dessert 153
desserts 140
dessert cart 152
destination 213
detached 58
detective 94
detergent 77
detour 195
deuce 230
develop *v* 271
diabetes 44
diagonal 164
dial *v* 99
diameter 164
diamond 273, 288
diaper 75
diaper bag 75
diaper rash cream 74
diaphragm 19, 21
diarrhea 44, 109
dice 272
dictionary 163
die *v* 26
diesel 199
diesel train 208
difficult 321
dig *v* 90, 227
digestive 19
digital 269
digital (radio) 179
digital camera 270
digital projector 163
digital radio 268
dilation 52
dill 133
dimensions 165
dimple 15
dining car 209
dining room 64
dinner 64, 158
dinner plate 65
diopter 51
diploma 169
dipstick 202
direct current 60
directions 260
director 254
directory assistance 99
dirt bike 205
dirty laundry 76
disabled parking 195
discharged 48
disconnected 99
discus 234
discuss *v* 163
disembark *v* 217
dishwasher 66
disinfectant solution 51
disposable 109
disposable camera 270
disposable diaper 30
disposable razor 73
dissertation 169
distance 310
distributor 203
district 315
dive 239
dive *v* 238
diver 238
divide *v* 165
divided by 165
divided highway 195
dividends 97
divider 173, 194
divorce 26
Diwali 27
DJ 179
Djibouti 317
do not bend *v* 98
dock 214, 216
dock *v* 217
doctor 45, 189
doctorate 169
documentary 178
dog 290
dog-sledding 247
doll 75
dollhouse 75
dolphin 290
dome 300
domestic flight 212
Dominica 314
Dominican Republic 314
dominoes 273
donkey 185
door 196, 198, 209
door chain 59
door knob 59
door knocker 59
door lock 200
doorbell 59
doormat 59
dormer 58
dorsal fin 294
dosage 109
double 151
double bass 256
double bassoon 257
double bed 71
double room 100
double-decker bus 196
doubles 230
dough 138
Dover sole 120
down 320
downhill skiing 247
download *v* 177
dragonfly 295
drain 61, 72, 299
drain cock 61
drainage 91
draining board 67
draw 223
draw *v* 162
drawer 66, 70, 172
drawing 275
dress 31, 34
dressage 243
dressed 159
dressed chicken 119
dressing 47, 158
dressing table 71
dribble *v* 223, 227
dried flowers 111
dried fruit 156
drill 50
drill *v* 79
drill bit 78
drill bits 80
drinking cup 75
drinking fountain 262
drinks 107, 144, 156
drip 53
drive *v* 195, 233
driver 196
driver's seat 196
driveshaft 202
drop anchor *v* 217
dropper 109, 167
drops 109
dropshot 230
drown *v* 239
drum 258
drum kit 258
drummer 258
dry 39, 41, 130, 145, 286, 321
dry *v* 76
dry-cleaner 115
dry dock 217
DTV converter box 269
duck 119, 185
duck egg 137
duckling 185
duffle bag 37
duffle coat 31
dugout 229
dumb bell 251
dumper truck 187
dunk *v* 227
duodenum 18
duplex 58
dusk 305
dust *v* 77
dustpan 77
duster 77
dust sheet 83
duty-free shop 213
DVD 269
DVD player 268
dyed 39
dynamo 207
- E**
eagle 292
ear 14
early
earring 36
Earth 280, 282
earthenware dish 69
earthquake 283
easel 174, 274
east 312
East Timor 319
Easter 27
easy 321
easy cook 130
eat *v* 64
eat-in 154
eating 75
eaves 58
éclair 140
eclipse 280
economics 169
economy class 211
Ecuador 315
eczema 44
edam 142
edge 246
editor 191
eel 294
egg 20
egg cup 65, 137
egg white 137
eggplant 125
eggs 137
Egypt 317
eight 308
eight hundred 308
eighteen 308
eighteenth 309
eighth 309
eightieth 309
eighty 308
ejaculatory duct 21
El Salvador 314
elbow 13
electric blanket 71
electric blood pressure monitor 45
electric car 199
electric drill 78
electric guitar 258
electric meter 60
electric razor 73
electric shock 46
electric train 208
electrical goods 105, 107
electrician 188
electricity 60
elephant 291
elevator 59, 100, 104
eleven 308
eleventh 309
elm 296
email 98, 177
email account 177
email address 177
embarrassed 25
embossed paper 83
embroidery 277
embryo 52
emerald 288
emergency 46

- emergency exit 210
 emergency lever 209
 emergency phone 195
 emergency room 48
 emergency services 94
 emigrate *v* 26
 emotions 25
 employee 24
 employer 24
 empty 321
 enamel 50
 encore 255
 encyclopedia 163
 end 321
 end zone 220
 endive 123
 endline 226
 endocrine 19
 endocrinology 49
 energy-saving bulb (eco bulb) 60
 engaged couple 24
 engine 202, 204, 208, 210
 engine room 214
 engineering 169
 English breakfast 157
 English mustard 135
 engraving 275
 enlarge *v* 172
 enlargement 271
 ENT (otolaryngology) 49
 entrance 59
 entrée 153
 envelope 98, 173
 environment 280
 epidural 52
 epiglottis 19
 epilepsy 44
 episiotomy 52
 equals 165
 equation 165
 equator 283
 equipment 233, 238
 equipment 165
 Equatorial Guinea 317
 equity 97
 eraser 163
 Eritrea 317
 erupt *v* 283
 escalator 104
 esophagus 19
 espresso 148
 essay 163
 essential oils 55
 estate 199
 Estonia 316
 estuary 285
 Ethiopia 317
 eucalyptus 296
 Europe 316
 evening 305
 evening dress 34
 evening menu 152
- events 243, 247
 evergreen 86
 evidence 181
 excavator 187
 excess baggage 212
 exchange rate 97
 excited 25
 excuse me 322
 executive 174
 exercise bike 250
 exercises 251
 exfoliate *v* 41
 exhaust pipe 203, 204
 exhibit *v* 261
 exhibition 261
 exit 210
 exit ramp 194
 exosphere 286
 expanding file 173
 expectant 52
 experiment 166
 expiration date 109
 exposure 271
 express train 209
 extend *v* 251
 extension 58
 extension cord 78
 exterior 198
 external hard drive 176
 extra time 223
 extraction 50
 extractor 66
 eye 14, 51, 244, 276
 eye shadow 40
 eye test 51
 eyebrow 14, 51
 eyebrow brush 40
 eyebrow pencil 40
 eyecup 269
 eyelash 14, 51
 eyelet 37
 eyelid 51
 eyeliner 40
 eyepiece 167
- F**
 fabric 277
 fabric conditioner 76
 face 14
 face cream 73
 face mask 225
 face pack 41
 face powder 40
 faceoff circle 224
 facial 41
 factory 299
 faint *v* 25, 44
 fair 41
 fairground 262
 fairway 232
 falcon 292
 Falkland Islands 315
 fall 237
 fall (autumn) 31, 307
- fall in love *v* 26
 fallopian tube 50
 family 22
 famous ruin 261
 fan 60, 202
 fan belt 203
 fans 258
 far 320
 fare 197, 209
 farm 182, 183, 184
 farmer 182, 189
 farmhouse 182
 farmland 182
 farmyard 182
 farsightedness 51
 fashion 277
 fast 321
 fast food 154
 fast-forward 269
 fastening 37
 fat 119, 321
 fat-free 137
 father 22
 father-in-law 23
 fault 230
 fava beans 122, 131
 fax 98, 172
 fax machine 172
 feather 293
 feature film 269
 February 306
 feed *v* 183
 feijoa 128
 female 12, 20
 feminine hygiene 108
 femur 17
 fence 85, 182, 243
 fencing 249
 feng shui 55
 fennel 122, 133
 fennel seeds 133
 fenugreek 132
 fern 86
 ferry 215, 216
 ferry terminal 216
 fertilization 20
 fertilize *v* 91
 fertilizer 91
 festivals 27
 fetus 52
 fever 44
 fiancé 24
 fiancée 24
 fiancer 127
 fibula 17
 field 182, 222, 225, 228, 234, 258, 266
 field *v* 225, 229
 field hockey 224
 fifteen 308
 fifteenth 309
 fifth 309
 fiftieth 309
 fifty 308
- fifty five thousand, five hundred 309
 fifty thousand 309
 fig 129
 fighter plane 211
 figure skating 247
 figurine 260
 Fiji 319
 filament 60
 file 81, 177
 filing cabinet 172
 fill *v* 82
 filler 83
 fillet 119, 121
 filleted 121
 filling 50, 140, 155
 film chamber 270
 film spool 271
 filter 270
 filter coffee 148
 filter paper 167
 fin 210
 finance 97
 financial advisor 97
 fingerprint 94
 finial 300
 finish line 234
 Finland 316
 fire 95
 fire alarm 95
 fire department 95
 fire engine 95
 fire escape 95
 fire extinguisher 95
 fire station 95
 firefighter 95, 189
 firelighter 266
 fireplace 63
 firm 124
 first 309
 first aid 47
 first-aid box 47
 first night 254
 fish 107, 120, 294
 fish and chips 155
 fish farm 183
 fisherman 189
 fishhook 244
 fishing 244, 245
 fishing boat 217
 fishing permit 245
 fishing port 217
 fishing rod 244
 fish-seller 114, 120, 188
 fist 15, 237
 fitness 250
 five 308
 five hundred 308
 flag 221, 232
 flageolet beans 131
 flakes 132
 flamingo 292
 flan 142
 flare 240
- flash 270
 flash gun 270
 flashlight 267
 flask 166
 flat 59, 256
 flat race 243
 flat tire 203, 207
 flat wood bit 80
 flatbread 139
 flatscreen TV 269
 flavored oil 134
 flax 184
 fleece 74
 flesh 124, 127, 129
 flex *v* 251
 flight attendant 190, 210
 flight number 213
 flint 288
 flipchart 174
 flip-flop 37
 flipper 239, 290
 float 238, 244
 float ball 61
 flock 183
 flood 287
 floor 58, 62, 71
 floor exercises 235
 floor plan 261
 florentine 141
 furet 122
 florist 110, 188
 floss *v* 50
 flours 138
 flower 297
 flowerbed 85, 90
 flowering plant 297
 flowering shrub 87
 flowers 110
 flu 44
 flute 139, 257
 fly 244, 295
 fly *v* 211
 fly-fishing 245
 flysheet 266
 foal 185
 focus *v* 271
 focusing knob 167
 fog 287
 foil 249
 folder 177
 foliage 110
 folk music 259
 follicle 20
 font 177
 food 118, 130, 149
 food hall 105
 food processor 66
 foot 12, 15, 310
 foot pedals (instrument) 257
 football 220
 footboard 71
 footpath 262

formal 34
 formal garden 84, 262
 fortieth 309
 forty 308
 forty minutes
 forward 222
 foul 222, 226
 foul ball 228
 foul line 229
 foundation 40
 fountain 85
 four 308
 four hundred 308
 four-door 200
 fourteen 308
 fourteenth 309
 fourth 309
 four-wheel drive 199
 fox 290
 foxglove 297
 foyer 59
 fraction 165
 fracture 46
 fragile 98
 fragranced 130
 frame 51, 62, 206, 230, 269
 France 316
 freckle 15
 free 321
 free kick 222
 free-range 118
 free weights 250
 freesia 110
 free-throw line 226
 freeway 194
 freeze 287
 freeze v 67
 freezer 67
 freight train 208
 freighter 215
 French bean 122
 French braid 39
 french fries 154
 French Guiana 315
 French horn 257
 French mustard 135
 French toast 157
 frequency 179
 fresh 121, 127, 130
 fresh cheese 136
 fresh fruit 157
 freshwater fishing 245
 fret 258
 fretsaw 81
 Friday 306
 fried 159
 fried chicken 155
 fried egg 157
 friend 24
 frieze 301
 frog 294
 from 320
 front crawl 239

front door 58
 front wheel 196
 frontage road 194, 216
 frontal 16
 frost 287
 froth 148
 frown 25
 frozen 121, 124
 frozen food 107
 frozen yogurt 137
 fruit 107, 126, 128
 fruit bread 139
 fruit cake 140
 fruit farm 183
 fruit juice 127, 156
 fruit tart 140
 fruit yogurt 157
 fry v 67
 frying pan 69
 fuel gauge 201
 fuel tank 204
 full 64, 266, 321
 full board 101
 full moon 280
 fumble 220
 funeral 26
 funnel 166, 214
 furniture store 115
 furrow 183
 fuse 60
 fuse box 60, 203
 fuselage 210

G

gable 300
 Gabon 317
 Galápagos Islands 315
 galaxy 280
 gale 286
 galley 214
 gallon 311
 gallop 243
 galvanized 79
 Gambia 317
 game 119, 230, 273
 game show 178
 games 272
 gangway 214
 garage 58, 199, 203
 garbage can 61, 67
 garbanzos 131
 garden 84
 garden center 115
 garden features 84
 garden pea 122
 garden plants 86
 garden styles 84
 garden tools 88
 gardener 188
 gardening 90
 gardening gloves 89
 gardens 261
 garland 111
 garlic 125, 132

garlic press 68
 garnet 288
 garter 35
 garter belt 35
 gas burner 61
 gas pump 199
 gas station 199
 gas tank 203
 gasket 61
 gasoline 199
 gate 85, 182, 247
 gate number 213
 gauze 47, 167
 gear lever 207
 gearbox 202, 204
 gears 206
 gearshift 201
 gel 38, 109
 gems 288
 generation 23
 generator 60
 genitals 12
 geography 162
 geometry 165
 Georgia 318
 gerbera 110
 Germany 316
 get a job v 26
 get married v 26
 get up v 71
 geyser 285
 Ghana 317
 giant slalom 247
 gift shop 114
 gill 294
 gin 145
 gin and tonic 151
 ginger 125, 133
 giraffe 291
 girder 186
 girl 23
 girlfriend 24
 girth 242
 glacier 284
 gladiolus 110
 gland 19
 glass 69, 152
 glass bottle 166
 glass stirrer 167
 glasses 51, 150
 glassware 64
 glaze v 139
 glider 211, 248
 gliding 248
 gloss 83, 271
 glove 224, 233, 236, 246
 gloves 36
 glue 275
 glue gun 78
 gneiss 288
 go to bed v 71
 go to sleep v 71
 goal 221, 223, 224

goal area 223
 goal line 220, 223, 224
 goalkeeper 222, 224
 goalpost 220, 222
 goat 185
 goat's cheese 142
 goat's milk 136
 goggles 238, 247
 going out 75
 gold 235, 289
 goldfish 294
 golf 232
 golf bag 233
 golf ball 233
 golf cart 232, 233
 golf clubs 233
 golf course 232
 golf shoe 233
 golfer 232
 gong 257
 good 321
 good afternoon 322
 good evening 322
 good morning 322
 good night 322
 goodbye 322
 goose 119, 293
 goose egg 137
 gooseberry 127
 gorge 284
 gorilla 291
 gothic 301
 grade 163
 graduate 169
 graduate v 26
 graduation ceremony 169
 graft v 91
 grains 130
 gram 310
 grandchildren 23
 granddaughter 22
 grandfather 22
 grandmother 22
 grandparents 23
 grandson 22
 granite 288
 grape juice 144
 grapefruit 126
 grapeseed oil 134
 graphite 289
 grass 86, 262
 grass bag 88
 grasshopper 295
 grassland 285
 grate v 67
 grated cheese 136
 grater 68
 gratin dish 69
 gravel 88
 gravity 280
 gray 39, 274
 graze 46
 greasy 39

Greece 316
 green 129, 232, 274
 green olive 143
 green onion 125
 green peas 131
 green salad 158
 green tea 149
 greenhouse 85
 Greenland 314
 Grenada 314
 grill pan 69
 grilled 159
 grip 78
 groceries 106
 grocery store 114
 groin 12
 groom 243
 ground 60, 132
 ground coffee 144
 ground cover 87
 ground floor 104
 ground meat 119
 ground sheet 267
 groundnut oil 135
 group therapy 55
 grout 83
 guard 236
 guard rail 195, 246
 Guatemala 314
 guava 128
 guest 64, 100
 guidebook 260
 guided tour 260
 guilty 181
 Guinea 317
 Guinea-Bissau 317
 guitarist 258
 gull 292
 gum 50
 gumdrop 113
 gun 94
 gutter 58, 299
 guy rope 266
 Guyana 315
 gym 101, 250
 gym machine 250
 gymnast 235
 gymnastics 235
 gynecologist 52
 gynecology 49
 gypsophila 110

H

hacksaw 81
 haddock 120
 hail 286
 hair 14, 38
 hair dye 40
 hairband 38
 hairdresser 38, 115, 188
 hair-dryer 38
 hairpin 38
 hairspray 38
 Haiti 314

- half an hour 304
 half-board 101
 half-time 223
 half-liter 311
 halibut fillets 120
 Halloween 27
 hallway 59
 halter 243
 halter neck 35
 ham 119, 143, 156
 hammer 80
 hammer v 79
 hammock 266
 hamper 263
 hamster 290
 hamstring 16
 hand 13, 15
 hand drill 81
 hand fork 89
 hand rail 59
 hand saw 89
 hand towel 73
 handbag 37
 handcuffs 94
 handicap 233
 handkerchief 36
 handle 36, 88, 106, 187, 200, 230
 handlebar 207
 handles 37
 handrail 196
 handsaw 80
 handset 99
 hang v 82
 hang-glider 248
 hang-gliding 248
 hanging basket 84
 hanging file 173
 happy 25
 harbor 217
 harbor master 217
 hard 129, 321
 hard candy 113
 hard cheese 136
 hard hat 186
 hard shoulder 194
 hardboard 79
 hardware 176
 hardware store 114
 hardwood 79
 haricot beans 131
 harness race 243
 harp 256
 harvest v 91, 183
 hat 36
 hatchback 199
 have a baby v 26
 Hawaii 314
 hay 184
 hayfever 44
 hazard 195
 hazard lights 201
 hazelnut 129
 hazelnut oil 134
 head 12, 19, 81, 230
 head v 222
 head injury 46
 headache 44
 headboard 70
 headlight 198, 205
 headphones 268
 headquarters 175
 headrest 200
 headsail 240
 health 44
 health food store 115
 heart 18, 119, 122, 273
 heart attack 44
 heater 60
 heater controls 201
 heather 297
 heating element 61
 heavy 321
 heavy metal 259
 hedge 85, 90, 182
 hedgehog 290
 heel 13, 15, 37
 height 165
 helicopter 211
 hello 322
 helmet 95, 204, 206, 220, 224, 228
 helpdesk 168
 hem 34
 hematite 289
 hemorrhage 46
 hen's egg 137
 herb 55, 86
 herb garden 84
 herbaceous border 35
 herbal remedies 108
 herbal tea 149
 herbalism 55
 herbicide 183
 herbs 133, 134
 herbs and spices 132
 herd 183
 hexagon 164
 high 321
 high chair 75
 high-definition 269
 high dive 239
 high-heeled shoe 37
 high jump 235
 high speed train 208
 highlights 39
 hiking 263
 hill 284
 Himalayas 313
 hip 12
 hippopotamus 291
 historic building 261
 history 162
 hit v 224
 hockey 224
 hockey stick 224
 hoe 88
 hold 215, 237
 hole 232
 hole in one 233
 hole punch 173
 holly 296
 home 58
 home delivery 154
 home entertainment 268
 home furnishings 105
 home plate 228
 homeopathy 55
 homework 163
 homogenized 137
 Honduras 314
 honeycomb 135
 honeymoon 26
 honeysuckle 297
 hood 31, 75, 198
 hoof 242, 291
 hook 187, 276
 hoop 226, 277
 horizontal bar 235
 hormone 20
 horn 201, 204, 291
 horror movie 255
 horse 185, 235, 242
 horse race 243
 horseback riding 242, 263
 horseradish 125
 horseshoe 242
 hose 89, 95
 hose reel 89
 hospital 48
 host 64
 hostess 64
 hot 124, 286, 321
 hot chocolate 144, 156
 hot dog 155
 hot-dog vendor 154
 hot drinks 144
 hot faucet 72
 hot-air balloon 211
 hotel 100, 264
 hot-water bottle 70
 hour 304
 hour hand 304
 house 58
 household products 107
 hovercraft 215
 hub 206
 hubcap 202
 hull 214, 240
 human resources 175
 humerus 17
 humid 286
 hummingbird 292
 hump 291
 hundred 308
 hundred and ten 308
 hundred thousand 308
 hundredth 309
 Hungary 316
 hungry 64
 hurdles 235
 hurricane 287
 husband 22
 husk 130
 hydrant 95
 hydrofoil 215
 hydrotherapy 55
 hypnotherapy 55
 hypoallergenic 41
 hypotenuse 164
I
 ice 120, 287
 ice and lemon 151
 ice bucket 150
 ice climbing 247
 ice cream 149
 ice cube 151
 ice hockey 224
 ice hockey player 224
 ice hockey rink 224
 ice maker 67
 ice cream 137
 iced coffee 148
 iced tea 149
 ice-skate 224
 ice-skating 247
 Iceland 316
 icicle 287
 icing 141
 icon 177
 identity tag 53
 igneous 288
 ignition 200
 iguana 293
 illness 44
 immigration 212
 impotent 20
 in 320
 in brine 143
 in front of 320
 in oil 143
 in sauce 159
 in syrup 159
 inbox 177
 inch 310
 incisor 50
 incubator 53
 index finger 15
 India 318
 Indian Ocean 312
 indigo 274
 Indonesia 319
 induce labor v 53
 industrial park 299
 infection 44
 infertile 20
 infield 228
 inflatable dinghy 215
 information 261
 information screen 213
 in-goal area 221
 inhaler 44, 109
 injection 48
 injury 46
 ink 275
 ink pad 173
 inlet 61
 inline skating 249
 inner core 282
 inner tube 207
 inning 228
 innocent 181
 inoculation 45
 insect repellent 108, 267
 inside 320
 insomnia 71
 inspector 94
 install v 177
 instant camera 270
 instep 15
 instructions 109
 instruments 256, 258
 insulating tape 81
 insulation 61
 insulin 109
 insurance 203
 intensive care unit 48
 interchange 194
 intercom 59
 intercostal 16
 intercourse 20
 interest rate 96
 interior 200
 internal systems 60
 international flight 212
 internet 177
 intersection 298
 interval 254
 interviewer 179
 into 320
 in-tray 172
 invertebrates 295
 investigation 94
 investment 97
 ionosphere 286
 iPod 268
 iPad 176
 Iran 318
 Iraq 318
 Ireland 316
 iris 51, 110
 iron 76, 109, 233, 289
 iron v 76
 ironing board 76
 island 282
 Israel 318
 Italy 316
 itinerary 260
 IUD 21
 Ivory Coast 317
J
 jack 203, 273
 jacket 32, 34
 jackhammer 187
 jade 288
 jam 134, 156
 Jamaica 314

- jar 134, 311
javelin 234
jaw 14, 17
jazz 259
jeans 31, 33
jelly bean 113
jellyfish 295
Jerusalem artichoke 125
jet 288
jet-skiing 241
jetty 217
jeweler 188
jewelry store 114
jewelry 36
jewelry box 36
jewelry-making 275
jigsaw 78
jigsaw puzzle 273
jodhpurs 242
jog in place 251
jogging 251, 263
jogging suit 31, 32
joint 17, 119
joker 273
Jordan 318
journal 168
journalist 190
judge 180
judo 236
jug 65
juices and milkshakes 149
juicy 127
July 306
jumbo shrimp 121
jump 237, 243
jump v 227
jump ball 226
jumping rope 251
June 306
Jupiter 280
jury 180
jury box 180
- K**
kale 123
kangaroo 291
karate 236
Karlíngrad 316
kayak 241
Kazakhstan 318
kebab 155, 158
keel 214
keep net 244
kendo 236
Kenya 317
kernel 122, 129, 130
ketchup 135, 154
kettle 66
kettledrum 257
key 59, 80, 176, 207
keyboard 176, 258
keypad 97, 99
kick 237, 239
- kick v 221, 223
kickboxing 236
kickstand 207
kid 185
kidney 18, 119
kilogram 310
kilometer 310
king 272, 273
kippers 157
kitchen 66, 152
kitchen knife 68
kitchenware 68, 105
kitten 290
kiwifruit 128
knead v 138
knee 12
knee pad 205
knee support 227
kneecap 17
knee-length 34
knife 65, 80
knife sharpener 68, 118
knight 272
knitting 277
knitting needle 277
knock out 237
knuckle 15
koala 291
kohlrabi 123
koi carp 294
kumquat 126
kung fu 236
Kuwait 318
Kyrgyzstan 318
- L**
labels 89
labia 20
laboratory 166
lace 35, 37
lace bobbin 277
lace-making 277
lace-up 37
lacrosse 249
lactose 137
ladder 95, 186
ladle 68
lady fingers 141
ladybug 295
lake 285
lamb 118, 185
lamp 62, 207, 217
land 282
land v 211
landing 59
landing gear 210
landing net 244
landlord 58
landscape 271, 284
landscape v 91
lane 234, 238
languages 162
Laos 318
lapel 32
- laptop 175
larch 296
large 321
large intestine 18
larynx 19
last week 307
lat 16
late 305
later 304
latex paint 83
latitude 283
Latvia 316
laugh v 25
launch 281
launch pad 281
laundromat 115
laundry 76
laundry basket 76
laundry service 101
lava 283
law 169, 180
lawn 85, 90
lawn rake 88
lawnmower 88, 90
lawyer 180, 190
lawyer's office 180
laxative 109
lead singer 258
leaded 199
leaf 122, 296
league 223
lean meat 118
learn v 163
leather shoes 32
leathers 205
Lebanon 318
lecture hall 169
leek 125
left 260
left field 228
left-hand drive 201
leg 12, 119
leg pad 225
leg press 251
legal advice 180
legal department 175
leggings 31
legumes 130
leisure 258, 254, 264
lemon 126
lemon curd 134
lemon grass 133
lemon sole 120
lemonade 144
length 165, 310
lens 270
lens (eye) 51
lens (glasses) 51
lens cap 270
lens case 51
Lesotho 317
lesson 163
let! 231
letter 98
- letter slot 58, 99
letterhead 173
lettuce 123
level 80, 187
lever 61, 150
Liberia 317
librarian 168, 190
library 168, 299
library card 168
Libya 317
license plate 198
liquor store 115
licorice 113
lid 61, 66
Liechtenstein 316
life events 26
life jacket 240
life preserver 240
life raft 240
lifeboat 214
lifeguard 239, 265
lifeguard tower 265
ligament 17
light 178, 321
light a fire v 266
light aircraft 211
light bulb 60
lighter 112
lighthouse 217
lighting 105
lightmeter 270
lightning 287
lights 94
lights switch 201
lily 110
lime 126, 296
limestone 288
limousine 199
line 244
line judge 220
line of play 233
linen 105, 277
linen basket 76
lines 165
linesman 223, 230
lingerie 35, 105
lining 32
lining paper 83
link 36
lintel 186
lion 291
lip 14
lip brush 40
lip gloss 40
lip liner 40
lipstick 40
liqueur 145
liquid 77
liquid dispenser 311
liquid measure 311
liter 311
literature 162, 169
Lithuania 316
little finger 15
- little toe 15
live 60, 178
live rail 209
liver 18, 118
livestock 183, 185
living room 62
lizard 293
load v 76
load line 214
loaf 139
loan 96, 168
lob 230
lobby 100, 255
lobster 121, 295
lock 59, 207
lockers 239
log on v 177
loganberry 127
logo 31
loin 121
lollipop 113
long 32
long jump 235
long wave 179
long-grain 130
long-handled shears 88
longitude 283
loofah 73
loom 277
loose tea 144
lose v 273
loser 273
lotion 109
lottery tickets 112
love 230
low 321
luge 247
luggage 100, 198, 213
luggage department 104
luggage hold 196
luggage rack 209
lumbar vertebrae 17
lunar module 281
lunch 64
lunch menu 152
lung 18
lunges 251
lining 32
lining paper 83
link 36
lintel 186
lion 291
lip 14
lip brush 40
lip gloss 40
lip liner 40
lipstick 40
liqueur 145
liquid 77
liquid dispenser 311
liquid measure 311
liter 311
literature 162, 169
Lithuania 316
little finger 15
- M**
macadamia 129
mace 132
Macedonia 316
machine gun 189
machinery 187
mackerel 120
macramé 277
Madagascar 317
magazine 112

- magazines 107
 magma 283
 magnesium 109
 magnet 167
 maid service 101
 mail carrier 98, 190
 mailbag 98, 190
 mailbox 99
 mainsail 240
 make a will *v* 26
 make friends *v* 26
 make the bed *v* 71
 makeup 40
 making bread 138
 malachite 288
 Malawi 317
 Malaysia 318
 Maldives 318
 male 12, 21
 Mali 317
 mallet 78, 275
 malt vinegar 135
 Malta 316
 malted drink 144
 mammals 290
 man 23
 manager 24, 174
 manchego 142
 mane 242, 291
 mango 128
 mangosteen 128
 manhole 299
 manicure 41
 mantle 282
 manual 200
 map 261
 maple 296
 maple syrup 134
 maracas 257
 marathon 234
 marble 288
 March 306
 margarine 137
 marina 217
 marinated 143, 159
 marine fishing 245
 marjoram 133
 mark *v* 227
 market 115
 marketing department 175
 marmalade 134, 156
 marrow 124
 Mars 280
 marshmallow 113
 martial arts 237
 martini 151
 marzipan 141
 mascara 40
 mashed 159
 masher 68
 mask 189, 228, 236, 239, 249
 masking tape 83
 masonry bit 80
 massage 54
 mast 240
 masters 169
 mat 54, 83, 235, 271
 match 230
 material 276
 materials 79, 187
 maternity 49
 maternity ward 48
 math 162, 164
 mattress 70, 74
 Mauritania 317
 Mauritius 317
 May 306
 maybe 322
 mayonnaise 135
 MDF 79
 meadow 285
 meal 64
 measles 44
 measure 150, 151
 measure *v* 310
 measurements 165
 measuring cup 69, 311
 measuring spoon 109
 meat 119
 meat and poultry 106
 meat tenderizer 68
 meatballs 158
 meathook 118
 mechanic 188, 203
 mechanics 202
 medals 235
 media 178
 medical examination 45
 medication 109
 medicine 109, 169
 medicine cabinet 72
 meditation 54
 Mediterranean Sea 313
 medium wave 179
 meeting 174
 meeting room 174
 melody 259
 melon 127
 memory 176
 memory stick 176
 men's clothing 32
 menswear 105
 menstruation 20
 menu 148, 153, 154
 menu bar 177
 mercury 289
 Mercury 280
 meringue 140
 mesosphere 286
 messages 100
 metacarpal 17
 metal 79
 metal bit 80
 metals 289
 metamorphic 288
 metatarsal 17
 meteor 280
 meter 310
 Mexico 314
 mica 289
 microphone 179, 258
 microscope 167
 microwave oven 66
 midday 305
 middle finger 15
 midnight
 midwife 53
 migraine 44
 mile 310
 milk 136, 156
 milk *v* 183
 milk carton 136
 milk chocolate 113
 milkshake 137
 millennium 307
 millet 130
 milligram 310
 milliliter 311
 millimeter 310
 mineral 144
 mineral spirits 83
 minerals 289
 mini bar 101
 minibus 197
 minivan 199
 mini-dress 34
 mint 113, 133
 mint tea 149
 minus 165
 minute 304
 minute hand 304
 minutes 174
 mirror 40, 71, 167
 miscarriage 52
 Miss 23
 missile 211
 mist 287
 miter block 81
 mitt 228
 mittens 30
 mix *v* 67, 138
 mixing bowl 66, 69
 mixing desk 179
 moat 300
 mobile 74
 model 169, 190
 model-making 275
 modeling tool 275
 moisturizer 41
 molar 50
 Moldova 316
 mole 14
 Monaco 316
 Monday 306
 money 97
 money order 98
 Mongolia 318
 monitor 172
 monitor 53
 monkey 291
 monkfish 120
 monopoly 272
 monorail 208
 monsoon 287
 month 306
 monthly 307
 monument 261
 Moon 280
 moonstone 288
 moor *v* 217
 mooring 217
 mop 77
 morning 305
 Morocco 317
 mortar 68, 167, 187
 mortgage 96
 mosque 300
 mosquito 295
 mosquito net 267
 moth 295
 mother 22
 mother-in-law 23
 motocross 249
 motor 88
 motor racing 249
 motorcycle 204
 motorcycle racing 249
 molding 63
 motor 88
 mountain 284
 mountain bike 206
 mountain range 282
 mouse 176, 290
 mousse 141
 mouth 14
 mouth guard 237
 mouthwash 72
 move 273
 movie 260, 271
 movie set 179
 movie theater 255, 299
 mow *v* 90
 Mozambique 317
 mozzarella 142
 Mr. 23
 Mrs. 23
 mudguard 205
 muffin 140
 muffin pan 69
 muffler 203, 204
 mug 65
 mulch *v* 91
 multigrain bread 139
 multiply *v* 165
 multivitamin tablets 109
 mumps 44
 mung beans 131
 muscles 16
 museum 261
 mushroom 125
 music 162
 music school 169
 musical 255
 musical score 255
 musical styles 259
 musician 191
 mussel 121, 295
 mustard 155
 mustard seed 131
 Myanmar 318

N

- naan bread 139
 nail 15, 80
 nail clippers 41
 nail file 41
 nail polish 41
 nail polish remover 41
 nail scissors 41
 Namibia 317
 nape 13
 napkin 65
 napkin ring 65
 narrow 321
 nation 315
 national park 261
 natural 256
 natural fiber 31
 naturopathy 55
 nausea 44
 navel 12
 navigate *v* 240
 near 320
 nearsightedness 51
 nebula 280
 neck 12, 258
 neck brace 46
 necklace 36
 nectarine 126
 needle 109, 276
 needle plate 276
 needlenose pliers 80
 needlepoint 277
 negative 271
 negative electrode 167
 neighbor 24
 neoclassical 301
 Nepal 318
 nephew 23
 Neptune 280
 nerve 19, 50
 nervous 19, 25
 net 217, 222, 226, 227, 231
 net *v* 245
 net curtain 63
 Netherlands 316
 nettle 297
 network 176
 neurology 49
 neutral 60

- neutral zone 224
 new 321
 new moon 280
 new potato 124
 New Year 27
 New Zealand 319
 newborn baby 53
 news 178
 newscaster 179, 191
 newspaper 112
 newsstand 112
 next week 306
 nib 163
 Nicaragua 314
 nickel 289
 niece 23
 Niger 317
 Nigeria 317
 night 305
 nightgown 35
 nightie 31
 nightwear 31
 nightstand 70
 nightstick 94
 nine 308
 nine hundred 308
 nineteen 308
 nineteen hundred 307
 nineteen hundred and one 307
 nineteen ten 307
 nineteenth 309
 ninetieth 309
 ninety 308
 ninth 309
 nipple 12
 no 322
 no entry 195
 no right turn 195
 no stopping 195
 nonstick 69
 noodles 158
 normal 39
 north 312
 North and Central America 314
 North Korea 318
 North Pole 283
 North Sea 312
 Northern Hemisphere 283
 Norway 316
 nose 14, 210
 nose clip 238
 noseband 242
 nosebleed 44
 nosewheel 210
 nostril 14
 notation 256
 note 97, 256
 notecard 173
 notepad 173
 notebook 163, 172
 notes 191
 notice board 173
 notions 105
 nougat 113
 November 306
 now 304
 nozzle 89
 number 226
 numbers 308
 numerator 165
 nurse 45, 48, 52, 189
 nursery 74
 nursing 53
 nursing bra 53
 nut 80
 nutmeg 132
 nuts 151
 nuts and dried fruit 129
 nylon 277
- O**
 oak 296
 oar 241
 oatmeal 156
 oats 130
 objective lens 167
 oboe 257
 obsidian 288
 obstetrician 52
 occupations 188, 190
 occupied 321
 ocean 282
 ocean liner 215
 octagon 164
 October 306
 octopus 121, 295
 odometer 201
 offal 118
 offers 106
 office 24, 172, 174
 office building 298
 office equipment 172
 office supplies 173
 off-piste 247
 off-side 223
 oil 142, 199
 oil paints 274
 oil tank 204
 oil tanker 215
 oils 134
 oily 41
 ointment 47, 109
 okra 122
 old 321
 olive oil 134
 olives 151
 Oman 318
 omelet 158
 on time 305
 on top of 320
 oncology 49
 one 308
 one billion 309
 one million 309
 one thousand 309
- one-way 194
 one-way system 298
 onion 124
 on-line 177
 onto 320
 onyx 289
 opal 288
 open 260, 321
 open sandwich 155
 open-top 260
 opera 255
 operating room 48
 operation 48
 operator 99
 ophthalmology 49
 opponent 236
 opposite 320
 optic 150
 optic nerve 51
 optician 51, 189
 orange 126, 274
 orange juice 148
 orangeade 144
 orbit 280
 orchestra 254, 256
 orchestra pit 254
 orchid 111
 order v 153
 oregano 133
 organic 91, 118, 122
 organic waste 61
 organizer 175
 origami 275
 ornamental 87
 orthopedics 49
 osteopathy 54
 ostrich 292
 otter 290
 ounce 310
 out 225, 228, 320
 out of bounds 226
 out of focus 271
 outboard motor 215
 outbuilding 182
 outdoor activities 262
 outer core 282
 outfield 229
 outlet 61
 outpatient 48
 outside 320
 out-tray 172
 oval 164
 ovary 20
 oven 66
 oven mitt 69
 ovenproof 69
 over 320
 over par 233
 overalls 30, 82
 overdraft 96
 overexposed 271
 overflow pipe 61
 overhead bin 210
 overhead projector 163
- overpass 194
 overture 256
 ovulation 20, 52
 owl 292
 oyster 121
 ozone layer 286
- P**
 Pacific Ocean 312
 pack 311
 pack of cigarettes 112
 package 99, 311
 pad 224
 paddle 241
 paddock 242
 pads 53, 220
 painkiller 109
 painkillers 47
 pail 77, 82, 265
 paint 83
 paint v 83
 paint can 83
 paint tray 83
 painter 191
 painting 62, 261, 274
 paints 274
 pajamas 33
 pak-choi 123
 Pakistan 318
 palate 19
 palette 274
 pallet 186
 palm 15, 86, 296
 palm hearts 122
 pan 310
 pan-fried 159
 Panama 314
 pancreas 18
 panda 291
 panties 35
 pants 32, 34
 panty liner 108
 papaya 128
 paper clip 173
 paper napkin 154
 paper tray 172
 papier-maché 275
 paprika 132
 Papua New Guinea 319
 par 233
 parachute 248
 parachuting 248
 paragliding 248
 Paraguay 315
 parallel 165
 parallel bars 235
 parallelogram 164
 paramedic 94
 parents 23
 park 262
 park v 195
 parka 31, 33
 parking brake 203
 parking meter 195
- parking lot 298
 parmesan 142
 parole 181
 parrot 293
 parsley 133
 parsnip 125
 partner 23
 pass 226
 pass v 195, 220, 223
 passcode 99
 passenger 216
 passenger port 216
 passion fruit 128
 Passover 27
 passport 213
 passport control 213
 pasta 158
 pastels 274
 pasteurized 137
 pasting brush 82
 pasting table 82
 pastry 140, 149
 pastry brush 69
 pasture 182
 patch 207
 patchwork 277
 pâté 142, 156
 path 58, 85
 pathology 49
 patient 45
 patio garden 85
 pattern 276
 pause 269
 paving 85
 pawn 272
 pay v 153
 pay-per-view channel 269
 payphone 99
 payment 96
 payroll 175
 peach 126, 128
 peacock 293
 peanut 129
 peanut butter 135
 peanuts 151
 pear 127
 peas 131
 pecan 129
 pectoral 16
 pectoral fin 294
 pedal 61, 206
 pedal v 207
 pedestrian zone 299
 pediatrics 49
 pedicure 41
 pediment 301
 peel v 67
 peeled shrimp 120
 pelican 292
 pelvis 17
 pen 163, 185
 pen holder 172
 pen pal 24

- penalty 222
penalty area 223
pencil 163, 275
pencil case 163
pencil sharpener 163
pendant 36
penguin 292
peninsula 282
penis 21
pentagon 164
peony 111
people 12, 16
pepper 64, 124, 152
peppercorn 132
pepperoni 142
percentage 165
percussion 257
perennial 86
perfume 41, 105
pergola 84
periodical 168
perm 39
perpendicular 165
persimmon 128
personal best 234
personal organizer 173, 175
personal trainer 250
Peru 315
pesticide 89, 183
pestle 68, 167
pet food 107
pet store 115
petal 297
petri dish 166
pharmacist 108, 189
pharmacy 108
pharynx 19
pheasant 119, 293
Phillips screwdriver 81
philosophy 169
Philippines 319
photo album 271
photo finish 234
photographer 191
photograph 271
photograph v 271
photography 270
phyllo pastry 140
physical education 162
physics 162, 169
physiotherapy 49
piano 256
piccolo 257
pick v 91
pick-and-mix 113
pickax 187
pickled 159
pickup 258
picnic 263
picnic bench 266
picture frame 271
pie 158
pie pan 69
piece 272
pier 217
pies 143
pig 185
pig farm 183
pigeon 292
pigeonhole 100
piglet 185
pigsty 185
pigtails 39
Pilates 251
pill 21, 109
pillar 300
pillion 204
pillow 70
pillowcase 71
pilot 190, 211
pin 60, 237, 249, 276
PIN 96
pincushion 276
pine 296
pine nut 129
pineapple 128
pineapple juice 149
pink 274
pint 311
pinto beans 131
pipe 112, 202
pipe cutter 81
pipette 167
piping bag 69
pistachio 129
pita bread 139
pitch v 229
pitch a tent v 266
pitcher 151, 229
pitcher's mound 228
pitches available 266
pith 126
pizza 154
pizzeria 154
place mat 64
place setting 65
placenta 52
plain 285
plane 81
plane v 79
planet 280, 282
plant v 183
plant pot 89
plants 86, 296
plaque 50
plaster v 82
plastic bag 122
plastic pants 30
plastic surgery 49
plate 283
plateau 284
platform 208
platform number 208
platinum 289
play 254, 269
play v 229, 273
player 221, 231, 273
playground 263
playhouse 75
playing 75
playpen 75
plea 180
please 322
plow v 183
plug 60, 72
plum 126
plumb line 82
plumber 188
plumbing 61
plunger 81
plus 165
Pluto 280
plywood 79
poach v 67
poached 159
pocket 32
pod 122
podium 235, 256
point 273
poisoning 46
poker 273
Poland 316
polar bear 291
Polaroid camera 270
pole 245, 282
pole vault 234
police 94
police car 94
police officer 94, 189
police station 94
polish 77
polish v 77
politics 169
polo 243
polyester 277
pomegranate 128
pommel 242
pommel horse 235
pond 85
ponytail 39
pool 249
pop 259
popcorn 255
poplar 296
popper 30
poppy 297
poppy seeds 138
porch 58
porch light 58
pore 15
pork 118
pork 145, 176, 214, 216
porter 100
portfolio 97
porthole 214
portion 64
portrait 271
Portugal 316
positive electrode 167
post office 98
postage 98
postal worker 98
postcard 112
poster 255
poster paint 274
postgraduate 169
postmark 98
pot v 91
potato 124
potpourri 111
potted plant 87, 110
potter's wheel 275
pottery 275
potty 74
pouch 291
poultry 119
poultry farm 183
pound 310
pour v 67
powder 77, 109
powder puff 40
powdered milk 137
pour 60
power cord 176
power outage 60
practice swing 233
pram 75
praying mantis 295
pregnancy 52
pregnancy test 52
pregnant 52
premature 52
premolar 50
prenatal 52
prerecorded 178
prescription 45
present 27
presentation 174
presenter 178
preservative 83
preserved fruit 134
press 178
presser foot 276
pressure valve 61
price 152, 199
price list 154
prickly pear 128
primer 83
primrose 297
principal 163
principality 315
print 271
print v 172
printer 172, 176
printing 275
prison 181
prison guard 181
private bathroom 100
private jet 211
private room 48
probe 50
problems 271
processed grains 130
procession 27
processor 176
produce stand 114, 188
producer 254
professor 169
program 176
program 254, 269
programming 178
propagate v 91
propeller 211, 214
proposal 174
prosciutto 143
prosecution 180
prostate 21
protractor 165
proud 25
prove v 139
province 315
prow 215
prune 129
prune v 91
pruners 89
psychiatry 49
psychotherapy 55
public address system 209
puck 224
pudding rice 130
Puerto Rico 314
puff pastry 140
pull up v 251
pulp 127
pulse 47
pumice 288
pumice stone 73
pump 37, 207
pumpkin 125
pumpkin seed 131
punch 237
punching bag 237
pup 290
pupil 51, 162
puppy 290
purple 274
pushup 251
purse 37
putt v 233
putter 233
pyramid 164
- Q**
Qatar 318
quadriceps 16
quail 119
quail egg 137
quart 311
quarter of an hour 304
quarterdeck 214
quartz 289
queen 272, 273
question 163
question v 163
quiche pan 69

quilt 71
 quilting 277
 quince 128
 quinoa 130
 quiver 249

R

rabbit 118, 290
 raccoon 290
 race 234
 race-car driver 249
 racecourse 243
 racehorse 243
 racing bike 205, 206
 racing dive 239
 rack 166
 racket 230
 racket games 231
 racquetball 231
 radar 214, 281
 radiator 60, 202
 radiccchio 123
 radio 179, 268
 radio antenna 214
 radio station 179
 radiology 49
 radish 124
 radius 17, 164
 rafter 186
 rafting 241
 rail 208
 rail network 209
 rain 287
 rain gear 245, 267
 rainbow 287
 rainbow trout 120
 raincoat 31, 32
 rainforest 285
 raisin 129
 rake 88
 rake v 90
 rally 230
 rally driving 249
 RAM 176
 Ramadan 26
 ramekin 69
 range 67
 rap 259
 rapeseed 184
 rapids 240, 284
 rappeling 248
 rash 44
 raspberry 127
 raspberry jam 134
 rat 290
 rattle 74
 raw 124, 129
 ray 294
 razor blade 73
 razorshell clam 121
 read v 162
 reading light 210
 reading list 168
 reading room 168

reamer 80
 rear light 207
 rear wheel 197
 rearview mirror 198
 receipt 152
 receive v 177
 receiver 99
 reception 100
 receptionist 100, 190
 record 234, 269
 record player 268
 record store 115
 recording studio 179
 rectangle 164
 rectum 21
 recycling bin 61
 red 145, 274
 red card 223
 red-eye 271
 red kidney beans 131
 red lentils 131
 red meat 118
 red mullet 120
 Red Sea 313
 reduce v 172
 reduced-fat milk 136
 reel 244
 reel in v 245
 referee 222, 226
 referral 49
 reflector 50, 204, 207
 reflector strap 205
 reflexology 54
 refrigerator 67
 reggae 259
 region 315
 register 100
 registered mail 98
 regulator 239
 reheat v 154
 reiki 55
 reins 242
 relationships 24
 relatives 23
 relaxation 55
 relay race 235
 release v 245
 remote control 269
 Renaissance 301
 renew v 168
 rent 58
 rent v 58
 repair kit 207
 reporter 179
 reproduction 20
 reproductive 19
 reproductive organs 20
 reptiles 293
 research 169
 reserve v 168
 residence hall 168
 respiratory 19
 rest 256

restaurant 101, 152
 result 49
 resurfacing 187
 resuscitation 47
 retina 51
 retire v 26
 return 231
 return address 98
 return date 168
 rewind 269
 rhinoceros 291
 rhombus 164
 rhubarb 127
 rhythmic gymnastics 235
 rib 17, 119
 rib cage 17
 ribbon 27
 ribbon 39, 111, 141, 235
 ribs 155
 rice 130, 158, 184
 rice pudding 140
 rider 242
 riding boot 242
 riding crop 242
 riding hat 242
 rigging 215, 240
 right 260
 right field 229
 right-hand drive 201
 rim 206
 rind 119, 127, 136, 142
 ring 36
 ring binder 173
 ring finger 15
 ring ties 89
 rings 235
 rinse v 38, 76
 ripe 129
 rise v 139
 river 284
 road bike 206
 road markings 194
 road signs 195
 roads 194
 road work 187, 195
 roast 158
 roast v 67
 roasted 129
 roasting pan 69
 robe 35, 38, 169
 rock climbing 248
 rock concert 258
 rock garden 84
 rocket 123
 rocks 284, 288
 Rocky Mountains 312
 rococo 301
 rodeo 243
 roll 139, 311
 roll v 67
 roller 83, 187
 roller coaster 262
 roller shade 63
 rollerblading 263

rolling pin 69
 romance 255
 Romania 316
 romper 30
 roof 58, 203
 roof garden 84
 roof tile 187
 roof rack 198
 rook 272
 room 58
 room key 100
 room number 100
 room service 101
 rooms 100
 rooster 185
 root 50, 124, 296
 rope 248
 rose 89, 110, 145
 rosé 145
 rosemary 133
 rotor blade 211
 rotten 127
 rough 232
 round 237
 round neck 33
 roundabout 195
 route number 196
 router 78
 row 210, 254
 row v 241
 rower 241
 rowboat 214
 rowing machine 250
 rubber band 173
 rubber boots 89
 rubber ring 265
 rubber stamp 173
 ruber 288
 ruck 221
 rudder 210, 241
 rug 63
 rugby 221
 ruler 163, 165
 rum 145
 rum and coke 151
 rump steak 119
 run 228
 run v 228
 running shoe 37
 runway 212
 rush 86
 rush hour 209
 Russian Federation 318
 rutabaga 125
 Rwanda 317
 rye bread 138

S

sad 25
 saddle 206, 242
 safari park 262
 safe 228
 safety 75, 240
 safety goggles 81, 167

safety pin 47
 saffron 132
 sage 133
 Sahara Desert 313
 sail 241
 sailboat 215
 sailing 240
 sailor 189
 salad 149
 salamander 294
 salami 142
 salary 175
 sales clerk 104, 188
 sales department 175
 salmon 120
 salt 64, 152
 salted 121, 129, 137, 143
 San Marino 316
 sand 85, 264
 sand v 82
 sandal 37
 sandals 31
 sandbox 263
 sandcastle 265
 sander 78
 sandpaper 81, 83
 sandstone 288
 sandwich 155
 sandwich counter 143
 sanitary napkin 108
 São Tomé and Príncipe 317
 sapphire 288
 sardine 120
 Sardinia 316
 satellite 281
 satellite dish 269
 satellite navigation 201
 satnav 195
 satsuma 126
 Saturday 306
 Saturn 280
 sauce 134, 143, 155
 saucepan 69
 Saudi Arabia 318
 sauna 250
 sausage 155, 157
 sausages 118
 sauté v 67
 save v 177, 223
 savings 96
 savings account 97
 savory 155
 saw v 79
 saxophone 257
 scaffolding 186
 scale 121, 256, 294
 scales 45, 53, 69, 98, 118, 166, 212, 293, 310
 scallop 121
 scalp 39
 scalpel 167

- scan 48, 52
 scanner 106, 176
 scarecrow 184
 scared 25
 scarf 31, 36
 schedule 197, 209, 261
 schist 288
 scholarship 169
 school 162, 299
 school bus 196
 schoolbag 162
 schoolboy 162
 schoolgirl 162
 schools 169
 science 162, 166
 science fiction movie
 255
 scientist 190
 scissors 38, 47, 82, 276
 scoop 68, 149
 scooter 205
 score 220, 256, 273
 score a goal v 223
 scoreboard 225
 scorpion 295
 scotch and water 151
 scrabble 272
 scrambled eggs 157
 scrape v 77
 scraper 82
 screen 59, 97, 176, 255,
 269
 screw 80
 screwdriver 80, 151
 screwdriver bits 80
 script 254
 scrollbar 177
 scrotum 21
 scrub v 77
 scrum 221
 scuba diving 239
 sculpting 275
 sculptor 191
 sea 264, 282
 sea bass 120
 sea bream 120
 sea horse 294
 sea lion 290
 sea plane 211
 seafood 121
 seal 290
 sealant 83
 sealed jar 135
 seam 34
 seamstress 191
 search v 177
 seasonal 129
 seasons 306
 seat 61, 204, 209, 210,
 242, 254
 seat back 210
 seat belt 198, 211
 seat post 206
 seating 254
 second 304, 309
 second floor 104
 second-hand 304
 second-hand store 115
 section 282
 security 212
 security bit 80
 security guard 189
 sedan 199
 sedative 109
 sedimentary 288
 seed 122, 127, 128, 130
 seed tray 89
 seeded bread 139
 seedless 127
 seedling 91
 seeds 88, 131
 seasaw 263
 segment 126
 self-defense 237
 self-rising flour 139
 self-tanning cream 41
 semi-hard cheese 136
 seminal vesicle 21
 semi-soft cheese 136
 semisweet chocolate
 113
 semolina 130
 send v 177
 send off 223
 Senegal 317
 sensitive 41
 sentence 181
 September 306
 series 179
 serve 231
 serve v 64, 231
 server 176
 service included 152
 service line 230
 service not included 152
 service provider 177
 service vehicle 212
 serving spoon 68
 sesame seed 131
 sesame oil 134
 set 178, 230, 254
 set v 38
 set honey 134
 set sail v 217
 set the alarm v 71
 set the table v 64
 seven 308
 seven hundred 308
 seventeen 308
 seventeenth 309
 seventh 309
 seventieth 309
 seventy 308
 sew v 277
 sewing basket 276
 sewing machine 276
 sexually transmitted
 disease 20
 shade 41
 shade plant 87
 shallot 125
 shallow end 239
 shampoo 38
 shapes 164
 share price 97
 shares 97
 shark 294
 sharp 256
 shaving 73
 shaving foam 73
 shears 89
 shed 84
 sheep 185
 sheep farm 183
 sheep's milk 137
 sheet 71, 74, 241
 shelf 67, 106
 shell 129, 137, 265, 293
 shelled 129
 shelves 66
 sherbet 141
 sherry 145
 shiatsu 54
 shield 88
 shin 12
 ship 214
 ships 215
 shipyard 217
 shirt 33
 shock 47
 shocked 25
 shoe department 104
 shoe store 114
 shoes 34, 37
 shoot v 223, 227
 shop 298
 shopping 104
 shopping bag 106
 shopping center 104
 shops 114
 short 32, 321
 short wave 179
 short-grain 130
 shorts 30, 33
 shot 151
 shotgun 234
 shoulder 13
 shoulder bag 37
 shoulder blade 17
 shoulder pad 35
 shoulder strap 37
 shout v 25
 shovel 187
 shower 72, 286
 shower block 266
 shower curtain 72
 shower door 72
 shower gel 73
 shower head 72
 showjumping 243
 shuffle v 273
 shutoff valve 61
 shutter 58
 shutter release 270
 shuttle bus 197
 shuttlecock 231
 shy 25
 Siberia 313
 Sicily 316
 side 164
 side effects 109
 side mirror 198
 side order 153
 side plate 65
 side-saddle 242
 side street 299
 sidedeck 240
 sideline 220, 226, 230
 sidewalk 298
 sidewalk café 148
 Sierra Leone 317
 sieve 68, 89
 sieve v 91
 sift v 138
 sigh v 25
 sightseeing 260
 sign 104
 signal 209
 signature 96, 98
 silk 277
 silo 183
 silt 85
 silver 235, 289
 simmer v 67
 Singapore 319
 singer 191
 single 151
 single room 100
 singles 230
 sink 38, 60, 61, 66, 72
 sinus 19
 siren 94
 sirloin steak 119
 sister 22
 sister-in-law 23
 site manager's office 266
 situp 251
 six 308
 six hundred 308
 sixteen 308
 sixteenth 309
 sixth 309
 sixtieth 309
 sixty 308
 skate 120, 247, 294
 skate v 224
 skate wings 120
 skateboard 249
 skateboarding 249, 263
 skein 277
 skeleton 17
 sketch 275
 sketch pad 275
 skewer 68
 ski 241, 246
 ski boot 246
 ski jacket 246
 ski jump 247
 ski pole 246
 ski run 246
 ski slope 246
 skier 246
 skiing 246
 skim milk 136
 skin 14, 119, 128
 skin care 108
 skinned 121
 skirt 30, 34
 skull 17
 skydiving 248
 skyscraper 299, 300
 slalom 247
 slate 288
 sledding 247
 sledgehammer 187
 sleeper 30
 sleeping 74
 sleeping bag 267
 sleeping compartment
 209
 sleeping mat 267
 sleeping pill 109
 sleet 286
 sleeve 34
 sleeveless 34
 slice 119, 139, 140, 230
 slice v 67
 sliced bread 138
 slicer 139
 slide 167, 263
 slide v 229
 sling 46
 slip 35
 slip-on 37
 slippers 31
 slope 284
 slotted spatula 68
 slotted spoon 68
 Slovakia 316
 Slovenia 316
 slow 321
 slug 295
 small 321
 small intestine 18
 small of back 13
 smartphone 176
 smash 231
 smile 25
 smoke 95
 smoke alarm 95
 smoked 118, 121, 143,
 159
 smoked fish 143
 smoking 112
 snack bar 113, 148
 snail 295

- snake 293
snare drum 257
sneeze 44
snore *v* 71
snorkel 239
snout 293
snow 287
snowboarding 247
snowmobile 247
snowsuit 30
soak *v* 130
soap 73, 178
soap dish 73
soap 220, 222
soccer field 220
soccer player 220
soccer player 222
soccer uniform 31, 222
socket 60, 80
socket wrench 80
socks 33
soda bread 139
soda water 144
sofa 62
sofabed 63
soft 129, 321
soft cheese 136
soft drink 154
soft drinks 144
soft toy 75
software 176
softwood 79
soil 85
solar system 280
solder 79, 80
solder *v* 79
soldering iron 81
soldier 189
sole 15, 37
solids 164
Solomon Islands 319
soluble 109
solvent 83
Somalia 317
somersault 235
son 22
sonata 256
song 259
son-in-law 22
sorrel 123
sorting unit 61
soufflé 158
soufflé dish 69
sound boom 179
sound technician 179
soundtrack 255
soup 153, 158
soup bowl 65
soup spoon 65
sour 127
sour cream 137
sourdough bread 139
south 312
South Africa 317
South Korea 318
South Sudan 317
Southern Hemisphere 283
Southern Ocean 313
souvenirs 260
sow *v* 90, 183
soybeans 131
space 280
space exploration 281
space heater 60
space shuttle 281
space station 281
space suit 281
spade 88, 265, 273
Spain 316
spare tire 203
spark plug 203
sparkling 144
sparring 237
sparrow 292
spatula 68, 167
speaker 174, 176, 258, 268
speaker stand 268
spearfishing 245
specials 152
spectators 233
speed limit 195
speed skating 247
speedboat 241
speedometer 201, 204
spell *v* 162
sperm 20
sphere 164
spices 132
spicy sausage 142
spider 295
spike *v* 90
spikes 233
spin 230
spin *v* 76
spin-dryer 76
spinach 123
spine 17
spire 300
spleen 18
splint 47
splinter 46
split ends 39
split peas 131
spoke 207
sponge 73, 74, 83
sponge cake 140
spool 245
spoon 65
sport fishing 245
sports 105, 220, 236, 248
sports car 198
sports field 168
sportcoat 33
sportsman 191
spotlight 259
sprain 46
spray 109
spray *v* 91
spray can 311
spray bottle 89
spring 71, 307
spring balance 166
spring greens 123
springboard 235, 238
sprinkler 89
sprinter 234
sprocket 207
spy hole 59
square 164, 165, 272, 299
square foot 310
square meter 310
squash 231
squat 251
squid 121, 295
squirrel 290
Sri Lanka 318
St. Kitts and Nevis 314
St. Lucia 314
St. Vincent and the Grenadines 314
stable 185, 243
stadium 223
staff 175, 256
stage 167, 254
stages 23
stainless steel 79
stair gate 75
staircase 59
stake 90
stake *v* 91
stalk 122, 297
stalls 254
stamen 297
stamp 98
stamp collecting 273
stamps 112
stance 232
stand 88, 205, 268
stapler 173
staples 173
star 280
star anise 133
starfish 295
starfruit 128
start school *v* 26
starter 153
starting block 234, 238
starting line 234
state 315
statement 180
stationery 105
steak 121
steam *v* 67
steam train 208
steamed 159
steepchase 243
steel wool 81
steering wheel 201
stem 111, 112, 297
stencil 83
stenographer 181
step machine 250
stepdaughter 23
stepfather 23
stepladder 82
stepmother 23
stepson 23
stereo 269
stereo system 268
sterile 47
stern 240
stethoscope 45
stew 158
stick 224, 249
sticks 133
still 144
sting 46, 295
stir *v* 67
stir-fry 158
stirrer 150
stirrup 242
stitch 277
stitch selector 276
stitches 52
stock broker 97
stock exchange 97
stocking 35
stocks 97, 110
stomach 18
stomachache 44
stone 36, 275
stone fruit 126
stop 269
stop button 197
stopper 166
stopwatch 234
store directory 104
stork 292
storm 287
stout 145
straight 39, 165
straight ahead 260
straighten *v* 39
straighteners 38
strap 35
strapless 34
stratosphere 286
straw 144, 154
strawberry 127
strawberry milkshake 149
stream 285
streaming 269
street 298
street corner 298
street sign 298
streetlight 298
stress 55
stretch 251
stretcher 94
strike 228, 237
string 230, 258
string of pearls 36
string bean 122
strings 256
strip *v* 82
stroke 44, 233, 239
strokes 231
stroller 75
strong 321
stub 96
study 63, 162
stuffed 159
stuffed olive 143
stump 225
styles 39, 239, 301
submarine 215
subsoil 91
substitute 223
substitution 223
subtract *v* 165
suburb 299
subway map 209
subway train 209
succulent 87
suction hose 77
Sudan 317
sugarcane 184
suit 273
sulfur 289
summer 31, 307
summons 180
sumo wrestling 237
Sun 280
sun hat 30, 265
sunbathe *v* 264
sunbed 41
sunblock 108, 265
sunburn 46
Sunday 306
sunflower 184, 297
sunflower oil 134
sunflower seed 131
sunglasses 51, 265
sunny 286
sunrise 305
sunroof 202
sunscreen 108
sunset 305
sunshine 286
suntan lotion 265
supermarket 106
supersonic jet 211
supplement 55
supply pipe 61
support 187
suppository 109
surf 241
surfboard 241
surfcasting 245
surfer 241
surfing 241
surgeon 48
surgery 45, 48
Suriname 315
surprised 25

- suspect 94, 181
suspension 203, 205
swallow 292
swamp 285
swan 293
Swaziland 317
sweater 33
sweatshirt 33
Sweden 316
sweep *v* 77
sweet 124, 127, 155
sweet potato 125
sweet spreads 134
sweetcorn 124
swim *v* 238
swimmer 238
swimming 238
swimming pool 101, 238, 250
swimsuit 238, 265
swing *v* 232
swings 263
swiss chard 123
switch 60
Switzerland 316
swivel chair 172
sword 236
swordfish 120, 294
symphony 256
synagogue 300
synchronized swimming 239
synthetic 31
Syria 318
syringe 109, 167
syrup 109
system 176
- T**
tab 173
table 64, 148
table tennis 231
tablecloth 64
tachometer 201
tack *v* 241, 277
tackle 245
tackle *v* 220, 223
tackle box 244
tadpole 294
tae kwon do 236
tag *v* 229
tai chi 236
tail 121, 210, 242, 280, 290, 294
tailbone 17
tailgate 198
taillight 204
tailor 191
tailored 35
tailor's 115
tailor's chalk 276
tailor's dummy 276
tailplane 210
Taiwan 319
- Tajikistan 318
take a bath *v* 72
take a shower *v* 72
take notes *v* 163
take off *v* 211
talcum powder 73
tall 321
tambourine 257
tampon 108
tan 41
tandem 206
tangerine 126
tank 61
Tanzania 317
tap 61, 66
tap water 144
tape deck 268
tape dispenser 173
tape measure 80, 276
target 249
target shooting 249
taro root 124
tarragon 133
Tasmania 319
tattoo 41
tax 96
taxi stand 213
tea 144, 149, 184
tea bag 144
tea with lemon 149
tea with milk 149
teacher 162, 191
teacup 65
team 220, 229
teapot 65
tear 51
teaspoon 65
teat 75
techniques 79, 159
teddy bear 75
tee 233
teeing ground 232
teenager 23
tee off *v* 233
telegram 98
telephone 99
telephone booth 99
teleprompter 179
telescope 281
television 268
television series 178
television studio 178
temperature 286
temperature gauge 201
temple 14, 300
ten 308
ten thousand 309
tenant 58
tend *v* 91
tendon 17
tennis 230
tennis court 230
tennis shoes 231
tenon saw 81
- tent 267
tent peg 266
tent pole 266
tenth 309
tequila 145
terminal 212
termite 295
terrace café 148
territory 315
test 49, 163
test tube 166
testicle 21
text (SMS) 99
text message 99
textbook 163
Thailand 318
thank you 322
Thanksgiving 27
theater 254, 299
theme park 262
therapist 55
thermal underwear 35
thermals 267
thermometer 45, 167
thermosphere 286
thermostat 61
thesis 169
thick 321
thigh 12, 119
thimble 276
thin 321
third 309
third floor 104
thirteen 308
thirteenth 309
thirtieth 309
thirty 308
this way up 98
this week 307
thistle 297
thoracic vertebrae 17
thread 276
thread *v* 277
thread guide 276
thread reel 276
three 308
three hundred 308
hatchback 200
three-point line 226
thriller 255
throat 19
throttle 204
through 320
throw 237
throw *v* 221, 227, 229
throw-in 223, 226
thruster 281
thumb 15
thumbtack 173
thunder 286
Thursday 306
thyme 133
thyroid gland 18
tibia 17
- ticket 209, 213
ticket gate 209
ticket inspector 209
ticket office 209, 216
tie 32
tiebreaker 230
tie-pin 36
tiger 291
tights 35, 251
tile 58, 272
tile *v* 82
till 106, 150
tiller 240
timber 187
time 234, 304
time out 220
timer 166
times 165, 261
timing 203
tip 36, 122, 246
tissue 108
title 168
titles 23
to 320
to go 154
toad 294
toast 157
toasted sandwich 149
toaster 66
tobacco 112, 184
today 306
toddler 30
toe 15
toe clip 207
toe strap 207
toenail 15
toffee 113
toggle 31
Togo 317
toilet 61, 72
toilet brush 72
toilet paper 72
toilet seat 72
toiletries 41, 107
toilets 104, 266
toll booth 194
tomato 125, 157
tomato juice 144, 149
tomorrow 306
ton 310
toner 41
tongs 150, 167
tongue 19, 37, 118
tonic water 144
tool rack 78
toolbar 177
toolbelt 186
toolbox 80
tools 187
tooth 50
toothache 50
toothbrush 72
toothpaste 72
top coat 83
- top-dress *v* 90
top tier 141
topaz 288
topiary 87
topping 155
topsoil 85
tornado 287
tortoise 293
tossed salad 158
touch line 221
touchdown 221
tour bus 197, 260
tour guide 260
tourer 205
touring bike 206
tourist 260
tourist attraction 260
tourist information 261
tourmaline 288
tournament 233
tow away *v* 195
tow truck 203
toward 320
towel bar 72
towels 73
tower 300
town 298
town hall 299
townhouse 58
toy 75
toy basket 75
toys 105
track 208, 234
track and field 234
tractor 182
traffic 194
traffic jam 195
traffic light 194
traffic police 195
trailer 266
train 35, 208
train *v* 91, 251
train station 208
trainer 37
training wheels 207
tram 196, 208
transfer 223
transformer 60
transmission 202
transplant *v* 91
transportation 194
trapezium 164
trapezius 16
trash 177
travel agent 190, 114
travel brochure 212
travel sickness pills 109
traveler's check 97
tray 152, 154
tray-table 210
tread 207
tread water *v* 239
treadmill 250
treble clef 256

triangle 164, 257
 triceps 16
 trifle 141
 trim *v* 39, 90
 trimester 52
 trimmer 88
 Trinidad and Tobago 314
 tripod 166, 270, 281
 trolley bus 196
 trombone 257
 tropic of Cancer 283
 tropic of Capricorn 283
 tropical fruit 128
 tropics 283
 troposphere 286
 trot 243
 trough 183
 trout 120
 trowel 89, 187
 truck 194
 truck driver 190
 truffle 113, 125
 trumpet 257
 trunk 198, 291, 296
 trunks 238
 try 221
 T-shirt 30, 33
 tub 311
 tuba 257
 tube 311
 Tuesday 306
 tugboat 215
 tulip 111
 tumble 235
 tumble-dryer 76
 tumbler 65
 tuna 120
 tune *v* 179
 tune the radio *v* 269
 tuning peg 258
 Tunisia 317
 turbocharger 203
 turf *v* 90
 Turkey 316
 turkey 119, 185, 293
 Turkmenistan 318
 turmeric 132
 turn 238
 turn *v* 79
 turn off the television *v* 269
 turn on the television *v* 269
 turn signal 198, 204
 turnip 124
 turpentine 83
 turquoise 289
 turret 300
 turtle 293
 tusk 291
 tutu 191
 tweezers 40, 47, 167
 twelfth 309
 twelve 308

twentieth 309
 twenty 308
 twenty minutes 304
 twenty thousand 309
 twenty-first 309
 twenty-one 308
 twenty-second 309
 twenty-third 309
 twenty-two 308
 twig 296
 twin bed 71
 twin room 100
 twine 89
 twins 23
 twist ties 89
 two 308
 two hundred 308
 two o'clock 304
 two thousand 307
 two thousand and one 307
 two-door 200
 types 199, 205
 types of buses 196
 types of cameras 270
 types of farms 183
 types of plants 86
 types of fishing 245
 types of trains 208
 tire 198, 205, 206
 tire iron 207
 tire pressure 203

U
 Uganda 317
 ugly fruit 126
 Ukraine 316
 ulna 17
 ultralight 211
 ultrasound 52
 ultraviolet rays 286
 umbilical cord 52
 umbrella 36, 233
 umbrella stand 59
 umpire 225, 229, 230
 uncle 22
 unconscious 47
 uncooked meat 142
 under 320
 under par 233
 undercoat 83
 underexposed 271
 undergraduate 169
 underpass 194
 underwear 32, 35
 underwired 35
 uniform 94, 189
 United Arab Emirates 318
 United Kingdom 316
 United States of America 314
 universe 280
 university 299

unleaded 199
 unpasteurized 137
 unpick *v* 277
 unsalted 137
 until 320
 up 320
 upset 25
 Uranus 280
 ureter 21
 urethra 20
 urinary 19
 urology 49
 Uruguay 315
 usher 255
 uterus 20, 52
 utility knife 81
 utility room 76
 Uzbekistan 318

V
 vacation 212
 vacuum cleaner 77, 188
 vacuum cup 53
 vacuum flask 267
 vagina 20
 valance 71
 valley 284
 valve 207
 vanilla 132
 Vanuatu 319
 varnish 79, 83
 vas deferens 21
 vase 63, 111
 Vatican City 316
 vault 235, 300
 veal 118
 vegetable garden 85, 182
 vegetable oil 135
 vegetable peeler 68
 vegetables 107, 122, 124
 veggie burger 155
 veil 35
 vein 19
 venetian blind 63
 Venezuela 315
 venison 118
 vent 283
 Venus 280
 verdict 181
 vest 33, 35, 251
 veterinarian 189
 vibraphone 257
 video game 269
 video phone 99
 video tape 269
 Vietnam 318
 viewfinder 271
 village 299
 vine 183
 vinegar 135, 142
 vineyard 183
 vintage 199

viola 256
 violin 256
 virus 44
 visa 213
 vise 78
 vision 51
 visiting hours 48
 visor 205
 vitamins 108
 V-neck 33
 vocal cords 19
 vodka 145
 voice message 99
 volcano 283
 volley 231
 volleyball 227
 voltage 60
 volume 165, 179, 269, 311
 vomit *v* 44

W
 waders 244
 wading pool 263
 waffles 157
 waist 12
 waistband 35
 waistcoat 33
 waiter 148, 152
 waiting room 45
 waitress 191
 wake up *v* 71
 walk 243
 walking boot 37, 267
 walkway 212
 wall 58, 186, 222
 wall light 62
 wallet 37
 wallpaper 82, 177
 wallpaper *v* 82
 wallpaper brush 82
 wallpaper paste 82
 walnut 129
 walnut oil 134
 walrus 290
 ward 48
 wardrobe 70
 warehouse 216
 warm 286
 warm up *v* 251
 warrant 180
 wash *v* 38, 77
 washer 80
 washer fluid 199
 washer fluid reservoir 202
 washing machine 76
 wasp 295
 waste disposal 61, 266
 waste disposal unit 61
 waste pipe 61
 wastebasket 172
 watch 36
 watch television *v* 269

water 144, 238
 water *v* 90, 183
 water bottle 206, 267
 water chamber 61
 water chestnut 124
 water garden 84
 water hazard 232
 water heater 61
 water jet 95
 water plant 86
 water polo 239
 watercolor paints 274
 watercross 123
 waterfall 285
 watering 89
 watering can 89
 watermelon 127
 waterskier 241
 waterskiing 241
 watersports 241
 wave 241, 264
 wavelength 179
 wax 41
 weak 321
 weather 286
 weaving 277
 website 177
 wedding 26, 35
 wedding cake 141
 wedding dress 35
 wedding reception 26
 wedge 37, 233
 Wednesday 306
 weed *v* 91
 weedkiller 91
 weeds 86
 week 306
 weekend 306
 weekly 307
 weigh *v* 310
 weight 166, 244
 weight bar 251
 weight belt 239
 weight training 251
 wellington boots 31
 west 312
 western 255
 Western Sahara 317
 wet 286, 321
 wet wipe 75, 108
 wetsuit 239
 whale 290
 wheat 130, 184
 wheel 198, 207
 wheel nuts 203
 wheelbarrow 88
 wheelchair 48
 wheelchair access 197
 whetstone 81
 whiplash 46
 whipped cream 137
 whisk 68
 whisk *v* 67
 whiskers 290

- whiskey 145
 white 39, 145, 272, 274
 white bread 139
 white chocolate 113
 white coffee 148
 white currant 127
 white flour 138
 white meat 118
 white rice 130
 whiting 120
 whole 129, 132
 whole milk 136
 whole-grain 131
 whole-grain mustard 135
 whole-wheat bread 139
 whole-wheat flour 138
 wicket 225
 wide 321
 width 165
 wife 22
 Wifi 269
 wig 39
 wild rice 130
 willow 296
 win v 273
 wind 241, 286
 windbreak 265
 windlass 214
 window 58, 96, 98, 177,
 186, 197, 209, 210
 windpipe 18
 windshield 198, 205
 windshield wiper 198
 windsurfer 241
 windsurfing 241
 windy 286
 wine 145, 151
 wine glass 65
 wine list 152
 wine vinegar 135
 wing 119, 210, 293
 wings 254
 winner 273
 winter 31, 307
 winter sports 247
 wipe v 77
 wire 79
 wire cutter 80
 wire strippers 81
 wires 60
 with 320
 withdrawal slip 96
 without 320
 witness 180
 wok 69
 wolf 290
 woman 23
 womb 52
 women's clothing 34,
 105
 wood 79, 233, 275, 285
 wood glue 78
 wood shavings 78
 wood stain 79
 wooden spoon 68
 woodpecker 292
 woodwind 257
 woodworking 275
 wool 277
 work 172
 work day 306
 workbench 78
 workshop 78
 world map 312
 worm 295
 worried 25
 wound 46
 wrap 155
 wrapping 111
 wreath 111
 wrench 80, 81, 203
 wrestling 236
 wrinkle 15
 wrist 13, 15
 wristband 230
 writ 180
 write v 162

X
 X-ray 48
 X-ray film 50
 X-ray machine 212
 X-ray viewer 45

Y
 yacht 215, 240
 yam 125
 yard 310
 yawn v 25
 year 163, 306
 yeast 138
 yellow 274
 yellow card 223
 Yemen 318
 yes 322
 yesterday 306
 yoga 54
 yogurt 137
 yolk 137, 157
 you're welcome 322
 Yugoslavia 316

Z
 Zambia 317
 zebra 291
 zero 308
 zest 126
 Zimbabwe 317
 zinc 289
 zip 277
 ZIP code 98
 zone 315
 zones 283
 zoo 262
 zoology 169
 zoom lens 270
 zucchini 125

remerciements • acknowledgments

DORLING KINDERSLEY would like to thank Tracey Miles and Christine Lacey for design assistance, Georgina Garner for editorial and administrative help, Sonia Gavira, Polly Boyd, and Cathy Meeus for editorial help, and Claire Bowers for compiling the DK picture credits.

The publisher would like to thank the following for their kind permission to reproduce their photographs:

Abbreviations key: a-above; b-below/bottom; c-center; f-far; l-left; r-right; t-top)

I23RF.com: Andriy Popov 34tl; Daniel Ernst 179cr; Hongqi Zhang 24cla. 175cr; Ingvar Bjork 60c; Kobby Dagan 259c; leonardo255 269c; Liubov Vadimovna (Luba) Nel 39cla; Ljupco Smokovski 75crb; Oleksandr Marynchenko 60bl; Olga Popova 33c; oneblink 49bc; Racorn 162tl; Robert Churchill 94c; Roman Gorielov 33bc; Ruslan Kudrin 35bc, 35br; Subbotina 39cra; Sutichak Yachaingkhom 39ctc; Tarzhanova 37ct; Vitaly Valua 39tl; Wavebreak Media Ltd 188bl; Wilawan Khasawong 75cb;

Action Plus: 224bc; **Alamy Images:** 154t; A.T. Willett 287bcl; Alex Segre 105ca, 105cb, 195cd; Ambrophoto 24cra; Blend Images 168cr; Cultura RM 33r; Doug Houghton 107fbr; Ekkapon Sriharun 172bl; Hugh Threlfall 35tl; 176tr; Ian Allenden 48br; Ian Dagnall (iPod is a trademark of Apple Inc., registered in the U.S. and other countries) 268tc, 270t; Ievgen Chepil 250bc; imagebroker 199tl, 249c; Keith Morris 178c; Martyn Evans 210b; MBI 175tl; Michael Burrell 213cra; Michael Foyle 184bl; Oleksiy Maksymenko 105tc; Paul Weston 168br; Prisma Bildagentur AG 246b; Radharc Images 197tr; RBtravel 112tl; Ruslan Kudrin 176tl; Sasa Huzjak 258t; Sergey Kravchenko 37ca; Sergio Azenha 270bc; Stanca Sanda (iPad is a trademark of Apple Inc., registered in the U.S. and other countries) 176bc; Stock Connection 287bcr; tarczas 35cr; vityal suprun 176cl; Wavebreak Media Ltd 39cl, 174b, 175tr; **Allsport/Getty Images:** 238cl; **Alvey and Towers:** 209 acr, 215bcl, 215bcr, 241cr; **Peter Anderson:** 188cbr, 271br.

Anthony Blake Photo Library: Charlie Stebbings 114cl; John Sims 114tcl; **Andyalt:** 98tl; **apple mac computers:** 268tr; **Arcaid:** John Edward Linden 301bl; Martine Hamilton Knight, Architects: Chapman Taylor Partners, 213cl; Richard Bryant 301br; **Argos:** 41tcl, 66cbl, 66cl, 66br, 66bcl, 69cl, 70bcl, 71t, 77tl, 269tc, 270tl; **Axiom:** Eitan Simanon 105bcr; Ian Cumming 104; Vicki Couchman 148cr; **Beken Of Cowes Ltd:** 215cb; **Bosch:** 76ctr, 76tc, 76tcl; **Camera Press:** 38tr, 256t, 257cr; Barry J. Holmes 148tr; Jane Hanger 159cr; Mary Germanou 259bc; **Corbis:** 78b; Anna Clopet 247tr; Ariel Skelley / Blend Images 52l; Bettmann 181tl, 181tr; Blue Jean Images 48bl; Bo Zauders 156t; Bob Rowan 152bl; Bob Winsett 247cbl; Brian Bailey 247br; Carl and Ann Purcell 162l; Chris Rainer 247ct; Craig Aurness 215bl; David H.Wells 249cbr; Dennis Marsico

274bl; Dimitri Lundt 236bc; Duomo 211tl; Gail Mooney 277ctr; George Lepp 248c; Gerald Nowak 239b; Gunter Marx 248cr; Jack Hollingsworth 231bl; Jacqui Hurst 277cbr; James L. Amos 247bl, 191cr, 220bcr; Jan Butchofsky 277cb; Johnathan Blair 243cr; Jose F. Poblete 191br; Jose Luis Pelaez.Inc 153tc; Karl Weatherly 220bl, 247tr; Kelly Mooney Photography 259tl; Kevin Fleming 249bc; Kevin R. Morris 105tr, 243tl, 243tc; Kim Sayer 249tr; Lynn Goldsmith 258t; Macduff Everton 231bcl; Mark Gibson 249bl; Mark L. Stephenson 249ct; Michael Pole 115tr; Michael S. Yamashita 247ctcl; Mike King 247cbl; Neil Rabinowitz 214br; Pablo Corral 115bc; Paul A. Sounders 169br, 249ctcl; Paul J. Sutton 224c, 224br; Phil Schermeister 227b, 248tr; R. W Jones 309; Richard Morrell 189bc; Rick Doyle 241cr; Robert Holmes 97br, 277ct; Roger Ressmeyer 169tr; Russ Schleipman 229; The Purcell Team 211ct; Vince Streato 194t; Wally McNamee 220br, 220bcl, 224bl; Wavebreak Media LTD 191bc; Yann Arhus-Bertrand 249tl; **Demetrio Carrasco / Dorling Kindersley (c) Herge / Les Editions Casterman:** 112ccl; **Dorling Kindersley:** Banbury Museum 35c; Five Napkin Burger 152t; **Dixons:** 270cl, 270cr, 270bl, 270bcl, 270bcr, 270ccr; **Dreamstime.com:** Alexander Podshivalov 179tr, 191cr; Alexxl66 268tl; Andersastphoto 176tc; Andrey Popov 191bl; Arne9001 190tl; Chaos 26c; Designstock 269cl; Monkey Business Images 26clb; Paul Michael Hughes 162tr; Serghei Starus 190bc; **Education Photos:** John Walmsley 26tl; **Empics Ltd:** Adam Day 236br; Andy Heading 243c; Steve White 249cbr; **Getty Images:** 48bcl, 100t, 114bcr, 154bl, 287tr; 94tr; Don Farrall / Digital Vision 176c; Ethan Miller 270bl; Inti St Clair 179bl; Liam Norris 188br; Sean Justice / Digital Vision 24br; **Dennis Gilbert:** 106tc; **Hulsta:** 70t; **Ideal Standard Ltd:** 72r; **The Image Bank/Getty Images:** 58; **Impact Photos:** Eliza Armstrong 115cr; Philip Achache 246t; **The Interior Archive:** Henry Wilson, Alfie's Market 114bl; Luke White, Architect: David Mikhail, 59tl; Simon Upton, Architect: Philippe Starck, St Martins Lane Hotel 100bcr, 100br; **iStockphoto.com:** asterix0597 163tl; EdStock 190br; RichLegg 26bc; SorinVidis 27cr; **Jason Hawkes Aerial Photography:** 216t; **Dan Johnson:** 35r; **Kos Pictures Source:** 215cbl, 240tc, 240tr; David Williams 216b; **Lebrecht Collection:** Kate Mount 169bc; **MP Visual.com:** Mark Swallow 202t; **NASA:** 280cr, 280ccl, 281tl; **P&O Princess Cruises:** 214bl; **P A Photos:** 181br; **The Photographers' Library:** 186bl, 186bc, 186t; **Plain and Simple Kitchens:** 66t; **Powerstock Photolibrary:** 169tl, 256t, 287tc; **PunchStock:** Image Source 195tr; **Rail Images:** 208c, 208 cbl, 209br; **Red Consultancy:** Odeon cinemas 257br; **Redferns:** 259br; Nigel Crane 259c; **Redx**

Features: 106br, 259tc, 259tr, 259bl, 280b; Charles Ommaney 1144cr; J.F.F Whitehead 243cl; Patrick Barth 101tl; Patrick Frilet 189cbl; Scott Wiseman 287bl; **Royalty Free Images:** Getty Images/Eyewire 154bl; **Science & Society Picture Library:** Science Museum 202b; **Science Photo Library:** IBM Research 190cla; NASA 281cr; **SuperStock:** Ingram Publishing 62; Juanma Aparicio / age fotostock 172t; Nordic Photos 269tl; **Skyscan:** 168t, 182c, 298; Quick UK Ltd 212; **Sony:** 268bc; **Robert Streeter:** 154br; **Neil Sutherland:** 82tr, 83tl, 90t, 118, 188ctr, 196t, 196tr, 299cl, 299bl; **The Travel Library:** Stuart Black 264t; **Travelex:** 97cl; **Vauxhall:** Technik 198t, 199tl, 199tr, 199cl, 199cr, 199ctcl, 199ctcr, 199ctcl, 199tr, 200; **View Pictures:** Dennis Gilbert, Architects: ACDP Consulting, 106t; Dennis Gilbert, Chris Wilkinson Architects, 209tr; Peter Cook, Architects: Nicholas Crimshaw and partners, 208t; **Betty Walton:** 185br; **Colin Walton:** 2, 4, 7, 9, 10, 28, 42, 56, 92, 95c, 99tl, 99ctcl, 102, 116, 120t, 138t, 146, 150t, 160, 170, 191ctcl, 192, 218, 252, 260br, 260l, 261tr, 261c, 261cr, 271cbl, 271cbr, 271ctcl, 278, 287br, 302, 401.

DK PICTURE LIBRARY:

Akhil Bahkshi; Patrick Baldwin; Geoff Brightling; British Museum; John Bulmer; Andrew Butler; Joe Cornish; Brian Cosgrove; Andy Crawford and Kit Houghton; Philip Dowell; Alistair Duncan; Gables; Bob Gathany; Norman Hollands; Kew Gardens; Peter James Kindersley; Vladimir Koziik; Sam Lloyd; London Northern Bus Company Ltd; Tracy Morgan; David Murray and Jules Selmes; Musée Vivant du Cheval, France; Museum of Broadcast Communications; Museum of Natural History; NASA; National History Museum; Norfolk Rural Life Museum; Stephen Oliver; RNLi; Royal Ballet School; Guy Ryeac; Science Museum; Neil Setchfield; Ross Simms and the Winchcombe Folk Police Museum; Singapore Symphony Orchestra; Smart Museum of Art; Tony Souter; Erik Svensson and Jeppe Wikstrom; Sam Tree of Keygrove Marketing Ltd; Barrie Watts; Alan Williams; Jerry Young.

Additional Photography by Colin Walton.

Colin Walton would like to thank:

A&A News, Uckfield; Abbey Music, Tunbridge Wells; Arena Mens Clothing, Tunbridge Wells; Burrells of Tunbridge Wells; Gary at Di Marco's; Jeremy's Home Store, Tunbridge Wells; Noakes of Tunbridge Wells; Ottakar's, Tunbridge Wells; Selby's of Uckfield; Sevenoaks Sound and Vision; Westfield, Royal Victoria Place, Tunbridge Wells.

All other images © Dorling Kindersley
For further information see: www.dkimages.com