

1SDC010001D0202



ABB SACE



# Electrical installation handbook

Volume 2

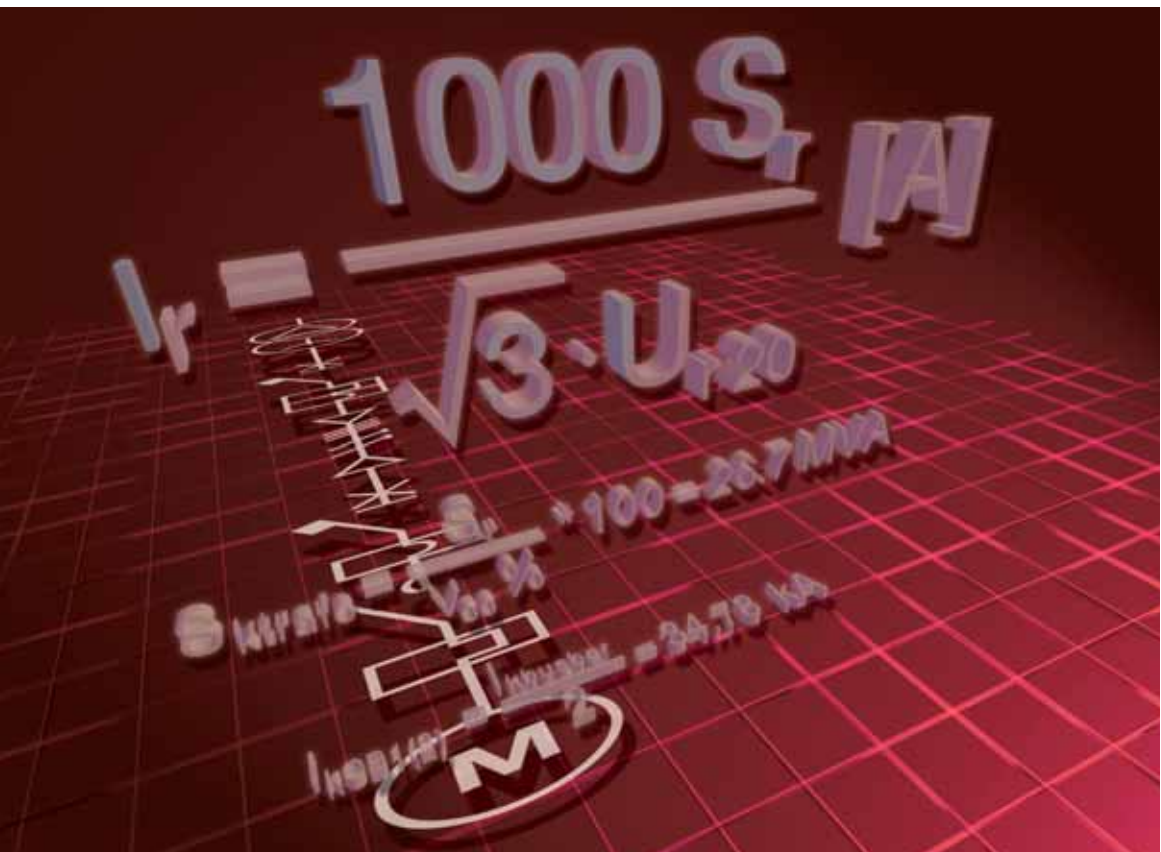
## Electrical devices

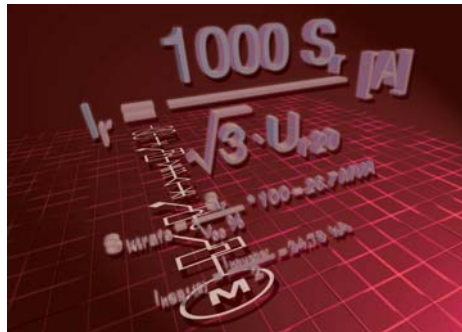

2<sup>nd</sup> edition  
February 2004

First edition 2003  
Second edition 2004

*Published by ABB SACE*  
*via Baioni, 35 - 24123 Bergamo (Italy)*

All rights reserved

---

# Index

<b>Introduction</b> .....	2
<b>1 Standards</b>	
1.1 General aspects .....	3
1.2 IEC Standards for electrical installation .....	15
<b>2 Protection of feeders</b>	
2.1 Introduction .....	22
2.2 Installation and dimensioning of cables .....	25
2.2.1 Current carrying capacity and methods of installation .....	25
Installation not buried in the ground .....	31
Installation in ground .....	44
2.2.2 Voltage drop .....	56
2.2.3 Joule-effect losses .....	66
2.3 Protection against overload .....	67
2.4 Protection against short-circuit .....	70
2.5 Neutral and protective conductors .....	78
2.6 Busbar trunking systems .....	86
<b>3 Protection of electrical equipment</b>	
3.1 Protection and switching of lighting circuits .....	101
3.2 Protection and switching of generators .....	110
3.3 Protection and switching of motors .....	115
3.4 Protection and switching of transformers .....	131
<b>4 Power factor correction</b>	
4.1 General aspects .....	146
4.2 Power factor correction method .....	152
4.3 Circuit-breakers for the protection and switching of capacitor banks .....	159
<b>5 Protection of human beings</b>	
5.1 General aspects: effects of current on human beings .....	162
5.2 Distribution systems .....	165
5.3 Protection against both direct and indirect contact .....	168
5.4 TT system .....	171
5.5 TN system .....	174
5.6 IT system .....	177
5.7 Residual current devices .....	179
5.8 Maximum protected length for the protection of human beings ...	182
<b>Annex A: Calculation tools</b>	
A.1 Slide rules .....	200
A.2 DOCWin .....	209
<b>Annex B: Calculation of load current <math>I_b</math></b> .....	209
<b>Annex C: Calculation of short-circuit current</b> .....	213
<b>Annex D: Calculation of the coefficient <math>k</math> for the cables</b> .....	227
<b>Annex E: Main physical quantities and     electrotechnical formulas</b> .....	230

---

## Introduction

### Scope and objectives

The scope of this electrical installation handbook is to provide the designer and user of electrical plants with a quick reference, immediate-use working tool. This is not intended to be a theoretical document, nor a technical catalogue, but, in addition to the latter, aims to be of help in the correct definition of equipment, in numerous practical installation situations.

The dimensioning of an electrical plant requires knowledge of different factors relating to, for example, installation utilities, the electrical conductors and other components; this knowledge leads the design engineer to consult numerous documents and technical catalogues. This electrical installation handbook, however, aims to supply, in a single document, tables for the quick definition of the main parameters of the components of an electrical plant and for the selection of the protection devices for a wide range of installations. Some application examples are included to aid comprehension of the selection tables.

### Electrical installation handbook users

The electrical installation handbook is a tool which is suitable for all those who are interested in electrical plants: useful for installers and maintenance technicians through brief yet important electrotechnical references, and for sales engineers through quick reference selection tables.

### Validity of the electrical installation handbook

Some tables show approximate values due to the generalization of the selection process, for example those regarding the constructional characteristics of electrical machinery. In every case, where possible, correction factors are given for actual conditions which may differ from the assumed ones. The tables are always drawn up conservatively, in favour of safety; for more accurate calculations, the use of DOCWin software is recommended for the dimensioning of electrical installations.

---

## 1 Standards

### 1.1 General aspects

In each technical field, and in particular in the electrical sector, a condition sufficient (even if not necessary) for the realization of plants according to the **“status of the art”** and a requirement essential to properly meet the demands of customers and of the community, is the respect of all the relevant laws and technical standards.

Therefore, a precise knowledge of the standards is the fundamental premise for a correct approach to the problems of the electrical plants which shall be designed in order to guarantee that **“acceptable safety level”** which is never absolute.

#### *Juridical Standards*

These are all the standards from which derive rules of behavior for the juridical persons who are under the sovereignty of that State.

#### *Technical Standards*

These standards are the whole of the prescriptions on the basis of which machines, apparatus, materials and the installations should be designed, manufactured and tested so that efficiency and function safety are ensured.

The technical standards, published by national and international bodies, are circumstantially drawn up and can have legal force when this is attributed by a legislative measure.

	Application fields		
	Electrotechnics and Electronics	Telecommunications	Mechanics, Ergonomics and Safety
International Body	IEC	ITU	ISO
European Body	CENELEC	ETSI	CEN

This technical collection takes into consideration only the bodies dealing with electrical and electronic technologies.

### IEC International Electrotechnical Commission

The *International Electrotechnical Commission* (IEC) was officially founded in 1906, with the aim of securing the international co-operation as regards standardization and certification in electrical and electronic technologies. This association is formed by the International Committees of over 40 countries all over the world.

The IEC publishes international standards, technical guides and reports which are the bases or, in any case, a reference of utmost importance for any national and European standardization activity.

IEC Standards are generally issued in two languages: English and French.

In 1991 the IEC has ratified co-operation agreements with CENELEC (European standardization body), for a common planning of new standardization activities and for parallel voting on standard drafts.

# 1 Standards

## CENELEC European Committee for Electrotechnical Standardization

The *European Committee for Electrotechnical Standardization* (CENELEC) was set up in 1973. Presently it comprises 27 countries (Austria, Belgium, Czech Republic, Denmark, Estonia, Finland, France, Germany, Greece, Hungary, Iceland, Ireland, Italy, Latvia, Lithuania, Luxembourg, Malta, Netherlands, Norway, Portugal, Poland, Slovakia, Slovenia, Spain, Sweden, Switzerland, United Kingdom) and cooperates with 8 affiliates (Albania, Bosnia and Herzegovina, Bulgaria, Croatia, Cyprus, Romania, Turkey, Ukraine) which have first maintained the national documents side by side with the CENELEC ones and then replaced them with the Harmonized Documents (HD). CENELEC hopes and expects Cyprus to become the 28<sup>th</sup> members before May 2004.

There is a difference between EN Standards and Harmonization Documents (HD): while the first ones have to be accepted at any level and without additions or modifications in the different countries, the second ones can be amended to meet particular national requirements.

EN Standards are generally issued in three languages: English, French and German.

From 1991 CENELEC cooperates with the IEC to accelerate the standards preparation process of International Standards.

CENELEC deals with specific subjects, for which standardization is urgently required.

When the study of a specific subject has already been started by the IEC, the European standardization body (CENELEC) can decide to accept or, whenever necessary, to amend the works already approved by the International standardization body.

## EC DIRECTIVES FOR ELECTRICAL EQUIPMENT

Among its institutional roles, the European Community has the task of promulgating directives which must be adopted by the different member states and then transposed into national law.

Once adopted, these directives come into juridical force and become a reference for manufacturers, installers, and dealers who must fulfill the duties prescribed by law.

Directives are based on the following principles:

- harmonization is limited to essential requirements;
- only the products which comply with the essential requirements specified by the directives can be marketed and put into service;
- the harmonized standards, whose reference numbers are published in the Official Journal of the European Communities and which are transposed into the national standards, are considered in compliance with the essential requirements;
- the applicability of the harmonized standards or of other technical specifications is facultative and manufacturers are free to choose other technical solutions which ensure compliance with the essential requirements;
- a manufacturer can choose among the different conformity evaluation procedure provided by the applicable directive.

The scope of each directive is to make manufacturers take all the necessary steps and measures so that the product does not affect the safety and health of persons, animals and property.

# 1 Standards

## “Low Voltage” Directive 73/23/CEE – 93/68/CEE

The Low Voltage Directive refers to any electrical equipment designed for use at a rated voltage from 50 to 1000 V for alternating current and from 75 to 1500 V for direct current.

In particular, it is applicable to any apparatus used for production, conversion, transmission, distribution and use of electrical power, such as machines, transformers, devices, measuring instruments, protection devices and wiring materials.

The following categories are outside the scope of this Directive:

- electrical equipment for use in an explosive atmosphere;
- electrical equipment for radiology and medical purposes;
- electrical parts for goods and passenger lifts;
- electrical energy meters;
- plugs and socket outlets for domestic use;
- electric fence controllers;
- radio-electrical interference;
- specialized electrical equipment, for use on ships, aircraft or railways, which complies with the safety provisions drawn up by international bodies in which the Member States participate.

## Directive EMC 89/336/EEC (“Electromagnetic Compatibility”)

The Directive on electromagnetic compatibility regards all the electrical and electronic apparatus as well as systems and installations containing electrical and/or electronic components. In particular, the apparatus covered by this Directive are divided into the following categories according to their characteristics:

- domestic radio and TV receivers;
- industrial manufacturing equipment;
- mobile radio equipment;
- mobile radio and commercial radio telephone equipment;
- medical and scientific apparatus;
- information technology equipment (ITE);
- domestic appliances and household electronic equipment;
- aeronautical and marine radio apparatus;
- educational electronic equipment;
- telecommunications networks and apparatus;
- radio and television broadcast transmitters;
- lights and fluorescent lamps.

The apparatus shall be so constructed that:

- a) the electromagnetic disturbance it generates does not exceed a level allowing radio and telecommunications equipment and other apparatus to operate as intended;
- b) the apparatus has an adequate level of intrinsic immunity to electromagnetic disturbance to enable it to operate as intended.

An apparatus is declared in conformity to the provisions at points a) and b) when the apparatus complies with the harmonized standards relevant to its product family or, in case there aren't any, with the general standards.

# 1 Standards

## CE conformity marking

The CE conformity marking shall indicate conformity to all the obligations imposed on the manufacturer, as regards his products, by virtue of the European Community directives providing for the affixing of the CE marking.



When the CE marking is affixed on a product, it represents a declaration of the manufacturer or of his authorized representative that the product in question conforms to all the applicable provisions including the conformity assessment procedures. This prevents the Member States from limiting the marketing and putting into service of products bearing the CE marking, unless this measure is justified by the proved non-conformity of the product.

Flow diagram for the conformity assessment procedures established by the Directive 73/23/EEC on electrical equipment designed for use within particular voltage range:

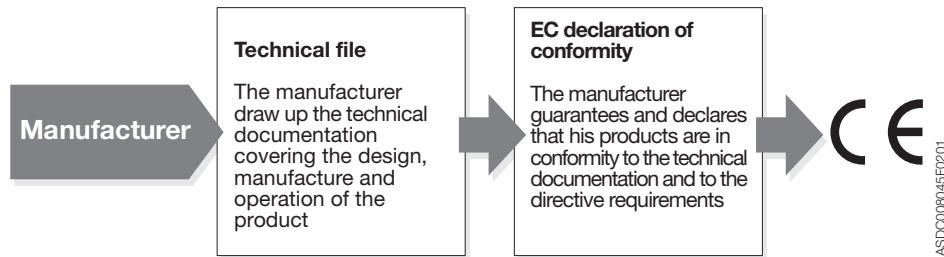

## Naval type approval

The environmental conditions which characterize the use of circuit breakers for on-board installations can be different from the service conditions in standard industrial environments; as a matter of fact, marine applications can require installation under particular conditions, such as:

- environments characterized by high temperature and humidity, including salt-mist atmosphere (damp-heat, salt-mist environment);
- on board environments (engine room) where the apparatus operate in the presence of vibrations characterized by considerable amplitude and duration.

In order to ensure the proper function in such environments, the shipping registers require that the apparatus has to be tested according to specific type approval tests, the most significant of which are vibration, dynamic inclination, humidity and dry-heat tests.

# 1 Standards

ABB SACE circuit-breakers (Isomax-Tmax-Emax) are approved by the following shipping registers:

• <b>RINA</b>	Registro Italiano Navale	Italian shipping register
• <b>DNV</b>	Det Norske Veritas	Norwegian shipping register
• <b>BV</b>	Bureau Veritas	French shipping register
• <b>GL</b>	Germanischer Lloyd	German shipping register
• <b>LRs</b>	Lloyd's Register of Shipping	British shipping register
• <b>ABS</b>	American Bureau of Shipping	American shipping register









It is always advisable to ask ABB SACE as regards the typologies and the performances of the certified circuit-breakers or to consult the section certificates in the website <http://bol.it.abb.com>.

## Marks of conformity to the relevant national and international Standards









The international and national marks of conformity are reported in the following table, for information only:

COUNTRY	Symbol	Mark designation	Applicability/Organization
EUROPE		-	Mark of compliance with the harmonized European standards listed in the ENEC Agreement.
AUSTRALIA		AS Mark	Electrical and non-electrical products. It guarantees compliance with SAA (Standard Association of Australia).
AUSTRALIA		S.A.A. Mark	Standards Association of Australia (S.A.A.). The Electricity Authority of New South Wales Sydney Australia
AUSTRIA		Austrian Test Mark	Installation equipment and materials

## 1 Standards









COUNTRY	Symbol	Mark designation	Applicability/Organization
AUSTRIA		ÖVE Identification Thread	Cables
BELGIUM		CEBEC Mark	Installation materials and electrical appliances
BELGIUM		CEBEC Mark	Conduits and ducts, conductors and flexible cords
BELGIUM		Certification of Conformity	Installation material and electrical appliances (in case there are no equivalent national standards or criteria)
CANADA		CSA Mark	Electrical and non-electrical products. This mark guarantees compliance with CSA (Canadian Standard Association)
CHINA		CCEE Mark	Great Wall Mark Commission for Certification of Electrical Equipment
Czech Republic		EZU' Mark	Electrotechnical Testing Institute
Slovakia Republic		EVPU' Mark	Electrotechnical Research and Design Institute

## 1 Standards









COUNTRY	Symbol	Mark designation	Applicability/Organization
CROATIA		KONKAR	Electrical Engineering Institute
DENMARK		DEMKO Approval Mark	Low voltage materials. This mark guarantees the compliance of the product with the requirements (safety) of the "Heavy Current Regulations"
FINLAND		Safety Mark of the Elektriska Inspektoratet	Low voltage material. This mark guarantees the compliance of the product with the requirements (safety) of the "Heavy Current Regulations"
FRANCE		ESC Mark	Household appliances
FRANCE		NF Mark	Conductors and cables – Conduits and ducting – Installation materials
FRANCE		NF Identification Thread	Cables
FRANCE		NF Mark	Portable motor-operated tools
FRANCE		NF Mark	Household appliances









## 1 Standards

COUNTRY	Symbol	Mark designation	Applicability/Organization
GERMANY		VDE Mark	For appliances and technical equipment, installation accessories such as plugs, sockets, fuses, wires and cables, as well as other components (capacitors, earthing systems, lamp holders and electronic devices)
GERMANY		VDE Identification Thread	Cables and cords
GERMANY		VDE Cable Mark	For cables, insulated cords, installation conduits and ducts
GERMANY		VDE-GS Mark for technical equipment	Safety mark for technical equipment to be affixed after the product has been tested and certified by the VDE Test Laboratory in Offenbach; the conformity mark is the mark VDE, which is granted both to be used alone as well as in combination with the mark GS
HUNGARY		MEEI	Hungarian Institute for Testing and Certification of Electrical Equipment
JAPAN		JIS Mark	Mark which guarantees compliance with the relevant Japanese Industrial Standard(s).
IRELAND		IIRS Mark	Electrical equipment
IRELAND		IIRS Mark	Electrical equipment



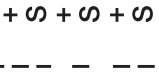





## 1 Standards

COUNTRY	Symbol	Mark designation	Applicability/Organization
ITALY		IMQ Mark	Mark to be affixed on electrical material for non-skilled users; it certifies compliance with the European Standard(s).
NORWAY		Norwegian Approval Mark	Mandatory safety approval for low voltage material and equipment
NETHERLANDS		KEMA-KEUR	General for all equipment
POLAND		KWE	Electrical products
RUSSIA		Certification of Conformity	Electrical and non-electrical products. It guarantees compliance with national standard (Gosstandard of Russia)
SINGAPORE		SISIR	Electrical and non-electrical products
SLOVENIA		SIQ	Slovenian Institute of Quality and Metrology
SPAIN		AEE	Electrical products. The mark is under the control of the Asociación Electrotécnica Española (Spanish Electrotechnical Association)



## 1 Standards

COUNTRY	Symbol	Mark designation	Applicability/Organization
SPAIN		AENOR	Asociación Española de Normalización y Certificación. (Spanish Standardization and Certification Association)
SWEDEN		SEMKO Mark	Mandatory safety approval for low voltage material and equipment.
SWITZERLAND	 * PZ 1	Safety Mark	Swiss low voltage material subject to mandatory approval (safety).
SWITZERLAND	 -----	-	Cables subject to mandatory approval
SWITZERLAND		SEV Safety Mark	Low voltage material subject to mandatory approval
UNITED KINGDOM		ASTA Mark	Mark which guarantees compliance with the relevant "British Standards"
UNITED KINGDOM		BASEC Mark	Mark which guarantees compliance with the "British Standards" for conductors, cables and ancillary products.
UNITED KINGDOM		BASEC Identification Thread	Cables

## 1 Standards

COUNTRY	Symbol	Mark designation	Applicability/Organization
UNITED KINGDOM		BEAB Safety Mark	Compliance with the "British Standards" for household appliances
UNITED KINGDOM		BSI Safety Mark	Compliance with the "British Standards"
UNITED KINGDOM		BEAB Kitemark	Compliance with the relevant "British Standards" regarding safety and performances
U.S.A.		UNDERWRITERS LABORATORIES Mark	Electrical and non-electrical products
U.S.A.		UNDERWRITERS LABORATORIES Mark	Electrical and non-electrical products
U.S.A.		UL Recognition	Electrical and non-electrical products
CEN		CEN Mark	Mark issued by the European Committee for Standardization (CEN): it guarantees compliance with the European Standards.
CENELEC		Mark	Cables

## 1 Standards

COUNTRY	Symbol	Mark designation	Applicability/Organization
CENELEC		Harmonization Mark	Certification mark providing assurance that the harmonized cable complies with the relevant harmonized CENELEC Standards – identification thread
EC		Ex EUROPEA Mark	Mark assuring the compliance with the relevant European Standards of the products to be used in environments with explosion hazards
CEEel		CEEel Mark	Mark which is applicable to some household appliances (shavers, electric clocks, etc).

### EC - Declaration of Conformity

The EC Declaration of Conformity is the statement of the manufacturer, who declares under his own responsibility that all the equipment, procedures or services refer and comply with specific standards (directives) or other normative documents.

The EC Declaration of Conformity should contain the following information:

- name and address of the manufacturer or by its European representative;
- description of the product;
- reference to the harmonized standards and directives involved;
- any reference to the technical specifications of conformity;
- the two last digits of the year of affixing of the CE marking;
- identification of the signer.

A copy of the EC Declaration of Conformity shall be kept by the manufacturer or by his representative together with the technical documentation.

## 1 Standards

### 1.2 IEC Standards for electrical installation

STANDARD	YEAR	TITLE
IEC 60027-1	1992	Letter symbols to be used in electrical technology - Part 1: General
IEC 60034-1	1999	Rotating electrical machines - Part 1: Rating and performance
IEC 60617-DB-12M	2001	Graphical symbols for diagrams - 12-month subscription to online database comprising parts 2 to 11 of IEC 60617
IEC 61082-1	1991	Preparation of documents used in electrotechnology - Part 1: General requirements
IEC 61082-2	1993	Preparation of documents used in electrotechnology - Part 2: Function-oriented diagrams
IEC 61082-3	1993	Preparation of documents used in electrotechnology - Part 3: Connection diagrams, tables and lists
IEC 61082-4	1996	Preparation of documents used in electrotechnology - Part 4: Location and installation documents
IEC 60038	1983	IEC standard voltages
IEC 60664-1	2000	Insulation coordination for equipment within low-voltage systems - Part 1: Principles, requirements and tests
IEC 60909-0	2001	Short-circuit currents in three-phase a.c. systems - Part 0: Calculation of currents
IEC 60865-1	1993	Short-circuit currents - Calculation of effects - Part 1: Definitions and calculation methods
IEC 60781	1989	Application guide for calculation of short-circuit currents in low-voltage radial systems
IEC 60076-1	2000	Power transformers - Part 1: General
IEC 60076-2	1993	Power transformers - Part 2: Temperature rise
IEC 60076-3	2000	Power transformers - Part 3: Insulation levels, dielectric tests and external clearances in air
IEC 60076-5	2000	Power transformers - Part 5: Ability to withstand short circuit
IEC/TR 60616	1978	Terminal and tapping markings for power transformers
IEC 60726	1982	Dry-type power transformers
IEC 60445	1999	Basic and safety principles for man-machine interface, marking and identification - Identification of equipment terminals and of terminations of certain designated conductors, including general rules for an alphanumeric system

## 1 Standards

STANDARD	YEAR	TITLE
IEC 60073	1996	Basic and safety principles for man-machine interface, marking and identification – Coding for indication devices and actuators
IEC 60446	1999	Basic and safety principles for man-machine interface, marking and identification - Identification of conductors by colours or numerals
IEC 60447	1993	Man-machine-interface (MMI) - Actuating principles
IEC 60947-1	2001	Low-voltage switchgear and controlgear - Part 1: General rules
IEC 60947-2	2001	Low-voltage switchgear and controlgear - Part 2: Circuit-breakers
IEC 60947-3	2001	Low-voltage switchgear and controlgear - Part 3: Switches, disconnectors, switch-disconnectors and fuse-combination units
IEC 60947-4-1	2000	Low-voltage switchgear and controlgear - Part 4-1: Contactors and motor-starters – Electromechanical contactors and motor-starters
IEC 60947-4-2	2002	Low-voltage switchgear and controlgear - Part 4-2: Contactors and motor-starters – AC semiconductor motor controllers and starters
IEC 60947-4-3	1999	Low-voltage switchgear and controlgear - Part 4-3: Contactors and motor-starters – AC semiconductor controllers and contactors for non-motor loads
IEC 60947-5-1	2000	Low-voltage switchgear and controlgear - Part 5-1: Control circuit devices and switching elements - Electromechanical control circuit devices
IEC 60947-5-2	1999	Low-voltage switchgear and controlgear - Part 5-2: Control circuit devices and switching elements – Proximity switches
IEC 60947-5-3	1999	Low-voltage switchgear and controlgear - Part 5-3: Control circuit devices and switching elements – Requirements for proximity devices with defined behaviour under fault conditions
IEC 60947-5-4	1996	Low-voltage switchgear and controlgear - Part 5: Control circuit devices and switching elements – Section 4: Method of assessing the performance of low energy contacts. Special tests
IEC 60947-5-5	1997	Low-voltage switchgear and controlgear - Part 5-5: Control circuit devices and switching elements - Electrical emergency stop device with mechanical latching function

## 1 Standards

STANDARD	YEAR	TITLE
IEC 60947-5-6	1999	Low-voltage switchgear and controlgear - Part 5-6: Control circuit devices and switching elements – DC interface for proximity sensors and switching amplifiers (NAMUR)
IEC 60947-6-1	1998	Low-voltage switchgear and controlgear - Part 6-1: Multiple function equipment – Automatic transfer switching equipment
IEC 60947-6-2	1999	Low-voltage switchgear and controlgear - Part 6-2: Multiple function equipment - Control and protective switching devices (or equipment) (CPS)
IEC 60947-7-1	1999	Low-voltage switchgear and controlgear - Part 7: Ancillary equipment - Section 1: Terminal blocks
IEC 60947-7-2	1995	Low-voltage switchgear and controlgear - Part 7: Ancillary equipment - Section 2: Protective conductor terminal blocks for copper conductors
IEC 60439-1	1999	Low-voltage switchgear and controlgear assemblies - Part 1: Type-tested and partially type-tested assemblies
IEC 60439-2	2000	Low-voltage switchgear and controlgear assemblies - Part 2: Particular requirements for busbar trunking systems (busways)
IEC 60439-3	2001	Low-voltage switchgear and controlgear assemblies - Part 3: Particular requirements for low-voltage switchgear and controlgear assemblies intended to be installed in places where unskilled persons have access for their use - Distribution boards
IEC 60439-4	1999	Low-voltage switchgear and controlgear assemblies - Part 4: Particular requirements for assemblies for construction sites (ACS)
IEC 60439-5	1999	Low-voltage switchgear and controlgear assemblies - Part 5: Particular requirements for assemblies intended to be installed outdoors in public places - Cable distribution cabinets (CDCs) for power distribution in networks
IEC 61095	2000	Electromechanical contactors for household and similar purposes

## 1 Standards

STANDARD	YEAR	TITLE
IEC 60890	1987	A method of temperature-rise assessment by extrapolation for partially type-tested assemblies (PTTA) of low-voltage switchgear and controlgear
IEC 61117	1992	A method for assessing the short-circuit withstand strength of partially type-tested assemblies (PTTA)
IEC 60092-303	1980	Electrical installations in ships. Part 303: Equipment - Transformers for power and lighting
IEC 60092-301	1980	Electrical installations in ships. Part 301: Equipment - Generators and motors
IEC 60092-101	1994	Electrical installations in ships - Part 101: Definitions and general requirements
IEC 60092-401	1980	Electrical installations in ships. Part 401: Installation and test of completed installation
IEC 60092-201	1994	Electrical installations in ships - Part 201: System design - General
IEC 60092-202	1994	Electrical installations in ships - Part 202: System design - Protection
IEC 60092-302	1997	Electrical installations in ships - Part 302: Low-voltage switchgear and controlgear assemblies
IEC 60092-350	2001	Electrical installations in ships - Part 350: Shipboard power cables - General construction and test requirements
IEC 60092-352	1997	Electrical installations in ships - Part 352: Choice and installation of cables for low-voltage power systems
IEC 60364-5-52	2001	Electrical installations of buildings - Part 5-52: Selection and erection of electrical equipment – Wiring systems
IEC 60227		Polyvinyl chloride insulated cables of rated voltages up to and including 450/750 V
	1998	Part 1: General requirements
	1997	Part 2: Test methods
	1997	Part 3: Non-sheathed cables for fixed wiring
	1997	Part 4: Sheathed cables for fixed wiring
	1998	Part 5: Flexible cables (cords)
	2001	Part 6: Lift cables and cables for flexible connections
	1995	Part 7: Flexible cables screened and unscreened with two or more conductors
IEC 60228	1978	Conductors of insulated cables
IEC 60245		Rubber insulated cables - Rated voltages up to and including 450/750 V
	1998	Part 1: General requirements
	1998	Part 2: Test methods
	1994	Part 3: Heat resistant silicone insulated cables

## 1 Standards

STANDARD	YEAR	TITLE
	1994	Part 5: Lift cables
	1994	Part 6: Arc welding electrode cables
	1994	Part 7: Heat resistant ethylene-vinyl acetate rubber insulated cables
	1998	Part 8: Cords for applications requiring high flexibility
IEC 60309-2	1999	Plugs, socket-outlets and couplers for industrial purposes - Part 2: Dimensional interchangeability requirements for pin and contact-tube accessories
IEC 61008-1	1996	Residual current operated circuit-breakers without integral overcurrent protection for household and similar uses (RCCBs) - Part 1: General rules
IEC 61008-2-1	1990	Residual current operated circuit-breakers without integral overcurrent protection for household and similar uses (RCCB's). Part 2-1: Applicability of the general rules to RCCB's functionally independent of line voltage
IEC 61008-2-2	1990	Residual current operated circuit-breakers without integral overcurrent protection for household and similar uses (RCCB's). Part 2-2: Applicability of the general rules to RCCB's functionally dependent on line voltage
IEC 61009-1	1996	Residual current operated circuit-breakers with integral overcurrent protection for household and similar uses (RCBOs) - Part 1: General rules
IEC 61009-2-1	1991	Residual current operated circuit-breakers with integral overcurrent protection for household and similar uses (RCBO's) Part 2-1: Applicability of the general rules to RCBO's functionally independent of line voltage
IEC 61009-2-2	1991	Residual current operated circuit-breakers with integral overcurrent protection for household and similar uses (RCBO's) - Part 2-2: Applicability of the general rules to RCBO's functionally dependent on line voltage
IEC 60670	1989	General requirements for enclosures for accessories for household and similar fixed electrical installations
IEC 60669-2-1	2000	Switches for household and similar fixed electrical installations - Part 2-1: Particular requirements – Electronic switches
IEC 60669-2-2	2000	Switches for household and similar fixed electrical installations - Part 2: Particular requirements – Section 2: Remote-control switches (RCS)
IEC 606692-3	1997	Switches for household and similar fixed electrical installations - Part 2-3: Particular requirements – Time-delay switches (TDS)

## 1 Standards

STANDARD	YEAR	TITLE
IEC 60079-10	1995	Electrical apparatus for explosive gas atmospheres - Part 10: Classification of hazardous areas
IEC 60079-14	1996	Electrical apparatus for explosive gas atmospheres - Part 14: Electrical installations in hazardous areas (other than mines)
IEC 60079-17	1996	Electrical apparatus for explosive gas atmospheres - Part 17: Inspection and maintenance of electrical installations in hazardous areas (other than mines)
IEC 60269-1	1998	Low-voltage fuses - Part 1: General requirements
IEC 60269-2	1986	Low-voltage fuses. Part 2: Supplementary requirements for fuses for use by authorized persons (fuses mainly for industrial application)
IEC 60269-3-1	2000	Low-voltage fuses - Part 3-1: Supplementary requirements for fuses for use by unskilled persons (fuses mainly for household and similar applications) - Sections I to IV
IEC 60127-1/10		Miniature fuses -
	1999	Part 1: Definitions for miniature fuses and general requirements for miniature fuse-links
	1989	Part 2: Cartridge fuse-links
	1988	Part 3: Sub-miniature fuse-links
	1996	Part 4: Universal Modular Fuse-Links (UMF)
	1988	Part 5: Guidelines for quality assessment of miniature fuse-links
	1994	Part 6: Fuse-holders for miniature cartridge fuse-links
IEC 60730-2-7	1990	Automatic electrical controls for household and similar use. Part 2: Particular requirements for timers and time switches
IEC 60364-1	2001	Electrical installations of buildings - Part 1: Fundamental principles, assessment of general characteristics, definitions
IEC 60364-4	2001	Electrical installations of buildings - Part 4: Protection for safety
IEC 60364-5	2001...2002	Electrical installations of buildings - Part 5: Selection and erection of electrical equipment
IEC 60364-6	2001	Electrical installations of buildings - Part 6: Verification
IEC 60364-7	1983...2002	Electrical installations of buildings. Part 7: Requirements for special installations or locations
IEC 60529	2001	Degrees of protection provided by enclosures (IP Code)

## 1 Standards

STANDARD	YEAR	TITLE
IEC 61032	1997	Protection of persons and equipment by enclosures - Probes for verification
IEC 61000-1-1	1992	Electromagnetic compatibility (EMC) - Part 1: General - Section 1: Application and interpretation of fundamental definitions and terms
IEC 61000-1-2	2001	Electromagnetic compatibility (EMC) - Part 1-2: General - Methodology for the achievement of the functional safety of electrical and electronic equipment with regard to electromagnetic phenomena
IEC 61000-1-3	2002	Electromagnetic compatibility (EMC) - Part 1-3: General - The effects of high-altitude EMP (HEMP) on civil equipment and systems

## 2 Protection of feeders

### 2.1 Introduction

The following definitions regarding electrical installations are derived from the Standard IEC 60050.

#### Characteristics of installations

**Electrical installation** (of a building) An assembly of associated electrical equipment to fulfil a specific purpose and having coordinated characteristics.

**Origin of an electrical installation** The point at which electrical energy is delivered to an installation.

**Neutral conductor** (symbol N) A conductor connected to the neutral point of a system and capable of contributing to the transmission of electrical energy.

**Protective conductor PE** A conductor required by some measures for protection against electric shock for electrically connecting any of the following parts:

- exposed conductive parts;
- extraneous conductive parts;
- main earthing terminal;
- earth electrode;
- earthed point of the source or artificial neutral.

**PEN conductor** An earthed conductor combining the functions of both protective conductor and neutral conductor

**Ambient temperature** The temperature of the air or other medium where the equipment is to be used.

#### Voltages

**Nominal voltage** (of an installation) Voltage by which an installation or part of an installation is designated.

Note: the actual voltage may differ from the nominal voltage by a quantity within permitted tolerances.

#### Currents

**Design current** (of a circuit) The current intended to be carried by a circuit in normal service.

**Current-carrying capacity** (of a conductor) The maximum current which can be carried continuously by a conductor under specified conditions without its steady-state temperature exceeding a specified value.

**Overcurrent** Any current exceeding the rated value. For conductors, the rated value is the current-carrying capacity.

**Overload current** (of a circuit) An overcurrent occurring in a circuit in the absence of an electrical fault.

**Short-circuit current** An overcurrent resulting from a fault of negligible impedance between live conductors having a difference in potential under normal operating conditions.

## 2 Protection of feeders

**Conventional operating current** (of a protective device) A specified value of the current which cause the protective device to operate within a specified time, designated conventional time.

**Overcurrent detection** A function establishing that the value of current in a circuit exceeds a predetermined value for a specified length of time.

**Leakage current** Electrical current in an unwanted conductive path other than a short circuit.

**Fault current** The current flowing at a given point of a network resulting from a fault at another point of this network.

#### Wiring systems

**Wiring system** An assembly made up of a cable or cables or busbars and the parts which secure and, if necessary, enclose the cable(s) or busbars.

#### Electrical circuits

**Electrical circuit** (of an installation) An assembly of electrical equipment of the installation supplied from the same origin and protected against overcurrents by the same protective device(s).

**Distribution circuit** (of buildings) A circuit supplying a distribution board.

**Final circuit (of building)** A circuit connected directly to current using equipment or to socket-outlets.

#### Other equipment

**Electrical equipment** Any item used for such purposes as generation, conversion, transmission, distribution or utilization of electrical energy, such as machines, transformers, apparatus, measuring instruments, protective devices, equipment for wiring systems, appliances.

**Current-using equipment** Equipment intended to convert electrical energy into another form of energy, for example light, heat, and motive power

**Switchgear and controlgear** Equipment provided to be connected to an electrical circuit for the purpose of carrying out one or more of the following functions: protection, control, isolation, switching.

**Portable equipment** Equipment which is moved while in operation or which can easily be moved from one place to another while connected to the supply.

**Hand-held equipment** Portable equipment intended to be held in the hand during normal use, in which the motor, if any, forms an integral part of the equipment.

**Stationary equipment** Either fixed equipment or equipment not provided with a carrying handle and having such a mass that it cannot easily be moved.

**Fixed equipment** Equipment fastened to a support or otherwise secured in a specific location.

## 2 Protection of feeders

### Installation dimensioning

The flow chart below suggests the procedure to follow for the correct dimensioning of a plant.

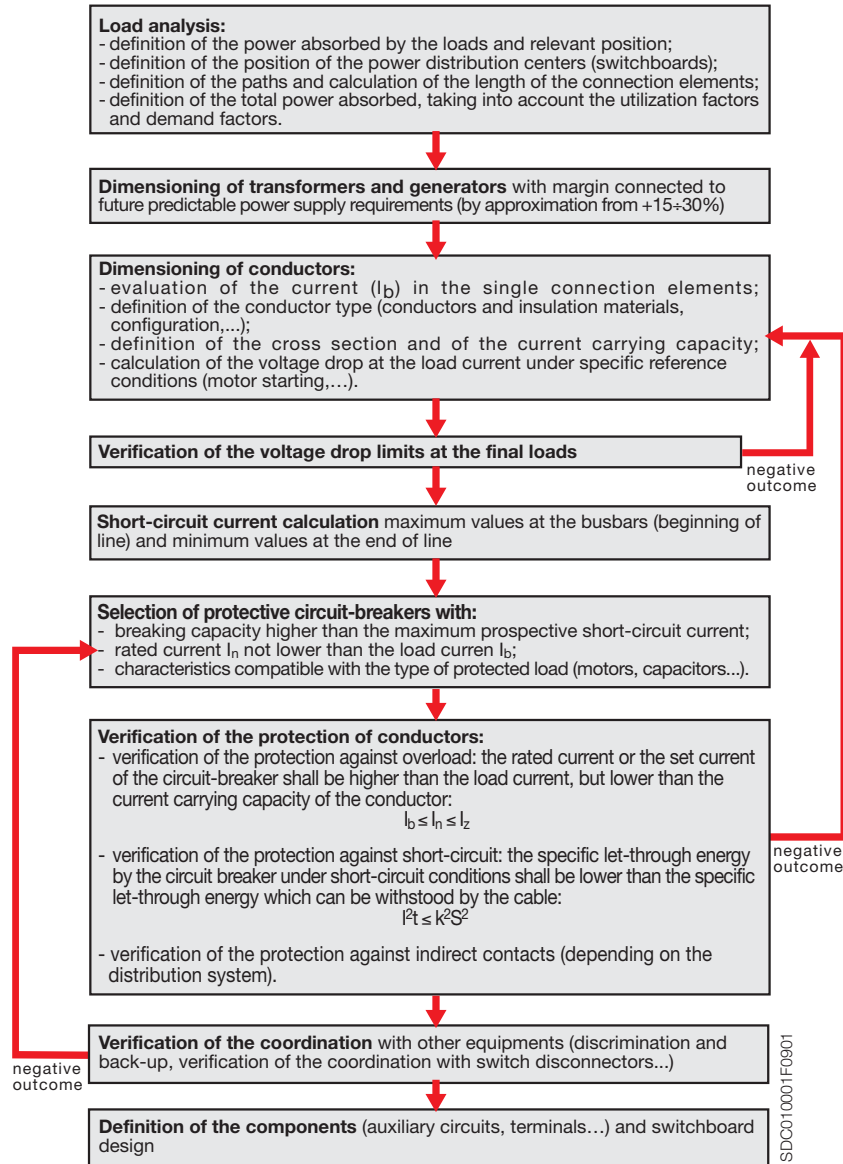

## 2 Protection of feeders

### 2.2 Installation and dimensioning of cables

For a correct dimensioning of a cable, it is necessary to:

- choose the type of cable and installation according to the environment;
- choose the cross section according to the load current;
- verify the voltage drop.

#### 2.2.1 Current carrying capacity and methods of installation

##### Selection of the cable

The international reference Standard ruling the installation and calculation of the current carrying capacity of cables in residential and industrial buildings is IEC 60364-5-52 "Electrical installations of buildings – Part 5-52 Selection and Erection of Electrical Equipment- Wiring systems".

The following parameters are used to select the cable type:

- conductive material (copper or aluminium): the choice depends on cost, dimension and weight requirements, resistance to corrosive environments (chemical reagents or oxidizing elements). In general, the carrying capacity of a copper conductor is about 30% greater than the carrying capacity of an aluminium conductor of the same cross section. An aluminium conductor of the same cross section has an electrical resistance about 60% higher and a weight half to one third lower than a copper conductor.
- insulation material (none, PVC, XLPE-EPR): the insulation material affects the maximum temperature under normal and short-circuit conditions and therefore the exploitation of the conductor cross section [see Chapter 2.4 "Protection against short-circuit"].
- the type of conductor (bare conductor, single-core cable without sheath, single-core cable with sheath, multi-core cable) is selected according to mechanical resistance, degree of insulation and difficulty of installation (bends, joints along the route, barriers...) required by the method of installation.

Table 1 shows the types of conductors permitted by the different methods of installation.

**Table 1: Selection of wiring systems**

Conductors and cables	Method of installation							
	Cable trunking (including skirting trunking, flush floor trunking)			Cable ducting	Cable ladder Cable tray Cable brackets	On in- sulators	Support wire	
	Without fixings	Clipped direct	Conduit					
Bare conductors	-	-	-	-	-	-	+	-
Insulated conductors	-	-	+	+	+	-	+	-
Sheathed cables (including armoured and mineral insulated)	Multi-core	+	+	+	+	+	0	+
	Single-core	0	+	+	+	+	0	+

- + Permitted.
- Not permitted.
- 0 Not applicable, or not normally used in practice.



## 2 Protection of feeders

For industrial installations, multi-core cables are rarely used with cross section greater than 95 mm<sup>2</sup>.

### Methods of installation

To define the current carrying capacity of the conductor and therefore to identify the correct cross section for the load current, the standardized method of installation that better suits the actual installation situation must be identified among those described in the mentioned reference Standard.

From Tables 2 and 3 it is possible to identify the installation identification number, the method of installation (A1, A2, B1, B2, C, D, E, F, G) and the tables to define the theoretical current carrying capacity of the conductor and any correction factors required to allow for particular environmental and installation situations.

**Table 2: Method of installation**

Situations	Method of installation							
	Cable trunking (including skirting trunking, flush floor trunking)				Cable ducting	Cable ladder Cable tray Cable brackets	On insulators	Support wire
	Without fixings	With fixings	Conduit	Conduit				
Building voids	40, 46, 15, 16	0	15, 16	-	0	30, 31, 32, 33, 34	-	-
Cable channel	56	56	54, 55	0	44	30, 31, 32, 33, 34	-	-
Buried in Ground	72, 73	0	70, 71	-	70, 71	0	-	-
Embedded in Structure	57, 58	3	1, 2 59, 60	50, 51, 52, 53	44, 45	0	-	-
Surface Mounted	-	20, 21	4, 5	6, 7, 8, 9, 12, 13, 14	6, 7, 8, 9	30, 31, 32, 33, 34	36	-
Overhead	-	-	0	10, 11	-	30, 31, 32, 33, 34	36	35

The number in each box indicates the item number in Table 3.  
 - Not permitted.  
 0 Not applicable or not normally used in practice.

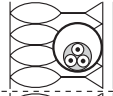
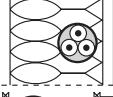
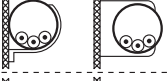
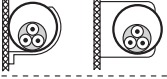
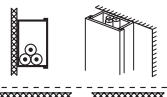
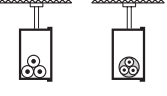
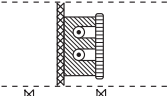
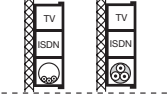
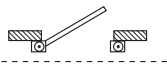
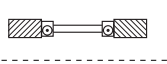
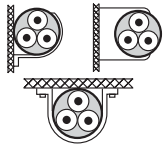

## 2 Protection of feeders

**Table 3: Examples of methods of installation**

Methods of installation	Item n.	Description	Reference method of installation to be used to obtain current-carrying capacity
 Room	1	Insulated conductors or single-core cables in conduit in a thermally insulated wall	A1
 Room	2	Multi-core cables in conduit in a thermally insulated wall	A2
 Room	3	Multi-core cable direct in a thermally insulated wall	A1
	4	Insulated conductors or single-core cables in conduit on a wooden, or masonry wall or spaced less than 0.3 times conduit diameter from it	B1
	5	Multi-core cable in conduit on a wooden, or masonry wall or spaced less than 0.3 times conduit diameter from it	B2
	6 7	Insulated conductors or single-core cables in cable trunking on a wooden wall – run horizontally (6) – run vertically (7)	B1
	8 9	Insulated conductors or single-core cable in suspended cable trunking (8) Multi-core cable in suspended cable trunking (9)	B1 (8) or B2 (9)
	12	Insulated conductors or single-core cable run in mouldings	A1
	13 14	Insulated conductors or single-core cables in skirting trunking (13) Multi-core cable in skirting trunking (14)	B1 (13) or B2 (14)
	15	Insulated conductors in conduit or single-core or multi-core cable in architrave	A1
	16	Insulated conductors in conduit or single-core or multi-core cable in window frames	A1
	20 21	Single-core or multi-core cables: – fixed on, or spaced less than 0.3 times (20) cable diameter from a wooden wall – fixed directly under a wooden ceiling (21)	C

1SD0010001FC0201

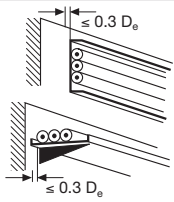
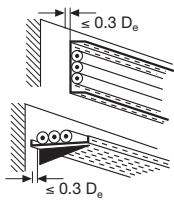
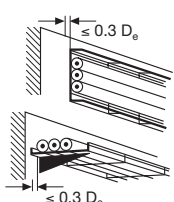
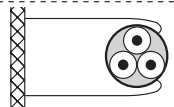
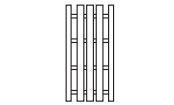
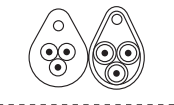

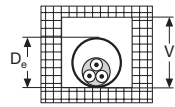
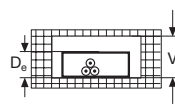
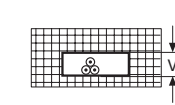
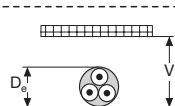
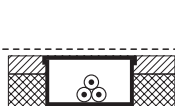
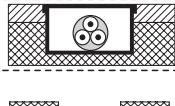
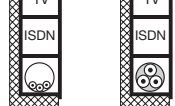
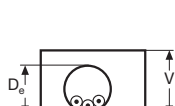

## 2 Protection of feeders

Methods of installation	Item n.	Description	Reference method of installation to be used to obtain current-carrying capacity
	30	On unperforated tray <sup>1</sup>	C
	31	On perforated tray <sup>1</sup>	E or F
	32	On brackets or on a wire mesh <sup>1</sup>	E or F
	33	Spaced more than 0.3 times cable diameter from a wall	E or F or G
	34	On ladder	E or F
	35	Single-core or multi-core cable suspended from or incorporating a support wire	E or F
	36	Bare or insulated conductors on insulators	G

## 2 Protection of feeders

Methods of installation	Item n.	Description	Reference method of installation to be used to obtain current-carrying capacity
	40	Single-core or multi-core cable in a building void <sup>2</sup>	1.5 D <sub>e</sub> ≤ V < 20 D <sub>e</sub> B2 V ≥ 20 D <sub>e</sub> B1
	24	Insulated conductors in cable ducting in a building void <sup>2</sup>	1.5 D <sub>e</sub> ≤ V < 20 D <sub>e</sub> B2 V ≥ 20 D <sub>e</sub> B1
	44	Insulated conductors in cable ducting in masonry having a thermal resistivity not greater than 2 Km/W	1.5 D <sub>e</sub> ≤ V < 5 D <sub>e</sub> B2 5 D <sub>e</sub> ≤ V < 50 D <sub>e</sub> B1
	46	Single-core or multi-core cable: - in a ceiling void - in a suspended floor <sup>1</sup>	1.5 D <sub>e</sub> ≤ V < 5 D <sub>e</sub> B2 5 D <sub>e</sub> ≤ V < 50 D <sub>e</sub> B1
	50	Insulated conductors or single-core cable in flush cable trunking in the floor	B1
	51	Multi-core cable in flush cable trunking in the floor	B2
	52 53	Insulated conductors or single-core cables in embedded trunking (52) Multi-core cable in embedded trunking (53)	B1 (52) or B2 (53)
	54	Insulated conductors or single-core cables in conduit in an unventilated cable channel run horizontally or vertically <sup>2</sup>	1.5 D <sub>e</sub> ≤ V < 20 D <sub>e</sub> B2 V ≥ 20 D <sub>e</sub> B1

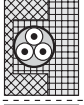
## 2 Protection of feeders

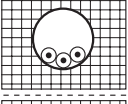
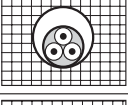
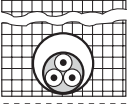
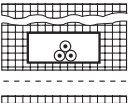
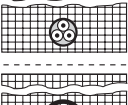
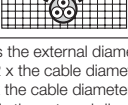
Methods of installation	Item n.	Description	Reference method of installation to be used to obtain current-carrying capacity
	55	Insulated conductors in conduit in an open or ventilated cable channel in the floor	B1
	56	Sheathed single-core or multi-core cable in an open or ventilated cable channel run horizontally or vertically	B1
	57	Single-core or multi-core cable direct in masonry having a thermal resistivity not greater than 2 Km/W Without added mechanical protection	C
	58	Single-core or multi-core cable direct in masonry having a thermal resistivity not greater than 2 Km/W With added mechanical protection	C
	59	Insulated conductors or single-core cables in conduit in masonry	B1
	60	Multi-core cables in conduit in masonry	B2
	70	Multi-core cable in conduit or in cable ducting in the ground	D
	71	Single-core cable in conduit or in cable ducting in the ground	D
	72	Sheathed single-core or multi-core cables direct in the ground - without added mechanical protection	D
	73	Sheathed single-core or multi-core cables direct in the ground - with added mechanical protection	D

<sup>1</sup>D<sub>e</sub> is the external diameter of a multi-core cable:  
 - 2.2 x the cable diameter when three single core cables are bound in trefoil, or  
 - 3 x the cable diameter when three single core cables are laid in flat formation.

<sup>2</sup>D<sub>e</sub> is the external diameter of conduit or vertical depth of cable ducting.

V is the smaller dimension or diameter of a masonry duct or void, or the vertical depth of a rectangular duct, floor or ceiling void.  
 The depth of the channel is more important than the width.

1SDC010003F0201

## 2 Protection of feeders

### Installation not buried in the ground: choice of the cross section according to cable carrying capacity and type of installation

The cable carrying capacity of a cable that is not buried in the ground is obtained by using this formula:

$$I_z = I_0 k_1 k_2 = I_0 k_{tot}$$

where:

- I<sub>0</sub> is the current carrying capacity of the single conductor at 30 °C reference ambient temperature;
- k<sub>1</sub> is the correction factor if the ambient temperature is other than 30 °C;
- k<sub>2</sub> is the correction factor for cables installed bunched or in layers or for cables installed in a layer on several supports.

#### Correction factor k<sub>1</sub>

The current carrying capacity of the cables that are not buried in the ground refers to 30 °C ambient temperature. If the ambient temperature of the place of installation is different from this reference temperature, the correction factor k<sub>1</sub> on Table 4 shall be used, according to the insulation material.

**Table 4: Correction factor for ambient air temperature other than 30 °C**

Ambient temperature (a) °C	Insulation			
	PVC	XLPE and EPR	Mineral (a)	
			PVC covered or bare not exposed to touch 70 °C	Bare not exposed to touch 105 °C
10	1.22	1.15	1.26	1.14
15	1.17	1.12	1.20	1.11
20	1.12	1.08	1.14	1.07
25	1.06	1.04	1.07	1.04
35	0.94	0.96	0.93	0.96
40	0.87	0.91	0.85	0.92
45	0.79	0.87	0.87	0.88
50	0.71	0.82	0.67	0.84
55	0.61	0.76	0.57	0.80
60	0.50	0.71	0.45	0.75
65	-	0.65	-	0.70
70	-	0.58	-	0.65
75	-	0.50	-	0.60
80	-	0.41	-	0.54
85	-	-	-	0.47
90	-	-	-	0.40
95	-	-	-	0.32

(a) For higher ambient temperatures, consult manufacturer.

## 2 Protection of feeders

### Correction factor $k_2$

The cable current carrying capacity is influenced by the presence of other cables installed nearby. The heat dissipation of a single cable is different from that of the same cable when installed next to the other ones. The factor  $k_2$  is tabled according to the installation of cables laid close together in layers or bunches.

Definition of layer or bunch

*layer*: several circuits constituted by cables installed one next to another, spaced or not, arranged horizontally or vertically. The cables on a layer are installed on a wall, tray, ceiling, floor or on a cable ladder;

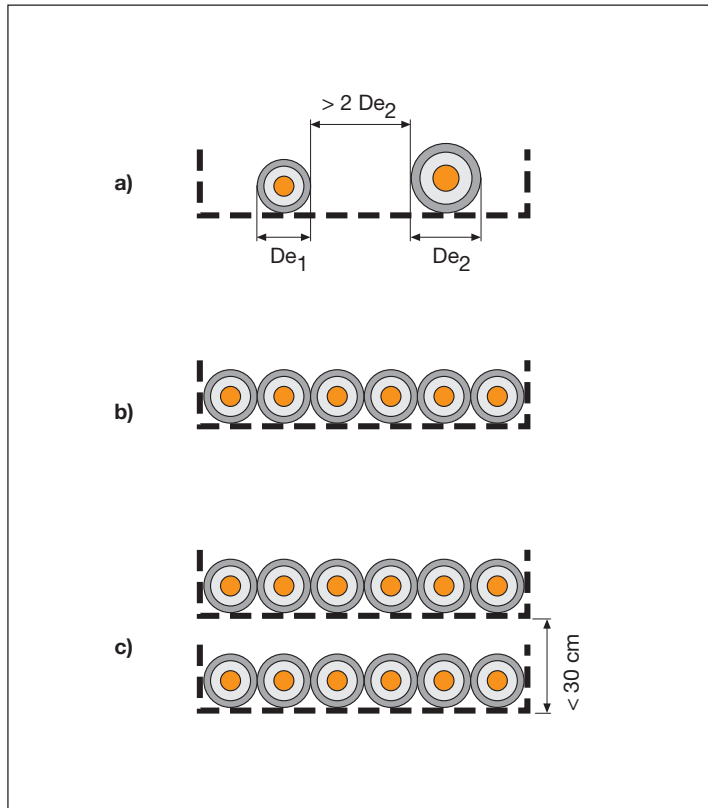

Cables in layers: a) spaced; b) not spaced; c) double layer

*bunch*: several circuits constituted by cables that are not spaced and are not installed in a layer; several layers superimposed on a single support (e.g. tray) are considered to be a bunch.

## 2 Protection of feeders

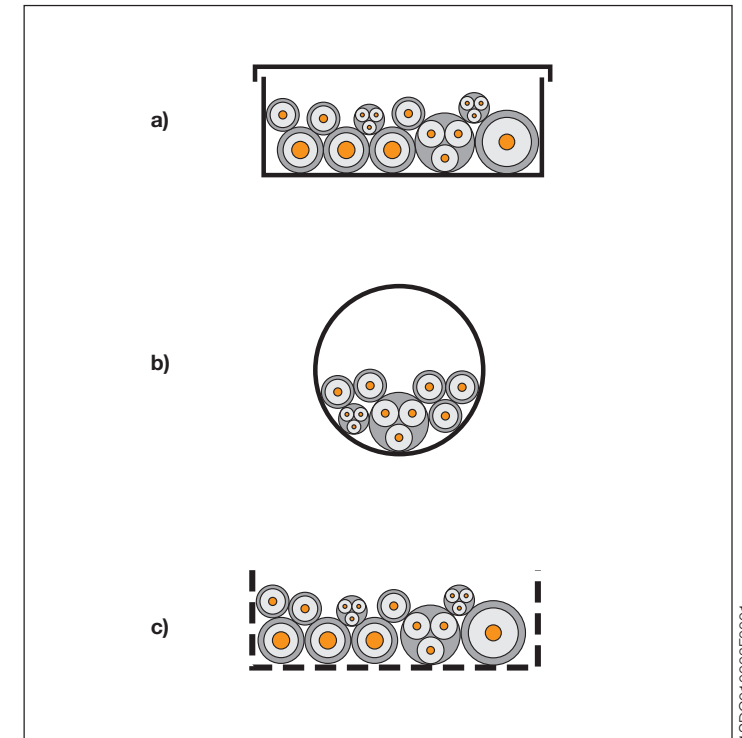

Bunched cables: a) in trunking; b) in conduit; c) on perforated tray

The value of correction factor  $k_2$  is 1 when:

- the cables are spaced:
  - two single-core cables belonging to different circuits are spaced when the distance between them is more than twice the external diameter of the cable with the larger cross section;
  - two multi-core cables are spaced when the distance between them is at least the same as the external diameter of the larger cable;
- the adjacent cables are loaded less than 30 % of their current carrying capacity.

The correction factors for bunched cables or cables in layers are calculated by assuming that the bunches consist of similar cables that are equally loaded. A group of cables is considered to consist of similar cables when the calculation of the current carrying capacity is based on the same maximum allowed operating temperature and when the cross sections of the conductors is in the range of three adjacent standard cross sections (e.g. from 10 to 25 mm<sup>2</sup>).

The calculation of the reduction factors for bunched cables with different cross sections depends on the number of cables and on their cross sections. These factors have not been tabled, but must be calculated for each bunch or layer.

## 2 Protection of feeders

The reduction factor for a group containing different cross sections of insulated conductors or cables in conduits, cable trunking or cable ducting is:

$$k_2 = \frac{1}{\sqrt{n}}$$

where:

- $k_2$  is the group reduction factor;
- $n$  is the number of circuits of the bunch.

The reduction factor obtained by this equation reduces the danger of overloading of cables with a smaller cross section, but may lead to under utilization of cables with a larger cross section. Such under utilization can be avoided if large and small cables are not mixed in the same group.

The following tables show the reduction factor ( $k_2$ ).

**Table 5: Reduction factor for grouped cables**

Item	Arrangement (cables touching)	Number of circuits or multi-core cables												To be used with current-carrying capacities, reference
		1	2	3	4	5	6	7	8	9	12	16	20	
1	Bunched in air, on a surface, embedded or enclosed	1.00	0.80	0.70	0.65	0.60	0.57	0.54	0.52	0.50	0.45	0.41	0.38	Methods A to F
2	Single layer on wall, floor or unperforated tray	1.00	0.85	0.79	0.75	0.73	0.72	0.72	0.71	0.70				Method C
3	Single layer fixed directly under a wooden ceiling	0.95	0.81	0.72	0.68	0.66	0.64	0.63	0.62	0.61	No further reduction factor for more than nine circuits or multicore cables			
4	Single layer on a perforated horizontal or vertical tray	1.00	0.88	0.82	0.77	0.75	0.73	0.73	0.72	0.72	Methods E and F			
5	Single layer on ladder support or cleats etc.	1.00	0.87	0.82	0.80	0.80	0.79	0.79	0.78	0.78				

NOTE 1 These factors are applicable to uniform groups of cables, equally loaded.

NOTE 2 Where horizontal clearances between adjacent cables exceeds twice their overall diameter, no reduction factor need be applied.

NOTE 3 The same factors are applied to:  
 – groups of two or three single-core cables;  
 – multi-core cables.

NOTE 4 If a system consists of both two- and three-core cables, the total number of cables is taken as the number of circuits, and the corresponding factor is applied to the tables for two loaded conductors for the two-core cables, and to the tables for three loaded conductors for the three-core cables.

NOTE 5 If a group consists of  $n$  single-core cables it may either be considered as  $n/2$  circuits of two loaded conductors or  $n/3$  circuits of three loaded conductors.

## 2 Protection of feeders

**Table 6: Reduction factor for single-core cables with method of installation F**

Method of installation in Table 3			Number of trays	Number of three-phase circuits (note 4)			Use as a multiplier to rating for
				1	2	3	
Perforated trays (note 2)	31		1	0.98	0.91	0.87	Three cables in horizontal formation
			2	0.96	0.87	0.81	
			3	0.95	0.85	0.78	
Vertical perforated trays (note 3)	31		1	0.96	0.86	–	Three cables in vertical formation
			2	0.95	0.84	–	
Ladder supports, cleats, etc. (note 2)	32 33 34		1	1.00	0.97	0.96	Three cables in horizontal formation
			2	0.98	0.93	0.89	
			3	0.97	0.90	0.86	
Perforated trays (note 2)	31		1	1.00	0.98	0.96	
			2	0.97	0.93	0.89	
			3	0.96	0.92	0.86	
Vertical perforated trays (note 3)	31		1	1.00	0.91	0.89	Three cables in trefoil formation
			2	1.00	0.90	0.86	
Ladder supports, cleats, etc. (note 2)	32 33 34		1	1.00	1.00	1.00	
			2	0.97	0.95	0.93	
			3	0.96	0.94	0.90	

NOTE 1 Factors are given for single layers of cables (or trefoil groups) as shown in the table and do not apply when cables are installed in more than one layer touching each other. Values for such installations may be significantly lower and must be determined by an appropriate method.

NOTE 2 Values are given for vertical spacings between trays of 300 mm. For closer spacing the factors should be reduced.

NOTE 3 Values are given for horizontal spacing between trays of 225 mm with trays mounted back to back and at least 20 mm between the tray and any wall. For closer spacing the factors should be reduced.

NOTE 4 For circuits having more than one cable in parallel per phase, each three phase set of conductors should be considered as a circuit for the purpose of this table.

## 2 Protection of feeders

**Table 7: Reduction factor for multi-core cables with method of installation E**

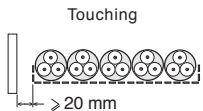
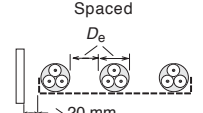
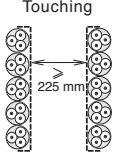
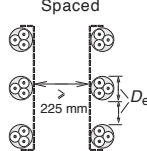
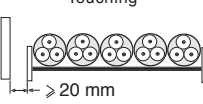
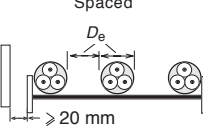
Method of installation in Table 3		Number of trays	Number of cables						
			1	2	3	4	6	9	
Perforated trays (note 2)	31	 <p>Touching</p> <p>&gt; 20 mm</p>	1	1.00	0.88	0.82	0.79	0.76	0.73
			2	1.00	0.87	0.80	0.77	0.73	0.68
			3	1.00	0.86	0.79	0.76	0.71	0.66
	31	 <p>Spaced</p> <p><math>D_e</math></p> <p>&gt; 20 mm</p>	1	1.00	1.00	0.98	0.95	0.91	–
			2	1.00	0.99	0.96	0.92	0.87	–
			3	1.00	0.98	0.95	0.91	0.85	–
Vertical perforated trays (note 3)	31	 <p>Touching</p> <p>225 mm</p>	1	1.00	0.88	0.82	0.78	0.73	0.72
			2	1.00	0.88	0.81	0.76	0.71	0.70
	31	 <p>Spaced</p> <p>225 mm</p> <p><math>D_e</math></p>	1	1.00	0.91	0.89	0.88	0.87	–
			2	1.00	0.91	0.88	0.87	0.85	–
			3	1.00	0.91	0.88	0.87	0.85	–
			4	1.00	0.91	0.88	0.87	0.85	–
Ladder supports, cleats, etc. (note 2)	32	 <p>Touching</p> <p>&gt; 20 mm</p>	1	1.00	0.87	0.82	0.80	0.79	0.78
			2	1.00	0.86	0.80	0.78	0.76	0.73
			3	1.00	0.85	0.79	0.76	0.73	0.70
	34	 <p>Spaced</p> <p><math>D_e</math></p> <p>&gt; 20 mm</p>	1	1.00	1.00	1.00	1.00	1.00	–
			2	1.00	0.99	0.98	0.97	0.96	–
			3	1.00	0.98	0.97	0.96	0.93	–

NOTE 1 Factors apply to single layer groups of cables as shown above and do not apply when cables are installed in more than one layer touching each other. Values for such installations may be significantly lower and must be determined by an appropriate method.

NOTE 2 Values are given for vertical spacings between trays of 300 mm and at least 20 mm between trays and wall. For closer spacing the factors should be reduced.

NOTE 3 Values are given for horizontal spacing between trays of 225 mm with trays mounted back to back. For closer spacing the factors should be reduced.

1SDC010005F0201

## 2 Protection of feeders

### To summarize:

The following procedure shall be used to determine the cross section of the cable:

- from Table 3 identify the method of installation;
- from Table 4 determine the correction factor  $k_1$  according to insulation material and ambient temperature;
- use Table 5 for cables installed in layer or bunch, Table 6 for single-core cables in a layer on several supports, Table 7 for multi-core cables in a layer on several supports or the formula shown in the case of groups of cables with different sections to determine the correction factor  $k_2$  appropriate for the numbers of circuits or multi-core cables;
- calculate the value of current  $I'_b$  by dividing the load current  $I_b$  (or the rated current of the protective device) by the product of the correction factors calculated:

$$I'_b = \frac{I_b}{k_1 k_2} = \frac{I_b}{k_{tot}}$$

- from Table 8 or from Table 9, depending on the method of installation, on insulation and conductive material and on the number of live conductors, determine the cross section of the cable with capacity  $I_0 \geq I'_b$ ;
- the actual cable current carrying capacity is calculated by  $I_z = I_0 k_1 k_2$ .

### 2 Protection of feeders

**Table 8: Current carrying capacity of cables with PVC or EPR/XLPE insulation (method A-B-C)**

S[mm <sup>2</sup> ]	Loaded conductors	A1		A2				B1				B2				C																									
		Cu		Al		Cu		Al		Cu		Al		Cu		Al		Cu		Al																					
		XLPE EPR	PVC	XLPE EPR	PVC	XLPE EPR	PVC	XLPE EPR	PVC	XLPE EPR	PVC	XLPE EPR	PVC	XLPE EPR	PVC	XLPE EPR	PVC	XLPE EPR	PVC	XLPE/EPR	PVC																				
	2	3	2	3	2	3	2	3	2	3	2	3	2	3	2	3	2	3	2	3	2	3	2	3	2	3	2	3													
1.5		19	17	14.5	13.5			18.5	16.5	14	13			23	20	17.5	15.5			22	19.5	16.5	15			24	22	19.5	17.5												
2.5		26	23	19.5	18	20	19	14.5	14	25	22	18.5	17.5	19.5	18	14.5	13.5	31	28	24	21	25	22	18.5	16.5	30	26	23	20	23	21	17.5	15.5	33	30	27	24	26	24	21	18.5
4		35	31	26	24	27	25	20	18.5	33	30	25	23	26	24	20	17.5	42	37	32	28	33	29	25	22.0	40	35	30	27	31	28	24	21	45	40	36	32	35	32	28	25
6		45	40	34	31	35	32	26	24	42	38	32	29	33	31	25	23	54	48	41	36	43	38	32	28	51	44	38	34	40	35	30	27.0	58	52	46	41	45	41	36	32
10		61	54	46	42	48	44	36	32	57	51	43	39	45	41	33	31	75	66	57	50	59	52	44	39	69	60	52	46	54	48	41	36	80	71	63	57	62	57	49	44
16		81	73	61	56	64	58	48	43	76	68	57	52	60	55	44	41	100	88	76	68	79	71	60	53	91	80	69	62	72	64	54	48	107	96	85	76	84	76	66	59
25		106	95	80	73	84	76	63	57	99	89	75	68	78	71	58	53	133	117	101	89	105	93	79	70	119	105	90	80	94	84	71	62	138	119	112	96	101	90	83	73
35		131	117	99	89	103	94	77	70	121	109	92	83	96	87	71	65	164	144	125	110	130	116	97	86	146	128	111	99	115	103	86	77	171	147	138	119	126	112	103	90
50		158	141	119	108	125	113	93	84	145	130	110	99	115	104	86	78	198	175	151	134	157	140	118	104	175	154	133	118	138	124	104	92	209	179	168	144	154	136	125	110
70		200	179	151	136	158	142	118	107	183	164	139	125	145	131	108	98	253	222	192	171	200	179	150	133	221	194	168	149	175	156	131	116	269	229	213	184	198	174	160	140
95		241	216	182	164	191	171	142	129	220	197	167	150	175	157	130	118	306	269	232	207	242	217	181	161	265	233	201	179	210	188	157	139	328	278	258	223	241	211	195	170
120		278	249	210	188	220	197	164	149	253	227	192	172	201	180	150	135	354	312	269	239	281	251	210	186	305	268	232	206	242	216	181	160	382	322	299	259	280	245	226	197
150		318	285	240	216	253	226	189	170	290	259	219	196	230	206	172	155																								
185		362	324	273	245	288	256	215	194	329	295	248	223	262	233	195	176																								
240		424	380	321	286	338	300	252	227	386	346	291	261	307	273	229	207																								
300		486	435	367	328	387	344	289	261	442	396	334	298	352	313	263	237																								
400																																									
500																																									
630																																									

TSDC010006FC0201

## 2 Protection of feeders

**Table 8: Current carrying capacity of cables with PVC or EPR/XLPE insulation (method E-F-G)**

S [mm <sup>2</sup> ]	Installation method	E								F								G										
		Cu		Al		Cu		Al		Cu		Al		Cu		Al		Cu				Al						
		XLPE EPR	PVC	XLPE EPR	PVC	XLPE EPR	PVC	XLPE EPR	PVC	XLPE EPR	PVC	XLPE EPR	PVC	XLPE EPR	PVC	XLPE EPR	PVC	XLPE EPR	PVC	XLPE EPR	PVC	XLPE EPR	PVC	XLPE EPR	PVC			
Loaded conductors	2				3				2				3				3				3H	3V	3H	3V	3H	3V	3H	3V
1.5	26	22			23	18.5																						
2.5	36	30	28	23	32	2	24	19.5																				
4	49	40	38	31	42	34	32	26																				
6	63	51	49	39	54	43	42	33																				
10	86	70	67	54	75	60	58	46																				
16	115	94	91	73	100	80	77	61																				
25	149	119	108	89	127	101	97	78	161	131	121	98	13	110	103	84	141	114	107	87	182	161	146	130	138	122	112	99
35	185	148	135	111	158	126	120	96	200	162	150	122	169	137	129	105	176	143	135	109	226	201	181	162	172	153	139	124
50	225	180	164	135	192	153	146	117	242	196	184	149	207	167	159	128	216	174	165	133	275	246	219	197	210	188	169	152
70	289	232	211	173	246	196	187	150	310	251	237	192	268	216	206	166	279	225	215	173	353	318	281	254	271	244	217	196
95	352	282	257	210	298	238	227	183	377	304	289	235	328	264	253	203	342	275	264	212	430	389	341	311	332	300	265	241
120	410	328	300	244	346	276	263	212	437	352	337	273	383	308	296	237	400	321	308	247	500	454	396	362	387	351	308	282
150	473	379	346	282	399	319	304	245	504	406	389	316	444	356	343	274	464	372	358	287	577	527	456	419	448	408	356	327
185	542	434	397	322	456	364	347	280	575	463	447	363	510	409	395	315	533	427	413	330	661	605	521	480	515	470	407	376
240	641	514	470	380	538	430	409	330	679	546	530	430	607	485	471	375	634	507	492	392	781	719	615	569	611	561	482	447
300	741	593	543	439	621	497	471	381	783	629	613	497	703	561	547	434	736	587	571	455	902	833	709	659	708	652	557	519
400									940	754	740	600	823	656	663	526	868	689	694	552	1085	1008	852	795	856	792	671	629
500									1083	868	856	694	946	749	770	610	998	789	806	640	1253	1169	982	920	991	921	775	730
630									1254	1005	996	808	1088	855	899	711	1151	905	942	746	1454	1362	1138	1070	1154	1077	900	852

1SD0C010100F0201



## 2 Protection of feeders

## 2 Protection of feeders

**Table 9: Current carrying capacity of cables with mineral insulation**

	Installation method	C						E or F						G			
		Metallic sheath temperature 70 °C			Metallic sheath temperature 105 °C			Metallic sheath temperature 70 °C			Metallic sheath temperature 105 °C			Metallic sheath temperature 70 °C		Metallic sheath temperature 105 °C	
		PVC covered or bare exposed to touch			Bare cable not exposed to touch			PVC covered or bare exposed to touch			Bare cable not exposed to touch			PVC covered or bare exposed to touch		Bare cable not exposed to touch	
Loaded conductors																	
	S[mm²]	2	3	3	2	3	3	2	3	3	2	3	3	3	3	3	3
500 V	1.5	23	19	21	28	24	27	25	21	23	31	26	29	26	29	33	37
	2.5	31	26	29	38	33	36	33	28	31	41	35	39	34	39	43	49
	4	40	35	38	51	44	47	44	37	41	54	46	51	45	51	56	64
	6	57	48	52	70	59	67	60	51	57	76	64	71	62	71	78	89
750 V	10	77	65	70	96	81	91	82	69	77	104	87	96	84	95	105	120
	16	102	86	92	127	107	119	109	92	102	137	115	127	110	125	137	157
	25	133	112	120	166	140	154	142	120	132	179	150	164	142	162	178	204
	35	163	137	147	203	171	187	174	147	161	220	184	200	173	197	216	248
	50	202	169	181	251	212	230	215	182	198	272	228	247	213	242	266	304
	70	247	207	221	307	260	280	264	223	241	333	279	300	259	294	323	370
	95	296	249	264	369	312	334	317	267	289	400	335	359	309	351	385	441
	120	340	286	303	424	359	383	364	308	331	460	385	411	353	402	441	505
	150	388	327	346	485	410	435	416	352	377	526	441	469	400	454	498	565
	185	440	371	392	550	465	492	472	399	426	596	500	530	446	507	557	629
	240	514	434	457	643	544	572	552	466	496	697	584	617	497	565	624	704

- Note 1 For single-core cables the sheaths of the cables of the circuit are connected together at both ends.
- Note 2 For bare cables exposed to touch, values should be multiplied by 0.9.
- Note 3  $D_e$  is the external diameter of the cable.
- Note 4 For metallic sheath temperature 105 °C no correction for grouping need to be applied.

1SDC010007F0201

## 2 Protection of feeders

### Installation in ground: choice of the cross section according to cable carrying capacity and type of installation

The current carrying capacity of a cable buried in the ground is calculated by using this formula:

$$I_z = I_0 k_1 k_2 k_3 = I_0 k_{\text{tot}}$$

where:

- $I_0$  is the current carrying capacity of the single conductor for installation in the ground at 20°C reference temperature;
- $k_1$  is the correction factor if the temperature of the ground is other than 20°C;
- $k_2$  is the correction factor for adjacent cables;
- $k_3$  is the correction factor if the soil thermal resistivity is different from the reference value, 2.5 Km/W.

#### Correction factor $k_1$

The current carrying capacity of buried cables refers to a ground temperature of 20 °C. If the ground temperature is different, use the correction factor  $k_1$  shown in Table 10 according to the insulation material.

**Table 10: Correction factors for ambient ground temperatures other than 20 °C**

Ground temperature °C	Insulation	
	PVC	XLPE and EPR
10	1.10	1.07
15	1.05	1.04
25	0.95	0.96
30	0.89	0.93
35	0.84	0.89
40	0.77	0.85
45	0.71	0.80
50	0.63	0.76
55	0.55	0.71
60	0.45	0.65
65	–	0.60
70	–	0.53
75	–	0.46
80	–	0.38

## 2 Protection of feeders

### Correction factor $k_2$

The cable current carrying capacity is influenced by the presence of other cables installed nearby. The heat dissipation of a single cable is different from that of the same cable installed next to the other ones.

The correction factor  $k_2$  is obtained by the formula:

$$k_2 = k_2' \cdot k_2''$$

Tables 11, 12, and 13 show the factor  $k_2'$  values for single-core and multi-core cables that are laid directly in the ground or which are installed in buried ducts, according to their distance from other cables or the distance between the ducts.

**Table 11: Reduction factors for cables laid directly in the ground**

Number of circuits	Cable to cable clearance (a)				
	Nil (cables touching)	One cable diameter	0.125 m	0.25 m	0.5 m
2	0.75	0.80	0.85	0.90	0.90
3	0.65	0.70	0.75	0.80	0.85
4	0.60	0.60	0.70	0.75	0.80
5	0.55	0.55	0.65	0.70	0.80
6	0.50	0.55	0.60	0.70	0.80

Multi-core cables



Single-core cables



NOTE The given values apply to an installation depth of 0.7 m and a soil thermal resistivity of 2.5 Km/W.

## 2 Protection of feeders

**Table 12: Reduction factors for multi-core cables laid in single way ducts in the ground**

Number of circuits	Cable to cable clearance (a)			
	Nil (cables touching)	0.25 m	0.5 m	1.0 m
2	0.85	0.90	0.95	0.95
3	0.75	0.85	0.90	0.95
4	0.70	0.80	0.85	0.90
5	0.65	0.80	0.85	0.90
6	0.60	0.80	0.80	0.90

Multi-core cables

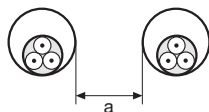

NOTE The given values apply to an installation depth of 0.7 m and a soil thermal resistivity of 2.5 Km/W.

**Table 13: Reduction factors for single-core cables laid in single way ducts in the ground**

Number of single-core circuits of two or three cables	Duct to duct clearance (a)			
	Nil (ducts touching)	0.25 m	0.5 m	1.0 m
2	0.80	0.90	0.90	0.95
3	0.70	0.80	0.85	0.90
4	0.65	0.75	0.80	0.90
5	0.60	0.70	0.80	0.90
6	0.60	0.70	0.80	0.90

Single-core cables



NOTE The given values apply to an installation depth of 0.7 m and a soil thermal resistivity of 2.5 Km/W.

## 2 Protection of feeders

For correction factor  $k_2''$ :

- for cables laid directly in the ground or if there are not other conductors within the same duct, the value of  $k_2''$  is 1;
- if several conductors of similar sizes are present in the same duct (for the meaning of "group of similar conductors", see the paragraphs above),  $k_2''$  is obtained from the first row of Table 5;
- if the conductors are not of similar size, the correction factor is calculated by using this formula:

$$k_2'' = \frac{1}{\sqrt{n}}$$

where:

n is the number of circuits in the duct.

### Correction factor $k_3$

Soil thermal resistivity influences the heat dissipation of the cable. Soil with low thermal resistivity facilitates heat dissipation, whereas soil with high thermal resistivity limits heat dissipation. IEC 60364-5-52 states as reference value for the soil thermal resistivity 2.5 Km/W.

**Table 14: Correction factors for soil thermal resistivities other than 2.5 Km/W**

Thermal resistivities Km/W	1	1.5	2	2.5	3
Correction factor	1.18	1.1	1.05	1	0.96

Note 1: the overall accuracy of correction factors is within  $\pm 5\%$ .

Note 2: the correction factors are applicable to cables drawn into buried ducts; for cables laid direct in the ground the correction factors for thermal resistivities less than 2.5 Km/W will be higher. Where more precise values are required they may be calculated by methods given in IEC 60287.

Note 3: the correction factors are applicable to ducts buried at depths of up to 0.8 m.

## 2 Protection of feeders

### To summarize:

Use this procedure to determine the cross section of the cable:

1. from Table 10, determine the correction factor  $k_1$  according to the insulation material and the ground temperature;
2. use Table 11, Table 12, Table 13 or the formula for groups of non-similar cables to determine the correction factor  $k_2$  according to the distance between cables or ducts;
3. from Table 14 determine factor  $k_3$  corresponding to the soil thermal resistivity;
4. calculate the value of the current  $I'_b$  by dividing the load current  $I_b$  (or the rated current of the protective device) by the product of the correction factors calculated:

$$I'_b = \frac{I_b}{k_1 k_2 k_3} = \frac{I_b}{k_{tot}}$$

5. from Table 15, determine the cross section of the cable with  $I_0 \geq I'_b$ , according to the method of installation, the insulation and conductive material and the number of live conductors;
6. the actual cable current carrying capacity is calculated by:

$$I_z = I_0 k_1 k_2 k_3$$

Table 15: Current carrying capacity of cables buried in the ground

S [mm <sup>2</sup> ]	Loaded conductors	D							
		Cu				Al			
		XLPE EPR		PVC		XLPE EPR		PVC	
	2	3	2	3	2	3	2	3	
1.5		26	22	22	18				
2.5		34	29	29	24	26	22	22	18.5
4		44	37	38	31	34	29	29	24
6		56	46	47	39	42	36	36	30
10		73	61	63	52	56	47	48	40
16		95	79	81	67	73	61	62	52
25		121	101	104	86	93	78	80	66
35		146	122	125	103	112	94	96	80
50		173	144	148	122	132	112	113	94
70		213	178	183	151	163	138	140	117
95		252	211	216	179	193	164	166	138
120		287	240	246	203	220	186	189	157
150		324	271	278	230	249	210	213	178
185		363	304	312	258	279	236	240	200
240		419	351	361	297	322	272	277	230
300		474	396	408	336	364	308	313	260

1SDDC010008F0201

## 2 Protection of feeders

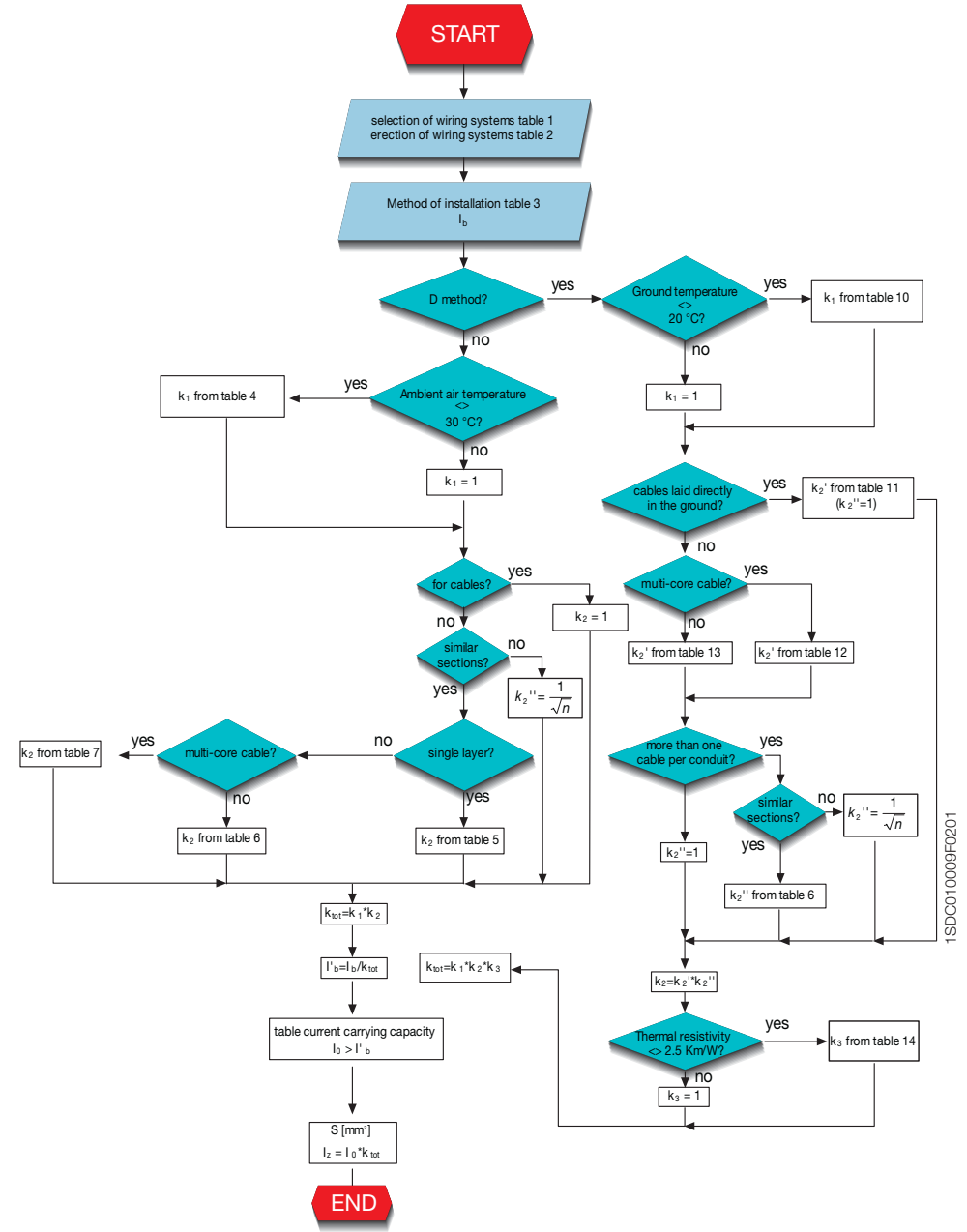

1SDDC010008F0201

## 2 Protection of feeders

### Note on current carrying capacity tables and loaded conductors

Tables 8, 9 and 15 provide the current carrying capacity of loaded conductors (current carrying conductors) under normal service conditions.

In single-phase circuits, the number of loaded conductors is two.

In balanced or slightly unbalanced three-phase circuits the number of loaded conductors is three, since the current in the neutral conductor is negligible.

In three-phase systems with high unbalance, where the neutral conductor in a multi-core cable carries current as a result of an unbalance in the phase currents the temperature rise due to the neutral current is offset by the reduction in the heat generated by one or more of the phase conductors. In this case the conductor size shall be chosen on the basis of the highest phase current. In all cases the neutral conductor shall have an adequate cross section.

### Effect of harmonic currents on balanced three-phase systems: reduction factors for harmonic currents in four-core and five-core cables with four cores carrying current

Where the neutral conductor carries current without a corresponding reduction in load of the phase conductors, the current flowing in the neutral conductor shall be taken into account in ascertaining the current-carrying capacity of the circuit.

This neutral current is due to the phase currents having a harmonic content which does not cancel in the neutral. The most significant harmonic which does not cancel in the neutral is usually the third harmonic. The magnitude of the neutral current due to the third harmonic may exceed the magnitude of the power frequency phase current. In such a case the neutral current will have a significant effect on the current-carrying capacity of the cables in the circuit.

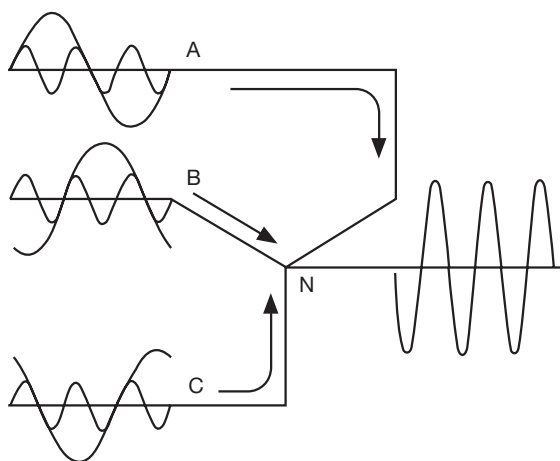

1SDC010007F0001

## 2 Protection of feeders

Equipment likely to cause significant harmonic currents are, for example, fluorescent lighting banks and dc power supplies such as those found in computers (for further information on harmonic disturbances see the IEC 61000). The reduction factors given in Table 16 only apply in the balanced three-phase circuits (the current in the fourth conductor is due to harmonics only) to cables where the neutral conductor is within a four-core or five-core cable and is of the same material and cross-sectional area as the phase conductors. These reduction factors have been calculated based on third harmonic currents. If significant, i.e. more than 10 %, higher harmonics (e.g. 9th, 12th, etc.) are expected or there is an unbalance between phases of more than 50 %, then lower reduction factors may be applicable: these factors can be calculated only by taking into account the real shape of the current in the loaded phases.

Where the neutral current is expected to be higher than the phase current then the cable size should be selected on the basis of the neutral current.

Where the cable size selection is based on a neutral current which is not significantly higher than the phase current, it is necessary to reduce the tabulated current carrying capacity for three loaded conductors.

If the neutral current is more than 135 % of the phase current and the cable size is selected on the basis of the neutral current, then the three phase conductors will not be fully loaded. The reduction in heat generated by the phase conductors offsets the heat generated by the neutral conductor to the extent that it is not necessary to apply any reduction factor to the current carrying capacity for three loaded conductors.

**Table 16: Reduction factors for harmonic currents in four-core and five-core cables**

Third harmonic content of phase current	Reduction factor			
	Size selection is based on phase current	Current to take in account for the cable selection $I_b'$	Size selection is based on neutral current	Current to take in account for the cable selection $I_b'$
%				
0 + 15	1	$I_b' = \frac{I_b}{k_{tot}}$	-	-
15 + 33	0.86	$I_b' = \frac{I_b}{k_{tot} \cdot 0.86}$	-	-
33 + 45	-	-	0.86	$I_b' = \frac{I_N}{0.86}$
> 45	-	-	1	$I_b' = I_N$

Where  $I_N$  is the current flowing in the neutral calculated as follows:  $I_N = \frac{I_b}{k_{tot}} \cdot 3 \cdot k_{III}$

$I_b$  is the load current;

$k_{tot}$  is the total correction factor;

$k_{III}$  is the third harmonic content of phase current;

## 2 Protection of feeders

### Example of cable dimensioning in a balanced three-phase circuit without harmonics

Dimensioning of a cable with the following characteristics:

- conductor material: : copper
- insulation material: : PVC
- type of cable: : multi-core
- installation: : cables bunched on horizontal perforated tray
- load current: : 100 A

Installation conditions:

- ambient temperature: : 40 °C
- adjacent circuits with
  - a) three-phase circuit consisting of 4 single-core cables, 4x50 mm<sup>2</sup>;
  - b) three-phase circuit consisting of one multi-core cable, 1x(3x50) mm<sup>2</sup>;
  - c) three-phase circuit consisting of 9 single-core (3 per phase) cables, 9x95 mm<sup>2</sup>;
  - d) single-phase circuit consisting of 2 single-core cables, 2x70 mm<sup>2</sup>.

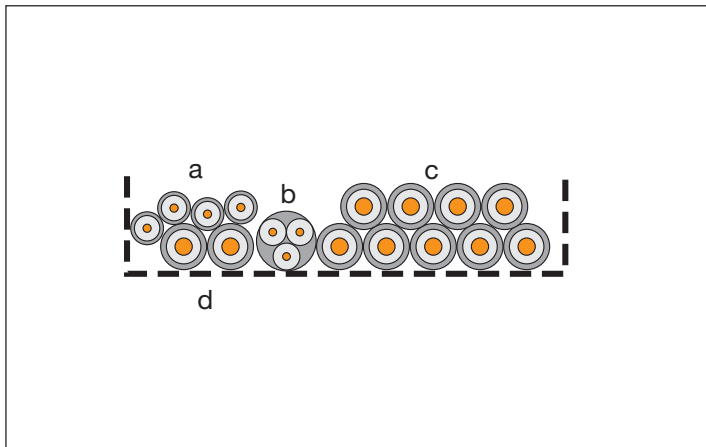

1SDC010008F0001

## 2 Protection of feeders

### Procedure:

Type of installation

In Table 3, it is possible to find the reference number of the installation and the method of installation to be used for the calculations. In this example, the reference number is 31, which corresponds to method E (multi-core cable on tray).

Correction factor of temperature  $k_1$

From Table 4, for a temperature of 40 °C and PVC insulation material,  $k_1 = 0.87$ .

$$k_1 = 0.87$$

Correction factor for adjacent cables  $k_2$

For the multi-core cables grouped on the perforated tray see Table 5. As a first step, the number of circuits or multi-core cables present shall be determined; given that:

- each circuit a), b) and d) constitute a separate circuit;
  - circuit c) consists of three circuits, since it is composed by three cables in parallel per phase;
  - the cable to be dimensioned is a multi-core cable and therefore constitutes a single circuit;
- the total number of circuits is 7.

Referring to the row for the arrangement (cables bunched) and to the column for the number of circuits (7)

$$k_2 = 0.54$$

After  $k_1$  and  $k_2$  have been determined,  $I'_b$  is calculated by:

$$I'_b = \frac{I_b}{k_1 k_2} = \frac{100}{0.87 \cdot 0.54} = 212.85 \text{ A}$$

From Table 8, for a multi-core copper cable with PVC insulation, method of installation E, with three loaded conductors, a cross section with current carrying capacity of  $I_0 \geq I'_b = 212.85 \text{ A}$ , is obtained. A 95 mm<sup>2</sup> cross section cable can carry, under Standard reference conditions, 238 A.

The current carrying capacity, according to the actual conditions of installation, is  $I_z = 238 \cdot 0.87 \cdot 0.54 = 111.81 \text{ A}$

## 2 Protection of feeders

### Example of dimensioning a cable in a balanced three-phase circuit with a significant third-harmonic content

Dimensioning of a cable with the following characteristics:

- conductor material: : copper
- insulation material: : PVC
- type of cable: : multi-core
- installation: : layer on horizontal perforated tray
- load current: : 115 A

Installation conditions:

- ambient temperature: : 30 °C
- no adjacent circuits.

#### Procedure:

Type of installation

On Table 3, it is possible to find the reference number of the installation and the method of installation to be used for the calculations. In this example, the reference number is 31, which corresponds to method E (multi-core cable on tray).

Temperature correction factor  $k_1$

From Table 4, for a temperature of 30 °C and PVC insulation material

$$k_1 = 1$$

Correction factor for adjacent cables  $k_2$

As there are no adjacent cables, so

$$k_2 = 1$$

After  $k_1$  and  $k_2$  have been determined,  $I'_b$  is calculated by:

$$I'_b = \frac{I_b}{k_1 k_2} = 115 \text{ A}$$

## 2 Protection of feeders

If no harmonics are present, from Table 8, for a multi-core copper cable with PVC insulation, method of installation E, with three loaded conductors, a cross section with current carrying capacity of  $I_0 \geq I'_b = 115 \text{ A}$ , is obtained. A 35 mm<sup>2</sup> cross section cable can carry, under Standard reference conditions, 126 A. The current carrying capacity, according to the actual conditions of installation, is still 126 A, since the value of factors  $k_1$  and  $k_2$  is 1.

The third harmonic content is assumed to be 28%.

Table 16 shows that for a third harmonic content of 28% the cable must be dimensioned for the current that flows through the phase conductors, but a reduction factor of 0.86 must be applied. The current  $I'_b$  becomes:

$$I'_b = \frac{I_b}{k_1 \cdot k_2 \cdot 0.86} = \frac{115}{0.86} = 133.7 \text{ A}$$

From Table 8, a 50 mm<sup>2</sup> cable with carrying capacity of 153 A shall be selected.

If the third harmonic content is 40 %, Table 16 shows that the cable shall be dimensioned according to the current of the neutral conductor and a reduction factor of 0.86 must be applied.

The current in the neutral conductor is:

$$I_N = \frac{I_b}{k_{tot}} \cdot 3 \cdot k_{III} = 115 \cdot 3 \cdot 0.4 = 138 \text{ A}$$

and the value of current  $I'_b$  is:

$$I'_b = \frac{I_N}{0.86} = \frac{138}{0.86} = 160.5 \text{ A}$$

From Table 8, a 70 mm<sup>2</sup> cable with 196 A current carrying capacity shall be selected.

If the third harmonic content is 60 %, Table 16 shows that the cable shall be dimensioned according to the current of the neutral conductor, but a reduction factor of 1 must be applied.

The current in the neutral conductor is:

$$I_N = \frac{I_b}{k_{tot}} \cdot 3 \cdot k_{III} = 115 \cdot 3 \cdot 0.6 = 207 \text{ A}$$

and current  $I'_b$  is:

$$I'_b = I_N = 207 \text{ A}$$

From Table 8, a 95 mm<sup>2</sup> cable with current carrying capacity of 238 A must be selected.

## 2 Protection of feeders

### 2.2.2 Voltage drop

In an electrical installation it is important to evaluate voltage drops from the point of supply to the load.

The performance of a device may be impaired if supplied with a voltage different from its rated voltage. For example:

- *motors*: the torque is proportional to the square of the supply voltage; therefore, if the voltage drops, the starting torque shall also decrease, making it more difficult to start up motors; the maximum torque shall also decrease;
- *incandescent lamps*: the more the voltage drops the weaker the beam becomes and the light takes on a reddish tone;
- *discharge lamps*: in general, they are not very sensitive to small variations in voltage, but in certain cases, great variation may cause them to switch off;
- *electronic appliances*: they are very sensitive to variations in voltage and that is why they are fitted with stabilizers;
- *electromechanical devices*: the reference Standard states that devices such as contactors and auxiliary releases have a minimum voltage below which their performances cannot be guaranteed. For a contactor, for example, the holding of the contacts becomes unreliable below 85% of the rated voltage.

To limit these problems the Standards set the following limits:

- IEC 60364-5-52 "Electrical installations of buildings. Selection and erection of electrical equipment - Wiring systems" Clause 525 states that "in the absence of other considerations it is recommended that in practice the voltage drop between the origin of consumer's installation and the equipment should not be greater than 4% of the rated voltage of the installation. Other considerations include start-up time for motors and equipment with high inrush current. Temporary conditions such as voltage transients and voltage variation due to abnormal operation may be disregarded".
- IEC 60204-1 "Safety of machinery – Electrical equipment of machines – General requirements" Clause 13.5 recommends that: "the voltage drop from the point of supply to the load shall not exceed 5% of the rated voltage under normal operating conditions".
- IEC 60364-7-714 "Electrical installations of buildings - Requirements for special installations or locations - External lighting installations" Clause 714.512 requires that "the voltage drop in normal service shall be compatible with the conditions arising from the starting current of the lamps".

## 2 Protection of feeders

### Voltage drop calculation

For an electrical conductor with impedance  $Z$ , the voltage drop is calculated by the following formula:

$$\Delta U = kZ I_b = k I_b \frac{L}{n} (r \cos \varphi + x \sin \varphi) \quad [V] \quad (1)$$

where

- $k$  is a coefficient equal to:
  - 2 for single-phase and two-phase systems;
  - $\sqrt{3}$  for three-phase systems;
- $I_b$  [A] is the load current; if no information are available, the cable carrying capacity  $I_z$  shall be considered;
- $L$  [km] is the length of the conductor;
- $n$  is the number of conductors in parallel per phase;
- $r$  [ $\Omega$ /km] is the resistance of the single cable per kilometre;
- $x$  [ $\Omega$ /km] is the reactance of the single cable per kilometre;
- $\cos \varphi$  is the power factor of the load:  $\sin \varphi = \sqrt{1 - \cos^2 \varphi}$ .

Normally, the percentage value in relation to the rated value  $U_r$  is calculated by:

$$\Delta u \% = \frac{\Delta U}{U_r} 100 \quad (2)$$

Resistance and reactance values per unit of length are set out on the following table by cross-sectional area and cable formation, for 50 Hz; in case of 60 Hz, the reactance value shall be multiplied by 1.2.



## 2 Protection of feeders

**Table 1: Resistance and reactance per unit of length of copper cables**

S [mm <sup>2</sup> ]	single-core cable		two-core/three-core cable	
	r[Ω/km] @ 80 [°C]	x[Ω/km]	r[Ω/km] @ 80 [°C]	x[Ω/km]
1.5	14.8	0.168	15.1	0.118
2.5	8.91	0.156	9.08	0.109
4	5.57	0.143	5.68	0.101
6	3.71	0.135	3.78	0.0955
10	2.24	0.119	2.27	0.0861
16	1.41	0.112	1.43	0.0817
25	0.889	0.106	0.907	0.0813
35	0.641	0.101	0.654	0.0783
50	0.473	0.101	0.483	0.0779
70	0.328	0.0965	0.334	0.0751
95	0.236	0.0975	0.241	0.0762
120	0.188	0.0939	0.191	0.074
150	0.153	0.0928	0.157	0.0745
185	0.123	0.0908	0.125	0.0742
240	0.0943	0.0902	0.0966	0.0752
300	0.0761	0.0895	0.078	0.075

**Table 2: Resistance and reactance per unit of length of aluminium cables**

S [mm <sup>2</sup> ]	single-core cable		two-core/three-core cable	
	r[Ω/km] @ 80 [°C]	x[Ω/km]	r[Ω/km] @ 80 [°C]	x[Ω/km]
1.5	24.384	0.168	24.878	0.118
2.5	14.680	0.156	14.960	0.109
4	9.177	0.143	9.358	0.101
6	6.112	0.135	6.228	0.0955
10	3.691	0.119	3.740	0.0861
16	2.323	0.112	2.356	0.0817
25	1.465	0.106	1.494	0.0813
35	1.056	0.101	1.077	0.0783
50	0.779	0.101	0.796	0.0779
70	0.540	0.0965	0.550	0.0751
95	0.389	0.0975	0.397	0.0762
120	0.310	0.0939	0.315	0.074
150	0.252	0.0928	0.259	0.0745
185	0.203	0.0908	0.206	0.0742
240	0.155	0.0902	0.159	0.0752
300	0.125	0.0895	0.129	0.075

## 2 Protection of feeders

The following tables show the  $\Delta U_x$  [V/(A·km)] values by cross section and formation of the cable according to the most common  $\cos\varphi$  values.

**Table 3: Specific voltage drop at  $\cos\varphi = 1$  for copper cables**

S[mm <sup>2</sup> ]	$\cos\varphi = 1$			
	single-core cable		two-core cable	three-core cable
	single-phase	three-phase	single-phase	three-phase
1.5	29.60	25.63	30.20	26.15
2.5	17.82	15.43	18.16	15.73
4	11.14	9.65	11.36	9.84
6	7.42	6.43	7.56	6.55
10	4.48	3.88	4.54	3.93
16	2.82	2.44	2.86	2.48
25	1.78	1.54	1.81	1.57
35	1.28	1.11	1.31	1.13
50	0.95	0.82	0.97	0.84
70	0.66	0.57	0.67	0.58
95	0.47	0.41	0.48	0.42
120	0.38	0.33	0.38	0.33
150	0.31	0.27	0.31	0.27
185	0.25	0.21	0.25	0.22
240	0.19	0.16	0.19	0.17
300	0.15	0.13	0.16	0.14

**Table 4: Specific voltage drop at  $\cos\varphi = 0.9$  for copper cables**

S[mm <sup>2</sup> ]	$\cos\varphi = 0.9$			
	single-core cable		two-core cable	three-core cable
	single-phase	three-phase	single-phase	three-phase
1.5	26.79	23.20	27.28	23.63
2.5	16.17	14.01	16.44	14.24
4	10.15	8.79	10.31	8.93
6	6.80	5.89	6.89	5.96
10	4.14	3.58	4.16	3.60
16	2.64	2.28	2.65	2.29
25	1.69	1.47	1.70	1.48
35	1.24	1.08	1.25	1.08
50	0.94	0.81	0.94	0.81
70	0.67	0.58	0.67	0.58
95	0.51	0.44	0.50	0.43
120	0.42	0.36	0.41	0.35
150	0.36	0.31	0.35	0.30
185	0.30	0.26	0.29	0.25
240	0.25	0.22	0.24	0.21
300	0.22	0.19	0.21	0.18

## 2 Protection of feeders

Table 5: Specific voltage drop at  $\cos\varphi = 0.85$  for copper cables

S[mm <sup>2</sup> ]	$\cos\varphi = 0.85$			
	single-core cable		two-core cable	three-core cable
	single-phase	three-phase	single-phase	three-phase
1.5	25.34	21.94	25.79	22.34
2.5	15.31	13.26	15.55	13.47
4	9.62	8.33	9.76	8.45
6	6.45	5.59	6.53	5.65
10	3.93	3.41	3.95	3.42
16	2.51	2.18	2.52	2.18
25	1.62	1.41	1.63	1.41
35	1.20	1.04	1.19	1.03
50	0.91	0.79	0.90	0.78
70	0.66	0.57	0.65	0.56
95	0.50	0.44	0.49	0.42
120	0.42	0.36	0.40	0.35
150	0.36	0.31	0.35	0.30
185	0.30	0.26	0.29	0.25
240	0.26	0.22	0.24	0.21
300	0.22	0.19	0.21	0.18

Table 6: Specific voltage drop at  $\cos\varphi = 0.8$  for copper cables

S[mm <sup>2</sup> ]	$\cos\varphi = 0.8$			
	single-core cable		two-core cable	three-core cable
	single-phase	three-phase	single-phase	three-phase
1.5	23.88	20.68	24.30	21.05
2.5	14.44	12.51	14.66	12.69
4	9.08	7.87	9.21	7.98
6	6.10	5.28	6.16	5.34
10	3.73	3.23	3.74	3.23
16	2.39	2.07	2.39	2.07
25	1.55	1.34	1.55	1.34
35	1.15	0.99	1.14	0.99
50	0.88	0.76	0.87	0.75
70	0.64	0.55	0.62	0.54
95	0.49	0.43	0.48	0.41
120	0.41	0.36	0.39	0.34
150	0.36	0.31	0.34	0.29
185	0.31	0.26	0.29	0.25
240	0.26	0.22	0.24	0.21
300	0.23	0.20	0.21	0.19

## 2 Protection of feeders

Table 7: Specific voltage drop at  $\cos\varphi=0.75$  for copper cables

S[mm <sup>2</sup> ]	$\cos\varphi = 0.75$			
	single-core cable		two-core cable	three-core cable
	single-phase	three-phase	single-phase	three-phase
1.5	22.42	19.42	22.81	19.75
2.5	13.57	11.75	13.76	11.92
4	8.54	7.40	8.65	7.49
6	5.74	4.97	5.80	5.02
10	3.52	3.05	3.52	3.05
16	2.26	1.96	2.25	1.95
25	1.47	1.28	1.47	1.27
35	1.10	0.95	1.08	0.94
50	0.84	0.73	0.83	0.72
70	0.62	0.54	0.60	0.52
95	0.48	0.42	0.46	0.40
120	0.41	0.35	0.38	0.33
150	0.35	0.31	0.33	0.29
185	0.30	0.26	0.29	0.25
240	0.26	0.23	0.24	0.21
300	0.23	0.20	0.22	0.19

Table 8: Specific voltage drop at  $\cos\varphi = 1$  for aluminium cables

S[mm <sup>2</sup> ]	$\cos\varphi = 1$			
	single-core cable		two-core cable	three-core cable
	single-phase	three-phase	single-phase	three-phase
1.5	48.77	42.23	49.76	43.09
2.5	29.36	25.43	29.92	25.91
4	18.35	15.89	18.72	16.21
6	12.22	10.59	12.46	10.79
10	7.38	6.39	7.48	6.48
16	4.65	4.02	4.71	4.08
25	2.93	2.54	2.99	2.59
35	2.11	1.83	2.15	1.87
50	1.56	1.35	1.59	1.38
70	1.08	0.94	1.10	0.95
95	0.78	0.67	0.79	0.69
120	0.62	0.54	0.63	0.55
150	0.50	0.44	0.52	0.45
185	0.41	0.35	0.41	0.36
240	0.31	0.27	0.32	0.28
300	0.25	0.22	0.26	0.22

## 2 Protection of feeders

Table 9: Specific voltage drop at  $\cos\varphi = 0.9$  for aluminium cables

S[mm <sup>2</sup> ]	$\cos\varphi = 0.9$			
	single-core cable		two-core cable	three-core cable
	single-phase	three-phase	single-phase	three-phase
1.5	44.04	38.14	44.88	38.87
2.5	26.56	23.00	27.02	23.40
4	16.64	14.41	16.93	14.66
6	11.12	9.63	11.29	9.78
10	6.75	5.84	6.81	5.89
16	4.28	3.71	4.31	3.73
25	2.73	2.36	2.76	2.39
35	1.99	1.72	2.01	1.74
50	1.49	1.29	1.50	1.30
70	1.06	0.92	1.06	0.91
95	0.78	0.68	0.78	0.68
120	0.64	0.55	0.63	0.55
150	0.53	0.46	0.53	0.46
185	0.44	0.38	0.44	0.38
240	0.36	0.31	0.35	0.30
300	0.30	0.26	0.30	0.26

Table 10: Specific voltage drop at  $\cos\varphi = 0.85$  for aluminium cables

S[mm <sup>2</sup> ]	$\cos\varphi = 0.85$			
	single-core cable		two-core cable	three-core cable
	single-phase	three-phase	single-phase	three-phase
1.5	41.63	36.05	42.42	36.73
2.5	25.12	21.75	25.55	22.12
4	15.75	13.64	16.02	13.87
6	10.53	9.12	10.69	9.26
10	6.40	5.54	6.45	5.58
16	4.07	3.52	4.09	3.54
25	2.60	2.25	2.63	2.27
35	1.90	1.65	1.91	1.66
50	1.43	1.24	1.43	1.24
70	1.02	0.88	1.01	0.88
95	0.76	0.66	0.76	0.65
120	0.63	0.54	0.61	0.53
150	0.53	0.46	0.52	0.45
185	0.44	0.38	0.43	0.37
240	0.36	0.31	0.35	0.30
300	0.31	0.27	0.30	0.26

## 2 Protection of feeders

Table 11: Specific voltage drop at  $\cos\varphi = 0.8$  for aluminium cables

S[mm <sup>2</sup> ]	$\cos\varphi = 0.8$			
	single-core cable		two-core cable	three-core cable
	single-phase	three-phase	single-phase	three-phase
1.5	39.22	33.96	39.95	34.59
2.5	23.67	20.50	24.07	20.84
4	14.85	12.86	15.09	13.07
6	9.94	8.61	10.08	8.73
10	6.05	5.24	6.09	5.27
16	3.85	3.34	3.87	3.35
25	2.47	2.14	2.49	2.16
35	1.81	1.57	1.82	1.57
50	1.37	1.18	1.37	1.18
70	0.98	0.85	0.97	0.84
95	0.74	0.64	0.73	0.63
120	0.61	0.53	0.59	0.51
150	0.51	0.45	0.50	0.44
185	0.43	0.38	0.42	0.36
240	0.36	0.31	0.34	0.30
300	0.31	0.27	0.30	0.26

Table 12: Specific voltage drop at  $\cos\varphi = 0.75$  for aluminium cables

S[mm <sup>2</sup> ]	$\cos\varphi = 0.75$			
	single-core cable		two-core cable	three-core cable
	single-phase	three-phase	single-phase	three-phase
1.5	36.80	31.87	37.47	32.45
2.5	22.23	19.25	22.58	19.56
4	13.95	12.08	14.17	12.27
6	9.35	8.09	9.47	8.20
10	5.69	4.93	5.72	4.96
16	3.63	3.15	3.64	3.15
25	2.34	2.02	2.35	2.03
35	1.72	1.49	1.72	1.49
50	1.30	1.13	1.30	1.12
70	0.94	0.81	0.92	0.80
95	0.71	0.62	0.70	0.60
120	0.59	0.51	0.57	0.49
150	0.50	0.43	0.49	0.42
185	0.42	0.37	0.41	0.35
240	0.35	0.31	0.34	0.29
300	0.31	0.27	0.29	0.25

## 2 Protection of feeders

### Example 1

To calculate a voltage drop on a three-phase cable with the following specifications:

- rated voltage: 400 V;
- cable length: 25 m;
- cable formation: single-core copper cable, 3x50 mm<sup>2</sup>;
- load current  $I_b$ : 100 A;
- power factor  $\cos\varphi$ : 0.9.

From Table 4, for a 50 mm<sup>2</sup> single-core cable it is possible to read that a  $\Delta U_x$  voltage drop corresponds to 0.81 V/(A·km). By multiplying this value by the length in km and by the current in A, it results:

$$\Delta U = \Delta U_x \cdot I_b \cdot L = 0.81 \cdot 100 \cdot 0.025 = 2.03 \text{ V}$$

which corresponds to this percentage value:

$$\Delta u\% = \frac{\Delta U}{U_r} \cdot 100 = \frac{2.03}{400} \cdot 100 = 0.51\%$$

### Example 2

To calculate a voltage drop on a three-phase cable with the following specifications:

- rated voltage: 690 V;
- cable length: 50 m;
- cable formation: multi-core copper cable, 2x(3x10) mm<sup>2</sup>;
- load current  $I_b$ : 50 A;
- power factor  $\cos\varphi$ : 0.85.

From Table 5, for a multi-core 10 mm<sup>2</sup> cable it is possible to read that  $\Delta U_x$  voltage drop corresponds to 3.42 V/(A·km). By multiplying this value by the length in km and by the current in A, and by dividing it by the number of cables in parallel, it results:

$$\Delta U = \Delta U_x \cdot I_b \cdot \frac{L}{2} = 3.42 \cdot 50 \cdot \frac{0.05}{2} = 4.28 \text{ V}$$

which corresponds to this percentage value:

$$\Delta u\% = \frac{\Delta U}{U_r} \cdot 100 = \frac{4.28}{690} \cdot 100 = 0.62\%$$

## 2 Protection of feeders

### Method for defining the cross section of the conductor according to voltage drop in the case of long cables

In the case of long cables, or if particular design specifications impose low limits for maximum voltage drops, the verification using as reference the cross section calculated on the basis of thermal considerations (calculation according to chapter 2.2.1 "Current carrying capacity and methods of installation") may have a negative result.

To define the correct cross section, the maximum  $\Delta U_{x\max}$  value calculated by using the formula:

$$\Delta U_{x\max} = \frac{\Delta u\% \cdot U_r}{100 \cdot I_b \cdot L} \quad (3)$$

is compared with the corresponding values on Tables 4+12 by choosing the smallest cross section with a  $\Delta U_x$  value lower than  $\Delta U_{x\max}$ .

### Example:

Supply of a three-phase load with  $P_u = 35 \text{ kW}$  ( $U_r = 400 \text{ V}$ ,  $f_r = 50 \text{ Hz}$ ,  $\cos\varphi = 0.9$ ) with a 140 m cable installed on a perforated tray, consisting of a multi-core copper cable with EPR insulation.

Maximum permitted voltage drop 2%.

Load current  $I_b$  is:

$$I_b = \frac{P_u}{\sqrt{3} \cdot U_r \cdot \cos\varphi} = \frac{35000}{\sqrt{3} \cdot 400 \cdot 0.9} = 56 \text{ A}$$

The Table 8 of Chapter 2.2.1 shows  $S = 10 \text{ mm}^2$ .

From Table 4, for the multi-core 10 mm<sup>2</sup> cable it is possible to read that the voltage drop per A and per km is 3.60 V/(A·km). By multiplying this value by the length in km and by the current in A, it results:

$$\Delta U = 3.60 \cdot I_b \cdot L = 3.6 \cdot 56 \cdot 0.14 = 28.2 \text{ V}$$

which corresponds to this percentage value:

$$\Delta u\% = \frac{\Delta U}{U_r} \cdot 100 = \frac{28.2}{400} \cdot 100 = 7.05\%$$

This value is too high.

Formula (3) shows:

$$\Delta U_{x\max} = \frac{\Delta u\% \cdot U_r}{100 \cdot I_b \cdot L} = \frac{2\% \cdot 400}{100 \cdot 56 \cdot 0.14} = 1.02 \text{ V/(A} \cdot \text{km)}$$

## 2 Protection of feeders

From Table 4 a cross section of 50 mm<sup>2</sup> can be chosen.

For this cross section  $\Delta U_x = 0.81 < 1.02 \text{ V/(A}\cdot\text{km)}$ .

By using this value it results:

$$\Delta U = \Delta U_x \cdot I_b \cdot L = 0.81 \cdot 56 \cdot 0.14 = 6.35 \text{ V}$$

This corresponds to a percentage value of:

$$\Delta u\% = \frac{\Delta U}{U_r} \cdot 100 = \frac{6.35}{400} \cdot 100 = 1.6\%$$

### 2.2.3 Joule-effect losses

Joule-effect losses are due to the electrical resistance of the cable.

The lost energy is dissipated in heat and contributes to the heating of the conductor and of the environment.

A first estimate of three-phase losses is:

$$P_j = \frac{3 \cdot r \cdot I_b^2 \cdot L}{1000} \text{ [W]}$$

whereas single-phase losses are:

$$P_j = \frac{2 \cdot r \cdot I_b^2 \cdot L}{1000} \text{ [W]}$$

where:

- $I_b$  is the load current [A];
- $r$  is the phase resistance per unit of length of the cable at 80 °C [ $\Omega/\text{km}$ ] (see Table 1);
- $L$  is the cable length [m].

**Table 1: Resistance values [ $\Omega/\text{km}$ ] of single-core and multi-core cables in copper and aluminium at 80 °C**

S [mm <sup>2</sup> ]	Single-core cable		Two-core/three-core cable	
	Cu	Al	Cu	Al
1.5	14.8	24.384	15.1	24.878
2.5	8.91	14.680	9.08	14.960
4	5.57	9.177	5.68	9.358
6	3.71	6.112	3.78	6.228
10	2.24	3.691	2.27	3.740
16	1.41	2.323	1.43	2.356
25	0.889	1.465	0.907	1.494
35	0.641	1.056	0.654	1.077
50	0.473	0.779	0.483	0.796
70	0.328	0.540	0.334	0.550
95	0.236	0.389	0.241	0.397
120	0.188	0.310	0.191	0.315
150	0.153	0.252	0.157	0.259
185	0.123	0.203	0.125	0.206
240	0.0943	0.155	0.0966	0.159
300	0.0761	0.125	0.078	0.129

## 2 Protection of feeders

### 2.3 Protection against overload

The Standard IEC 60364-4-43 "Electrical installation of buildings - Protection against overcurrent" specifies coordination between conductors and overload protective devices (normally placed at the beginning of the conductor to be protected) so that it shall satisfy the two following conditions:

$$I_b \leq I_n \leq I_z \quad (1)$$

$$I_2 \leq 1.45 \cdot I_z \quad (2)$$

Where:

- $I_b$  is the current for which the circuit is dimensioned;
- $I_z$  is the continuous current carrying capacity of the cable;
- $I_n$  is the rated current of the protective device; for adjustable protective releases, the rated current  $I_n$  is the set current;
- $I_2$  is the current ensuring effective operation in the conventional time of the protective device.

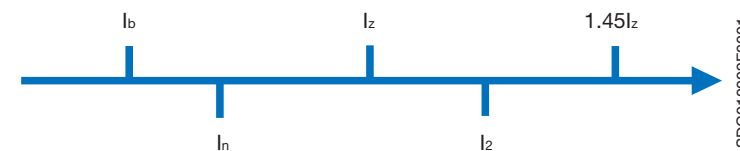

According to condition (1) to correctly choose the protective device, it is necessary to check that the circuit-breaker has a rated (or set) current that is:

- higher than the load current, to prevent unwanted tripping;
  - lower than the current carrying capacity of the cable, to prevent cable overload.
- The Standard allows an overload current that may be up to 45% greater than the current carrying capacity of the cable but only for a limited period (conventional trip time of the protective device).

The verification of condition (2) is not necessary in the case of circuit-breakers because the protective device is automatically tripped if:

- $I_2 = 1.3 \cdot I_n$  for circuit-breakers complying with IEC 60947-2 (circuit-breakers for industrial use);
- $I_2 = 1.45 \cdot I_n$  for circuit-breakers complying with IEC 60898 (circuit-breakers for household and similar installations).

Therefore, for circuit-breakers, if  $I_n \leq I_z$ , the formula  $I_2 \leq 1.45 \cdot I_z$  will also be verified.

When the protective device is a fuse, it is also essential to check formula (2) because IEC 60269-2-1 on "Low-voltage fuses" states that a  $1.6 \cdot I_n$  current must automatically melt the fuse. In this case, formula (2) becomes  $1.6 \cdot I_n \leq 1.45 \cdot I_z$  or  $I_n \leq 0.9 \cdot I_z$ .

## 2 Protection of feeders

**To summarize:** to carry out by a fuse protection against overload, the following must be achieved:

$$I_b \leq I_n \leq 0.9 \cdot I_z$$

and this means that the cable is not fully exploited.

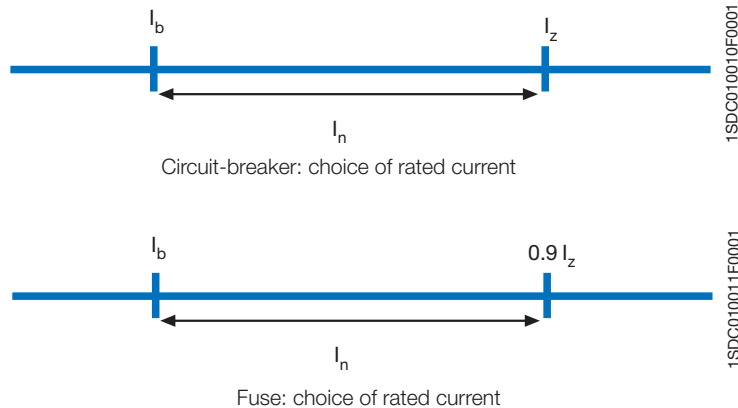

Where the use of a single conductor per phase is not feasible, and the currents in the parallel conductors are unequal, the design current and requirements for overload protection for each conductor shall be considered individually.

### Examples

#### Example 1

*Load specifications*

$P_r = 70 \text{ kW}$ ;  $U_r = 400 \text{ V}$ ;  $\cos\varphi = 0.9$ ; three-phase load so  $I_b = 112 \text{ A}$

*Cable specifications*

$I_z = 134 \text{ A}$

*Protective device specifications*

T1B160 TMD  $I_n 125$ ; set current  $I_1 = 125 \text{ A}$

## 2 Protection of feeders

#### Example 2

*Load specifications*

$P_r = 80 \text{ kW}$ ;  $\cos\varphi = 0.9$ ;  $U_r = 400 \text{ V}$ ; three-phase load so  $I_b = 128 \text{ A}$

*Cable specifications*

$I_z = 171 \text{ A}$

*Protective device specifications*

T2N160 PR221DS-LS  $I_n 160$ ; set current  $I_1 = 0.88 \times I_n = 140.8 \text{ A}$

#### Example 3

*Load specifications*

$P_r = 100 \text{ kW}$ ;  $\cos\varphi = 0.9$ ;  $U_r = 400 \text{ V}$ ; three-phase load so  $I_b = 160 \text{ A}$

*Cable specifications*

$I_z = 190 \text{ A}$

*Protective device specifications*

T3N250 TMD  $I_n 200$ ; set current  $I_1 = 0.9 \times I_n = 180 \text{ A}$

#### Example 4

*Load specifications*

$P_r = 25 \text{ kW}$ ;  $\cos\varphi = 0.9$ ;  $U_r = 230 \text{ V}$ ; single-phase load so  $I_b = 121 \text{ A}$

*Cable specifications*

$I_z = 134 \text{ A}$

*Protective device specifications*

T1B160 1P TMF  $I_n 125$

## 2 Protection of feeders

### 2.4 Protection against short-circuit

A cable is protected against short-circuit if the specific let-through energy of the protective device ( $I^2t$ ) is lower or equal to the withstood energy of the cable ( $k^2S^2$ ):

$$I^2t \leq k^2S^2 \quad (1)$$

where

- $I^2t$  is the specific let-through energy of the protective device which can be read on the curves supplied by the manufacturer (see *Electrical installation handbook*, Vol. 1, Chapter 3.4 "Specific let-through energy curves") or from a direct calculation in the case of devices that are not limiting and delaying;
- $S$  is the cable cross section [ $\text{mm}^2$ ]; in the case of conductors in parallel it is the cross section of the single conductor;
- $k$  is a factor that depends on the cable insulating and conducting material. The values of the most common installations are shown in Table 1; for a more detailed calculation, see Annex D.

**Table 1: Values of k for phase conductor**

	Conductor insulation					
	PVC $\leq 300 \text{ mm}^2$	PVC $> 300 \text{ mm}^2$	EPR XLPE	Rubber 60 °C	Mineral	
					PVC	Bare
<b>Initial temperature °C</b>	70	70	90	60	70	105
<b>Final temperature °C</b>	160	140	250	200	160	250
<b>Material of conductor:</b>						
<b>Copper</b>	115	103	143	141	115	135/115 <sup>a</sup>
<b>Aluminium</b>	76	68	94	93	-	-
<b>tin-soldered joints in copper conductors</b>	115	-	-	-	-	-

<sup>a</sup> This value shall be used for bare cables exposed to touch.

NOTE 1 Other values of k are under consideration for:  
- small conductors (particularly for cross section less than  $10 \text{ mm}^2$ );  
- duration of short-circuit exceeding 5 s;  
- other types of joints in conductors;  
- bare conductors.

NOTE 2 The nominal current of the short-circuit protective device may be greater than the current carrying capacity of the cable.

NOTE 3 The above factors are based on IEC 60724.

1SDC010010F0201

## 2 Protection of feeders

Table 2 shows the maximum withstood energy for cables according to the cross section, the conductor material and the type of insulation, which are calculated by using the parameters of Table 1.

**Table 2: Maximum withstood energy for cables  $k^2S^2$  [(kA)<sup>2</sup> s]**

Cable	k	Cross section [ $\text{mm}^2$ ]							
		1.5	2.5	4	6	10	16	25	35
PVC	Cu 115	$2.98 \cdot 10^{-2}$	$8.27 \cdot 10^{-2}$	$2.12 \cdot 10^{-1}$	$4.76 \cdot 10^{-1}$	1.32	3.39	8.27	$1.62 \cdot 10^1$
	Al 76	$1.30 \cdot 10^{-2}$	$3.61 \cdot 10^{-2}$	$9.24 \cdot 10^{-2}$	$2.08 \cdot 10^{-1}$	$5.78 \cdot 10^{-1}$	1.48	3.61	7.08
EPR/XLPE	Cu 143	$4.60 \cdot 10^{-2}$	$1.28 \cdot 10^{-1}$	$3.27 \cdot 10^{-1}$	$7.36 \cdot 10^{-1}$	2.04	5.23	$1.28 \cdot 10^1$	$2.51 \cdot 10^1$
	Al 94	$1.99 \cdot 10^{-2}$	$5.52 \cdot 10^{-2}$	$1.41 \cdot 10^{-1}$	$3.18 \cdot 10^{-1}$	$8.84 \cdot 10^{-1}$	2.26	5.52	$1.08 \cdot 10^1$
Rubber	Cu 141	$4.47 \cdot 10^{-2}$	$1.24 \cdot 10^{-1}$	$3.18 \cdot 10^{-1}$	$7.16 \cdot 10^{-1}$	1.99	5.09	$1.24 \cdot 10^1$	$2.44 \cdot 10^1$
	Al 93	$1.95 \cdot 10^{-2}$	$5.41 \cdot 10^{-2}$	$1.38 \cdot 10^{-1}$	$3.11 \cdot 10^{-1}$	$8.65 \cdot 10^{-1}$	2.21	5.41	$1.06 \cdot 10^1$

Cable	k	Cross section [ $\text{mm}^2$ ]							
		50	70	95	120	150	185	240	300
PVC	Cu 115	$3.31 \cdot 10^1$	$6.48 \cdot 10^1$	$1.19 \cdot 10^2$	$1.90 \cdot 10^2$	$2.98 \cdot 10^2$	$4.53 \cdot 10^2$	$7.62 \cdot 10^2$	$1.19 \cdot 10^3$
	Al 76	$1.44 \cdot 10^1$	$2.83 \cdot 10^1$	$5.21 \cdot 10^1$	$8.32 \cdot 10^1$	$1.30 \cdot 10^2$	$1.98 \cdot 10^2$	$3.33 \cdot 10^2$	$5.20 \cdot 10^2$
EPR/XLPE	Cu 143	$5.11 \cdot 10^1$	$1.00 \cdot 10^2$	$1.85 \cdot 10^2$	$2.94 \cdot 10^2$	$4.60 \cdot 10^2$	$7.00 \cdot 10^2$	$1.18 \cdot 10^3$	$1.84 \cdot 10^3$
	Al 94	$2.21 \cdot 10^1$	$4.33 \cdot 10^1$	$7.97 \cdot 10^1$	$1.27 \cdot 10^2$	$1.99 \cdot 10^2$	$3.02 \cdot 10^2$	$5.09 \cdot 10^2$	$7.95 \cdot 10^2$
G2	Cu 141	$4.97 \cdot 10^1$	$9.74 \cdot 10^1$	$1.79 \cdot 10^2$	$2.86 \cdot 10^2$	$4.47 \cdot 10^2$	$6.80 \cdot 10^2$	$1.15 \cdot 10^3$	$1.79 \cdot 10^3$
	Al 93	$2.16 \cdot 10^1$	$4.24 \cdot 10^1$	$7.81 \cdot 10^1$	$1.25 \cdot 10^2$	$1.95 \cdot 10^2$	$2.96 \cdot 10^2$	$4.98 \cdot 10^2$	$7.78 \cdot 10^2$

1SDC010002E0901

The formula (1) must be verified along the whole length of the cable. Due to the shape of the specific let-through energy curve of a circuit breaker, it is generally sufficient to verify formula (1) only for the maximum and minimum short-circuit current that may affect the cable. The maximum value is normally the value of the three-phase short-circuit current at the beginning of the line, while the minimum value is the value of the phase to neutral short-circuit current (phase to phase if the neutral conductor is not distributed) or phase to earth at the end of the cable.

## 2 Protection of feeders

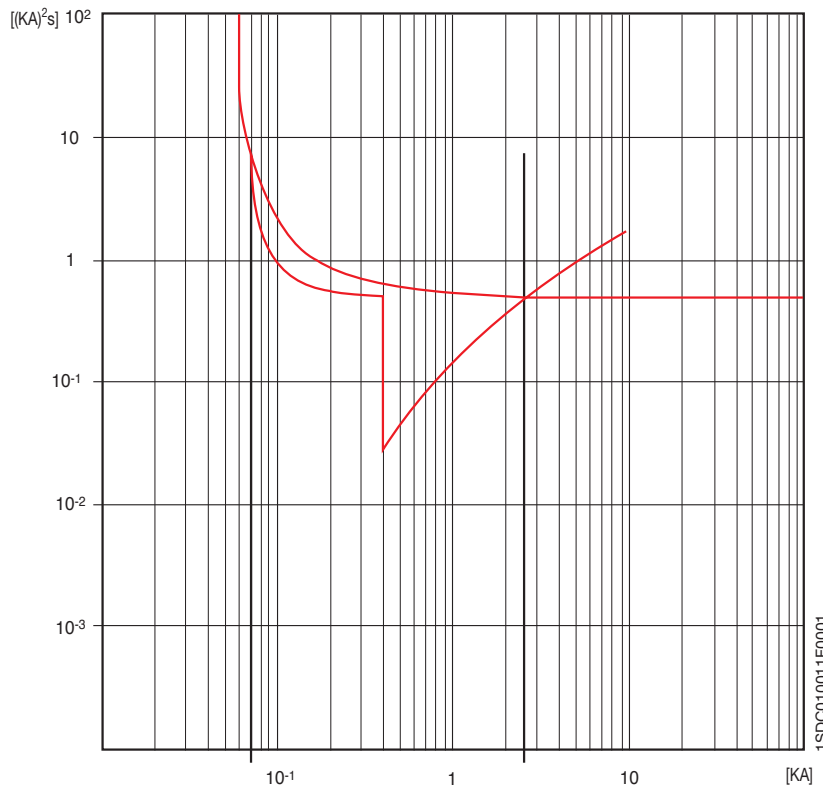

This verification can be simplified by comparing only the let-through energy value of the circuit-breaker at the maximum short-circuit current with the withstood energy of the cable and by ensuring that the circuit breaker trips instantaneously at the minimum short-circuit current: the threshold of the short-circuit protection (taking into consideration also the tolerances) shall therefore be lower than the minimum short-circuit current at the end of the conductor.

## 2 Protection of feeders

### Calculation of short-circuit current at end of the conductor

Minimum short-circuit current can be calculated by the following approximate formulas:

$$I_{kmin} = \frac{0.8 \cdot U_r \cdot k_{sec} \cdot k_{par}}{1.5 \cdot \rho \cdot \frac{2L}{S}} \quad \text{with non-distributed neutral conductor} \quad (2.1)$$

$$I_{kmin} = \frac{0.8 \cdot U_0 \cdot k_{sec} \cdot k_{par}}{1.5 \cdot \rho \cdot (1+m) \cdot \frac{L}{S}} \quad \text{with distributed neutral conductor} \quad (2.2)$$

where:

- $I_{kmin}$  is the minimum value of the prospective short-circuit current [kA];
- $U_r$  is the supply voltage [V];
- $U_0$  is the phase to earth supply voltage [V];
- $\rho$  is the resistivity at 20 °C of the material of the conductors in  $\Omega\text{mm}^2/\text{m}$  and is:
  - 0.018 for copper;
  - 0.027 for aluminium;
- $L$  is the length of the protected conductor [m];
- $S$  is the cross section of the conductor [ $\text{mm}^2$ ];
- $k_{sec}$  is the correction factor which takes into account the reactance of the cables with cross section larger than 95  $\text{mm}^2$ :

$S[\text{mm}^2]$	120	150	180	240	300
$k_{sec}$	0.9	0.85	0.80	0.75	0.72

- $k_{par}$  is the correcting coefficient for conductors in parallel:

number of parallel conductors	2	3	4	5
$k_{par}^*$	2	2.7	3	3.2

\* $k_{par} = 4 \cdot (n-1)/n$  where:  $n$  = number of conductors in parallel per phase

- $m$  is the ratio between the resistances of the neutral conductor and the phase conductor (if they are made of the same material  $m$  is the ratio between the cross section of the phase conductor and the cross section of the neutral conductor).

After calculating the minimum short-circuit current, verify that

$$I_{kmin} > 1.2 \cdot I_3 \quad (3)$$

where:

- $I_3$  is the current that trips the magnetic protection of the circuit-breaker;
- 1.2 is the tolerance at the trip threshold.



## 2 Protection of feeders

### Example

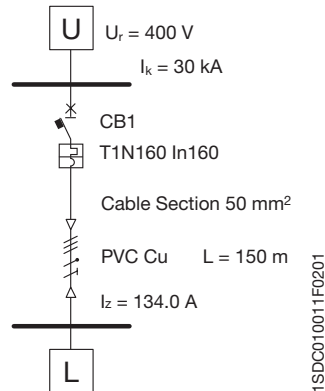

Choice of CB1

System data:  
 Rated voltage 400 V  
 $I_k = 30 \text{ kA}$

Cable data:  
 Insulated copper conductor in PVC  
 Length = 150 m  
 $S = 50 \text{ mm}^2$   
 $I_z = 134 \text{ A}$

Protection against short-circuit at the beginning of the conductor

T1N160 In160 (breaking capacity 36 kA@400 V)  
 $I^2t (@30 \text{ kA}) = 7.5 \cdot 10^{-1} \text{ (kA)}^2\text{s}$  (for the curves of specific let-through energy, see Volume 1, Chapter 3.4)  
 $k^2S^2 = 115^2 \cdot 50^2 = 3.31 \cdot 10^1 \text{ (kA)}^2\text{s}$   
 The cable is therefore protected against short-circuit at the beginning of the conductor.

Protection against short-circuit at end of the conductor

The minimum short-circuit current at end of the conductor ( $k_{sec}=1$  and  $k_{par}=1$ ) is:

$$I_{kmin} = \frac{0.8 \cdot U \cdot k_{sec} \cdot k_{par}}{1.5 \cdot \rho \cdot \frac{2L}{S}} = 1.98 \text{ kA}$$

The magnetic threshold of the circuit breaker T1N160 In160 is set at 1600 A. If tolerance is 20%, the circuit breaker shall definitely trip if the values exceed 1920 A; the cable is therefore fully protected against short-circuit.

### Maximum protected length

The formula (3), when solved for the length, enables the maximum length protected by the protective device to be obtained for a precise instantaneous trip threshold. In Table 3, the maximum protected length can be identified for a given cross section of the cable and for the setting threshold of the instantaneous protection of the circuit breaker against short-circuit:

- three-phase system, 400 V rated voltage;
- non-distributed neutral;
- copper conductor with resistivity equal to 0.018  $\Omega\text{mm}^2/\text{m}$ .

The values on the table below take into account the 20% tolerance coefficient for the magnetic trip value, the increase in cable resistivity due to heating caused by the short-circuit current and the reduction of voltage due to the fault.

The correction factors shown after the table must be applied if the system conditions are different from the reference conditions.

## 2 Protection of feeders

Table 3: Maximum protected length

$I_B$ [A]	section [mm <sup>2</sup> ]															
	1.5	2.5	4	6	10	16	25	35	50	70	95	120	150	185	240	300
20	370	617														
30	246	412	658													
40	185	309	494	741												
50	148	247	395	593												
60	123	206	329	494												
70	105	176	282	423	705											
80	92	154	246	370	617											
90	82	137	219	329	549											
100	74	123	197	296	494	790										
120	61	102	164	246	412	658										
140	52	88	141	211	353	564										
150	49	82	131	197	329	527										
160	46	77	123	185	309	494	772									
180	41	68	109	164	274	439	686									
200	37	61	98	148	247	395	617									
220	33	56	89	134	224	359	561	786								
250	29	49	79	118	198	316	494	691								
280	26	44	70	105	176	282	441	617								
300	24	41	65	98	165	263	412	576								
320	23	38	61	92	154	247	386	540	772							
350	21	35	56	84	141	226	353	494	705							
380	19	32	52	78	130	208	325	455	650							
400	18	30	49	74	123	198	309	432	617							
420	17	29	47	70	118	188	294	412	588							
450	16	27	43	65	110	176	274	384	549	768						
480	15	25	41	61	103	165	257	360	514	720						
500	14	24	39	59	99	158	247	346	494	691						
520	14	23	38	57	95	152	237	332	475	665						
550	13	22	35	53	90	144	224	314	449	629						
580	12	21	34	51	85	136	213	298	426	596	809					
600	12	20	32	49	82	132	206	288	412	576	782					
620	11	19	31	47	80	127	199	279	398	558	757					
650	11	19	30	45	76	122	190	266	380	532	722					
680	10	18	29	43	73	116	182	254	363	508	690					
700	10	17	28	42	71	113	176	247	353	494	670	847				
750	16	26	39	66	105	165	230	329	461	626	790	840				
800	15	24	37	62	99	154	216	309	432	586	667	787				
850	14	23	34	58	93	145	203	290	407	552	627	741				
900	13	21	32	55	88	137	192	274	384	521	593	700				
950	13	20	31	52	83	130	182	260	364	494	561	663				
1000	12	19	29	49	79	123	173	247	346	469	533	630	731			
1250	15	23	40	63	99	138	198	277	375	427	504	585	711			
1500	13	19	33	53	82	115	165	230	313	356	420	487	593			
1600	12	18	31	49	77	108	154	216	293	333	394	457	556	667		
2000	14	25	40	62	86	123	173	235	267	315	365	444	533			
2500	11	20	32	49	69	99	138	188	213	252	292	356	427			
3000	16	26	41	58	82	115	156	178	210	244	296	356				
3200	15	25	39	54	77	108	147	167	197	228	278	333				
4000	12	20	31	43	62	86	117	133	157	183	222	267				
5000	10	16	25	35	49	69	94	107	126	146	178	213				
6300	13	20	27	39	55	74	85	100	116	141	169					
8000	10	15	22	31	43	59	67	79	91	111	133					
9600	13	18	26	36	49	56	66	76	93	111						
10000	12	17	25	35	47	53	63	73	89	107						
12000	10	14	21	29	39	44	52	61	74	89						
15000	12	16	23	31	36	42	49	59	71							
20000	12	17	23	27	31	37	44	53								
24000	10	14	20	22	26	30	37	44								
30000	12	16	20	25	30	40	49									

## 2 Protection of feeders

Correction factor for voltage other than 400 V:  $k_v$

Multiply the length value obtained from the table by the correction factor  $k_v$ :

$U_r$ [V] (three-phase value)	$k_v$
230 <sup>(*)</sup>	0.58
400	1
440	1.1
500	1.25
690	1.73

<sup>(\*)</sup> 230 V single-phase is the equivalent of a three-phase 400 V system with distributed neutral and with the cross section of the phase conductor the same as the cross section area of the neutral conductor, so that  $k_v$  is 0.58.

Correction factor for distributed neutral:  $k_d$

Multiply the length value obtained from the table by the correction factor  $k_d$ :

$$k_d = \frac{2}{\sqrt{3}} \cdot \frac{1}{1 + \frac{S}{S_N}}$$

where

- $S$  is the phase cross section [mm<sup>2</sup>];
- $S_N$  is the neutral cross section [mm<sup>2</sup>].

In particular:

$$\text{if } S = S_N \rightarrow k_d \text{ is } 0.58;$$

$$\text{if } S = 2 \cdot S_N \rightarrow k_d \text{ is } 0.39.$$

Correction factor for aluminium conductors:  $k_r$

If the cable is in aluminium, multiply the length value obtained from the table above by the correction factor  $k_r = 0.67$ .

## 2 Protection of feeders

To summarize:

On the table, for the cross section and magnetic trip threshold it is possible to read a maximum protected value  $L_0$ . This length shall then be multiplied, if necessary, by the correction factors in order to obtain a value that is compatible with the installation operating conditions:

$$L = L_0 k_v k_d k_r$$

### Example 1

Neutral not distributed

Rated voltage = 400 V

Protective device: T2N160 TMD In100

Magnetic threshold:  $I_3 = 1000$  A

Phase cross section = Neutral cross section = 70 mm<sup>2</sup>

The table shows that at  $I_3 = 1000$  A, the 70 mm<sup>2</sup> cable is protected up to 346 m.

### Example 2

Neutral distributed

Rated voltage = 400 V

Protective device: T3S250 TMD In200

Magnetic threshold:  $I_3 = 2000$  A

Phase cross section = 300 mm<sup>2</sup>

Neutral cross section = 150 mm<sup>2</sup>

For  $I_3 = 2000$  A and  $S = 300$  mm<sup>2</sup>, a protected length equivalent of  $L_0 = 533$  m is obtained.

By applying the correction factor  $k_d$  required when the neutral is distributed:

$$k_d = \frac{2}{\sqrt{3}} \cdot \frac{1}{1 + \frac{S}{S_N}} = \frac{2}{\sqrt{3}} \cdot \frac{1}{1 + \frac{300}{150}} = 0.39$$

$$L = L_0 \cdot 0.39 = 533 \cdot 0.39 = 207.9 \text{ m}$$

This is the maximum protected length with neutral distributed.

## 2 Protection of feeders

### 2.5 Neutral and protective conductors

#### Neutral conductor

The neutral conductor is a conductor that is connected to the system neutral point (which generally but not necessarily coincides with the star centre of the secondary windings of the transformer or the windings of the generator); it is able to contribute to the transmission of electric power, thereby making available a voltage that is different from the phase to phase voltage. In certain cases and under specific conditions, the functions of neutral conductor and protective conductor can be combined in a single conductor (PEN).

#### Protection and disconnection of the neutral conductor

If fault conditions arise, a voltage to earth may occur on the neutral conductor. This may be caused by a phase to neutral short-circuit and by the disconnection of the neutral conductor due to accidental breaking or to tripping of single-pole devices (fuses or single-pole circuit breakers).

If the neutral conductor only is disconnected in a four-conductor circuit, the supply voltage to the single-phase loads may be altered so that they are supplied by a voltage different from the  $U_0$  phase to neutral voltage (as shown in Fig. 1). Therefore, all the necessary measures to prevent this type of fault shall be taken, e.g. by not protecting the neutral conductor with single-pole devices.

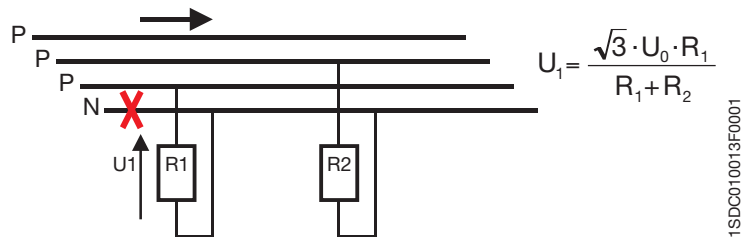

**Figure 1: Disconnection of the neutral conductor**

Moreover, in TN-C systems, voltage to earth arising on the neutral conductor constitutes a hazard for people; in fact, since this conductor is also a protective conductor, this voltage reaches the connected exposed conductive parts. For TN-C systems, the Standards specify minimum cross sections (see next clause) for the neutral conductor in order to prevent accidental breaking and they forbid the use of any device (single-pole or multi-pole) that could disconnect the PEN. The need for protection on the neutral conductor and the possibility of disconnecting the circuit depend on the distribution system:

1SDC010013F0001

## 2 Protection of feeders

*TT or TN systems:*

- if the cross section of the neutral conductor is the same or larger than the cross section of the phase conductor, there is neither the need to detect overcurrents on the neutral conductor nor to use a breaking device (neutral conductor is not protected or disconnected); this requirement applies only if there are no harmonics that may, at any instant, cause r.m.s. current values on the neutral conductor higher than the maximum current detected on the phase conductors;
- if the cross section of the neutral conductor is less than the cross section of the phase conductor, overcurrents on the neutral conductor must be detected so as to have the phase conductors, but not necessarily the neutral conductor, disconnected (neutral conductor protected but not disconnected): in this case the overcurrents on the neutral conductor do not need to be detected if the following conditions are simultaneously fulfilled:
  1. the neutral conductor is protected against short-circuit by the protective device of the phase conductors;
  2. the maximum current that can flow through the neutral conductor during normal service is lower than the neutral current carrying capacity.

In TN-S systems, the neutral need not be disconnected if the supply conditions are such that the neutral conductor can be considered to be reliable at earth potential. As already mentioned, in TN-C systems, the neutral conductor is also a protective conductor and cannot therefore be disconnected. Furthermore, if the neutral conductor is disconnected, the exposed conductive parts of the single-phase equipment could take the system rated voltage to earth. In certain specific cases, the neutral conductor has to be disconnected to prevent currents circulating between parallel supply sources (see Figures 2 and 3).

**Figure 2: Three-phase alternative power supply with a 4-pole switch**

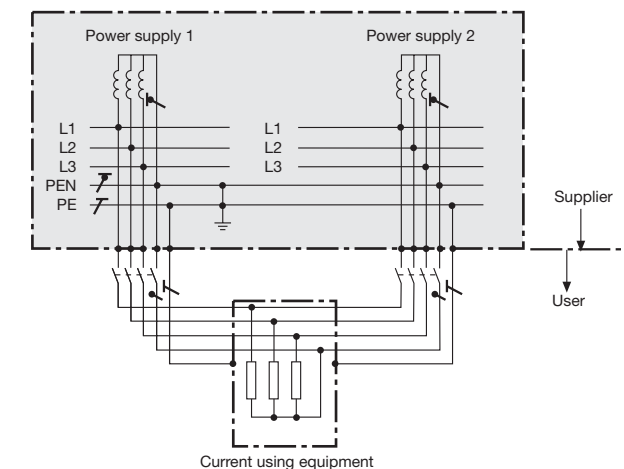

NOTE - This method prevents electromagnetic fields due to stray currents in the main supply system of an installation. The sum of the currents within one cable must be zero. This ensures that the neutral current will flow only in the neutral conductor of the respective switched on circuit. The 3rd harmonic (150 Hz) current of the line conductors will be added with the same phase angle to the neutral conductor current.

1SDC010012F0201

## 2 Protection of feeders

**Figure 3: Three-phase alternative power supply with non-suitable 3-pole switch**

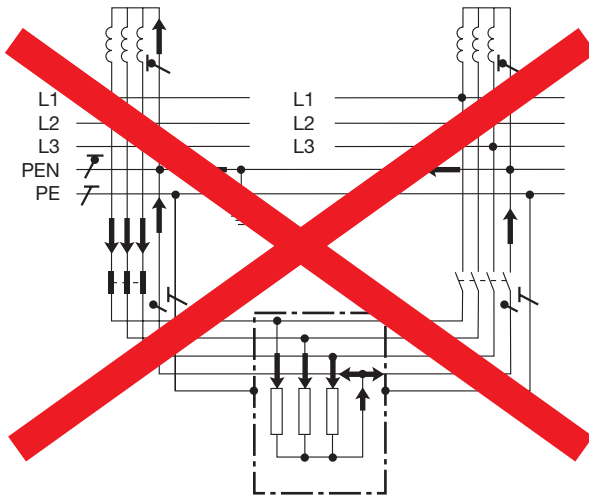

NOTE – A three-phase alternative power supply with a non-suitable 3-pole switch, due to unintentional circular stray currents generating electromagnetic fields.

*IT system:*

The Standard advises against distributing the neutral conductor in IT systems. If the neutral conductor is distributed, the overcurrents must be detected on the neutral conductor of each circuit in order to disconnect all the live conductors on the corresponding circuit, including the neutral one (neutral conductor protected and disconnected).

Overcurrents do not need to be detected on the neutral conductor in any of the following cases:

- the neutral conductor is protected against short-circuit by a protective device fitted upstream;
- the circuit is protected by a residual current device with rated residual current lower than 0.15 times the current carrying capacity of the corresponding neutral conductor. This device must disconnect all the live conductors, the neutral conductor included.

For all distribution systems, whenever necessary, connection and disconnection of the neutral conductor, shall ensure that:

- the neutral conductor is not disconnected before the phase conductor;
- the neutral conductor is connected at the same moment or before the phase conductor.

1SDC010014F0001

## 2 Protection of feeders

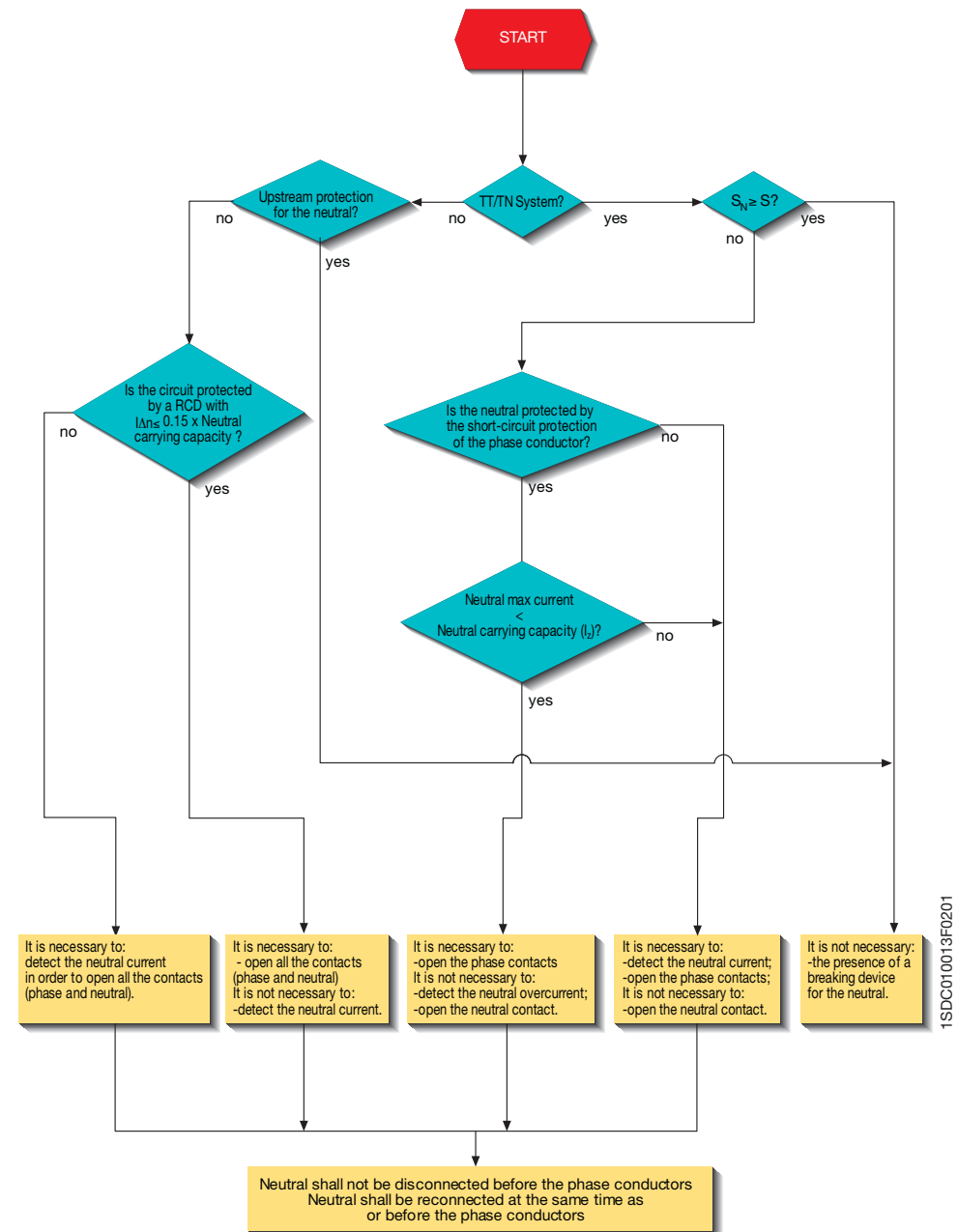

1SDC010013F0201

## 2 Protection of feeders

### Determination of the minimum cross section of the neutral conductor

The neutral conductor, if any, shall have the same cross section as the line conductor:

- in single-phase, two-wire circuits whatever the section;
- in polyphase and single-phase three-wire circuits, when the size of the line conductors is less than or equal to 16 mm<sup>2</sup> in copper, or 25 mm<sup>2</sup> in aluminium.<sup>1</sup>

The cross section of the neutral conductor can be less than the cross section of the phase conductor when the cross section of the phase conductor is greater than 16 mm<sup>2</sup> with a copper cable, or 25 mm<sup>2</sup> with an aluminium cable, if both the following conditions are met:

- the cross section of the neutral conductor is at least 16 mm<sup>2</sup> for copper conductors and 25 mm<sup>2</sup> for aluminium conductors;
- there is no high harmonic distortion of the load current. If there is high harmonic distortion (the harmonic content is greater than 10%), as for example in equipment with discharge lamps, the cross section of the neutral conductor cannot be less than the cross section of the phase conductors.

**Table 1: Minimum cross sections of the neutral conductor**

	Phase cross section S [mm <sup>2</sup> ]	Min. neutral cross section S <sub>N</sub> [mm <sup>2</sup> ]
<b>Single-phase/two-phase circuits</b>		
Cu/Al	Any	S*
<b>Three-phase circuits</b>		
Cu	S ≤ 16	S*
	S > 16	16
<b>Three-phase circuits</b>		
Al	S ≤ 25	S*
	S > 25	25

\*for TN-C systems, the Standards specify a minimum cross section of 10 mm<sup>2</sup> for copper and 16 mm<sup>2</sup> for aluminium conductors

<sup>1</sup> The cross section of phase conductors shall be dimensioned in compliance with the instructions of the Chapter 2.2.1 "Current carrying capacity and methods of installation"

## 2 Protection of feeders

### Protective conductor

#### Determination of the minimum cross sections

The minimum cross section of the protective conductor can be determined by using the following table:

**Table 2: Cross section of the protective conductor**

Cross section of line conductor S [mm <sup>2</sup> ]	Minimum cross section of the corresponding protective conductor [mm <sup>2</sup> ]	
	If the protective conductor is of the same material as the line conductor	If the protective conductor is not of the same material as the line conductor
S ≤ 16	S	$\frac{k_1}{k_2} \cdot S$
16 < S ≤ 25	16*	$\frac{k_1}{k_2} \cdot 16$
S > 25	$\frac{S}{2}$	$\frac{k_1}{k_2} \cdot \frac{S}{2}$

Where

k<sub>1</sub> is the value of k for the line conductor, selected from Table 1 Chapter 2.4 according to the materials of the conductor and insulation;

k<sub>2</sub> is the value of k for the protective conductor.

\* For a PEN conductor, the reduction of the cross section is permitted only in accordance with the rules for sizing of the neutral conductor.

1SDC010014F0201

For a more accurate calculation and if the protective conductor is subjected to adiabatic heating from an initial known temperature to a final specified temperature (applicable for fault extinction time no longer than 5s), the minimum cross section of the protective conductor S<sub>PE</sub> can be obtained by using the following formula:

$$S_{PE} = \frac{\sqrt{I^2 t}}{k} \quad (1)$$

where:

- S<sub>PE</sub> is the cross section of the protective conductor [mm<sup>2</sup>];
- I is the r.m.s. current flowing through the protective conductor in the event of a fault with low impedance [A];
- t is the trip time of the protective device [s];

## 2 Protection of feeders

- $k$  is a constant which depends on the material of the protective conductor, on the type of insulation and on initial and final temperature. The most common values can be taken from Tables 3 and 4.

**Table 3: Values of  $k$  for insulated protective conductors not incorporated in cables and not bunched with other cables**

Conductor insulation	Temperature °C <sup>b</sup>		Material of conductor		
	Initial	Final	Copper	Aluminium	Steel
			Values for $k$		
70 °C PVC	30	160/140 <sup>a</sup>	143/133 <sup>a</sup>	95/88 <sup>a</sup>	52/49 <sup>a</sup>
90 °C PVC	30	143/133 <sup>a</sup>	143/133 <sup>a</sup>	95/88 <sup>a</sup>	52/49 <sup>a</sup>
90 °C thermosetting	30	250	176	116	64
60 °C rubber	30	200	159	105	58
85 °C rubber	30	220	168	110	60
Silicon rubber	30	350	201	133	73

<sup>a</sup> The lower value applies to PVC insulated conductors of cross section greater than 300 mm<sup>2</sup>.  
<sup>b</sup> Temperature limits for various types of insulation are given in IEC 60724.

1SDC010015F0201

## 2 Protection of feeders

Further values of  $k$  can be taken from the Tables in Annex D, which provides the formula for accurate calculation of the value of  $k$ .

If Table 2 or formula (1) do not provide a standardized cross section, a larger standardized cross section shall be chosen.

Regardless of whether Table 2 or formula (1) are used, the cross section of the protective conductor, which is not part of the supply cable, shall be at least:

- 2.5 mm<sup>2</sup> Cu/16 mm<sup>2</sup> Al, if a mechanical protection is provided;
- 4 mm<sup>2</sup> Cu/16 mm<sup>2</sup> Al, if no mechanical protection is provided.

For current using equipment intended for permanent connection and with a protective conductor current exceeding 10 mA, reinforced protective conductors shall be designed as follows:

- either the protective conductor shall have a cross-sectional area of at least 10 mm<sup>2</sup> Cu or 16 mm<sup>2</sup> Al, through its total run;
- or a second protective conductor of at least the same cross-sectional area as required for protection against indirect contact shall be laid up to a point where the protective conductor has a cross-sectional area not less than 10 mm<sup>2</sup> Cu or 16 mm<sup>2</sup> Al. This requires that the appliance has a separate terminal for a second protective conductor.

When overcurrent protective devices are used for protection against electric shock, the protective conductor shall be incorporated in the same wiring system as the live conductors or be located in their immediate proximity.

**Table 4: Values of  $k$  for protective conductors as a core incorporated in a cable or bunched with other cables or insulated conductors**

Conductor insulation	Temperature °C <sup>b</sup>		Material of conductor		
	Initial	Final	Copper	Aluminium	Steel
			Values for $k$		
70 °C PVC	70	160/140 <sup>a</sup>	115/103 <sup>a</sup>	76/68 <sup>a</sup>	42/37 <sup>a</sup>
90 °C PVC	90	160/140 <sup>a</sup>	100/86 <sup>a</sup>	66/57 <sup>a</sup>	36/31 <sup>a</sup>
90 °C thermosetting	90	250	143	94	52
60 °C rubber	60	200	141	93	51
85 °C rubber	85	220	134	89	48
Silicon rubber	180	350	132	87	47

<sup>a</sup> The lower value applies to PVC insulated conductors of cross section greater than 300 mm<sup>2</sup>.  
<sup>b</sup> Temperature limits for various types of insulation are given in IEC 60724.

1SDC010015F0201

## 2 Protection of feeders

### 2.6 Busbar trunking systems (BTSs)

In electrical installations for industrial environments, busbar trunking systems (BTSs) optimize the power distribution despite the inevitable modifications that are carried out (additions, displacements, replacement of loads) and to facilitate maintenance work and safety verifications.

They are mainly used for:

- supplying sources of light, safety and low power distribution;
- lighting lines (medium power);
- power supply and distribution (medium and large power);
- supplying moving equipment (bridge cranes).

Busbar trunking systems are subject to the following Standards:

- IEC 60439 – 1 “Low-voltage switchgear and controlgear assemblies – Part 1: Type-tested and partially type-tested assemblies”
- IEC 60439 – 2 “Low-voltage switchgear and controlgear assemblies – Part 2: Particular requirements for busbar trunking systems (busways)”.

BTSs consist of:

- *conductors/busbars*;
- *coupling*: electrical and mechanical connecting elements for different elements;
- *straight elements*: base elements of the line for carrying energy from the source to the loads;
- *routing elements*: flexible joints for the creation of curves or overcoming obstacles, horizontal and vertical angles, tee joints and cross elements to create any type of route;
- *pull boxes*: elements that enable lamps or operating machines to be supplied directly with integrated protection (fuses or circuit breakers);
- *suspensions/accessories*: hanging and fixing elements for BTS and for any support required for special loads (lighting components, etc).

### Dimensioning of a BTS

To dimension a BTS, the load current must be determined using the following data:

*Power supply*

- General type of load supply:
  - single-phase
  - three-phase.
- Type of BTS supply:
  - from one end;
  - from both ends;
  - central power supply.
- Rated voltage
- Short-circuit current at the supply point
- Ambient temperature.

*Loads*

- Number, distribution, power and  $\cos\varphi$  and type of loads supplied by the same BTS

## 2 Protection of feeders

*BTS geometry*

- Type of installation:
  - flat;
  - edge-on;
  - vertical.
- Length.

NOTE: BTSs shall be placed at a distance from the walls and the ceilings in such a way as to enable visual inspection of connections during assembly and to facilitate insertion of the branch units.

If possible, it is preferable to install the BTS edge-on so as to improve mechanical resistance and reduce any possible deposit of powder and polluting substances that might affect the level of internal insulation.

### Load current calculation for three-phase system

Load current  $I_b$  for a three-phase system is calculated by the following formula:

$$I_b = \frac{P_t \cdot b}{\sqrt{3} \cdot U_r \cdot \cos\varphi_m} \quad [\text{A}] \quad (1)$$

where:

- $P_t$  is the sum of the active power of all the installed loads [W];
- $b$  is the supply factor, which is:
  - 1 if the BTS is supplied from one side only;
  - 1/2 if the BTS is supplied from the centre or from both ends simultaneously;
- $U_r$  is the operating voltage [V];
- $\cos\varphi_m$  is the average power factor of the loads.

### Choice of BTS current carrying capacity

A BTS shall be chosen so that its current carrying capacity  $I_z$  complies with the following formula:

$$I_b \leq I_{z0} \cdot k_t = I_z \quad (2)$$

where:

- $I_{z0}$  is the current that the BTS can carry for an indefinite time at the reference temperature (40 °C);
- $I_b$  is the load current;
- $k_t$  is the correction factor for ambient temperature values other than the reference ambient temperature shown on Table 1.

**Table 1: Correction factor  $k_t$  for ambient temperature other than 40 °C**

Ambient Temperature [°C]	15	20	25	30	35	40	45	50
$k_t$	1.2	1.17	1.12	1.08	1.05	1	0.95	0.85

## 2 Protection of feeders

Note: the following tables refer to Zucchini S.p.A. products

**Table 2: Current carrying capacity  $I_{z0}$  of copper BTS**

Size	Type	Number of conductors	$I_{z0}$ [A]	$r_{ph}^*$ [mΩ/m]	$x_{ph}$ [mΩ/m]	$U_r$ [V]
25	LB254 25A 4 cond. Cu	4	25	6.964	1.144	400
25	HL254 25A 4 cond. Cu	4	25	6.876	1.400	400
25	HL2544 25A 4+4 cond. Cu	4+4	25	6.876	1.400	400
40	LB404 40A 4 cond. Cu	4	40	3.556	0.792	400
40	HL404 40A 4 cond. Cu	4	40	3.516	1.580	400
40	HL4044 40A 4+4 cond. Cu	4+4	40	3.516	1.580	400
40	SL 40A 4 cond. Cu	4	40	2.173	0.290	400
63	SL 63A 4 cond. Cu	4	63	1.648	0.637	400
100	MS 100A 4 cond. Cu	4	100	0.790	0.366	400
160	MS 160A 4 cond. Cu	4	160	0.574	0.247	400
160	SB4 160A 4 cond. Cu	4	160	0.335	0.314	500
160	SB5 160A 5 cond. Cu	5	160	0.335	0.314	500
160	SB6 160A 5 cond. Cu	5	160	0.335	0.314	500
160	SB7 160A 4 cond. Cu	4	160	0.335	0.314	500
250	MR 250A 4 cond. Cu	4	250	0.285	0.205	1000
250	MRf 250A 5 cond. Cu	5	250	0.285	0.205	1000
250	SB4 250A 4 cond. Cu	4	250	0.194	0.205	500
250	SB5 250A 5 cond. Cu	5	250	0.194	0.205	500
250	SB6 250A 5 cond. Cu	5	250	0.194	0.205	500
250	SB7 250A 4 cond. Cu	4	250	0.194	0.205	500
315	MR 315A 4 cond. Cu	4	315	0.216	0.188	1000
315	MRf 315A 5 cond. Cu	5	315	0.216	0.188	1000
350	SB4 350A 4 cond. Cu	4	350	0.142	0.188	500
350	SB5 350A 5 cond. Cu	5	350	0.142	0.188	500
350	SB6 350A 5 cond. Cu	5	350	0.142	0.188	500
350	SB7 350A 4 cond. Cu	4	350	0.142	0.188	500
400	MR 400A 4 cond. Cu	4	400	0.115	0.129	1000
400	MRf 400A 5 cond. Cu	5	400	0.115	0.129	1000
500	SB4 500A 4 cond. Cu	4	500	0.092	0.129	500
500	SB5 500A 5 cond. Cu	5	500	0.092	0.129	500
500	SB6 500A 5 cond. Cu	5	500	0.092	0.129	500
500	SB7 500A 4 cond. Cu	4	500	0.092	0.129	500
630	MR 630A 4 cond. Cu	4	630	0.073	0.122	1000
630	MRf 630A 5 cond. Cu	5	630	0.073	0.122	1000
700	SB4 700A 4 cond. Cu	4	700	0.077	0.122	500
700	SB5 700A 5 cond. Cu	5	700	0.077	0.122	500

## 2 Protection of feeders

Size	Type	Number of conductors	$I_{z0}$ [A]	$r_{ph}^*$ [mΩ/m]	$x_{ph}$ [mΩ/m]	$U_r$ [V]
700	SB6 700A 5 cond. Cu	5	700	0.077	0.122	500
700	SB7 700A 4 cond. Cu	4	700	0.077	0.122	500
800	MR 800A 4 cond. Cu	4	800	0.047	0.122	1000
800	MRf 800A 5 cond. Cu	5	800	0.047	0.122	1000
800	SC 800A 4 cond. Cu	4	800	0.038	0.027	1000
800	SB4 800A 4 cond. Cu	4	800	0.072	0.122	500
800	SB5 800A 5 cond. Cu	5	800	0.072	0.122	500
800	SB6 800A 5 cond. Cu	5	800	0.072	0.122	500
800	SB7 800A 4 cond. Cu	4	800	0.072	0.122	500
1000	MR 1000A 4 cond. Cu	4	1000	0.038	0.120	1000
1000	MRf 1000A 5 cond. Cu	5	1000	0.038	0.120	1000
1000	SC 1000A 4 cond. Cu	4	1000	0.037	0.026	1000
1000	HRC1 1000A 4 cond. Cu	4	1000	0.038	0.097	1000
1000	SB4 1000A 4 cond. Cu	4	1000	0.068	0.120	500
1000	SB5 1000A 5 cond. Cu	5	1000	0.068	0.120	500
1000	SB6 1000A 5 cond. Cu	5	1000	0.068	0.120	500
1000	SB7 1000A 4 cond. Cu	4	1000	0.068	0.120	500
1200	SC 1200A 4 cond. Cu	4	1200	0.035	0.021	1000
1250	SC 1250A 4 cond. Cu	4	1250	0.034	0.023	1000
1250	HRC1 1250A 4 cond. Cu	4	1250	0.035	0.076	1000
1500	SC 1500A 4 cond. Cu	4	1500	0.030	0.022	1000
1600	SC 1600A 4 cond. Cu	4	1600	0.025	0.018	1000
1600	HRC1 1600A 4 cond. Cu	4	1600	0.034	0.074	1000
2000	SC 2000A 4 cond. Cu	4	2000	0.020	0.015	1000
2000	HRC1 2000A 4 cond. Cu	4	2000	0.025	0.074	1000
2400	SC 2400A 4 cond. Cu	4	2400	0.019	0.012	1000
2500	SC 2500A 4 cond. Cu	4	2500	0.016	0.011	1000
2500	HRC1 2500A 4 cond. Cu	4	2500	0.019	0.040	1000
3000	SC 3000A 4 cond. Cu	4	3000	0.014	0.011	1000
3000	HRC2 3000A 4 cond. Cu	4	3000	0.017	0.031	1000
3200	SC 3200A 4 cond. Cu	4	3200	0.013	0.009	1000
3200	HRC2 3200A 4 cond. Cu	4	3200	0.015	0.031	1000
4000	SC 4000A 4 cond. Cu	4	4000	0.011	0.007	1000
4000	HRC2 4000A 4 cond. Cu	4	4000	0.011	0.026	1000
5000	SC 5000A 4 cond. Cu	4	5000	0.008	0.005	1000
5000	HRC2 5000A 4 cond. Cu	4	5000	0.008	0.023	1000

\*phase resistance at  $I_{z0}$



## 2 Protection of feeders

Table 3: Current carrying capacity  $I_{z0}$  of aluminium BTS

Size	Type	Number of conductors	$I_{z0}$ [A]	$r_{ph}^*$ [mΩ/m]	$x_{ph}$ [mΩ/m]	$U_r$ [V]
160	MR 160A 4 cond. Al	4	160	0.591	0.260	1000
160	MRf 160A 5 cond. Al	5	160	0.591	0.260	1000
160	SB4 160A 4 cond. Al	4	160	0.431	0.260	500
160	SB5 160A 5 cond. Al	5	160	0.431	0.260	500
160	SB6 160A 5 cond. Al	5	160	0.431	0.260	500
160	SB7 160A 4 cond. Al	4	160	0.431	0.260	500
250	MR 250A 4 cond. Al	4	250	0.394	0.202	1000
250	MRf 250A 5 cond. Al	5	250	0.394	0.202	1000
250	SB4 250A 4 cond. Al	4	250	0.226	0.202	500
250	SB5 250A 5 cond. Al	5	250	0.226	0.202	500
250	SB6 250A 5 cond. Al	5	250	0.226	0.202	500
250	SB7 250A 4 cond. Al	4	250	0.226	0.202	500
315	MR 315A 4 cond. Al	4	315	0.236	0.186	1000
315	MRf 315A 5 cond. Al	5	315	0.236	0.186	1000
315	SB4 315A 4 cond. Al	4	315	0.181	0.186	500
315	SB5 315A 5 cond. Al	5	315	0.181	0.186	500
315	SB6 315A 5 cond. Al	5	315	0.181	0.186	500
315	SB7 315A 4 cond. Al	4	315	0.181	0.186	500
400	MR 400A 4 cond. Al	4	400	0.144	0.130	1000
400	MRf 400A 5 cond. Al	5	400	0.144	0.130	1000
400	SB4 400A 4 cond. Al	4	400	0.125	0.130	500
400	SB5 400A 5 cond. Al	5	400	0.125	0.130	500
400	SB6 400A 5 cond. Al	5	400	0.125	0.130	500
400	SB7 400A 4 cond. Al	4	400	0.125	0.130	500
500	SB4 500A 4 cond. Al	4	500	0.102	0.127	500
500	SB5 500A 5 cond. Al	5	500	0.102	0.127	500
500	SB6 500A 5 cond. Al	5	500	0.102	0.127	500
500	SB7 500A 4 cond. Al	4	500	0.102	0.127	500
630	MR 630A 4 cond. Al	4	630	0.072	0.097	1000
630	MRf 630A 5 cond. Al	5	630	0.072	0.097	1000
630	SC 630A 4 cond. Al	4	630	0.072	0.029	1000

## 2 Protection of feeders

Size	Type	Number of conductors	$I_{z0}$ [A]	$r_{ph}^*$ [mΩ/m]	$x_{ph}$ [mΩ/m]	$U_r$ [V]
630	SB4 630A 4 cond. Al	4	630	0.073	0.097	500
630	SB5 630A 5 cond. Al	5	630	0.073	0.097	500
630	SB6 630A 5 cond. Al	5	630	0.073	0.097	500
630	SB7 630A 4 cond. Al	4	630	0.073	0.097	500
800	MR 800A 4 cond. Al	4	800	0.062	0.096	1000
800	MRf 800A 5 cond. Al	5	800	0.062	0.096	1000
800	SC 800A 4 cond. Al	4	800	0.067	0.027	1000
800	SB4 800A 4 cond. Al	4	800	0.071	0.096	500
800	SB5 800A 5 cond. Al	5	800	0.071	0.096	500
800	SB6 800A 5 cond. Al	5	800	0.071	0.096	500
800	SB7 800A 4 cond. Al	4	800	0.071	0.096	500
1000	SC 1000A 4 cond. Al	4	1000	0.062	0.023	1000
1000	HRC1 1000A 4 cond. Al	4	1000	0.068	0.087	1000
1200	SC 1200A 4 cond. Al	4	1200	0.054	0.023	1000
1250	SC 1250A 4 cond. Al	4	1250	0.044	0.021	1000
1250	HRC1 1250A 4 cond. Al	4	1250	0.044	0.066	1000
1500	SC 1500A 4 cond. Al	4	1500	0.041	0.023	1000
1600	SC 1600A 5 cond. Al	4	1600	0.035	0.017	1000
1600	HRC1 1600A 4 cond. Al	4	1600	0.041	0.066	1000
2000	SC 2000A 4 cond. Al	4	2000	0.029	0.016	1000
2000	HRC1 2000A 4 cond. Al	4	2000	0.034	0.053	1000
2250	HRC2 2250A 4 cond. Al	4	2250	0.032	0.049	1000
2400	SC 2400A 4 cond. Al	4	2400	0.028	0.012	1000
2500	SC 2500A 4 cond. Al	4	2500	0.022	0.011	1000
2500	HRC2 2500A 4 cond. Al	4	2500	0.022	0.034	1000
3000	SC 3000A 4 cond. Al	4	3000	0.020	0.011	1000
3200	SC 3200A 4 cond. Al	4	3200	0.017	0.009	1000
3200	HRC2 3200A 4 cond. Al	4	3200	0.020	0.034	1000
4000	SC 4000A 4 cond. Al	4	4000	0.014	0.008	1000
4000	HRC2 4000A 4 cond. Al	4	4000	0.017	0.024	1000
4500	HRC2 4500A 4 cond. Al	4	4500	0.014	0.024	1000

\*phase resistance at  $I_{z0}$

## 2 Protection of feeders

### BTS protection

#### Protection against overload

BTSs are protected against overload by using the same criterion as that used for the cables. The following formula shall be verified:

$$I_b \leq I_n \leq I_z \quad (3)$$

where:

- $I_b$  is the current for which the circuit is designed;
- $I_n$  is the rated current of the protective device; for adjustable protective devices, the rated current  $I_n$  is the set current;
- $I_z$  is the continuous current carrying capacity of the BTS.

NOTE - The protection against short-circuit does not need to be checked if MCBs up to 63 A are used whenever correctly dimensioned for overload protection. In such cases, in fact, protection against both thermal and electrodynamic effects is certainly adequate because of the energy and peak limitations offered by these protective devices.

#### Protection against short-circuit

The BTS must be protected against thermal overload and electrodynamic effects due to the short-circuit current.

##### Protection against thermal overload

The following formula shall be fulfilled:

$$I^2 t_{CB} \leq I^2 t_{BTS} \quad (4)$$

where:

- $I^2 t_{CB}$  is the specific let-through energy of the circuit-breaker at the maximum short-circuit current value at the installation point. This can be extrapolated from the curves shown in Volume 1 Chapter 3.4;
- $I^2 t_{BTS}$  is the withstood energy of the BTS and it is normally given by the manufacturer (see Tables 4 and 5).

##### Protection against electrodynamic effects

The following formula shall be fulfilled:

$$I_{kp\ CB} \leq I_{kp\ BTS} \quad (5)$$

where:

- $I_{kp\ CB}$  is the peak limited by the circuit-breaker at the maximum short-circuit current value at the installation point. This can be extrapolated from the limitation curves shown in Volume 1, Chapter 3.3;
- $I_{kp\ BTS}$  is the maximum peak current value of the BTS (see Tables 4 and 5).

## 2 Protection of feeders

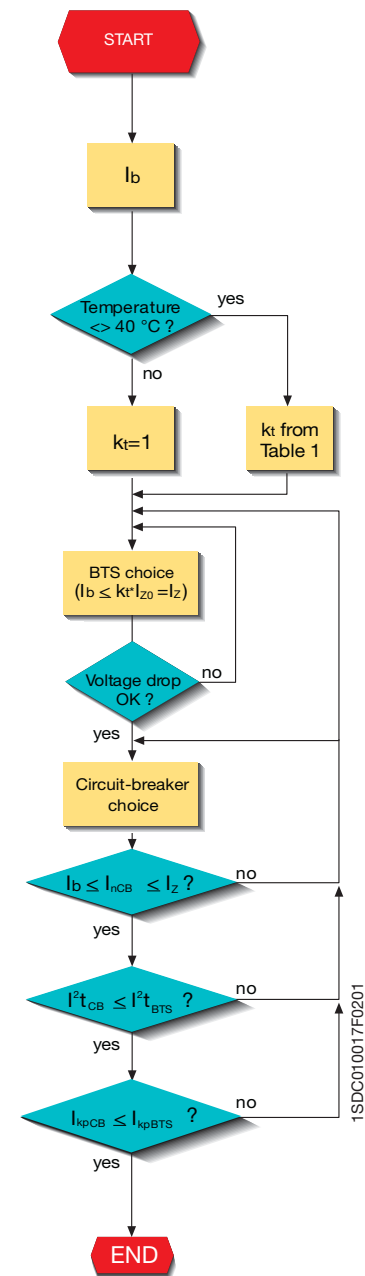

## 2 Protection of feeders

Table 4: Values of the withstood energy and peak current of copper BTS

Size	Type	$I_{ph}^2t_{ph}$ [(kA) <sup>2</sup> s]	$I_{N}^2t_{N}$ [(kA) <sup>2</sup> s]	$I_{PE}^2t_{PE}$ [(kA) <sup>2</sup> s]	$I_{peakph}$ [kA]	$I_{peakN}$ [kA]
25	LB254 25A 4 cond. Cu	0.48	0.48	0.48	10	10
25	HL254 25A 4 cond. Cu	0.64	0.64	0.64	10	10
25	HL2544 25A 4+4 cond. Cu	0.64	0.64	0.64	10	10
40	LB404 40A 4 cond. Cu	0.73	0.73	0.73	10	10
40	HL404 40A 4 cond. Cu	1	1	1	10	10
40	HL4044 40A 4+4 cond. Cu	1	1	1	10	10
40	SL 40A 4 cond. Cu	7.29	7.29	7.29	10	10
63	SL 63A 4 cond. Cu	7.29	7.29	7.29	10	10
100	MS 100A 4 cond. Cu	20.25	20.25	20.25	10	10
160	MS 160A 4 cond. Cu	30.25	30.25	30.25	10	10
160	SB4 160A 4 cond. Cu	100	60	60	17	10.2
160	SB5 160A 5 cond. Cu	100	100	100	17	10.2
160	SB6 160A 5 cond. Cu	100	100	100	17	10.2
160	SB7 160A 4 cond. Cu	100	100	100	17	10.2
250	MR 250A 4 cond. Cu	312.5	187.5	187.5	52.5	31.5
250	MRf 250A 5 cond. Cu	312.5	312.5	312.5	52.5	31.5
250	SB4 250A 4 cond. Cu	169	101.4	101.4	26	15.6
250	SB5 250A 5 cond. Cu	169	169	169	26	15.6
250	SB6 250A 5 cond. Cu	169	169	169	26	15.6
250	SB7 250A 4 cond. Cu	169	169	169	26	15.6
315	MR 315A 4 cond. Cu	312.5	187.5	187.5	52.5	31.5
315	MRf 315A 5 cond. Cu	312.5	312.5	312.5	52.5	31.5
350	SB4 350A 4 cond. Cu	169	101.4	101.4	26	15.6
350	SB5 350A 5 cond. Cu	169	169	169	26	15.6
350	SB6 350A 5 cond. Cu	169	169	169	26	15.6
350	SB7 350A 4 cond. Cu	169	169	169	26	15.6
400	MR 400A 4 cond. Cu	900	540	540	63	37.8
400	MRf 400A 5 cond. Cu	900	900	900	63	37.8
500	SB4 500A 4 cond. Cu	756.25	453.75	453.75	58	34.8
500	SB5 500A 5 cond. Cu	756.25	756.25	756.25	58	34.8
500	SB6 500A 5 cond. Cu	756.25	756.25	756.25	58	34.8
500	SB7 500A 4 cond. Cu	756.25	756.25	756.25	58	34.8
630	MR 630A 4 cond. Cu	1296	777.6	777.6	75.6	45.4
630	MRf 630A 5 cond. Cu	1296	1296	1296	75.6	45.4
700	SB4 700A 4 cond. Cu	756.25	453.75	453.75	58	34.8
700	SB5 700A 5 cond. Cu	756.25	756.25	756.25	58	34.8

## 2 Protection of feeders

Size	Type	$I_{ph}^2t_{ph}$ [(kA) <sup>2</sup> s]	$I_{N}^2t_{N}$ [(kA) <sup>2</sup> s]	$I_{PE}^2t_{PE}$ [(kA) <sup>2</sup> s]	$I_{peakph}$ [kA]	$I_{peakN}$ [kA]
700	SB6 700A 5 cond. Cu	756.25	756.25	756.25	58	34.8
700	SB7 700A 4 cond. Cu	756.25	756.25	756.25	58	34.8
800	MR 800A 4 cond. Cu	1296	777.6	777.6	75.6	45.4
800	MRf 800A 5 cond. Cu	1296	1296	1296	75.6	45.4
800	SC 800A 4 cond. Cu	3969	3969	2381.4	139	83.4
800	SB4 800A 4 cond. Cu	756.25	453.75	453.75	58	34.8
800	SB5 800A 5 cond. Cu	756.25	756.25	756.25	58	34.8
800	SB6 800A 5 cond. Cu	756.25	756.25	756.25	58	34.8
800	SB7 800A 4 cond. Cu	756.25	756.25	756.25	58	34.8
1000	MR 1000A 4 cond. Cu	1296	777.6	777.6	75.6	45.4
1000	MRf 1000A 5 cond. Cu	1296	1296	1296	75.6	45.4
1000	SC 1000A 4 cond. Cu	3969	3969	2381.4	139	83.4
1000	HRC1 1000A 4 cond. Cu	1600	1600	960	84	50.4
1000	SB4 1000A 4 cond. Cu	1024	614.4	614.4	60	36
1000	SB5 1000A 5 cond. Cu	1024	1024	1024	60	36
1000	SB6 1000A 5 cond. Cu	1024	1024	1024	60	36
1000	SB7 1000A 4 cond. Cu	1024	1024	1024	60	36
1200	SC 1200A 4 cond. Cu	7744	7744	4646.4	194	116.4
1250	SC 1250A 4 cond. Cu	7744	7744	4646.4	194	116.4
1250	HRC1 1250A 4 cond. Cu	2500	2500	1500	105	63
1500	SC 1500A 4 cond. Cu	7744	7744	4646.4	194	116.4
1600	SC 1600A 4 cond. Cu	7744	7744	4646.4	194	116.4
1600	HRC1 1600A 4 cond. Cu	2500	2500	1500	105	63
2000	SC 2000A 4 cond. Cu	7744	7744	4646.4	194	116.4
2000	HRC1 2000A 4 cond. Cu	3600	3600	2160	132	79.2
2400	SC 2400A 4 cond. Cu	7744	7744	4646.4	194	116.4
2500	SC 2500A 4 cond. Cu	7744	7744	4646.4	194	116.4
2500	HRC1 2500A 4 cond. Cu	4900	4900	2940	154	92.4
3000	SC 3000A 4 cond. Cu	30976	30976	18585.6	387	232.2
3000	HRC2 3000A 4 cond. Cu	8100	8100	4860	198	118.8
3200	SC 3200A 4 cond. Cu	30976	30976	18585.6	387	232.2
3200	HRC2 3200A 4 cond. Cu	8100	8100	4860	198	118.8
4000	SC 4000A 4 cond. Cu	30976	30976	18585.6	387	232.2
4000	HRC2 4000A 4 cond. Cu	8100	8100	4860	198	118.8
5000	SC 5000A 4 cond. Cu	30976	30976	18585.6	387	232.2
5000	HRC2 5000A 4 cond. Cu	10000	10000	6000	220	132

## 2 Protection of feeders

**Table 5: Values of the withstood energy and peak current of aluminium BTS**

Size	Type	$I_{ph}^2t_{ph}$ [(kA) <sup>2</sup> s]	$I_N^2t_N$ [(kA) <sup>2</sup> s]	$I_{PE}^2t_{PE}$ [(kA) <sup>2</sup> s]	$I_{peakph}$ [kA]	$I_{peakN}$ [kA]
160	MR 160A 4 cond. Al	112.5	67.5	67.5	30	18
160	MRf 160A 5 cond. Al	112.5	112.5	112.5	30	18
160	SB4 160A 4 cond. Al	100	60	60	17	10.2
160	SB5 160A 5 cond. Al	100	100	100	17	10.2
160	SB6 160A 5 cond. Al	100	100	100	17	10.2
160	SB7 160A 4 cond. Al	100	100	100	17	10.2
250	MR 250A 4 cond. Al	312.5	187.5	187.5	52.5	31.5
250	MRf 250A 5 cond. Al	312.5	312.5	312.5	52.5	31.5
250	SB4 250A 4 cond. Al	169	101.4	101.4	26	15.6
250	SB5 250A 5 cond. Al	169	169	169	26	15.6
250	SB6 250A 5 cond. Al	169	169	169	26	15.6
250	SB7 250A 4 cond. Al	169	169	169	26	15.6
315	MR 315A 4 cond. Al	625	375	375	52.5	31.5
315	MRf 315A 5 cond. Al	625	625	625	52.5	31.5
315	SB4 315A 4 cond. Al	169	101.4	101.4	26	15.6
315	SB5 315A 5 cond. Al	169	169	169	26	15.6
315	SB6 315A 5 cond. Al	169	169	169	26	15.6
315	SB7 315A 4 cond. Al	169	169	169	26	15.6
400	MR 400A 4 cond. Al	900	540	540	63	37.8
400	MRf 400A 5 cond. Al	900	900	900	63	37.8
400	SB4 400A 4 cond. Al	625	375	375	52.5	31.5
400	SB5 400A 5 cond. Al	625	625	625	52.5	31.5
400	SB6 400A 5 cond. Al	625	625	625	52.5	31.5
400	SB7 400A 4 cond. Al	625	625	625	52.5	31.5
500	SB4 500A 4 cond. Al	625	375	375	52.5	31.5
500	SB5 500A 5 cond. Al	625	625	625	52.5	31.5
500	SB6 500A 5 cond. Al	625	625	625	52.5	31.5
500	SB7 500A 4 cond. Al	625	625	625	52.5	31.5
630	MR 630A 4 cond. Al	1296	777.6	777.6	75.6	45.4
630	MRf 630A 5 cond. Al	1296	1296	1296	75.6	45.4
630	SC 630A 4 cond. Al	1444	1444	866.4	80	48

## 2 Protection of feeders

Size	Type	$I_{ph}^2t_{ph}$ [(kA) <sup>2</sup> s]	$I_N^2t_N$ [(kA) <sup>2</sup> s]	$I_{PE}^2t_{PE}$ [(kA) <sup>2</sup> s]	$I_{peakph}$ [kA]	$I_{peakN}$ [kA]
630	SB4 630A 4 cond. Al	1024	614.4	614.4	67.5	40.5
630	SB5 630A 5 cond. Al	1024	1024	1024	67.5	40.5
630	SB6 630A 5 cond. Al	1024	1024	1024	67.5	40.5
630	SB7 630A 4 cond. Al	1024	1024	1024	67.5	40.5
800	MR 800A 4 cond. Al	1296	777.6	777.6	75.6	45.4
800	MRf 800A 5 cond. Al	1296	1296	1296	75.6	45.4
800	SC 800A 4 cond. Al	1764	1764	1058.4	88	52.8
800	SB4 800A 4 cond. Al	1024	614.4	614.4	67.5	40.5
800	SB5 800A 5 cond. Al	1024	1024	1024	67.5	40.5
800	SB6 800A 5 cond. Al	1024	1024	1024	67.5	40.5
800	SB7 800A 4 cond. Al	1024	1024	1024	67.5	40.5
1000	SC 1000A 4 cond. Al	6400	6400	3840	176	105.6
1000	HRC1 1000A 4 cond. Al	1600	1600	960	84	50.4
1200	SC 1200A 4 cond. Al	6400	6400	3840	176	105.6
1250	SC 1250A 4 cond. Al	6400	6400	3840	176	105.6
1250	HRC1 1250A 4 cond. Al	2500	2500	1500	105	63
1500	SC 1500A 4 cond. Al	6400	6400	3840	176	105.6
1600	SC 1600A 4 cond. Al	6400	6400	3840	176	105.6
1600	HRC1 1600A 4 cond. Al	2500	2500	1500	105	63
2000	SC 2000A 4 cond. Al	6400	6400	3840	176	105.6
2000	HRC1 2000A 4 cond. Al	3600	3600	2160	132	79.2
2250	HRC2 2250A 4 cond. Al	4900	4900	2940	154	92.4
2400	SC 2400A 4 cond. Al	25600	25600	15360	352	211.2
2500	SC 2500A 4 cond. Al	25600	25600	15360	352	211.2
2500	HRC2 2500A 4 cond. Al	8100	8100	4860	198	118.8
3000	SC 3000A 4 cond. Al	25600	25600	15360	352	211.2
3200	SC 3200A 4 cond. Al	25600	25600	15360	352	211.2
3200	HRC2 3200A 4 cond. Al	8100	8100	4860	198	118.8
4000	SC 4000A 4 cond. Al	25600	25600	15360	352	211.2
4000	HRC2 4000A 4 cond. Al	8100	8100	4860	198	118.8
4500	HRC2 4500A 4 cond. Al	10000	10000	6000	220	132

## 2 Protection of feeders

### Protection of the outgoing feeders

If the outgoing feeder, which generally consists of cable duct, is not already protected against short-circuit and overload by the device located upstream of the cable, the following measures shall be taken:

- *protection against short-circuit:*

there is no need to protect the feeder against the short-circuit if simultaneously:

- the length does not exceed 3 metres;
- the risk of short-circuit is minimized;
- there is no inflammable material nearby.

In explosive environments and environments with greater risk of fire, protection against short-circuit is always required;

- *protection against overload:*

the current carrying capacity of the feeder is generally lower than that of the BTS. It is therefore necessary to protect also the feeder against overload.

The protection device against overload can be placed inside the pull box or on the incoming panel.

In the latter case, protection against overload can also be provided by the circuit-breakers protecting the single outgoing feeder from the panel only if the sum of their rated currents is lower or equal to the current carrying capacity  $I_z$  of the outgoing feeder.

In locations with greater risk of fire, the overload protection device shall be installed at the outgoing point, i.e. inside the pull box.

### Voltage drop

If a BTS is particularly long, the value of the voltage drop must be verified. For three-phase systems with a power factor ( $\cos\varphi_m$ ) not lower than 0.8, the voltage drop can be calculated by using the following simplified formula:

$$\Delta u = \frac{a \cdot \sqrt{3} \cdot I_b \cdot L \cdot (r_t \cdot \cos\varphi_m + x \cdot \sin\varphi_m)}{1000} \text{ [V]} \quad (6a)$$

For single-phase BTS the formula is:

$$\Delta u = \frac{a \cdot 2 \cdot I_b \cdot L \cdot (r_t \cdot \cos\varphi_m + x \cdot \sin\varphi_m)}{1000} \text{ [V]} \quad (6b)$$

where:

- $a$  is the current distribution factor, which depends on the circuit supply and the arrangement of the electric loads along the BTS, as shown in Table 6:

## 2 Protection of feeders

**Table 6: Current distribution factor**

Type of supply	Arrangement of loads	Current distribution factor
From one end only	Load concentrated at the end	1
	Evenly distributed load	0.5
From both ends	Evenly distributed load	0.25
	Load concentrated at the ends	0.25
Central	Load concentrated at the ends	0.25
	Evenly distributed load	0.125

- $I_b$  is the load current [A];
- $L$  is the BTS length [m];
- $r_t$  is the phase resistance per unit of length of BTS, measured under thermal steady-state conditions [ $m\Omega/m$ ];
- $x$  is the phase reactance per unit of length of BTS [ $m\Omega/m$ ];
- $\cos\varphi_m$  is average power factor of the loads.

Percentage voltage drop is obtained from:

$$\Delta u\% = \frac{\Delta u}{U_r} \cdot 100 \quad (7)$$

where  $U_r$  is rated voltage.

To reduce the voltage drop in very long BTS the power can be supplied at an intermediate position rather than at the end (see Table 6).

### Calculation of voltage drop for unevenly distributed loads

If the loads cannot be considered to be evenly distributed, the voltage drop can be calculated more accurately by using the formulas below.

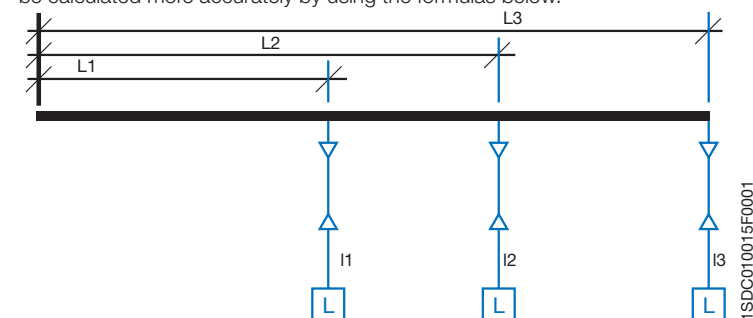

For the distribution of the three-phase loads shown in the figure, the voltage drop can be calculated by the following formula if the BTS has a constant cross section (as usual):

$$\Delta u = \sqrt{3} [r_t (I_1 L_1 \cos\varphi_1 + I_2 L_2 \cos\varphi_2 + I_3 L_3 \cos\varphi_3) + x (I_1 L_1 \sin\varphi_1 + I_2 L_2 \sin\varphi_2 + I_3 L_3 \sin\varphi_3)]$$

## 2 Protection of feeders

Generally speaking, this formula becomes:

$$\Delta u = \frac{\sqrt{3} r_t \cdot \sum I_i \cdot L_i \cdot \cos \varphi_{mi} + x \cdot \sum I_i \cdot L_i \cdot \sin \varphi_{mi}}{1000} \text{ [V]} \quad (8)$$

where:

- $r_t$  is the phase resistance per unit of length of BTS, measured under thermal steady-state conditions [mΩ/m];
- $x$  is the phase reactance per unit of length of BTS [mΩ/m];
- $\cos \varphi_{mi}$  is average power factor of the  $i$ -th load;
- $I_i$  is  $i$ -th load current [A];
- $L_i$  is the distance of the  $i$ -th load from the beginning of the BTS [m].

### Joule-effect losses

Joule-effect losses are due to the electrical resistance of the BTS. The losses are dissipated in heat and contribute to the heating of the trunking and of the environment. Calculation of power losses is useful for correctly dimensioning the air-conditioning system for the building. Three-phase losses are:

$$P_j = \frac{3 \cdot r_t \cdot I_b^2 \cdot L}{1000} \text{ [W]} \quad (9a)$$

while single-phase losses are:

$$P_j = \frac{2 \cdot r_t \cdot I_b^2 \cdot L}{1000} \text{ [W]} \quad (9b)$$

where:

- $I_b$  is the current used [A];
- $r_t$  is the phase resistance per unit of length of BTS measured under thermal steady-state conditions [mΩ/m];
- $L$  is the length of BTS [m].

For accurate calculations, losses must be assessed section by section on the basis of the currents flowing through them; e.g. in the case of distribution of loads shown in the previous figure:

	Length	Current	Losses
1° section	$L_1$	$I_1+I_2+I_3$	$P_1=3r_t L_1(I_1+I_2+I_3)^2$
2° section	$L_2-L_1$	$I_2+I_3$	$P_2=3r_t(L_2-L_1)(I_2+I_3)^2$
3° section	$L_3-L_2$	$I_3$	$P_3=3r_t(L_3-L_2)I_3^2$
Total losses in BTS			$P_{tot}=P_1+P_2+P_3$

## 3 Protection of electrical equipment

### 3.1 Protection and switching of lighting circuits

#### Introduction

Upon supply of a lighting installation, for a brief period an initial current exceeding the rated current (corresponding to the power of the lamps) circulates on the network. This possible peak has a value of approximately 15+20 times the rated current, and is present for a few milliseconds; there may also be an inrush current with a value of approximately 1.5+3 times the rated current, lasting up to some minutes. The correct dimensioning of the switching and protection devices must take these problems into account.

Peak current diagram

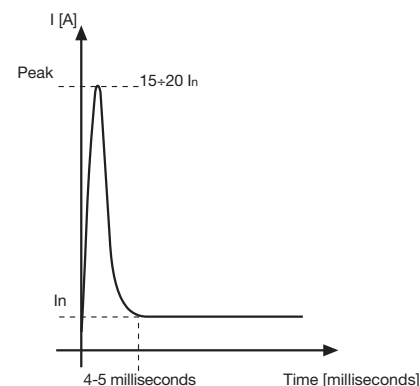

Inrush current diagram

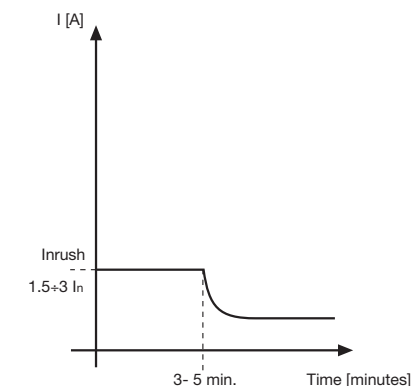

The most commonly used lamps are of the following types:

- incandescent;
- halogen;
- fluorescent;
- high intensity discharge: mercury vapour, metal halide and sodium vapour.

### Incandescent lamps

Incandescent lamps are made up of a glass bulb containing a vacuum or inert gas and a tungsten filament. The current flows through this filament, heating it until light is emitted.

The electrical behaviour of these lamps involves a high peak current, equal to approximately 15 times the rated current; after a few milliseconds the current returns to the rated value. The peak is caused by the lamp filament which, initially cold, presents a very low electrical resistance. Subsequently, due to the very fast heating of the element, the resistance value increases considerably, causing the decrease in the current absorbed.

## 3 Protection of electrical equipment

### Halogen lamps

Halogen lamps are a special type of incandescent lamp in which the gas contained within the bulb prevents the vaporized material of the tungsten filament from depositing on the surface of the bulb and forces re-deposition on the filament. This phenomenon slows the deterioration of the filament, improves the quality of the light emitted and increases the life of the lamp.

The electrical behaviour of these lamps is the same as that of incandescent lamps.

### Fluorescent lamps

Fluorescent lamps are a so-called discharge light source. The light is produced by a discharge within a transparent enclosure (glass, quartz, etc. depending on the type of lamp) which contains mercury vapour at low pressure.

Once the discharge has started, the gas within the enclosure emits energy in the ultraviolet range which strikes the fluorescent material; in turn, this material transforms the ultraviolet radiation into radiation which has a wavelength within the visible spectrum. The colour of the light emitted depends upon the fluorescent material used.

The discharge is created by an appropriate peak in voltage, generated by a starter. Once the lamp has been switched on, the gas offers an ever lower resistance, and it is necessary to stabilize the intensity of the current, using a controller (reactor); this lowers the power factor to approximately 0.4+0.6; normally a capacitor is added to increase the power factor to a value of more than 0.9

There are two types of controllers, magnetic (conventional) and electronic, which absorb from 10% to 20% of the rated power of the lamp. Electronic controllers offer specific advantages such as a saving in the energy absorbed, a lower dissipation of heat, and ensure a stable, flicker-free light. Some types of fluorescent lamps with electronic reactors do not need a starter.

*Compact fluorescent lamps* are made up of a folded tube and a plastic base which contains, in some cases, a conventional or electronic controller.

The value of the inrush current depends upon the presence of a power factor correction capacitor:

- non PFC lamps have inrush currents equal to approximately twice the rated current and a turn-on time of about ten seconds;
- in PFC lamps, the presence of the capacitor allows the reduction of the turn-on time to a few seconds, but requires a high peak current, determined by the charge of the capacitor, which can reach 20 times the rated current.

If the lamp is fitted with an electronic controller, the initial transient current may lead to peak currents equal to, at maximum, 10 times the rated current.

## 3 Protection of electrical equipment

### High intensity discharge lamps: mercury vapour, metal halide and sodium vapour

The functioning of high intensity discharge lamps is the same as that of fluorescent lamps with the difference that the discharge occurs in the presence of a gas at high pressure. In this case, the arc is able to vaporize the metallic elements contained in the gas, releasing energy in the form of radiation which is both ultraviolet and within the visible spectrum. The special type of bulb glass blocks the ultraviolet radiation and allows only the visible radiation to pass through. There are three main types of high intensity discharge lamps: mercury vapour, metal halide and sodium vapour. The colour characteristics and the efficiency of the lamp depend upon the different metallic elements present in the gas, which are struck by the arc.

High intensity discharge lamps require a suitably sized controller and a heating period which can last some minutes before the emission of the rated light output. A momentary loss of power makes the restarting of the system and the heating necessary.

Non PFC lamps have inrush currents of up to twice the rated current for approximately 5 minutes.

PFC lamps have a peak current equal to 20 times the rated current, and an inrush current of up to twice the rated current for approximately 5 minutes.

Lamp type		Peak current	Inrush current	Turn-on time
Incandescent lamps		15In	-	-
Halogen lamps		15In	-	-
Fluorescent lamp	Non PFC	-	2In	10 s
	PFC	20In		1+6 s
High intensity discharge lamps	Non PFC	-	2In	2+8 min
	PFC	20In	2In	2+8 min

### Protection and switching devices

IEC 60947-4-1 identifies two specific utilization categories for lamp control contactors:

- AC-5a switching of electric discharge lamps;
- AC-5b switching of incandescent lamps.

The documentation supplied by the manufacturer includes tables for contactor selection, according to the number of lamps to be controlled, and to their type.

### 3 Protection of electrical equipment

For the selection of a protection device the following verifications shall be carried out:

- the trip characteristic curve shall be above the turning-on characteristic curve of the lighting device to avoid unwanted trips; an approximate example is shown in Figure1;
- coordination shall exist with the contactor under short-circuit conditions (lighting installations are not generally characterized by overloads).

With reference to the above verification criteria, the following tables show the maximum number of lamps per phase which can be controlled by the combination of ABB circuit-breakers and contactors for some types of lamps, according to their power and absorbed current  $I_b^{(*)}$ , for three phase installations with a rated voltage of 400 V and a maximum short-circuit current of 15 kA.

(\*) For calculation see Annex B Calculation of load current  $I_b$

### 3 Protection of electrical equipment

**Figure 1: Approximate diagram for the coordination of lamps with protection and switching devices**

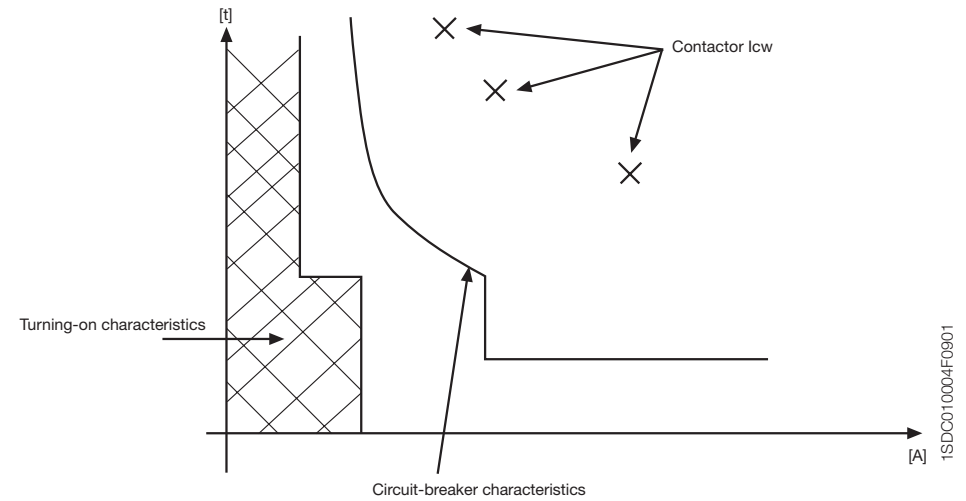

**Table 1: Incandescent and halogen lamps**

U <sub>r</sub> = 400 V		I <sub>k</sub> = 15 kA											
Incandescent/halogen lamps													
Circuit-breaker type		S270 D20	S270 D20	S270 D25	S270 D32	S270 D50		T2N160 In63	T2N160 In63	T2N160 In100	T2N160 In100	T2N160 In100	T2N160 In160
Setting PR221 DS		----	----	----	----	----		L= 0.68- A S= 8- B	L= 0.92- A S= 10- B	L= 0.68- A S= 8- B	L= 0.76- A S= 8- B	L= 1- A S= 10- B	L= 0.68- A S= 7- B
Contactor type		A26	A26	A26	A26	A30		A40	A50	A63	A75	A95	A110
Rated Power [W]	Rated current I <sub>b</sub> [A]	N° lamps per phase											
60	0.27	57	65	70	103	142		155	220	246	272	355	390
100	0.45	34	38	42	62	85		93	132	147	163	210	240
200	0.91	17	19	20	30	42		46	65	73	80	105	120
300	1.37	11	12	13	20	28		30	43	48	53	70	80
500	2.28	6	7	8	12	16		18	26	29	32	42	48
1000	4.55	3	4	4	6	8		9	13	14	16	21	24



### 3 Protection of electrical equipment

Table 2: Fluorescent lamps

Ur= 400 V		Ik= 15 kA											
Fluorescent lamps non PFC													
Circuit-breaker type		S270 D16	S270 D20	S270 D20	S270 D32	S270 D40		S270 D50	S270 D63	T2N160 In100	T2N160 In100	T2N160 In100	T2N160 In160
Setting PR221 DS										L= 0.68- A S= 10- B	L= 0.76- A S= 10- B	L= 0.96- A- S= 10- B	S= 0.68- A S= 10- B
Contactor type		A26	A26	A26	A26	A30		A40	A50	A63	A75	A95	A110
Rated Power [W]	Rated current Ib [A]	N° lamps per phase											
20	0.38	40	44	50	73	100		110	157	173	192	250	278
40	0.45	33	37	42	62	84		93	133	145	162	210	234
65	0.7	21	24	27	40	54		60	85	94	104	135	150
80	0.8	18	21	23	35	47		52	75	82	91	118	132
100	1.15	13	14	16	24	33		36	52	57	63	82	92
110	1.2	12	14	15	23	31		35	50	55	60	79	88

1SD001003R0201

Ur= 400 V		Ik= 15 kA										
Fluorescent lamps PFC												
Circuit-breaker type		S270 D25	S270 D25	S270 D32	S270 D40	S270 D63		T2N160 In63	T2N160 In63	T2N160 In100	T2N160 In100	T2N160 In100
Setting PR221 DS		---	---	---	---	---		L= 0.68- A S= 8- B	L= 1- A S= 10- B	L= 0.68- A S= 10- B	L= 0.76- A S= 10- B	L= 0.96- A S= 10- B
Contactor type		A26	A26	A26	A26	A30		A40	A50	A63	A75	A95
Rated Power [W]	Rated current Ib [A]	Capacitor [μF]	N° lamps per phase									
20	0.18	5	83	94	105	155	215	233	335	360	400	530
40	0.26	5	58	65	75	107	150	160	230	255	280	365
65	0.42	7	35	40	45	66	92	100	142	158	173	225
80	0.52	7	28	32	36	53	74	80	115	126	140	180
100	0.65	16	23	26	29	43	59	64	92	101	112	145
110	0.7	18	21	24	27	40	55	59	85	94	104	135

### 3 Protection of electrical equipment

**Table 3: High intensity discharge lamps**

U= 400 V		I <sub>k</sub> = 15 kA		Fluorescent lamps non PFC									
Circuit-breaker type		S270 D16	S270 D2	S270 D20	S270 D32	S270 D40		S270 D40	S270 D50	S270 D63	T2N160 In100	T2N160 In100	T2N160 In160
Setting PR221 DS											L= 0.8- B S= 6.5- B	L= 1- B S= 8- B	L= 0.8- B S= 6.5- B
Contactor type		A26	A26	A26	A26	A30		A40	A50	A63	A75	A95	A110
Rated Power [W]	Rated current I <sub>b</sub> [A]	N° lamps per phase											
150	1.8	6	7	8	11	15		17	23	26	29	38	41
250	3	4	4	5	7	9		10	14	16	17	23	25
400	4.4	3	3	3	4	6		7	9	10	12	15	17
600	6.2	1	2	2	3	4		5	7	8	8	11	12
1000	10.3	-	1	1	2	3		3	4	5	5	6	7

U= 400 V		I <sub>k</sub> = 15 kA		Fluorescent lamps PFC									
Circuit-breaker type		S270 D16	S270 D20	S270 D20	S270 D32	S270 D40		S270 D40	T2N160 In100	T2N160 In100	T2N160 In100	T2N160 In160	T2N160 In160
Setting PR221 DS		---	---	---	---	---		---	L= 0.8- B S= 6.5- B	L= 0.88- B S= 6.5- B	L= 1- B S= 6.5- B	L= 0.84- B S= 4.5- B	L= 0.88- B S= 4.5- B
Contactor type		A26	A26	A26	A26	A30		A40	A50	A63	A75	A95	A110
Rated Power [W]	Rated current I <sub>b</sub> [A]	Capacitor [μF]	N° lamps per phase										
150	1	20	13	14	15	23	28	30	50	58	63	81	88
250	1.5	36	8	9	10	15	18	20	33	38	42	54	59
400	2.5	48	5	5	6	9	11	12	20	23	25	32	36
600	3.3	65	4	4	5	7	8	9	15	17	19	24	27
1000	6.2	100	-	-	-	4	4	5	8	9	10	13	14

**Example:**

Switching and protection of a lighting system, supplied by a three phase network at 400 V 15 kA, made up of 55 incandescent lamps, of 200 W each, per phase. In Table 1, on the row corresponding to 200 W, select the cell showing the number of controllable lamps immediately above the number of lamps per phase present in the installation. In the specific case, corresponding to the cell for 65 lamps per phase the following equipment are suggested:

- ABB Tmax T2N160 In63 circuit-breaker with PR221/DS type electronic release, with protection L set at 0.92, curve A and protection S set at 10, curve B;
- A50 contactor.

## 3 Protection of electrical equipment

### 3.2 Protection and switching of generators

The need to guarantee an ever greater continuity of service has led to an increase in the use of emergency supply generators, either as an alternative to, or in parallel with the public utility supply network.

Typical configurations include:

- "Island supply" (independent functioning) of the priority loads in the case of a lack of energy supply through the public network;
- supply to the user installation in parallel with the public supply network.

Unlike the public supply network, which has a constant contribution, in case of a short-circuit, the current supplied by the generator is a function of the parameters of the machine itself, and decreases with time; it is possible to identify the following successive phases:

1. a subtransient phase: with a brief duration (10÷50 ms), characterized by the subtransient reactance  $X''_d$  (5÷20% of the rated impedance value), and by the subtransient time constant  $T''_d$  (5÷30 ms);
2. a transitory phase: may last up to some seconds (0.5÷2.5 s), and is characterized by the transitory reactance  $X'_d$  (15÷40% of the rated impedance value), and by the transitory time constant  $T'_d$  (0.03÷2.5 s);
3. a synchronous phase: may persist until the tripping of external protection, and is characterized by the synchronous reactance  $X_d$  (80÷300% of the rated impedance value).

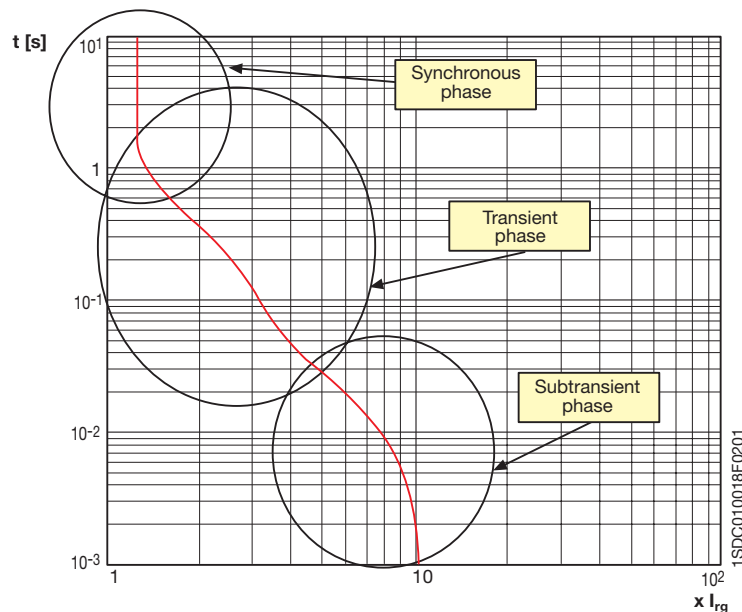

## 3 Protection of electrical equipment

As a first approximation, it can be estimated that the maximum value of the short-circuit current of a generator, with rated power  $S_{rg}$ , at the rated voltage of the installation  $U_r$ , is equal to:

$$I_{kg} = \frac{I_{rg} \cdot 100}{X''_d \%}$$

where

$I_{rg}$  is the rated current of the generator:

$$I_{rg} = \frac{S_{rg}}{\sqrt{3} \cdot U_r}$$

The circuit-breaker for the protection of the generator shall be selected according to the following criteria:

- the set current higher than the rated current of the generator:  $I_1 \geq I_{rg}$ ;
- breaking capacity  $I_{cu}$  or  $I_{cs}$  higher than the maximum value of short-circuit current at the installation point:
  - in the case of a single generator:  $I_{cu}(I_{cs}) \geq I_{kg}$ ;
  - in the case of  $n$  identical generators in parallel:  $I_{cu}(I_{cs}) \geq I_{kg} \cdot (n-1)$ ;
  - in the case of operation in parallel with the network:  $I_{cu}(I_{cs}) \geq I_{kNet}$ , as the short-circuit contribution from the network is normally greater than the contribution from the generator;
- for circuit-breakers with thermomagnetic releases: low magnetic trip threshold:  $I_3 = 2.5/3 \cdot I_{rg}$ ;
- for circuit-breakers with electronic releases:
  - trip threshold of the delayed short-circuit protection function (S), set between 1.5 and 4 times the rated current of the generator, in such a way as to "intercept" the decrement curve of the generator:  $I_2 = (1.5+4) \cdot I_{rg}$ ; if the function S is not present, function I can be set at the indicated values  $I_3 = (1.5+4) \cdot I_{rg}$ ;
  - trip threshold of the instantaneous short-circuit protection function ( $I_3$ ) set at a value greater than the rated short-circuit current of the generator, so as to achieve discrimination with the devices installed downstream, and to allow fast tripping in the event of a short-circuit upstream of the device (working in parallel with other generators or with the network):

$$I_3 \geq I_{kg}$$

### 3 Protection of electrical equipment

The following tables give ABB SACE suggestions for the protection and switching of generators; the tables refer to 400 V (Table 1), 440 V (Table 2), 500 V (Table 3) and 690 V (Table 4).

**Table 1** 400 V

S <sub>g</sub> [kVA]	MCB	MCCB	ACB
4	S20L/S260 B6		
6	S20L/S260 B10	T2 160 In=10	
7			
9	S20L/S260 B13		
11	S20L/S260 B16	T2 160 In=25	
14			
17	S20L/S260 B25		
19			
21	S20L/S260 B32		
22			
28	S20L/S260 B50	T2 160 In=63	
31			
35	S20L/S260 B63		
38			
42			
44			
48	S280 B80	T2 160 In=100	
55	S280 B100		
69			
80		T2 160 In=160	
87		T2 160	
100		T4 250	
111			
138		T3 250	
159		T4 250	
173			
180			
190		T4 320	
208			
218			
242		T5 400	
277			
308			
311			
346		T5 630	
381		S6 800	
415			
436			
484		S6 800	
554		S7 1250	E1/E2 1250
692			
727		S7 1250	E2/E3 1600
865			E2/E3 2000
1107		S7 1600	E3 3200
1730			E3 3200/E4 4000
2180		S8 3200	E4 4000
2214			
2250			E4 4000
2500			
2800			
3150			E6 5000/6300
3500			

**Table 2** 440 V

S <sub>g</sub> [kVA]	MCB	MCCB	ACB
4	S20L/S260 B6		
6	S20L/S260 B8	T2 160 In=10	
7	S20L/S260 B10		
9	S20L/S260 B13		
11	S20L/S260 B16	T2 160 In=25	
14	S20L/S260 B20		
17	S20L/S260 B25		
19			
21	S20L/S260 B32		
22			
28	S20L/S260 B40		
31	S20L/S260 B50	T2 160 In=63	
35			
38			
42	S20L/S260 B63		
44			
48	S280 B80	T2 160 In=100	
55	S280 B100		
69			
80		T2 160 In=160	
87			
100		T2 160 In=160	
111			
138		T4 250	
159		T3 250	
173		T4 250	
180			
190		T4 320	
208			
218			
242		T5 400	
277			
308			
311			
346		T5 630	
381		S6 800	
415			
436			
484		S6 800	
554		S7 1000	E1/E2 1250
692		S7 1000	
727		S7 1250	E2/E3 1600
865			E2/E3 2000
1107		S7 1600	E3 2500
1730			E3 2500
2180		S8 3200	E3 3200
2214			
2250			E4 3600
2500			E4 4000
2800			
3150			E6 5000/6300
3500			

1SDC010016F0001

### 3 Protection of electrical equipment

**Table 3** 500 V **Table 4** 690 V

S <sub>g</sub> [kVA]	MCB	MCCB	ACB
4			
6		T2 160 In=10	
7			
9			
11			
14		T2 160 In=25	
17			
19			
21			
22			
28			
31			
35		T2 160 In=63	
38			
42			
44			
48			
55		T2 160 In=100	
69			
80			
87			
100		T2 160 In=160	
111			
138		T3 250	
159		T4 250	
173			
180		T4 250	
190			
208			
218		T4 320	
242			
277		T5 400	
308			
311			
346		T5 630	
381		S6 800	
415			
436			
484		S6 800	
554		S7 1000	E1/E2 1250
692		S7 1250	
727			
865		S7 1600	E2/E3 1600
1107		S8 2500	E3 2500
1730			
2180		S8 3200	E3 3200
2214			
2250			
2500			E4 4000
2800			
3150			E6 5000/6300
3500			

Note: It is always advisable to check that the settings of the releases are correct with respect to the effective decrement curve of the current of the generator to be protected.

1SDC010017F0001

### 3 Protection of electrical equipment

#### Example:

Protection of a generator with  $S_{rg} = 100$  kVA, in a system with a rated voltage of 440 V.

The generator parameters are:

$U_r = 440$  V

$S_{rg} = 100$  kVA

$f = 50$  Hz

$I_{rg} = 131.2$  A

$X'_{d} = 6.5$  % (subtransient reactance)

$X''_{d} = 17.6$  % (transient reactance)

$X_d = 230$  % (synchronous reactance)

$T''_{d} = 5.5$  ms (subtransient time constant)

$T'_d = 39.3$  ms (transient time constant)

From table 2, an ABB SACE T2N160 circuit-breaker is selected, with  $I_n = 160$  A, with electronic release PR221-LS. For correct protection of the generator, the following settings are selected:

function L: 0.84 – A, corresponding to 134.4 A, value greater than  $I_{rg}$   
function I: 1.5

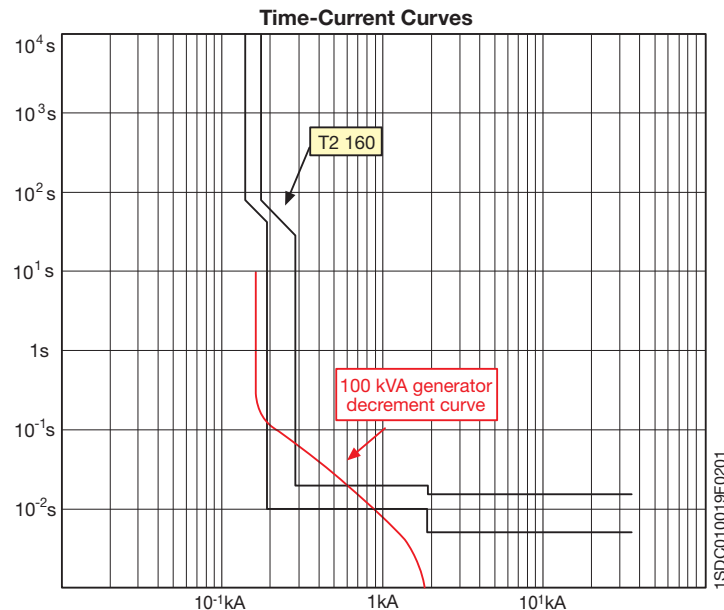

### 3 Protection of electrical equipment

#### 3.3 Protection and switching of motors

##### Electromechanical starter

The starter is designed to:

- start motors;
- ensure continuous functioning of motors;
- disconnect motors from the supply line;
- guarantee protection of motors against working overloads.

The starter is typically made up of a switching device (contactor) and an overload protection device (thermal release).

The two devices must be coordinated with equipment capable of providing protection against short-circuit (typically a circuit-breaker with magnetic release only), which is not necessarily part of the starter.

The characteristics of the starter must comply with the international Standard IEC 60947-4-1, which defines the above as follows:

**Contactor:** a mechanical switching device having only one position of rest, operated otherwise than by hand, capable of making, carrying and breaking currents under normal circuit conditions including operating overload conditions.

**Thermal release:** thermal overload relay or release which operates in the case of overload and also in case of loss of phase.

**Circuit-breaker:** defined by IEC 60947-2 as a mechanical switching device, capable of making, carrying and breaking currents under normal circuit conditions and also making, carrying for a specified time and breaking currents under specified abnormal circuit conditions.

The main types of motor which can be operated and which determine the characteristics of the starter are defined by the following utilization categories:

**Table 1: Utilization categories and typical applications**

Current type	Utilization categories	Typical applications
Alternating Current ac	AC-2	Slip-ring motors: starting, switching off
	AC-3	Squirrel-cage motors: starting, switching off during running <sup>(1)</sup>
	AC-4	Squirrel-cage motors: starting, plugging, inching

<sup>(1)</sup> AC-3 categories may be used for occasionally inching or plugging for limited time periods such as machine set-up; during such limited time periods the number of such operations should not exceed five per minutes or more than ten in a 10 minutes period.

### 3 Protection of electrical equipment

The choice of the starting method and also, if necessary, of the type of motor to be used depends on the typical resistant torque of the load and on the short-circuit power of the motor supplying network.

With alternating current, the most commonly used motor types are as follows:

- asynchronous three-phase squirrel-cage motors (AC-3): the most widespread type due to the fact that they are of simple construction, economical and sturdy; they develop high torque with short acceleration times, but require elevated starting currents;
- slip-ring motors (AC-2): characterized by less demanding starting conditions, and have quite a high starting torque, even with a supply network of low power.

#### Starting methods

The most common starting methods for asynchronous squirrel-cage motors are detailed below:

##### Direct starting

With direct starting, the DOL (Direct On Line) starter, with the closing of line contactor KL, the line voltage is applied to the motor terminals in a single operation. Hence a squirrel-cage motor develops a high starting torque with a relatively reduced acceleration time. This method is generally used with small and medium power motors which reach full working speed in a short time. These advantages are, however, accompanied by a series of drawbacks, including, for example:

- high current consumption and associated voltage drop which may cause damages to the other parts of the system connected to the network;
- violent acceleration which has negative effects on mechanical transmission components (belts, chains and mechanical joints), reducing working life.

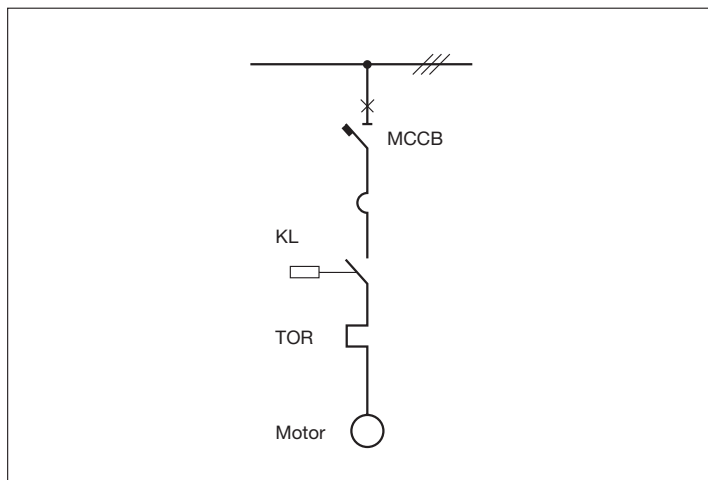

### 3 Protection of electrical equipment

Other types of starting for squirrel-cage motors are accomplished by reducing the supply voltage of the motor: this leads to a reduction in the starting current and of the motor torque, and an increase in the acceleration time.

##### Star-Delta starter

The most common reduced voltage starter is the Star-Delta starter (Y-Δ), in which:

- on starting, the stator windings are star-connected, thus achieving the reduction of peak inrush current;
- once the normal speed of the motor is nearly reached, the switchover to delta is carried out.

After the switchover, the current and the torque follow the progress of the curves associated with normal service connections (delta).

As can be easily checked, starting the motor with star-connection gives a voltage reduction of  $\sqrt{3}$ , and the current absorbed from the line is reduced by  $1/3$  compared with that absorbed with delta-connection.

The start-up torque, proportional to the square of the voltage, is reduced by 3 times, compared with the torque that the same motor would supply when delta-connected.

This method is generally applied to motors with power from 15 to 355 kW, but intended to start with a low initial resistant torque.

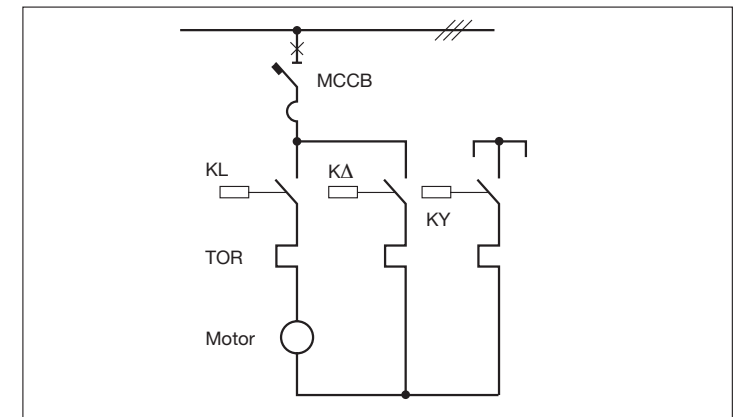

##### Starting sequence

By pressing the start button, contactors KL and KY are closed. The timer starts to measure the start time with the motor connected in star. Once the set time has elapsed, the first contact of the timer opens the KY contactor and the second contact, delayed by approximately 50 ms, closes the KΔ contactor. With this new configuration, contactors KL and KΔ closed, the motor becomes delta-connected.

### 3 Protection of electrical equipment

The thermal release TOR, inserted in the delta circuit, can detect any 3<sup>rd</sup> harmonic currents, which may occur due to saturation of the magnetic pack and by adding to the fundamental current, overload the motor without involving the line.

With reference to the connection diagram, the equipment used for a Star/Delta starter must be able to carry the following currents:

$$\frac{I_r}{\sqrt{3}} \quad \text{KL line contactor and K}\Delta \text{ delta contactor}$$

$$\frac{I_r}{3} \quad \text{KY star contactor}$$

$$\frac{I_r}{\sqrt{3}} \quad \text{overload protection release}$$

where  $I_r$  is the rated current of the motor.

#### Starting with autotransformers

Starting with autotransformers is the most functional of the methods used for reduced voltage starting, but is also the most expensive. The reduction of the supply voltage is achieved by using a fixed tap autotransformer or a more expensive multi tap autotransformer.

Applications can be found with squirrel-cage motors which generally have a power from 50 kW to several hundred kilowatts, and higher power double-cage motors.

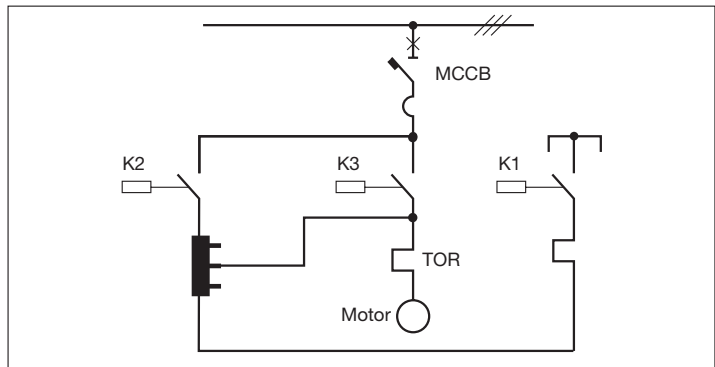

The autotransformer reduces the network voltage by the factor  $K$  ( $K=1.25\div 1.8$ ), and as a consequence the start-up torque is reduced by  $K^2$  times compared with the value of the full rated voltage.

On starting, the motor is connected to the taps of the autotransformer and the contactors K2 and K1 are closed.

### 3 Protection of electrical equipment

Therefore, the motor starts at a reduced voltage, and when it has reached approximately 80% of its normal speed, contactor K1 is opened and main contactor K3 is closed. Subsequently, contactor K2 is opened, excluding the autotransformer so as to supply the full network voltage.

#### Starting with inductive reactors or resistors

This type of starting is used for simple or double-cage rotors. The reduction of the supply voltage is achieved by the insertion of inductive reactors or resistors, in series to the stator. On start-up, the current is limited to 2.5÷3.5 times the rated value.

On starting, the motor is supplied via contactor K2; once the normal speed is reached, the reactors are short-circuited by the closing of contactor K1, and are then excluded by the opening of contactor K2.

It is possible to achieve exclusions by step of the resistors or reactors with time-delayed commands, even for motors with power greater than 100 kW.

The use of reactors notably reduces the power factor, while the use of resistors causes the dissipation of a high power (Joule effect), even if limited to the starting phase.

For a reduction  $K$  (0.6÷0.8) of the motor voltage, the torque is reduced by  $K^2$  times (0.36÷0.64).

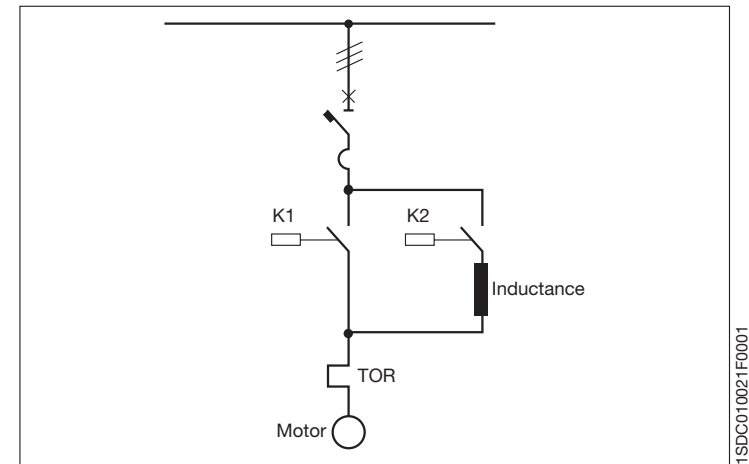

In compliance with the above mentioned Standard, starters can also be classified according to tripping time (trip classes), and according to the type of coordination achieved with the short-circuit protection device (Type 1 and Type 2).

### 3 Protection of electrical equipment

#### Trip classes

The trip classes differentiate between the thermal releases according to their trip curve.

The trip classes are defined in the following table 2:

**Table 2: Trip class**

Trip Class	Tripping time in seconds (Tp)
10A	$2 < T_p \leq 10$
10	$4 < T_p \leq 10$
20	$6 < T_p \leq 20$
30	$9 < T_p \leq 30$

where  $T_p$  is the cold trip time of the thermal release at 7.2 times the set current value (for example: a release in class 10 at 7.2 times the set current value must not trip within 4 s, but must trip within 10 s).

It is normal procedure to associate class 10 with a normal start-up type, and class 30 with a heavy duty start-up type.

#### Coordination type

##### Type 1

It is acceptable that in the case of short-circuit the contactor and the thermal release may be damaged. The starter may still not be able to function and must be inspected; if necessary, the contactor and/or the thermal release must be replaced, and the breaker release reset.

##### Type 2

In the case of short-circuit, the thermal release must not be damaged, while the welding of the contactor contacts is allowed, as they can easily be separated (with a screwdriver, for example), without any significant deformation.

In order to clearly determine a coordination type, and therefore the equipment necessary to achieve it, the following must be known:

- power of the motor in kW and type;
- rated system voltage;
- rated motor current;
- short-circuit current at installation point;
- starting type: DOL or Y/Δ - normal or heavy duty – Type 1 or Type 2.

The requested devices shall be coordinated with each other in accordance with the prescriptions of the Standard.

For the most common voltages and short-circuit values (400 V - 440 V - 500 V - 690 V 35 kA - 50 kA) and for the most frequently used starting types, such as direct starting and Star/Delta starting, for asynchronous squirrel-cage motor (AC-3), ABB supplies solutions with:

- magnetic circuit-breaker - contactor - thermal release;
- thermomagnetic circuit-breaker - contactor;
- thermomagnetic circuit-breaker with PR212 MP electronic release – contactor.

### 3 Protection of electrical equipment

The following is an example of the type of tables available:

**Table 3: 400 V 50 kA DOL Normal Type 2 (Tmax, Isomax – Contactor – TOR)**

Motor		MCCB		Contactor	Thermal Overload Release		
P <sub>e</sub> [kW]	I <sub>r</sub> [A]	Type	I <sub>3</sub> [A]	Type	Type	Current setting	
						min. [A]	max. [A]
0.37	1.1	T2S160 MF 1.6	21	A9	TA25DU1.4	1	1.4
0.55	1.5	T2S160 MF 1.6	21	A9	TA25DU1.8	1.3	1.8
0.75	1.9	T2S160 MF 2	26	A9	TA25DU2.4	1.7	2.4
1.1	2.8	T2S160 MF 3.2	42	A9	TA25DU4	2.8	4
1.5	3.5	T2S160 MF 4	52	A16	TA25DU5	3.5	5
2.2	5	T2S160 MF 5	65	A26	TA25DU6.5	4.5	6.5
3	6.6	T2S160 MF 8.5	110	A26	TA25DU8.5	6	8.5
4	8.6	T2S160 MF 11	145	A30	TA25DU11	7.5	11
5.5	11.5	T2S160 MF 12.5	163	A30	TA25DU14	10	14
7.5	15.2	T2S160 MA 20	210	A30	TA25DU19	13	19
11	22	T2S160 MA 32	288	A30	TA42DU25	18	25
15	28.5	T2S160 MA 52	392	A50	TA75DU42	29	42
18.5	36	T2S160 MA 52	469	A50	TA75DU52	36	52
22	42	T2S160 MA 52	547	A50	TA75DU52	36	52
30	56	T2S160 MA 80	840	A63	TA75DU80	60	80
37	68	T2S160 MA 80	960	A75	TA75DU80	60	80
45	83	T2S160 MA 100	1200	A95	TA110DU110	80	110
55	98	T3S250 MA 160	1440	A110	TA110DU110	80	110
75	135	T3S250 MA 200	1800	A145	TA200DU175	130	175
90	158	T3S250 MA 200	2400	A185	TA200DU200	150	200
110	193	T4S320 PR221-I In320	2720	A210	E320DU320	100	320
132	232	T5S400 PR221-I In400	3200	A260	E320DU320	100	320
160	282	T5S400 PR221-I In400	4000	A300	E320DU320	100	320
200	349	T5S630 PR221-I In630	5040	AF400	E500DU500	150	500
250	430	T5S630 PR221-I In630	6300	AF460	E500DU500	150	500
290	520	S6S800 PR211-I In800	8000	AF580	E800DU800	250	800
315	545	S6S800 PR211-I In800	9600	AF580	E800DU800	250	800
355	610	S6S800 PR211-I In800	9600	AF750	E800DU800	250	800

MA: magnetic only adjustable release  
MF: fixed magnetic only release



### 3 Protection of electrical equipment

**Table 4: 400 V 50 kA DOL Heavy duty Type 2  
(Tmax, Isomax – Contactor – TOR)**

Motor		MCCB		Contactor	Thermal Overload Release			
P <sub>e</sub> [kW]	I <sub>r</sub> [A]	Type	Setting of the magnetic release [A]	Type	Type**	No. of turns of the CT primary coil	Setting range	
							min. [A]	max. [A]
0.37	1.1	T2S160 MF 1.6	21	A9	TA25DU1.4*		1	1.4
0.55	1.5	T2S160 MF 1.6	21	A9	TA25DU1.8*		1.3	1.8
0.75	1.9	T2S160 MF 2	26	A9	TA25DU2.4*		1.7	2.4
1.1	2.8	T2S160 MF 3.2	42	A9	TA25DU4*		2.8	4
1.5	3.5	T2S160 MF 4	52	A16	TA25DU5*		3.5	5
2.2	5	T2S160 MF 5	65	A26	TA25DU6.5*		4.5	6.5
3	6.6	T2S160 MF 8.5	110	A26	TA25DU8.5*		6	8.5
4	8.6	T2S160 MF 11	145	A30	TA25DU11*		7.5	11
5.5	11.5	T2S160 MF 12.5	163	A30	TA450SU60	4	10	15
7.5	15.2	T2S160 MA 20	210	A30	TA450SU60	3	13	20
11	22	T2S160 MA 32	288	A30	TA450SU60	2	20	30
15	28.5	T2S160 MA 52	392	A50	TA450SU80	2	23	40
18.5	36	T2S160 MA 52	469	A50	TA450SU80	2	23	40
22	42	T2S160 MA 52	547	A50	TA450SU80		40	60
30	56	T2S160 MA 80	840	A63	TA450SU80		55	80
37	68	T2S160 MA 80	960	A95	TA450SU80		55	80
45	83	T2S160 MA 100	1200	A110	TA450SU105		70	105
55	98	T3S250 MA 160	1440	A145	TA450SU140		95	140
75	135	T3S250 MA 200	1800	A185	TA450SU185		130	185
90	158	T3S250 MA 200	2400	A210	TA450SU185		130	185
110	193	T4S320 PR221-I In320	2720	A260	E320DU320		100	320
132	232	T5S400 PR221-I In400	3200	A300	E320DU320		100	320
160	282	T5S400 PR221-I In400	4000	AF400	E500DU500		150	500
200	349	T5S630 PR221-I In630	5040	AF460	E500DU500		150	500
250	430	T5S630 PR221-I In630	6300	AF580	E500DU500***		150	500
290	520	S6S800 PR211-I In800	8000	AF750	E800DU800		250	800
315	545	S6S800 PR211-I In800	9600	AF750	E800DU800		250	800
355	610	S6S800 PR211-I In800	9600	AF750	E800DU800		250	800

\* Provide a by-pass contactor of the same size during motor start-up

\*\* For type E releases choose tripping class 30

\*\*\* Connecting kit not available. To use the connecting kit, replacement with release E800DU800 is necessary

MA: magnetic only adjustable release

MF: fixed magnetic only release

TSDC010020F0201

### 3 Protection of electrical equipment

**Table 5: 400 V 50 kA Y/Δ Normal Type 2  
(Tmax, Isomax – Contactor – TOR)**

MOTOR		MCCB		Contactor			Thermal Overload Release	
P <sub>e</sub> [kW]	I <sub>r</sub> [A]	Type	I <sub>3</sub> [A]	LINE	DELTA	STAR	Type	[A]
				Type	Type	Type		
18.5	36	T2S160 MA52	469	A50	A50	A26	TA75DU25	18-25
22	42	T2S160 MA52	547	A50	A50	A26	TA75DU32	22-32
30	56	T2S160 MA80	720	A63	A63	A30	TA75DU42	29-42
37	68	T2S160 MA80	840	A75	A75	A30	TA75DU52	36-52
45	83	T2S160 MA100	1050	A75	A75	A30	TA75DU63	45 - 63
55	98	T2S160 MA100	1200	A75	A75	A40	TA75DU63	45 - 63
75	135	T3S250 MA160	1700	A95	A95	A75	TA110DU90	66 - 90
90	158	T3S250 MA200	2000	A110	A110	A95	TA110DU110	80 - 110
110	193	T3S250 MA200	2400	A145	A145	A95	TA200DU135	100 - 135
132	232	T4S320 PR221-I In320	2880	A145	A145	A110	E200DU200	60 - 200
160	282	T5S400 PR221-I In400	3600	A185	A185	A145	E200DU200	60 - 200
200	349	T5S630 PR221-I In630	4410	A210	A210	A185	E320DU320	100 - 320
250	430	T5S630 PR221-I In630	5670	A260	A260	A210	E320DU320	100 - 320

MA : magnetic only adjustable release

TSDC010023F0201

### 3 Protection of electrical equipment

**Table 6: 440 V 50 kA DOL Normal Type 2  
(Tmax, Isomax – Contactor – TOR)**

Motor		MCCB		Contactor	Thermal Overload Release		
P <sub>e</sub> [kW]	I <sub>r</sub> [A]	Type	I <sub>s</sub> [A]	Type	Type	Current setting	
						min. [A]	max. [A]
0.37	1	T2H160 MF 1	13	A9	TA25DU1.4	1	1.4
0.55	1.4	T2H160 MF 1.6	21	A9	TA25DU1.8	1.3	1.8
0.75	1.7	T2H160 MF 2	26	A9	TA25DU2.4	1.7	2.4
1.1	2.2	T2H160 MF 2.5	33	A9	TA25DU3.1	2.2	3.1
1.5	3	T2H160 MF 3.2	42	A16	TA25DU4	2.8	4
2.2	4.4	T2H160 MF 5	65	A26	TA25DU5	3.5	5
3	5.7	T2H160 MF 6.5	84	A26	TA25DU6.5	4.5	6.5
4	7.8	T2H160 MF 8.5	110	A30	TA25DU11	7.5	11
5.5	10.5	T2H160 MF 11	145	A30	TA25DU14	10	14
7.5	13.5	T2H160 MA 20	180	A30	TA25DU19	13	19
11	19	T2H160 MA 32	240	A30	TA42DU25	18	25
15	26	T2H160 MA 32	336	A50	TA75DU32	22	32
18.5	32	T2H160 MA 52	469	A50	TA75DU42	29	42
22	38	T2H160 MA 52	547	A50	TA75DU52	36	52
30	52	T2H160 MA 80	720	A63	TA75DU63	45	63
37	63	T2H160 MA 80	840	A75	TA75DU80	60	80
45	75	T2H160 MA 100	1050	A95	TA110DU90	65	90
55	90	T4H250 PR221-I In160	1200	A110	TA110DU110	80	110
75	120	T4H250 PR221-I In250	1750	A145	E200DU200	60	200
90	147	T4H250 PR221-I In250	2000	A185	E200DU200	60	200
110	177	T4H250 PR221-I In250	2500	A210	E320DU320	100	320
132	212	T4H320 PR221-I In320	3200	A260	E320DU320	100	320
160	260	T5H400 PR221-I In400	3600	A300	E320DU320	100	320
200	320	T5H630 PR221-I In630	4410	AF 400	E500DU500	150	500
250	410	T5H630 PR221-I In630	5355	AF 460	E500DU500	150	500
290	448	S6H630 PR211-I In630	7560	AF 580	E500DU500*	150	500
315	500	S6H800 PR211-I In800	8000	AF 580	E800DU800	250	800
355	549	S6H800 PR211-I In800	9600	AF 580	E800DU800	250	800

\* Connection kit not available  
MA: magnetic only adjustable release  
MF: fixed magnetic only release

1SDC010024F0201

### 3 Protection of electrical equipment

**Table 7: 440 V 50 kA DOL Heavy duty Type 2  
(Tmax, Isomax – Contactor – TOR)**

Motor		MCCB		Contactor	Thermal Overload Release			
P <sub>e</sub> [kW]	I <sub>r</sub> [A]	Type	Setting of the magnetic release [A]	Type	Type**	No. of turns of the CT primary coil	Setting range	
							min. [A]	max. [A]
0.37	1	T2H160 MF 1	13	A9	TA25DU1.4*		1	1.4
0.55	1.4	T2H160 MF 1.6	21	A9	TA25DU1.8*		1.3	1.8
0.75	1.7	T2H160 MF 2	26	A9	TA25DU2.4*		1.7	2.4
1.1	2.2	T2H160 MF 2.5	33	A9	TA25DU3.1*		2.2	3.1
1.5	3	T2H160 MF 3.2	42	A16	TA25DU4*		2.8	4
2.2	4.4	T2H160 MF 5	65	A26	TA25DU5*		3.5	5
3	5.7	T2H160 MF 6.5	84	A26	TA25DU6.5*		4.5	6.5
4	7.8	T2H160 MF 8.5	110	A30	TA25DU11*		7.5	11
5.5	10.5	T2H160 MF 11	145	A30	TA25DU14*		10	14
7.5	13.5	T2H160 MA 20	180	A30	TA450SU60	4	10	15
11	19	T2H160 MA 32	240	A30	TA450SU80	3	18	27
15	26	T2H160 MA 32	336	A50	TA450SU60	2	20	30
18.5	32	T2H160 MA 52	469	A50	TA450SU80	2	28	40
22	38	T2H160 MA 52	547	A50	TA450SU80	2	28	40
30	52	T2H160 MA 80	720	A63	TA450SU60		40	60
37	63	T2H160 MA 80	840	A95	TA450SU80		55	80
45	75	T2H160 MA 100	1050	A110	TA450SU105		70	105
55	90	T4H250 PR221-I In160	1200	A145	E200DU200		60	200
75	120	T4H250 PR221-I In250	1750	A185	E200DU200		60	200
90	147	T4H250 PR221-I In250	2000	A210	E320DU320		100	320
110	177	T4H250 PR221-I In250	2500	A260	E320DU320		100	320
132	212	T4H320 PR221-I In320	3200	A300	E320DU320		100	320
160	260	T5H400 PR221-I In400	3600	AF400	E500DU500		150	500
200	320	T5H630 PR221-I In630	4410	AF460	E500DU500		150	500
250	410	T5H630 PR221-I In630	5355	AF580	E500DU500***		150	500
290	448	S6H630 PR211-I In630	7560	AF750	E500DU500***		150	500
315	500	S6H800 PR211-I In800	8000	AF 750	E800DU800		250	800
355	549	S6H800 PR211-I In800	9600	AF 750	E800DU800		250	800

\* Provide a by-pass contactor of the same size during motor start-up  
\*\* For type E releases choose tripping class 30  
\*\*\* Connecting kit not available. To use the connecting kit, replacement with release E800DU800 is necessary

MA: magnetic only adjustable release  
MF: fixed magnetic only release

1SDC010021F0201

### 3 Protection of electrical equipment

**Table 8: 440 V 50 kA Y/Δ Normal Type 2  
(Tmax, Isomax – Contactor – TOR)**

MOTOR		MCCB		Contactor			Thermal Overload Release	
$P_e$ [kW]	$I_r$ [A]	Type	$I_3$ [A]	LINE Type	DELTA Type	STAR Type	Type	[A]
18.5	32	T2H160 MA52	392	A 50	A 50	A 16	TA75DU25	18-25
22	38	T2H160 MA52	469	A 50	A 50	A 26	TA75DU25	18-25
30	52	T2H160 MA80	720	A 63	A 63	A 26	TA75DU42	29-42
37	63	T2H160 MA80	840	A 75	A 75	A 30	TA75DU42	29-42
45	75	T2H160 MA80	960	A 75	A 75	A30	TA75DU52	36-52
55	90	T2H160 MA100	1150	A 75	A 75	A40	TA75DU63	45 - 63
75	120	T4H250 PR221-I In250	1625	A95	A95	A75	TA80DU80	60-80
90	147	T4H250 PR221-I In250	1875	A95	A95	A75	TA110DU110	80-110
110	177	T4H250 PR221-I In250	2250	A145	A145	A95	E200DU200	60-200
132	212	T4H320 PR221-I In320	2720	A145	A145	A110	E200DU200	60-200
160	260	T5H400 PR221-I In400	3200	A185	A185	A145	E200DU200	60-200
200	320	T5H630 PR221-I In630	4095	A210	A210	A185	E320DU320	100-320
250	410	T5H630 PR221-I In630	5040	A260	A260	A210	E320DU320	100-320

MA : Magnetic only adjustable release

1SDC010028F0201

### 3 Protection of electrical equipment

**Table 9: 500 V 50 kA DOL Normal Type 2  
(Tmax, Isomax – Contactor – TOR)**

Motor		MCCB		Contactor	Thermal Overload Release	
$P_e$ [kW]	$I_r$ [A]	Type	$I_3$ [A]	Type	Type	Current setting
						min. [A]   max. [A]
0.37	0.88	T2L160 MF 1	13	A9	TA25DU1.0	0.63   1
0.55	1.2	T2L160 MF 1.6	21	A9	TA25DU1.4	1   1.4
0.75	1.5	T2L160 MF 1.6	21	A9	TA25DU1.8	1.3   1.8
1.1	2.2	T2L160 MF 2.5	33	A9	TA25DU3.1	2.2   3.1
1.5	2.8	T2L160 MF 3.2	42	A16	TA25DU4	2.8   4
2.2	4	T2L160 MF 4	52	A26	TA25DU5	3.5   5
3	5.2	T2L160 MF 6.5	84	A26	TA25DU6.5	4.5   6.5
4	6.9	T2L160 MF 8.5	110	A30	TA25DU8.5	6   8.5
5.5	9.1	T2L160 MF 11	145	A30	TA25DU11	7.5   11
7.5	12.2	T2L160 MF 12.5	163	A30	TA25DU14	10   14
11	17.5	T2L160 MA 20	240	A30	TA25DU19	13   19
15	23	T2L160 MA 32	336	A50	TA75DU25	18   25
18.5	29	T2L160 MA 52	392	A50	TA75DU32	22   32
22	34	T2L160 MA 52	469	A50	TA75DU42	29   42
30	45	T2L160 MA 52	624	A63	TA75DU52	36   52
37	56	T2L160 MA 80	840	A75	TA75DU63	45   63
45	67	T2L160 MA 80	960	A95	TA80DU80	60   80
55	82	T2L160 MA 100	1200	A110	TA110DU90	65   90
75	110	T4H250 PR221-I In160	1440	A145	E200DU200	60   200
90	132	T4H250 PR221-I In250	1875	A145	E200DU200	60   200
110	158	T4H250 PR221-I In250	2250	A185	E200DU200	60   200
132	192	T4H320 PR221-I In320	2720	A210	E320DU320	100   320
160	230	T5H400 PR221-I In400	3600	A260	E320DU320	100   320
200	279	T5H400 PR221-I In400	4000	A300	E320DU320	100   320
250	335	T5H630 PR221-I In630	4725	AF 400	E 500DU500	150   500
290	394	T5H630 PR221-I In630	5040	AF 460	E 500DU500	150   500
315	440	S6L630 PR211-I In630	7560	AF 580	E 500DU500*	150   500
355	483	S6L630 PR211-I In630	7560	AF 580	E 800DU800	250   800

\* Connection kit not available  
MA: magnetic only adjustable release  
MF: fixed magnetic only release

1SDC010028F0201

### 3 Protection of electrical equipment

**Table 10: 500 V 50 kA DOL Heavy duty Type 2**  
(Tmax, Isomax – Contactor – TOR)

Motor		MCCB		Contactor	Thermal Overload Release			
P <sub>e</sub> [kW]	I <sub>r</sub> [A]	Type	Setting of the magnetic release [A]	Type	Type**	No. of turns of the CT primary coil	Setting range	
							min. [A]	max. [A]
0.37	0.88	T2L160 MF 1	13	A9	TA25DU1.0*		0.63	1
0.55	1.2	T2L160 MF 1.6	21	A9	TA25DU1.4*		1	1.4
0.75	1.5	T2L160 MF 1.6	21	A9	TA25DU1.8*		1.3	1.8
1.1	2.2	T2L160 MF 2.5	33	A9	TA25DU3.1*		2.2	3.1
1.5	2.8	T2L160 MF 3.2	42	A16	TA25DU4*		2.8	4
2.2	4	T2L160 MF 4	52	A26	TA25DU5*		3.5	5
3	5.2	T2L160 MF 6.5	84	A26	TA25DU6.5*		4.5	6.5
4	6.9	T2L160 MF 8.5	110	A30	TA25DU8.5*		6	8.5
5.5	9.1	T2L160 MF 11	145	A30	TA25DU11*		7.5	11
7.5	12.2	T2L160 MF 12.5	163	A30	TA450SU60	4	10	15
11	17.5	T2L160 MA 20	240	A30	TA450SU60	3	13	20
15	23	T2L160 MA 32	336	A50	TA450SU60	2	20	30
18.5	29	T2L160 MA 52	392	A50	TA450SU80	2	27.5	40
22	34	T2L160 MA 52	469	A50	TA450SU80	2	27.5	40
30	45	T2L160 MA 52	624	A63	TA450SU60		40	60
37	56	T2L160 MA 80	840	A75	TA450SU60		40	60
45	67	T2L160 MA 80	960	A95	TA450SU80		55	80
55	82	T2L160 MA 100	1200	A145	TA450SU105		70	105
75	110	T4H250 PR221-I In160	1440	A145	E200DU200		60	200
90	132	T4H250 PR221-I In250	1875	A185	E200DU200		60	200
110	158	T4H250 PR221-I In250	2123	A210	E320DU320		100	320
132	192	T4H320 PR221-I In320	2720	A260	E320DU320		100	320
160	230	T5H400 PR221-I In400	3200	A300	E320DU320		100	320
200	279	T5H400 PR221-I In400	3600	AF400	E500DU500		150	500
250	335	T5H630 PR221-I In630	4725	AF460	E500DU500		150	500
290	394	T5H630 PR221-I In630	5040	AF580	E500DU500***		150	500
315	440	S6L630 PR211-I In630	7560	AF750	E500DU500***		150	500
355	483	S6L630 PR211-I In630	7560	AF750	E500DU500		150	500

\* Provide a by-pass contactor of the same size during motor start-up

\*\* For type E releases choose tripping class 30

\*\*\* Connecting kit not available. To use the connecting kit, replacement with release E800DU800 is necessary

MA: magnetic only adjustable release

MF: fixed magnetic only release

1SDC010021F0201

### 3 Protection of electrical equipment

**Table 11: 500 V 50 kA Y/Δ Normal Type 2**  
(Tmax, Isomax – Contactor – TOR)

MOTOR		MCCB		Contactor			Thermal Overload Release	
P <sub>e</sub> [kW]	I <sub>r</sub> [A]	Type	I <sub>s</sub> [A]	LINE	DELTA	STAR	Type	[A]
				Type	Type	Type		
22	34	T2L160 MA52	430	A 50	A 50	A 16	TA75DU25	18-25
30	45	T2L160 MA52	547	A 63	A 63	A 26	TA75DU32	22-32
37	56	T2L160 MA80	720	A 75	A 75	A 30	TA75DU42	29-42
45	67	T2L160 MA80	840	A 75	A 75	A30	TA75DU52	36 - 52
55	82	T2L160 MA100	1050	A 75	A 75	A30	TA75DU52	36 - 52
75	110	T4H250 PR221-I In250	1375	A95	A95	A50	TA80DU80	60-80
90	132	T4H250 PR221-I In250	1750	A95	A95	A75	TA110DU90	65-90
110	158	T4H250 PR221-I In250	2000	A110	A110	A95	TA110DU110	80-110
132	192	T4H320 PR221-I In320	2560	A145	A145	A95	E200DU200	60-200
160	230	T4H320 PR221-I In320	2880	A145	A145	A110	E200DU200	60-200
200	279	T5H400 PR221-I In400	3400	A210	A210	A145	E320DU320	100-320
250	335	T5H630 PR221-I In630	4410	A210	A210	A185	E320DU320	100-320
290	394	T5H630 PR221-I In630	5040	A260	A260	A210	E320DU320	100-320

MA: magnetic only adjustable release

1SDC010021F0201

### 3 Protection of electrical equipment

#### Example:

For a Y/Δ Normal starting Type 2, of a three phase asynchronous squirrel-cage motor with the following data:

rated voltage  $U_r = 400$  V

short-circuit current  $I_k = 50$  kA

rated motor power  $P_e = 200$  kW

from Table 5, on the relevant row, the following information can be found:

- $I_r$  (rated current): 349 A;
- short-circuit protection device: circuit-breaker T5S630 PR221-I In630;
- magnetic trip threshold:  $I_3 = 4410$  A;
- line contactor: A210;
- delta contactor: A210;
- star contactor: A185;
- thermal release E320DU320, setting range 100+320 A  
(to be set at  $\frac{I_r}{\sqrt{3}} = 202$  A).

### 3 Protection of electrical equipment

#### 3.4 Protection and switching of transformers

##### General aspects

Transformers are used to achieve a change in the supply voltage, for both medium and low voltage supplies.

The choice of the protection devices must take into account transient insertion phenomena, during which the current may reach values higher than the rated full load current; the phenomenon decays in a few seconds.

The curve which represents these transient phenomena in the time-current diagram, termed "inrush current  $I_0$ ", depends on the size of the transformer and can be evaluated with the following formula (the short-circuit power of the network is assumed to be equal to infinity)

$$I_0 = \frac{K \cdot I_{1r} \cdot e^{(-t/\tau)}}{\sqrt{2}}$$

where:

K ratio between the maximum peak inrush current value ( $I_0$ ) and the rated current of the transformer ( $I_{1r}$ ): ( $K = I_0 / I_{1r}$ );

$\tau$  time constant of the inrush current;

$I_{1r}$  rated current of the primary;

t time.

The table below shows the indicative values for t and K parameters referred to rated power  $S_r$  for oil transformers.

$S_r$ [kVA]	50	100	160	250	400	630	1000	1600	2000
$K = I_0 / I_{1r}$	15	14	12	12	12	11	10	9	8
$\tau$ [s]	0.10	0.15	0.20	0.22	0.25	0.30	0.35	0.40	0.45

Further to the above consideration, the following diagram shows the inrush current curve for a 20/0.4kV of 400kVA transformer. This transformer has an inrush current during the very first moments equal to about 8 times the rated current; this transient phenomenon stops after a few tenths of a second.

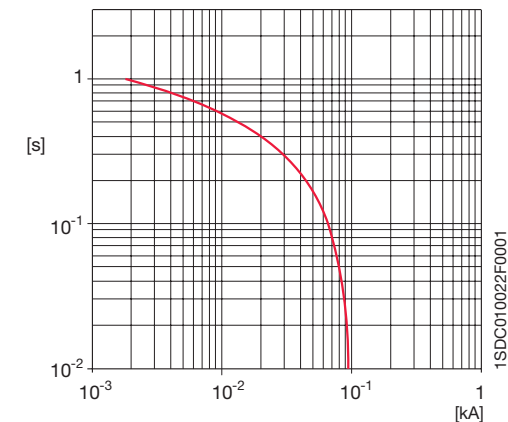

### 3 Protection of electrical equipment

The transformer protection devices must also guarantee that the transformer cannot operate above the point of maximum thermal overload under short-circuit conditions; this point is defined on the time-current diagram by the value of short-circuit current which can pass through the transformer and by a time equal to 2 s, as stated by Standard IEC 60076-5. The short-circuit current ( $I_k$ ) flowing for a fault with low impedance at the LV terminals of the transformer is calculated by using the following formula:

$$I_k = \frac{U_r}{\sqrt{3} \cdot (Z_{Net} + Z_t)} \quad [A] \quad (1)$$

where:

- $U_r$  is the rated voltage of the transformer [V];
- $Z_{Net}$  is the short-circuit impedance of the network [ $\Omega$ ];
- $Z_t$  is the short-circuit impedance of the transformer; from the rated power of the transformer ( $S_r$  [VA]) and the percentage short-circuit voltage ( $u_k\%$ ) it is equal to:

$$Z_t = \frac{u_k\% \cdot U_r^2}{100 \cdot S_r} \quad [\Omega] \quad (2)$$

Considering the upstream short-circuit power of the network to be infinite ( $Z_{Net}=0$ ), formula (1) becomes:

$$I_k = \frac{U_r}{\sqrt{3} \cdot Z_t} = \frac{U_r}{\sqrt{3} \cdot \left( \frac{u_k\% \cdot U_r^2}{100 \cdot S_r} \right)} = \frac{100 \cdot S_r}{\sqrt{3} \cdot u_k\% \cdot U_r} \quad [A] \quad (3)$$

The diagram below shows the inrush current curve for a 20/0.4 kV of 400 kVA transformer ( $u_k\% = 4\%$ ) and the point referred to the thermal ability to withstand the short-circuit current ( $I_k$ ; 2 sec.).

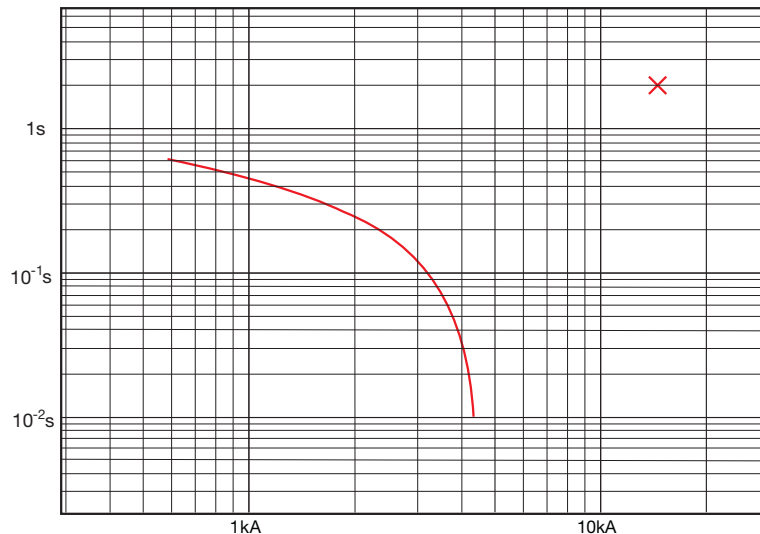

1SDC010023F0001

### 3 Protection of electrical equipment

In summary: for the correct protection of the transformer and to avoid unwanted trips, the trip curve of the protection device must be above the inrush current curve and below the overload point.

The diagram below shows a possible position of the time-current curve of an upstream protection device of a 690/400 V, 250 kVA transformer with  $u_k\% = 4\%$ .

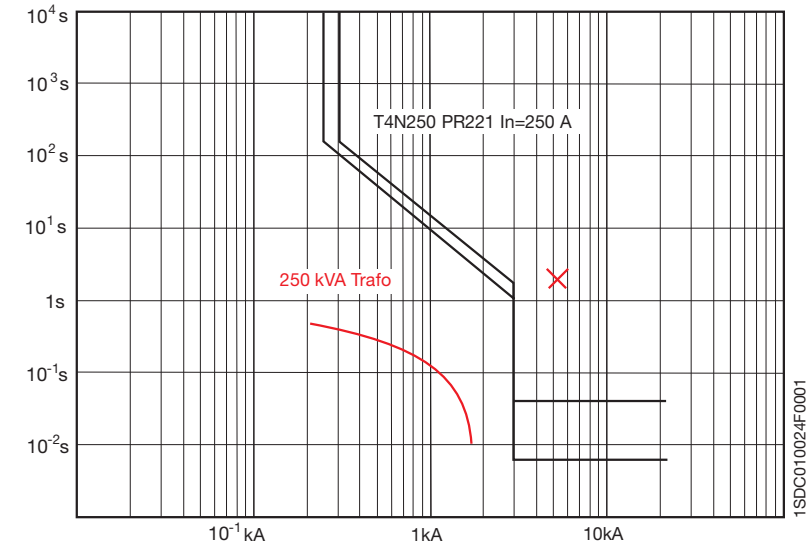

1SDC010024F0001

#### Criteria for the selection of protection devices

For the protection at the LV side of MV/LV transformers, the selection of a circuit-breaker shall take into account:

- the rated current at LV side of the protected transformer (this value is the reference value for the rated current of the circuit-breaker and the setting of the protections);
- the maximum short-circuit current at the point of installation (this value determines the minimum breaking capacity ( $I_{cu}/I_{cs}$ ) of the protection device).

*MV/LV unit with single transformer*

The rated current at the LV side of the transformer ( $I_r$ ) is determined by the following formula:

$$I_r = \frac{1000 \cdot S_r}{\sqrt{3} \cdot U_{r20}} \quad [A] \quad (4)$$

where:

- $S_r$  is the rated power of the transformer [kVA];
- $U_{r20}$  is the rated LV no-load voltage of the transformer [V].

### 3 Protection of electrical equipment

The full voltage three-phase short-circuit current ( $I_k$ ), at the LV terminals of the transformer, can be expressed as (assuming that the short-circuit power of the network is infinite):

$$I_k = \frac{100 \cdot I_r}{u_k \%} \quad [\text{A}] \quad (5)$$

where:

$u_k\%$  is the short-circuit voltage of the transformer, in %.

The protection circuit-breaker must have:

$$I_n \geq I_r;$$

$$I_{cu} (I_{cs}) \geq I_k.$$

If the short-circuit power of the upstream network is not infinite and cable or busbar connections are present, it is possible to obtain a more precise value for  $I_k$  by using formula (1), where  $Z_{Net}$  is the sum of the impedance of the network and of the impedance of the connection.

*MV/LV substation with more than one transformer in parallel*

For the calculation of the rated current of the transformer, the above applies (formula 4).

The breaking capacity of each protection circuit-breaker on the LV side shall be higher than the short-circuit current equivalent to the short-circuit current of each equal transformer multiplied by the number of them minus one.

As can be seen from the diagram below, in the case of a fault downstream of a transformer circuit-breaker (circuit-breaker A), the short-circuit current that flows through the circuit-breaker is equal to the contribution of a single transformer. In the case of a fault upstream of the same circuit-breaker, the short-circuit current that flows is equal to the contribution of the other two transformers in parallel.

### 3 Protection of electrical equipment

For a correct dimensioning, a circuit-breaker with a breaking capacity higher than twice the short-circuit current of one of the transformers must be chosen (assuming that all the transformers are equal and the loads are passive).

The circuit-breakers positioned on the outgoing feeders (circuit-breakers B) shall have a breaking capacity higher than the sum of the short-circuit currents of the three transformers, according to the hypothesis that the upstream network short-circuit power is 750 MVA and the loads are passive.

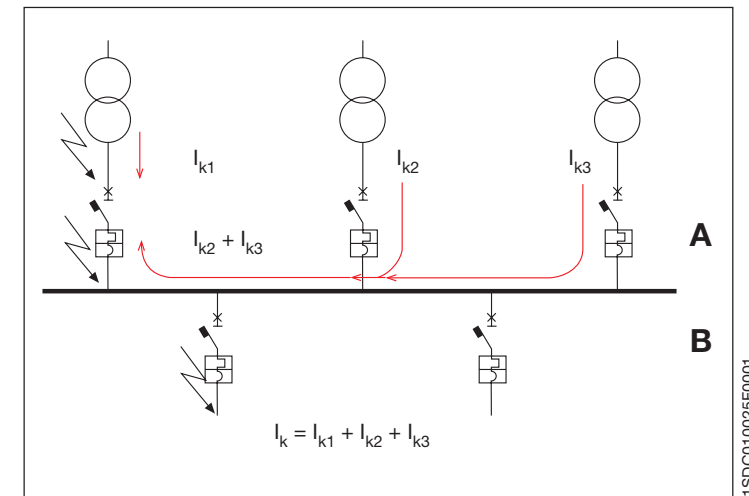

### 3 Protection of electrical equipment

#### Selection of the circuit-breaker

The following tables show some possible choices of ABB SACE circuit-breakers, according to the characteristics of the transformer to be protected.

**Table 1: Protection and switching of 230 V transformers**

Transformer				Circuit-breaker "A" (LV side)									
Sr	uk	Trafo Ir	Busbar Ib	Trafo Feeder Ik	ABB SACE Circuit-breaker	Release		Busbar Ik					
		[A]	[A]	[kA]		size	setting		[kA]	32 A	63 A	125 A	160 A
1 x 63	4	158	158	3.9	T1B160	In=160	1	3.9	S250/S260	T1B160			
2 x 63		158	316	3.9	T1B160	In=160	1	7.9	S250/S260	T1B160			
1 x 100	4	251	251	6.3	T4N320	In=320	0.9	6.3	S250/S260	T1B160			
2 x 100		251	502	6.2	T4N320	In=320	0.9	12.5	S250/S260	T1B160			
1 x 125	4	314	314	7.8	T5N400	In=400	0.9	7.8	S250/S260	T1B160			
2 x 125		314	628	7.8	T5N400	In=400	0.9	15.6	S250/S260	T1B160			
1 x 160	4	402	402	10.0	T5N630	In=630	0.7	10.0	S250/S260	T1B160			
2 x 160		402	803	9.9	T5N630	In=630	0.7	19.9		T1B160			
1 x 200	4	502	502	12.5	T5N630	In=630	0.9	12.5	S250/S260	T1B160			
2 x 200		502	1004	12.4	T5N630	In=630	0.9	24.8		T1B160			
1 x 250	4	628	628	15.6	T5N630	In=630	1	15.6	S250/S260	T1B160			
2 x 250		628	1255	15.4	T5N630	In=630	1	30.9		T1C160			
1 x 315	4	791	791	19.6	S6N800	In=800	1	19.6		T1B160			
2 x 315		791	1581	19.4	S6N800	In=800	1	38.7		T1C160			
1 x 400	4	1004	1004	24.8	S7S1250/E1B1250	In=1250	0.9	24.8		T1B160			
2 x 400		1004	2008	24.5	S7S1250/E1B1250	In=1250	0.9	48.9		T1N160			
1 x 500	4	1255	1255	30.9	S7S1600/E2B1600	In=1600	0.9	30.9	S6N800	T1C160			
2 x 500		1255	2510	30.4	S7S1600/E2B1600	In=1600	0.9	60.7		T2N160			
1 x 630	4	1581	1581	38.7	S7S1600/E2B1600	In=1600	1	38.7		T1C160			
2 x 630		1581	3163	37.9	S7S1600/E2B1600	In=1600	1	75.9		T2S160			
3 x 630	5	1581	4744	74.4	S7S1600/E3S1600	In=1600	1	111.6		T2L160			
1 x 800		2008	2008	39.3	E3N2500	In=2500	0.9	39.3		T1C160			
2 x 800	5	2008	4016	38.5	E3N2500	In=2500	0.9	77.0		T2S160			
3 x 800		2008	6025	75.5	E3H2500	In=2500	0.9	113.2		T2L160			
1 x 1000	5	2510	2510	48.9	E3N3200	In=3200	0.8	48.9		T1N160			
2 x 1000		2510	5020	47.7	E3N3200	In=3200	0.8	95.3		T2H160			
3 x 1000	5	2510	7531	93.0	E3H3200	In=3200	0.8	139.5		T4L250			
1 x 1250		3138	3138	60.7	E3N3200	In=3200	1	60.7		T2N160			
2 x 1250	5	3138	6276	58.8	E3N3200	In=3200	1	117.7		T2L160			
3 x 1250		3138	9413	114.1	S8V3200/E6V3200	In=3200	1	171.2		T4L250			

### 3 Protection of electrical equipment

Circuit-breaker "B" (Feeder circuit-breaker)										
Feeder circuit-breaker type and rated current										
250 A	400 A	630 A	800 A	1250 A	1600 A	2000 A	2500 A	3200 A	4000 A	
T3N250										
T3N250	T5N400									
T3N250	T5N400									
T3N250	T5N400									
T3N250	T5N400	T5N630								
T3N250	T5N400									
T3N250	T5N400	T5N630								
T3N250	T5N400	T5N630	S6N800							
T3N250	T5N400	T5N630	S6N800							
T3N250	T5N400	T5N630	S6N800	S7S1250						
T3N250	T5N400	T5N630	S6N800							
T3N250	T5N400	T5N630	S6N800	S7S1250/E1N1250	S7S1600/E2N1600					
T3N250	T5N400	T5N630	S6N800							
T3S250	T5N400	T5N630	S6N800	S7S1250/E2N1250	S7S1600/E2N1600	E2N2000				
T3N250	T5N400	T5N630	S6N800	S7S1250/E1N1250						
T3S250	T5S400	T5S630	S6S800	S7S1250/E2L1250	S7S1600/E2L1600	E3H2000	E3H2500			
T4L250	T5L400	T5L630	S6L800	S7L1250/E2L1250	S7L1600/E2L1600	E3L2000	E3L2500	E6V3200		
T3N250	T5N400	T5N630	S6N800	S7S1250/E1B1250	S7S1600/E2B1600					
T3S250	T5S400	T5S630	S6S800	S7S1250/E2L1250	S7S1600/E2L1600	E3H2000	E3H2500	E3H3200		
T4L250	T5L400	T5L630	S6L800	S7L1250/E2L1250	S7L1600/E2L1600	E3L2000	E3L2500	E6V3200	E6V4000	
T3N250	T5N400	T5N630	S6N800	S7S1250/E1N1250	S7S1600/E2N1600	E2N2000				
T4H250	T5H400	T5H630	S6H800	S7H1250/E2L1250	S7H1600/E2L1600	E3H2000	E3H2500	E3H3200	E4H4000	
T4L250	T5L400	T5L630	S6L800	S7L1250	S7L1600	E6V3200	E6V3200	E6V3200	E6V4000	
T3S250	T5N400	T5N630	S6N800	S7S1250/E2N1250	S7S1600/E2N1600	E2N2000	E3N2500			
T4L250	T5L400	T5L630	S6L800	S7L1250/E2L1250	S7L1600/E2L1600	E3L2000	E3L2500	E6V3200	E6V4000	
T4L250	T5L400	T5L630	S6L800	S7L1250	S7L1600					

1SD0010035F0201









### 3 Protection of electrical equipment

#### NOTE

The tables refer to the previously specified conditions; the information for the selection of circuit-breakers is supplied only with regard to the current in use and the prospective short-circuit current. For a correct selection, other factors such as selectivity, back-up protection, the decision to use limiting circuit-breakers etc. must also be considered. Therefore, it is essential that the design engineers carry out precise checks.

It must also be noted that the short-circuit currents given are determined using the hypothesis of 750 MVA power upstream of the transformers, disregarding the impedances of the busbars or the connections to the circuit-breakers.

#### Example:

Supposing the need to size breakers A1/A2/A3, on the LV side of the three transformers of 630 kVA 20/0.4 kV with  $u_k\%$  equal to 4% and outgoing feeder circuit-breakers B1/B2/B3 of 63-400-800 A:

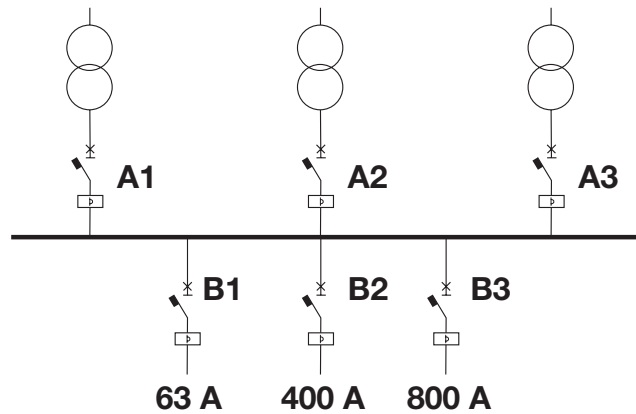

1SDC010026F0001

### 3 Protection of electrical equipment

From Table 2, corresponding to the row relevant to 3x630 kVA transformers, it can be read that:

#### Level A circuit-breakers (LV side of transformer)

- Trafo  $I_T$  (909 A) is the current that flows through the transformer circuit-breakers;
- Busbar  $I_b$  (2727 A) is the maximum current that the transformers can supply;
- Trafo Feeder  $I_k$  (42.8 kA) is the value of the short-circuit current to consider for the choice of the breaking capacity of each of the transformer circuit-breakers;
- S7S1250 or E1N1250 is the size of the transformer circuit-breaker;
- $I_n$  (1000 A) is the rated current of the transformer circuit-breaker (electronic release chosen by the user);
- Setting (0.95) indicates the set value of function L of the electronic release.

#### Level B circuit-breakers (outgoing feeder)

- Busbar  $I_k$  (64.2 kA) is the short-circuit current due to the contribution of all three transformers;
- corresponding to 63 A, read circuit-breaker B1 Tmax T2H160;
- corresponding to 400 A, read circuit-breaker B2 Tmax T5H400;
- corresponding to 800 A, read circuit-breaker B3 Isomax S6L.800 or E2N1250.

The choice made does not take into account discrimination/back-up requirements. Refer to the relevant chapters for selections appropriate to the various cases.

## 4 Power factor correction

### 4.1 General aspects

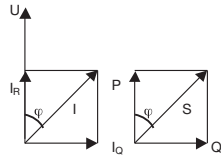

In alternating current circuits, the current absorbed by the user can be represented by two components:

- the active component  $I_R$ , in phase with the supply voltage, is directly correlated to the output (and therefore to the part of electrical energy transformed into energy of a different type, usually electrical with different characteristics, mechanical, light and/or thermal);
- the reactive component  $I_Q$ , in quadrature to the voltage, is used to produce the flow necessary for the conversion of powers through the electric or magnetic field. Without this, there could be no flow of power, such as in the core of a transformer or in the air gap of a motor.

In the most common case, in the presence of ohmic-inductive type loads, the total current ( $I$ ) lags in comparison with the active component  $I_R$ .

In an electrical installation, it is necessary to generate and transmit, other than the active power  $P$ , a certain reactive power  $Q$ , which is essential for the conversion of electrical energy, but not available to the user. The complex of the power generated and transmitted constitutes the apparent power  $S$ .

Power factor ( $\cos\varphi$ ) is defined as the ratio between the active component  $I_R$  and the total value of the current  $I$ ;  $\varphi$  is the phase shifting between the voltage  $U$  and the current  $I$ .

It results:

$$\cos\varphi = \frac{I_R}{I} = \frac{P}{S} \quad (1)$$

The reactive demand factor ( $\tan\varphi$ ) is the relationship between the reactive power and the active power:

$$\tan\varphi = \frac{Q}{P} \quad (2)$$

## 4 Power factor correction

Table 1 shows some typical power factors:

**Table 1: Typical power factor**

Load	$\cos\varphi$	$\tan\varphi$
	power factor	reactive demand factor
Transformers (no load condition)	0.1+0.15	9.9+6.6
Motor (full load)	0.7+0.85	1.0+0.62
Motor (no load)	0.15	6.6
Metal working apparatuses:		
- Arc welding	0.35+0.6	2.7+1.3
- Arc welding compensated	0.7+0.8	1.0+0.75
- Resistance welding:	0.4+0.6	2.3+1.3
- Arc melting furnace	0.75+0.9	0.9+0.5
Fluorescent lamps		
- compensated	0.9	0.5
- uncompensated	0.4+0.6	2.3+1.3
Mercury vapour lamps	0.5	1.7
Sodium vapour lamp	0.65+0.75	1.2+0.9
AC DC converters	0.6+0.95	1.3+0.3
DC drives	0.4+0.75	2.3+0.9
AC drives	0.95+0.97	0.33+0.25
Resistive load	1	0

The power factor correction is the action increasing the power factor in a specific section of the installation by locally supplying the necessary reactive power, so as to reduce the current value to the equivalent of the power required, and therefore the total power absorbed from the upstream side. Thus, both the line as well as the supply generator can be sized for a lower apparent power value required by the load.

In detail, as shown by Figure 1 and Figure 2, increasing the power factor of the load:

- decreases the relative voltage drop  $u_{rp}$  per unit of active power transmitted;
- increases the transmittable active power and decreases the losses, the other dimensioning parameters remaining equal.

## 4 Power factor correction

Figure 1: Relative voltage drop

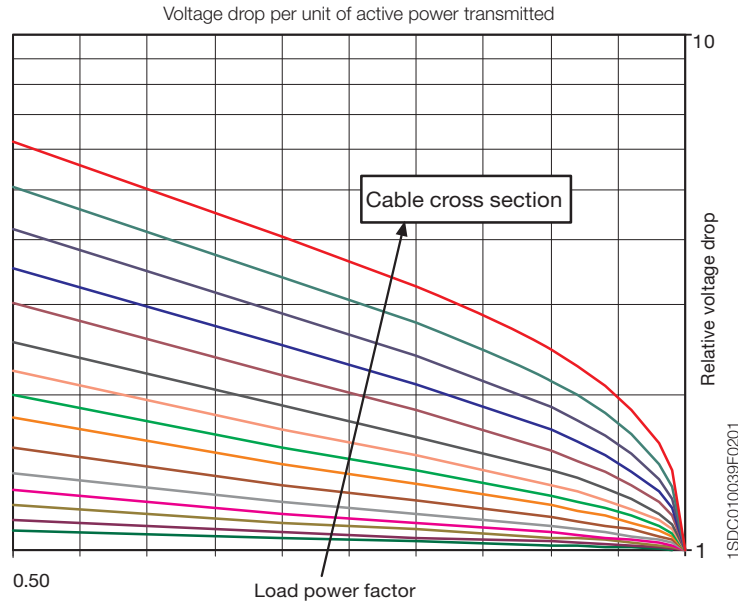
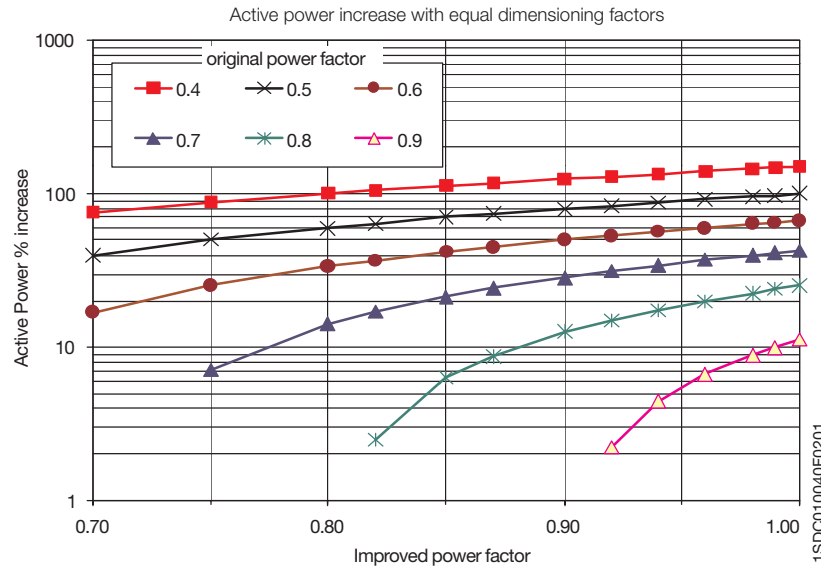

Figure 2: Transmittable active power



## 4 Power factor correction

The distribution authority is responsible for the production and transmission of the reactive power required by the user installations, and therefore has a series of further inconveniences which can be summarized as:

- oversizing of the conductors and of the components of the transmission lines;
- higher Joule-effect losses and higher voltage drops in the components and lines.

The same inconveniences are present in the distribution installation of the final user. The power factor is an excellent index of the size of the added costs and is therefore used by the distribution authority to define the purchase price of the energy for the final user.

The ideal situation would be to have a  $\cos\varphi$  slightly higher than the set reference so as to avoid payment of legal penalties, and at the same time not to risk having, with a  $\cos\varphi$  too close to the unit, a leading power factor when the power factor corrected device is working with a low load.

The distribution authority generally does not allow others to supply reactive power to the network, also due to the possibility of unexpected overvoltages.

In the case of a sinusoidal waveform, the reactive power necessary to pass from one power factor  $\cos\varphi_1$  to a power factor  $\cos\varphi_2$  is given by the formula:

$$Q_c = Q_2 - Q_1 = P \cdot (\tan\varphi_1 - \tan\varphi_2) \quad (3)$$

where:

P is the active power;

$Q_1, \varphi_1$  are the reactive power and the phase shifting before power factor correction;

$Q_2, \varphi_2$  are the reactive power and the phase shifting after power factor correction;

$Q_c$  is the reactive power for the power factor correction.

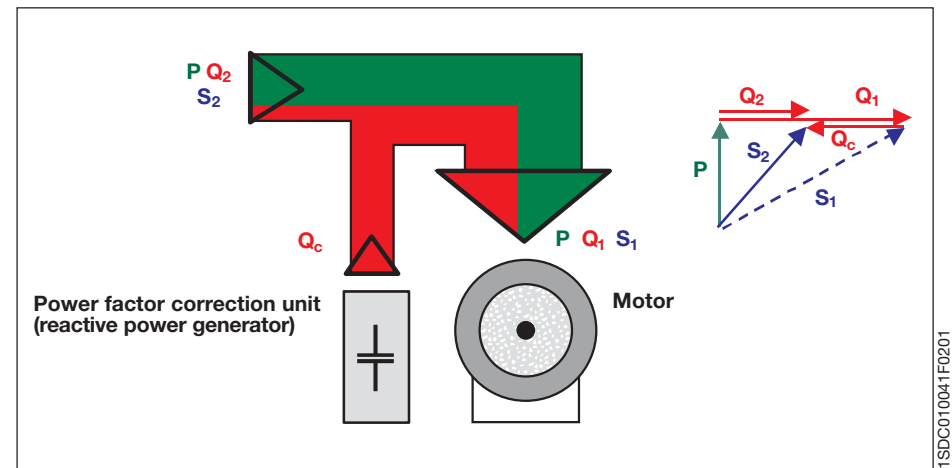

## 4 Power factor correction

Table 2 shows the value of the relationship

$$K_c = \frac{Q_c}{P} = \tan\varphi_1 - \tan\varphi_2 \quad (4)$$

for different values of the power factor before and after the correction.

**Table 2: Factor  $K_c$**

$K_c$	$\cos\varphi_2$													
$\cos\varphi_1$	0.80	0.85	0.90	0.91	0.92	0.93	0.94	0.95	0.96	0.97	0.98	0.99	1	
0.60	0.583	0.714	0.849	0.878	0.907	0.938	0.970	1.005	1.042	1.083	1.130	1.191	1.333	
0.61	0.549	0.679	0.815	0.843	0.873	0.904	0.936	0.970	1.007	1.048	1.096	1.157	1.299	
0.62	0.515	0.646	0.781	0.810	0.839	0.870	0.903	0.937	0.974	1.015	1.062	1.123	1.265	
0.63	0.483	0.613	0.748	0.777	0.807	0.837	0.870	0.904	0.941	0.982	1.030	1.090	1.233	
0.64	0.451	0.581	0.716	0.745	0.775	0.805	0.838	0.872	0.909	0.950	0.998	1.058	1.201	
0.65	0.419	0.549	0.685	0.714	0.743	0.774	0.806	0.840	0.877	0.919	0.966	1.027	1.169	
0.66	0.388	0.519	0.654	0.683	0.712	0.743	0.775	0.810	0.847	0.888	0.935	0.996	1.138	
0.67	0.358	0.488	0.624	0.652	0.682	0.713	0.745	0.779	0.816	0.857	0.905	0.966	1.108	
0.68	0.328	0.459	0.594	0.623	0.652	0.683	0.715	0.750	0.787	0.828	0.875	0.936	1.078	
0.69	0.299	0.429	0.565	0.593	0.623	0.654	0.686	0.720	0.757	0.798	0.846	0.907	1.049	
0.70	0.270	0.400	0.536	0.565	0.594	0.625	0.657	0.692	0.729	0.770	0.817	0.878	1.020	
0.71	0.242	0.372	0.508	0.536	0.566	0.597	0.629	0.663	0.700	0.741	0.789	0.849	0.992	
0.72	0.214	0.344	0.480	0.508	0.538	0.569	0.601	0.635	0.672	0.713	0.761	0.821	0.964	
0.73	0.186	0.316	0.452	0.481	0.510	0.541	0.573	0.608	0.645	0.686	0.733	0.794	0.936	
0.74	0.159	0.289	0.425	0.453	0.483	0.514	0.546	0.580	0.617	0.658	0.706	0.766	0.909	
0.75	0.132	0.262	0.398	0.426	0.456	0.487	0.519	0.553	0.590	0.631	0.679	0.739	0.882	
0.76	0.105	0.235	0.371	0.400	0.429	0.460	0.492	0.526	0.563	0.605	0.652	0.713	0.855	
0.77	0.079	0.209	0.344	0.373	0.403	0.433	0.466	0.500	0.537	0.578	0.626	0.686	0.829	
0.78	0.052	0.183	0.318	0.347	0.376	0.407	0.439	0.474	0.511	0.552	0.599	0.660	0.802	
0.79	0.026	0.156	0.292	0.320	0.350	0.381	0.413	0.447	0.484	0.525	0.573	0.634	0.776	
0.80		0.130	0.266	0.294	0.324	0.355	0.387	0.421	0.458	0.499	0.547	0.608	0.750	
0.81		0.104	0.240	0.268	0.298	0.329	0.361	0.395	0.432	0.473	0.521	0.581	0.724	
0.82		0.078	0.214	0.242	0.272	0.303	0.335	0.369	0.406	0.447	0.495	0.556	0.698	
0.83		0.052	0.188	0.216	0.246	0.277	0.309	0.343	0.380	0.421	0.469	0.530	0.672	
0.84		0.026	0.162	0.190	0.220	0.251	0.283	0.317	0.354	0.395	0.443	0.503	0.646	
0.85			0.135	0.164	0.194	0.225	0.257	0.291	0.328	0.369	0.417	0.477	0.620	
0.86			0.109	0.138	0.167	0.198	0.230	0.265	0.302	0.343	0.390	0.451	0.593	
0.87			0.082	0.111	0.141	0.172	0.204	0.238	0.275	0.316	0.364	0.424	0.567	
0.88			0.055	0.084	0.114	0.145	0.177	0.211	0.248	0.289	0.337	0.397	0.540	
0.89			0.028	0.057	0.086	0.117	0.149	0.184	0.221	0.262	0.309	0.370	0.512	
0.90				0.029	0.058	0.089	0.121	0.156	0.193	0.234	0.281	0.342	0.484	

## 4 Power factor correction

### Example

Supposing the need to change from 0.8 to 0.93 the power factor of a three-phase installation ( $U_r = 400 \text{ V}$ ) which absorbs an average power of 300 kW. From Table 2, at the intersection of the column corresponding to the final power factor (0.93), and the row corresponding to the starting power factor (0.8), the value of  $K_c$  (0.355) can be read. The reactive power  $Q_c$  which must be generated locally shall be:

$$Q_c = K_c \cdot P = 0.355 \cdot 300 = 106.5 \text{ kvar}$$

Due to the effect of power factor correction, the current absorbed decreases from 540 A to 460 A (a reduction of approximately 15%).

### Characteristics of power factor correction capacitor banks

The most economical means of increasing the power factor, especially for an installation which already exists, is installing capacitors.

Capacitors have the following advantages:

- low cost compared with synchronous compensators and electronic power converters;
- ease of installation and maintenance;
- reduced losses (less than 0.5 W/kvar in low voltage);
- the possibility of covering a wide range of powers and different load profiles, simply supplying in parallel different combinations of components, each with a relatively small power.

The disadvantages are sensitivity to overvoltages and to the presence of non-linear loads.

The Standards applicable to power factor correction capacitors are as follows:

- IEC 60831-1 "Shunt power capacitors of the self-healing type for a.c. systems having a rated voltage up to and including 1000 V - Part 1: General - Performance, testing and rating - Safety requirements - Guide for installation and operation";
- IEC 60931-1 "Shunt power capacitors of the non-self-healing type for a.c. systems having a rated voltage up to and including 1000 V - Part 1: General-Performance, testing and rating - Safety requirements - Guide for installation and operation".

## 4 Power factor correction

The characteristics of a capacitor, given on its nameplate, are:

- rated voltage  $U_r$ , which the capacitor must withstand indefinitely;
- rated frequency  $f_r$  (usually equal to that of the network);
- rated power  $Q_c$ , generally expressed in kvar (reactive power of the capacitor bank).

From this data it is possible to find the size characteristics of the capacitors by using the following formulae (5):

	Single-phase connection	Three-phase star-connection	Three-phase delta-connection
Capacity of the capacitor bank	$C = \frac{Q_c}{2\pi f_r \cdot U_r^2}$	$C = \frac{Q_c}{2\pi f_r \cdot U_r^2}$	$C = \frac{Q_c}{2\pi f_r \cdot U_r^2 \cdot 3}$
Rated current of the components	$I_{rc} = 2\pi f_r \cdot C \cdot U_r$	$I_{rc} = 2\pi f_r \cdot C \cdot U_r / \sqrt{3}$	$I_{rc} = 2\pi f_r \cdot C \cdot U_r$
Line current	$I_l = I_{rc}$	$I_l = I_{rc}$	$I_l = I_{rc} \cdot \sqrt{3}$

1SDC010005F0901

With three-phase systems, for the same reactive power, the star-connection requires a capacity 3 times larger and subjects the capacitors to a voltage and a current times less than the analogous delta-connection.

Capacitors are generally supplied with connected discharge resistance, calculated so as to reduce the residual voltage at the terminals to 75 V in 3 minutes, as stated in the reference Standard.

## 4.2 Power factor correction method

### Single PFC

Single or individual power factor correction is carried out by connecting a capacitor of the correct value directly to the terminals of the device which absorbs reactive power.

Installation is simple and economical: capacitors and load can use the same overload and short-circuit protection, and are connected and disconnected simultaneously.

The adjustment of  $\cos\varphi$  is systematic and automatic with benefit not only to the energy distribution authority, but also to the whole internal distribution system of the user.

This type of power factor correction is advisable in the case of large users with constant load and power factor and long connection times.

Individual PFC is usually applied to motors and fluorescent lamps. The capacitor units or small lighting capacitors are connected directly to loads.

## 4 Power factor correction

### Individual PFC of motors

The usual connection diagrams are shown in the following Figure:

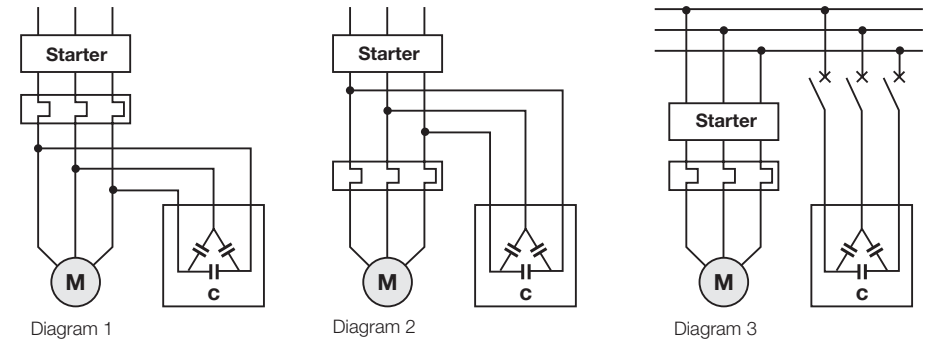

Diagram 1

Diagram 2

Diagram 3

1SDC010028F0001

In the case of direct connection (diagrams 1 and 2) there is a risk that after disconnection of the supply, the motor will continue to rotate (residual kinetic energy) and self-excite with the reactive energy supplied by the capacitor bank, acting as an asynchronous generator. In this case, the voltage is maintained on the load side of the switching and control device, with the risk of dangerous overvoltages of up to twice the rated voltage value.

However, in the case of diagram 3, to avoid the risk detailed above, the normal procedure is to connect the PFC bank to the motor only when it is running, and to disconnect it before the disconnection of the motor supply.

As a general rule, for a motor with power  $P_r$ , it is advisable to use a PFC with reactive power  $Q_c$  below 90% of the reactive power absorbed by the no-load motor  $Q_0$ , at rated voltage  $U_r$ , to avoid a leading power factor.

Considering that under no-load conditions, the current absorbed  $I_0$  [A] is solely reactive, if the voltage is expressed in volts, it results:

$$Q_c = 0.9 \cdot Q_0 = 0.9 \cdot \frac{\sqrt{3} \cdot U_r \cdot I_0}{1000} \text{ [kvar]} \quad (6)$$

The current  $I_0$  is generally given in the documentation supplied by the manufacturer of the motor.



## 4 Power factor correction

Table 3 shows the values of reactive power for power factor correction of some ABB motors, according to the power and the number of poles.

**Table 3: Reactive power for power factor motor correction**

$P_r$ [kW]	$Q_c$ [kvar]	Before PFC		After PFC	
		$\cos\varphi_r$	$I_r$ [A]	$\cos\varphi_2$	$I_2$ [A]
<b>400V / 50 Hz / 2 poles / 3000 r/min</b>					
7.5	2.5	0.89	13.9	0.98	12.7
11	2.5	0.88	20	0.95	18.6
15	5	0.9	26.5	0.98	24.2
18.5	5	0.91	32	0.98	29.7
22	5	0.89	38.5	0.96	35.8
30	10	0.88	53	0.97	47.9
37	10	0.89	64	0.97	58.8
45	12.5	0.88	79	0.96	72.2
55	15	0.89	95	0.97	87.3
75	15	0.88	131	0.94	122.2
90	15	0.9	152	0.95	143.9
110	20	0.86	194	0.92	181.0
132	30	0.88	228	0.95	210.9
160	30	0.89	269	0.95	252.2
200	30	0.9	334	0.95	317.5
250	40	0.92	410	0.96	391.0
315	50	0.92	510	0.96	486.3
<b>400V / 50 Hz / 4 poles / 1500 r/min</b>					
7.5	2.5	0.86	14.2	0.96	12.7
11	5	0.81	21.5	0.96	18.2
15	5	0.84	28.5	0.95	25.3
18.5	7.5	0.84	35	0.96	30.5
22	10	0.83	41	0.97	35.1
30	15	0.83	56	0.98	47.5
37	15	0.84	68	0.97	59.1
45	20	0.83	83	0.97	71.1
55	20	0.86	98	0.97	86.9
75	20	0.86	135	0.95	122.8
90	20	0.87	158	0.94	145.9
110	30	0.87	192	0.96	174.8
132	40	0.87	232	0.96	209.6
160	40	0.86	282	0.94	257.4
200	50	0.86	351	0.94	320.2
250	50	0.87	430	0.94	399.4
315	60	0.87	545	0.93	507.9

## 4 Power factor correction

$P_r$ [kW]	$Q_c$ [kvar]	Before PFC		After PFC	
		$\cos\varphi_r$	$I_r$ [A]	$\cos\varphi_2$	$I_2$ [A]
<b>400V / 50 Hz / 6 poles / 1000 r/min</b>					
7.5	5	0.79	15.4	0.98	12.4
11	5	0.78	23	0.93	19.3
15	7.5	0.78	31	0.94	25.7
18.5	7.5	0.81	36	0.94	30.9
22	10	0.81	43	0.96	36.5
30	10	0.83	56	0.94	49.4
37	12.5	0.83	69	0.94	60.8
45	15	0.84	82	0.95	72.6
55	20	0.84	101	0.96	88.7
75	25	0.82	141	0.93	123.9
90	30	0.84	163	0.95	144.2
110	35	0.83	202	0.94	178.8
132	45	0.83	240	0.95	210.8
160	50	0.85	280	0.95	249.6
200	60	0.85	355	0.95	318.0
250	70	0.84	450	0.94	404.2
315	75	0.84	565	0.92	514.4
<b>400V / 50 Hz / 8 poles / 750 r/min</b>					
7.5	5	0.7	18.1	0.91	13.9
11	7.5	0.76	23.5	0.97	18.4
15	7.5	0.82	29	0.97	24.5
18.5	7.5	0.79	37	0.93	31.5
22	10	0.77	45	0.92	37.5
30	12.5	0.79	59	0.93	50.0
37	15	0.78	74	0.92	62.8
45	20	0.78	90	0.93	75.4
55	20	0.81	104	0.93	90.2
75	30	0.82	140	0.95	120.6
90	30	0.82	167	0.93	146.6
110	35	0.83	202	0.94	178.8
132	50	0.8	250	0.93	214.6

## 4 Power factor correction

### Example

For a three-phase asynchronous motor, 110 kW (400 V - 50 Hz - 4 poles), the PFC power suggested in the table is 30 kvar.

### Individual power factor correction of three-phase transformers

A transformer is an electrical device of primary importance which, due to the system requirements, is often constantly in service.

In particular, in installations constituted by several transformer substations, it is advisable to carry out power factor correction directly at the transformer.

In general, the PFC power ( $Q_c$ ) for a transformer with rated power  $S_r$  [kVA] should not exceed the reactive power required under minimum reference load conditions.

Reading the data from the transformer nameplate, the percentage value of the no-load current  $i_0\%$ , the percentage value of the short-circuit voltage  $u_k\%$ , the iron losses  $P_{fe}$  and the copper losses  $P_{cu}$  [kW], the PFC power required is approximately:

$$Q_c = \sqrt{\left(\frac{i_0\%}{100} \cdot S_r\right)^2 - P_{fe}^2} + K_L^2 \cdot \sqrt{\left(\frac{u_k\%}{100} \cdot S_r\right)^2 - P_{cu}^2} \approx \left(\frac{i_0\%}{100} \cdot S_r\right) + K_L^2 \cdot \left(\frac{u_k\%}{100} \cdot S_r\right) \quad [\text{kvar}] \quad (7)$$

where  $K_L$  is the load factor, defined as the relationship between the minimum reference load and the rated power of the transformer.

### Example

Supposing the need for PFC of a 630 kVA oil-distribution transformer which supplies a load which is less than 60% of its rated power.

From the data on the transformer nameplate:

$$i_0\% = 1.8\%$$

$$u_k\% = 4\%$$

$$P_{cu} = 8.9 \text{ kW}$$

$$P_{fe} = 1.2 \text{ kW}$$

The PFC power of the capacitor bank connected to the transformer is:

$$Q_c = \sqrt{\left(\frac{i_0\%}{100} \cdot S_r\right)^2 - P_{fe}^2} + K_L^2 \cdot \sqrt{\left(\frac{u_k\%}{100} \cdot S_r\right)^2 - P_{cu}^2} = \sqrt{\left(\frac{1.8\%}{100} \cdot 630\right)^2 - 1.2^2} + 0.6^2 \cdot \sqrt{\left(\frac{4\%}{100} \cdot 630\right)^2 - 8.9^2} = 19.8 \text{ kvar}$$

while, when using the simplified formula, the result is:

$$Q_c = \left(\frac{i_0\%}{100} \cdot S_r\right) + K_L^2 \cdot \left(\frac{u_k\%}{100} \cdot S_r\right) = \left(\frac{1.8\%}{100} \cdot 630\right) + 0.6^2 \cdot \left(\frac{4\%}{100} \cdot 630\right) = 20.4 \text{ kvar}$$

## 4 Power factor correction

Table 4 shows the reactive power of the capacitor bank  $Q_c$  [kvar] to be connected on the secondary side of an ABB transformer, according to the different minimum estimated load levels.

**Table 4: PFC reactive power for ABB transformers**

$S_r$ [kVA]	$u_k\%$ [%]	$i_0\%$ [%]	$P_{fe}$ [kW]	$P_{cu}$ [kW]	$Q_c$ [kvar]				
					0	0.25	0.5	0.75	1
<b>Oil Distribution Transformer MV-LV</b>									
50	4	2.9	0.25	1.35	1.4	1.5	1.8	2.3	2.9
100	4	2.5	0.35	2.30	2.5	2.7	3.3	4.3	5.7
160	4	2.3	0.48	3.20	3.6	4	5	6.8	9.2
200	4	2.2	0.55	3.80	4.4	4.8	6.1	8.3	11
250	4	2.1	0.61	4.50	5.2	5.8	7.4	10	14
315	4	2	0.72	5.40	6.3	7	9.1	13	18
400	4	1.9	0.85	6.50	7.6	8.5	11	16	22
500	4	1.9	1.00	7.40	9.4	11	14	20	28
630	4	1.8	1.20	8.90	11	13	17	25	35
800	6	1.7	1.45	10.60	14	16	25	40	60
1000	6	1.6	1.75	13.00	16	20	31	49	74
1250	6	1.6	2.10	16.00	20	24	38	61	93
1600	6	1.5	2.80	18.00	24	30	47	77	118
2000	6	1.2	3.20	21.50	24	31	53	90	142
2500	6	1.1	3.70	24.00	27	37	64	111	175
3150	7	1.1	4.00	33.00	34	48	89	157	252
4000	7	1.4	4.80	38.00	56	73	125	212	333

<b>Cast Resin Distribution Transformer MV-LV</b>									
100	6	2.3	0.50	1.70	2.2	2.6	3.7	5.5	8
160	6	2	0.65	2.40	3.1	3.7	5.5	8.4	12
200	6	1.9	0.85	2.90	3.7	4.4	6.6	10	15
250	6	1.8	0.95	3.30	4.4	5.3	8.1	13	19
315	6	1.7	1.05	4.20	5.3	6.4	9.9	16	24
400	6	1.5	1.20	4.80	5.9	7.3	12	19	29
500	6	1.4	1.45	5.80	6.8	8.7	14	23	36
630	6	1.3	1.60	7.00	8	10	17	29	45
800	6	1.1	1.94	8.20	8.6	12	20	35	56
1000	6	1	2.25	9.80	9.7	13	25	43	69
1250	6	0.9	3.30	13.00	11	15	29	52	85
1600	6	0.9	4.00	14.50	14	20	38	67	109
2000	6	0.8	4.60	15.50	15	23	45	82	134
2500	6	0.7	5.20	17.50	17	26	54	101	166
3150	8	0.6	6.00	19.00	18	34	81	159	269

### Example

For a 630 kVA oil-distribution transformer with a load factor of 0.5, the necessary PFC power is 17 kvar.

## 4 Power factor correction

### PFC in groups

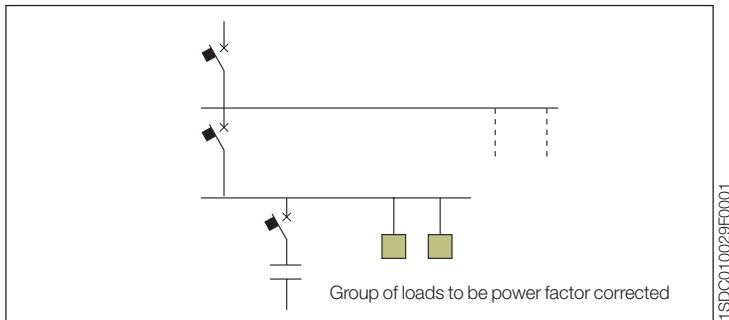

This consists of local power factor correction of groups of loads with similar functioning characteristics by installing a dedicated capacitor bank. This method achieves a compromise between the economical solution and the correct operation of the installation, since only the line downstream of the installation point of the capacitor bank is not correctly exploited.

### Centralized PFC

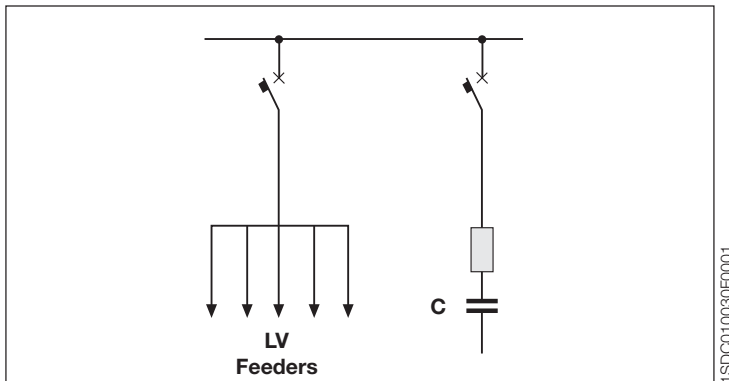

The daily load profile is of fundamental importance for the choice of the most suitable type of power factor correction.

In installations, in which not all loads function simultaneously and/or in which some loads are connected for only a few hours a day, the solution of using single PFC becomes unsuitable as many of the capacitors installed could stay idle for long periods.

In the case of installations with many loads occasionally functioning, thus having a high installed power and a quite low average power absorption by the loads which function simultaneously, the use of a single PFC system at the installation origin ensures a remarkable decrease in the total power of the capacitors to be installed.

## 4 Power factor correction

Centralized PFC normally uses automatic units with capacitor banks divided into several steps, directly installed in the main distribution switchboards; the use of a permanently connected capacitor bank is only possible if the absorption of reactive energy is fairly regular throughout the day.

The main disadvantage of centralized PFC is that the distribution lines of the installation, downstream of the PFC device, must be dimensioned taking into account the full reactive power required by the loads.

### 4.3 Circuit-breakers for the protection and switching of capacitor banks

The circuit-breakers for the protection and switching of capacitor banks in LV shall:

1. withstand the transient currents which occur when connecting and disconnecting the banks. In particular, the instantaneous magnetic and electronic releases shall not trip due to these peak currents;
2. withstand the periodic or permanent overcurrents due to the voltage harmonics and to the tolerance (+15%) of the rated value of capacity;
3. perform a high number of no-load and on-load operations, also with high frequency;
4. be coordinated with any external device (contactors).

Furthermore, the making and breaking capacity of the circuit-breaker must be adequate to the short-circuit current values of the installation.

Standards IEC 60831-1 and 60931-1 state that:

- the capacitors shall normally function with an effective current value up to 130% of their rated current  $I_{rc}$  (due to the possible presence of voltage harmonics in the network);
- a tolerance of +15% on the value of the capacity is allowed.

The maximum current which can be absorbed by the capacitor bank  $I_{cmax}$  is:

$$I_{cmax} = 1.3 \cdot 1.15 \cdot \frac{Q_c}{\sqrt{3} \cdot U_r} \approx 1.5 \cdot I_{rc} \quad (8)$$

Therefore:

- the rated current of the circuit-breaker shall be greater than  $1.5 \cdot I_{rc}$ ;
- the overload protection setting shall be equal to  $1.5 \cdot I_{rc}$ .

The connection of a capacitor bank, similar to a closing operation under short-circuit conditions, associated with transient currents with high frequency (1+15 kHz), of short duration (1+3 ms), with high peak ( $25+200 I_{rc}$ ).

Therefore:

- the circuit-breaker shall have an adequate making capacity;
- the setting of the instantaneous short-circuit protection must not cause unwanted trips.

## 4 Power factor correction

The second condition is generally respected:

- for thermomagnetic releases, the magnetic protection shall be set at a value not less than  $10 \cdot I_{cmax}$

$$I_3 \geq 10 \cdot I_{cmax} = 15 \cdot I_{rc} = 15 \cdot \frac{Q_c}{\sqrt{3} \cdot U_r} \quad (9)$$

- for electronic releases, the instantaneous short-circuit protection shall be deactivated ( $I_3 = \text{OFF}$ ).

Hereunder, the selection tables for circuit-breakers: for the definition of the version according to the required breaking capacity, refer to Volume 1, Chapter 3.1 "General characteristics".

The following symbols are used in the tables (they refer to maximum values):

- $I_{nCB}$  = rated current of the protection release [A];
- $I_{rc}$  = rated current of the connected capacitor bank [A];
- $Q_C$  = power of the capacitor bank which can be connected [kvar] with reference to the indicated voltage and 50 Hz frequency;
- $N_{mech}$  = number of mechanical operations;
- $f_{mech}$  = frequency of mechanical operations [op/h];
- $N_{el}$  = number of electrical operations with reference to a voltage of 415 V for Tmax and Isomax moulded-case circuit breakers (Tables 5 and 6), and to a voltage of 440 V for Emax air circuit-breakers (Table 7);
- $f_{el}$  = frequency of electrical operations [op/h].

**Table 5: Selection table for Tmax moulded-case circuit-breakers**

CB Type	$I_{nCB}$	$I_{rc}$	$Q_C$ [kvar]			$N_{mech}$	$f_{mech}$	$N_{el}$	$f_{el}$	
	[A]	[A]	400 V	440 V	500 V	690 V	[op/h]		[op/h]	
T1 B-C-N 160	160	107	74	81	92	127	25000	240	8000	120
T2 N-S-H-L 160*	160	107	74	81	92	127	25000	240	8000	120
T3 N-S 250*	250	167	115	127	144	199	25000	240	8000	120
T4 N-S-H-L-V 250	250	167	115	127	144	199	20000	240	8000	120
T4 N-S-H-L-V 320	320	213	147	162	184	254	20000	240	6000	120
T5 N-S-H-L-V 400	400	267	185	203	231	319	20000	120	7000	60
T5 N-S-H-L-V 630	630	420	291	320	364	502	20000	120	5000	60

\* for plug-in version reduce the maximum power of the capacitor bank by 10%

**Table 6: Selection table for SACE Isomax S moulded-case circuit-breakers**

CB Type	$I_{nCB}$	$I_{rc}$	$Q_C$ [kvar]			$N_{mech}$	$f_{mech}$	$N_{el}$	$f_{el}$	
	[A]	[A]	400 V	440 V	500 V	690 V	[op/h]		[op/h]	
S6 N-S-H-L 800	800	533	369	406	462	637	20000	120	5000	60
S7 S-H-L 1250	1250	833	577	635	722	996	10000	120	7000	20
S7 S-H-L 1600	1600	1067	739	813	924	1275	10000	120	5000	20
S8 H-V 2000	2000	1333	924	1016	1155	1593	10000	120	3000	20
S8 H-V 2500	2500	1667	1155	1270	1443	1992	10000	120	2500	20
S8 H-V 3200	3200	2133	1478	1626	1847	2550	10000	120	1500	10

## 4 Power factor correction

**Table 7: Selection table for SACE Emax air circuit-breakers**

CB Type	$I_{nCB}$	$I_{rc}$	$Q_C$ [kvar]			$N_{mech}$	$f_{mech}$	$N_{el}$	$f_{el}$	
	[A]	[A]	400 V	440 V	500 V	690 V	[op/h]		[op/h]	
E1 B-N	1250	834	578	636	722	997	25000	60	10000	30
E2 B-N	1250	834	578	636	722	997	25000	60	15000	30
E2 B-N	1600	1067	739	813	924	1275	25000	60	12000	30
E2 B-N	2000	1334	924	1017	1155	1594	25000	60	10000	30
E3 N-S-H	1250	834	578	636	722	997	20000	60	12000	20
E3 N-S-H	1600	1067	739	813	924	1275	20000	60	10000	20
E3 N-S-H	2000	1334	924	1017	1155	1594	20000	60	9000	20
E3 N-S-H	2500	1667	1155	1270	1444	1992	20000	60	8000	20
E3 N-S-H	3200	2134	1478	1626	1848	2550	20000	60	6000	20
E4 S-H	3200	2134	1478	1626	1848	2550	15000	60	7000	10
E6 H-V	3200	2134	1478	1626	1848	2550	12000	60	5000	10

## 5 Protection of human beings

### 5.1 General aspects: effects of current on human beings

Danger to persons due to contact with live parts is caused by the flow of the current through the human body. The effects are:

- **tetanzation:** the muscles affected by the current flow involuntary contract and letting go of gripped conductive parts is difficult. Note: very high currents do not usually induce muscular tetanization because, when the body touches such currents, the muscular contraction is so sustained that the involuntary muscle movements generally throw the subject away from the conductive part;
- **breathing arrest:** if the current flows through the muscles controlling the lungs, the involuntary contraction of these muscles alters the normal respiratory process and the subject may die due to suffocation or suffer the consequences of traumas caused by asphyxia;
- **ventricular fibrillation:** the most dangerous effect is due to the superposition of the external currents with the physiological ones which, by generating uncontrolled contractions, induce alterations of the cardiac cycle. This anomaly may become an irreversible phenomenon since it persists even when the stimulus has ceased;
- **burns:** they are due to the heating deriving, by Joule effect, from the current passing through the human body.

The Standard IEC 60479-1 "Effects of current on human being and livestock" is a guide about the effects of current passing through the human body to be used for the definition of electrical safety requirements. This Standard shows, on a time-current diagram, four zones to which the physiological effects of alternating current (15 +100 Hz) passing through the human body have been related.

## 5 Protection of human beings

Figure 1: Time-current zones of the effects of alternating current on the human body

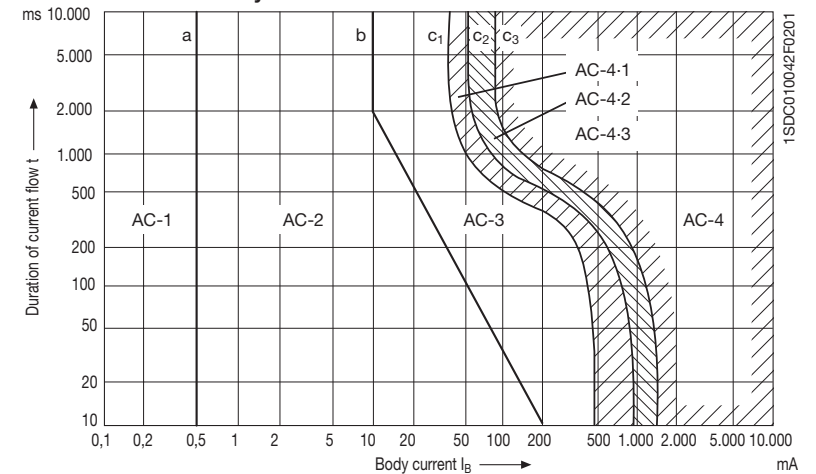

Zone designation	Zone limits	Physiological effects
AC-1	Up to 0.5 mA line a	Usually no reaction.
AC-2	0.5 mA up to line b*	Usually no harmful physiological effects.
AC-3	Line b up to curve c <sub>1</sub>	Usually no organic damage to be expected. Likelihood of cramplike muscular contractions and difficulty in breathing for durations of current-flow longer than 2 s. Reversible disturbances of formation and conduction of impulses in the heart, including atrial fibrillation and transient cardiac arrest without ventricular fibrillation increasing with current magnitude and time.
AC-4	Above curve c <sub>1</sub>	Increasing with magnitude and time, dangerous pathophysiological effects such as cardiac arrest, breathing arrest and severe burns may occur in addition to the effects of zone 3.
AC-4.1	c <sub>1</sub> - c <sub>2</sub>	Probability of ventricular fibrillation increasing up to about 5%.
AC-4.2	c <sub>2</sub> - c <sub>3</sub>	Probability of ventricular fibrillation up to about 50%.
AC-4.3	Beyond curve c <sub>3</sub>	Probability of ventricular fibrillation above 50%.

\* For durations of current-flow below 10 ms, the limit for the body current for line b remains constant at a value of 200 mA.

This Standard gives also a related figure for direct current. By applying Ohm's law it is possible to define the safety curve for the allowable voltages, once the human body impedance has been calculated. The electrical impedance of the human body depends on many factors. The above mentioned Standard gives different values of impedance as a function of the touch voltage and of the current path.

## 5 Protection of human beings

The Standard IEC 60479-1 has adopted precautionary values for the impedance reported in the figure so as to get the time-voltage safety curve (Figure 2) related to the total touch voltage  $U_T$  (i.e. the voltage which, due to an insulation failure, is present between a conductive part and a point of the ground sufficiently far, with zero potential).

This represents the maximum no-load touch voltage value; thus, the most unfavorable condition is taken into consideration for safety's sake.

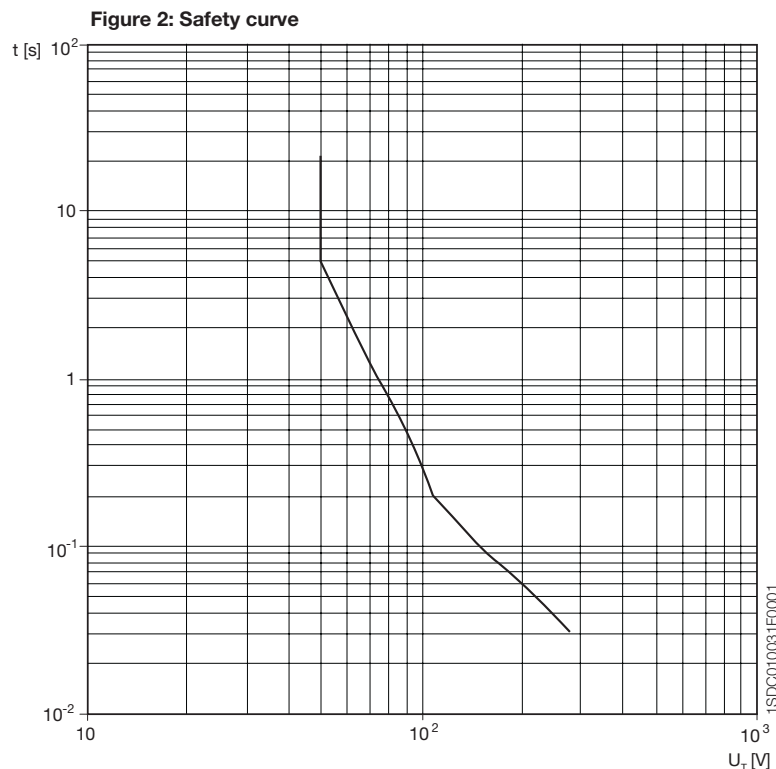

From this safety curve it results that for all voltage values below 50 V, the tolerance time is indefinite; at 50 V the tolerance time is 5 s. The curve shown in the figure refers to an ordinary location; in particular locations, the touch resistance of the human body towards earth changes and consequently the tolerable voltage values for an indefinite time shall be lower than 25 V.

Therefore, if the protection against indirect contact is obtained through the disconnection of the circuit, it is necessary to ensure that such breaking is carried out in compliance with the safety curve for any distribution system.

## 5 Protection of human beings

### 5.2 Distribution systems

The earth fault modalities and the consequences caused by contact with live parts, are strictly related to the neutral conductor arrangement and to the connections of the exposed conductive parts.

For a correct choice of the protective device, it is necessary to know which is the distribution system of the plant.

IEC 60364-1 classifies the distribution systems with two letters.

The first letter represents the relationship of the power system to earth:

- T: direct connection of one point to earth, in alternating current systems, generally the neutral point;
- I: all live parts isolated from earth, or one point, in alternating current systems, generally the neutral point, connected to earth through an impedance.

The second letter represents the relationship of the exposed conductive parts of the installation to earth:

- T: direct electrical connection of the exposed conductive parts to earth;
- N: direct electrical connection of the exposed conductive parts to the earthed point of the power system.

Subsequent letters, if any, represent the arrangement of neutral and protective conductors:

- S: protective function is provided by a conductor separate from the neutral conductor;
- C: neutral and protective functions combined as a single conductor (PEN conductor).

Three types of distribution system are considered:

#### TT System

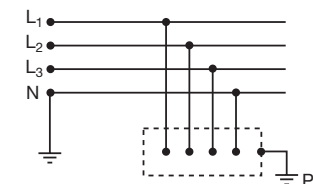

#### TN System

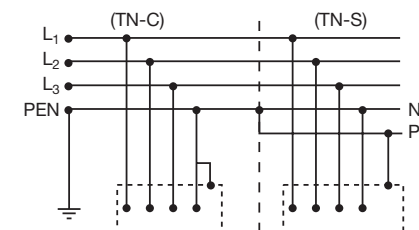

## 5 Protection of human beings

### IT System

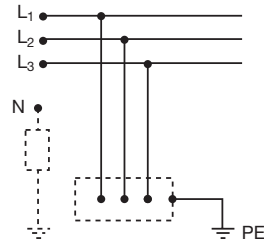

1SDC010034F0001

In **IT** systems, the neutral conductor and the exposed conductive parts are connected to earth electrodes electrically independent; the fault current flows towards the power supply neutral point through earth (Fig. 1):

**Figure 1: Earth fault in IT systems**

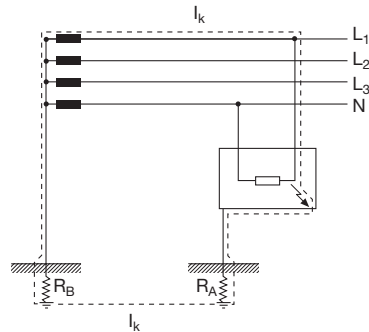

1SDC010035F0001

In **IT** installations, the neutral conductor is connected to the supply star center, it is usually distributed and has the function of making the phase voltage (e.g. 230 V) available, useful for single-phase load supply. The exposed conductive parts, on the contrary, singularly or collectively, are locally connected to earth. **IT** systems are generally used for civil installations.

**TN** systems are typically used when the power supply is distributed to loads having their own electrical substation. The neutral conductor is directly earthed in the substation; the exposed conductive parts are connected to the same earthing point of the neutral conductor, and can be locally earthed.

Three types of TN system are considered according to the arrangement of neutral and protective conductors:

1. TN-C neutral and protective functions are combined in a single conductor (PEN conductor);
2. TN-S neutral and protective conductors are always separated;
3. TN-C-S neutral and protective functions are combined in a single conductor in a part of the system (PEN) and are separated in another part (PE + N).

## 5 Protection of human beings

In **TN** systems, the fault current flows towards the power supply neutral point through a solid metallic connection, practically without involving the earth electrode (Figure 2).

**Figure 2: Earth fault in TN systems**

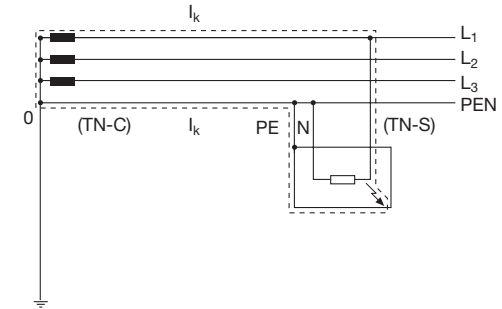

1SDC010036F0001

**IT** systems have no live parts directly connected to earth, but they can be earthed through a sufficiently high impedance. Exposed conductive parts shall be earthed individually, in groups or collectively to an independent earthing electrode.

The earth fault current flows towards the power supply neutral point through the earthing electrode and the line conductor capacitance (Figure 3).

**Figure 3: Earth fault in IT systems**

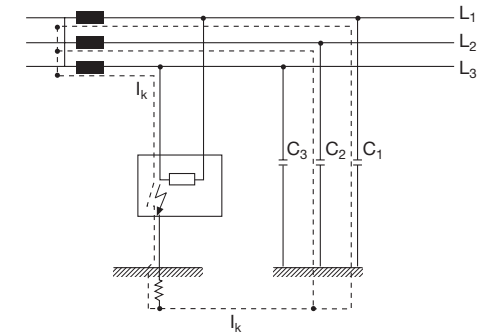

1SDC010037F0001

These distribution systems are used for particular plants, where the continuity of supply is a fundamental requirement, where the absence of the supply can cause hazards to people or considerable economical losses, or where a low value of a first earth fault is required. In these cases, an insulation monitoring device shall be provided for optical or acoustic signalling of possible earth faults, or failure of the supplied equipment.

---

## 5 Protection of human beings

---

### 5.3 Protection against both direct and indirect contact

Contacts of a person with live parts can be divided in two categories:

- direct contacts;
- indirect contacts.

A direct contact occurs when a part of the human body touches a part of the plant, usually live (bare conductors, terminals, etc.).

A contact is indirect when a part of the human body touches an exposed conductive parts, usually not live, but with voltage presence due to a failure or wear of the insulating materials.

The measures of protection against **direct contact** are:

- insulation of live parts with an insulating material which can only be removed by destruction (e.g. cable insulation);
- barriers or enclosures: live parts shall be inside enclosures or behind barriers providing at least the degree of protection IPXXB or IP2X; for horizontal surfaces the degree of protection shall be of at least IPXXD or IP4X (for the meaning of the degree of protection codes please refer to Volume 1, Chapter 6.1 Electrical switchboards);
- obstacles: the interposition of an obstacle between the live parts and the operator prevents unintentional contacts only, but not an intentional contact by the removal of the obstacle without particular tools;
- placing out of reach: simultaneously accessible parts at different potentials shall not be within arm's reach.

An additional protection against direct contact can be obtained by using residual current devices with a rated operating residual current not exceeding 30 mA. It must be remembered that the use of a residual current device as a mean of protection against direct contacts does not obviate the need to apply one of the above specified measures of protection.

The measures of protection against **indirect contact** are:

- automatic disconnection of the supply: a protective device shall automatically disconnect the supply to the circuit so that the touch voltage on the exposed conductive part does not persist for a time sufficient to cause a risk of harmful physiological effect for human beings;
- supplementary insulation or reinforced insulation, e.g. by the use of Class II components;

---

## 5 Protection of human beings

- non-conducting locations: locations with a particular resistance value of insulating floors and walls ( $\geq 50 \text{ k}\Omega$  for  $U_r \leq 500 \text{ V}$ ;  $\geq 100 \text{ k}\Omega$  for  $U_r > 500 \text{ V}$ ) and without protective conductors inside
- electrical separation, e.g. by using an isolating transformer to supply the circuit;
- earth-free local equipotential bonding: locations where the exposed conductive parts are connected together but not earthed.

Finally, the following measures provide combined protection against both direct and indirect contact:

- SELV (Safety Extra Low Voltage) system and PELV (Protective Extra Low Voltage) system;
- FELV (Functional Extra Low Voltage) system.

The protection against both direct and indirect contact is ensured if the requirements stated in 411 from IEC 60364-4-41 are fulfilled; particularly:

- the rated voltage shall not exceeds 50 V ac r.m.s. and 120 V ripple-free dc;
- the supply shall be a SELV or PELV source;
- all the installation conditions provided for such types of electrical circuits shall be fulfilled.

A SELV circuit has the following characteristics:

- 1) it is supplied by an independent source or by a safety source. Independent sources are batteries or diesel-driven generators. Safety sources are supplies obtained through an isolating transformer;
- 2) there are no earthed points. The earthing of both the exposed conductive parts as well as of the live parts of a SELV circuit is forbidden;
- 3) it shall be separated from other electrical systems. The separation of a SELV system from other circuits shall be guaranteed for all the components; for this purpose, the conductors of the SELV circuit may be contained in multi-conductor cables or may be provided with an additional insulating sheath.

A PELV circuit has the same prescription of a SELV system, except for the prohibition of earthed points; in fact in PELV circuits, at least one point is always earthed.



## 5 Protection of human beings

FELV circuits are used when for functional reasons the requirements for SELV or PELV circuits cannot be fulfilled; they require compliance with the following rules:

- a) protection against direct contact shall be provided by either:
  - barriers or enclosures with degree of protection in accordance with what stated above (measures of protection against direct contact);
  - insulation corresponding to the minimum test voltage specified for the primary circuit. If this test is not passed, the insulation of accessible non-conductive parts of the equipment shall be reinforced during erection so that it can withstand a test voltage of 1500 V ac r.m.s. for 1 min.;
- b) protection against indirect contact shall be provided by:
  - connection of the exposed conductive parts of the equipment of the FELV circuit to the protective conductor of the primary circuit, provided that the latter is subject to one of the measures of protection against direct contact;
  - connection of a live conductor of the FELV circuit to the protective conductor of the primary circuit provided that an automatic disconnection of the supply is applied as measure of protection;
- c) plugs of FELV systems shall not be able to enter socket-outlets of other voltage systems, and plugs of other voltage systems shall not be able to enter socket-outlets of FELV systems.

Figure 1 shows the main features of SELV, PELV and FELV systems.

Figure 1: SELV, PELV, FELV systems

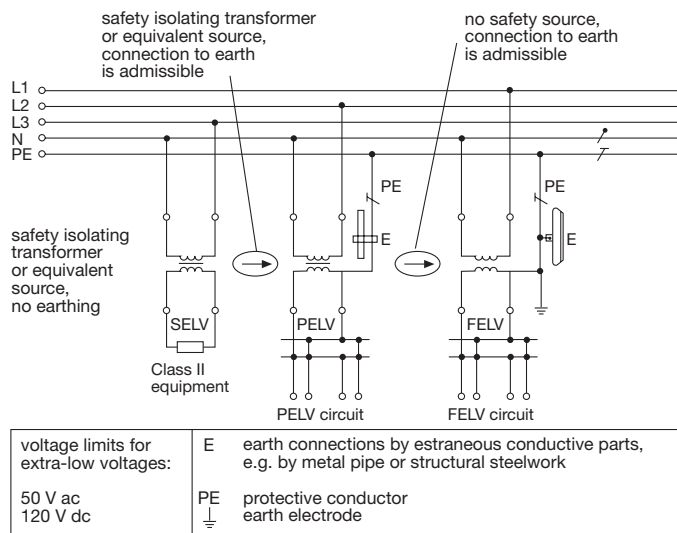

Note 1: Overcurrent protective devices are not shown in this figure.

## 5 Protection of human beings

### 5.4 TT System

An earth fault in a TT system involves the circuit represented in Figure 1:

Figure 1: Earth fault in TT system

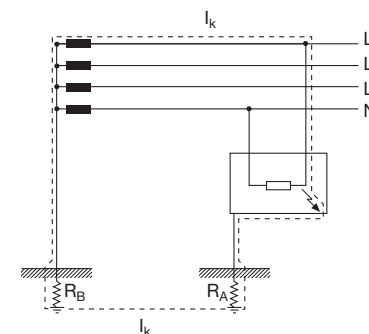

1SDC010035F0001

The fault current involves the secondary winding of the transformer, the phase conductor, the fault resistance, the protective conductor and the earth electrode resistance (plant earthing system ( $R_A$ ) and earthing system which the neutral is connected to ( $R_B$ )).

According to IEC 60364-4 requirements, the protective devices must be coordinated with the earthing system in order to rapidly disconnect the supply, if the touch voltage reaches harmful values for the human body.

Assuming 50 V (25 V for particular locations) as limit voltage value, the condition to be fulfilled in order to limit the touch voltage on the exposed conductive parts under this limit value is:

$$R_t \leq \frac{50}{I_a} \quad \text{or} \quad R_t \leq \frac{50}{I_{\Delta n}}$$

where:

- $R_t$  is the total resistance, equal to the sum of the earth electrode ( $R_A$ ) and the protective conductor for the exposed conductive parts [ $\Omega$ ];
- $I_a$  is the current causing the automatic operation within 5 s of the overcurrent protective device, read from the tripping curve of the device [A];
- $I_{\Delta n}$  is the rated residual operating current, within one second, of the circuit-breaker [A].

## 5 Protection of human beings

From the above, it is clear that  $R_t$  value is considerably different when using automatic circuit-breakers instead of residual current devices.

In fact, with the former, it is necessary to obtain very low earth resistance values (usually less than  $1 \Omega$ ) since the 5 s tripping current is generally high, whereas, with the latter, it is possible to realize earthing systems with resistance value of thousands of ohms, which are easier to be carried out.

Table 1 reports the maximum earth resistance values which can be obtained using residual current devices, with reference to an ordinary location (50 V):

**Table 1: Earth resistance values**

$I_{\Delta n}$ [A]	$R_t$ [ $\Omega$ ]
0.01	5000
0.03	1666
0.1	500
0.3	166
0.5	100
3	16
10	5
30	1.6

### Example:

Assuming to provide protection by using an automatic circuit-breaker Tmax T1B160 In125, the trip current value in less than 5 s, read from the tripping characteristic curve, is about 750 A, when starting from cold conditions (the worst case for thermomagnetic releases).

So:

$$R_t \leq \frac{50}{750} = 0.06 \Omega$$

In order to provide the required protection, it must be necessary to carry out an earthing system with an earth resistance  $R_t \leq 0.06 \Omega$ , which is not an easily obtainable value.

On the contrary, by using the same circuit-breaker mounting ABB SACE RC221 residual current release, with rated residual operating current  $I_{\Delta n} = 0.03$  A, the required value of earth resistance is:

$$R_t \leq \frac{50}{0.03} = 1666.6 \Omega$$

which can be easily obtained in practice.

## 5 Protection of human beings

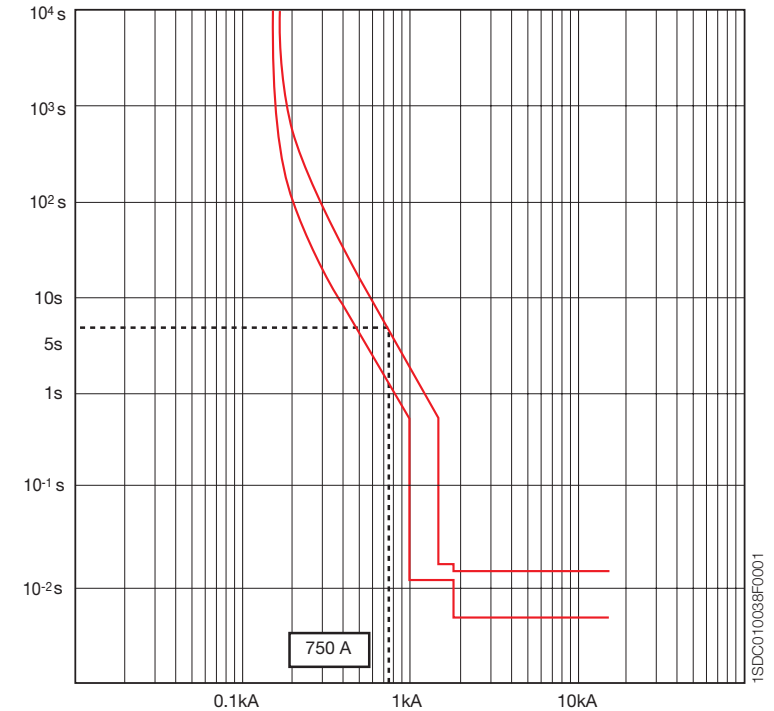

In an electrical installation with a common earthing system and loads protected by devices with different tripping currents, for the achievement of the coordination of all the loads with the earthing system, the worst case - represented by the device with the highest tripping current - shall be considered.

As a consequence, when some feeders are protected by overcurrent devices and some others by residual current devices, all the advantages deriving from the use of residual current releases are nullified, since the  $R_t$  shall be calculated on the basis of the  $I_{5s}$  of the overcurrent device and since it is the highest tripping current between these two kind of devices.

Therefore, it is advisable to protect all the loads of a TT system by means of residual current circuit-breakers coordinated with the earthing system to obtain the advantages of both a quick disconnection of the circuit when the fault occurs as well as an earthing system which can be easily accomplished.

## 5 Protection of human beings

### 5.5 TN System

An earth fault in a TN system involves the circuit represented in Figure 1:

Figure 1: Earth fault in TN system

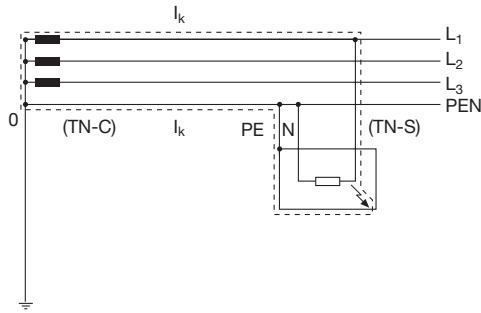

1SDC010038FD001

The fault loop does not affect the earthing system and is basically formed by the connection in series of the phase conductor and of the protective conductor. To provide a protection with automatic disconnection of the circuit, according to IEC 60364-4 prescriptions, the following condition shall be fulfilled:

$$Z_s \cdot I_a \leq U_0$$

where:

- $Z_s$  is the impedance of the fault loop comprising the source, the live conductor up to the point of the fault and the protective conductor between the point of the fault and the source [ $\Omega$ ];
- $U_0$  is the nominal ac r.m.s. voltage to earth [V];
- $I_a$  is the current causing the automatic operation of the disconnecting protective device within the time stated in Table 1, as a function of the rated voltage  $U_0$  or, for distribution circuits, a conventional disconnecting time not exceeding 5 s is permitted [A]; if the protection is provided by means of a residual current device,  $I_a$  is the rated residual operating current  $I_{\Delta n}$ .

Table 1: Maximum disconnecting times for TN system

$U_0$ [V]	Disconnecting time [s]
120	0.8
230	0.4
400	0.2
> 400	0.1

## 5 Protection of human beings

In TN installations, an earth fault with low impedance occurring on the LV side causes a short circuit current with quite high value, due to the low value of the impedance of the fault loop. The protection against indirect contact can be provided by automatic circuit-breakers: it is necessary to verify that the operating current within the stated times is lower than the short-circuit current.

The use of residual current devices improves the conditions for protection in particular when the fault impedance doesn't have a low value, thus limiting the short-circuit current; this current can persist for quite long time causing overheating of the conductors and fire risks.

Finally, it is important to highlight the fact that the residual current devices cannot be used in TN-C system, since the neutral and protective functions are provided by a unique conductor: this configuration prevents the residual current device from working.

### Example:

In the plant represented in Figure 2, the earth fault current is:

$$I_{kLG} = 3 \text{ kA}$$

The rated voltage to earth is 230 V, therefore, according to Table 1, it shall be verified that:

$$I_a (0.4s) \leq \frac{U_0}{Z_s} = I_{kLG} = 3 \text{ kA}$$

Figure 2

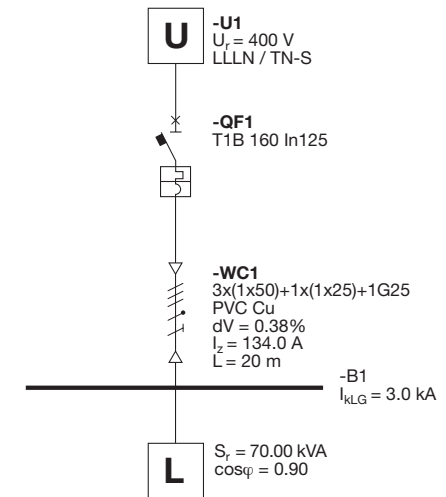

1SDC010038FD001

## 5 Protection of human beings

From the tripping curve (Figure 3), it is clear that the circuit-breaker trips in 0.4 s for a current value lower than 950 A. As a consequence, the protection against indirect contact is provided by the same circuit-breaker which protects the cable against short-circuit and overload, without the necessity of using an additional residual current device.

Figure 3: LG Time-Current curves

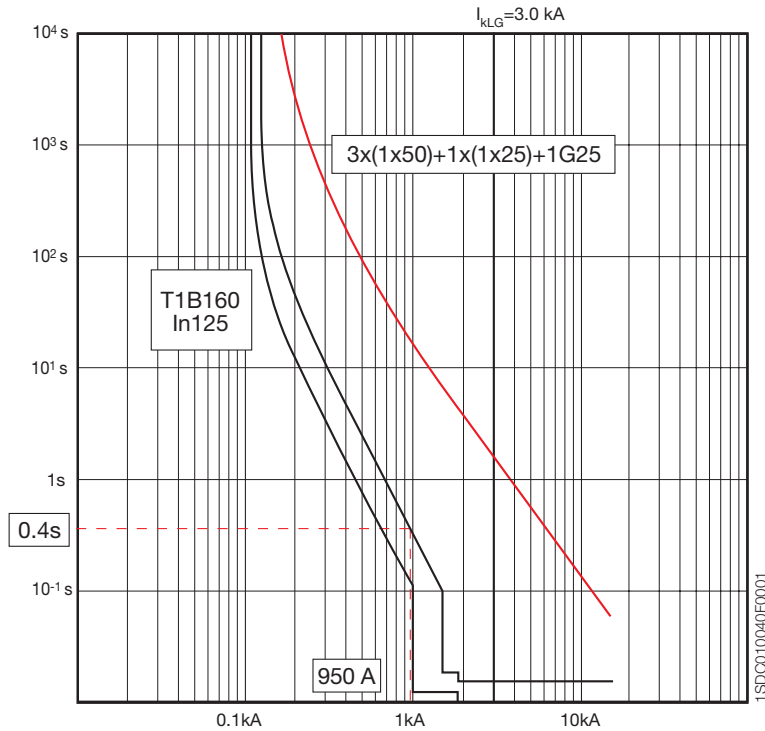

1SDC010040F0001

## 5 Protection of human beings

### 5.6 IT System

As represented in Figure 1, the earth fault current in an IT system flows through the line conductor capacitance to the power supply neutral point. For this reason, the first earth fault is characterized by such an extremely low current value to prevent the overcurrent protections from disconnecting; the deriving touch voltage is very low.

Figure1: Earth fault in IT system

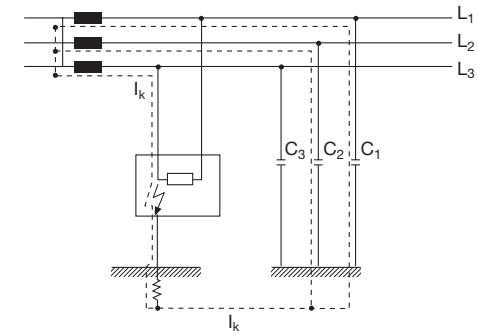

1SDC010037F0001

According to IEC 60364-4, the automatic disconnection of the circuit in case of the first earth fault is not necessary only if the following condition is fulfilled:

$$R_t \cdot I_d \leq U_L$$

where:

- $R_t$  is the resistance of the earth electrode for exposed conductive parts [ $\Omega$ ];
- $I_d$  is the fault current, of the first fault of negligible impedance between a phase conductor and an exposed conductive part [A];
- $U_L$  is 50 V for ordinary locations (25 V for particular locations).

If this condition is fulfilled, after the first fault, the touch voltage value on the exposed conductive parts is lower than 50 V, tolerable by the human body for an indefinite time, as shown in the safety curve (see Chapter 5.1 "General aspects: effects of current on human beings").

In IT system installations, an insulation monitoring device shall be provided to

## 5 Protection of human beings

indicate the occurrence of a first earth fault; in the event of a second fault, the supply shall be disconnected according to the following modalities:

- where exposed conductive parts are earthed in groups or individually, the conditions for protection are the same as for TT systems (see Chapter 5.4 "TT system");
- where exposed conductive parts are interconnected by a protective conductor collectively earthed, the conditions of a TN system apply; in particular, the following conditions shall be fulfilled:  
if the neutral is not distributed:

$$Z_s \leq \frac{U_r}{2 \cdot I_a}$$

if the neutral is distributed:

$$Z'_s \leq \frac{U_0}{2 \cdot I_a}$$

where

- $U_0$  is the rated voltage between phase and neutral [V];
- $U_r$  is the rated voltage between phases [V];
- $Z_s$  is the impedance of the fault loop comprising the phase conductor and the protective conductor of the circuit [ $\Omega$ ];
- $Z'_s$  is the impedance of the fault loop comprising the neutral conductor and the protective conductor of the circuit [ $\Omega$ ];
- $I_a$  is the operating current of the protection device in the disconnecting time specified in Table 1, or within 5 s for distribution circuits.

**Table 1: Maximum disconnecting time in IT systems**

Rated voltage $U_0/U_r$ [V]	disconnecting time [s]	
	neutral not distributed	neutral distributed
120/240	0.8	5
230/400	0.4	0.8
400/690	0.2	0.4
580/1000	0.1	0.2

IEC 60364-4 states that, if the requirements mentioned at point b) cannot be fulfilled by using an overcurrent protective device, the protection of every supplied load shall be provided by means of a residual current device.

The residual current device threshold shall be carefully chosen in order to avoid unwanted tripping, due also to the particular path followed by the first fault current through the line conductor capacitance to the power supply neutral point (instead of the faulted line, another sound line with higher capacitance could be affected by a higher fault current value).

## 5 Protection of human beings

### 5.7 Residual current devices (RCDs)

#### Generalities on residual current circuit-breakers

The operating principle of the residual current release is basically the detection of an earth fault current, by means of a toroid transformer which embraces all the live conductors, included the neutral if distributed.

**Figure 1: Operating principle of the residual current device**

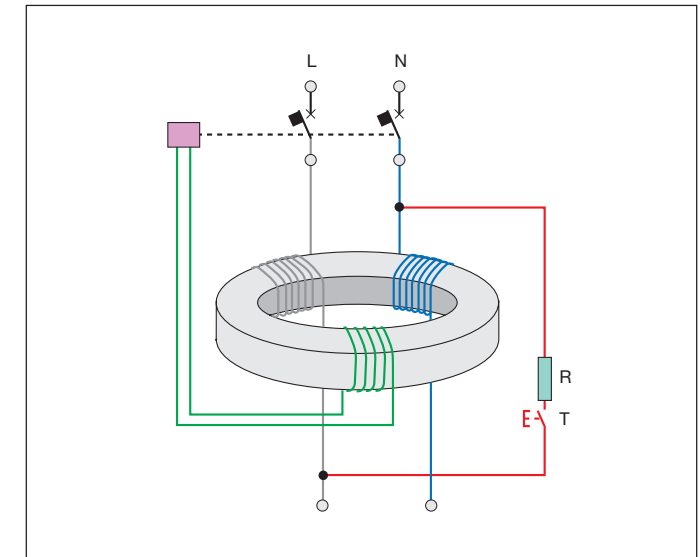

In absence of an earth fault, the vectorial sum of the currents  $I_{\Delta}$  is equal to zero; in case of an earth fault if the  $I_{\Delta}$  value exceeds the rated residual operating current  $I_{\Delta n}$ , the circuit at the secondary side of the toroid sends a command signal to a dedicated opening coil causing the tripping of the circuit-breaker. A first classification of RCDs can be made according to the type of the fault current they can detect:

- AC type: the tripping is ensured for residual sinusoidal alternating currents, whether suddenly applied or slowly rising;
- A type: tripping is ensured for residual sinusoidal alternating currents and residual pulsating direct currents, whether suddenly applied or slowly rising;
- B type: tripping is ensured for residual direct currents, for residual sinusoidal alternating currents and residual pulsating direct currents, whether suddenly applied or slowly rising.

Another classification referred to the operating time delay is:

- undelayed type;
- time delayed S-type.

## 5 Protection of human beings

RCDs can be coupled, or not, with other devices; it is possible to distinguish among:

- pure residual current circuit-breakers (RCCBs): they have only the residual current release and can protect only against earth fault. They must be coupled with thermomagnetic circuit-breakers or fuses, for the protection against thermal and dynamical stresses;
- residual current circuit-breakers with overcurrent protection (RCBOs): they are the combination of a thermomagnetic circuit-breaker and a RCD; for this reason, they provide the protection against both overcurrents as well as earth fault current;
- residual current circuit-breakers with external toroid: they are used in industrial plants with high currents. They are composed by a release connected to an external toroid with a winding for the detection of the residual current; in case of earth fault, a signal commands the opening mechanism of a circuit-breaker or a line contactor.

Given  $I_{\Delta n}$  the operating residual current, a very important parameter for residual current devices is the residual non-operating current, which represents the maximum value of the residual current which does not cause the circuit-breaker trip; it is equal to  $0.5 I_{\Delta n}$ . Therefore, it is possible to conclude that:

- for  $I_{\Delta} < 0.5 I_{\Delta n}$  the RCD shall not operate;
- for  $0.5 I_{\Delta n} < I_{\Delta} < I_{\Delta n}$  the RCD could operate;
- for  $I_{\Delta} > I_{\Delta n}$  the RCD shall operate.

For the choice of the rated operating residual current, it is necessary to consider, in addition to the coordination with the earthing system, also the whole of the leakage currents in the plant; their vectorial sums on each phase shall not be greater than  $0.5 I_{\Delta n}$ , in order to avoid unwanted tripping.

### Discrimination between RCDs

The Standard IEC 60364-5-53 states that discrimination between residual current protective devices installed in series may be required for service reasons, particularly when safety is involved, to provide continuity of supply to the parts of the installation not involved by the fault, if any. This discrimination can be achieved by selecting and installing RCDs in order to provide the disconnection from the supply by the RCD closest to the fault.

There are two types of discrimination between RCDs:

- horizontal discrimination: it provides the protection of each line by using a dedicated residual current circuit-breaker; in this way, in case of earth fault, only the faulted line is disconnected, since the other RCDs do not detect any fault current. However, it is necessary to provide protective measures against indirect contacts in the part of the switchboard and of the plant upstream the RCD;
- vertical discrimination: it is realized by using RCDs connected in series.

**Figure 2: Horizontal discrimination between RCDs**

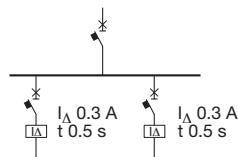

## 5 Protection of human beings

**Figure 3: Vertical discrimination between RCDs**

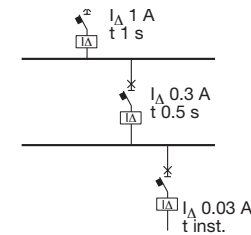

According to IEC 60364-5-53, to ensure discrimination between two residual current protective devices in series, these devices shall satisfy both the following conditions:

- the non-actuating time-current characteristic of the residual current protective device located on the supply side (upstream) shall lie above the total operating time-current characteristic of the residual current protective device located on the load side (downstream);
- the rated residual operating current on the device located on the supply side shall be higher than that of the residual current protective device located on the load side.

**The non-actuating time-current characteristic** is the curve reporting the maximum time value during which a residual current greater than the residual non-operating current (equal to  $0.5 I_{\Delta n}$ ) involves the residual current circuit-breaker without causing the tripping.

As a conclusion, discrimination between two RCDs connected in series can be achieved:

- for S type residual current circuit-breakers, located on the supply side, (complying with IEC 61008-1 and IEC 61009), time-delayed type, by choosing general type circuit-breakers located downstream with  $I_{\Delta n}$  equal to one third of  $I_{\Delta n}$  of the upstream ones;
- for electronic residual current releases (RC221/222/223, RCQ) by choosing the upstream device with time and current thresholds directly greater than the downstream device, keeping carefully into consideration the tolerances (see Vol. 1, Chapter 2.3: Type of release).

For the protection against indirect contacts in distribution circuits in TT system, the maximum disconnecting time at  $I_{\Delta n}$  shall not exceed 1 s (IEC 60364-4-41, § 413.1)

## 5 Protection of human beings

### 5.8 Maximum protected length for the protection of human beings

As described in the previous chapters, the Standards give indications about the maximum disconnecting time for the protective devices, in order to avoid pathophysiological effects for people touching live parts.

For the protection against indirect contact, it shall be verified that the circuit-breaker trips within a time lower than the maximum time stated by the Standard; this verification is carried out by comparing the minimum short-circuit current of the exposed conductive part to be protected with the operating current corresponding to the time stated by the Standard.

The minimum short-circuit current occurs when there is a short-circuit between the phase and the protective conductors at the farthest point on the protected conductor.

For the calculation of the minimum short-circuit current, an approximate method can be used, assuming that:

- a 50 % increasing of the conductors resistance, with respect to the 20 °C value, is accepted, due to the overheating caused by the short-circuit current;
- a 80 % reduction of the supply voltage is considered as effect of the short-circuit current;
- the conductor reactance is considered only for cross sections larger than 95 mm<sup>2</sup>.

The formula below is obtained by applying Ohm's law between the protective device and the fault point.

*Legend of the symbols and constants of the formula:*

- 0.8 is the coefficient representing the reduction of the voltage;
- 1.5 is the coefficient representing the increasing in the resistance;
- $U_r$  is the rated voltage between phases;
- $U_0$  is the rated voltage between phase and ground;
- $S$  is the phase conductor cross section;
- $S_N$  is the neutral conductor cross section;
- $S_{PE}$  is the protection conductor cross section;
- $\rho$  is the conductor resistivity at 20 °C;
- $L$  is the length of the cable;
- $m = \frac{S \cdot n}{S_{PE}}$  is the ratio between the total phase conductor cross section (single phase conductor cross section  $S$  multiplied by  $n$ , number of conductors in parallel) and the protective conductor cross section  $S_{PE}$  assuming they are made of the same conductor material;
- $m_1 = \frac{S_N \cdot n}{S_{PE}}$  is the ratio between the total neutral conductor cross section (single neutral conductor cross section  $S_N$  multiplied by  $n$ , number of conductors in parallel) and the protective conductor cross section  $S_{PE}$  assuming they are made of the same conductor material;
- $k_1$  is the correction factor which takes into account the reactance of cables with cross section larger than 95 mm<sup>2</sup>, obtainable from the following table:

Phase conductor cross section [mm <sup>2</sup> ]	120	150	185	240	300
$k_1$	0.90	0.85	0.80	0.75	0.72

## 5 Protection of human beings

- $k_2$  is the correction factor for conductors in parallel, obtainable by the following formula:

$$k_2 = 4 \frac{n-1}{n}$$

- where  $n$  is the number of conductor in parallel per phase;
- 1.2 is the magnetic threshold tolerance allowed by the Standard.

### TN system

The formula for the evaluation of the minimum short circuit current is:

$$I_{kmin} = \frac{0.8 \cdot U_0 \cdot S}{1.5 \cdot 1.2 \cdot \rho \cdot (1+m) \cdot L} \cdot k_1 \cdot k_2$$

and consequently:

$$L = \frac{0.8 \cdot U_0 \cdot S}{1.5 \cdot 1.2 \cdot \rho \cdot (1+m) \cdot I_{kmin}} \cdot k_1 \cdot k_2$$

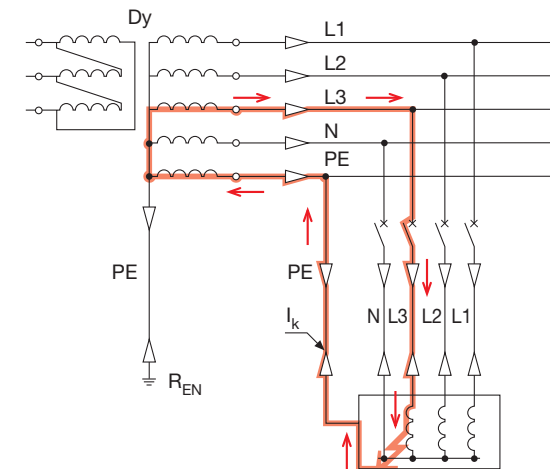

1SDC010043F0001

### IT system

The formulas below are valid when a second fault turns the IT system into a TN system.

It is necessary to separately examine installations with neutral not distributed and neutral distributed.

## 5 Protection of human beings

### Neutral not distributed

When a second fault occurs, the formula becomes:

$$I_{kmin} = \frac{0.8 \cdot U_r \cdot S}{2 \cdot 1.5 \cdot 1.2 \cdot \rho \cdot (1+m) \cdot L} \cdot k_1 \cdot k_2$$

and consequently:

$$L = \frac{0.8 \cdot U_r \cdot S}{2 \cdot 1.5 \cdot 1.2 \cdot \rho \cdot (1+m) \cdot I_{kmin}} \cdot k_1 \cdot k_2$$

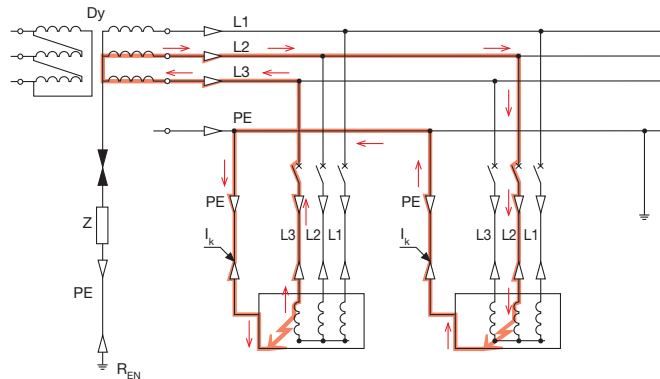

1SDC010044F0001

### Neutral distributed

Case A: three-phase circuits in IT system with neutral distributed

The formula is:

$$I_{kmin} = \frac{0.8 \cdot U_0 \cdot S}{2 \cdot 1.5 \cdot 1.2 \cdot \rho \cdot (1+m) \cdot L} \cdot k_1 \cdot k_2$$

and consequently:

$$L = \frac{0.8 \cdot U_0 \cdot S}{2 \cdot 1.5 \cdot 1.2 \cdot \rho \cdot (1+m) \cdot I_{kmin}} \cdot k_1 \cdot k_2$$

Case B: three-phase + neutral circuits in IT system with neutral distributed

The formula is:

$$I_{kmin} = \frac{0.8 \cdot U_0 \cdot S_N}{2 \cdot 1.5 \cdot 1.2 \cdot \rho \cdot (1+m_1) \cdot L} \cdot k_1 \cdot k_2$$

and consequently:

$$L = \frac{0.8 \cdot U_0 \cdot S_N}{2 \cdot 1.5 \cdot 1.2 \cdot \rho \cdot (1+m_1) \cdot I_{kmin}} \cdot k_1 \cdot k_2$$

## 5 Protection of human beings

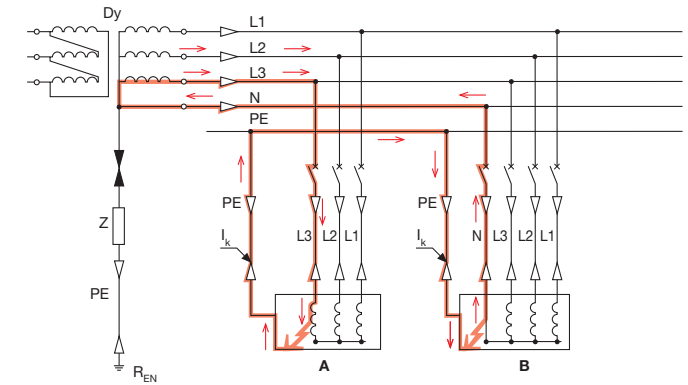

1SDC010045F0001

### Note for the use of the tables

The tables showing the maximum protected length (MPL) have been defined considering the following conditions:

- one cable per phase;
- rated voltage equal to 400 V (three-phase system);
- copper cables;
- neutral not distributed, for IT system only;
- protective conductor cross section according to Table 1:

**Table 1: Protective conductor cross section**

Phase conductor cross section S [mm <sup>2</sup> ]	Protective conductor cross section S <sub>PE</sub> [mm <sup>2</sup> ]
S ≤ 16	S
16 < S ≤ 35	16
S > 35	S/2

Note: phase and protective conductors having the same isolation and conductive materials

Whenever the S function (delayed short-circuit) of electronic releases is used for the definition of the maximum protected length, it is necessary to verify that the tripping time is lower than the time value reported in Chapter 5.5 Table 1 for TN systems and in Chapter 5.6 Table 1 for IT systems.

For conditions different from the reference ones, the following correction factors shall be applied.



## 5 Protection of human beings

### Correction factors

**Correction factor for cable in parallel per phase:** the value of the maximum protected length read in Table 2 (TN system) or Table 3 (IT system) shall be multiplied by the following factor:

n	2	3	4	5	6	7	8
$k_p$	2	2.7	3	3.2	3.3	3.4	3.5

n is the number of conductors in parallel per phase.

**Correction factor for three-phase voltage different from 400 V:** the value of the maximum protected length read in Table 2 (TN system) or Table 3 (IT system) shall be multiplied by the following factor:

voltage [V]	230	400	440	500	690
$k_v$	0.58	1	1.1	1.25	1.73

For 230 V single-phase systems, no correction factor is necessary.

**Correction factor for aluminium cables:** the value of the maximum protected length read in Table 2 (TN system) or Table 3 (IT system) shall be multiplied by the following factor:

$k_{Al}$	0.64
----------	------

**Correction factor for protective conductor cross section  $S_{PE}$  different from the cross sections stated in Table 1:** the value of the maximum protected length shall be multiplied by the coefficient corresponding to the phase conductor cross section and to the ratio between the protective conductor (PE) and the phase cross sections:

$S_{PE}/S$	0.5	0.55	0.6	0.66	0.75	0.87	1	1.25	1.5	2
$k_{PE}$	0.67	0.71	0.75	0.80	0.86	0.93	1.00	1.11	1.20	1.33
≤16 mm <sup>2</sup>	0.85	0.91	0.96	1.02	1.10	1.19	1.28	1.42	1.54	1.71
25 mm <sup>2</sup>	1.06	1.13	1.20	1.27	1.37	1.48	1.59	1.77	1.91	2.13
35 mm <sup>2</sup>	1.00	1.06	1.13	1.2	1.29	1.39	1.5	1.67	1.8	2.00
>35 mm <sup>2</sup>										

**Correction factor for neutral distributed in IT systems (for Table 3 only):** the value of the maximum protected length shall be multiplied by 0.58.

## 5 Protection of human beings

### TN system MPL by MCB

Table 2.1: Curve Z

CURVE	Z	Z	Z	Z	Z	Z	Z	Z	Z
In	≤10	13	16	20	25	32	40	50	63
I <sub>Δ</sub>	30	39	48	60	75	96	120	150	189
S	$S_{PE}$								
1.5	1.5	173	133	108	86	69	54	43	
2.5	2.5	288	221	180	144	115	90	72	58
4	4	461	354	288	231	185	144	115	92
6	6	692	532	432	346	277	216	173	138
10	10	1153	886	721	577	461	360	288	231
16	16	1845	1419	1153	923	738	577	461	369
25	16	2250	1730	1406	1125	900	703	563	450

Table 2.2: Curve B

CURVE	B	B	B	B	B	B	B	B	B	B	B	B	B
In	≤6	8	10	13	16	20	25	32	40	50	63	80	100
I <sub>Δ</sub>	30	40	50	65	80	100	125	160	200	250	315	400	500
S	$S_{PE}$												
1.5	1.5	173	130	104	80	65	52	42	32	26			
2.5	2.5	288	216	173	133	108	86	69	54	43	35	27	
4	4	461	346	277	213	173	138	111	86	69	55	44	35
6	6	692	519	415	319	259	208	166	130	104	83	66	52
10	10	1153	865	692	532	432	346	277	216	173	138	110	86
16	16	1845	1384	1107	852	692	554	443	346	277	221	176	138
25	16	2250	1688	1350	1039	844	675	540	422	338	270	214	169
35	16												190

Table 2.3: Curve C

CURVE	C	C	C	C	C	C	C	C	C	C	C	C	C	C
In	≤3	4	6	8	10	13	16	20	25	32	40	50	63	80
I <sub>Δ</sub>	30	40	60	80	100	130	160	200	250	320	400	500	630	800
S	$S_{PE}$													
1.5	1.5	173	130	86	65	52	40	32	26	21	16	13		
2.5	2.5	288	216	144	108	86	67	54	43	35	27	22	17	14
4	4	461	346	231	173	138	106	86	69	55	43	35	28	22
6	6	692	519	346	259	208	160	130	104	83	65	52	42	33
10	10	1153	865	577	432	346	266	216	173	138	108	86	69	55
16	16	1845	1384	923	692	554	426	346	277	221	173	138	111	88
25	16	2250	1688	1125	844	675	519	422	338	270	211	169	135	107
35	16													95



## 5 Protection of human beings

TN system MPL  
by MCCB

Table 2.8: Tmax T3 TMD

S	S <sub>PE</sub>	T3	T3	T3	T3	T3	T3	T3
		In	63	80	100	125	160	200
		I <sub>Δ</sub>	10 In	10 In	10 In	10 In	10 In	10 In
4	4	17	13	10	8			
6	6	25	20	16	13	10	8	
10	10	42	33	26	21	16	13	10
16	16	67	52	42	34	26	21	17
25	16	81	64	51	41	32	26	20
35	16	91	72	58	46	36	29	23
50	25	139	109	87	70	55	44	35
70	35	194	153	122	98	76	61	49
95	50	273	215	172	137	107	86	69
120	70	331	261	209	167	130	104	83
150	95	411	324	259	207	162	130	104
185	95	418	329	263	211	165	132	105
240	120	499	393	315	252	197	157	126

Table 2.9: Tmax T4 TMD/TMA

S	S <sub>PE</sub>	T4	T4	T4	T4	T4	T4	T4	T4	T4	
		In	20	32	50	80	100	125	160	200	250
		I <sub>Δ</sub>	320 A	10 In	10 In	5...10 In	5...10 In	5...10 In	5...10 In	5...10 In	5...10 In
1.5	1.5	14	14	9	11...5	9...4	7...3	5...3	4...2	3...2	3...1
2.5	2.5	23	23	14	18...9	14...7	12...6	9...5	7...4	6...3	5...2
4	4	36	36	23	29...14	23...12	18...9	14...7	12...6	9...5	7...4
6	6	54	54	35	43...22	35...17	28...14	22...11	17...9	14...7	11...5
10	10	90	90	58	72...36	58...29	46...23	36...18	29...14	23...12	18...9
16	16	144	144	92	115...58	92...46	74...37	58...29	46...23	37...18	29...14
25	16	176	176	113	141...70	113...56	90...45	70...35	56...28	45...23	35...18
35	16	198	198	127	158...79	127...63	101...51	79...40	63...32	51...25	40...20
50	25	300	300	192	240...120	192...96	154...77	120...60	96...48	77...38	60...30
70	35	420	420	269	336...168	269...135	215...108	168...84	135...67	108...54	84...42
95	50	590	590	378	472...236	378...189	302...151	236...118	189...94	151...76	118...59
120	70	717	717	459	574...287	459...229	367...184	287...143	229...115	184...92	143...72
150	95	891	891	570	713...356	570...285	456...228	356...178	285...143	228...114	178...89
185	95	905	905	579	724...362	579...290	463...232	362...181	290...145	232...116	181...90
240	120	1081	1081	692	865...432	692...346	554...277	432...216	346...173	277...138	216...108
300	150	1297	1297	830	1038...519	830...415	664...332	519...259	415...208	332...166	259...130

## 5 Protection of human beings

TN system MPL  
by MCCB

Table 2.10: Tmax T5 TMA

S	S <sub>PE</sub>	T5	T5	T5	T5	
		In	320	400	500	630
		I <sub>Δ</sub>	5...10 In	5...10 In	5...10 In	5...10 In
1,5	1,5	3...1	2...1	2...1	1...1	
2,5	2,5	5...2	4...2	3...1	2...1	
4	4	7...4	6...3	5...2	4...2	
6	6	11...5	9...4	7...3	5...3	
10	10	18...9	14...7	12...6	9...5	
16	16	29...14	23...12	18...9	15...7	
25	16	35...18	28...14	23...11	18...9	
35	16	40...20	32...16	25...13	20...10	
50	25	60...30	48...24	38...19	31...15	
70	35	84...42	67...34	54...27	43...21	
95	50	118...59	94...47	76...38	60...30	
120	70	143...72	115...57	92...46	73...36	
150	95	178...89	143...71	114...57	91...45	
185	95	181...90	145...72	116...58	92...46	
240	120	216...108	173...86	138...69	110...55	
300	150	259...130	208...104	166...83	132...66	

Table 2.11: Tmax T2 with PR221 DS-LS

S	S <sub>PE</sub>	T2	T2	T2	T2	T2
		In	10	25	63	100
		I <sub>Δ</sub>	5.5 In	5.5 In	5.5 In	5.5 In
1.5	1.5	79	31	12		
2.5	2.5	131	52	21		
4	4	210	84	33	21	
6	6	315	126	50	31	20
10	10	524	210	83	52	33
16	16	839	335	133	84	52
25	16	1023	409	162	102	64
35	16	1151	460	183	115	72
50	25	1747	699	277	175	109
70	35	2446	979	388	245	153
95	50	3434	1374	545	343	215
120	70	4172	1669	662	417	261
150	95	5183	2073	823	518	324
185	95	5265	2106	836	526	329

Note: if the setting of function I is different from the reference value (5.5), the value of the MPL shall be multiplied by the ratio between the reference value and the set value.

## 5 Protection of human beings

TN system MPL  
by MCCB

Table 2.12: Tmax T4-T5 with PR221 - PR222

		T4	T4	T4	T4	T5	T5	T5
In		100	160	250	320	320	400	630
I <sub>3</sub>		6.5 In	6.5 In	6.5 In	6.5 In	6.5 In	6.5 In	6.5 In
S	S <sub>PE</sub>							
1,5	1,5							
2,5	2,5							
4	4							
6	6	29	18					
10	10	48	30	19				
16	16	77	48	31	24	24	19	
25	16	94	59	38	30	30	24	15
35	16	106	66	43	33	33	27	17
50	25	161	101	65	50	50	40	26
70	35	226	141	90	71	71	56	36
95	50	317	198	127	99	99	79	50
120	70	385	241	154	120	120	96	61
150	95	478	299	191	150	150	120	76
185	95	486	304	194	152	152	121	77
240	120	581	363	232	181	181	145	92
300	150	697	435	279	218	218	174	111

Note: if the setting of function I is different from the reference value (6.5), the value of the MPL shall be multiplied by the ratio between the reference value and the set value.

Table 2.13: SACE Isomax S6+S8 with PR211- PR212

		S6	S7	S7	S8	S8	S8	S8	
In		800	1000	1250	1600	1600	2000	2500	3200
I <sub>3</sub>		6 In	6 In	6 In	6 In	6 In	6 In	6 In	6 In
S	S <sub>PE</sub>								
2,5	2,5								
4	4								
6	6								
10	10								
16	16								
25	16								
35	16								
50	25	20							
70	35	28	22	18	14	14			
95	50	39	31	25	20	20	16	13	10
120	70	48	38	31	24	24	19	15	12
150	95	59	48	38	30	30	24	19	15
185	95	60	48	39	30	30	24	19	15
240	120	72	58	46	36	36	29	23	18
300	150	86	69	55	43	43	35	28	22

Note: if the setting of function S or I is different from the reference value (6), the MPL value shall be multiplied by the ratio between the reference value and the set value. Besides, using function S the MPL shall be multiplied by 1.1.

## 5 Protection of human beings

IT system MPL  
by MCB

Table 3.1: Curve Z

CURVE		Z	Z	Z	Z	Z	Z	Z	Z	Z	
In		≤8	10	13	16	20	25	32	40	50	63
I <sub>3</sub>		30	30	39	48	60	75	96	120	150	189
S	S <sub>PE</sub>										
1.5	1.5	150	150	115	94	75	60	47	37		
2.5	2.5	250	250	192	156	125	100	78	62	50	40
4	4	400	400	307	250	200	160	125	100	80	63
6	6	599	599	461	375	300	240	187	150	120	95
10	10	999	999	768	624	499	400	312	250	200	159
16	16	1598	1598	1229	999	799	639	499	400	320	254
25	16	1949	1949	1499	1218	974	780	609	487	390	309

Table 3.2: Curve B

CURVE		B	B	B	B	B	B	B	B	B	B	B	B	
In		≤6	8	10	13	16	20	25	32	40	50	63	80	100
I <sub>3</sub>		30	40	50	65	80	100	125	160	200	250	315	400	500
S	S <sub>PE</sub>													
1.5	1.5	150	112	90	69	56	45	36	28	22				
2.5	2.5	250	187	150	115	94	75	60	47	37	30	24		
4	4	400	300	240	184	150	120	96	75	60	48	38	30	24
6	6	599	449	360	277	225	180	144	112	90	72	57	45	36
10	10	999	749	599	461	375	300	240	187	150	120	95	75	60
16	16	1598	1199	959	738	599	479	384	300	240	192	152	120	96
25	16	1949	1462	1169	899	731	585	468	365	292	234	186	146	117
35	16												165	132

Table 3.3: Curve C

CURVE		C	C	C	C	C	C	C	C	C	C	C	C	C	C		
In		≤3	4	6	8	10	13	16	20	25	32	40	50	63	80	100	125
I <sub>3</sub>		30	40	60	80	100	130	160	200	250	320	400	500	630	800	1000	1250
S	S <sub>PE</sub>																
1.5	1.5	150	112	75	56	45	35	28	22	18	14	11					
2.5	2.5	250	187	125	94	75	58	47	37	30	23	19	15	12			
4	4	400	300	200	150	120	92	75	60	48	37	30	24	19	15	12	10
6	6	599	449	300	225	180	138	112	90	72	56	45	36	29	22	18	14
10	10	999	749	499	375	300	230	187	150	120	94	75	60	48	37	30	24
16	16	1598	1199	799	599	479	369	300	240	192	150	120	96	76	60	48	38
25	16	1949	1462	974	731	585	450	365	292	234	183	146	117	93	73	58	47
35	16														82	66	53

### 5 Protection of human beings

IT system MPL  
by MCB

Table 3.4: Curve K

CURVE	K	K	K	K	K	K	K	K	K	K	K	K	K	K	K	K	K	K	K	K	K	K	K	K
In	≤2	≤3	4	4.2	5.8	6	8	10	11	13	15	16	20	25	26	32	37	40	41	45	50	63		
I <sub>s</sub>	28	42	56	59	81	84	112	140	154	182	210	224	280	350	364	448	518	560	574	630	700	882		
S	S <sub>PE</sub>																							
1.5	1.5	161	107	80	76	55	54	40	32	29	25	21	20	16	13	12	10	9	8					
2.5	2.5	268	178	134	127	92	89	67	54	49	41	36	33	27	21	21	17	14	13	13	12			
4	4	428	285	214	204	148	143	107	86	78	66	57	54	43	34	33	27	23	21	21	19	17	14	
6	6	642	428	321	306	221	214	161	128	117	99	86	80	64	51	49	40	35	32	31	29	26	20	
10	10	1070	713	535	510	369	357	268	214	195	165	143	134	107	86	82	67	58	54	52	48	43	34	
16	16	1712	1141	856	815	590	571	428	342	311	263	228	214	171	137	132	107	93	86	84	76	68	54	
25	16	2088	1392	1044	994	720	696	522	418	380	321	278	261	209	167	161	130	113	104	102	93	84	66	

Table 3.5: Curve D

CURVE	D	D	D	D	D	D	D	D	D	D	D	D	D	D	D	D	
In	≤2	3	4	6	8	10	13	16	20	25	32	40	50	63	80	100	
I <sub>s</sub>	40	60	80	120	160	200	260	320	400	500	640	800	1000	1260	1600	2000	
S	S <sub>PE</sub>																
1.5	1.5	112	75	56	37	28	22	17	14	11	9	7	6				
2.5	2.5	187	125	94	62	47	37	29	23	19	15	12	9	7	6		
4	4	300	200	150	100	75	60	46	37	30	24	19	15	12	10	7	6
6	6	449	300	225	150	112	90	69	56	45	36	28	22	18	14	11	9
10	10	749	499	375	250	187	150	115	94	75	60	47	37	30	24	19	15
16	16	1199	799	599	400	300	240	184	150	120	96	75	60	48	38	30	24
25	16	1462	974	731	487	365	292	225	183	146	117	91	73	58	46	37	29
35															41	33	

### 5 Protection of human beings

IT system MPL  
by MCCB

Table 3.6: Tmax T1 TMD

	T1	T1	T1	T1	T1	T1
In	≤50	63	80	100	125	160
I <sub>s</sub>	500 A	10 In	10 In	10 In	10 In	10 In
S	S <sub>PE</sub>					
1.5	1.5	5				
2.5	2.5	8				
4	4	13	11	8	7	5
6	6	20	16	12	10	8
10	10	33	26	21	17	13
16	16	53	42	33	27	21
25	16	65	52	41	32	26
35	16	73	58	46	37	29
50	25	111	88	69	55	44
70	35	155	123	97	78	62
95	50	218	173	136	109	87

Table 3.7: Tmax T2 TMD

	T2	T2	T2	T2	T2	T2	T2	T2	T2	T2	T2	T2	T2	T2	T2	T2	T2
In	1.6	2	2.5	3.2	4	5	6.3	8	10	12.5	16-50	63	80	100	125	160	
I <sub>s</sub>	10 In	10 In	10 In	10 In	10 In	10 In	10 In	10 In	10 In	10 In	10 In	500 A	10 In	10 In	10 In	10 In	
S	S <sub>PE</sub>																
1.5	1.5	213	170	136	106	85	68	54	43	34	27	7					
2.5	2.5	355	284	227	177	142	113	90	71	57	45	11					
4	4	567	454	363	284	227	182	144	113	91	73	18	14	11	9	7	
6	6	851	681	545	426	340	272	216	170	136	109	27	22	17	14	11	
10	10	1419	1135	908	709	567	454	360	284	227	182	45	36	28	23	18	
16	16	2270	1816	1453	1135	908	726	576	454	363	291	73	58	45	36	29	
25	16				1384	1107	886	703	554	443	354	89	70	55	44	35	
35	16						997	791	623	498	399	100	79	62	50	40	
50	25							946	757	605	477	151	120	95	76	61	
70	35									847	212	168	132	106	85	66	
95	50										297	236	186	149	119	93	
120	70											361	287	226	181	145	
150	95												449	356	281	224	
185	95													456	362	285	

## 5 Protection of human beings

IT system MPL  
by MCCB

Table 3.8: Tmax T3 TMD

In	Is	T3	T3	T3	T3	T3	T3	T3
		63	80	100	125	160	200	250
		10 In	10 In	10 In	10 In	10 In	10 In	10 In
S	S <sub>PE</sub>							
4	4	14	11	9	7			
6	6	22	17	14	11	9	7	
10	10	36	28	23	18	14	11	9
16	16	58	45	36	29	23	18	15
25	16	70	55	44	35	28	22	18
35	16	79	62	50	40	31	25	20
50	25	120	95	76	61	47	38	30
70	35	168	132	106	85	66	53	42
95	50	236	186	149	119	93	74	59
120	70	287	226	181	145	113	90	72
150	95	356	281	224	180	140	112	90
185	95	362	285	228	182	142	114	91
240	120	432	340	272	218	170	136	109

Table 3.9: Tmax T4 TMD/TMA

In	Is	T4	T4	T4	T4	T4	T4	T4	T4	T4	
		20	32	50	80	100	125	160	200	250	320
		320 A	10 In	10 In	5...10 In	5...10 In	5...10 In	5...10 In	5...10 In	5...10 In	
S	S <sub>PE</sub>										
1.5	1.5	12	12	7	9...5	7...4	6...3	5...2	4...2	3...1	2...1
2.5	2.5	20	20	12	16...8	12...6	10...5	8...4	6...3	5...2	4...2
4	4	31	31	20	25...12	20...10	16...8	12...6	10...5	8...4	6...3
6	6	47	47	30	37...19	30...15	24...12	19...9	15...7	12...6	9...5
10	10	78	78	50	62...31	50...25	40...20	31...16	25...12	20...10	16...8
16	16	125	125	80	100...50	80...40	64...32	50...25	40...20	32...16	25...12
25	16	152	152	97	122...61	97...49	78...39	61...30	49...24	39...19	30...15
35	16	171	171	110	137...69	110...55	88...44	69...34	55...27	44...22	34...17
50	25	260	260	166	208...104	166...83	133...67	104...52	83...42	67...33	52...26
70	35	364	364	233	291...146	233...117	186...93	146...73	117...58	93...47	73...36
95	50	511	511	327	409...204	327...164	262...131	204...102	164...82	131...65	102...51
120	70	621	621	397	497...248	397...199	318...159	248...124	199...99	159...79	124...62
150	95	772	772	494	617...309	494...247	395...198	309...154	247...123	198...99	154...77
185	95	784	784	502	627...313	502...251	401...201	313...157	251...125	201...100	157...78
240	120	936	936	599	749...375	599...300	479...240	375...187	300...150	240...120	187...94
300	150	1124	1124	719	899...449	719...360	575...288	449...225	360...180	288...144	225...112

## 5 Protection of human beings

IT system MPL  
by MCCB

Table 3.10: Tmax T5 TMA

In	Is	T5	T5	T5	T5
		320	400	500	630
		5...10 In	5...10 In	5...10 In	5...10 In
S	S <sub>PE</sub>				
1.5	1.5	2...1	2...1	1...1	1...1
2.5	2.5	4...2	3...2	2...1	2...1
4	4	6...3	5...2	4...2	3...2
6	6	9...5	7...4	6...3	5...2
10	10	16...8	12...6	10...5	8...4
16	16	25...12	20...10	16...8	13...6
25	16	30...15	24...12	19...10	15...8
35	16	34...17	27...14	22...11	17...9
50	25	52...26	42...21	33...17	26...13
70	35	73...36	58...29	47...23	37...18
95	50	102...51	82...41	65...33	52...26
120	70	124...62	99...50	79...40	63...32
150	95	154...77	123...62	99...49	78...39
185	95	157...78	125...63	100...50	80...40
240	120	187...94	150...75	120...60	95...48
300	150	225...112	180...90	144...72	114...57

Table 3.11: Tmax T2 with PR221 DS-LS

In	Is	T2	T2	T2	T2	
		10	25	63	100	160
		5.5 In	5.5 In	5.5 In	5.5 In	
S	S <sub>PE</sub>					
1.5	1.5	68	27	11		
2.5	2.5	113	45	18		
4	4	182	73	29	18	
6	6	272	109	43	27	17
10	10	454	182	72	45	28
16	16	726	291	115	73	45
25	16	886	354	141	89	55
35	16	997	399	158	100	62
50	25	1513	605	240	151	95
70	35	2119	847	336	212	132
95	50	2974	1190	472	297	186
120	70	3613	1445	573	361	226
150	95	4489	1796	713	449	281
185	95	4559	1824	724	456	285

Note: if the setting of function I is different from the reference value (5.5), the MPL value shall be multiplied by the ratio between the reference value and the set value.

## 5 Protection of human beings

IT system MPL by MCCB Table 3.12: Tmax T4-T5 with PR221-PR222

		T4	T4	T4	T4	T5	T5	T5
In		100	160	250	320	320	400	630
I <sub>Δ</sub>		6.5 In	6.5 In	6.5 In	6.5 In	6.5 In	6.5 In	6.5 In
S	S <sub>PE</sub>							
1.5	1.5							
2.5	2.5							
4	4							
6	6	25	16					
10	10	42	26	17				
16	16	67	42	27	21	21	17	
25	16	82	51	33	26	26	20	13
35	16	92	58	37	29	29	23	15
50	25	140	87	56	44	44	35	22
70	35	196	122	78	61	61	49	31
95	50	275	172	110	86	86	69	44
120	70	333	208	133	104	104	83	53
150	95	414	259	166	129	129	104	66
185	95	421	263	168	132	132	105	67
240	120	503	314	201	157	157	126	80
300	150	603	377	241	189	189	151	96

Note: if the setting of function I is different from the reference value (6.5), the value of the MPL shall be multiplied by the ratio between the reference value and the set value.

## 5 Protection of human beings

IT system MPL by MCCB

Table 3.13: SACE Isomax S6-S8 with PR211-212

		S6	S7	S7	S7	S8	S8	S8	S8
In		800	1000	1250	1600	1600	2000	2500	3200
I <sub>Δ</sub>		6 In	6 In	6 In	6 In	6 In	6 In	6 In	6 In
S	S <sub>PE</sub>								
2.5	2.5								
4	4								
6	6								
10	10								
16	16								
25	16								
35	16								
50	25	17							
70	35	24	19	16	12	12			
95	50	34	27	22	17	17	14	11	9
120	70	41	33	26	21	21	17	13	10
150	95	51	41	33	26	26	21	16	13
185	95	52	42	33	26	26	21	17	13
240	120	62	50	40	31	31	25	20	16
300	150	75	60	48	37	37	30	24	19

Note: if the setting of function S or I is different from the reference value (6), the MPL value shall be multiplied by the ratio between the reference value and the set value. Besides, using function S, the MPL shall be multiplied by 1.1.

## Annex A: Calculation tools

### A.1 Slide rules

These slide rules represent a valid instrument for a quick and approximate dimensioning of electrical plants.

All the given information is connected to some general reference conditions; the calculation methods and the data reported are gathered from the IEC Standards in force and from plant engineering practice. The instruction manual enclosed with the slide rules offers different examples and tables showing the correction coefficients necessary to extend the general reference conditions to those actually required.

These two-sided slide rules are available in four different colors, easily identified by subject:

- yellow slide rule: cable sizing;
- orange slide rule: cable verification and protection;
- green slide rule: protection coordination;
- blue slide rule: motor and transformer protection.

## Annex A: Calculation tools

### Yellow slide rule: cable sizing

Side ●

Definition of the current carrying capacity, impedance and voltage drop of cables.

Side ●●

Calculation of the short-circuit current for three-phase fault on the load side of a cable line with known cross section and length.

In addition, a diagram for the calculation of the short-circuit current on the load side of elements with known impedance.

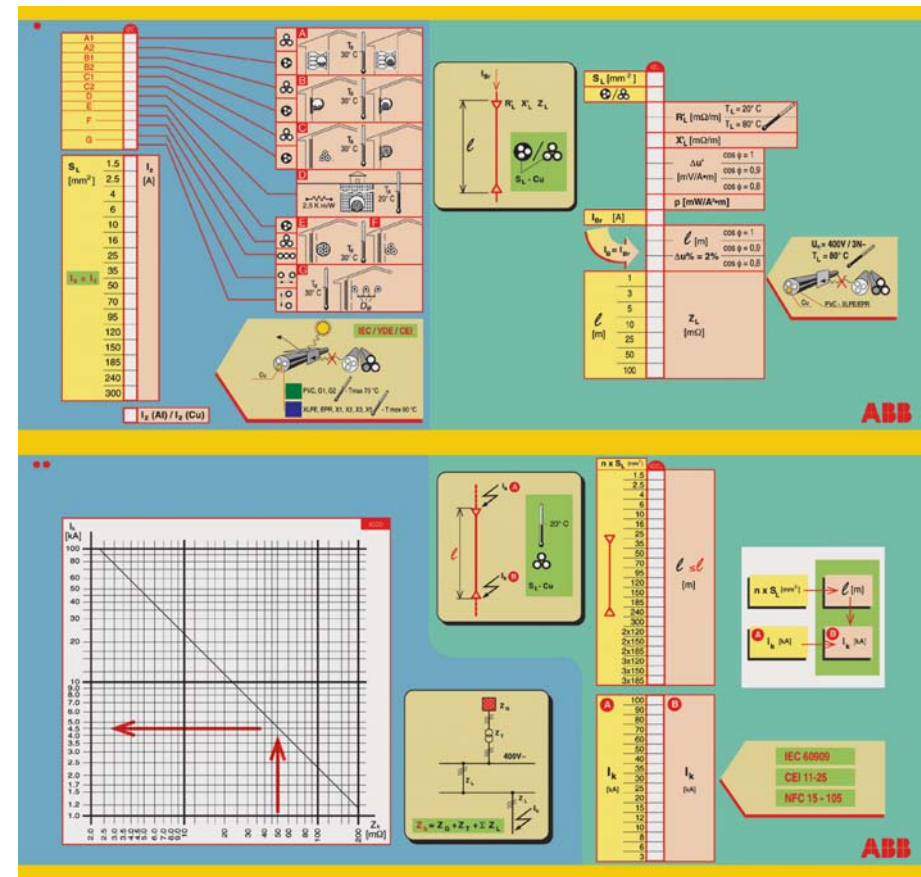



## Annex A: Calculation tools

### Orange slide rule: cable verification and protection

Side ●

Verification of cable protection against indirect contact and short-circuit with ABB SACE MCCBs (moulded-case circuit-breakers).

Side ●●

Verification of cable protection against indirect contact and short-circuit with ABB MCBs (modular circuit-breakers).

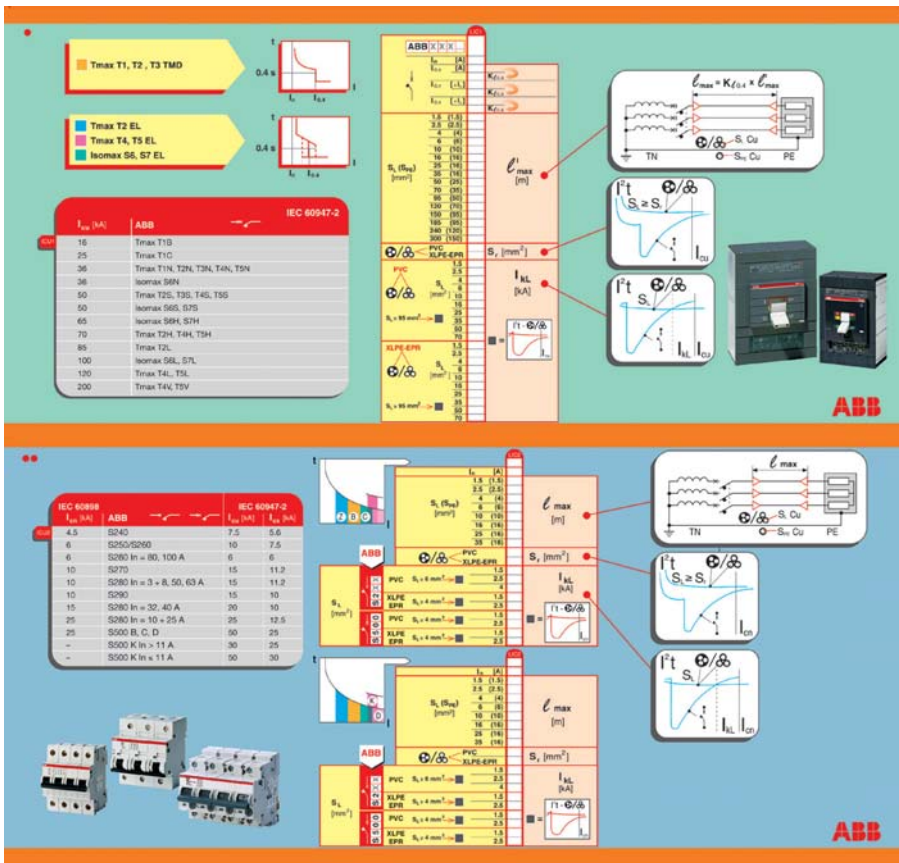

## Annex A: Calculation tools

### Green slide rule: protection coordination

Side ●

Selection of the circuit-breakers when back-up protection is provided.

Side ●●

Definition of the limit selectivity current for the combination of two circuit-breakers in series.

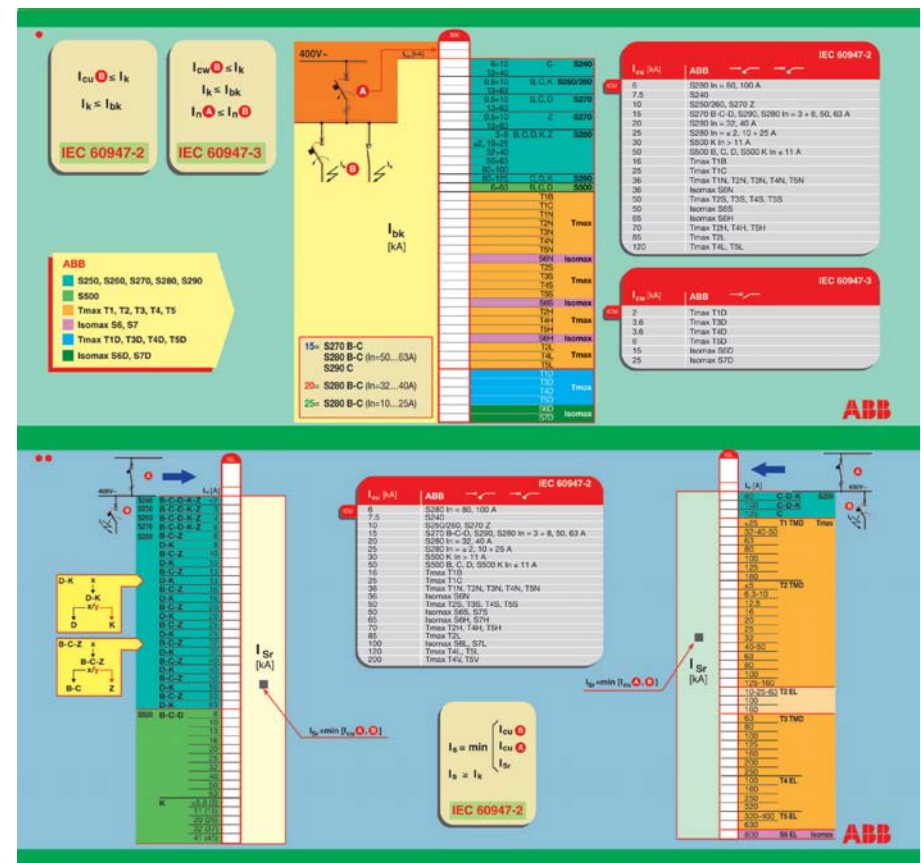

## Annex A: Calculation tools

### Blue slide rule: motor and transformer protection

Side ●

Selection and coordination of the protection devices for the motor starter, DOL start-up (type 2 coordination in compliance with the Standard IEC 60947-4-1).

Side ●●

Sizing of a transformer feeder.

In addition, a diagram for the calculation of the short-circuit current on the load side of transformers with known rated power.

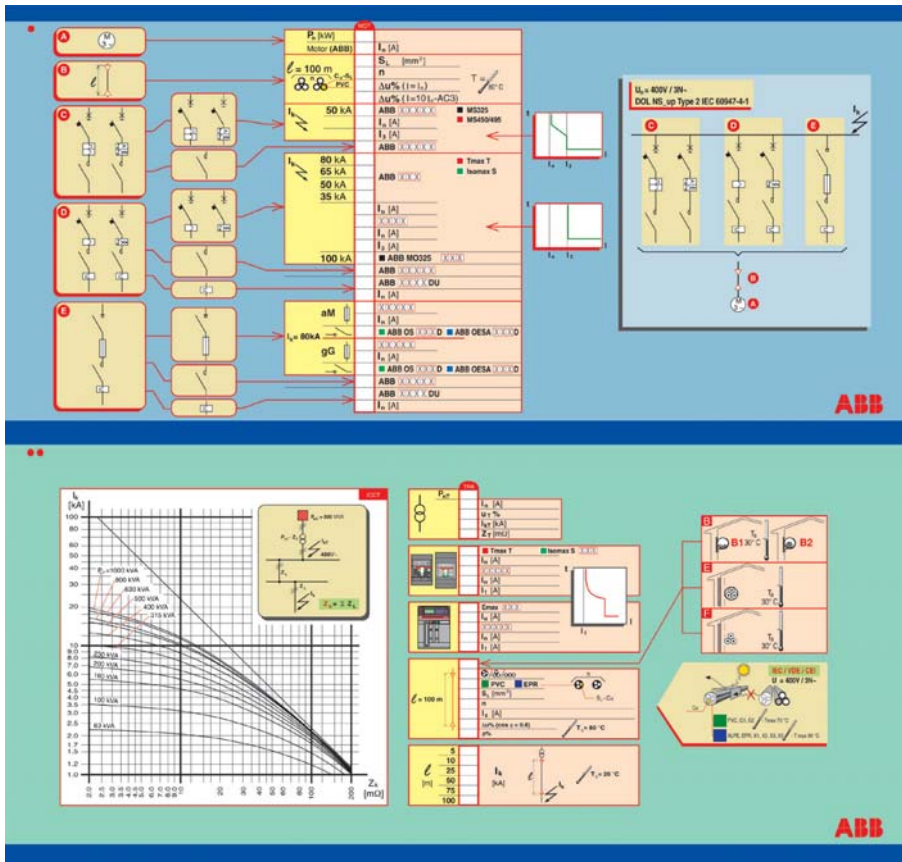

1SDC008062F0001

## Annex A: Calculation tools

### A.2 DOCWin

DOCWin is a software for the dimensioning of electrical networks, with low or medium voltage supply.

Networks can be completely calculated through simple operations starting from the definition of the single-line diagram and thanks to the drawing functions provided by an integrated CAD software.

### Drawing and definition of networks

Creation of the single-line diagram, with no limits to the network complexity. Meshed networks can also be managed.

- The diagram can be divided into many pages.
- The program controls the coherence of drawings in real time.
- It is possible to enter and modify the data of the objects which form the network by using a table.
- It is possible to define different network configurations by specifying the status (open/closed) of the operating and protective devices.

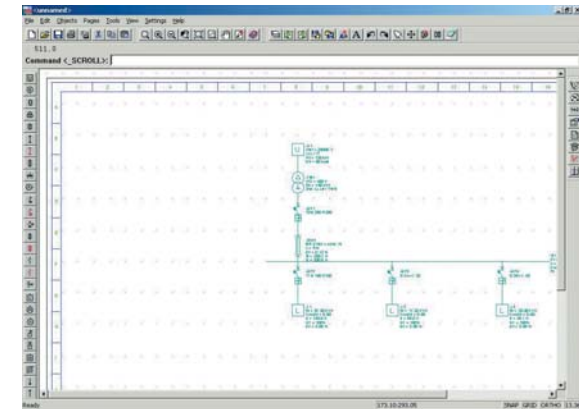

### Supplies

- There are no pre-defined limits: the software manages MV and LV power supplies and generators, MV/LV and LV/LV transformers, with two or three windings, with or without voltage regulator, according to the requirements.

### Network calculation

- Load Flow calculation using the Newton-Raphson method. The software can manage networks with multiple slacks and unbalances due to single- or two-phase loads. Magnitude and phase shift of the node voltage and of the branch current are completely defined for each point of the network, for both MV as well as LV.
- Calculation of the active and reactive power required by each single power source.

## Annex A: Calculation tools

- Management of local (motors) and centralized power factor correction with capacitor banks.
- Management of the demand factor for each single node of the network and of the utilization factor on the loads.
- Short-circuit current calculation for three-phase, phase-to-phase, phase-to-neutral, phase-to-ground faults. The calculation is also carried out for MV sections, in compliance with the Standards IEC 60909-1, IEC 61363-1 (naval installations) or with the method of symmetric components, taking into account also the time-variance contribution of rotary machines (generators and motors).
- Calculation of switchboard overtemperature in compliance with Standard IEC 60890. The power dissipated by the single apparatus is automatically derived by the data files of the software, and can be considered as a function of the rated current or of the load current.

### Cable line sizing

- Cable line sizing according to thermal criteria in compliance with the following Standards: CEI 64-8 (tables CEI UNEL 35024-35026), IEC 60364, VDE 298-4, NFC 15-100, IEC 60092 (naval installations) and IEC 60890.
- Possibility of setting, as additional calculation criterion, the economic criteria stated in the Standard IEC 60827-3-2.
- Possibility of setting, as additional calculation criterion, the maximum allowed voltage drop.
- Automatic sizing of busbar trunking system.
- Sizing and check on the dynamic withstand of busbars in compliance with the Standard IEC 60865.

### Curves and verifications

- Representation of:
  - time / current curves (I-t),
  - current / let-through energy curves (I-I<sup>2</sup>t),
  - current limiting curves (peak): visual check of the effects of the settings on the trip characteristics of protection devices.

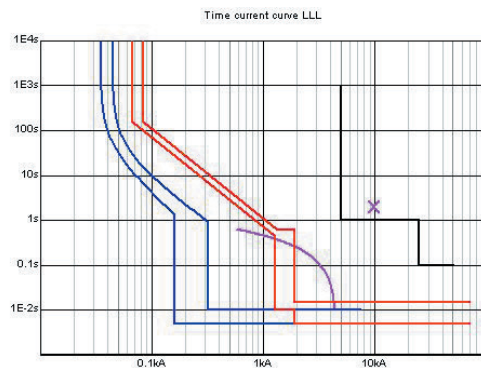

## Annex A: Calculation tools

- Representation of the curves of circuit-breakers, cables, transformers, motors and generators.
- Possibility of entering the curve of the utility and of the MV components point by point, to verify the tripping discrimination of protection devices.
- Verification of the maximum voltage drop at each load.
- Verification of the protection devices, with control over the setting parameters of the adjustable releases (both thermomagnetic as well as electronic).

### Selection of operating and protection devices

- Automatic selection of protection devices (circuit-breakers and fuses)
- Automatic selection of operating devices (contactors and switch disconnectors)
- Discrimination and back-up managed as selection criteria, with discrimination level adjustable for each circuit-breaker combination.

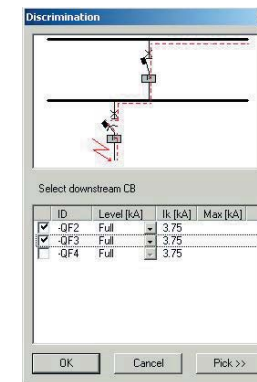

- Discrimination and back-up verification also through quick access to coordination tables.

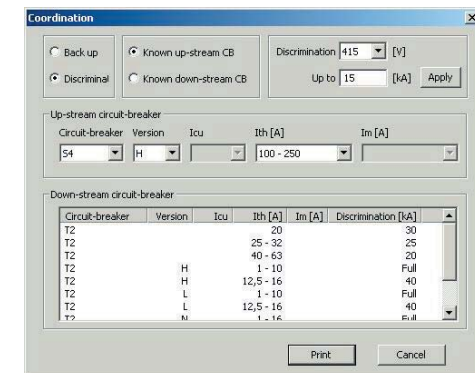

## Annex A: Calculation tools

- Motor coordination management through quick access to ABB tables.

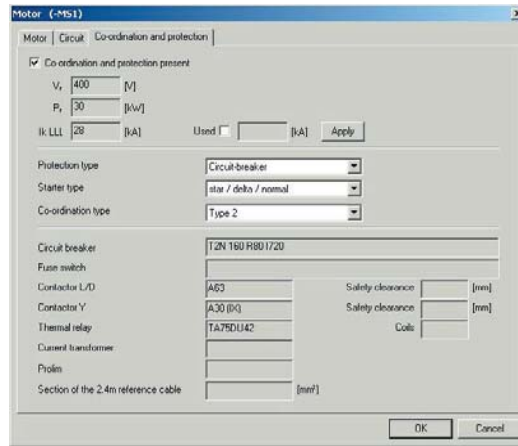

### Printouts

- Single-line diagram, curves and reports of the single components of the network can be printed by any printer supported by the hardware configuration.
- All information can be exported in the most common formats of data exchange.
- All print modes can be customized.

## Annex B: Calculation of load current $I_b$

### Generic loads

The formula for the calculation of the load current of a generic load is:

$$I_b = \frac{P}{k \cdot U_r \cdot \cos\varphi}$$

where:

- P is the active power [W];
- k is a coefficient which has the value:
  - 1 for single-phase systems or for direct current systems;
  - $\sqrt{3}$  for three-phase systems;
- $U_r$  is the rated voltage [V] (for three-phase systems it is the line voltage, for single-phase systems it is the phase voltage);
- $\cos\varphi$  is the power factor.

Table 1 allows the load current to be determined for some power values according to the rated voltage. The table has been calculated considering  $\cos\varphi$  to be equal to 0.9; for different power factors, the value from Table 1 must be multiplied by the coefficient given in Table 2 corresponding to the actual value of the power factor ( $\cos\varphi_{act}$ ).

**Table 1: Load current for three-phase systems with  $\cos\varphi = 0.9$**

P [kW]	$U_r$ [V]						
	230	400	415	440	500	600	690
0.03	0.08	0.05	0.05	0.04	0.04	0.03	0.03
0.04	0.11	0.06	0.06	0.06	0.05	0.04	0.04
0.06	0.17	0.10	0.09	0.09	0.08	0.06	0.06
0.1	0.28	0.16	0.15	0.15	0.13	0.11	0.09
0.2	0.56	0.32	0.31	0.29	0.26	0.21	0.19
0.5	1.39	0.80	0.77	0.73	0.64	0.53	0.46
1	2.79	1.60	1.55	1.46	1.28	1.07	0.93
2	5.58	3.21	3.09	2.92	2.57	2.14	1.86
5	13.95	8.02	7.73	7.29	6.42	5.35	4.65
10	27.89	16.04	15.46	14.58	12.83	10.69	9.30
20	55.78	32.08	30.92	29.16	25.66	21.38	18.59
30	83.67	48.11	46.37	43.74	38.49	32.08	27.89
40	111.57	64.15	61.83	58.32	51.32	42.77	37.19
50	139.46	80.19	77.29	72.90	64.15	53.46	46.49
60	167.35	96.23	92.75	87.48	76.98	64.15	55.78
70	195.24	112.26	108.20	102.06	89.81	74.84	65.08
80	223.13	128.30	123.66	116.64	102.64	85.53	74.38
90	251.02	144.34	139.12	131.22	115.47	96.23	83.67
100	278.91	160.38	154.58	145.80	128.30	106.92	92.97
110	306.80	176.41	170.04	160.38	141.13	117.61	102.27
120	334.70	192.45	185.49	174.95	153.96	128.30	111.57
130	362.59	208.49	200.95	189.53	166.79	138.99	120.86
140	390.48	224.53	216.41	204.11	179.62	149.68	130.16
150	418.37	240.56	231.87	218.69	192.45	160.38	139.46
200	557.83	320.75	309.16	291.59	256.60	213.83	185.94

Annex B: Calculation of load current I<sub>b</sub>

P [kW]	U <sub>r</sub> [V]						
	230	400	415	440	500	600	690
	I <sub>b</sub> [A]						
250	697.28	400.94	386.45	364.49	320.75	267.29	232.43
300	836.74	481.13	463.74	437.39	384.90	320.75	278.91
350	976.20	561.31	541.02	510.28	449.05	374.21	325.40
400	1115.65	641.50	618.31	583.18	513.20	427.67	371.88
450	1255.11	721.69	695.60	656.08	577.35	481.13	418.37
500	1394.57	801.88	772.89	728.98	641.50	534.58	464.86
550	1534.02	882.06	850.18	801.88	705.65	588.04	511.34
600	1673.48	962.25	927.47	874.77	769.80	641.50	557.83
650	1812.94	1042.44	1004.76	947.67	833.95	694.96	604.31
700	1952.39	1122.63	1082.05	1020.57	898.10	748.42	650.80
750	2091.85	1202.81	1159.34	1093.47	962.25	801.88	697.28
800	2231.31	1283.00	1236.63	1166.36	1026.40	855.33	743.77
850	2370.76	1363.19	1313.92	1239.26	1090.55	908.79	790.25
900	2510.22	1443.38	1391.21	1312.16	1154.70	962.25	836.74
950	2649.68	1523.56	1468.49	1385.06	1218.85	1015.71	883.23
1000	2789.13	1603.75	1545.78	1457.96	1283.00	1069.17	929.71

Table 2: Correction factors for load current with cosφ other than 0.9

cosφ <sub>act</sub>	1	0.95	0.9	0.85	0.8	0.75	0.7
k <sub>cosφ</sub> *	0.9	0.947	1	1.059	1.125	1.2	1.286

\* For cosφ<sub>act</sub> values not present in the table,  $k_{\cos\varphi} = \frac{0.9}{\cos\varphi_{act}}$

Table 3 allows the load current to be determined for some power values according to the rated voltage. The table has been calculated considering cosφ to be equal to 1; for different power factors, the value from Table 3 must be multiplied by the coefficient given in Table 4 corresponding to the actual value of the power factor (cosφ<sub>act</sub>).

Table 3: Load current for single-phase systems with cosφ = 1 or dc systems

P [kW]	U <sub>r</sub> [V]						
	230	400	415	440	500	600	690
	I <sub>b</sub> [A]						
0.03	0.13	0.08	0.07	0.07	0.06	0.05	0.04
0.04	0.17	0.10	0.10	0.09	0.08	0.07	0.06
0.06	0.26	0.15	0.14	0.14	0.12	0.10	0.09
0.1	0.43	0.25	0.24	0.23	0.20	0.17	0.14
0.2	0.87	0.50	0.48	0.45	0.40	0.33	0.29
0.5	2.17	1.25	1.20	1.14	1.00	0.83	0.72
1	4.35	2.50	2.41	2.27	2.00	1.67	1.45
2	8.70	5.00	4.82	4.55	4.00	3.33	2.90
5	21.74	12.50	12.05	11.36	10.00	8.33	7.25
10	43.48	25.00	24.10	22.73	20.00	16.67	14.49
20	86.96	50.00	48.19	45.45	40.00	33.33	28.99

Annex B: Calculation of load current I<sub>b</sub>

P [kW]	U <sub>r</sub> [V]						
	230	400	415	440	500	600	690
	I <sub>b</sub> [A]						
30	130.43	75.00	72.29	68.18	60.00	50.00	43.48
40	173.91	100.00	96.39	90.91	80.00	66.67	57.97
50	217.39	125.00	120.48	113.64	100.00	83.33	72.46
60	260.87	150.00	144.58	136.36	120.00	100.00	86.96
70	304.35	175.00	168.67	159.09	140.00	116.67	101.45
80	347.83	200.00	192.77	181.82	160.00	133.33	115.94
90	391.30	225.00	216.87	204.55	180.00	150.00	130.43
100	434.78	250.00	240.96	227.27	200.00	166.67	144.93
110	478.26	275.00	265.06	250.00	220.00	183.33	159.42
120	521.74	300.00	289.16	272.73	240.00	200.00	173.91
130	565.22	325.00	313.25	295.45	260.00	216.67	188.41
140	608.70	350.00	337.35	318.18	280.00	233.33	202.90
150	652.17	375.00	361.45	340.91	300.00	250.00	217.39
200	869.57	500.00	481.93	454.55	400.00	333.33	289.86
250	1086.96	625.00	602.41	568.18	500.00	416.67	362.32
300	1304.35	750.00	722.89	681.82	600.00	500.00	434.78
350	1521.74	875.00	843.37	795.45	700.00	583.33	507.25
400	1739.13	1000.00	963.86	909.09	800.00	666.67	579.71
450	1956.52	1125.00	1084.34	1022.73	900.00	750.00	652.17
500	2173.91	1250.00	1204.82	1136.36	1000.00	833.33	724.64
550	2391.30	1375.00	1325.30	1250.00	1100.00	916.67	797.10
600	2608.70	1500.00	1445.78	1363.64	1200.00	1000.00	869.57
650	2826.09	1625.00	1566.27	1477.27	1300.00	1083.33	942.03
700	3043.48	1750.00	1686.75	1590.91	1400.00	1166.67	1014.49
750	3260.87	1875.00	1807.23	1704.55	1500.00	1250.00	1086.96
800	3478.26	2000.00	1927.71	1818.18	1600.00	1333.33	1159.42
850	3695.65	2125.00	2048.19	1931.82	1700.00	1416.67	1231.88
900	3913.04	2250.00	2168.67	2045.45	1800.00	1500.00	1304.35
950	4130.43	2375.00	2289.16	2159.09	1900.00	1583.33	1376.81
1000	4347.83	2500.00	2409.64	2272.73	2000.00	1666.67	1449.28

Table 4: Correction factors for load current with cosφ other than 1

cosφ <sub>act</sub>	1	0.95	0.9	0.85	0.8	0.75	0.7
k <sub>cosφ</sub> *	1	1.053	1.111	1.176	1.25	1.333	1.429

\* For cosφ<sub>act</sub> values not present in the table,  $k_{\cos\varphi} = \frac{1}{\cos\varphi_{act}}$

## Lighting circuits

The current absorbed by the lighting system may be deduced from the lighting equipment catalogue, or approximately calculated using the following formula:

$$I_b = \frac{P_L n_L k_B k_N}{U_{rL} \cos\varphi}$$

where:

- P<sub>L</sub> is the power of the lamp [W];
- n<sub>L</sub> is the number of lamps per phase;
- k<sub>B</sub> is a coefficient which has the value:
  - 1 for lamps which do not need any auxiliary starter;
  - 1.25 for lamps which need auxiliary starters;
- k<sub>N</sub> is a coefficient which has the value:
  - 1 for star-connected lamps;
  - √3 for delta-connected lamps;
- U<sub>rL</sub> is the rated voltage of the lamps;
- cosφ is the power factor of the lamps which has the value:
  - 0.4 for lamps without compensation;
  - 0.9 for lamps with compensation.

## Annex B: Calculation of load current I<sub>b</sub>

### Motors

Table 5 gives the approximate values of the load current for some three-phase squirrel-cage motors, 1500 rpm at 50 Hz, according to the rated voltage.

Note: these values are given for information only, and may vary according to the motor manufacturer and depending on the number of poles

**Table 5: Motor load current**

Motor power		Rated current of the motor at:								
[kW]	PS = hp	220-230 V [A]	240 V [A]	380-400 V [A]	415 V [A]	440 V [A]	500 V [A]	600 V [A]	660-690 V [A]	
0.06	1/12	0.38	0.35	0.22	0.20	0.19	0.16	0.12	-	
0.09	1/8	0.55	0.50	0.33	0.30	0.28	0.24	0.21	-	
0.12	1/6	0.76	0.68	0.42	0.40	0.37	0.33	0.27	-	
0.18	1/4	1.1	1	0.64	0.60	0.55	0.46	0.40	-	
0.25	1/3	1.4	1.38	0.88	0.85	0.76	0.59	0.56	-	
0.37	1/2	2.1	1.93	1.22	1.15	1.06	0.85	0.77	0.7	
0.55	3/4	2.7	2.3	1.5	1.40	1.25	1.20	1.02	0.9	
0.75	1	3.3	3.1	2	2	1.67	1.48	1.22	1.1	
1.1	1.5	4.9	4.1	2.6	2.5	2.26	2.1	1.66	1.5	
1.5	2	6.2	5.6	3.5	3.5	3.03	2.6	2.22	2	
2.2	3	8.7	7.9	5	5	4.31	3.8	3.16	2.9	
2.5	3.4	9.8	8.9	5.7	5.5	4.9	4.3	3.59	3.3	
3	4	11.6	10.6	6.6	6.5	5.8	5.1	4.25	3.5	
3.7	5	14.2	13	8.2	7.5	7.1	6.2	5.2	4.4	
4	5.5	15.3	14	8.5	8.4	7.6	6.5	5.6	4.9	
5	6.8	18.9	17.2	10.5	10	9.4	8.1	6.9	6	
5.5	7.5	20.6	18.9	11.5	11	10.3	8.9	7.5	6.7	
6.5	8.8	23.7	21.8	13.8	12.5	12	10.4	8.7	8.1	
7.5	10	27.4	24.8	15.5	14	13.5	11.9	9.9	9	
8	11	28.8	26.4	16.7	15.4	14.4	12.7	10.6	9.7	
9	12.5	32	29.3	18.3	17	15.8	13.9	11.6	10.6	
11	15	39.2	35.3	22	21	19.3	16.7	14.1	13	
12.5	17	43.8	40.2	25	23	21.9	19	16.1	15	
15	20	52.6	48.2	30	28	26.3	22.5	19.3	17.5	
18.5	25	64.9	58.7	37	35	32	28.5	23.5	21	
20	27	69.3	63.4	40	37	34.6	30.6	25.4	23	
22	30	75.2	68	44	40	37.1	33	27.2	25	
25	34	84.4	77.2	50	47	42.1	38	30.9	28	
30	40	101	92.7	60	55	50.1	44	37.1	33	
37	50	124	114	72	66	61.9	54	45.4	42	
40	54	134	123	79	72	67	60	49.1	44	
45	60	150	136	85	80	73.9	64.5	54.2	49	
51	70	168	154	97	90	83.8	73.7	61.4	56	
55	75	181	166	105	96	90.3	79	66.2	60	
59	80	194	178	112	105	96.9	85.3	71.1	66	
75	100	245	226	140	135	123	106	90.3	82	
80	110	260	241	147	138	131	112	96.3	86	
90	125	292	268	170	165	146	128	107	98	
100	136	325	297	188	182	162	143	119	107	
110	150	358	327	205	200	178	156	131	118	
129	175	420	384	242	230	209	184	153	135	
132	180	425	393	245	242	214	186	157	140	
140	190	449	416	260	250	227	200	167	145	
147	200	472	432	273	260	236	207	173	152	
160	220	502	471	295	280	256	220	188	170	
180	245	578	530	333	320	289	254	212	190	
184	250	590	541	340	325	295	259	217	200	
200	270	626	589	370	340	321	278	235	215	
220	300	700	647	408	385	353	310	260	235	
250	340	803	736	460	425	401	353	295	268	
257	350	826	756	475	450	412	363	302	280	
295	400	948	868	546	500	473	416	348	320	
315	430	990	927	580	535	505	445	370	337	
355	480	1080	1010	636	580	549	483	405	366	
400	545	1250	1130	710	650	611	538	450	410	
450	610	1410	1270	800	740	688	608	508	460	
475	645	1490	1340	850	780	730	645	540	485	
500	680	1570	1420	890	830	770	680	565	510	
560	760	1750	1580	1000	920	860	760	630	570	
600	810	-	-	1080	990	920	810	680	610	
670	910	-	-	1200	1100	1030	910	760	680	

## Annex C: Calculation of short-circuit current

A short-circuit is a fault of negligible impedance between live conductors having a difference in potential under normal operating conditions.

### Fault typologies

In a three-phase circuit the following types of fault may occur:

- three-phase fault;
- two-phase fault;
- phase to neutral fault;
- phase to PE fault.

In the formulas, the following symbols are used:

- I<sub>k</sub> short-circuit current;
- U<sub>r</sub> rated voltage;
- Z<sub>L</sub> phase conductor impedance;
- Z<sub>N</sub> neutral conductor impedance;
- Z<sub>PE</sub> protective conductor impedance.

The following table briefly shows the type of fault and the relationships between the value of the short-circuit current for a symmetrical fault (three phase) and the short-circuit current for asymmetrical faults (two phase and single phase) in case of faults far from generators. For more accurate calculation, the use of DOCWin software is recommended.

### Three-phase fault

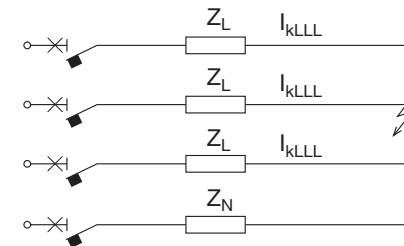

$$Z_c = \sqrt{R_c^2 + X_c^2}$$

### Two-phase fault

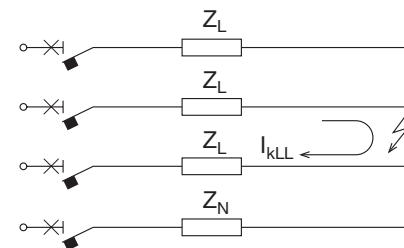

$$I_{kLL} = \frac{U_r}{2Z_L} = \frac{\sqrt{3}}{2} I_{kLLL} = 0.87 I_{kLLL}$$

## Annex C: Calculation of short-circuit current

### Phase to neutral fault

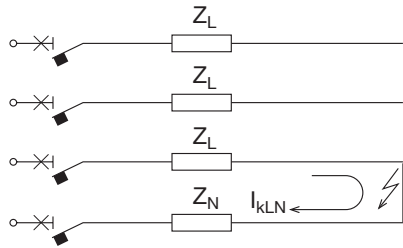

$$I_{kLN} = \frac{U_r}{\sqrt{3}(Z_L + Z_N)}$$

If  $Z_L = Z_N$  (cross section of neutral conductor equal to the phase conductor one):

$$I_{kLN} = \frac{U_r}{\sqrt{3}(Z_L + Z_N)} = \frac{U_r}{\sqrt{3}(2Z_L)} = 0.5 I_{kLLL}$$

If  $Z_N = 2Z_L$  (cross section of neutral conductor half the phase conductor one):

$$I_{kLN} = \frac{U_r}{\sqrt{3}(Z_L + Z_N)} = \frac{U_r}{\sqrt{3}(3Z_L)} = 0.33 I_{kLLL}$$

If  $Z_N = 0$  limit condition:

$$I_{kLN} = \frac{U_r}{\sqrt{3}(Z_L + Z_N)} = \frac{U_r}{\sqrt{3}(Z_L)} = I_{kLLL}$$

### Phase to PE fault

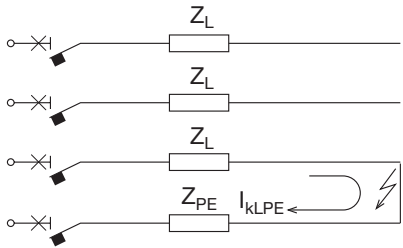

$$I_{kLPE} = \frac{U_r}{\sqrt{3}(Z_L + Z_{PE})}$$

If  $Z_L = Z_{PE}$  (cross section of protective conductor equal to the phase conductor one):

$$I_{kLPE} = \frac{U_r}{\sqrt{3}(Z_L + Z_{PE})} = \frac{U_r}{\sqrt{3}(2Z_L)} = 0.5 I_{kLLL}$$

If  $Z_{PE} = 2Z_L$  (cross section of protective conductor half to the phase conductor one):

$$I_{kLPE} = \frac{U_r}{\sqrt{3}(Z_L + Z_{PE})} = \frac{U_r}{\sqrt{3}(3Z_L)} = 0.33 I_{kLLL}$$

If  $Z_{PE} = 0$  limit condition:

$$I_{kLPE} = \frac{U_r}{\sqrt{3}(Z_L + Z_{PE})} = \frac{U_r}{\sqrt{3}(Z_L)} = I_{kLLL}$$

The following table allows the approximate value of a short-circuit current to be found quickly.

Note	Three-phase short-circuit	Two-phase short-circuit	Phase to neutral short-circuit	Phase to PE short-circuit (TN system)
$I_{kLLL}$	$I_{kLLL}$	$I_{kLL} = 0.87 I_{kLLL}$	$I_{kLN} = 0.5 I_{kLLL} (Z_L = Z_N)$ $I_{kLN} = 0.33 I_{kLLL} (Z_L = 0.5 Z_N)$ $I_{kLN} = I_{kLLL} (Z_N = 0)$	$I_{kLPE} = 0.5 I_{kLLL} (Z_L = Z_{PE})$ $I_{kLPE} = 0.33 I_{kLLL} (Z_L = 0.5 Z_{PE})$ $I_{kLPE} = I_{kLLL} (Z_{PE} = 0)$
$I_{kLL}$	$I_{kLLL} = 1.16 I_{kLL}$	-	$I_{kLN} = 0.58 I_{kLL} (Z_L = Z_N)$ $I_{kLN} = 0.38 I_{kLL} (Z_L = 0.5 Z_N)$ $I_{kLN} = 1.16 I_{kLL} (Z_N = 0)$	$I_{kLPE} = 0.58 I_{kLL} (Z_L = Z_{PE})$ $I_{kLPE} = 0.38 I_{kLL} (Z_L = 0.5 Z_{PE})$ $I_{kLPE} = 1.16 I_{kLL} (Z_{PE} = 0)$
$I_{kLN}$	$I_{kLLL} = 2 I_{kLN} (Z_L = Z_N)$ $I_{kLLL} = 3 I_{kLN} (Z_L = 2 Z_N)$ $I_{kLLL} = I_{kLN} (Z_N = 0)$	$I_{kLL} = 1.73 I_{kLN} (Z_L = Z_N)$ $I_{kLL} = 2.6 I_{kLN} (Z_L = 2 Z_N)$ $I_{kLL} = 0.87 I_{kLN} (Z_N = 0)$	-	-

## Annex C: Calculation of short-circuit current

### Determination of the short-circuit current

In order to determine the short-circuit current the “short-circuit power method” can be used. This method allows the determination of the approximate short-circuit current at a point in an installation in a simple way; the resultant value is generally acceptable. However, this method is not conservative and gives more accurate values, the more similar the power factors of the considered components are (network, generators, transformers, motors and large section cables etc.).

For more accurate calculation, the use of DOCWin software for the dimensioning of installations is recommended.

The “short-circuit power method” calculates the short-circuit current  $I_k$  based on the formula:

Three-phase short-circuit 
$$I_k = \frac{S_k}{\sqrt{3} \cdot U_r}$$

Two-phase short-circuit 
$$I_k = \frac{S_k}{2 \cdot U_r}$$

where:

- $S_k$  is the short-circuit apparent power seen at the point of the fault;
- $U_r$  is the rated voltage.

To determine the short-circuit apparent power  $S_k$ , all the elements of the network shall be taken into account, which may be:

- elements which contribute to the short-circuit current: network, generators, motors;
- elements which limit the value of the short-circuit current: conductors and transformers.

The procedure for the calculation of the short-circuit current involves the following steps:

1. calculation of the short-circuit power for the different elements of the installation;
2. calculation of the short-circuit power at the fault point;
3. calculation of the short-circuit current.

### Calculation of the short-circuit power for the different elements of the installation

The short-circuit apparent power  $S_k$  shall be determined for all the components which are part of the installation:

### Network

An electrical network is considered to include everything upstream of the point of energy supply.

## Annex C: Calculation of short-circuit current

Generally, the energy distribution authority supplies the short-circuit apparent power ( $S_{knet}$ ) value at the point of energy supply. However, if the value of the short-circuit current  $I_{knet}$  is known, the value of the power can be obtained by using, for three-phase systems, the following formula:

$$S_{knet} = \sqrt{3} U_r I_{knet}$$

where  $U_r$  is the rated voltage at the point of energy supply.

If the aforementioned data are not available, the values for  $S_{knet}$  given in the following table can be taken as reference values:

Net voltage $U_r$ [kV]	Short-circuit power $S_{knet}$ [MVA]
$U_p$ to 20	500
$U_p$ to 32	750
$U_p$ to 63	1000

### Generator

The short-circuit power is obtained from:

$$S_{kgen} = \frac{S_r \cdot 100}{X_{d\%}}$$

where  $X_{d\%}$  is the percentage value of the subtransient reactance ( $X_{d''}$ ) or of the transient reactance ( $X_{d'}$ ) or of the synchronous reactance ( $X_d$ ), according to the instant in which the value of the short-circuit power is to be evaluated.

In general, the reactances are expressed in percentages of the rated impedance of the generator ( $Z_d$ ) given by:

$$Z_d = \frac{U_r^2}{S_r}$$

where  $U_r$  and  $S_r$  are the rated voltage and power of the generator.

Typical values can be:

- $X_{d''}$  from 10 % to 20 %;
- $X_{d'}$  from 15 % to 40 %;
- $X_d$  from 80 % to 300 %.

Normally, the worst case is considered, that being the subtransient reactance. The following table gives the approximate values of the short-circuit power of generators ( $X_{d''} = 12.5\%$ ):

$S_r$ [kVA]	50	63	125	160	200	250	320	400	500	630	800	1000	1250	1600	2000	2500	3200	4000
$S_{kgen}$ [MVA]	0.4	0.5	1.0	1.3	1.6	2.0	2.6	3.2	4.0	5.0	6.4	8.0	10.0	12.8	16.0	20.0	25.6	32.0

## Annex C: Calculation of short-circuit current

### Asynchronous three-phase motors

Under short-circuit conditions, electric motors contribute to the fault for a brief period (5-6 periods).

The power can be calculated according to the short-circuit current of the motor ( $I_k$ ), by using the following expression:

$$S_{kmot} = \sqrt{3} \cdot U_r \cdot I_k$$

Typical values are:

$$S_{kmot} = 5 \div 7 S_{rmot}$$

( $I_k$  is about  $5 \div 7 I_{rmot}$ : 5 for motors of small size, and 7 for larger motors).

### Transformers

The short-circuit power of a transformer ( $S_{ktrafo}$ ) can be calculated by using the following formula:

$$S_{ktrafo} = \frac{100}{u_k \%} \cdot S_r$$

The following table gives the approximate values of the short-circuit power of transformers:

$S_r$ [kVA]	50	63	125	160	200	250	320	400	500	630	800	1000	1250	1600	2000	2500	3200	4000
$u_k$ %	4	4	4	4	4	4	4	4	4	4	5	5	5	6	6	6	6	6
$S_{ktrafo}$ [MVA]	1.3	1.6	3.1	4	5	6.3	8	10	12.5	15.8	16	20	25	26.7	33.3			

### Cables

A good approximation of the short-circuit power of cables is:

$$S_{kcable} = \frac{U_r^2}{Z_c}$$

where the impedance of the cable ( $Z_c$ ) is:

$$Z_c = \sqrt{R_c^2 + X_c^2}$$

The following table gives the approximate values of the short-circuit power of cables, at 50 and 60 Hz, according to the supply voltage (cable length = 10 m):



## Annex C: Calculation of short-circuit current

S [mm <sup>2</sup> ]	S <sub>k,cable</sub> [MVA] @50 Hz					S <sub>k,cable</sub> [MVA] @60 Hz				
	230 [V]	400 [V]	440 [V]	500 [V]	690 [V]	230 [V]	400 [V]	440 [V]	500 [V]	690 [V]
1.5	0.44	1.32	1.60	2.07	3.94	0.44	1.32	1.60	2.07	3.94
2.5	0.73	2.20	2.66	3.44	6.55	0.73	2.20	2.66	3.44	6.55
4	1.16	3.52	4.26	5.50	10.47	1.16	3.52	4.26	5.50	10.47
6	1.75	5.29	6.40	8.26	15.74	1.75	5.29	6.40	8.26	15.73
10	2.9	8.8	10.6	13.8	26.2	2.9	8.8	10.6	13.7	26.2
16	4.6	14.0	16.9	21.8	41.5	4.6	13.9	16.9	21.8	41.5
25	7.2	21.9	26.5	34.2	65.2	7.2	21.9	26.4	34.1	65.0
35	10.0	30.2	36.6	47.3	90.0	10.0	30.1	36.4	47.0	89.6
50	13.4	40.6	49.1	63.4	120.8	13.3	40.2	48.7	62.9	119.8
70	19.1	57.6	69.8	90.1	171.5	18.8	56.7	68.7	88.7	168.8
95	25.5	77.2	93.4	120.6	229.7	24.8	75.0	90.7	117.2	223.1
120	31.2	94.2	114.0	147.3	280.4	29.9	90.5	109.5	141.5	269.4
150	36.2	109.6	132.6	171.2	326.0	34.3	103.8	125.6	162.2	308.8
185	42.5	128.5	155.5	200.8	382.3	39.5	119.5	144.6	186.7	355.6
240	49.1	148.4	179.5	231.8	441.5	44.5	134.7	163.0	210.4	400.7
300	54.2	164.0	198.4	256.2	488.0	48.3	146.1	176.8	228.3	434.7

With *n* cables in parallel, it is necessary to multiply the value given in the table by *n*. If the length of the cable (*L<sub>act</sub>*) is other than 10 m, it is necessary to multiply the value given in the table by the following coefficient:

$$\frac{10}{L_{act}}$$

### Calculation of the short-circuit power at the fault point

The rule for the determination of the short-circuit power at a point in the installation, according to the short-circuit power of the various elements of the circuit, is analogue to that relevant to the calculation of the equivalent admittance. In particular:

- the power of elements in series is equal to the inverse of the sum of the inverses of the single powers (as for the parallel of impedances);

$$S_k = \frac{1}{\sum \frac{1}{S_i}}$$

- the short-circuit power of elements in parallel is equal to the sum of the single short-circuit powers (as for the series of impedances).

$$S_k = \sum S_i$$

The elements of the circuit are considered to be in series or parallel, seeing the circuit from the fault point.

In the case of different branches in parallel, the distribution of the current between the different branches shall be calculated once the short-circuit current at the fault point has been calculated. This must be done to ensure the correct choice of protection devices installed in the branches.

## Annex C: Calculation of short-circuit current

### Calculation of the short-circuit current

To determine the short-circuit current in an installation, both the fault point as well as the configuration of the system which maximize the short-circuit current involving the device shall be considered. If appropriate, the contribution of the motors shall be taken into account.

For example, in the case detailed below, for circuit-breaker CB1, the worst condition occurs when the fault is right upstream of the circuit-breaker itself. To determine the breaking capacity of the circuit-breaker, the contribution of two transformers in parallel must be considered.

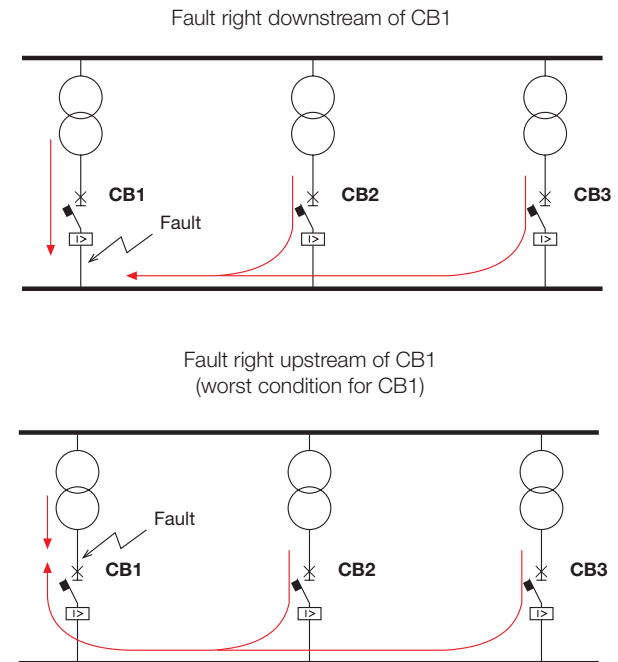

Once the short-circuit power equivalent at the fault point has been determined, the short-circuit current can be calculated by using the following formula:

Three-phase short-circuit  $I_k = \frac{S_k}{\sqrt{3} \cdot U_r}$

Two-phase short-circuit  $I_k = \frac{S_k}{2 \cdot U_r}$

## Annex C: Calculation of short-circuit current

As a first approximation, by using the following graph, it is possible to evaluate the three-phase short-circuit current downstream of an object with short-circuit power ( $S_{kEL}$ ) known; corresponding to this value, knowing the short-circuit power upstream of the object ( $S_{kUP}$ ), the value of  $I_k$  can be read on the y-axis, expressed in kA, at 400 V.

**Figure 1: Chart for the calculation of the three-phase short-circuit current at 400 V**

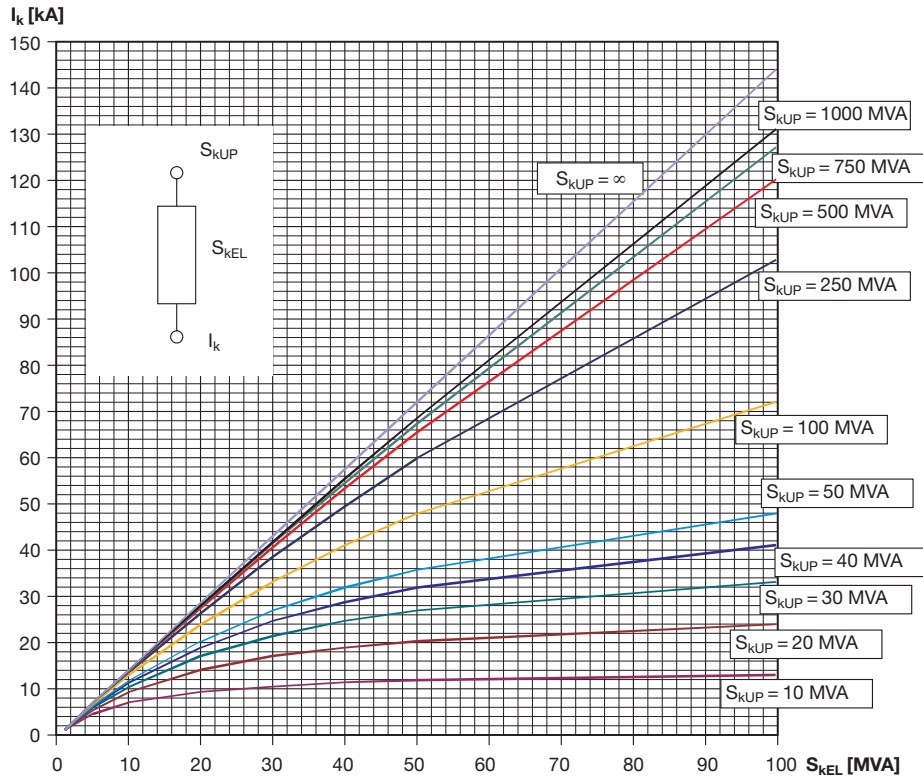

## Annex C: Calculation of short-circuit current

### Examples:

The following examples demonstrate the calculation of the short-circuit current in some different types of installation.

#### Example 1

Upstream network:  $U_r = 20000\text{ V}$   
 $S_{knet} = 500\text{ MVA}$

Transformer:  $S_r = 1600\text{ kVA}$   
 $u_k\% = 6\%$   
 $U_{1r} / U_{2r} = 20000 / 400$

Motor:  $P_r = 220\text{ kW}$   
 $I_{kmot}/I_r = 6.6$   
 $\cos\phi_r = 0.9$   
 $\eta = 0.917$

Generic load:  $I_{rL} = 1443.4\text{ A}$   
 $\cos\phi_r = 0.9$

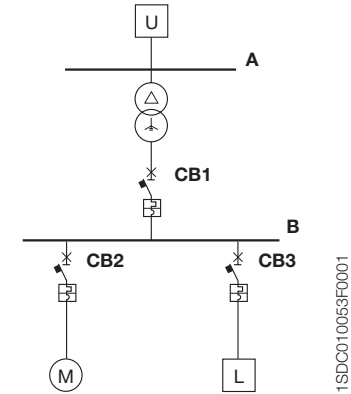

#### Calculation of the short-circuit power of different elements

Network:  $S_{knet} = 500\text{ MVA}$

Transformer:  $S_{ktrafo} = \frac{100}{u_k\%} \cdot S_r = 26.7\text{ MVA}$

Motor:  $S_{rmot} = \frac{P_r}{\eta \cdot \cos\phi_r} = 267\text{ kVA}$

$S_{kmot} = 6.6 \cdot S_{rmot} = 1.76\text{ MVA}$  for the first 5-6 periods (at 50 Hz about 100 ms)

#### Calculation of the short-circuit current for the selection of circuit-breakers

##### Selection of CB1

For circuit-breaker CB1, the worst condition arises when the fault occurs right downstream of the circuit-breaker itself. In the case of a fault right upstream, the circuit-breaker would be involved only by the fault current flowing from the motor, which is remarkably smaller than the network contribution.

## Annex C: Calculation of short-circuit current

The circuit, seen from the fault point, is represented by the series of the network with the transformer. According to the previous rules, the short-circuit power is determined by using the following formula:

$$S_{kCB1} = \frac{S_{knet} \cdot S_{ktrafo}}{S_{knet} + S_{ktrafo}} = 25.35 \text{ MVA}$$

the maximum fault current is:

$$I_{kCB1} = \frac{S_{kCB1}}{\sqrt{3} \cdot U_r} = 36.6 \text{ kA}$$

The transformer LV side rated current is equal to 2309 A; therefore the circuit-breaker to select is an Emax E3N 2500.

Using the chart shown in Figure 1, it is possible to find  $I_{kCB1}$  from the curve with  $S_{kUP} = S_{knet} = 500 \text{ MVA}$  corresponding to  $S_{kEL} = S_{ktrafo} = 26.7 \text{ MVA}$ :

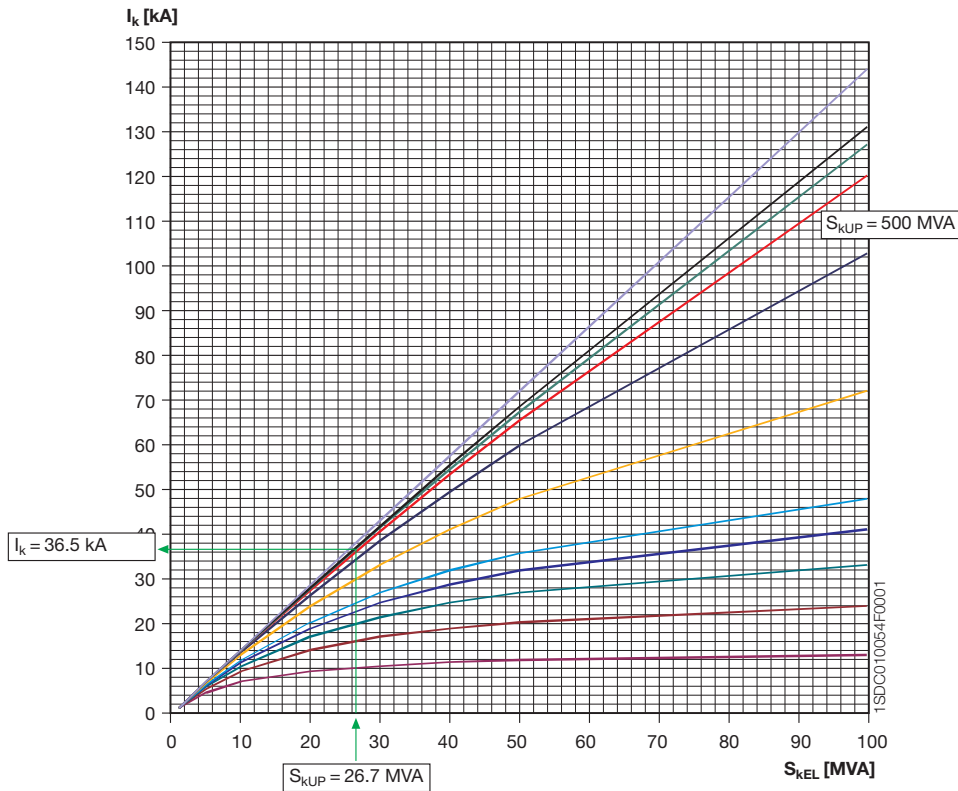

## Annex C: Calculation of short-circuit current

### Selection of CB2

For circuit-breaker CB2, the worst condition arises when the fault occurs right downstream of the circuit-breaker itself. The circuit, seen from the fault point, is represented by the series of the network with the transformer. The short-circuit current is the same used for CB1.

$$I_{kCB1} = \frac{S_{kCB1}}{\sqrt{3} \cdot U_r} = 36.6 \text{ kA}$$

The rated current of the motor is equal to 385 A; the circuit-breaker to select is a Tmax T5H 400.

### Selection of CB3

For CB3 too, the worst condition arises when the fault occurs right downstream of the circuit-breaker itself.

The circuit, seen from the fault point, is represented by two branches in parallel: the motor and the series of the network and transformer. According to the previous rules, the short-circuit power is determined by using the following formula:

Motor // (Network + Transformer)

$$S_{kCB3} = S_{kmot} + \frac{1}{\frac{1}{S_{knet}} + \frac{1}{S_{ktrafo}}} = 27.11 \text{ MVA}$$

$$I_{kCB3} = \frac{S_{kCB3}}{\sqrt{3} \cdot U_r} = 39.13 \text{ kA}$$

The rated current of the load L is equal to 1443 A; the circuit-breaker to select is a SACE Isomax S7S 1600, or an Emax E2N1600.

### Example 2

The circuit shown in the diagram is constituted by the supply, two transformers in parallel and three loads.

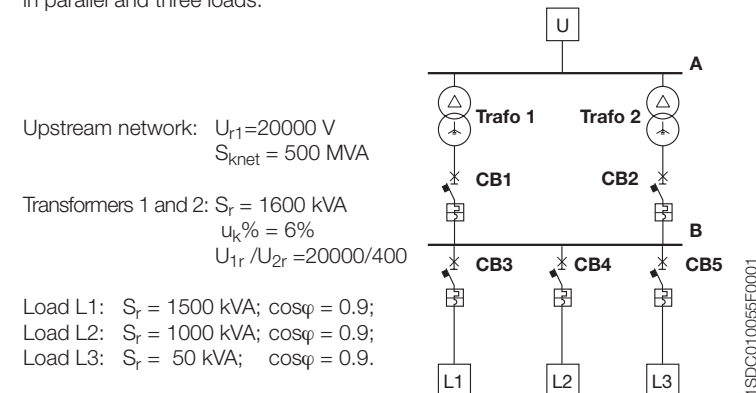

## Annex C: Calculation of short-circuit current

Calculation of the short-circuit powers of different elements:

Network  $S_{knet} = 500 \text{ MVA}$

Transformers 1 and 2  $S_{ktrafo} = \frac{S_r}{U_k \%} \cdot 100 = 26.7 \text{ MVA}$

### Selection of CB1 (CB2)

For circuit-breaker CB1 (CB2) the worst condition arises when the fault occurs right downstream of the circuit-breaker itself. According to the previous rules, the circuit seen from the fault point, is equivalent to the parallel of the two transformers in series with the network: Network + (Trafo 1 // Trafo 2). The short-circuit current obtained in this way corresponds to the short-circuit current at the busbar. This current, given the symmetry of the circuit, is distributed equally between the two branches (half each). The current which flows through CB1 (CB2) is therefore equal to half of that at the busbar.

$$S_{kbusbar} = \frac{S_{knet} \cdot (S_{trafo1} + S_{trafo2})}{S_{knet} + (S_{trafo1} + S_{trafo2})} = 48.2 \text{ MVA}$$

$$I_{kbusbar} = \frac{S_{kbusbar}}{\sqrt{3} \cdot U_r} = 69.56 \text{ kA}$$

$$I_{kCB1(2)} = \frac{I_{kbusbar}}{2} = 34.78 \text{ kA}$$

The circuit-breakers CB1(CB2) to select, with reference to the rated current of the transformers, are Emax E3N 2500.

### Selection of CB3-CB4-CB5

For these circuit-breakers the worst condition arises when the fault occurs right downstream of the circuit-breakers themselves. Therefore, the short-circuit current to be taken into account is that at the busbar:

$$I_{kCB3} = I_{kbusbar} = 69.56 \text{ kA}$$

The circuit-breakers to select, with reference to the current of the loads, are:  
 CB3: Emax E3S 2500  
 CB4: Emax E3S 1600  
 CB5: Tmax T2H 160

## Annex C: Calculation of short-circuit current

### Determination of the short-circuit current $I_k$ downstream of a cable as a function of the upstream one

The table below allows the determination, in a conservative way, of the three-phase short-circuit current at a point in a 400 V network downstream of a single pole copper cable at a temperature of 20 °C. Known values:  
 - the three-phase short-circuit current upstream of the cable;  
 - the length and cross section of the cable.

Cable section [mm <sup>2</sup> ]	Length [m]																																			
1.5																																				
2.5																																				
4	0.9	1.2	1.4	1.6	1.9	2.3	2.8	3.7	4.7	6.6	9.4	14	19	25	38																					
6				0.8	1.1	1.4	1.8	2.1	2.5	2.8	3.5	4.2	5.6	7	10	14	21	28	38	56																
10						0.9	1.2	1.4	1.9	2.3	2.9	3.5	4.1	4.7	5.8	7	9.4	12	16	23	35	47	63	94												
16								0.9	1.1	1.5	1.9	2.2	3	3.7	4.7	5.6	6.5	7.5	9.3	11	15	19	26	37	56	75	100	150								
25			0.9	1.2	1.4	1.7	2.3	2.9	3.5	4.6	5.8	7.2	8.7	10	12	14	17	23	29	41	58	87	116	155	233											
35				1.2	1.6	2	2.4	3.2	4	4.8	6.4	8	10	12	14	16	20	24	32	40	56	80	121	161	216	324										
50					1.1	1.7	2.3	2.8	3.4	4.5	5.7	6.8	9	11	14	17	20	23	28	34	45	57	79	113	170	226	303	455								
70						0.8	1.5	2.3	3.1	3.8	4.6	6.2	7.7	9.2	12	15	19	23	27	31	38	46	62	77	108	154	231	308	413							
95							1	2	3	4	5	6	8	10	12	16	20	25	30	35	40	50	60	80	100	140	200	300	400							
120								1.2	2.4	3.6	4.8	6	7.2	10	12	14	19	24	30	36	42	48	60	72	96	120	168	240	360	481						
150									1.4	2.8	4.2	5.6	7	8.4	11	14	17	23	28	35	42	49	56	70	84	113	141	197	281	422						
185										1.6	3.2	4.8	6.4	8	10	13	16	19	26	32	40	48	56	64	80	96	128	160	224	320	480					
240											1.8	3.7	5.5	7.3	9.1	11	15	18	22	29	37	46	55	64	73	91	110	146	183	256	366	549				
300												2	4	6	8	10	12	16	20	24	32	40	50	60	70	80	100	120	160	200	280	400				
2x120													2.4	4.8	7.2	10	12	14	19	24	29	38	48	60	72	84	96	120	144	192	240	336	481			
2x150														2.8	5.6	8.4	11	14	17	23	28	34	45	56	70	84	98	113	141	169	225	281	394	563		
2x185															3.2	6.4	10	13	16	19	26	32	38	51	64	80	96	112	128	160	192	256	320	448		
3x120																3.6	7.2	11	14	18	22	29	36	43	58	72	90	108	126	144	180	216	288	360	505	
3x150																	4.2	8.4	13	17	21	25	34	42	51	68	84	105	127	148	169	211	253	338	422	
3x185																		4.8	10	14	19	24	29	38	48	58	77	96	120	144	168	192	240	288	384	480

$I_k$ upstream [kA]	$I_k$ downstream [kA]																								
100	96	92	89	85	82	78	71	65	60	50	43	36	31	27	24	20	17	13	11	7.8	5.6	3.7	2.7	2.0	1.3
90	86	83	81	78	76	72	67	61	57	48	42	35	31	27	24	20	17	13	11	7.8	5.6	3.7	2.7	2.0	1.3
80	77	75	73	71	69	66	62	57	53	46	40	34	30	27	24	20	17	13	10	7.7	5.5	3.7	2.7	2.0	1.3
70	68	66	65	63	62	60	56	53	49	43	38	33	29	26	23	19	16	13	10	7.6	5.5	3.7	2.7	2.0	1.3
60	58	57	56	55	54	53	50	47	45	40	36	31	28	25	23	19	16	12	10	7.5	5.4	3.7	2.7	2.0	1.3
50	49	48	47	46	45	44	43	41	39	35	32	29	26	23	21	18	15	12	10	7.3	5.3	3.6	2.6	2.0	1.3
40	39	39	38	38	37	37	35	34	33	31	28	26	24	22	20	17	15	12	10	7.1	5.2	3.6	2.6	2.0	1.3
35	34	34	34	33	33	32	32	31	30	28	26	24	22	20	19	16	14	11	10	7.1	5.1	3.5	2.6	2.0	1.3
30	30	29	29	29	28	28	28	27	26	25	23	22	20	19	18	16	14	11	9.3	7.0	5.0	3.5	2.6	1.9	1.3
25	25	24	24	24	24	23	23	22	21	21	19	18	17	16	14	13	11	9.0	6.8	5.0	3.4	2.6	1.9	1.3	
20	20	20	20	19	19	19	18	18	18	17	16	15	15	14	13	12	10	8.4	6.5	4.8	3.3	2.5	1.9	1.3	
15	15	15	15	15	15	14	14	14	14	14	13	13	12	12	12	11	10	8.7	7.6	6.1	4.6	3.2	2.5	1.9	1.3
12	12	12	12	12	12	12	12	11	11	11	11	11	10	10	10	9.3	8.8	7.8	7.0	5.7	4.4	3.1	2.4	1.9	1.3
10	10	10	10	10	10	10	9.5	9.4	9.2	9.0	8.8	8.5	8.3	8.1	7.7	7.3	6.5	5.9	5.0	3.9	2.9	2.3	1.8	1.2	
8.0	8.0	7.9	7.9	7.9	7.8	7.8	7.7	7.7	7.6	7.5	7.4	7.2	7.1	6.9	6.8	6.5	6.2	5.7	5.2	4.5	3.7	2.8	2.2	1.7	1.2
6.0	6.0	5.9	5.9	5.9	5.9	5.8	5.8	5.8	5.7	5.6	5.5	5.4	5.3	5.2	5.1	4.9	4.8	4.4	4.1	3.6	3.1	2.4	2.0	1.6	1.1
3.0	3.0	3.0	3.0	3.0	3.0	3.0	2.9	2.9	2.9	2.9	2.9	2.8	2.8	2.8	2.7	2.7	2.6	2.5	2.4	2.2	2.0	1.7	1.4	1.2	0.9

## Annex C: Calculation of short-circuit current

### Note:

- In the case of the  $I_k$  upstream and the length of the cable not being included in the table, it is necessary to consider:
    - the value right above  $I_k$  upstream;
    - the value right below for the cable length.
- These approximations allow calculations which favour safety.
- In the case of cables in parallel not present in the table, the length must be divided by the number of cables in parallel.

### Example

Data  
 Rated voltage = 400 V  
 Cable section = 120 mm<sup>2</sup>  
 Conductor = copper  
 Length = 29 m

Upstream short-circuit current = 32 kA

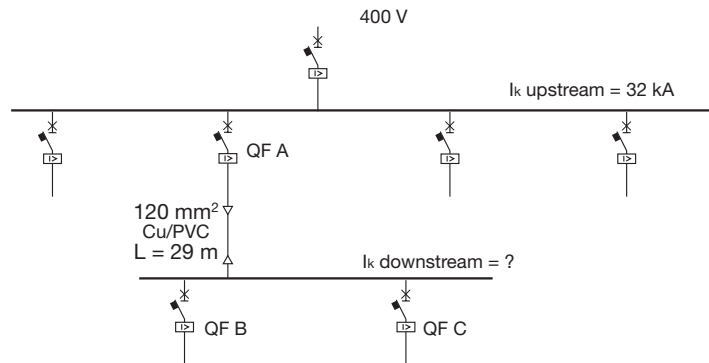

### Procedure

In the row corresponding to the cable cross section 120 mm<sup>2</sup>, it is possible to find the column for a length equal to 29 m or right below (in this case 24). In the column of upstream short-circuit current it is possible to identify the row with a value of 32 kA or right above (in this case 35). From the intersection of this last row with the previously identified column, the value of the downstream short-circuit current can be read as being equal to 26 kA.

## Annex D: Calculation of the coefficient k for the cables (k<sup>2</sup>S<sup>2</sup>)

By using the formula (1), it is possible to determine the conductor minimum section S, in the hypothesis that the generic conductor is submitted to an adiabatic heating from a known initial temperature up to a specific final temperature (applicable if the fault is removed in less than 5 s):

$$S = \frac{\sqrt{I^2 t}}{k} \quad (1)$$

where:

- S is the cross section [mm<sup>2</sup>];
  - I is the value (r.m.s) of prospective fault current for a fault of negligible impedance, which can flow through the protective device [A];
  - t is the operating time of the protective device for automatic disconnection [s];
- k can be evaluated using the tables 2+7 or calculated according to the formula (2):

$$k = \sqrt{\frac{Q_c (B+20)}{\rho_{20}} \ln \left( 1 + \frac{\theta_f - \theta_i}{B + \theta_i} \right)} \quad (2)$$

where:

- $Q_c$  is the volumetric heat capacity of conductor material [J/°Cmm<sup>3</sup>] at 20 °C;
- B is the reciprocal of temperature coefficient of resistivity at 0 °C for the conductor [°C];
- $\rho_{20}$  is the electrical resistivity of conductor material at 20 °C [Ωmm];
- $\theta_i$  initial temperature of conductor [°C];
- $\theta_f$  final temperature of conductor [°C].

Table 1 shows the values of the parameters described above.

Table 1: Value of parameters for different materials

Material	B [°C]	$Q_c$ [J/°Cmm <sup>3</sup> ]	$\rho_{20}$ [Ωmm]	$\sqrt{\frac{Q_c (B+20)}{\rho_{20}}}$
Copper	234.5	3.45·10 <sup>-3</sup>	17.241·10 <sup>-6</sup>	226
Aluminium	228	2.5·10 <sup>-3</sup>	28.264·10 <sup>-6</sup>	148
Lead	230	1.45·10 <sup>-3</sup>	214·10 <sup>-6</sup>	41
Steel	202	3.8·10 <sup>-3</sup>	138·10 <sup>-6</sup>	78

## Annex D: Calculation of the coefficient k for the cables ( $k^2S^2$ )

Table 2: Values of k for phase conductor

	Conductor insulation					
	PVC ≤ 300 mm <sup>2</sup>	PVC ≤ 300 mm <sup>2</sup>	EPR XLPE	Rubber 60 °C	Mineral PVC	Bare
Initial temperature °C	70	70	90	60	70	105
Final temperature °C	160	140	250	200	160	250
Material of conductor:						
<i>copper</i>	115	103	143	141	115	135/115 <sup>a</sup>
<i>aluminium</i>	76	68	94	93	-	-
<i>tin-soldered joints in copper conductors</i>	115	-	-	-	-	-

<sup>a</sup> This value shall be used for bare cables exposed to touch.

Table 3: Values of k for insulated protective conductors not incorporated in cables and not bunched with other cables

Conductor insulation	Temperature °C <sup>b</sup>		Material of conductor		
	Initial	Final	Copper	Aluminium Value for k	Steel
70 °C PVC	30	160/140 <sup>a</sup>	143/133 <sup>a</sup>	95/88 <sup>a</sup>	52/49 <sup>a</sup>
90 °C PVC	30	160/140 <sup>a</sup>	143/133 <sup>a</sup>	95/88 <sup>a</sup>	52/49 <sup>a</sup>
90 °C thermosetting	30	250	176	116	64
60 °C rubber	30	200	159	105	58
85 °C rubber	30	220	166	110	60
Silicone rubber	30	350	201	133	73

<sup>a</sup> The lower value applies to PVC insulated conductors of cross section greater than 300 mm<sup>2</sup>.

<sup>b</sup> Temperature limits for various types of insulation are given in IEC 60724.

Table 4: Values of k for bare protective conductors in contact with cable covering but not bunched with other cables

Cable covering	Temperature °C <sup>a</sup>		Material of conductor		
	Initial	Final	Copper	Aluminium Value for k	Steel
PVC	30	200	159	105	58
Polyethylene	30	150	138	91	50
CSP	30	220	166	110	60

<sup>a</sup> Temperature limits for various types of insulation are given in IEC 60724.

## Annex D: Calculation of the coefficient k for the cables ( $k^2S^2$ )

Table 5: Values of k for protective conductors as a core incorporated in a cable or bunched with other cables or insulated conductors

Conductor insulation	Temperature °C <sup>b</sup>		Material of conductor		
	Initial	Final	Copper	Aluminium Value for k	Steel
70 °C PVC	70	160/140 <sup>a</sup>	115/103 <sup>a</sup>	76/68 <sup>a</sup>	42/37 <sup>a</sup>
90 °C PVC	90	160/140 <sup>a</sup>	100/86 <sup>a</sup>	66/57 <sup>a</sup>	36/31 <sup>a</sup>
90 °C thermosetting	90	250	143	94	52
60 °C rubber	60	200	141	93	51
85 °C rubber	85	220	134	89	48
Silicone rubber	180	350	132	87	47

<sup>a</sup> The lower value applies to PVC insulated conductors of cross section greater than 300 mm<sup>2</sup>.

<sup>b</sup> Temperature limits for various types of insulation are given in IEC 60724.

Table 6: Values of k for protective conductors as a metallic layer of a cable e.g. armour, metallic sheath, concentric conductor, etc.

Conductor insulation	Temperature °C		Material of conductor			
	Initial	Final	Copper	Aluminium Value for k	Lead	Steel
70 °C PVC	60	200	141	93	26	51
90 °C PVC	80	200	128	85	23	46
90 °C thermosetting	80	200	128	85	23	46
60 °C rubber	55	200	144	95	26	52
85 °C rubber	75	220	140	93	26	51
Mineral PVC covered <sup>a</sup>	70	200	135	-	-	-
Mineral bare sheath	105	250	135	-	-	-

<sup>a</sup> This value shall also be used for bare conductors exposed to touch or in contact with combustible material.

Table 7: Value of k for bare conductors where there is no risk of damage to any neighbouring material by the temperature indicated

Conductor insulation	Material of conductor						
	Initial temperature °C	Copper		Aluminium		Steel	
		Maximum temperature °C	k value	Maximum temperature °C	k value	Maximum temperature °C	k value
Visible and in restricted area	30	228	500	125	300	82	500
Normal conditions	30	159	200	105	200	58	200
Fire risk	30	138	150	91	150	50	150

## Annex E: Main physical quantities and electrotechnical formulas

### The International System of Units (SI)

#### SI Base Units

Quantity	Symbol	Unit name
Length	m	metre
Mass	kg	kilogram
Time	s	Second
Electric Current	A	ampere
Thermodynamic Temperature	K	kelvin
Amount of Substance	mol	mole
Luminous Intensity	cd	candela

#### Metric Prefixes for Multiples and Sub-multiples of Units

Decimal power	Prefix	Symbol	Decimal power	Prefix	Symbol
10 <sup>24</sup>	yotta	Y	10 <sup>-1</sup>	deci	d
10 <sup>21</sup>	zetta	Z	10 <sup>-2</sup>	centi	c
10 <sup>18</sup>	exa	E	10 <sup>-3</sup>	milli	m
10 <sup>15</sup>	peta	P	10 <sup>-6</sup>	mikro	μ
10 <sup>12</sup>	tera	T	10 <sup>-9</sup>	nano	n
10 <sup>9</sup>	giga	G	10 <sup>-12</sup>	pico	p
10 <sup>6</sup>	mega	M	10 <sup>-15</sup>	femto	f
10 <sup>3</sup>	kilo	k	10 <sup>-18</sup>	atto	a
10 <sup>2</sup>	etto	h	10 <sup>-21</sup>	zepto	z
10	deca	da	10 <sup>-24</sup>	yocto	y

## Annex E: Main physical quantities and electrotechnical formulas

### Main quantities and SI units

Quantity Symbol	Name	SI unit Symbol	Name	Other units Symbol	Name	Conversion
<b>Length, area, volume</b>						
l	length	m	metre	in	inch	1 in = 25.4 mm
				ft	foot	1 ft = 30.48 cm
				fathom	fathom	1 fathom = 6 ft = 1.8288 m
				mile	mile	1 mile = 1609.344 m
				sm	sea mile	1 sm = 1852 m
A	area	m <sup>2</sup>	square metre	yd	yard	1 yd = 91.44 cm
				a	are	1 a = 10 <sup>2</sup> m <sup>2</sup>
				ha	hectare	1 ha = 10 <sup>4</sup> m <sup>2</sup>
V	volume	m <sup>3</sup>	cubic metre	l	litre	1 l = 1 dm <sup>3</sup> = 10 <sup>-3</sup> m <sup>3</sup>
				UK pt	pint	1 UK pt = 0.5683 dm <sup>3</sup>
				UK gal	gallon	1 UK gal = 4.5461 dm <sup>3</sup>
				US gal	gallon	1 US gal = 3.7855 dm <sup>3</sup>
<b>Angles</b>						
α, β, γ	plane angle	rad	radian	°	degrees	1° = $\frac{\pi}{180}$ · rad
Ω	solid angle	sr	steradian			
<b>Mass</b>						
m	mass, weight	kg	kilogram	lb	pound	1 lb = 0.45359 kg
ρ	density	kg/m <sup>3</sup>	kilogram			
v	specific volume	m <sup>3</sup> /kg	cubic metre for kilogram			
M	moment of inertia	kg·m <sup>2</sup>	kilogram for square metre			
<b>Time</b>						
t	duration	s	second			
f	frequency	Hz	Hertz	1 Hz = 1/s		
ω	angular frequency	1/s	reciprocal second	ω = 2πf		
v	speed	m/s	metre per second	km/h	kilometre per hour	1 km/h = 0.2777 m/s
				mile/h	mile per hour	1 mile/h = 0.4470 m/s
				knot	kn	1 kn = 0.5144 m/s
g	acceleration	m/s <sup>2</sup>	metre per second squared			
<b>Force, energy, power</b>						
F	force	N	newton	kgf	1 N = 1 kg·m/s <sup>2</sup> 1 kgf = 9.80665 N	
p	pressure/stress	Pa	pascal	bar	bar	1 Pa = 1 N/m <sup>2</sup> 1 bar = 10 <sup>5</sup> Pa
W	energy, work	J	joule	1 J = 1 W·s = 1 N·m		
P	power	W	watt	Hp	horsepower	1 Hp = 745.7 W
<b>Temperature and heat</b>						
T	temperature	K	kelvin	°C	Celsius	T[K] = 273.15 + T [°C]
				°F	Fahrenheit	T[K] = 273.15 + (5/9)·(T [°F]-32)
Q	quantity of heat	J	joule			
S	entropy	J/K	joule per kelvin			
<b>Photometric quantities</b>						
I	luminous intensity	cd	candela			
L	luminance	cd/m <sup>2</sup>	candela per square metre			
Φ	luminous flux	lm	lumen	1 lm = 1 cd·sr		
E	illuminance	lux		1 lux = 1 lm/m <sup>2</sup>		

## Annex E: Main physical quantities and electrotechnical formulas

### Main electrical and magnetic quantities and SI units

Quantity	SI unit	Other units	Conversion			
Symbol	Name	Symbol	Name			
I	current	A	ampere			
V	voltage	V	volt			
R	resistance	Ω	ohm			
G	conductance	S	siemens			
X	reactance	Ω	ohm			
B	susceptance	S	siemens			
Z	impedance	Ω	ohm			
Y	admittance	S	siemens			
P	active power	W	watt			
Q	reactive power	var	reactive volt ampere			
S	apparent power	VA	volt ampere			
Q	electric charge	C	coulomb	Ah	ampere/hour	1 C = 1 A·s 1 Ah = 3600 A·s
E	electric field strength	V/m	volt per metre			
C	electric capacitance	F	farad	1 F = 1 C/V		
H	magnetic field	A/m	ampere per metre			
B	magnetic induction	T	tesla	G	gauss	1 T = 1 V·s/m <sup>2</sup> 1 G = 10 <sup>-4</sup> T
L	inductance	H	henry	1 H = 1 Ω·s		

### Resistivity values, conductivity and temperature coefficient at 20 °C of the main electrical materials

conductor	conductivity resistivity ρ <sub>20</sub> [mm <sup>2</sup> Ω/m]	χ <sub>20</sub> =1/ρ <sub>20</sub> [m/mm <sup>2</sup> Ω]	temperature coefficient α <sub>20</sub> [K <sup>-1</sup> ]
Aluminium	0.0287	34.84	3.8·10 <sup>-3</sup>
Brass, CuZn 40	≤ 0.067	≥ 15	2·10 <sup>-3</sup>
Constantan	0.50	2	-3·10 <sup>-4</sup>
Copper	0.0175	57.14	3.95·10 <sup>-3</sup>
Gold	0.023	43.5	3.8·10 <sup>-3</sup>
Iron wire	0.1 to 0,15	10 to 6.7	4.5·10 <sup>-3</sup>
Lead	0.208	4.81	3.9·10 <sup>-3</sup>
Magnesium	0.043	23.26	4.1·10 <sup>-3</sup>
Manganin	0.43	2.33	4·10 <sup>-6</sup>
Mercury	0.941	1.06	9.2·10 <sup>-4</sup>
Ni Cr 8020	1	1	2.5·10 <sup>-4</sup>
Nickeline	0.43	2.33	2.3·10 <sup>-4</sup>
Silver	0.016	62.5	3.8·10 <sup>-3</sup>
Zinc	0.06	16.7	4.2·10 <sup>-3</sup>

## Annex E: Main physical quantities and electrotechnical formulas

### Main electrotechnical formulas

#### Impedance

resistance of a conductor at temperature θ	$R_{\theta} = \rho_{\theta} \cdot \frac{\ell}{S}$
conductance of a conductor at temperature θ	$G_{\theta} = \frac{1}{R_{\theta}} = \chi_{\theta} \cdot \frac{S}{\ell}$
resistivity of a conductor at temperature θ	$\rho_{\theta} = \rho_{20} [1 + \alpha_{20} (\theta - 20)]$
capacitive reactance	$X_C = \frac{-1}{\omega \cdot C} = -\frac{1}{2 \cdot \pi \cdot f \cdot C}$
inductive reactance	$X_L = \omega \cdot L = 2 \cdot \pi \cdot f \cdot L$
impedance	$Z = R + jX$
module impedance	$Z = \sqrt{R^2 + X^2}$
phase impedance	$\varphi = \arctan \frac{R}{X}$
conductance	$G = \frac{1}{R}$
capacitive susceptance	$B_C = \frac{-1}{X_C} = \omega \cdot C = 2 \cdot \pi \cdot f \cdot C$
inductive susceptance	$B_L = \frac{-1}{X_L} = -\frac{1}{\omega \cdot L} = -\frac{1}{2 \cdot \pi \cdot f \cdot L}$
admittance	$Y = G - jB$
module admittance	$Y = \sqrt{G^2 + B^2}$
phase admittance	$\varphi = \arctan \frac{B}{G}$

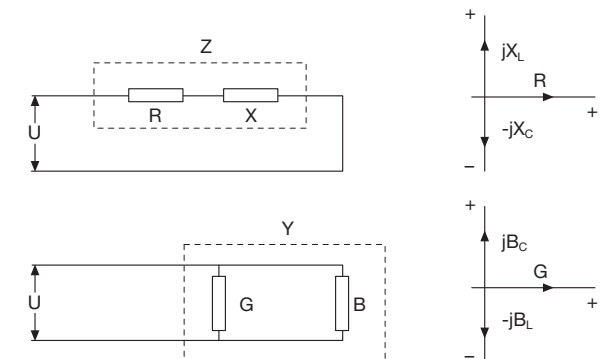



## Annex E: Main physical quantities and electrotechnical formulas

Impedances in series

$$Z = Z_1 + Z_2 + Z_3 + \dots$$

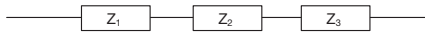

Admittances in series

$$Y = \frac{1}{\frac{1}{Y_1} + \frac{1}{Y_2} + \frac{1}{Y_3} + \dots}$$

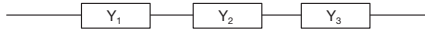

Impedances in parallel

$$Z = \frac{1}{\frac{1}{Z_1} + \frac{1}{Z_2} + \frac{1}{Z_3} + \dots}$$

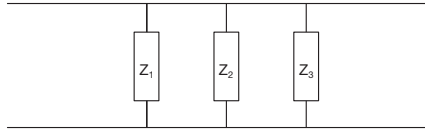

Admittances in parallel

$$Y = Y_1 + Y_2 + Y_3 + \dots$$

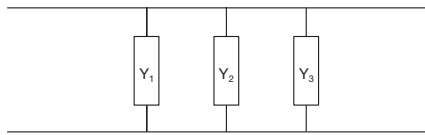

Delta-star and star-delta transformations

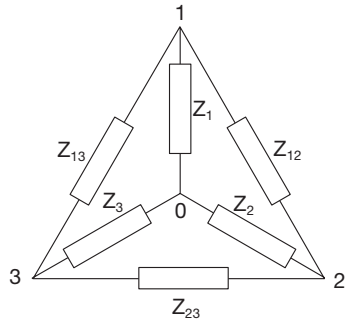

$Y \rightarrow \Delta$ $Z_{12} = Z_1 + Z_2 + \frac{Z_1 \cdot Z_2}{Z_3}$ $Z_{23} = Z_2 + Z_3 + \frac{Z_2 \cdot Z_3}{Z_1}$ $Z_{13} = Z_3 + Z_1 + \frac{Z_3 \cdot Z_1}{Z_2}$	$\Delta \rightarrow Y$ $Z_1 = \frac{Z_{12} \cdot Z_{13}}{Z_{12} + Z_{13} + Z_{23}}$ $Z_2 = \frac{Z_{12} \cdot Z_{23}}{Z_{12} + Z_{13} + Z_{23}}$ $Z_3 = \frac{Z_{23} \cdot Z_{13}}{Z_{12} + Z_{13} + Z_{23}}$
---	---

## Annex E: Main physical quantities and electrotechnical formulas

### Transformers

Two-winding transformer

rated current	$I_r = \frac{S_r}{\sqrt{3} \cdot U_r}$
short-circuit power	$S_k = \frac{S_r}{u_k\%} \cdot 100$
short-circuit current	$I_k = \frac{S_k}{\sqrt{3} \cdot U_r} = \frac{I_r}{u_k\%} \cdot 100$
longitudinal impedance	$Z_T = \frac{u_k\%}{100} \cdot \frac{U_r^2}{S_r} = \frac{u_k\%}{100} \cdot \frac{S_r}{3 \cdot I_r^2}$
longitudinal resistance	$R_T = \frac{p_k\%}{100} \cdot \frac{U_r^2}{S_r} = \frac{p_k\%}{100} \cdot \frac{S_r}{3 \cdot I_r^2}$
longitudinal reactance	$X_T = \sqrt{Z_T^2 - R_T^2}$

Three-winding transformer

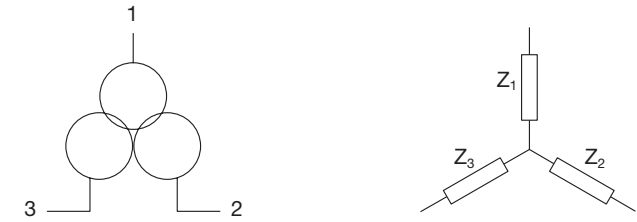

$Z_{12} = \frac{u_{12}}{100} \cdot \frac{U_r^2}{S_{r12}}$	$Z_1 = \frac{1}{2} (Z_{12} + Z_{13} - Z_{23})$
$Z_{13} = \frac{u_{13}}{100} \cdot \frac{U_r^2}{S_{r13}}$	$Z_2 = \frac{1}{2} (Z_{12} + Z_{23} - Z_{13})$
$Z_{23} = \frac{u_{23}}{100} \cdot \frac{U_r^2}{S_{r23}}$	$Z_3 = \frac{1}{2} (Z_{13} + Z_{23} - Z_{12})$

## Annex E: Main physical quantities and electrotechnical formulas

### Voltage drop and power

	single-phase	three-phase	continuous
<b>voltage drop</b>	$\Delta U = 2 \cdot l \cdot \ell \cdot (r \cdot \cos\varphi + x \cdot \sin\varphi)$	$\Delta U = \sqrt{3} \cdot l \cdot \ell \cdot (r \cdot \cos\varphi + x \cdot \sin\varphi)$	$\Delta U = 2 \cdot l \cdot \ell \cdot r$
<b>percentage voltage drop</b>	$\Delta u = \frac{\Delta U}{U_r} \cdot 100$	$\Delta u = \frac{\Delta U}{U_r} \cdot 100$	$\Delta u = \frac{\Delta U}{U_r} \cdot 100$
<b>active power</b>	$P = U \cdot I \cdot \cos\varphi$	$P = \sqrt{3} \cdot U \cdot I \cdot \cos\varphi$	$P = U \cdot I$
<b>reactive power</b>	$Q = U \cdot I \cdot \sin\varphi$	$Q = \sqrt{3} \cdot U \cdot I \cdot \sin\varphi$	-
<b>apparent power</b>	$S = U \cdot I = \sqrt{P^2 + Q^2}$	$S = \sqrt{3} \cdot U \cdot I = \sqrt{P^2 + Q^2}$	-
<b>power factor</b>	$\cos\varphi = \frac{P}{S}$	$\cos\varphi = \frac{P}{S}$	-
<b>power loss</b>	$\Delta P = 2 \cdot \ell \cdot r \cdot I^2$	$\Delta P = 3 \cdot \ell \cdot r \cdot I^2$	$\Delta P = 2 \cdot \ell \cdot r \cdot I^2$

### Caption

- $\rho_{20}$  resistivity at 20 °C
- $\ell$  total length of conductor
- $S$  cross section of conductor
- $\alpha_{20}$  temperature coefficient of conductor at 20 °C
- $\theta$  temperature of conductor
- $\rho\theta$  resistivity against the conductor temperature
- $\omega$  angular frequency
- $f$  frequency
- $r$  resistance of conductor per length unit
- $x$  reactance of conductor per length unit
- $u_k\%$  short-circuit percentage voltage of the transformer
- $S_r$  rated apparent power of the transformer
- $U_r$  rated voltage of the transformer
- $p_k\%$  percentage impedance losses of the transformer under short-circuit conditions



Due to possible developments of standards as well as of materials, the characteristics and dimensions specified in this document may only be considered binding after confirmation by ABB SACE.

---

ABB SACE S.p.A.  
An ABB Group Company

*L. V. Breakers*

Via Baioni, 35

24123 Bergamo - Italy

Tel.: +39 035.395.111 - Telefax: +39 035.395.306-433

**<http://www.abb.com>**