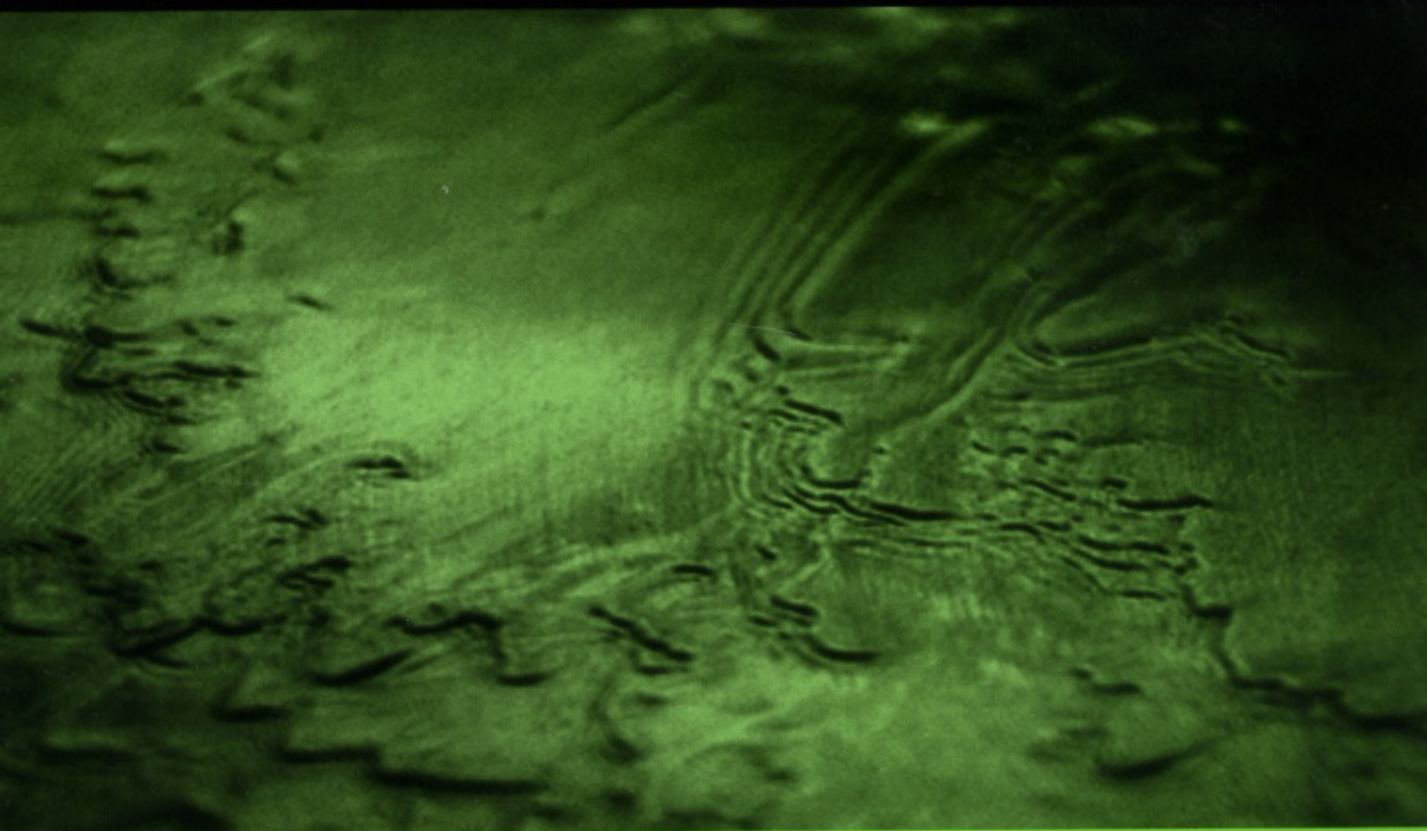



Handbook of Green Chemistry & Technology



**James Clark &
Duncan Macquarrie**

 **Blackwell
Publishing**

Handbook of

GREEN CHEMISTRY AND TECHNOLOGY

Edited by

JAMES CLARK

AND

DUNCAN MACQUARRIE



Blackwell
Science

© 2002 by
Blackwell Science Ltd
Editorial Offices:
Osney Mead, Oxford OX2 0EL
25 John Street, London WC1N 2BS
23 Ainslie Place, Edinburgh EH3 6AJ
350 Main Street, Malden
MA 02148 5018, USA
54 University Street, Carlton
Victoria 3053, Australia
10, rue Casimir Delavigne
75006 Paris, France

Other Editorial Offices:

Blackwell Wissenschafts-Verlag GmbH
Kurfürstendamm 57
10707 Berlin, Germany

Blackwell Science KK
MG Kodonmacho Building
7-10 Kodonmacho Nihombashi
Chuo-ku, Tokyo 104, Japan

Iowa State University Press
A Blackwell Science Company
2121 S. State Avenue
Ames, Iowa 50014-8300, USA

The right of the Author to be identified
as the Author of this Work has been
asserted in accordance with the
Copyright, Designs and Patents Act 1988.

All rights reserved. No part of
this publication may be reproduced,
stored in a retrieval system, or
transmitted, in any form or by any
means, electronic, mechanical,
photocopying, recording or otherwise,
except as permitted by the UK
Copyright, Designs and Patents Act
1988, without the prior permission
of the publisher.

First published 2002

Set in 9 on 11½ pt Meridien
by Best-set Typesetter Ltd., Hong Kong
Printed and bound in Great Britain by
MPG Books Ltd, Bodmin, Cornwall

The Blackwell Science logo is a
trade mark of Blackwell Science Ltd,
registered at the United Kingdom
Trade Marks Registry

DISTRIBUTORS

Marston Book Services Ltd
PO Box 269
Abingdon
Oxon OX14 4YN
(Orders: Tel: 01235 465500
Fax: 01235 465555)

USA

Blackwell Science, Inc.
Commerce Place
350 Main Street
Malden, MA 02148 5018
(Orders: Tel: 800 759 6102
781 388 8250
Fax: 781 388 8255)

Canada

Login Brothers Book Company
324 Saulteaux Crescent
Winnipeg, Manitoba R3J 3T2
(Orders: Tel: 204 837-3987
Fax: 204 837-3116)

Australia

Blackwell Science Pty Ltd
54 University Street
Carlton, Victoria 3053
(Orders: Tel: 03 9347 0300
Fax: 03 9347 5001)

A catalogue record for this title
is available from the British Library

ISBN 0-632-05715-7

Library of Congress
Cataloging-in-Publication Data

Green chemistry and technology/edited
by James Clark and Duncan
Macquarrie.

p. cm.

Includes bibliographical references
and index.

ISBN 0-632-05715-7 (alk. paper)

1. Environmental chemistry—
Industrial applications. 2.
Environmental management.
I. Clark, James H. II. Macquarrie,
Duncan J.

TP155.2.E58 G73 2002
660—dc21

2001037619

For further information on
Blackwell Science, visit our website:
www.blackwell-science.com

Contributors

Adisa Azapagic, Dipl-Ing, MSc, PhD Department of Chemical and Process Engineering, University of Surrey, Guildford, Surrey GU2 7XH, UK

Joseph J. Bozell, PhD National Renewable Energy Laboratory, 1617 Cole Boulevard, Golden, CO 80401, USA

P. Cintas, MSc, PhD Departamento de Quimica Orgánica, Facultad de Ciencias, Universidad de Extremadura, E-06071, Bádajoz, Spain

James Clark, BSc, PhD, CChem, FRSC Clean Technology Centre, Department of Chemistry, University of York, York YO10 5DD, UK

A. A. Clifford, MA, DSc, DPhil School of Chemistry, University of Leeds, Leeds LS2 9JT, UK

Ian R. Dunkin, BSc, PhD, DSc, CChem, FRSC Department of Pure and Applied Chemistry, University of Strathclyde, Thomas Graham Building, 295 Cathedral Street, Glasgow G1 1XL, UK

Georges Gelbard, PhD Institut de Recherches sur la Catalyse—CNRS, 2 avenue Albert Einstein, 69626 Villeurbanne Cedex, France

Thomas E. Graedel, BS, MA, MS, PhD Yale School of Forestry and Environmental Studies, Sage Hall, Yale University, 205 Prospect Street, New Haven, CT 06511, USA

Brian Grievson, BSc, PhD, CChem, MRSC Department of Chemistry, University of York, York YO10 5DD, UK

Mark A. Harmer, BSc, PhD DuPont Central Research and Development, Experimental Station, PO Box 80356, Wilmington, DE 19880-0356, USA

John V. Holder, BSc, PhD, CChem, FRSC Environmental Limited, Faculty of Science, Maudland Building, University of Central Lancashire, Preston PR1 2HE, UK

Herbert L. Holland, BA, MA, MSc, PhD Institute for Molecular Catalysis, Department of Chemistry, Brock University, St. Catharines, Ontario L2S 3A1, Canada

István T. Horváth, PhD, DSc Department of Organic Chemistry, Eötvös University, Pázmány Péter sétány 1/A, H-1117 Budapest, Hungary

Roshan Jachuck, BSc, BTech, PhD Process Intensification and Innovation Centre (PIIC), Department of Chemical and Process Engineering, University of Newcastle upon Tyne, Newcastle upon Tyne NE1 7RU, UK

Mike Lancaster, BSc, MPhil Clean Technology Centre, Department of Chemistry, University of York, York YO10 5DD, UK

Walter Leitner, PhD Max-Planck-Institut für Kohlenforschung, Kaiser-Wilhelm-Platz 1, 45470 Mülheim an der Ruhr, Germany

Duncan Macquarrie, BSc, PhD Clean Technology Centre, Department of Chemistry, University of York, York YO10 5DD, UK

Keith Martin, BSc, PhD Contract Chemicals Ltd, Penrhyn Road, Knowsley Business Park, Prescot, Merseyside L34 9HY, UK

Timothy J. Mason, BSc, PhD, DSc Sonochemistry Centre, School of Natural and Environmental Sciences, Coventry University, Coventry CV1 5FB, UK

József Rábai, PhD Department of Organic Chemistry, Eötvös University, Pázmány Péter sétány 1/A, H-1117 Budapest, Hungary

Gadi Rothenberg, BSc, MSc, PhD Clean Technology Centre, Chemistry Department, University of York, York YO10 5DD, UK

William R. Sanderson, BSc, CChem, MRSC, MACS Consultant to Solvay SA, c/o Solvay Interlox Ltd, PO Box 7, Baronet Road, Warrington WA4 6HB, UK

Yoel Sasson, BSc, MSc, PhD Casali Institute of Applied Chemistry, The Hebrew University of Jerusalem, Jerusalem 91904, Israel

Keith Scott, BSc, PhD, FICHEME Department of Chemical and Process Engineering, University of Newcastle upon Tyne, Newcastle upon Tyne NE1 7RU, UK

Christopher R. Strauss, BSc, MSc, PhD CSIRO Molecular Science, Private Bag 10, Clayton South 3169, Victoria, Australia, and Centre for Green Chemistry, School of Chemistry, PO Box 23, Monash University, Victoria, 3800, Australia

Zoltán Szlávik, PhD Department of Organic Chemistry, Eötvös University, Pázmány Péter sétány 1/A, H-1117 Budapest, Hungary

Nathalie Tanchoux, PhD Laboratoire de Matériaux Catalytiques et Catalyse en Chimie Organique, UMR 5618 ENSCM/CNRS, 8 Rue de l'École Normale, 34296 Montpellier cedex 5, France

Tony Y. Zhang, PhD Chemical Process Research and Development, Lilly Research Laboratories, Eli Lilly and Company, Lilly Corporate Center, Indianapolis, IN 46285-4813, USA

Contents

Contributors	iii
Preface	xvii
1 Introduction	1
<i>James H. Clark</i>	
1 Introduction	1
1.1 Chemistry—past, present and future	1
1.2 The costs of waste	3
1.3 The greening of chemistry	3
References	9
2 Principles of Sustainable and Green Chemistry	10
<i>Mike Lancaster</i>	
1 Introduction	10
2 Green Chemistry and Industry	10
3 Waste Minimisation and Atom Economy	12
3.1 Atom economy	12
3.2 Some inherently atom economic reactions	13
3.3 Some inherently atom uneconomic reactions	15
4 Reduction of Materials Use	15
4.1 Catalytic solutions	16
4.2 Question the need for protection	17
4.3 Reduction of non-renewable raw material use	17
4.4 Process intensification	19
5 Reduction of Energy Requirement	20
5.1 Some energy efficiency improvements	21
5.2 Alternative energy sources	22
6 Reduction of Risk and Hazard	22
6.1 Inherently safe design	22
6.2 Alternative solvents	25
7 Conclusions	25
References	26
3 Chemistry and the Environment	28
<i>John V. Holder</i>	
1 Introduction	28

2	Chemistry of the Atmosphere	28
2.1	Structure of the atmosphere	28
2.2	Tropospheric pollution	30
2.3	Stratospheric pollution	38
2.4	Pollution of the built environment	39
3	Chemistry of the Terrestrial Environment	39
3.1	The Earth's crust	39
3.2	Pollution of the land	40
3.3	Freshwaters	43
3.4	Pollution of freshwater	44
4	Chemistry of the Oceans	50
4.1	Chemistry of the open ocean	50
4.2	Chemistry of estuaries	51
4.3	Pollution of the oceans	52
5	Conclusion	54
	References	54
	Bibliography	55
4	Green Chemistry and Sustainable Development	56
	<i>Thomas E. Graedel</i>	
1	The Concept of Sustainability	56
2	Green Chemistry and Sustainability's Parameters	56
2.1	Sustainable use of chemical feedstocks	57
2.2	Sustainable use of water	58
2.3	Sustainable use of energy	59
2.4	Environmental resilience	59
3	A Sustainability Scenario	60
	References	60
5	Life-cycle Assessment: a Tool for Identification of More Sustainable Products and Processes	62
	<i>Adisa Azapagic</i>	
1	Introduction	62
2	The LCA Methodology	62
2.1	Methodological framework	63
3	The Applications of LCA	69
3.1	Product-oriented LCA	69
3.2	Process-oriented LCA	73
4	Conclusions	80
5	Appendix	81
5.1	Definition of environmental impacts	81
	References	83
6	Industrial Processes using Solid Acid Catalysts	86
	<i>Mark A. Harmer</i>	

1	Introduction	86
2	Concepts in Acidity and Solid Acid Catalysts	87
3	Industrial Applications of Solid Acid Catalysts	90
3.1	Zeolite-based solid acid catalysts	90
3.2	Heteropolyacid-based solid acid catalysts	98
3.3	Sulfated zirconia	102
3.4	Ion-exchange resins	104
3.5	Acidic and pillared clays	107
4	Some Recent Developments in Catalytic Materials and Processes	108
4.1	The 'Kvaerner Process' and esterification chemistry	108
4.2	Nafion [®] /silica nanocomposites	109
4.3	Haldor–Topsoe alkylation process to high-octane fuels	114
4.4	Mobil–Badger cumene process	115
4.5	Isodewaxing process (Chevron)	116
5	Summary	117
	Acknowledgements	117
	References	117
7	Micelle-templated Silicas as Catalysts in Green Chemistry	120
	<i>Duncan Macquarrie</i>	
1	Introduction	120
2	Structured Mesoporous Materials	120
2.1	Synthesis of micelle-templated materials	120
2.2	Post-functionalisation of micelle-templated materials	123
2.3	Direct preparation of organically modified micelle-templated silicas	123
3	Catalytic Applications	125
3.1	Fundamental activity of micelle-templated silicas and aluminosilicas	125
3.2	Micelle-templated materials with enhanced acidity	126
3.3	Oxidation catalysis	128
3.4	Base catalysis (other than oxidations)	139
3.5	Enantioselective catalysis	144
4	Conclusion	146
	References	147
8	Polymer-supported Reagents	150
	<i>Georges Gelbard</i>	

1	Introduction	150
1.1	A breakthrough in organic synthetic methods or a fancy for doing things differently?	150
1.2	Polymeric tools for organic synthesis	150
1.3	What is really possible and what is still expected	151
2	Making Functional Polymers	152
2.1	General schemes	152
2.2	Required properties	153
2.3	Copolymerisation with usual monomers	153
2.4	Polystyrenes	154
2.5	Spacers	155
2.6	Polyacrylates	156
2.7	Polyvinylpyridines	158
2.8	Polybenzimidazoles	158
2.9	Polyphosphazenes	158
2.10	Chlorofluoropolymers	158
3	Syntheses with Polymer-supported Reagents	159
3.1	Acid chlorides and anhydrides	161
3.2	Alcohols	161
3.3	Aldehydes and ketones	163
3.4	Amides and lactams	167
3.5	Amines	168
3.6	Azides	170
3.7	Azo dyes	170
3.8	Bromo-, chloro- and iodoaromatics	170
3.9	Carbodiimides	172
3.10	Epoxides	172
3.11	Esters and lactones	173
3.12	Ethers	174
3.13	Fluoro derivatives	175
3.14	Halides and dehalogenation reactions	176
3.15	Halohydrins	178
3.16	Isoxazolidines	178
3.17	Nitriles	180
3.18	Sulfoxides	181
3.19	Thiocyanates and ureas	181
3.20	Thiiranes, thiols and disulfides	181
3.21	Wittig and Wittig-related reactions	183
4	Conclusion	183
	References	183
9	Biocatalysis	188
	<i>Herbert L. Holland</i>	
1	Introduction	188

2	Chemical Production by Biocatalysis	188
2.1	Bulk chemicals	188
2.2	Pharmaceuticals	190
2.3	Flavour and fragrance compounds	191
2.4	Carbohydrates	192
2.5	Enantiomerically pure synthons	194
2.6	Polymers	195
3	Green Biocatalytic Processes	197
3.1	Biocatalysis in supercritical CO ₂	198
3.2	Biocatalysis in waste treatment	198
3.3	Biodesulfurisation	202
4	Conclusions	202
	References	203
10	Recent Advances in Phase-transfer Catalysis	206
	<i>Yoel Sasson and Gadi Rothenberg</i>	
1	Introduction	206
2	Progress in Classical PTC Reactions	207
2.1	Nucleophilic aliphatic and aromatic substitutions	207
2.2	Phase-transfer catalysis elimination and isomerisation reactions	208
2.3	Base-promoted C, N, O and S alkylation and arylation reactions	211
2.4	Alkylations (C, N, O and S) in alicyclic and heterocyclic syntheses	215
3	Inverse PTC	218
4	Three Liquid Phases and Triphase Catalysis	220
5	Asymmetric PTC	222
6	Phase-transfer Catalysis in Polymerisation Processes	227
7	Applications of PTC in Analytical Chemistry	230
8	Phase Transfer Combined with Metal Catalysis	230
8.1	Phase transfer in homogeneous transition metal catalysis	230
8.2	Catalysis by onium-salt-stabilised transition metal nanoclusters	233
8.3	Phase transfer in heterogeneous catalysis	234
8.4	Phase-transfer catalysis activation of metallic and non-metallic reagents	239
9	Hydrogen Peroxide and Other PTC Oxidations and Halogenations	239
9.1	Hydrogen peroxide and alkyl hydroperoxide oxidations	239
9.2	Other oxidising agents	241

10	Supercritical and Ionic Liquid PTC	243
11	New Experimental Tools and Modelling Techniques in PTC Research	245
	References	246
11	Hydrogen Peroxide in Waste Minimisation—Current and Potential Contributions	258
	<i>William R. Sanderson</i>	
1	Introduction	258
1.1	Factors in the introduction of new technology	258
1.2	Scope of this chapter	258
1.3	Manufacture of hydrogen peroxide	259
1.4	Uses of hydrogen peroxide	259
2	Peroxygen Systems and their Reactivity	261
2.1	Effect of acids and bases	261
2.2	Oxygen species	262
2.3	Peracids and organic activation	263
2.4	Catalytic activation	265
3	State of Progress on Main Catalytic Systems	268
3.1	Redox metal and oxo–metal complexes	268
3.2	Peroxo–metal systems	270
3.3	Polyoxometallates and heteropolyanions	272
3.4	Zeolitic and smectitic materials	273
3.5	Enzymes	276
4	Developments in Catalysed Oxidations for Chemical Synthesis	276
4.1	Oxidations at carbon	277
4.2	Oxidations at nitrogen	288
4.3	Oxidations at sulfur	291
4.4	Halogenations	293
5	Developments in Catalysed Oxidations for Effluent Treatment	294
5.1	Catalysed H ₂ O ₂ systems	294
5.2	Advanced oxidation processes (AOPs)	295
5.3	Treatment of refractory effluents	296
5.4	Gaseous effluent treatment	297
5.5	Soil remediation	297
	References	297
12	Waste Minimisation in Pharmaceutical Process Development: Principles, Practice and Challenges	306
	<i>Tony Y. Zhang</i>	

1	Introduction	306
2	Focus of Process Chemistry	310
2.1	Safety	310
2.2	Increasing complexity	311
2.3	Means of purification	311
2.4	Choice of starting material	311
2.5	Yields	311
2.6	Number and order of steps	312
2.7	Robustness	312
2.8	Solvents	312
2.9	Reagents	314
2.10	Reaction temperature	314
2.11	Heavy metals	314
2.12	Endurance	314
3	Example 1	314
4	Example 2	317
5	Conclusion	319
	References	319
13	Green Catalysts for Industry	321
	<i>Keith Martin</i>	
1	Introduction	321
2	Supported Reagents	322
3	Envirocats™	322
3.1	Envirocat EPZ10	322
3.2	Envirocat EPZG	322
3.3	Envirocat EPZE	323
3.4	Envirocat EPIC	323
3.5	Envirocat EPAD	323
4	Advantages of Envirocats	323
4.1	Friedel–Crafts reactions	323
4.2	Esterifications	323
4.3	Oxidations	324
5	Activation of Envirocats	324
6	General Methods for Using Envirocats	325
6.1	Catalyst concentration	325
6.2	Reaction temperature	325
7	Commercial Applications of Envirocats	325
7.1	Benzoylations	325
7.2	Acylation	325
7.3	Benzylations	326
7.4	Olefin alkylation	326
7.5	Aromatic bromination	327
7.6	Sulfonylation	327
7.7	Esterifications	328
7.8	Aerobic oxidations	328
8	Other Applications of Envirocat Catalysts	329
8.1	Envirocat EPZG	330

8.2	Envirocat EPIC	331
8.3	Envirocat EPZ10	332
9	The Second Generation of Envirocats	332
9.1	Envirocat EPA10	333
9.2	Envirocat EPCS	334
10	Future Envirocats	335
11	Conclusions	335
	References	336
14	Green Chemistry in Practice	338
	<i>Joseph J. Bozell</i>	
1	Introduction	338
2	What is the Impact of Green Process Technology on the Chemical Industry?	338
3	Overview	340
4	Catalysis	341
4.1	Examples of heterogeneous catalysis in practice	341
4.2	Examples of homogeneous catalysis in practice	344
5	Renewables as Chemical Feedstocks and Biocatalysis	352
5.1	The case for renewables	353
5.2	Examples of the use of renewable feedstocks for the production of chemicals	355
5.3	Bioproduction of chemicals in industry	356
6	Conclusions	361
	References	362
15	Process Intensification for Green Chemistry	366
	<i>Roshan Jachuck</i>	
1	Introduction	366
2	Relevance to Green Chemistry	366
3	Spinning Disc Reactor	368
4	Microreactors	369
5	Intensified Cross-corrugated Multifunctional Membrane	370
6	Conclusions	371
	References	371
16	Sonochemistry	372
	<i>Timothy J. Mason and P. Cintas</i>	
1	Introduction	372
1.1	Sonochemistry	372
1.2	Power ultrasound	373
1.3	Apparatus available for sonochemistry	374
2	Sonochemistry in Chemical Synthesis	376

2.1	The nature of sonochemical reactions	377
2.2	Ultrasonic preparation of micro- and nanostructured materials	385
3	Ultrasound in Electrochemistry: Sonoelectrochemistry	387
3.1	Electroplating	388
3.2	Electrosynthesis	388
4	Ultrasound in Environmental Protection and Waste Control	388
4.1	Chemical decontamination	389
4.2	Biological decontamination	391
5	Enhanced Extraction of Raw Materials from Plants	392
6	Large-scale Sonochemistry	392
6.1	Batch systems	392
6.2	Flow systems	392
7	Conclusions	393
	References	393
17	Applications of Microwaves for Environmentally Benign Organic Chemistry	397
	<i>Christopher R. Strauss</i>	
1	Background	397
2	Properties of Microwaves	397
3	Influence of Microwave Heating on Chemical Reactions	397
4	Rate Studies and Investigations into 'Microwave Effects'	398
5	Approaches to Microwave-assisted Organic Chemistry	399
5.1	Solvent-free methods	400
5.2	Methods with solvents	401
6	Advantages of the Pressurised Microwave Systems	403
6.1	Elevated temperature	403
6.2	Rapid heating, cooling and ease of use for high-temperature reactions	404
6.3	Control of heating	406
6.4	Exothermic reactions, differential heating and viscous reaction mixtures	406
6.5	Reaction vessels	406
6.6	Reactions with a distillation step	407
6.7	Flexible operation	407
7	High-temperature Water as a Medium or Solvent for Microwave-assisted Organic Synthesis	407
7.1	Reactions in high-temperature water	408

7.2	Reactions in aqueous acid and base	410
7.3	Limiting salt formation	410
7.4	Avoiding solvent extraction through resin-based adsorption processes	410
8	Metal-catalysed Processes	410
9	Enzymatic Processes	411
10	Deuteration and Tritiation	412
11	Tandem Technologies	412
12	Conclusion	412
	References	413
18	Photochemistry	416
	<i>Ian R. Dunkin</i>	
1	Photons as Clean Reagents	416
1.1	Reduced usage of reagents	416
1.2	Lower reaction temperatures	416
1.3	Control of selectivity	417
1.4	Photochemical reactions for industry	420
2	General Problems with Photochemical Processes	421
2.1	Specialized photochemical reactors and process technology	421
2.2	Window fouling	422
2.3	The cost of photons	422
3	The Light Ahead	423
3.1	Photochemical reactors	423
3.2	Light sources	425
4	Conclusions	426
5	The Basics of Photochemistry	427
5.1	Light and energy	427
5.2	Absorption of light by molecules	428
5.3	Excited-state processes	430
	Acknowledgements	431
	References	431
19	Electrochemistry and Sustainability	433
	<i>K. Scott</i>	
1	Introduction	433
2	Green Electrochemistry	433
3	Electrochemistry Fundamentals	434
3.1	Electrode potential, kinetics and mass transport	435
3.2	Electrochemical cells	439
4	Electrochemistry and Energy Sustainability	442
4.1	Fuel cells	443
5	Electrochemical Synthesis	447
5.1	Metal salt preparation	448
5.2	In situ generation of reagents	448

5.3	Influence of counter-electrode	449
5.4	Paired synthesis	449
5.5	Organic electrosynthesis	450
6	Electrochemical Waste Minimisation	453
6.1	Recovery and recycling of metal ions	454
6.2	Cell technology and applications	457
6.3	Integration of electrodeposition with other separations	458
6.4	Electrochemical ion exchange	459
6.5	Electrochemical membrane processes	459
6.6	Electrohydrolysis	461
	References	464
20	Fuel Cells: a Clean Energy Technology for the Future	466
	<i>Brian Grievson</i>	
1	Introduction	466
2	Fuel Cell Electrochemistry	466
3	Fuel Cell Technology	468
3.1	Alkaline fuel cell	469
3.2	Solid polymer fuel cell	470
3.3	Phosphoric acid fuel cell	471
3.4	Molten carbonate fuel cell	472
3.5	Solid oxide fuel cell	473
4	Fuel Cell Applications	476
4.1	General economics	476
4.2	Transport applications	477
4.3	Stationary power generation applications	478
4.4	Battery replacement applications	479
5	The Future of Fuel Cells	479
	References	480
21	Supercritical Carbon Dioxide as an Environmentally Benign Reaction Medium for Chemical Synthesis	482
	<i>Nathalie Tanchoux and Walter Leitner</i>	
1	Introduction	482
2	Phase Behaviour and Solubility in Supercritical Reaction Mixtures	483
3	Supercritical CO ₂ as a Replacement for Organic Solvents	485
4	Use of Supercritical CO ₂ for Safer Processes	487
5	Improvement of Process Performance	490
5.1	Process intensification	490
5.2	Improvement of changes in stereoselectivity	493
5.3	Enhanced catalyst lifetime	495

6	Use of Supercritical CO ₂ for Product Separation and Catalyst Recycling	495
6.1	Multiphase processes using supercritical CO ₂ as a reaction and separation phase	495
6.2	Single-phase reactions with subsequent separation using supercritical CO ₂ as the reaction and separation phase	496
7	Simultaneous Use of Supercritical CO ₂ as Reaction Medium and Reagent	498
8	Conclusion	499
	References	500
22	Chemistry in Fluorous Biphasic Systems	502
	<i>József Rábai, Zoltán Szlávik and István T. Horváth</i>	
1	Introduction	502
2	The Fluorous Biphasic Concept	502
3	Fluorous Solvents	503
4	Synthesis of Fluorous Compounds	504
5	Fluorous Extraction	508
6	Fluorous Synthesis	509
7	Fluorous Reagents	510
8	Fluorous Tags	515
9	Fluorous Biphasic Catalysis	520
10	Relationship between Fluorous and Supercritical Carbon Dioxide Media	520
11	Economical Feasibility of Fluorous Biphasic Chemistry	520
	References	521
23	Extraction of Natural Products with Superheated Water	524
	<i>A. A. Clifford</i>	
1	Introduction	524
2	Properties of Superheated Water	524
3	Extraction of Materials Other Than Natural Products	526
4	Chromatography with Superheated Water	526
5	Extraction of Rosemary	526
6	Extraction of Other Plant Materials	527
7	Process Development	528
8	Extraction with Reaction	529
	References	531
	Index	532

Preface

The chemical industry is arguably the most successful and diverse sector of the manufacturing industry. Chemical products go into pharmaceuticals and healthcare, agriculture and food, clothing and cleaning, electronics, transport and aerospace.

While the nineteenth century saw the emergence of chemistry as the ‘central discipline’ linking to physics, biology, medicine and materials, the twentieth century witnessed the rapid growth of the chemical and allied industries with virtually all the strongest economies incorporating chemical manufacturing. Indeed the industry became a major if not the major source of exports in many of the most powerful nations. What does the twenty-first century offer for chemistry and chemical manufacturing?

As I state in my opening to Chapter 1, chemistry is having a difficult time. On the one hand the demand for chemical products is higher than ever and can be expected to grow at >5% per annum with the emergence of the super-states in the East with their enormous populations seeking, quite reasonably, to match the standards of healthcare, housing, clothing and consumer goods we have grown accustomed to in the developed world. However, there is unprecedented social, economic and environmental pressure on the chemical industry to ‘clean up its act’ and make chemical processes and products more sustainable and environmentally compatible. The general public is much more aware of the mistakes of the industry—pollution, explosions etc.—than of its countless benefits largely thanks to a media that is more than willing and able to publicise bad news stories about chemicals.

The image of the chemical industry has been deteriorating over the last 20 plus years. This is now so serious that chemical manufacturing is often ranked alongside such unpopular industries as nuclear power and tobacco. We have also seen marked reductions in the numbers of students applying to read chemistry, chemical engineering and related subjects and it is not unreasonable to see some cor-

relation between these trends. It is absolutely vital that we see no further reduction in our most important feedstock—the young people seeking careers in chemistry.

We are frequently told that we are now in a global market where product manufacturing can take place at a site on the other side of the globe to where the product is required. It is very questionable if this is sustainable since the concept relies on low-cost transport: a major cause of resource depletion and pollution production. However, what is clear is that manufacturing is becoming highly competitive with the developing countries expanding their industrial base at a remarkable rate. Furthermore, as these countries also present the largest growth markets, close-to-market manufacturing could well become very important. To compete in the markets of the future a chemical company needs to operate at very high levels of efficiency, where efficiency will increasingly include ‘atom efficiency’, making maximum use of its raw materials, and producing very low levels of waste since growing waste disposal costs will add to the economic burden of wasted resources. Governments and trans-national organisations such as the EU will make this even more essential by taxing waste, fining pollution and rewarding innovation and greener manufacturing. In every respect, the cost of waste will grow.

In this book we consider the challenges and opportunities that these drivers offer chemistry and the chemical industries. The title *Green Chemistry and Technology* has been carefully chosen to show from the beginning that we require innovation and imaginative chemical technology to drive the subject and industry forward in this new century.

Green chemistry is a concept which seeks to help chemists to improve the environmental performance and safety of chemical processes and to reduce the risks to man and the environment of chemical products. The principles of sustainable and green chemistry are described in Chapter 2. Important terms and methods such as atom economy, waste minimisation

and reductions in materials and energy consumption and in risk and hazard are introduced and illustrated. These are the fundamentals of green chemistry.

If we are to make a real difference to the impact of chemistry on the environment then it is essential that we understand the chemistry of the environment. The chemistry of the atmosphere, the terrestrial environment and the oceans is introduced in Chapter 3. This focuses on pollution and its effects. A better understanding of the chemistry of the environment will help us to improve the eco-design of new chemical products.

The sustainable development of global society should not compromise the needs of future generations. It is complementary to green chemistry which seeks to make chemicals and chemical manufacturing environmentally benign and hence leaving the planet unharmed for our children. The concept of sustainability is discussed in Chapter 4 where the sustainable use of chemical feedstocks, water and energy are considered in turn. A sustainability scenario is also described.

How are we to measure the success of our efforts to make chemicals and chemical manufactory more sustainable and in keeping with the principles of green chemistry? Life cycle assessment is probably the most powerful tool for the identification of more sustainable products and processes. LCA methodology and its applications are discussed in Chapter 5.

The 'Clean Technology Toolkit' contains many well established technologies which despite being known, need to be better applied at least in certain areas of chemistry so as to help reduce environmental impact. Catalysis is arguably the most important tool in the green chemistry armoury and several chapters of this book are dedicated to the subject and in particular to its applications in more speciality chemicals manufacturing where catalysis has been relatively underexploited. Chemical and biochemical, homogeneous and heterogeneous catalysis are all renewed in this context.

In Chapter 6, some of the newer solid acids and their applications as replacements for traditional acids are described. Acid catalysis is by far the most important area of catalysis and the successful substitution of traditional but dangerous and polluting acids, such as H_2SO_4 , HF and AlCl_3 is one of the most important goals of green chemistry. Increasingly we will want to design catalysts to the molecular level so as to ensure better control over their performance.

This is especially challenging for heterogeneous catalysis but progress is being made especially in the context of sol-gel chemistry and its use to grow inorganic-organic hybrid materials with excellent compatibility in organic environments. Some of these new and exciting materials are described in Chapter 7, where applications in areas including base catalysis, oxidation catalysis and enantioselective catalysis are described. These include zeolite-based materials, resins, clays and nanocomposites.

Polymer-supported reagents are intrinsically compatible with organic systems and are ideally suited as direct replacements for soluble reagents. Making and using functional polymers is the subject of Chapter 8. Their applications in synthesis, already proven, are remarkably diverse and demonstrate environmentally friendly routes to numerous important classes of organic compounds.

Chemistry will not be able to solve all the problems of the green chemistry revolution. We must learn to make better use of other sciences and technologies, and biochemistry is one of the most important of these. In Chapter 9, chemical production by biocatalysis is described. The range of processes in which biocatalysis has been proven is already impressive and includes the production of bulk chemicals, pharmaceuticals, polymers and flavour and fragrance chemicals.

Phase transfer catalysis largely (but not exclusively) involves homogeneous catalysis and seeks to avoid the use of the more toxic solvents through the use of mixed aqueous or solid and non-aqueous (e.g. hydrocarbon) solvents. The essential chemistry occurs at the interface where the catalyst operates. Recent advances in phase transfer catalysis including asymmetric synthesis and triphase catalysis (where very high reaction rates can be achieved) are described in Chapter 10.

Oxidation is the most important chemical method for introducing functionality into a molecule. While hydrocarbons continue to be our major feedstock, oxidation and selective oxidation in particular, will continue to be vital for almost every sector of the chemical and allied industries. Unfortunately, a long history of oxidation chemistry carries with it some very hazardous and polluting methods of oxidation notably through the use of metallic oxidants. The source of oxygen is fundamentally important in designing cleaner oxidation reactions. Air or oxygen is often the most attractive, and hydrogen peroxide,

which will give only water as a by-product, is a clean second best. Many very effective, low polluting oxidation reactions using hydrogen peroxide are now known and a wide range of these are described and discussed in Chapter 11, which includes progress on main catalytic systems and other environmental applications.

Pharmaceutical manufacturing does not suffer from such low public esteem as other sectors of the chemical industries but pharmaceutical syntheses are invariably associated with relatively high levels of waste. Greening such a process presents special challenges such as reducing the number of steps and less utilisation of auxiliaries. Waste minimisation in pharmaceutical process development is addressed in Chapter 12.

Green chemistry in practice is the focus of Chapters 13 and 14. Commercial catalysts designed for cleaner synthesis notably reduced waste liquid phase Friedel-Crafts, and oxidation reactions are described in Chapter 13. This is followed by a chapter highlighting examples of homogeneous and heterogeneous catalysis in practice, the use of renewable feedstocks in chemical production, and the bio-production of chemicals in industry.

The chemical industry of the twenty-first century is likely to look very different to that of the twentieth century. Apart from lower emissions—to air, land and water—it should be more compatible with its environment, lower profile and generally smaller than the vast areas of skyscraping equipment long associated with chemicals manufacturing. Smaller means less storage, small flexible reactors and ‘just-in-time manufacturing’, Innovate chemical and process engineering will be as or even more vital to this revolution than new chemistry. Process intensification is at the heart of green chemical technology and is outlined in Chapter 15. The chapter includes consideration of established techniques such as membranes and newer techniques such as spinning disc reactors.

New techniques or the application of established techniques in new ways represent more important tools in the green chemistry toolkit. The basic ideas and some of the more interesting applications of sonochemistry are described in Chapter 16. This includes sonochemical synthesis, the use of ultrasound in environmental protection and the combination of sonochemistry and electrochemistry. In Chapter 17 many microwave-assisted reactions are

described. Here rate effects and some unexpected additional benefits of an alternative energy source have been proven. Pressurised microwave systems and the use of high temperature water as a medium for organic synthesis are discussed in some detail.

Photons can be considered as clean reagents and photochemistry can offer numerous advantages over conventional reactions including lower reaction temperatures and control of reaction selectivity. Some of the problems of photochemical processes are addressed and future trends considered.

Electrochemistry is a rather neglected technology in the context of organic chemicals manufacturing but the green chemistry revolution opens a new door to its better exploitation. In Chapter 19, the arguments for this are considered. Proven examples of electrochemical synthesis including the preparation of metal salts, the in-situ generation of reagents and organic electrosynthesis are described.

Fuel cells represent one of the most exciting and often cited examples of possible cleaner energy technologies for the future. Chapter 20 deals with fuel cell technology covering the major types of fuel cell available and fuel cell applications in transport, stationary power generation and battery replacement applications. The future of fuel cells is also considered.

Alternative solvents represent the other major entry in the green chemistry toolkit and are the subject of an enormous research effort. While aspects of these, the use of water, supercritical fluids and ionic liquids are considered in various stages in this handbook, supercritical carbon dioxide, fluorine biphasic systems and supercritical water are the subjects of somewhat more detailed consideration. Chapter 21 describes the use of supercritical CO₂ as an environmentally benign reaction medium for chemical synthesis. Various improvements in process performance, including intensification, stereoselectivity and enhanced catalyst lifetime, are described. Additional discussion covers the use of supercritical CO₂ for product separation and catalyst recycling as well as the simultaneous use of the fluid as a solvent and reagent.

Fluorine biphasic systems are one of the more ingenious inventions for green chemistry in recent years. Chapter 22 describes the idea behind their use and their synthesis before describing fluorine extractions, synthesis, reagents and tags. Finally, the relationship between fluorine and supercritical CO₂

media is described and the economic feasibility of fluororous biphasic chemistry is considered.

The final chapter in this handbook considers the specialist solvent superheated water. Apart from a possible alternative solvent for some organic reactions this remarkable liquid can also be used for the extraction of natural products and other materials.

We have made real progress since I wrote the editorial introduction to the *Chemistry of Waste Minimization* six years ago. The concept of green chemistry has emerged and been widely accepted both in technology and in its principles all over the world. Green chemistry conferences are now becoming commonplace, a dedicated journal is available, introductory books have been published and educational activities are becoming apparent at all levels. The green chemistry toolkit is now quite large with exciting developments in alternative reaction media, heterogeneous catalysis, cleaner synthesis, and reactor design. Most importantly there are now a good number of exciting examples of green chemistry in practice—real examples of where industry has achieved the triple bottom line of environmental,

economic and societal benefit. But still greater challenges lie ahead. The chemical industry of the twenty-first century needs to fully embrace the principles of green chemistry through higher atom efficiency giving better utilisation of raw materials, less waste, simpler and safer processes based on flexible smaller reactions, safer products and an increasing utilisation of renewable feedstocks. These should be exciting rather than depressing times for chemistry and chemical technology; there are countless opportunities for innovation and the application of new cleaner technologies. The potential benefits of successfully ‘greening the chemical industry’ are enormous and of benefit to all society and future generations.

I would like to express my thanks and those of my co-editor Duncan Macquarrie to all of the contributors to this book, for accepting their tasks cheerfully and for completing their tasks so effectively. A final word of thanks to Melanie Barrand who somehow managed to balance the needs and constraints of the editors, authors and publishers in getting this handbook together.

Chapter 1: Introduction

JAMES H. CLARK

1 Introduction

1.1 Chemistry—past, present and future

Chemistry is having a difficult time. While society continues to demand larger quantities of increasingly sophisticated chemical products, it also regards the industries that manufacture these products with increasing degrees of suspicion and fear.

The range of chemical products in today's society is enormous and these products make an invaluable contribution to the quality of our lives. In medicine, the design and manufacture of pharmaceutical products has enabled us to cure diseases that have ravaged humankind throughout history. Crop protection and growth enhancement chemicals have enabled us to increase our food yields dramatically. It is particularly revealing to note that, although the twentieth century saw an increase in world population from 1.6 to 6 billion, it also saw an increase in life expectancy of almost 60% [1]!

Chemistry has played, and continues to play, a fundamental role in almost every aspect of modern society, and, as the enormous populations in China, India and the emerging nations demand western levels of healthcare, food, shelter, transport and consumer goods, so the demands on the chemicals industries will grow.

The successful development of the chemicals industries has almost had an inverse relationship with public perception. Since writing, over five years ago, in the introduction to *The Chemistry of Waste Minimisation*, that 'The public image of the chemical industry has badly deteriorated in the last ten years . . .' [2], the situation has worsened. Major surveys of public opinion throughout Europe in 2000 revealed that in no country was the majority of people favourably disposed towards the chemical industry [3,4]. The most favourable interpretation of the data is that in some of the major centres of chemicals manufacturing (e.g. Germany) more people gave positive than negative views on chemicals

manufacturing, but for many European countries the ratio of unfavourable to favourable views was alarmingly high (e.g. Sweden, 2.8; France, 2.2; Spain, 1.5; Belgium, 1.3).

In the UK, a steady decline in public perception over many years is clearly evident (Fig. 1.1). It is especially disturbing to analyse the survey data more closely and to note, for example, that the 16–24-year age group has the lowest opinion of the chemicals industries. This is the most critical group for chemistry. We need to maintain a high level of interest and enthusiasm for chemistry at secondary and tertiary education levels so that we can maintain the supply of a large number of highly intelligent, motivated and qualified young people for our industries, universities, schools and other walks of life. At present, however, the poor image of chemistry is adversely affecting demand. In the UK, for example, the number of applicants to read chemistry at university has been falling steadily for several years (Fig. 1.2).

The number of applicants to read chemical engineering is even more alarming (<1000 in the year 2000 in the UK). Similarly, even more worrying statistics are evident in many countries, although on a more optimistic note the shortfall in suitably qualified chemists is at least making prospective employers more competitive in the offers they are making to potential recruits. This should lead to greater remuneration benefits in a profession where salary does not always reflect qualifications and achievement.

Why does chemistry suffer from such a tarnished image? Public opinion is fickle and subject to misunderstanding and confusion, often reinforced by the media. The pharmaceuticals industry, for example, is highly regarded by the public despite the fact that it represents an increasingly large part of the chemicals industries. 'Chemistry' does not cause the same hostile reaction as 'chemicals' because it is the latter that many people associate with disasters, spills and unwanted additives to their

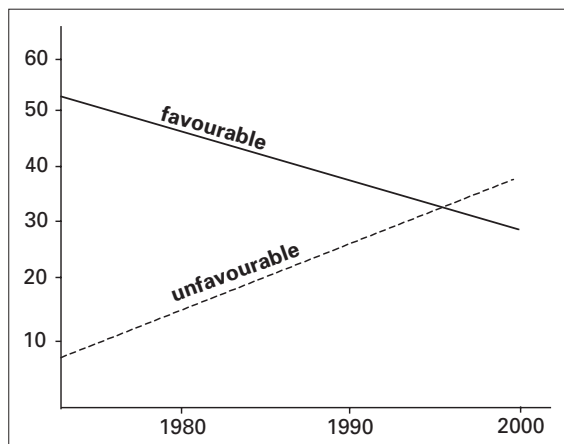


Fig. 1.1 Trends in the favourability to the chemical industry of the general public (smoothed plots) (based on MORI Opinion Poll figures in the period 1980–2000).

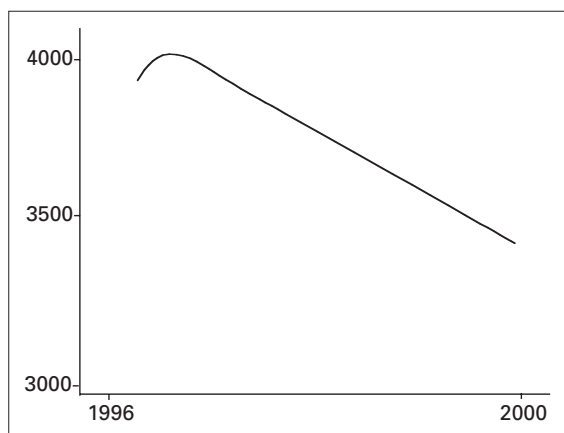


Fig. 1.2 Trend in the number of applications to study chemistry in UK universities (source: UCAS).

foods, drinks or consumer products. It is revealing to note the recent change in name of the leading trade association for the chemicals industry in the USA from The American Chemical Manufacturers Association to The American Chemistry Council. Indeed, a cynical view might be that we can solve our image problems overnight by reinventing ourselves as ‘molecular engineers’!

In 1995 I wrote that chemistry’s bad image was ‘...largely due to concerns over adverse environmental impact’ [2]. The growth in the chemicals

industries in the twentieth century was at the cost of producing millions of tonnes of waste, and if we extend the discussion to include health and safety issues then we must add the chemical disasters that have led to much unfavourable publicity and have hardened the views of many critics. The increasing levels of environmental awareness among the general public make it even more important that the chemicals industries ‘clean up their act’. Public acceptability of environmental pressure groups adds to their influence and together they effectively force governments to use legislation to force industry into making improvements.

How much do we need to change? Although early work to ‘green’ the manufacture of chemicals was focused largely on reducing the environmental impact of chemical processes, a much wider view will be necessary in the new century. An exaggerated but illustrative view of twentieth century chemical manufacturing can be written as a recipe [5]:

- (1) Start with a petroleum-based feedstock.
- (2) Dissolve it in a solvent.
- (3) Add a reagent.
- (4) React to form an intermediate chemical.
- (5) Repeat (2)–(4) several times until the final product is obtained; discard all waste and spent reagent; recycle solvent where economically viable.
- (6) Transport the product worldwide, often for long-term storage.
- (7) Release the product into the ecosystem without proper evaluation of its long-term effects.

The recipe for the twenty-first century will be very different:

- (1) Design the molecule to have minimal impact on the environment (short residence time, biodegradable).
- (2) Manufacture from a renewable feedstock (e.g. carbohydrate).
- (3) Use a long-life catalyst.
- (4) Use no solvent or a totally recyclable benign solvent.
- (5) Use the smallest possible number of steps in the synthesis.
- (6) Manufacture the product as required and as close as possible to where it is required.

The broader picture will apply not only to chemical manufacturing but also to transportation, legislation

and, most critically, education. We must train the new generation of chemists to think of the environmental, social and economic factors in chemicals manufacturing.

1.2 The costs of waste

In the time taken to read one page of this book, several tonnes of hazardous waste will have been released to the air, water and land by industry, and the chemicals industry is by far the biggest source of such waste. This is only a fraction of the true scale of the problem. Substances classified as 'hazardous' only represent a very small number of the total number of substances in commercial use. In the mid-1990s in the USA, for example, only about 300 or so of the 75 000 commercial substances in use were classified as hazardous. Clearly a much higher proportion of commercial chemicals presents a threat to humans and to the environment, and as mounting pressure will lead to an ever-increasing number of chemicals being tested then the scale of the 'hazardous waste' problem will take on ever more frightening proportions. Yet this only represents one 'cost' of waste and the cost of waste can be truly enormous.

Compliance with existing environmental laws will cost new EU member states well over E10 billion; a similar amount is spent each year in the USA to treat and dispose of waste. Governments across the globe are increasing the relative costs of waste disposal to discourage the production of waste and to encourage recycling and longer product lifetimes.

Although, in general terms, company accounting practices are highly developed, when it comes to industrial chemical processes, particularly for smaller companies working with multi-purpose plants in the speciality chemicals area, the true breakdown of manufacturing costs is often unknown. Sophisticated process monitoring and information technology developments are beginning to allow the true production costs to become evident. What this shows is that the cost of waste can easily amount to 40% of the overall production costs for a typical speciality chemical product (Fig. 1.3).

However, the costs of effluent treatment and waste disposal actually tell only part of the story. There are other direct costs to production resulting from inefficient manufacturing, by-product generation and raw material and energy inefficiencies. Industry also

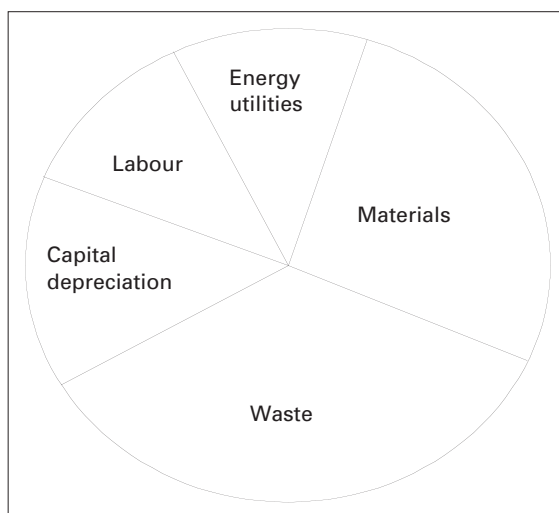


Fig. 1.3 Production costs for speciality chemicals.

is becoming increasingly aware of the indirect costs of waste on deteriorating public relations (as described in Section 1.1). These affect the attitudes of the workforce and hence their morale and performance, and also that of their neighbours who can lobby local authorities to impose tighter standards and legislation. As a society, we can add the largely unknown but certain to be substantial (if not catastrophic) costs to the environment (including human health). All of these costs will grow into the future through tougher legislation, greater fines, increased waste disposal costs, greater public awareness and diminishing raw materials, forcing the adoption of more efficient manufacturing (Fig. 1.4).

1.3 The greening of chemistry

Sustainable development is now accepted by governments, industry and the public as a necessary goal for achieving the desired combination of environmental, economic and societal objectives. The challenge for chemists and others is to develop new products, processes and services that achieve all the benefits of sustainable development. This requires a new approach whereby the materials and energy input to a process are minimised and thus utilised at maximum efficiency. The dispersion of harmful chemicals in the environment must be minimised or, preferably, completely eliminated. We must maxi-

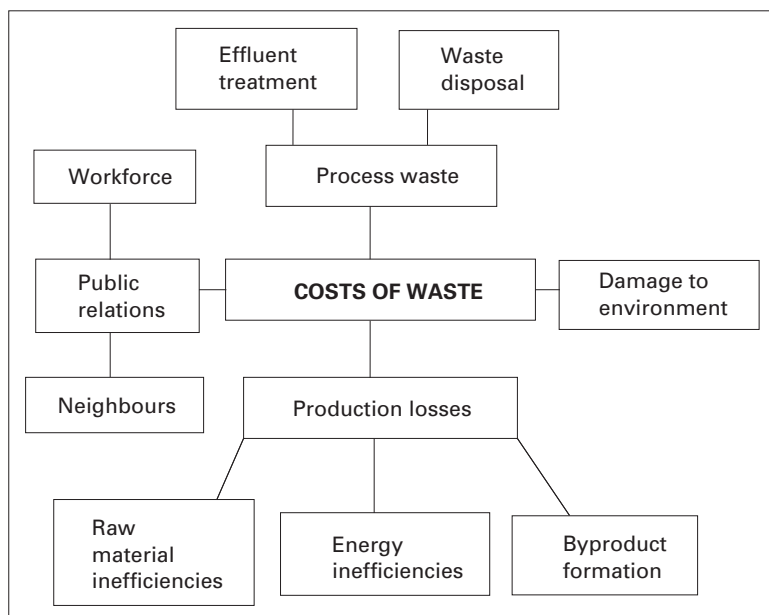


Fig. 1.4 The costs of waste.

mise the use of renewable resources and extend the durability and recyclability of products, and all of this must be achieved in a way that provides economic benefit to the producer (to make the greener product and process economically attractive) and enables industry to meet the needs of society.

We can start by considering the options for waste management within a chemical process (Fig. 1.5). The hierarchy of waste management techniques now has prevention, through the use of cleaner processes, as by far the most desirable option. Recycling is considered to be the next most favourable option and, from an environmental standpoint, is particularly important for products that do not dissipate rapidly and safely into the environment. Disposal is certainly the least desirable option. The term 'cleaner production' encompasses goals and principles that fall nicely within the remit of waste minimisation. The United Nations Environmental Programme describes cleaner production as:

'The continuous application of an integrated preventative environmental strategy to processes and products to reduce risks to humans and the environment. For production processes, cleaner production includes conserving raw materials, and

reducing the quality and toxicity of all emissions and wastes before they leave a process.'

Cleaner production and clean synthesis fall under the heading of waste reduction at source and, along with retrofitting, can be considered as the two principal technological changes. Waste reduction at source also covers good housekeeping, input material changes and product changes.

There are many ways to define the efficiency of a chemical reaction. Yield and selectivity traditionally have been employed, although these do not necessarily give much information about the waste produced in a process. From an environmental (and increasingly economic) point of view, it is more important to know how many atoms of the starting material are converted to useful products and how many to waste. Atom economy is a quantitative measure of this by, for example, calculating the percentage of oxygen atoms that end up in the desired product [6]. We can illustrate this by considering a typical oxidation reaction whereby an alcohol, for example, is converted to a carboxylic acid using chromium(VI) as the stoichiometric oxidant. The material inputs for this reaction are the organic substrate, a source of chromium(VI), acid (normally sul-

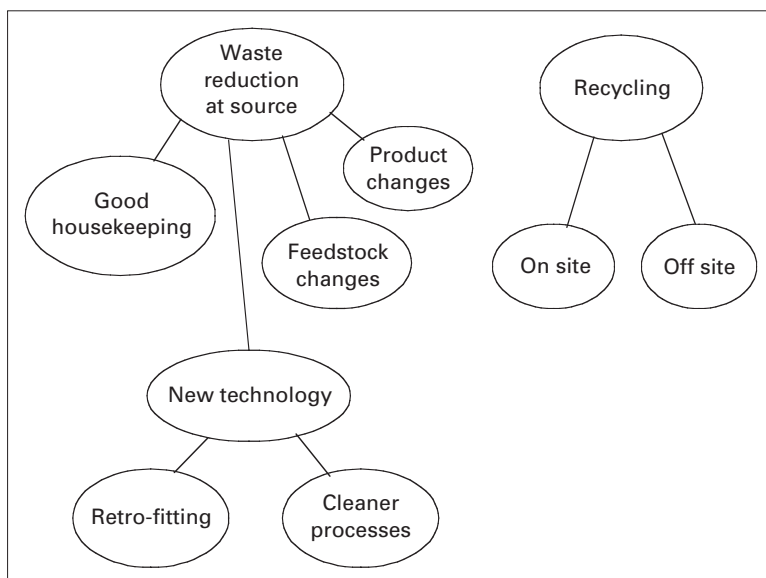


Fig. 1.5 Options for waste management within a chemical manufacturing process.

Table 1.1 'Atom accounts' for a typical partial oxidation reaction using chromate

Element	Fate	Atom utilisation
C	Product(s)	Up to 100%
H	Product(s) + waste acid	<100%
Cr	Chromium waste	0%
Na	Salt waste	0%
S	Salt waste (after acid neutralisation)	0%
O	Product(s) + waste	<<100%

furic) and a solvent. Ironically, the substrate usually is the minor component in this witches' brew! The 'atom accounts' for the process make alarming reading (Table 1.1) [7], with only carbon likely to approach 100% atom efficiency, and this depends on reaction selectivity.

It is also revealing to compare the relative efficiencies of process types or even industrial sectors on the basis of the amount of waste produced divided by the amount of product. This so-called E factor [8] is a clear indication of how the traditional organic chemicals manufacturing processes that have been the lifeblood of the fine, speciality and pharmaceutical chemicals industries are no longer acceptable in these environmentally conscious days (Table 1.2).

Table 1.2 Relative efficiencies of different chemicals manufacturing sectors

Industry sector	Product tonnage	By-product weight/ Product weight
Oil refining	10^6 – 10^8	<0.1
Bulk chemicals	10^4 – 10^6	1–5
Fine chemicals	10^2 – 10^4	5–50+
Pharmaceuticals	10 – 16^3	25–100+

An interesting variation of the quantification of the efficiency of chemical processes is to consider their energy efficiency via 'lost work'. This has been estimated by calculating the theoretical work potential of the raw materials and of the final product. In this way the thermodynamic efficiency, and hence the lost work for industrial processes, can be calculated [9]. When this exercise is carried out for some of the largest scale chemical processes, even these often are shown to be very inefficient (Table 1.3). Thus, although large-scale chemical processes often may be relatively atom efficient, at least compared with the largely inefficient reactions utilised at the lower volume end of chemicals manufacturing, these can show low energetic efficiencies. It seems that we cannot be proud of the effective utilisation of precious resources because very little of that goes on in chemical manufacturing.

Table 1.3 Global 'lost work' in major chemical processes

Process	Theoretical work potential (kJ mol ⁻¹ final product)		
	Raw materials	Final product ^a	Thermodynamic efficiency (%)
Natural gas + air → methanol	1136	717	63
Natural gas + air → hydrogen	409	236	58
Ammonia (from natural gas + air) → nitric acid	995	43	4
Copper ore → copper	1537	130	9
Bauxite → aluminium	4703	888	19

^a Excludes any 'steam credit'.

The term 'green chemistry' is becoming the worldwide term used to describe the development of more eco-friendly, sustainable chemical products and processes. The term was coined almost ten years ago by the US Environmental Protection Agency and has been defined as:

'The utilisation of a set of principles that reduces or eliminates the use or generation of hazardous substances in the design, manufacture and application of chemical products' (Paul Anastas)

This is elaborated further in the form of the so-called Principles of Green Chemistry:

- Waste prevention is better than treatment or clean-up
- Chemical synthesis should maximise the incorporation of all starting materials
- Chemical synthesis ideally should use and generate non-hazardous substances
- Chemical products should be designed to be non-toxic
- Catalysts are superior to reagents
- The use of auxiliaries should be minimised
- Energy demands in chemical syntheses should be minimised
- Raw materials increasingly should be renewable
- Derivations should be minimised
- Chemical products should break down into innocuous products
- Chemical processes require better control
- Substances should have minimum potential for accidents

The chemical technologies, both new and established, that are described in this book address these principles by considering atom efficiency, alternative energy sources, the use of alternative feedstocks, in-

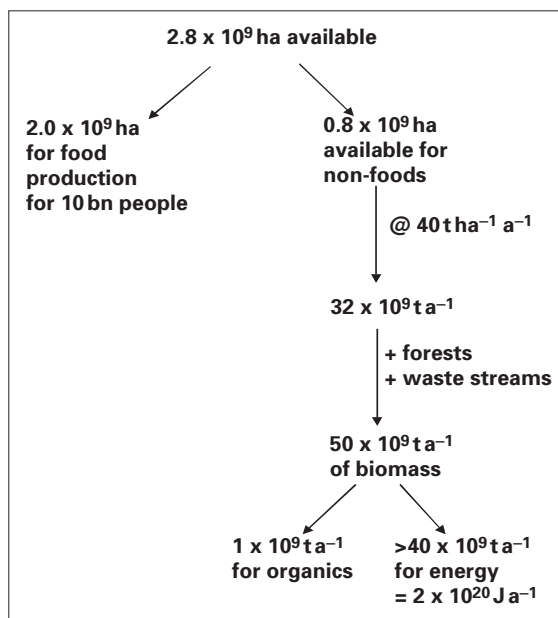


Fig. 1.6 Biomass utilisation in 2040.

novative engineering, clean synthesis and process improvements.

It is, perhaps, worth focusing briefly on one of these principles as we enter the century where oil reserves will be seriously diminished: 'Raw materials increasingly should be renewable'. Can we base the future chemical industry on biomass? Remarkably, at least some of the better calculations show that this is a very likely scenario [10]. With a modest increase in farming efficiency to improve crop yield to about 40 t ha⁻¹ year⁻¹ we will need only less than 1% of the biomass available globally to provide all the raw material necessary to feed the entire organic chemicals industry by 2040 (Fig. 1.6).

Assuming a global population of 10 billion by that year, we can still reasonably expect to produce enough 'spare' biomass to supply some 19% of the energy requirements of that future society (Table 1.4).

This would still make us very reliant on fossil fuels but, significantly, much less dependent on oils, the most vulnerable of the major energy sources based on the current rate of utilisation. Feeding, maintaining and providing material comforts for all is indeed within our grasp if, to paraphrase Mahatma Gandhi, we seek to satisfy our need and not our greed.

By incorporating raw materials considerations into the 'big picture' we can move towards the ultimately

essential concept of life-cycle assessment. The life-cycle of a product can be considered as [11]:

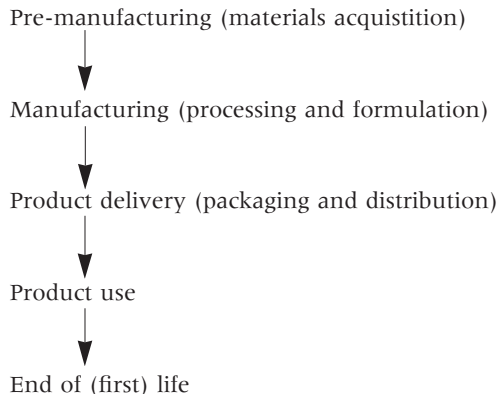


Table 1.4 From fossil to green

Energy source	Percentage of energy sources	
	1990 ^a	2040 ^b
Oil	38	17
Coal	20	18
Gas	16	14
Biomass	16	19
Hydro	5	5
Nuclear	5	6
Solar	—	14
Wind	—	7

^a Based on an energy consumption of 3.5×10^{20} J.

^b Based on an energy consumption of 1×10^{21} J.

This model can be elaborated for a life-cycle assessment for chemical products (Fig. 1.7).

This quickly allows us to recognise the vital importance of the other end of the product cycle: end of life. The recycling of waste is not embraced strictly by the principles of green chemistry, because they are focused on avoiding waste at source, but its importance cannot be ignored. If a product cannot be dissipated quickly and safely into the environment, then it is essential that it or its component parts are efficiently recycled. We can no longer afford single-use products.

Pollution prevention options can be considered at every stage in the life-cycle of a chemical product (Fig. 1.8) [11]. In general, we should be looking

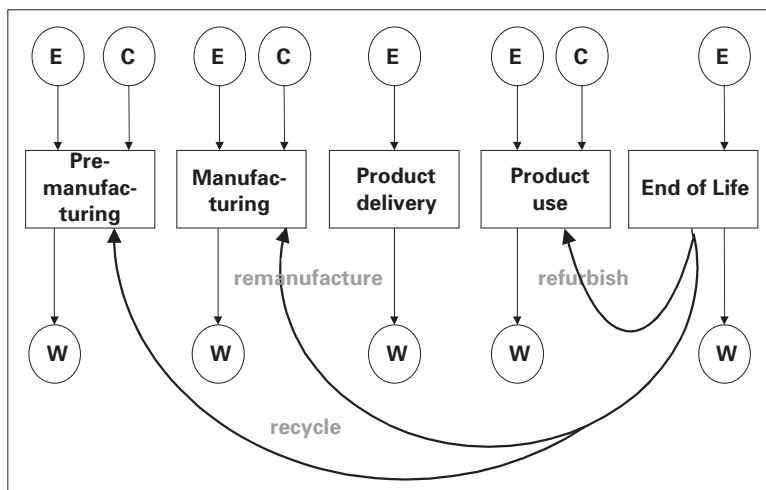


Fig. 1.7 Life-cycle assessment for chemical products (E = energy input; C = consumables input; W = waste).

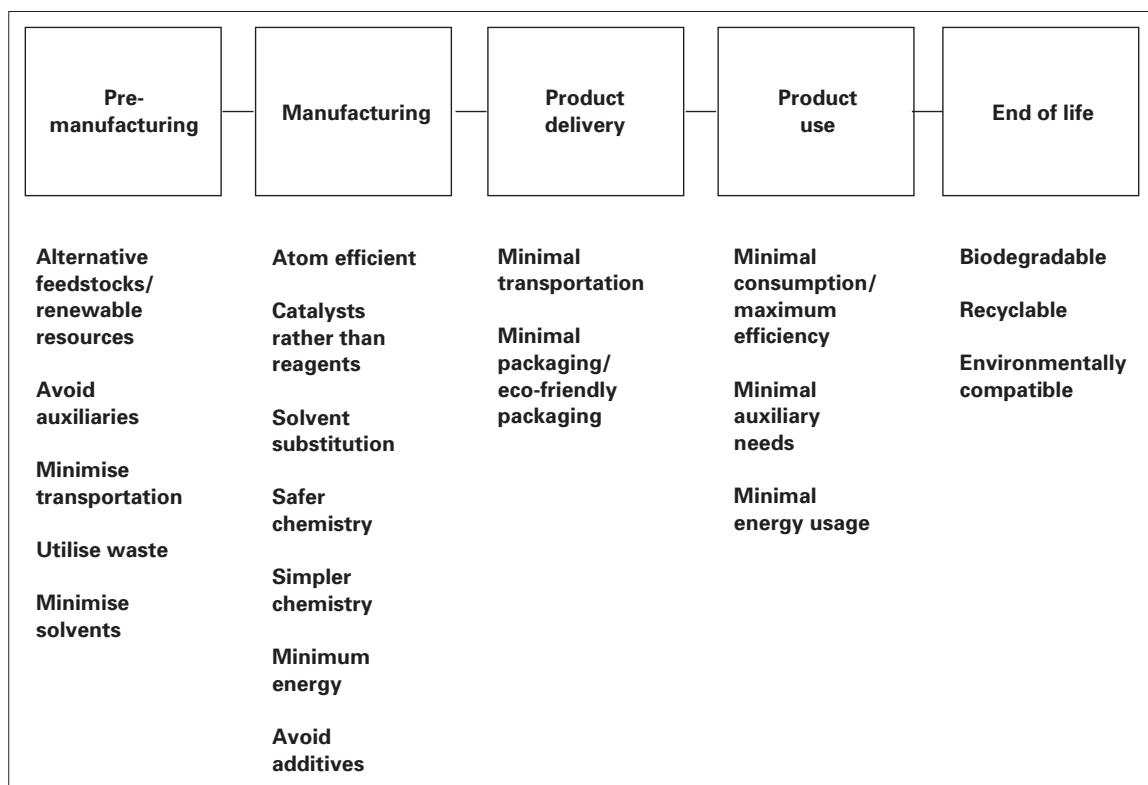


Fig. 1.8 Pollution prevention options in the life-cycle of a chemical product.

increasingly at the industrial ecology goals for green chemistry [11]:

- Adopt a life-cycle perspective regarding chemical products and processes
- Realise that the activities of your suppliers and customers determine, in part, the greenness of your product
- For non-dissipative products, consider recyclability
- For dissipative products (e.g. pharmaceuticals, crop-protection chemicals), consider the environmental impact of product delivery
- Perform green process design as well as green product design

Life-cycle assessment is given better and more detailed consideration in later chapters in this book.

A number of green chemistry and sustainable chemistry initiatives now are in place or becoming

established in various corners of the globe, including the USA, UK, Australia and Japan. In the UK, the Green Chemistry Network (GCN) [12] was established in 1998 with funding from the Royal Society of Chemistry. The GCN has its hub based at the University of York in England and benefits from close collaboration with the world-famous Science Education Group and the Chemical Industries Education Centre, as well as the staff of one of the UK's most successful Chemistry Departments. The GCN promotes green chemistry through increased awareness, education and training and facilitates the sharing of good practice in green chemistry through conferences, technology transfer activities and by acting as a focal point for relevant information. It is doing this by providing educational material for all levels, training courses for industrialists and teachers, conferences and seminars on green chemistry, technology transfer brokerage, databases of green chemistry articles and links to other relevant activities, notably through a dynamic website.

The GCN works alongside the Royal Society of

Chemistry journal, *Green Chemistry*, which provides news on grants, initiatives, educational and industrial development and conferences, as well as a who's-who on green chemistry research and regular peer-reviewed articles from chemistry and chemical engineering university departments and chemical and pharmaceutical companies across the world.

The US Green Chemistry Institute (GCI) has been promoting the principles and practice of green chemistry for several years. The GCI, which now has core funding from, and links with, the American Chemical Society (ACS), is dedicated to encouraging environmentally benign chemical synthesis and promoting research and education. The US Presidential Green Chemistry Awards Programme recognises and publicises achievements by industry and academe, encouraging industry to talk openly about its innovative clean chemistry and providing scientists and education with some excellent case studies. There are now green-chemistry-related award schemes in several other countries, including the UK, Italy, Australia and Japan. Major green chemistry or sustainable chemistry networks and related initiatives have been set up across the globe with significant developments, including a series of Gordon Green Chemistry conferences (in the USA and UK) and the

first International Union of Pure and Applied Chemistry (IUPAC) International Symposium of Green Chemistry (in India). The greening of chemistry is truly underway!

References

1. Breslau, R. *Chemistry Today and Tomorrow*. Awareness Chemical Society, Washington, 1997.
2. Clark, J. H. *The Chemistry of Waste Minimisation*. Blackie Academic, London, 1995.
3. MORI. *The Public Image of the Chemical Industry*. Research study conducted for the Chemical Industries Association. MORI, London, 1999.
4. CEFIC. *CEFIC Pan European Survey 2000*. Image of the Chemical Industry Summary. CEFIC, Brussels, 2000.
5. Based on: Woodhouse, E. J. *Social Reconstruction of a Technoscience?: The Greening of Chemistry*. <http://www.rpi.edu/~woodhe/docs/green.html>
6. Trost, B. M. *Angew Chem. Int. Food Engl.*, 1995, **34**, 259.
7. Clark, J. H. *Green Chem.*, 1999, **1**, 1.
8. Sheldon, R. A. *Chemtech*, 1994, **March**, 38.
9. Hinderink, A. P., van der Kooi, H. J., & de Swaan Arons, J. *Green Chem.*, 1999, **1**, G176.
10. Okkerse, C., & van Bekkum, H. *Green Chem.*, 1999, **1**, 107.
11. Anastas, P. T., & Lankey, R. L. *Green Chem.*, 2000, **2**, 289.
12. See <http://www.rsc.org/greenchem/>

Chapter 2: Principles of Sustainable and Green Chemistry

MIKE LANCASTER

1 Introduction

In the modern context, the terms 'sustainable development' and 'green chemistry' have been around for less than 15 years. Discussion of sustainability began, essentially, when the 1987 UN Commission on Environment and Development (usually referred to as the Bruntland Commission) noted that economic development might lead to a deterioration, not an improvement, in the quality of people's lives [1]. This led to the now commonly accepted definition of 'sustainable development' as being:

'Development which meets the needs of the present without compromising the ability of future generations to meet their own needs.'

This definition is intentionally broad, covering all aspects of society. The debate on what it actually means, in practical terms, for different disciplines and sectors of society continues, and indeed there are those who argue that it is a contradiction in terms. However, working interpretations of the definition are becoming established [2]. For example, in planning it is the process of urban revitalisation that seeks to integrate urbanisation with nature preservation; in biology it is associated with the protection of biodiversity; in economics it is the accounting for 'natural capital'.

Sustainable development has particular relevance for chemistry-based industries because it is concerned with avoidance of pollution and the reckless use of natural resources. In essence it is being recognised increasingly as the pursuit of the principles and goals of green chemistry.

The Green Chemistry Movement was started in the early 1990s by the US Environmental Protection Agency (EPA) as a means of encouraging industry and academia to use chemistry for pollution prevention. More specifically, the green chemistry mission was:

'To promote innovative chemical technologies that reduce or eliminate the use or generation of haz-

ardous substances in the design, manufacture and use of chemical products.'

In conjunction with the American Chemical Society, the EPA developed green chemistry into a set of twelve guiding principles [3]. These principles can be summarised as being concerned with ensuring that:

- The maximum amounts of reagents are converted to useful product (atom economy)
- Production of waste is minimised through reaction design
- Non-hazardous raw materials and products are used and produced wherever possible
- Processes are designed to be inherently safe
- Greater consideration is given to using renewable feedstocks
- Processes are designed to be energy efficient

These principles and associated terminology are becoming widely accepted as a universal code of practice as the Green Chemistry Movement spreads out of the USA into Europe, Australia and Asia. It is evident from these principles that green chemistry encompasses much more of the concepts of sustainability than simply preventing pollution; two important aspects are the design for energy efficiency and the use of renewable feedstocks.

This chapter will explore some of the key features of these principles, many of which will be dealt with in greater depth in other parts of the book, and assess the relevance and opportunities for the chemical industry.

2 Green Chemistry and Industry

Chemical companies worldwide now are taking the issue of sustainable and green chemistry seriously. A combination of increasing amounts of legislation, increased public awareness and concern and the realisation that eco-efficiency is good for business are rapidly increasing the rate of change. The first real proof that the chemical industry was serious about environmental concerns came with the 'responsible

Table 2.1 Key principles and indicators of the Responsible Care Programme

Principles	Indicators
Resource Conservation—waste reduction Experience Learning—sharing best practice	Safety—lost time accidents Waste Emissions—continuous reduction
Process Safety—risk management improvements Product Stewardship—risk assessment	Energy Consumption—targeted
Policy—HSE policy to reflect commitment Management Systems—address impact of activities	

HSE, Health & Safety Executive.

care' concept, which was developed by the Canadian Chemical Producers Association in 1989 and has been adopted since by many industry association members throughout the world. The key behind responsible care is the continuous delivery of health, safety and environmental improvements related to both products and processes. Some of the guiding principles and performance indicators of the Responsible Care Programme are shown in Table 2.1; the similarity of many of these to the principles of green chemistry is self-evident.

Despite this overall commitment, environmental protection also is often seen by industry as a necessary cost to comply with increasingly stringent legislation. There is a great deal of justification in this view; a recent survey, commissioned by the UK Department of Environment Transport and Regions [4], showed that expenditure on environmental protection, by the UK industry, had risen from £2482 million in 1994 to £4274 million in 1997. The chemical industry bore the brunt of this expenditure, which was some 24% of the total spend. Looking at the capital expenditure element of these figures (Fig. 2.1), it is evident that the chemical industry is heavily focused on end-of-pipe solutions rather than on the integrated process approach, which would prevent many of the environmental issues arising.

Clearly there is significant scope for wider adoption and investment in cleaner and greener processes, thus avoiding the need for much of the end-of-pipe expenditure. One of the major goals of green chemistry is to demonstrate that adoption of the principles, by industry, can create a competitive advantage [5]. In this context it is helpful to look at green chemistry as a reduction process.

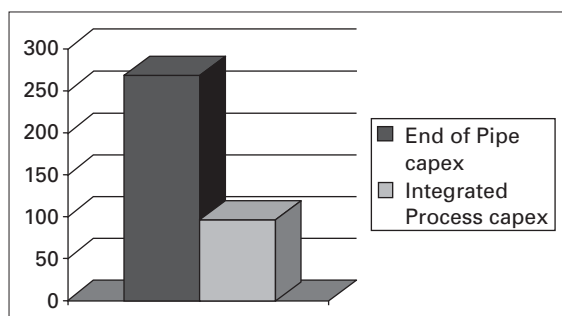


Fig. 2.1 The 1997 capital expenditure by the UK chemical industry (£million) on environmental protection.

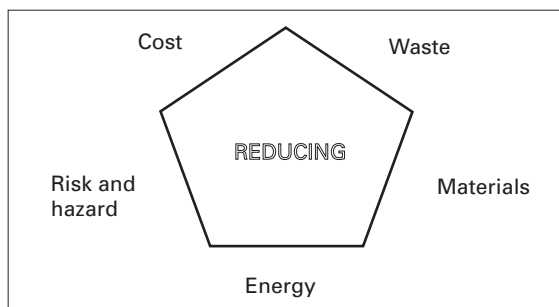


Fig. 2.2 Green chemistry as a reduction process.

The simple model of Fig. 2.2 incorporates the key elements of green chemistry in a way that finance directors, environmentalists, production managers, R&D technologists and chief executives can all understand and, hopefully, buy into.

By looking at the principles of green chemistry as a tool-kit for achieving this reduction process, it

becomes more evident that as waste, energy, etc. are reduced the cost of the process also normally will be reduced. This economic advantage undoubtedly will be the biggest driver for change. There will, however, be other advantages for industry, not least of which will be an improvement in the public image, which is at an all time low in many countries [6] mainly due to the perception that the industry is environmentally unfriendly. We can see now how green chemistry becomes connected to the increasingly important business concept of the 'triple bottom line' in which business performance is measured not only in terms of profitability but also in terms of the environmental and social performance of the company. Although it is easy to buy into the concepts of sustainable development, it is often more difficult to achieve the objectives in practice. Many of these difficulties are to do with culture and the way chemistry and related disciplines are taught and practised. What is really required is a culture change both in education and industry. In education the principles of green chemistry need to be the underlying theme, not taught in isolation. In industry the principles of sustainability should form part of the company ethos and be reflected in management systems and procedures.

3 Waste Minimisation and Atom Economy

3.1 Atom economy

Generations of chemists, especially organic chemists, have been educated to devise synthetic reactions to maximise yield and purity. Although these are worthy goals, reactions may proceed in 100% yield to give a product of 100% purity and still produce more waste than product. In simplistic terms, Equation 2.1:



in which A and B react to give product C in high yield and high purity, also leads to the formation of by-products (or waste) D and E in stoichiometric quantities. For many years phenol was manufactured via the reaction of sodium benzene sulfonate (from benzene sulfonation) with sodium hydroxide; the products of this reaction are sodium phenolate (which is hydrolysed subsequently to phenol), sodium sulfite and water. Even if the reaction proceeds in quantitative yield, it is evident from looking at the molecular weights of the product (sodium phenolate) and unwanted by-products (sodium sulfite and water) that, in terms of weight, the reaction produces more waste than product. Historically, however, the chemist would not consider the production of this aqueous salt waste to be of any importance when designing the process.

The atom economy concept proposed by Trost [7] is one of the most useful tools available for design of reactions with minimum waste. The concept is that for economic and environmental reasons reactions should be designed to be atom efficient, i.e. as many of the reacting atoms as possible should end up in useful products. In the example shown in Fig. 2.3 all the carbon atoms present in the starting material are incorporated into the product, giving a carbon atom efficiency of 100%, but none of the sulfur ends up as useful product and hence the atom efficiency for sulfur is 0%. Overall, the atom efficiency of the reaction is defined as the ratio of the molecular weights of desired product to the sum of the molecular weights of all materials produced in the process. In the above example the atom efficiency would be $116/260$ or 44.6%.

The concept of atom economy has been expanded usefully by Sheldon [8,9], by the introduction of the term 'E factor', which is the ratio of the kilograms of

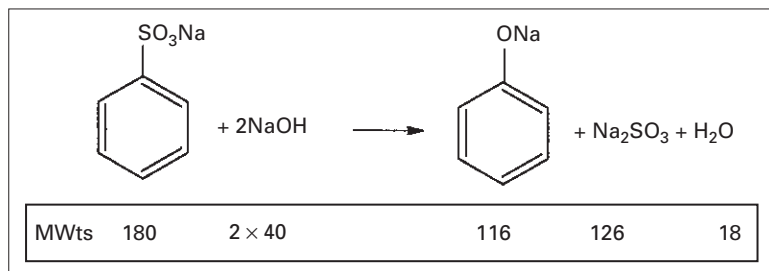


Fig. 2.3 Benzene sulfonate route to phenol.

by-product per kilogram of product. In this context, by-product is taken to mean everything other than useful product, including any solvent consumed. This concept is particularly useful for comparing industrial processes, where the yield also can be taken into account. Assuming a 100% yield for the example in Fig. 2.3, we would have an E factor of 144/116 or 1.24 (the water produced could be justifiably ignored, improving the E factor to 1.08). According to Sheldon, this is typical of a bulk chemicals production process, however in the fine chemicals industry the E factor can be as high as 50 whereas in the pharmaceuticals sector it may be even higher, which is striking evidence of the waste problem faced by chemistry-based industries.

The cost and associated environmental problems of disposing the sodium sulfite produced in the phenol process contributed to its replacement, on economic grounds, by the cumene process. In this process the final step involves the acid-catalysed decomposition of cumene hydroperoxide to phenol and acetone (Fig. 2.4). In this case both the phenol and acetone are wanted products, hence apart from a very small amount of acid (used to aid decomposition of the hydroperoxide) this reaction has a 100% atom efficiency and a zero E factor, indicating a completely waste-free process (assuming 100% yield).

Of course the atom economy concept should not replace consideration of yield, ease of product isolation, purity requirements, etc. when devising a chemical synthesis but it should be thought of as an additional consideration. The economics of chemical production are changing, particularly in the fine, speciality and pharmaceuticals sectors, where waste generation and other environmental considerations are becoming an increasingly significant [10] proportion of the overall manufacturing cost.

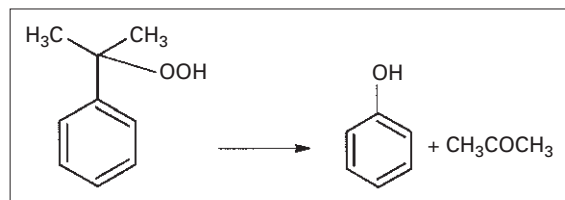


Fig. 2.4 Cumene route to phenol.

3.2 Some inherently atom economic reactions

By their very nature some reaction types are likely to produce less waste than others by virtue of being inherently atom efficient. These reaction types are worth considering when devising a synthetic strategy. Obviously other factors also need to be taken into account in determining the most efficient, competitive and eco-friendly route. These factors include:

- Cost and availability of raw materials
- Toxicity/hazardous nature of raw materials
- Yield
- Ease of product isolation and purification
- Solvent requirements
- Energy requirements
- Equipment requirements, cost and availability
- Process times
- Nature of waste materials

Pericyclic [11] reactions occur via a concerted process through a cyclic transition state. These reactions are typified by the Diels–Alder reaction, sigmatropic rearrangements and cheletropic additions, amongst others, and have theoretical atom efficiencies of 100% and hence should be high on the list of considerations when designing synthetic pathways.

Organic fungicides have played a vital role in ensuring the plentiful supply of food and, although many are not perfect from an environmental point of view, they are generally more eco-friendly and less toxic than the mercury-based fungicides that they replaced. One of the major classes of contact fungicides used today are the sulfenamides, typified by Captan and the related materials Folpet and Difoltan [12]. The starting reaction to all these materials is the Diels–Alder addition of maleic anhydride to butadiene (Fig. 2.5).

Many Diels–Alder reactions are carried out in organic solvents, and non-recoverable lewis acids such as aluminium chloride frequently are used to extend the range and speed up the reactions. Both of these may detract from the ‘greenness’ but there are examples where these reactions occur rapidly without the use of catalysts or organic solvents. 2,2,5-Trisubstituted tetrahydrofurans are a novel class of antifungal compounds; their synthesis involves the key Diels–Alder reaction shown in Fig. 2.6. Saksena [13] found that the reaction proceeded

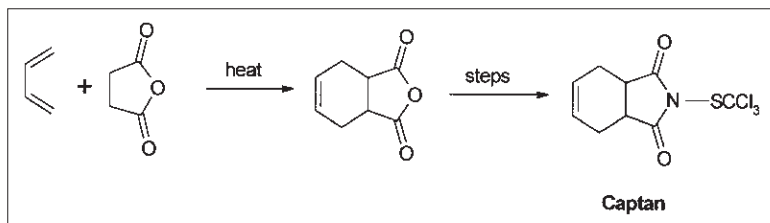


Fig. 2.5 Captan synthesis.

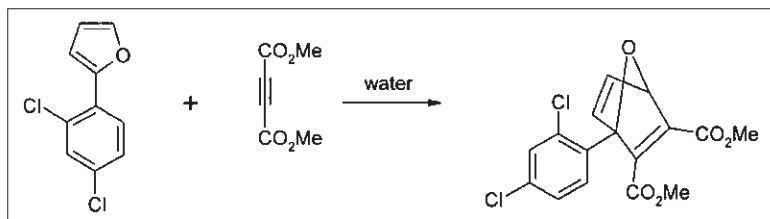


Fig. 2.6 Water-based Diels–Alder reaction—intermediate to antifungal compounds.

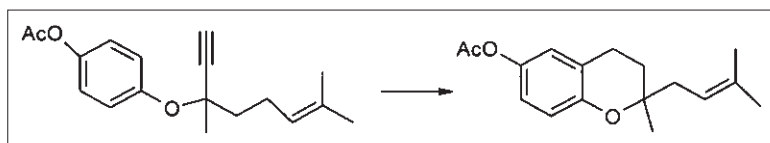


Fig. 2.7 Claisen rearrangement en route to cordiachromene.

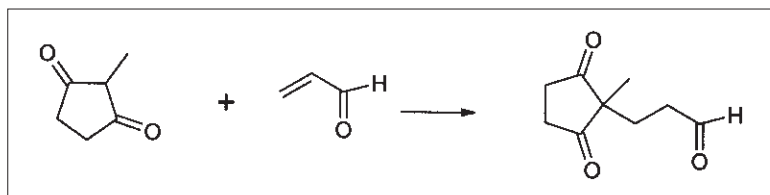


Fig. 2.8 A green Michael addition.

in virtually quantitative yield when water was used as solvent, whereas in organic solvents a highly complex mixture of products was obtained.

Claisen rearrangements are another class of ‘waste-free’ pericyclic reactions of significant importance. Claisen rearrangement of the propargyl ether, which proceeds in 85% yield (Fig. 2.7), is at the heart of a simple route to cordiachromene [14], a natural product that shows significant antibacterial and anti-inflammatory properties.

Addition reactions, in which two molecules combine to form a single molecule of product, are another class of inherently waste-free reactions of

widespread applicability. By their very nature, addition reactions involve an unsaturated bond and are typified by reactions such as electrophilic addition of halogens to alkenes and nucleophilic additions to carbonyls.

Michael additions normally are carried out with base catalysts, however there have been several recent examples of very green Michael additions that occur in high yield in water. A striking example of this is the addition of acrolein to 2-methyl-1,3-cyclopentadione [15], which proceeds in quantitative yield in water at ambient temperature (Fig. 2.8).

3.3 Some inherently atom uneconomic reactions

Similarly there are reactions that will usually produce some waste material; these are typified by substitution and elimination reactions. These reactions should be viewed with caution when designing green syntheses and, if a viable alternative is not possible, attempts made either to recycle or to find a use for the eliminated or substituted product.

The Wittig reaction is highly useful for forming carbon-carbon double bonds and is widely used industrially in the manufacture of vitamins and pharmaceuticals. Although normally proceeding in high yield under mild conditions, it is an inherently wasteful reaction producing a mole equivalent of phosphine oxide per mole of product (Fig. 2.9).

The phosphine oxide normally is converted to calcium phosphate for disposal. It is this 0% phosphorus atom efficiency that makes the Wittig reaction expensive, as well as environmentally problematic, and limits its usefulness to the production of high-value-added products. The greenness of the reaction can be improved, however, by converting the oxide back to triphenyl phosphine [16,17]. This recycling process, developed by the multinational chemical company BASF, involves chlorination of the phosphine oxide with phosgene, reduction with aluminium powder and hydrolysis. Although not a particularly green process (because it involves the use of hazardous reagents and produces aluminium hydroxide waste), overall, comparing the whole processes including triphenyl phosphine manufacture (Equation 2.2), the BASF route is more environmentally benign and cost effective.



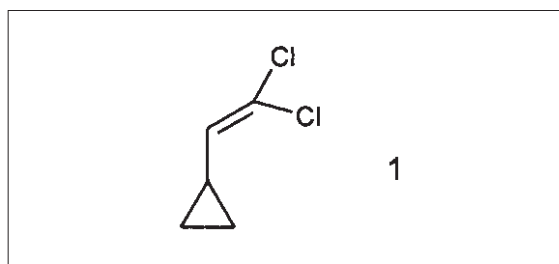
Specific, more environmentally benign alternatives to the Wittig reaction now are being sought. The key (intermediate **1**) to the anti-HIV drug Efavirenza has been produced in a one-pot process (see Scheme 2.1) with an overall yield of 92% [18]. The process involves reaction of cyclopropylcarboxaldehyde (the

same starting material as used in the Wittig reaction) with trichloromethyl anion generated *in situ*, acetylation and removal of acetate and chloride groups. The process still produces significant amounts of waste but it is much more environmentally benign waste.

4 Reduction of Materials Use

Frequently, many chemical reactions involve the use of reagents such as protecting groups and so-called catalysts that do not end up in the useful product. Organic solvents, often thought to be essential but sometimes not actually required at all, fall into this category. Some of these materials end up as waste and some are recovered, but in all cases valuable resources and energy are consumed that do not form part of the required product.

Materials and money often are wasted in the design of chemical reactors, and new thinking about plant and ancillary equipment design (the process intensification concept) is part of the chemical engineering solution to greener chemical processes. There is a significant amount of synergy between the chemistry and engineering approaches to materials reduction. Frequently, low reactor utilisation, because of large solvent volumes for example, may necessitate the building of additional plant. By using the concepts of green chemistry to integrate the



Scheme 2.1

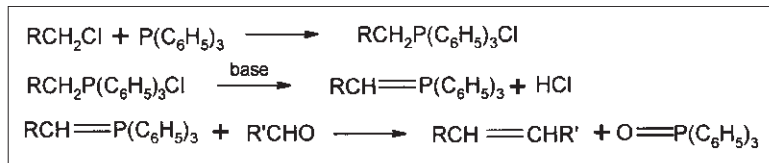


Fig. 2.9 Typical Wittig reaction.

chemistry and plant design, significant material savings can be made.

4.1 Catalytic solutions

Organic chemists very rarely write balanced equations and this can hide a multitude of sins. Taking Friedel–Crafts reactions as an example, alkylation and acylation reactions often are referred to as being catalysed by lewis acids such as aluminium chloride; although this is partially true, it is frequently ignored that the acylation reaction requires more than stoichiometric amounts of AlCl_3 (Fig. 2.10) [19].

In the alkylation reaction AlCl_3 is required only in small amounts, but in the acylation reaction it complexes with the ketone product and is taken out of the catalytic cycle. In both cases, reactions usually are quenched with water, leading to copious amounts of aluminous waste and releasing three equivalents of HCl . In the case of the acylation of 1,3-dimethylbenzene and assuming a quantitative yield, more than 0.9 kg of AlCl_3 are wasted per kilogram of dimethyl acetophenone produced.

A recent, but classic, example of overcoming the wasted materials issue in aromatic acylations is the Hoechst Celanese route to the analgesic ibuprofen [20]. The reaction involves acylation of isobutylbenzene with acetic anhydride, a process that had been carried out traditionally with AlCl_3 in an organic solvent. The Hoechst Celanese process employs liquid HF as both a true catalyst and solvent, the HF

being, for all practical purposes, completely recycled. Although the purist could argue that this process may not be particularly ‘intrinsically safe’ due to the potential hazard associated with handling HF , it is considerably greener in the context of reduced materials consumption.

Much academic and industrial research effort has gone into the greening of Friedel–Crafts processes, with the aim of developing benign, easily recyclable, inexpensive, active solid catalysts that are highly selective and avoiding wasted raw materials and by-products. For the alkylation reaction zeolites generally have provided the commercial solution to this problem, with major areas of research work centred on the avoidance of olefin oligomerisation and the development of catalysts stable to the operating conditions. Returning to the production of phenol from cumene (see above), the first step involves the alkylation of benzene with propene, which was carried out originally with AlCl_3 ; today, several commercial zeolite-based processes have been developed. The Mobil process, developed in 1993, employs a high-silica catalyst ZMS-5 that gives almost stoichiometric yields, whereas Dow Chemical have developed a process based on de-aluminated mordenite [21]. The development of solid acid catalysts to solve the many problems associated with the acylation reaction generally has proved more problematic, but for activated substrates such as aryl ethers Rhone-Poulenc have developed an H-beta-zeolite catalyst [22].

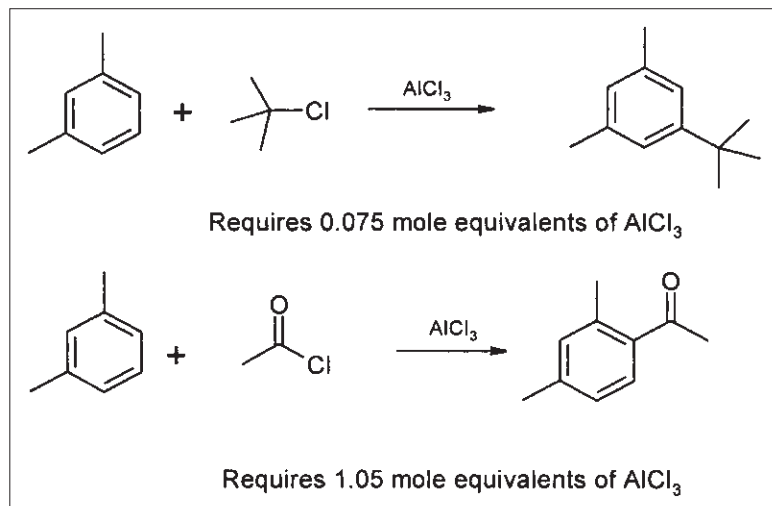


Fig. 2.10 Typical Friedel–Crafts reactions.

Another very important industrial process that essentially gives a free ride to a reactant is that of aromatic nitration. Aromatic nitro compounds are used widely as intermediates for dyes, plastics and pharmaceuticals, and for monosubstituted aromatic substrates it is often the *para*-isomer that is the required product. Conventional nitration technology uses a mixture of concentrated nitric and sulfuric acids, the latter acid often being used in considerable molar excess. The sulfuric acid is present in order to generate nitronium ions, which are the active nitration species and, in principle, are still present unchanged in the product mix. In practice, the reaction mix usually is quenched with water, leading to copious amounts of acidic waste to be disposed of. Smith *et al.* [23] have developed a more selective *para*-alkylation procedure that does not involve the use of sulfuric acid. *Para*-selectivity is enhanced by the use of recoverable zeolites but more than equimolar amounts of acetic anhydride are required to generate the active nitrating species ($\text{CH}_3\text{CO}_2\text{NO}_2$) and to mop up the water formed; material usage therefore is still high.

True catalytic nitration technology has been developed using lanthanide(III) triflates [24]. Lanthanide(III) triflates are unusual in that they function as strong Lewis acids, are stable to water and hence are recoverable from aqueous solutions. Using ytterbium or scandium triflate at levels as low as 1 mol.% and equimolar amounts of nitric acid, nitration of a range of aromatic compounds was achieved at around 90% conversion.

Rearrangements inherently should be atom efficient processes but sometimes the 'catalyst' required to cause the rearrangement cannot be readily recovered and reused. This is the case with some production processes for ethylidene norbornene (ENB) from vinylidene norbornene (VNB) (Fig. 2.11). The ENB is used as the 'diene' component in ethene-propene diene monomer (EPDM) rubbers and it is often manufactured by Diels-Alder reaction of cyclopentadiene with butadiene, followed by rearrangement of the so-formed VNB using sodium/potassium amalgam in liquid ammonia. Although most of the liquid ammonia (which is also used as a solvent) is recovered, there is significant loss of metals. Sumitomo [25] have developed an alternative solid base catalyst (Na/NaOH on γ -alumina) that avoids waste and improves the safety aspects of the process.

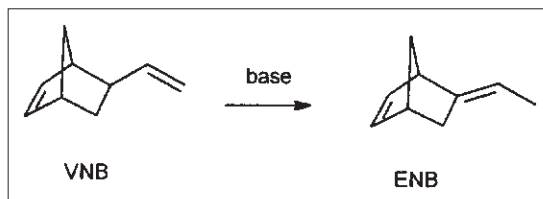


Fig. 2.11 Rearrangement of vinylidene norbornene (VNB) to ethylidene norbornene (ENB).

4.2 Question the need for protection

Another major source of raw material wastage comes from the use of protecting groups, frequently used in the synthesis of pharmaceuticals; these are necessarily used in stoichiometric amounts. Not only are the raw materials wasted but their use frequently requires an additional two process steps, involving increased uses of solvents, lower yields, etc. Wherever possible, the use of ancillary reagents such as protecting groups should be avoided. An excellent example of process simplification in which a three-step route has been reduced to a single step by a biotransformation is the manufacture of 6-aminopenicillanic acid, an antibiotic intermediate [26].

The original process involved protection of the carboxylate group in penicillin G by silylation; this reaction also requires dimethyl aniline to remove the HCl produced during silylation (Fig. 2.12). In the biocatalytic process, genetically engineered and immobilised penicillin amidase is used to deacylate penicillin G directly.

There are many additional green benefits to the biocatalytic process, including:

- Avoidance of dichloromethane solvent—water is used in the biocatalytic process
- Energy savings—reaction carried out at 30°C as against -50°C for the protection step
- Fewer safety problems— PCl_5 also was used in the non-biocatalytic process

4.3 Reduction of non-renewable raw material use

The debate on when the supply of crude oil and gas will run out will not be settled for some considerable time. There is, however a growing consensus of opinion that, at least as far as oil is concerned, if we

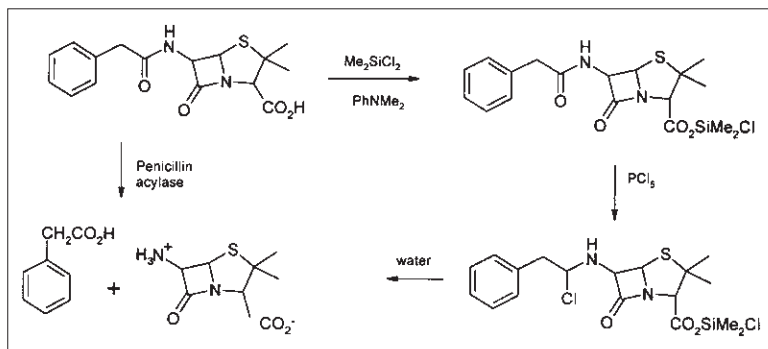


Fig. 2.12 Routes to 6-aminopenicillanic acid.

continue to use resources at the current rate we will face a significant shortage (combined with a very high price) some time in the second half of this century [27]. The use of non-renewable resources for chemicals manufacture must be put into perspective: approximately 90% of crude oil currently is used to provide energy via burning of oil, gasoline and diesel, with only 8% of crude being converted into chemicals. The two main arguments for reducing our dependency on fossils and increasing our use of renewable feedstocks are:

- (1) To conserve valuable supplies of fossil fuels for future generations (a core principle of sustainability).
- (2) To reduce global emissions of greenhouse gases, especially carbon dioxide (renewable resources being CO_2 -neutral overall).

Reduction in the use of fossil fuels for chemicals manufacture will have some benefit on conserving resources and reducing CO_2 emissions, but these will be small compared to what can be achieved by using renewable resources for energy production. Chemicals manufacture from renewable resources, therefore, ideally should provide additional benefits such as reduced hazard, more efficient process, reduced cost, reduced pollution, meeting market needs, etc. Additionally, it is important to look at the whole process, including growing, transport, etc., to ensure that the total energy consumed (or total CO_2 emission) is lower when employing the renewable resource. Chemistry does have a vital role to play in reducing the requirement for fossil fuels, e.g. more efficient combustion processes, the development of energy-efficient solar and fuel cells and the production of biodiesel.

Table 2.2 Some disadvantages of vegetable-oil-based diesel

High viscosity
Lower volatility
Reactivity of unsaturated chains, leading to gum formation
Increased coking

There is nothing particularly new about using vegetable-based diesel oils [28] but during the last 60 years or so the advent of relatively inexpensive and technically superior petroleum-based diesel has prevented their widespread use. In recent years there has been considerable renewed interest in the competitive production of biodiesel to overcome many of the environmental issues associated with the petroleum-based material [29]. Some of the disadvantages of vegetable-oil-based diesel are shown in Table 2.2.

These disadvantages generally preclude the use of unmodified vegetable oils, although there are many examples of 20–50% blends with conventional diesel being used for prolonged periods [30]. Transesterification has been the major technique employed to overcome these technical problems (especially high viscosity), although at added cost. Typically the anhydrous oil (triglycerides) is heated with methanol and a basic catalyst to give a mixture of methyl esters and glycerol, which is recovered as a valuable co-product. Although sodium hydroxide and sodium methoxide are widely used as catalysts, a ‘green’ process involving a reusable immobilised lipase catalyst and supercritical carbon dioxide has been demonstrated [31].

The main obstacle to widespread use of biodiesel is the cost, of which up to 75% can be the raw

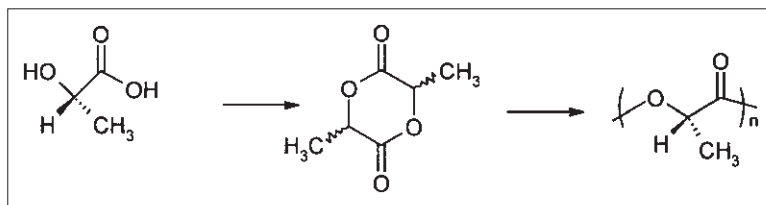


Fig. 2.13 Polylactic acid synthesis.

vegetable oil cost; this has focused attention onto the use of used cooking oil for example, but non-uniformity, availability and collection issues have prevented commercial use to date.

Use of renewable resources for making polymers is an area receiving much attention due to the relative ease of making biodegradable plastics with useful chemical and physical properties. It is important to caution against the perception, however, that just because a plastic is made from a renewable resource it is automatically greener than one made from petroleum. Many petroleum-based polymers such as polyethylene [32] and polyisoprene are fairly readily biodegraded; it is the additives (antioxidants) specifically added to prevent degradation, thus ensuring a useful life, that are the causes of many of the environmental problems. As in the case of biodiesel, one of the main issues preventing growth of the 'renewable polymers' sector is cost. In many cases the cost is associated with the relatively small amount of the required chemical being present in the crop, entailing high extraction cost and the production of large quantities of waste. In these cases a holistic approach is required with, for example, waste biomass being used as a fuel.

Recent advances in producing polylactic acid (PLA) from corn starch have led to the building of the first large-scale commercial production unit by Cargill-Dow [33]. The commercial viability of the polymer relies on novel processing that can be used to manipulate the molecular weight, crystallinity and chain branching, enabling materials with a wide range of end uses and markets to be made. Potential applications for PLA include:

- Packaging—PLA can have the processability of polystyrene and the strength properties of poly(ethylene terephthalate), with good resistance to fats and oils.
- Textiles—PLA has good drape, wrinkle and UV-light-resistance properties.

The process involves fermentation of unrefined dextrose, derived from corn, to give D- and L-lactic acids, which are converted to D-, L- and *meso*-lactides before polymerisation (Fig. 2.13). By controlling the D, L and *meso* ratio, together with molecular weight, polymer properties can be tailored to meet product specifications [34].

Society in the not too distant future will need to find viable alternatives to the use of fossil fuels for energy and probably for the synthesis of many chemicals. If the solution is to grow our energy, as opposed to using solar cells for example, then we will need to face the issues concerned with land usage [35]. Although there is no real shortage of land on the planet, there are serious debates as to the viability of growing most of our energy needs. These debates centre on land quality, accessibility, nearness to population centres, etc.

4.4 Process intensification

When designing a chemical process the engineering aspects are as important as the chemistry and it is often the lack of interaction between chemists and engineers at an early enough stage that results in processes being developed that are not as green or efficient as they otherwise could be. In many ways process intensification can be regarded as the engineering solution to green chemistry problems; the concept originated in the 1970s as a means of making large reductions in the cost of processing systems [36]. Like many cost reduction concepts, process intensification is concerned mainly with reducing materials use and energy consumption by reducing plant footprint and increasing throughput. Some of the key aspects of process intensification are shown in Fig. 2.14 [37].

A fuller account of process intensification is presented elsewhere in the book but in the context of materials reduction it is worth mentioning an

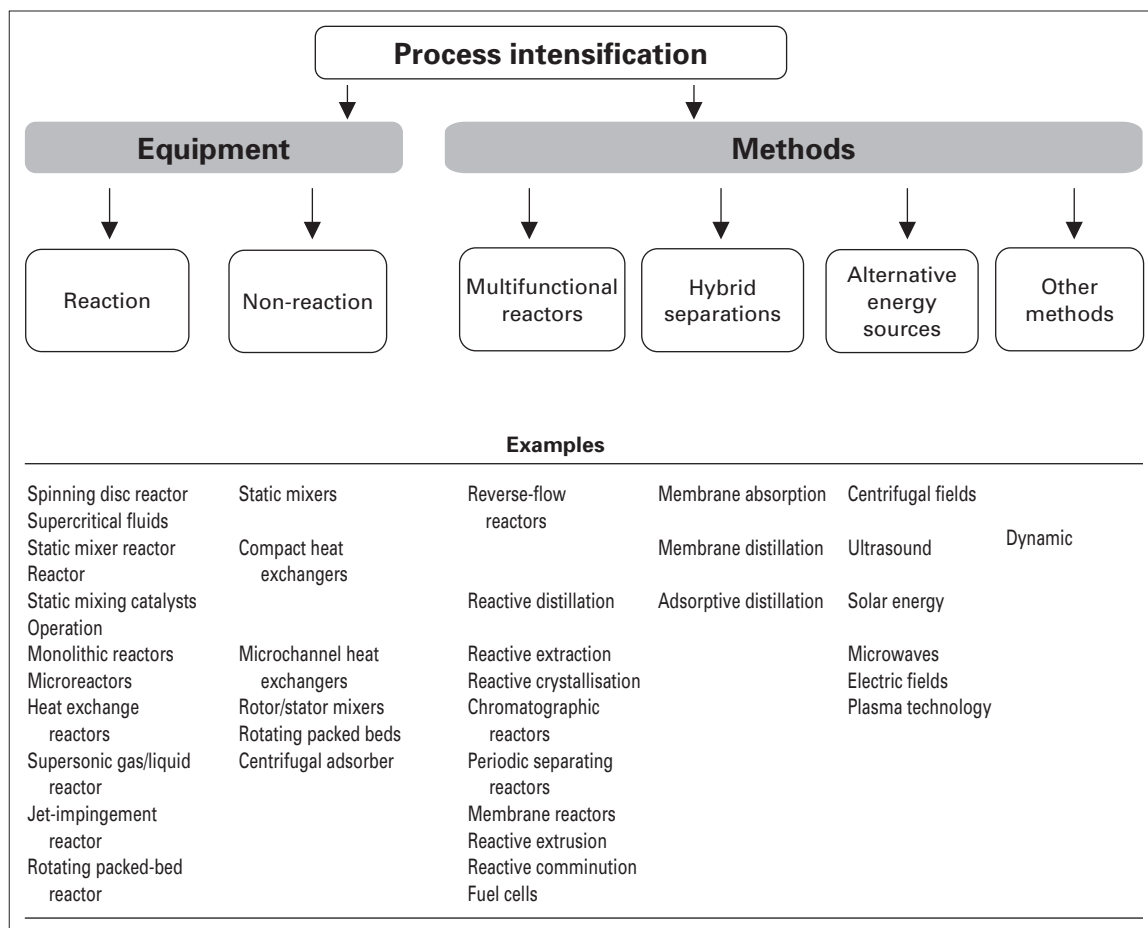


Fig. 2.14 Adapted from Ref. 37. (Reproduced with permission of American Institute of Chemical Engineers.)

example where process intensification has led to significant improvements in throughput overcoming the need for additional plant to be built. Formation of a gel by-product necessitated frequent shut down of a Dow Corning process involving a gas/liquid reaction in a packed column [38]. Owing to increased demand, the company were faced with building another plant at a cost of some US\$5 million or making significant improvements in productivity. The key problems were identified as poor gas–liquid mixing and mass transfer, which were readily solved at a cost of US\$22 000 by adding a static mixer. The result was a 42% increase in productivity, avoid-

ing the requirement for a new plant together with all the materials and energy waste that this would entail.

5 Reduction of Energy Requirement

More than 75% of the world's energy comes from fossil resources [39], with approximately half of the rest coming from biomass and the remainder coming from non-carbon sources. This dependency on fossil fuels has two major consequences:

- (1) It is leading to rapidly diminishing reserves of this valuable non-renewable resource.
- (2) It is contributing to the increasing concentration of CO₂ in the atmosphere.

Although these consequences are not in dispute, there is some dispute over the significance of both rising CO₂ levels and the level of contribution made by the burning of fossil fuels [40]. Governments of most countries now accept that reduction of both the use of fossil fuels and CO₂ emissions will be of environmental benefit and agreements and legislation are being put in place to meet these objectives [41].

Energy requirements of chemical reactions frequently are overlooked at the R&D stage and, for all but the largest commodity processes, were not considered seriously at the production stage either, at least until the oil crisis in the 1970s. As energy has become more expensive and legislative drivers have encouraged greater energy efficiency and conservation, we have seen significant changes in process design. Many of these changes have focused on engineering aspects, such as using hot process streams from one part of a process to heat up incoming raw materials, whereas a combination of process re-engineering and catalysis has led to energy savings in many large-scale chemical processes. Even so, energy conservation is one of the most ignored of the 12 Principles of Green Chemistry, especially by chemists!

5.1 Some energy efficiency improvements

Ammonia has been synthesised chemically for almost 100 years. The original electric ark process operated at temperatures of over 3000°C and was highly inefficient. The Haber process was a huge leap for energy efficiency, brought about by the use of a reduced magnetite catalyst [42]. Although the underlying principles of the Haber process have changed little, the energy consumption of the process is now less than 40% of the original process [43].

Initially the energy utilisation of the process was less than 20%, however with the replacement of coal by oil, and later gas, as the preferred feedstock the energy efficiency rose to around 60%. Optimisation of turbine equipment, the steam distribution networks and the design of radical flow converters with small-sized catalyst particles have made significant contributions to energy efficiency improvements without significant changes being made to the chemistry.

The production of sulfuric acid has gone through similar historical improvements [43]. The main energy savings have been made in the production of sulfur dioxide, which is the initial step in the process. Originally this was produced by roasting the ore (pyrites) in multiple hearth furnaces and later rotary kilns, the energy produced being lost to the surroundings. The development of fluidised bed technology enabled more than 50% of the excess energy to be recovered and used to raise steam. Many modern plants use sulfur (recovered from oil and gas) as the feedstock and this produces much cleaner SO₂, eliminating the requirement for a cleaning step and saving further energy.

When considering the eco-efficiency and competitiveness of competing processes it is vital that the energy requirements of the process are considered. Unfortunately this detailed information is not readily available for most small- to medium-scale processes. As a striking example of how the energy requirements for producing a given chemical can vary from process to process, let us consider titanium dioxide production. The annual production of TiO₂ is approximately 4.5 million tonnes, made via two competing processes—the sulfate process and the chloride process.

The sulfate process essentially involves three stages:

- (1) Dissolution of the ore (ilmenite) in sulfuric acid and removal of iron impurities
- (2) Formation of hydrated TiO₂ by treatment of the sulfate with base
- (3) Dehydration in a calciner

All three stages are energy intensive [44].

By contrast, the chloride process can, for simplicity, be broken down into two steps:

- (1) Chlorination of the ore with Cl₂ and purification of TiCl₄ by distillation
- (2) Oxidation by burning

Overall, the chloride process is much less energy intensive (by a factor of around 5 [44]), one of the main reasons being the avoidance of large amounts of water that need to be removed by energy-intensive evaporation.

With such a huge energy differential it could be assumed that the chloride process should have shut-down economics, however around 40% of TiO₂ is

still produced via the sulfate route, although this is diminishing. There are two main reasons for this: the sulfate process can use lower grade and therefore less-expensive ores; and it produces anatase pigments as well as rutile, which is the sole product of the chloride process.

5.2 Alternative energy sources

The energy required to bring about chemical reactions is supplied largely by external thermal sources of heat, such as steam, hot oil and electrical heating elements. When designing a process for energy efficiency these conventional energy sources, which do not target the energy, may not be the most efficient and alternatives should be considered. There is currently growing interest in alternative sources of energy that can target specific molecules or bonds, giving both energy savings and improved selectivity. Such alternative energy sources include microwaves and photochemical, ultrasonic and electrochemical sources, some of which are discussed in detail in other chapters of this book. Industrial manufacturing processes using electrochemistry [45] (the obvious example being chlorine/sodium hydroxide manufacture) and, to a somewhat lesser extent, photochemistry [46] (e.g. the synthesis of vitamin D₃, as discussed in most photochemistry textbooks) have been used for many years, with a great deal of success for niche products. Others, such as the use of microwave reactors, are still confined largely to the R&D laboratory. One fairly rare example of microwave energy being used for chemical production is in the vulcanisation of rubber [47], where heat-up rates can be up to 100 times faster than when conventional heating methods are used. As well as saving energy, process productivity is greatly improved and the rubber obtained is less contaminated than that produced using a liquid curing medium.

Although strictly speaking outside the scope of green chemistry, the importance of photochemical and electrochemical techniques to remediation and

end-of-pipe technologies should not be overlooked. For example, photocatalysis plays an important role in the purification and treatment of wastewater [48], whereas the use of electrochemical techniques for the recovery of heavy metals from electroplating processes is becoming widespread [49].

6 Reduction of Risk and Hazard

6.1 Inherently safe design

December 1984 saw the world's worst chemical disaster, with over 3000 people killed and 50 000 people injured. The name Bhopal became synonymous with all that was bad about the chemical industry [50] and the repercussions from the tragedy transformed industries' views on risk and hazard forever. The product made at Bhopal was the insecticide carbaryl (Fig. 2.15); although the chemistry involved was fairly simple, it involved the use of two highly hazardous chemicals, phosgene and methylisocyanate (MIC).

The immediate cause of the accident was the ingress (during routine maintenance) of a large quantity of water into a storage tank containing up to 60 tonnes of intermediate MIC. This caused a large increase in temperature and pressure, eventually causing the storage tank to explode and a toxic gas cloud containing MIC and its hydrolysis products, including hydrogen cyanide, to be released over the nearby town.

It is very easy to blame people, procedures and equipment failure in cases such as this but statistically these will always occur because people are subject to human error, procedures can always be improved with hindsight and even the most well-engineered equipment will fail eventually. It is much more beneficial to identify the real root cause of the problem and to eliminate it. In this case the root cause was the large-scale storage of toxic MIC, so the question is: could carbaryl have been manufactured efficiently without MIC being stored? The answer is yes, but that is irrelevant; what is relevant is that

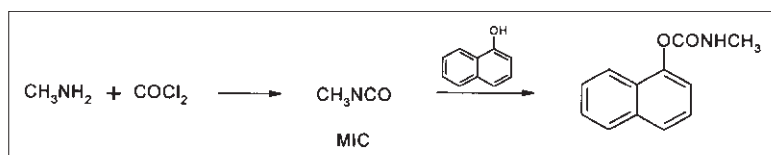


Fig. 2.15 The Bhopal route to carbaryl.

such questions are addressed seriously at the process design stage—the concept of ‘inherently safer design’ [51].

In simple terms, the risk to the environment, human life, etc. is a function of the hazard and the exposure to that hazard. Conventionally, for a given known hazard (e.g. the toxic effects of MIC) the risk has been controlled by reducing exposure through protective equipment, safety devices and other control methods. The basic concept of inherently safer design is that instead of controlling exposure it is the hazards that are, as far as possible, designed out of the process—the ‘what you don’t have can’t harm you approach’. In the Bhopal case such a design would have avoided the storage of both MIC and phosgene. Phosgene would have been made on site (the ‘just in time’ concept) and the use of MIC could have been avoided altogether by initially reacting naphthol with phosgene and subsequently reacting the so-formed chloroformate with methylamine.

Adipic acid manufacture provides a suitable case study that not only involves inherently safe design but also embraces many of the principles of green chemistry discussed above.

World production of adipic acid is approximately 2 million t year⁻¹, the majority of which goes into the manufacture of Nylon 6:6 [52]. More than 90% of adipic acid is manufactured by the oxidation of cyclohexane via a two-stage process (Fig. 2.16) involving initial oxidation with air using a cobalt naphthenate or boric acid catalyst followed by oxidation of the ketone/alcohol mix with an excess of nitric acid [53].

Although this process has been operated successfully for many years by many large chemical companies, there are many associated green and sustainable issues connected with it:

- (1) The Flixborough disaster in 1974 occurred in a cyclohexane oxidation plant operating at 150°C and 10bar pressure. In order to get high selec-

tivity, the plant needed to operate at low conversions (<10%) and so large quantities of process chemicals were held [54]. Although the immediate cause of the disaster at Flixborough is thought to be incorrect installation of bellows, the root causes were the very large inventory of flammable in-process chemicals and the use of oxidation chemistry, which, due to the potential for operating in the explosive region, particularly at air inlet points, can lead to uncontrolled reaction.

- (2) Subsequent to the reaction, the product mix is quenched with water, which removes trace amounts of water-soluble by-products and the catalyst. Although the cobalt is largely recovered (using an ion exchange column for example), this process could contribute to heavy metals entering the environment and is somewhat wasteful of materials and energy. In the case of boric acid catalysts, the yield and conversions are higher, due to the stability to further oxidation of the cyclohexanol borate ester, but the acid must be recovered by evaporation, which is an equipment- and energy-intensive process.
- (3) In stage 2 of the process there are the obvious corrosion problems associated with the use of concentrated nitric acid, necessitating the use of high-grade stainless-steel and titanium equipment, but the most concerning issue is nitrous oxide emission—a greenhouse gas 200 times more potent than carbon dioxide. Until recently, it has been estimated that some 10% of nitrous oxide entering the atmosphere came from adipic acid plants, which is 0.3 kg N₂O kg⁻¹ adipic acid [55].

So what are the questions that need to be asked to make this process greener and more sustainable? The following list is by no means exhaustive but is indicative of the kind of thought process we should be

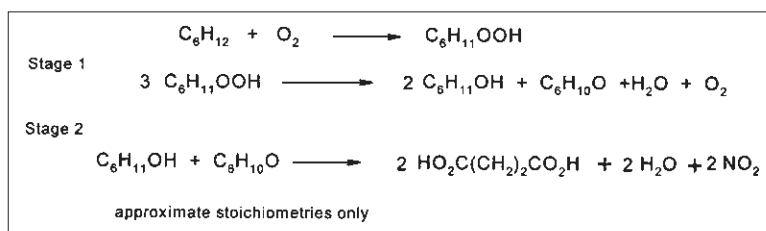


Fig. 2.16 Conventional route to adipic acid.

encouraging our young chemists and engineers to adopt.

- Is the product (adipic acid) required or is there an alternative?
- Are there any alternative routes that can be evaluated and compared?
- Can the ketone/alcohol mix be produced avoiding the inherent hazards involved with oxidation?
- Can the ketone/alcohol mix be produced with lower risk?
- Can the large hydrocarbon inventory be reduced?
- Is there an alternative to the nitric acid oxidation step?
- Can nitrous oxide be recycled in the process to a useful material?
- Can nitrous oxide emissions be avoided?

These types of questions need to be addressed from both the technical and economic viewpoint, with the aim of identifying a more environmentally friendly product or route that is also commercially viable.

Of course many of these questions have been addressed, sometimes in an attempt to improve process and eco-efficiency, and at other times industry has been forced to consider alternatives based on public and legislative pressure following Flixborough and increased concern over the greenhouse effect for example.

Following pressure to reduce nitrous oxide emissions, all major adipic acid manufacturers agreed to adopt some form of nitrous oxide abatement measure by 1998. Most of these procedures involve end-of-pipe technology that overcomes the immediate problem, at some significant cost, but does not address the real issue of avoiding nitrous oxide production. Some of the abatement technologies involved are: catalytic reduction in the presence of methane to nitrogen and carbon dioxide; catalytic dissociation into nitrogen and oxygen; and oxidation to nitric oxide, which can be used to make nitric acid.

In the cyclohexane oxidation stage, small improvements to rate and conversion have been made by improved design of air/liquid mixers and heat exchangers (process intensification) [51], but the inherent hazards associated with stage 1 of the process largely remain.

Perhaps the preferred answer to achieving a greener, more inherently safe process is to find an alternative route. Production of cyclohexanol by catalytic hydrogenation of phenol proceeds in high yield and high selectivity, and at first sight overcomes the cyclohexane oxidation issues. However, the starting material for both routes is benzene, and phenol production involves a similar oxidation step (see cumene route discussed above). Thus, it may be argued that cyclohexanol production has been 'greened' but the issues have been put back a stage. On the other hand, it could be argued that because phenol is produced anyway the number of oxidation plants required has been reduced and therefore the overall risk has been reduced. Although the phenol route is practised, unfavourable economics have prevented widespread adoption of this process.

What could be—at least if the economics were more favourable—the perfect green and sustainable solution has been identified by Frost [56]. The process involves synthesis of adipic acid from glucose via catechol (Fig. 2.17) using a genetically modified *Escherichia coli* biocatalyst.

Several other processes, with varying degrees of greenness, have been developed over the years, including carboalkoxylation of butadiene [57] and dicarbonylation of 1,4-dimethoxybut-2-ene [58], but for various reasons these have not been commercially successful.

The most successful move towards sustainability has been made by Asahi Kasei Corp. [59], who have developed a commercial route to cyclohexanol based on the hydration of cyclohexene (Fig. 2.18). The process relies on the use of a novel high-silica H-

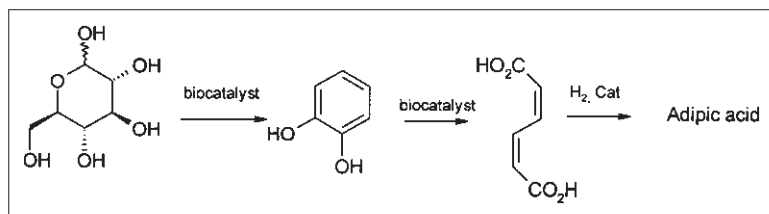


Fig. 2.17 Green route to adipic acid.

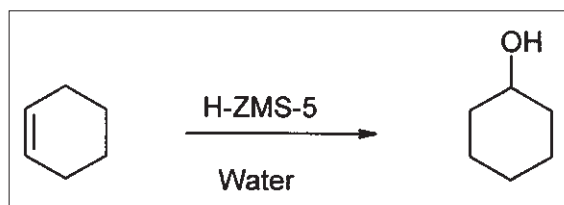


Fig. 2.18 Asahi route to cyclohexanol.

ZMS-5 catalyst and the hydrophobic properties of this catalyst enable selective adsorption of cyclohexene to take place.

6.2 Alternative solvents

The use of benign solvents is of vital importance to the development of green chemistry. The concept is introduced here for convenience but could have been discussed equally under waste minimisation and materials reduction. The use of organic solvents in industry is widespread and, although they play a valuable ‘enabling’ role, they are responsible for significant amounts of pollution to air and water. To control the pollution, industry is spending increasing amounts on volatile organic compounds and other effluent control measures. Many organic solvents are also toxic, necessitating the use of personal protective equipment; although these are being phased out by industry, many are still commonly used in research.

The greenest solution is to use no solvent at all, a concept not considered by most practising chemists, at least where solid reactants are concerned. Raston [60] has reported a striking example of what can be achieved. The widely used aldol condensation usually is carried out in solvents such as ethanol, however Raston’s group have demonstrated that selective, high-yielding conversions could be achieved by grinding together a solid carbonyl compound with sodium hydroxide using a pestle and mortar.

Water is also a much under-utilised solvent for organic reactions and offers the potential for cheaper and safer processes. Water is especially worth considering as a solvent for high-temperature reactions where the ionic product of water is high, making it a stronger acid and base, and where the polarity is lower, making it a better solvent for organic com-

pounds. Largely because of legislation on volatile organic compounds the use of water as a solvent is being more widely studied by industry, where the cost and environmental benefits are becoming realised [61].

Supercritical carbon dioxide, ionic liquids and fluorous biphasic systems all are being studied actively as eco-friendly alternatives to the use of organic solvents. These solvents are discussed elsewhere; all have potential benefits and some disadvantages that should be considered.

Having moved away from highly toxic solvents such as benzene and carbon tetrachloride some years ago, we are now entering a new era where there are real alternatives being developed to common solvents such as toluene, dichloromethane and dimethylformamide. When developing a process, all these alternatives should be considered.

Approaches such as life-cycle assessment are vital in enabling sound decisions to be made. For example, when considering the use of supercritical carbon dioxide against toluene, one should take account of the energy involved in generating and recirculating the supercritical CO₂ as well as assessing the potential pollution risk involved with using toluene and the comparative hazards of flammability versus the use of high-pressure equipment, etc.

7 Conclusions

Chemicals, subtly disguised as medicines, pesticides, cosmetics, clothing, fuel, protective packaging, household items, etc., have contributed enormously to the improved quality of life and increased longevity the human race has experienced during the twentieth century. Unfortunately, without intent but sometimes without adequate knowledge or thought, chemists and engineers, through the products and processes devised, have caused significant harm to the environment.

The challenge to chemists and engineers in the twenty-first century is to continue to reap all the social and economic benefits that chemistry has to offer but without causing damage to the environment (in the widest sense) or preventing our children and grandchildren from doing the same in the next century. This is what green and sustainable chemistry is all about, but how can we achieve this worthy goal? The answer is complex, involves all of

society and will involve aspects of all of the following, coming together as a coherent package:

- (1) **Technology.** A significant amount of valuable green technology exists, as is evident from publications such as this and the references therein. Further green technology needs to be developed and, more importantly, this technology needs to be commercially viable. In the short- to medium-term future we are likely to see significant reductions in the use of hazardous volatile organic solvents through increased use of benign alternatives. More widespread use of catalysts to reduce waste and improve selectivity, particularly in the speciality and pharmaceutical industry, undoubtedly will be forthcoming. Engineeringwise, we will see something of a design revolution, reducing materials and energy use and improving safety. However, in terms of sustainability we require significant advances in the development of renewable sources of energy.
- (2) **Education.** Increased environmental awareness and the role that science can play need to be taught at an early age. In tertiary education the principles of green chemistry need to underpin the whole undergraduate and graduate course structure and not be taught as a separate course. It is the culture and mind-set that we teach students of today that will determine the greenness of tomorrow's processes and products.
- (3) **Society** in general has a huge role to play. Consumer power is a major force in determining the products that industry produces. Sometimes sustainability comes at a price, either economic- or performancewise; it is the informed consumer who needs to make this choice, e.g. water-based versus solvent-based paint. As stakeholders in industry, individuals and organisations also can have an influential role in ensuring that sustainable practices are adopted.
- (4) **Governments** have a role to play in formulating policies to encourage sustainable development and in ensuring that there is an even competitive playing field throughout the world. Governments also should be encouraging the development of green technologies through R & E funding mechanisms.
- (5) **Industry** has the prime purpose of adding value to shareholder investment. However, there is the

growing realisation that the key to future success lies with not one but three bottom lines: economic, environmental and social. The costs of causing environmental harm are becoming unacceptably high in every sense. This, coupled with increasing knowledge of the long-term effects that chemicals have on the environment and the technical advances are helping to ensure that new products and processes are much greener than those being replaced.

The goal of a green and sustainable society cannot be achieved overnight; the path is long and uncertain. Undoubtedly we will take a few wrong turns along the way, but there is growing agreement on the general way forward. Although science can help move towards the ideal of completely avoiding risk, hazard, pollution, etc., society at large will ultimately determine what is acceptable in terms of the cost-benefit issues posed by sustainable development.

Although, as discussed at the beginning of the chapter, the modern ideas of sustainable and green chemistry are only around ten years old, we should not lose sight of the fact that some of the objectives have been pursued for many years. A quote from R. W. Hofmann, the first President of The Royal College of Chemistry, London, made in 1848 is just as relevant today as it was then:

'In an ideal chemical factory there is, strictly speaking, no waste but only product. The better a real factory makes use of its waste, the closer it gets to its ideal, the bigger is the profit.'

References

1. World Commission on Environment and Development. *Our Common Future*. Oxford University Press, Oxford, 1987.
2. Basiago, A. D. *Sustain. Dev.*, 1995, **3**, 109.
3. Anastas, P. T., & Warner, J. C., *Green Chemistry, Theory and Practice*. Oxford University Press, Oxford, 1998.
4. Environmental Protection Expenditure by UK Industry. *Survey of 1997 Expenditure*, final report to the DETR. ECOTEC Research and Consulting, Birmingham, UK, 1999.
5. Lancaster, M. *Environ. Bus. Mag.*, 1999, **May**, 34.
6. MORI. *The Public Image of the Chemical Industry*, report for the CIA. MORI, London, 1999.
7. Trost, B. M. *Science*, 1991, **254**, 1471.
8. Sheldon, R. A. *Chemtech*, 1994, **March**, 38.
9. Sheldon, R. A. *J. Chem. Tech. Biotechnol.*, 1997, **68**, 381.

10. Lancaster, M. *Green Chem.*, 2000, **2**, G65.
11. For a full introduction to pericyclic reactions, see: Fleming, I. *Frontier Orbitals and Organic Chemical Reactions*. J. W. Arrowsmith, Bristol, 1992.
12. Heaton, A. *The Chemical Industry*, Chapt. 7. Blackie Academic & Professional, Glasgow, 1996.
13. Saksena, A. K., Girijavallabhan, V. M., Chen, Y. T., Jao, E., *et al.* *Heterocycles*, 1993, **35**, 129.
14. Kahn, P. H., & Cossy, J. *Tetrahedron Lett.*, 1999, **40**, 8113.
15. Lavallee, J. F., & Deslongchamps, P. *Tetrahedron Lett.*, 1988, **29**, 6033.
16. *German patent DE 4 326 952* to BASF, 1993.
17. *German patent DE 4 326 953* to BASF, 1993.
18. Wang, Z., Campagna, S., Xu, G., Pierce, M. E., Fortunak, J. M., & Confalone, P. N. *Tetrahedron Lett.*, 2000, **41**, 4007.
19. Doyle, M. P., & Mungwall, W. S. *Experimental Organic Chemistry*. John Wiley, Chichester, 1980.
20. *European Patent Application 0284310* to Hoechst Celanese, 1988.
21. Tanabe, K., & Holderich, W. F. *Appl. Catal. A: General*, 1999, **181**, 399.
22. WO Patent 96/35655 to Rhodia, 1996.
23. Smith, K., Musson, A., & DeBoos, G. A. *Chem. Commun.*, 1996, 469.
24. Barrett, A. G. M., Waller, F. J., Braddock, D. C., & Ramprasad, D. *Chem. Commun.*, 1997, 613.
25. Nojiri, N., & Misono, M. *Appl. Catal. A*, 1993, **93**, 103.
26. Verweij, J., & de Vroom, E. *Rec. Trav. Chim. Pays-Bas*, 1993, **112**, 66.
27. Campbell, C. J., & Laherrere, J. H. *Sci. Am.*, 1998, **March**, 60.
28. Shay, E. G. *Biomass Bioen.*, 1993, **4**, 227.
29. Ma, F., & Hanna, M. A. *Bioresource Technol.*, 1999, **70**, 1.
30. Adams, C., Peters, J. F., Rand, M. C., Schroer, B. J., & Pzremke, M. C. *J. Am. Oil Chem. Soc.*, 1983, **60**, 1574.
31. Jackson, M. A., & King, J. W. *J. Am. Oil Chem. Soc.*, 1996, **62**, 815.
32. Wasserbauer, R., Beranova, M., Vancurova, D., & Dolezel, B. *Biomaterials*, 1990, **11**, 36.
33. Environmental Data Services. *ENDS Report 2000*, Vol. 300. ENDS, London, pp. 19–21.
34. Dartee, M. *Green-Tech 2000*, Utrecht, April 2000.
35. Okkerse, C., & van Bekkum, H. *Green Chem.*, 1999, **1**, 107.
36. Ramshaw, C. *Green Chem.*, 1999, **1**, G15.
37. Stankiewicz, A. I., & Moulijn, J. A. *Chem. Eng. Prog.*, 2000, **Jan.**, 23.
38. Green, A., Johnson, B., & John, A. *Chem. Eng.*, 1999, **Dec.**, 66.
39. Victor, D. *Nature*, 1998, **395**, 837.
40. Armor, J. N. *J. Appl. Catal. A: General*, 2000, **194/195**, 3.
41. For a summary of the Kyoto agreement, see: www.unfccc.de
42. Adams, C. *Chem. Ind.*, 1999, **19**, 740.
43. Muller, H. In *Ullmans Encyclopedia of Industrial Chemistry*, 5th edn, Vol. 25. VCH, Wurzburg, 1994, pp. 635–703.
44. Brown, H. L., Hamel, B. B., & Hedman, B. A. *Energy Analysis of 108 Industrial Processes*. Fairmont Press, Lilburn, GA, 1996.
45. Scott, K. *Electrochemical Processes for Clean Technology*. Royal Society of Chemistry, London, 1995.
46. Bouchy, A., Andre, J. C., George, E., & Viriot, M. L. *J. Photochem. Photobiol.*, 1989, **48**, 447.
47. Meredith, R. J. *J. Elast. Plast.*, 1996, **8**, 191.
48. Ollis, D. F., & Al-Ekabi, H. *Photocatalytic Purification and Treatment of Water and Air, Trace Metals in the Environment*, Vol. 3. Elsevier, Amsterdam, 1993.
49. Robinson, D., & Walsh, F. C. *Hydrometallurgy*, 1991, **26(93)**, 115.
50. Everest, L. *Behind the Poison Cloud: Union Carbide's Bhopal Massacre*. Banner Press, Birmingham, AL, 1986.
51. Kletz, T. *Process Plants. A Handbook for Inherently Safer Design*. Taylor & Francis, London, 1998.
52. *Eur. Chem. News*, 1999, **71**, 18.
53. Davis, D. D. In *Ullmans Encyclopedia of Industrial Chemistry*, 5th edn, Vol. A1. VCH, New York, 1985, pp. 269–278.
54. Scott, R. *Process Optimisation*, Symposium Series 100. Institution of Chemical Engineers, Rugby, UK, 1987.
55. Thiemens, M. H., & Trogler, W. C. *Science*, 1991, **251**, 932.
56. Draths, K. M., & Frost, J. W. In *Green Chemistry, Frontiers in Benign Chemical Synthesis and Processes* (Anastas, P. T., & Williamson, T. C. eds). Oxford University Press, Oxford, 1998.
57. *US Patent 4 259 520* to BASF, 1981.
58. *Chem. Eng. News*, 1984, **62(18)**, 28.
59. *DE Patent 3441072* to Asahi Kasei Corp., 1985.
60. Raston, C. L., & Scott J. L., *Green Chem.*, 2000, **2**, 49.
61. Cook, S. J. *Green Chem.*, 1999, **1**, 138.

Chapter 3: Chemistry and the Environment

JOHN V. HOLDER

1 Introduction

'There is a sufficiency in the world for man's need but not for man's greed.'

Mahatma Gandhi (1869–1948)

To fulfil its part in sustainable World development, chemistry is changing. This 'greening' of chemistry involves two main thrusts. First, production, use and disposal of hazardous chemicals is being reduced and, where possible, eliminated. This must, however, be achieved while maintaining or improving the quality of human life, the natural environment and industrial competitiveness. Second, the environmental impact of anthropogenic chemicals is being studied so that it may be better understood, monitored and controlled.

More specifically, chemistry can contribute to:

- Understanding and reducing the enhanced greenhouse effect
- Understanding the role of chlorofluorocarbons and other materials that affect the ozone layer and finding alternatives
- Understanding and reducing the effects of volatile organic compounds that contribute to low-level photochemical smog
- Understanding and minimising the effects of acidic pollutants such as sulfur dioxide and nitrogen oxides
- Finding alternatives to non-renewable energy resources such as oil, gas and coal
- Contributing to waste minimisation and improved waste treatment and disposal
- Understanding the effects of toxic materials on both humans and the environment and finding alternatives
- Improving current chemical processes

Research is continuing to support these goals. New synthetic pathways are being developed using renewable feedstocks, alternative reaction conditions, solvents and catalysts to increase energy and atom efficiency and to reduce waste. Simultaneously

the toxicology, metabolism and biogeochemical cycling of environmental contaminants and pollutants are being elucidated.

It is logical, therefore, for a book on sustainable chemistry to begin by looking at the natural chemistry of the environment and how this is being affected by the perturbations introduced by humans, which may lead to unsustainable situations locally or globally.

This chapter will attempt briefly to summarise the current position in what is a large and complex field. The chemistry of the natural environment will be introduced and the sources and causes of pollution will be reviewed, together with some of the toxicological and other environmental impacts. The importance of chemical speciation on the biogeochemical cycling of anthropogenic chemicals will be highlighted.

2 Chemistry of the Atmosphere

2.1 Structure of the atmosphere

'The most alarming of all man's assaults upon the environment is the contamination of air, earth, rivers and sea . . . this pollution is for the most part irrecoverable.'

Rachel Carson (1907–1964)

The Earth's atmosphere is layered, forming concentric spheres of markedly differing properties (Fig. 3.1). As the smallest of Earth's compartments, the atmosphere provides the smallest reservoir and hence the most susceptible to pollution. This pollution affects principally the lowest two layers. From the Earth's surface to a height of 8–15 km is the troposphere. This is thinnest at the poles and thickest at the equator and shows seasonal variations. It is well mixed: vertically by solar-powered convection and horizontally by the Earth's rotation (Coriolis force). Mixing ensures that species exhibiting long lifetimes (Table 3.1) are uniformly distributed around the globe.

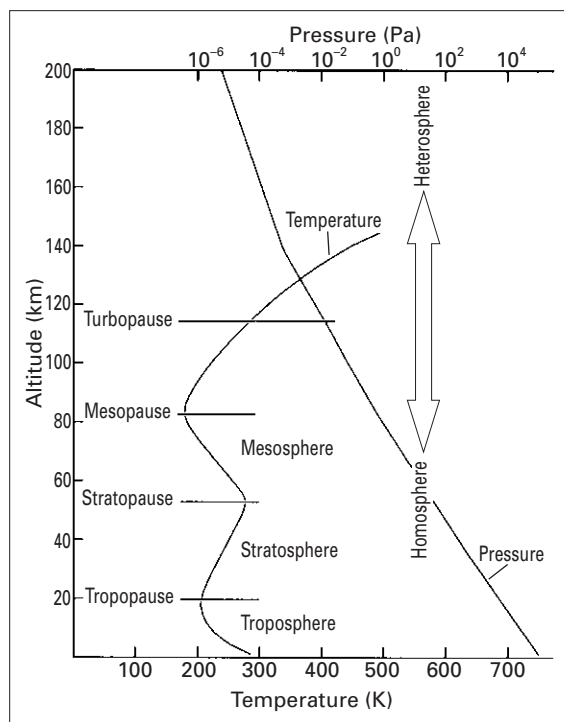


Fig. 3.1 The vertical structure of the atmosphere and associated temperature and pressure variations.

The temperature declines linearly with height because the main heating mechanism is through absorption of solar energy by the planet's surface, followed by conduction and convection. Pressure declines logarithmically with height and the vast majority of the mass of the atmosphere is contained in its lowest layer, which is also the initial recipient of almost all the pollution.

Above the troposphere is the stratosphere. Here, heating is due to absorption of solar UV by oxygen and ozone molecules, which increases with increasing distance from the planet's surface. Temperature, therefore, increases with height and radiation intensity. With hotter, less-dense strata on top there is less convection and the effect of the Earth's rotation also is felt less strongly at this greater distance. This leads to less mixing and a layered structure. Some pollution is introduced directly into the stratosphere by jet aeroplane exhausts and naturally by volcanoes. Pollution also crosses the boundary from the troposphere. The latter normally is very slow but can increase where tropospheric 'folding' occurs.

The atmosphere is the least massive of the Earth's environmental compartments, being only 0.2% of the mass of the hydrosphere (oceans plus terrestrial waters) and 0.02% of the mass of the crust. It weighs

Table 3.1 Composition of unpolluted air

Gas	Formula	Concentration (ppm)	Approximate residence time
Nitrogen	N ₂	780 820	10 ⁶ years
Oxygen	O ₂	209 450	5000 years
Argon	Ar	9340	Not cycled
Carbon dioxide	CO ₂	360	100 years
Neon	Ne	18.18	Not cycled
Helium	He	5.24	Not cycled
Methane	CH ₄	1.70	15 years
Krypton	Kr	1.14	Not cycled
Hydrogen	H ₂	0.50	10 years
Nitrous oxide	N ₂ O	0.31	120 years
Carbon monoxide	CO	0.12	65 days
Xenon	Xe	0.09	Not cycled
Ozone	O ₃	0.01	100 days
Nitric oxide/nitrogen dioxide	NO/NO ₂	10 ⁻⁶ /10 ⁻²	1 day
Sulfur dioxide	SO ₂	10 ⁻³ -10 ⁻²	10 days
Ammonia	NH ₃	10 ⁻⁴ -10 ⁻³	5 days
Nitric acid	HNO ₃	10 ⁻⁵ -10 ⁻³	1 day
Water vapour	H ₂ O	Variable between 5000 and 40000 ppm	

Source: Refs 1 and 2.

about 5.2×10^9 million tonnes (Mt) and is the most vulnerable reservoir to pollution. It did not always have its present composition. The primitive atmosphere probably comprised CO_2 , N_2 , H_2 , H_2O and H_2S with traces of CH_4 , HCl , HBr and HI and the inert gases, similar to volcanic gases today. There was no oxygen. We know this because 2.5-billion-year-old pebbles of the oxidisable minerals pitchblende and pyrite, which clearly in the past have been rounded by water on the planet's surface but are now locked under old sediments, show no signs of oxidation.

The origins of life are conjectural but we do know that photosynthetically active organisms evolved around 2 billion years ago. They used solar radiation to separate hydrogen from water to build their bodies and released the unwanted oxygen. This first pollutant changed the world forever, allowing all modern life to evolve by taking advantage of the energetically favourable oxidative metabolic processes.

Air pollutants may be in gaseous, aerosol, droplet or particulate form. Pollutants emitted directly into the atmosphere are termed primary. Pollutants that are formed in the atmosphere from primary pollutants by chemical or photochemical reaction are termed secondary.

2.2 Tropospheric pollution

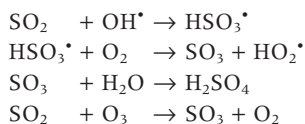
Pre-1970, tropospheric pollution was considered principally to be smoke, soot and odours. Today the definition must embrace many other substances that produce objectionable or deleterious effects on humans, animals or vegetation or otherwise alter the natural balance of an ecosystem.

Primary pollutants

Sulfur species. The most abundant natural sulfur species is sulfate in sea spray. This, however, rapidly returns to the ocean and is not considered further here. Other natural sources, including sulfur dioxide (SO_2) and hydrogen sulfide from volcanos and dimethyl sulfide, carbonyl sulfide and carbon disulfide from biological processes, are estimated to introduce some 20–30Mt of sulfur into the global atmosphere annually. The anthropogenic total is 70–100Mt, principally from combustion but also from sulfide ore roasting and sulfuric acid (H_2SO_4) manufacture. Sulfur is present in most fuels: 1–2%

by weight in coal and 2–3% in heavy fuel oils, with decreasing amounts in lighter oils and natural gas.

More than 97% of the sulfur emitted in combustion is as SO_2 . The remainder is largely as sulfur trioxide, which in the presence of water vapour is transformed rapidly into H_2SO_4 . Sulfur dioxide persists for an average of ten days in the atmosphere before oxidation and transformation to the acid.

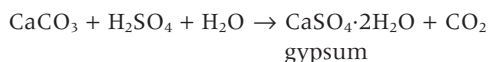


Both SO_2 and H_2SO_4 at sufficient concentrations will produce harmful effects. For the average person SO_2 at above 5 ppm (13mgm^{-3}) irritates the mucous membrane, inducing coughing. Continuous exposure diminishes the sense of smell and taste and, in more serious cases, causes oedema (swelling and fluid in the lungs). The frequency with which the cilia in the lungs oscillate and hence the efficiency of the lung protection mechanism is reduced. The bronchii are constricted and the risk of bronchitis is increased.

The formation of H_2SO_4 combined with natural fog and man-made smoke in weather inversion conditions led to the notorious London smogs of the first half of the twentieth century, culminating in 1952 when a surplus of 3500–4000 deaths over the expected was recorded [3].

The Clean Air Act (1956) legislation that followed the London smog incidents initiated substantial reductions in emissions. The change from coal-fired domestic heating to electricity and the increased use of nuclear energy and natural gas made the major contributions to achieving this. The UK emissions, which had totalled 6.34Mt of sulfur in 1970, declined to 1.66Mt in 1997.

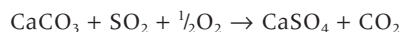
Foliage is damaged by contact with SO_2 , and inorganic materials also suffer corrosion. Carbonates in sandstones, limestones and mortars are attacked:



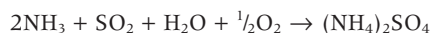
The gypsum produced is soluble and may leach out in rainwater. However, if it remains in situ it occupies a larger volume than the original carbonate, causing internal pressure and mechanical stress to the structure. Old glass, with its high alkali and

alkaline-earth content, is attacked, as is monumental iron and bronze. Organic materials such as paper, leather and textiles, which retain water, absorb SO₂ causing the cellulose and proteins to dissolve in the resulting acids.

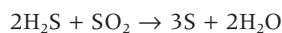
Alteration of the combustion processes alone is insufficient to control sulfur emission. Either pre-treatment of fuels or desulfurisation of flue gas using calcium carbonate is necessary to reduce emissions:



Apart from adding to global warming through CO₂ release, this process also consumes huge quantities of limestone. Other processes include the addition of ammonia to flue gases:



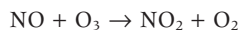
and the reduction of the SO₂ to elemental sulfur by stoichiometric addition of hydrogen sulfide:



Nitrogen species. Natural sources of the nitrogen oxides NO and NO₂, referred to collectively as NO_x, introduce some 20–30 Mt of nitrogen per year into the atmosphere, mainly from lightning-induced combinations of atmospheric N₂ and O₂, biogenic sources in the soil and natural fires. Atmospheric oxidation of ammonia, mainly from animal excreta, also contributes to NO_x. By comparison, anthropogenic sources of NO₂, which arise mainly from combustion processes, contribute a further 20 Mt.

A third oxide of nitrogen, N₂O, is released from soils, especially those treated with fertilisers, and from industrial sources, particularly nitric acid and adipic acid production. The most abundant nitrogen oxide in the atmosphere is N₂O but it is rather unreactive and non-toxic.

The NO_x production in stationary combustion plants is affected by the fuel nitrogen content, burner design, combustion temperature and air excess. The emissions are mainly NO, with about 10% NO₂, although oxidation by atmospheric ozone shifts the ratio so that most of the atmospheric burden is as NO₂.



The NO_x emissions from stationary processes can be reduced by about 50% by control of the combustion process parameters. Further removal requires treat-

ment such as the addition of stoichiometric quantities of ammonia:



Road vehicle fuels contain negligible nitrogen and the NO_x arises solely through the high-temperature combination of atmospheric N₂ and O₂. Road transport contributes approximately 50% and power stations 25% of the NO_x emissions.

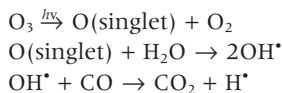
Precious metal catalysts are used to effect reductions in emissions of NO_x, carbon monoxide and unburnt hydrocarbons from lead-free petrol-vehicle exhausts, converting these gases into water, nitrogen and carbon dioxide.

Nitrogen dioxide is a pulmonary irritant and high concentrations can produce oedema. It also contributes synergistically to the effects of other pollutants and participates in ozone formation and photochemical smogs. The NO₂ in damp air converts to nitric acid, leading to acid deposition with similar effects to sulfuric acid.

Emissions of NO_x in the UK gradually increased until the early 1990s due to increased traffic but are now declining slowly as vehicle emission regulations take effect and power station emissions decline, with the shift away from coal to other fuels. The UK anthropogenic emissions of NO_x were 2.43 Mt in 1970, 2.67 Mt in 1990 and 1.83 Mt in 1997. The N₂O emissions are dominated by agricultural sources and in 1997 were 0.19 Mt [4].

Carbon monoxide. Small amounts of CO occur in the atmosphere naturally from volcanoes and atmospheric methane oxidation. Carbon monoxide is, however, a largely anthropogenic pollutant principally associated with motor vehicle emissions. These contribute up to 98% of the CO in urban areas and 75% on average nationally in the UK. Emission from properly adjusted stationary combustion processes is negligible.

Carbon monoxide is removed from the atmosphere only slowly by reaction with hydroxyl radicals formed mainly by the photolytic break-up of ozone via the energetic singlet oxygen:



The hydrogen radical then may react with CO₂ and NO to regenerate the hydroxyl radical:

$H^* + O_2 + M \rightarrow HOO^* + M$ (third body to remove energy)

$HOO^* + NO \rightarrow NO_2 + OH^*$

Destruction of CO normally takes place after dilution and dispersion in the atmosphere. However, where air changes are slow, e.g. in high-rise areas—the so-called ‘urban canyons’—concentrations of CO may reach 100 ppm, at which point the clinical symptoms of headache, fatigue and loss of mental alertness may become evident.

Carbon monoxide is absorbed through the lungs into the bloodstream, where it reacts with haemoglobin to reduce the oxygen-carrying capacity of the blood. Haemoglobin’s affinity for CO is 200–300 times greater than its affinity for oxygen.

Emissions of CO in the UK reduced from 8.85 Mt in 1970 to 7.57 Mt in 1990 and 5.09 Mt in 1997, largely due to the impact of catalytic converters on motor vehicle exhausts [4].

Volatile organic compounds. Volatile organic compounds (VOCs), which are mainly but not exclusively hydrocarbons, emanate from a range of sources. The most abundant, methane, comes from the anaerobic fermentation of organic materials in rice paddies and northern wetlands, plus enteric fermentation in ruminants’ digestive systems. Methane is released also from coal mining, landfills, gas extraction and biomass burning. In the UK, animals account for some 30% of methane release, landfill gas accounts for almost 50% and natural gas leakage and mining account for just under 10% each. Estimates of methane emissions showed a decline from 3.77 Mt in 1970 to 2.73 Mt in 1997, primarily due to the decline in coal mining and increased methane recovery from landfills [4].

Other natural hydrocarbons such as isoprene, the pinenes and other terpenes are released from trees and can contribute to photochemical smogs.

The largest source of non-methane hydrocarbons in the UK is road transport, with just under 40%, but solvent releases (e.g. from paints and adhesives) contribute almost 30%, extraction and distillation of fossil fuels contribute 10% and other non-combustion processes contribute almost 17%. Ambient air samples in London have been shown to contain more than 200 different hydrocarbons, the major contributors being ethyne (8.8 ppb), *n*-butane

(6.7 ppb) and isopentane (3.5 ppb), with the aromatics benzene, toluene, ethylbenzene and the xylenes all being around 2 ppb [5].

Hydrocarbon pollution is of concern for three reasons: some compounds (e.g. benzene) are carcinogenic and others are thought to cause neuro-toxicological symptoms such as dizziness and amnesia, the role of hydrocarbons as precursors of photochemical ozone (see earlier section on sulfur species); and the contribution that hydrocarbons make to global warming, particularly methane.

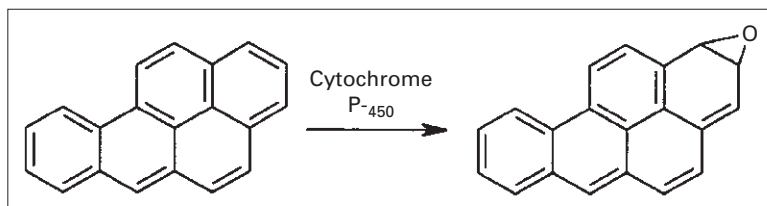
The UK emissions of non-methane hydrocarbons have been estimated as 2.4 Mt in 1970, 2.73 Mt in 1990 and 2.13 Mt in 1997 [4]. The reductions are primarily in road transport and in the industrial sectors, in response to the United Nations Economic Commission for Europe (UNECE) Protocol to reduce VOCs by 30% by the year 2000 relative to 1988. The Chemical Industries Association publishes indicators of performance with respect to environmental discharges. The 2000 report [6] claims that the industries’ emissions of VOCs have declined by 46% since 1995, with 58 000 t being discharged in the UK in 1999.

Persistent organic pollutants. Certain groups of organic compounds, although present in the atmosphere only at low concentration, have the potential to cause detriment to human health through inhalation or ingestion on food. Depending upon the temperature, they may be in the vapour phase or adsorbed onto particles.

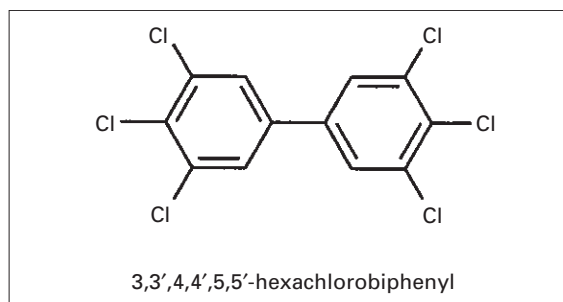
Polycyclic aromatic hydrocarbons (PAHs) are the products of combustion, e.g. in coal fires and diesel engines, and often are found in combination with soot. Sixteen compounds containing 2–6 rings have been identified, some of which are carcinogenic or are metabolised to carcinogens (see Scheme 3.1). For example, benzo[*a*]pyrene is metabolised in the liver to benzo[*a*]pyrene 1,2-epoxide, which is a proven carcinogen.

Other PAHs exhibiting carcinogenic properties are the benzofluoranthenes, benz[*a*]anthracene, dibenzo[*ah*]anthracene and indeno[1,2,3-*cd*]pyrene.

Polychlorinated biphenyls (PCBs), (see Scheme 3.2): have been used as electrical insulating fluids and are linked to the impairment of immune responses, hepatotoxicity, reproductive toxicity and other toxic effects. Their potency in humans is



Scheme 3.1



Scheme 3.2

thought to be less than other species and therefore extrapolation of laboratory data is difficult.

Polychlorinated dibenzo-*p*-dioxins (PCDD) and polychlorinated dibenzofurans (PCDF), with chlorine atoms substituted at some or all of the numbered positions, originate in combustion processes. They are formed in incinerators or runaway exothermic chemical reactions, as happened at the ICMESA chemical plant in Seveso, Italy, in 1976 (see Scheme 3.3). They exhibit a range of toxicities, depending upon the chlorine atom substitution. Only those chlorinated at the 2, 3, 7 and 8 positions are considered significant. Of these, 2,3,7,8-tetrachlorodibenzo-*p*-dioxin is the most toxic and addition of further chlorine atoms reduces the toxicity. The furans generally are less toxic than the equivalent dioxin. In summing the toxicity of PCDDs and PCDFs, each is weighted by its toxicity relative to 2,3,7,8-tetrachlorodibenzo-*p*-dioxin and expressed as grammes of toxic equivalent (TEQ).

The only undisputed effect in humans is the chloracne (a disfiguring skin ailment) resulting from high exposure at Seveso. The PCDDs and PCDFs also were present as contaminants in Agent Orange, a defoliant used during the Vietnam War to which veterans were exposed.

The UK emissions of persistent organic pollutants decreased significantly between 1990 and 1997. The

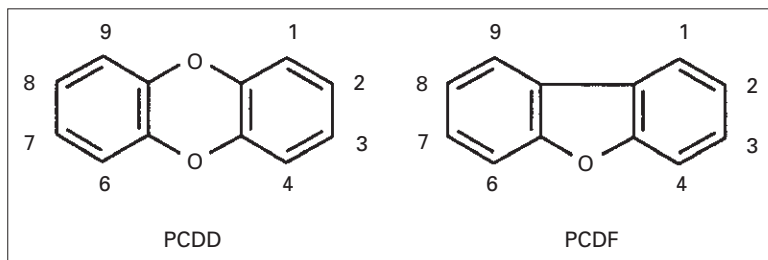
PAH emissions fell from 6463 to 1745t, the PCB emissions fell from 6.8 to 3.2t and the PCDD/PCDF emissions fell from 1083 to 325g TEQ [4].

Suspended particles. Airborne particles are diverse in size and composition. Owing to coagulation at the lower end and rapid deposition at the higher, the majority by mass are in the range 0.1–10 μ m. Transient nuclei from condensation of vapour, e.g. from motor vehicle exhausts and H₂SO₄ from SO₂ oxidation, peak at around 0.02–0.03 μ m. Coagulation of smaller particles produces a second peak at around 0.2–0.3 μ m and mechanically generated particles, e.g. volcanic and wind blown dusts, peak at around 10 μ m. Traditionally, atmospheric particulate measurement has been either as black smoke or as gravimetrically determined particulate matter (PM), i.e. PM₁₀ (in practice this equates to particles of less than 10 μ m in diameter). Black smoke principally comes from coal burning and diesel exhausts, of which the latter has come to dominate with 95% of the total. The PM₁₀ is dominated by road traffic emissions and secondary pollutants (ammonium sulfate and ammonium nitrate particles), with contributions from dried sea spray and wind blown dusts.

Particulate air pollution was one of the first types of pollution demonstrated to have serious health effects and there is evidence linking ambient particulate levels, irrespective of their chemical composition, with lung disfunction, respiratory disease and mortality [7].

Black smoke emissions in the UK declined from 1.07Mt in 1970 to 0.31Mt in 1997, due largely to the switch from coal to smokeless fuels and natural gas. This has been offset partially by the increase in diesel-engine road vehicles. The PM₁₀ emissions in the same period declined from 0.51 to 0.18Mt [4].

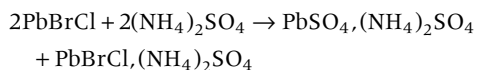
Heavy and toxic metals. Heavy metal pollution of the troposphere mainly concerns lead, although local discharges (e.g. arsenic from copper smelting and



Scheme 3.3

glass manufacture, mercury from the chloralkali industry and battery manufacture and trace metals in coal, including arsenic, cadmium, chromium, mercury, manganese, nickel, lead, antimony and vanadium) also contribute to the hazards.

Lead emissions arise principally from the use of lead tetraethyl additives in petrol. The lead is emitted from the exhaust as a mixture of halides from reactions with other additives. The halides react with ambient ammonium sulfate in the atmosphere:



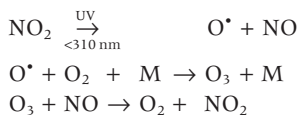
Lead is a neurotoxin that induces intellectual dullness, reduced consciousness and, in extreme cases, coma and death.

The UK emissions of lead have declined sharply following reductions in the lead content of petrol and later the elimination of leaded petrol. Emissions in 1997 were 1.31 kilotonne (kt), compared with 7.54 kt in 1970 [4]. Emissions of other metals also are showing a strongly declining trend.

Other air toxics. In addition to the elements and compounds dealt with above, there are thousands of commercial chemicals used in the UK. Many hundreds of these may find their way into the atmosphere, where they may have adverse health or environmental effects. Examples include asbestos from construction, demolition, pipe and furnace replacement and mining, hydrogen sulfide from paper manufacture and oil refining and fluorides from aluminium smelting and phosphate fertiliser manufacture. A convenient list of hazardous air pollutants is provided by the 1990 US Clean Air Act Amendments (Table 3.2).

Secondary pollutants

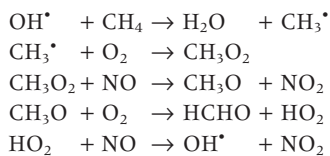
Ozone. Atmospheric reactions involving oxides of nitrogen and hydrocarbons under solar ultraviolet radiation yield a range of secondary products, the most important of which is ozone:



where M is a third body, e.g. N_2 , that carries away excess energy.

In sunny urban areas such as Los Angeles, California, ozone concentrations have reached 450 ppb. In Britain's less intense sunlight, levels exceeding 100 ppb can occur during the fewer than 30 days per year when anticyclonic conditions occur in summer, and a peak of 250 ppb was measured at Harwell in Berkshire in 1976.

Creation and destruction of O_3 are thus in equilibrium. If, however, NO_2 is enhanced by contributions from anthropogenic sources, the equilibrium in the last of the above three equation shifts, reducing O_3 destruction. The NO_2 is formed in atmospheric reactions involving OH^* radicals, hydrocarbons, O_2 and NO :



The OH^* is regenerated at the end of the reaction sequence and is recycled. A range of aldehydes, depending upon which hydrocarbon begins the sequence, also are formed as secondary products.

Table 3.2 Substances listed as hazardous air pollutants by the US Clean Air Act Amendments 1990 quoted in *The Wiley Encyclopaedia of Environmental Pollution and Cleanup* (Ref. 8)

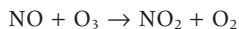
Acetaldehyde	3,3'-Dimethyl benzidine	<i>N</i> -Nitrosodimethylamine
Acetamide	Dimethyl carbamoyl chloride	<i>N</i> -Nitrosomorpholine
Acetonitrile	Dimethyl formamide	Parathion
Acetophenone	1,1-Dimethyl hydrazine	Pentachloronitrobenzene
2-Acetylaminofluorene	Dimethyl phthalate	Pentachlorophenol
Acrolein	Dimethyl sulfate	Phenol
Acrylamide	4,6-Dinitro- <i>o</i> -cresol, and salts	<i>p</i> -Phenylenediamine
Acrylic acid	2,4-Dinitrophenol	Phosgene
Acrylonitrile	2,4-Dinitrotoluene	Phosphine
Allyl chloride	1,4-Dioxane	Phosphorus
4-Aminobiphenyl	1,2-Diphenylhydrazine	Phthalic anhydride
Aniline	Epichlorohydrin	Polychlorinated biphenyls
<i>o</i> -Anisidine	1,2-Epoxybutane	1,3-Propane sultone
Asbestos	Ethyl acrylate	β -Propiolactone
Benzene	Ethyl benzene	Propionaldehyde
Benzidine	Ethyl carbamate	Propoxur (Baygon)
Benzotrichloride	Ethyl chloride	Propylene dichloride
Benzyl chloride	Ethylene dibromide	Propylene oxide
Biphenyl	Ethylene dichloride	1,2-Propylenimine
Bis(2-ethylhexyl)phthalate	Ethylene glycol	Quinoline
Bis(chloromethyl)ether	Ethylene imine	Quinone
Bromoform	Ethylene oxide	Styrene
1,3-Butadiene	Ethylene thiourea	Styrene oxide
Calcium cyanamide	Ethylidene dichloride	2,3,7,8-Tetrachlorodibenzo- <i>p</i> -dioxin
Caprolactam	Formaldehyde	1,1,2,2-Tetrachloroethane
Captan	Heptachlor	Tetrachloroethylene
Carbaryl	Hexachlorobenzene	Titanium tetrachloride
Carbon disulfide	Hexachlorobutadiene	Toluene
Carbon tetrachloride	Hexachlorocyclopentadiene	2,4-Toluene diamine
Carbonyl sulfide	Hexachloroethane	2,4-Toluene diisocyanate
Catechol	Hexamethyl-1,6-diisocyanate	<i>o</i> -Toluidine
Chloramben	Hexamethylphosphoroamide	Toxaphene
Chlordane	Hexane	1,2,4-Trichlorobenzene
Chlorine	Hydrazine	1,1,2-Trichloroethane
Chloroacetic acid	Hydrochloric acid	Trichloroethylene
2-Chloroacetophenone	Hydrogen fluoride	2,4,5-Trichlorophenol
Chlorobenzene	Hydroquinone	2,4,6-Trichlorophenol
Chlorobenzilate	Isophorone	Trimethylamine
Chloroform	Lindane (all isomers)	Trifluralin
Chloromethyl methyl ether	Maleic anhydride	2,2,4-Trimethylpentane
Chloroprene	Methanol	Vinyl acetate
Cresylic acid	Methoxychlor	Vinyl bromide
<i>o</i> -Cresol	Methyl bromide	Vinyl chloride
<i>m</i> -Cresol	Methyl chloride	Vinylidene chloride
<i>p</i> -Cresol	Methyl chloroform	<i>o</i> -Xylenes
Cumene	Methyl ethyl ketone	<i>m</i> -Xylenes
2,4-D, salts and esters	Methyl hydrazine	<i>p</i> -Xylenes
DDE	Methyl iodide	Antimony compounds
Diazomethane	Methyl isobutyl ketone	Arsenic compounds
Dibenzofurans	Methyl isocyanate	Beryllium compounds
1,2-Dibromo-3-chloropropane	Methyl methacrylate	Cadmium compounds
Dibutylphthalate	Methyl- <i>tert</i> -butyl ether	Chromium compounds
1,4-Dichlorobenzene	4,4-Methylene bis(2-chloroaniline)	Cobalt compounds
3,3-Dichlorobenzidene	Methylene chloride	Cyanide compounds

Table 3.2 Continued

Dichloroethyl ether	Methylene diphenyl diisocyanate	Glycol ethers
1,3-Dichloropropene	4,4'-Methylenedianiline	Lead compounds
Dichlorvos	Naphthalene	Manganese compounds
Diethanolamine	Nitrobenzene	Mercury compounds
<i>N,N</i> -Diethyl aniline	4-Nitrobiphenyl	Fine mineral fibres
Diethyl sulfate	4-Nitrophenol	Nickel compounds
3,3-Dimethoxybenzidine	2-Nitropropane	Polycyclic organic matter
Dimethyl aminoazobenzene	<i>N</i> -Nitroso- <i>N</i> -methylurea	Radionuclides (including radon)
		Selenium compounds

2,4-D = 2,4-dichlorophenoxyacetic acid; DDE = *p,p'*-dichlorophenyl dichloroethene.

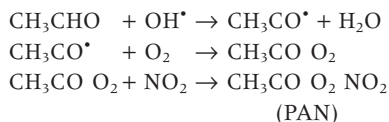
The O₃ and NO₂ concentrations depend on sunlight intensity and emission volume and therefore vary with the time of day as well as with the time of year. The morning rush produces an NO and hydrocarbon peak. Oxidation of the NO to NO₂ then leads to a rise in O₃ during the middle of the day, which decreases as the sun goes down and further NO from the evening rush contributes to its removal:



Hydrocarbons differ in their potential for photochemical ozone creation, depending upon how quickly they react with OH[•]. Methane has a low potential but a high concentration and so still makes the major contribution. Substituted aromatics such as toluene and the xylenes and unsaturated hydrocarbons such as ethene and propene have high potentials but lower concentrations and so contribute less.

Ozone is a powerful oxidant and causes detriment to human lung function in the form of inflammation and scarring at levels above about 50 ppm. The O₃ levels in London are declining at an average rate of 0.9 ppb per year due to emission legislation but levels in other cities, e.g. Athens, are continuing to rise [9].

Peroxyacetyl nitrate (PAN). As we have seen, atmospheric photochemistry generates O₃, aldehydes and free radicals such as HO₂[•] and OH[•]. There is no effective sink for these radicals and they recycle during daylight hours. In the presence of NO₂ this can lead to the formation of peroxides such as PAN:



Benzaldehyde from aromatics in the fuel is converted to peroxybenzoyl nitrate (PBzN). Both peroxides are eye irritants and phytotoxicants.

Enhanced greenhouse effect

The sun radiates with a mean surface temperature of 5700°C and the Earth with a mean surface temperature of -23°C at the cloud tops (Fig. 3.2). The Earth therefore receives and radiates heat in different parts of the spectrum. Gases in the atmosphere absorb both incoming and outgoing radiation. Ozone absorbs most of the incoming short-wavelength UV and H₂O, CH₄, CO₂, O₃ and N₂O absorb in the outgoing infrared. The net effect is that the Earth's surface is maintained some 30°C warmer than it would be otherwise. This global warming is termed the greenhouse effect. However, the greenhouse gases, especially CO₂, CH₄ and N₂O, are increased by human activities and other gases such as chlorofluorocarbons (CFC) also are produced, which absorb in the 8–13 μm window through which the Earth loses most of its heat.

The CFCs are a family of short-chain halocarbon compounds used as refrigerants, foam inflators and propellants and include CFCl₃, CF₂Cl₂ and C₂F₃Cl₃. They were considered initially to be inert but now are known to have an impact not only on global warming but also on stratospheric ozone depletion.

The contribution of a gas to global warming is a function of its electromagnetic radiation absorption efficiency (its radiative forcing potential) and its concentration. Thus, CH₄ is about 10 times and CF₂Cl₂ about 7000 times as effective as CO₂ at absorbing energy, but CO₂ makes the major contribution because of its higher concentration. Estimates of the relative contributions to global warming put CO₂

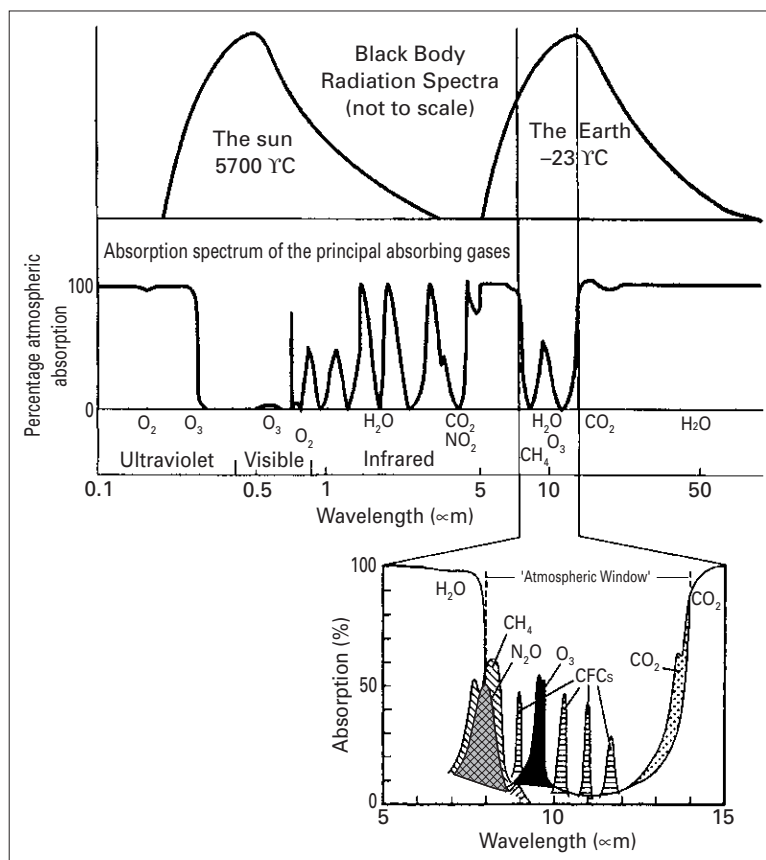


Fig. 3.2 Radiation spectra from the Sun (5700°C) and Earth (-23°C)—not to scale (Ref. 10); absorption spectra of the natural greenhouse gases (Ref. 10); and absorption by anthropogenic gases in the 8–13 μm window (Ref. 11).

at 50–55%, CH₄ at 15–18%, N₂O at 6%, CFC₃ plus CFC₂ at 14–17% and other CFCs at 7% of the current total.

Studies of Antarctic and Greenland ice cores show a remarkable correlation between atmospheric CO₂ concentration and the surface temperature at which the original snow was laid down (Fig. 3.3).

The Earth is currently in a warm phase after the last Ice Age 20 000 years ago, mirroring a similar phase 120 000 years ago when the CO₂ concentration rose to 290 ppm. However, a very rapid rise in CO₂ level over the last 200 years has taken the concentration to 360 ppm, which is well beyond the range of natural variation in the last million years.

Global temperatures have risen by 1°C since the 1920s and current predictions are that if significant action is not taken then temperatures by the end of this century will have risen by 1–3.5°C. Sea levels will rise by 0.2–1 m, rainfall patterns will alter

perhaps catastrophically and food production patterns may not be adaptable in time.

Not all areas of the globe will become warmer. The driving force for the Gulf Stream is the cooling of the Greenland Sea and the plunging to the sea bed of the cold salty water. If this is reduced by warming in Greenland, the Gulf Stream could cease to flow, leading to 5–10°C lower temperatures in Britain! Melting of the Arctic ice already is in evidence, as shown by the recent natural opening of a navigable passage across the north coast of Russia producing a 'North-East Passage' to Japan and the Far East from Europe.

Action has been initiated through the Framework Convention on Climate Change signed by over 160 countries at the Earth Summit (Rio de Janeiro, 1992) and developed through the Kyoto Protocol in 1997. To reverse current trends it will be necessary to sequester CO₂ from fossil fuel burning, reduce deforestation and increase afforestation, become more

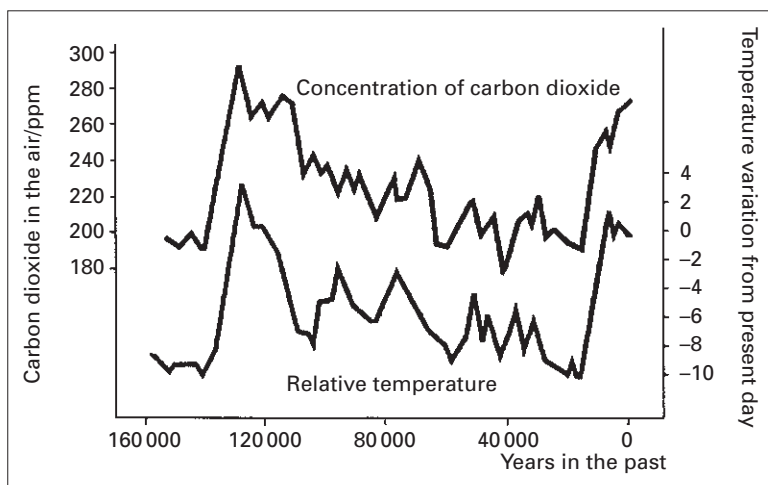


Fig. 3.3 Correlation between atmospheric CO₂ concentration and surface temperature based on data from the Office of Science and Technology Policy, Washington, 2000 (Ref. 12).

energy efficient, increase non-fossil energy sources and reduce other CO₂ and CH₄ emissions from anthropogenic sources.

The 1999 atmospheric measurements at Mace Head, Ireland, under the AGAGE Programme [13] show that atmospheric CO₂ concentrations currently are growing steadily at 1.8 ppm or about 0.5% per year. Methane also has been growing steadily but the rate has slowed from 10 ppb per year to around 1 ppb (0.06%) per year. Nitrous oxide is growing at 0.64 ppb (0.2%) per year and tropospheric O₃ is growing at 0.24 ppb (2.4%) per year. Chlorofluorocarbons are generally declining so that the atmospheric chlorine budget, which peaked at 2.0 ppb total chlorine in 1992, is now falling.

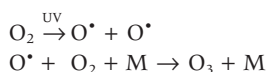
2.3 Stratospheric pollution

'The sun and the moon and the stars would have disappeared long ago had they happened to be within the reach of predatory human hands.'

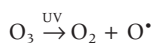
H. Havelock Ellis (1859–1939)

Ozone depletion

Ozone is formed naturally in the stratosphere through the dissociation of O₂ by UV light (180–240 nm):



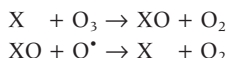
However, it is photodissociated rapidly by UV light (200–300 nm):



and on rare occasions by reaction with O[•] radicals:

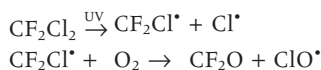


But destruction of O₃ occurs much faster than can be explained by the above two reactions. Other reactions are involved:



where X may be NO or the radicals OH[•], H[•], Cl[•] or Br[•]. These are not consumed in the reaction and cycle many times, catalysing O₃ destruction.

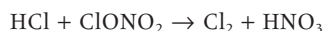
Chlorofluorocarbons can diffuse unaltered into the stratosphere, where they are photodissociated, e.g.:



adding chlorine species to the ozone-destroying radicals. The more stable reservoir species HCl and ClONO₂ are formed from the Cl[•] but these can regenerate Cl₂ molecules when conditions change.

Ozone depletion became evident with the discovery in 1985 that 50% of the normal column ozone content over Antarctica had been destroyed. The depletion has been found to be seasonal. In the Antarctic winter a vortex forms, trapping air in

the lower stratosphere while the temperature drops to -80°C . Clouds of fine $\text{HNO}_3 \cdot 3\text{H}_2\text{O}$ particles form and their surfaces facilitate reaction of the reservoir chlorine species to form chlorine molecules:



When the sunlight returns, photolysis resumes and a pulse of Cl^* is generated:



Other halogens also contribute to ozone depletion. Bromine species from methyl bromide derived from soil fumigation, biomass burning, leaded petrol and halon fire suppressants are particularly potent.

The UN Convention on Protection of the Ozone Layer (Vienna Convention, 1985) set in place policies that began the process of reducing ozone-depleting chemicals in the stratosphere. The use of hydrochlorofluorocarbons (which have shorter lifetimes in the troposphere) as substitutes for CFCs has assisted in this.

2.4 Pollution of the built environment

‘Get your room full of good air, then shut up the windows and keep it. It will last for years.’

Stephen Leacock (1869–1944)

Indoor air, both industrial and domestic, contains a complex mixture of thousands of chemical species, especially if cigarette smoke is present. Concentrations of toxic and carcinogenic substances are likely to be higher indoors than out, especially in industrial environments. The major groups of concern are: radon, asbestos, other inorganics, organic compounds and particulates.

Radon

Radon is produced by the decay of uranium or thorium isotopes in the rocks, soils and building materials. It is a gas that diffuses through fissures and accumulates in air spaces such as mines, factories and houses. It has a short half-life ($\text{Rn-222} = 3.82$ days), decaying to alpha-emitting isotopes of lead and polonium (Pb-210 , Po-210 , Po-214 , Po-218). These are solids and adhere to particles in the air that are inhaled and lodge in the lungs. They have very short half-lives and deliver a high dose of strongly ionising alpha particles to a small area of tissue, a process that can lead to lung cancer.

The use of radon trapping below buildings and frequent air changes to sweep the gas and its decay products away can control the hazard. An action level of 200Bq m^{-3} has been proposed by the National Radiological Protection Board.

Asbestos and other inorganics

Asbestos is the name for a group of natural fibrous minerals whose inertness and inflammability led to widespread use as insulating materials and vehicle brake linings. However, the fibres readily become airborne and, once inhaled, reside in the lungs for decades leading to irritation and eventually to disease (asbestosis).

Other inorganic substances that can become workplace pollutants of concern include compounds of arsenic, beryllium, cadmium, chromium (VI), nickel carbonyl and subsulfide, selenium sulfide, carbon monoxide and nitrogen dioxide.

Particles less than $10\mu\text{m}$ in diameter, whatever their composition, may produce respiratory irritation or allergic response and provide a pathway to the lungs and hence the bloodstream for a wide range of non-volatile toxins that may become suspended through mechanical or heating operations.

Organic compounds

Organic compounds of particular concern for the indoor environment, which are known or suspected carcinogens, include benzene, *p*-dichlorobenzene, carbon tetrachloride, chloroform, methylene chloride, formaldehyde and PAHs.

3 Chemistry of the Terrestrial Environment

3.1 The Earth's crust

‘Whoever could make two ears of corn grow upon a spot of ground where only one grew before would deserve better of mankind than the whole race of politicians put together.’

Jonathan Swift (1667–1745)

The Earth's crust comprises principally siliceous rocks, giving it an average elemental composition of: oxygen, 46.6%; silicon, 27.7%; aluminium, 8.1%; iron, 5.0%; calcium, 3.6%; sodium, 2.8%; potassium, 2.6%; magnesium, 2.1%. The remaining 75

stable elements and the dozen or so natural radioactive elements together contribute the remaining 1.5%. The surface of the crust that forms the interface with the atmosphere and terrestrial waters is a complex biogeochemical mixture that we call soil.

Soil chemistry

Soil differs substantially in chemical as well as physical and biological properties from the underlying rock. It is a matrix of mineral particles, organic material, aqueous solutions and gases and is populated by micro- and macroorganisms. The mineral component is made up of sub-2- μm particles of clay with other minerals, principally iron, aluminium and to a lesser extent manganese oxides and hydroxides. Clays are secondary minerals produced from igneous rocks by weathering and glaciation. They comprise combinations of sheets of Si-O tetrahedra and Al-OH octahedra linked by hydrogen bonds. There are two dominant patterns of layer combination. The first has alternating tetrahedral and octahedral layers, e.g. crystalite ($\text{Mg}_4\text{Si}_4\text{O}_{10}(\text{OH})_8$) and kaolinite ($\text{Al}_4\text{Si}_4\text{O}_{10}(\text{OH})_8$) (Fig. 3.4). The second has repeating units of tetrahedral, octahedral and tetrahedral layers and includes illite ($\text{K}_{1.6}\text{Si}_{6.4}\text{Al}_{3.6}\text{O}_{20}(\text{OH})_4$) and vermiculite ($\text{Mg}_{6.6}\text{Si}_{6.8}\text{Al}_{1.2}\text{O}_{20}(\text{OH})_4$). Isomorphous substitution of Al^{3+} for Si^{4+} and Mg^{2+} for Al^{3+} in the layers of some clays gives rise to excess negative charges on their surfaces and confers the ability to absorb and exchange cations from aqueous solution.

The main form of iron in soils is ferrihydrite ($\text{Fe}_2\text{O}_3 \cdot 2\text{FeOOH} \cdot n\text{H}_2\text{O}$) and the main form of aluminium is the amorphous hydroxide that crystallizes

as Gibbsite ($\gamma\text{Al}(\text{OH})_3$). These oxides have pH-dependent surface charges, being positively charged under acidic and negatively charged under alkaline conditions. Other soil minerals include quartz (SiO_2), which confers acidity, and calcite (CaCO_3), which buffers the soil pH to between 7 and 8.5.

The amount of organic matter in soil varies from less than 1% in arid regions to 10% in humid, temperate regions. It comprises humic compounds (colloidal polymerised products of plant decomposition) and non-humic material (undecomposed and partially decomposed dead plant and soil organisms). Humic compounds have a high pH-dependent capacity for complexing cations and adsorbing non-polar organic molecules.

The most important parameter affecting ionic contaminant behaviour in soils is acidity. The pH of soil normally lies in the range 4–8.5, although extremes of 2 and 10.5 have been measured. Aridity leads to higher pH and humidity leads to lower pH. Microbial activity is highest at pH 6–8 and metal mobility is greatest at low pH.

Redox conditions in soils reflect the oxygen availability. They can affect plant growth and determine the microorganisms present. The balance of oxidation and reduction also determines the speciation of the elements, particularly C, O, S, N, Fe and Mn.

3.2 Pollution of the land

‘Such prosperity as we have known it up to the present is the consequence of rapidly spending the planet’s irreplaceable capital.’

Aldous Huxley (1894–1963)

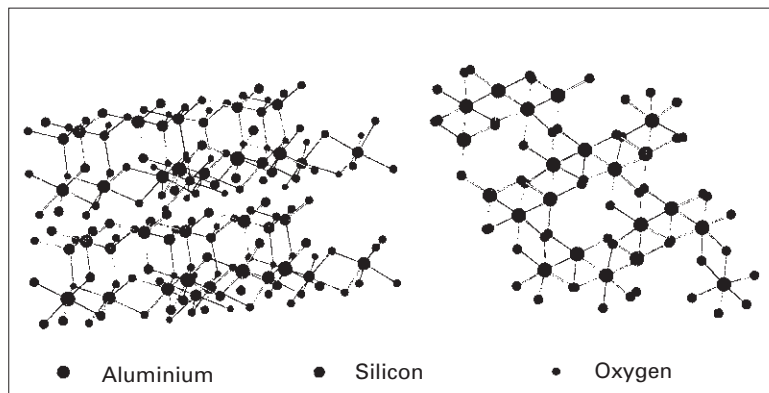


Fig. 3.4 Idealised structure of kaolinite (two views).

Although air and water tend to dilute and disperse contamination, soil retains and concentrates many pollutants by sorption or filtration, preventing their migration to ground and surface waters. Organic pollutants thus retained then may be metabolised and broken down by microorganisms. Inorganic and persistent organic pollutants are not degraded and can concentrate to potentially harmful levels. Pathways to humans include: take-up into plants and animals, leading to incorporation in food; leaching into drinking water, leading to inhalation; and suspension in the atmosphere, leading to direct skin contact.

The UK Department of Environment, Transport and the Regions (DETR) defines contaminated land as 'land which represents an actual or potential hazard to health or the environment as a result of previous or current use' and many of the most contaminated sites are current or former industrial premises such as mines, smelters, refineries, chemical manufacturers and scrap yards. The pollutants may be raw materials, catalysts, electrodes, chemical products or wastes. Other sites may be contaminated by leakage or direct application of pesticides, radioactive fall-out, heavy metals from paints, sewage sludge and vehicle exhausts or pollutant deposits from aerial discharges.

Where pollution becomes severe the land may be considered derelict, which is defined as 'so damaged by industrial or other development that it is incapable of beneficial use without treatment'. It is difficult to estimate the extent of contaminated land, not least because of the legal position on liability for clean-up. The whole of the land surface of the UK is tainted to some extent by human activities. The area of contaminated land in Britain, based upon DETR's definition, has been estimated at 360 000 hectares, some 208 000 hectares of which have been redeveloped. The investigation and remediation costs have been put at £15.2 billion [14]. Petrol stations, engineering works and coal preparation works are the three highest cost categories. Sewage works occupy almost one-third of the total area and chemical works, with over 4000 sites occupying 7500 hectares, have an estimated remediation cost of almost £0.5 billion.

Major land contaminants

Heavy and toxic metals. The most important metals with regard to potential toxic hazard are As,

Cd, Cr(VI), Hg, Pb and Zn. Other metals, which in small quantities are essential for healthy growth, may, when in excess, lead to toxic hazard. These include Co, Cu, Mn, Mo, Ni and Se.

Most metals are strongly adsorbed by soil, although Cd and Zn tend to be least strongly adsorbed and can leach under acidic conditions.

Sources of toxic metals include metalliferous mining, smelting, thermal processing of metals and wastes, pigments, catalysts, electrodes, polymer stabilisers, electrical contacts, solders, batteries, sewage sludge, domestic waste disposal, corrosion, food additives, pesticides, wood preservatives, coal and oil burning, lubricants and shotgun pellets.

Hydrocarbons. Aliphatic hydrocarbons with straight and branched chains from CH_4 to $\text{C}_{76}\text{H}_{154}$ may derive from all fossil fuels. Single and multiple ring aromatics with and without nitrogen or sulfur are important constituents of petroleum deposits. Hydrocarbons form the main organic pollutants by weight in soil, especially in industrial sites where they can pose toxic, flammability and explosion hazards. The lower molecular weight hydrocarbons are readily degraded in soil and so pose shorter-lived hazards than other organic pollutants.

Sources of hydrocarbon pollution include fuel storage and transportation and leakage and disposal of used oils.

Persistent organic pollutants and pesticides. The PAHs, PCBs, PCDDs and PCDFs are not readily degraded in the terrestrial environment and their hazards have been discussed earlier (Section 2.2). Pesticides comprise a wide range of organic compounds deliberately spread on the land to destroy insects, mites, nematodes, molluscs, weeds, bacteria and fungi. Some examples are listed in Table 3.3. These exhibit a range of toxicities and toxic mechanisms in target species and in non-target species, including humans. They also exhibit a range of chemical stability and persistence in the environment. Generally, the trend has been to reduce risk by moving from more persistent to less persistent compounds, albeit at higher cost, as exemplified in the insecticides where pyrethroids are less persistent than organophosphates, which in turn are less persistent than organochlorines. However, the breakdown rate may be affected by soil composition and pH, moisture, microorganisms, temperature and

Table 3.3 Some examples of commonly used pesticide groups and their target organisms

Target	Group	Example
Insects	Organochlorines	DDT
	Organophosphates	Parathion
	Hexachlorocyclohexanes	Lindane
	Carbamates	Aldicarb
	Pyrethroids	Cypermethrin
Weeds	Phenoxyacetic acids	2,4,5-T
	Toluidines	Trifluralin
	Triazines	Atrazine
	Phenyl ureas	Fenuron
	Bipyridyls	Paraquat
	Glycines	Glyphosate
	Phenoxypropionates	Mecoprop
	Hydroxyl nitrates	Ioxynil
	Carbamates	Barban
	Fungi	Heavy metal compounds
Dithiocarbamates		Maneb
Phthalimides		Captan
Antibiotics		Cycloheximide
Benzimidazoles		Benomyl
Pyrimidines		Ethirimol

sunlight, and some breakdown products are themselves toxic to wildlife or phytotoxic towards crops.

Less than about 10% of the sprayed pesticide reaches the intended target. Of the remainder, some volatilises and some remains in the soil but most leaches into groundwater.

The major problems with pesticides are associated direct exposure, contamination of groundwater and surface water and entry into the food chain through crops. Organochlorine pesticides have been linked conclusively to health detriment in humans and banned or voluntarily withdrawn in most countries. Chronic organophosphate exposure also has been associated with symptoms of fatigue, muscle failure, nausea, suicidal thoughts, genital deformities in children and sensitisation to common household chemicals [15]. The pyrethroid permethrin is a possible carcinogen and endocrine disrupter and may be connected with the incurable illness MCS (multiple chemical sensitivity), which leaves sufferers sensitised to other common chemical substances such as detergents, tobacco smoke and traffic fumes. It has been speculated that as many as 200 000 people die each year worldwide as a result of pesticide poison-

ing. The true picture is unclear but Third World use of pesticides like DDT, which are banned elsewhere, remains extensive and will not cease until technical solutions at affordable prices are found.

In the UK, pesticide application in agriculture has been estimated at between 0.2 and 5.0 kg per hectare but is declining with the increased demand for organically grown produce and may decline further if the controversial use of genetically modified crops is more widely permitted.

Other toxic materials. Sewage sludge contains a range of contaminants from household chemicals, liquid fuels, lubricants, cleaning agents and industrial effluent. These include toxic metals, PCBs, aromatic amines and nitroamines, phenols, PAHs, hydrocarbons, phthalate esters, inorganic nitrates and phosphates. Spreading sewage sludge on the land can lead to the concentration of some species in the soil and although the nutrients present may stimulate microorganisms to degrade persistent organic pollutants, leaching and run-off also can contribute to eutrophication.

Radionuclide contamination arises from chronic aerial and marine discharges from nuclear establishments, principally Sellafield in the UK and Marcoule and Cap la Hague in France, and from acute discharges linked to accidents such as the 1957 Windscale fire and Chernobyl in 1986. The longer-lived radionuclides such as Cs-137 and Sr-90 are most persistent and pose the largest hazard, although the risks to human life and health are small by comparison to other pollutants.

The chemical industry generates and uses perhaps as many as 100 000 different chemicals. Hazards range from severe to trivial. Priority lists of hazardous commercial chemicals are given in Section 3.4.

Some 3000 pharmaceuticals are also discharged to sewer and deposited in sludges on agricultural land. Very little is known of their environmental impact and few studies have been carried out. Preliminary evidence [16] suggests that real risk to human health and wildlife may be posed. Antibiotics such as oxytetracycline, veterinary growth promoters, hormone disruptors in contraceptive pills, antidepressants such as Prozac and antihypertensive drugs such as Verapamil are the main areas of concern and current study.

Remediation of contaminated land

Reclamation may be effected by isolation, covering or removal of contaminated materials or by in situ decontamination.

Excavation and removal to landfill and covering with a low-permeability, high-cation-exchange clay—the so-called ‘dig and dump’ method—has the advantage of low cost but the disadvantages of leaving the contaminant unchanged and possibly being located near to human activity. Excavated soil may be incinerated (temperatures greater than 1000°C to destroy PCBs or TCDDs and TCDFs) prior to landfill disposal. Washing of removed soil with surfactants, acids or chelating agents or treatment in bioreactors or biodegradation piles also may be carried out prior to disposal. The cleaned soil is unsuitable for supporting plant growth unless mixed with organic compost.

In situ decontamination techniques include:

- Thermal treatment: incineration, thermal desorption or vitrification
- Separation: vacuum extraction, solvent extraction, washing, air stripping
- Fixation: thermoplastics, concrete, increased pH to reduce cation mobility
- Bioremediation: soil microorganisms, crop growth using pollutant-accumulating genotypes
- Chemical treatment: ozonation of hydrocarbons, UV photolysis of C–Cl bonds, contaminant-specific neutralisation

3.3 Freshwaters

‘We are living beyond our means. As a people we have developed a lifestyle that is draining the Earth of its priceless and irreplaceable resources without regard for the future of our children and people all round the globe.’

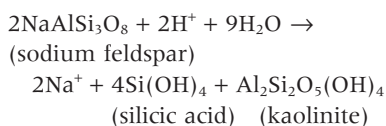
Margaret Meade (1901–1978)

Of the total mass of water on the planet (1.46 × 10¹⁸t), terrestrial freshwaters comprise only a little over 1%. Of this, the vast majority (99.99%) is groundwater, with lakes contributing only 0.009%, rivers contributing 0.0001% and a further 0.0001% being held in the atmosphere. Substantially more freshwater (3% of the total mass of water) is bound up as ice in glaciers and icecaps.

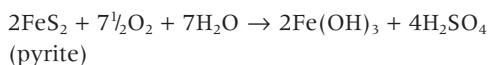
Human use of freshwater for industry, food production, health and hygiene is currently about 8% of renewable resources and is expanding rapidly. If no effective action is taken on global water resources, a crisis may not be far away.

Terrestrial aquatic chemistry

Water is the main factor in the weathering of rock. Thermal expansion and contraction or physical abrasion of the rock, caused by water, leads to fragmentation and the exposure of increased surface area to aqueous dissolution and this dissolution often involves hydrogen ions from dissolved acids, both organic and inorganic:



or oxidation with free oxygen:



The pH of unpolluted rainwater is around 5.6 due to the dissociation of carbonic acid from dissolved CO₂:



Increased atmospheric CO₂ concentration will increase this but more significant acidification comes from SO₂ and NO₂ pollution, which produce the more highly ionised strong acids H₂SO₄ and HNO₃.

Redox potential (*Eh*) also may determine the behaviour of chemical species in the environment, especially if the rock or mineral was formed under reducing conditions in an early geological age. A range of *Eh*–pH combinations is possible. Most environments are in the pH range 3–10. Redox potential is constrained by the presence of water. Under very oxidising conditions of *Eh* = 0.6–1.2 Vs (depending upon the pH) water is oxidised to molecular oxygen and under very reducing conditions of *Eh* = 0.0 to –0.6 Vs (again, depending upon pH) water is reduced to molecular hydrogen. This sets the limits for the range of possible environmental redox potentials where water is present.

3.4 Pollution of freshwater

'He who drinks a tumbler of London water has literally in his stomach more animated beings than there are men, women and children on the face of the globe.'

Sydney Smith (1771–1845)

The major detrimental effects of pollution of freshwaters are:

- Toxicity—acute or chronic damage to life
- Acidity/alkalinity—disturbance of the natural pH of living things
- Deoxygenation—removal of life support
- Eutrophication—excess nutrients
- Heating—disturbance of the natural temperature
- Aesthetic damage—discolouration, odours, litter

Any chemical present in high enough concentration may be deemed a pollutant. The main pathway to man for these pollutants is through the drinking water. The quality requirements for public water supplies in England and Wales are made under the Water Supply (Water Quality) Regulations 1989 and must comply with the relevant EU Directive.

Water quality is measured against a series of parameters:

- (1) Dissolved oxygen—although poorly soluble in water, oxygen is fundamental to aquatic life. Its solubility is inversely proportional to temperature, ranging at saturation from 14.6 mg l^{-1} at 0°C to 7.6 mg l^{-1} at 30°C .
- (2) Biological oxygen demand (BOD) is a measure of the rate at which microorganisms use the dissolved oxygen. A low BOD indicates clean water or that the microorganisms are dead, dying or otherwise restricted from consuming oxygen. It is directly proportional to temperature.
- (3) Chemical oxygen demand (COD) is a measure of the total load of oxidisable material, both organic and inorganic, in the water.
- (4) Total organic carbon (TOC) is a measure of material such as lignin, humic acids or synthetic organic compounds, which resist microbial decomposition.
- (5) Absorbable organic halogen (AOH) is a measure of halocarbon pollutants.
- (6) Acidity (pH) is a measure of the hydrogen ion concentration.

- (7) Alkalinity measures the buffering capacity of water against acid pollution, normally as a result of the carbonate/bicarbonate buffering system from dissolved CO_2 .
- (8) Conductivity is a measure of dissolved ions in solution.
- (9) Nutrient content is a measure of the nitrogen (as nitrate, nitrite, ammonia and organic nitrogen) and phosphorus (as various phosphates).

Other parameters include turbidity, colour, odour, bacteria, viruses, heavy metals and toxic organic solids content. Some or all of the above may be incorporated in Statutory Water Quality Objectives, which are developed for individual stretches of water and relate to intended use.

Sources of pollution

The 1976 EU Dangerous Substances Directive listed dangerous substances that were to be controlled to agreed European Community levels (List 1—the 'Black List'):

- (1) Organohalogen compounds and substances that may form such compounds in the aquatic environment.
- (2) Organophosphorus compounds.
- (3) Organotin compounds.
- (4) Substances that possess carcinogenic, mutagenic or teratogenic properties in or via the aquatic environment.
- (5) Mercury and its compounds.
- (6) Cadmium and its compounds.
- (7) Mineral oils and hydrocarbons.
- (8) Cyanides.

or to national standards (List 2—the 'Grey List'):

- (1) The following metalloids and metals and their compounds: zinc, copper, nickel, chromium, lead, selenium, arsenic, antimony, molybdenum, titanium, tin, barium, beryllium, boron, uranium, vanadium, cobalt, thallium, tellurium, silver.
- (2) Biocides and their derivatives not appearing in List 1.
- (3) Substances that have a deleterious effect on taste/odour of groundwater and compounds liable to cause the formation of such substances in such water and render it unfit for human consumption.

- (4) Toxic or persistent organic compounds of silicon and substances that may cause the formation of such compounds in water, excluding those that are biologically harmless or are converted rapidly in water into harmless substances.
- (5) Inorganic compounds of phosphorus and elemental phosphorus.
- (6) Fluorides and cyanides.
- (7) Substances that have an adverse effect on the oxygen balance, particularly ammonia and nitrates.

The UK publishes priority lists of dangerous chemicals: the Red List and First Priority Candidate Red List (Table 3.4), for which the control regime is more stringent than for the Black List, containing a precautionary element and requiring Best Available Technology Not Entailing Excessive Cost (BATNEEC).

Pollution may emanate from a point source, e.g. a pipe or channel from a factory or sewage treatment

Table 3.4 Red List priority toxic chemicals

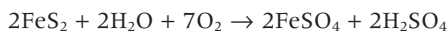
Red List	First Priority Candidate Red List
Aldrin	2-Amino-4-chlorophenol
Atrazine	Anthracene
Azinphos-methyl	Azinphos-ethyl
Cadmium and its compounds	Biphenyl
DDT (including metabolites DDD and DDE)	Chloroacetic acid
1,2-Dichloroethane	2-Chloroethanol
Dichlorvos	4-Chloro-2-nitrotoluene
Dieldrin	Cyanuric chloride
Endosulfan	2,4-Dichlorophenoxyacetic acid (including salts and esters)
Endrin	Demeton-O
Fenitrothion	1,4-Dichlorobenzene
Hexachlorobenzene	1,1-Dichloroethylene
Hexachlorobutadiene	1,3-Dichloropropan-2-ol
γ -Hexachlorocyclohexane	1,3 Dichloropropene
Malathion	Dimethoate
Mercury and its compounds	Ethylbenzene
PCBs	Fenthion
Pentachlorophenol	Hexachloroethane
Simazine	Linuron
Trichlorobenzene (all isomers)	Mevinphos
Trifluralin	Parathion (including parathion-methyl)
Triorganotin compounds	Pyrazon 1,1,1-Trichloroethane

plant, or a non-point source, e.g. farm run-off, construction site, land disturbance or mine.

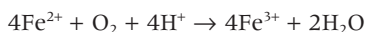
The Chemical Industries Association *Indicators of Performance* 2000 report [6] claims that total discharges of Red List substances have been reduced by 96% since 1990, with some 14t being discharged in 1999.

Effects of pollution

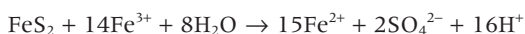
Acidification. Acidification of the terrestrial environment takes place via the deposition of acids derived from aerial SO_2 and NO_x pollution (see Section 2.2) and from industrial acid discharges, particularly acid mine drainage. In underground coal and metal mines the pumping of groundwater exposes pyrite (FeS_2) in the lower strata, which becomes subject to aerial oxidation:



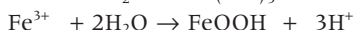
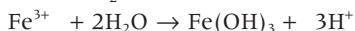
Additionally, when the water returns to the mine after extraction and pumping cease, the sulfuric acid and iron(II) sulfate dissolve. The iron(II) is oxidised slowly by bacteria to iron(III) in the acidic conditions:



which liberates more acid by reaction with the now covered pyrite:



When the iron(II)- and acid-bearing water reaches the surface it oxidises rapidly, depositing orange ferric hydroxide ($\text{Fe}(\text{OH})_3$) and oxyhydroxide (FeOOH) precipitates and releasing further acid:



The acids released leach toxic metals from mine spoil, particularly Cu, Pb, Cd, Sn and As, and carry them to streams and groundwater.

Acidification of soil can overcome the natural carbonate buffering, lowering the pH by as much as two units. Phosphate and nitrate anions may become remobilised and aluminium, manganese and zinc leach from the soil.

Acid rain also leaches nutrient cations Ca^{2+} , K^+ and Mg^{2+} previously held as complex ions in the soil, replacing them with H^+ with resulting reductions in

plant growth and resistance to disease, pests and frost. Nutrient leaching also causes problems for invertebrates that rely on vegetation for shell-forming minerals as well as food.

Acidification of streams disrupts the ability of fish to regulate internal salt concentrations at the gill surfaces and, at pH 5 and below, to the formation of a gelatinous $\text{Al}(\text{OH})_3$ precipitate in the gills. Both processes lead to higher fish mortality.

Effects are not restricted to fish. All aspects of freshwater ecosystems are affected by increased acidity. Populations of microorganisms, plants and animals change considerably and there is a general reduction in species diversity and fecundity leading to general decline of populations.

Eutrophication. Eutrophication is the enrichment of waters by inorganic plant nutrients. Of the 18 essential elements that make up these nutrients, nitrogen as NO_3^- and phosphorus as PO_4^{3-} are the limiting elements. Eutrophication is a natural phenomenon; with lakes and rivers becoming more eutrophic with age.

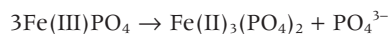
However, the rate at which this is occurring has been accelerated by human activities. In particular: the burning of fossil fuels increases the nitrogen content of rain; deforestation and clearance of river banks for social access increases erosion and the release of nutrients previously bound in the soil; atmospheric nitrogen is being mobilised through industrial fixation and introduction to the biosphere as commercial fertiliser; the washing of manure from intensive farming directly into streams cuts short the natural process; and the use of phosphorus in detergents as tripolyphosphates has increased dramatically the phosphorus content of sewage effluent and storm drainage.

Nitrate is highly soluble and fertilisers form the main source of this ion in rivers, accounting for 70% of the annual mass flow of nitrogen in some agricultural areas. Half of the nitrogen applied to crops is lost to terrestrial waters.

Phosphorus is largely insoluble, being held as calcium and iron phosphates. It enters terrestrial waters mainly through erosion, although in some areas 90% of the phosphorus now enters the rivers via sewage effluent.

In eutrophic lakes oxygen consumption exceeds supply due to rapid plant and algal growth. Reducing conditions therefore prevail in the sediments at

the bottom of the lake. This results in the release of further phosphorus previously bound as insoluble iron(III) phosphate:



As phosphorus is normally the limiting element, this accelerates the eutrophication of the lake.

The main effects of eutrophication are reduction in species diversity and changes to the dominant biota, e.g. the predominance of coarse fish over salmonids, increased biomass growth, high rates of photosynthesis and excess oxygen at the lake surface leading to blue-green algal bloom, increased odour and turbidity, reduced light to the lake bed, increased sedimentation, and stratification of the lake with anoxic conditions prevailing in the lower layers due to increased decomposition of organic matter. Increased algal growth leads to a decline in amenity value of the lake or river and increased vegetation impedes navigation. Treatment works may become blocked and algal blooms may cause previously potable water to become undrinkable.

It is possible to control artificial eutrophication through control of all nutrient input. Controlling the phosphorus input alone is the best approach because it is derived mainly from point sources, e.g. sewage treatment works, whereas nitrogen enters via diffuse sources and requires extensive controlled areas bordering waterways for its management. The principal method for phosphate removal is chemical flocculation with iron or aluminium sulfate.

An alternative treatment is biomanipulation through re-establishment of herbivorous zooplankton in the lake by initial removal of planktivorous fish. The zooplankton eat the blue-green algae, re-establishing water clarity. This technology is relatively novel and it is unclear whether the reversal of eutrophication is permanent.

Hormone-disrupting chemicals. Some synthetic chemicals that have been released into the environment can mimic natural hormones and there is a question of whether this poses a threat to human health and wildlife.

Many functions of the body are controlled by hormones within the endocrine system. The hormones are secreted from the glands and travel to the organs, where they lock on to receptors to trigger specific responses. Some examples are as shown in Table 3.5. The first endocrine-disrupting synthetic chemicals

Table 3.5 Examples of hormones and their functions

Hormone	Produced by	Function
Oestradiol	Ovaries	Controls egg production
Testosterone	Testes	Controls sperm production
Adrenaline	Adrenal glands	Increases heart beat
Thyroxine	Thyroid gland	Controls metabolic rate
Human growth factor	Pituitary gland	Controls growth
Insulin	Pancreas	Controls blood sugar levels

identified interfered with oestrogen (oestradiol), either by blocking the receptors so that the response was not triggered or by locking on to the receptor to cause a spurious response. This mimicking property is termed oestrogenicity and depends upon the molecule fitting and blocking or actuating the oestrogen receptor by presenting correctly sized and spaced polar groups. The chemicals exhibiting this property are termed xeno-oestrogens.

Xeno-oestrogens include chlorinated pesticides such as DDT, surfactants such as alkylphenol ethoxylates and their breakdown products, plasticisers such as phthalates, bisphenol A, which is used in epoxy resin and polycarbonate food packaging, PCBs and dioxins. There is evidence that drinking water supplies also are being contaminated by endocrine-disrupting chemicals in resins, cements and pipelines used in delivering water to homes [17].

The EC has drawn up a draft priority list of potential endocrine-disrupting compounds containing pesticides, biocides and industrial chemicals that have had at least one study providing evidence of disruption in an intact organism (Table 3.6). The substances have been ranked as high, medium or low concern, depending upon the degree of human and wildlife exposure, environmental persistence and bioaccumulative behaviour. The list will be used to prioritise future research but is contentious and has been challenged by sections of the chemical industry.

A more restricted list drawn up by the UK Environment Agency and included in a new strategy document [18] has been praised by industry but criticised by environmental groups.

The similarity of the molecular configurations of oestrogen and some xeno-oestrogens may be seen below (see Scheme 3.4):

In addition, many plants produce low levels of oestrogenic chemicals called phyto-oestrogens

and these are present in many foods, particularly soya beans and other pulses, cabbage, spinach and grains.

Although xeno-oestrogens generally do not mimic oestrogen exactly, there is growing concern that adverse effects on the reproductive health of humans and wildlife are occurring. Some of the putative effects are given in Table 3.7. The estrogenicity of a suspect chemical can be assayed using yeast cells that express the human oestrogen receptor coupled with the enzyme galactosidase and a yellow galactoside dye. When an oestrogen mimic is present, the chromophore is released, becoming red in the free state [19].

Heavy and toxic metals. Industrial pollution from metals on EC Lists 1 and 2 emanates from a range of industries, the principal ones being paper, petrochemicals, bleach, fertiliser, steel, non-ferrous metals, motor vehicles, aircraft, glass, ceramics, cement, leather and steam power plants.

Household waste also contains heavy metals, which may enter the surface water and groundwater through seepage from landfill and sewage treatment. Heavy metals also were used as wood preservatives until the 1970s, when they were banned but still arise from old timber.

When metals reach the water they are diluted quickly and then precipitated as carbonates, sulfates or sulfides or adsorbed onto mineral or organic sediments. Metal concentrations on sediments in rivers and lakes can be up to 10000 times greater than in the supernatant water. Metals in sediments can become remobilised and hence ecotoxicologically active as a result of a variety of processes such as physical disturbances during spate conditions, bioaccumulation in algae followed by their death and anaerobic decay or reductively as in the case of inorganic manganese.

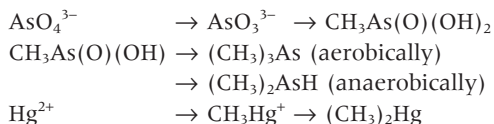
Table 3.6 EC Draft Priority List of potential endocrine-disrupting chemicals (from CEC Com (2001) 262, pp. 15–19, quoted in *ENDS Report 306*, p. 42, July 2000)

Pesticides		Industrial chemicals		Biocides	
Chlordane	High	Styrene	High	Tributylstannyl salicylate	High
Chlordane	High	Butylbenzyl phthalate	High	Methoxyethylacrylate	
(<i>cis</i> and <i>trans</i>)	High	Di(2-ethylhexyl) phthalate	High	tributyltin copolymer	High
Kepone		Di- <i>n</i> -butyl phthalate	High	Stannane,	
Mirex	High	Bisphenol A	High	(benzoyloxy)tributyl-	High
Toxaphene	High	PCB	High	Stannane, 1,2-phenylene	
DDT	High	PCB 153	High	bis (carbonyloxy)	High
<i>p</i> , <i>p'</i> -DDT	High	PCB 169	High	Stannane, tributylmethacrylate	High
Tetrachloro-DDT	High	PCB 47	High	Stannane, tributyl-,	
Vinclozolin	High	PCB 77	High	mono(napthenoyloxy)	High
Maneb	High	Aroclor 1242	High	Stannane, tributyl (1-oxo-9-	
Metam sodium	High	Aroclor 1248	High	octadecenyl)	High
Thiram	High	Aroclor 1254	High	Stannane, tributyl(octadeca-	
Lindane	High	Aroclor 1260	High	9,12-dienoyloxy)	High
Linuron	High	Polybrominated biphenyl ethers	High	Stannane, tributylfluoro	High
Atrazine	High	1,2,3,7,8-Pentachlorodibenzodioxin	High	Stannane, tributyl	
Acetochlor	High	2,3,7,8-Tetrachlorodibenzodioxin	High	[[[1,2,3,4,4a,4b,5,6,10,10a-	
Alachlor	High	1,2,3,7,8-Pentachlorodibenzofuran	High	decahydro-7- <i>iso</i> -propyl-1,	
Tripheny	High	3,4-Dichloroaniline	High	4a-dimethyl-1-phenanthryl]	
Nitrofen	Medium	4- <i>tert</i> -Octylphenol	Medium	carbonyl]oxy]	High
		Nonylphenol	Medium	Tributyltin carboxylate	High
		Tetrabutyltin	Low	Tributyl[(2-methyl-1-oxo-2-	
		4-Nitrotoluene	Low	propenyl)oxy]stannane	High
				Tributyltin naphthalate	High
				Tributyltin polyethoxylate	High
				Tri- <i>n</i> -propyltin	High
				Tributyltin hydride and oxide	High
				Triphenyltin acetate	High
				Hexachlorobenzene	High

Males	Females	Wildlife
Decreased sperm counts or quality	Breast cancer	Infertility
Testicular cancer	Cardiovascular effects	Sex changes (Imposex)
Undescended testes		Dysfunctional immune system
Malformed penis		Developmental abnormalities
Intelligence deficit	Intelligence deficit	Thyroid dysfunction
Neurological problems	Neurological problems	Behavioural abnormalities

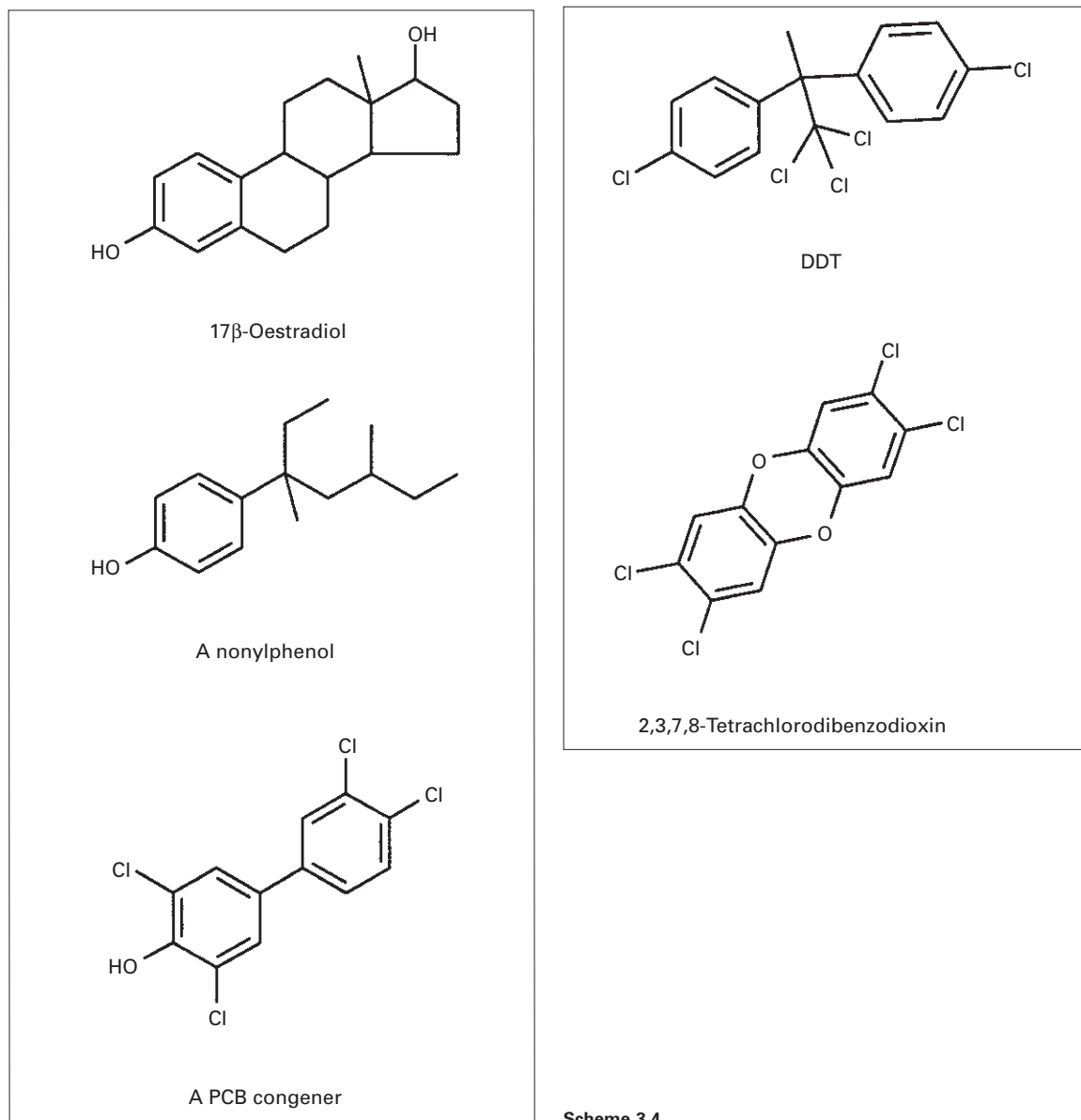
Table 3.7 Putative effects of oestrogen mimics on human and animal health

Some metals, e.g. arsenic and mercury, undergo microbial alkylation:



Mercury toxicity is enhanced by this process, whereas the toxicity of organic arsenic species is significantly lower than that of the inorganic arsenic species arsenite and arsenate.

The importance of speciation in metal ecotoxicology cannot be overemphasised. The toxicity of alkyl lead compounds, for example, increases with the



Scheme 3.4

number of alkyl groups and chromium(III) and chromium(VI) are significantly different in toxicity, the latter being toxic and a known carcinogen.

Synthetic organic chemicals. A wide range of organic compounds are synthesized for industrial and agricultural use, including drugs, solvents, cleaners, degreasers, petroleum products, preserva-

tives and pesticides. Many percolate into the soil and accumulate in aquifers and surface waters, sometimes reaching drinking water supplies. A recent survey [20], for example, showed that over 20% of private water supplies in Wales are contaminated with sheep dip chemicals.

Some of the most widely used solvents in the UK are the chlorocarbons CH_2Cl_2 , CHCl_3 , CCl_3CH_3 , CCl_4 ,

CHCl:CCl₂ and CCl₂:CCl₂ and, although there has been a decrease in usage over the past 25 years, most still are found frequently in drinking water.

Pesticides found in UK drinking water include atrazine, chlortoluon, isoproturon, mecoprop and simazine. A major source of insecticide in freshwater is from sheep dipping. When organochlorine pesticides such as lindane were banned, they were replaced by the less persistent organophosphorus groups. These, however, are now coming under suspicion of causing health problems and the use of synthetic pyrethroids has increased. However, although the latter have low environmental persistence and are largely non-toxic to mammals, they are at least 100 times more toxic to invertebrates in the aquatic environment than organophosphates and are resulting in the death of significant numbers of aquatic organisms in UK rivers.

4 Chemistry of the Oceans

4.1 Chemistry of the open ocean

‘How inappropriate to call this planet Earth when it is quite clearly ocean.’

Arthur C. Clarke (1917–)

The oceans and seas of the world cover 71% of the planet’s surface, i.e. $3.6 \times 10^8 \text{ km}^2$, with a depth of 0–10 km, averaging 3.7 km. They contain 97% of all the water on the planet and until recently were considered infinite sinks for anthropological pollution.

However, the fragility of the marine environment, especially estuaries, coastal waters and enclosed seas such as the Baltic and Mediterranean, is now recognised. Millions of years of constant conditions have led to marine organisms becoming highly specialised and consequently intolerant to environmental change.

Seawater is saline. Salinity is defined as the weight in grammes of inorganic ions dissolved in one kilogramme of water. However, because it is normally measured in terms of conductance and quoted relative to known standards, it has no units. Open ocean waters are well mixed and have a narrow range of salinities between 32 and 37. Most are around 35.

The main inorganic chemical species in seawater with a basis salinity of 35 are given in Table 3.8. Evidence that the salinity and ionic composition of seawater have remained more or less constant over the

Table 3.8 Concentrations of the principal ions in seawater (basis salinity = 35)

Element	Chemical species	(mol l ⁻¹)	(g kg ⁻¹)
Sodium	Na ⁺	4.79×10^{-1}	10.77
Magnesium	Mg ²⁺	5.44×10^{-2}	1.29
Calcium	Ca ²⁺	1.05×10^{-2}	0.4123
Potassium	K ⁺	1.05×10^{-2}	0.3991
Strontium	Sr ²⁺	9.51×10^{-5}	0.00814
Chlorine	Cl ⁻	5.59×10^{-1}	19.353
Sulfur	SO ₄ ²⁻ , NaSO ₄ ⁻	2.89×10^{-2}	0.905
Carbon	HCO ₃ ⁻ , CO ₃ ²⁻	2.35×10^{-3}	0.276
Bromine	Br ⁻	8.62×10^{-4}	0.673
Boron	B(OH) ₃ , B(OH) ₄ ⁻	4.21×10^{-4}	0.0445
Fluorine	F ⁻ , MgF ⁺	7.51×10^{-5}	0.00139

Source: Refs 21 and 22.

last 900 million years comes from evaporites: salts deposited in constant sequences and thicknesses from evaporating seawater basins cut off from the open ocean.

The residence times of ions in seawater reflect the way in which biogeochemical cycling is operating and influence their ecotoxicity. Most residence times are very long (10^4 – 10^8 years) compared with that of the water itself (3.8×10^4 years). Ions with the highest solubility generally have the longest residence times. Alkali and alkaline-earth metals, halogens and oxo-anions thus tend to remain in solution for a long time. Elements that readily form hydroxides, such as Al and Fe, reside only for a relatively short time in solution. The ecotoxicity of a pollutant is generally higher when in solution than when adsorbed on sediments.

Inputs of chemicals take place from the atmosphere, rivers, glaciers, hydrothermal sources, sediments and basement rock. Sinks are principally sediments, precipitates and biological removal but also include sea to air fluxes, evaporites and geological subduction of the seabed.

Residence times for the major ions based on steady-state assumptions are given in Table 3.9. The ionic strength of seawater is approximately 0.7 mol l^{-1} and the acidity/alkalinity is buffered by carbonate/bicarbonate to pH 8.

In addition to dissolved salts the oceans contain dissolved gases and a large number of organic compounds in solution and particles in suspension. The dissolved oxygen concentration varies from

Table 3.9 Residence times of some major species in seawater

Ion	Residence time (years)
K ⁺	7 × 10 ⁶
Na ⁺	6.8 × 10 ⁷
Li ⁺	2.3 × 10 ⁶
Mg ²⁺	1.2 × 10 ⁷
Ca ²⁺	1 × 10 ⁶
Sr ²⁺	4 × 10 ⁶
Fe(OH) ₃	2 × 10 ²
Al(OH) ₃	1 × 10 ²
Cl ⁻	1.3 × 10 ⁸
Br ⁻	1 × 10 ⁸
SO ₄ ²⁻	1.2 × 10 ⁷
HCO ₃ ⁻	9 × 10 ⁴

Source: Refs 10 and 22.

280 μg kg⁻¹ at the surface, where it is in equilibrium with atmospheric oxygen, to 20 μg kg⁻¹ at 500 m depth as the oxygen is used in chemical and biochemical oxidation. In deeper waters, which originate at the poles where oxidation reactions are less prevalent, the oxygen level is higher, rising to 150 μg kg⁻¹ at 4000 m depth. The dissolved oxygen concentration determines the redox potential of the water. Oxidising conditions normally prevail. However, where large quantities of organic material reach the deep ocean, oxygen depletion can lead to reducing conditions in which, for example, NO₃⁻ is reduced to NO₂⁻. In exceptional circumstances some enclosed seas such as the Black Sea and some Norwegian fiords can become anoxic at depth.

Surface chemistry also plays a significant role in biogeochemical cycling, particularly of metal ions. Exchange of material from solution to suspended particulates followed by sedimentation provides an effective scavenging mechanism. The cation exchange capacities of some sorptive materials are given in Table 3.10.

4.2 Chemistry of estuaries

The ion composition of freshwater principally comprises Ca²⁺ and HCO₃⁻, whereas seawater is dominated by Na⁺ and Cl⁻. Moreover, the total ionic concentration of river water is 500 times less than seawater. Estuaries are mixing zones between the two, with sharp gradients in ionic strength and

Table 3.10 Cation exchange capacities of some sorptive materials

Material	Cation exchange capacity (milliequivalents per 100 g)
Kaolinite	3–15
Illite	10–40
Chlorite	20–50
Montmorillonite	80–120
Fe(OH) ₃ (freshly precipitated)	10–25
Silicic acid (amorphous)	11–34
Humic acids	170–590

Source: Ref. 23.

chemical composition. This has a significant impact on the substantial loads of suspended sediments carried by rivers and the speciation of dissolved cations. The position of this mixing zone shows seasonal variation due to non-uniform river flux.

The pH of river water will vary depending upon the geology over which the river flows, but it is normally below that of seawater (pH 8) and the importance of OH⁻ ions for the water chemistry increases down the estuary. Increasing Cl⁻ concentration causes the formation of chloro-complexes of metals such as Cd, Hg and Zn. Metals such as Mn and Zn, which in river water may be complexed by humic materials, may become displaced in the complexes by Ca and Mg as the latter metals increase in concentration as the river meets the sea.

The most significant chemistry taking place in the estuary, however, concerns particulate dissolution, precipitation and deposition. River particulates are kept in suspension by the mutual repulsion of their surface negative charges. As ionic strength increases, these charges become neutralised by cations, leading to coagulation or flocculation with organic materials followed by deposition. Other particulate processes include cation exchange and the precipitation of Fe and Mn oxyhydroxides.

Estuaries are areas of high biological activity and can capture and trap dissolved nutrients. When the fresh and brackish water organisms meet stronger saline conditions they die and rupture, releasing the nutrients to create localised areas of high concentration.

4.3 Pollution of the oceans

'Pollution is nothing but the resources we are not harvesting. We allow them to disperse because we've been ignorant of their value.'

R. Buckminster Fuller (1895–1983)

Pathways by which anthropogenic pollutants are delivered to the oceans include river run-off, wet and dry atmospheric deposition, marine dumping (e.g. of sewage sludge, radioactive waste and dredge spoil), discharges from ships and coastal pipeline discharges.

Pollutants that enter the oceans may be diluted and dispersed by circulation mechanisms, concentrated by ingestion and retention by marine biota, degraded by chemical and biological processes or deposited in the sediments. The pollutants thus affect all compartments of the ocean and have their greatest impact in coastal and enclosed seas close to the sources. The most significant pollutants include hydrocarbons, sewage, persistent organic compounds, toxic metals and artificial radionuclides.

Hydrocarbons

The main sources of in situ marine hydrocarbon pollution are tanker operations and accidents, maritime bilge and fuel oils, coastal refineries, marine terminals and offshore production. The main sources from land are municipal wastes, including motor vehicle fuels and lubricants, industrial wastes, urban run-off and atmospheric fall-out. There are no consistent estimates of marine oil release but a figure of between one and three million tonnes per year may be realistic and this figure may be declining.

Crude oil is the main in situ component and is a complex mixture of aliphatic and aromatic hydrocarbons with some heterocyclic compounds. Molecular weights range from 40 to over 200, with consequent ranges of vapour pressure, oil–water partition coefficient and water solubility. The effects can depend upon the composition of the oil as well as the prevailing weather and ecology of the area.

Oil pollution adversely affects marine communities and has damaging impacts on marine and coastal habitats. The longer chain aliphatic hydrocarbons and PAHs deplete marine populations over extensive areas because of their toxicity, rapid uptake by biota and environmental persistence. They bioaccumulate

and biomagnify due to their lipid solubility, moving up the trophic levels entering the human food chain through finfish and shellfish. The PAHs comprise about 2% of crude oil but include some of the slowest components to degrade. The PAH components thus may be used to identify pollution sources and monitor the weathering process.

Hydrocarbons also adsorb readily onto particulates and accumulate in sediments where they pose a chronic threat to the bottom-dwelling (benthic) flora and fauna. Soluble hydrocarbons such as the monocyclic aromatics kill plankton exposed to them at levels above 5 mg l⁻¹. Anthropogenic sources of marine oil pollution exceed natural sources (excluding biosynthesis) by a factor of between 3 and 10.

Removal processes include evaporation, dissolution, dispersion, emulsification, photochemical oxidation, adsorption and biodegradation.

Sewage

Sewage may reach the oceans in untreated or partially treated forms through rivers or coastal discharge or as dumped sewage sludge. It poses aesthetic and health risks and carries with it other pollutants such as metals, nutrients and organics. At the beginning of the 1990s some 5 million tonnes of wet sewage sludge were dumped by the UK in the North Sea every year but this practice has now ceased.

Persistent organic pollutants

Anthropogenic organic compounds exist in a large variety and all may potentially find their way to the oceans. Halogenated compounds such as organochlorine pesticides, PCBs, dioxins, dibenzofurans and chlorinated solvents pose a major threat. As an example, over 60% (230 000 t) of all environmental PCBs are estimated to reside in the water of the open oceans, 35% (130 000 t) in the coastal sediments and relatively tiny amounts in soils (2400 t), terrestrial waters (3500 t) and the air (550 t).

Other persistent organics that are causes for concern in the marine environment are organophosphorus pesticides, solvents, endocrine disruptors and PAHs. The PAHs are now believed to be 1000 times more toxic to marine organisms after exposure to sunlight than in their unphotolysed form [24].

Heavy and toxic metals

Certain metals exhibit extreme persistence, high toxicity and bioaccumulative tendencies in the marine environment. They are normally grouped into those elements essential for metabolic function but toxic at higher concentrations, such as Fe, Mn, Co, Cu, V and Zn, and those not required for metabolic activity and toxic even at low concentrations, such as As, Cd, Hg, Pb, Se and Sn.

Principal anthropogenic sources are listed in section 3.2. The metals reach the sea via riverine flow, coastal discharge and atmospheric deposition. The principal sink is the sediments due to the rapid sorption and complexation of the metals with suspended particles followed by coagulation and deposition.

Speciation again plays a crucial role in physical and chemical behaviour and environmental toxicity. Metals may be in solution as free metal ions, e.g. Cd^{2+} , as inorganic complexes, e.g. HgCl_4^{2-} , or as low-molecular-weight organic complexes, e.g. zinc fulvates. They may be in colloidal form in high-molecular-weight organic complexes, e.g. lead humates, in particulate form adsorbed onto inorganic colloids (e.g. Pb-Fe(OH)_3) or clays (e.g. nickel montmorillonite) or precipitated (e.g. MnO_2). They may exist also as organometallic compounds, e.g. tributyltin, lead tri- and tetra-alkyls or methylmercury. This last group is of particular concern because of its proven extreme toxicity to marine life and humans. An approximate order of increasing toxicity of inorganic metals is Co, Al, Cr, Pb, Ni, Zn, Ca, Cd and Hg, although this varies depending upon the target species and the metal speciation. At toxic levels these metals act as enzyme inhibitors and adversely affect cell membranes. Organometallics attack the central nervous system and reproductive systems.

Recent (1999) monitoring in Britain has shown that metal levels, particularly Cd, Pb and As, in shellfish from designated production areas exceed proposed EC food safety standards due to industrial pollution [25].

Radionuclides

Radionuclides in estuaries and marine environments derive from both natural and anthropogenic sources, the former being overwhelmingly greater in the open oceans and in all but the few estuaries that are near to major nuclear plants.

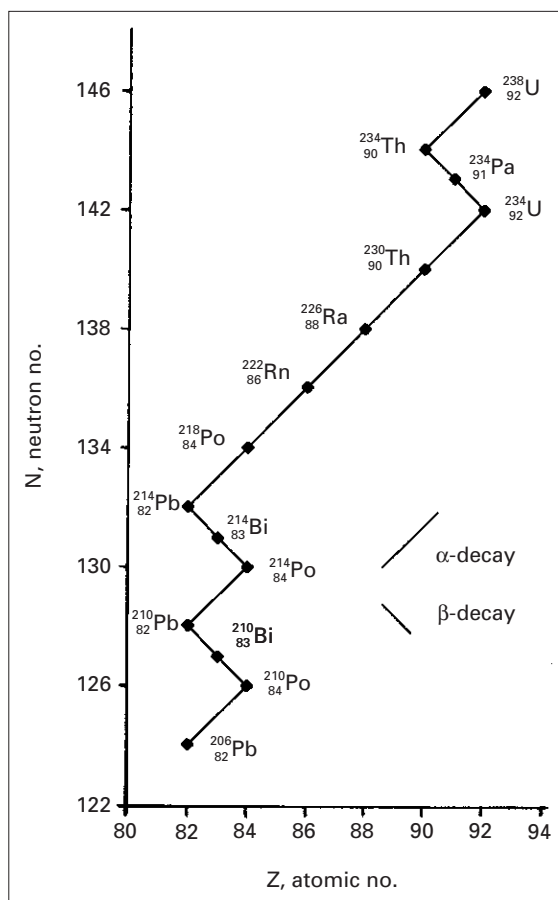


Fig. 3.5 Segre plot of the radioactive decay chain of Uranium-238.

Natural radioactivity comprises cosmogenic and primordial radionuclides and their radioactive decay products. Cosmogenic nuclides arise from bombardment of the planet by cosmic rays (protons) and include ^{14}C , ^{87}Rb and ^3H (tritium). Primordial radionuclides were formed in supernova explosions and, because of their immense lifetimes (greater than a billion years), have survived since the formation of the solar system. They include ^{238}U and ^{232}Th . They decay, albeit slowly, to produce radioactive daughters including ^{226}Ra , ^{222}Rn , ^{220}Rn and ^{210}Po . The decay chain for ^{238}U is shown in Fig. 3.5. Alpha decay results in the loss of two protons and two neutrons; beta decay results in the conversion of one neutron into one proton and the emission of one electron.

Table 3.11 Concentrations of the main radionuclides in seawater

Radionuclide	Concentration (Bqkg ⁻¹)
Potassium-40	11.84
Rubidium-87	1.07
Tritium	Up to 0.11
Uranium-234	0.05
Uranium-238	0.04
Carbon-14	0.007
Radium-226	Less than 10 ⁻²
Radium-222	Less than 10 ⁻²
Potassium-210	Less than 10 ⁻²
Thorium isotopes	Less than 10 ⁻²

Source: Ref. 26.

Seawater has a natural radioactivity of 12.6 Bq l⁻¹ (a becquerel (Bq) is one disintegration per second) and marine sediments are in the range 200–1000 Bq kg⁻¹ (see Table 3.11).

Anthropogenic sources are mainly from atmospheric nuclear weapons testing (which has declined sharply since the Test Ban Treaty in 1963) and nuclear power generation operations. The latter include fuel fabrication, electrical power generation, reprocessing and waste management. Biologically significant nuclides from weapons testing are ¹⁴C (half-life 5730 years), ¹³⁷Cs (30.07 years), ⁸⁹Sr (50.53 days), ⁹⁰Sr (28.79 years) and ¹³¹I (8.02 days). Chronic discharges from power production are dominated by ⁸⁵Kr (10.76 years) and from reprocessing by ¹⁴C, ⁶⁰Co (5.27 years), ⁹⁰Sr, ⁹⁹Tc (211 000 years), ¹⁰⁶Ru (373.6 days), ^{110m}Ag (249.8 days), ¹³⁷Cs and ²³⁹Pu (24 110 years), ²⁴¹Pu (14.35 days), ²³⁷Np (2.144 million years) and ²⁴¹Am (432.2 years).

Acute radioactive discharges from reactor accidents tend to be dominated by the volatile radioisotopes of I and Cs, although significantly increased ¹⁰⁶Ru (367 days) levels in fish also were detected following Chernobyl.

Radionuclides, of course, behave chemically identically to their stable isotopes. Radiation of marine organisms occurs internally from ingestion and absorption and externally from immersion. Little evidence exists for biomagnification and doses are almost exclusively sub-lethal, the one exception being carnivorous fish in the Marshall Islands due to ¹³¹I from weapons testing fall-out.

Radiation causes ion and free radical formation in tissue, which can lead to cell death or mutation. This in turn can lead to a range of short-term and long-term effects to the exposed individual (somatic) and potentially through chromosomal aberrations to succeeding generations (genetic). For the short-term effects to become apparent a fairly high threshold dose is necessary but for longer term somatic and for genetic effects there is theoretically no threshold.

Discharges from the nuclear fuel cycle peaked in the 1970s and early 1980s and now, under the effects of stricter legislation, have fallen to about 1.5% of the peak levels for beta-emitting nuclides and 0.15% for the alpha-emitters.

Sections of the Irish Sea adjacent to the Sellafield site of British Nuclear Fuels Limited (BNFL) have received some of the highest discharges of radioactivity in the world. Sampling of seawater close to the site shows alpha levels of 7 Bq kg⁻¹ and beta/gamma levels of 10 Bq kg⁻¹ from anthropogenic sources [27]. This may be compared with the natural background level in seawater of 12 Bq l⁻¹.

To illustrate the effects of legislation in this area the concentration of ¹³⁷Cs, a typical long-lived beta/gamma emitter, has fallen steadily, reflecting the reduced discharges, and currently stands at 0.3 Bq kg⁻¹ (1% of peak levels).

5 Conclusion

'The world can only be grasped by action not by contemplation. The hand is the cutting edge of the mind.'

Jacob Bronowski (1908–1974)

If pollution, and particularly chemical pollution, did not exist it is doubtful whether the study of the environment and its chemistry would have reached the intensity it has at the turn of the millennium. Intervention to minimise and remediate environmental pollution effects should be on the 'if it ain't broke don't fix it' principle. However, in places the environment is broken and we must intervene immediately to fix it. Exactly where and how it can be fixed needs careful study *and* action. It is hoped that this book will help to point the way.

References

1. Brimblecombe, P. *Air Composition and Chemistry*, 2nd edn. Cambridge University Press, Cambridge, 1996.

2. Seinfeld, J. H. *Atmospheric Chemistry and Physics of Air Pollution*. John Wiley, Chichester, 1986.
3. Ministry of Health. *Report on Public Health and Medical Subjects No. 95*. HMSO, London, 1954.
4. Goodwin, J. W. L., Salway, A. G., Egglestone, H. S., Murrells, T. P., & Berry, J. E. *UK Emissions of Air Pollutants 1970 to 1997*, 11th Annual Report of the National Atmospheric Emissions Inventory, 2000. <http://www.aeat.co.uk/netcen/airqual/naei/annreport/intro.html>
5. Harrison, R. M. In *Pollution: Causes Effects and Control*, Harrison, R. M., ed. 3rd edn. Royal Society of Chemistry, London, p. 163.
6. Chemical Industries Association (CIA). *Indicators of Performance*. <http://www.cia.org.uk/industry/iop.htm> quoted in ENDS Report 306, July 2000. Environmental Data Services, London, 2000, p. 9.
7. Walters, S., & Ayres, J. In *Pollution: Causes Effects and Control*, (Harrison, R. M., ed.), 3rd edn. Royal Society of Chemistry, London, 1996, p. 249.
8. Wolff, G. In *The Wiley Encyclopaedia of Environmental Pollution and Cleanup* (Meyers, R. A., ed.). John Wiley, 1999, p. 589.
9. Clarke, A. G., & Tomlin, A. S. In *Understanding our Environment* (Harrison, R. M., ed.), 3rd edn. Royal Society of Chemistry, London, 1999, p. 59.
10. Andrews, J. E., Brimblecombe, P., Jickells, T. D., & Liss, P. S. *An Introduction to Environmental Chemistry*. Blackwell Science, Oxford, 1996.
11. Turco, R. P. *Earth Under Siege: from Air Pollution to Global Change*. Oxford University Press, Oxford, 1997.
12. Office of Science and Technology Policy (OSTP) 2000. <http://www.ostp.gov/>
13. Simmonds, P. G. *The History of Atmospheric Measurements at Mace Head, Ireland: Implications of the Changing Trends in National and Anthropogenic Trace Gases*. Royal Society of Chemistry Distinguished Guest Lecture Programme, London, 3 March 1999. Data available at http://cdiac.esd.ornl.gov/ftp/ale_gage_Agage/AGAGE/
14. ENDS (June 2000) Report 305. Environmental Data Services Ltd, London, 2000, p. 4.
15. Ashford, N., & Miller, C. S. *Chemical Exposures: Low Levels and High Stakes*, 2nd edn. John Wiley, Chichester, 1998.
16. ENDS (May 2000) Report 304. Environmental Data Services, London, 2000, p. 25.
17. ENDS (June 1999) Report 293. Environmental Data Services, London, 1999, p. 4.
18. ENDS (March 2000) Report 302. Environmental Data Services, London, 2000, p. 39.
19. Shaw, I. C., & Chadwick, J. *Principles of Environmental Toxicology*. Taylor & Francis, London, 1998, p. 53.
20. Mackinson, G. In ENDS (February 2000) Report 302. Environmental Data Services, London, 2000, p. 40.
21. Dyrssen, D., & Wedborg, M. *The Sea* (Goldberg, E., ed.). John Wiley, Chichester, 1974.
22. De Mora, S. J. In *Understanding our Environment* (Harrison, R. M., ed.), 3rd edn. Royal Society of Chemistry, London, 1999, pp. 151–152.
23. Förstner, U., & Wittman, G. T. W. *Metal Pollution in the Aquatic Environment*, 2nd edn. Springer-Verlag, Berlin, 1981, p. 486.
24. ENDS (May 2000) Report 304. Environmental Data Services, London, 2000, p. 12.
25. ENDS (October 1999) Report 297. Environmental Data Services, London, 1999, p. 14.
26. Clark, R. B. *Marine Pollution*, 4th edn. Oxford University Press, Oxford, 1997.
27. BNFL. *Annual Report on Radioactive Discharges and Monitoring the Environment*. British Nuclear Fuels Limited, Risley, Cheshire, 1998.

Bibliography

- Andrews, J. E., Brimblecombe, P., Jickells, T. D., & Liss, P. S. *An Introduction to Environmental Chemistry*. Blackwell Science, Oxford, 1996.
- Fellenberg, G. *The Chemistry of Pollution*. John Wiley, Chichester, 2000.
- Harrison, R. M. *Pollution: Causes Effects and Control*, 3rd edn. Royal Society of Chemistry, London, 1996.
- Harrison, R. M. *Understanding our Environment*, 3rd edn. Royal Society of Chemistry, London, 1999.
- Harrison, R. M., & De Mora, S. J. *Introductory Chemistry for the Environmental Sciences*, 2nd edn. Cambridge University Press, Cambridge, 1996.
- Meyers, R. A. *The Wiley Encyclopaedia of Environmental Pollution and Cleanup*. John Wiley, New York, 1999.
- O'Neill, P. *Environmental Chemistry*, 2nd edn. Chapman & Hall, London, 1993.
- Peirce, J. J., Weiner, R. F., & Vesilind, P. A. *Environmental Pollution and Control*, 4th edn. Butterworth-Heinemann, Woburn, MA, 1998.
- Shaw, I. C., & Chadwick, J. *Principles of Environmental Toxicology*. Taylor & Francis, London, 1998.

Chapter 4: Green Chemistry and Sustainable Development

THOMAS E. GRAEDEL

1 The Concept of Sustainability

Few books result in major shifts in societal perspective, but one that did was *Our Common Future*, a 1987 product of the World Commission on Environment and Development [1]. In that book, the committee recognised that continued industrial and societal development was necessary if a growing planetary population was to be fed, housed and provided with a satisfactory quality of life. It also recognised that it was necessary to make such development sustainable over time, to 'meet the needs of the present without compromising the ability of future generations to meet their own needs'. Twelve years later, in *Our Common Journey*, the Board on Sustainable Development of the US National Research Council reinforced and expanded this basic concept [2].

As a result of these initiatives 'sustainable development' has become a common phrase, and many corporations advertise their operations as 'sustainable'. The use of the word is seldom defined in this context, but it is clear that two central implications are:

- (1) Using natural resources at rates that do not unacceptably draw down supplies over the long term.
- (2) Generating and dissipating residues at rates no higher than can be assimilated readily by the natural environment.

Accordingly, one cannot evaluate the environmental performance of a facility solely on the basis of such classical green chemistry metrics as the rate of reduction in the volume or toxicity of disposable by-products. In addition, it is necessary to evaluate one's processes and operations in terms of long time spans, broad spatial scales and complex interactions with natural systems, and taking actions that are indicated by such an evaluation whether they are regulated or not.

This perspective of sustainable development demands new ways of measuring and understanding

the industry–environment relationship. It is the core of our thinking in the evaluation of an individual facility, an entire industrial sector or the entire technology of the planet. If a facility, a corporation or a sector is to be truly 'sustainable', it must see its activities not from a parochial viewpoint but from one that encompasses the long-term requirements of 'Spaceship Earth'.

2 Green Chemistry and Sustainability's Parameters

The keys to sustainable development, as expressed by the Board on Sustainable Development [2], are defining what should be sustained, by whom and for how long. Figure 4.1 introduces the temporal consideration. No-one seriously proposes trying to maintain sustainable development over time spans relevant to ice ages, major continental drift or the life of the planet; as a society we clearly have neither the knowledge nor the ability to plan such a campaign. At the short end of the time scale, no serious arguments are presented that sustainability will be lost in the next decade or so (individual plant and animal species excepted). It is perhaps not impossible to argue for a half-millennium or millenium focus, but none of our political or social systems operate on anything like those time scales. Inevitably, we are reduced to thinking about actions that can be taken within the 20–100-year range. Thus, the suggestion of the Board on Sustainable Development [2] of a target time of perhaps two generations (50 years or thereabouts) seems as good a choice as any.

What is it that we would like to sustain? From the perspective of green chemists, there appear to be four items of interest in this regard:

- (1) Chemical feedstocks.
- (2) Energy for feedstock processing.
- (3) Water for feedstock processing.
- (4) An environment sufficiently resilient to be

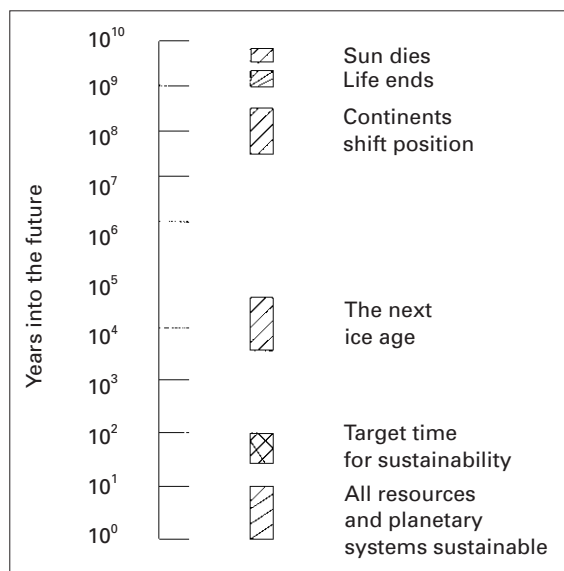


Fig. 4.1 Temporal projections of future events in Earth history, including the target interval for sustainability planning.

capable of receiving whatever residues are dissipated.

If it is agreed that these are reasonable targets for sustainability in the green chemistry sector, the next step is to determine what levels of use are sustainable in each regard. This is the discussion that follows.

2.1 Sustainable use of chemical feedstocks

It is, of course, impossible to make synthetic chemicals without chemical feedstock starting materials. Most of those materials traditionally have been inorganic materials or petrochemicals. In the case of the former (calcium carbonate, phosphates, etc.), known stocks are generally high enough so that sustainability over a 50-year time span is not a serious concern [3]. For petrochemical feedstocks, however, supply concerns are more relevant. There is general agreement among petroleum geologists that the all-time production peak in crude oil production will occur within the 2010–2020 period, declining thereafter [4,5].

Almost all petroleum is processed and used as fuel, with only about 3% serving as petrochemical feedstock [6]. Petrochemical use thus will not control the

supply of crude oil, and there is every reason to anticipate an extraction and use pattern more or less as shown in Fig. 4.2. Because crude oil is replenished on time scales of many millions of years, because current rates of use are clearly unsustainable and because the decline in supply is so close in time, it does not appear possible to construct a scenario in which petroleum feedstocks can be made sustainable.

Experience and theory in green chemistry indicate that there are many potential paths from starting materials to products, and, for many products, alternative potential starting materials [7]. In the case of petrochemicals, the obvious potential alternatives are feedstocks based on biotechnology and derived from agricultural approaches [8,9]. As shown in Fig. 4.2, this means that development of biotechnological feedstocks needs to be brought on line rapidly, because they will probably need to overtake feedstocks based on petroleum within about 30–40 years and become the dominant feedstock in about 60–70 years, as shown in Table 4.1. The time window within which the feedstock transition must begin to occur if the chemical industry is to be sustainable thus is almost upon us, and no chemical corporation can legitimately call itself sustainable unless it is planning and acting so as to become part of the feedstock transition.

Unlike petrochemical feedstocks, which are drawn from below the Earth's surface by oil rigs having rather small surface footprints, feedstocks based on biotechnology inherently become part of the activities of global agriculture. The central goal of agriculture, of course, is to provide food for people and animals; biotechnological feedstocks will never be more than a tiny fraction of that activity. As with petroleum feedstocks and petroleum, biotechnological feedstocks seem destined to ride on the back of the world's approach to agriculture, for better or worse. We are therefore brought to considerations of the sustainability of agriculture. In this connection, Ruttan [10] suggests that sufficient agricultural land is not a long-term limitation, especially for the high-value commodities one can expect chemical feedstocks to be. In some fragile resource areas there may be limitations, but they are most likely to manifest themselves for low-value crops.

The discussion above relates to feedstock sustainability from a source standpoint but not from a magnitude of use standpoint. Although using smaller

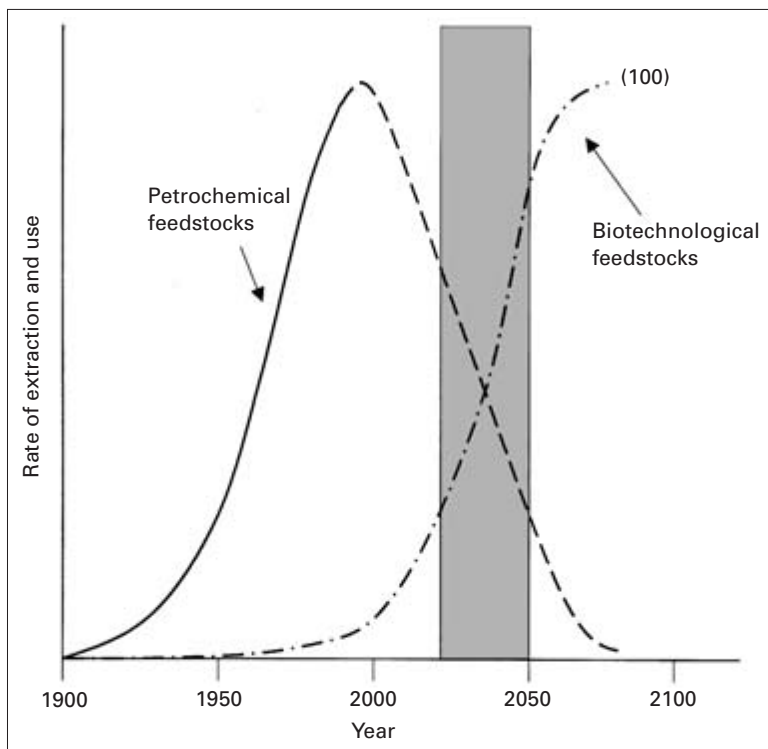


Fig. 4.2 Historic and sustainability scenarios for petrochemical and biotechnological feedstocks. The transition from dominance by the former to the latter will need to occur between about 2015 and 2050, as shown by hatching.

Table 4.1 Proportions of feedstocks from different sources suitable for sustainable development of the synthetic organic chemicals sector

Year	Biotechnological feedstocks (wt.%)	Petrochemical feedstocks (wt.%)
2000	0	100
2020	25	75
2035	50	50
2050	75	25
2065	100	0

amounts of resources to produce the same amounts of products is almost always preferable from an environmental standpoint, the fact that feedstocks for synthetic chemicals are minor proportions of petrochemical or biotechnological flows means that the sustainability of those feedstocks will not be determined by the magnitude of chemical industry use. Thus, although environmental performance in the synthetic chemicals sector is indeed related to the

magnitudes of chemical flows, sustainability of feedstocks realistically can be related only to their origin.

2.2 Sustainable use of water

Many resources are marketed on a global basis and one can make the argument that their sustainability should be evaluated on that scale. The issue clearly is different for water, which is a resource under stress because of supply variations in space and time and because of the magnitude of human use [11,12]. Because of these source and use patterns, water sustainability reasonably can be assessed only at the watershed level. To do so, one first determines the supply of water, then the uses to which it can be allocated and finally the allocation of the available water to those uses. Each of these steps is contentious to some degree; the method described here is intended to begin the discussion, not to be definitive.

One begins by identifying the watershed in which the synthetic chemical facility of interest is located, and determining its spatial extent and human population. The average rainfall for the watershed then is

determined from meteorological data; this is the basic water source magnitude. Because a minimum reasonable level of per capita water use is about 100l day⁻¹ [13], the available non-residential amount N is:

$$N = R - 100P$$

where R is the rainfall rate for the watershed (in l day⁻¹) and P is the population. (The average domestic water use in developed countries is significantly higher than 100l day⁻¹ per capita, but from a sustainability standpoint this constitutes a target worth shooting for.)

The next step is to allocate N among non-residential users: agriculture, industry, commercial, etc. Ideally, such an allocation would be based on minimum need for specific purposes, just as was done above for individual residential use. There are, however, no equivalent data for the great variety of non-residential uses. As a pragmatic alternative, one can perform the allocation on the basis of land occupied, the idea being that the same amount of water can be made available to each segment of land. The approach is as follows:

- (1) Determine the total land within the watershed (\square) and the total land occupied by residential uses (ρ).
- (2) Determine the land occupied by the facility being assessed (Φ).
- (3) Compute the facility's sustainable water use allocation (A):

$$A = \frac{\Phi N}{\square - \rho}$$

This procedure automatically allocates water for common uses (parks, nature preserves, etc.) and would assure a sustainable level of water use within the watershed if complied with by all water users.

2.3 Sustainable use of energy

As discussed above in the case of chemical feedstocks, the use of fossil fuels is ultimately unsustainable because of supply considerations [14,15]. It appears possible as well that use of any energy-producing source that involves combustion and CO₂ generation may be constrained by global warming concerns (e.g. the Kyoto Protocol). Thus, truly sustainable energy resources can be regarded as fissile materials, hydropower, solar power, wind power, geothermal power and ocean power, whereas un-

Table 4.2 Proportion of energy from different sources suitable for sustainable development of the synthetic organic chemicals sector

Year	Fossil fuel and biomass energy (%)	Non-fossil fuel and biomass energy (%)
2000	77 ^a	23 ^a
2025	60	40
2050	40	60
2075	20	80
2100	0	100

^a Contemporaneous global average values given in Ref. 14.

sustainable sources are petroleum, natural gas, coal and biomass.

A facility moving towards sustainability is therefore one that is beginning a transition from unsustainable sources of energy to sustainable ones. Given the levels of fossil fuels still available, a reasonable period for that transition is 100 years. A facility's progress thus may be measured by the proportion of sustainable sources in the fuel mix from which it derives energy.

The average global proportion of contemporaneous sustainable energy sources is about 23%. In the present work, a facility is defined as sustainable in energy if it is meeting or exceeding the schedule shown in Table 4.2. As Fig. 4.3 indicates, the transition from predominantly unsustainable energy sources to predominantly sustainable ones then should occur in about 2035–2040.

As with feedstock use, it is not possible in any straightforward way to define a precise quantity of energy use as sustainable or not. The difficulty is that although the trends attributable to global change seem increasingly clear, their magnitudes and implications are less so [16,17]. Accordingly, although decreased energy use is almost certainly desirable from an environmental standpoint, the sustainability of that use can be related only to the origin of the energy supply and not to the magnitude of use.

2.4 Environmental resilience

The final element of the sustainability of a facility refers to the capability of the ecosystems with which it is in contact to receive any dissipated residues without suffering significant degradation. This criterion, easily stated, in practice has proved essen-

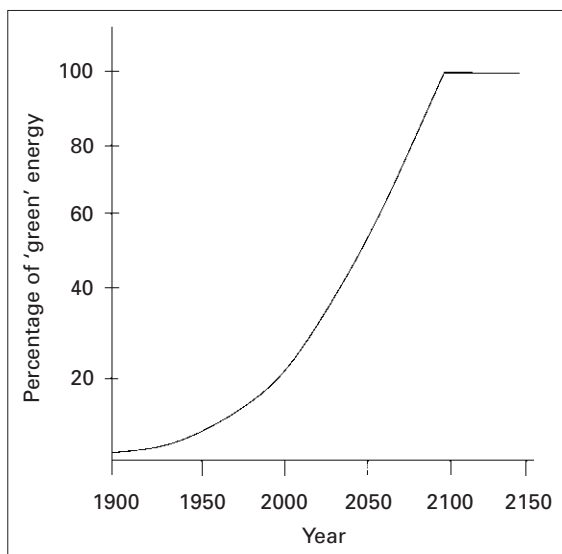


Fig. 4.3 Historic and sustainability scenarios for alternative energy sources: fossil fuel plus biomass; and non-fossil fuel plus biomass.

tially impossible to quantify. For some inorganic species, such as the sulfate ion, the concept of 'critical loads' [18] has provided general guidelines. For most emittants, however, the potential environmental implications have proven too diverse and too subtle to yield a simple quantitation.

What approach can a facility manager take to this challenge if quantitation remains elusive? The only possible approach is to adopt 'zero discharge' as a target. Although probably unattainable in practice, such a goal has the potential to inspire markedly improved environmental performance. An appropriate approach to the preservation of environmental resilience thus is to reduce gradually all emissions to the environment from industrial processes to zero in 50 years (the sustainability horizon). The transition towards zero discharge is outlined in Table 4.3.

3 A Sustainability Scenario

Superior environmental performance relative to one's peers is important. However, the more challenging goal of progress towards sustainable environmental performance is crucial if we are to preserve civilisation more or less as we know it. The discussion above argues that for the synthetic

Table 4.3 The transition to zero discharge

Year	Percentage of year 2000 discharge
2000	100
2010	80
2020	60
2030	40
2040	20
2050	0

chemicals sector there are four actions that have the potential to meet that difficult challenge:

- (1) Begin and maintain a transition from petrochemical to biotechnological feedstocks.
- (2) Develop a strategy for limiting water use to a reasonable allocation of the locally available supply.
- (3) Begin and maintain a transition from fossil fuel and/or biomass energy to more sustainable energy.
- (4) Establish a programme designed to achieve near-zero discharges to the environment within 50 years or less.

Green chemistry as a field has made substantial progress by reducing by-product generation, energy use and discharge toxicity [19]. It has not yet defined or approached sustainability, however. The challenges of sustainability are substantial and they are not traditional. They are also potentially achievable, or near to it. It is past the time to get started.

References

1. World Commission on Environment and Development. *Our Common Future*. Oxford University Press, Oxford, 1987.
2. Board on Sustainable Development. *Our Common Journey*. National Academy Press, Washington, DC, 1999.
3. Kesler, S. E. *Mineral Resources, Economics, and the Environment*. Macmillan, New York, 1994.
4. Campbell, C. J., & Laherrere, J. H. *Sci. Am.*, 1998, **278**, 78.
5. Kerr, R. A. *Science*, 2000, **289**, 237.
6. US Environmental Protection Agency. *Profile of the Petroleum Refining Industry*, Report EPA/310-R-95-013. EPA, Washington, DC, 1995.
7. Anastas, P. T., & Lankey R. L. *Green Chem.*, 2001, **3**, 289.

8. Moffat, A. S. *Science*, 1995, **268**, 659.
9. US Department of Energy. *Technology Vision—The U.S. Chemical Industry*. www.oit.doe.gov/chemicals/pdfs/chemvision2020.pdf, 1996 (accessed 6/25/99).
10. Ruttan, V. W. *Proc. Natl. Acad. Sci. USA*, 1999, **96**, 5960.
11. Postel, S. L., Daily, G. C., & Ehrlich, P. R. *Science*, 1996, **271**, 785.
12. Vörösmarty, C. J., Green, P., Salisbury, J., & Lammers, R. B. *Science*, 2000, **289**, 284.
13. Gleick, P. H. *Water Int.*, 1996, **21**, 83.
14. Nakićenović, N., Grübler, A., & McDonald, A. *Global Energy Perspectives*. Cambridge University Press, Cambridge, 1998.
15. United Nations Development Programme. *World Energy Assessment*. United Nations, New York, 2000.
16. Houghton, J. T., Meira Filho, L. G., Callander, B. A., Harris, N., Kattenberg, A., & Maskell, A. *Climate Change 1995: The Science of Climate Change*. Cambridge University Press, Cambridge, 1996.
17. Watson, R. T., Zinyowera, M. C., & Moss, R. H. *Climate Change 1995: Impacts, Adaptations and Mitigation of Climate Change: Scientific–Technical Analyses*. Cambridge University Press, Cambridge, 1996.
18. Lövblad, G., Grennfelt, P., Westling, O., Sverdrup, H., & Warfvinge, P. *Water, Air, Soil Pollut.*, 1995, **85**, 2431.
19. Graedel, T. E. *Green Chem.*, 1999, **1**, G126.

Chapter 5: Life-cycle Assessment: a Tool for Identification of More Sustainable Products and Processes

ADISA AZAPAGIC

1 Introduction

Although it is still not clear how sustainable development may be achieved on a practical level, there is a general agreement, at least on a theoretical level, that sustainable development is about a simultaneous satisfaction of social, environmental and economic goals. This idea is shown graphically in Fig. 5.1, where the three components of sustainable development—society, environment and economy—are represented as overlapping lobes whereby the economic systems draw on environmental resources to provide goods and services to society. Following the Brundtland definition of sustainable development [1], the area where all the three lobes overlap is a sustainable activity that ‘meets the needs of the present without compromising the ability of future generations to meet their own needs’.

The emergence of the concept of sustainable development in the late 1980s soon prompted discussions on which economic and industrial activities could be considered sustainable and how progress towards sustainability might be monitored and measured [2]. With the growing awareness of the public and the resulting pressures on industry and governments, one component of sustainability—the environment—started to receive particular attention and this led to increased efforts to reduce the environmental impacts of economic systems.

One of these efforts was directed towards the development of tools and techniques that could help industry and policy-makers to identify environmentally more sustainable practices. As a result, the early 1990s saw a rekindled interest in one of such tools—life-cycle assessment (LCA). Although LCA had been used in some industrial sectors in the early 1970s, most notably in the energy sector, it started to receive wider attention and methodological devel-

opment only with a growing interest in sustainability, when its relevance as an environmental management tool in both corporate and public decision-making became more evident [2,3]. Because LCA enables the assessment of environmental impacts along the whole life-cycle of an activity, it provides a full picture of economic interactions with the environment. This means that, in terms of the model of sustainable development shown in Fig. 5.1, LCA can be positioned on the overlap between the economic and environmental lobes. It also means that, if used correctly, LCA can contribute to the identification of more sustainable activities and business practices. The role of LCA in the context of sustainable development is illustrated and discussed in the rest of this chapter.

2 The LCA Methodology

Life-cycle assessment is a tool for assessing the environmental performance of a product, process or activity from ‘cradle to grave’, i.e. from extraction of raw materials to final disposal. As mentioned above, LCA is not a new tool. It had been used in the early 1970s when it was known as ‘net energy analysis’ [4,5] and considered only energy consumption in the life-cycle of a product or a process. Some later studies included wastes and emissions [6–8] but none of them went further to quantify the potential impacts of human interventions into the environment.

It is only in the early 1990s that LCA as we know it today started to emerge. Today the methodology is almost fully developed, although a few methodological issues still remain unresolved. Some of these are mentioned briefly below, within a more detailed introduction to the LCA methodology.

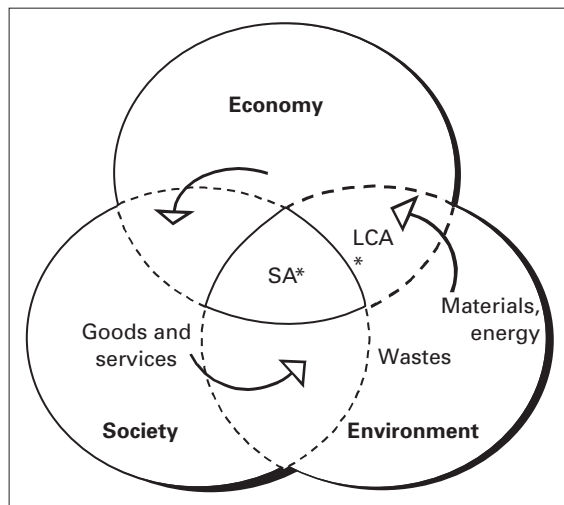


Fig. 5.1 Positioning LCA within the context of sustainable development (SA = sustainable activity).

2.1 Methodological framework

Two major international bodies have been involved in developing the LCA methodology: the Society for Environmental Toxicology and Chemistry (SETAC) and the International Standardization Organization (ISO). Much of the pioneering work was done by SETAC in the first half of the 1990s, and further methodological developments by ISO have followed on from that work. This is probably the reason why the two methodologies have converged and the differences between them are in detail only. The early SETAC definition of LCA, which is still widely quoted, reads [9,10]:

‘Life Cycle Assessment is a process to evaluate the environmental burdens associated with a product, process, or activity by identifying and quantifying energy and materials used and wastes released to the environment; to assess the impact of those energy and material uses and releases to the environment; and to identify and evaluate opportunities to effect environmental improvements. The assessment includes the entire life cycle of the product, process or activity.’

A much more succinct but otherwise similar ISO definition defines LCA as [11]:

‘... a compilation and evaluation of the inputs, outputs and the potential environmental impacts of a product system throughout its life cycle’.

Compared with other environmental management tools, LCA is probably not much different in what it is trying to achieve, i.e. to identify opportunities for reducing the environmental impacts of a system. However, the main difference lies in the way the system boundaries are defined: in conventional environmental systems analysis, such as environmental impact assessment, the system boundary is drawn around a manufacturing site or a plant, whereas in LCA the boundary is set to encompass the following life-cycle stages:

- Extraction and processing of raw materials
- Manufacturing
- Transportation and distribution
- Use, reuse and maintenance
- Recycling
- Final disposal

As illustrated in Fig. 5.2, the life-cycle of a product starts from the extraction and processing of raw materials, which then are transported to the manufacturing site to produce a product. The product then is transported to the user and at the end of its useful life is either recycled or is disposed of in a landfill. In all of these stages, materials and energy are consumed and wastes and emissions generated. By taking into account the whole life-cycle of an activity along the supply chain, LCA enables the identification of the most significant impacts and stages in the life-cycle that need to be targeted for improvements. Such a holistic approach avoids shifting of the environmental burdens from one stage to another, as often may be the case in conventional environmental systems analysis where the system boundary is drawn too narrowly.

Both SETAC [10] and ISO [11–14] define four phases within the LCA methodological framework, with small differences between the two methodologies, as outlined in Table 5.1. Although it is expected that the ISO methodology eventually will supersede the SETAC methodology, the latter still remains more widely used by LCA practitioners. Thus, the following discussion refers to the SETAC methodology with an explanation of the differences between the two methodologies, where appropriate.

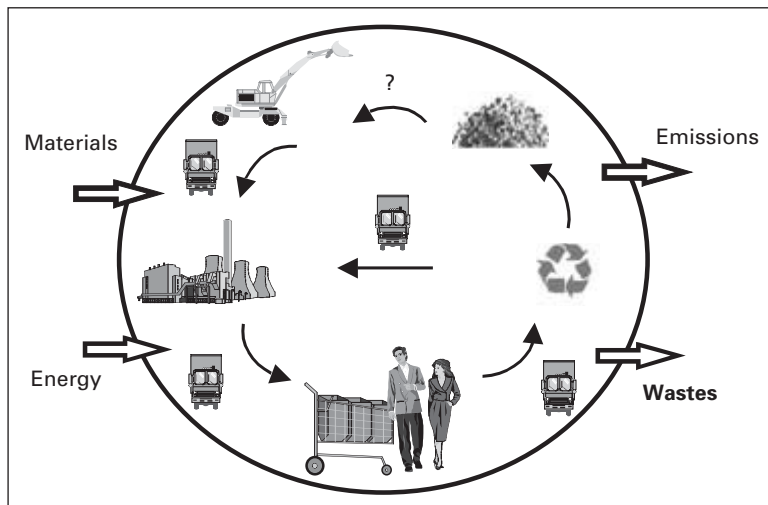


Fig. 5.2 The life-cycle of a product or activity.

SETAC	ISO 14040 series
(1) Goal Definition and Scoping	(1) Goal and Scope Definition (ISO 14041)
(2) Inventory Analysis	(2) Inventory Analysis (ISO 14041)
(3) Impact Assessment	(3) Impact Assessment (ISO 14042)
(4) Improvement Assessment	(4) Interpretation (ISO 14043)

Table 5.1 The SETAC and ISO definitions of the four phases within LCA methodology

Goal definition and scoping

The first and probably most critical phase of an LCA study is Goal Definition and Scoping. This component includes defining the purpose of the study and its intended use, i.e. whether the study is going to be used internally by a company for improving the performance of the system or externally, e.g. for marketing or influencing public policy. Scoping explains what assumptions have been made and why, and defines the limitations of the study, system and the system boundaries, including its spatial and temporal limits.

It must be borne in mind that in LCA the system boundary should be drawn to encompass all stages in the life-cycle from extraction of raw materials to the final disposal. This is referred to as a ‘cradle-to-grave’ approach. However, in some cases the scope of the study will demand a different approach, where it is not appropriate to include all stages in the life-cycle. This is most often the case with commodities for instance, which can have a number of different uses so that it is not possible to follow their numer-

ous life-cycles after the manufacturing stage. The scope of such studies is from ‘cradle to gate’, and they follow a product from the extraction of raw materials to the factory gate.

One of the most important elements of an LCA study—the *functional unit*—also is defined in this phase. The functional unit is a quantitative measure of the output of products or services that the system delivers. In comparative studies it is crucial that the systems are compared on the basis of equivalent function, i.e. the functional unit. For example, comparison of different drinks packaging should be based on their equivalent function, which is to contain a certain amount of beverage. The functional unit then is defined as ‘the quantity of packaging necessary to contain a specified volume of beverage’.

This phase also includes an assessment of the data quality and establishing the specific data quality goals. Goal definition and scope are constantly reviewed and refined during the process of carrying out an LCA, as additional information on the system becomes available.

Inventory analysis

Life-cycle inventory (LCI) analysis is the second phase in undertaking an LCA study. It is the most objective of all LCA phases and represents a quantitative description of the system. Inventory analysis includes:

- Further definition of the system and its boundaries
- Representing the system in the form of flow diagrams
- Data collection
- Allocation of environmental burdens
- Calculation and reporting of the results
- Sensitivity analysis

On the basis of the system definition in the Goal Definition and Scoping phase, the system is defined and characterised further in the LCI in order to identify clearly the data needs. A system is defined as a collection of materially and energetically connected operations (including, for example, manufacturing process, transport process or fuel extraction process) that performs some defined function. The system is separated from its surroundings by a system boundary. The environment then is interpreted in the thermodynamic sense as ‘that which surrounds the system’, i.e. everything else except the system under study [15]. Thus for these purposes ‘the environment’ is defined along with the system, by exclusion. This simple (or reductionist) definition is illustrated by Fig. 5.3.

The system is disaggregated into a number of inter-linked subsystems and their interconnectedness is shown by flow diagrams (see Fig. 5.3). Depending on how detailed the available data are, the subsystems can represent the unit operations or a group of units. Each subsystem is described in detail by flows of materials and energy, as well as emissions to air

and water and solid wastes. All inputs and outputs of the subsystems are balanced in this phase and data are normalised with respect to the unit output from each subsystem. This is equivalent to carrying out mass and energy balances, an approach central to process systems analysis. On the basis of the data collected for a period statistically relevant for the study, the environmental burdens, i.e. resource depletion and emissions to air and solid wastes, then are calculated for the whole system and the results are listed in the inventory tables and represented graphically. Environmental burdens include, for instance, fossil fuel consumption, emissions of sulfur dioxide, emissions of metals to water and volume of solid waste, and they can be calculated as:

$$B_j = \sum_{i=1}^I bc_{j,i}x_i \tag{5.1}$$

where $bc_{j,i}$ is burden j from process or activity x_i . A simple example in Box 5.1 illustrates how the burdens can be calculated.

It is often useful to divide the system into foreground and background, as shown in Fig. 5.4. The foreground system is defined as the set of processes directly affected by the study delivering a functional unit specified in the Goal and Scope Definition [16]. The background system is that which supplies energy and materials to the foreground system, usually via a homogeneous market so that individual plants and operations cannot be identified. Differentiation between foreground and background systems is important also for deciding on the type of data to be used.

Data collection and reliability are some of the main issues in LCA because the results and conclusions of an LCA study will be determined by the data used. Depending on the source, data can be ‘marginal’ or ‘average’. Marginal or process-specific data are

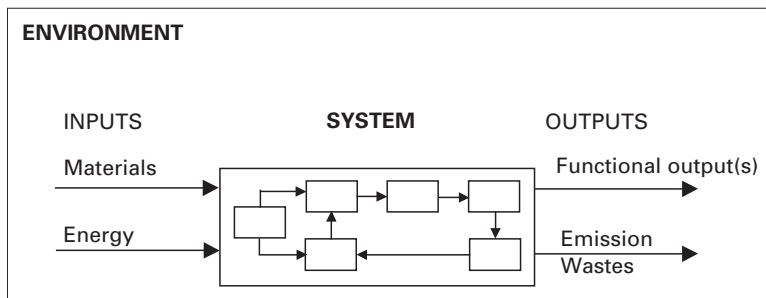
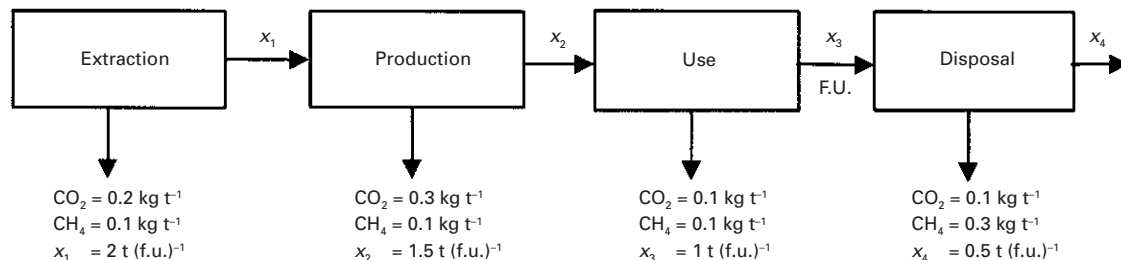


Fig. 5.3 System definition in inventory analysis.

Box 5.1: Calculating burdens and impacts—an example

The system shown below has one functional output and each activity x_i from extraction of raw materials to final disposal generates a certain amount of CO₂ and CH₄ emissions. For example, activity x_1 , 'Extraction', generates 2 t of raw mater-

ials per functional unit (f.u.). This activity is associated with emissions of 0.2 kg of CO₂ and 0.1 kg of CH₄ per tonne of raw materials extracted. The functional unit is represented by $x_3 = 1$ t, the output from the activity 'Use'.



Using Eqn. (5.1), the total environmental burdens per functional unit related to the emissions of CO₂ and CH₄ are therefore:

$$B_{CO_2} = \sum bc_{CO_2} x_i = (0.2 \times 2) + (0.3 \times 1.5) + (0.1 \times 1) + (0.1 \times 0.5) \Rightarrow B_{CO_2} = 1.0 \text{ t (f.u.)}^{-1}$$

$$B_{CH_4} = \sum bc_{CH_4} x_i = (0.1 \times 2) + (0.1 \times 1.5) + (0.1 \times 1) + (0.3 \times 0.5) \Rightarrow B_{CH_4} = 0.6 \text{ t (f.u.)}^{-1}$$

The global warming potential related to these two greenhouse gases can be calculated by applying Eqn. (5.2) and the classification factors given in Table A1 in the Appendix:

$$E_{GWP} = ec_{CO_2} B_{CO_2} + ec_{CH_4} B_{CH_4} = (1 \times 1) + (11 \times 0.6) \Rightarrow E_{GWP} = 7.6 \text{ t (f.u.)}^{-1}$$

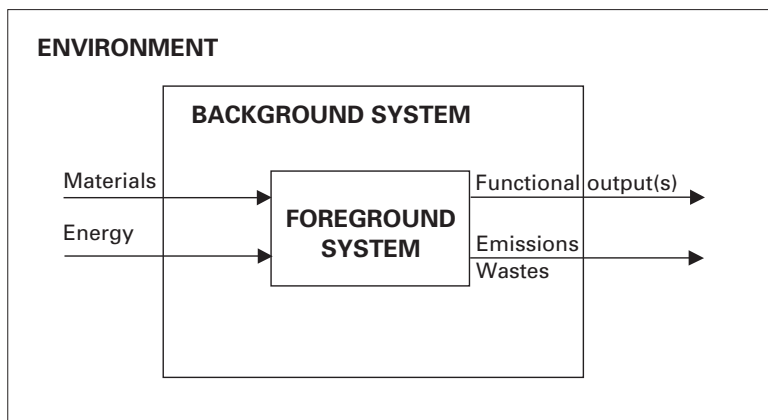


Fig. 5.4 Foreground and background system.

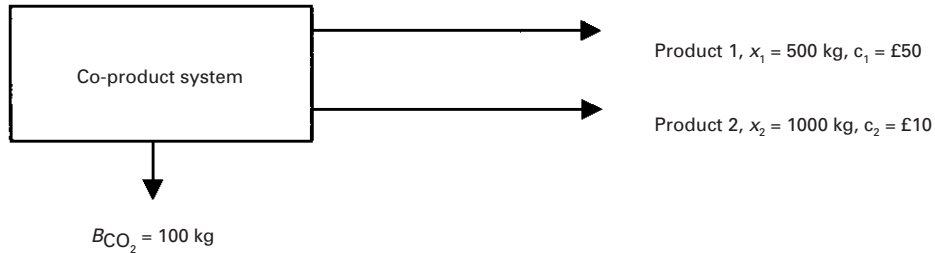
sourced directly from the manufacturers and usually are more reliable than average data, which can be obtained from different public or commercial LCA databases (e.g. PEMS [17] or DEAM [18]). Marginal data should always be used for the foreground

system; average data are acceptable for the background.

Because the data quality varies in all LCIs, it is necessary also to perform a sensitivity analysis in order to identify the effects that data variability, uncer-

Box 5.2: Allocation of environmental burdens—an example

Consider a co-product system producing two products or functional outputs (product 1 and product 2) and generating an emission of CO₂. A simple flow diagram of this system is shown below. The allocation problem is related to identifying a correct



Mass basis:

$$\begin{aligned} \text{Product 1: } bc_1 &= [x_1 / (x_1 + x_2)] B_{\text{CO}_2} \\ &= [500 / (500 + 1000)] 100 \Rightarrow bc_1 = 33.3 \text{ kg CO}_2 \end{aligned}$$

$$\begin{aligned} \text{Product 2: } bc_2 &= [x_2 / (x_1 + x_2)] B_{\text{CO}_2} \\ &= [1000 / (500 + 1000)] 100 \Rightarrow bc_2 = 66.7 \text{ kg CO}_2 \end{aligned}$$

Economic basis:

$$\begin{aligned} \text{Product 1: } bc_1 &= [c_1 / (c_1 + c_2)] B_{\text{CO}_2} \\ &= 50 / (50 + 10) 100 \Rightarrow bc_1 = 83.3 \text{ kg CO}_2 \end{aligned}$$

$$\begin{aligned} \text{Product 2: } bc_2 &= [c_2 / (c_1 + c_2)] B_{\text{CO}_2} \\ &= 10 / (50 + 10) 100 \Rightarrow bc_2 = 16.7 \text{ kg CO}_2 \end{aligned}$$

Obviously, the allocation coefficients obtained by using these two different methods are quite different for the same functional outputs. For example,

method for apportioning the total CO₂ emissions to each product. For illustration purposes only, two (arbitrary) approaches most often used for allocation are shown here: mass outputs x of the products and their economic value c .

the mass-based approach allocates 33.3% of the total CO₂ emissions to product 1, whereas allocation based on the economic value of the products assigns 83.3% of the total CO₂ burden to the same product. This means that in this case the use of the two different allocation methods would lead to completely different results of the study. This simple example thus illustrates the importance of using the appropriate allocation approach, depending on the type of system analysed. Although mass flows and economic value are simple to use, they are often chosen arbitrarily without considering other allocation methods and causal relationships in the system. The ISO three-step procedure [12] described in the main text is thus helpful as a guide to identifying the correct allocation approach for any type of system.

tainties and data gaps have on the final results of the study.

The Inventory Analysis phase also includes allocation of environmental burdens, the problem encountered in multiple-function systems, such as co-product systems, waste treatment and recycling [15]. Allocation is the process of assigning to each function of a multiple-function system only those environmental burdens that each function generates. An example of a co-product system is a naphtha cracker, which produces ethylene, propylene, butenes and pyrolysis gasoline. The allocation problem here is to assign to each of the products or

functional outputs only those environmental burdens for which each product is responsible. The usual (arbitrary) approach is to use either mass or economic basis, allocating the total burden according to the mass output or economic value of each product or functional output. This is illustrated in Box 5.2.

As demonstrated on the simple example in Box 5.2, the allocation method usually will influence the results of the study so that the identification of an appropriate allocation method is crucial. To guide the choice of the correct allocation method, ISO recommends the following three-step procedure [12]:

- (1) If possible, allocation should be avoided by expanding the system boundaries or disaggregating the given process into different sub-processes.
- (2) If it is not possible to avoid allocation, then the allocation problem must be solved by using system modelling based on physical causation, which reflects the underlying physical relationships among the functional units.
- (3) Where physical relationships cannot be established, other relationships, including the economic value of the functional outputs, can be used.

Further reading and real industrial examples on allocation can be found in Refs 15, 19 and 20.

Impact assessment

The effects of the environmental burdens identified in the Inventory Analysis phase are assessed and characterised in the Impact Assessment phase. This part of LCA is based on both quantitative and qualitative procedures to characterise and assess the environmental impacts of a system. It consists of four steps:

- (1) Classification.
- (2) Characterisation.
- (3) Normalisation.
- (4) Valuation.

Classification is a qualitative step in which the burdens are aggregated into a smaller number of impact categories to indicate the potential impacts on human and ecological health and on resource depletion. The aggregation is done on the basis of potential impacts of the burdens, so that one burden can be associated with a number of impacts; e.g. volatile organic compounds (VOCs) contribute to both global warming and ozone depletion. The approach used most widely for classification of the impacts is known as 'problem-oriented' [21], whereby the burdens are aggregated according to their relative contributions to the environmental effects that they may have. The impacts most commonly considered in LCA are:

- Resource depletion
- Global warming
- Ozone depletion
- Acidification
- Eutrophication

- Photochemical oxidant formation (photochemical smog)
- Human toxicity
- Aquatic toxicity

The definitions of these impacts are given in the Appendix.

Characterisation is a quantitative step to calculate the total environmental impacts of the burdens estimated in inventory analysis. This is a quantitative phase of LCA and should be based on the scientific findings on the relevant environmental impacts. In the problem-oriented approach, the impacts are calculated relative to a reference substance. For instance, CO₂ is a reference gas for determining the global warming potential of other related gases, such as CH₄ and other VOCs. In general terms, impact E_k can be calculated by using Equation 5.2:

$$E_k = \sum_{j=1}^J ec_{k,j} B_j \quad (5.2)$$

where $ec_{k,j}$ represents the relative contribution of burden B_j to impact E_k , as defined by the problem-oriented approach. The calculation procedure for different impact categories is given in the Appendix. A simple illustration of the calculation of global warming can be found in Box 5.1.

Research on LCI assessment methods to calculate impact categories is still ongoing [22]. It is recognised that there is a relatively large uncertainty in impact assessment associated with number and type of impact categories considered, range of burdens included within each category, parameters used within the modelling of impacts and the model used for each impact category [23]. To address some of the problems related in particular to modelling of impacts, research has been initiated to incorporate multimedia fate modelling into LCA to calculate the local and regional environmental impacts of products and activities. One such model is USES-LCA (Uniform System for the Evaluation of Substances, adapted for LCA) [24]. However, further work is required in this area before fate modelling is adapted fully and used routinely in LCA.

Normalisation of impacts on the total emissions or extractions in a certain area over a given period of time also can be carried out within the Impact Assessment phase. Some argue that because LCA is global in its character, total world annual impacts should be used as the basis for normalisation. Total

emissions of global warming gases and world resource depletion can be calculated relatively easily; however, other impacts, such as acidification or human toxicity, are more difficult to determine on the global level so that normalisation still is not a reliable method for comparing the different environmental impacts from a system.

Valuation is the final and most subjective step of impact assessment, in which the relative significance of different impacts is weighted so that they can be compared among themselves. As a result, different environmental impacts are reduced to a single environmental impact function, *EI*, as a measure of environmental performance. This can be represented by Equation 5.3:

$$EI = \sum_{k=1}^K w_k E_k \quad (5.3)$$

where w_k is the relative importance of impact E_k .

A number of techniques have been suggested for use in valuation. They are based mainly on expressing preferences by decision-makers, by 'experts' or by the public. Some of these methods include multi-attribute utility theory, analytical hierarchy process, impact analysis matrix, cost-benefit analysis and contingent valuation [25]. However, because of a number of problems and difficulties associated with using these techniques, there is no consensus at present on how to aggregate the environmental impacts into a single environmental impact function.

Improvement assessment

In the SETAC methodology, Improvement Assessment is the final phase of the LCA methodology and is aimed at identifying the possibilities for improving the environmental performance of the system. This phase can be carried out before an LCA study is completed because the opportunities for improvements can be detected at an early stage of carrying out the study. The redesign of the product or a process as a result of the Improvement Assessment phase is not part of the LCA—it is one of its applications.

In the ISO methodology this phase is known as Interpretation [14]. The Interpretation phase also is aimed at improvements and innovations, but in addition it covers the following steps: identification of major burdens and impacts, identification of stages in the life-cycle that contribute the most to these impacts, evaluation of these findings, sensitivity analysis and final recommendations.

Further details on LCA methodology can be found in Refs 10 and 11–14.

3 The Applications of LCA

As an environmental management tool, LCA has several objectives:

- To provide as complete a picture as possible of the interactions of an activity with the environment
- To identify major environmental impacts and the life-cycle stages or 'hot spots' contributing to these impacts
- To compare environmental impacts of alternative product, processes or activities
- To contribute to the understanding of the overall and interdependent nature of the environmental consequences of human activities
- To provide decision-makers with information on the environmental effects of these activities and identify opportunities for environmental improvements.

These objectives have governed the use of LCA in both corporate and public decision-making arenas, which to date have included:

- Assessment and comparison of consumer products
- Support of environmental management systems
- Process selection and system optimisation
- Environmental reporting and marketing
- Policy formulation at national and international levels

The body of literature on LCA applications is vast and its review is outside the scope of this chapter. Instead, some typical examples are chosen here to illustrate the usefulness of LCA as a tool for identifying environmentally more sustainable products and processes.

3.1 Product-oriented LCA

Historically, most of the LCA literature and case studies have been product-oriented [9,21,25–34]. The early LCA studies, originating in the 1980s, compared different consumer products, including beverage packaging, washing machines and detergents. The scope of the studies and number of products analysed expanded in the early 1990s and to date include LCA studies of products in the following industrial sectors: chemical [35–37], gas [38,39],

metals and minerals [40–42], polymer [27,43], paper [44,45], textile and leather [46–48], electronic [49,50], manufacturing [51], agriculture [52,53] and food and drinks [54–56].

Cross-sectorial market competition, the EC End-of-life Waste Management Regulations and more recently the EC Integrated Product Policy have been the main drivers for product-oriented LCA activity in Europe [57–59]. One of the end-of-life management regulations is the Packaging and Packaging Waste Directive [60,61], which requires that a certain amount of the packaging must be recovered after use and recycled. Other examples include the proposed EC Directives on End-of-life Vehicles [62] and on Waste Electrical and Electronic Equipment [63]. Manufacturers of products that may be affected by end-of-life management regulations have tried to influence the regulatory process and the impacts of these regulations in the market by using LCA to support their claims.

The LCA-based claims have been used also in cross-sectorial competition, both by the commodity and final product producers. Examples of these include plastic versus paper packaging [8,27] and phosphates versus perborates in the detergent industry [64]. Many of these studies have been carried out by the manufacturers themselves, and some of them have used it for marketing purposes. This has attracted criticism from independent organisations and consumers who have questioned the validity of these studies and their findings. In an attempt to protect the consumer and encourage the provision of independent information on consumer products, policy-makers in Europe have introduced and formalised various eco-labelling schemes. In addition to the EU eco-labelling scheme [65–67], some countries have their own, including the ‘Blue Angel’ in Germany and the ‘Nordic Swan’ in Scandinavia. The objective of these schemes is to help consumers choose environmentally more acceptable products from a group of equivalent products.

To illustrate the application of LCA for identifying more sustainable products, a simple case study of two packaging materials—glass and carton—is considered below.

Case study I: glass versus carton packaging

The purpose of the study is to compare the life-cycle impacts of two packaging products: glass bottle and

carton. Both products have the same function—to contain a certain amount of liquid. Based on their equivalent function, the functional unit can be defined as ‘containing 1000 liters of liquid in one-liter containers’. It is assumed that the glass and carton containers each weigh 405 and 34.5 g, respectively, so that the total amount of packaging required to contain 1000 l of liquid is:

$$\text{Glass: } m_g = 1000 \times 405 \text{ g} = 405 \text{ kg}$$

$$\text{Carton: } m_c = 1000 \times 34.5 \text{ g} = 34.5 \text{ kg}$$

Note that for illustrative purposes the quantity of liquid and the size of containers have been chosen arbitrarily.

The LCA flow diagrams of the two systems are shown in Figs 5.5 and 5.6. The scope of the study is ‘from cradle to grave’ and all activities from the extraction and processing of raw materials through the manufacture of containers to their final disposal have been taken into account, including transportation. It has been assumed that 40% of the glass bottles are recycled, with the rest being landfilled; all the carton containers are disposed of in a landfill. Both the PEMS database and LCA software [17] have been used for this study and the results of inventory analysis and impact assessment are shown in Figs 5.7–5.9. It is apparent that for most of the burden categories shown in Figs 5.7 and 5.8 the carton is preferable compared with the glass bottle. The only notable exceptions to this are the use of renewable resources (wood) and chemical oxygen demand (COD); the cardboard manufacturing process also generates large quantities of waste water contaminated by non-biodegradable organic chemicals.

The aggregation of environmental burdens into impact categories in the Impact Assessment phase reveals that there are three significant impacts in the life-cycles of these two packaging materials—fossil reserves depletion, global warming and landfill space (volume)—and that overall carton packaging is environmentally preferable. Although the glass bottles are recycled, the difference between the carton and glass bottles for the three significant burdens is five-fold. The main reason for this is that, although some energy is saved by glass recycling, the production of soda ash that is used in the glass manufacturing process is so energy intensive that it outweighs the benefits of recycling at this level (40%). Thus, the LCA highlights the additional burdens associated

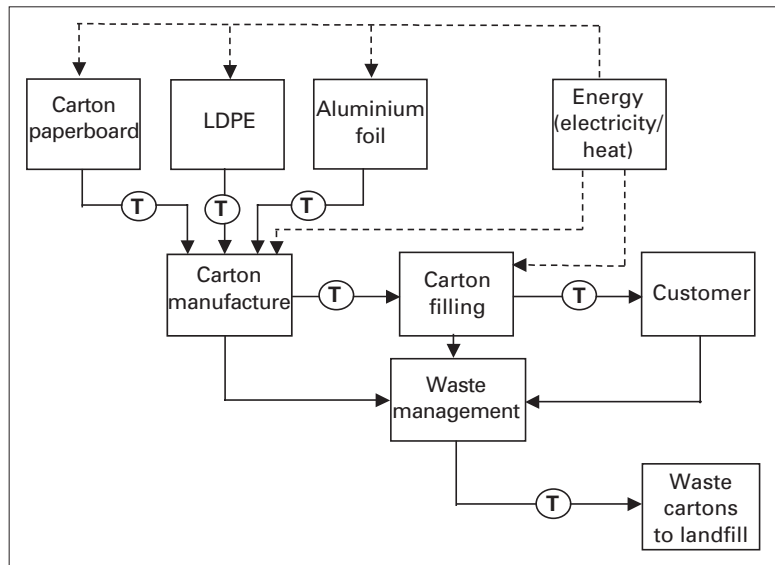


Fig. 5.5 Flow diagram of the life-cycle of carton packaging (T = transport, LDPE = low-density polyethylene).

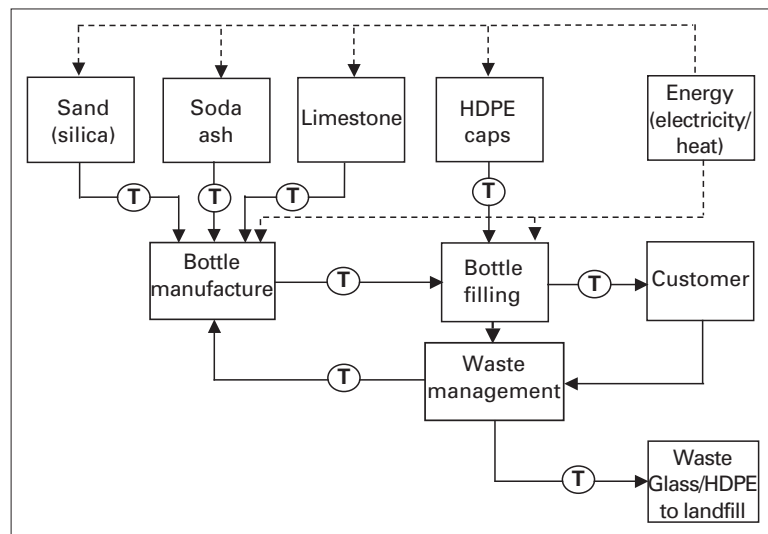


Fig. 5.6 Flow diagram of the life-cycle of glass bottle (T = transport, HDPE = high-density polyethylene).

with the processing of raw materials that often are not considered because of the perception that the raw materials are abundant and that glass recycling is carried out solely for energy conservation [23]. Furthermore, this type of analysis also indicates that glass reuse might be more sustainable environmentally than recycling.

This simplified case study illustrates what kind of information can be obtained through an LCA study. Firstly, it can identify and quantify the major

burdens and impacts during the life-cycle of a product. Secondly, it can identify the 'hot spots' in the system, showing which life-cycle stages contribute to these impacts the most and which therefore should be targeted for improvements. Finally, LCA provides information to consumers or decision-makers on which products or practices are more sustainable environmentally. Similar analysis can be used for process evaluation. This is discussed in the next section.

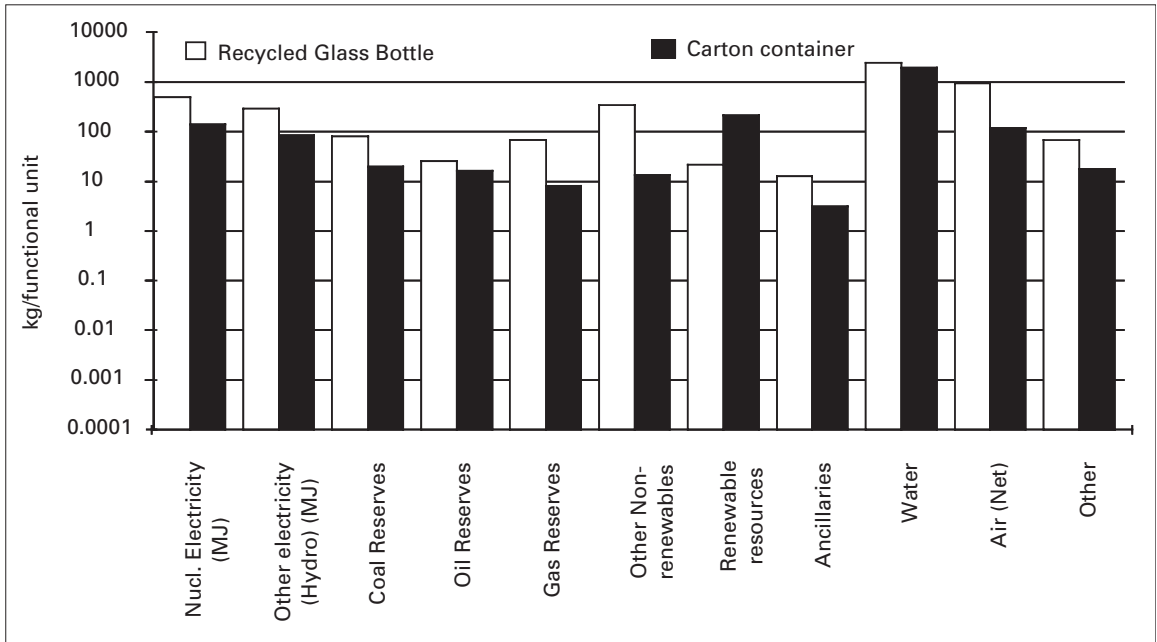


Fig. 5.7 Glass bottle versus carton: resource requirements.

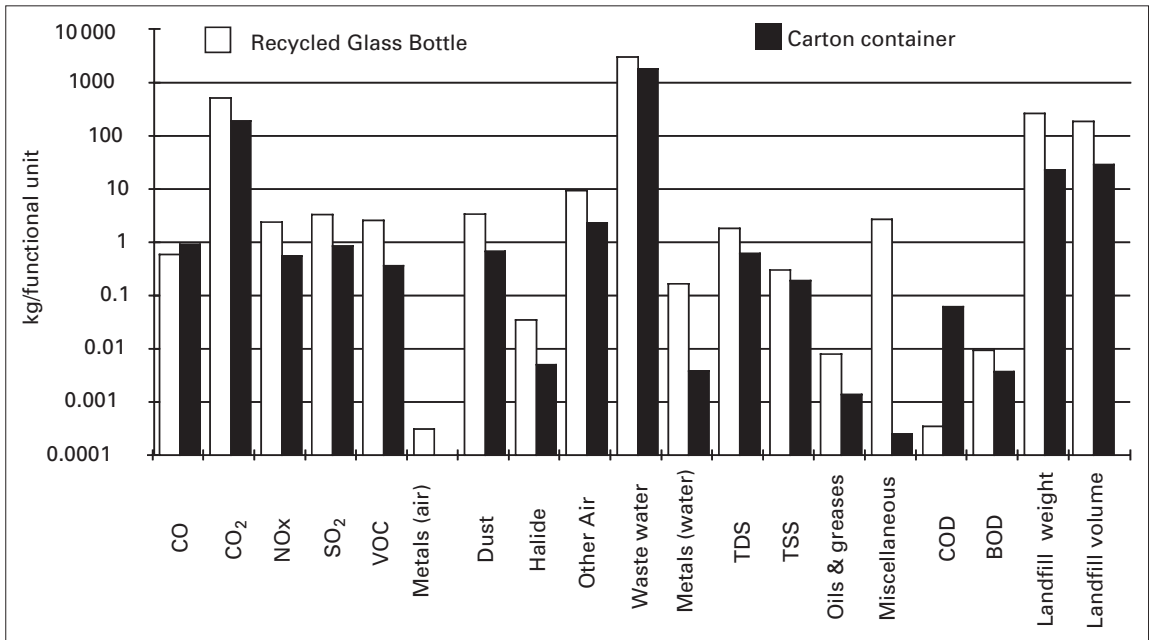


Fig. 5.8 Glass bottle versus carton: emissions to air and water and solid waste (TDS = total dissolved solids, TSS = total suspended solids, BOD = biological oxidation demand).

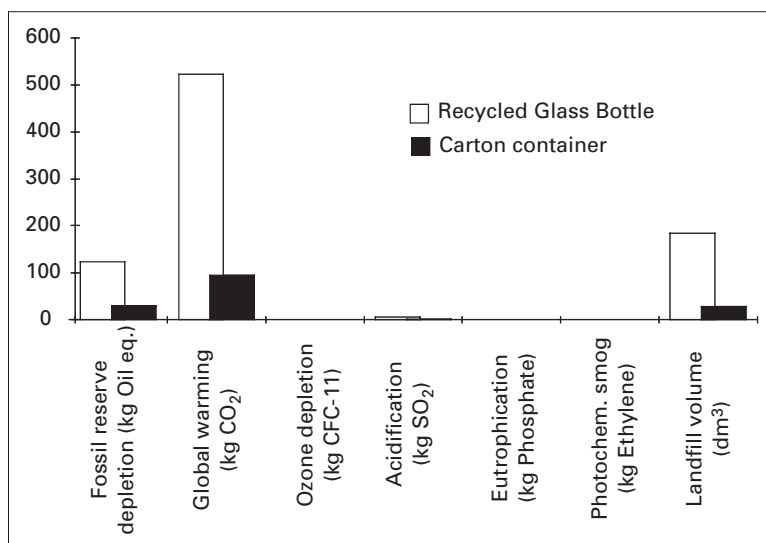


Fig. 5.9 Glass bottle versus carton: environmental impacts.

3.2 Process-oriented LCA

The potential of LCA as a tool for process evaluation has been recognised only relatively recently and this has led to the development of the life-cycle approaches for process selection and optimisation. An extensive review of these LCA applications can be found in Ref. 3. In addition to these uses of LCA, an LCA-based approach for environmental technology assessment also has been proposed [68]. This section gives a brief overview of these approaches and demonstrates, with a couple of examples, the value of LCA as a tool for the identification of more sustainable processes and technologies.

Life-cycle assessment for technology assessment and process selection

Technology assessment is an analytical tool used to help understand the likely impacts of the use of a new technology by an industry or by society. Technology assessment includes an examination of the costs of the technology, the economic benefits and its environmental, social and political impacts. Environmental technology assessment (ETA) specifically analyses a technology's implications for human health, natural resources and ecosystems.

All technologies, whether they are infrastructural or the development of a new commercial product, e.g. a new facility for automobiles or basic chemicals, go through the same generic development cycle

[69]. As shown in Fig. 5.10, first is the identification of a need, problem or opportunity, and then the choice of alternatives, the selection of sites and technologies and the design and operation. In the case of manufacturing or industrial facilities, there is also production and delivery of the product or service. Over time, there must be monitoring, upgrading, repair, maintenance and often an expansion of facilities. Ultimately, one is confronted with the question of abandonment and disposal and replacement.

In the system shown in Fig. 5.10 there are few or no direct environmental impacts associated with the first six stages of technology assessment because these are the planning components. The majority of environmental impacts associated with a technology are generated in stages 7–13, which involve the construction, operation, maintenance, disposal and repair or replacement of the facility. It is argued that these are the stages for which LCA should be carried out to assess the impacts of all alternative technological options, including the acquisition and use of raw materials and energy and waste disposal [68]. At present, ETA assesses only site-specific operations and their environmental impacts, ignoring the impacts generated upstream or downstream from the use of technology.

In this respect, ETA is similar to environmental impact assessment (EIA) and the assessment of 'best practicable environmental option' (BPEO)—their objective is to identify the best process or technology

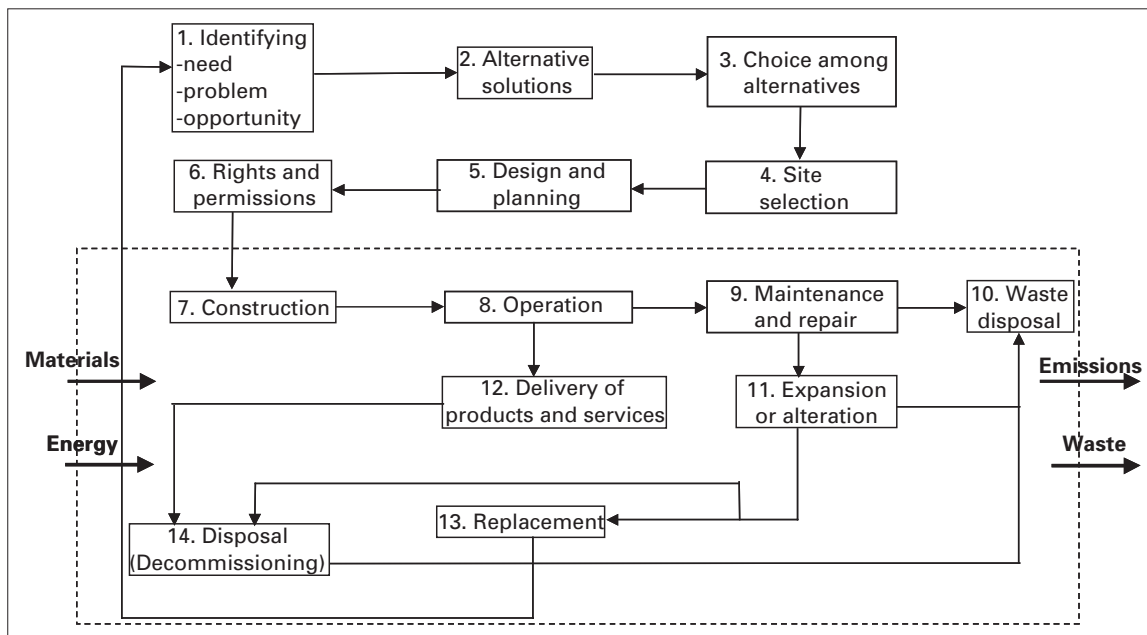


Fig. 5.10 The LCA for environmental technology assessment: (—) LCA boundary.

among the alternatives and so reduce impacts on the environment. However, although they may ensure minimum impacts from the manufacturing site or facility itself, they may lead to an increase of impacts elsewhere in the life-cycle. This has been demonstrated already for the current approach of choosing BPEO for the end-of-pipe abatement of SO_2 , NO_x and VOCs [3]. The findings of these studies confirm that if a more sustainable process and technological options are to be identified, they must be assessed in the context of LCA.

The LCA-based approach for ETA introduced above can be applied also for process selection, e.g. for identifying BPEO. The difference between the use of LCA for technology assessment and process selection is in scope only: the LCA-ETA follows the life-cycle of a technology from concept to decommissioning ('cradle to grave'), whereas the use of LCA for process selection may be more limited and may only include the operation stage, the raw materials and energy use and waste disposal ('cradle to gate'). The life-cycle approach now is integral in the EU Directive on Integrated Pollution Prevention and

Control (IPPC) [70]. The Directive requires that the 'best available technique' (BAT), which is equivalent to BPEO regulated within IPPC in the UK, must be chosen by considering the environment as a whole, including indirect releases, consumption of raw materials and waste disposal. A life-cycle approach for the determination of BAT for IPPC is elaborated further in Ref. 71.

The use of LCA as a tool for process selection is illustrated now in the case study of technologies for VOC abatement.

Case study II: VOC abatement

Yates [72] compared the life-cycle impacts of the end-of-pipe processes for VOC removal. The case study investigated the effect of flow rate ($1000\text{--}20\,000\text{ m}^3\text{ h}^{-1}$) and concentrations ($200\text{--}1200\text{ mg m}^{-3}$) of mainly xylene in the waste stream on the choice of BPEO/BAT. Four processes were examined: activated carbon adsorption with steam regeneration (ACA-SR), catalytic oxidation, cryogenic recovery and biological oxidation (BO).

The functional unit was defined as the 'removal of one 1 kg of the VOC (xylene)'. The system boundary was drawn from 'cradle to gate', including the

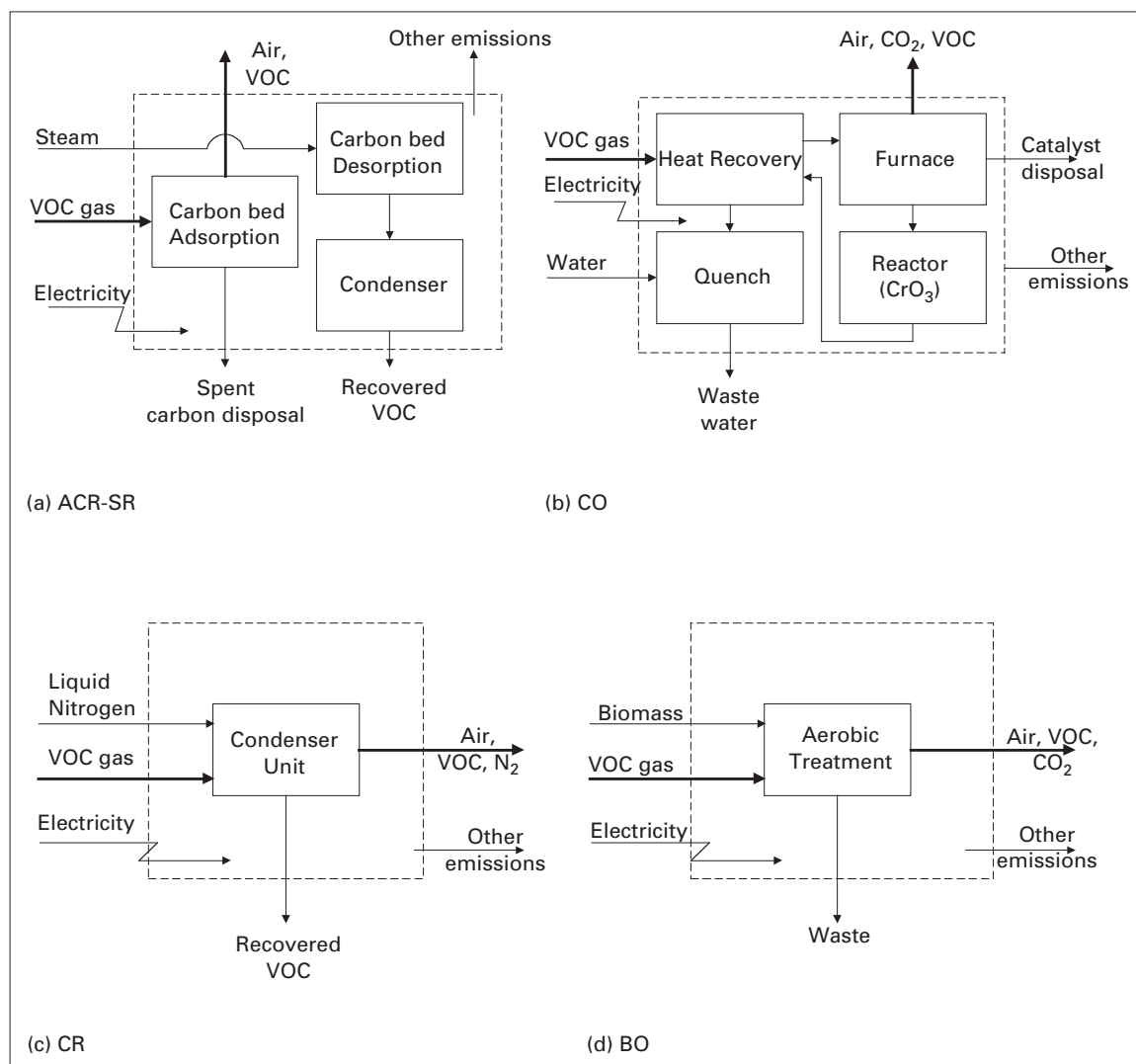


Fig. 5.11 Life-cycles of VOC abatement techniques [3]: (a) ACA-SR, activated carbon adsorption with steam regeneration; (b) CO, catalytic oxidation; (c) CR, cryogenic recovery of VOCs; (d) BO, biological oxidation.

burdens from the operation stage, production of raw materials and energy and waste disposal. The flow diagrams of these processes are shown in Fig. 5.11 [3]. In the ACA-SR process, steam is used to regenerate the carbon bed and recover xylene in situ. The desorbed VOC off-gas stream is condensed to yield a water/organic mixture that is phase-split. In the

catalytic oxidation process, gaseous VOCs are destroyed via oxidation over a catalyst at temperatures of 250–350°C. Heat recovery from the oxidation process is sufficient to satisfy the heat requirements of the system and avoid the need for additional heat supply. Cryogenic recovery, on the other hand, operates by lowering the temperature of the gas stream below the VOC's dew point. Temperatures as low as –150°C can be reached by using liquid nitrogen. If the VOC condensate is of sufficient purity, i.e. contains mainly one component (as in this case study), it may be recovered directly for reuse. Finally, the biological treatment utilises

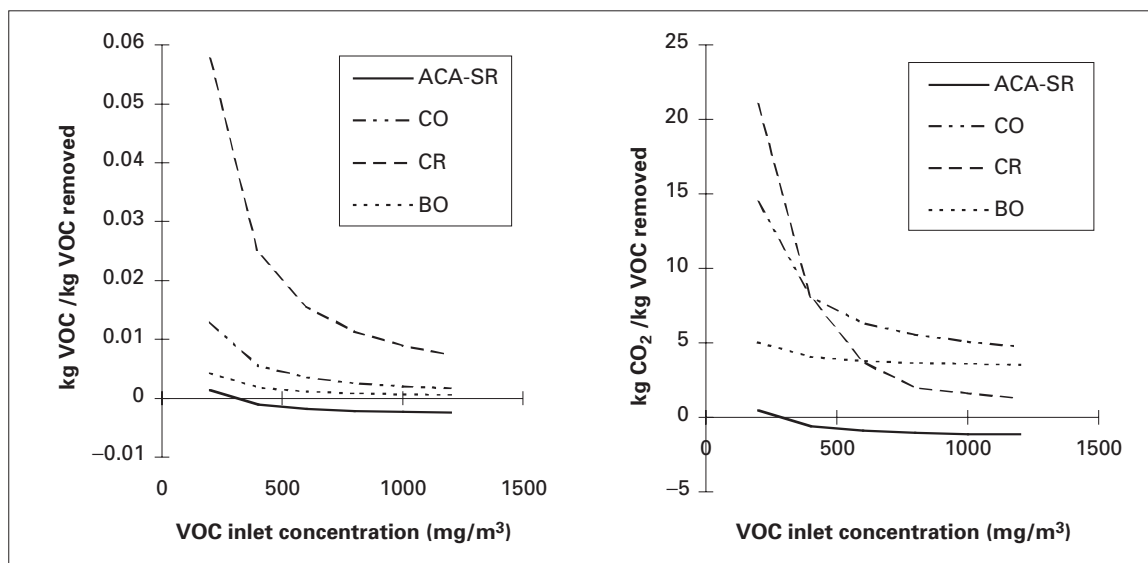


Fig. 5.12 Life-cycle CO_2 and VOC emissions for VOC abatement technologies [3]: Flow rate = $5000 \text{ m}^3 \text{ h}^{-1}$; outlet VOC = 50 mg m^{-3} ; ACA-SR = activated carbon adsorption with steam regeneration; CO = catalytic oxidation, $T_{\text{oxidation}} = 350^\circ\text{C}$; CR = cryogenic recovery, $T_{\text{cooling}} = -50^\circ\text{C}$; BO = biological oxidation.

microorganisms to oxidise organic material in the liquid phase.

The study found that removal of the VOC by these processes generated the additional emissions of VOCs and other pollutants elsewhere in the life-cycle [72]. The worst process in these terms was the cryogenic recovery at low VOC inlet concentrations, which for each kilogram of VOC removed generated on additional 0.06 kg of VOC and 22 kg of CO_2 (see Fig. 5.12). The main reason for this is a high energy requirement for the production of liquid nitrogen, which exceeds the benefits of VOC recovery. These findings lead to the conclusion that a pollutant recovery may not always be a better option environmentally than destroying it, as stimulated by the waste management hierarchy set out by the European Commission [73] and the Environment Agency [74] in the UK. However, as the amount of VOC recovered increases, the cryogenic process becomes more competitive and for inlet VOC concentrations above 600 mg m^{-3} it becomes the second most favourable option to ACA-SR in terms of CO_2 emis-

sions. Thus, depending on the operating conditions of the system, the cryogenic recovery process ranges from being the worst option to approaching the BPEO/BAT. The ACA-SR process was found to be the BPEO/BAT over all flow rates and concentrations investigated. Furthermore, the VOC and CO_2 emissions were negative due to crediting the system for the recovery of xylene and the associated avoided burdens, which otherwise would arise from the energy-intensive primary production of this solvent (Fig. 5.12). Thus, contrary to the findings for cryogenic recovery, it is more beneficial environmentally to recover the pollutant in the ACA-SR process rather than to destroy it.

This case study therefore highlights the value of LCA for process selection, in that it challenges the widely accepted 'truths' on waste management hierarchy and shows the importance of considering the operating conditions of the system throughout the whole life-cycle for identifying more sustainable options.

Life-cycle assessment and process optimisation

Another process-oriented application of LCA is for process optimisation. As noted earlier, one of the objectives of LCA is to identify options for environmental improvements of a system in which complete supply chains are considered. The main problem

encountered here, however, is finding the optimum improvement strategies and choosing the best alternative in a decision environment with a number of often conflicting objectives. To aid the decision-making process, an optimisation tool—optimum LCA performance (OLCAP)—has been developed by Azapagic and Clift [75]. The OLCAP combines LCA and process optimisation and defines an optimisation problem in this context as follows:

$$\begin{aligned} \text{Minimise } & f(\mathbf{x}, \mathbf{y}) = [f_1, f_2 \dots f_p] \\ & h(\mathbf{x}, \mathbf{y}) = 0 \\ & g(\mathbf{x}, \mathbf{y}) < 0 \\ & \mathbf{x} \in \mathbf{X} \subseteq \mathbf{R}^n \\ & \mathbf{y} \in \mathbf{Y} \subseteq \mathbf{Z}^q \end{aligned} \quad (5.4)$$

where f is a vector of environmental objective functions, $h(\mathbf{x}, \mathbf{y}) = 0$ and $g(\mathbf{x}, \mathbf{y}) < 0$ are equality and inequality constraints and \mathbf{x} and \mathbf{y} are the vectors of continuous and integer variables, respectively. The constraints and objective functions include all activities from ‘cradle to grave’ or ‘cradle to gate’, depending on the scope of the study. The equality constraints may be defined by energy and material balances; the inequality constraints may describe material availabilities, heat requirements, capacities, etc. A vector of n continuous variables may include material and energy flows, pressures, compositions, sizes of unit operations, etc., whereas a vector of q integer variables may be represented by alternative materials or technologies in the system or a number of trucks for the transport of raw materials. Depending on the type of constraints and objectives, the model described by Eqns (5.4) can be linear or non-linear.

The optimisation problem in the context of LCA is equivalent to a conventional optimisation model except that in addition to an economic function it also involves the environmental objectives, defined as the burdens or impacts [3,75]. Thus a single objective optimisation problem usually employed in conventional process optimisation is, in the LCA context, transformed into a multi-objective one. The system is optimised simultaneously on a number of environmental objectives, subject to certain constraints encompassing all activities from cradle to grave. This results in an n -dimensional non-inferior or Pareto surface with a number of optimum solutions for system improvements. By definition, none of the objective functions on the Pareto surface can be improved without worsening the value of any

other objective function. Therefore, some trade-offs between objective functions are necessary in order to reach the preferred optimum solution in a given situation. Full details of this methodology can be found in Azapagic and Clift [75] and this is not elaborated further here. Instead, the value of LCA in system optimisation is illustrated on a case study of the Scotch Whisky system.

Case study III: the Scotch whisky system

An LCA study of Scotch grain whisky, used in Scotch whisky blends with malt whisky, has been carried out to identify the major environmental impacts and key stages in the life-cycle with the aim of identifying options for improving the environmental performance of the whole system [56]. The system boundaries include all activities from extraction of raw materials through crop farming and the manufacturing process to the matured product leaving the factory gate. A flow diagram of the Scotch whisky life-cycle is shown in Fig. 5.13. The use and product disposal stages are outside the scope of the study and therefore are not considered, making this in effect a ‘cradle-to-gate’ study. The functional unit is defined as ‘operation of the system for one year’, which is equivalent to the total annual output of whisky of 36 million litres of pure alcohol (lpa) and 40 000 t year⁻¹ of by-products (animal feed and CO₂).

As shown in Fig. 5.13, the system is divided into foreground and background. The foreground comprises the manufacturing process itself, i.e. malting plant, grain distillery and maturation, whereas the background includes all other activities that supply material and energy to the foreground, including the farming subsystem. Cereal grain, either wheat or maize, is used as the main raw material for the process. The malting plant provides malted barley, used in the distillery plant as a source of saccharification enzymes. The grain distillery subsystem includes the operations of starch extraction from the grain by cooking, its conversion to sugars with the aid of malted barley in the mashing process and fermentation to metabolise the sugars to produce a wash of about 7% (v/v) ethanol. Carbon dioxide gas evolved during fermentation is recovered, purified, liquefied and sold as a by-product. The spent wash from distillation contains grain solids that are processed also as a by-product and sold back to the agricultural sector as animal feed.

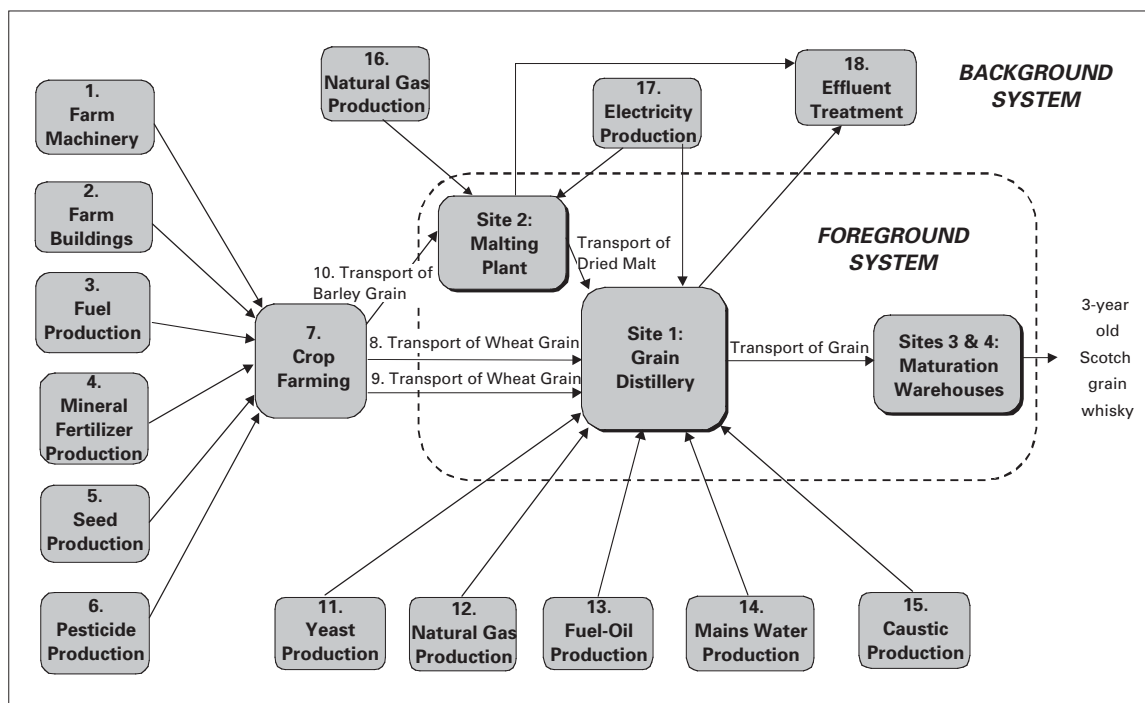


Fig. 5.13 'Cradle-to-gate' flow diagram of the Scotch whisky system.

Distillation of the fermented wash draws a spirit distillate just below 94.8% (v/v) ethanol. The new-make grain spirit then is reduced with water and casked. Full casks are loaded onto lorries and transported directly from the distillery to the maturation warehouses, where spirit matures for a minimum of 3 years and usually up to 8 or 12 years. Spirit losses by evaporation through wooden cask walls are about 2% (v/v) per year.

Figure 5.14 shows relative contributions of the main life-cycle stages of each of the environmental impact categories calculated according to the problem-oriented approach in LCA [21]. It is apparent that acidification, eutrophication and human and aquatic toxicity are attributable mainly to the background system, with the largest contribution from farming activities and the manufacture of mineral fertilisers. Global warming is contributed to equally by the background (fertilisers and farming activities)

and the foreground (distillery and maturation). Ozone depletion, photochemical oxidant formation and non-renewable energy use arise mainly in the foreground system, in the grain distillery and spirit maturation warehouse.

Thus, with respect to the environmental impacts considered in this LCA study, there are three dominant stages in the life-cycle of the whisky system:

- (1) Manufacturing of mineral fertilisers for application on the arable farm.
- (2) Arable farming to produce the raw material input to the whisky manufacturing process.
- (3) The whisky manufacturing process (particularly cooking, distillation, by-products recovery, maturation).

Therefore, LCA has helped to identify the key stages in the life-cycle that should be targeted to achieve the largest improvements, both in the foreground and the background. In discussions with the whisky manufacturers, the following improvement options were identified:

For the background system:

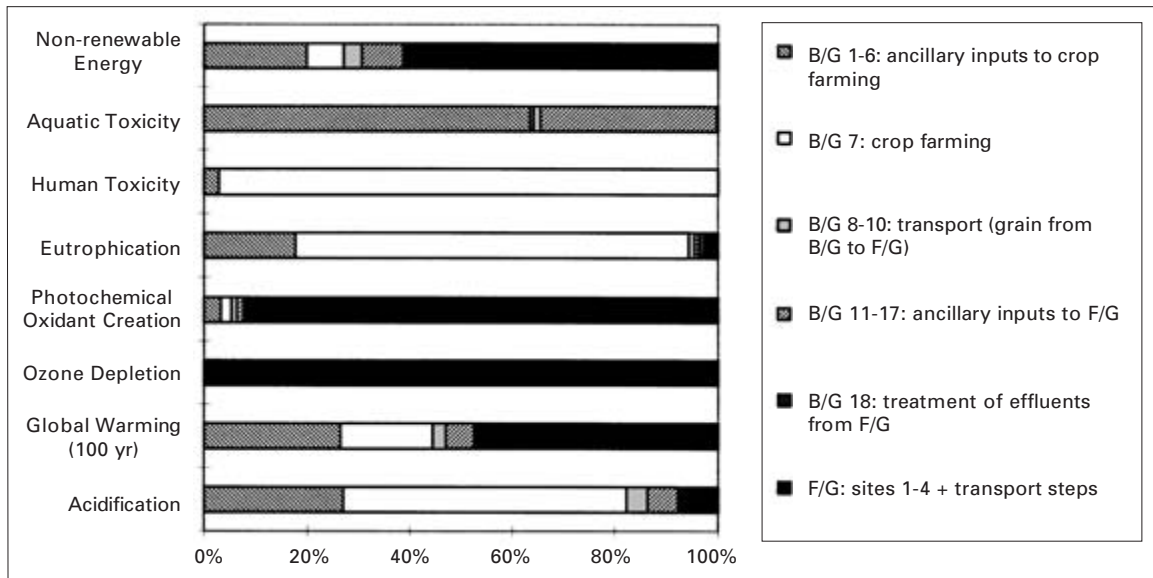


Fig. 5.14 Life-cycle impacts of the Scotch whisky system (B/G = background; F/G = foreground).

- Substitution of intensively farmed grain for organically grown cereal (wheat, maize and barley)

For the foreground system:

- The use of artificial enzymes for grain starch liquefaction and saccharification instead of malt addition, to reduce costs and remove the requirement for barley production
- Recycling of part of the distillation effluent to the cooking process to reduce energy, water usage and amount of effluent for treatment
- Very high gravity brewing instead of conventional brewing to reduce energy and water usage and amount of effluent for treatment
- Anaerobic digestion of spent wash and utilisation of generated biogas as fuel, displacing the animal feed plants
- Optimisation of maturation conditions by optimising fill strength and cask size to prevent product evaporation losses.

The OLCAP methodology [75] has been used to integrate these improvement options into the LCA optimisation framework as defined by Eqns. (5.4). The results of optimisation are compared with the

current operations in Fig. 5.15. To preserve confidentiality, the impacts of the optimised system are expressed relative to the current operations. It is obvious that almost all impacts from the optimised system are lower than those from the current operations. For example, global warming and energy use are reduced by 45%. The largest improvements are noticed for human and aquatic toxicity, with reductions of almost 100% and 80%, respectively. The main reason for these reductions is the elimination of pesticides in organic farming.

On the other hand, there is a significant increase in two other impacts, i.e. eutrophication and acidification. A 250% increase in eutrophication is due to the application of organic fertiliser (manure) and associated emissions of nitrates to water and lower productivity per area of land in organic farming [52]. A similar increase in acidification (210%) is due to ammonia emissions from the manure and additional farm machinery required per tonne of grain in organic farming. Organic farming also carries a financial penalty because of the higher price of organic grain, which at present is about twice that of intensive-farming grain. The question facing the decision-makers then is whether a nearly complete elimination of human and aquatic toxicity is more important than a twofold increase in eutrophication, acidification and costs. This is equivalent to the valuation step in LCA, which involves elicitation of the

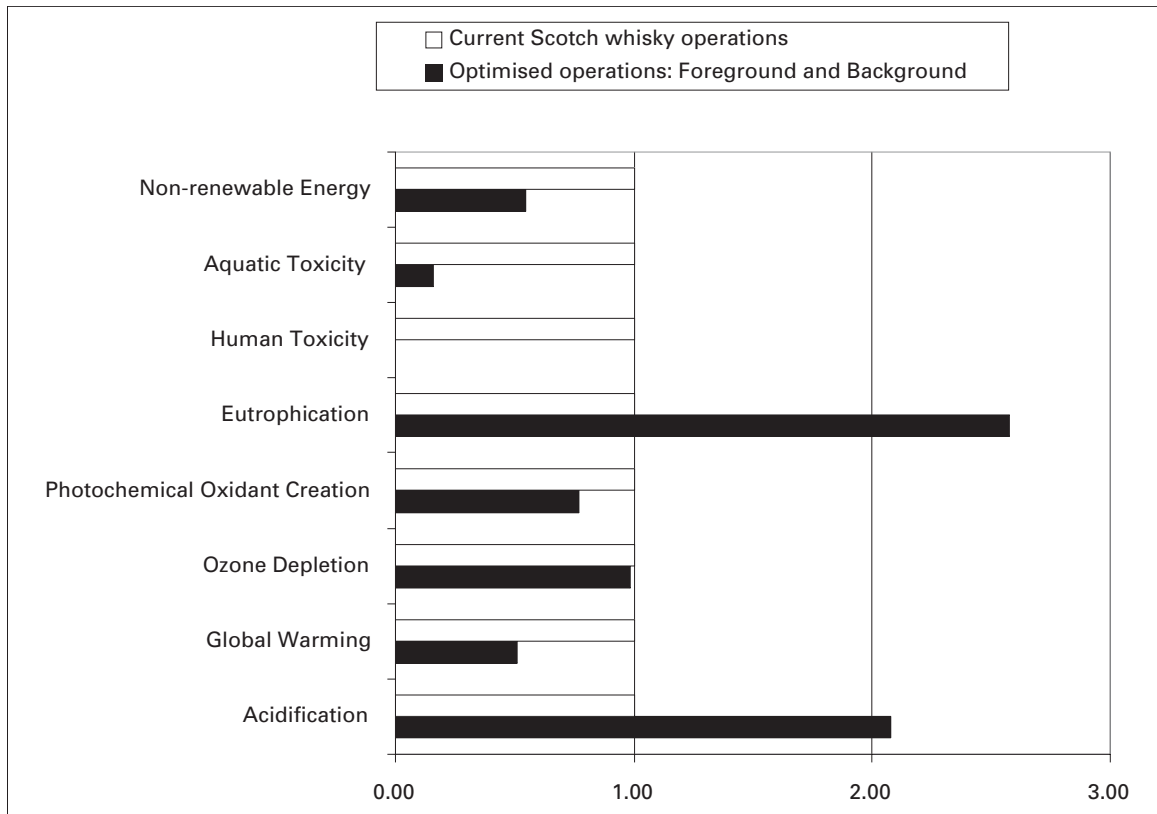


Fig. 5.15 The Scotch whisky system: comparison of the current and optimised operations.

importance that decision-makers attach to different impacts and subsequent aggregation of the impacts into a single impact function. In the OLCAP methodology, the expression of preferences and aggregation of impacts are carried out in the post-optimal analysis when it is much clearer which impacts are significant and what their trade-offs are. In that way the decision-makers know exactly what they lose or gain with each option and are much more likely to reach a compromise decision, which may be particularly important in situations with conflicting interests. If, on the other hand, valuation is carried out before the trade-offs are explored, important information may be lost and suboptimal or unsustainable options chosen as a result.

4 Conclusions

The move towards sustainable development requires a paradigm shift from a fractured view of the envi-

ronment, with the emphasis on one stage of the life-cycle, to a more holistic life-cycle approach to environmental management. Life-cycle assessment is a tool that enables and supports such a paradigm shift because it embodies life-cycle thinking and so provides a full picture of human interactions with the environment. Numerous studies already have demonstrated the value of LCA as a tool for identifying more sustainable products and processes and this chapter has attempted to summarise and illustrate some of the LCA applications in this area.

The application of LCA for both product and process analysis shows that LCA can help to identify major stages and impacts in the life-cycle of the system. If combined with multi-objective system optimisation, it provides a powerful tool for guiding the choice of improvement options for more sustainable practices along whole supply chains.

However, before LCA is adopted more widely by industry and policy-makers, efforts to understand and apply LCA have to be made by all the stakeholders involved, be it LCA practitioners, industry, public or government. On the other hand, if this

is to happen, then further development of LCA has to be directed towards its meeting the needs and expectations of these stakeholders. It is only then that we can expect this approach to become integrated fully into corporate and public policy decision-making.

5 Appendix

5.1 Definition of environmental impacts

This section gives an overview of the calculation procedure to estimate the contributions of burdens identified in the Inventory Analysis phase to the different impact categories. The procedure is based on the problem-oriented approach [21]. All impact categories are normalised to the functional unit. The numerical values of the classification factors of some of the burdens are given in Table A5.1.

Abiotic resource depletion

Abiotic resource depletion includes depletion of non-renewable resources, i.e. fossil fuels, metals and minerals. The total impact is calculated as:

$$E_1 = \sum_{j=1}^J \frac{B_j}{ec_{1,j}} \quad (A1.1)$$

where B_j is the quantity of a resource used per functional unit and $ec_{1,j}$ represents the total estimated world reserves of that resource.

Global warming potential

Global warming potential (GWP) is calculated as a sum of emissions of the greenhouse gases (CO_2 , N_2O , CH_4 and VOCs) multiplied by their respective GWP factors, $ec_{2,j}$:

$$E_2 = \sum_{j=1}^J ec_{2,j} B_j \quad (\text{kg}) \quad (A1.2)$$

where B_j represents the emission of greenhouse gas j . The GWP factors, $ec_{2,j}$, for different greenhouse gases are expressed relative to the global warming potential of CO_2 , which is therefore defined to be unity. The values of GWP depend on the time horizon over which the global warming effect is assessed. The GWP factors for shorter times (20 and 50 years) provide an indication of the short-term effects of greenhouse gases on the climate, whereas

the GWP factors for longer periods (100 and 500 years) are used to predict the cumulative effects of these gases on the global climate.

Ozone depletion potential

The ozone depletion potential (ODP) category indicates the potential of emissions of chlorofluorohydrocarbons (CFCs) and chlorinated hydrocarbons for depleting the ozone layer and is expressed as:

$$E_3 = \sum_{j=1}^J ec_{3,j} B_j \quad (\text{kg}) \quad (A1.3)$$

where B_j is the emission of ozone-depleting gas j . The ODP factors $ec_{3,j}$ are expressed relative to the ozone depletion potential of CFC-11.

Acidification potential

Acidification potential is based on the contributions of SO_2 , NO_x , HCl , NH_3 and HF to the potential acid deposition, i.e. on their potential to form H^+ ions. Acidification potential is calculated according to the formula:

$$E_4 = \sum_{j=1}^J ec_{4,j} B_j \quad (\text{kg}) \quad (A1.4)$$

where $ec_{4,j}$ represents the acidification potential of gas j expressed relative to the acidification potential of SO_2 , and B_j is its emission in kilograms per functional unit.

Eutrophication potential

Eutrophication potential is defined as the potential to cause over-fertilisation of water and soil, which can result in increased growth of biomass. It is calculated as:

$$E_5 = \sum_{j=1}^J ec_{5,j} B_j \quad (\text{kg}) \quad (A1.5)$$

where B_j is an emission of species such as NO_x , NH_4^+ , N , PO_4^{3-} , P and COD , and $ec_{5,j}$ are their respective eutrophication potentials. Eutrophication potential is expressed relative to PO_4^{3-} .

Photochemical oxidants creation potential

Photochemical oxidants creation potential (POCP), or photochemical smog, is usually expressed relative

Table A5.1 Selected classification factors^a for the LCA impact categories

Burdens	Resource depletion (world reserves)	Global warming potential for 100 years (equiv. to CO ₂)	Ozone depletion potential (equiv. to CFC-11)	Acidification potential (equiv. to SO ₂)	Eutrophication potential (equiv. to PO ₄ ³⁻)	Photochemical smog POCP (equiv. to ethylene)	Human toxicity	Aquatic toxicity (m ³ mg ⁻¹)
Coal reserves	8.72E + 13 t							
Oil reserves	1.24E + 11 t							
Gas reserves	1.09E + 14 m ³							
CO							0.012	
CO ₂		1						
NO _x				0.7	0.13		0.78	
SO ₂				1.0			1.2	
HC excl CH ₄						0.416	1.7	
CH ₄		11				0.007		
Aldehydes						0.443		
Chlorinated HC		400	0.5				0.98	
CFCs		5000	0.4				0.022	
Other VOC		11	0.005			0.007		
As							4700	
Hg							120	
F ₂							0.48	
HCl				0.88				
HF				1.6			0.48	
NH ₃				1.88			0.02	
As							1.4	1.81 × 10 ⁸
Cr							0.57	9.07 × 10 ⁸
Cu							0.02	1.81 × 10 ⁹
Fe							0.0036	
Hg							4.7	4.54 × 10 ¹¹
Ni							0.057	2.99 × 10 ⁸
Pb							0.79	1.81 × 10 ⁹
Zn							0.0029	3.45 × 10 ⁸
Fluorides							0.041	
Nitrates					0.42		0.00078	
Phosphates					1.0		0.00004	
Oils, greases								4.54 × 10 ⁷
Ammonia					0.33		0.0017	
Chlor. solv./comp							0.29	5.44 × 10 ⁷
Cyanides							0.057	
Pesticides							0.14	1.18 × 10 ⁹
Phenols							0.048	5.35 × 10 ⁹
COD					0.022			

^a All classification factors are expressed in kg kg⁻¹, unless stated otherwise. HC, hydrocarbons.

to the POCP classification factors of ethylene and is calculated as:

$$E_6 = \sum_{j=1}^J ec_{6,j} B_j \quad (\text{kg}) \quad (\text{A1.6})$$

where B_j are the emissions of different contributory species, primarily VOCs, classified into the categories of: alkanes, halogenated hydrocarbons, alcohols, ketones, esters, ethers, olefins, acetylenes, aromatics and aldehydes; and $ec_{6,j}$ are their respective

classification factors for photochemical oxidation formation.

Human toxicity potential

Human toxicity potential (HTP) is calculated by adding releases toxic to humans to three different media, i.e. air, water and soil:

$$E_7 = \sum_{j=1}^J ec_{7,jA} B_{jA} + \sum_{j=1}^J ec_{7,jW} B_{jW} + \sum_{j=1}^J ec_{7,jS} B_{jS} \quad (\text{kg}) \tag{A1.7}$$

where $ec_{7,jA}$, $ec_{7,jW}$ and $ec_{7,jS}$ are human toxicological classification factors for the effects of toxic emission to air, water and soil, respectively, and B_{jA} , B_{jW} and B_{jS} represent the respective emissions of different toxic substances into the three media. The toxicological factors are calculated using the acceptable daily intake or the tolerable daily intake of the toxic substances. The human toxicological factors are still at an early stage of development so that HTP can be taken only as an indication and not as an absolute measure of the toxicity potential.

Aquatic toxicity potential

Aquatic toxicity potential (ATP) can be calculated as:

$$E_{8A} = \sum_{j=1}^J ec_{8,jA} B_{jA} \quad (\text{m}^3) \tag{A1.8}$$

where $ec_{8,jA}$ represents the toxicity classification factors of different aquatic toxic substances and B_{jA} are their respective emissions to the aquatic ecosystems. The ATP is based on the maximum tolerable concentrations of different toxic substances in water by aquatic organisms. Similar to the HTP, classification factors for ATP are still developing so it can be used only as an indication of potential toxicity.

References

1. The Brundtland Commission. *Our Common Future, The Report of the World Commission on Environment and Development*. Oxford University Press, Oxford, 1987.
2. Azapagic, A., & Perdan, S. *Trans. Inst. Chem. Eng. Part B*, 2000, **78**, 243.
3. Azapagic, A. *Chem. Eng. J.*, 1999, **73**, 1.
4. Boustead, I. *The Milk Bottle*. Open University Press, Milton Keynes, 1972.

5. Hannon, B. *System Energy and Recycling: a Study of the Beverage Industry*. Center for Advanced Computation, University of Illinois, Urbana, 1972.
6. Ayres, R. U. *Process Classification for the Industrial Material Sector*, Technical Report. United Nations Statistical Office, New York, 1978.
7. Hunt, R. G., & Franklin, W. E. *Resources and Environmental Profile Analysis of 9 Beverage Container Alternatives*, Contract (68-01-1848). US EPA, Washington, DC, 1974.
8. Boustead, I. *Environmental Impact of the Major Beverage Packaging Systems—U.K. Data 1986 in Response to the E.E.C. Directive 85/339*. INCPEN, London, 1989, pp. 1–4.
9. Fava, J., Dennison, R., Jones, B., Curran, M. A., et al. *A Technical Framework for Life-Cycle Assessment*. SETAC and SETAC Foundation for Environmental Education, Inc., Washington, DC, 1991.
10. Consoli, F., Allen, D., Boustead, I., Fava, J., et al. *Guidelines for Life-Cycle Assessment: a 'Code of Practice'*. SETAC, Brussels, 1993.
11. ISO. *Environmental Management—Life Cycle Assessment—Principles and Framework*, ISO/DIS 14040. HMSO, London, 1997.
12. ISO. *Environmental Management—Life Cycle Assessment—Goal and Scope Definition and Life Cycle Inventory Analysis*, ISO/DIS 14041. HMSO, London, 1998.
13. ISO. *Environmental Management—Life Cycle Assessment—Life Cycle Impact Assessment*, ISO/CD 14042. HMSO, London, 1998.
14. ISO. *Environmental Management—Life Cycle Assessment—Life Cycle Interpretation*, ISO/CD 14043. HMSO, London, 1998.
15. Azapagic, A., & Clift, R. *J. Cleaner Prod.*, 1999, **7**, 101.
16. Clift, R., Frischknecht, R., Huppes, G., Tillman, A.-M., & Weidema, B. *Toward a Coherent Approach to Life Cycle Inventory Analysis*, Report of the Working Group on Inventory Enhancement. SETAC-Europe, Brussels, 1998.
17. PIRA. *PEMS 3 LCA Software and Database*. PIRA International, Leatherhead, UK, 1995.
18. Ecobalance. *DEAM—Database for Environmental Analysis and Management*. Ecobalance UK, Arundel, West Sussex, 1997.
19. Azapagic, A., & Clift, R. *Int. J. LCA*, 1999, **4**, 357.
20. Azapagic, A., & Clift, R. *Int. J. LCA*, 2000, **5**, 31.
21. Heijungs, R., Guinee, J. B., Huppes, G., Lankreijer, R. M., et al. *Environmental Life Cycle Assessment of Products: Background and Guide*. MultiCopy, Leiden, 1992.
22. Bare, J. C., Hofstetter, P., Pennington, D. W., & Udo de Haes, H. A. Midpoints versus Endpoints: the Sacrifices and Benefits. *International Journal of LCA*, 2000, **5**, 319.
23. Nicholas, M. J. *The Application of Environmental Life Cycle Approaches to Industrial Pollution Control and Policy-making: A Case Study of the Glass Industry. Volume 1*. EngD Porfolio, University of Surrey, 2001.

24. Huijbregts, M., Thissen, U., Guineé, J. B., Jager, T., *et al.* *Chemosphere*, 2000, **41**, 541.
25. Fava, J., Consoli, F., Denison, R., Dickson, K., Mohin, T., & Vigon, B. *A Conceptual Framework for Life-Cycle Impact Assessment*. SETAC and SETAC Foundation for Environmental Education, Inc., Pensacola, USA, 1993.
26. Tillman, A.-M., Baumann, H., Eriksson, E., & Rydberg, T. *Life-Cycle Analysis of Packaging Materials. Calculation of Environmental Load*. Chalmers Industri Teknik, Gothenburg, Sweden, 1991.
27. Boustead, I. *Eco-balance Methodology for Commodity Thermoplastics*. PWMI, Brussels, 1992.
28. Pedersen, B., & Christiansen, K. In *Product Life Cycle Assessment—Principles and Methodology*, Vol. 9. Nordic Council of Ministers, Copenhagen, 1992, p. 238.
29. Guinée, J. B., Heijungs, R., Udo de Haes, H. A., & Huppes, G. *J. Cleaner Prod.*, 1993, **1**, 81.
30. Keoleian, G. A. *J. Cleaner Prod.*, 1993, **1**, 143.
31. Weidema, B. P., & Krüger, I. *Environmental Assessment of Products: a Textbook on Life Cycle Assessment*, 2nd edn. UETP-EEE, Finnish Association of Graduate Engineers, Helsinki, 1993.
32. Pedersen, B. *Environmental Assessment of Products. A Course on Product Life Cycle Assessment*. UETP-EEE, Helsinki, 1993.
33. Vigon, B. W., Tolle, D. A., Cornaby, B. W., Latham, H. C., *et al.* *Life Cycle Assessment: Inventory Guidelines and Principles*. US EPA, Washington, DC, 1993.
34. Azapagic, A. In *Science, Technology and Innovation Policy: Opportunities and Challenges for the 21st Century* (Conceicao, P., Gibson, D., Heitor, M. V., & Shariq, S., eds), IC2 Management and Management Science Series No. 8. Quorum Books, Westport, CT, 2000, pp. 519–530.
35. Ophus, E., & Digernes, V. *Jocca-Surf. Coat. Int.*, 1996, **79**, 156.
36. Dobson, I. D. *Prog. Org. Coat.*, 1996, **27**, 55.
37. Franke, M., Kluppel, H., Kirchert, K., & Olschewski, P. *Tenside Surfact. Deterg.*, 1995, **32**, 508.
38. Aresta M., & Tommasi, I. *Energy Conv. Manage.*, 1997, **38**(SS), S373.
39. Rice, G. In *The Application of Life Cycle Assessment to Industrial Process Selection*. EngD Portfolio, University of Surrey, 1997, pp. 62 and 56.
40. Robertson, J. G. S., Wood, J. R., Ralph, B., & Fenn, R. *J. Power Sources*, 1997, **67**, 225.
41. Chubbs, S. T., & Steiner, B. A. *Environ. Prog.*, 1998, **17**, 92.
42. Azapagic, A., & Clift, R. *Int. J. LCA*, 1999, **4**, 133.
43. Yoda, N. *J. Macromol. Sci.—Pure Appl. Chem.*, 1996, **A33**, 1807.
44. Seppala, J., Melanen, M., Jouttijarvi, T., Kauppi, L., & Leikola, N. *Resources Conserv. Recycl.*, 1998, **23**, 87.
45. Backlund, B. *Svensk Papperstid.-Nord. Cellul.*, 1998, **101**, 49. (in Swedish).
46. Kuusinen, T. L., Barker, R. H., & Alexander, D. A. *Tappi J.*, 1998, **81**, 179.
47. Puntener, A. G. *J. Soc. Leather Technol. Chem.*, 1998, **82**, 1.
48. Beck, A., Scheringer, M., & Hungerbühler, K. *Int. J. LCA*, 2000, **5**, 335.
49. Miyamoto, S., & Tekawa, M. *Nec Res. Dev.*, 1998, **39**, 77.
50. de Langhe, P., Criel, S., & Ceuterick, D. *IEEE Trans. Compon. Packag. Manu. Technol., Part A*, 1998, **21**, 154.
51. Mori, Y., Huppes, G., Udo de Haes, H. A., & Otoma, S. *Int. J. LCA*, 2000, **5**, 327.
52. Audlsey, E., Alber, S., Clift, R., Cowell, S., *et al.* *Harmonisation of Environmental Life Cycle Assessment for Agriculture*, Final Report. Concerted Action AIR3-CT94-2028, Silsoe, UK, 1997.
53. Haas, G., Wetterich, F., & Geier, U. *Int. J. LCA*, 2000, **5**, 345.
54. Cederberg, C. *Life Cycle Assessment of Milk Production—A Comparison of Conventional and Organic Farming*, SIK Report No. 643. The Swedish Institute for Food and Biotechnology (SIK), Gothenburg, Sweden, 1998.
55. Andersson, K., & Ohlsson, T. *Int. J. LCA*, 1999, **4**, 25.
56. Bell, G. M., Azapagic, A., Faraday, D. B. F., & Schulz, R. A. *Sustainable Practices for Potable Spirits Manufacturing: Traditional vs. Alternative Processes*, Presented at the AIChE Spring Meeting, Atlanta, 5–9 March 2000.
57. Baumann, H. *Int. J. LCA*, 1996, **1**, 122.
58. Berkhout, F. *Global Environmental Change Programme Briefings*, No. 14, June 1997. EPSRC Programme Office, Swindon, 1997.
59. Ernst & Young & SPRU. *Integrated Product Policy*, A Report for European Commission DGXI. <http://europa.eu.int/comm/environment/ipp/home.htm>, 1998.
60. EC. *Offic. J. Eur. Commun.*, 1994, **L 365**, 10.
61. HMSO. *Producer Responsibility Obligations (Packaging Waste) Regulations*. HMSO, London, 1997.
62. Schmidt, W.-P., & Beyer, H.-M. *Int. J. LCA*, 1999, **4**, 121.
63. EC. *Proposal for a Directive of the European Parliament and of the Council on Waste Electrical and Electronic Equipment*, COM (2000) 347 Final. EC, Brussels, 13 June 2000. <http://www.europa.eu.int/eur-lex/en/index.html>.
64. Wilson, B., & Jones, B. *The Phosphate Report: A Life Cycle Study to Evaluate the Environmental Impact of Phosphate and Zeolite A-PCA as Alternative Builders in UK Laundry Detergent Formulations*. Landbank Environmental Research and Consulting, London, 1994.
65. EC. *Offic. J. Eur. Commun.*, 1992, **L 99**, 1.
66. Clift, R. *J. Cleaner Prod.*, 1993, **1**, 155.
67. Udo de Haes, H. A., Clift, R., Griesshammer, L., & Jensen, A. A. *Practical Guidelines for Life Cycle Assessment for the EU Ecolabelling Programme*. Final Report of Third Phase. EU, Brussels, 1996.
68. Azapagic, A. *Life Cycle Assessment and Zero Emission: How to Focus the Problem?* Keynote Lecture, Workshop on Zero Emissions and Technological Assessment in a

- Global World. CETEM/IATAFI, Rio de Janeiro, 27–30 October 1997.
69. Coates, J. F. *Anticipating Environmental Effects of Technology*. A Primer and Workbook. UNEP Industry and Environment, Paris, November 1995.
70. EC. *Offic. J. Eur. Commun.*, 1996, **L 257**, 27.
71. Nicholas, M. J., Clift, R., Azapagic, A., Walker, F. C., & Porter, D. E. *Trans. Inst. Chem. Eng. Part B*, 2000, **78**, 193.
72. Yates, A. *LCA: Clean-up Technologies and Abatement of Gaseous Pollutant Emissions from Chemical Processing Plant*. EngD Portfolio, University of Surrey, 1998.
73. Bahu, R., Crittenden, B., & O'Hara, J. *Management of Process Industry Waste*. IChemE, Rugby, 1997.
74. Environment Agency. *Waste Minimisation: an Environmental Good Practice Guide for Industry*. The Environment Agency, Bristol, 1998.
75. Azapagic, A., & Clift, R. *Comput. Chem. Eng.*, 1999, **23**, 1509.

Chapter 6: Industrial Processes using Solid Acid Catalysts

MARK A. HARMER

1 Introduction

Catalysis lies at the very heart of waste minimisation. Indeed, one of the main goals of scientists working in the area is to produce products with 100% yield and 100% selectivity. By careful choice and design of catalysts, this eventually will allow us to manufacture chemicals with zero waste. As pointed out by Anastas *et al.* [1], catalysis has manifested its role as a fundamental tool in pollution prevention. The general topic of catalysis is intimately linked with the design, development and implementation of green chemistry. The term 'green chemistry' refers to the design of chemical products and processes that reduce or eliminate the use and generation of hazardous substances. In this chapter we draw attention to the growing role that solid acid catalysis is playing within this arena. At the outset we point out an often overlooked simple fact that reducing waste due to increased yield represents a huge economic driver. Improving the economics of a process while reducing waste often go hand in hand.

Throughout this chapter we will guide the reader to recent key publications that describe in detail some of the concepts that will be discussed. In the area of solid acid catalysis, for example, we are fortunate to have an excellent collection of review articles covering the many different kinds of solid acid catalysts. In total there are approximately 103 known industrial processes that use solid acid catalysts [2]. The kind of reactions practiced include alkylation, etherification, cracking, dehydration, condensation, hydration, oligomerisations, esterification, isomerisation and disproportionation. The types of catalysts used include zeolites, oxides, ion-exchange resins, phosphates, clays, complex oxides, heteropolyacids and sulfated zirconia. Anastas [3] has helped to design a set of principles (twelve in total) that help to define how we can reduce or eliminate the use or generation of hazardous substances in the design, manufacture and application of chemical products. It was shown that catalysis is

one of the primary tools for achieving all twelve of the principles of green chemistry. One good example of using substances that possess little or no toxicity to human health or the environment is in the manufacture of cumene. Traditionally, solid phosphoric acid or aluminium trichloride catalyse the benzene alkylation with propene. These catalysts are corrosive and are categorised as hazardous wastes. This process has been improved using the Mobil-Badger cumene process, where the catalyst used (a zeolite) is environmentally inert and gives high yields of product.

This chapter outlines the use of solid acid catalysts as an alternative to or as a replacement for homogeneous (liquid) acid catalysts such as hydrofluoric acid. There has been a strong interest in the use of solid acid catalysts as a replacement to homogeneous catalysts such as HF, AlCl₃ and H₂SO₄. Although these latter catalysts are very effective, they produce highly corrosive media with chemically reactive waste streams. Purification can be both difficult and hazardous. The major challenge in this area is in the development of cost-effective, highly active, selective and stable solid acid replacements. By contrast, the solid acid counterparts are easier to handle, purification is simpler and cheaper and the general operation of a large chemical process is safer. Some of the well-known industrial processes today use homogeneous acid catalysts and the preference would be to use a solid rather than a liquid. Two examples are in the synthesis of ibuprofen (more commonly used in the form of Advil™) and in the synthesis of high-'octane' fuels, which are based almost exclusively on the use of HF (and sulfuric acid for high-octane fuels). In the pharmaceuticals industry, aluminium chloride often is used as a stoichiometric reagent in a number of chemical transformations, such as acylation chemistry. For every pound of the desired product there can be several pounds of waste (from spent, stoichiometric reagent). Clearly, the ability to use a solid that is highly active, catalytic and yet safe to handle would

represent a major breakthrough in any one of the reactions described above.

Our aim is to introduce the reader to some of the accomplishments and challenges in the development and use of solid acid catalysts. The literature in this fascinating area is extensive and no attempt has been made to provide a comprehensive review of this topic. Our approach has been to provide brief overviews of some of the well-known research and development in the use of solid acid catalysts. We then describe some selected case studies of different reaction types or new development of materials, reactor design and engineering. We would like to point out also that there are a number of other approaches based upon acid catalysts that may offer similar advantages in terms of waste minimisation, high yield and ease of product separation. These would include the use of ionic liquids as catalysts and the use of supercritical solvents as an alternative reaction medium for enhancing the reactivity and conversion of reagents to products. In this chapter we will specifically describe the Mobil–Badger process for the product of cumene, the Kvaerner process using ion-exchange resins and novel reactor design in esterification reactions, the use of new fixed-bed alkylation technology to make high-octane fuels, the development of new Nafion[®]-based nanocomposite technology for a number of different applications and prospects for heteropolyacids and sulfated zirconias.

2 Concepts in Acidity and Solid Acid Catalysts

In this chapter we will use the Brønsted definition of an acid: ‘An acid is a species with a tendency to give up a proton’ [4]. The species that accepts the proton is the base. The concept of the Brønsted acid strength of a molecule AH in solution is very well understood. It is quantified in terms of the equilibrium constant for the proton transfer reaction (Equation 6.1):

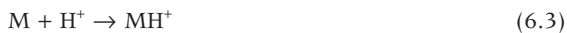


where B is a reference base. When B is H₂O and the equilibrium is measured in water, the resulting scale is the familiar pK_a scale. This is also true of the gas-phase proton affinity of molecules. The gas-phase measurement is essentially an unambiguous measure of acidity because it is solvent free. Acid

strengths of solutions of strong acids, where the equilibrium constant for Equation 6.1 lies far to the right, are typically measured using families of indicators of varying base strengths (e.g. the neutral bases known as Hammett indicators). In solution, quantitative scales of Brønsted acidity are based upon the determination of equilibrium constants for these kinds of reactions. The well-known Hammett acidity function for an acid is expressed as Equation 6.2:

$$H_0 = \text{p}K_a + \log[\text{B}]/[\text{BH}^+] \quad (6.2)$$

where the acid (AH) protonates the indicator base (B) to form the corresponding conjugated acid (HB⁺) and base (A⁻). In contrast the gas-phase proton affinity of a molecule M is defined as the negative of the enthalpy for the hypothetical reaction of Equation 6.3:



in isolation from its surroundings. In practice, experimental determination of proton affinities involves the measurement of proton transfer of equilibria between two gas-phase bases. The general concept of acidity in both solution [5] and the gas phase [6] has been described in detail in the literature and volumes exist that describe values for a range of compounds. A range of techniques have been employed, such as spectrophotometric methods, by using an appropriate series of colour indicators, the use of nuclear magnetic resonance methods, heats of protonation of weak bases, etc. A useful crossover point in terms of acid strength is based upon 100% sulfuric acid, which is known to have a Hammett acidity constant *H*₀ of −12. Thus, acids with acidity constants greater than −12, such as −14.1 for CF₃SO₃H, are often referred to as ‘superacids’. One of the strongest acids known is based upon the mixture of HSO₃F with SbF₅, where the acidity can range from about −14 to −26 (*H*₀).

In the case of solid acid catalysts, similar methods using Hammett acidity functions are possible but are often regarded with some scepticism. This is largely due to the fact that when in the solid state the chemistry is much more complicated than when in either a solution or gas phase. Scales of solution acid strengths are very solvent dependent. Every solid matrix may have a solvent-like role in determining proton transfer equilibrium constants, but the situation is even more complicated because the individ-

Table 6.1 Acid strength of various solid acids

Solid acid	H_o^a	$-\Delta H_{ads} (NH_3)(kJ\ mol^{-1})$
H ₃ PW ₁₂ O ₄₀	-13.16	195
C _{82.5} H _{10.5} PW ₁₂ O ₄₀	-13.16	—
SO ₄ ²⁻ /ZrO ₂	-14.52	165
H-ZSM-5	-12.70	150
SiO ₂ -Al ₂ O ₃	-12.70	145
Nafion®[5]	ca.-12	

ual molecular species involved in the proton exchange [1] cannot be represented by a single equilibrium structure as in 'homogeneous solution'. The local geometry near the acid site may play an important role. For example, one important concept in acidity relates to the stabilisation of the deprotonated acid site (the anion) within the solid-state matrix. A rich interplay of a large number of interrelated effects come into play. Tabulated values of solid acid strength, as shown in Table 6.1 [7], should be used as a broad indication of relative acidities, and the details of every catalytic reaction have to be studied on a case-by-case basis in order to include all of the potential influences upon reaction activity. Acid strength (assuming that it can be defined broadly) may play anything from a major role to a minor role in reaction activity.

As with the solution phase, many acid strength measurements of solids have been inferred from the use of colour indicators. For example, the base forms of *p*-nitrotoluene and 2,4-dinitrotoluene (with pKa values of -11.35 and -13.75) are colourless, compared with the acid forms that are yellow. A number of problems exist with these kinds of techniques, especially when the catalyst itself is coloured. The other possibility is that the colour or the bond arising from the acid form of the indicator may be produced also by surface sites that are not active for catalysis. To gain any confidence in an inference of acid strength, normally a number of different approaches must be utilised, each of which has its own series of advantages and pitfalls. These range from the use of calorimetry, the adsorption and temperature-programmed desorption (TPD) of base molecules (such as ammonia or pyridine on acid sites) and vibrational spectroscopic methods, including nuclear magnetic resonance.

Infrared (IR) spectroscopy is a very useful technique for looking directly at the hydroxyls present

on a solid acid catalyst. Attempts have been made to measure the surface concentration of different hydroxyl groups on the basis of the assignment of O-H stretching frequencies, albeit with limited success. In the case of H-Y zeolites, for example, two hydroxyl features are observed: at 3640 and 3540 cm⁻¹. In both cases the different hydroxyl frequencies represent Al-(OH)-Si groups in channels of different dimensions. The H-ZSM-5 zeolite contains at least three different types of hydroxyls. The acidic (Al-(OH)-Si) hydroxyl is observed at 3605 cm⁻¹. The complexity of measuring acid strength and correlating specific protons on a particular solid acid catalyst with activity has been described in detail by Fourier & Gorte [8]. A detailed analysis of the proton transfer characteristics of a number of zeolites is described. A good example of the use of foliner transform infrared spectroscopy (FTIR) for acidity studies in zeolites is given by Paze *et al.* [9]. Of course, the proton transfer chemistry in complex reaction environments often is determined from kinetic rather than thermodynamic control. The H/D exchange reactions on H-ZSM-5 revealed some of the complications that can occur in the use of IR with probe molecules to examine proton-donating sites. Deuteration of hydroxyls followed by toluene exchange was used as an indirect way to determine the relative concentrations of Al-(OH)-Si (3605 cm⁻¹) and Si(OH) (3500 cm⁻¹) sites. The IR observations are combined with TPD of the adsorbed toluene. Three types of hydroxyls were shown to be present. The bands at 3605 and 3500 cm⁻¹ are in roughly comparable amounts. It was possible to exchange all three types of H-ZSM-5 hydroxyls with toluene. From these results, however, the authors point out that it is not reasonable to conclude that these hydroxyl sites are each individually strong enough acids to have favourable equilibrium constants for proton transfer to toluene. No H/D exchange with toluene occurs on a zeolite containing O-D silanols that have been exposed to ammonia coverage of one molecule per Al. The general conclusion is that H/D exchange between toluene and silanol sites is indirect, occurring either by exchange with protonated toluene at Al-(OH)-Si sites at high adsorbate loadings or through hydrogen diffusion on the lattice. This also shows that the identified acid site that has been characterised may be an 'innocent' bystander in the actual catalysis. Information from a collection of techniques, catalytic studies, and microstructural

studies does, however, help to build up a picture of reactivity in these complex reaction systems.

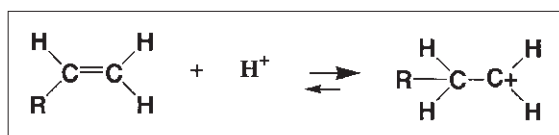
Sometimes, the most useful information on surface acidity can be obtained by studying the IR characteristic of adsorbed base molecules, such as pyridine. The Brønsted acid sites (pyridinium ions) appear at 1540 and 1640 cm^{-1} , and correlations of numbers of acid sites (as a function of certain desorption temperatures) and reaction activity have been made. An informative discussion of some of the issues in this approach is given by Kubelkova *et al.* [10].

Nuclear magnetic resonance (NMR) has been used extensively to study solid acid catalysts. Proton NMR is a useful technique for determining the number, strength and accessibility of acidic protons in zeolites. This has been reviewed recently by Pfeifer *et al.* [11]. In the case of acidic zeolites, a relationship between acid strength of different Brønsted acid sites and its chemical shifts has been reported. The acidic bridging OH site ^1H chemical shifts can be found in the range of 3.8–5.2 ppm (from trimethylsilyl) as compared to values for the non-acidic silanol (ca. 2 ppm) and OH at the non-framework Al (2.5–3.5 ppm). It is possible to measure the influence of zeolite treatments on the final concentrations of all OH groups, including the acidic bridged hydroxyls. A good correlation between acidity and catalytic activity of solid acid catalysts has been described. Hunger *et al.* have argued that the chemical shifts of bridging hydroxyls in zeolites increase with Si/Al ratio to a value of about 10 [12]. Higher Si/Al ratios produce no additional chemical shift. It was suggested that all zeolites with Si/Al ratios greater than 10 have comparable proton affinities. This conclusion is implied also by calorimetric studies.

Nuclear magnetic resonance has been useful also to investigate and follow the structures and transformations of adsorbed species. One of the goals has been to identify reaction intermediates. Biaglow *et al.* [13] have reported the ^{13}C spectra of acetone, bound at a stoichiometry of one per Brønsted site, for a range of zeolites. The results shown in Table 6.2 [13] illustrate distinguishable isotropic chemical shifts for a variety of acidic zeolites. These range from 10.1 ppm for SAPO-5 to 18.7 ppm for H-ZSM-22. These differences result from local structural differences of the hydrogen-bound complexes that are related to acidity. Line width measurements also have been used as a measure of the molecular

Table 6.2 Chemical shift tensor of the C-2 carbon of chemisorbed acetone relative to the neat solid

Sample	Chemical shift at 125 K (ppm)	Peak width at 295 K (ppm)	Zeolite channel size (Å)
H-ZSM-22	18.7	230	5.4
H-ZSM-5A	16.9	200	5.6
H-ZSM-5B	16.8	200	5.6
H-ZSM-12	16.7	103	6.2
H-Mordenite	15.1	103	7.8
SAPO-5	10.1	84	7.3
HY zeolite	12.9	44	13.4



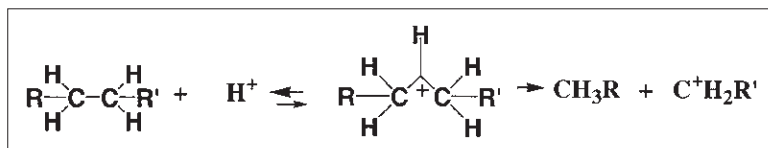
Scheme 6.1

motion at the site. These kinds of measurements allow one to understand both site proton affinity and the interaction energies from the adsorbate/zeolite framework.

Other techniques are finding increasing use in the study of adsorbates on the acidic sites of acid catalysts. Fraissard *et al.* have described the use of ultraviolet (UV) laser photoexcitation of quinoline, an *N*-heteroaromatic base adsorbed on the surface of acidic Y-zeolite and Nafion[®] (an acidic ion-exchange material). This has been shown to be a very sensitive fluorescent probe for characterising interactions with the various acidic sites within these solid acid catalysts [14].

Reaction chemistry can be used also as a probe for acidity [15]. For example, the isomerisation of *n*-butane is generally regarded as a reaction that requires strong acidity, whereas olefin isomerisation reactions are generally considered to be catalysed by weak acids. The protonated intermediates involved in these kinds of reactions include carbenium ions. For olefins, these form quite readily with a range of solid acids. The general equilibrium is shown in Scheme 6.1: the role of the intermediate carbenium ion can be inferred readily from the reaction chemistry.

The isomerisation of *n*-butane is thought to go via a carbonium ion, which is unstable and reacts to give



Scheme 6.2

smaller paraffins (or hydrogen) and carbenium ions. These react with paraffins to give additional products (see Scheme 6.2).

The rate of *n*-butane isomerisation (e.g. sulfated zirconia has a value of $5 \times 10^{-9} \text{ mol s}^{-1} \text{ g}^{-1}$) then can act as a guide for relative acidity. The stronger acids such as sulfated zirconia or heteropolyacids are known to catalyse the isomerisation of *n*-butane, rather than a much 'weaker' acid such as an Amberlyst[®] ion-exchange resin (see below), which is essentially inactive for this reaction.

3 Industrial Applications of Solid Acid Catalysts

Tanabe & Hoelderich [2] recently have published a very useful survey of the industrial applications of both solid acid and solid base catalysis, and some of the salient points will be described here. Two complementary earlier reviews also deal with a number of commercial applications [16,17]. Of the 127 industrial processes practiced using these catalysts, 103 are based upon solid acid catalysts. It should be noted that this number does not reflect all of the processes using solid acid catalysts because at least a number of these are proprietary in nature. A number count for the different types of reactions and types of catalysts was described. These industrial processes include dehydration and condensation (18), isomerisation (15), alkylation (13), etherification (10), cracking (8), aromatisation (7), hydration (7), oligomerisation (6), hydrocracking (4), esterification (3) and disproportionation (2), with other processes making up the total to 127. The catalysts used include zeolites (74), oxides (54), ion-exchange resins (16), phosphates (16), clays (4) and a number of less-well-defined catalysts. Of all the catalysts specified, the number of ZSM-5 plus high-silica pentasil zeolites is the largest of the various zeolites.

For each of the reaction types listed, we have selected an example of a specific industrial reaction, a catalyst used and an example of the scale of manufacturing (Table 6.3). We point out, however, that

a number of alternative catalysts are used in some of these reactions in different manufacturing plants. Full details can be found in the literature [2].

3.1 Zeolite-based solid acid catalysts

Zeolites are crystalline materials with open framework structures. Approximately 200 million pounds of zeolites are used as catalysts. The primary building blocks of zeolites are $[\text{SiO}_4]^{4-}$ and $[\text{AlO}_4]^{5-}$ tetrahedra, which are linked by their corners to form channels and cages (or cavities) of discrete size. The pore opening can range from 3 to 20 Å. Owing to charge differences of the Al and Si tetrahedra, the total charge of an aluminium-containing zeolite (molecular sieve) is negative and hence is balanced by cations, protons, alkali or alkaline-earth metal ions. The beauty of these zeolite structures is the great diversity yet fine control of the structure. Zeolites offer various systems of channels and cavities, resulting in one-, two- or three-dimensional diffusion for included guest molecules. The aluminosilicate backbone of a zeolite can be represented in a number of ways, including the well-known sodalite cage structure shown in Fig. 6.1.

The sodalite cage structure (centre and left) is constructed of openings containing four- and six-membered rings of $[\text{SiO}_4]^{4-}$ and $[\text{AlO}_4]^{5-}$ tetrahedra. The faujasite structure (right) is constructed of sodalite cages connected through oxygen bridges containing six-rings and the largest pore opening is a 12-membered ring. The variety in structure types provides a range of pore dimensions consisting of ring openings containing 8-membered rings, the medium-pore zeolites with 10-membered ring openings and the large-pore materials with 12-membered ring openings. A very good discussion of zeolite structures is described in *Inclusion Chemistry with Zeolites: Nanoscale Materials by Design* [18]. Figure 6.2 shows the mordenite structure of HZSM-5. The sheer elegance of these types of materials and their ability to carry out shape-selective catalysis is self-evident. It is clear how the structure of the zeolite can direct

Table 6.3 Industrial Process based upon solid acid catalysts

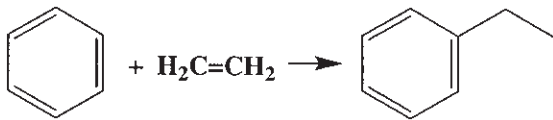
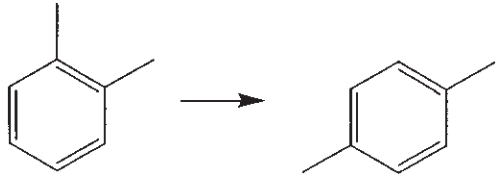
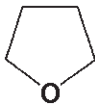
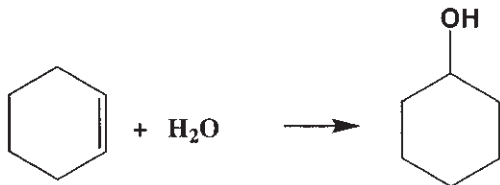

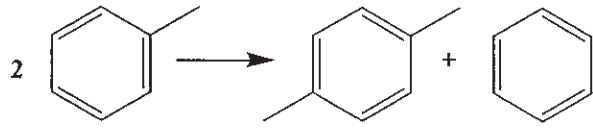
Industrial Process	Catalyst	Manufacturing scale
(1) Alkylation 	H-ZSM-5	1 billion lb year ⁻¹ Hoechst Ag
(2) <i>o</i> -Xylene isomerisation to paraxylene 	H-ZSM-5	120000 t year ⁻¹ Mobil
(3) Dehydration $\text{HOCH}_2(\text{CH}_2)_2\text{CH}_2\text{OH} \rightarrow$ 	Ion-exchange resin	20 000 t year ⁺
(4) Catalytic cracking: Heavy fractions Middle and light distillate	Calcined kaolin Ultrastable US-Y zeolite	50 000 bpd 40 000 bpd
(5) Etherification $i\text{-C}_4 + \text{MeOH} \rightarrow \text{MTBE}$	Ion-exchange resin	700000 t year ⁻¹ Sabric/Shell
(6) Hydrocracking process Lube dewaxing: Wax oils + H₂ → lower mol. wt.	ZSM-5	15 000 bpd
(7) Hydration 	Novel highly siliceous H-ZSM-5	80 000 t year ⁻¹

Table 6.3 Continued

Industrial Process	Catalyst	Manufacturing scale
(8) Esterification	Ion-exchange resin	20000t year ⁻¹
		
(9) Oligomerisation	H ₃ PO ₄ /SiO ₂	
$C_4 \rightarrow \text{linear octanes}$		
(10) Disproportionation	ZSM-5	>14000 bpd
		

bpd = barrels per day.

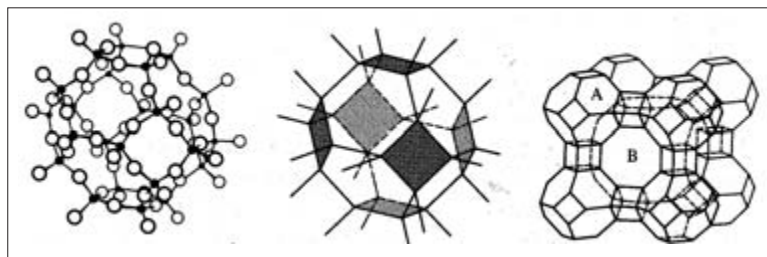


Fig. 6.1 Zeolite microstructures.

and dictate much of the chemistry it performs. In the following section we describe some of the reaction chemistries that have been carried out. As pointed out earlier, we have chosen to point out just a few of the reactions of interest and the reader is encouraged to read the more-detailed reviews cited.

Davis recently has provided a nice account of zeolite-based catalysts for chemical synthesis [19]. This builds upon an earlier review by Venuto [20]. As pointed out in Table 6.3, zeolites have been used extensively in the petrochemical industries (alkylation, isomerisation and cracking chemistry). Zeolite catalysis is expanding into the areas of speciality and fine chemicals synthesis. One target molecule that

was suggested by Davis was the synthesis of 6-acetyl-2-methoxynaphthalene from the acylation of methoxynaphthalene. The product is an intermediate for naproxen, a non-steroidal anti-inflammatory agent. With beta zeolites 1-acetyl-2-methoxynaphthalene is the main product, and a world market of \$971 for naproxen represents the 2,6-difunctionalisation of naphthalene via zeolite catalysis.

Davis points out some of the trends in zeolite catalysis for chemicals synthesis: increased emphasis on low temperatures, liquid-phase reactions, smaller scale processes and an increase in the variety of reaction chemistries. In the case of zeolite-based chemistry, there is a drive to use small-particle-size zeolites

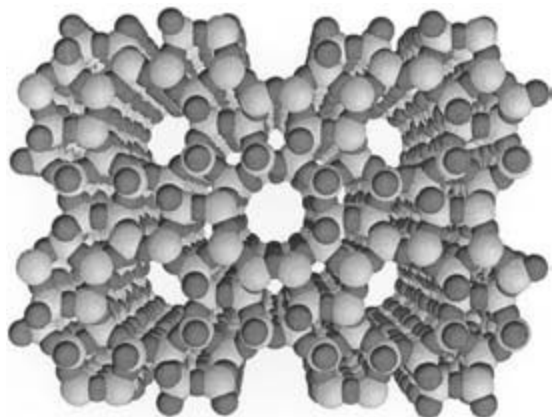


Fig. 6.2 Zeolite structure.

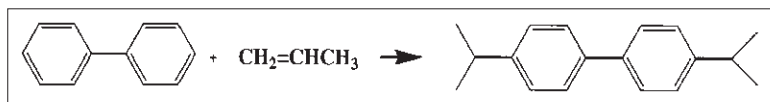
to achieve acceptable rates (overcoming diffusion problems). The use of colloidal-size nanocrystalline zeolites is expanding. Reactions that would be of particular interest would be acylation using acetic acid as the acylating agent, nitration with nitric acid and anti-Markovnikov additions. Rhodia has established the first industrial applications of zeolites for the acylation of anisole and veratrole [21]. The drive here is to replace stoichiometric agents such as aluminium trichloride, or more hazardous material such as HF. Activated aromatics (e.g. anisole) with acetic anhydride over zeolites have been demonstrated, although more developments are needed in the acylation with acetic acid or other non-activated reactants.

Botella *et al.* recently have described the acylation of toluene with acetic anhydride over beta zeolites [21]. At 150°C with an arene/anhydride molar ratio of 10–20, high yields of 4-methylacetophenone were obtained, with selectivity close to 100%. Catalyst decay was ascribed to adsorption of the product to acid sites, which subsequently undergo further reaction to strongly adsorbed products that block acid sites for further reactivity. The effects of Si/Al ratio, variations of the zeolite hydrophilic/hydrophobic character and particle size were investigated. Of these three variables it appears that the particle size had the most pronounced effect. The smaller particle size of the H-beta zeolite (ca. 0.05 μm compared with ca. 2 μm) showed the highest activity: ca. 83% conversion with 100% selectivity (compared with ca. 50% conversion). Although some effects of the

Si/Al ratio were noted, it appeared that these effects were minor in comparison. An improvement in activity and reduction in coking was ascribed to the ease of product removal from the smaller particle size zeolite, freeing up acid sites for further reactivity and physically clearing pore channels more readily to allow easier diffusion of reactants and products. Further optimisation is needed, however, in these kinds of systems due to deactivation. It was pointed out that both understanding these kinds of interactions and tailoring the zeolite catalyst are needed to prevent these kinds of deactivation pathways.

The use of zeolites for the synthesis of fine chemicals is discussed also by Hoelderich & Heinz; they describe the research and development of zeolite catalysis in the 1980s and 1990s [16]. The reactions described include olefin oligomerisation, dewaxing, alkylation of arenes, the *para*-directed isomerisation of xylenes and the disproportionation or alkylation of monosubstituted arenes. From an environmental standpoint they also describe some shortcomings of some of the present-day catalysts. The Beckmann rearrangement—cyclohexanone oxime rearranged to caprolactam (an important precursor to Nylon 6)—is carried out in sulfuric acid. Large amounts of ammonium sulfate are used due to neutralisation of the oleum (sulfuric acid) used in the oximation. The rearrangement is considered to be an environmentally unacceptable drawback. There are several studies on the rearrangement of the cyclohexanone oxime to caprolactam over zeolite catalysts. This new route has a number of advantages compared with the conventional method. It is energetically and economically favourable as well as environmentally friendly.

Corma & Garcia have reviewed the use of zeolites [22]. They have categorised zeolites as solid acid catalysts based upon reactions with low, medium and high acid strength requirements. The vapour-phase Beckman rearrangement to caprolactam was described using high-silica ZSM-5. The best catalyst for the process was a solid containing indium in the framework, which corresponds to the lowest acid strength. Acetal formation and hydrolysis was described as a reaction that requires medium-strength acid sites. The formation of acetals by the reaction of carbonyl groups and alcohols or diols has been catalysed by acid zeolites. It was suggested also that the skeletal isomerisation of *n*-alkanes occurs at the bridging Si—(OH)—Al acid sites having one Al in

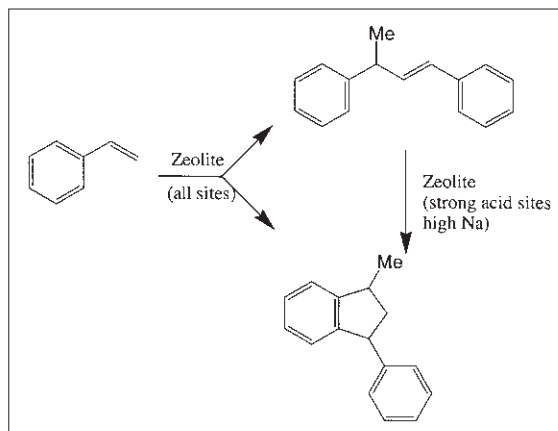


Scheme 6.3

the next coordination shell of Si. Infrared spectroscopy showed that these sites are not the strongest acid sites within the mordenite.

The diisopropylation of biphenyl and naphthalene over large-pore zeolites is a good example of microstructural control to optimise selectivity and yield (see Scheme 6.3). The propylation of naphthalene over amorphous catalysts such as silica–alumina produces equal amounts of the 2,6 and 2,7 isomers plus small amounts of the other dialkyl isomers [23]. The alkylation of biphenyl with propene to produce 4,4'-diisopropylbiphenyl has been investigated using Y-faujasite, beta-offretite, mordenite, ZSM-8 and ZSM-5 as catalysts. Mordenite was found to be the most active and selective to 4,4'-diisopropylbiphenyl. The selectivity decreases with conversion due to isomerisation of 4,4'-diisopropylbiphenyl to the more thermodynamically stable 3,4'-diisopropylbiphenyl isomer. It was found that a partially exchanged mordenite (with an optimum value of 55% of the sodium ions exchanged for protons) gave the highest conversion. This partially exchanged mordenite suppresses subsequent isomerisation of the primary product and at the same time exhibits a complete propene selectivity toward alkylation. If more acidic mordenite is used (higher Na⁺ to H⁺ exchange), other undesired processes such as propene oligomerisation and product isomerisation are favoured. Controlling the correct balance of acidity is used to optimise the reaction. Delamination of mordenites also was found to reduce coke formation by lowering the acid site density. It also produces a pseudo-three-dimensional pore system by the formation of macropores that make the catalysts less sensitive to deactivation by coke.

The sodium content within a series of HNaY zeolites (with different amounts of sodium) was varied and the phenol alkylation with methanol was studied. As in the case above, the product distribution is highly sensitive to the number and strength of acid sites. The anisole/cresol ratio varied from about 3 to 13 as the sodium was varied from <0.01% to 0.8%. Lower acid strength materials gave the best yields of anisole.



Scheme 6.4

As we describe below (formation of cumene and ethylbenzene), zeolites are effective commercial catalysts for a range of electrophilic aromatic alkylations using a variety of reactants such as olefins, alcohols and halogenated hydrocarbons. In the case of olefins, the reaction is believed to proceed via protonation of the olefin to generate a carbenium ion, which then undergoes electrophilic substitution on the ring. In the case of ethylbenzene an overall yield of 99% is obtained [24]. Another good example of the dependence of product distribution on acid strength is given by the dimerisation of styrene ring acid zeolites (see Scheme 6.4). The primary product, 1,3-diphenylbutene, can be isomerised further to the ring-closed dimer of 1-methyl-3-phenylindane. This reaction requires stronger acid sites [22]. Zeolite catalysts with a lower level of exchanged sodium (50% of Na to H exchanged in HNaY) yield the linear dimer and indanic dimer at 36 and 33%, respectively. This contrasts to values of about 20% and 65%, respectively, with a higher sodium exchanged (higher acid strength sites) zeolite. The ability to fine-tune product distribution based upon acid strength is clearly a powerful tool that zeolite-based systems offer.

A kinetic study of benzene isopropylation with isopropyl alcohol on alumino- and ferrisilicate has shown that the rate of the overall reaction is controlled by the desorption rate of cumene. The activity does not follow the acidity of the catalysts. This is a good illustration that acidity alone does not always determine reactivity, so any correlations need to take into account a wide range of factors. It was observed that MFI ferrisilicates possessing low-strength acid sites are the most convenient catalysts for achieving *para*-selectivity in the alkylation.

Corma *et al.* [22] are careful to point out that factors other than acid strength may play a large role in both the activity and selectivity of solid acid catalysts. Zeolites exhibit better selectivities than the commercially used Amberlyst®-15 resin for the gas-phase methylation of isobutene with methanol. This was rationalised in terms of the differences in adsorption characteristics of the two reactants. High amounts of methanol relative to isobutene were adsorbed on the zeolites compared with the ion-exchange catalysts. This preferred adsorption of methanol in zeolites suppresses the formation of by-products arising from isobutene adsorption on acid sites, such as dimerisation and oligomerisation.

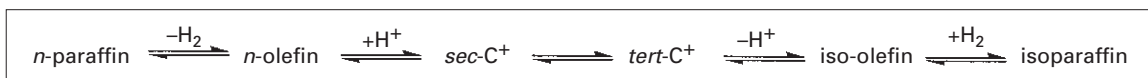
An interesting contrast for the zeolites H-mordenite and H-ZSM-5 is observed in propene hydration where the rate was measured as a function of concentration of acid sites. Mordeinite shows a linear dependence (higher rate with higher number of acid sites), whereas H-ZSM-5 peaks at about 0.4 (meq protons/gram) and then drops off dramatically. In the case of H-ZSM-5, the rate of hydration is influenced by intracrystalline diffusion and by the strength of reactant adsorption. Careful optimisation of acidity, pore structure and adsorption/desorption is always needed to tailor these catalysts for specific reaction chemistries. Large-scale production of isopropanol by catalytic propene hydration over a modified beta zeolite has been demonstrated. Zeolites also are effective catalysts for both the dehydration of alcohols to olefins (the reverse of the hydration reaction above) and the formation of ethers due to intermolecular reaction.

It is clear from the above examples that zeolites play a dominant role in the use and application of solid acid catalysts. One potential limitation of zeolites is the size limitation of the pore structure (typically 12 Å). Corma *et al.* [22] provided a very nice

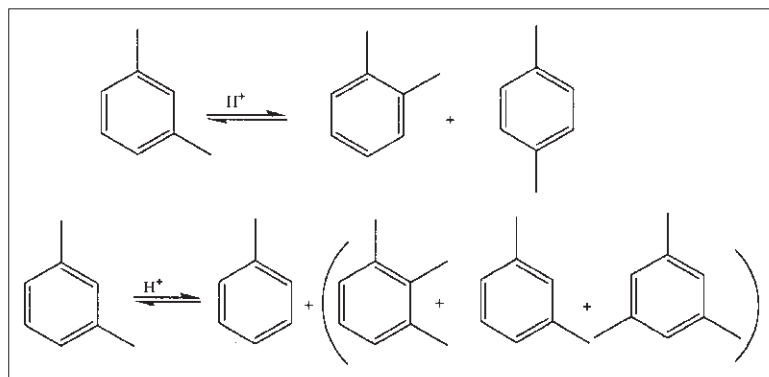
example of the use of one of the so-called MCM-41 zeolitic-type materials. These materials have larger uniform pores that lie in the range 10–100 Å. These materials were developed originally by scientists at Mobil. The general acid strength of these is speculated to be lower than some of the zeolitic-type materials. The advantage of larger pore size compared with beta zeolites was demonstrated via a series of acetalisation reactions. The acetalisation of aldehydes using different molecular sized alcohols was studied: heptanol, phenylheptanol and diphenylheptanol. Although the conversion of the smaller molecular sized heptanol/aldehyde (ca. 95%) was comparable for the zeolite and MCM-41, using diphenylacetaldehyde gave only 8% conversion over beta zeolite compared with 80% conversion over the MCM-41 material.

The second implication of the larger MCM-41 material is that these materials should deactivate at a slower rate than the smaller pore zeolites (such as HY zeolite), where plugging occurs in the smaller pore structures. It should be noted, however, that many of the larger pore MCM-41 materials will not have the stereospecificity that a small-pore zeolite imposes and thus one may expect poorer selectivity than the more traditional zeolites. A second [25] example for the catalytic application of mesoporous materials is in the use of MCM-41 aluminosilicate for alkylation of the bulky 2,4-di-*tert*-butylphenol with cinnamyl alcohol. It was shown that although this alkylation does not occur in the restricted environment of an HY zeolite (pore size 7.4 Å), the primary alkylation product 6,8-di-*tert*-2-phenyl-2,3-phenyl-2,3-dihydro[4H]benzopyran is formed with MCM-41.

A nice example of the control of molecular selectivity is shown in the use of the zeolite ferrierite (FER is a one-dimensional pore structure with a 10-membered pore ring opening) [26]. Isobutene is used in the formation of MTBE (methyl-*tert*-butyl ether) as an oxygenate octane booster in gasoline, although, as pointed out later, the use of MTBE is being restricted due to the potential effects of groundwater contamination. These medium-pore zeolites are highly selective for the olefin skeletal isomerisation reaction. A mechanism has been proposed in which the highly branched C8 olefins are trapped within the zeolite pores as a result of geometric constraints and are selectively cracked to yield isobutene. A more detailed account of the isomeri-



Scheme 6.5



Scheme 6.6

sation of olefins using zeolites has been described by Corma [24,27–29].

In the skeletal isomerisation of alkanes, the conversion and selectivity are strongly increased when Pt or Pd is incorporated into the acidic zeolite and the reaction is carried out in the presence of hydrogen. The reaction sequence is as shown in Scheme 6.5, where the proposed mechanism involves the formation of an intermediate olefin that is produced by dehydrogenation of the alkane on the metallic site. The olefin then is protonated to form a carbenium-ion-like transition state, which can isomerise. It has been proposed also that the reaction pathway may go via a penta-coordinated carbonium ion rather than a true carbonium ion.

Very strong acid sites (such as mordenite) are required to isomerise short-chain alkanes such as C₄–C₅, because the reaction goes through primary carbenium ions. With mordenite the maximum strength is produced by modifying the framework Si/Al ratios of ca. 10, with essentially isolated Al atoms. With long-chain *n*-paraffins, milder acidities and larger pores are desired in order to minimise cracking of the branched products formed. Bifunctional catalysts based upon faujasite, ZSM-5 and phosphate-based zeolites (SAPO-5) show good selectivities for branching isomerisation of long-chain paraffins.

One of the best examples to illustrate the role played by shape selectivity is shown by the

isomerisation–transalkylation of alkyl aromatics. The *p/o* selectivity for ZSM-5 is about 2.9 compared with a value of about unity for mordenite. The preferable isomerisation reaction of *m*-xylene to the disproportionation reaction for ZSM-5 is ca. 33 compared with a ratio of ca. 1–2 for mordenite. The isomerisation of alkylaromatics is always accompanied by competitive transalkylation reactions (see Scheme 6.6).

In the case of *m*-xylene, the most important product commercially is the *para* compound, a precursor to terephthalic acid. The thermodynamic equilibrium ratio at room temperature is 24, 60 and 16 for the *p*-, *m*- and *o*-isomers, respectively. When using large-pore zeolites, transalkylation occurs via a bimolecular mechanism of the intermediates to form unwanted transalkylation products. The transalkylation reaction can be reduced by using zeolites with smaller pore size, which favours the unimolecular internal isomerisation. Thus, with mordenite (the size of the window in the intracrystalline cavity being ca. 6.8 Å, the transalkylation reaction is much more prominent than ZSM-5 (ca. 5.7 Å cavity size). The conversion to the preferred *p*-isomer (*p*-xylene) is also enhanced relative to the *o*-isomer, due to the higher diffusion coefficient of the *p*-isomer compared with the *o*-isomer within the ZSM-5 zeolite (two orders of magnitude for the *p*-isomer). This difference allows the *p*-xylene to escape more readily than the *o*-isomer outside the zeolite crystalline cage. With a slower diffusion time for the *o*-

isomer, sufficient time occurs to isomerise within the framework to the *p*-isomer. This is a good example of controlling and reducing bimolecular reactions and optimizing selectivity based upon size constraint effects.

The high selectivity imparted within a zeolite structure is exemplified by the catalysed nitration of mono-substituted benzenes using stoichiometric amounts of acetic anhydride in the presence of the H-beta zeolite. The conventional catalysts in nitrations employ sulfuric acid as a catalyst. The *para* selectivity is greater than 99% with a phenyl substituent on the benzene ring, as compared with about 82% for ethylbenzene.

Zeolites are well known as excellent catalytic cracking catalysts in the oil refining industry. Gas-oil cracking is the basis for the production of at least 30% of the gasoline, olefins and isoparaffins in the petrochemical industry. The reaction mechanism appears to go via carbenium- and carbonium-ion-like intermediates (see Scheme 6.7), as described by Corma [24].

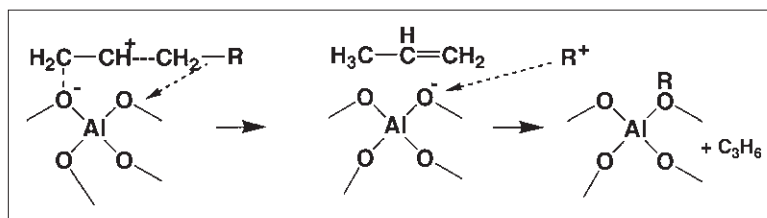
It has been proposed that one way to stabilise the carbenium ion pair (to the zeolite) is through a beta scission process, which produces an olefin in the gas phase and a new alkoxy group that remains adsorbed. Olah *et al.* suggested that the transition state appears as a two-point interaction of ethane with the OH and a neighbouring oxygen [5]. The reaction coordinate of protolytic cracking represents concerted stretching of the O–H bond and the bridging hydroxyl group, combined with heterolytic splitting of the carbon–carbon bond in the protonated ethane molecule. A free alkane is formed, along with the formation of an alkoxy group on the neighbouring basic oxygen of the former acid site.

In the case of *n*-alkanes, protolytic cracking occurs. When the shorter carbenium ion is on the surface, cracking may occur via two routes: protolytic crack-

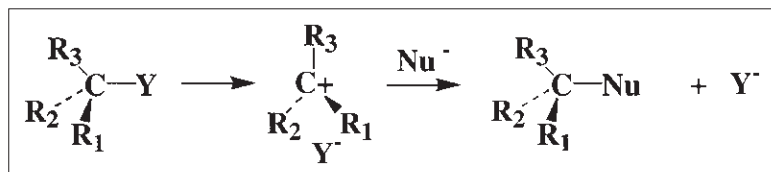
ing if the carbenium ion desorbs and regenerates the original Brønsted site; and β -scission if hydride transfer from a reactant molecule to the adsorbed carbenium ion occurs. Reaction pathways and yields are very dependent upon zeolite chemical composition and geometry. A high Si/Al framework ratio, while reducing coke, increases cracking. The ZSM-5 catalyst exhibits selective cracking of molecules in the gasoline range, which produces an increase in the gasoline research octane number (RON) and also an increase in the production of propylene. Using beta or MCM—22 increases RON and shifts the C4 and C5 products to the more desirable isobutylene and isoamylene products. In summary, zeolites have played a prolific role in the control and optimisation of gasoline products. The relative rate of cracking of linear and branched alkanes depends upon and can be controlled by the geometrical constraints within the zeolite feedstocks, which ultimately help to optimise fuel use and energy consumption.

One very important reaction in which zeolites are not very effective is in the alkylation of isobutane and butene. The product, trimethylpentane, is a key ingredient in high-octane fuels. The drive here is to replace sulfuric acid and HF with solid acid catalysts that are clearly safer to handle. Although zeolites show very high initial activity, these catalysts deactivate very rapidly and no suitable zeolite catalyst has been identified at this point.

Zeolites are well known for the effective oligomerisation of olefins. Olefin oligomerisation and aromatisation of C2–C10 olefins are the basis of Mobil's olefin to gasoline distillation process. Reaction products range from iso-olefins, which can be hydrogenated to form premium-quality low-point jet fuel and distillate fuel, to aromatics using higher reaction temperatures. Again, the desired products can be controlled carefully by temperature, zeolite composition (Si/Al ratio), texture (crystal size) and catalyst conformation, as shown for ZSM-5.



Scheme 6.7



Scheme 6.8

Zeolites have been found also to catalyse effectively a number of esterification reactions, such as the esterification of carboxylic acids with alcohols. Composite hydrophilic membranes of KA, NaA, CaA and NaX zeolites and polyvinyl alcohol were found to be convenient heterogeneous catalysts for the esterification of acetic acid with ethanol because they combine the presence of active sites with the selective pervaporation–transport of alcohol–water mixtures. In general, however, ion-exchange resins are very active and are the preferred catalysts for esterification reactions.

In addition to the above-cited references we strongly recommend the earlier reviews by Venuto [20] and Hoelderich & Van Bekkum [30]. Venuto cites nearly 600 references and breaks down reaction types in some 25 tables, classified in many cases via reaction mechanism such as nucleophilic substitution (SN type) at an aliphatic carbon. The SN1 process is a two-step ionisation process via a carbocation intermediate as shown in Scheme 6.8. The reaction pathway is dependent upon the nucleophile (Nu), the leaving group (Y) and the substituents (R₁, R₂ and R₃) on the saturated carbon under attack. This review [20] also has collated a number of potential reaction intermediates, such as the intermediates present in the formation of ethers (a pathway for carbocation reactions with olefins that can react via a variety of pathways) and intermediates in isomerisation–transalkylation chemistry and simple addition to olefinic double bonds. The effects of electronic, steric, strain and neighbouring group effects, solvent and surrounding matrix all strongly affect the reaction pathway and efficacy. As Venuto points out, one of the main features of a zeolite is that reactions that occur within 4–8 Å zeolite micropores—a size range closely mapping that of simple organic molecules—constrain the size of the reactants that can enter, the transition states and intermediates that can be formed and the size and shape of products that can exist, as expected. Although this rich interplay of structure–property processing

correlations is formidable, these are the exact tools of the zeolitic chemist that have allowed tailoring of these materials to optimise a range of industrially important reactions.

3.2 Heteropolyacid-based solid acid catalysts

Heteropolyacids are well-known, highly active acid catalysts and the use of these interesting materials has been described in detail in a number of excellent reviews [31]. These acids often have been described as superacids. The bulk of these catalysts are based mainly upon homogeneous catalysts; there are relatively few examples of true heterogeneous catalysts. One of the inherent drawbacks of many heteropolyacids is the solubility of these materials in polar solvents such as water and ethanol. One of the most interesting materials within this class is the heteropolyacid Cs_{2.5}H_{0.5}PW₁₂O₄₀, which is the most insoluble of the known heteropolyacids.

Heteropolyacids having the Keggin structure are composed of a central tetrahedron (XO₄, X = P, Si, Ge, etc.) surrounded by 12 MO₆ octahedra (M = W, Mo or V) arranged in four groups of three edge-sharing M₃O₁₃. The structure of such a heteropolyacid is shown in Fig. 6.3.

Heteropolyacids (HPAs) are used in a number of industrial applications: the gas-phase ester synthesis of ethyl acetate at BP; hydration of *n*-butane and isobutylene; and the synthesis of acetic acid from ethylene. These catalysts are particularly attractive due to the high inherent acid strength; the Hammett indicator test suggests that H₃PW₁₂O₄₀ possesses superacidity. Drago *et al.* [32] determined the following acid strength scale by calorimetric titrations: H₃PW₁₂O₄₀ > CF₃SO₃H > H₂SO₄ > ClC₆H₄COOH. The tungsten derivative is the strongest of all of the HPAs and has a higher acidity than H₃MoW₁₂O₄₀.

Okuhara *et al.* [33] have written an excellent paper on the microstructure of caesium hydrogen salts of 12-tungstophosphoric acids and have compared these to H₃PW₁₂O₄₀. These caesium salts are essen-

tially insoluble and are probably the leading candidates for potentially useful true solid HPA catalysts. The $\text{Cs}_{2.5}\text{H}_{0.5}\text{PW}_{12}\text{O}_{40}$ catalyst is formed via the addition of Cs_2CO_3 to aqueous solutions of $\text{H}_3\text{PW}_{12}\text{O}_{40}$. Using this approach, ultrafine crystallites in the acid form ($\text{H}_3\text{PW}_{12}\text{O}_{40}$) are deposited epitaxially on the surface of $\text{Cs}_3\text{PW}_{12}\text{O}_{40}$ crystallites. Upon gentle heating, H^+ and Cs^+ migrate in the solid state from a nearly uniform solid solution in which the protons distribute randomly throughout the entire bulk, the final composition is $\text{Cs}_{2.5}\text{H}_{0.5}\text{PW}_{12}\text{O}_{40}$ (when the Cs/H ratio is set to 2.5–0.5). This was confirmed using x-ray diffraction (XRD) and ^{31}P -NMR. The $\text{Cs}_{2.5}\text{H}_{0.5}\text{PW}_{12}\text{O}_{40}$ catalyst has mesopores as well as micropores, which are interparticle voids of the crystallites. The high catalytic activity of $\text{Cs}_{2.5}\text{H}_{0.5}\text{PW}_{12}\text{O}_{40}$ reported for solid–liquid reaction systems is attributed to the strength and number of accessible acid sites and the mesoporous structure that allows rapid transport of reactants and products within the HPA.

As synthesised, the surface area (m^2g^{-1}) and crystallite size (\AA) within the agglomerated powders of



Fig. 6.3 Heteropolyacid.

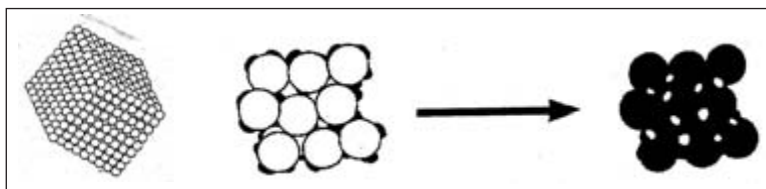
$\text{H}_3\text{PW}_{12}\text{O}_{40}$ and $\text{Cs}_{2.5}\text{H}_{0.5}\text{PW}_{12}\text{O}_{40}$ are 5 and 135, and 2264 and 69, respectively. Thus, the Cs salts are comprised of aggregates of extremely small crystallites linked together, which in turn build in mesoporosity and microporosity (hence the much higher surface area). Some of the highest surface areas are obtained at a Cs/H ratio of 2.5–0.5. The small crystallite size of the $\text{Cs}_{2.5}\text{H}_{0.5}\text{PW}_{12}\text{O}_{40}$ catalyst was confirmed also using scanning electron microscopy. This was in stark contrast to $\text{H}_3\text{PW}_{12}\text{O}_{40}$, which under the resolution observed had a smooth non-porous appearance. Under these conditions, most of the HPA is crystallised from an aqueous solution, which reflects the lower solubility of the $\text{Cs}_{2.5}$ species (Fig. 6.4).

The high catalytic activity of the solid acid catalyst $\text{Cs}_{2.5}\text{H}_{0.5}\text{PW}_{12}\text{O}_{40}$ arises in part by the ease of access to the acid sites within the microstructure. The role of the Cs is to help develop a microstructure that, due to its nucleation and growth, has a large amount of porosity within the particulates. These acid sites are highly acidic and catalyse a range of reactions. In contrast, $\text{H}_3\text{PW}_{12}\text{O}_{40}$, which is also extremely acidic, actually has a higher number of acid sites but only a small proportion of these are available for reactivity. A clear challenge would be to develop a very high surface area form of $\text{H}_3\text{PW}_{12}\text{O}_{40}$. One prerequisite for at least some reactions has to be the need for insolubility, creating a truly active solid acid catalyst.

The high activity of $\text{Cs}_{2.5}\text{H}_{0.5}\text{PW}_{12}\text{O}_{40}$ has been realised in a number of reactions. The heteropolyacid was more active by two orders of magnitude than aluminosilicate, sulfated zirconia, H-ZSM-5 and sulfuric acid for the decomposition of cyclohexyl acetate and the alkylation of 1,3,5-trimethyl benzene.

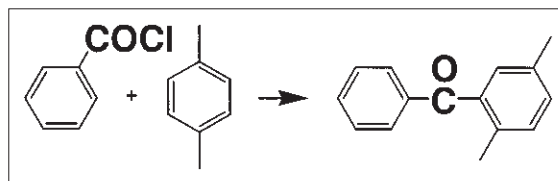
Supported HPA has been an active area of interest as a means of increasing the surface area, e.g. $\text{H}_3\text{PW}_{12}\text{O}_{40}$ [34]. In general, at low loadings HPAs strongly interact with the supports, reducing some of the catalytic properties, whereas the bulk properties prevail at higher loadings. The most frequently used

Fig. 6.4 Formation of 'porous' heteropolyacids: initial cubic crystallite of C3 (left) and conversion of adsorbed $\text{H}_3\text{PW}_{12}\text{O}_{40}$ to the solid of $\text{Cs}_{2.5}\text{H}_{0.5}\text{PW}_{12}\text{O}_{40}$ (right).



support is silica, but supports also include the mesoporous pure silica molecular sieve MCM-41 and in some cases carbon. In all of these approaches the potential for leaching exists and careful consideration has to be given to catalyst solubility in the catalytic reaction of interest. Mizuno *et al.* [31] have described the use of insoluble solid acid catalysts for liquid-phase reactions using both supported and non-supported HPAs. The $\text{Cs}_{2.5}\text{H}_{0.5}\text{PW}_{12}\text{O}_{40}$ catalysed the alkylation of isobutane with butenes, and the catalytic activity was higher than that of $\text{H}_3\text{PW}_{12}\text{O}_{40}$ and aluminosilicates. The usual problem of catalyst deactivation was observed for this reaction. The $(\text{NH}_4)_2\text{HPW}_{12}\text{O}_{40}$ HPA was an efficient catalyst for the liquid-phase Friedel–Crafts alkylation (benzylation) of benzene and the acylation of *p*-xylene with benzoic anhydride or benzoyl chloride. In the case of $(\text{NH}_4)_2\text{HPW}_{12}\text{O}_{40}$, however, the catalyst partially dissolved during the reaction and also began to lose activity. In contrast, no deterioration was observed for the benzoylation of *p*-xylene with benzoic anhydride catalysed by the same HPA. It was noted that these types of acids (HPAs) were more active than Nafion[®] and some modified clays. The $\text{Cs}_{2.5}\text{H}_{0.5}\text{PW}_{12}\text{O}_{40}$ HPA was extremely active for the hydrolysis of 2-methylphenyl acetate in excess water compared with H-ZSM-5 and sulfated zirconia (which was almost inactive). The HPAs were found to be active catalysts in the liquid-phase esterification of 2,6-pyridinedicarboxylic acid with *n*-butanol, although again it was pointed out that some dissolution of the HPAs may be occurring. Some Pt-promoted $\text{Cs}_{2.1}\text{H}_{0.9}\text{PW}_{12}\text{O}_{40}$ catalysts also have been shown recently to be very effective catalysts in the demanding reaction of skeletal isomerisation of *n*-butane [7].

Okuhara & Nakato [7] have described a number of catalytic reactions based upon mesoporous heteropoly compounds. The $\text{Cs}_{2.5}\text{H}_{0.5}\text{PW}_{12}\text{O}_{40}$ HPA catalysed the isomerisation of *n*-butane at 573 K with smaller deactivation, and the rate of isobutane formation and the selectivity were much higher than those of sulfated zirconia. The $\text{Cs}_{2.5}\text{H}_{0.5}\text{PW}_{12}\text{O}_{40}$ HPA also was an efficient insoluble catalyst in the esterification of acetic acid with ethanol, although Amberlyst[®]-15 was found to be a superior catalyst. These kinds of esterification reactions do not, in general, need very high acid strength. The Friedel–Crafts acylation over $\text{Cs}_{2.5}\text{H}_{0.5}\text{PW}_{12}\text{O}_{40}$ and $\text{H}_3\text{PW}_{12}\text{O}_{40}$ was studied using a range of acylating



Scheme 6.9

agents and aromatic compounds, such as *p*-xylene. It was reported that anisole and *p*-xylene are acylated with benzoic anhydride and acetic anhydride by the Cs salt without dissolution of the catalyst (see Scheme 6.9).

Typical conversions of the partial salt and the acid were 57% and 3%, respectively. The HPAs were not very active for the more demanding reaction of benzene with acetic acid. It is clear that HPAs, especially based upon insoluble Cs salts, may be attractive acylation catalysts for applications in fine chemicals.

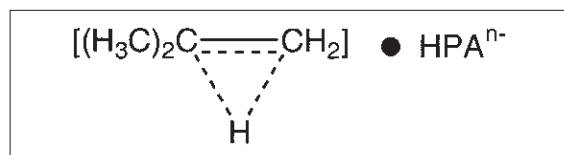
Izumi *et al.* [35] attempted to immobilise heteropoly compounds within a silica matrix and used these to study some water-based hydrolysis reactions. The $\text{Cs}_{2.5}\text{H}_{0.5}\text{PW}_{12}\text{O}_{40}$ HPA was active for the hydrolysis of ethyl acetate and retained its catalytic activity after a hydrothermal treatment at 393 K. These salts, however, form colloidal suspension after the reaction in the presence of a large excess of water, and recovery of the catalyst is difficult. In the case of the silica-immobilised catalyst, the catalyst exhibited activities for hydrolysis of ethyl acetate as high as that of unsupported $\text{Cs}_{2.5}\text{H}_{0.5}\text{PW}_{12}\text{O}_{40}$, and the catalyst used was recovered successfully from the solution by filtration. Okuhara also points out the potential use of meso- and microporous HPAs as shape-selective catalysts (namely product shape selectivity) for *n*-butane skeletal isomerisations. The HPAs are very active also in the formation of MTBE, with a selectivity of 95% [36,37], particularly a dimeric form of the Keggin ion known as Dawson type ($\text{H}_6\text{P}_2\text{W}_{18}\text{O}_{62}$). Other reactions include isopropanol dehydration, the dehydration of diols, the oligomerisation of propene and the etherification of phenethyl alcohol with alkanols [38]. In the case of MTBE, the gas-phase synthesis of MTBE over HPAs has been described using unsupported and supported catalysts [39,40]. The superior activity of dodecaphosphoric acid supported on K-10 clay in

comparison with K-10, pillared clays, sulfated zirconia, Amberlyst-15 and H-ZSM-5 in the single-pot synthesis of MTBE from *t*-butanol and methanol has been established by Yadav & Bokade [38].

The high activity of the HPAs (e.g. in the hydration of isobutylene) is in part due to the high acidity of the proton but also due to the stabilising effects of the anion and HPA upon the reaction intermediates. This has been described in an extensive review [41] for isobutylene hydration. The proposed reaction mechanism involves an intermediate formed from the protonated isobutylene and a heteropolyanion as shown in Scheme 6.10. The existence of a significant interaction between the heteropolyanion and the carbenium ion is supported by the presence of alkyl-heteropoly complexes.

Farneth *et al.* [42] reported the formation of methyl groups and ethyl groups attached directly to the heteropolyanion (methoxy and ethoxy, respectively). A methoxy group that occupies a bridging site in the HPA lattice is shown to be a key intermediate in the dehydration mechanism $\text{CH}_3^+ \cdots \text{O}_{\text{ku}}$. The structure of the methoxy intermediate is confirmed by spectral comparison with an identical, methylated Keggin anion salt of known structure $[(n\text{-C}_6\text{H}_{13})_4\text{N}]_2\text{OCH}_3\text{PMO}_{12}\text{O}_{39}$.

The review by Okuhara *et al.* [41] gives an excellent account of a wide range of heterogeneous HPA-catalysed reactions, including dehydration,



Scheme 6.10

hydration, conversion of methanol into hydrocarbons, esterification, ester decomposition, alkylation, dealkylation, acylation, skeletal isomerisation and a number of other reactions including dehydrogenation of monomethylamine and the formation of methylamine from ammonia and methanol. The general industrial utility of these kinds of catalysts is reflected in the recent patent literature [43]. Some of the reactions described include the isomerisation of nonenes using supported HPAs with better feed utilisation, the formation of alkylated diphenylamines (which eliminates AlCl_3 waste), the formation of polyisobutylene (which eliminates AlCl_3 waste and BF_3 waste) and the formation of *t*-butylacrylamide (eliminates sulfuric acid waste and hence sulfate waste).

Researchers at BP Chemical have developed a new acetyl technology based upon HPAs [44]. The vapour-phase reaction of ethylene with acetic acid over silicotungstic acid supported on silica was reported to give a commercially viable activity and catalyst lifetime for the manufacture of ethyl acetate. This is a good example of catalyst design and process optimisation based upon a catalyst that had been regarded previously as an inferior catalyst for this kind of chemistry. About half of the world's manufacturing capacity (ca. 1 million tonnes per annum in total) is prepared via the Wacker process, which uses $\text{PdCl}_2/\text{CuCl}_2$, but this has a number of economic and environmental drawbacks, including the use and subsequent disposal of significant feeds of HCl (>3 kg t^{-1} of product). The process is complex, requiring waste treatment equipment, and the corrosive nature of the catalyst leads to high capital investment. An improved process has been developed using silicotungstic acid (on silica), which appears to be commercially viable and environmentally better than the current process. Table 6.4 compares the

Table 6.4 Solid acid catalysts for the reaction of ethylene with acetic acid to give ethyl acetate

Catalyst	Ethylene/acetic acid molar feed ratio	Temp. (°C)	Water in feed (mol. %)	Ethyl acetate space-time yield ($\text{g l}^{-1} \text{h}^{-1}$)
H-Montmorillonite	5/1	200	0	144
XE386 resin	5/1	155	0	120
Nafion®	5/1	170	0	102
HY zeolite	5/1	200	0	2
H-Theta-1	5/1	200	0	0
$\text{H}_4\text{SiW}_{12}\text{O}_{40}/\text{silica}$	12/1	180	0	380

activity of a selection of solid acid catalysts for the vapour-phase reaction of acetic acid with ethylene to form ethyl acetate. The supported HPA is the most active catalyst.

In order to achieve a commercially viable process, a thorough investigation of reactor design and process engineering, including the use of supported catalysts, was undertaken. Some process options include operation with a high ethylene/acetic acid feed ratio, addition of 3–8 mol.% steam (which leads to ethanol and diethyl ether, which can be recycled in the reactor) and protection of the catalyst from ingress of corrosive metal impurities. By judicious choice of catalysts and optimising process conditions, a previously non-viable catalyst system has been transformed into a commercially viable and environmentally attractive process.

3.3 Sulfated zirconia

The synthesis of sulfated zirconia, its structural characterisation and its catalytic properties have been described in an excellent review by Yadav & Nair [45]. Sulfated zirconia is generally described as a solid superacid, although the performance is strongly related to the method of preparation. These kinds of materials are normally prepared from zirconium hydroxide, which then is treated with either ammonium sulfate or sulfuric acid, followed by calcination (typically to 500–700°C). The precise nature of the acidity is the subject of considerable controversy, including whether these materials are mainly Lewis acids or Brønsted acids. Owing to the high activity of these catalysts for *n*-butane isomerisation, these catalysts are at the very least strongly acidic catalysts. Clark *et al.* [46] have shown recently that these kinds of catalysts under normal use conditions pick up sufficient moisture to lead to a performance that is more akin to the behaviour of Brønsted acid sites. Two shortcomings of these kinds of acids are deactivation due to coke formation and acid leaching. These have

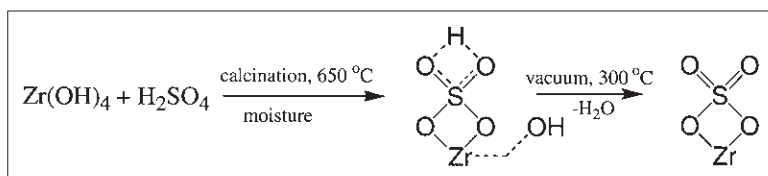
been overcome to a large extent by modification, using various transition metals such as platinum and refining the synthetic methodology.

In terms of the synthesis [47–49], it is found that catalysts obtained by sulfating the amorphous hydrated ZrO_2 possess a significantly higher activity than that obtained by sulfating microcrystalline samples [45]. The effects of different sulfating agents and their post-treatment have been studied in detail. With the use of microscopy and diffraction techniques, it has been found that the nature of the acid surface sulfates grafted by any of the techniques on amorphous or precrystallised zirconia is similar, although local acid site identification is complicated to define.

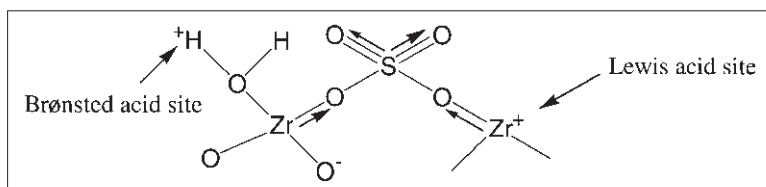
A number of models have been proposed to identify the nature of the active sites. A few of these proposed structures are shown in the schemes below, however the reader is encouraged to refer to more detailed descriptions found in the literature. Kumbhar *et al.* [50] had speculated the structure of sulfated zirconia as shown in Scheme 6.11.

A similar model has been proposed by Yamaguchi [51]. The dried surface has been described as having a highly covalent character, with Lewis acid-type sites. Partial hydration (water acting as a weak Lewis base) of the catalyst initially tends to convert the surface sulfates to a lesser covalent form and then into an ionic form. This results in the transformation of the strong Lewis sites to Brønsted acid sites. Another model has been proposed by Arata & Hino [52] for the structure of the active site, wherein the sulfate bridges across two zirconium atoms (see Scheme 6.12). The formation of Brønsted sites results from the uptake of water molecules as a weak Lewis base on the Lewis acid sites.

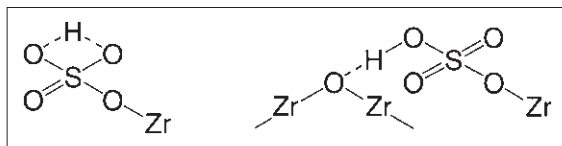
Kustov *et al.* [53] have proposed schemes for both an ionic structure, with a proton forming a multi-centre bond with the sulfate anion, and a covalent structure, with hydrogen-bonded hydroxyl groups (see Scheme 6.13).



Scheme 6.11



Scheme 6.12



Scheme 6.13

Like many other solid acid catalysts, the exact nature of the acid sites is complex and depends very strongly upon the synthesis procedure. This in part may explain the variation in the numbers of different structural models within these catalysts. This does imply that these very interesting materials merit greater study in order to produce greater and yet more controlled superacidity.

As we discuss briefly below, these materials have found wide applications for a variety of reactions. In many cases, however, these materials deactivate quickly. To solve this problem, sulfated zirconia catalysts modified with various metals such as Pt, Pd, Ir, Fe and Mn have been found to exhibit better catalytic activity. It has been shown, for example, that Pt-promoted sulfated zirconia has higher rates for alkane isomerisation than non-promoted systems. The stability of the catalysts was increased towards deactivation during the isomerisation of alkanes. One possible role for the supported Pt is the cleansing of sites by hydrogenation of the coke that causes deactivation. Hattori has proposed a possible mechanism of protonic acid site generation on Pt-modified sulfated zirconia in the presence of hydrogen [54]. He has proposed a dissociative adsorption of hydrogen on the Pt particles to form H atoms, which subsequently undergo spillover on the support. The H atom migrates on the surface to Lewis sites [54] where it loses an electron to form a proton stabilized on the surface O atoms near the Lewis acid sites (Fig. 6.5).

Sulfated zirconia has been used for a range of catalytic reactions, such as Friedel–Crafts alkylation,

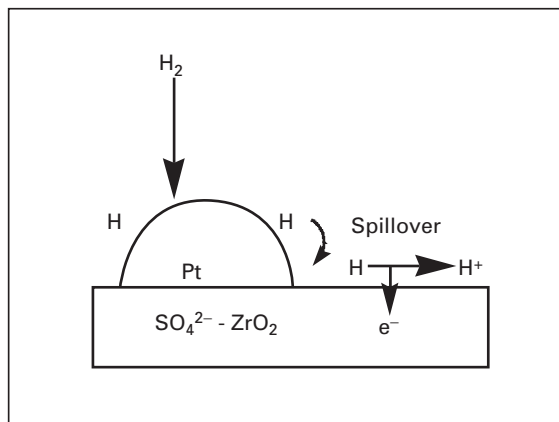


Fig. 6.5 Mechanism of hydrogen spillover.

acylation, condensation, esterification, etherification, isomerisation, nitration, cracking, dehydration, oligomerisation, etc. The reader is referred to the literature for a more detailed account of each of these processes [45–49]. As far as the authors are aware, there are relatively few examples of industrial applications of these types of catalysts; although with further process optimisation these materials inevitably will expand into more commercial use. Much of the chemistry that is described, such as in the alkylation of phenol with MTBE, MTBE synthesis and acylation-type chemistry, shows that these catalysts are very active, although other catalysts such as HPAs or ion-exchange resins tend (but not always) to give higher activity. In the etherification of beta-naphthol with methanol, HPAs gave the highest conversion (93%); Amberlyst®-15 (92%) with sulfated zirconia gave about 18%. In the case of toluene nitration, sulfated zirconia has similar activity to supported HPAs. Many of the reactions described require Brønsted acidity and, under the condition of catalyst synthesis, in many cases optimisation of Lewis sites rather than the Brønsted sites may have taken place.

The importance of Brønsted acidity has been pointed out in a very interesting paper by Clark *et al.* [46]. They have investigated the use of sulfated zirconia as new solid acid-based routes to linear alkyl benzenes. The alkylation of benzene with 1-dodecene was reported in 1999. The 1-dodecene conversion was quite low, with conversions of around 12%. Supported HPAs, acid clays and alumina pillared clays showed conversions close to 100%. In contrast to this, Clark showed that a very high conversion could be achieved using a commercial supply of sulfated zirconia [46].

As pointed out by Clark, sulfated zirconia has been reported to possess high Lewis acid activity and this has encouraged some studies on its use in liquid-phase Friedel–Crafts benzylation reactions. However, these have met with only moderate success. Clark points out that under normal handling conditions these catalysts pick up sufficient water to render these almost exclusively Brønsted-type acids. Thus, these types of catalyst may not be expected to show high activity in the area of acylations that prefer Lewis-type acidity. Using these commercial ‘Brønsted’-type catalysts did indeed show low activity for the acylation of benzene with benzoyl chloride. The formation of linear alkylbenzenes was studied due to the commercial importance of this reaction (for surfactants, etc.) and the fact that it is known that this reaction requires Brønsted acid sites. The alkylation of benzene with 1-dodecene over sulfated zirconia resulted in complete conversion of the alkene with the formation of 93% of the monododecylbenzene, 43% of which is the preferred 2-isomer. Interestingly, if the Brønsted sites are converted to Lewis sites by calcination above 500°C, then the activity drops dramatically. Activity and selectivity are comparable to those of aluminium trichloride. A microporous sample of sulfated zirconia was found to deactivate after the initial reaction, whereas mesoporous sulfated zirconia was reusable. The authors found that deactivated catalysts can be regenerated by both solvent extraction and thermal treatment; the latter resulted in complete regeneration of catalyst activity. Under the right preparation and handling conditions, sulfated zirconia appears to be a very attractive catalyst for the alkylation of benzene. In view of this work, it may be interesting to reinvestigate a number of earlier reported reactions in a controlled way to access in more detail the

effect of the relative amounts of Lewis and Brønsted sites upon reactivity.

3.4 Ion-exchange resins

Ion-exchange resins have been used for a range of commercial applications. For example:

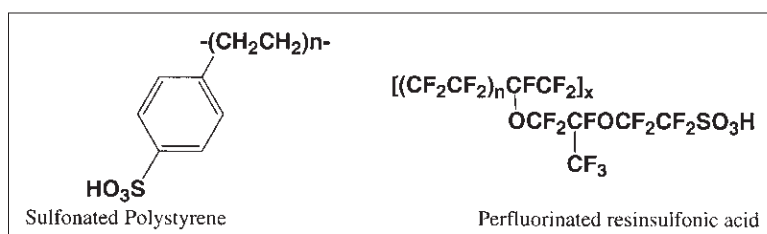
- (1) The etherification of olefins with alcohols, e.g. the coupling of isobutene with methanol to form methyl *tert*-butyl ether (MTBE). Owing to the concern of water contamination by MTBE, it seems likely that MTBE will be phased out in the USA. Other reactions include dehydration of alcohols to olefins or ethers, e.g. *t*-butanol dehydration to form isobutene.
- (2) Alkylation of phenols to alkyl phenols.
- (3) The condensation reactions, e.g. manufacture of bisphenol-A (more than 2 billion lb per annum) from phenol and acetone.
- (4) Olefin hydration to form alcohols, e.g. propene hydration to form 2-propanol.
- (5) Purification of the phenol stream after decomposition of the cumene hydroperoxide to phenol and acetone.
- (6) Ester hydrolysis and other reactions.

A wide variety of reactions have been described, ranging from alkylation with olefins, alkyl halides, alkyl esters, isomerisation, transalkylation, acylation, nitration, ether and ester synthesis, acetals, thioacetals, hydration and rearrangement chemistry [55,56]. Sharma *et al.* give a detailed account on both the microstructure and applications of polystyrene-based ion-exchange resins, with approximately 300 different reactions described [57,58].

It is also noteworthy how the use and application of these types of resins grow dramatically as the microstructure of these materials is improved. Prior to about 1960, polystyrene-based resins were essentially gel-type resins whose swelling characteristics depended upon the solvent or reactants. In non-swelling media the active sites were largely inaccessible for reactivity. This problem was overcome with the development of ‘macroporous’ ion-exchange resins in the early 1960s [59]. A good understanding and optimisation of this material for a range of catalytic reactions has pioneered the way for these ion-exchange resins to become industry’s catalyst of choice in several key areas. These include MTBE

Table 6.5 Physical properties of some cation-exchange resins

Catalyst	Surface area (m ² g ⁻¹)	Pore volume (mlg ⁻¹)	Capacity (meqH ⁺ g ⁻¹)	Max. operating Temp. (°C)	H ₀
Amberlyst®-15	0.35	4.8	120	-2.2	
Nafion® NR50	0.02	Non-porous	0.9	280	-12
Nafion®/silica nanocomposite	200	0.7	0.15	280	>-12

**Scheme 6.14**

formation (gasoline additive), the synthesis of bisphenol A (polymer intermediate), hydration and phenol alkylation chemistry.

Earlier reviews by Bhagade & Nageshwar addressed hydration, dehydration, esterification, ester hydrolysis and alkylation individually [60]. Widdecke's review discussed the design and industrial applications of polymeric acid catalysts [61]. The book *Ion Exchangers* provided a very comprehensive monograph on the ion-exchange resins, including catalytic applications [62]. Albright analysed various aspects of the fundamentals for the catalysis by porous acidic ion-exchange resins [63].

One major difference with the styrene-based and perfluorinated resinsulfonic acids is clearly acid strength. The Hammett acidity function (H_0) of about -11 to -13 for perfluorinated resins, compared with about -2.2 for Amberlyst®-15, shows that the perfluorocarbon-based resins have very high acidity [5]. A second difference between the two resin systems is the number of acid sites, which is approximately five times greater for the styrene-based systems. As a result, reactions that do not require especially strong acidity show high activity using the lower acid strength but higher acid density styrene-based materials. Reactions that require higher acid strength with higher temperature can be carried out more efficiently with the higher acid strength and more thermally stable perfluorinated resinsulfonic acids [64]. Prior to 1996, most of the catalytic work

with Nafion® resin had been performed with the pure polymer that does not swell in non-polar solvents. This clearly has limited the number of feasible applications due to the low apparent activity. High-surface-area Nafion® resin/silica nanocomposites have been developed since that, like macroporous resin, can function in non-swelling solvents [65].

In Table 6.5 we show the physical properties of three cation-exchange resins: Amberlyst®-15 is a macroreticular sulfonated polystyrene-based ion-exchange resin with 20% divinylbenzene (see Scheme 6.14). The open structure is shown in Fig. 6.6(a) under a magnification of about 300×. Nafion® resin is a perfluorinated resinsulfonic acid with a terminal $\text{CF}_2\text{CF}_2\text{SO}_3\text{H}$ group. This material is chemically stable (as expected due to the fluorocarbon nature of the backbone) and thermally stable up to 280°C, at which temperature the sulfonic acid groups begin to decompose [64]. In order to increase the acid site accessibility of Nafion® resin-based catalysts (which is low due to the low surface area of the polymer: $<0.1\text{ m}^2\text{g}^{-1}$, Table 6.5), a new class of solid acid catalyst based upon a high-surface-area Nafion® resin/silica nanocomposite has been developed, where nanometre-size Nafion® resin particles are entrapped within a highly porous silica network [65]. A more detailed description is given in the following section.

A scanning electron micrograph of the nanocomposite is shown in Fig. 6.6(b). The microstructure has

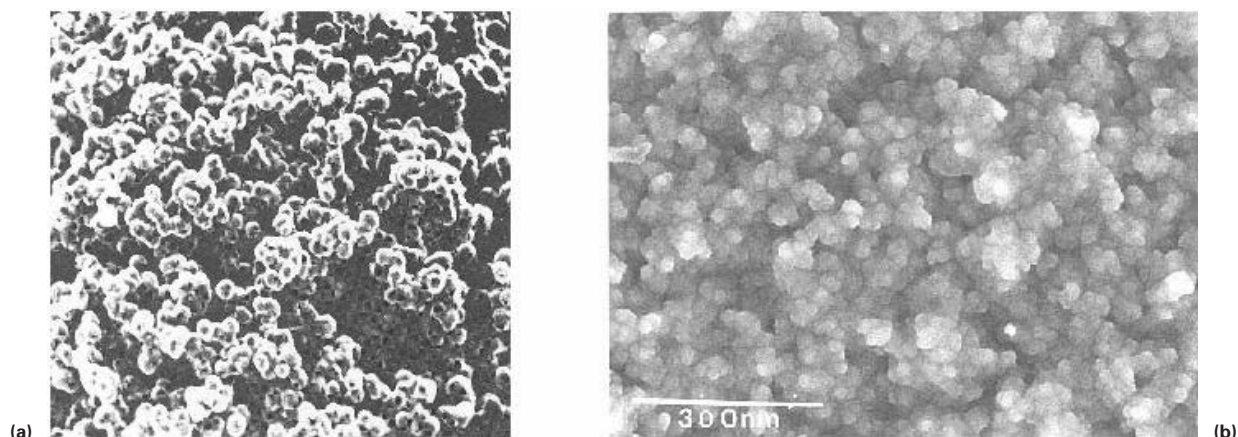


Fig. 6.6 Scanning electron micrographs of: (a) microspherical 'macroreticular' resin; (b) Nafion[®] resin/silica nanocomposite.

similar characteristics to the macroreticular-based resins although the pore structure is slightly smaller (pore diameters are typically ca. 15–20 nm).

Commercial applications for ion-exchange resins

Ethers are widely used as octane boosters in the fuel for motor vehicles. The most commonly used ethers include: methyl *tert*-butyl ether (MTBE), ethyl *tert*-butyl ether (ETBE) and *tert*-amyl methyl ether (TAME). They are made by the addition of methanol to isobutene, ethanol to isobutene and methanol to 2-methyl-1 (or 2)-butene, respectively, over an acid catalyst. Commercially, MTBE is produced in the liquid phase over a macroporous sulfonic acid resin catalyst, e.g. Amberlyst[®]-15, Dowex[®] or M32. The macroporous resin is preferred due to the high accessibility of its acid groups [66–68].

Longer chain alkyl ethers were prepared readily by heating the corresponding alcohols ($C_nH_{2n+1}OH$, $n > 3$) in the liquid phase with Nafion resin catalyst [69]. Amberlyst[®] resin catalyst is limited in this application due to the temperature requirement, e.g. $>140^\circ\text{C}$. Nafion[®] resin also was an effective catalyst for catalysing the condensation polymerisation of alkane diols to form the corresponding polyether glycols [70].

Ion-exchange resins (sulfonic-acid-modified polystyrenes) have been used commercially for a number of years for the hydration of isobutylene to *t*-butanol. *Tert*-butyl alcohol may be used directly or indirectly

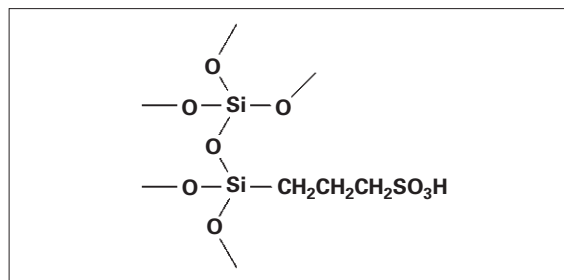
as a fuel additive. Deutsche Texaco has commercialised a process that uses a strong acid resin to catalyse the direct hydration of olefins such as propylene (in water) to produce the corresponding alcohol. Macroreticular materials (e.g. Amberlyst[®]-15) are preferred because they tend to foul less readily than gels in long-term tests. The hydration of isobutylene to *t*-butanol has been commercialized by UOP/Huels in the early 1980s. The use of resin catalysts in Europe and Japan in two plants alone accounts for an annual production of at least 100 000 t year⁻¹ [71]. Ion-exchange resins are effective catalysts for a number of dehydration-type chemistries. These include the dehydration of *t*-butanol to isobutylene and also the dehydration of butane diol to tetrahydrofuran. This latter reaction has been carried out by Davy-McKee as early as 1985 on 20 000 t year⁻¹. Of course the most well-known reaction is the formation of bisphenol A [72]. Degussa also has demonstrated the use of strongly acidic inorganic and organic ion-exchange resins in the formation of 2-vinyl-4-hydroxymethyl-1,3-dioxolanes [73]. These catalysts are based upon the polycondensation of a suitable alkyl-sulfonic-acid-functionalised organosilane monomer (see Scheme 6.15). The catalyst is a solid with a siliceous matrix and a high concentration of anchored ligand groups. These kinds of catalysts are active for a number of different types of reactions, such as the esterification of free fatty acids, the esterification of acid anhydrides to form the corresponding diesters and the condensation reaction to form bisphenol A.

Olah *et al.* recently have reported the use of Nafion[®] as a highly efficient solid acid catalyst for the

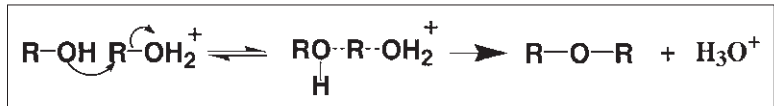
bimolecular conversion of alcohols to ethers in excellent yields [74]. The method provides excellent yield, easy isolation of the product and ready regeneration of the catalyst in the case of primary alcohols. The mechanism for the reaction involves the in situ formation of an oxonium ion, where Nafion[®] converts the hydroxyl group of the alcohol into a better leaving group by protonation. The ether then is formed by the nucleophilic attack of alcohol on the oxonium ion in a bimolecular reaction (S_N2) as shown in Scheme 6.16.

The water was removed by azeotropic distillation using toluene as an inert solvent. Dihexyl ether was formed in about 97% yield at a temperature of 145°C, with similar yields for longer chain alcohols leading to di(*n*-octyl) ether (95%).

An eco-friendly catalytic route for the preparation of perfumery-grade methyl anthranilate from anthranilic acid and methanol has been reported by Yadav & Krishnan [75]. Among the catalysts studied, Amberlyst[®]-15 and Indion-130 resins were found to be the most effective. Other heterogeneous catalysts such as ZSM-5, Filtrol-24 and dodecatungstophosphoric acid were found to be totally ineffective. Ion-exchange resins (macroreticular) were found to be the catalysts of choice in the selective synthesis of monoglycerides from glycerol and oleic acid in the presence of solid acid catalysts. Ion-exchange resins were found to give greater selectivity (ca. 90%) compared with zeolites and clays [76]. A number of studies have appeared recently on the process opti-



Scheme 6.15



Scheme 6.16

misations for a variety of esterification reactions. Amberlite[®] XH 2071 has been shown to be a very effective catalyst for the manufacture of methacrylic acid esters using methacrylic acid with alkyl *t*-butyl ethers at 55°C, with a high selectivity of 98% [77]. High yields have been reported also in the following esterification reactions: methyl esterification of L-phenylalanine (and methanol) [78], the direct esterification of 1-butene with acrylic acid [79], acetic acid and butanol [80], the reaction of glycol ether acetate with acetic acid [81], esterification of acetic acid and propyl alcohol [82] and, finally, the *trans*-esterification of cyclohexyl acrylate with *n*-butanol and 2-ethylhexanol [83].

We strongly encourage the readers of this chapter to look at the excellent reviews of Sharma *et al.* and also the work of Olah *et al.*, who have extensively reviewed the use of ion-exchange resins (macro-porous, polystyrene based) and perfluorinated resin sulfonic acids, respectively [55–57].

3.5 Acidic and pillared clays

Very recent accounts of the synthesis and catalytic applications of acidic and pillared clays have been described [84,85] and so only a brief description of these materials will be presented. The reader is referred also to a number of excellent earlier reviews [86–88]. Clays have a layered-type structure wherein the silicates (SiO_4) form tetrahedral sheets linked via an octahedral sheet of alumina. Charge compensation effects (replacing Si with Al) lead to a net negative charge that is compensated by ions in-between the sheets (Fig. 6.7).

These interlamellar cations are generally exchangeable and their amounts indicate the cation-exchange capacity (CEC) of the clay. Natural montmorillonite (one of the most common clays) has limited activity. These clays are often acid activated by treatment with acids such as sulfuric acid. This results in a change in the surface area, porosity and the type and concentrations of the ions in the exchange sites. The acidity is due to either the free acid, e.g. in acid-treated clays, or the dissociation of

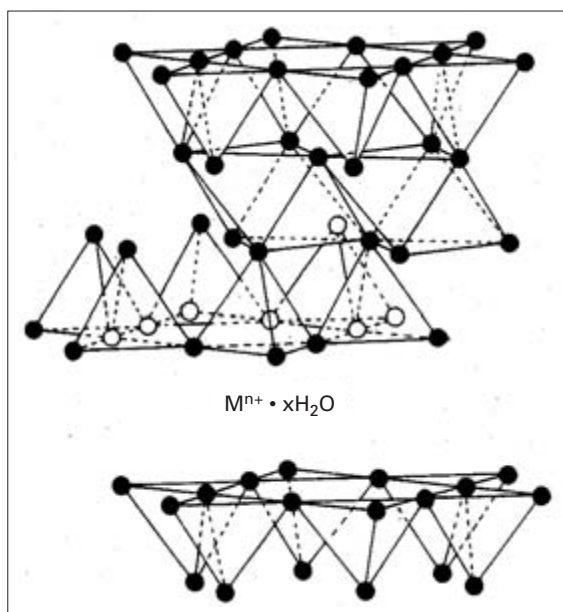


Fig. 6.7 Structure showing a 2:1 layer lattice silicate, with cations in-between the sheets.

water molecules in the interlayer. During activation, Al^{3+} and Mg^{2+} are removed from the octahedral sites in the clay layers. These cations are relocated in the interlayer space, where they act as acid centres. Clays are known to catalyse a wide range of reactions, including alkylation-type chemistry (e.g. benzene and 1-dodecene), acylation chemistry (the acylation of diisobutylene with acetic acid using a commercial acid-treated clay F-240), dimerisation chemistry (of α -methylstyrene), oligomerisation chemistry (of C_{10-24} linear olefins for lubricant base oils), etherification reactions (*t*-butanol with methanol), esterification reactions (reaction of myristic acid with propylene over Englehard F-24) and condensation reactions (such as the condensation of barbituric acid with arylcarboxyaldehydes). Acid-treated clays effectively catalyse a variety of reactions that are useful for the synthesis of a wide range of industrially important products.

One of the limitations of clays is the lack of thermal stability. This problem has been addressed by developing a wide variety of pillared clays. The layered clays are intercalated with inorganic polyoxocations such as the Al_{13} polycation. These serve to increase the pore size of the clays, to increase

the stability and to introduce additional acid sites (Lewis and Brønsted). A number of mixed-oxide pillared clays also have been developed, such as Zr–Al pillared clays. A detailed review on the synthesis and applications of these materials has been described [85]. As with acid-treated clays, pillared clays are active in applications such as cumene cracking, *n*-heptane isomerisation, gas-oil cracking and toluene alkylation. We do note, however, that many of the earlier commercially used clays have since been replaced by the more selective zeolite-type catalysts.

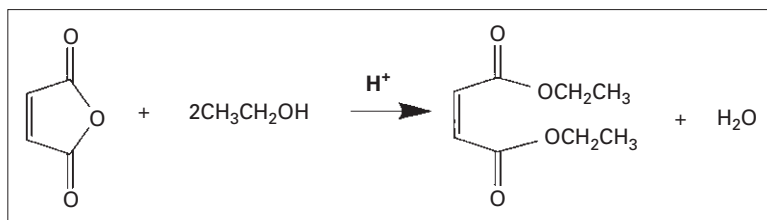
4 Some Recent Developments in Catalytic Materials and Processes

4.1 The 'Kvaerner Process' and esterification chemistry

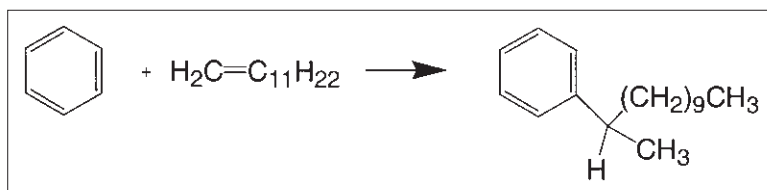
Rohm & Haas have described the use of ion-exchange resin catalysts as solid acid replacements for homogeneous catalysts in a number of esterification reactions [89]. The use of these polymeric catalysts minimises waste streams compared with homogeneous catalysts in the manufacture of butane diol. The esterification of maleic anhydride with ethanol to produce diethyl maleate (see Scheme 6.17) has been reported with high yield [89]. The product then is hydrogenated to give the linear alcohol butane diol.

This process has been commercialised by Rohm & Haas with Kvaerner Process Technology and has been used successfully by BASF in three large-scale plants. The conventional esterification process employs sulfuric acid or methane sulfonic acid and results in sulfur contamination of the final ester product. This also has the effect of poisoning a hydrogenation catalyst that is used downstream. In general the process efficiency is less than 96% and the neutralisation step creates a waste disposal problem.

One of the key breakthroughs in this area came from an improved design of the catalyst. The original types of catalysts used would allow high proportions of the alcohol to penetrate deep inside the catalyst. As a result, alcohol dehydration to the ether occurs, which reduces the overall yield. This problem was circumvented by designing a catalyst where the majority of the acid sites were accessible on the surface to both the acid and alcohol, yielding a very



Scheme 6.17



Scheme 6.18

rapid esterification reaction with negligible amounts of etherification. Using a resin catalyst eliminates final ester contamination (from the sulfuric acid using a homogeneous catalyst) and minimises effluent problems. The esterification processes (20 000 MPTA plant) for the production of the diethyl maleate is a two-stage process involving an autocatalytic exothermic first stage to produce a monoester, followed by a catalytic second stage to produce the diester. The production of methyl esters of natural fatty acids also has been developed using a novel counter-current reactor design to operate at conversions of 99.8% with a selectivity of >99%. The C₁₀-type fatty acids are esterified with methanol and then hydrogenated to the linear alcohols. The example of replacing a homogeneous catalyst (sulfuric acid) with a heterogeneous catalyst is more efficient, more cost-effective and environmentally cleaner.

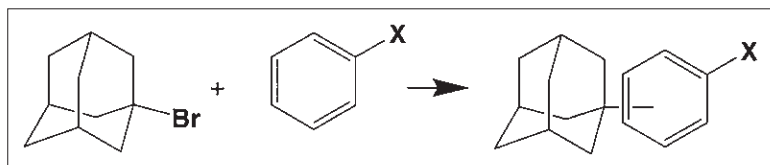
4.2 Nafion[®]/silica nanocomposites

Recently we have developed a highly active form of Nafion[®] where the Nafion[®] resin is highly dispersed within and throughout the porous silica network at the tens of nanometres level [65]. The microstructure may be regarded as a porous silica network that contains a large number of 'pockets' of very strong acid sites (the Nafion[®] polymer) in domains of about 10–20 nm. This significantly increases the effective surface area of the Nafion[®] resin particles by several orders of magnitude and as a result the catalytic

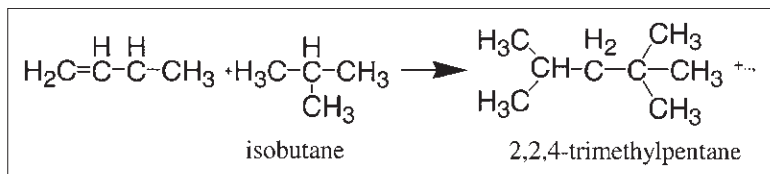
activity of this material per unit weight of Nafion[®] resin has been found to be up to 1000 times higher than in the pure polymer. This has opened up the potential applications dramatically. This work has been summarized recently [90].

The use of ion-exchange resins for difficult alkylation reactions was almost non-existent [58]. One reaction of interest is in the alkylation of benzene with C₁₂ olefins for the formation of linear alkyl benzenes. These materials, when sulfonated, represent the basis of the detergents industry. In the current commercial process, HF is used as the catalyst and there is an obvious drive to replace this very hazardous material with a solid acid catalyst. The products of these reactions contain a mixture of alkylbenzenes with the phenyl group attached to different carbon atoms in the linear hydrocarbon chain. The 2-phenyl isomer is the most preferred product (see Scheme 6.18).

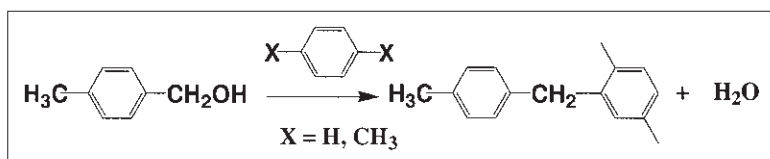
Branched isomers, which are the result of skeletal isomerisation of the linear hydrocarbon chain, are very undesirable due to lower biodegradability. It has been shown recently that the Nafion[®] resin/silica nanocomposite is a very active catalyst for this reaction [90,91]. Conversions of 99% at 80°C are obtained; the products contain >95% linear alkyl benzenes and the rest (<5%) are the ca. 4% branched alkylates from the ca. 4% branched olefins (impurity in the feed), dimers of 1-dodecene and di-substituted benzene. The linearity of the alkylation using 1-dodecene is >99%. The nanocomposite catalyst was approximately 400× more active than the



Scheme 6.19



Scheme 6.20



Scheme 6.21

Amberlyst[®]-15 and pure Nafion[®] NR50 resin catalysts. In comparison with the pure polymer these results illustrate the greater accessibility to the strong acid sites within the high-surface-area composite (compared with the non-porous, non-swollen pure Nafion[®] polymer) in this reaction medium.

A direct comparison was carried out on the benzene propylation to cumene using Amberlyst[®]-15, Nafion[®] NR50 resin and a Nafion[®] resin/silica composite, in addition to the propylation of naphthalene [64]. The reaction rates ($\text{mM} (\text{meqH}^+)^{-1} \text{h}^{-1}$) and conversions for Amberlyst[®]-15, Nafion[®] NR50 resin and the nanocomposite were 0.6 (10.7), 2.0 (2.2) and 87.5 (16.2), respectively. A similar trend has been reported for the benzene propylation to cumene.

One interesting comparative study has been reported on the adamantylation of substituted benzenes with 1-bromo-adamantane catalysed by solid acids including ion-exchange and ionomer resins, HY zeolite, sulfated zirconia and supported superacids on HY zeolite and SiO_2 [92] (see Scheme 6.19). Amberlyst[®] XN-1010 gave high catalytic activity with high regioselectivity, with almost exclusive formation of *p*-adamantylated benzenes. High conversions (ca. 100%) were obtained with catalysts

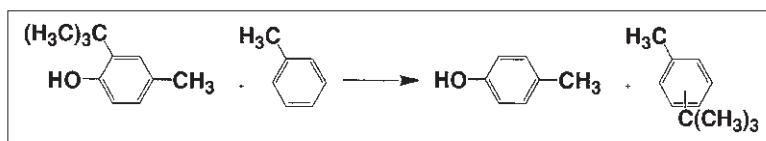
such as Nafion[®] resin, Nafion[®] resin/silica composites, Amberlysts[®], HY and HY-supported perfluorooctylsulfonic acids and heteropolyacids on silica, with somewhat lower activities with sulfated zirconia.

One of the most important reactions in the petroleum industry is the 1-butene alkylation of isobutane (see Scheme 6.20). To the author's knowledge there is still no good example of a highly active and, most importantly, stable solid acid catalyst.

Botella *et al.* [93] have studied a variety of solid acid catalysts, including a number of Nafion[®] resin/silica composite catalysts. Higher initial activities also were reported but the catalysts were inactive after a few cycles. The formation of high octane fuel (such as 2,2,4-trimethylpentane) using *stable*, solid acid catalysts still remains an elusive Holy Grail to many in the research community.

The Friedel-Crafts benzylation of benzene and *p*-xylene with benzyl alcohol was reported recently (see Scheme 6.21). Amberlyst[®]-type resins are essentially inactive whereas the stronger Nafion[®] resin and especially the Nafion[®] resin/silica nanocomposites are very active catalysts [94]. The effective reaction rate of the methylbenzyl alcohol with benzene catalysed using Amberlyst[®]-15 and the Nafion[®]

Scheme 6.22



Scheme 6.23

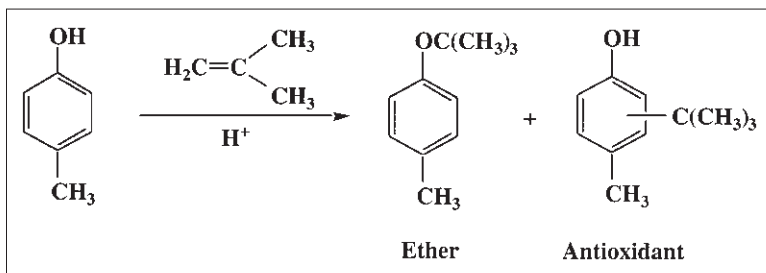


Table 6.6 The *p*-cresol conversion, the product selectivity over solid acid catalysts after 1 h at 50°C and alkylation rate

Catalyst	Conversion (%)	Selectivity (%)		Alkylation rate (mM g ⁻¹ catalyst h ⁻¹)
		Ether	Alkylates	
13% Nafion [®] /SiO ₂	82.6	0.6	99.4	581.0
Nafion [®] NR50	19.5	28.2	71.8	54.8
Amberlyst [®] -15	62.4	14.5	85.5	171.0

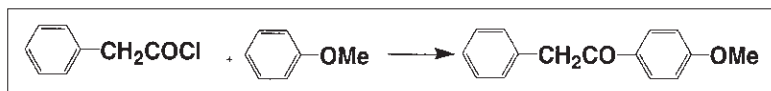
resin/silica nanocomposite have values of 0.8 and 1030, respectively (mM (meqH⁺)⁻¹ h⁻¹). A benzyla-tion product yield of >97% is found.

Nafion[®]-resin-based catalysts are effective catalysts for the transalkylation of alkylbenzenes (see Scheme 6.22). The transfer of a *t*-butyl group occurs very easily over the Nafion[®] and Nafion[®] resin/silica composites. 2-*t*-Butyl-*p*-cresol is converted with an excess of toluene to give *p*-cresol and *n*-*t*-butyl-toluene in about 99% yield.

Alkylated phenols and derivatives are widely used commercially as antioxidants, herbicides, insecticides, fragrances, polymerisation inhibitors, lubricants [95], etc. Alkylated phenols are typically made by cation-exchange-resin (e.g. Amberlyst[®]-15, -16)-catalysed alkylation of phenol with the corresponding olefins and the reaction proceeds preferentially in the *para* position [96]. The use of a resin catalyst in this reaction has almost entirely replaced H₂SO₄ and BF₃ catalyst systems. Our results show that the 13 wt.% Nafion[®] resin/silica composite is a very effective catalyst for catalysing the alkylation of *p*-

cresol with isobutene under mild conditions (see Scheme 6.23 and Table 6.6). Under the conditions employed, the Nafion[®] resin/silica composite seems to be more active and more selective for catalysing the C-alkylation versus O-alkylation.

Olefin isomerisation involving *cis*-/*trans*- transformation or double bond migration is a relatively easy chemistry. However, various solid acid catalysts frequently encounter quick deactivation [97]. The 13 wt.% Nafion[®] resin/silica composite was a very active catalyst for the olefin isomerisation, *cis*-/*trans*-transformations and the double bond migrations. The olefin isomer products are useful in the formulation of well fluids, especially in offshore drilling. Clarebeau & Steylaerts used Amberlyst[®], Nafion[®] resin pellets and Nafion[®] resin/silica composites to catalyse the isomerization of 1-olefins with 14–20 carbon atoms [98]. Very high catalyst turnover numbers were reported with the Nafion[®] resin/silica composite catalysts. This composite also is active for the isomerisation of 1-butene to the *cis*- and *trans*-2-butene isomers [99]. Using the composite catalyst



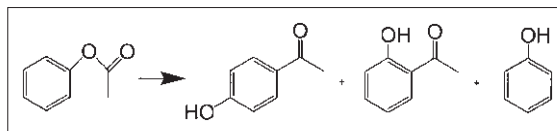
Scheme 6.24

the equilibrium distribution of the *n*-butenes was formed at 50°C. The composite catalyst has higher activity than Amberlyst[®]-15 resin for aluminosilicates and its catalytic lifetime is much longer than H-ZSM-5 under the reaction conditions.

The composite is very effective for catalysing long-chain olefin isomerisation. 1-Dodecene isomerization to its linear isomers was carried out in the liquid phase at 75°C over the 13 wt.% Nafion[®] resin/silica composite, plain Nafion[®] resin, Amberlyst[®]-15 resin and H-ZSM-5 catalysts. The first-order rates are 190, <1, 13 and 4 ($\text{mMg}^{-1} \text{calyst h}^{-1}$), respectively. The data clearly indicate the drastically enhanced accessibility of the sulfonic acid sites inside the composite versus the plain Nafion[®] polymer resin. The significantly higher activity of the composite in comparison with that of the Amberlyst[®]-15 resin could be due mostly to the higher inherent acid strength of the Nafion[®] resin.

The composite is effective also in the solid-acid-catalysed dimerisation of α -methylstyrene (AMS) [100]. The unsaturated dimers of AMS, particularly 2,4-diphenyl-4-methyl-1-pentene, are industrially important and are useful as chain-transfer agents or molecular weight regulators in the production of polymers. The first-order rate constants for 13 wt.% composite, supported 2 wt.% Nafion[®] resin on shot coke (carbon) and Amberlyst[®]-15 resin are 110.1, 0.1 and $0.6 \text{ mM meqH}^{+1} \text{ h}^{-1}$, respectively, in cumene. Almost three orders of rate enhancement are observed, which reflects an increased access to the acid sites. These types of catalysts are efficient also in propylene oligomerisation.

The traditional catalysts used in acylation chemistry suffer from several drawbacks: from the use of stoichiometric amounts of catalysts (AlCl_3 , BF_3) to extensive problems with disposal of the associated waste stream. Ion-exchange resins have not played a strong role in this area compared with some more recent developments in both zeolite chemistry and the careful design of aluminum-chloride-modified supports. The acylation of anisole with carboxylic acid chlorides (see Scheme 6.24) occurs very rapidly with these catalysts, with short reaction times and high selectivity. In some cases 100% conversion with

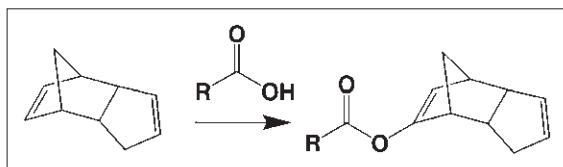


Scheme 6.25

97% selectivity was obtained. Using Nafion[®]-based catalysts, from traces to ca. 98% conversion were obtained using the following aromatics: toluene (trace), *o*-xylene (1.3%), *m*-xylene (18%), 2,4,6-trimethylbenzene (98%) and anisole (40%) [101]. Heidekum *et al.* [102] recently reported on the Fries rearrangement of phenyl acetate (to hydroxyacetophenones) and found that both Nafion[®]-based and zeolitic-type catalysts were very effective (see Scheme 6.25). Hydroxyacetophenone is a valuable precursor in the pharmaceutical industry for the formation of *p*-hydroxyacetanilide (painkiller). The reaction reached high selectivity when high phenol levels were used. The excess phenol reacts with one of the intermediates (a ketene) to prevent an irreversible consecutive reaction leading to poor selectivity. Both an H-BEA zeolite and Nafion[®] resin/silica nanocomposite gave >90% selectivity.

A recent study on the esterification of several cyclic olefins with saturated and unsaturated carboxylic acids has been studied over Amberlyst[®]-15, Nafion[®] and the highly dispersed form of Nafion[®] (Nafion[®]/silica nanocomposites) [103]. The Nafion[®]-based catalyst materials are superior to the weaker acidity Amberlyst[®] catalysts when less-active olefins are used and especially at low temperatures. The esterification of cyclic olefins with carboxylic acids such as dicyclopentadiene or naturally occurring terpenes yields compounds of industrial value (for the flavour and fragrance industry) (see Scheme 6.26).

A 91% yield of the esterified product is obtained over the composite compared with <5% for Amberlyst[®]-15. In the simple esterification of benzoic acid with *n*-butanol, an Amberlyst[®] catalyst and a pure Nafion[®] resin catalyst showed good activity. In summary, in many esterification reactions ion-exchange resins offer high reactivity.



Scheme 6.26

We have found also that the catalytic activity of these new materials can be tailored by varying the catalyst synthesis. This opens up the possibility of fine tuning these catalysts. The extent of the Nafion[®] dispersion can be varied within the silica. This change of the Nafion/silica microstructure in turn affects the catalytic activity. In the dimerisation of AMS a highly dispersed form of the Nafion[®] gives the optimum activity. However, in the case of acylation or alkylation chemistry, a slightly aggregated form of the Nafion[®] is preferred. A comparison of the two types of catalysts developed can be found in the literature [90]. In the nanocomposite, acid sites are localised within discrete Nafion[®] domains. Decreasing the domain size can be thought of as increasing the acid site dispersion by increasing the effective surface area of the acidic regions. Using high-resolution transmission electron microscopy and scanning electron microscopy we have found that the microstructures obtained from alkoxide precursors contain a highly dispersed form of the Nafion[®] resin, which we refer to as Type 1 catalysts. For the Type 1 catalyst, Nafion[®] domains are ca. 10–30 nm in size and distributed uniformly throughout the porous silica network. The Nafion[®] dispersion is ca. 5000 times greater than the pure unswollen polymer.

Table 6.7 shows a comparison of a number of catalytic reactions investigated using the Nafion[®] resin/silica nanocomposites prepared from the two alternative silica precursors. In general Type 2 (which is made from sodium silicate as the silica source) leads to a Nafion[®] resin/silica microstructure that is about 10 times more active in the industrially important area of alkylations than reported previously using the alkoxide route (Type 1) [90], specifically the formation of cumene and linear alkyl benzenes.

The catalytic activity was compared using the Type 1 and Type 2 catalysts for seven different reactions, including alkylations, acylation, olefin isomerisation, the dimerisation of AMS and hydroperoxide decom-

position. What is particularly interesting is that Type 2 catalyst is very effective for alkylation chemistry but the reverse is true in the case of AMS dimerisation and hydroperoxide decomposition. In the case of olefin isomerisation there appears to be only a small difference between the two materials investigated. For each reaction the catalyst and conditions have been optimised to give very high conversions with good selectivity. In the case of AMS chemistry the only three products observed were 2,4-diphenyl-4-methyl-1-pentene (I), 2,4-diphenyl-4-methyl-2-pentene (II) and the saturated dimer 1,1,3-trimethyl-3-phenylindan (III).

The reactions that are faster for the Type 1 catalyst are those that are the most likely to be rate-limited by the initial proton transfer. We have demonstrated that proton transfer *is* rate-limiting for the AMS dimerisation. It seems logical that the reaction rates are optimised for the catalysts that have the better dispersed, more accessible acid site distribution when proton transfer is rate-limiting. Palinko *et al.* [104] have reported on the surface characterization of both Nafion[®] and a Nafion[®]/silica composite catalyst by infrared microscopy. The composite was made using silicon alkoxide and would correspond to a Type 1 catalyst. One conclusion reached was that of interaction of the highly dispersed sulfonate groups (SO₃H) containing pockets of the Nafion[®] and the hydroxyl groups of the silica within the composite. It was suggested also that this may lead to some decrease in acidity. The influence of the composition within the Nafion[®]/silica composites on the isobutane/2-butene alkylation also has been reported [93] and a similar conclusion was observed. In the highly dispersed Nafion[®]/silica systems, the sulfonic groups of the polymer interact to a greater extent with the silanol groups of the silica, resulting in a decrease in the activity of the sulfonic acid groups. In the Type 2 materials, where the Nafion[®] is more aggregated, one would expect the interaction of the sulfonate groups (SO₃H) and the hydroxyl groups (SiOH) of the silica to be reduced considerably, leading to a material with an acidity that is more 'Nafion[®]-like.' Overall, then, we are inclined to think of the ratio of rates for Type 1 and Type 2 catalysts as the result of a trade-off between acid site accessibility (more favourable for Type 1 catalysts) and acid site ion-pair microsolvation effects (which may have a higher inherent acidity that is more favourable for Type 2 catalysts) [42]. It appears that one can tune the cat-

Table 6.7 Initial reaction rates for Nafion[®] resin/silica-catalysed reactions in the liquid phase

Reaction	Rate		
	Type 1 (via alkoxide route)	Type 2 (via silicate route)	Conversion ^a (%)
Benzene/dodecene alkylation (a)	32	430	99
Transalkylation (d)	1100	3086	98
Benzene propylation (c)	46	289	30
Freidel–Crafts acylation (b)	200	900	80
1-Dodecene isomerisation (e)	1280	1580	99
AMS dimerisation (f)	6500	1980	98
Hydroperoxide decomposition (g)	1750	1040	99

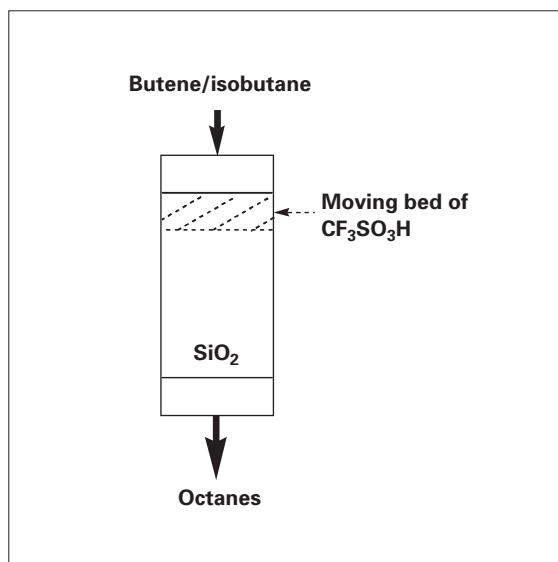
^a Conversions shown are found using the optimum catalyst (typically 5 wt.% loading) according to the following conditions: (a) at 80°C from benzene (21.5 g) alkylation with 1-dodecene (10 g) using 2 g of catalyst after 2 h of reaction time; (b) acylation of *m*-xylene (21 g) with benzoyl chloride (10 g) at 140°C after 2 h with 1 g of catalyst; (c) benzene alkylation with propene at 70°C (using a 20-g solution of benzene saturated in bubbling propene) with 1 g of catalyst after 1 h of reaction time; (d) *t*-butyl-*p*-cresol (10 g) with toluene (30 g) with 1 g of catalyst at 115°C after 1 h of reaction time; (e) 1-dodecene (25 g) at 80°C with 1 g of catalyst after 1 h of reaction time; (f) alphasethylstyrene dimerisation (6 g of AMS in 54 g of cumene as solvent, 0.5 g of catalyst added) at 50°C after 20 min of reaction time; (g) decomposition of cumene hydroperoxide (35 g) with 0.1 g of catalyst at 50°C to form phenol and acetone after 1 h of reaction time.

alytic activity of a number of industrially important reactions by tailoring the microstructure.

4.3 Haldor–Topsoe alkylation process to high-octane fuels

One of the most important reactions in the petroleum industry is the 1-butene alkylation of isobutane. Isobutane is one of the key ingredients and every gallon of petrol we use contains about 10–15% of the alkylate isooctane from this reaction. The reaction is catalysed using either HF or sulfuric acid. The total catalyst sales are about \$600M per year. This reaction has been studied intensively in both industry and academia due to its enormous importance. New processing routes have been explored because there is a drive to replace the HF or sulfuric acid. The HF is hazardous and sulfuric acid is more costly (the cost of the catalyst is higher per barrel of alkylate than HF) and there is a lack of infrastructure in some areas.

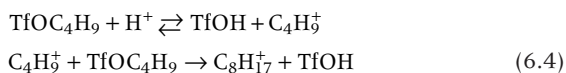
The ideal catalyst would most likely be a solid acid catalyst but over many years and numerous studies no suitable catalyst has been identified. The main problem is that the solid acid catalysts, although being very active at the beginning, die quickly and the reactivity is very short-lived. Haldor–Topsoe have developed a new fixed-bed alkylation technology by applying a supported liquid superacid (triflic acid) in

**Fig. 6.8** Supported liquid acid.

a moveable catalyst zone. The reactor system is shown in Fig. 6.8.

In a typical process a mixture of 1-butene and isobutane is fed into a bed of the catalyst. The homogeneous acid moves slowly down the column. Excellent alkylation chemistry is found, with 100% conversion to the desired alkylates (up to 80%

octanes, the rest being C5, C6 C7 and C9). The triflic acid moves down the catalyst support (a moving bed) and catalyses the alkylation chemistry. It may be described as a pseudo solid. As the catalyst begins to elute it can be recycled to maintain activity. This kind of system offers a number of processing advantages compared with the use of HF and sulfuric acid, not least of all the safer handling in this present system compared with HF. It is interesting to speculate why this system (a pseudo solid) works but all solid acid catalysts deactivate quickly. Some suggestions for this derive from the paper by Hommeltoft *et al.* [105]. The mechanism of butene alkylation of isobutane catalysed by triflic acid consists of multiple steps (11 in total). In the first step the olefin forms a stable ester. It is then postulated that this requires a second proton (shown in Equation 6.4) to push the chemistry further. Without this, a stable ester forms and the alkylation reaction essentially shuts down in favour of other hydrocarbon chemistry such as oligomerisations, which foul up the catalyst. The formation of acid-soluble oil by-products represents a serious complication when a solid acid catalyst is used in isobutane alkylation. This would reasonably explain why solid acid catalysts do not work. According to this suggested mechanism a second proton is needed and in the case of a solid the solid simply may not have the flexibility to provide a second acid site at the reaction centre. Hence deactivation occurs. It will be interesting to see more work on this kind of model and the implications it has for the use of solid acid catalysts.



The new alkylation process represents a compromise between the wish for safety of a solid catalyst and the chemistry of isobutane alkylation, which favours a liquid catalyst. The mobility of the catalyst on the column also, it is claimed, allows the removal of passivated catalyst from the reactor for recovery outside the reactor without interruption of the alkylation process. From a processing point of view it has been shown that the catalyst zone movement can be reversed, allowing it to work back through the reactor. Results from bench-scale tests show product qualities comparable with the qualities obtained using established technologies. Because the reaction takes place on a solid support in a fixed bed, the

operation resembles that of solid catalysts in a fixed bed regarding safety and engineering.

The company UOP™ recently described a new ‘alkylene process’ based upon some improved engineering concepts, using what is claimed to be a true heterogeneous, solid alkylation catalyst [106]. The alkylene process produces a paraffinic alkylate equivalent to the product from HF alkylation plants. In the liquid acid alkylation process, the key reaction steps are promoted by intimate contact of the acid with hydrocarbon at an adequate isobutane/olefin ratio. The process uses a high catalyst/olefin ratio, which appears to be a key parameter related to catalyst activity through the reactor. The optimum catalyst/olefin ratio balances the costs of additional catalyst inventory against improved catalyst stability. What appears unique about the alkylene process is the ease by which heavy hydrocarbons are removed from the catalyst surface (via contact with either hydrogen or hydrogen-saturated isobutane). A fluidised-bed reactor was used in order to overcome the deactivation problems, ensuring short contact times, minimising the degradation of the initial alkylate and reducing the catalyst deactivation per pass. The alkylene process design consists of three separate sections: the feed-treating section, the reactor section and the fractionation section. The key to this reactor concept is to minimise the deactivation mechanism and maximise the regeneration methods to prevent fouling and hence maintain activity. Although the nature of the catalyst was not described, UOP™ has developed an interesting liquid-phase transport reactor that optimises engineering design via mathematical modelling and physical modelling to yield a continuous process to produce high-quality alkylate.

4.4 Mobil–Badger cumene process

Cumene traditionally has been manufactured using either solid phosphoric acid or aluminium trichloride. Both of these catalysts have handling and environmental problems. Solid phosphoric acid is corrosive and lacks stability and selectivity to cumene. Aluminium trichloride also is corrosive and disposal of the catalyst is detrimental to the environment. The first application of the Mobil–Badger cumene process at the Georgia Gulf’s Pasadena plant, based upon a zeolite catalyst, overcomes many of these problems [107] (Fig. 6.9).

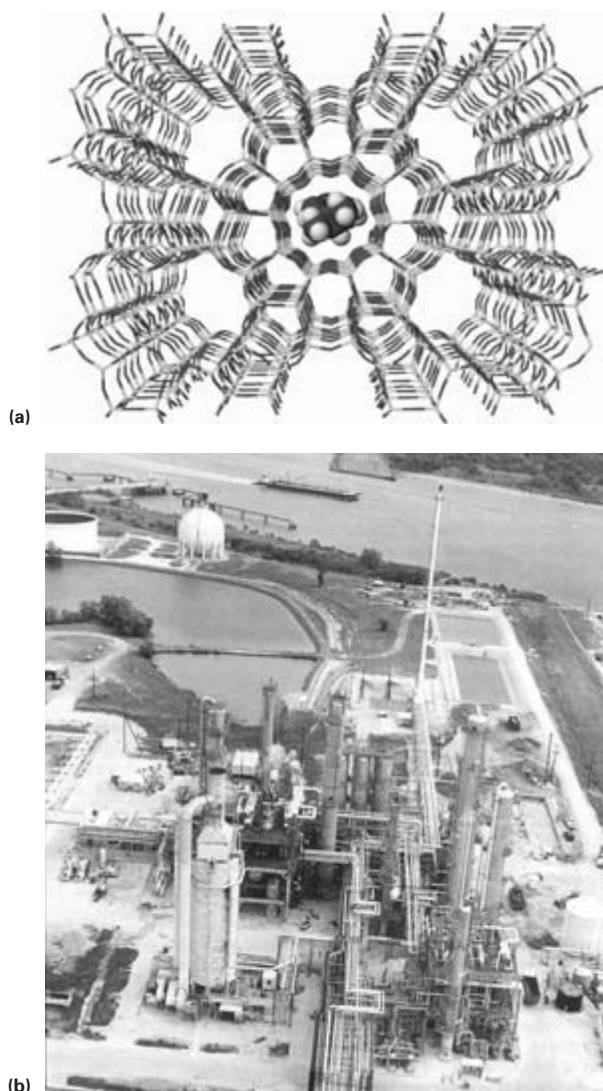


Fig. 6.9 Use of zeolite catalyst (a) in the industrial formation of cumene (b).

Mobil introduced a new proprietary zeolite, MCM-22, that gives high activity for the formation of cumene. Presumably, the fine pore structure of the zeolite helps to control the specificity of the reaction. In Fig. 6.9 we show the fit of a cumene molecule within ZSM-5 for comparison. I find it a somewhat rewarding thought that careful design of catalysts can, with skilful engineering methods, lead to large-scale production as shown in Fig. 6.9. The engineering aspects were developed by Raytheon and the

process has been licensed to at least ten plants worldwide. Liquid propylene and benzene are fed into the reactor where propylation is completed. Any polyisopropylbenzene then is treated in a separate reactor and transalkylated back to cumene. A series of distillation columns are used to collect product and recycle unwanted products. Using this process, nearly stoichiometric yields are achieved as a result of high propylene conversion, transalkylation of polyalkylbenzenes to cumene, high catalyst selectivity and insignificant formation of heavies. The high yield results in less by-product and waste streams than older processes. The catalyst itself, unlike supported phosphoric acid and aluminium trichloride, is environmentally inert, requires no special packaging or handling, can be removed readily from the reactor and can be regenerated. The low temperature of operation prevents the formation of significant amounts of by-products. The purity of the cumene produced is 99.97% or higher.

As the plant was converted to a more environmentally friendly zeolite catalyst, the new process showed improved product quality, lower production costs, lower maintenance cost and reduced corrosion. The seven plants now in operation have a combined capacity of over 3 million t year⁻¹, which meets more than 55% of the worldwide demand for cumene. Two excellent accounts relating to this topic include the article by Marcus & Cormier, 'Going Green with Zeolites,' and a description by Meima *et al.* on the production of cumene [108,109]. Meima describes a number of processes to cumene: Dow-Kellogg process, CDTech process, Mobil-Raytheon process (Badger), UOP process and Enichem process. The CDTech process makes use of catalytic distillation. The distillation of reactants and products takes place in one vessel. The details of many of these processes are often proprietary, although it appears that all of these are based on zeolitic-type materials. The ZSM-5 catalyst, for example, is used in a number of process technologies, including cumene, ethylbenzene, xylene isomerisation and toluene disproportionation to olefin recovery in the case of the petrochemical industry.

4.5 Isodewaxing process (Chevron)

O'Rear & Scheurman [110] recently have described the use of zeolite catalysis in Chevron. Isodewaxing[®] and Aromax[®] are two examples of zeolite catalysts

that Chevron have commercialised over the last 10 years. Isodewaxing is essentially an improvement in hydroprocessing technology that allows cost-effective production of a high yield of base oils. In Europe many manufacturers who use solvent-refined lube oils are limited in the current process technology in terms of product quality. Lighter viscosity grades for increased fuel economy and improved high-temperature shear viscosity characteristics are needed in modern engine designs. Chevron's isodewaxing process is the most economical way to produce high-quality base oils. The most desirable hydrocarbons in base oils are C20+ isoparaffins with high viscosity, low pour point and excellent resistance to oxidation. The isodewaxing process isomerises the molecular structure of wax into desirable C20+ isoparaffins.

The two processes for dewaxing are solvent-based and catalytic. Solvents (such as methyl ethyl ketone) are used to remove wax by crystallisation and filtration. Chevron's isodewaxing process, commercialized in 1993, catalytically isomerises the wax into the desired fractions with a base oil yield of 6400 barrels per day (bpd), compared with 5300 bpd from solvent dewaxing (from 10000 bpd of hydrocracker feed). Isodewaxing can process feeds with low wax content or those with close to 100% wax. Ultrahigh-viscosity-index lube oils can be prepared from waxy feedstocks by isomerisation over an intermediate-pore-diameter silicoaluminophosphate (SAPO) molecular sieve catalyst [111,112]. The medium-pore-size sieves inhibit the formation of multi-branched isomers and the cracking that can accompany it. Either Pt or Pd on SAPO-11 (an intermediate-pore molecular sieve) has a high selectivity for wax isomerisation and a low selectivity for secondary hydrocarbon cracking. Thus Pt-SAPO-11 is a highly effective catalyst for reducing the pour point of fuels and lubes by wax isomerisation [111,112].

5 Summary

In summary, we have described a number of examples where solid acid catalysts have been used successfully to reduce waste. The key is to understand catalyst design, reaction chemistry and process optimisation through engineering. In a number of cases, hazardous and wasteful processes have been replaced by environmentally benign processes with yields of up to 99.99% efficiency. No one single cat-

alyst is suitable for all interconversions and there appears to be a strong need for a wide range of catalysts that are constantly being improved. Through the diligent work of scientists in the field, the goal of zero emissions and zero waste becomes closer and closer on the horizon.

Acknowledgements

I am indebted to the help of my colleagues Q. Sun, W. E. Farneth and L. Manzer (Dupont) over the years. I am grateful also to W. F. Hoelderich and A. Heidekum (University of Technology RWTH, Aachen, Germany) for work on the Nafion®/silica composites over the years. In addition I appreciate the help of D. Corbin (DuPont) for help on the zeolite section. Finally, I would like to acknowledge a number of industrial and academic institutions for help on various aspects of this chapter, including BP Chemical, Zeolite International, W. R. Grace, J. White of Engelhard and G. D. Yadav (Matunga, India).

References

1. Anastas, P. T., Bartlett, L. B., Kirchoff M. M., & Williamson, T. C. *Catal. Today*, 2000, **55**, 11.
2. Tanabe K., & Hoelderich, W. F. *Appl. Catal. A*, 1999, **181**, 399.
3. Anastas P. T., & Warner J. C. *Green Chemistry: Theory and Practice*. Oxford University Press, Oxford, 1998.
4. Brønsted, J. *Recl. Trav. Chim. Pays-Bas*, 1923, **42**, 718.
5. Olah, G. A., Prakash, G. K. S., & Sommer, J. *Superacids*. John Wiley, New York, 1985.
6. Koppel, I. A., Burk, P., Koppel, I., Leito, I., *et al. J. Am. Chem. Soc.*, 2000, **122**, 5114.
7. Okuhara, T., & Nakato, T. *Cat. Surve. Jpn.*, 1998, **2**, 31.
8. Farneth, W. E., & Gorte, R. J. *Chem. Rev.*, 1995, **95**, 615.
9. Paze, C., Bordiga, S., Lamberti, C., Salvalaggio, M., Zecchina, A., & Bellussi, G. *J. Phys. Chem. B*, 1997, **101**, 4740.
10. Kubelkova, L., Kotrla J., & Florian, J. *J. Phys. Chem.*, 1995, **99**, 10285.
11. Pfeifer, H., Freude, D., & Kaerger, J. *Stud. Surf. Sci. Catal.*, 1991, **65**, 89.
12. Hunger, M., Freude, D., Fenzke, D., & Pfeifer, H. *Chem. Phys. Lett.*, 1992, **191**, 391.
13. Biaglow, A. I., Gorte, R. J., & White, D. *J. Catal.*, 1994, **148**, 779.
14. Lassoued, A., Lalo, C., Deson, J., Batamack, P., Fraissard, J. *et al. Chem. Phys. Lett.*, 1999, **3030**, 368.
15. Cheung, T. K., & Gates, B. C. *Chemtech*, 1997, **Sept.**, 28.
16. Hoelderich, W. F., & Heinz, D. *Res. Chem. Intermed.*, 1998, **24**, 337.

17. Armor, J. N. *App. Catal.*, 1991, **78**, 141.
18. Abrams, L., & Corbin, D. R. In *Inclusion Chemistry With Zeolites: Nanoscale Materials by Design* (Herron, N., & Corbin, D. R., eds). Kluwer Academic, Dordrecht, 1995, p. 1.
19. Davis, M. E. *Microp. Mesop. Mater.*, 1998, **21**, 173.
20. Venuto, P. B. *Microp. Mater.*, 1994, **2**, 297.
21. Botella, P., Corma, A., Lopez-Nieto, J. M., Valencia, S., & Jacquot, R. *J. Catal.*, 2000, **195**, 161.
22. Corma, A., & Garcia, H. *Catal. Today*, 1997, **38**, 257.
23. Horsley, J. A. *Chemtech*, 1997, **Oct.**, 45.
24. Corma, A. *Chem. Rev.*, 1995, **95**, 559.
25. Beck, J. S., & Vartuli, J. C. *Curr. Opin. Solid State Mater. Chem.*, 1996, **1**, 76.
26. Maxell, I. E., & Lednere, P. W. *Curr. Opin. Solid State Mater. Chem.*, 1996, **1**, 57.
27. Corma, A. *Curr. Opin. Solid State Mater. Chem.*, 1997, **2**, 63.
28. Corma, A. *Chem. Rev.*, 1997, **97**, 2373.
29. Corma, A., & Martinez, A. *Catal. Rev. Sci. Eng.*, 1993, **35**, 483.
30. Hoelderich, W. F., & Van Bekkum, H. *Stud. Surf. Sci. Catal.*, 1991, **58**, 631.
31. Mizuno, N., & Misono, M. *Chem. Rev.*, 1998, **98**, 199.
32. Drago, R. S., Dias, J. A., Maier, T. J. *Am. Chem. Soc.*, 1997, **119**, 7702.
33. Okuhara, T., Wantanabe, H., Nishimura, T., Inumaru, K., & Misono, M. *Chem. Mater.*, 2000, **12**, 2230.
34. Marme, F., Coudurier, G., & Viedrine, J. C. *Microp. Mesop. Mater.*, 1998, **22**, 151.
35. Izumi, Y., Ono, M., Kitagawa, M., Yoshida, M., & Urabe, K. *Microp. Mater.*, 1995, **5**, 225.
36. Misono, M. *Korean J. Chem. Eng.*, 1997, **14**, 427.
37. Mizuno, N., & Misono, M. *Curr. Opin. Solid State Mater. Sci.*, 1997, **2**, 84.
38. Yadav, G. D., & Bokade, V. V. *App. Catal. A: Gen.*, 1996, **147**, 299.
39. Shikata, S., Nakata, S., Okuhara, T., & Misono, M. *J. Catal.*, 1997, **166**, 263.
40. Shikata, S., Nakata, S., Okuhara, T., & Misono, M. *J. Mol. Catal. A: Gen.*, 1995, **100**, 49.
41. Okuhara, T., Mizuno, N., & Misono, M. *Adv. Catal.*, 1996, **41**, 113.
42. Farneth, W. E., Staley, R. H., Domaille, P. J., & Farlee, R. D. *J. Am. Chem. Soc.*, 1987, **109**, 4018.
43. US Patents 5986155, 5817831, 5710225 and 5712413.
44. Howard, M. J., Sunley, G. J., Poole, A. D., Watth, R. J., & Sharma, B. K. *Stud. Surf. Sci. Catal.*, 1999, **121**, 61.
45. Vadav, G. D., & Nair, J. J. *Microp. Mesop. Mater.*, 199, **33**, 1.
46. Clark, J. H., Monks, G. L., Nightingale, D. J., Price, P. M., & White, J. F. *J. Catal.*, 2000, **193**, 348.
47. Parvulescu, V., Coman, S., Grange, P., & Parvulescu, V. I. *App. Catal. A: Gen.*, 1999, **176**, 27.
48. Song, X., & Sayari, A. *Catal. Rev. Sci. Eng.*, 1996, **38**, 329.
49. Ward, D. A., & Ko, E. I., *J. Catal.*, 1994, **150**, 18.
50. Kumbhar, P. S., Yadav, V. M., & Yadav, G. D. In *Chemically Modified Oxide Surfaces* (Leyden, D. E., & Collins, W. T., eds). Gordon and Breach, Langhorne, PA, 1989, p. 81.
51. Yamaguchi, T. *Appl. Catal.*, 1990, **61**, 1.
52. Arata, K., & Hino, M. *Appl. Catal.*, 1990, **59**, 197.
53. Kustov, L. M., Kazansky, V. B., Figueras, F., & Tichit, D. *J. Catal.*, 1994, **150**, 143.
54. Hattori, H. *Stud. Surf. Sci. Catal.*, 1993, **77**, 69.
55. Olah, G. A. In *Acidity and Basicity of Solids* (Fraissard, J., & Petrakis, L., eds). Kluwer Academic, Dordrecht, 1994, pp. 305–334.
56. Olah, G. A., Iyer, P. S., & Prakash, G. K. S. *Synthesis*, 1986, **7**, 513.
57. Sharma, M. M. *React. Polym.*, 1995, **20**, 1.
58. Chakrabarti, A., & Sharma, M. M. *React. Polym.*, 1993, **20**, 1.
59. Kun, K. A., & Kunin, R. J. *Polym. Sci., Part A-1*, 1968, **6**, 2689.
60. Bhagade, S. S., & Nageshwar, G. D. *Chem. Petro-Chem. J.*, 1977, **8**, 9; 1978, **9**, 3; 1978, **9**, 21; 1980, **11**, 23; 1980, **12**, 21.
61. Widdecke, H. In *Syntheses and Separations Using Functional Polymers* (Sherrington, D. C., & Hodge, P., eds). John Wiley, Chichester, 1988, p. 149.
62. Neier, W. In *Ion Exchangers* (Dorfner, K., ed.). Walter de Gruyter, Berlin, 1991, p. 981.
63. Albright, R. L. *Catal. Supp. React. Polym.*, 1987, **6**, 329.
64. Samms, S. R., Wasmus, S., & Savinell, R. F. *J. Electrochem. Soc.*, 1996, **143**, 1498.
65. Harmer, M. A., Sun, Q., & Farneth, W. E. *J. Am. Chem. Soc.*, 1996, **118**, 7708.
66. Panneman, H. J., & Beenackers, A. A. C. M. *Ind. Eng. Chem. Res.*, 1995, **34**, 4318.
67. Parra, D., Izquierdo, J. F., Cunill, F., Tejero, J., et al. *Ind. Eng. Chem. Res.*, 1998, **37**, 3575.
68. Buttersack, C. *React. Polym.*, 1989, **10**, 143.
69. Olah, G. A., Shamma, T., & Surya Prakash, G. K. *Catal. Lett.*, 1997, **46**, 1.
70. Gunatillake, P. A., Meijs, G. F., Chatelier, R. C., McIntosh, D. M., & Rizzardo, E. *Polym. Int.*, 1992, **27**, 275.
71. Armor, I. N. *Appl. Catal.*, 1991, **78**, 141.
72. Chauvel, A., Delmon, B., & Hoelderich, W. F. *Appl. Catal. A*, 1994, **115**, 173.
73. Wieland, S., & Panster, P. In *Heterogeneous Catalysis and Fine Chemistry IV* (Blaser, H. U., Baiker, A., & Prins, R., ed.). Elsevier, Amsterdam, 1997, pp. 67–74.
74. Olah, G. A., Shamma, T., & Prakash, G. K. S. *Catal. Lett.*, 1997, **46**, 1–4.
75. Yadav, G. D., & Krishnan, M. S. *Org. Process Res. Dev.*, 1998, **2**, 86.
76. Yadav, G. D. *Org. Process Res. Dev.*, 1997, **1**, 97.
77. Yoshida, K., & Okita, T. Japanese Patent 96-231008 960830.

78. Fan, K., Ouyang, P., & Wu, X. *Huaxue Yanjiu Yu Yingyong*, 1999, **11**, 83.
79. Aguado, A. J., Romero, M. D., Rodriguez, A. R., Ferrer, J. R., & Perez, M. A. *Rev. R. Acad. Cienc. Exactas, Fis. Nat. Madrid.*, 1996, **90**, 211.
80. Liao, S., & Zhang, X. *Huanan Ligon Daxue Xuebao, Ziran Kexueban*, 1997, **25**, 88.
81. Yan, G., Zhong, L., & Yan, X. *Huaxue Yu Nianhe*, 1997, **1**, 26.
82. Bart, H. J., Kaltenbrunner, W., & Landschuetzer, H. *Int. J. Chem. Kinet.*, 1996, **2**, 649.
83. Saha, B., & Streat, M. *React. Funct. Polym.*, 1999, **40**, 13.
84. Gil, A., Gandia, L. M., & Vicente, M. A. *Catal. Rev., Sci.Eng.*, 2000, **42**, 145.
85. Chitnis, S. R., & Sharma, M. M. *React. Funct. Polym.*, 1997, **32**, 93.
86. Figueras, F. *Catal. Rev., Sci.Eng.*, 1988, **30**, 457.
87. Rm, Barrer, M. *Phil. Trans. R. Soc. Lond. A*, 1984, **311**, 333.
88. Adams, J. M., Martin, K., & McCabe, R. W. *J. Incl. Phen.*, 1987, **5**, 663.
89. Rohm & Haas, US Patent 5426199.
90. Harmer, M. A., Sun, Q., Vega, A. J., Farneth, W. E., Heidekum, A., & Hoelderich, W. F. *Green Chem.*, 2000, **6**, 7.
91. Harmer, M. A., Farneth, W. E., & Sun, Q. *Adv. Mater.*, 1998, **10**, 1255.
92. Olha, G. A., Torok, B., Shamma, T., Torok, M., & Prakash, G. K. S. *Catal. Lett.*, 1996, **42**, 5.
93. Botella, P., Corma, A., & Lopez, M. *J. Catal.*, 1999, **185**, 371.
94. Sun, Q., Harmer, M. A., & Farneth, W. E. *Ind. Eng. Chem. Res.*, 1997, **36**, 5541.
95. Rosenwald, R. H. In *Kirk-Othmer Encyclopedia of Chemical Technology* (Grayson, M., ed.). John Wiley, New York, 1978, pp. 50–72.
96. Campbell, C. B., Onopchenko, A., & Young, D. C. *Ind. Eng. Chem. Res.*, 1990, **29**, 642.
97. Slomkiewicz, P. M. *React. Funct. Polym.*, 1997, **33**, 299.
98. Clarembeau, M., & Steylaerts, P. US Patent 5,849,974.
99. Sun, Q., Harmer, M. A., & Farneth, W. E. *J. Chem. Soc., Chem. Commun.*, 1996, 1201.
100. Sun, Q., Farneth, W. E., & Harmer, M. A. *J. Catal.*, 1996, **164**, 62A.
101. Heidekum, A., Harmer, M. A., & Hoelderich, W. F. *J. Catal.*, 1999, **188**, 230.
102. Heidekum, A., Harmer, M. A., & Hoelderich, W. F. *J. Catal.*, 1998, **176**, 260.
103. Heidekum, A., Harmer, M. A., & Hoelderich, W. F. *J. Catal.*, 1999, **181**, 217.
104. Palinko, A., Torok, B., Surya Prakash, G. K., & Olah, G. A. *Appl. Catal. A: Gen.*, 1998, **174**, 147.
105. Hommeltoft, S. I., Efelund, O., & Zavilla, J. *Ind. Eng. Chem. Rev.*, 1997, **36**, 3491.
106. Steigleder, K. Z., Gosling, C. D., Spinner, J. B., & Shields, D. J. AICHe 2000 Spring Meeting, 3rd International Conference on Refinery Processing, Atlanta, Georgia, USA, March 2000, p. 529.
107. Guarino, R. F., & Li, C. H. *Hydrocarbon Eng.*, 1999, **Oct.**, 39.
108. Marcus, B. K., & Cormier, W. E. *Chem. Eng. Prog.*, 1999, **June**, 47.
109. Meima, G. R., Van der Aalst, M. J. M., Samson, M. S. U., Garces, J. M., & Lee, J. G. *Jahrgang*, 1996, **718**, 315.
110. O'Rear, D. J., & Scheurman, G. L. 214th National Meeting of American Chemical Society, Las Vegas, Sept. 1997, p. 863.
111. Miller, S. J. *Macrop. Mater.*, 1994, **2**, 439.
112. Miller, S. J. *Stud. Surf. Sci. Catal.*, 1994, **84**, 2319.

Chapter 7: Micelle-templated Silicas as Catalysts in Green Chemistry

DUNCAN MACQUARRIE

1 Introduction

The subject of this chapter is the use of micelle-templated silicas as catalysts for green chemistry. Micelle-templated silicas (and related materials) are mesoporous inorganic solids that serve as supports for catalysts or, with appropriate framework substitution, as catalysts in their own right. Limiting the chapter to these structured mesoporous systems leaves out the large body of work carried out on amorphous, irregular mesoporous solids such as modified chromatographic silicas. However, the potential of the newer, structured materials parallels that of the amorphous materials in the majority of cases, with the additional benefit of a more regular structure capable of shape selectivity in some applications and a more regular environment for the catalytic centre. Reviews on functional mesoporous, amorphous systems are available [1–5].

2 Structured Mesoporous Materials

The ability to produce mesoporous materials with highly controllable structural features has been enhanced dramatically by the discovery of the micelle-templated silicas [6–8] and, less directly relevant so far to green chemistry, many other metal oxides. These materials can be produced relatively easily using sol–gel techniques with micellar templates. In this respect, the synthesis of such materials can be considered as being broadly analogous to those of the microporous zeolites discussed elsewhere in the book. The synthesis of zeolites involves the (hydrolysis and) condensation of inorganic monomeric species around a single molecule template (typically a quaternary ammonium salt), leading to a regular inorganic material with occluded template molecules. This very regular material then is treated thermally to remove the template molecules, leaving behind a highly structured *microporous* solid. Within the pores are found catalytically active sites, usually associated with a heteroatom

such as Al (acid zeolite) or a transition metal (redox-active zeolites). The most well-known and successful example of the latter class is the titanium silicalite zeolite TS-1, which is a very effective oxidation catalyst that functions by the activation of hydrogen peroxide [9–13].

Although these microporous materials are exceptionally good at the transformation of small molecules and are used extensively in industry for the conversion of small-molecule hydrocarbon feedstocks, their small pore size precludes them from wider use, in particular limiting their application in synthetic organic chemistry.

The advent of the first of the micelle-templated materials brought with it the promise of an extension of the remarkable chemistry associated with zeolites to such larger molecule chemistry. Although the extension to such systems has not been quite as direct as initially expected, these materials are nonetheless displaying great promise in a range of applications, including many for which zeolites are not suitable. Reviews on the synthesis and properties of these systems are available [14–21], as are reviews on catalytic applications [22,23].

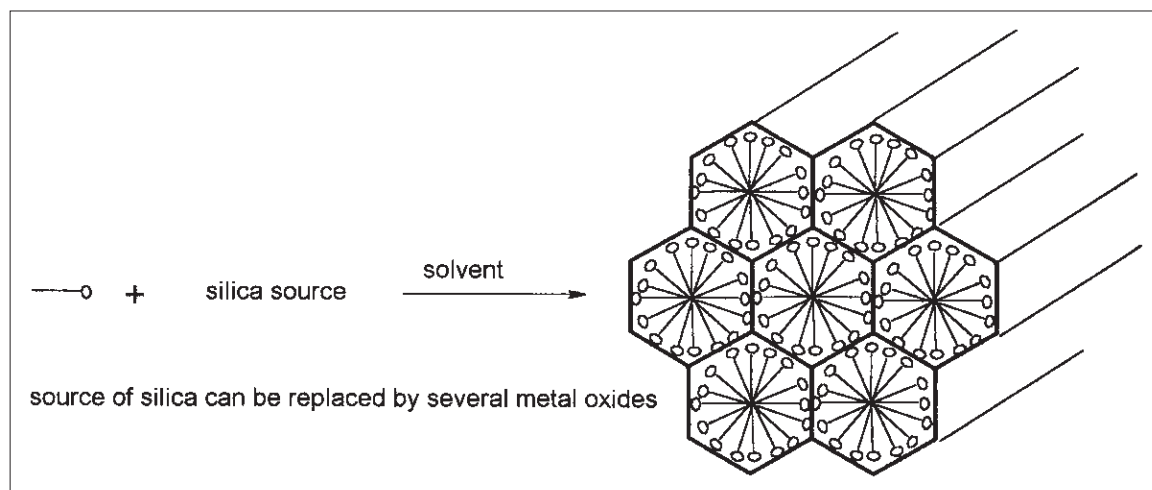
2.1 Synthesis of micelle-templated materials

One of the most positive aspects of these materials is that the synthesis of the materials is generally relatively simple (manipulatively speaking; the detailed nature of the chemistry involved is very complex). Coupled with a great deal of flexibility, the range of materials accessible is remarkably high. Already, a wide range of materials can be prepared, including silicas (either purely silica-containing or doped with a wide range of other transition and non-transition elements), alumina [24–26], zirconia [27–29], tin oxide, niobium and tantalum oxides [30–32]. Additionally, it is possible to incorporate organic groups during the synthesis as well as post-synthetically [33–35].

The basic synthetic strategy involves the condensation of an appropriate monomer (for silica species this is typically $(\text{EtO})_4\text{Si}$ (tetraethyl orthosilicate, TEOS) or a salt of the SiO_4^{2-} anion). The condensation is carried in the presence of a surfactant, which exists as micellar aggregates before the start of reaction or, more typically, forms micellar aggregates as the hydrolysis reaction proceeds. The micellar aggregates generally are thought to be rod-like and the inorganic precursors assemble around these rods, condensing to give a silica framework encasing the micelles (Fig. 7.1). Depending on the nature of the surfactant, these silica-micelle tubes can align with each other to differing degrees, with charged surfactants appearing to give the highest long-range order. In the final stage of the synthetic procedure, the template is removed from the composite material formed, leaving what is essentially an amorphous silica with regular cylindrical pores where the micellar template was.

The fact that the pores are formed by the removal of template allows the control of pore size by simply adjusting the synthesis conditions to expand or contract the micelle. This can be done by a number of well-established methods (Fig. 7.2). Apart from changing the chain length of the surfactant, the addition of co-surfactants or micelle-swelling agents can change the pore diameter by an enormous extent.

Fig. 7.1 Idealised mechanism for the synthesis of micelle-templated materials.



Co-surfactants are typically short-chain alcohols that become incorporated in the outer layer of the micelle (the palisade layer). This allows the surfactant tail to curl up somewhat, reducing the head-to-tail distance and contracting the micelle. Similarly, the use of aromatics such as mesitylene can have one of two effects. In solvent mixtures of low polarity the aromatic molecules can partition in the palisade layer, again causing contraction of micelles and lower pore size. On the other hand, in highly polar mixtures in which the aromatic is insoluble, the aromatic will partition in the centre of the micelle and thus minimise solvent–aromatic interactions. This means that the micelle swells and the pore diameter is increased. This effect was utilised in the initial work of Beck *et al.*, who prepared materials with pore sizes of up to 10 nm by this route. Similar phenomena have been demonstrated using alkanes as swelling agent.

The choice of surfactant is an important feature of the synthetic design. A variety of approaches have been developed and these have been categorised into an overall framework by Stucky *et al.* [36,37]. The possible systems that have been defined are indicated in Fig. 7.3.

The most commonly utilised methods involve three groups of surfactants—the quaternary ammonium salts (S^+), the neutral amines (S^0) and the block copolymers (N^0). The block copolymers are typically poly(ethylene glycols) endcapped with long alkyl chains or poly(ethylene glycol-co-propylene glycol-ethylene glycol) triblock polymers. The choice

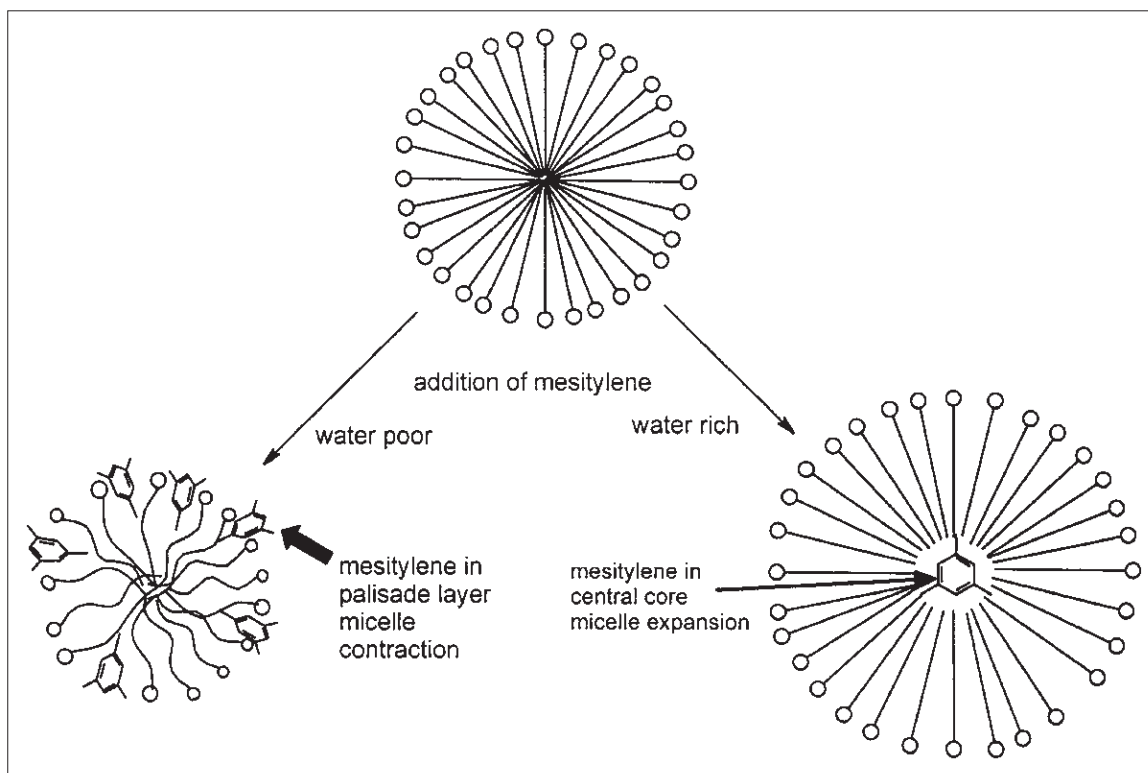


Fig. 7.2 Control over pore size by micelle expansion and contraction.

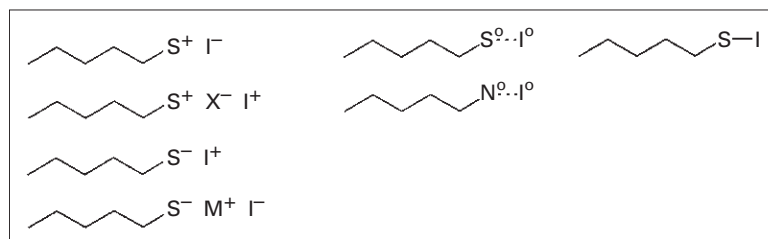


Fig. 7.3 Schematic summary of the possible templating systems used for micelle-templated assembly: I, inorganic species; S, surfactant head group (S^+ , typically trimethylammonium; S^- , typically sulfonate; S^\ominus , NH_2); N^\ominus , a polyether; X^- and M^+ , mediating counter-ions; —, H-bond interactions. The right-hand structure with its full bond between S and I is a covalently attached system.

of template can influence the material in several ways. The charged templates produce the materials with the most extensive long-range order and possibly the tightest pore size distribution, whereas the

non-charged materials display lower long-range order and slightly wider pore size distributions (although these are still very narrow). It is unlikely that, in the majority of cases, either of these factors will be of major importance in catalytic applications. However, a very important factor in the production of catalysts based on this technology is the recovery of template, both on economic and environmental grounds. Here, the quaternary-derived materials suffer from a major drawback. It is very difficult to remove the template in such a way that it can be recovered [38]. The traditional method to remove

templates from such materials is to calcine the material and burn the template out. It has been shown that solvent extraction methods are poorly suited to remove quaternary ammonium templates from these materials, not least because the template can exist as a counter-ion if there is Al in the framework (this imparts a negative charge on the inorganic matrix, which is counterbalanced by the quaternary cation). This can be ion exchanged but the process is relatively difficult and leads to salt waste being produced. It is likely that more recent advances, such as supercritical fluid extraction using CO₂ doped with methanol [39,40] or just CO₂ (for the case of amine templates), may prove to be effective routes to template removal and recovery [41]. Jaroniec's recent discovery that the template can be removed by reaction with silanes (Fig. 7.4) is a major and remarkable step towards the efficient and clean preparation of organically modified MCMs (see Section 2.3) [42].

In contrast, the removal of neutral surfactants (amines and polyethers) is very simple. The relatively weak interactions between the template and the wall of the material (H-bonding) can be broken easily by heating in a H-bonding solvent such as water or ethanol, and the template can be recovered completely, leaving behind the inorganic framework and a solution of template [43,44]. These methods are currently the greenest way to prepare such materials.

Thus, several routes exist to form a host of materials that all display high surface area, controllable and well-defined porosity (both shape and size of pores) and excellent stability. In terms of catalytic applications, the vast majority of cases involve silicas or materials that are predominantly silica with small amounts of other ions (typically tri- or tetravalent). The subsequent modification of these materials constitutes a further elaboration of these materials.

2.2 Post-functionalisation of micelle-templated materials

Analogously to silicas, these materials can be reacted with a range of other compounds, both inorganic and organic, to give a range of modified materials. Examples include post-modification with AlCl₃ [45,46], organic functions such as simple amines [47–50], transition metal complexes [51–57] and chiral catalytic centres [58–63] all leading to catalytic materials with a range of active centres. The post-functionalisation relies on the same methodology as for the analogous reaction on amorphous silicas [64,65] (Fig. 7.5), although the organic modification of these materials does allow for one novel route.

Typically, the functionalisation of silicas with organic groups takes place via an organically modified silane (RO)₃SiR', where R is usually Me or Et and R' contains the active group. These molecules react with the surface of the silica by one (or both) of two routes: the hydrolysis–condensation reaction (when the reaction is carried out in protic solvents); or a metathetical route involving siloxane bridges, which predominates in non-hydroxylic solvents such as toluene [66] (Fig. 7.6).

2.3 Direct preparation of organically modified micelle-templated silicas

The hydrolysis–condensation reaction is the reaction that takes place during the synthesis of silicas (and micelle-templated silicas) when TEOS is used as the source of silica (a similar reaction occurs with the anionic silicate route, where SiO⁻ units are protonated to give SiOH, which then condenses in a similar way). This has prompted researchers to develop routes to organically modified materials where TEOS is not condensed alone, but rather in conjunction with one or even two additional organosilanes, in the presence of a template, leading

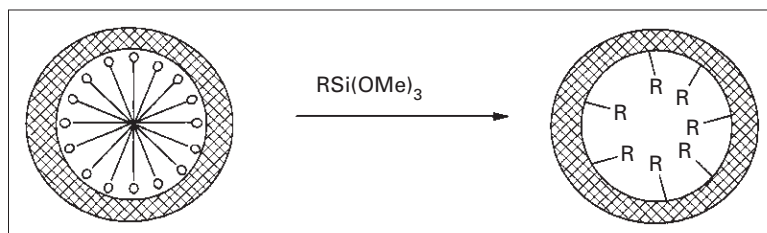


Fig. 7.4 Direct template removal and functionalisation.

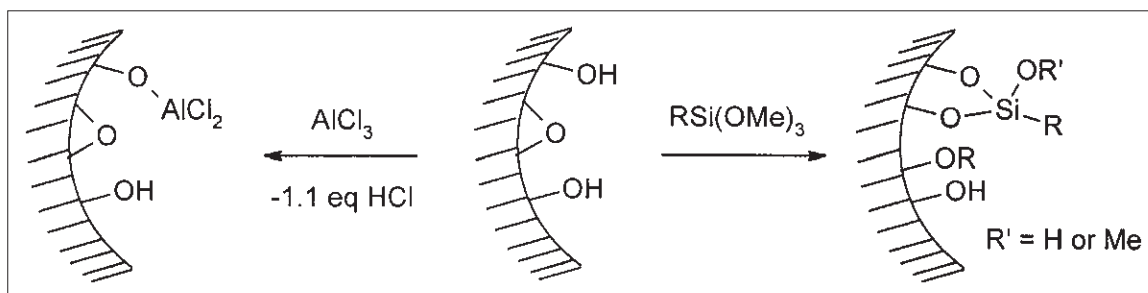


Fig. 7.5 Representative mechanisms for the functionalisation of micelle-templated silicas [64,65]. Group R can be functionalised further to elaborate the group if required.

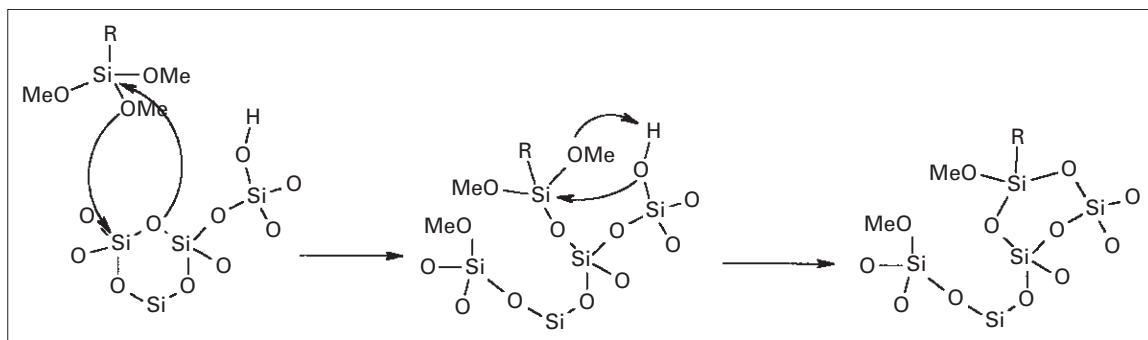


Fig. 7.6 Proposed mechanisms for the functionalisation of silica surfaces with silanes.

directly to the preparation of organically modified micelle-templated silicas (Fig. 7.7). This aspect of these materials has been reviewed recently from the materials perspective [21].

Examples of materials prepared with quaternary salts, neutral amines and polyethers are known [33–35], the latter two groups being more accessible due to the ease of template removal, which is especially important in the preparation of solids containing organic functions. This route has the advantages of simplicity—one step fewer is required, complete incorporation of both silanes is often the case (rarely achieved with post-functionalisation, where excess silane is required to drive the reaction) and complete recovery of template using one of the reaction solvents makes the process simple, mild and atom efficient. This has been demonstrated in the case of aminopropyl-functionalised HMS materials (those prepared with a long-chain amine template), which

are active basic catalysts [67,68]. Furthermore, much higher loadings can be achieved and the silanes are incorporated more robustly into the framework, leading to more thermally and solvolytically stable materials. This latter point has been demonstrated by Macquarrie *et al.*, who have published details of the stability of such materials using ^{29}Si magic-angle spinning nuclear magnetic resonance (^{29}Si MAS NMR) to quantify the extent of binding of the silane to the material [69] and thermal analysis, which indicated that in one material organic groups were not lost until $>500^\circ\text{C}$ [34]. The different synthetic procedure may lead to materials that have different distributions of sites on the surface than those found in post-modification of (calcined) silicas and micelle-templated silicas, where grafting (in toluene) is thought to take place only on hydrophobic patches [66].

These materials are characterised by a very high surface area, controllable and regular pore size and geometry (which is very well suited to diffusion) and excellent thermal stability. In some cases, particularly where in-pore chemistry is vital to the success

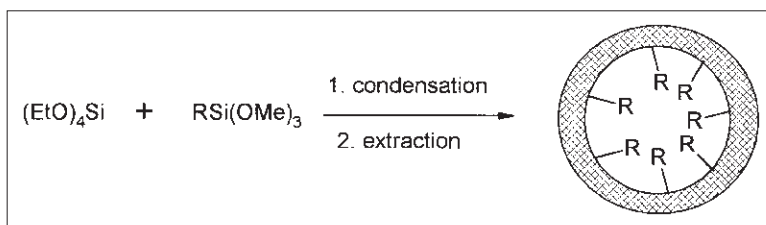


Fig. 7.7 Direct route to organically modified micelle-templated silicas.

of the catalyst (e.g. shape selectivity or enantioselective reactions, where inclusion phenomena may play a key role in transition state determination), the small amount of external surface sites may need to be blocked, leaving the only active sites inside the pores. This can be done by using an appropriate poison of large dimensions to block selectively the external sites while causing minimal disruption to in-pore sites. Poisons such as triphenylamine [45,46] have been used to block external acid sites, whereas large silanes such as $\text{Ph}_2\text{Si}(\text{OR})_2$ have been used successfully to cap external silanols [59,70], which are often a source of some catalytic activity.

In summary, there exists a range of methods for preparing catalysts under controlled conditions that display a range of excellent properties, including structural regularity, high surface area and chemical and thermal stability, the synthesis of which can be modified by choice of templating agent and synthesis conditions and can be modified subsequently by a range of techniques. Further sections of this chapter will concentrate on the catalytic applications of these materials.

3 Catalytic Applications

3.1 Fundamental activity of micelle-templated silicas and aluminosilicas

Because the zeolites display exceptional acidic properties, especially when containing a small quantity of Al in their framework, it is not surprising that early attempts to utilise their larger pore congeners focused on similar acidic processes. Somewhat disappointingly, the MCMs and related compounds are only mildly acidic. Thus, with a few exceptions, the hydrocarbon cracking reactions typical of zeolites are beyond the scope of these materials.

More typical of the reactivity is the formation of tetrahydropyranyl ethers (Fig. 7.8)—a useful protec-

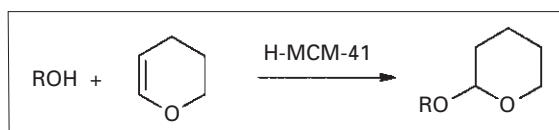


Fig. 7.8 Protection of alcohols as tetrahydropyranyl ethers.

tion strategy in synthetic chemistry that can be carried out with the H^+ form of MCM-41 [71].

The catalyst H-MCM-41 has been found to be a good catalyst for the acylation of 2-methoxynaphthalene (Fig. 7.9), which is of interest in the synthesis of intermediates for Naproxen, an anti-inflammatory [72]. The catalyst is capable of the acylation of this activated substrate in reasonable conversion and good selectivity towards the 1-acyl isomer. The acylating agent used is acetic anhydride, making the process potentially green, with the acetic acid by-product potentially recyclable. The Zn-exchanged MCM-41 also is a reasonably active catalyst for the same reaction, but using acetyl chloride as acylating agent. The reaction in this case is somewhat less selective. The H-MCM-41 catalyst also has shown activity in the related Fries rearrangement [73].

In short, the activity of the acid forms of MCM-41 (and probably its other mesoporous analogues) is substantially lower than the very high levels of acidity displayed by the zeolites. Thus, few real opportunities have arisen where these materials have shown promise as direct analogues of zeolites. Nonetheless, they have shown, and continue to show, great promise as catalyst supports and their heteroatom analogues (especially Ti) also display interesting behaviour in a range of applications.

The Na form of MCM-41 has been shown to have some activity for the Knoevenagel condensation [74,75]. This material, being slightly acidic due to the silanols in the walls but also containing mildly basic

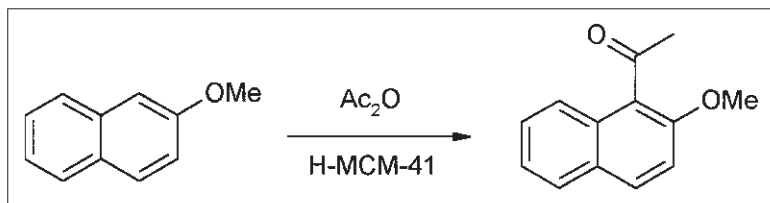


Fig. 7.9 Acylation of 2-methoxynaphthalene.

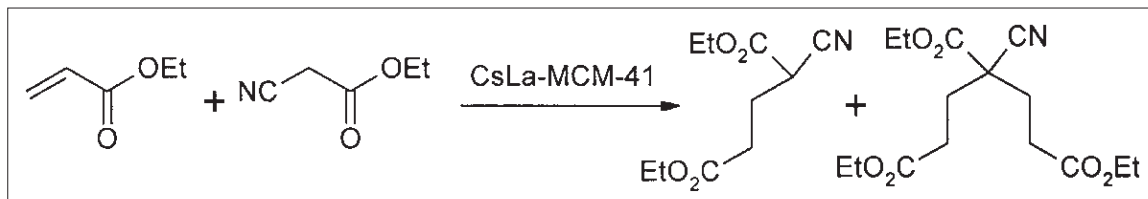


Fig. 7.10 Michael addition catalysed by basic MCM-41 catalysts.

sites, is ideal for the Knoevenagel condensation and, indeed, is a reasonably active catalyst for this important reaction, albeit significantly less active than the aminopropyl-containing materials discussed later, which also combine mild acid and base sites. The basicity of the Na-MCM-41 can be enhanced by doping with either Cs⁺ ions (which gives a more basic material of limited stability) or a combination of Cs⁺ and lanthanum ions, leading to a stable and highly basic catalyst (Fig. 7.10) [75]. These materials are effective in the Michael reaction of diethyl malonate with neopentylglycol diacrylate [76]. Selectivity was moderate and the double addition product was obtained in significant quantities. Selectivity with this catalyst was poorer than with the tertiary amine catalysts discussed in Section 3.4 [77], although the solvent and nucleophile are different (ethanol in this case, but bulk nitroalkane for the amine catalysts). The influence of solvent may be critical, because Mdoe observed considerable quantities of double addition product in water but not in nitroalkane [78].

3.2 Micelle-templated materials with enhanced acidity

The major problems to be solved in the realm of acid catalysis involve the replacement of AlCl₃ and mineral acids, especially sulfuric acid. Mesoporous

materials have been developed that contribute to the replacement of these acids in some applications. Clark *et al.* have published details of a mesoporous silica post-treated with AlCl₃, which has activity similar to that of AlCl₃ [45,46]. This material is directly analogous to the amorphous silica version, which was described in 1995 [79]. The preparation of the material is simple but requires some care in order to produce an active catalyst. The catalyst displays activity equivalent to AlCl₃ in Friedel–Crafts alkylation reaction of benzene with 1-alkenes, particularly longer chain alkenes such as 1-dodecene. This reaction is of enormous industrial importance, being the first step towards the production of linear alkylbenzene sulfonates, a major class of surfactants. As with all Friedel–Crafts alkylations, the product aromatic is more active than the substrate and thus will be alkylated readily twice, causing problems for selectivity. The dialkyl product is of no use and levels are minimised normally by using a large excess of benzene, meaning that vessel utilisation is poor. The original amorphous silica-based catalyst displayed identical activity to homogeneous AlCl₃ and thus did not improve selectivity greatly. However, a series of catalysts based on the adsorption of AlCl₃ onto different mesoporous silicas, with and without poisoning of external sites with triphenylamine, was shown to have a major influence on monoalkylation/dialkylation selectivity, as shown in Fig. 7.11.

It can be seen that the selectivity increases as alkene chain length increases, and reaches around 95%. This is achieved at a benzene/dodecene ratio of 2:1, which is much more concentrated than is

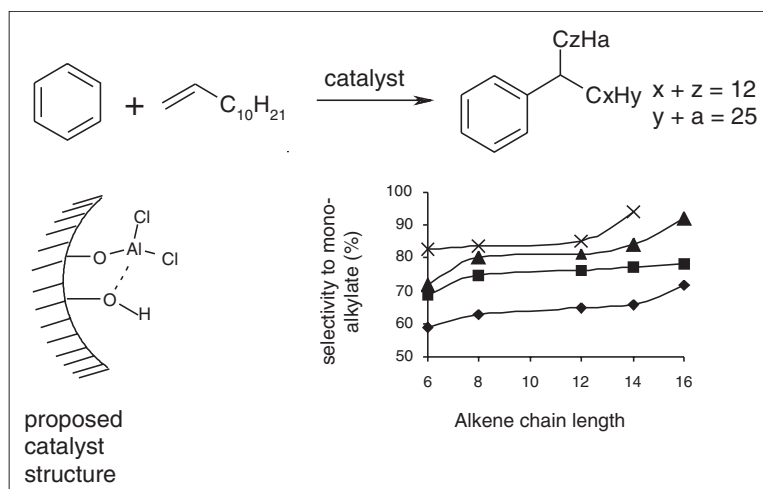


Fig. 7.11 Alkylation of benzene with 1-alkene over AlCl₃-HMS catalysts. Crosses: AlCl₂-HMS₂₄-Ph₃N; triangles: AlCl₂-HMS₂₄-Ph₃N; squares: AlCl₂-K100; diamonds: AlCl₃.

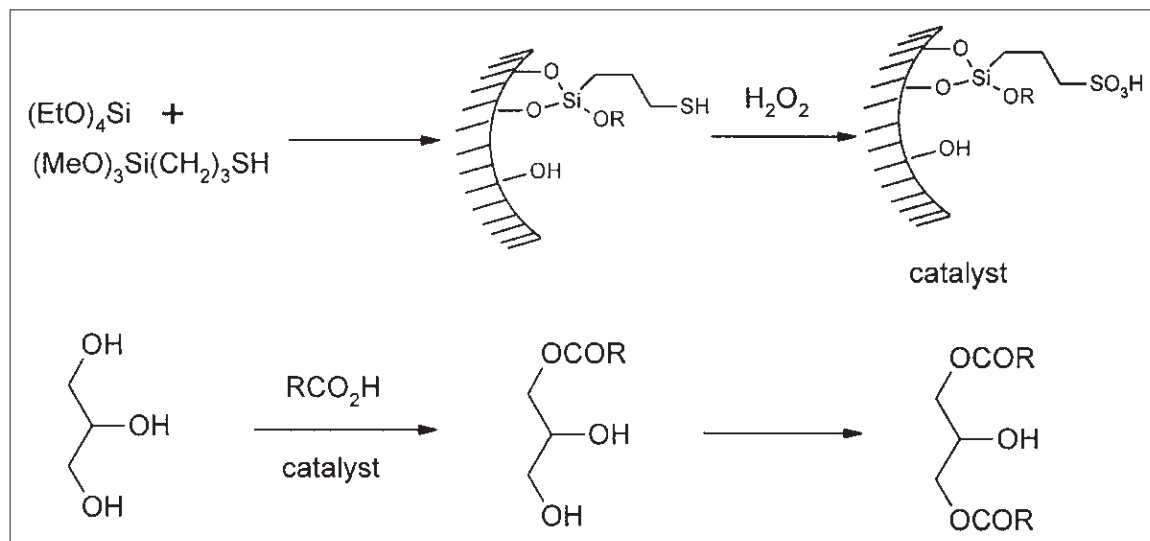


Fig. 7.12 Preparation of a solid sulfonic acid and its use in glycerol esterification.

possible with the homogeneous version. Eventually, reaction stops as the pores become too small, but the behaviour of the catalyst makes it a very promising alternative to homogeneous aluminium chloride. Similar results were obtained with catalysts of differing pore sizes over the range 1.6–2.4 nm.

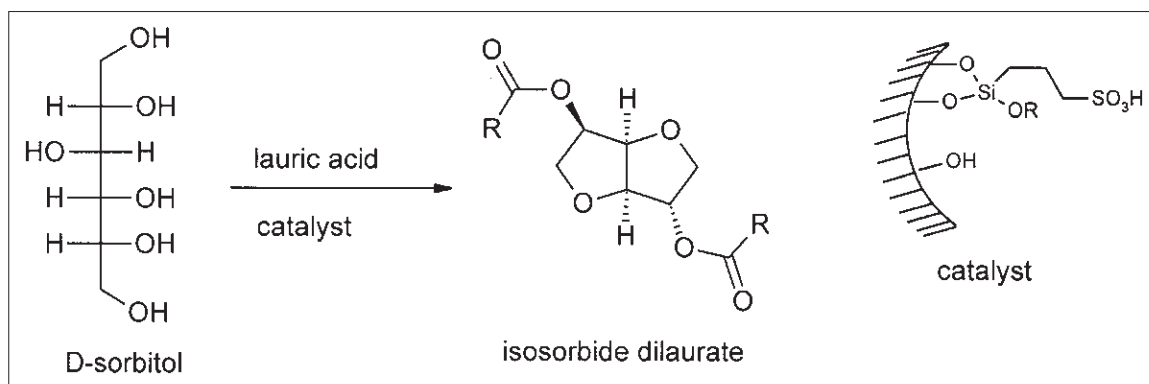
Contributions to the replacement of sulfuric acid also have been made. Jacobs & De Vos have

extended the one-step preparation of organically modified mesoporous materials [34,69] to prepare mercaptopropyl-modified materials, which they then oxidised using hydrogen peroxide to give a supported sulfonic acid [80]. They have then utilised this material in some acid-catalysed reactions. The materials show excellent activity in the mono-esterification of glycerol with fatty acids, a reaction of significance in the preparation of emulsifiers and one that is complicated by the similar reactivities of the three hydroxyl groups in glycerol (Fig. 7.12).

Alternative strategies are discussed under base catalysis (Section 3.4). The catalysts were prepared via the one-pot route and post-modification. Selectivities were found to be excellent, giving yields of monoglyceride above 50%, which outperforms Amberlyst® resin and H-USY zeolite. The catalyst is reusable with virtually identical activity [81]. A related application—the esterification of sorbitol with lauric acid—is disclosed in a second publication [82]. Isosorbide dilaurate is formed in excellent selectivity and high yields under mild conditions (Fig. 7.13). The hydrophobicity of the materials is cited as a reason for the excellent activity of the mesoporous materials, allowing the adsorption of the fatty acid.

Increasing the hydrophobicity of the catalysts has been achieved by co-condensation of the mercaptopropylsilane, a methylsilane and tetramethyl orthosilicate [83]. They studied the effect of varying the sulfonic acid/methyl ratio of the oxidised catalysts in the monoesterification of glycerides. They found that increasing the amount of methyl groups led to a significant increase in reaction rate up to a certain ratio and then a subsequent decrease. Activity per SO₃H group increased substantially and then levelled off. With these catalysts, better selectivities and yields were obtained than with the catalysts above, indicating that the ability to control catalyst hydrophobicity is of vital importance in the performance of these catalysts (Fig. 7.14) [84]. These results mirror those found both for epoxidation catalysts and base catalysts, as discussed below.

Fig. 7.13 Preparation of isosorbide dilaurate.



A second application of this material is the Friedel–Crafts alkylation of furan with acetone to give the difurylmethane derivative shown in Fig. 7.15 [82]. The strongly acidic catalyst produces an excellent yield of product (up to 95%) without any indication of by-products resulting from the self-condensation of acetone.

A simplified route to the one-pot materials has been published by Stucky *et al.* recently [85]. Their innovation involves the use of polyether templates for the synthesis of the materials, which is carried out in the presence of hydrogen peroxide to give directly the sulfonic acid after template removal.

The strongly acidic nature of the catalysts appears to make them promising candidates for a range of applications where strong Brønsted acidity is required.

3.3 Oxidation catalysis

The advent of mesoporous materials and their relationship to the microporous zeolites has led to a substantial amount of work in the field of oxidation, especially as the discovery of templated mesoporous silicas came only about a decade after the discovery of the Ti-containing zeolite TS-1, a discovery that made an enormous impact on oxidation catalysis but was hampered by the small pore size of the material (ca. 0.6 nm) [11–13].

Epoxidation

One of the major successes of TS-1 was epoxidation. Because there is a wide range of target epoxides of

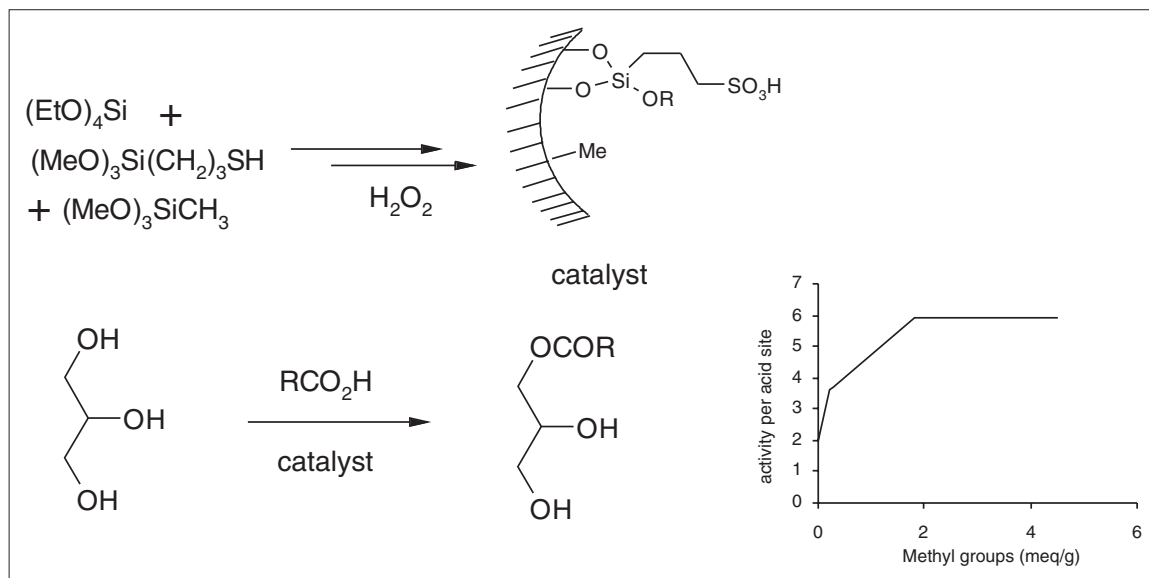


Fig. 7.14 Influence of hydrophobisation of the surface on esterification activity.

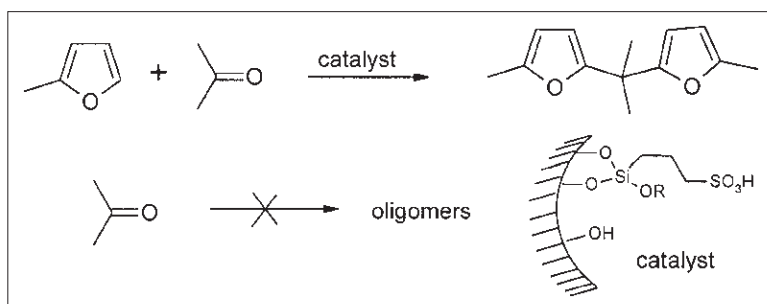


Fig. 7.15 Formation of difurylmethanes using sulfonic acid catalysts.

varying size and bulkiness, many attempts have been made to mimic TS-1 using mesoporous analogues. The work has met with some success but it has also highlighted the dangers of assuming that the newer mesoporous materials are simply zeolites of larger pore size. As was seen for the acid catalysts described earlier, the activities can be very different. This is true for the Ti materials too, where the much more hydrophilic nature of the mesoporous materials causes a significant reduction in activity and selectivity compared with that of the hydrophobic TS-1. The following section details the attempts to produce an effective Ti catalyst that can be used in epoxidation reactions, especially with the green oxidant hydrogen peroxide [86]. Following on from this is a

discussion of alternative catalytic systems that can be used in epoxidation.

Early attempts to prepare and use Ti-containing mesoporous materials met with enough success to encourage several groups to modify the catalysts and to enhance their activity significantly. Initial work was done by the groups of Pinnavaia [87] and Corma [88,89], both of whom showed that Ti-containing materials could be synthesised readily in a straightforward extension of the all-Si procedures available using tetraalkyl titanates in addition to the silica precursor, and that the materials were active in epoxidations using hydrogen peroxide. As might be expected, bulkier substrates could be reacted within the pores of the catalyst than is possible with TS-1,

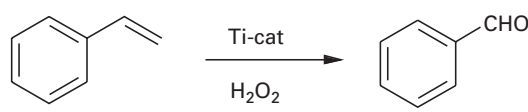
and this opened up a wide range of important transformations for these new catalysts. For example, the oxidation of α -terpineol proceeded smoothly in Ti-MCM-41 but not in TS-1, where the substrate is too bulky to enter the pores. A large-pore Ti-zeolite, Ti-BETA, also was evaluated and shown to be less active than Ti-MCM-41 in this reaction. Selectivity towards epoxide was moderate in both cases but better with the MCM material [89]. Pinnavaia's group [90] showed that Ti-HMS materials (prepared via neutral amine templating) were more active than Ti-MCM materials, due to the presence of textural porosity, which allows better access to the mesopores (Fig. 7.16). The Ti-HMS and Ti-MCM materials prepared by Pinnavaia also displayed the ability to oxidise aromatics, and this will be discussed later.

One drawback that was rapidly evident from this initial work was that the catalysts caused a substantial amount of non-productive decomposition of hydrogen peroxide. Several subsequent papers have addressed this problem, which is thought to be related to the hydrophilicity of the catalysts [91,92], being high enough to promote a substantial amount of peroxide decomposition but low enough to allow access and reaction of alkenes with the hydrogen peroxide. This is in apparent contrast to the work described above relating to fatty acid esterification, where the hydrophobicity of the catalysts was cited as a reason for their high activity. One possible explanation may lie in the different requirements of the different reactants. If we assume that the surface of the catalyst is strongly H-bonding active (which is likely to be the case due to the high numbers of polar hydroxyl groups on the surface), this would allow a strong interaction between the surface and the acid group in the fatty acid (beneficial due to activation of the reactant). This adsorption would render the

interior of the pores more hydrophobic due to the long alkyl chain of the acid, and encourage adsorption/desorption of products and reactants (even taking into account some pore size reduction due to partial blockage). A similarly strong interaction thus would be expected with hydrogen peroxide. However, in this case the interaction would be detrimental due to the increased likelihood of decomposition to water and oxygen. Thus, two modes of adsorption of hydrogen peroxide on Ti-substituted mesoporous silicas are possible: an interaction with SiOH, leading to destruction of the reagent; and an interaction with Ti=O, leading to activation and epoxidation. An alternative explanation may be that the active sites of the two catalysts lie in different regions of the two materials (calcined silicas and MTS materials consist of hydrophobic and hydrophilic patches [66]).

Interestingly, TS-1, which is known to be hydrophobic, causes very little hydrogen peroxide decomposition, which is another instance where the detailed chemistry of the zeolite systems and their templated analogues differs significantly. Such differences between the exact details of the surface chemistry of various silica materials (zeolitic, amorphous silica and the various micelle-templated materials) appear often, and it is important not to assume that the surface chemistry of all these systems is similar and will have little influence on the catalytic properties of the materials.

Efforts to enhance the hydrogen peroxide utilisation of these new catalysts have been made, with great success. Coverage of the surface of these materials with non-polar trialkylsilyl groups has been shown to enhance the performance of the catalysts substantially. In these cases, large increases in epoxide yield [92] and improvements in hydrogen



Catalyst	pore volume		conversion	selectivity	H ₂ O ₂ decomposition
	framework	textural			
Ti-MCM	0.68 cm ³ g ⁻¹	0.02 cm ³ g ⁻¹	10%	82%	3.8%
Ti-HMS	0.68 cm ³ g ⁻¹	0.72 cm ³ g ⁻¹	28%	77%	2.2%

Fig. 7.16 The influence of textural porosity on the efficiency of reaction between styrene and hydrogen peroxide. Similar trends were seen for the oxidation of methyl methacrylate to methyl pyruvate and the oxidation of phenols to quinones.

peroxide utilisation [91] were noted. In one case (hexane oxidation with Ti-MCM-41/ H_2O_2) silylation caused a reduction in hydrogen peroxide decomposition from 74.7% to 0%, albeit at low conversion levels. Similar results were obtained with epoxidations (ca. 60% decomposition to 0% upon silylation) (Fig. 7.17). Similar results have been noted with other systems such as guanidines [93] in the base-catalysed epoxidation using hydrogen peroxide (see Section 3.4).

A related paper by Kochkar & Figueras [94] describes an approach where the surface polarity was reduced by incorporating phenyl groups during the synthesis of the material. This approach has proved successful also in base catalysis [68] (see Section 3.4).

A further enhancement in activity has been found by the incorporation of Ge into the MCM-41 framework. Post-incorporation of Ti centres led to a 40% increase in catalyst lifetime in epoxidation reactions, using organic peroxides such as cumene

hydroperoxide and *t*-BuOOH [95]. Abbenhuis *et al.* have demonstrated the efficiency and reusability of a novel supported Ti silsesquioxane (Fig. 7.18) in the epoxidation of alkenes with *t*-BuOOH in hexane [96].

The paper by Abbenhuis *et al.* [96] contains some very interesting information on some aspects of the catalyst system that were not discussed in many of the previous papers and that may have some generality and help to develop further this family of catalysts. Firstly, the Ti species was supported on a variety of MCM-41 support materials, with varying quantities of Al in the framework. It is clear from the catalytic results that the presence of Al is very damaging to both the activity of the catalyst and its stability towards leaching. Leaching of catalytically active material from the all-Si MCM-41 catalysts was not observed, and the leaching in other cases could be stopped by silylation of the surface, something that is not found on amorphous silica-supported Ti silsesquioxane. Further insights into the stability of

Fig. 7.17 Enhanced utilisation of hydrogen peroxide via surface treatment.

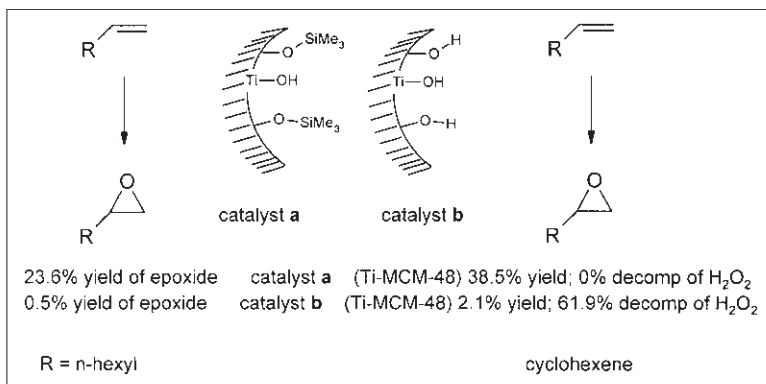
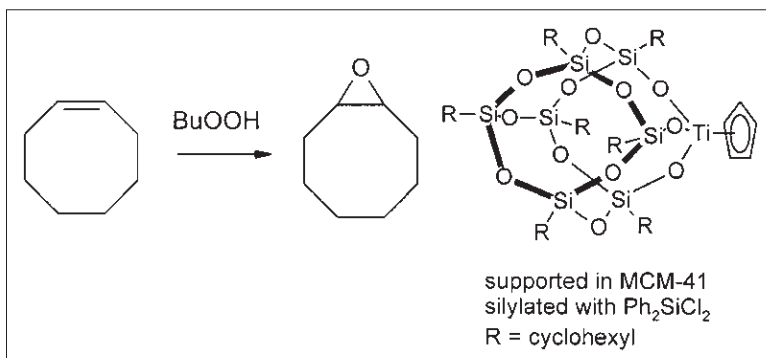


Fig. 7.18 Epoxidation of cyclooctene with supported titanopolysilsesquioxanes.



both Ti-substituted and Ti-grafted MCM-41 materials have been provided by Chen *et al.* [97]. They investigated the epoxidation of cyclohexene with hydrogen peroxide and *t*-BuOOH. With hydrogen peroxide in methanol they found that the products isolated were due to ring opening of the first-formed epoxide (i.e. diols and methanol-based ring-opening products). Even worse, Ti leaching was almost complete within the first cycle. With *t*-BuOOH (in hydrocarbon solvent) this behaviour was not observed, epoxide was formed with excellent selectivity (due, no doubt, to the much less nucleophilic environment) and Ti leaching was not observed. This behaviour is consistent with that found by Abbenhuis *et al.* [96] and suggests that hydrogen peroxide can damage untreated Ti-containing materials. Whether surface modification with silanes [91,92] or by incorporation of polarity-modifying groups [68,94] can enhance the stability of these catalysts has not yet been clarified.

An interesting extension of this work is the one-pot synthesis of isopulegol epoxide [98] (Fig. 7.19). This two-step reaction involves an acid-catalysed cyclisation of citronellal to isopulegol, followed by epoxidation of the exocyclic double bond.

Excellent selectivity of >98% was found in the first step and 90% for the second. An overall conversion of 76% was achieved. One of the drawbacks of the system is that the choice of solvent is made very difficult by the conflicting requirements of the first and second steps. The optimum process was found to be cyclisation catalysed by Ti-MCM-41 (prepared by post-modification of MCM-41 by titanocene dichloride, followed by calcination [95,99]) in toluene, followed by addition of *t*-BuOOH in acetonitrile. This was found to be the best compromise between the conflicting solvent requirements for both steps.

Unfortunately, it leads to a mixed solvent system at the end of the reaction. The authors also demonstrated that the reaction is heterogeneous and that no catalytically active species are leached from the catalyst.

An example of the efficient oxidation of bulky substrates is provided by the oxidation of cholesterol [100] in two different ways. The use of Ti-containing materials leads to the efficient epoxidation of cholesterol, whereas using Zr in place of Ti leads to the oxidation of a CHOH group to C=O. (Fig. 7.20).

A further related paper describes the use of Ti-substituted micelle-templated aluminophosphate materials as catalysts for the epoxidation of alkenes using hydrogen peroxide in acetonitrile [101].

Another potential advantage of these larger pore materials that has remained unexamined so far (with the exception of some examples of the use of *t*-BuOOH and one of cumene hydroperoxide) is that the larger pores also will allow access to larger, potentially chiral peroxides, which may find use in systems where hydrogen peroxide does not function effectively.

These materials represent an important step towards extending the chemistry of TS-1 to larger substrates. Of particular importance is the fact that Ti-containing amorphous silicas have been reported as being unsuitable for such chemistry, due to low stability [102].

Pinnavaia demonstrated the utility of Mn complexes supported in Al-MCM-41 as an oxidation catalyst [103]. They exploited the charged framework of the material to immobilise an Mn(bipy)₂ dication on the walls, and showed that the resultant material was an efficient oxidation catalyst for the oxidation of styrene to epoxide, diol and further to benzaldehyde, using various oxidants. The enhanced

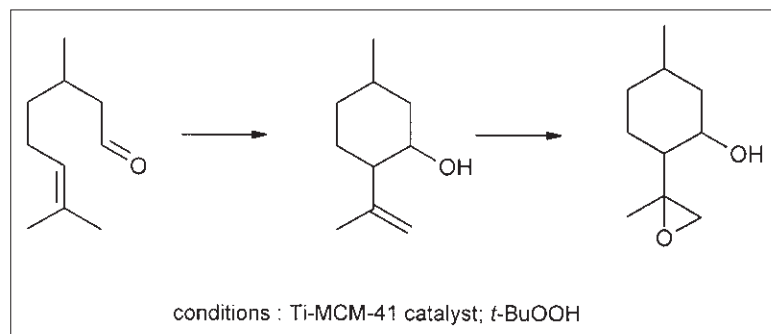


Fig. 7.19 Conversion of citronellal into isopulegol using Ti-MCM-41.

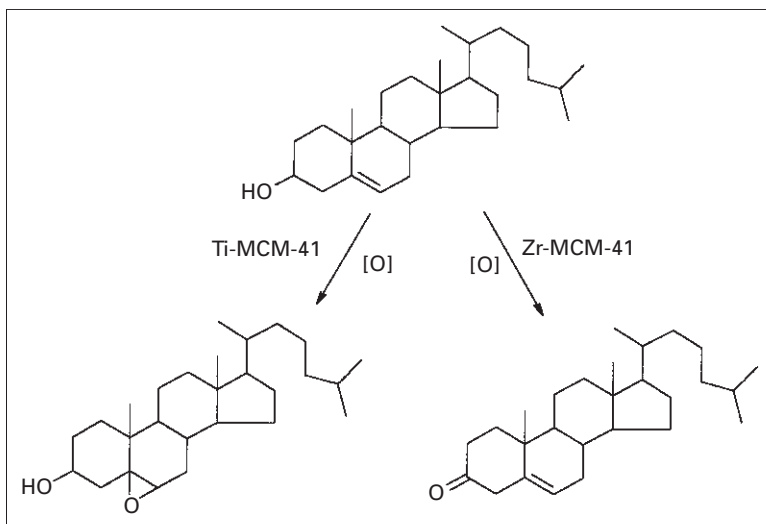


Fig. 7.20 Differing oxidation routes of cholesterol as a function of metal centre.

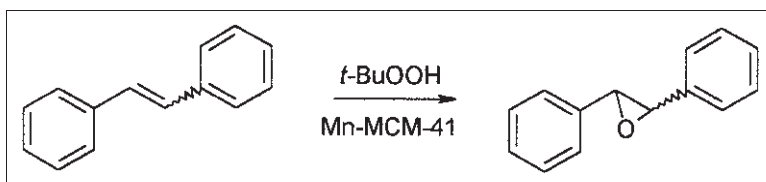


Fig. 7.21 Epoxidation of stilbene with Mn-MCM-41 catalyst.

activity compared to a homogeneous catalyst, as well as its reusability indicated that such materials would be potentially useful oxidation catalysts.

Yonemitsu *et al.* [104] have published details of an Mn-substituted MCM-41 that displays very good activity in the epoxidation of stilbene. They compared a range of different materials and preparation methods, as well as primary oxidants. They found that a 93% yield of stilbene oxide could be produced using *t*-BuOOH as oxidant, with the optimum solvent being (unfortunately) acetonitrile/dimethylformamide (a 9:1 mixture). The catalyst could be reused several times with the same activity, and testing the material for leaching proved negative. Their catalyst also could epoxidise bulky alkenes such as 2-naphthylethene. On the basis of product distributions, a radical mechanism was proposed (Fig. 7.21).

Sutra and Brunel [52,105] have published details of the immobilisation of an Mn Schiff's base catalyst. The catalyst is based on a triamine system whose terminal amines form the Schiff's base with salicylaldehyde and the central amine is used to attach the

catalyst to the surface via displacement of a chlorine atom. Attachment and subsequent oxidation of Mn(II) gives the complex. The catalyst was studied in the epoxidation of styrene. Unfortunately, this catalyst collapsed under the basic conditions of hypochlorite oxidation without oxidation, hydrogen peroxide was non-productively decomposed and only iodosylbenzene proved to be an effective oxidant. Conversions and selectivities were moderate (Fig. 7.22). Whether buffering of the hypochlorite solution [106] or surface passivation [93] would help the performance of the catalyst would be interesting to ascertain.

Tsang *et al.* have developed an improved version of this catalyst and an improved epoxidation methodology, leading to a very efficient Mn-based epoxidation catalyst [107]. In contrast to the all-inorganic system of Yonemitsu, they utilised a Schiff's base complex as the catalytic centre, in an extension of the methodology first described by Sutra & Brunel [52]. They compared Schiff's bases prepared using salicylaldehyde (N,O-coordination) and pyridine-2-aldehyde (N,N-coordination) as ligands for Mn and

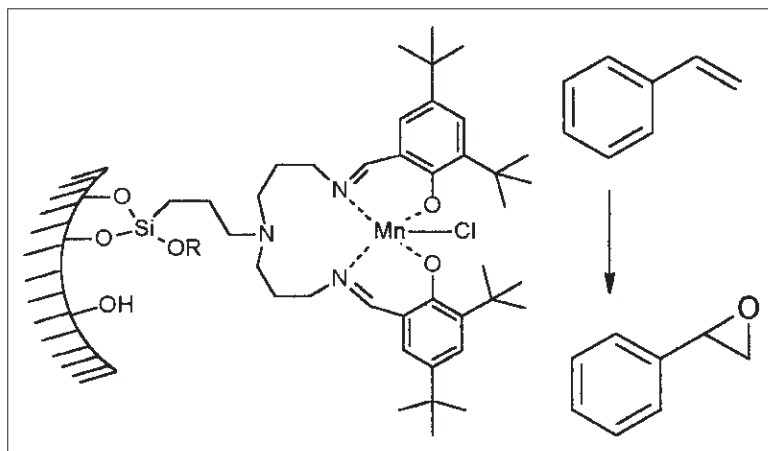


Fig. 7.22 Epoxidation of styrene with a supported Mn-salen.

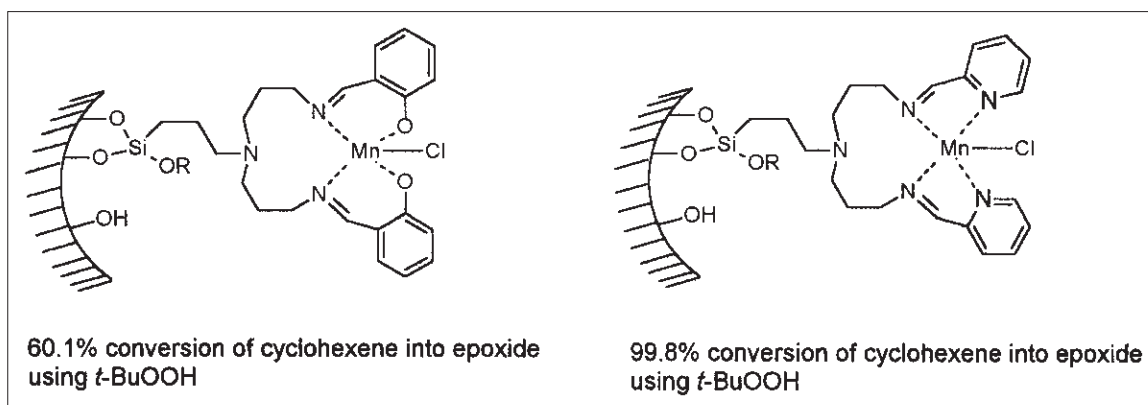


Fig. 7.23 Comparison of tetradentate Mn complexes in epoxidation.

found that the N,N-system gave much better results (Fig. 7.23). Initial rates of reaction were 10 times higher and the yield of cyclohexene oxide (99.8% versus 60.1%) and selectivity towards the oxidant *t*-BuOOH (99.5% versus 88%) also were much improved. Interestingly, the authors also found that low loadings of metal gave more efficient catalysts, an observation that they ascribed to being due to increased levels of O-centred bridging interactions between adjacent Mn centres in the higher loaded samples.

Rao *et al.* have published work on two catalysts immobilised on Al-MCM-48, a support with a cubic three-dimensional pore structure [108]. They sup-

ported $\text{Mn}^{\text{II}}(\text{bipy})^{2+}$ by adsorption of its nitrate onto the material, followed by washing and drying. The resultant pink solid was an effective catalyst for the epoxidation of styrene with hydrogen peroxide. Although there is no explicit leaching study (hydrogen peroxide often can cause significant leaching of metals from solid supports), the substantially better results obtained with the supported catalyst compared with the homogeneous analogue (turnover number of 82 versus 7) and the demonstration of significant differences in the activity of the Al-MCM-48 and Al-MCM-41 materials indicate that the oxidation takes place (predominantly) in-pore.

Che *et al.* have published details of a supported Ru-porphyrin and its catalytic activity towards epoxidation [55,109]. They prepared the catalyst by functionalisation of MCM-41 with aminopropyl trimethoxysilane, followed by complexation of an

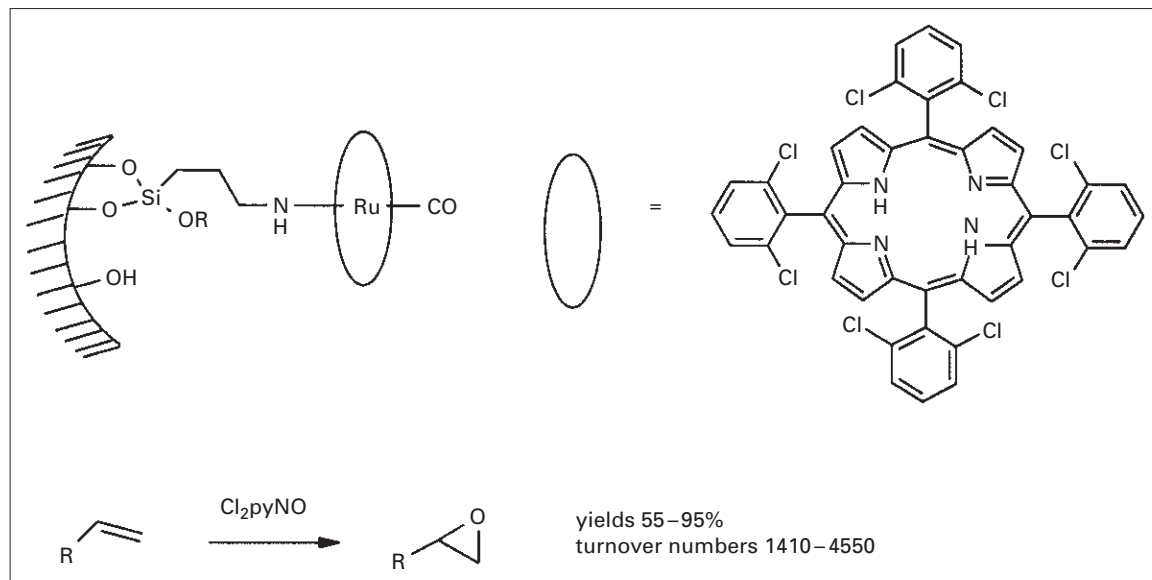
Ru tetrakis (2,6-dichlorophenyl) porphyrin, via an $N \cdots Ru$ interaction (Fig. 7.24).

This catalyst was capable of the epoxidation of several alkenes using 2,6-dichloropyridine *N*-oxide as the terminal oxidant. Alternative, greener oxidants were not used and some leaching of the metal centre in the catalyst was noted. Nonetheless, the reactions proceeded very well and with excellent turnover numbers. Although the combination of poor atom efficiency in the oxidant and the loss of metal from the catalyst mean that work remains to be done on this system to make it more robust, the high turnover numbers are impressive, especially for a porphyrin-based system. Additionally, selectivity changes were noted, which indicate that steric factors may be at play that are absent in homogeneous systems, thus indicating a significant role for the pore walls—something that may be of importance in the design of heterogeneous catalysts.

Metal-free epoxidation catalysts

Jacobs *et al.* published the first example of a guanidine unit supported on the surface of a micelle-templated silica material in 1997 [110] (Fig. 7.25).

Fig. 7.24 Epoxidations catalysed by immobilised Ru-porphyrins.



They attached the guanidine by first grafting a glycidyl silane onto the surface of the support, followed by ring-opening of the epoxide ring with 1,5,7-triazabicyclo[4.4.0]dec-5-ene (TBD) (Fig. 7.25, catalyst A).

Guanidines are of great interest in the field of heterogeneous base catalysis because they are powerful enough bases to act as replacements for hydroxide in synthetic applications. In addition to their potential in typical base-catalysed reactions (see below) they are also excellent catalysts for the base-catalysed epoxidation of electron-deficient alkenes. This provides a nucleophilic route to these epoxides and complements the metal-centred routes.

The materials produced in this way were tested in the epoxidation of enones, leading to epoxides that are particularly labile towards attack by water. Nonetheless, they showed that high selectivities could be obtained at low to medium conversion of substrate. The results obtained with this catalyst and those of the following catalyst are shown in Fig. 7.25.

Further work by Brunel & Macquarrie [93] utilising variations on a different strategy developed by Brunel *et al.* [111] has led to a different type of guanidine catalyst (Fig. 7.25, catalyst B). In this case the authors have shown that silylation of the surface had a major positive influence on the efficiency of the reaction. They achieved very high conversions

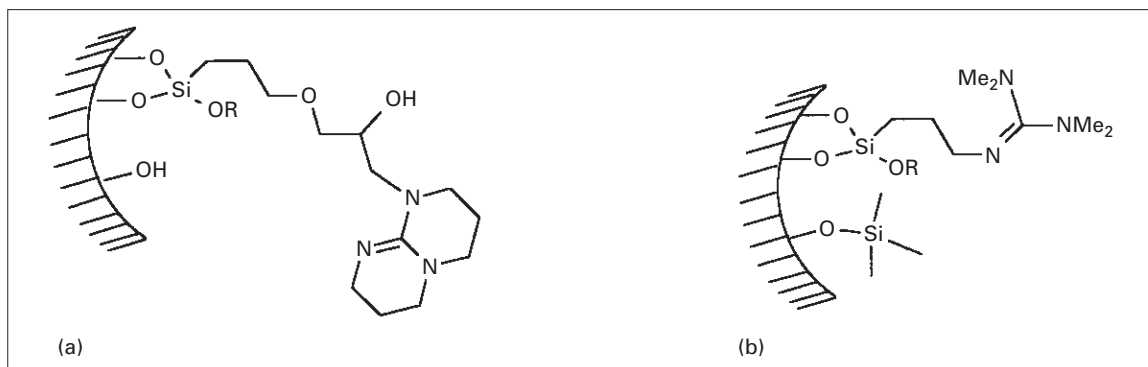


Fig. 7.25 (a) Guandinine catalysts prepared by Jacobs [110] and (b) Macquarrie *et al.* [93].

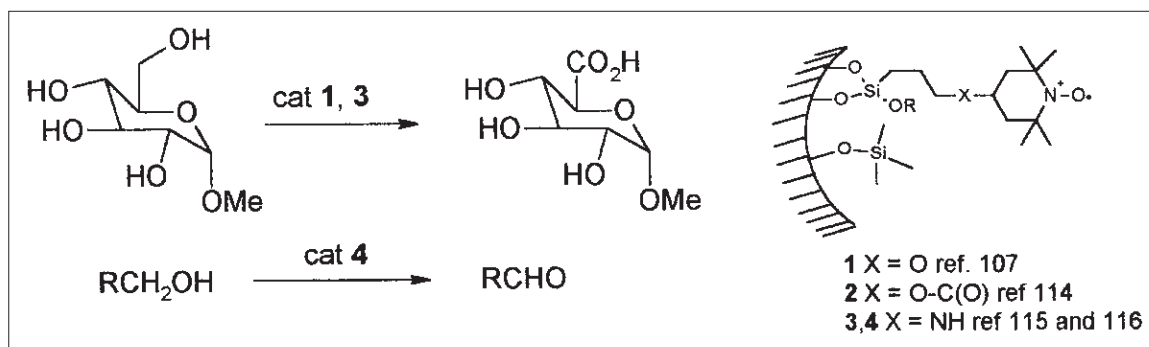


Fig. 7.26 Oxidations catalysed by heterogenised TEMPO systems.

with their optimum catalyst (89%), excellent selectivity towards the epoxide product (again 89%) and, significantly, a very large enhancement in selectivity towards hydrogen peroxide. This latter variable is of great importance because low selectivity towards hydrogen peroxide means that large volumes have to be used to compensate for decomposition—leading to high dilutions and poor vessel occupancy—but also that a great deal of water is present, which can reduce significantly the selectivity towards the organic product by ring-opening reactions. It also leads to a more difficult product recovery and more waste. Without silylation of the surface, hydrogen peroxide selectivities were <10%, whereas silylated materials led to an increase to 50–56% selectivity.

The use of 2,2,6,6-tetramethyl-1-piperidinyloxy (TEMPO) as a metal-free oxidation catalyst was reviewed by van Bekkum [112]. More recently, attempts have been made to immobilise TEMPO onto mesoporous silicas in order to use it in a heterogeneous manner [106,113–115] (Fig. 7.26). Different routes for anchoring the TEMPO moiety to the surface were used but all involved the readily available 4-functionalised TEMPOs. Brunel *et al.* [113] have provided an elegant and sensitive method to check that the linkage of the TEMPO to the surface is covalent, and not just physisorbed, by using charge transfer complexes. The oxidations performed have followed the earlier trends, where TEMPO has found much greater application in the oxidation of sugars than in other areas of organic chemistry. Van Bekkum *et al.* [106] investigated the oxidation of an α -methyl glucoside using hypochlorite as oxidant. They found that at pH 9 the TEMPO was leached into solution, but that at pH 8 this did not happen. They

ascribed this to the instability of the material under alkaline conditions. Similarly, Pagliaro *et al.* [115] showed that reaction of D-methylglucose to the uronic acid was carried out efficiently using their TEMPO system (strictly speaking prepared from a non-templated sol-gel synthesis and thus unlikely to be structured regularly) and NaOBr. Bolm & Frey [114] found that the immobilised TEMPO would selectively oxidise primary alcohols to aldehydes in very good yields, with little over-oxidation.

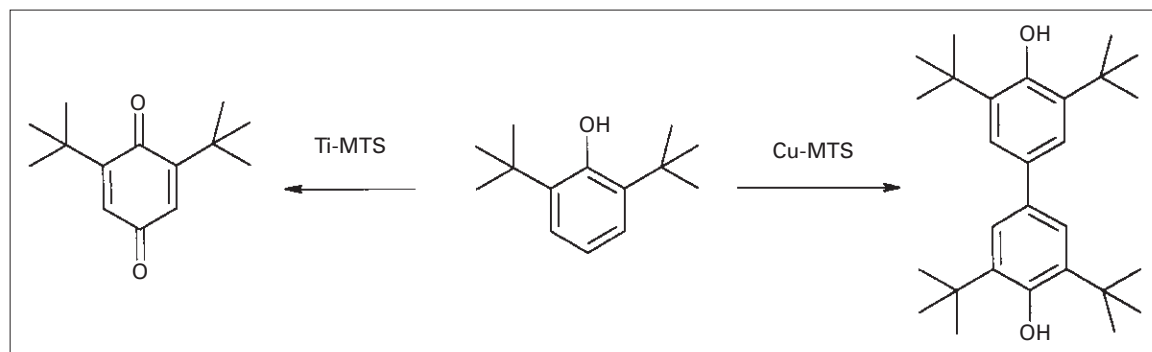
Other papers dealing with enantioselective epoxidations will be discussed in Section 3.5.

Arene hydroxylation

Several authors have investigated the hydroxylation of aromatics to give phenols. This important oxidation type is, like epoxidation, one of the typical TS-1 oxidations. Interestingly, little appears to have been done with Ti-containing micelle-templated silicas in the hydroxylation of aromatics. However, other metal-containing materials have been investigated with some success.

Pinnavaia *et al.* [87,90] described the use of Ti-containing materials prepared via different routes for the oxidation of 2,6-di-*t*-butylphenol to the corresponding quinone (Fig. 7.27). Using hydrogen peroxide as oxidant, they showed that Ti-HMS (prepared via the neutral amine templating route [43]) outperformed Ti-MCM-41. Anatase (TiO₂) was almost inert and the small pore size of TS-1 precluded any oxidation. Decomposition of hydrogen peroxide was minimal in each case (<10%).

Fig. 7.27 Oxidation of phenols using two different oxidation catalysts (MTS = micelle-templated silica).



An alternative oxidation pathway is followed with the catalysts studied by Tsuruya *et al.* [116]. They have published details of a Cu-impregnated MCM-41 catalyst that caused the oxidative dimerisation of the same phenol in air (Fig. 7.27). The different catalyst/oxidant combination leads to complete selectivity towards dimerisation products, without any hydroxylation being observed. The Ti-peroxide system is known to produce Ti-OOH species that are capable of transferring oxygen to electron-rich substrates, whereas the role of Cu(II) is to carry out a one-electron oxidation of the phenol, followed by dimerisation, (some) subsequent oxidation to the quinonoid product and presumably aerial oxidation of Cu(I) to Cu(II). The exact direction that such reactions take can be influenced profoundly by the choice of reaction conditions (e.g. solvent, ligands around the metal) [117,118].

Thus, the use of Cu(II)-HMS and hydrogen peroxide has been found to be active in the hydroxylation of phenol itself [119]. The authors found that the combination of the Cu-containing material and aqueous hydrogen peroxide effected the oxidation of phenol to dihydroxybenzenes in a conversion of 36%. No organic co-solvent was used. Indeed, the use of solvents (methanol or acetone) caused the reaction to stop completely. Interestingly, the Ti-containing analogue of this material displayed no activity in the hydroxylation reaction, in contrast to the findings of Pinnavaia *et al.* This curious result may be explicable on the basis of the aqueous environment of the catalysts—Pinnavaia's study utilised acetone as the solvent (possibly to aid the transfer/activation of hydrogen peroxide) and it is well known that TS-1 is at its most active when a co-solvent such as methanol is used [11–13].

Iron(III)(acac)₃ has been supported inside the pores of MCM-41 and used as a catalyst for the oxidation of phenol [120], giving catechol (66%), hydroquinone (27%) and benzoquinone (7%). They found that the oxidation proceeded best with aqueous hydrogen peroxide and in water as solvent.

Rao *et al.* [108] have published preliminary details of a Cu-based system for the oxidation of phenol. Their work involves the incorporation of Cu(II) acetate dimer into the cubic Al-containing MCM-48. The oxidation of phenol was studied in buffered aqueous medium at ambient temperature using air as oxidant. Conversion was 36% and the product was 'predominantly' catechol. Turnover numbers are (at 37) modest but nonetheless are almost 10 times higher than with unsupported copper acetate.

Further work on a related system (Cu ion-exchanged into Al-MCM-41) also has been published [121]. The authors found that this was the most effective method for the attachment of Cu and that MCM-41 was a superior support to a range of other (amorphous) materials and zeolites. Their results were obtained from the system benzene/air/ascorbic acid. The latter is used as a reductant for the Cu species. The oxidation of benzene to phenol is considerably more difficult than that of phenol to diphenolics, and the yields of phenol obtained were never higher than 1.5%. Although this work indicates that such an oxidation is possible in principle, an efficient separation method (coupled to higher conversions) would need to be found before the method could be of value. Vanadium-containing MCM-41 also has been found to be an active catalyst for the oxidation of benzene with dilute hydrogen peroxide. Phenol was the only liquid product [122].

Immobilised metallophthalocyanines also have been developed that are capable of the oxidation of phenols using hydrogen peroxide as solvent [123].

In particular the iron-containing tetrasulfophthalocyanine was superior to the other catalysts and to homogeneous versions of the catalyst. Curiously, the dimeric form of the organometallic species was more active than the monomeric species, which is the opposite of what is normally found.

The efficient coupling of phenols is an increasingly important area of research, especially with the increasing importance of ligands such as binaphthyls in asymmetric catalysis (see Refs 124 and 125). Corma *et al.* [126] have published details of MCM-41-supported Fe and Cu catalysts that are excellent for the oxidative coupling of 2-naphthol to the (racemic) 1,1'-binaphthol, which is one of the most important of the binaphthyl systems in catalysis. Their results (with metal-exchanged MCM-41 catalysts) show that Fe gives 99% conversion of the naphthol and 100% selectivity towards the desired product under an air atmosphere. Copper-exchanged materials display significantly lower selectivities (Fig. 7.28). A comparison with many other systems indicates that the Fe-MCM catalyst is the optimum system for this reaction. The authors also show that, even with a pore size of 35 Å, diffusion of the product out of the pore system is not the limiting factor.

Alkane oxidation

The oxidation of simple, unfunctionalised alkanes is a difficult task and some progress has been made in the oxidation of models such as cyclohexane. The products of this oxidation are the alcohol and ketone, which can be oxidised further (together) to give caprolactone, a key intermediate for both nylon and poly(caprolactone). For example, a supported Ru-bipy complex (Fig. 7.29) has been prepared [127], and its activity in the oxidation of cyclohexane has been studied (Fig. 7.29).

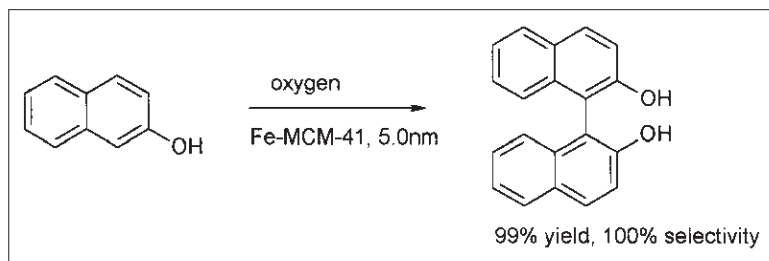


Fig. 7.28 Preparation of binaphthols using mesoporous catalysts.

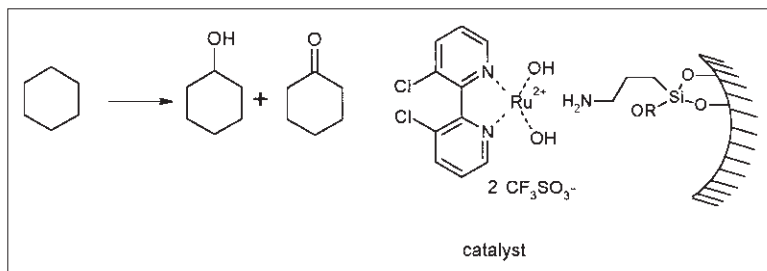


Fig. 7.29 Oxidation of cyclohexane with immobilised Ru-bipy complex.

The supported catalyst was capable of the oxidation of cyclohexane (and of other hydrocarbons) with *t*-BuOOH to give the alcohol and ketone. The ratio of ketone to alcohol was higher than that found with the homogeneous complex, a result that was explained by the competitive adsorption of the alcohol on the pore surface, excluding alkane, thus being preferentially oxidised to ketone. A further interesting fact is that the turnover number decreases with loading and is generally higher than that found with the homogeneous catalyst. No explanation was given, but this may indicate that higher dispersion of the metal centres may minimise the formation of inactive dimeric or oligomeric species, as postulated by Thomas *et al.* with the Co-based system discussed next. No leaching was observed either by 'hot filtration' or by atomic absorption.

Thomas *et al.* have published details of a supported trimeric Co species that is also an effective stable catalyst for the oxidation of cyclohexane [57]. They supported the complex shown in Fig. 7.30 by functionalising MCM-41 with bromopropyl trimethoxysilane and then treating this with an aqueous solution of glycine to give the supported amino acid ligand. Complexation with the Co precursor then was carried out and the expected change in structure of the Co complex (caused by replacement of a bridging OH with a bridging carboxylate) was shown by in situ extended x-ray adsorption fine structure (EXAFS) studies.

Catalytic activity was good, again using *t*-BuOOH as primary oxidant, and steady rates of oxidation of ca. 200 turnovers per hour could be sustained for several days (giving a turnover number of $\geq 10\,000$). Ketone/alcohol ratios were remarkably high, reaching 3.3 after prolonged reaction times. Again, leaching could not be observed by either 'hot filtration' or by atomic absorption studies.

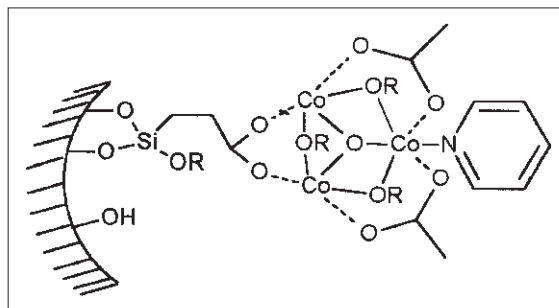


Fig. 7.30 Structure of supported trimeric Co complex.

3.4 Base catalysis (other than oxidations)

The subject of base catalysis has been investigated by a number of authors. A few papers deal with inorganic bases supported on micelle-templated silicas but the majority deal with nitrogen bases, ranging from simple amines to the much more basic guanidines as potential replacements for bases such as alkali metal hydroxides in synthesis. The activity of the latter types of catalysts in the base-catalysed epoxidation reaction has been described already.

Alkali-containing MCM-41 materials were prepared and evaluated as basic catalysts by Kloetstra & van Bekkum [74]. They used an Al/Si material and ion-exchanged the desired metal cation into the structure, replacing the H and Na present from the synthesis. The Na-exchanged material displayed reasonable activity in the Knoevenagel reaction of benzaldehyde and ethyl cyanoacetate, a carbon acid with a pK of around 11. This relatively facile reaction is one of the most commonly studied reactions in such systems and is not particularly demanding. Conversions and selectivities were good, in reasonable times. Direct comparison with other catalytic systems is made difficult, despite

the large quantity of data, by the well-known complexity of solvent effects in the reaction [67,128–130]. More interestingly, the materials were capable of the more demanding aldol reaction (see below), giving good to excellent yields of condensation products in the reaction between benzaldehyde and a series of acetophenones (pK_{a} -ca. 20) and related compounds at 150°C. Similarly Michael additions of diethyl malonate (pK_{a} -ca. 13) to enones were possible using the more strongly basic Cs-exchanged materials.

Improvements to these catalysts included the Cs_2O impregnated versions [76] and further improvements to the stability of the catalysts were made by the use of binary caesium–lanthanum oxides supported on MCM-41 [75].

Simple amine bases include aminopropyl-substituted materials, dimethylaminopropyl and aminoethylaminopropyl equivalents. These materials are mild bases that are capable of a range of reactions, such as Michael, Knoevenagel and related reactions involving carbon acids with pK_{a} values typically of <13.

The simplest of these systems is the aminopropyl-substituted system, derived from the cheap 3-aminopropyl trimethoxysilane. Both grafted and one-pot variations have been prepared and evaluated as catalysts for the Knoevenagel reaction.

Laspéras *et al.* [131] (Fig. 7.31) and Brunel [47] have published details of the catalytic behaviour of aminopropyl groups grafted onto MCM-41-type materials. These materials then were utilised in the Knoevenagel reaction of benzaldehyde and ethyl cyanoacetate, this time in dimethylsulfoxide as solvent. Conversions and yields were very good, and reaction times were around 5–10 times faster than the metal-substituted MCMs discussed previously. It

was shown that activity was proportional to loading over a fairly wide range and it was proposed that the active site was in fact the imine, possibly explaining the faster reaction rate. The related piperidine catalyst (formed by displacement of chlorine from chloropropyl-substituted MCMs by piperidine) was significantly less active. The catalysts could be recovered and reused after activation.

Macquarrie has prepared a range of corresponding materials using the one-pot co-condensation method [34,67–69] and neutral amines as templates. These materials are very efficient catalysts for the Knoevenagel reaction, allowing the formation of condensation products from ketones such as cyclohexanone and dialkyl ketones in high yields and selectivities (Fig. 7.32).

As can be seen, turnover numbers are good and are 4–5 times higher than those obtained for the grafted aminopropyl silicas (based on amorphous chromatographic silica) [67,130]. Turnover numbers increase further when a second polarity-modifying group is added (catalyst **3**) by co-condensation of tetraethoxysilane, aminopropyl trimethoxysilane and phenyl trimethoxysilane in one pot. An additional benefit of this bifunctional catalyst system is that the rate is increased substantially purely by modifying the polarity of the system. Post-functionalisation of the aminopropyl material by silylation actually caused a reduction in activity in this case, possibly by pore size reduction, although this is also found in the phenyl-substituted materials; an alternative explanation may be silylation of the NH_2 group.

A very surprising result indeed is the almost complete lack of activity of the catalyst in the reaction between benzaldehyde and ethyl cyanoacetate, which is the standard (and often only) reaction used to characterise many such catalysts. These results indicate that the nature of the catalyst is significantly different to the grafted materials, which is confirmed

Fig. 7.31 Catalysts used in the Knoevenagel condensation by Laspéras *et al.* [131].

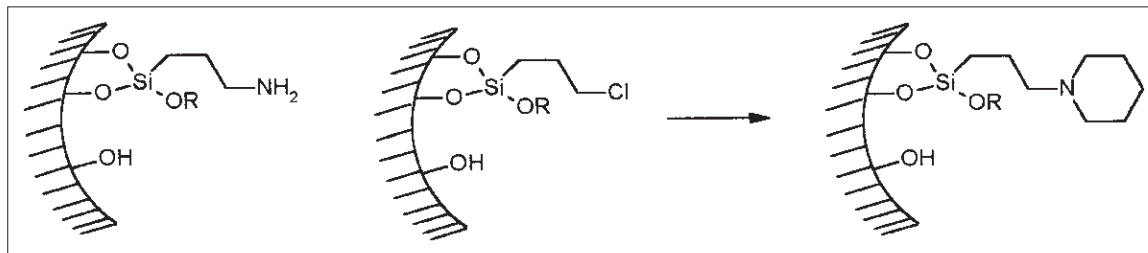


Fig. 7.32 Aminopropylsilica (1), aminopropyl micelle-templated silica (MTS) (2) and aminopropyl/phenyl MTS (3) as compared in the Knoevenagel condensation [67–69,130]. (Solid boxes: relative rates (arbitrary units); striped boxes: turnover numbers (mol product/mol active sites) y-axis.)

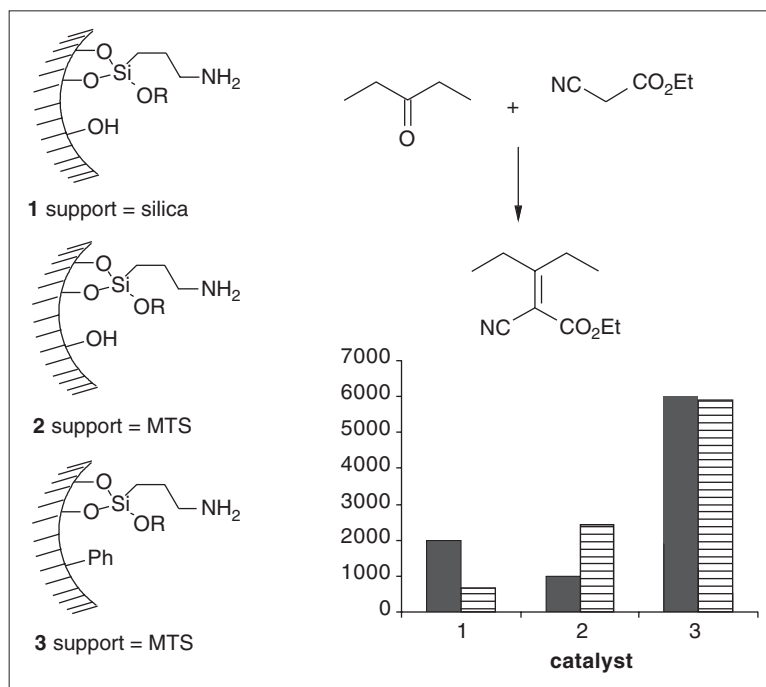
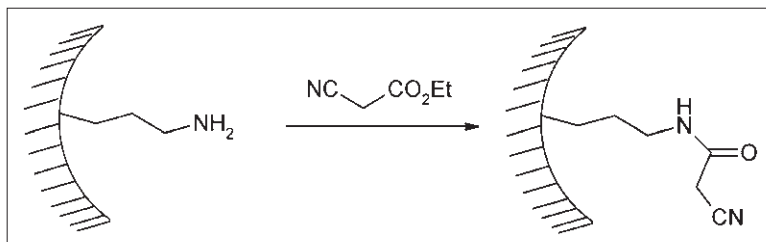


Fig. 7.33 Poisoning mechanism for grafted aminopropylsilica catalysts in the Knoevenagel reaction.



by the poisoning mechanism for the grafted materials (formation of an amide by acylation with the ethyl cyanoacetate (Fig. 7.33) not being operative for the in situ materials).

Closer examination of the reactivity of the amino groups in both types of materials showed that the amine groups in grafted materials behave as normal amines, i.e. both nucleophilic and basic in character; that in the one-pot material is almost completely lacking in nucleophilicity but the material is of a similar (if slightly reduced) basicity [69]. The reasons for this are not yet clear, but one important consequence is that the in situ prepared materials do not form imines during the reaction, something that is likely to be linked to the low activity seen in the

reactions involving benzaldehyde compared with grafted materials. The micelle-templated silica materials also perform best in toluene, whereas the grafted materials are most effective in cyclohexane. It is thought that the enhanced polarity of the micelle-templated silica materials may be the cause of this behaviour. This work indicates clearly that significant differences can exist in what appear to be very similar materials.

It is clear, however, that the activity of this type of catalyst in the Knoevenagel reaction is complex and is influenced not just by the solvent but also by the potential for acid–base catalysis that exists in a system where a weak base is attached to the surface of a weakly acidic solid (the classical ‘best’ catalyst

for such reactions is a combination of piperidine and acetic acid [132]) and the highly hydroxylic nature of the system, which may facilitate efficiently the transfer of protons required in the reaction.

The Linstead variation of the Knoevenagel reaction is unusual in that it generates β,γ -unsaturated products rather than the expected α,β -unsaturated condensation products [133–135]. This reaction is part of a useful and relatively clean route to coconut lactone (Fig. 7.34). The condensation is normally carried out by homogeneous base, often used in large quantities, but the use of a supported guanidine allows it to be carried out with catalytic quantities of base. Yields are good and the major by-product is the aldol product arising from two moles of aldehyde.

A related catalyst prepared by grafting aminoethylaminopropyl groups onto MCM-41 has been described [49]. This catalyst is an efficient Knoevenagel catalyst but, additionally, the authors showed that it was active in the aldol reaction (Fig. 7.35). Acetone ($pK = \text{ca. } 20$) was found to react readily with a range of aldehydes under remarkably mild conditions (50°C for a few hours), giving mixtures of the aldol adduct and the dehydrated product in varying

ratios. In both reaction types the catalyst could be reused several times.

The synthesis of monoglycerides is of considerable importance due to their use as emulsifiers and antimicrobial reagents. Acid-catalysed routes suffer from over-esterification due to acid catalysts [136], leading to the less useful diglycerides, and the wasteful protection/deprotection methods that must be employed [137], although zeolitic routes have achieved some success [138]. Enzymatic routes are possible, but difficulties exist with low conversion rates and complex separations [139–142]. Two groups have investigated the use of supported amine functions as catalysts for a base-catalysed ring opening of glycidol, an alternative reaction that leads selectively to monoglycerides.

Brunel *et al.* published details of aminopropyl and supported piperidine catalysts that are active in the synthesis of monoglycerides by this route [47,50]. Interestingly, they found that the catalyst was more active upon reuse than initially. This was attributed to a reaction between glycidol and the surface silanols, leading to a slower rate for fresh catalyst than for catalysts that had reacted already with glycidol. The piperidine catalyst was less affected by this

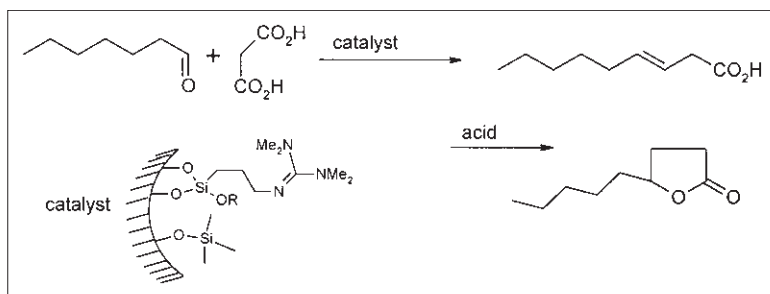


Fig. 7.34 Linstead-Knoevenagel condensation promoted by supported guanidines.

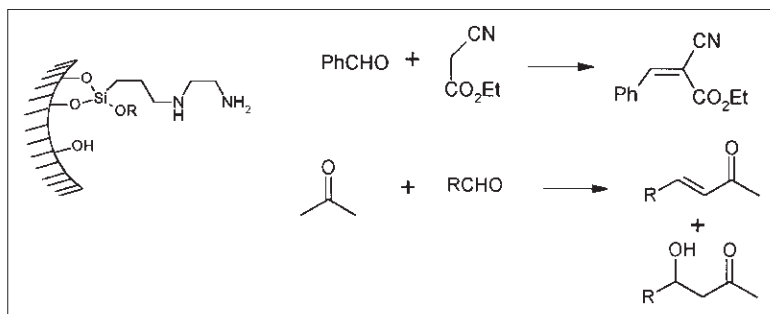


Fig. 7.35 Reactions catalysed by a diamino-micelle-templated silica.

phenomenon and catalysts that had been passivated by trimethylsilylation gave even better performance. The best yields obtained were 90% with a passivated piperidine catalyst (Fig. 7.36).

A second group led by Jaenicke also has published results in this area [143]. They investigated a range of supported bases, including supported primary and tertiary amines, a supported guanidine and a supported pyrimidine. Potentiometric titrations showed that the pyrimidine was only weakly basic, as expected, and that the guanidine was somewhat more basic than the primary and tertiary amines (but by less than 1 pK unit, indicating an interaction with the surface that reduces the basic strength of the catalyst). As Brunel found, the catalysts improve with reuse and good results were obtained for all the catalysts investigated. Yields ranged from 84% (second reuse) to 95%, with the guanidine catalyst being the best (Fig. 7.36).

The use of supported guanidines has been explored in a number of reactions, including the Knoevenagel (where little real advantage appears over the simpler and cheaper aminopropyl materials), the Michael addition, base-catalysed epoxidation, aldol condensations and transesterifications. These materials, which are close to being sufficiently basic to be a direct replacement for metal hydroxides in synthesis, are thus promising and versatile catalysts. However, some evidence is available that suggests that the presence of the silica surface can reduce their basicity [143] compared to free guanidines, but leaving them significantly stronger bases than aminopropyl systems for example [69]. How much surface treatments and enhanced catalyst design can reduce this interaction remains to be seen.

Transesterifications can be carried out under acidic or basic conditions. Brunel's group have shown that the TBD guanidine catalyst (see Fig. 7.25) is a selec-

tive and efficient catalyst for the transesterification of ethyl propionate [111]. This catalyst carried out the reaction somewhat more slowly than a homogeneous equivalent, but reasonable conversions were obtained. It should be noted that without separation of the released alcohol high conversions are hampered by re-equilibration in this type of reaction, and that the rate and efficiency of separation of the evolved alcohol often can limit the apparent reaction rate.

Schuchardt *et al.* also have published work relating to the transesterification of soybean oil with methanol using MCM-supported guanidines [144]. Rates were lower than unsupported catalysts but similar conversions were obtained. Solid catalysts for this reaction are particularly valuable because the longer chain esters that can be produced are valuable as synthetic lubricants and therefore must have very low levels of acid or base present to minimise corrosion of engine parts under conditions of high temperature and mechanical pressure. Water washing is difficult due to phase separation problems and the risk of slight levels of hydrolysis.

Corma *et al.* [145] have published details on a novel supported hydroxide that is a useful base catalyst. They supported trimethoxysilylpropyltrimethylammonium chloride onto MCM-41 by grafting. Subsequent ion-exchange with tetramethylammonium hydroxide in methanol gave the supported trimethylammonium hydroxide. They showed that this material was an excellent catalyst for the Knoevenagel reaction of benzaldehyde and ethyl cyanoacetate, as well as for the corresponding reaction using phenylsulphonylacetonitrile as the carbon acid. The catalyst also was active in the Michael addition.

The Michael addition of carbon acids to enones is an atom-efficient transformation that can be carried

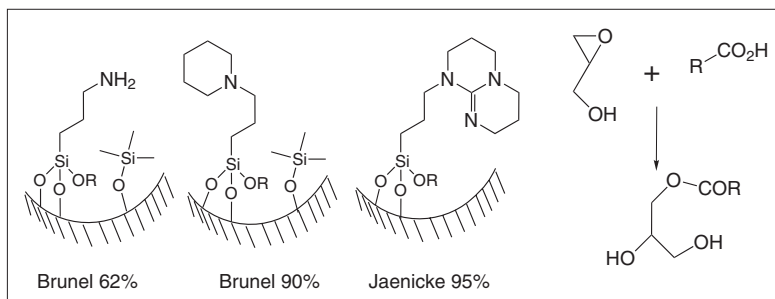


Fig. 7.36 Monoglyceride formation by various catalysts.

out using dimethylaminopropyl-functionalised silica-organic hybrids [77]. The tertiary amine functionalised materials were substantially better catalysts than primary or secondary materials (possibly due to their reduced ability to be a Michael nucleophile themselves) and the hybrid system was much more efficient and faster than a silica-based material of the same loading. Increased loadings led to a further enhancement in rate, and catalysts could be recycled and reused with little loss in activity being seen until the sixth use. Jacobs' guanidine catalyst (Fig. 7.25, catalyst A) was shown to be active in the Michael addition of ethyl cyanoacetate and diethyl malonate (pK values of 11 and 13, respectively) to acceptors such as enones and acrylates. Yields were excellent and reactions were rapid under mild conditions [110].

Corma's supported quaternary hydroxide [145] effectively catalysed the Michael reaction of ketoesters, diesters and ethyl cyanoacetate with enones, although in some cases significant amounts of double addition were noted.

3.5 Enantioselective catalysis

This represents one of the most challenging areas of catalysis, especially for heterogeneous systems. Few examples of heterogeneous enantioselective catalysts have been demonstrated; only a small proportion of those that are known approach acceptable levels of enantioselectivity. Polymer-supported catalysts and modified noble metal hydrogenation catalysts are two major areas of heterogeneous enantioselective catalysis where good results have been obtained after several years of considerable efforts. Both of these areas are outside the scope of this review, but excellent reviews are available for those interested [146–150]. One of the prime lessons to be learnt

from these areas is that excellent levels of activity can be achieved with heterogeneous systems but that a great deal of care must be exercised in the design of the catalyst and the reaction conditions. Indeed, it is clear that the heterogenisation (on a highly polar, polarising, hydrogen-bonding, wet surface) of a carefully and thoroughly designed catalyst that has been optimised for use in a very dry, low-polarity organic solvent is unlikely to deliver immediately a similarly efficient material. On the other hand, if these factors can be taken into account, the steric limitations imposed by a tightly controlled reaction space (such as a very regular pore) are exactly what most homogeneous catalysts try to achieve by the incorporation of bulky groups. Thus, with the correct design of catalyst in the right pore system, very selective catalysts should be possible. Up until recently, the only highly regular pore systems available were in the zeolites, and these were too small to be of general use as enantioselective hosts. Nevertheless, Corma *et al.* demonstrated that such pore systems could be very efficient as hosts for highly efficient enantioselective catalysts [151–154].

Laspéras *et al.* [58,155,156] have carried out a detailed study on the utility of supported ephedrine as catalysts for the alkylation of benzaldehyde with diethylzinc, a reaction that goes through an N,O-ZnR chelate (Fig. 7.37). Their initial work displayed similar reactivity/activity trends to systems based on amorphous silica [157,158] and homogeneous versions [155]. They found that the optimum catalyst required that the ephedrine molecules were spaced by the use of non-reactive alkyl spacers attached to the surface, that there was direct interaction of the ephedrine hydroxyl with the silica surface making alternative less-enantioselective centres) and that the surface itself plays a role in activating the

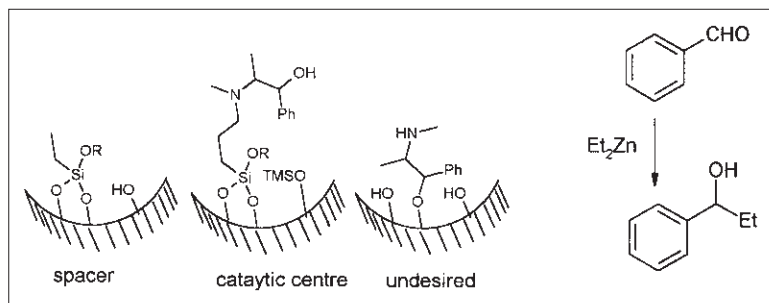


Fig. 7.37 Surface structures in a supported ephedrine catalyst.

diethylzinc, leading to non-enantioselective alkylation. Control over these factors can be achieved and the final catalyst was shown to be equally selective to the homogeneous system.

Hutchings *et al.* [159,160] have published details of an Mn-MCM-41-based catalyst that displays good selectivity in the epoxidation of stilbenes. Their catalyst is prepared using a different approach to that described above. They prepare Al-MCM-41 and exchange the cationic charge-balancing cations in the material with Mn(II) ions, followed by calcination to give Mn-exchanged MCM-41. This material then is interacted with a chiral salen ligand, the Mn is oxidised to Mn(III) and the resultant complex is used as a catalyst for the epoxidation of stilbene with iodobenzene (Fig. 7.38). Although the homogeneous equivalent of the catalyst gives predominantly the *trans*-epoxide (in an enantiomeric excess of 78%), the immobilised catalyst gives slightly more of the *cis*-isomer, with the enantiomeric excess of the *trans*-isomer being almost that of the homogeneous system (70%). The *cis*-product is obviously a *meso*-compound. Selective silanisation of different sites within the catalyst indicated that sites on the external (out-of-pore) sites led to essentially identical behaviour to the homogeneous catalyst, whereas the internal sites gave substantially more *cis*-epoxide product. Interestingly, the iodobenzene co-product was found to be a poison of the heterogeneous catalyst but not of the homogeneous version.

A similar type of complex has been prepared by Kim & Shin [60]. They used a different approach to the immobilisation of the catalyst, which involved a stepwise construction of the ligand system on the surface followed by complexation of the metal (Fig.

7.39). Reaction with styrene and methylstyrene gave epoxides in good conversions and with enantiomeric excesses typically slightly superior to those found in solution with equivalent complexes.

A very recent example of a supported ferrocenyl-Pd complex illustrates the enormous potential of this class of materials compared with both homogeneous and amorphous heterogeneous materials. A collaborative project between the groups led by Thomas and Johnson [59] has provided a chiral ferrocenylphosphine anchored onto the walls of MCM-41. The external surface of the material first was passivated with a bulky silane to ensure that all the catalytic sites were situated within the material's pores. The chiral ferrocenylphosphine then was attached to the walls of the support by reaction of a pendant amine with a surface-bound bromoalkane. This surface-bound ligand system then was treated with a Pd complex to generate the active catalyst. The reaction studied was the allylic substitution of cinnamyl acetate with benzylamine, which can lead to a linear amine (achiral) or to allylic substitution (a chiral product) (Fig. 7.40).

The dependence of the reaction path on the nature of the catalyst is remarkable. With a homogeneous palladium catalyst the only product is the thermodynamically favoured linear substitution product. With an amorphous silica support there is a little (2%) of the allylic substitution product, with a 43% enantiomeric excess reported. Astonishingly, the allylic product is favoured (51% selectivity) over the linear with the MCM-41-based catalyst, which is an enormous change in regioselectivity. Furthermore, enantioselectivity with the (*S*)-isomer of the catalyst is >99% but with the (*R*)-isomer it is 93%. This is a

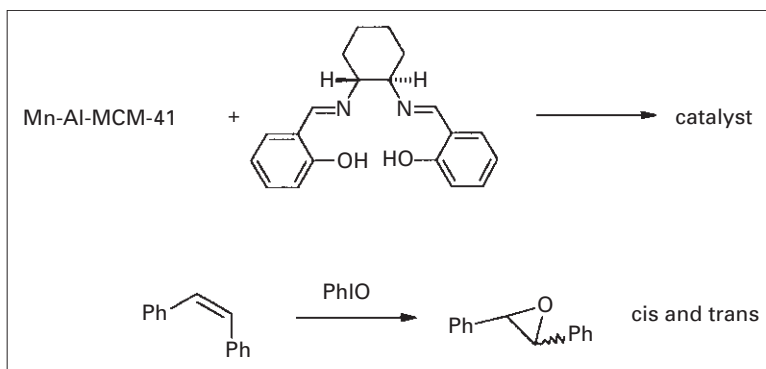


Fig. 7.38 Preparation and use of an Mn-exchanged Al-MCM-41 catalyst in epoxidations.

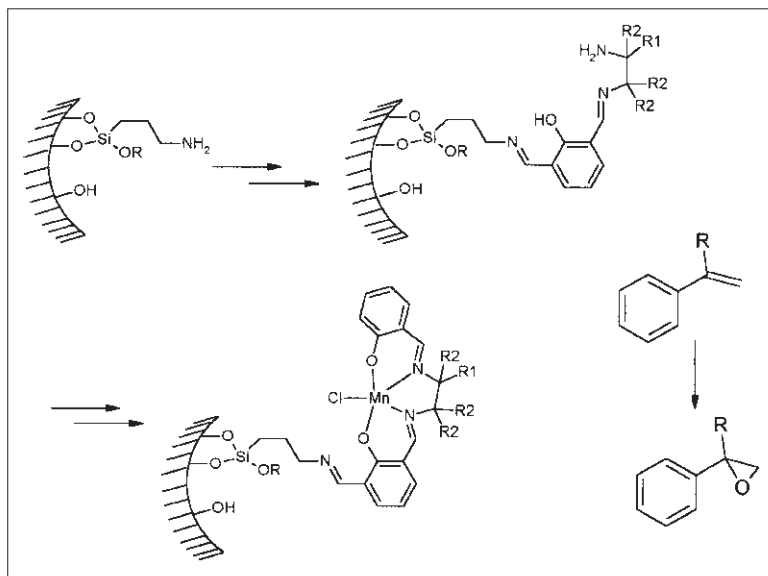


Fig. 7.39 Preparation of an Mn(III)-salen complex and its behaviour in epoxidations.

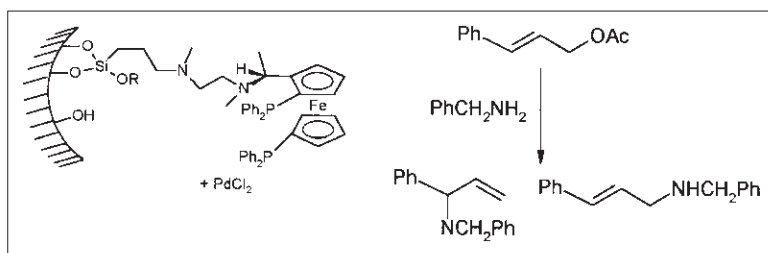


Fig. 7.40 Enantioselective catalysis using supported ferrocenyl complexes.

very rare case of a heterogeneous enantioselective catalyst dramatically outperforming its homogeneous counterpart, and indicates the very real potential of well-defined and designed heterogeneous catalysts in this highly challenging area of chemistry.

4 Conclusion

The use of highly structured mesoporous materials in catalysis has developed remarkably rapidly since the discovery of micelle-templated synthesis a decade ago. A huge variety of structures has been prepared, of which the silica-based materials have been the most prolifically exploited. Their large pore size has allowed them to be utilised in almost all branches of organic chemistry with success and as we learn more about their preparation and properties this trend will continue. Already, significant progress has been made in materials preparation,

with effort being expended to ensure that catalyst preparation can be green. Much has been learnt about the ability to control many of the key parameters, such as pore size, surface area, surface chemistry and particle size. Perhaps, more importantly, the synthesis of many of these materials is remarkably simple. This is particularly true of the ambient temperature and pressure conditions required for the neutral templated materials, where template removal also is simple to perform. These classes also have the important advantage of template recovery.

Examples of significant progress in acid, base, oxidation and enantioselective catalysis testify further to the wide range of applicational areas in which these catalysts have been applied with success. Much has been learnt about the importance of surface passivation in many processes and further strides certainly will be made in the following few years. This will require a combination of materials chemistry,

organic synthetic expertise and, increasingly, the involvement of engineers to optimise catalyst presentation and incorporate novel reactor design as an integral step of catalysis.

References

1. Corma, A. *Chem. Rev.*, 1997, **97**, 2373.
2. Corma, A. *Chem. Rev.*, 1995, **95**, 559.
3. Hattori, H. *Chem. Rev.*, 1995, **95**, 537.
4. Clark, J. H., & Macquarrie, D. J. *Chem. Commun.*, 1998, 853.
5. Clark, J. H., Macquarrie, D. J., & Price, P. M. *J. Chem. Soc. Dalton Trans.*, 2000, 101.
6. Beck, J. S., Chu, C. T.-W., Johnson, I. D., Kresge, C. T., *et al.* WO Patent 91/11390.
7. Beck, J. S., Vartuli, J. C., Roth, W. J., Leonowicz, M. E., *et al.* *J. Am. Chem. Soc.*, 1992, **114**, 10834.
8. Kresge, C. T., Leonowicz, M. E., Roth, W. J., Vartuli, J. C., & Beck, J. S. *Nature*, 1992, **359**, 710.
9. Saxton, R. J. *Top. Catal.*, 1999, **9**, 43.
10. Corma, A. *Chem. Rev.*, 1997, **97**, 2373.
11. Perego, G., Bellusi, G., Corno, C., Tarramasso, M., Buonomo, F., & Esposito, A. *Stud. Surf. Sci. Catal.*, 1986, **28**, 129.
12. Notari, B. *Stud. Surf. Sci. Catal.*, 1987, **37**, 413.
13. Clerici, M. G., & Ingallina, P. *J. Catal.*, 1993, **140**, 71.
14. Brinker, C. J. *Curr. Opin. Solid State Mater. Sci.*, 1996, **1**, 798.
15. Vartuli, J. C., Kresge, C. T., Roth, W. J., McCullen, S. B., *et al.* In *Advanced Catalysts and Nanostructured Materials* (Moser, W. R., ed.). Academic Press, New York, 1996, pp. 1–19.
16. Stucky, G. D., Huo, Q., Firouzi, A., Chmelka, B. F., *et al.* *Stud. Surf. Sci. Catal.*, 1997, **105**, 3.
17. Raman, N. K., Anderson, M. T., & Brinker, C. J. *Chem Mater.*, 1996, **8**, 1682.
18. Antonelli, D. M., & Ying, J. Y. *Curr. Opin. Coll. Interface Sci.*, 1996, **1**, 523.
19. Behrens, P. *Angew. Chem. Int. Ed.*, 1996, **108**, 515.
20. Zhao, X. S., Lu, G. Q., & Millar, G. J. *Ind. Eng. Chem. Res.*, 1996, **35**, 2075.
21. Stein, A., Melde, B. J., & Schroden, R. C. *Adv. Mater.*, 2000, **12**, 1403.
22. Sayari, A. *Chem. Mater.*, 1996, **8**, 1840.
23. Ying, J. Y., Mehnert, C. P., & Wong, M. S. *Angew. Chem. Int. Ed.*, 1999, **38**, 56.
24. Bagshaw, S. A., & Pinnavaia, T. J. *Angew. Chem. Int. Ed. Engl.*, 1996, **35**, 1102.
25. Vaudry, F., Khodobandeh, S., & Davis, M. E. *Chem. Mater.*, 1996, **8**, 1451.
26. Yada, M., Machida, M., & Kijama, T. *Chem. Commun.*, 1996, 769.
27. Hudson, M. J., & Knowles, J. A. *J. Mater. Chem.*, 1996, **6**, 89.
28. Reddy, J. S., & Sayari, A. *Catal. Lett.*, 1996, **38**, 219.
29. Ciesla, U., Schacht, S., Stucky, G. D., Unger, K. K., & Schüth, F. *Angew. Chem. Int. Ed. Engl.*, 1996, **35**, 541.
30. Antonelli, D. M., & Ying, J. Y. *Angew. Chem. Int. Ed. Engl.*, 1996, **34**, 2014.
31. Antonelli, D. M., Nakahira, A., & Ying, J. Y. *Inorg. Chem.*, 1996, **35**, 3126.
32. Antonelli, D. M., & Ying, J. Y. *Chem. Mater.*, 1996, **8**, 874.
33. Burkitt, S. L., Sims, S. D., & Mann, S. *Chem. Commun.*, 1996, 1367.
34. Macquarrie, D. J. *Chem. Commun.*, 1996, 1961.
35. Richer, R., & Mercier, L. *Chem. Commun.*, 1998, 1775.
36. Huo, Q., Margolese, D. I., Ciesla, U., Feng, P., *et al.* *Nature*, 1994, **368**, 317.
37. Huo, Q., Margolese, D. I., Ciesla, U., Demuth, D. G., *et al.* *Chem. Mater.*, 1994, **6**, 1176.
38. Prins, R., & Hitz, S. *J. Catal.*, 1997, **168**, 194.
39. Kawi, S., & Lai, M. W. *Chem. Commun.*, 1998, 1407.
40. Kawi, S., & Lai, M. W. *Chemtech*, 1998, **28**, 26.
41. Kawi, S., & Goh, A. H. *Stud. Surf. Sci. Catal.*, 2000, **129**, 231.
42. Jaroniec, M., & Antochshuk, V. *Chem. Mater.*, 2000, **12**, 2496.
43. Tanev, P. T., & Pinnavaia, T. J. *Science*, 1995, **267**, 865.
44. Pinnavaia, T. J., Prouzet, E., & Bagshaw, S. A. *Science*, 1995, **269**, 1242.
45. Price, P. M., Clark, J. H., Martin, K., Macquarrie, D. J., & Bastock, T. W. *Org. Proc. Res. Dev.*, 1998, **2**, 221.
46. Clark, J. H., Price, P. M., Martin, K., Macquarrie, D. J., & Bastock, T. W. *J. Chem. Res. (S)*, 1997, 430.
47. Brunel, D. *Microp. Mesop. Mater.*, 1999, **27**, 329.
48. Brunel, D., Cauvel, A., Fajula, F., Di Renzo, F. *Stud. Surf. Sci. Catal.*, 1995, **97**, 173.
49. Choudary, B. M., Lakshmi Kantam, M., Sreekanth, P., Bandopadhyay, T., Figueras, F., & Tuel, A. *J. Mol. Catal.*, 1999, **142**, 361.
50. Cauvel, A., Renard, G., & Brunel, D. *J. Org. Chem.*, 1997, **62**, 749.
51. Liu, C., Ye, X., & Wu, Y. *Catal. Lett.*, 1996, **36**, 263.
52. Sutra, P., & Brunel, D. *Chem. Commun.*, 1996, 2485.
53. Rao, Y. Y. S., De Vos, D. E., Bein, T., & Jacobs, P. A. *Chem. Commun.*, 1997, 355.
54. Diaz, J. F., Balkus Jr. K. J., Bedioui, F., Kurshev, V., & Kevan, L. *Chem. Mater.*, 1997, **9**, 61.
55. Liu, C. J., Li, S. G., Pang, W. Q., & Che, C. M. *Chem. Commun.*, 1997, 65.
56. O'Brien, S., Tudor, J., Barlow, S., Drewitt, M. J., Heyes, S. J., & O'Hare, D. *Chem. Commun.*, 1997, 641.
57. Maschmeyer, T., Oldroyd, R. D., Sankar, G., Thomas, J. M., *et al.* *Angew. Chem. Int. Ed. Engl.*, 1997, **36**, 1639.
58. Bellocq, N., Brunel, D., Laspéras, M., & Moreau, P. *Stud. Surf. Sci. Catal.*, 1997, **108**, 485.
59. Johnson, B. F. G., Raynor, S. A., Shephard, D. S., Maschmeyer, T., *et al.* *Chem. Commun.*, 1999, 1167.
60. Kim, G.-J., & H-Shin, J. *Tetrahedron Lett.*, 1999, **40**, 682.

61. Piaggio, P., McMorn, P., Laugham, C., Bethell, D., *et al.* *New J. Chem.*, 1998, **22**, 1167.
62. Zhou, X.-G., Li, X.-Q., Huang, J.-S., Li, S.-G., Li, L.-S., & Che, C.-M. *Chem. Commun.*, 1999, 1789.
63. Bae, S. J., Kim, S.-W., Hyeon, T., & Kim, B. M. *Chem. Commun.*, 2000, 31.
64. Hertl, W. J. *Phys. Chem.*, 1968, **72**, 1248.
65. Plueddeman, E. J. *Silane Coupling agents*, 2nd edn. Plenum Press, New York, 1991.
66. Brunel, D., Cauvel, A., Di Renzo, F., Fajula, F., *et al.* *New J. Chem.*, 2000, **24**, 807.
67. Macquarrie, D. J., & Jackson, D. B. *Chem. Commun.*, 1997, 1781.
68. Macquarrie, D. J. *Green Chem.*, 1999, **1**, 195.
69. Macquarrie, D. J., Mdoe, J. E. G., Jackson, D. B., & Clark, J. H. *New J. Chem.* 1999, **23**, 539.
70. Anwander, R., Nagl, I., Widenmeyer, M., Engelhardt, G., *et al.* *J. Phys. Chem.*, 2000, **104**, 3352.
71. Kloetstra, K. R., & van Bekkum, H. *J. Chem. Res. (S)*, 1995, 26.
72. Gunnewegh, E. A., Gopie, S. S., & van Bekkum, H. *J. Mol. Catal. A*, 1996, **106**, 151.
73. van Bekkum, H., Hoefnagel, A. J., van Koten, M. A., Gunnewegh, E. A., Vogt, A. H. G., & Kouwenhoven, H. W. *Stud. Surf. Sci. Catal.*, 1994, **83**, 379.
74. Kloetstra, K. R., & van Bekkum, H. *Chem. Commun.*, 1995, 1005.
75. Kloetstra, K. R., van Laren, M., & van Bekkum, H. *J. Chem. Soc. Faraday Trans.*, 1997, **93**, 1211.
76. Kloetstra, K. R., & van Bekkum, H. *Stud. Surf. Sci. Catal.*, 1997, **105**, 431.
77. Mdoe, J. E. G., Macquarrie, D. J., & Clark, J. H. *Synlett*, 1998, 625.
78. Mdoe, J. E. G. DPhil Thesis, University of York, 1999.
79. Clark, J. H., Martin, K., Teasdale, A. J., & Barlow, S. J. *Chem. Commun.*, 1995, 2037.
80. Van Rhijn, W. M., De Vos, D. E., Sels, B. F., Bossaert, W. D., & Jacobs, P. A. *Chem. Commun.*, 1998, 317.
81. Bossaert, W. D., De Vos, D. E., Van Rhijn, W. M., Bullen, J., Grobet, P. J., & Jacobs, P. A. *J. Catal.*, 1999, **182**, 156.
82. Van Rhijn, W. M., De Vos, D. E., Bossaert, W., Bullen, J., *et al.* *Stud. Surf. Sci. Catal.*, 1998, **117**, 183.
83. Diaz, I., Marquez-Alvarez, C., Mohino, F., Perez-Pariente, J., & Sastre, E. *J. Catal.*, 2000, **193**, 283.
84. Diaz, I., Marquez-Alvarez, C., Mohino, F., Perez-Pariente, J., & Sastre, E. *J. Catal.*, 2000, **193**, 295.
85. Margolese, D., Melero, J. A., Christiansen, S. C., Chmelka, B. F., & Stucky, G. D. *Chem. Mater.*, 2000, **12**, 2448.
86. Dusi, M., Mallat, T., & Baiker, A. *Catal. Rev.—Sci. Eng.*, 2000, **42**, 213.
87. Tanev, P. T., Chibwe, M., & Pinnavaia, T. J. *Nature*, 1994, **368**, 321.
88. Corma, A., Navarro, M. T., & Pariente, J. P. *Chem. Commun.*, 1994, 147.
89. Blasco, T., Corma, A., Navarro, M. T., & Pérez Pariente, J. *J. Catal.*, 1994, **156**, 65.
90. Zhang, W., Fröba, M., Wang, J., Tanev, P. T., Wong, J., & Pinnavaia, T. J. *J. Am. Chem. Soc.*, 1996, **118**, 9164.
91. Tatsumi, T., Koyamo, K. A., & Igarishi, N. *Chem. Commun.*, 1998, 325.
92. D'Amore, M. B., & Schwarz, S. *Chem. Commun.*, 1999, 121.
93. Macquarrie, D. J., Blanc, A., Brunel, D., Renard, G., & Quinn, C. R. *Green Chem.*, 2000, **2**, 283.
94. Kochkar, H., & Figueras, F. *J. Catal.*, 1997, **171**, 42.
95. Oldroyd, R. D., Sankar, G., Thomas, J. M., & Ozkaya, D. *J. Phys. Chem. B*, 1998, **102**, 1849.
96. Krijnen, S., Abbenhuis, H. C. L., Hanssen, R. W. J. M., van Hooff, J. H. C., & van Santen, R. A. *Angew. Chem. Int. Ed.*, 1998, **37**, 356.
97. Chen, L. Y., Chuah, G. K., & Jaenicke, S. *Catal. Lett.*, 1998, **50**, 107.
98. Guidotti, M., Moretti, G., Psaro, R., & Ravasio, N. *Chem. Commun.*, 2000, 1789.
99. Maschmeyer, T., Rey, F., Sankar, G., & Thomas, J. M. *Nature*, 1995, **378**, 159.
100. Verkruysee, K. A., Klingeleers, D. M., Collings T., & Jacobs, P. A. *Stud. Surf. Sci. Catal.*, 1998, **117**, 469.
101. Kapoor, M. P., & Raj, A. *Appl. Catal. A. Gen.*, 2000, **203**, 311.
102. Neumann, R., Chava, M., & Levin, M. *Chem. Commun.*, 1993, 1685.
103. Kim, S. S., Zhang, W. Z., & Pinnavaia, T. J. *Catal. Lett.*, 1997, **43**, 149.
104. Yonemitsu, M., Tanaka, Y., & Iwamoto, M. *J. Catal.*, 1998, **178**, 207.
105. Sutra, P., & Brunel, D. *Proc. 3rd Supported Reagents and Catalysis Conference*, Limerick (Hodnett, B. K., Clark, J. H., Kybett, A. P., & Smith, K., eds). Royal Society of Chemistry, London, 1997, p. 54.
106. Verhoef, M. J., Peters, J. A., & van Bekkum, H. *Stud. Surf. Sci. Catal.*, 1999, **125**, 465.
107. Lau, S. H., Caps, V., Yeung, K.-W., Wong, K.-Y., & Tsang, S. C. *Microp. Mesop. Mater.*, 1999, **32**, 279.
108. Eswaramoorthy, M., Neeraj, & Rao, C. N. R. *Chem. Commun.*, 1998, 615.
109. Liu, C.-J., Yu, W.-Y., Li, S.-G., & Che, C.-M. *J. Org. Chem.*, 1998, **63**, 7364.
110. Subba Rao, Y. V., De Vos, D. E., & Jacobs, P. A. *Angew. Chem. Int. Ed. Engl.*, 1997, **23**, 2661.
111. Derrien, A., Renard, G., & Brunel, D. *Stud. Surf. Sci. Catal.*, 1998, **117**, 445.
112. de Nooy, A. E. J., Besemer, A. C., & van Bekkum, H. *Synthesis*, 1996, **10**, 1153.
113. Brunel, D., Lentz, P., Sutra, P., Deroide, B., Fajula, F., & Nagy, J. B. *Stud. Surf. Sci. Catal.*, 1999, **125**, 237.
114. Bolm, C., & Frey, T. *Chem. Commun.*, 1999, 1795.
115. Ciriminna, R., Blum, J., Avnir, D., & Pagliaro, M. *Chem. Commun.*, 2000, 1441.

116. Fujiyama, H., Kohara, I., Iwai, K., Nishiyama, S., Tsuruya, S., & Masai, M. *J. Catal.*, 1999, **188**, 417.
117. Capdevielle, P., & Maumy, M. *Tetrahedron Lett.*, 1983, **24**, 5611.
118. Kauthari, V. M., & Tazuma, J. J. *J. Catal.*, 1976, **41**, 180.
119. Fu, Z. H., Chen, J. H., Yin, D. L., Yin, D. H., Zhang, L. X., & Zhang, Y. Y. *Catal. Lett.*, 2000, **66**, 105.
120. Liu, C. B., Ye, X. K., & Wu, Y. *J. Chem. Tech. Biotech.*, 1997, **70**, 384.
121. Okamura, J., Nishiyama, S., Tsuruya, S., & Masai, M. *J. Mol. Catal.*, 1998, **135**, 133.
122. Chen, Y. W., & Lu, Y. H. *Ind. Eng. Chem. Res.*, 1999, **38**, 1893.
123. Sorokin, A. B., & Tuel, A. *Catal. Today*, 2000, **57**, 45.
124. Noyori, R., & Takaya, H. *Acc. Chem. Res.*, 1990, **23**, 345.
125. Blaser, H.-U. *Chem. Rev.*, 1992, **92**, 935.
126. Armengerol, E., Corma, A., Garcia, H., & Primo, J. *Eur. J. Org. Chem.*, 1999, **2**, 1915.
127. Cheng, A. K.-W., Lin, W.-Y., Li, S.-G., Che, C.-M., & Pang, W.-Q. *New J. Chem.*, 1999, **23**, 733.
128. Laszlo, P. *Acc. Chem. Res.*, 1986, **19**, 121.
129. Lednor, P. W., & de Ruiter, R. *J. Chem. Soc. Chem. Commun.*, 1991, 1625.
130. Lambert, A., Priest, A., Mdoe, J. E. G., Macquarrie, D. J., & Clark, J. H. *React. Polym.*, 1997, **35**, 153.
131. Laspéras, M., Lloret, T., Chaves, L., Rodriguez, I., Cauvel, A., & Brunel, D. *Stud. Surf. Sci. Catal.*, 1997, **108**, 75.
132. Jones, G. R. *Org. React.*, 1967, **15**, 204.
133. Linstead, R. P. *J. Chem. Soc.*, 1933, 557.
134. Corey, E. J. *J. Am. Chem. Soc.*, 1952, **94**, 5897.
135. Ragoussis, N. *Tetrahedron Lett.*, 1987, **28**, 93.
136. Heykants, E., Verrelst, V. H., Parton, R. F., & Jacobs, P. A. *Stud. Surf. Sci. Catal.*, 1997, **105**, 1277.
137. Mattson, F. H., & Volenheimer, R. A. *J. Lipid Res.*, 1962, **3**, 281.
138. Aracil, M., & Corma, A. PCT/ES 93/00100 and WO 94/13617.
139. Ganset, C. *Stud. Surf. Sci. Catal.*, 1991, **59**, 93.
140. US Dept. of Agriculture, US Patent 5747305.
141. Opta Food Ingredients, US Patent 5316927.
142. Reetz, M. T., Zonta, A., & Simpelkamp, J. *Angew. Chem. Int. Ed.*, 1995, **34**, 301.
143. Lin, X., Chuah, G. K., & Jaenicke, S. *J. Mol. Catal.*, 1999, **150**, 287.
144. Sercheli, R., Vargas, R. M., & Schuchardt, U. *J. Am. Oil Chem. Soc.*, 1999, **76**, 1207.
145. Rodriguez, I., Iborra, S., Corma, A., Rey, F., & Jordá, J. L. *Chem. Commun.*, 1999, 593.
146. Canali, L., & Sherrington, D. C. *Chem. Soc. Rev.*, 1999, **28**, 85.
147. Sherrington, D. C. *Chem. Commun.*, 1998, 2275.
148. Hodge, P. *Chem. Soc. Rev.*, 1997, **26**, 417.
149. Blossey, E. C., & Ford, W. T. In *Comprehensive Polymer Science. The Synthesis, Characterisation, Reactions and Applications of Polymers* (Allen, G., & Bevington, J. C., eds), Vol. 6. Pergamon, New York, 1989, pp. 81–114.
150. Akelah, A., & Sherrington, D. C. *Chem. Rev.*, 1981, **81**, 557.
151. Corma, A., Iglesias, M., Delpino, C., & Sanchez, F. J. *Organomet. Chem.*, 1992, **431**, 233.
152. Corma, A., Iglesias, M., Delpino, C., & Sanchez, F. *Stud. Surf. Sci. Catal.*, 1993, **75**, 2293.
153. Carmona, A., Corma, A., Iglesias, M., Sanjose, A., & Sanchez, F. *J. Organomet. Chem.*, 1995, **492**, 11.
154. Sabater, M. J., Corma, A., Domenech, A., Formes, V., & Garcia, H. *Chem. Commun.*, 1997, 1285.
155. Laspéras, M., Bellocq, N., Brunel, D., & Moreau, P. *Tetrahedron Asymm.*, 1998, **9**, 3053.
156. Bellocq, N., Abramson, S., Laspéras, M., Brunel, D., & Moreau, P. *Tetrahedron Asymm.*, 1999, **10**, 3229.
157. Soai, K., & Niwa, S. *Chem. Rev.*, 1992, **92**, 833.
158. Soai, K., Niwa, S., & Watanabe, M. *J. Org. Chem.*, 1988, **53**, 927.
159. Piaggio, P. A., McMorn, P., Langham, C., Bethell, D., et al. *New J. Chem.*, 1998, **22**, 1167.
160. Piaggio, P. A., McMorn, P., Murphy, D., Bethell, D., et al. *J. Chem. Soc. Perkin Trans 2*, 2000, 2008.

Chapter 8: Polymer-supported Reagents

GEORGES GELBARD

1 Introduction

1.1 A breakthrough in organic synthetic methods or a fancy for doing things differently?

Synthetic organic reactions performed in homogeneous solution are deemed advantageous because they allow reproducibility, great ease of maintaining concentration and temperature uniformly throughout the reaction medium and appear easier to achieve; furthermore, simple kinetic laws can be drawn and continuous spectroscopic monitoring can be performed.

The use of polymer-supported reagents is for heterogenisation of previously homogeneous systems and the reasons for trapping *one* of the reaction partners into an insoluble and porous carrier need to be justified. Substrates, reagents, catalysts or co-solvents are the molecular species concerned in this approach: they become covalently bound to an insoluble carrier to give molecules that are reactive but kept on a leash!

Such techniques are quite familiar now and were inspired from the biochemical world: the technique of affinity chromatography allowed the purification of enzymes by the interaction of an immobilised receptor and an enzyme in solution, finally leading to the automated peptides synthesis device invented by Merrifield [1]. This device was a great breakthrough that triggered intensive interest in similar areas: polysaccharides, polynucleotides and general methods in organic synthesis. The current is in the use of supported reagents as a smart and clean synthetic procedure: it allows reactions to be performed more selectively, more efficiently and with an easier work-up, as will be shown.

The aim of this chapter is to give precise concepts and concise, but significant, examples in the synthesis of chemical families of compounds with the help of polymer-supported reagents and catalysts. A large number of books, dedicated chapters and reviews

have been published already [2–18], not only concerning the organic polymers but also the use of inorganic carriers [19–22]; such studies developed at the same time as the grafting of reagents on the surface of oxides, essentially silica. Throughout this chapter 'P—*f*' will represent a functional group *f* covalently bound to a polymer P, usually a cross-linked polystyrene in the shape of small spherical beads.

1.2 Polymeric tools for organic synthesis

According to the role of the species that are grafted, different reactive polymers and different methods of use can be considered.

Polymeric reagents

The functional group is a conventional reagent that modifies a low-molecular-weight substrate S_0 that is in solution; the excess of reagent P—*f* ensures high conversion to product S_1 and filtration affords a solution of the pure final compound. The polymer contains the spent P—*f*' and the excess of reagent (Fig. 8.1). The reaction can be drawn to completion with an excess of reagent; the recovered polymeric material can be regenerated with an external agent.

Polymeric carriers

The substrate S_0 to be modified is temporarily covalently bound to the polymer, the external reagent R_0 in solution affords the expected reaction, filtration eliminates the excess and spent reagent in solution and the product is recovered by cleavage. Here, too, the reaction can be drawn to completion with an excess of solution of the reagent (Fig. 8.2).

This process, which requires two extra steps of grafting and cleavage, is nevertheless a helpful method that can be performed repeatedly on the same immobilised substrate, which is progressively transformed into the required molecule. This is a unique way of performing sequential transformations when multistep syntheses are required.

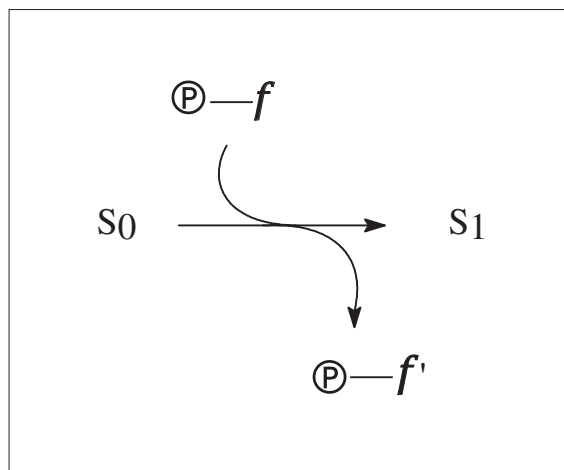


Fig. 8.1 Polymer-supported reagents.

Polymeric catalysts

Any kind of ion, organic or organometallic molecule with a well-defined catalytic activity can be immobilised ionically or covalently on polymer carriers (Fig. 8.3); even enzymes have been entrapped into polymeric matrices. This aspect is the common area of both homogeneous and heterogeneous catalysis; the 'immobilisation' of soluble catalytic species allows the reuse or the recovery of expensive materials: enzymes, precious metal derivatives, chiral species.

1.3 What is really possible and what is still expected

Easy separation

This is the first and most important feature: reactants and products are separated by simple filtration, affording a single product in one phase.

Solvent dependence

In usual reactions in solution, the solvent must dissolve all the components that are involved, but when one reactant is immobilised the others can fit with a larger choice of solvents. The polymer itself can induce local solvation effects.

Completion

Reactions can be made almost quantitative with an excess of reagent, the remaining and the spent

reagents being isolated by filtration to give the pure product in solution (Fig. 8.1) or bound to the polymer (Fig. 8.2); no further extraction, chromatography or extra distillation is generally required.

Concentration effects

High concentrations of catalysts or reagents can be obtained inside the polymeric material; this concentration may be beyond the common solubility. This aspect is important in catalysis when a good diffusion is provided. Conversely, with a very low degree of functionalisation, intramolecular reactions are favoured versus intermolecular reactions; this is an alternative to the high dilution conditions that can be achieved now in a restricted volume of reactants.

Safety of handling

Being insoluble and non-volatile, polymers can bind ill-smelling or noxious reagents; once the reagent has been grafted (with the usual care when handling As , Br_2 , HF , S , Se or Sn products or their derivatives), the polymer can be stored and used upon request under less severe safety conditions.

Environmental requirements are fulfilled more easily when wastes and co-reagents stay in a solid and filtrable phase and when reduced amounts of solvent are used in the final work-up.

Recycling

Depending on the relative price of the final product versus that of the starting polymer beads, the polymeric carrier can be recycled or not. Immobilised enzymes and organometallic derivatives of precious metals are expected to be recycled as catalysts; ion-exchanged resins usually are reloaded with fresh salts.

In a different area, at the end of a multistep synthesis of an expensive biologically active molecule, the price of the starting polymer carrier often becomes non-significant.

Workbench strategy

This approach allowed the bloom of multistep syntheses on a solid phase: once a starting molecule is bound, a cascade of different reactions are performed repeatedly with a series of reagents in solution;

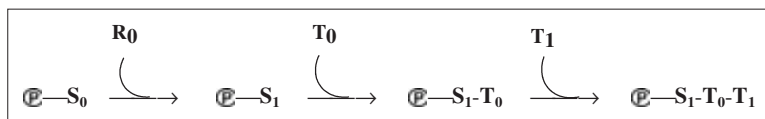


Fig. 8.2 Polymer-supported molecules in multistep synthesis.

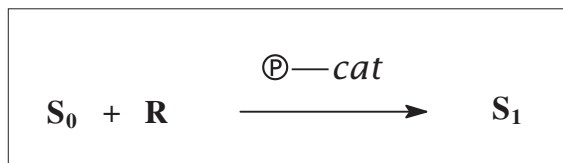


Fig. 8.3 Polymer-supported catalytic species.

the final elaborated molecule is released from the support (not as simply as a ripe fruit from the branch).

The alleged analogy relies on the following sequence: molecules are brought on the workbench, immobilised on the vice, carefully hand-processed and finally released in a turn.

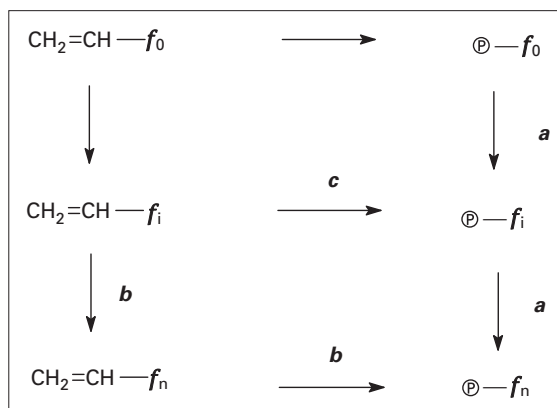


Fig. 8.4 General schemes of making functional polymers.

2 Making Functional Polymers

2.1 General schemes

Considering $P-f_n$ as the required functional polymer, there are two fundamental approaches: when a starting polymeric material $P-f_0$ is available, the native function f_0 is transformed into f_n by a reaction or a (short) sequence of reactions (Fig. 8.4, path *a*); and when a starting monomer containing f_n is available, the polymer is obtained by copolymerisation with that monomer $CH_2=CH-f_n$ or by modifying an available monomer $CH_2=CH-f_0$ (Fig. 8.4, path *b*). These are extreme situations. In fact, the monomer may require a transformation from $CH_2=CH-f_0$ to the intermediate monomer $CH_2=CH-f_i$ and then copolymerisation gives the intermediate material $P-f_i$ that is modified to get the required $P-f_n$ (Fig. 8.4, path *c*).

The choice depends on the availability of the materials, the stability and the reactivity of the relevant monomers. The method preferred by most organic chemists is to modify a ready-made polymer, especially when they are not familiar with polymerisation procedures.

The polymer in hand has a well-defined composition and morphology and the required chemical

modifications are performed easily. It should be recalled, however, that these modifications are not introduced homogeneously inside the beads: the outer sphere of the particles is more dense in functional groups than the inner part beneath; this is not important if it is a unique transformation (Fig. 8.4, path *a*).

When using the final material for a given reaction, the substrate need not diffuse further inside the beads to be transformed; these 'superficial' reagents allow fast reactions provided that there is enough reagent. On the contrary, if a modification sequence has been required (Fig. 8.4, path *c*) the transformations may not be completed deeper inside, giving $P-f_{(n-i)}$ intermediates.

The copolymerisation method (Fig. 8.4, path *b*) allows a possible purification of the monomer $CH_2=CH-f_i$ at each step from $CH_2=CH-f_0$ to $CH_2=CH-f_n$ and the final copolymerisation affords a much more homogeneous material in terms of spatial distribution of the functional groups, but a significant part of the reactive functions buried in the centre of the beads is less accessible to the substrate. With this last approach, the polymerisation conditions need to be experienced each time due to the

different kinetic parameters of each monomer, including the cross-linking agent.

2.2 Required properties

The polymeric material that will be used as a carrier must fulfil several requirements:

- (1) The polymer must be insoluble in a variety of solvents used in the reaction; this is ensured by connecting the individual chains (see below for cross-linking).
- (2) The polymer must be chemically inert with respect to the reactants and the product(s), especially with electrophilic and strong base compounds.
- (3) The polymer must afford good diffusion of solvent and reactants; this is provided by swelling for gel-type polymers or by the high porosity of macroporous polymers; swelling is ensured when the monomeric units have a similar polarity to that of the solvent. Accessibility is improved when the reactive function is put away, by means of a 'spacer', from the polymer chain.
- (4) The reactive functions must give complete, clean and unambiguous reactions.
- (5) The polymer must possess a sufficient degree of functionalisation to afford a good capacity of functional groups.
- (6) The polymer must be thermally stable in the usual range of temperature.
- (7) The polymer must be mechanically stable enough under the stirring conditions; gel-type resins are more resistant to attrition than macroporous resins but the damage can be reduced when using the 'tea-bag' technique.
- (8) The polymer should be regenerated easily after use by a simple procedure.

2.3 Copolymerisation with usual monomers

The polymeric materials transformed into polymer-supported reagents usually are obtained by radical copolymerisation of a mixture of three vinylic monomers:

- (1) The chain agent, which is the main physical constituent of the carrier and plays the role of a diluent along the chains (styrene, methylmethacrylate; Fig. 8.5a).

- (2) The functional monomer, which will be transformed further into the required active group (chloromethylstyrene, glycidyl methacrylate, acrylonitrile, 4-vinyl pyridine, vinyl acetate; Fig. 8.5b).
- (3) The cross-linking agent—a bifunctional monomer that gives insolubility to the final material: divinylbenzene, ethylene glycol dimethacrylate, trimethylolpropane trimethacrylate (Fig. 8.5c).

Cross-linking of polystyrene generally is performed with technical divinylbenzene (DVB), which is a mixture containing only about 50% of divinylbenzene (one-third of the *meta* and two-thirds of the *para* isomer) and 50% of ethyl styrene, which behaves like styrene; thus when a resin is said to be 1% cross-linked it means that 2% of technical DVB was used in the copolymerisation procedure.

With acrylates and methacrylate-based monomers, ethylene glycol dimethacrylate (EGDMA) and trimethylolpropane trimethacrylate (TRIM) are used as cross-linking agents; swelling properties can be improved with a more flexible molecule such as 1,6-hexanediol diacrylate [23]. The preparation of these copolymers is well documented in the literature [24–27].

Fortunately, several of these copolymers are available commercially; they are ready to use or can be processed simply to get the required functional groups. Some significant structures are given in Table 8.1. The suitable monomer $\text{CH}_2=\text{CH}-f_n$, when readily available, may not survive some anionic or cationic polymerisation conditions, in which case it is necessary to introduce protecting groups that are removed afterwards [28].

According to the polymerisation process and the amount of cross-linking agent introduced, two series of polymeric beads can be obtained:

- *Gel type*: when usually less than 8% of cross-linking agent is involved, the polymer network is made of quite independent chains that are loosely connected. In suitable solvents the polymer chains become solvated as if they were free, so the material swells up to the limit. This ensures a good diffusion of reactants and products (Fig. 8.6a).
- *Macroporous type*: when the polymerisation is performed with a very high content of cross-linking agent, a network of tightly connected chains is obtained. To ensure some diffusion in such a

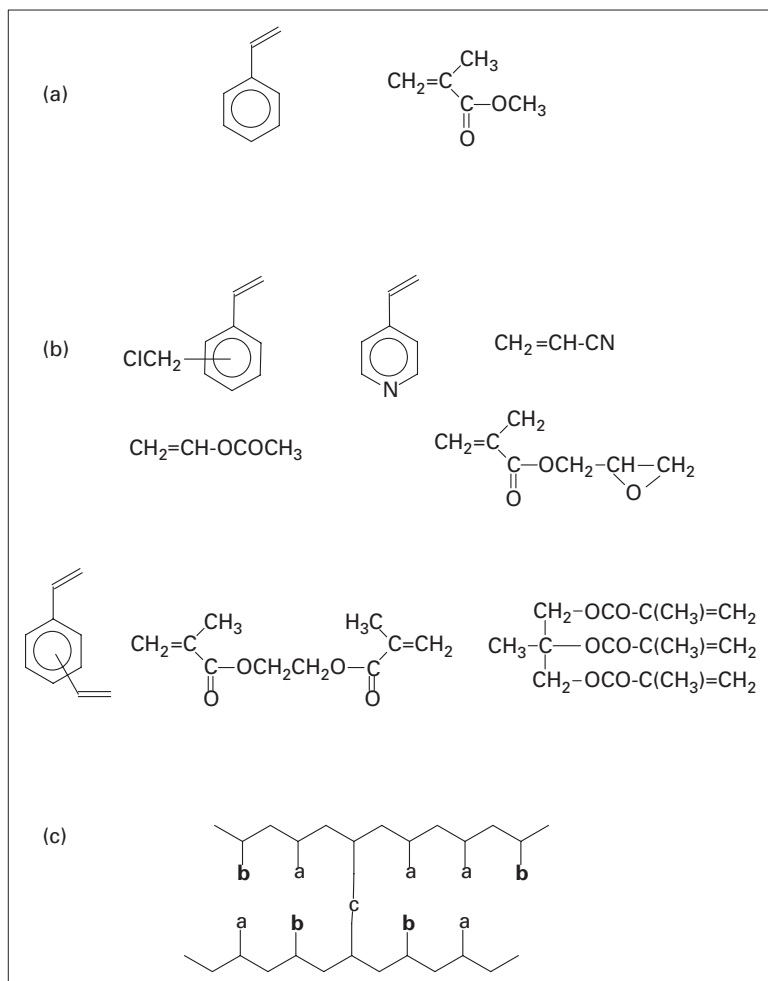


Fig. 8.5 Topological scheme in cross-linking.

compact material, the polymerisation is performed in the presence of inert molecules in solution, so that the polymer network is formed around aggregates of these so-called 'porogen' molecules, affording a discontinuous material with open pores of diameter up to 600 Å.

A schematic view would correspond to a sponge-like material with large channels where the post-functionalisation gives active groups that are at the surface of the stiff walls (Fig. 8.6b).

2.4 Polystyrenes

Some macroporous styrene-based copolymers may exhibit interesting properties when a high porous volume is obtained; this can be obtained when a

minimum amount of porogens such as soluble (linear) polystyrene or dibutyl phthalate is introduced in the medium during the polymerisation [29].

For practical reasons, due to the techniques of polymerisation, the final materials appear as translucent or opaque spherical beads of size 0.2–2 mm in diameter, which allows easy handling, transfer and filtration.

The most popular starting material is 'Merrifield's polymer'—a gel-type chloromethylated polystyrene (P—C₆H₄—CH₂—Cl) with which Merrifield performed the first successful synthesis of polypeptides [1].

More than 50 different functional groups have been introduced through nucleophilic reactions at the benzylic position [30], a few examples are given

Table 8.1 Some available supported reagents

Aminomethyl-polystyrene
Benzenesulfonic acid
Bengal Rose B
Borohydride-exchanged resin
Bromopolystyrene
Chloramine T, polymer bound
2- <i>t</i> -Butylimino-2-diethylamino-1,3-dimethyl-perhydro-1,3,2-diazaphosphorine
2-Chlorotriyl chloride
Cyanide-exchanged resin
Dialkylaminomethyl-polystyrene (dimethyl, diisopropyl, morpholino)
Dimethylaminopyridine on polystyrene
(Poly)ethyleneglycol, polymer bound
Hexamethylphosphotriamide
Maleimidobutyramidomethyl-polystyrene
Methylbenzhydramine, polymer bound
Merrifield polymer (chloromethylated polystyrene)
Poly(methylmethacrylate)
Poly(4-vinylpyridine)
Poly(4-vinylpyridine) hydrobromide, perbromide
Pyridinium chlorochromate
Pyridinium dichromate
Pyridinium toluene-4-sulfonate
Styrene-divinylbenzene copolymer
1,5,7-Triazabicyclo[4.4.0]dec-5-ene, polystyrene bound
Tribromide-exchanged resin
Triphenylphosphine, polymer bound

in Fig. 8.7. Macroporous polystyrenes get a renewal of interest through post-functionalisation: the condition of copolymerisation with high contents of DVB gives a substantial amount of free pendant vinylic groups that survive after the reaction [27] and are still useful for further radical grafting of functional groups [31,32] (Fig. 8.8). More details on these transformations will be given in the following sections according to the kind of properties of each polymer reagent.

2.5 Spacers

The fact that supported reagents (and catalysts) are made essentially from gel-type polymers must be stressed. It has been experienced that a good swelling of the material ensures better diffusion of substrates and products through the beads; this is an aspect of the necessary accessibility of molecules in solution towards the 'reactive site'.

The early functional polymers result from simple functionalisation of polystyrene; as shown in Fig. 8.5, the reactive site is very close to the polymeric chain (which in fact is coiled, not straight), which induces severe steric hindrance. To improve the freedom of the reactive site, extensions have been

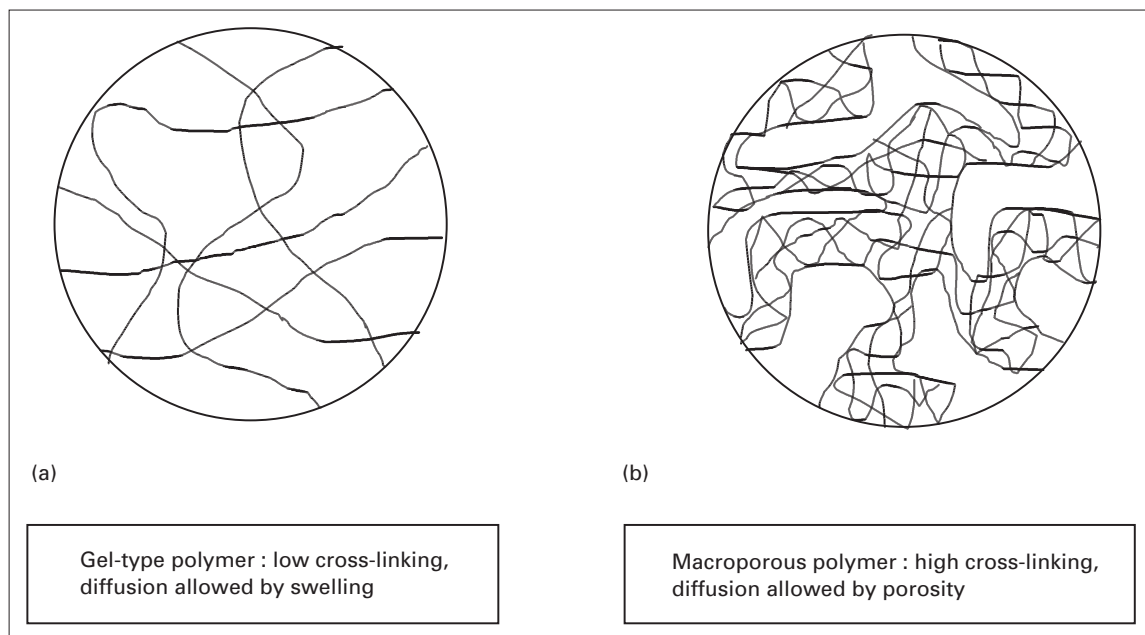


Fig. 8.6 Schematic structure of gel-type and macroporous polymers.

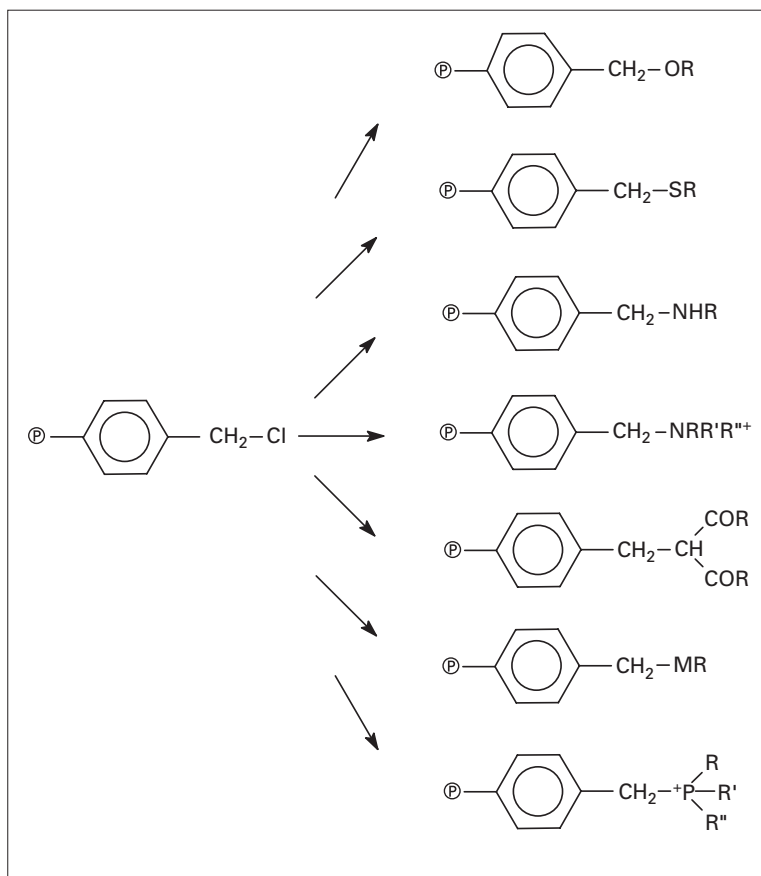


Fig. 8.7 Chemical derivatisations of chloromethylated polystyrene.

introduced between the function and the polymer chain: these 'spacers' provide an increase in the mobility of the functional chain and afford better accessibility to the reactants.

For instance, the introduction of an additional benzyloxy group on polystyrene resins gives the Wang resins, which are improved materials (Fig. 8.9a); even better properties are obtained after grafting longer chains, such as polyethyleneglycols, to give the TantaGel resins (Fig. 8.9b). These resins are obtained by the O-alkylation of phenols or polyethyleneglycols with chloromethylated polystyrenes in basic media [33–35]; they are used widely in solid-phase synthesis (see previous section). Other spacers have been introduced by alkylation (Fig. 8.10a) or by acylation with anhydrides (Fig. 8.10b) or acid chlorides (Fig. 8.10c) in the presence of Lewis acids; the terminal group is modified afterwards [36–38].

2.6 Polyacrylates

In contrast to styrene, functionalised acrylates and acrylamides are available, so convenient polyacrylic resins can be obtained. They are more polar than polystyrenes and can swell in a wider range of solvents, but because of the presence of an ester linkage their use in strong reducing, acidic or basic conditions is restricted; the presence of Lewis acids should be avoided too [39–41].

For instance, radical copolymerization of β -aminoethyl methacrylate with TRIS as a cross-linker affords a polymeric support that shows excellent swelling properties in a broad range of solvents, including water, alcohols, tetrahydrofuran, dichloromethane and N,N-dimethylformamide [42] (Fig. 8.11).

Amino derivatives also can be obtained by the nucleophilic opening of the oxirane ring in polygly-

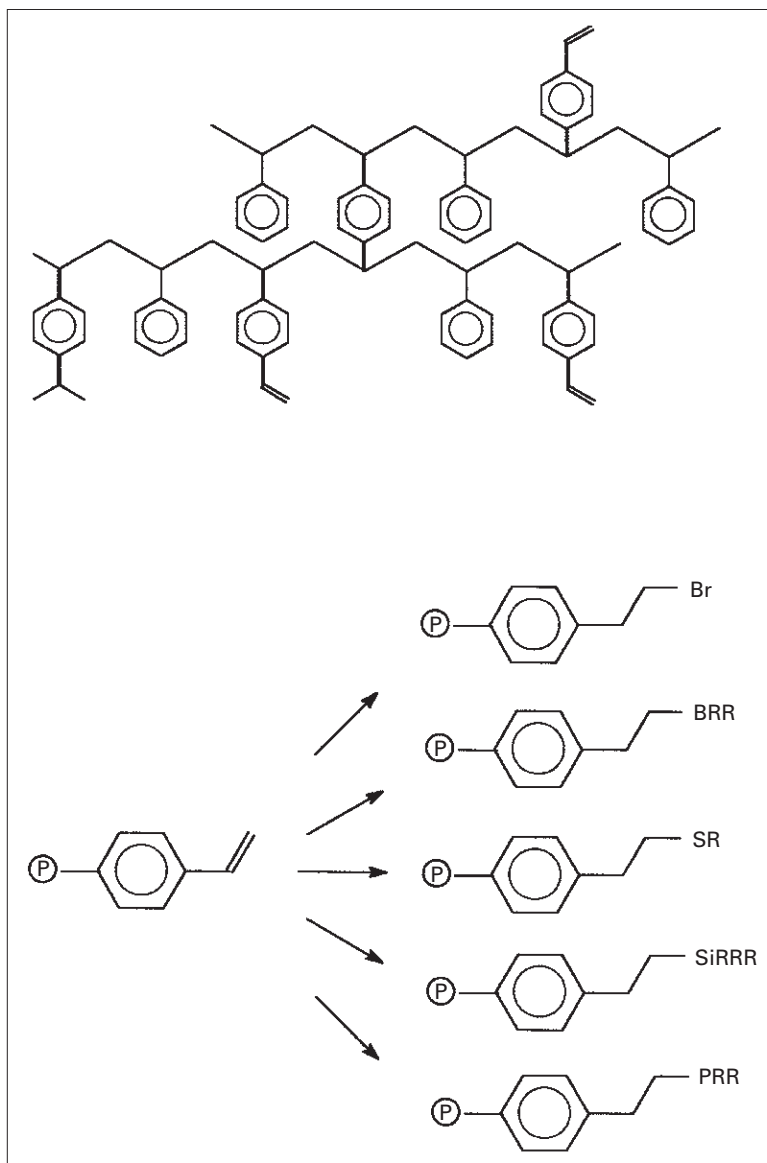


Fig. 8.8 Post-grafting on residual vinyl groups.

cidyl methacrylate copolymers [43–45], after which further modifications are possible.

Polyacrylates with pendant halomethyl groups can be considered as the polyester analogues of the chloromethyl polystyrenes; they present potential uses for a wide range of useful transformations [46,47]. Such linear polyesters can be obtained also by the polyaddition reactions of bisepoxides such as the diglycidyl ether of bisphenol A, with bis(haloac-

toxy) esters such as 1,4-bis[(chloroacetoxy) methyl] benzene (Fig. 8.12). A cross-linked material also would be obtained.

A simpler method to obtain such a material is the opening reaction of the oxirane ring in polyglycidyl methacrylate copolymers with methyl iodide [48]; this one-step reaction gives reactive iodoalkyl groups (Fig. 8.13).

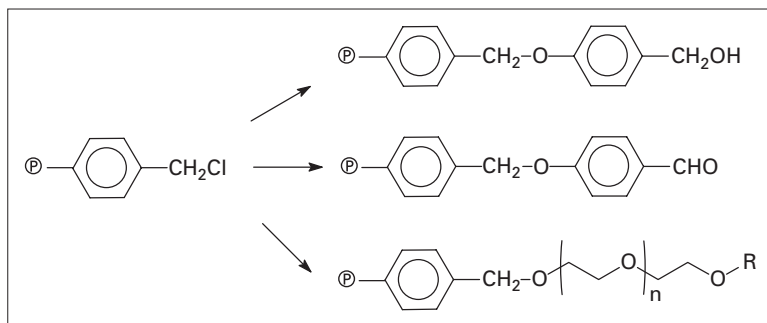


Fig. 8.9 Benzyloxy and polyethyleneglycol spacers.

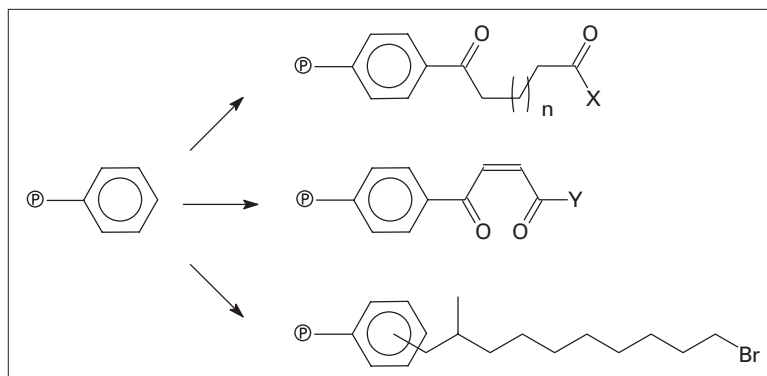


Fig. 8.10 Spacers introduced by Friedel-Crafts grafting.

2.7 Polyvinylpyridines

Both 2- and 4-vinylpyridines can copolymerise with DVB under the same conditions as for styrene to give similar cross-linked bead-shaped materials. They are available now on the market and can be modified into several reagents [49–52]; those made from the 4-isomer are more reactive (Fig. 8.14).

2.8 Polybenzimidazoles

These insoluble homopolymers are not cross-linked; they are obtained by thermal polycondensation of phthalic acid with tetraaminobiphenyls (Fig. 8.15). The resulting material is processed to give porous beads or fibres, exhibits a high thermal stability and is resistant to oxidation. This inertness has made the chemical modifications more difficult, but several examples are known [53–57].

2.9 Polyphosphazenes

These linear homopolymers are obtained by the

thermal polymerisation of cyclotri(dichlorophosphazene) into poly(dichlorophosphazene) [58–60]; this material contains only nitrogen and phosphorus atoms in the main chain and a very high content of $>PCL_2$ units (Fig. 8.16). With respect to other polymers, there are many more starting points for functionalisation: the very electrophilic chlorine atoms allow a series of subsequent substitutions to give a large number of different side groups.

2.10 Chlorofluoropolymers

With the exception of Nafion™, polyhalogenated polymers are of limited value due to the absence of porosity and the difficulty in performing surface graftings. However, when a limited degree of functionalisation is required, which can be the case in catalysis with organometallic complexes, it is possible to introduce specific groups such as hydroxyls, carbonyls, carboxyls and amines at the surface of chlorofluoropolymers (PTFE, PVF₂) by a substitution reaction [61] of the halogens under strongly basic conditions.

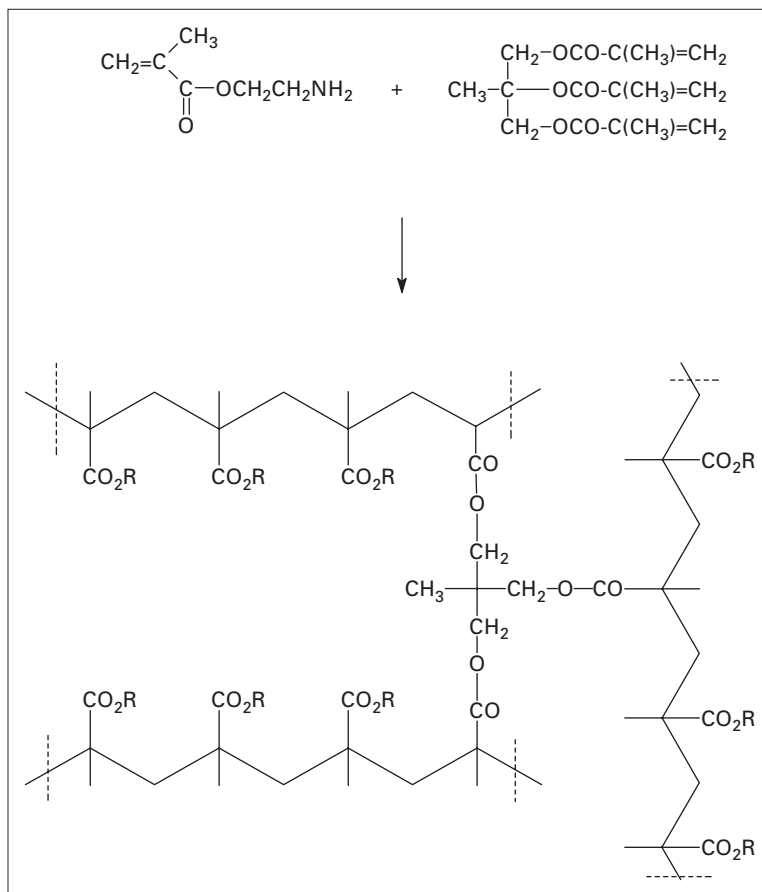


Fig. 8.11 Cross-linked polymethacrylate.

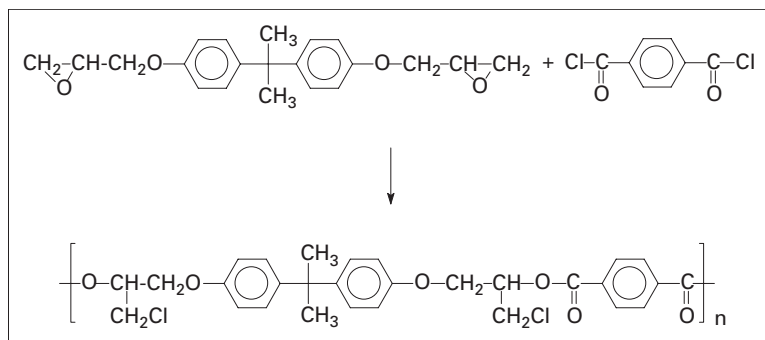


Fig. 8.12 Linear polyester with pendant chloromethyl groups.

3 Syntheses with Polymer-supported Reagents

It is beyond the scope of this chapter to deal with all the aspects of functional polymers as tools for organic synthesis, as mentioned in section 1.2;

polymer-supported homogeneous catalysts (Fig. 8.3) will not be included here and the multistep synthesis performed on a molecule temporarily bound on a polymer (Fig. 8.2) is a technique that must be considered separately.

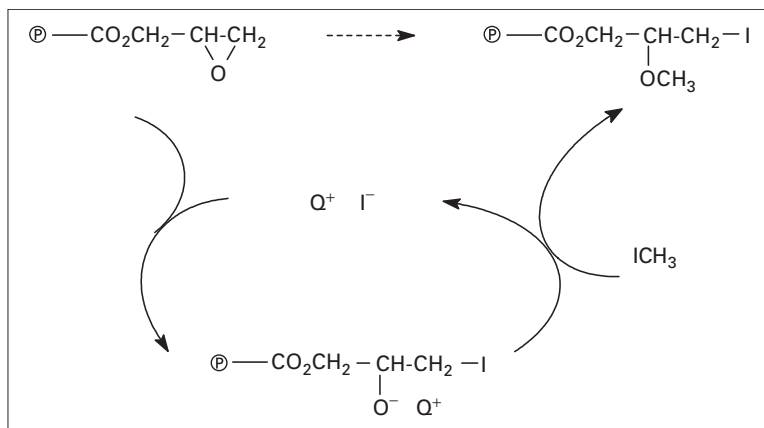


Fig. 8.13 Polymethacrylate with pendant iodomethyl groups.

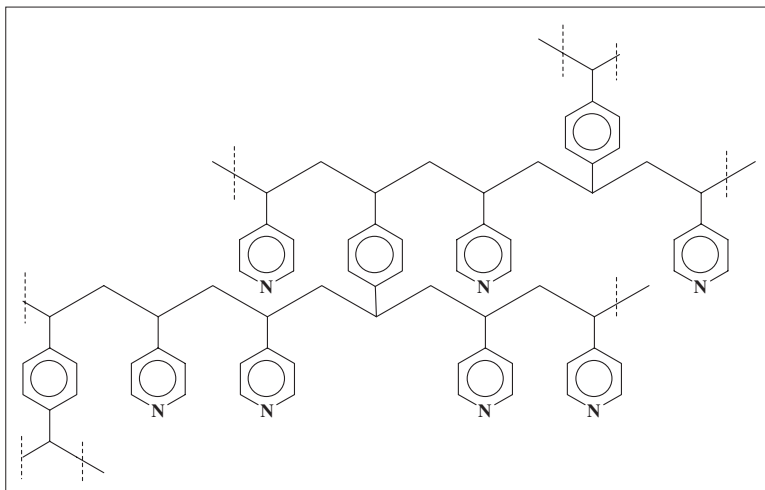


Fig. 8.14 Cross-linked poly(4-vinylpyridine).

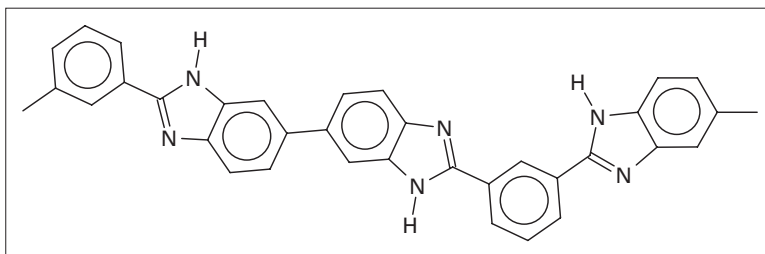


Fig. 8.15 Polybenzimidazole.

Solid-phase synthesis (SPS) is now a powerful tool in drug research for the accelerated production of families of molecules to be screened, and several books, reviews and dedicated journals are now available [62–70]. This section thus will be devoted to

methods of performing (according to Fig. 8.1) a discrete and unique transformation of a molecule in solution with an excess of reagent immobilised on an organic polymer. It should be recalled that the interest for the organic chemist lies more in the

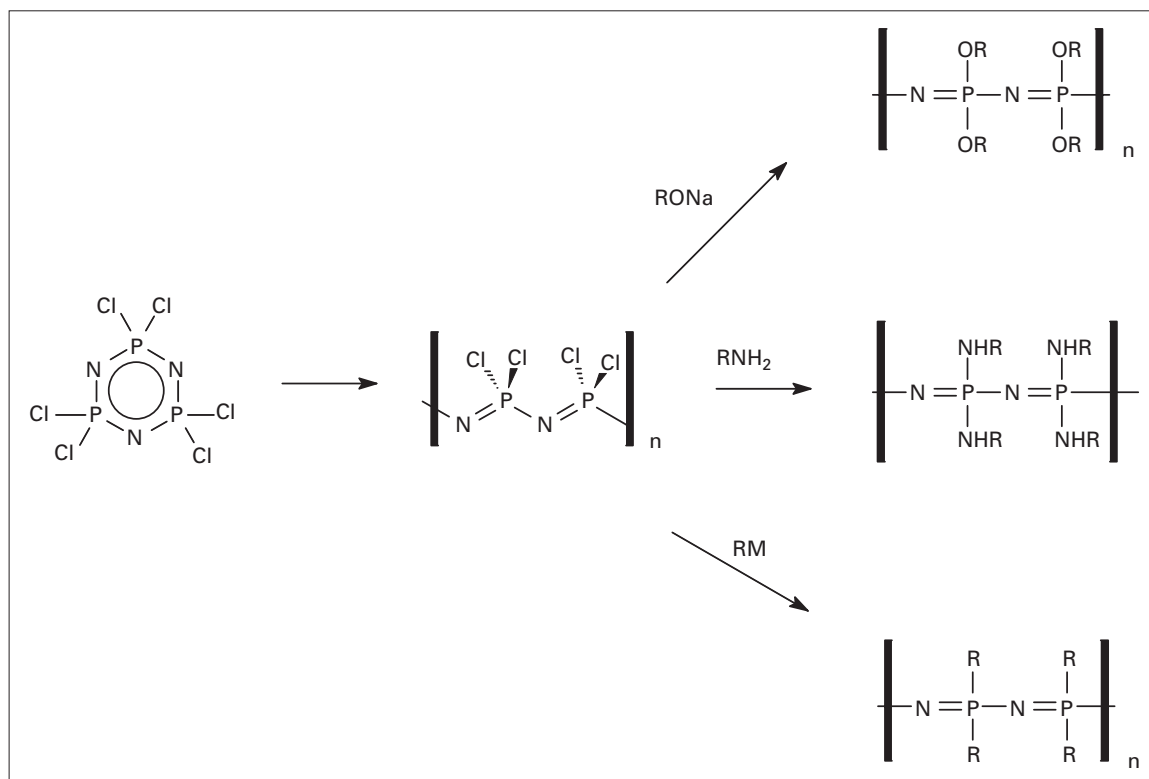


Fig. 8.16 Polyphosphazenes.

targeted molecule than in the way it is made; thus, instead of displaying a catalogue of reactive polymers, this section has been arranged according to the expected molecules to be synthesised with respect to the required polymer-supported reagent.

3.1 Acid chlorides and anhydrides

The immobilised form of the Appel system $\text{P}(\text{C}_6\text{H}_5)_3/\text{CCl}_4$ is obtained from a triphenylphosphine-grafted polystyrene resin (Fig. 8.17); this allows the simple conversion of some free carboxylic acids into their corresponding chloride without the evolution of HCl .

Aliphatic and aromatic acids are transformed at room temperature and the recycling of the phosphine oxide back to the initial phosphine may be possible [71,72].

Acid anhydrides are obtained by dehydration of acids with a polymer-supported carbodiimide that is

obtained by previous dehydration of a supported urea (Fig. 8.18) [73,74]. The spent reagent is the starting urea, which can be reconverted to the carbodiimide.

3.2 Alcohols

The hydrolysis of alkyl halides into alcohols or the recovery of free alcohols from formate esters is performed with anion-exchanged resins in their formate or bicarbonate form (Fig. 8.19). Reaction of primary halides in acetone or tetrahydrofuran gave the formate esters in good yields; they are hydrolysed to the corresponding alcohols by a brief treatment with hydrochloric acid. Alternatively, reaction of primary and secondary alkyl bromides or iodides in tetrahydropyran or 1,4-dioxane gave the corresponding alcohols directly in good yields [75]. The latter reaction can be carried out successfully in the presence of other base-sensitive functions such as ester or amide groups.

However, the usual way of getting alcohols is the reduction of aldehydes and ketones; several borane

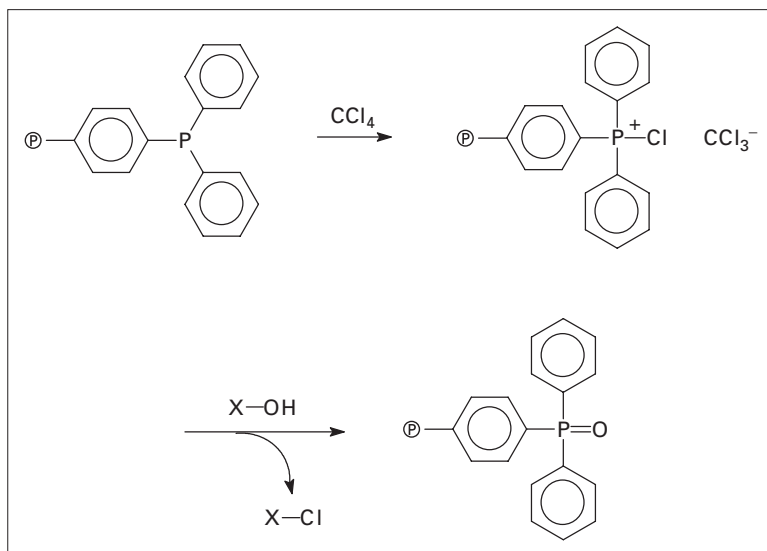


Fig. 8.17 Acid chlorides from an Appel reagent.

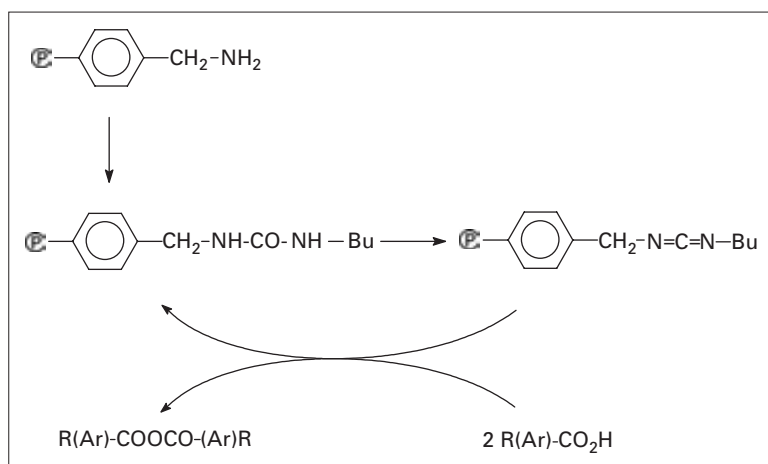


Fig. 8.18 Acid chlorides from carbodiimides.

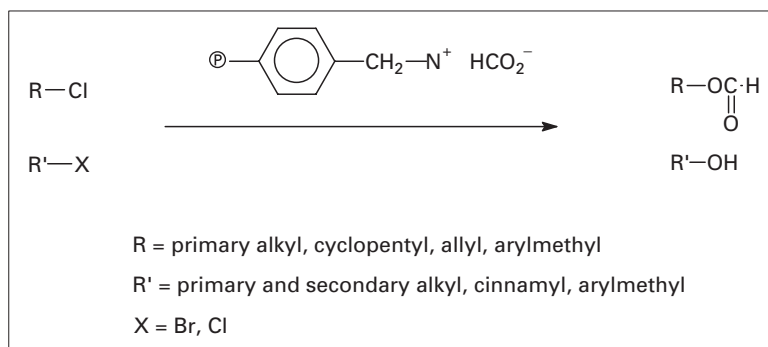


Fig. 8.19 Hydrolysis of halides to alcohols.

Fig. 8.20 Borane reduction of carbonyls into alcohols.

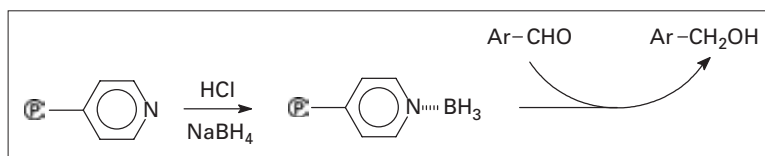
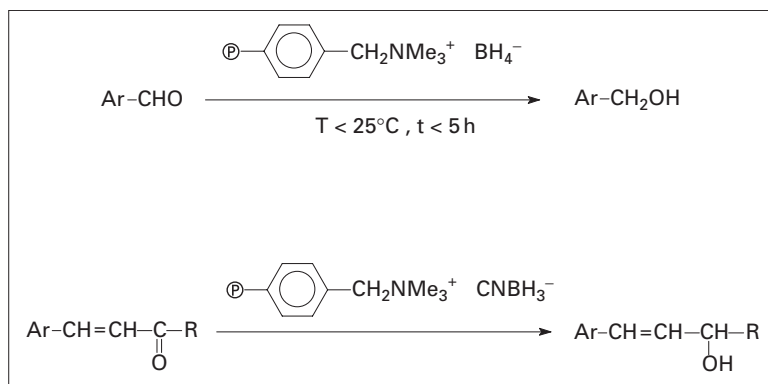


Fig. 8.21 Selective reduction of α - β -unsaturated aldehydes.



(but no alane) derivatives have been used on polymers in the form of neutral or ionic species. The Lewis complex given by BH_3 with polymeric amines such as cross-linked polyvinylpyridine is able to reduce aliphatic and aromatic aldehydes and ketones (Fig. 8.20): substituted benzaldehydes are reduced in hot benzene [76].

The reactivity is increased significantly in acidic conditions, so aliphatic and alicyclic aldehydes and ketones are reduced. The polymeric hydride then can be regenerated easily [77]. Such reductions are performed more easily with ionic borane-derived reagents BH_4^- and CNBH_3^- when immobilised on anion-exchange resins.

The ionic borohydrides were found to be interesting for the reduction of several functional groups and the selectivity in the reduction of carbonyls: aldehydes are more reactive than ketones; unhindered ketones and electrophilic carbonyls are reduced more easily than the respective hindered and aliphatic counterparts [78]; and α - β -unsaturated aldehydes and ketones are reduced very selectively to the β -enol, contrary to NaBH_4 that gives mixtures of alcohols [79] (Fig. 8.21).

The reactivity/selectivity display can be tuned further in the presence of nickel or lanthanide salts [80] and the reactivity in the reduction of both aldehyde and ketones is increased with the $\text{BH}_4^-/\text{CuSO}_4$

system [81]; this was not the case with $\text{Zn}(\text{BH}_4)_2$ immobilised on cross-linked poly(4-vinylpyridine) [82], presumably because the electrophilic assistance provided by the Zn cation is buffered by the nitrogen atom of the pyridine ring. Anyway, this reagent allows the reduction of only aldehydes, even in the presence of ketones.

Interestingly, the primary but not the secondary alcohols are obtained by regioselective hydrogenolysis of epoxides with chloroaluminium tetrahydroborate on polyvinylpyridine [83] (Fig. 8.22); the reagent is obtained by treating polyvinylpyridine first with AlCl_3 and then by an exchange reaction with LiBH_4 .

The stereochemical inversion of secondary alcohols is performed by a Mitsunobu-like reaction using a polymer-bound triphenylphosphine (Fig. 8.23) [84]; the ester that formed in the presence of a benzoic acid and diethyl azodicarboxylate (DEAD) is hydrolysed with a base.

3.3 Aldehydes and ketones

The conventional oxidations of alcohols to aldehydes and ketones can be performed with permanganate, chromates and chlorochromates on polyvinylpyridinium and anion-exchanged resins (Fig. 8.24). No over-oxidation of aldehydes to acids

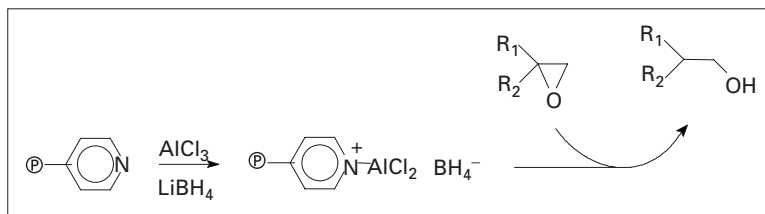


Fig. 8.22 Regioselective hydrogenolysis of epoxides.

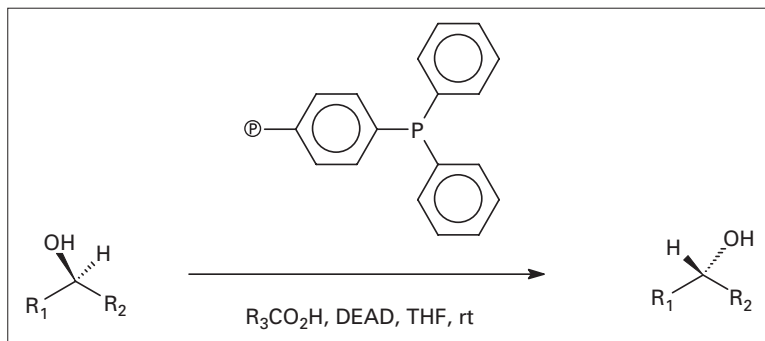


Fig. 8.23 Stereochemical inversion of secondary alcohols.

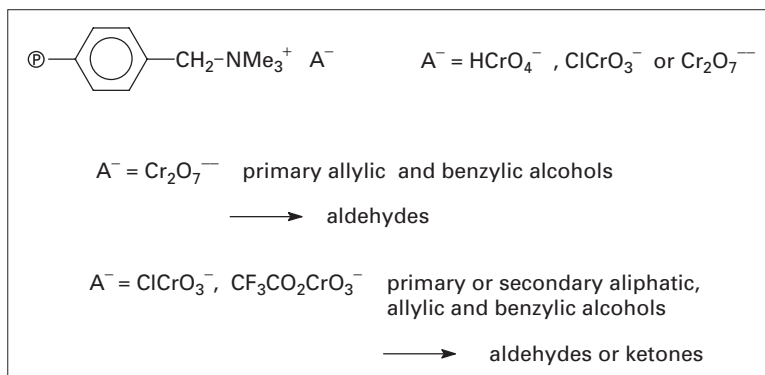


Fig. 8.24 Oxidations with chromates.

is observed [85–87] but some esters may form via a different sequence: the aldehyde and the starting alcohol give a hemi-acetal, which is oxidised further to the ester. Although all these supported metallates can be regenerated, the spent metal is collected in the acid or basic washings; the use of such heavy-metal-based reagents is not so clean in terms of environmental aspects.

Silver dichromate on polyethyleneimine [88] and pyrazolium chromate, chlorochromate or permanganate [89–91] immobilised on copolymers of methylmethacrylate with EGDMA or DVB as cross-linking agents are stable, mild and efficient oxidising

reagents for the oxidation of hydroxy compounds to the corresponding carbonyl compounds (Fig. 8.25).

More interesting are the N-halogenated polyamides for the oxidation of alcohols to aldehydes or ketones; they are obtained very simply from powdered commercially available Nylon 6-6, Nylon 6 or Nylon 3 after treatment with *t*-butyl hypochlorite (Fig. 8.26).

Among the different polyamides examined, only Nylon 6-6 is chlorinated at the higher level regardless of the chlorinating agent being used (*t*-BuOCl, Cl_2O , or HClO) [92,93]. Recycling appears to be possible.

Fig. 8.25 Oxidations with chromates and permanganates on polypyrazole.

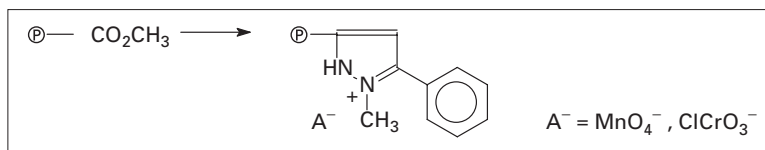


Fig. 8.26 Oxidations with N-halogenated nylons.

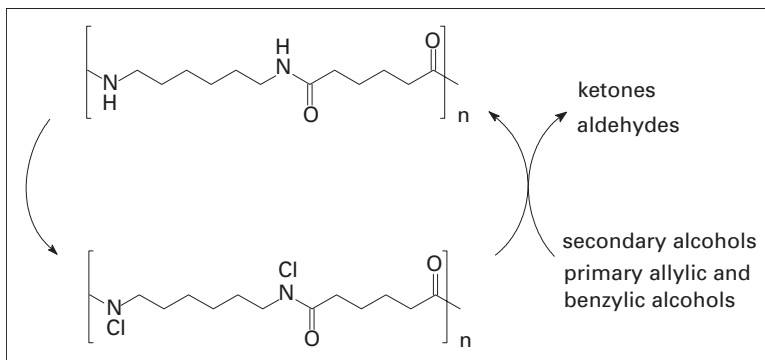
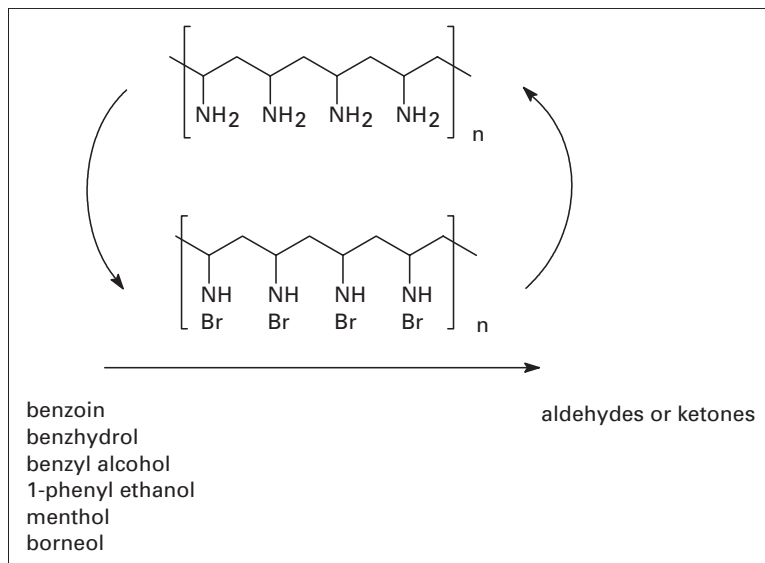


Fig. 8.27 Oxidation with poly(*N*-bromoacrylamide).



The bromination of polyacrylamide with hypobromite [94] similarly gives a poly(*N*-bromoacrylamide), which is convenient for obtaining aldehydes and ketones (Fig. 8.27).

The Swern oxidation of primary and secondary alcohols with dimethylsulfoxide (DMSO) also is performed with polystyrene-grafted methylsulfoxides [95] in the presence of 1,3-dicyclohexylcarbodiimide

(DCCI) or trifluoroacetic anhydride as electrophilic co-reactants (Fig. 8.28a). The grafting of sulfoxide units is performed better with the readily available 6-(methylsulfinyl)hexanoic acid and the oxidation is run with oxalyl chloride [96]; borneol is oxidised quantitatively to camphor (Fig. 8.28b). The reduced 6-(methylthio)hexanoic acid can be reoxidised with sodium metaperiodate. These are good examples of

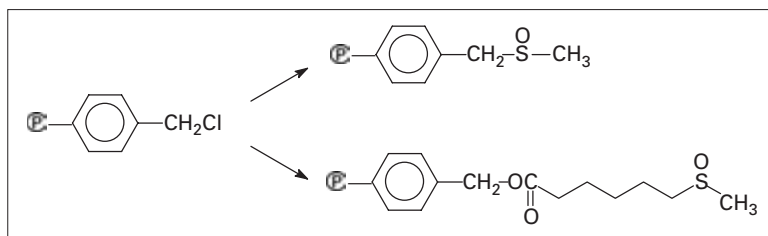


Fig. 8.28 Oxidations with sulfoxides.

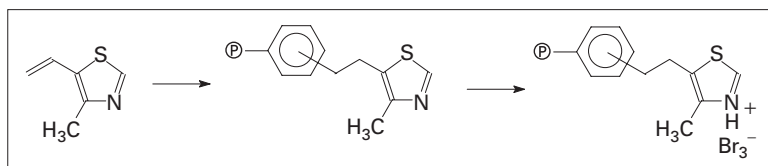


Fig. 8.29 Oxidations with hydrotribromide on polythiazoles.

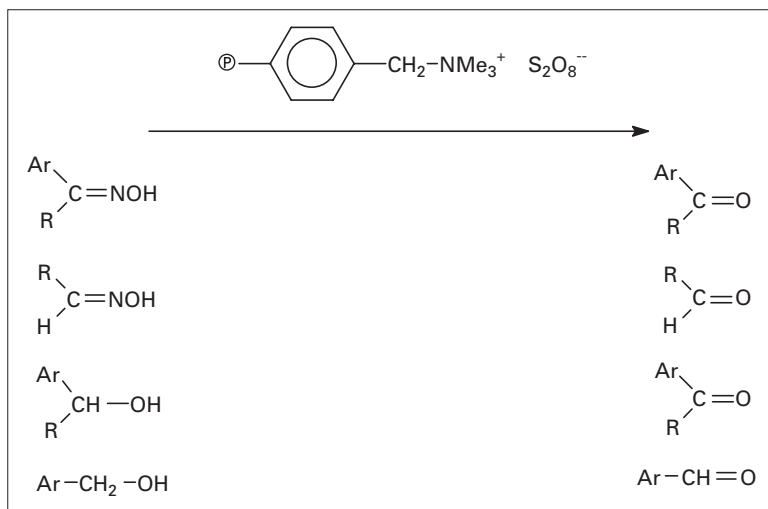


Fig. 8.30 Oxidations with peroxodisulfate-exchanged resins.

odourless sulfoxides and methyl sulfides through polymer modification.

The copolymerisation of 4-methyl-5-vinylthiazole affords a thiazolic support that is treated with hydrogen bromide and bromine to give the hydrotribromide [97], which can oxidise primary and secondary alcohols in basic aqueous solution (Fig. 8.29).

A peroxodisulfate-exchanged resin is a stable, mild and clean oxidation reagent of benzylic alcohols and oximes to carbonyl compounds [98,99]; anhydrous and aprotic solvents are required (Fig. 8.30a). On the other hand, reduction reactions sometimes are used to obtain carbonyl compounds: dithionite-exchanged resins are excellent reagents for the selec-

tive reduction of C=C double bonds of α - β -unsaturated aldehydes and ketones [100]; some terpenic ketones were chosen as examples. In the steroid series [101], oxidation of alkenes with ozone followed by reduction of the ozonide with supported triphenylphosphine gives aldehydes and ketones. A supported perruthenate is used in the conversion of primary and secondary alcohols to pure aldehydes and ketones [102] (Fig. 8.31).

A way of making ketones from aldehydes is described through the formation of dithiolanes with a polymer containing pendant dithiols groups: alkylation of the lithium salt followed by hydrolysis affords the free ketones and the starting polymer

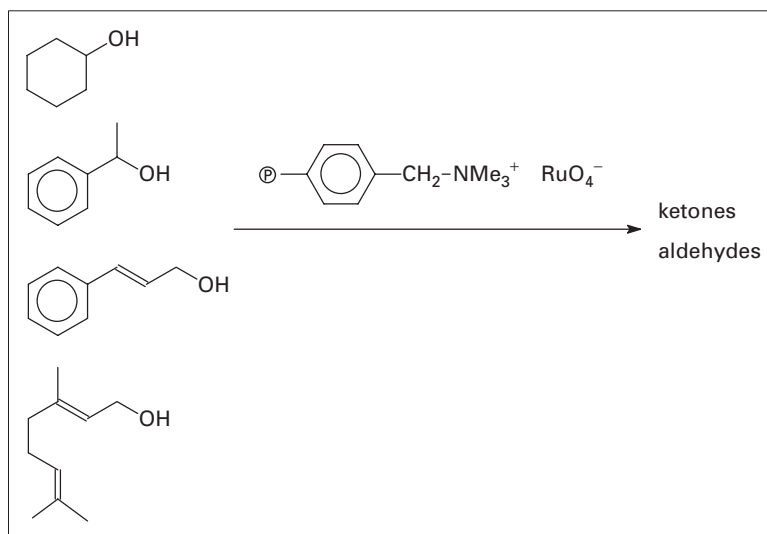


Fig. 8.31 Oxidations with a perruthenate-exchanged resin.

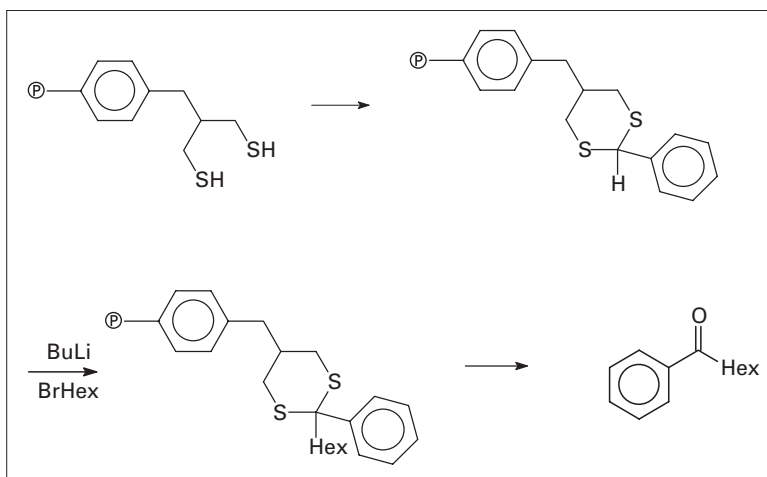


Fig. 8.32 Alkylation of aldehydes.

[103] (Fig. 8.32). Polymers with pendant diols and diamine groups can bind reversibly aldehydes and ketones in the form of cyclic ketals or aminals; this allows separation or temporary protection during diversification reactions [104]. Also, volatile or steroidal ketones give dioxanes or dioxolanes with a glycerol-grafted polystyrene [105] (Fig. 8.33a).

In a similar way, when a chlorosulfonated polystyrene is first reacted with ethylenediamine or diethylenetriamine to the corresponding sulfonamides, it reacts with aromatic aldehydes to give imidazolines [106]. The recovery of the aldehydes is easy (Fig. 8.33b).

3.4 Amides and lactams

The formation of amides is a straightforward reaction when the acid chloride is available, which is not generally the case; things become easier when the acid chlorides are formed in situ from the carboxylic acid. The halide complex of a supported triphenylphosphine [107] (Fig. 8.16) can be used for such a reaction: peptide synthesis is possible with an N-protected amino acid and an O-protected amino acid. The reagent is non-racemising and compatible with the protecting groups.

In a more conventional way, the mixed

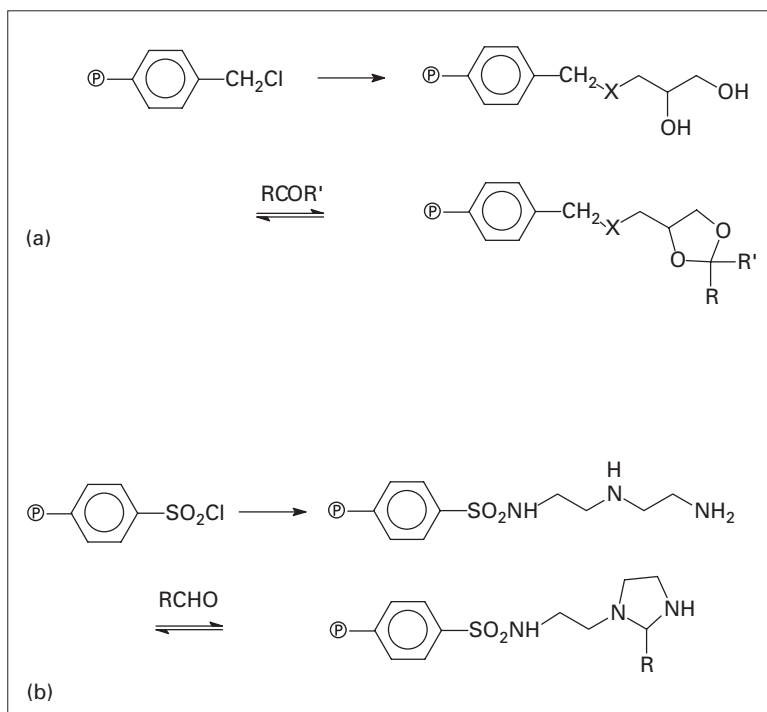


Fig. 8.33 Immobilisation of aldehydes with ketals, amins and imidazolidines.

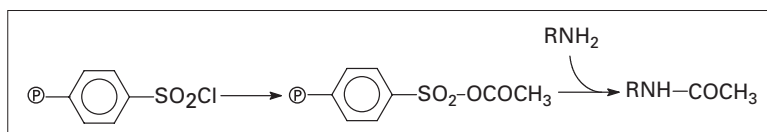


Fig. 8.34 Amides with mixed anhydrides.

anhydrides from polystyrenesulfonic and carboxylic acids afford the acylation of amines [108]; the reaction occurs readily when pyridine is added as a co-reactant, because an acylpyridinium salt is likely to form (Fig. 8.34).

Other acyl transfer agents are available, such as hydroxamic esters, *N*-hydroxysuccinimidyl esters and 1-hydroxybenzotriazoles (HOBT) in their polystyrene-grafted analogues.

Weak nucleophiles such as anilines are acylated through the hydroxamic esters [109] (Fig. 8.35a) whereas the HOBT reagent [110] (Fig. 8.35b) is efficient for peptide couplings even in wet solvents; the hydroxysuccinimidyl reagent gives amides at room temperature [111].

Medium-ring lactams (azocinone, azonin-2-one) can be made via intramolecular cyclisation reaction

of α - ω -aminocarboxylic acids with a simpler HOBT [112].

Direct conversions of mixtures of acid and alcohol are achieved readily with polymer-supported carbodiimides as condensing agents (Fig. 8.18); an even more efficient carbodiimide, similar to the soluble 1-(3-dimethylaminopropyl)-3-ethylcarbodiimide (EDC), is described [113].

3.5 Amines

Secondary and tertiary amines are obtained readily by the reduction of intermediate imines or immoniums or directly from a mixture of lower amines and aldehyde or ketones [114–117]; these reductive aminations are performed with the same supported BH_4^- and CNBH_3^- systems as those mentioned in Fig. 8.36.

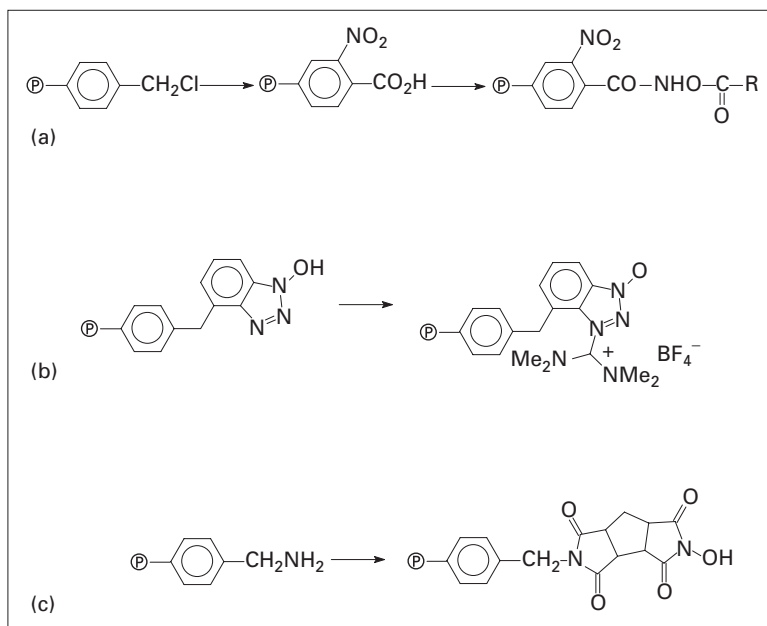


Fig. 8.35 Amides with activated esters.

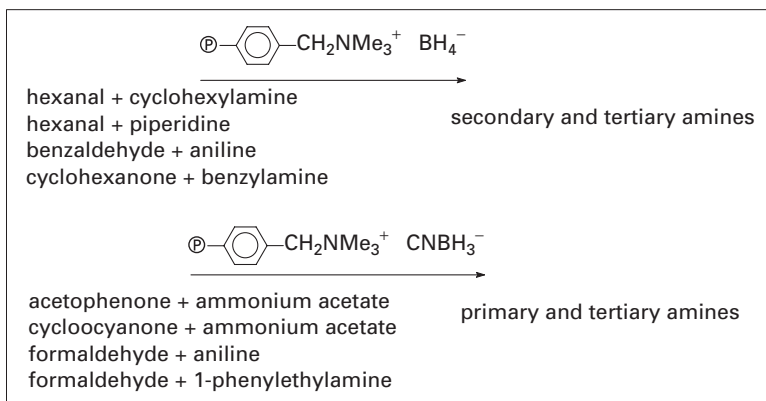


Fig. 8.36 Reductions of imines and ammoniums to amines.

The *N,N*-dimethyl derivatives of primary amines thus can be obtained directly in an aqueous solution of formaldehyde [114,115], without a prolonged heating time in formic acid as in the conventional Eschweiler–Clarke procedure.

The same supported boranes can reduce aryl and benzyl azides [116] to primary amines but the reduction of simple alkyl azides (obtained from alcohols through halides or tosylates) requires the presence of nickel or copper [117–119] salts as electrophilic assistants (Fig. 8.37).

These $\text{BH}_4^-/\text{Ni}(\text{AcO})_2$ and $\text{BH}_4^-/\text{CuSO}_4$ systems easily reduce aryl and alkyl nitro groups to primary amines [119]; benzaldoximes are similarly reduced to benzylamines [120]. Oximes and hydrazones also are readily reduced into amines and hydrazines, respectively, in the presence of LiCl as electrophilic assistant [121].

Unsymmetrical secondary amines are obtained by alkylation of primary amines with polystyrene sulfonic acid esters as alkylating agents; the copolymer is chlorosulfonated and reacted with alcohols to give

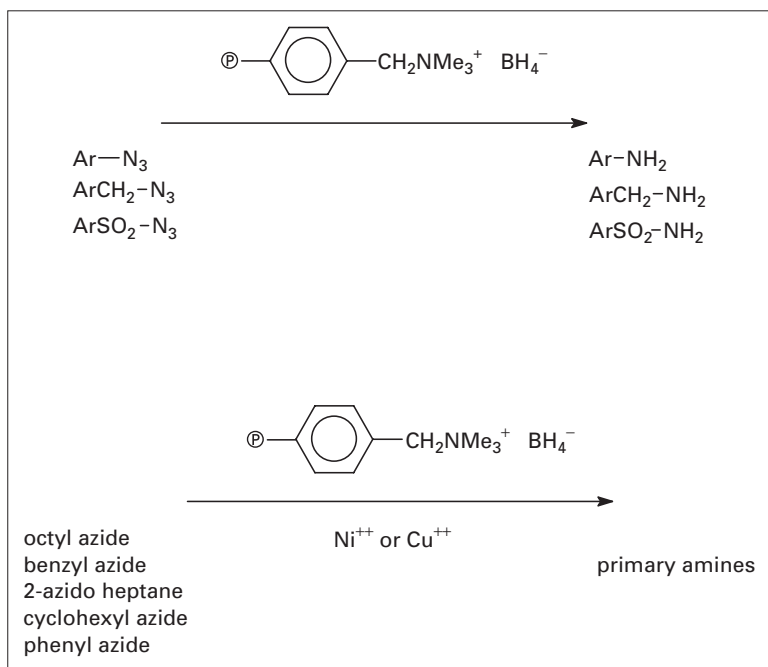


Fig. 8.37 Reductions of azides.

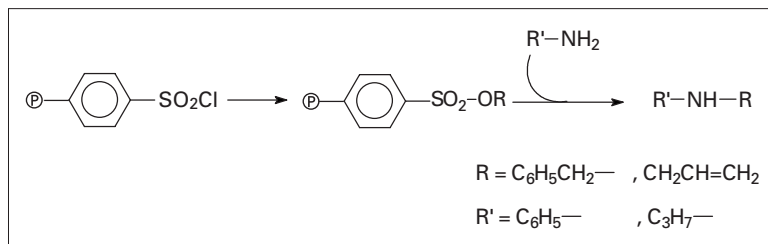


Fig. 8.38 Alkylations of primary amines with tosylates.

the corresponding sulfonates and the reactions with primary amines give the corresponding secondary amines [122] (Fig. 8.38).

A variety of tertiary arylamines are obtained by a Heck coupling reaction between a primary and secondary amine (dialkyl or alkylaryl) and a polymer-bound aromatic bromide; these amination reactions are catalysed by a palladium complex in solution (Fig. 8.39). The final product is cleaved with an acid [123,124].

3.6 Azides

Alkyl and benzyl halides are converted at room temperature into the corresponding azides with azide-exchanged resins [125] (Fig. 8.40); mesylates and tosylates appear less reactive. Azides are intermedi-

ates that are usually reduced into amines (see section 3.4).

3.7 Azo dyes

A nitrite-exchanged resin can convert aromatic amine hydrochlorides into the corresponding diazonium salts [126]; subsequent coupling with phenols or with *N,N*-dimethylanilines readily gives the azo dyes without coloured wastes.

3.8 Bromo-, chloro- and iodoaromatics

These are useful intermediates in Pd-catalysed coupling reactions. The electrophilic halogenation of aromatic rings is performed with some polymeric analogues of *N*-bromo- and *N*-chlorosuccinimide

Fig. 8.39 Alkylations of primary and secondary amines by Heck coupling.

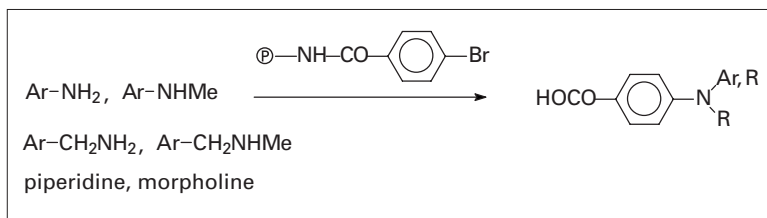


Fig. 8.40 Azide-exchanged resins.

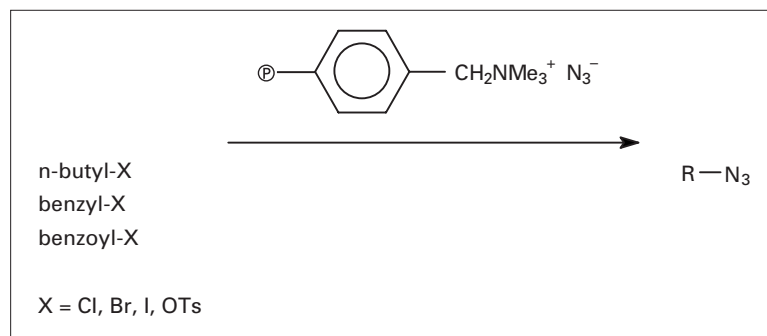
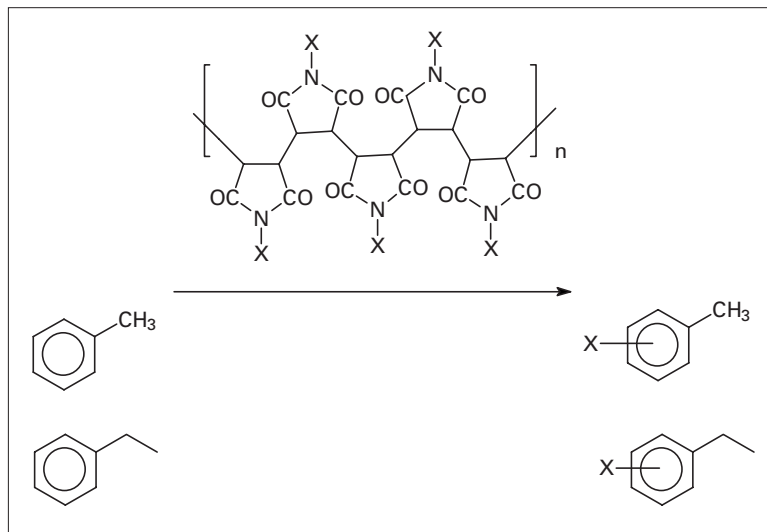


Fig. 8.41 Halogenations with poly(*N*-halogenoimides).



(NBS and NCS); poly(*N*-bromoacrylamide)—obtained by bromination of polyacrylamide with hypobromite—is convenient for the bromination of styrene, stilbene and some phenols [127]. A poly(*N*-chloromaleimide) selectively halogenates the ring of toluene, methylbenzenes, cumene and methyl-naphthalenes.

Interestingly, soluble NCS is not selective at all.

Similarly, poly(*N*-bromomaleimide) cross-linked with DVB is the insoluble analogue of NBS but the bromination of toluene, cumene and ethylbenzene gives a mixture of products with the halogen atoms on the ring and/or on the side chain [128,129]. (Fig. 8.41).

The halogenating properties are completely different from the complex given by bromine with

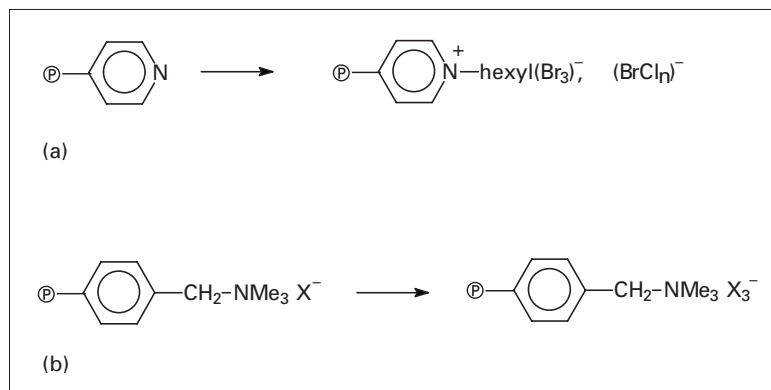


Fig. 8.42 Halogenations with polyhalide-exchanged resins.

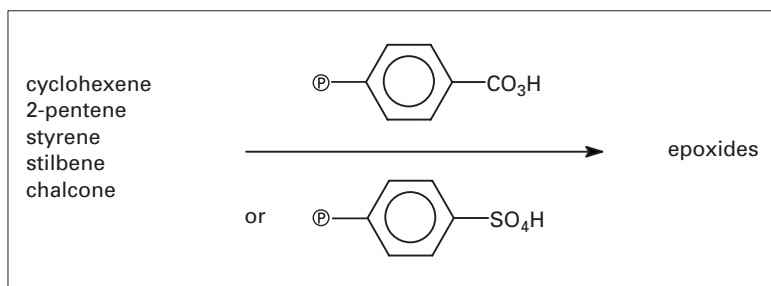


Fig. 8.43 Epoxides from peracids.

polyvinylpyridine [130] (Fig. 8.42a); here the bromination occurs exclusively on the side chain of the same alkylaromatics.

A similar poly(pyridinium hydrobromide–perbromide) performs the selective bromination of methylarylketones to bromomethyl derivatives; in this polymer, the pyridine rings are grafted onto a polymethylmethacrylate polymer by the lithium salt of α -picoline [131]; the hydrobromide is formed and bromine is added to give the tribromide reagent.

Such trihalides can be obtained also from halide-exchanged resins to which chlorine or bromine is added (Fig. 8.42b) [132–134]; halogenations occur regioselectively in the *para*-position of substituted benzenes.

Similar polyhalides (dichloroiodide, tetrachloroiodide and dibromoiodide) [135] afford the iodination of activated benzene and naphthalene derivatives such as amines and phenols; the selectivity in the monoiodination of the aromatic ring can be monitored.

3.9 Carbodiimides

Dehydration of ureas and thioureas into carbodiimides [136] can be performed by the supported triphenylphosphine- Br_2 reagent shown in Fig. 8.17.

3.10 Epoxides

Epoxidation of alkenes is performed with supported percarboxylic and persulfonic acids; these are obtained by treating polyvinylbenzoic acids or polystyrene sulfonic acids with hydrogen peroxide in the presence of mineral acids [137–139] (Fig. 8.43).

The reduced acidic forms can be reoxidised but the carboxylic reagent exhibits decreasing capacity after repeated recyclings: some irreversible degradation occurs on the polystyrene backbone. Epoxides can be obtained also from sulfonium ylides: a polystyrene-supported sulfide is quaternised, transformed into the ylide with a base and then reacted with a carbonyl compound [140] (Fig. 8.44).

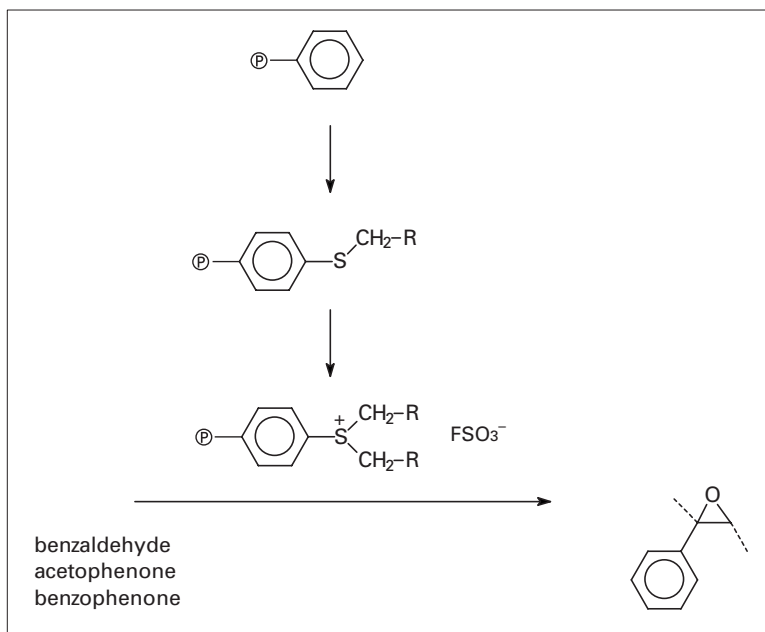


Fig. 8.44 Epoxides from sulfonium ylides.

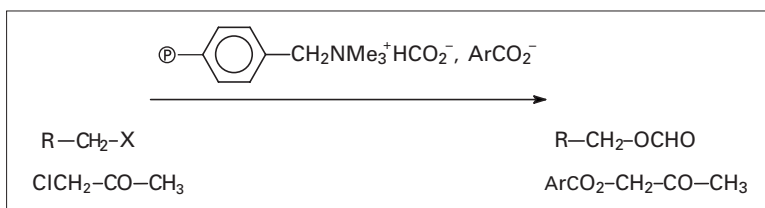


Fig. 8.45 Esters from carboxylate-exchanged resins.

3.11 Esters and lactones

Direct esterification with a mixture of acid and alcohol is performed in neutral conditions with condensing agents such as the supported triphenylphosphine- I_2 complex or with the same phosphine polymer in CCl_4 [141]. However, polymer-supported carbodiimides are more convenient condensing agents; they are obtained by dehydration of a supported urea [73,74].

Formate esters (further hydrolysed into alcohols) are obtained readily by the reaction of halides with formate-exchanged resins [142]. Carboxylate-exchanged resins also are nucleophilic enough to react with chloroacetone to give β -ketoalkyl esters in a high state of purity [143] (Fig. 8.45).

Lactones or oligomeric polyesters are obtained from ω -bromoalkylcarboxylic acids when treated

with bicarbonate-exchanged resins [144] (Fig. 8.46); as the length of the ω -bromoalkylcarboxylate chain increases, lactones form first and then oligomers become predominant.

The reductive acetylation of aliphatic or aromatic aldehydes (but not ketones) to the corresponding acetates is performed cleanly in refluxing ethyl acetate with a polyvinylpyridine-supported zinc borohydride (Fig. 8.47) as reducing agent [145].

Saturated esters can be obtained by selective reduction of the $C=C$ double bond of α - β -unsaturated esters by supported borohydride [146]. Strong electrophilic species such as halogenoacetoxy derivatives can add to alkenes, and thus halodiacetate-exchanged resins [147] efficiently promote the 1,2-haloacetoxylation of aliphatic and benzylic alkenes, alkynes and alkoxyallenes.

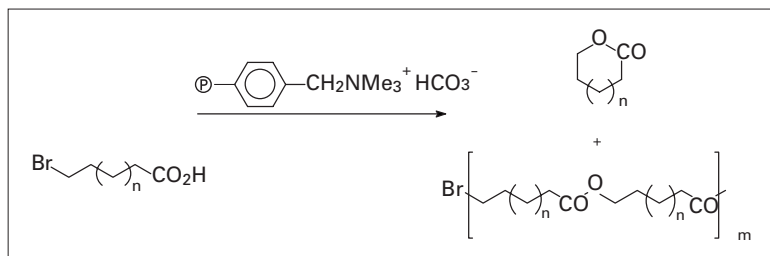


Fig. 8.46 Lactones from bicarbonate-exchanged resins.

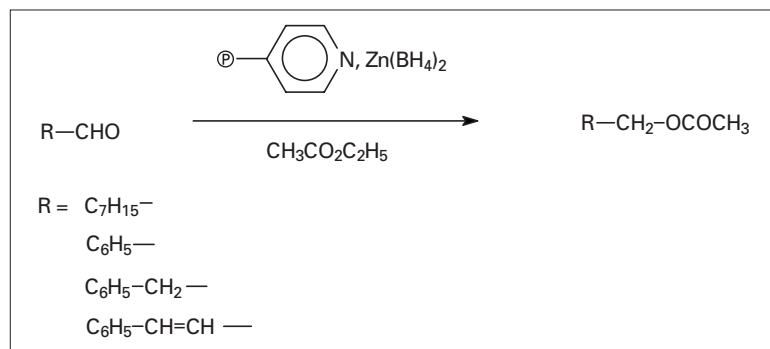


Fig. 8.47 Reductive acetylation of carbonyls.

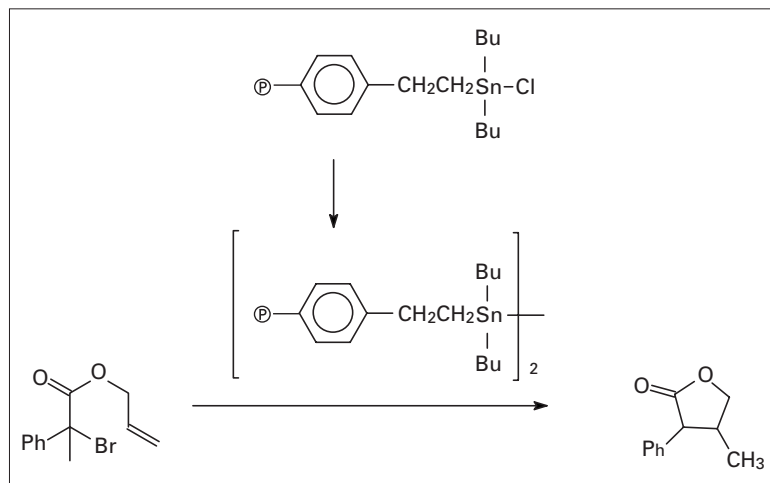


Fig. 8.48 Cyclisations of haloesters to butyrolactones.

The radical cyclisations of acyclic α -haloesters to γ -butyrolactones are performed with a polystyrene-supported distannane prepared by treatment of a tin halide resin with lithium or sodium naphthalenide [148] (Fig. 8.48).

The conventional oxidation of ketones to esters and lactones is performed through Bayer–Villiger reactions with supported percarboxylic and persul-

fonic acids; as used for epoxidations [139] (Fig. 8.49).

3.12 Ethers

Phenoxide-exchanged resins react easily with dichloromethane, halides or epichlorhydrin to give

Fig. 8.49 Esters and lactones from Baeyer–Villiger oxidations.

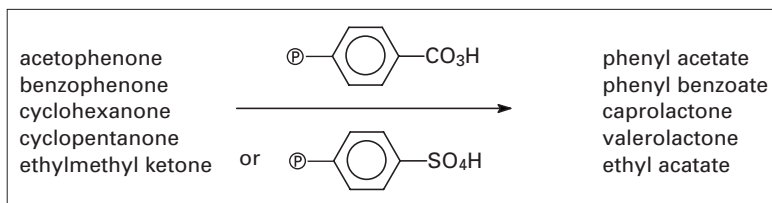


Fig. 8.50 Ethers from phenoxide-exchanged resins.

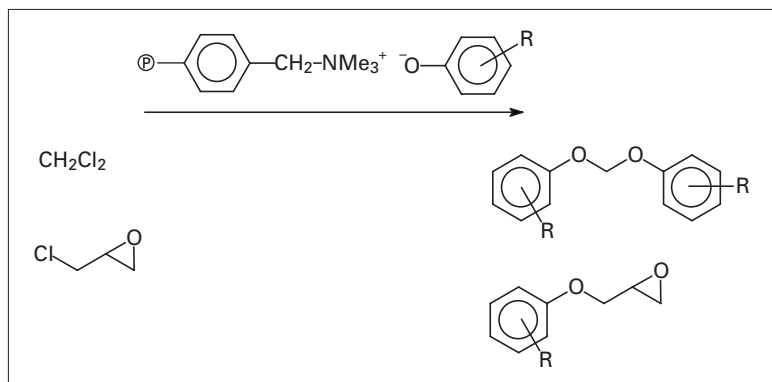
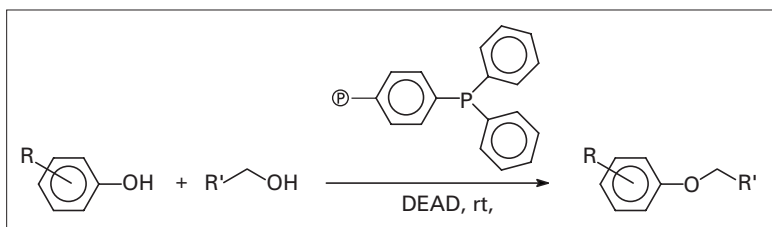


Fig. 8.51 Ethers from Mitsunobu reactions.



symmetric bis(aryl) ethers [149], propranolol [150] or alkyl aryl ethers [151] (Fig. 8.50).

Other phenyl ethers are obtained through a Mitsunobu reaction between a phenol and an alcohol with polystyrene–triphenylphosphine and in the presence of diethyl azodicarboxylate (DEAD) [152] (Fig. 8.51).

Glycosides are obtained with a bromoselenic reagent obtained by treating polystyrene with dimethylselenide and butyllithium and then with bromine: alcohols add to tri-*O*-benzylglycol and give 2-deoxyglycosides [153] after cleavage of the C—Se bond with Bu_3SnH /azobisisobutyronitrile (AIBN).

3.13 Fluoro derivatives

Alkyl fluorides are obtained by nucleophilic substitution reactions of chlorides, bromides and

mesylates with fluoride-exchanged resins [154,155] (Fig. 8.52).

Nucleophilic fluorinations also are possible with a polystyrene-supported fluoroalkylamine (FAR) that is stable enough to be stored [156]. Primary, secondary and tertiary alcohols are converted into the corresponding fluoroalkanes (Fig. 8.53).

The polymeric equivalent of the pyridine–poly(hydrogen fluoride) complex also is a hydrofluorination agent, obtained from cross-linked polyvinylpyridine, that performs the fluorination of secondary and tertiary alcohols and the addition of HF to alkenes and alkynes [157,158] (Fig. 8.54).

It should be noted that aliphatic tertiary amines also can give liquid tris(hydrogen fluoride) complexes that are non-fuming, distillable and easy to handle [159]. The supported analogues could be obtained with adequate polymeric tertiary amines.

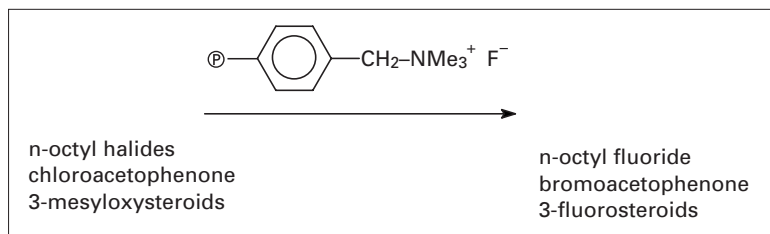


Fig. 8.52 Fluorination with fluoride-exchanged resins.

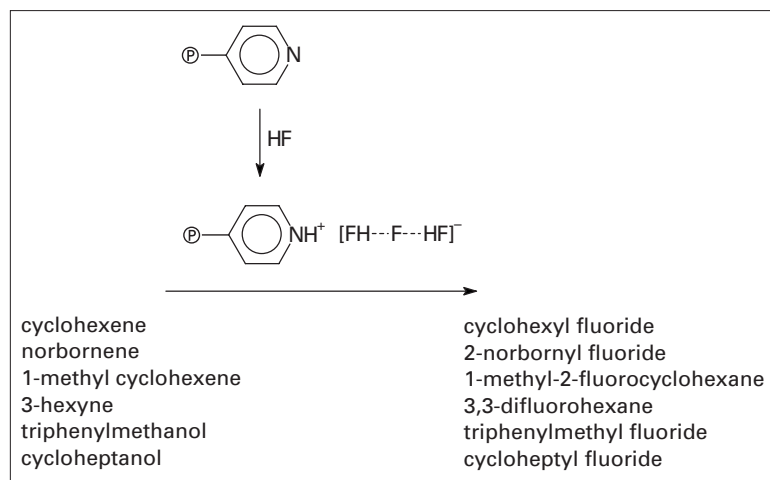


Fig. 8.53 Fluorination with fluoroalkylamine.

3.14 Halides and dehalogenation reactions

There are many methods of introducing halogens at non-aromatic carbons and the choice between electrophilic or nucleophilic reagents depends on the nature of the molecule. From alkyl or benzyl halides the halogen exchange is performed readily through Finkelstein reactions with anion-exchange resins in the required halide form [151,160]. The formation of chlorides from primary alcohols is performed in CCl_4 with polystyrene-supported triphenylphosphine [161,162] but secondary alcohols give a substantial amount of alkenes by elimination. With this reagent it has been shown that the active species is a triphenylphosphine dichloride, which can be obtained directly with triphosgene (Fig. 8.55); high yields in benzyl chlorides are obtained at room temperature from the corresponding benzyl alcohols [163]; the triphenylphosphine groups in the spent reagent are regenerated with triphosgene.

The addition of halogens to activated alkenes such as diarylethylene is performed with quaternary

poly(vinylpyridinium) bromotrichloride, obtained by the addition of chlorine to a quaternised polyvinylpyridine polymer [164] (Fig. 8.56a). These ionic species are more selective than the neutral ones, obtained by the direct addition of chlorine or bromine to polyvinylpyridine [165] (Fig. 8.56b).

The selective α -monohalogenation of aliphatic and aromatic ketones is performed in satisfactory yield with iododichloride- and iodotetrachloride-exchanged resins [166,167]; the tetrachloroiodate has a higher reactivity than the dichloroiodate (Fig. 8.57).

On the contrary, the removal of a halogen atom by hydrogenolysis is a reaction that appears essentially at the end of a synthetic sequence. Tin and germanium hydrides are the most familiar reagents and they react readily through a radical mechanism.

New polystyrene-supported organotin hydrides are prepared by reduction with borohydrides or ditin or tin halide compounds; hydrogenolysis is reported for alkyl and benzylbromo derivatives [168–171] (Fig. 8.58).

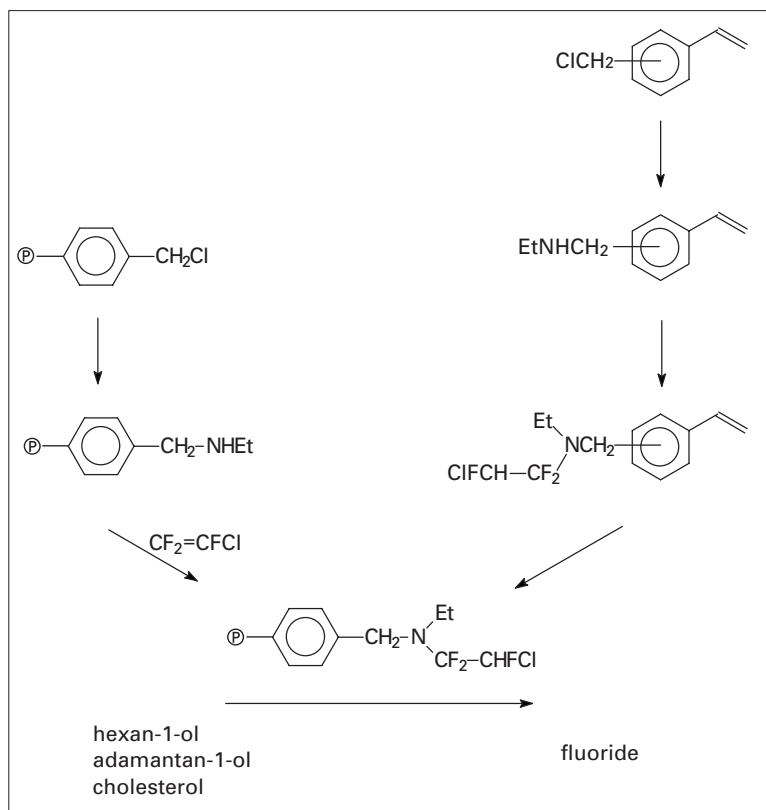


Fig. 8.54 Fluorination with HF.

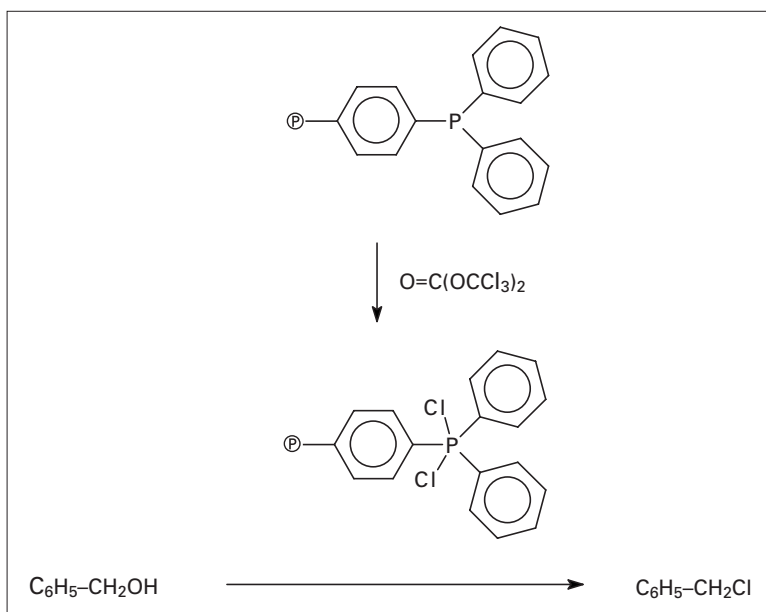


Fig. 8.55 Chlorides from alcohols.

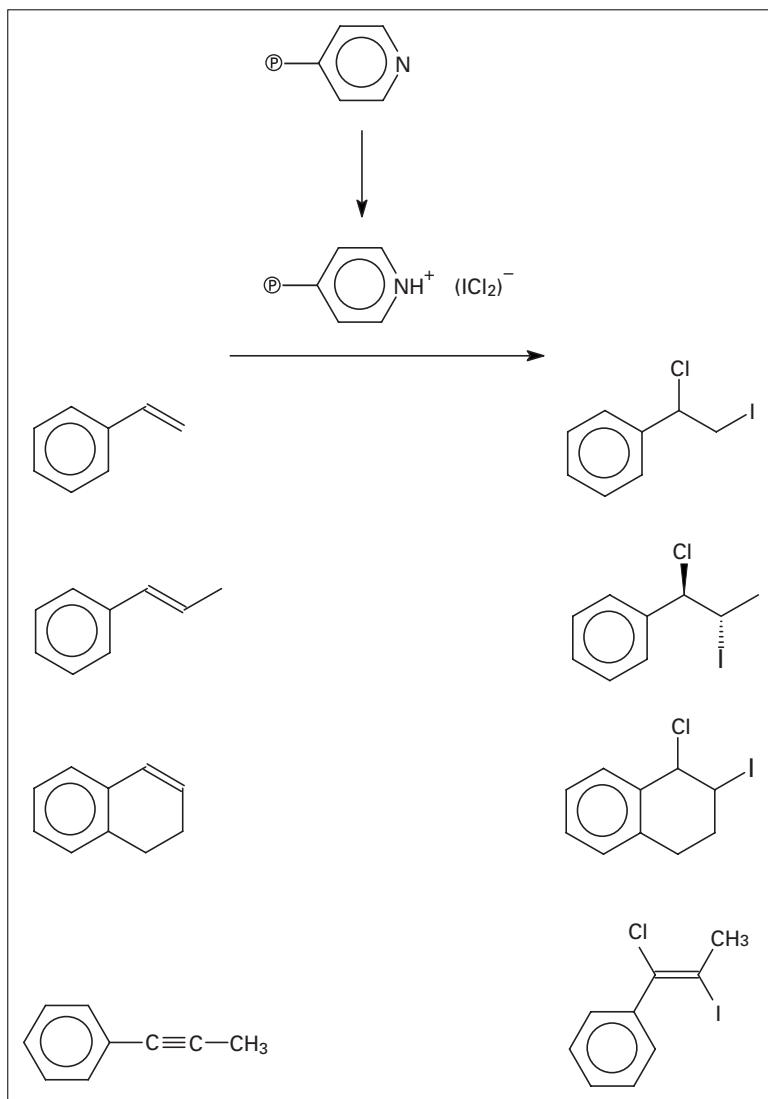


Fig. 8.56 Addition of halides to alkenes.

The first reported polystyrene-supported organogermanium hydrides are obtained by functionalisation of a polystyrene or by polymerisation of a functionalised styrene; the ease of reduction of organic halides follows the order: C-I > C-Br > C-Cl [172] (Fig. 8.59).

3.15 Halohydrins

The opening of steroidal epoxides into sensitive halohydrins is performed in neutral conditions with the

polystyrene-triphenylphosphine-halogen complex; chlorhydrins, bromhydrins and iodhydrins are obtained cleanly [173].

3.16 Isoxazolidines

Hydroxylamines, when oxidised by perruthenate-exchanged resins [102], give nitrones that are trapped by dipolarophiles such as acrylates in a one-pot reaction to give isoxazolidines.

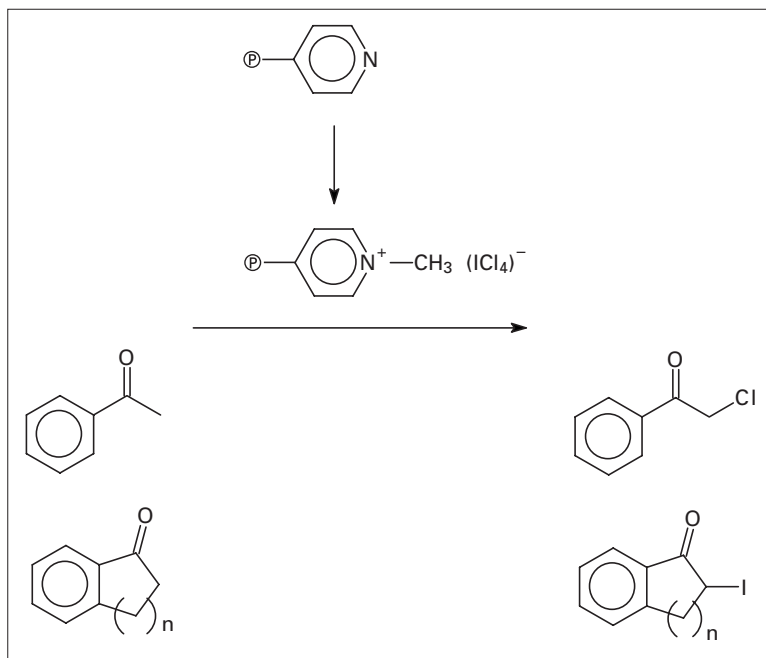


Fig. 8.57 Halogenation of ketones.

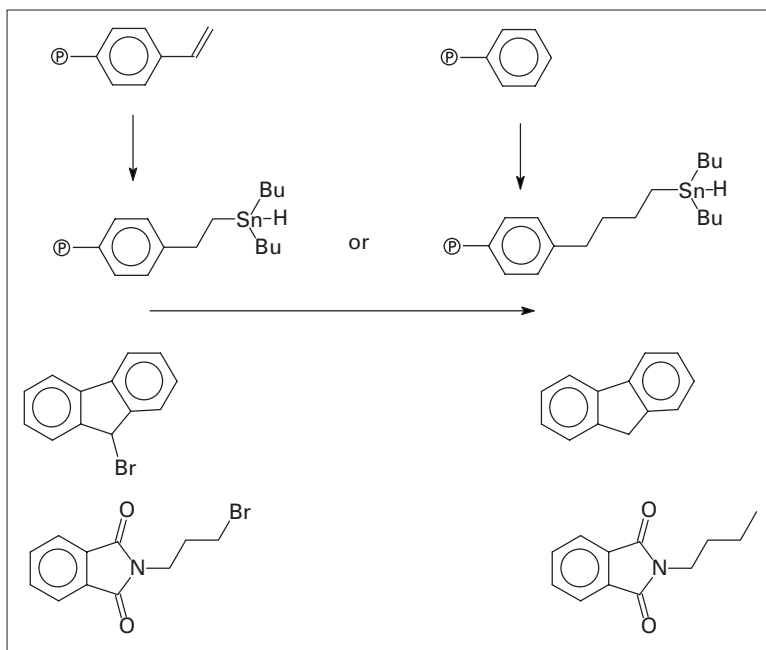


Fig. 8.58 Dehalogenation by tin hydrides.

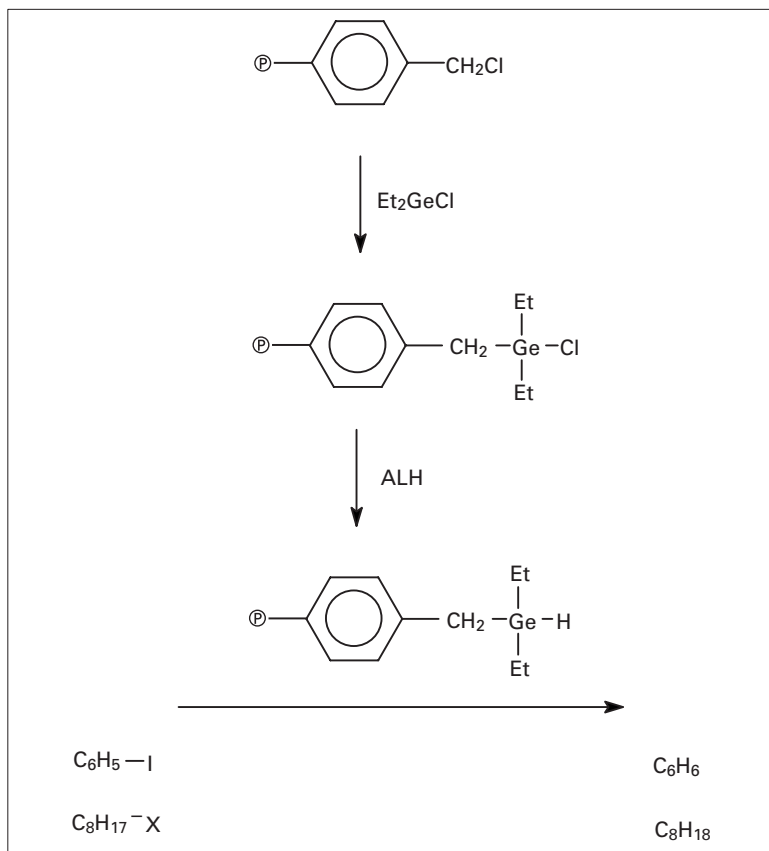


Fig. 8.59 Dehalogenation by germanium hydrides.

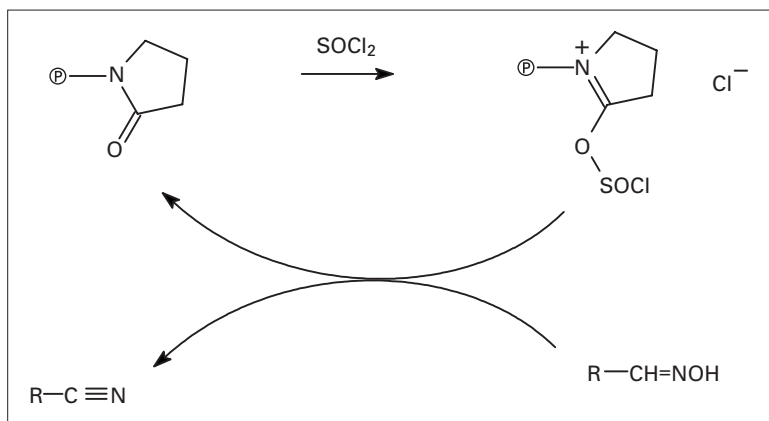


Fig. 8.60 Dehydration reactions to nitriles.

3.17 Nitriles

Similarly to other nucleophilic substitution reactions, the cyanation of alkyl halides is performed with cyanide-exchanged resins [174]. The dehydra-

tion of carboxamides and aldoximes into nitriles can be performed either by a polystyrene-triphenylphosphine [71] or with a chlorosulfinic reagent obtained by the reaction of thionyl chloride with a soluble polyvinylpyrrolidone [175] (Fig. 8.60); however, a

Fig. 8.61 Sulfoxides by oxidation of sulfones.

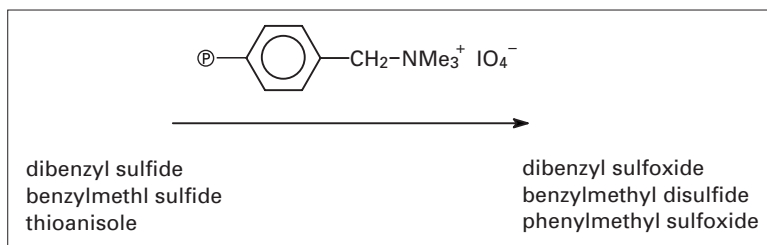
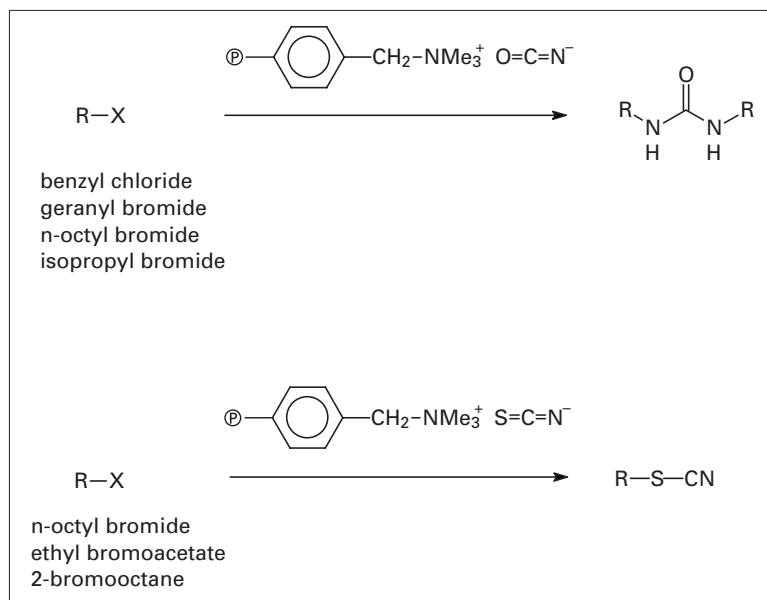


Fig. 8.62 Ureas and thiocyanates from cyanate- and thiocyanate-exchanged resins.



cross-linked polyvinylpyrrolidone is available (Polypladone[®] from International Speciality Products, Wayne, NJ).

3.18 Sulfoxides

Aliphatic and aromatic sulfides are oxidised selectively to sulfoxides by periodate-exchanged resins [176] (Fig. 8.61); no over-oxidation to sulfones is observed.

3.19 Thiocyanates and ureas

Cyanate- and thiocyanate-exchanged resins convert halides into ureas and thiocyanates, respectively [177] (Fig. 8.62); the nucleophilicity is strong enough to perform the reaction in apolar solvents.

Secondary-amine-attached Wang resins can be converted to the corresponding carbamoyl chlorides by treatment with triphosgene; further reaction with primary or secondary amines affords ureas in high yield and chemical purity [178].

3.20 Thiiranes, thiols and disulfides

Conversion of epoxides to episulfides is performed with thiocyanate-exchanged resins in apolar solvents [179]; nucleophilic substitution of alkyl and benzyl halides by hydrosulfite-exchanged resin affords clean thiols at room temperature in acetonitrile; no trace of disulfide is detected [180]. When treated with elemental sulfur in benzene, hydroxide-exchanged resins give an S_2 nucleophilic equivalent that reacts with acyl chloride to give acyl disulfides [181] (Fig. 8.63).

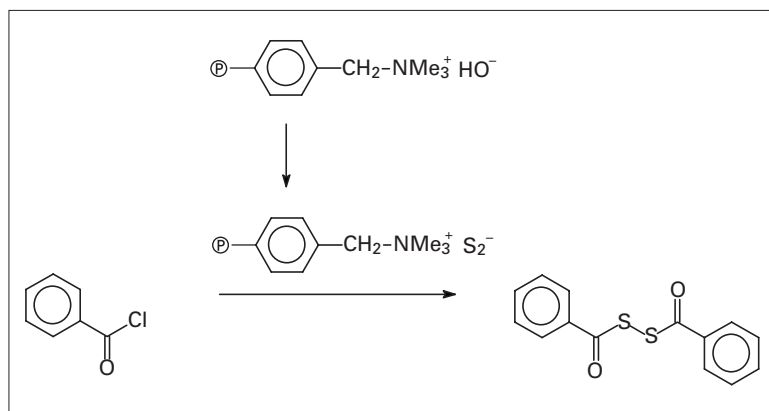


Fig. 8.63 Acyl disulfides from sulfur-exchanged resins.

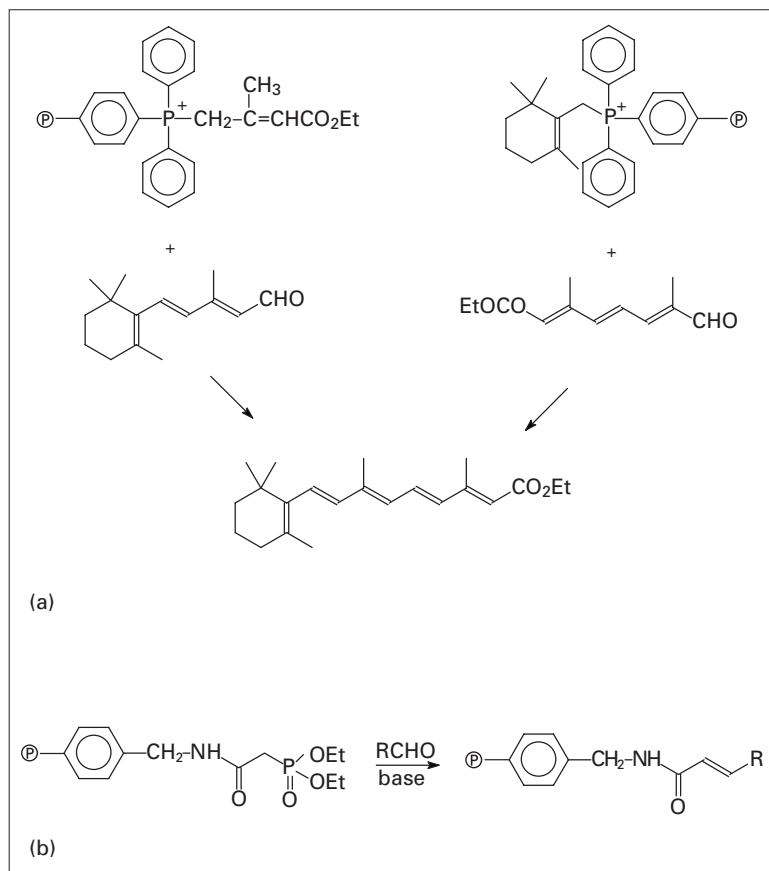


Fig. 8.64 Alkenes from Wittig and Horner-Wadsworth-Emmons reactions.

The oxidation of aromatic and benzylic thiols to disulfides is described with the polyvinylpyridine–bromine complex in acetonitrile [182].

3.21 Wittig and Wittig-related reactions

The syntheses of functionalised alkenes through Wittig and Horner–Wadsworth–Emmons (HWE) reactions were performed more conveniently when the elimination of the spent phosphine oxide or phosphate anion became easier. Two approaches are described: either the aldehyde is linked to the polymer and the organosphorus reagent is in the solution; or the aldehyde is in the solution and is reacted with a phosphonate-exchanged resin or a phosphonium salt obtained by quaternisation of a phosphane-linked polymer with the appropriate alkyl halide (Fig. 8.64a).

A few examples show that for a given supported phosphonium the reaction conditions must be adapted to the base (to form the ylide) and to the aldehyde [183–185]. The general scheme is applied successfully in the synthesis of ethyl retinoate [186] (Fig. 8.62a). Interestingly, functionalised phosphonates, when acidic enough, can be immobilised under their anionic form to react with aldehydes and ketones in solution; the phosphate anion remains on the resin, affording a clean reaction [187].

When a labile phosphonate is covalently bound to a support it can react with a variety of aldehydes under mild basic conditions; an excess of aldehyde gives high conversions to alkenes [188] (Fig. 8.64b). In a reciprocal approach, phosphorane ylides and phosphonate anions in solution react smoothly with resin-bound aldehydes and ketones to provide alkenes in good yields and purities, as assessed after the cleavage of the final product; excellent stereoselectivities are obtained with aldehydes [189].

4 Conclusion

The aim of this chapter was to display the more representative molecules and functions that can be obtained through a stoichiometric and single transformation step. As significant tools for the synthesis, the smart use of polymer-supported reagents is the result of a multi-disciplinary approach that gathers up organic synthesis, polymer chemistry, inorganic chemistry and physicochemistry of surfaces.

A wide range of compounds thus can be prepared provided that the required reagent is available. Fortunately, several of these reagents are now commercially available: polystyrene, chloromethylated polystyrene, polyvinylpyridine, polyvinylpyrrolidone and copolymers, polybenzimidazole and some polyesters can be obtained from manufacturers and some retailers; processed polymers containing functional groups are found in the catalogues of manufacturers and dealers: Advances Chemtech, Aldrich, Agilent, DuPont Pharma, Fluka, Novabiochem, Polymer Laboratories and Poly-science. Some significant reagents are reported in Table 8.1.

References

1. Blossey, E. C., & Neckers, D. C. *Solid-Phase Synthesis, Benchmark Papers in Organic Chemistry*, Vol. 2. Dowden-Hutchinson-Ross & John Wiley, New York, 1975.
2. Shuttlewood, S. J., Allin, S. M., Wilson, R. D., & Nasturica, D. *Synthesis*, 2000, 1035.
3. Bhattacharyya, S. *Combin. Chem. High Through Screen.* 2000, **3**, 65.
4. Thompson, L. A. *Curr. Opin. Chem. Biol.*, 2000, **4**, 324.
5. James, I. W. *Tetrahedron*, 1999, **55**, 4855.
6. Drewry, D. H., Coe, D. M., & Poon, S. *Med. Res. Rev.*, 1999, **19**, 97.
7. Brown, R. C. D. *J. Chem. Soc. Perkin Trans. I*, 1998, 3293.
8. Shuttlewood, S. J., Allin, S. M., & Sharma, P. K. *Synthesis*, 1997, 1217.
9. Schlick, S., Bortel, E., & Dyrek, K. *Acta Polym.*, 1996, **47**, 1.
10. Kricheldorf, H. R. *Handbook of Polymer Synthesis*. Marcel Dekker, New York, 1991.
11. Sherrington, D. C., & Hodge, P. *Synthesis and Separations using Functional Polymers*. John Wiley, New York, 1988.
12. Polymer-Supported Organic Reagents and Catalysts: 30th Microsymposium on Macromolecules. *Pure Appl. Chem.*, 1988, **3**, 60.
13. Stiles, A. B. *Catalyst Supports and Supported Catalysts*. Butterworths, London, 1987.
14. Ford, W. T. *Polymer Reagents and Catalysts*, ACS Symp. Ser. 308. ACS, Washington, 1986.
15. Kaeding, W. W., & Barile, G. C. In *New Monomers and Polymers* (Culbertson, B. M., & Pittman, C. U., Jr., eds), *Polym. Sci. Technol.* Vol. 25. Plenum Press, New York, 1984, p. 223.
16. Gelbard, G. *Actual. Chim.*, 1984, **Feb.**, 7.
17. Hodge, P., & Sherrington, D. C. *Polymer-supported Reactions in Organic Synthesis*. John Wiley, Chichester, 1980.

18. Mathur, N. K., Narang, C. K., & Williams, R. E. *Polymers as Aids in Organic Chemistry*. Academic Press, New York, 1980.
19. Clark, J. H. *Catalysis of Organic Reactions by Supported Inorganic Reagents*. VCH, New York, 1994.
20. Smith, K. J. *Solid Supports and Catalysis in Organic Synthesis*. Ellis Horwood-Prentice Hall, New York, 1992.
21. Clark, J. H., Kybett, A. P., & McQuarrie, D. J. *Supported Reagents; Preparation, Analysis, and Applications*. VCH, New York, 1992.
22. Laszlo, P. *Preparative Chemistry using Supported Reagents*. Academic Press, New York, 1987.
23. Arunan, C., Naaraj, R., & Pillai, V. N. R. *Peptides*, 2000, **21**, 773.
24. Nicholson, J. W. *The Chemistry of Polymers*. Royal Society of Chemistry, London, 1996.
25. Sandler, S. R., & Caro, W. *Polymer Syntheses*, Vol. 1. Academic Press, New York, 1992.
26. Ebdon, J. R. *New Methods of Polymer Synthesis*. Blackie, London, 1991.
27. Guyot, A. *Pure Appl. Chem.*, 1988, **60**, 365; Guyot, A. In *Synthesis and Separations using Functional Polymers* (Sherrington, D. C., & Hodge, P., eds). John Wiley, New York, 1988, p. 1.
28. Schulz, D. N., Datta, S., & Waymouth, R. M. In *Functional Polymers* (Patil, A. O., Schulz, D. N., & Novak, B. M., eds), ACS Symp. Ser. 704. ACS, Washington, 1998, p. 38.
29. Lewandowski, K., Svec, F., & Frechet, J. M. J. *J. Appl. Polym. Sci.*, 1998, **67**, 597.
30. Montheard, J. P., Chatzopoulos, M., & Camps, M. *J. Macromol. Sci. Rev. Macromol. Chem. Phys.*, 1988, **C28**, 503.
31. Mercier, A., Deleuze, H., & Mondain-Monval, O. *React. Funct. Polym.*, 2000, **46**, 67.
32. Stranix, B. R., Gao, J. P., Barghi, R., Salha, J., & Darling, G. D. *J. Org. Chem.*, 1997, **62**, 8987.
33. Kimura, Y., & Regen, S. L. *J. Org. Chem.*, 1983, **48**, 195.
34. Heffernan, J. G., McKenzie, W. M., & Sherrington, D. C. *J. Chem. Soc. Perkin Trans. II*, 1981, 514.
35. Regen, S. L., Heh, J. C., & McLick, J. *J. Org. Chem.*, 1979, **44**, 1961.
36. Tomoi, M., Kori, N., & Kakuishi, H. *React. Polym.*, 1985, **3**, 341.
37. Luis, S. V., Burguete, M. I., & Altava, B. *React. Funct. Polym.*, 1995, **26**, 75.
38. Kurbanova, R. A., Mirzaoglu, R., Akovali, G., Rzaev, Z. M. O., Karatas, I., & Okudan, A. *J. Appl. Polym. Sci.*, 1996, **59**, 235.
39. Ranucci, E., & Ferruti, P. *Macromol. Rapid Commun.*, 1998, **20**, 1.
40. Ferruti, P. In *Reactions on Polymers* (Moore, J. A., ed.). Reidel, Dordrecht, 1973, p. 73.
41. Akelah, A., Hassanein, M., Selim, A., & Kenawy, E. R. *Eur. Polym. J.*, 1986, **22**, 983.
42. Kempe, M., & Barany, G. *J. Am. Chem. Soc.*, 1996, **118**, 7083.
43. Swec, F. *Angew. Makromol. Chem.*, 1986, **144**, 39.
44. Hradil, J., & Swec, F. *Polym. Bull.*, 1985, **14**, 265.
45. Swec, F., Hradil, J., Coupek, J., & Kalal, J. *Angew. Makromol. Chem.*, 1975, **48**, 135.
46. Nishikubo, T., Kameyama, A., & Ogawa, K. *J. Polym. Sci. A—Polym. Chem.*, 1997, **35**, 3791.
47. Kameyama, A., Watanbe, S., Kobayashi, E-i., & Nishikubo, T. *Macromolecules*, 1992, **25**, 1307.
48. Gelbard, G., Breton, F., Sherrington, D. C., & Quenard, M. *J. Mol. Catal.*, 2000, **153**, 7.
49. Goe, G. L., Scriven, E. F. V., & Sowers, E. E. In *Speciality Chemicals: Innovations in Industrial Synthesis and Applications* (Pearson, B., ed.). Elsevier, London, 1991, p. 397.
50. *Reillex Report 2-6*. Reilly Chemicals, Indianapolis, 1987-1990.
51. Frechet, J. M. J., & Vivas de Meftahi, M. *Br. Polym. J.*, 1984, **16**, 193.
52. *Reilly Report: Linear Polyvinylpyridines, Properties and Applications*. Reilly Tar & Chemicals, Indianapolis, 1983.
53. Cassidy, P. E. *Thermally Stable Polymers*. Marcel Dekker, New York, 1980.
54. Miller, M., & Sherrington, D. C. *J. Chem. Soc. Chem. Commun.*, 1994, 55; *J. Chem. Soc. Perkin Trans. II*, 1994, 2091.
55. Hu, M., Pearce, E. M., & Kwei, T. K. *J. Polym. Sci. A: Polym. Chem.*, 1993, **31**, 553.
56. Kotze, M. H., Green, B. R., & Ellis, P. *React. Polym.*, 1991, **14**, 129.
57. Brock, T., & Sherrington, D. C. *Polymer*, 1992, **33**, 1773.
58. Allcock, H. R. In *Functional Polymers* (Patil, A. O., Schulz, D. N., & Novak, B. M., eds). ACS Symp. Ser. 704. ACS, Washington, 1998, p. 260.
59. De Jaeger, R., & Gleria, M. *Prog. Polym. Sci.*, 1998, **23**, 179.
60. Allcock, H. R. In *Inorganic and Organometallic Polymers II* (Wisian-Neilson, P., Allcock, H. R., & Wynne, K. J., eds), ACS Symp. Ser. 572. ACS, Washington, 1994, p. 208.
61. Jagur-Grodzinski, J. *Prog. Polym. Sci.*, 1992, **17**, 361.
62. *J. Chem. Soc., Perkin Trans. I*, graphical abstracts at the end of most issues; *J. Combin. Chem. Combin. Chem. High Through Screen*.
63. Seneci, P. *Solid Phase Synthesis and Combinatorial Techniques*. John Wiley, New York, 2000.
64. Zaragoza-Dörwald, F. *Organic Synthesis on Solid Phase*. John Wiley, New York, 2000.
65. Vaino, A. R., & Janda, K. D. *J. Combin. Chem.*, 2000, **2**, 579.
66. Bennet, W. D., Christensen, J. W., Hamaker, L. K., Peterson, M. L., Rhodes, M. R., & Sanei, H. H. *Advanced ChemTech Handbook of Combinatorial and*

- Solid Phase Organic Chemistry*. Advanced ChemTech, Louisville, 1998, p. 35.
67. Gallop, M. A. *Solid-Phase Synthesis of Compound Libraries*, Acros Organics Reviews. Geel, Belgium, 1998.
 68. Kaldor, S. W., & Siegel, M. G. *Curr. Opin. Chem. Biol.*, 1997, **1**, 101.
 69. Hermkens, P. H. H., Ottenheijm, H. C. J., & Rees, D. *Tetrahedron*, 1996, **52**, 4527.
 70. Früchtel, J. G., & Jung, G. *Angew. Chem. Int. Ed. Engl.*, 1996, **35**, 17.
 71. Harrison, C. R., Hodge, P., & Rogers, W. J. *Synthesis*, 1977, 41.
 72. Hodge, P., & Richardson, G. *J. Chem. Soc. Chem. Commun.*, 1975, 622.
 73. Wolman, Y., Kivty, S., & Frankel, M. *J. Chem. Soc. Chem. Commun.*, 1967, 629.
 74. Weinschenker, N. M., & Shen, C. M. *Tetrahedron Lett.*, 1972, 3281, 3285.
 75. Ruddick, C. L., Hodge, P., & Houghton, M. P. *Synthesis*, 1996, 1359.
 76. Hallensleben, M. L. *J. Polym. Sci. Polym. Symp.*, 1974, **47**, 1.
 77. Domb, A., & Avny, Y. *J. Macromol. Sci. Chem.*, 1985, **A22**, 183.
 78. Gibson, H. W., & Bailey, F. C. *J. Chem. Soc. Chem. Commun.*, 1977, 815.
 79. Sande, A. R., Jagadale, M. H., Mane, R. B., & Salunkhe, M. M. *Tetrahedron Lett.*, 1984, **25**, 3501.
 80. Yoon, N. M., Choi, J., & Shon, Y. S. *Synth. Commun.*, 1993, **23**, 3047.
 81. Sim, T. B., & Yoon, N. M. *Bull. Chem. Soc. Jpn.*, 1997, **70**, 1101.
 82. Firouzabadi, H., Tamami, B., & Gourdarzian, N. *Synth. Commun.*, 1991, **21**, 2275.
 83. Tamami, B., Lakouraj, M. M., & Yeganeh, H. *J. Chem. Res. (S)*, 1997, 330.
 84. White, J. M., Tunoori, A. R., Dutta, D., & Georg, G. I. *Combin. Chem. High Through Screen.*, 2000, **3**, 103.
 85. Frechet, J. M. J., Darling, P., & Farrall, M. J. *J. Org. Chem.*, 1981, **46**, 1723.
 86. Brunelet, T., Jouitteau, C., & Gelbard, G. *J. Org. Chem.*, 1986, **51**, 4016.
 87. Yang, H., & Li, B. *Synth Commun.*, 1991, **21**, 1521.
 88. Goudarzian, N., Ghahramani, P., & Hossini, S. *Polym. Int.*, 1996, **39**, 61.
 89. Abraham, S., Rajan, P. K., & Sreekumar, K. *Proc. Indian Acad. Sci.—Chem. Sci.*, 1996, **108**, 437.
 90. Abraham, S., Rajan, P. K., & Sreekumar, K. *Polym. J.*, 1997, **29**, 12.
 91. Tamami, B., & Yeganeh, H. *Tetrahedron*, 1997, **53**, 7889.
 92. Schutzenberg, H., & Schultz, R. C. *Angew. Makromol. Chem.*, 1971, **18**, 175.
 93. Schutzenberg, H., Klump, G., Kaczmar, U., Turner, R., & Schultz, R. C. *Polym. Prepr. Am. Chem. Soc. Div. Polym. Chem.*, 1972, **13**, 866.
 94. George, B. K., & Pillai, V. N. R. *Macromolecules*, 1988, **21**, 1867.
 95. Yaccoub, E., & Le Perchec, P. *React. Polym.*, 1989, **10**, 45.
 96. Liu, Y. Q., & Vederas, J. C. *J. Org. Chem.*, 1996, **61**, 7856.
 97. Kessat, A., Babadjamian, A., & Iraqi, A. *Eur. Polym. J.*, 1998, **34**, 323.
 98. Lakouraj, M. M., & Bahrami, K. *J. Chem. Res. (S)*, 2000, 222.
 99. Minghu, W., Guichun, Y., & Zuxing, C. *React. Funct. Polym.*, 2000, **44**, 97.
 100. Gelbard, G., Louis-André, O., & Cherkaoui, O. *React. Polym.*, 1991, **15**, 111.
 101. Ferraboschi, P., Gambero, C., Azadani, M. N., & Santaniello, E. *Synth. Commun.*, 1986, **16**, 667.
 102. Hinzen, B., & Ley, S. V. *J. Chem. Soc. Perkin Trans. I*, 1997, 1908.
 103. Bertini, V., Lucchesini, Poggi, M., & De Munno, A. *J. Org. Chem.*, 2000, **65**, 4839.
 104. Maltais, R., Bérubé, M., Marion, O., Labrecque, R., & Poirier, D. *Tetrahedron Lett.*, 2000, **41**, 1691.
 105. Ceita, L., Gaviña, P., Laverina, N. L., Llopis, C., Mestres, R., & Tortajada, A. *React. Funct. Polym.*, 2000, **31**, 265.
 106. Biçak, N., & Senkal, B. F. *J. Polym. Sci. A, Polym. Chem.*, 1997, **35**, 2857.
 107. Landi, J. J., & Brinkman, H. R. *Synthesis*, 1992, 1093.
 108. Ang, T. L., & Harwood, J. *Macromol. Sci. Chem.*, 1973, **A7**, 1079.
 109. Sophiamma, P. N., & Sreekumar, K. *React. Funct. Polym.*, 1997, **35**, 169.
 110. Chinchilla, R., Dodsworth, D. J., Nàjera, C., & Soriano, J. M. *Tetrahedron Lett.*, 2000, **41**, 2463.
 111. Shao, H., Zhang, Q., Goodnow, R., Chen, L., & Tam, S. *Tetrahedron Lett.*, 2000, **41**, 4257.
 112. Huang, W., & Kaliventros, A. G. *Tetrahedron Lett.*, 1995, **35**, 9113.
 113. Desai, M. C., & Stramiello, L. M. *Tetrahedron Lett.*, 1993, **34**, 7685.
 114. Yoon, N. M., Kim, E. G., Shon, H. S., & Choi, J. *Synth. Commun.*, 1993, **23**, 1595.
 115. Hutchins, R. O., Natale, N. R., & Taffer, I. M. *J. Chem. Soc. Chem. Commun.*, 1978, 1088.
 116. Kabalka, G. W., Wadgaonkar, P. P., & Chatla, N. *Synth. Commun.*, 1990, **20**, 293.
 117. Yoon, N. M., Choi, J., & Shon, Y. S. *Synth. Commun.*, 1993, **23**, 3047.
 118. Sim, T. B., & Yoon, N. M. *Bull. Chem. Soc. Jpn.*, 1997, **70**, 1101.
 119. Yoon, N. M., & Choi, J. *Synlett*, 1993, 135.
 120. Bangdar, B. P., Nikat, S. M., & Wadgondar, P. P. *Synth. Commun.*, 1995, **25**, 863.
 121. Baruah, B., Dutta, M. P., Boruah, A., Prajapati, D., & Shindhu, J. S. *Synlett*, 1999, 409.
 122. Bicak, N., & Senkal, B. F. *React. Funct. Polym.*, 1996, **29**, 123.

123. Willoughby, C. A., & Chapman, K. T. *Tetrahedron Lett.*, 1996, **37**, 7191.
124. Ward, Y. D., & Farina, V. *Tetrahedron Lett.*, 1996, **37**, 6993.
125. Hassner, A., & Stern, M. *Angew. Chem. Int. Ed. Engl.*, 1986, **5**, 478.
126. Caldarelli, M., Baxendale, I. R., & Ley, S. L. *Green Chem.*, 2000, **2**, 43.
127. George, B. K., & Pillai, V. N. R. *Macromolecules*, 1988, **21**, 1867.
128. Yaroslowsky, C., Patchornik, A., & Katchalski, E. *Tetrahedron Lett.*, 1970, 3629.
129. Yaroslowsky, C., & Katchalsky, E. *Tetrahedron Lett.*, 1972, 5173.
130. Yaroslowsky, C. In *Reactions on Polymers* (Moore, J. A., ed.). Reidel, Dordrecht, 1973, p. 111.
131. Akelah, A., Selim, A., & El-Hamshary, H. *Eur. Polym. J.*, 1988, **24**, 1111.
132. Zajc, B., & Zupan, M. *Tetrahedron*, 1989, **45**, 7869.
133. Sket, B., & Zupan, M. *Tetrahedron Lett.*, 1984, **40**, 2865.
134. Sket, B., Zupet, P., & Zupan, M. *J. Chem. Soc. Perkin Trans. I*, 1989, 2279.
135. Mitra, S. S., & Sreekumar, K. *React. Funct. Polym.*, 1997, **32**, 281.
136. Akelah, A., & El-Borai, M. *Polymer*, 1980, **21**, 255.
137. Harrison, C. R., & Hodge, P. *J. Chem. Soc. Chem. Commun.*, 1974, 1009.
138. Frechet, J. J., & Haque, K. E. *Macromolecules*, 1975, **8**, 130.
139. Pande, C. S., & Jain, N. *Synth. Commun.*, 1989, **19**, 1271.
140. Farrall, M. J., Durst, T., & Frechet, J. M. J. *Tetrahedron Lett.*, 1979, **3**, 203.
141. Caputo, R., Corrado, E., Ferreri, C., & Palumbo, G. *Synth. Commun.*, 1987, **17**, 1629.
142. Ruddick, C. L., Hodge, P., & Houghton, M. P. *Synthesis*, 1996, 1359.
143. Salunkhe, M. M., Sande, A. R., Kanade, A. S., & Wadgaonkar, P. P. *Synth. Commun.*, 1997, **27**, 2885.
144. Hodge, P., Jilong, J., Owen, G. J., & Houghton, M. P. *Polymer*, 1996, **37**, 5059.
145. Tamami, B., Goudarzian, N., & Kiasat, A. R. *Eur. Polym. J.*, 1997, **33**, 977.
146. Nag, A., Sarkar, A., Sarkar, S. K., & Palit, S. K. *Synth. Commun.*, 1987, **17**, 1007.
147. Monenschein, H., Sourkouni-Argirusi, G., Schubothe, K., O'Hare, T., & Kirschning, A. *Org. Lett.*, 1999, **1**, 2101.
148. Junggebauer, J., & Neumann, W. P. *Tetrahedron*, 1997, **53**, 1301.
149. Salunkhe, M. M., Salunkhe, D. G., Kanade, A. S., Mane, R. B., & Wadgaonkar, P. P. *Synth. Commun.*, 1990, **20**, 1143.
150. Damle, S. V., Patil, P. N., & Salunke, M. M. *Synth. Commun.*, 1999, **29**, 1689.
151. Gelbard, G., & Colonna, S. *Synthesis*, 1977, 113.
152. Geethakumari, K., & Sreekumar, K. *Indian J. Chem.*, 1998, **37B**, 331.
153. Nicolaou, K. C., Pastor, J., Barluenga, S., & Wissinger, N. *Chem. Commun.*, 1998, 1947.
154. Cainelli, G., & Manescalchi, F. *Synthesis*, 1976, 472.
155. Gelbard, G., Colonna, S., & Cesarotti, E. *J. Chem. Soc. Perkin Trans. I*, 1979, 2248.
156. Banks, R. E., Barrage, A. K., & Khoshdel, E. *J. Fluor. Chem.*, 1981, **17**, 93.
157. Olah, G. A., & Li, X. Y. *Synlett*, 1990, 267.
158. Zupan, M., Sket, B., & Johar, Y. *Macromol. Sci. Chem.*, 1982, **A17**, 759.
159. Franz, R. *J. Fluor. Chem.*, 1980, **15**, 423.
160. Cainelli, G., Manescalchi, F., & Panunzio, M. *Synthesis*, 1976, 472.
161. Regen, S. L., & Lee, D. P. *J. Org. Chem.*, 1975, **40**, 1669.
162. Sherrington, D. C., Craig, D. J., Dagleish, J., Domlin, J., & Meeham, G. V. *Eur. Polym. J.*, 1977, **13**, 73.
163. Licea-Claverie, A., Rivero, I. A., & Garcia, B. L. *Polym. Bull.*, 1996, **37**, 415.
164. Zajc, B., & Zupan, M. *Tetrahedron*, 1990, **46**, 6161.
165. Zabicky, J., Mhasakkar, M., & Oren, I. *Macromolecules*, 1990, **23**, 3755.
166. Mitra, S. S., & Sreekumar, K. *Polymer*, 1997, **38**, 1363.
167. Sket, B., & Zupan, M. *J. Org. Chem.*, 1986, **51**, 929.
168. Ruel, G., Dumartin, G., Delmond, B., Lalere, B., Donard, O. F. X., & Pereyre, M. *Appl. Organomet. Chem.*, 1995, **9**, 591.
169. Ruel, G., Dumartin, G., Pourcel, M., Delmond, B., Donard, O. F. X., & Pereyre, M. *Tetrahedron Lett.*, 1998, **39**, 4663.
170. Gerlach, M., Jordens, M., Kuhn, H., Neumann, W. P., & Peterseim, M. *J. Org. Chem.*, 1991, **56**, 5971.
171. Gerigk, U., Gerlach, M., Neumann, W. P., Vieler, R., & Weintritt, V. *Synthesis*, 1990, 448.
172. Mochida, K., Sugimoto, H., & Yokoyama, Y. *Polyhedron*, 1997, **16**, 1767.
173. Caputo, R., Ferreri, C., Noviello, S., & Palumbo, G. *Synthesis*, 1986, 499.
174. Gordon, M., De Pamphilis, M. L., & Griffin, C. E. *J. Org. Chem.*, 1963, **28**, 698.
175. Tamani, B., & Kiasat, A. R. *J. Chem. Res. (S)*, 1999, 444.
176. Harrison, C. R., & Hodge, P. *J. Chem. Soc. Perkin Trans. I*, 1982, 509.
177. Cainelli, G., & Manescalchi, F. *Synthesis*, 1979, 141.
178. Wang, G. T., Chen, Y. W., Wang, S. D., Sciotti, R., & Sowin, T. *Tetrahedron Lett.*, 1997, **38**, 1895.
179. Tamami, B., & Kiasat, A. R. *Synth. Commun.*, 1996, **26**, 3953.
180. Bangdar, B. P., & Pawar, S. B. *J. Chem. Res.*, 1998, 212.
181. Tamani, B., & Kiasat, A. R. *Synth. Commun.*, 1998, **28**, 1275.
182. Christensen, L. W., & Heacoc, D. J. *Synthesis*, 1978, 50.

183. Castella, J., Font, J., & Vorgili, A. *J. Chem. Soc. Perkin Trans. I*, 1979, 1.
184. Clark, S. D., Harrison, C. R., & Hodge, P. *Tetrahedron Lett.*, 1980, **21**, 1375.
185. Hughes, T. *Tetrahedron Lett.*, 1996, **37**, 7595.
186. Bernard, M., Ford, W. T., & Nelson, E. C. *J. Org. Chem.*, 1983, **48**, 3164.
187. Cainelli, G., Contento, M., Manescalchi, F., & Regnoli, R. *J. Chem. Soc. Perkin Trans. I*, 1980, 2516.
188. Johnson, C. R., & Zhang, B. R. *Tetrahedron Lett.*, 1995, **36**, 9253.
189. Vagner, J., Krchnak, V., Lebl, M., & Barany, G. *Coll. Cz. Chem. Commun.*, 1996, **61**, 1697.

Chapter 9: Biocatalysis

HERBERT L. HOLLAND

1 Introduction

Biological reagents are used in chemistry both for the production of defined products (biocatalysis) and for the removal of specific toxic materials by conversion to benign products (biodegradation). Biocatalysis—the use of a biological system to catalyse the conversion of a single material (the substrate) to a defined product—has a long history in organic chemistry, and specific biocatalytic steps have been used in the industrial production of both bulk and fine chemicals for many years [1]. The ability of enzymes to catalyse organic reactions in the moderate pH range of 4–9 at reasonable temperatures (usually 10–50°C) and without extremes of pressure or the addition of metals can provide an environmentally acceptable method of performing many reactions that otherwise may require highly acidic or alkaline environments, high energy input for heating or toxic metal catalysts. Biodegradation is a natural process but can be applied consciously for the removal of specific target waste products from industrial processes. This chapter will cover aspects of both biocatalysis and biodegradation, focusing on processes that have application or potential application for the replacement of traditional chemical methods in industrial processes.

2 Chemical Production by Biocatalysis

2.1 Bulk chemicals

Although the production of acetic acid from ethanol using a strain of *Acetobacter* has been carried out for almost 200 years, it was not until comparatively recently that biocatalysis was used for the production of other bulk chemicals. A milestone in this area was the commercialisation in 1985 of the use of a nitrile hydratase enzyme from *Rhodococcus* to convert acrylonitrile into acrylamide (Fig. 9.1), a process currently used for the production of the latter on a multi-thousand-tonne scale annually. The biocat-

alytic method for this conversion replaced a chemical process involving acid catalysis and eliminated the formation of acrylic acid as a side product [2].

Biocatalytic nitrile hydrolysis also has been employed systematically by the Lonza group as a method for the production of substituted nicotinic acids and nicotinamide, as illustrated in Fig. 9.2 [3].

The largest scale industrial biotransformation is currently the conversion of glucose to fructose by the enzyme glucose isomerase, which accounts for the production of approximately 10 million tonnes of high-fructose syrup annually (Fig. 9.3) [4].

The food industry also uses the enzyme β -galactosidase for the conversion of lactose into glucose and galactose (Fig. 9.4), a key process in the production of low-lactose milk products on a large scale, with up to 250 000 litres of milk being processed on a daily basis [5].

In the pharmaceutical industry, the largest scale biocatalytic process is the conversion of the fermentation product penicillin G into 6-aminopenicillanic acid by the enzyme penicillin acylase (Fig. 9.5) [5]. The latter is used as the starting point for the production of chemically modified penicillins, and is produced on scales approaching 16 000 tonnes per year. This biotransformation is carried out under neutral conditions and without the need for elevated temperatures; the chemical process that it superseded required the use of low temperatures, anhydrous conditions and organic solvents to avoid decomposition of the reactive product.

The above examples of large-scale chemical production using biocatalysts do not constitute a comprehensive list. Other examples that are carried out on smaller but still impressive scales are considered in Sections 2.2–2.6, but the examples outlined above illustrate the scope of biocatalysis for the production of bulk chemicals, ranging from commodity chemicals and pharmaceutical products to the products of the food industry.

The factors that are involved in selecting a biocatalytic process for industrial chemical production

Fig. 9.1 Conversion of acrylonitrile to acrylamide by nitrile hydratase.

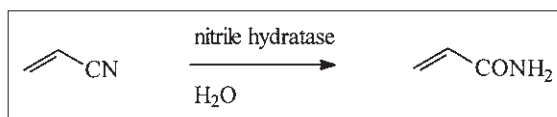


Fig. 9.2 Some nicotinic acids and nicotinamide produced by enzymatic nitrile hydrolysis.

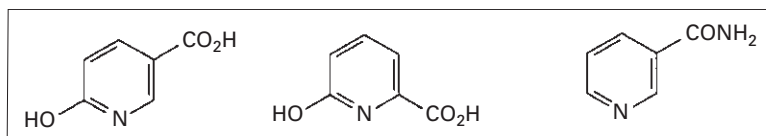


Fig. 9.3 Conversion of glucose to fructose by glucose isomerase.

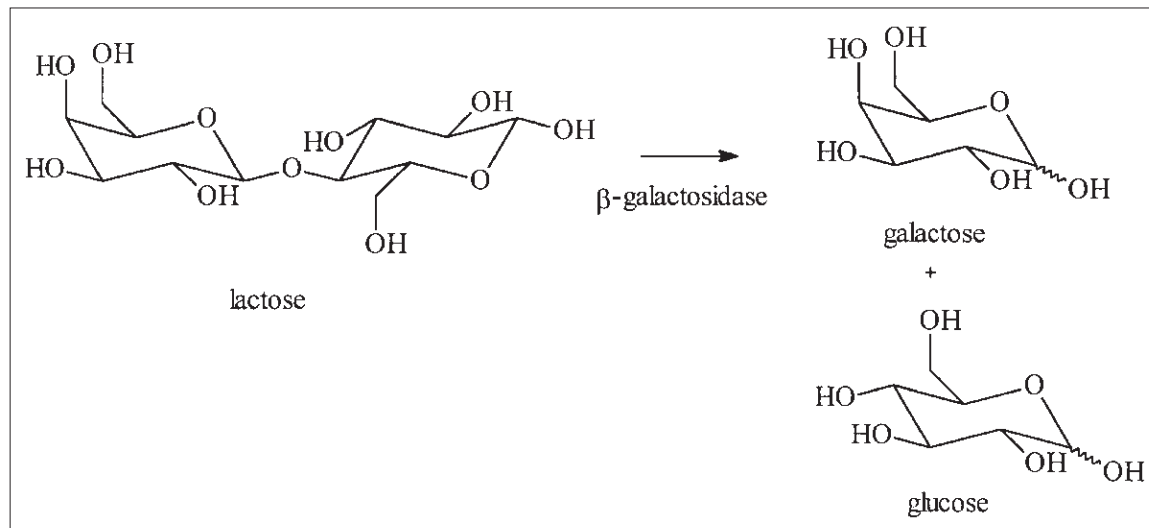
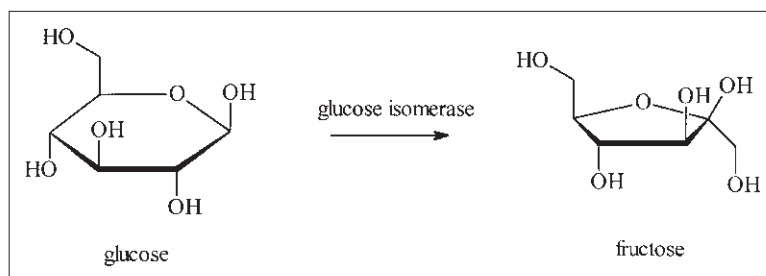


Fig. 9.4 Conversion of lactose to glucose and galactose by β -galactosidase.

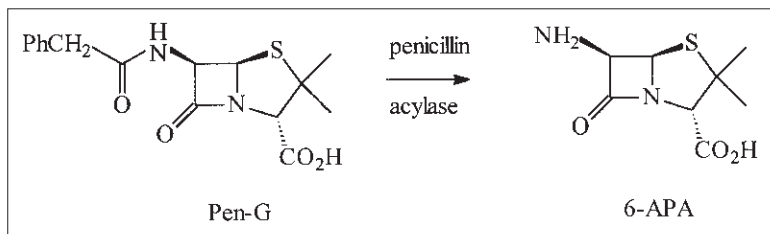


Fig. 9.5 Conversion of penicillin G (Pen-G) to 6-aminopenicillanic acid (6-APA) by penicillin acylase.

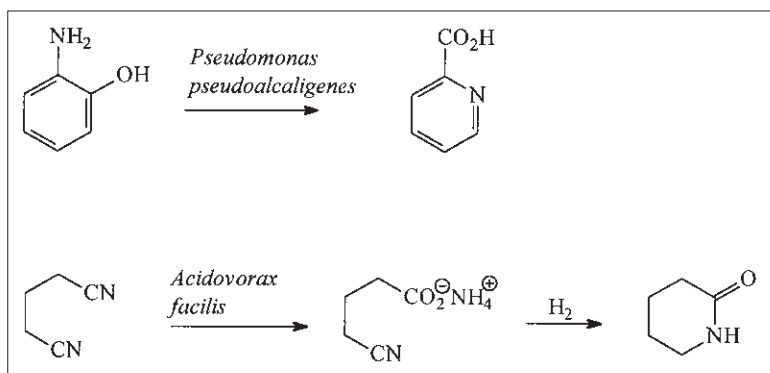


Fig. 9.6 Biocatalytic processes for the production of picolinic acids and lactams.

have been presented in detail elsewhere [6–9]. In many cases, the key factor is the chemical selectivity exhibited by biocatalysts, but coupled with this are the environmental pressures that are exerted by economic factors or by legislation to use catalysts that can operate under friendly conditions. Among processes that currently show potential for the use of biocatalysts to replace chemical reagents are the production of picolinic acids from 2-aminophenols by a dioxygenase enzyme produced by *Pseudomonas pseudoalcaligenes* [10], and the use of the microbial biocatalyst *Acidovorax facilis* ATCC 55746 followed by hydrogenation for the production of lactams from aliphatic dinitriles [11] (Fig. 9.6). The former process can replace traditional chemical methods for the preparation of a range of substituted picolinic acids used as starting materials for pharmaceuticals, herbicides and dyes, whereas the latter replaces a chemical process requiring high temperatures, acid catalysis and organic solvents.

2.2 Pharmaceuticals

Although the production of 6-aminopenicillanic acid by penicillin acylase presented in Fig. 9.5 constitutes the largest scale application of biocatalysis for the

production of pharmaceutical products, it was not the first such example. From the 1950s the production of cortisone and related anti-inflammatory steroids has relied on a biocatalytic hydroxylation reaction to introduce an oxygen atom at carbon-11 of a suitable precursor such as progesterone, illustrated in Fig. 9.7. Production of the closely related prednisone steroids is dependent also on a biocatalytic reaction, the dehydrogenation of ring A at the C-1(2) position, usually using an *Arthrobacter* species, and variants of the hydroxylation reaction are used in the production of a range of oxygenated steroids [12].

The first industrial application of bakers' yeast for the stereoselective reduction of a ketone was in production of the progestomimetic steroid trimegestrone (RU 27987), illustrated in Fig. 9.8 [13]. This process—the final step in a multistep synthesis—is performed in aqueous suspension at 40°C and obviates the need for metal hydride reductants and organic reaction solvents, although the requirement for an extraction solvent (toluene) and the low productivity (a 240-fold excess of yeast to substrate was required on a w/w basis) detract from the attractiveness of the process.

Other biocatalytic reactions with direct application

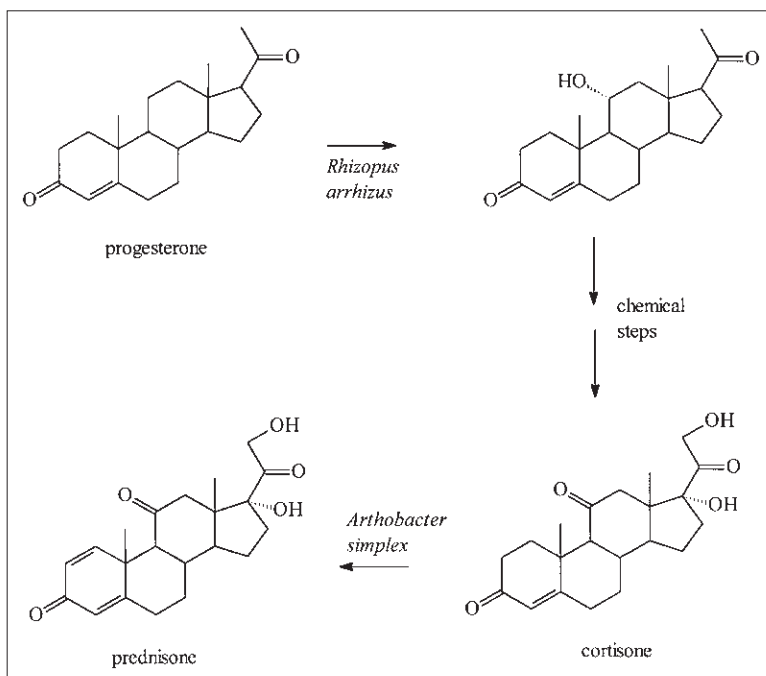


Fig. 9.7 Biocatalysis in the production of anti-inflammatory steroids.

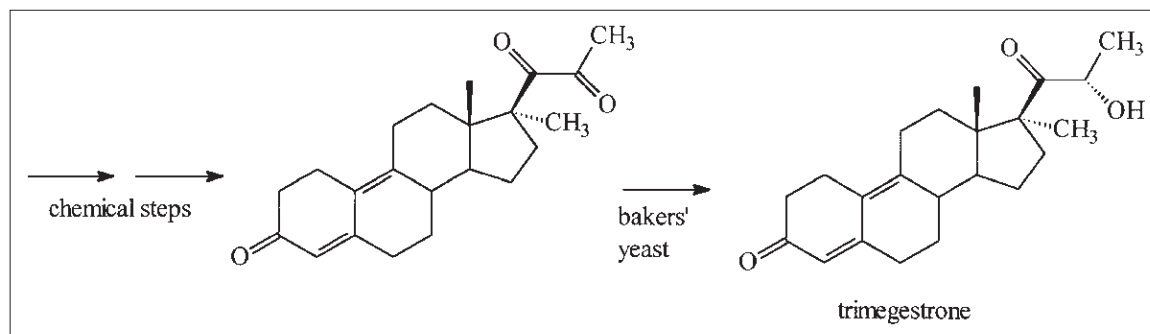


Fig. 9.8 Production of trimegestrone using bakers' yeast.

to the pharmaceutical industry have been reviewed recently [14,15]; one particularly promising development is the use of plant cells for the production of target compounds closely related to plant natural products, exemplified by the conversion of synthetic precursors to analogues of the podophyllotoxin family as outlined in Fig. 9.9 [16].

The target compounds in this series of conversions are analogues of the clinically valuable antineoplastic agent etoposide; other plant cell cultures are used for the production of a range of pharmaceutical natural products, including the anti-cancer drugs

vinblastine and vincristine obtained from cell cultures of *Catharanthus roseus* [17].

2.3 Flavour and fragrance compounds

The impetus for the use of biocatalysis in the production of compounds for the food and fragrance industries is twofold: the necessity for the control of absolute stereochemistry in the product; and the possibility that materials produced in this way may be described as 'natural' rather than 'nature-identical' and so command the higher price associated with the former. The use of biological systems for the production of flavour compounds by fermentation and

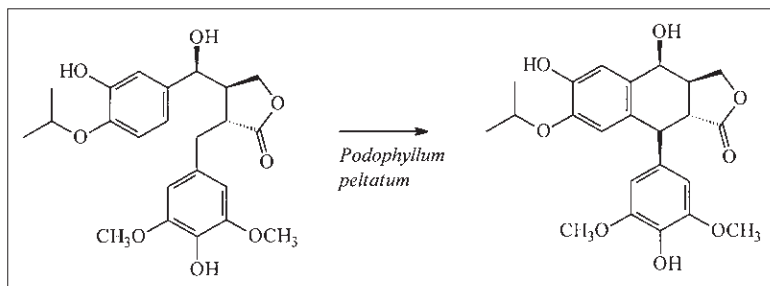


Fig. 9.9 Production of a podophyllotoxin by *Podophyllum peltatum*.

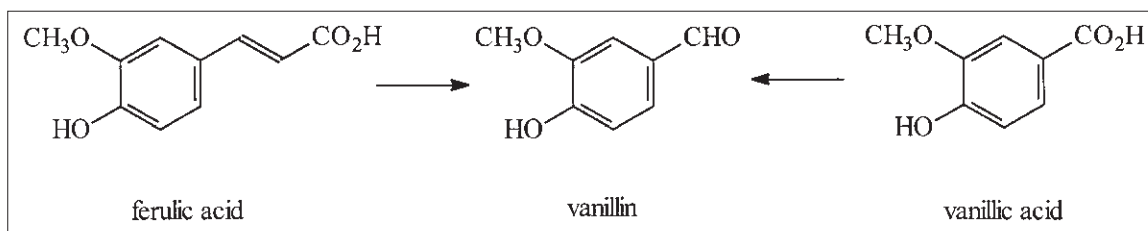


Fig. 9.10 Biocatalytic routes for the formation of vanillin.

extraction has a long history [18,19], but the application of biocatalysis—the conversion of a single substrate to a targeted product—is a more recent development of the field. In the latter area, a prime target is the widely used flavour chemical vanillin, which can be produced from either ferulic acid [20] or vanillic acid [21] by biocatalysis using a variety of microbial systems (Fig. 9.10). One of these, the fungus *Pycnoporus cinnabarinus*, has been developed as a biocatalyst for the conversion of vanillic acid into vanillin at levels of over 1 g l^{-1} under scaleable conditions [21].

In an application employing an isolated enzyme biocatalyst methyl anthranilate, an important topnote flavour agent in Concord grape juice can be obtained efficiently from *N*-methyl methyl anthranilate by *N*-demethylation using soybean peroxidase (SBPO) and hydrogen peroxide (Fig. 9.11). The substrate for this conversion is readily obtainable from a renewable source (citrus leaves), making the process an attractive one for the production of the target compound [22].

The slimming aid and dietary supplement *L*-carnitine is produced on a multi-hundred-tonne scale annually. One route for its preparation is the hydroxylation of γ -butyrobetaine using a mutant bacterial

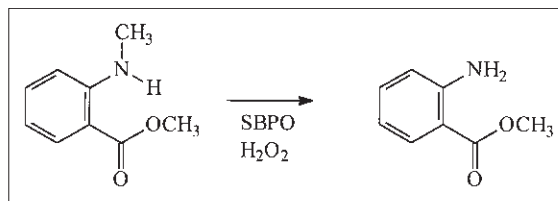


Fig. 9.11 Production of methyl anthranilate using soybean peroxidase (SBPO).

strain in which the enzymic pathway for degradation of the production is absent (Fig. 9.12) [23]. This process has been optimised by the Lonza group and production levels of over 100 g l^{-1} are attainable.

Another large-scale application—the production of the artificial sweetener aspartame—was developed by the Tosoh Corporation in Japan and uses the isolated enzyme thermolysin to couple suitably protected aspartate and phenylalanine precursors (Fig. 9.13) [24]. This process has been optimised to operate with racemic phenylalanine methyl ester, the coupling reaction being specific for the natural (*L*) isomer.

2.4 Carbohydrates

The classic example of carbohydrate production by biocatalysis is the manufacture of vitamin C (ascor-

Fig. 9.12 Production of L-carnitine from γ -butyrobetaine.

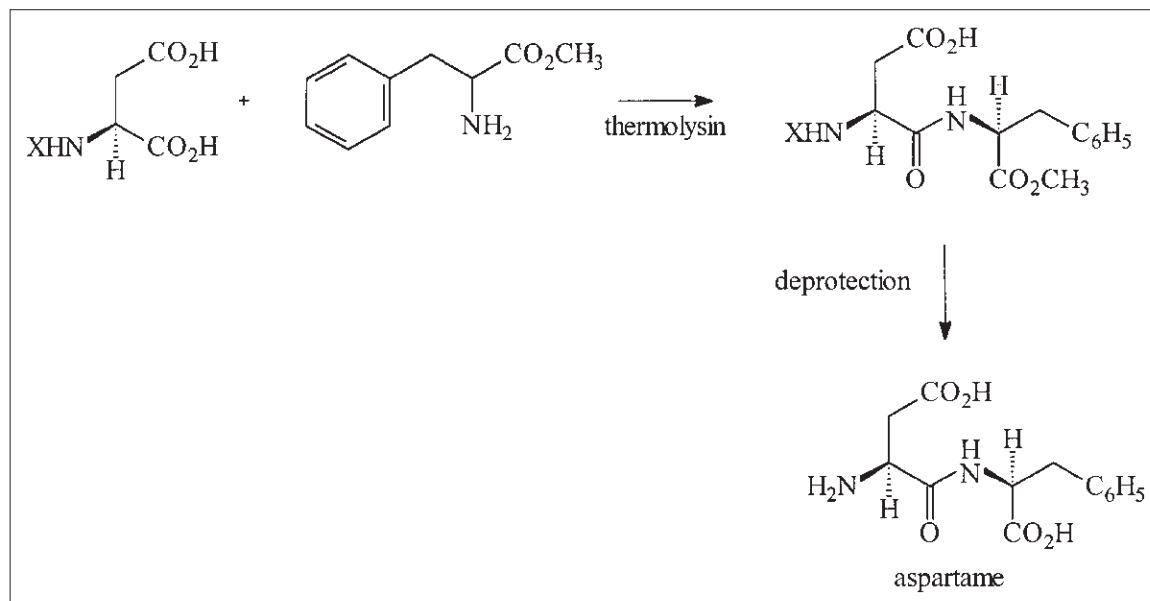
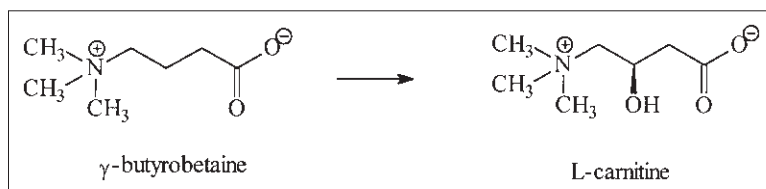


Fig. 9.13 Production of aspartame by enzymatic peptide coupling using thermolysin.

bic acid). The original process combines chemical and biocatalytic steps, the latter being an oxidation of D-sorbitol to L-sorbose by *Acetobacter suboxydans*. Recent developments in metabolic pathway engineering of *Erwinia herbicola* bacteria have produced a strain capable of conversion of D-glucose into 2-ketogulonic acid (the immediate precursor for vitamin C) at levels of 120g l^{-1} in a yield greater than 60% [25] (Fig. 9.14), and in an improvement on the original process the production of L-sorbose from D-sorbitol using *Gluconobacter oxydans* has been optimised at levels of 200g l^{-1} [26].

The formation of glycosidic derivatives is an area in which biocatalysis confers valuable regio- and stereospecificity, and has potential for the production of carbohydrate-derived products. The use of

menthol as a food additive is often limited by solubility and its propensity to sublime, but the non-volatile α -glucopyranosyl derivative, readily converted to menthol by the action of glucosidase enzymes in normal metabolism, presents an alternative source of menthol. This derivative is produced stereoselectively from maltose and menthol by biocatalysis using the food-approved microorganism *Xanthomonas campestris*, illustrated in Fig. 9.15 [27]. The product accumulated directly in crystalline form in high yield (>99%) during the biocatalytic reaction, obviating the need for solvent extraction.

The large-scale production of glycosyl transferase enzymes for similar transformations has been developed using a recombinant over-expression system in *Escherichia coli* [28].

The use of carbohydrates as renewable starting materials for the production of other chemicals has been explored using metabolic pathway engineering. Strains of *Escherichia coli* have been constructed that

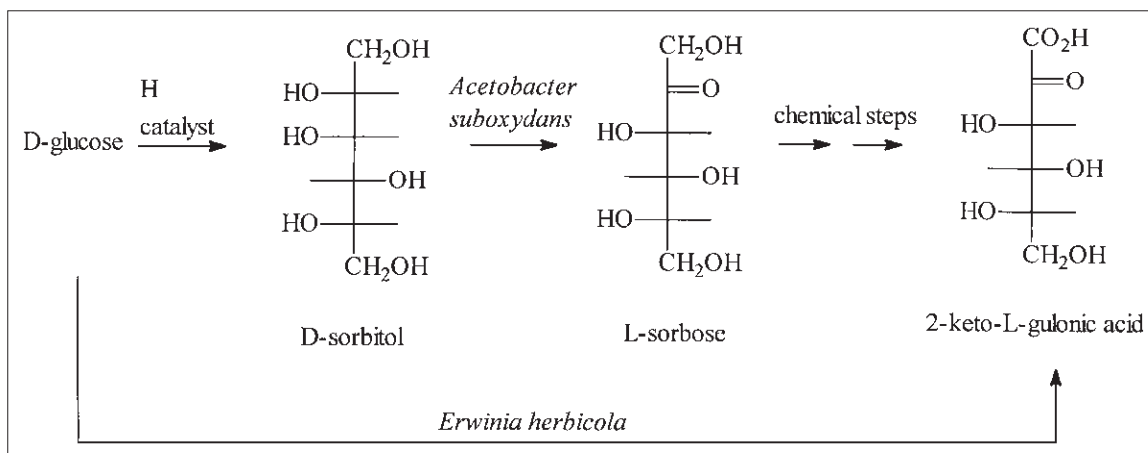


Fig. 9.14 Biocatalytic methods for the formation of 2-keto-L-gulonic acid in the production of vitamin C.

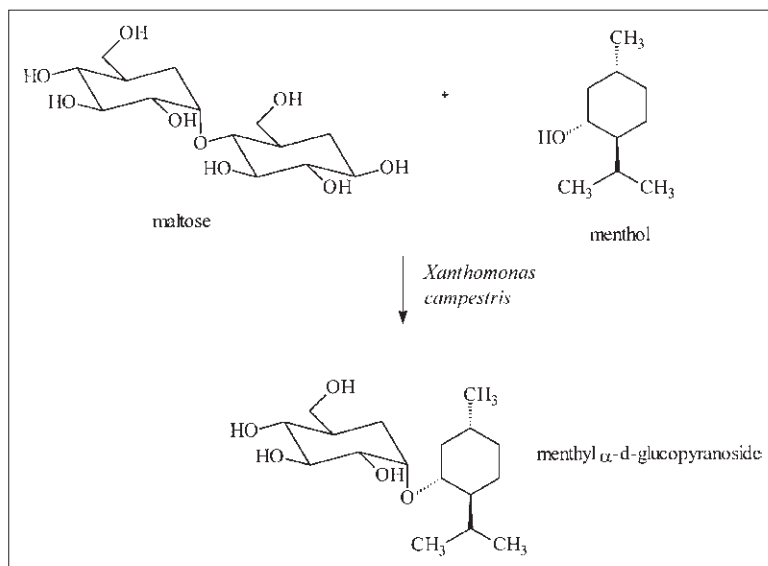


Fig. 9.15 Production of menthyl- α -D-glucopyranoside using *Xanthomonas campestris*.

convert D-glucose into quinic acid [29], *cis,cis*-muconic acid (a chemical precursor of adipic acid) [30], catechol [31], phenylalanine [32], phenyllactic acid [32], shikimic acid [33] and 3-dehydroshikimic acid [34], as summarised in Fig. 9.16. The co-requirement for glucose as a growth substance in these conversions limits the absolute yield of the conversions, but manipulation of the biosynthetic pathways has resulted in several of these conversions approaching the theoretical maximum for carbon flow from glucose into the appropriate end product.

2.5 Enantiomerically pure synthons

Although biocatalysis can be used to produce a large variety of chiral materials [35,36], the number of examples of such processes that involve the use of renewable resources is fairly limited. Two recent examples of the biocatalytic preparation of chiral starting materials both employ substrates of plant origin for the production of chiral synthons. 13(*S*)-Hydroperoxy-9(*Z*),11(*E*)-octadecadienoic acid can be produced efficiently on a large scale from linoleic

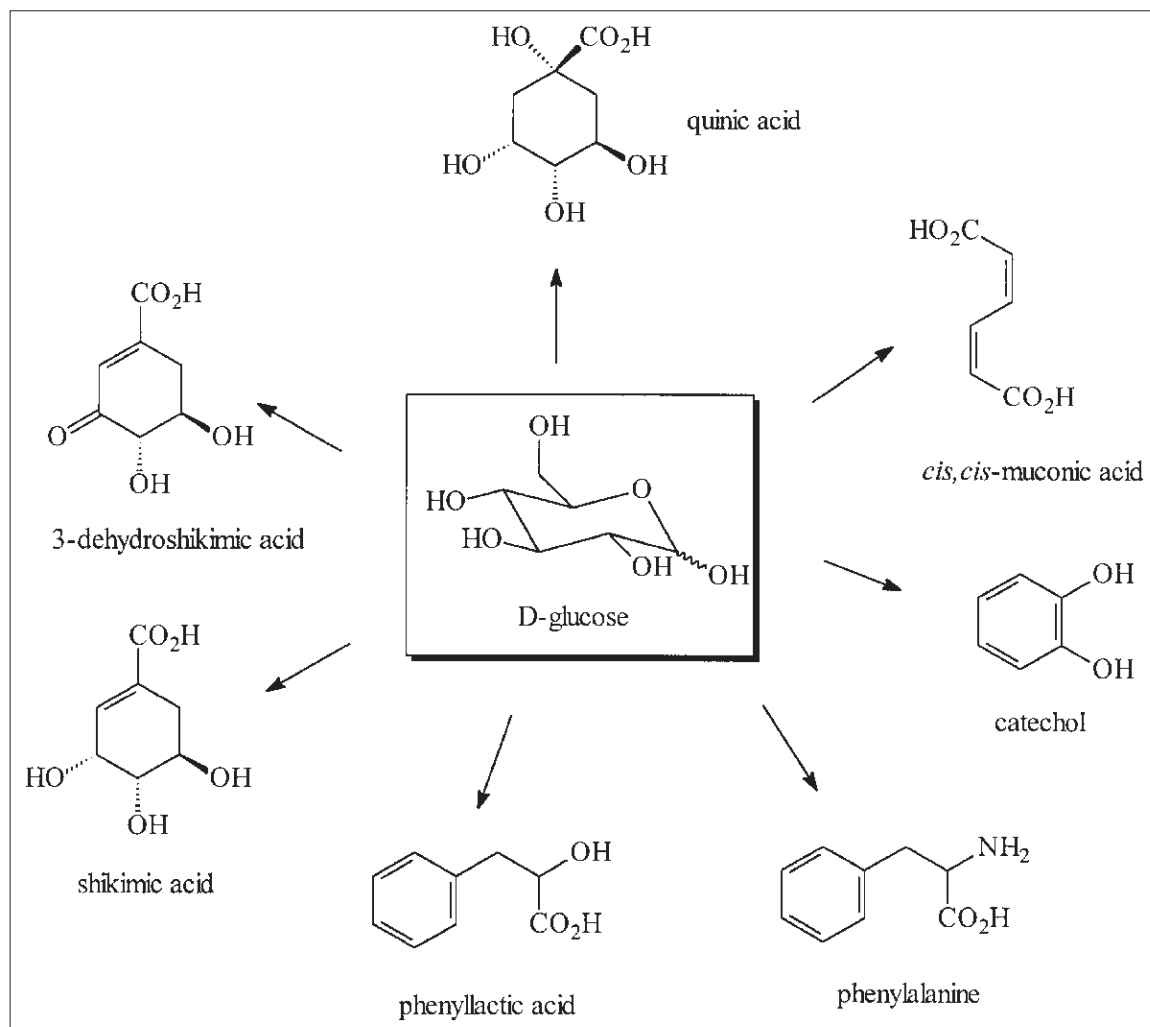


Fig. 9.16 Products of metabolic pathway engineering in *Escherichia coli*.

acid (or hydrolysed safflower seed oil) using a crude lipoxygenase enzyme preparation from soybeans (SBLO) (Fig. 9.17) [37,38]. The product of this reaction may be reduced to the corresponding alcohol ((+)-coriolic acid), or by steam distillation converted to (*S*)-2-nonen-4-olide, a member of the flavour lactone family [39].

A range of chiral 4- and 5-substituted 1,3-oxazolidine-2-thiones is available via hydrolysis of glucosinolates of plant origin using an immobilised myrosinase enzyme preparation [40,41]. This is illustrated in Fig. 9.18 for the preparation of *epi*-goitrin

from *epi*-progoitrin; the latter is obtainable in large quantity by extraction of residues from the commercial oil crop plant *Crambe abyssinica*, and the 1,3-oxazolidine-2-thiones produced in this way can serve as chiral starting materials for a variety of chemical syntheses [41].

2.6 Polymers

Biocatalytic polymer formation by whole cell systems is limited to the production of biopolymers such as the poly(hydroxyalkanoates) typified by poly(3-hydroxybutyrate-co-3-hydroxyvalerate), produced by *Ralstonia eutropha* and marketed by Monsanto as Biopol® [42]. The economics of poly(hydroxyalkanoate) pro-

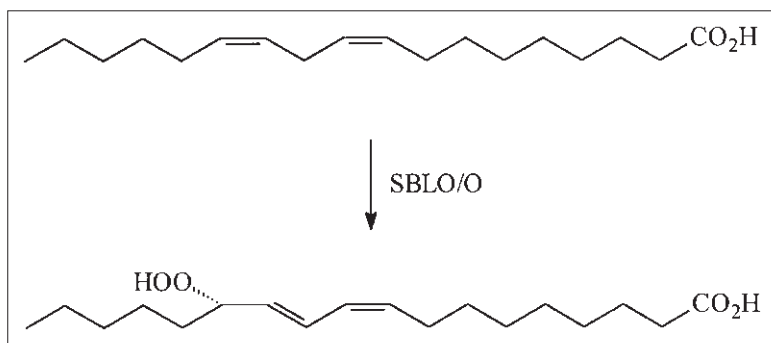


Fig. 9.17 Production of 13(S)-hydroperoxy-9(Z),11(E)-octadecadienoic acid from linoleic acid using soybean lipoxygenase (SBLO).

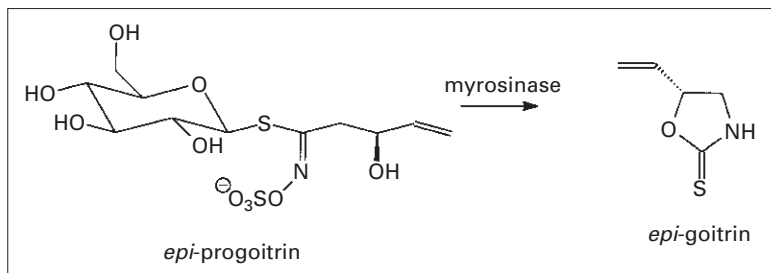


Fig. 9.18 Formation of *epi-goitrin* from *epi-progoitrin* using myrosinase.

duction by bacterial fermentation have been discussed and found to depend largely on the nature of the hydroxyalkanoate monomer [43]. The use of isolated enzymes as catalysts for polymerisation reactions has several distinct areas of application: the use of cellulase for the enzymatic polymerisation of activated glycosidic monomers to produce polysaccharides of defined structure has been reviewed recently [44,45], as has the use of lipases for the production of polyesters [45,46]. The latter process can proceed by the polymerisation of lactones, the self-condensation of hydroxyesters or by the polymerisation of a mixture of diol/diester or diol/diacid monomers, as illustrated in Fig. 9.19.

The polymerisation of lactones is the most well studied of these options and has been reported for monomers ranging from butyrolactone to 16-membered macrolides [47–52]. Isolated lipase preparations from *Candida antarctica* or *Pseudomonas cepacia* are used most frequently for these reactions, but thermophilic lipases also are suitable catalysts [48]. In most cases the degree of polymerisation is not high, with products typically less than molecular weight (M_w) 10 000, but higher values can be obtained when the reaction is performed in an organic solvent [49].

The lipase-catalysed self-condensation of hydroxyacids or hydroxyesters has not been investigated extensively but polymerisation of methyl 7-hydroxyheptanoate by porcine pancreatic lipase has been reported to yield products with M_w -12 000 in low yield (9%) [53]. In contrast, much higher degrees of polymerisation often are observed during the lipase-catalysed polymerisation of mixed diester/diol [54–56] or diacid/diol monomers [57,58]. These latter reactions can be performed under non-aqueous [56] or solvent-free conditions [55,58] and products with M_w up to 130 000 have been reported [57].

Peroxidase enzymes in combination with hydrogen peroxide can replace metal ions as catalysts for the polymerisation of phenols and anilines, illustrated for *para*-substituted phenolic substrates in Fig. 9.20.

Horseradish peroxidase has been used for the polymerisation of phenols [59], thiophenols [60] and anilines [61]. The products, being electrically conducting redox agents, have a range of useful properties but are generally of low molecular weight and undefined chemical structure. In an attempt to elucidate the nature of the monomer linking during polymerisation, a nuclear magnetic resonance (NMR) study of the polymerisation of 8-hydroxyquinoline-5-sulfonic

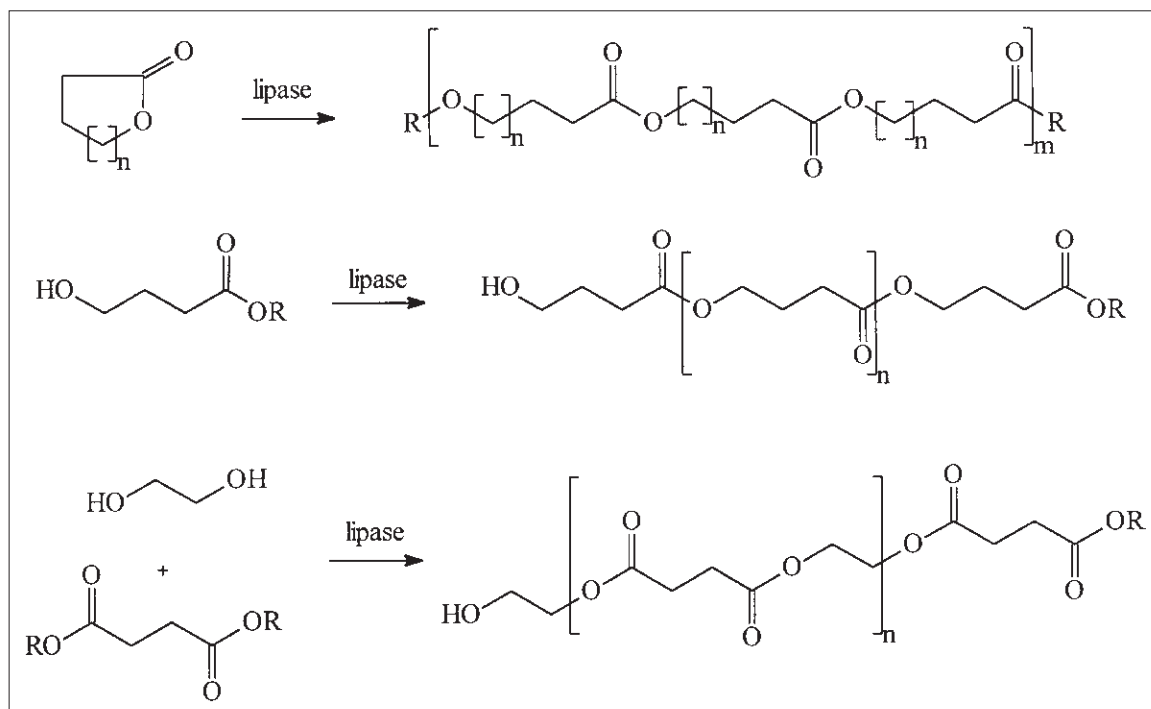


Fig. 9.19 Routes for the formation of polyesters by catalysis using lipase enzymes.

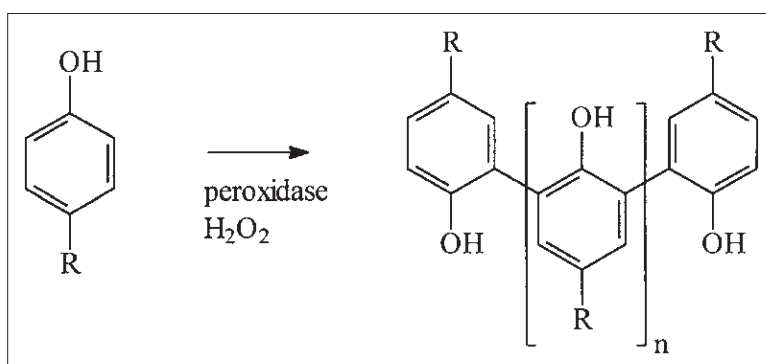


Fig. 9.20 Enzymic polymerisation of phenols.

acid established that linking at positions *ortho* to the phenol group was the preferred method of polymerisation, but whether this is a general feature remains to be established [62].

3 Green Biocatalytic Processes

The replacement of a chemical catalyst by an enzyme does not *per se* meet the requirements for green or

sustainable chemistry [63], and although enzymes operate in water as their natural environment it is paradoxical that some of their desirable properties, such as the ability of hydrolytic enzymes to make rather than break ester or amide bonds, are only exhibited under conditions of low water activity, typically in an organic solvent [64]. This section will consider an alternative—the use of supercritical carbon dioxide as a solvent for enzyme reactions—

and also explore enzyme-based techniques for the removal of specific target compounds from aqueous waste streams and petroleum feedstock.

3.1 Biocatalysis in supercritical carbon dioxide

Hydrolytic enzymes, particularly lipases, often exhibit a remarkable degree of activity and stability when used in supercritical carbon dioxide as a solvent. Enzymatic reactions in supercritical carbon dioxide have been reviewed thoroughly very recently [65,66] and only the major features of the process will be presented here. The vast majority of the enzymes studied in this way are lipases, and a critical level of water is required for enzyme activity. Under low-water conditions synthetic reactions are observed (ester and amide formation), typified by the kinetic resolution shown in Fig. 9.21 [67], but with increasing water concentration the hydrolytic reaction is preferred.

The enzyme Novozyme 435 (*Candida antarctica* lipase) retains partial activity for up to 14 h at 140°C in supercritical carbon dioxide [68]. The ability of such enzymes to operate under these conditions, with the associated advantages of enhanced rate and substrate solubility and without any negative effect on selectivity, suggest an increased application of this promising method for kinetic resolution and transesterification reactions.

3.2 Biocatalysis in waste treatment

Chemical treatment of organic wastes frequently involves acid- or base-catalysed hydrolyses or high-

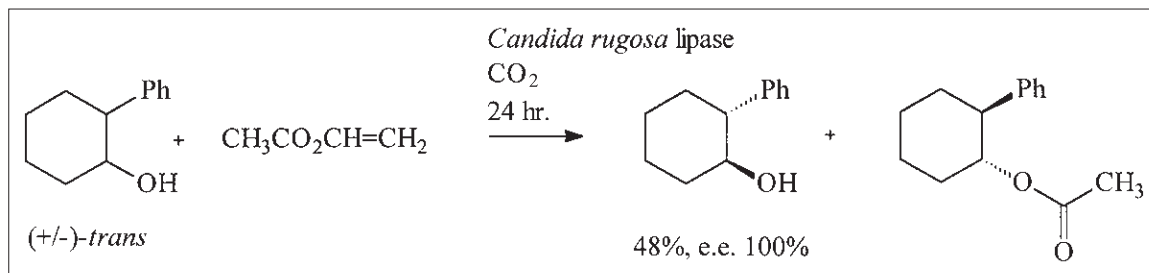
temperature incineration or oxidation, the latter often in the presence of a metal catalyst [69]. The biocatalytic treatment of organic waste materials, although perhaps not completely compatible with the concept of sustainable chemistry, nevertheless can provide a more environmentally acceptable, if interim, solution to some existing problems of waste management. Biological rather than chemical treatment of organic wastes may comprise complete degradation to carbon dioxide and inorganic ions (biodegradation), or the conversion of a specified toxic waste material to a non-toxic effluent of defined structure (biotransformation). The limitations and parameters of the microbial treatment of complex industrial waste materials have been well defined some time ago [70–72] and the present discussion will focus on the biocatalytic treatment of specific waste materials.

Phenolics

The toxicity of phenol and phenolic derivatives in industrial wastewaters is well documented and they can be found in wastes from oil refineries and paper processing plants at concentrations up to 1.5 g l⁻¹ [73]. Phenol can be removed effectively from aqueous solution by biocatalytic oxidation using a variety of species [74]. Immobilised cells of *Pseudomonas putida* [74] can tolerate and oxidise phenol at levels up to 1.5 g l⁻¹ [74] and similar concentrations are completely mineralised by *Candida tropicalis* or *Alcaligenes faecalis* in the presence of high salt concentrations [75].

Alternative methods for phenol removal have been developed that use isolated enzyme biocatalysts. A capillary membrane bioreactor containing immobilised polyphenol oxidase from the common mushroom *Agaricus bisporus* can oxidise phenolic material at up to 2 mM concentrations in effluent

Fig. 9.21 Kinetic resolution by lipase-catalysed transesterification in supercritical carbon dioxide.



from a coal-gas conversion plant in a two-stage process in which the coloured oxidation products were removed subsequently by adsorption using chitosan [76]. A similar two-stage process has been reported for the removal of a number of phenolic compounds from aqueous solution using co-immobilised laccase/tyrosinase coupled with adsorption of the products by polyclar [77]. Both of these examples involve the enzymic oxidation of phenols to *ortho*-quinones, spontaneous polymerisation of the latter in water and removal of the insoluble polymeric products by adsorption or filtration (Fig. 9.22).

Cyanides

Cyanide ion is a potent inhibitor of oxidative metabolism and its removal from effluents is an essential part of many waste treatment protocols, particularly in the mining and metal processing industries [78]. Immobilised cells of *Pseudomonas putida* have been reported to convert cyanide ion at up to 120 mM aqueous concentration into carbon dioxide and ammonia: the same cells also were able to degrade cyanate and thiocyanate ions, the former to ammonia and carbon dioxide and the latter to ammonia, carbon dioxide and an unspecified sulfur-containing product [78]. A range of organic nitriles including acrylonitrile and adiponitrile also can be converted, initially to the corresponding carboxylic acids, by a *Pseudomonas* species (S1) that additionally is able to metabolise inorganic cyanide [79].

Halo compounds

Halo compounds represent a major part of many industrial effluents and their removal by biodegradation has been studied for many years [69–72,80]. Because halogenated compounds are more persistent in the environment than their non-halogenated analogues, a major route for remediation of the former is by dehalogenation, and prominent targets for this process are the chlorinated aromatic compounds. Although this family of compounds are particularly resistant to biodegradation, they are nevertheless

susceptible to dehalogenation by hydrolytic, reductive and oxidative routes, summarised in Fig. 9.23 [81].

None of these routes is a general process and each is applicable to only a narrow range of substrates. The hydrolytic dehalogenation reaction carried out by species of *Pseudomonas* or *Arthrobacter* is generally dependent on the presence of a *para*-carboxylate group, although exceptions are known, and reductive dehalogenation also is known to apply only to a limited range of substrates at the present time [81,82]. The oxidative dehalogenation route potentially is more generally applicable, and examples involving the dioxygenase-catalysed route illustrated in Fig. 9.23 have been reported for several chlorinated mononuclear and biaryl aromatic substrates [83]. Another route for oxidative dehalogenation of aromatic compounds is the conversion of pentachlorophenol to tetrachloroquinone by strains of *Pseudomonas*, *Flavobacterium* and *Mycobacterium*, dependent on the activity of a monooxygenase enzyme and illustrated in Fig. 9.24.

An alternative strategy for the biocatalytic processing of polychlorinated aromatics using the process of Fig. 9.24 relies on the monooxygenase-catalysed conversion of a chlorinated hydrocarbon to the corresponding chlorinated phenol and treatment of the latter by chlorophenol-degrading microorganisms such as the *Pseudomonas* bacteria [84].

Non-aromatic haloalkanes also are targets for bioremediation: the activities of haloalkane dehalogenase enzymes in microorganisms such as *Rhodococcus* species and *Xanthobacter autotrophicus* (a bacterium capable of growing on 1,2-dichloroethane as a sole source of carbon) can be exploited for the bioremediation of soils contaminated with such compounds [82]. However, in spite of the enzyme activities discussed above, many halogenated organic compounds still are persistent in the environment and biocatalytic degradation often produces a range of products without removal of the halogen atom from the substrate. This is exemplified by metabolism of the herbicide metolachlor by the common

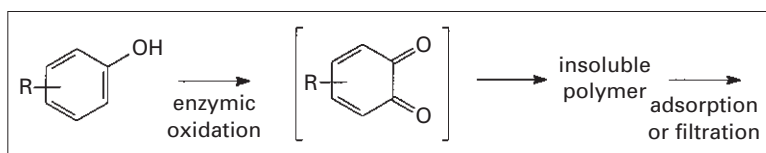


Fig. 9.22 Removal of phenols from water via oxidation to *ortho*-quinones.

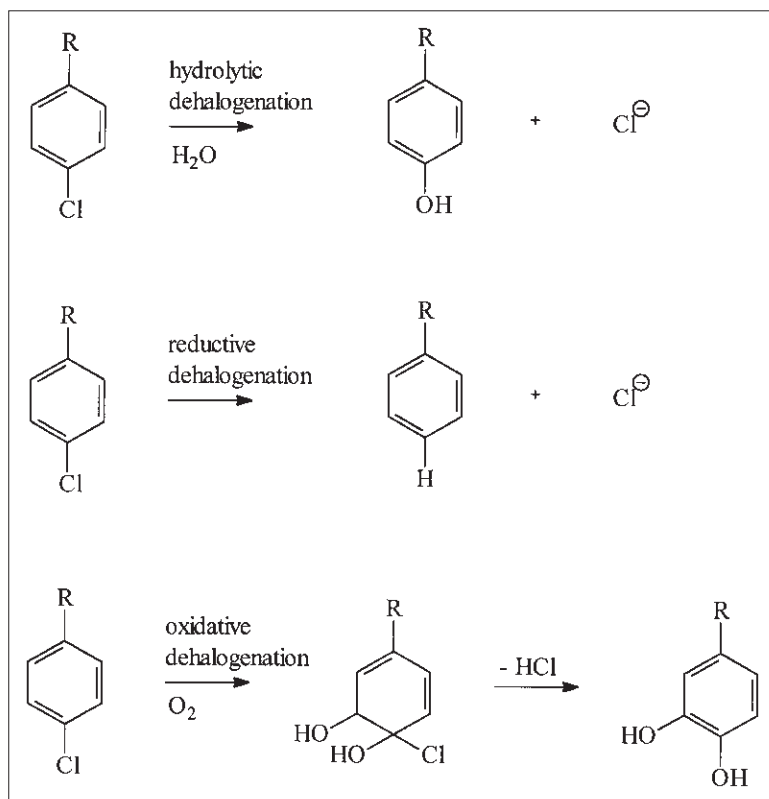


Fig. 9.23 Biocatalytic routes for the removal of halide from chlorinated aromatic compounds.

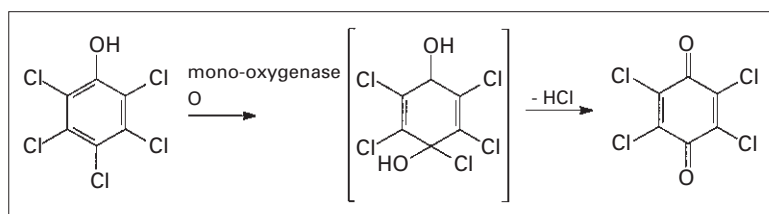


Fig. 9.24 Mono-oxygenase-catalysed dehalogenation of pentachlorophenol.

fungus *Cunninghamella elegans* (Fig. 9.25), where a range of metabolic products is obtained in which the chlorine substituent of the substrate remains intact [85].

Miscellaneous pollutants

The detoxification of pesticides by microbial enzymes represents a major route for their removal from the environment [86], and in a logical extension of this area methods have been developed for the detoxification of specific classes of pesticides by biocatalytic

processing in non-environmental settings in a controlled and reproducible manner. The latter technology is applicable, for example, to the destruction of organophosphate pesticides and the organophosphate nerve gases stockpiled from military operations. An immobilised suspension of genetically constructed *Escherichia coli* with an organophosphorus hydrolase enzyme anchored on the outer cell surface can efficiently hydrolyse a series of organophosphate esters, including paraoxon, diazoxon and methylparathion, during repeated cycles over long periods [87].

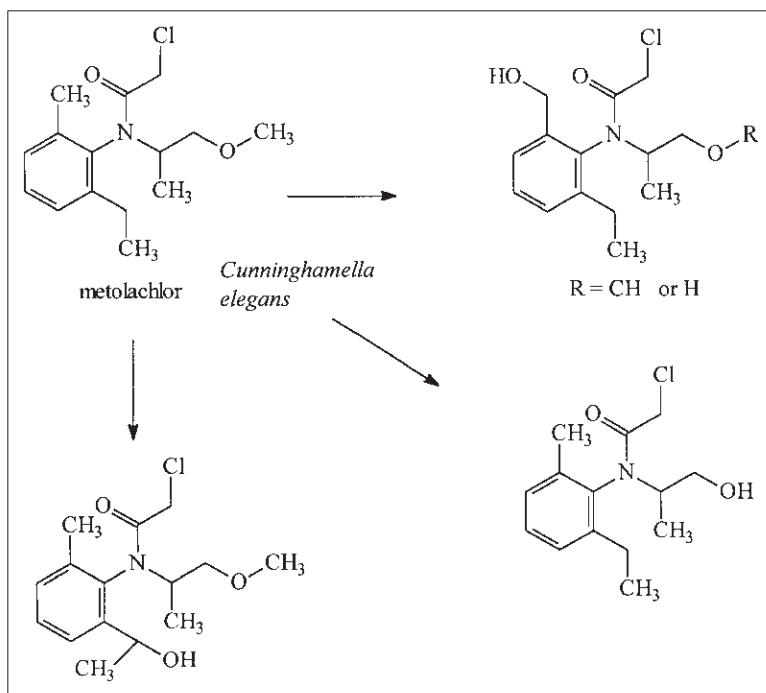


Fig. 9.25 Metabolism of metolachlor by *Cunninghamella elegans*.

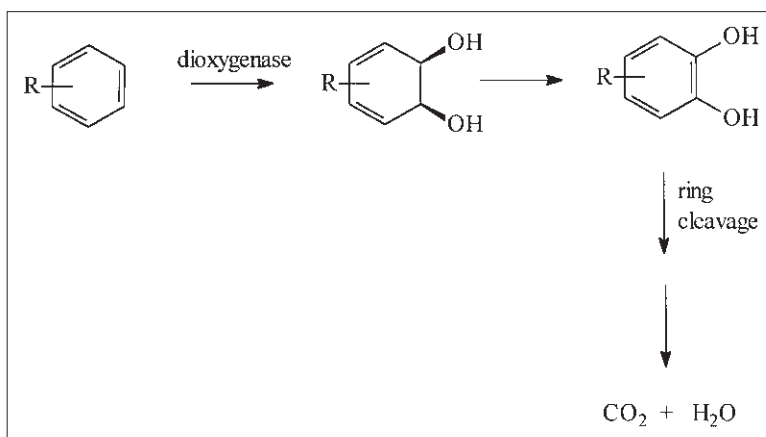


Fig. 9.26 The dioxygenase pathway for the biodegradation of arenes.

Another application of biocatalytic processing relevant to the military area concerns the remediation of soils and water run-off from former military sites that are contaminated with explosives. A number of microbial systems are known to be capable of the mineralisation of TNT (2,4,6-trinitrotoluene): some of these operate via reduction of nitro groups to

amines [88], but others such as *Pseudomonas savastanoi* also perform reductive denitration to yield products such as 2,4-dinitrotoluene [89].

Many bacterial systems are capable of the oxidation of aromatic hydrocarbons using a pathway dependent on the activity of dioxygenase enzymes for the oxidation of an arene to a *cis*-dihydrodiol as

the first step in the biodegradation of the former class of compounds (Fig. 9.26) [90]. This process has been examined systematically as a means for the removal of organic solvents such as benzene, toluene and xylenes from aqueous effluent streams [91]; heteroaromatic products such as the quinolines, typically released in coal gasification and fossil fuel processing activities, also are subject to biodegradation by this and other pathways [92].

An alternative application for the nitrile-hydrolysing enzymes of *Rhodococcus*, other than the production of acrylamide (Fig. 9.1), lies in the ability of several strains of *Rhodococcus* bacteria to hydrolyse both nitriles and amides to carboxylic acids at very low substrate concentrations. This makes them ideal biocatalysts for the removal of materials such as acrylonitrile and acrylamide from aqueous waste streams, in addition to their application for the removal of impurities in the manufacturing processes involving these compounds [93].

3.3 Biodesulfurisation

The removal of sulfur from fossil fuels, particularly crude oil, is a priority problem for the energy industry. Conventional desulfurisation involves reaction of petroleum fractions with an inorganic catalyst and hydrogen under high temperature and pressure conditions (hydrodesulfurisation or hydrotreating). This is an energy-consuming process that may involve some degradation of the fuel value of the product, whereas biodesulfurisation—a process for the removal of organically bound sulfur by microbial

action—can take place at ambient temperature and pressure with loss of calorific value of the product [94]. One of the major sulfur-containing contaminants of middle-distillate petroleum fractions is dibenzothiophene, and a process for its removal by treatment with a *Rhodococcus* bacterium (strain IGTS8) is based on the degradation of dibenzothiophene to 2-hydroxybiphenyl, as illustrated in Fig. 9.27.

The sulfur atom of the precursor is released as sulfite ion, which can be converted readily to sulfate under the conditions of the transformation and removed as a water-soluble or precipitated salt [95]. The enzyme system of *Rhodococcus* also is able to transform substituted dibenzothiophenes by an analogous pathway [96,97], and the process has been developed by Energy BioSystems Corporation (now Enchira Biotechnology Corporation) as a practical alternative and supplement to chemical hydrodesulfurisation of middle-distillate petroleum [94–96]. Other sulfur-containing contaminants, particularly the dihydrobenzothiophenes formed during chemical hydrodesulfurisation, can be oxidised by other microbial biocatalysts such as *Pseudomonas*, but without removal of the sulfur atom [98].

4 Conclusions

Although replacement of chemical processes by biological catalysts usually results in a more sustainable process, the costs associated with the use of a biocatalyst, arising for example from short catalyst lifetimes and the need to invest in specialised equipment, often can exceed those of the traditional

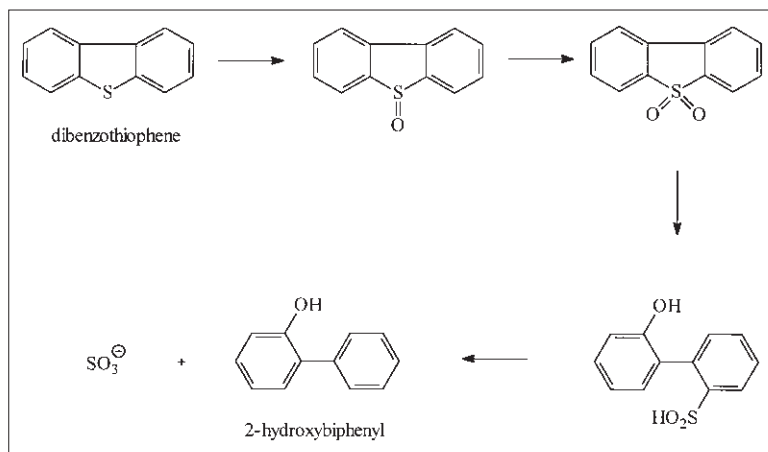


Fig. 9.27 Conversion of dibenzothiophene to 2-hydroxybiphenyl by *Rhodococcus* IGTS8.

chemical-based operation. The success of industrial biocatalysis has been largely in those areas for which the chemical alternative is either not available (e.g. glucose–fructose isomerisation and corticosteroid production) or simply not viable on the scales required (e.g. penicillin production). The success of biocatalysis in other areas has been limited, but the demonstration that biocatalytic processes can provide a product of higher quality than the corresponding chemical process (e.g. in acrylamide production) has provided an impetus for the continuing investigation of the use of biological catalysis in chemical production. The number of microorganisms that have been examined systematically for their potential in this area represent only a small fraction of those available [99], and this, together with the ability of microbiologists to produce tailor-made catalysts by genetic manipulation [100], leaves the field open for the discovery of new and useful biocatalysts for future application in a wider range of chemical processes than has been possible up to now.

References

- Wandrey, C., Liese, A., & Kihumbu, D. *Org. Process Res. Dev.*, 2000, **4**, 286.
- Yamada, H., & Kobayashi, M. *Biosci. Biotechnol. Biochem.*, 1996, **60**, 1391.
- Petersen, M., & Kiener, A. *Green Chem.*, 1999, **1**, 99.
- Sime, J. T. *J. Chem. Educ.*, 1999, **76**, 1658.
- Cheetham, P. In *Applied Biocatalysis* (Cabral, J. M. S., Best, D., Boross, L., & Tramper, H., eds). Harwood Academic Publishers, London, 1994, pp. 47–108.
- Schulze, B., & Wubbolts, M. G. *Curr. Opin. Biotechnol.*, 1999, **10**, 609.
- Liese, A., & Filho, M. V. *Curr. Opin. Biotechnol.*, 1999, **10**, 595.
- Sheldon, R. A. *Chimia*, 1996, **50**, 418.
- Rozzell, J. D. *Bioorg. Med. Chem.*, 1999, **7**, 2253.
- He, Z., & Spain, J. C. *J. Ind. Microbiol. Biotechnol.*, 2000, **25**, 25.
- Gavagan, J. E., Fager, S. K., Fallon, R. D., Folsom, P. W., et al. *J. Org. Chem.*, 1998, **63**, 4792.
- Kieslich, K. *Bull. Soc. Chim. Fr.*, 1980, **11**, 9.
- Crocq, V., Masson, C., Winter, J., Richard, C., et al. *Org. Process Res. Dev.*, 1997, **1**, 2.
- Kieslich, K. *Acta Biotechnol.*, 1991, **6**, 559.
- Buckland, B. C., Robinson, D. K., & Chartrain, M. *Metab. Eng.*, 2000, **2**, 42.
- Kutney, J. P. *Pure Appl. Chem.*, 1999, **71**, 1025; 1998, **70**, 2093.
- Kutney, J. P. *Pure Appl. Chem.*, 1996, **68**, 2073.
- Patterson, R. L. S., Charlewood, B. V., MacLeod, G., & Williams, A. A. *Bioformation of Flavours*. Royal Society of Chemistry, London, 1992.
- Keppler, J. G. *J. Am. Oil Chem. Soc.*, 1977, **54**, 474.
- Lesage-Meessen, L., Haon, M., Delattre, M., Thibault, J. F., Colonna Ceccaldi, B., & Asther, M. J. *Biotechnol.*, 1996, **50**, 107.
- Stentelaire, C., Lesage-Meessen, L., Oddou, J., Bernard, O., et al. *J. Biosci. Bioeng.*, 2000, **89**, 223.
- Van Haandel, M. J. H., Sarabér, F. C. E., Boersma, M. G., Laane, C., et al. *J. Agric. Food. Chem.*, 2000, **48**, 1949.
- Kulla, H. G. *Chimia*, 1991, **45**, 81.
- Oyama, K. In *Chirality in Industry* (Collins, A. N., Sheldrake, G. N., & Crosby, J., eds). John Wiley, Chichester, 1992, pp. 237–247.
- Glazer, A. N., & Nikaido, H. *Microbial Biotechnology*. W. H. Freeman, New York, 1995, p. 552.
- De Wulf, P., Soetaert, W., & Vandamme, E. J. *Biotechnol. Bioeng.*, 2000, **69**, 339.
- Nakagawa, H., Dobashi, Y., Sato, T., Yoshida, K., et al. *J. Biosci. Bioeng.*, 2000, **89**, 138.
- Hermann, G. F., Wang, P., Shen, G.-J., Garcia-Junceda, E., et al. *J. Org. Chem.*, 1994, **59**, 6356.
- Draths, K. M., Wrad, T. L., & Frost, J. W. *J. Am. Chem. Soc.*, 1992, **114**, 9725.
- Draths, K. M., & Frost, J. W. *J. Am. Chem. Soc.*, 1994, **116**, 399.
- Draths, K. M., & Frost, J. W. *J. Am. Chem. Soc.*, 1995, **117**, 2395.
- Snell, K. D., Draths, K. M., & Frost, J. W. *J. Am. Chem. Soc.*, 1996, **118**, 5605.
- Draths, K. M., Knop, D. R., & Frost, J. W. *J. Am. Chem. Soc.*, 1999, **121**, 1603.
- Li, K., Mikola, M. R., Draths, K. M., Worden, R. M., & Frost, J. W. *Biotechnol. Bioeng.*, 1999, **64**, 61.
- Patel, R. N. *Stereoselective Biocatalysis*. Marcel Dekker, New York, 2000.
- Collins, A. N., Sheldrake, G. N., & Crosby, J. *Chirality in Industry*. John Wiley, Chichester, 1992.
- Martini, D., Iacazio, G., Ferrand, D., Buono, G., & Triantaphylides, C. *Biocatalysis*, 1994, **11**, 47.
- Elshof, M. B. W., Janssen, M., Veldink, G. A., & Vliengenthart, J. F. G. *Rec. Trav. Chim. Pays-Bas*, 1996, **115**, 499.
- Fuganti, C., Rigoni, R., Zucchi, G., Barbeni, M., Cisero, M., & Villa, M. *Biotechnol. Lett.*, 1995, **17**, 301.
- Leoni, O., Bernardi, R., Gueyrard, D., Rollin, P., & Palmieri, S. *Tetrahedron Asymm.*, 1999, **10**, 4775; 2000, **11**, 2245.
- Gueyrard, D., Grumel, V., Leoni, O., Palmieri, S., & Rollin, P. *Heterocycles*, 2000, **52**, 827.
- Madden, L. A., Anderson, A. J., & Asrar, J. *Macromolecules*, 1998, **31**, 5660.
- Choi, J., & Lee, S. Y. *Appl. Microbiol. Biotechnol.*, 2000, **53**, 646.

44. Shoda, S.-I., & Kobayashi, S. *Macromol. Symp.*, 1995, **99**, 179.
45. Kobayashi, S. *Polym. Mater. Sci. Eng.*, 1996, **74**, 32.
46. Gross, R. A., Xu, J., Svirkin, Y. Y., Henderson, L. A., et al. *Polym. Mater. Sci. Eng.*, 1996, **74**, 67.
47. Nobes, G. A. R., Kazlauskas, R. J., & Marchessault, R. H. *Macromolecules*, 1996, **29**, 4829.
48. Xie, W., Li, J., Chen, D., & Wang, P. G. *Macromolecules*, 1997, **30**, 6997.
49. Kobayashi, S., Uyama, H., & Namekawa, S. *Polym. Degrad. Stabil.*, 1998, **59**, 195.
50. Kobayashi, S., Uyama, H., Namekawa, S., & Hayakawa, H. *Macromolecules*, 1998, **31**, 5655.
51. Dong, H., Cao, S.-G., Li, Z.-Q., Han, S.-P., You, D.-L., & Shen, J.-C. *J. Polym. Sci. A: Polym. Chem.*, 1999, **37**, 1265.
52. Dong, H., Wang, H.-D., Cao, S.-G., & Shen, J.-C. *Biotechnol. Lett.*, 1998, **20**, 905.
53. Knani, D., Gutman, A. L., & Kohn, D. H. *J. Polym. Sci. A: Polym. Chem.*, 1993, **31**, 1221.
54. Uyama, H., Yaguchi, S., & Kobayashi, S. *J. Mol. Catal. B:Enzym.*, 1998, **5**, 491.
55. Chaudhary, A. K., Kline, B. J., Beckman, E. J., & Russell, A. J. *Polym. Prepr.*, 1997, **38**, 396.
56. Chaudhary, A. K., Beckman, E. J., & Russell, A. J. *Biotechnol. Bioeng.*, 1997, **55**, 227.
57. Linko, Y.-Y., Lämäsä, M., Wu, X., Uosukainen, E., Seppälä, J., & Linko, P. *J. Biotechnol.*, 1998, **66**, 41.
58. Binns, F., Harffrey, P., Roberts, S. M., & Taylor, A. J. *Polym. Sci. A: Polym. Chem.*, 1998, **36**, 2069.
59. Wang, P., Martin, B. D., Parida, S., Rethwisch, D. G., & Dordick, J. S. *J. Am. Chem. Soc.*, 1995, **117**, 12885.
60. Premachandran, R., Banerjee, S., John, V. T., McPherson, G. L., Akkara, J. A., & Kaplan, D. L. *Chem. Mater.*, 1997, **9**, 1342.
61. Samuelson, L. A., Anagnostopoulos, A., Alva, K. S., Kumar, J., & Tripathy, S. K. *Macromolecules*, 1998, **31**, 4376.
62. Alva, K. S., Samuelson, L., Kumar, J., Tripathy, S., & Chollis, A. L. *J. Appl. Polym. Sci.*, 1998, **70**, 1257.
63. Anastas, P. T., & Warner, J. C. *Green Chemistry*. Oxford University Press, Oxford, 1998.
64. Vulfson, E. N., Halling, P. J., & Holland, H. L. In *Methods in Biotechnology* (Woodley, J., ed.). Humana Press, London, 2001, pp. 241–649.
65. Hartmann, T., Schwabe, E., Scheper, T., & Combes, D. In *Stereoselective Biocatalysis* (Patel, R. N., ed.). Marcel Dekker, New York, 2000, pp. 799–838.
66. Mesiano, A. J., Beckman, E. J., & Russell, A. J. *Chem. Rev.*, 1999, **99**, 623.
67. Celia, E. C., Cernia, E., D'Acquarica, I., Palocci, C., & Soro, S. *J. Mol. Catal. B:Enzym.*, 1999, **6**, 495.
68. Overmeyer, A., Schrader-Lippelt, S., Kasche, V., & Brunner, G. *Biotechnol. Lett.*, 1999, **21**, 65.
69. Bretscher, H. In *Microbial Degradation of Xenobiotics and Recalcitrant Compounds* (Leisinger, T., Cook, A. M., Hütter, R., & Nüesch, J., eds). Academic Press, London, 1981, pp. 65–74.
70. Chakrabarty, A. M. *Biodegradation and Detoxification of Environmental Pollutants*. CRC Press, Boca Raton, FL, 1982.
71. Ghisalba, O. *Experientia*, 1983, **39**, 1247.
72. Scholze, R. J., Smith, E. D., Bandy, J. T., Wu, Y. C., & Basilico, J. V. *Biotechnology for Degradation of Toxic Chemicals in Hazardous Wastes*. Noyes Data Corporation, New Jersey, 1988.
73. Bond, R. G., & Straub, C. P. *Handbook of Environmental Control*, Vol. 4. CRC Press, Boca Raton, FL, 1974.
74. Hannaford, A. M., & Kueck, C. J. *Ind. Microbiol. Biotechnol.*, 2000, **22**, 121.
75. Bastos, A. E. R., Tornisiello, V. L., Nozawa, S. R., Trevors, J. T., & Rossi, A. J. *Ind. Microbiol. Biotechnol.*, 2000, **24**, 403.
76. Edwards, W., Bownes, R., Leukes, W. D., Jacobs, E. P., et al. *Enzyme Microb. Technol.*, 1999, **24**, 209.
77. Krastanov, A. J. *Ind. Microbiol. Biotechnol.*, 2000, **24**, 383.
78. Chapatwala, K. D., Babu, G. R. V., Vijaya, O. K., Kumar, K. P., & Wolfram, J. H. *J. Ind. Microbiol. Biotechnol.*, 1999, **20**, 28.
79. Dhillon, J. K., & Shivaraman, N. *Can. J. Microbiol.*, 1999, **45**, 201.
80. Ghosal, D., You, I.-S., Chatterjee, D. K., & Chakrabarty, A. M. *Science*, 1985, **228**, 135.
81. Copley, S. D. *Chem. Biol.*, 1997, **4**, 169.
82. Swanson, P. E. *Curr. Opin. Biotechnol.*, 1999, **10**, 365.
83. Bruhlmann, F., & Chen, W. *Biotechnol. Bioeng.*, 1999, **63**, 544.
84. Jones, J. P., O'Hare, E. J., & Wong, L.-L. *Chem. Commun.*, 2000, 247.
85. Pothuluri, J. V., Evans, F. E., Doerge, D. R., Churchwell, M. I., & Cerniglia, C. E. *Arch. Environ. Contam. Toxicol.*, 1997, **32**, 117.
86. Johnson, L. M., & Talbot, H. W. *Experientia*, 1983, **39**, 1236.
87. Mulhandani, A., Kaneva, I., & Chen, W. *Biotechnol. Bioeng.*, 1999, **63**, 216.
88. Rieger, P.-G., & Knackmuss, H.-J. In *Biodegradation of Nitroaromatic Compounds* (Spain, J. C., ed.). Plenum Press, New York, 1995, pp. 1–18.
89. Martin, J. L., Comfort, S. D., Shea, P. J., Kokjohn, T. A., & Drijber, R. A. *Can. J. Microbiol.*, 1997, **43**, 447.
90. Holland, H. L. *Organic Synthesis with Oxidative Enzymes*. VCH, New York, 1992, p. 199.
91. Choi, Y.-B., Lee, J.-Y., & Kim, H.-S. *Biotechnol. Bioeng.*, 1992, **40**, 1403.
92. Fetzner, S., Tshisuaka, B., Lingens, F., Kappl, R., & Hüttermann, J. *Angew. Chem. Int. Ed. Eng.*, 1998, **37**, 576.
93. Hughes, J., Armitage, Y. C., & Symes, K. C. *Ant. Van Leeuwenhoek*, 1998, **74**, 107.
94. Gray, K. A., Pogrebinsky, O. S., Mrachko, G. T., Xi,

- L., Monticello, D. J., & Squires, C. H. *Nature Biotech.*, 1996, **14**, 1705.
95. Oldfield, C., Pogrebinsky, O., Simmonds, J., Olsen, E. S., & Kulpa, C. F. *Microbiology*, 1997, **143**, 2961.
96. Folsom, B. R., Schieche, D. R., DiGrazia, P. M., Werner, J., & Palmer, S. *Appl. Environ. Microbiol.*, 1999, **65**, 4967.
97. Ohsjiro, T., Hirata, T., & Izumi, Y. *FEMS Microbiol. Lett.*, 1996, **142**, 65.
98. Kropp, K. G., Andersson, J. T., & Fedorak, P. M. *Appl. Environ. Microbiol.*, 1997, **63**, 3032.
99. Staley, J. T., & Witholt, B. *Curr. Opin. Microbiol.*, 2000, **3**, 235.
100. Zelder, O., & Hauer, B. *Curr. Opin. Microbiol.*, 2000, **3**, 248.

Chapter 10: Recent Advances in Phase-transfer Catalysis

YOEL SASSON AND GADI ROTHENBERG

1 Introduction

Thirty years since its overture, the realm of phase-transfer catalysis (PTC) is still highly dynamic and creative [1]. The field that started merely as a technique for rate enhancement of simple aliphatic nucleophilic substitution [2] and hydroxide base-promoted reactions [3] evolved into a paradigm covering numerous areas of multiphase reactions and processes with applications in essentially all fields of organic syntheses, industrial chemistry [4], biotechnology and material science and technology. Phase-transfer catalysis can be encountered in the synthesis of advanced pharmaceuticals, nutraceuticals, fragrances and crop protection chemicals, in the manufacturing of highly advanced engineering plastics and in the fabrication of sophisticated materials for semiconductors, electro-optical and data storage devices [5]. Phase-transfer catalysts are being combined with enzymes in biotechnological processes [6] and with transition metals in supramolecular chemistry and nanotechnology [7]. Phase-transfer catalysis has a major role in the contemporary global thrust of replacing traditional industrial operations with sustainable and cleaner technologies [8]. It also contributes genuine protocols for the recovery and recycling of side products and wastes [9], including depolymerisation and reuse of plastic and rubber wastes [10]. A worthy demonstration also is the worldwide effort to implement CO₂ as an alternative chemical feedstock [11], a challenging undertaking in which PTC will most likely play a major role. A particularly acute capacity is ascribed to PTC in chemical safety issues. In his brand new book *Practical Process R&D*, Anderson [12] confides the following 'tip': 'PTC can provide a safe, highly effective approach to reactions with NaCN and NaN₃'. The author principally relates to the higher activity of these nucleophiles in apolar organic phase where they are not solvated, thus the reactions are faster and the need for molar excess (required when working in polar solvents such as dimethyl sulfoxide) is eliminated.

At the outset of October 2000 we retrieved over 7700 references from the CAPlus file of the Chemical Abstracts Service under the term: 'phase transfer catal?'. This number is perpetually growing at an annual rate of 430–500 references, including 130–150 patents.

Although the main present-day trend in PTC development is in industrial application of known methodologies, we have concurrently witnessed, throughout the last few years, an incessant flow of novel and inspiring PTC concepts and ideas. Some characteristic instances are the revolutionary asymmetric cinchona-based phase-transfer catalysts reported simultaneously by Corey and Lygo, and the highly thermally stable guanidinium-based catalysts invented by Brunelle (applied in high-temperature polymerisation). Additional illustrations are the creative living, chain growth PTC polycondensation developed by Yokozawa and the combined quaternary ammonium/tungsten catalyst introduced by Noyori in his 'halide free' environmentally benign hydrogen peroxide oxidation. Other innovative concepts are the nano-sized metal particles stabilised in organic media by a layer of lipophilic quaternary ammonium salts, the modification of conventional heterogeneous catalysts by phase-transfer agents and the development of numerous one-pot cascade (or 'domino') PTC reactions. Ingenious new analytical and process experimental techniques, such as novel spectroscopic and electrochemical methods for visualisation of surface phenomena and microwave irradiation in the activation of solid/liquid PTC reactions, were introduced recently into PTC research.

Several reviews covering specific areas in PTC have appeared during the last three years. Totten *et al.* surveyed the various aspects of poly(ethylene glycol)s (PEGs) as phase-transfer catalysts [13] and Loupy *et al.* [14] and Deshayes *et al.* [15] reviewed the application of microwave radiation in phase catalysis and other systems. Loupy reported on solvent-free reactions [16], Cook & Halpern reviewed PTC borohydride reductions [17] (see also

Yadav *et al.* [18]) and Abele & Lukevics surveyed [19] reactions of carbanions with carbon tetrachloride or carbon tetrabromide, mainly under PTC conditions. Toader & Bulacovschi [20] addressed the area of polycondensation PTC processes and Naik & Doraiswamy addressed the engineering aspects of PTC [21]. Use of quaternary phosphonium salts in PTC was reviewed by Wolff *et al.* [22]. Halpern scrutinised the benefits and challenges of PTC technology application in the pharmaceutical industry [23], Clark & Tavener interpreted the highlights and frontiers in PTC research at the outset of 1997 [24] and Dupont *et al.* [25], Olivier [26] and Welton [27] reviewed the application of ionic liquids as green solvents.

Our objective here is to present a comprehensive and critical outline of the major PTC breakthroughs and developments of the last 4 years since the last monograph in the field was printed [28].

2 Progress in Classical PTC Reactions

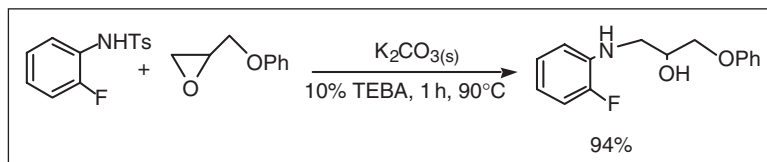
2.1 Nucleophilic aliphatic and aromatic substitutions

Historically, the simple aliphatic nucleophilic substitution was the incipient PTC process to be discovered and explored. Exchange of alkyl halides with nucleophiles such as cyanide, carboxylates, phenolates, thiocyanate and other halides is the most thoroughly investigated PTC reaction. In recent years this field has matured and only scant new findings were reported in contemporary literature. Some advanced developments were the syntheses of trimethylsilylazide from trimethylsilyl chloride [29] and of alkyl azides and α -azidoketones from alkyl bromides [30] and tosyloxyketones [31], respectively, both with sodium azide. α -Haloboronic esters were converted to α -azidoboronic esters using sodium azide and tetra-*n*-butylammonium bromide (TBAB) catalyst [32], and fluoroalkyl thiocyanate was prepared from the corresponding iodides [33]. The tandem

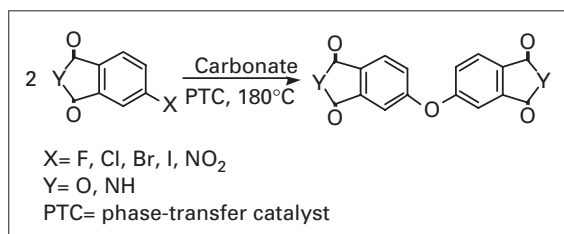
PTC reaction of alkyl halides, first with thiocyanate and then with azide to yield 5-alkylthiotetrazoles [34], and the reaction of thioacetate anion with 2-bromocarboxylic acids also were reported [35]. Attempts to react isocyanate under PTC conditions did not succeed in the past. However, in a recent patent from Cytec, cyanuric chloride was reacted with potassium cyanate in the presence of alcohols to yield 1,3,5-triazine carbamate [36]. Another interesting discovery was made by Ohtani *et al.* [37]. These authors found that, in the presence of quaternary phosphonium salts, thiocyanate turned into an active leaving group. Thus, alkyl and benzyl thiocyanate were exchanged efficiently with potassium halides or azide. The equilibration of alkyl halides with alkyl thiocyanate also was authenticated.

Ring opening of epoxides using PTC methodology proceeded regioselectively. For example, phenylacetone nitrile reacted with cyclohexene oxide to yield a diastereoisomeric mixture of γ -hydroxyphenylacetic acids [38]. Glycidols (Scheme 10.1) reacted with trifluoroacetamide to form amidoalcohols [39].

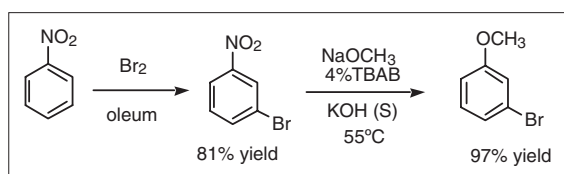
Significant progress was made also in PTC aromatic substitutions. The industrially important tetrafunctional monomer oxibisphthalic anhydride was reported in three independent patents. The first, by Bromine Compounds [40], disclosed the reaction of 4-halophthalic anhydride with the dipotassium (or sodium) salt of 4-halophthalate in refluxing 1,2-dichlorobenzene in the presence of tetraphenylphosphonium bromide (TPPB). A second process was revealed in a Japanese patent [41] where a halophthalic anhydride (F, Cl, Br or I) was reacted with a carbonate salt in a solvent in the presence of TPPB. Co-catalysis by iodide or fluoride anions also was claimed. The third technology was reported by GE Plastics, wherein hexaethylguanidinium chloride was used as the phase-transfer catalyst. In this patent either 4-chloro-4-nitrophthalic anhydride or phthalimide was used as starting material and the base was either a carbonate or an alkanoate (Scheme 10.2) [42].



Scheme 10.1



Scheme 10.2



Scheme 10.3

Although PTC substitution of active aromatic chlorine is a standard method for the synthesis of 4- or 2-nitroethers (such as nitroanisoles or phenetoles) [43], the preparation of 3-nitroanisole is not straightforward. Methoxydenitration of 3-bromonitrobenzene has been used in a unique procedure for the synthesis of 3-bromoanisole (Scheme 10.3) [44].

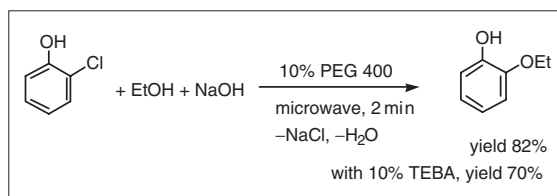
Thiomethoxydenitration was used for the preparation of thioether-substituted aromatic ketones [45].

Jiang *et al.* [46] reported a remarkable aromatic substitution reaction. They applied microwave irradiation in the substitution of 2-chlorophenol with ethoxide anion in the presence of 10 mol.% PEG-400 or triethylbenzylammonium chloride (TEBA) catalysts to obtain high yields of the corresponding phenol ether (Scheme 10.4). This reaction was never reported beforehand.

Although strong bases such as hydroxides usually are required for aromatic substitution, some reactions using carbonates also were recorded. A typical example is the N-arylation of pyrrolidino fullerene (Scheme 10.5) [47].

Similar aliphatic substitution of benzyl bromide was achieved in 70% yield under microwave irradiation [48].

Other recent citations include the sulfonation of 2,4-dinitrochlorobenzene with sodium sulfite catalysed by PEG [49], the arylation of benzotriazole by



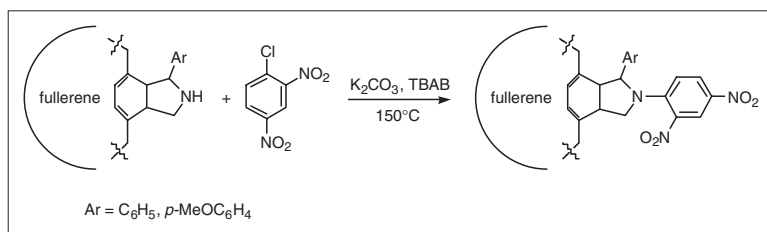
Scheme 10.4

activated aryl halides catalysed by cetyltrimethylammonium bromide (CTAB) [50] and the synthesis of thioether-substituted benzaldehydes by reaction of halobenzaldehydes with metal mercaptides catalysed by TBAB [51]. Thioether-substituted aromatic ketones also were prepared in a similar way [52].

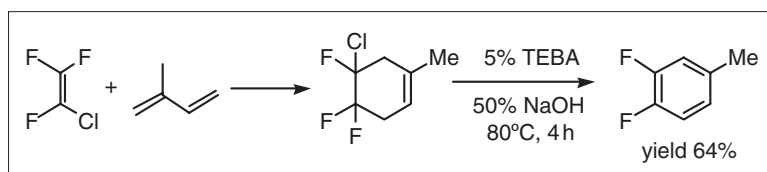
Aromatic nucleophilic cyanation proceeds under regular PTC conditions only with activated aryl fluorides. Thus, 4-fluoro-3-nitrobenzotrifluoride was converted to 2-nitro-4-trifluoromethylbenzotrifluoride by NaCN in the presence of Bu_4NHSO_4 [53]. Less-reactive substrates such as 2-nitrochlorobenzenes or 2-nitrobromobenzenes still reacted with NaCN under phase-transfer conditions but required the presence of copper salts as co-catalysts [54]. Cyanation of non-activated benzenes normally called for the presence of a noble metal catalyst. For example, aryl cyanides were prepared from aryl iodides under inverse PTC (see Chapters 4 and 7) conditions in the presence of ZnCl_2 and $\text{PdCl}_2[\text{PPh}_2(m\text{-C}_6\text{H}_4\text{SO}_3\text{Na})]$ [55].

2.2 Phase-transfer catalysis in elimination and isomerisation reactions

Phase-transfer catalysis dehydrohalogenation under basic conditions remained the procedure of choice for the syntheses of speciality olefins and acetylenes. Some recent industrial examples are the preparation of *meta*-substituted styrenes via elimination of α -bromoethylbenzenes [56], the conversion of α -olefins to terminal acetylenes [57] and the production of vinylidene chloride via the continuous PTC elimination of 1,1,2-trichloroethane [58]. Other examples include the production of fluorinated unsaturated hydrocarbons by dehydrofluorination of saturated fluorohydrocarbons containing $-\text{CHF}-\text{CHF}-$ in the presence of potassium carbonate [59] and the surface modification of poly(vinylidene fluoride) by alkaline PTC treatment [60]. Synthesis of *ortho*-difluorobenzene derivatives was by the dehy-



Scheme 10.5



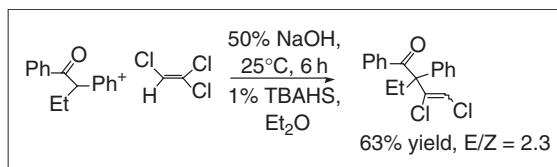
Scheme 10.6

dihalogenation of the cyclohexenes formed via the addition of 1,3-diene with chlorotrifluoroethylene (Scheme 10.6) [61].

A PTC/base-catalysed aromatisation was reported also for dihydrophenanthridine [62]. Jonczyk recently disclosed a tandem process combining elimination and addition steps [63]. In this reaction (Scheme 10.7) HCl was eliminated first from trichloroethylene to yield dichloroacetylene, which adds to the enolate anion formed from an enolisable ketone followed by protonation.

Total carbonisation of low-molecular-weight chloro- and bromohydrocarbons such as methylene chloride or bromide, chloroform, bromoform and trichloroethane was carried out over a large excess of solid KOH at room temperature and anhydrous conditions using TBAB [64]. The product was analysed as amorphous nanoparticles of carbon obtained in yields of up to 80%. Poly(vinyl chloride) was dehydrochlorinated into polyenes in a tetrahydrofuran (THF)/aqueous KOH medium in the presence of PEGs [65]. Conversions of 30–80% were achieved at room temperature after 2 h.

Another useful PTC transformation via elimination was the N-chloroallylation of aniline with 1,2,3-trichloropropane to yield N-(2-chloroallyl)aniline [66]. 1,2-Dichlorovinyl ethers were prepared by a tandem elimination–etherification sequence of trichloroethylene with primary alcohols [67]. Koch reported a procedure for the destruction of mustard gas by double dehydrochlorination into non-toxic divinyl sulfide [68]. Furan was the product of the



Scheme 10.7

double dehydrobromination of 3,4-dibromo-THF in the presence of NaOH and TBAB in methanol [69].

It is common knowledge that the extraction ability of hydroxide ions into organic phases by quaternary ammonium salts is very poor, particularly when hydrophilic anions such as bromide are present. Consequently, the rate of dehalogenation in a system containing base and phase-transfer catalyst is slow. An adequate solution has been the addition of a weak acid such as alcohol as co-catalyst [70]. Under these conditions the basicity is transferred to the organic phase by the deprotonated anion of the co-catalyst. Sivorski [71] recently has studied the triple elimination of hexachlorobenzene to 1,2,4-trichlorobenzene, and Makosza [72] has examined the dehydrobromination of bromocyclohexane. Both authors resolved that the pK_a of the co-catalyst was the major factor determining its efficacy. Optimal activity was obtained with YH acids, which formed a strong enough conjugated base Y^- for the elimination to proceed but still possessed sufficient extraction potential. It was found that benzyl alcohol and trifluoroethanol were excellent co-catalysts,

whereas picric acid and *t*-BuOH performed poorly. Interestingly, Sivorski and co-workers have shown that phenol in low concentration (up to 0.001 M) was an effective co-catalyst but at higher concentrations its activity dropped sharply. This phenomenon was attributed to the formation of the less-active QY-HY adducts when the concentration of the additive exceeded the concentration of the quaternary catalyst [73]. We have discovered recently that the catalytic role of alcohols in the extraction of basicity into organic phase by lipophilic onium salts could be exercised for the conversion of sodium hydroxide into other valuable hydroxides (such as potassium, caesium or tetralkylammonium) via a two-stage extraction process [74].

A related process was the isomerisation of alkenes and alkynes under basic conditions. Shioiri [75] has demonstrated a novel synthesis of diaryllallenes via isomerisation of arylbenzyl acetylenes (Scheme 10.8). When a chiral phase-transfer catalyst was used in this system, up to 35% enantiomeric excess (*ee*) could be obtained.

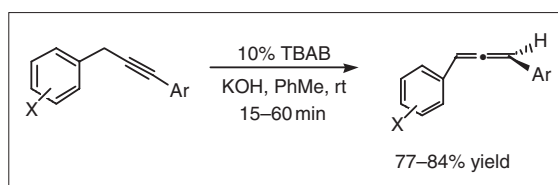
Vinylidene carbenes were prepared by Mizuno via double HBr elimination of 1,1-dibromocyclopropane under basic PTC conditions. The latter readily reacted

(Scheme 10.9) with electron-rich olefins to generate vinylidene cyclopropanes [76].

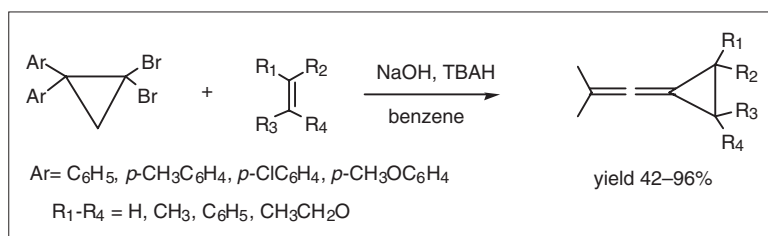
Starting with 1,1-dibromo-2,3-diarylcyclopropane in the absence of an alkene acceptor, the same group was able to form alkynyl carbenes, which dimerised easily to (*E*)- and (*Z*)-3-hexene-1,5-diynes (Scheme 10.10) [77].

Another PTC/base-catalysed isomerisation has been the conversion of the carotenoid leutin to its isomer zeaxanthin (a useful golden-yellow foodstuff pigment) [78].

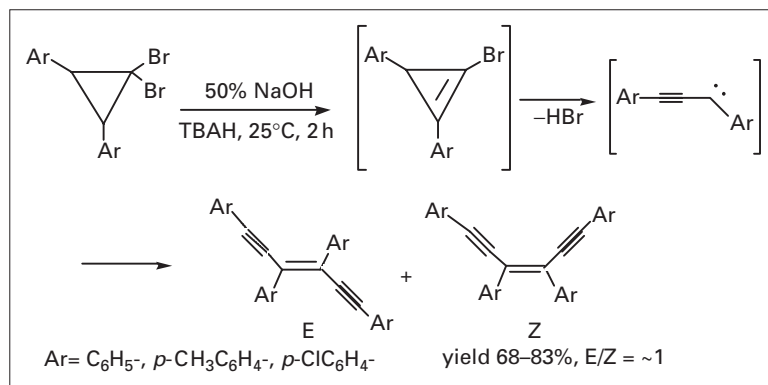
Weak uncharged bases such as dimethylamine also could be extracted and activated by phase-transfer techniques. This was shown by Alcaide [79], who used benzyltributylammonium bromide to catalyse



Scheme 10.8



Scheme 10.9

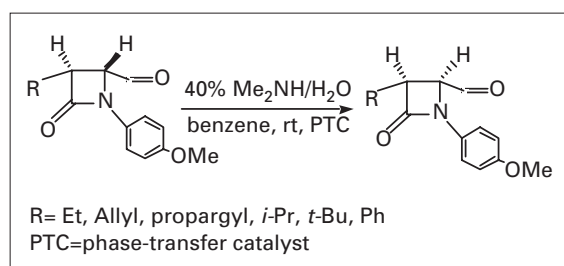


Scheme 10.10

the C₄ epimerization of *cis*-4-formyl-2-azetidinone in organic phase by aqueous dimethylamine (Scheme 10.11). Reaction time was halved in the presence of the quaternary ammonium salt. The mechanism apparently proceeded via H-bond extraction of the amine into the organic phase. In a related H-bond PTC extraction, tetra-*n*-butylammonium iodide (TBAI) was used to accelerate the amination of a ω-chloropropyl intermediate with methylamine in a MeOH/PhMe solvent system [80].

2.3 Base-promoted C, N, O and S alkylation and arylation reactions

Alkylations of weak O–H, N–H, S–H and C–H acids is a classical PTC operation and has been the theme of numerous synthetic and mechanistic studies in the past. The field has reached a certain degree of saturation in recent years and most of the late published information dealt with the application of customary methods to various new substrates. However, some novel developments should be mentioned: activation and reaction of very weak acids such as methyl ketones and amino acids; arylations of weak carbon acids; and novel syntheses of assorted ring systems under PTC conditions. In addition, recent developments in etherification, esterification, transesterification and condensation reaction also are presented here.



Scheme 10.11

Alkylation of very weak carbon acids

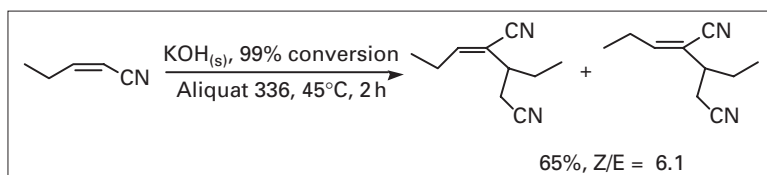
Methyl 1-naphthyl ketone was bis-alkylated in 41–78% yield using alkyl iodides in a benzene/KOH solid/liquid system [81]. Pinacolone was monoalkylated using *p*-chlorobenzyl chloride, KOC(CH₃)₃, KI and a tetramethylammonium chloride (TMAC) catalyst [82]. 2-Pentenenitrile was dimerised selectively using catalytic solid KOH and Aliquat 336 (Scheme 10.12) [83].

Tri-(2-propyl)cyclopentadiene was prepared via alkylation of cyclopentadiene in aqueous NaOH in the presence of Aliquat 336 [84]. Cyclopentadiene with two or three different alkyl substituents was synthesised similarly [85], as was tetraalkyl(cyclohexyl)-substituted cyclopentadiene [86].

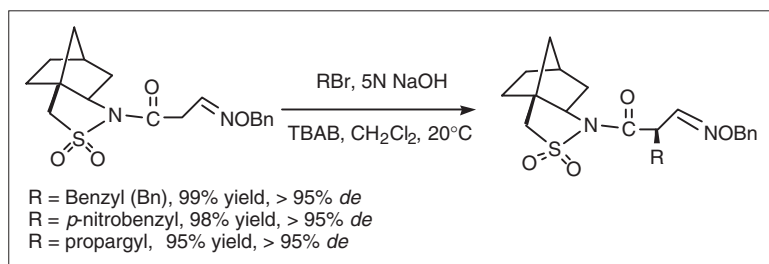
Landini *et al.* published a comprehensive study on the kinetics and mechanism of the alkylation of deoxybenzoin in the presence of 50% solution or solid NaOH or KOH catalysed by macrocyclic polyethers such as perhydrodibenzo-18-crown-6 or [2.2.2,C₁₀] cryptand [87]. Their results prompted a standard interfacial mechanism via deprotonation, complex formation and extraction, followed by a rate-determining organic-phase reaction of C- and O-alkylations. Remarkably, 100% C-alkylation product was obtained using the crown ether catalyst with 19 M NaOH and *n*-butyl iodide.

Significant progress was made in PTC syntheses and modifications of natural and unnatural amino acids using various O-, N- and C-alkylation techniques. The N-protected serine was O-alkylated efficiently with various alkyl bromides or iodides by applying solid KOH in the presence of Aliquat 336 [88].

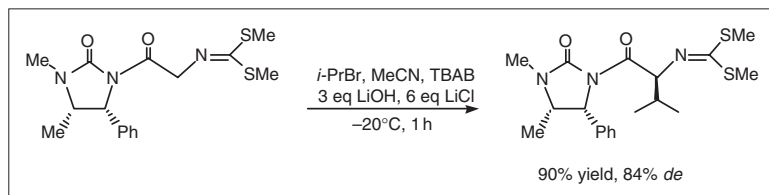
Schiff-base-activated glycine supported on soluble PEG was alkylated readily with various electrophiles in the presence of a carbonate base to yield esters of α-amino acids, which then were cleaved from the polymer. Here, the PEG performed both as a support for the substrate and as a phase-transfer catalyst [89]. Cyclic amino acid derivatives were prepared in a similar way [90].



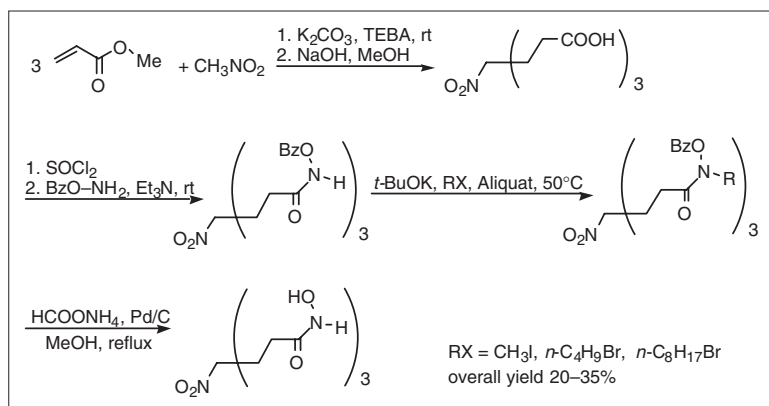
Scheme 10.12



Scheme 10.13



Scheme 10.14



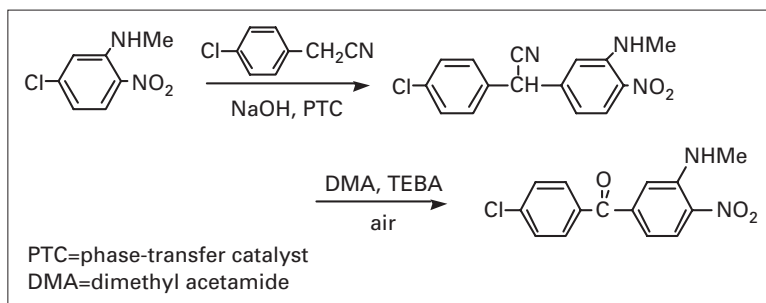
Scheme 10.15

Carbon alkylation of N-protected glycinate ester with $\text{RCH}_2\text{CH}_2\text{Br}$ afforded—after deprotection and hydrolysis—a series of γ -fluoro- α -amino acids [91]. The alkylation step was achieved using 50% aqueous sodium hydroxide and TEBA as a catalyst. A highly diastereo- and chemoselective monoalkylation of an N-(β -oximino)acyl compound (Scheme 10.13) was reported by Miyabe [92], who used 10% TBAB in a 5N NaOH/ CH_2Cl_2 biphasic system at 25°C .

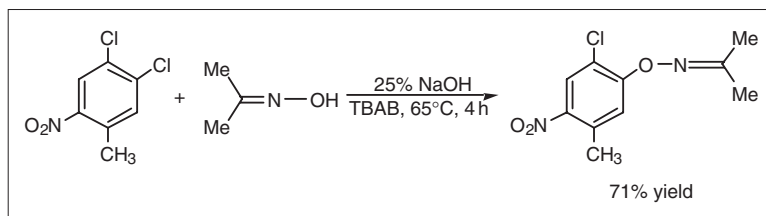
1,5-Dimethyl-4-phenylimidazolidin-2-one-derived iminic glycinimides also were alkylated diastereoselectively (Scheme 10.14) by alkyl iodides and by Michael acceptors in the presence of TBAB and an LiOH/LiCl mixture [93].

N-Alkylation of a benzyl-ether-protected trihydroxamic acid was carried out by Labidalle *et al.* [94]. The multistep synthesis combined a triple PTC Michael reaction of nitromethane with methyl acrylate, followed, after reaction with *O*-benzylhydroxylamine, by a PTC N-alkylation using potassium *t*-butoxide base and Aliquat 336 catalyst at 50°C (Scheme 10.15).

Arylation of phenylacetonitrile was reported by a team from Janssen [95]. In a description of a scaleable process for the synthesis of the aromatase inhibitor R83842, these authors copiously demonstrated the advantages of PTC methodology over traditional synthetic strategies. Thus, the use of KMnO_4 ,



Scheme 10.16



Scheme 10.17

LiAlH_4 , NaH and dimethyl sulfate was circumvented and replaced with environmentally benign alternatives, chiefly under PTC conditions. In this process diaryl acetonitrile was formed via PTC arylation of arylacetonitrile. Direct air oxidation yielded the desired diaryl ketone (Scheme 10.16).

Phase-transfer catalysis in etherification, esterification and hydrolysis reactions

These reactions are traditional PTC domains. Only a few recent reports communicate genuine new developments and some are summarised below.

A comprehensive study on the synthetic scope and mechanism of the etherification of halo esters was carried out by Yang *et al.* [96]. The kinetics and mechanism of the solid/liquid allylation of sodium phenoxide was elucidated by the same group [97]. Wang analysed the PTC mechanism of the reaction of 2,4,6-tribromophenol with dibromomethane [98] and with α -bromo-*o*-xylene [99]. An exceptional phenomenon in which the reaction rate in these reactions did not change monotonously with the concentration of the base (KOH) was observed. The rate increased, decreased, increased again and then remained constant with increasing amount of KOH. This peculiar finding was attributed to the non-linear change in the distribution of the intermediate ArOQ (Q-quaternary ammonium) between the phases and

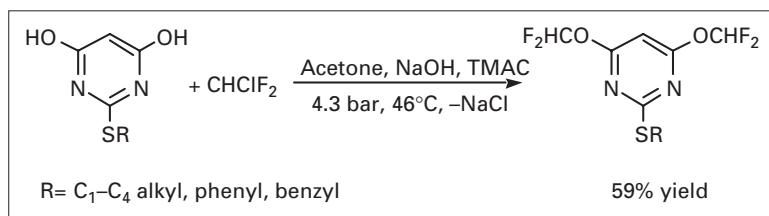
its hydration in the organic phase. Sawant *et al.* published a comprehensive study explicating the process development aspects of the reaction of benzyl chloride to yield benzyl ether [100].

Oxime ethers were prepared via basic PTC alkylation of oximes with dialkylcarbonates [101] or dialkyl sulfates [102]. Acetone oxime was etherified (Scheme 10.17) with substituted nitrochlorobenzene in the presence of TBAB [103].

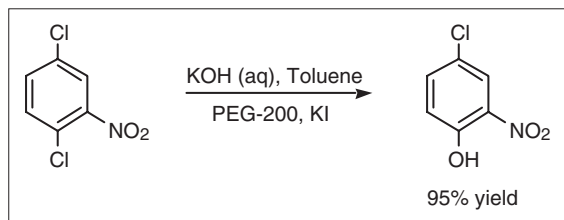
Aromatic difluoromethyl ethers were prepared from substituted phenols and CHClF_2 . Typical substrates (Scheme 10.18) were hydroxybenzaldehydes [104] and dihydroxypyrimidines [105].

The solid/liquid PTC reaction of dipotassium phthalate with benzyl bromide to yield dibenzyl phthalate was analysed by Yang & Wu [106]. These researchers resolved a kinetic model based on the solid/liquid equilibration of the substrate in the presence of the onium catalyst. The rate data under different conditions of concentration, agitation, temperature, solvent and catalyst was interpreted using pseudo-second-order kinetics. The model and some of the conclusions of Yang & Wu were challenged by Pilipauskas [107], who rejected the possibility of heterogeneous anion exchange and solubilisation in the above reaction.

Hydrolysis of benzyl and alkyl chlorides to the corresponding alcohols via ester intermediates is a well-established PTC technique [108]. This methodology



Scheme 10.18



Scheme 10.19

was developed further into an industrial processes by Sawant [109], who used benzoate esters for the hydrolysis of benzyl chloride, and by Prasad, who hydrolysed 2-chloroacetamides to 2-hydroxyacetamides via formate intermediates [110]. The same procedure was used by Oda, who treated halo-terminated polypropylene to hydroxy-terminated polymer using formate ester intermediates [111]. 4,4'-Bis(hydroxymethyl)biphenyl was prepared in a similar way by the hydrolysis of the corresponding dichloride [112]. Aryl halides usually do not require the engagement of ester intermediates, so 1,4-dichloronitrobenzene was hydrolysed regioselectively (Scheme 10.19) to 4-chloro-2-nitrophenol [113].

Hydrolysis under basic conditions in PTC was used also for the purification of epoxy resins by reducing the remaining chlorine content. After treatment at 60°C with $\text{KOH}_{(\text{aq})}$ /TEBA the chlorine content of the polymer was reduced to 700 ppm [114].

Phase-transfer catalysis in transesterification

Sugar esters were prepared from a fatty acid alkyl ester and a polyol such as mono- or disaccharide in the presence of a base and a phase-transfer catalyst (ammonium salt, crown ether or PEG) [115]. The PTC/base transesterification of protected carbohydrates with methyl benzoate and dodecanoate was enhanced by microwave irradiation [116].

Methyl methacrylate was transesterified with various alcohols and diols in the presence of K_2CO_3 and TBAB in hexane [117]. Peresters were prepared from cumyl or *t*-butyl hydroperoxides via reaction with acid halides using a tetra-*n*-butylammonium hydrogen sulfate (TBAHS) catalyst [118].

Phase-transfer catalysis in aldol and related condensation reactions

Because carbonyl compounds are stronger electrophiles than typical PTC substrates such as alkyl halides, there was no apparent call for catalysis in condensation processes, e.g. Aldol, Knoevenagel, Darzen, Perkin, Prins or Wittig reactions. This view changed in recent years and PTC techniques currently are utilised routinely in this widespread family of reactions.

Bentley *et al.* [119] have studied the condensation of benzophenones with acetonitrile initiated by solid potassium hydroxide. Although this reaction proceeds also in the absence of catalyst, a 30-fold rate increase was monitored when Aliquat 336 was added to the reaction mixture. Other phase-transfer agents such as TBAI, TBAB, TEBA or TBAHS exhibited inferior performance. Intriguingly, the rate of this solid/liquid reaction was almost independent of the amount and appearance (crushed or pellets) of the KOH used and of the stirring rate. Reaction rate was affected strongly by the presence of water, temperature and *para*-substituents on the benzophenone. The authors concluded that the rate-determining step was the organic-phase reaction between the acetonitrile anion and the ketone. It is imperative to note in this context that acetonitrile could not be alkylated with alkyl halides or sulfonates under PTC conditions.

Methylene-bridged bis(cyclopentadienyl) compounds were prepared by condensation of formaldehyde with, for example, indene using NaOH and TEBA [120]. The PTC Darzen reaction of chloroace-

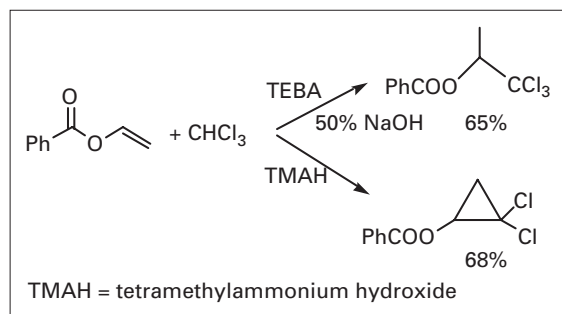
tonitrile with cyclohexanone also was explored [121].

The PTC Michael reactions of various substrates were studied by Diaz-Barra *et al.* [122]. Fedorynski *et al.* [123] have shown that under certain conditions (Scheme 10.20) trichloromethyl anion can be added to Michael acceptors rather than generating the anticipated dichlorocarbene.

The mechanism and selectivity of the PTC Wittig reaction of benzyltriphenylphosphonium salt with benzaldehyde was studied by Hwang *et al.* [124]. In other examples of PTC Wittig reactions, aldehydes were transformed efficiently into allylic dioxalanes [125] and styrylheptalenes were prepared from the corresponding formyl compounds [126].

2.4 Alkylations (C, O, N and S) in alicyclic and heterocyclic syntheses

The PTC alkylation and dialkylation of C, N, O, S and Se nucleophiles turned into one of the most favourable methods in the synthesis of alicyclic and heterocyclic [127] compounds. We can classify the following four categories in this field: large-size ring



Scheme 10.20

formation by double intermolecular alkylation at two different nucleophilic sites on the same substrate [128]; medium-size ring syntheses via intermolecular double alkylation at the same nucleophilic atom; medium-size and strained ring syntheses via intramolecular alkylation; and three-member ring formation via carbene or nitrene intermediates.

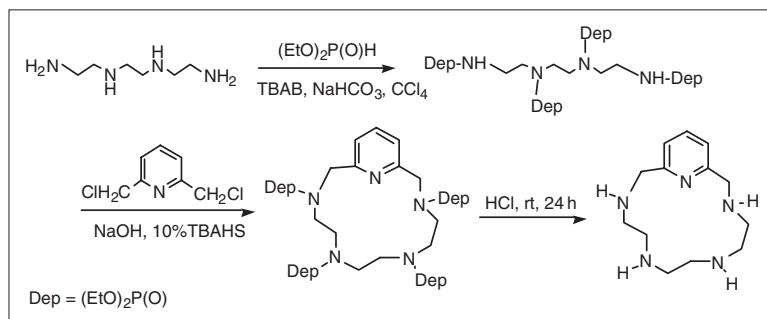
Large-ring preparation via dual-site bis-alkylation

Various macrocyclic receptors were synthesised by Kumar *et al.* using PTC techniques. Two recent examples are the synthesis of an anthraquinone base coronand [129] and the preparation of Ag^+ -selective di- and trithiabenzene- and benzenapyridinacyclophanes using $\text{K}_2\text{CO}_3/\text{DMF}/\text{TBAHS}$ solid/liquid thioetherification and acylation reactions [130]. The resulting ionophores extracted Ag^+ up to 600 times more than the similar sized Pb^{2+} .

Polyazacyclophanes were prepared via bis-alkylation of protected polyamines with bis(chloromethyl)arenes. Phase-transfer catalysis was used both in the protection of the polyamine by the diethoxyphosphoryl (Dep) group and in the alkylation step [131] (Scheme 10.21).

Medium-size rings via single-site bis-alkylations

In the early days of PTC, Makosza [132] discovered numerous reactions of 1,2-dibromoethane with active methylene compounds in the presence of PTC/50% NaOH to yield disubstituted cyclopropanes. Present-day methods call for a solid/liquid system using carbonates as base. Thus, malononitrile was reacted with dibromoethane in the absence of a solvent to yield 98% of 1,1-dicyanocyclopropane [133].



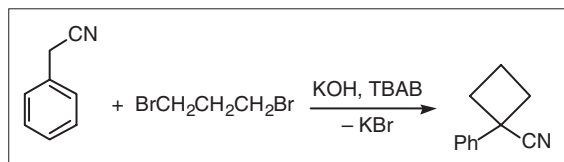
Scheme 10.21

More challenging has been the synthesis of four-membered rings. Phenylacetonitrile (PAN) is a useful single-site substrate for four-membered ring formation via a bis-alkylation protocol. In a recent patent from Knoll [134], the latter was reacted (Scheme 10.22) with 1,3-dibromopropane to yield cyclobutane derivatives.

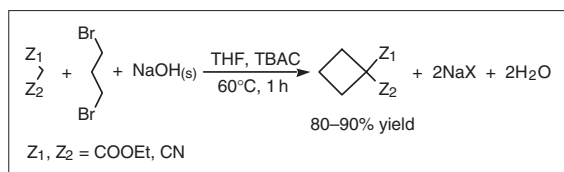
A similar procedure was utilized by Wang for the synthesis of the corresponding cyclopentane by reacting PAN with 1,4-dibromobutane [135].

We have shown that malonate derivatives also are effectual building blocks for the synthesis of four-membered rings, e.g. in the reaction of 1,3-dibromopropanes with diethylmalonate and ethylcyanoacetate in the presence of solid NaOH under phase-transfer conditions (Scheme 10.23) [136].

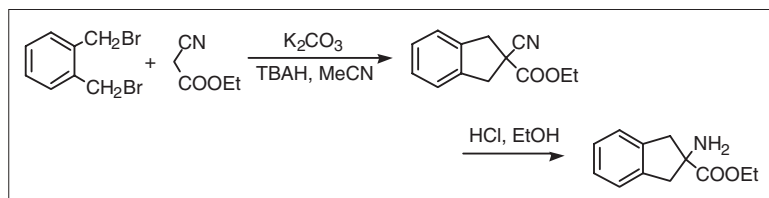
We found that PTC did not alter the rate of reaction but significantly affected the selectivity. Although in the absence of the catalyst the main reaction observed was hydrolysis of the malonate esters to acids, in its presence high yields (80–90%) of the cyclobutane derivative were obtained. When the solid NaOH was replaced with 50% aqueous solution, again the selectivity shifted to hydrolysis.



Scheme 10.22



Scheme 10.23



Scheme 10.24

No cyclisation reaction took place when 1,3-dichloropropane or 1-bromo-3-chloropropane was applied as an alkylating agent. Under similar conditions malononitrile was converted smoothly to 1,1-dicyanocyclobutane in THF or acetonitrile. However, the catalyst had no effect on this system. This observation is in contrast with a recent Korean patent claiming the PTC alkylation of malononitrile in the presence of carbonate bases [137].

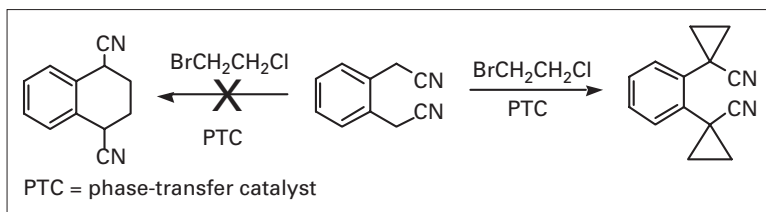
Dimethyl malonate was reacted with dichloroethane in the presence of fine-particle K₂CO₃ and TBAB to yield 1,1-bis(methoxycarbonyl)cyclopropane [138]. Higher yields were claimed for this process in a recent patent from Mitsui [139] that used a combination catalyst system, a mixture of tetra-*n*-butylammonium chloride (TBAC) and crown ether. Ethyl isocynoacetate is a highly reactive glycine equivalent. It was used for the preparation of novel cyclic α -amino acid derivatives. Typical examples were cyclisation of the latter with 1,2-bis(bromomethyl)benzene and 1,8-bis(bromomethyl)naphthalene under solid/liquid PTC conditions (Scheme 10.24) [140].

The driving force (proximity effect [141]) favouring formation of three-member rings via single-site dialkylation over six-member rings via dual-site dialkylation was demonstrated by Fedorynski [142], who carried out the following reaction (Scheme 10.25).

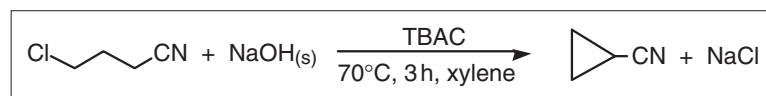
Double cyclopropanation reaction was preferred over six-membered ring formation. Four-membered to six-membered rings were prepared in high yields by PTC bis-alkylation of (phenylsulfonyl) methylphosphonate with ω -dibromoalkane [143]. The sulfonyl group then was removed by desulfonation.

Cyclisation via intramolecular alkylation

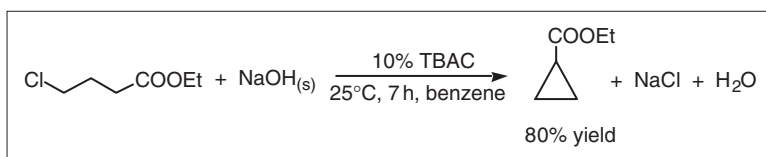
The intramolecular PTC cyclisation of 4-chlorobutyronitrile (CBN) (Scheme 10.26) was first reported in a Ciba-Geigy 1980 patent [144].



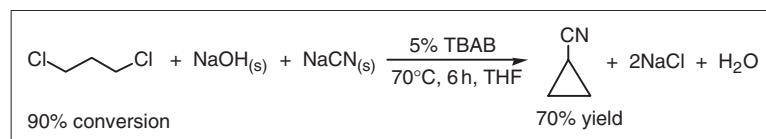
Scheme 10.25



Scheme 10.26



Scheme 10.27



Scheme 10.28

We have demonstrated recently that this reaction proceeded via a genuine PTC/OH extraction mechanism provided that chloride was the only anion in the system besides hydroxide [145]. With 4-bromobutanenitrile (BBN) as a substrate, a standard interfacial mechanism was realised. This conclusion was supported by the following observations: BBN reacts ten times slower than CBN; CBN did not react at all when hydrophilic quaternary compounds such as TEBA were used as catalysts, whereas BBN reacted normally under these conditions; the reaction of CBN was not sensitive to a stirring rate above 400 rpm, whereas the cyclisation rate of BBN was dependent on the stirring rate even at 1200 rpm; intramolecular alkylation of CBN followed a zero-order rate, whereas BBN reacted in a first-order mechanism; and the actual presence of a quaternary ammonium hydroxide (QOH) intermediate was positively validated by detection of its Hoffmann degradation products.

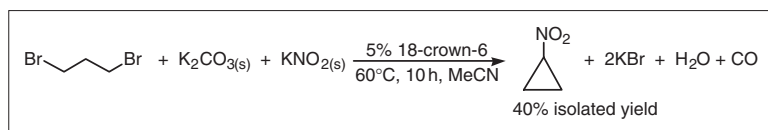
It should be noted that aliphatic nitriles could not be alkylated under the above conditions. Thus,

benzyl chloride or 1,3-dichloropropane gave no reaction with butyronitrile.

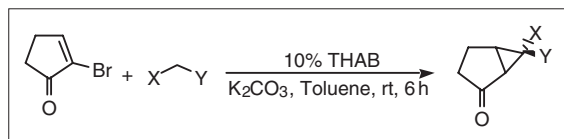
In an identical procedure (Scheme 10.27) we were able to prepare ethyl cyclopropylcarboxylate [146]. This reaction demonstrated the low activity of solid NaOH towards hydrolysis; 50% NaOH also was quite effective in the alkylation process and only with 20% or lower concentration of the base did hydrolysis become the major reaction. In addition, we have confirmed that cyclobutyl cyanide and cyclobutane carboxylate esters cannot be prepared in an analogous way. Our paper [147] claiming this route was later found to be erroneous [148].

We also discovered that cyanide and hydroxide anions do not severely intercede with each other in typical PTC systems. Consequently we were able to develop a tandem one-pot reaction (Scheme 10.28) in which 1,3-dichloropropane was converted directly to cyclopropyl cyanide [149].

Applying the same concept for the synthesis of nitrocyclopropane was feasible only with a weaker



Scheme 10.29



Scheme 10.30

base (carbonate) and a crown ether catalyst (Scheme 10.29).

A novel strategy for the stereoselective synthesis of 1,2,3-trisubstituted cyclopropanes was developed by Shioiri [150]. In his method (Scheme 10.30), the cyclopropanation was attained via intermolecular Michael addition of an active methylene compound to an α -halocycloalkenone followed by intramolecular alkylation. This reaction was carried out with various malonate and cyanoacetate esters as well as with nitromethane. In a later work [151] the same reaction was carried out stereoselectively in the presence of chiral phase-transfer catalysts derived from quinidine. Up to 83% ee was reported. An intramolecular Michael reaction leading to cyclopropanes was demonstrated also by Hell *et al.* [152].

Another example of a one-pot dual-step ring formation was reported by Ennis *et al.* [153], who reacted bromotoluidine with chlorobutyryl chloride in the presence of TBAC to yield aryl pyrrolidinone (Scheme 10.31). α -Bromolactams were prepared similarly via the PTC cyclisation of 2-bromo-4-chlorobutyryl chloride with primary amines such as cyclopropylamine [154].

Cyclopropanation via addition of carbenes to alkenes

Synthesis of cyclopropane derivatives via dihalocarbene addition to olefins has been one of the incipient and most widely used PTC processes, meticulously studied with hundreds of synthetic examples [155]. The subject has been reviewed by several authors [156]. Dichlorocarbene formation from chloroform under PTC/OH⁻ conditions also was one of the rudimentary illustrations of the interfacial PTC

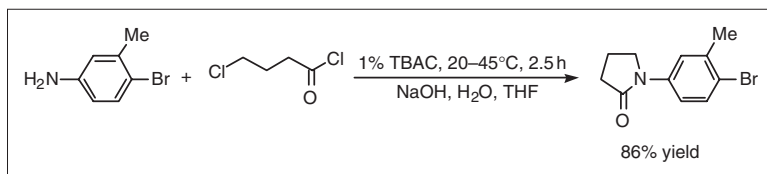
mechanism proposed by Makosza [157]. This mechanism disputes the possibility of OH⁻ extraction into the organic phase and argues for interfacial deprotonation of chloroform followed by anion exchange and extraction of the trichloromethyl anion by the quaternary catalyst into the organic phase. In a recent study Makosza & Kryłowa [158] totally ruled out the engagement of QOH in carbene formation under PTC conditions. This was concluded using a system where *N*-benzylpyridinium chloride was applied both as a substrate and as a catalyst in reaction with CHCl₃/NaOH. The 2-trichloromethyl-*N*-benzylpyridine adduct was found to be extremely sensitive to the presence of OH⁻, resulting in decomposition and tar formation. This clearly affirms that in the studied system not only are QOH not intermediates in the formation of QCCL₃ in the interfacial region but in the presence of chloroform they are not formed at all.

Dihalocarbenes were prepared also by reduction of perhalomethanes. A recent demonstration was presented by Novikov [159], who reacted active lead with dibromodifluoromethane (solid liquid system) in the presence of TBAB in dichloromethane. The generated difluorocarbene reacted via cascade reaction with an imine and dimethylacetylene dicarboxylate to yield fluoropyrrole (Scheme 10.32).

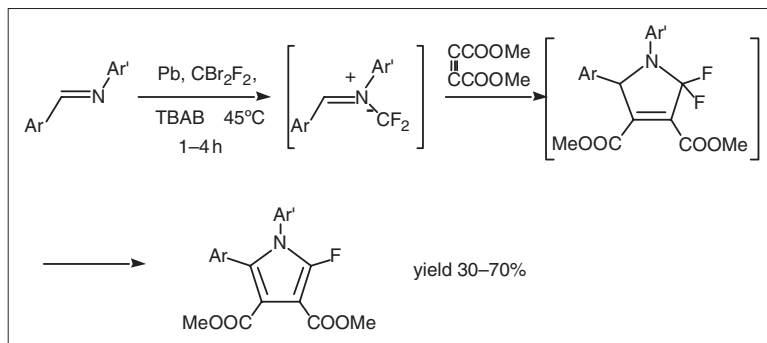
A creative new method for the generation of dichlorocarbene was revealed by Campbell & Rusling [160], who used electrochemical reduction of CCl₄ or CBr₂Cl₂ in microemulsions with a carbon electrode. In the addition of dichlorocarbene to cyclohexene, up to 80% current efficiency was attained.

3 Inverse PTC

From its early genesis, PTC theory and practice have focused unjustifiably on transport of reactants (mostly anions) from the aqueous phase to the organic phase where the reaction took place. Of no less interest and capacity for practical implementation is the opposite possibility, namely transport of lipophilic reactants from the organic phase into the



Scheme 10.31



Scheme 10.32

aqueous phase to react with charged or hydrophilic species. This methodology, which has great potential for water-based 'green' organic syntheses, is termed 'inverse PTC' and is based on three different mechanisms of organic/aqueous transport:

- (1) Reversible conversion of an organophilic substrate into an ionic water-soluble intermediate.
- (2) Complexation of organic substrates by highly hydrophilic cyclodextrins or water-soluble calixarenes.
- (3) Solubilisation of organic substrates by aqueous micellar systems.

Inverse PTC was introduced originally by Mathias [161], who studied the catalytic effect of 4-*N,N*-dimethylaminopyridine (DMAP) on the acylation reaction of alanine with acyl halides in a water/organic two-phase system. Fife [162] described a related reaction of acyl halides in the organic phase with carboxylate anions in aqueous phase to yield anhydrides catalysed by pyridine *N*-oxide (PNO). Both groups argue for the formation of a water-soluble acylpyridinium intermediate, which transfers the acyl halide into the aqueous phase to encounter the other substrate. The kinetics and mechanism of inverse PTC PNO-catalysed anhydride formation was studied profoundly by Jwo. Some examples are the reactions of benzoyl chloride with benzoate [163], acetate [164] and butanoate [165] simple carboxy-

late [166] (formate to octanoate) and dicarboxylate [167] (oxalate to adipate, maleate, fumarate and phthalate) anions. Additional kinetic studies were carried out with PNO-catalysed reactions of chlorobenzoyl chloride [168] or dichlorobenzoyl chloride [169] with chlorobenzoate, bromobenzoyl chloride with bromobenzoate [170] and fluoro- and butylbenzoyl chloride with benzoate [171]. It was resolved that this family of reactions proceeded via the following four-step mechanism:

- (1) Formation of ionic intermediate between the catalyst and the acyl halide in the organic phase: $\text{RCOCl}_{(\text{org})} + \text{PNO}_{(\text{org})} \rightarrow \text{RCOONP}^+\text{Cl}^-_{(\text{org})}$.
- (2) Transport of the intermediate salt from the organic to the aqueous phase: $\text{RCOONP}^+\text{Cl}^-_{(\text{org})} \rightarrow \text{RCOONP}^+\text{Cl}^-_{(\text{aq})}$.
- (3) Aqueous phase reaction of the intermediate with the carboxylate anion: $\text{RCOONP}^+\text{Cl}^-_{(\text{aq})} + \text{R}'\text{COO}^-_{(\text{aq})} \rightarrow \text{RCOOCOR}'_{(\text{aq})} + \text{PNO}_{(\text{aq})}$.
- (4) Extraction of the product and the catalyst into the organic phase: $\text{RCOOCOR}'_{(\text{aq})} + \text{PNO}_{(\text{aq})} \rightarrow \text{RCOOCOR}'_{(\text{org})} + \text{PNO}_{(\text{org})}$.

Based on a comprehensive kinetic study it was concluded that the rate-limiting step in the anhydride formation mechanism is the aqueous phase ion-pair generation (step 1). The kinetics was found to follow a pseudo-first-order rate law, with the rate constant being a linear function of the PNO catalyst

concentration in the aqueous phase. Consequently, the distribution coefficient of PNO between the phases is a significant factor in the overall rate equation [172]. The rate was determined to depend strongly on the stirring rate up to 1200 rpm. The pH is also a critical factor and when it exceeded pH 12 the process was complicated by competing hydrolysis of the acyl halide.

A related exchange reaction of benzoic and chlorobenzoic anhydrides in the chloroform phase also was catalysed by PNO [173].

Another reaction prone to inverse PTC is the acylation of water-soluble amines (such as amino acids) by acyl halides. Hippuric acid was synthesised from benzoyl chloride and glycine in the presence of DMAP catalyst [174]. An identical procedure was applied for the protection of the amino group in serine [175]. The mechanism of the DMAP- and PNO-catalysed acylation of sodium glycinate [176] and other amino acid salts [177] by benzoyl chloride was studied by Jwo.

Sulfide-based inverse PTC was proposed by Shaffer [178] in the polythioetherification of 1,8-dibromooctane with sodium sulfide. A similar mechanism was inferred by Takeishi [179] for the thiocyanation of benzyl chlorides.

Cyclodextrins and modified cyclodextrins are another notable family of inverse phase-transfer catalysts. These were utilised mainly in biphasic transition-metal-catalysed reactions. Metal-free cyclodextrin-induced inverse PTC systems are rare [180]. Trotta has demonstrated that lipophilic esters are hydrolysed better using cyclodextrins than in the normal phase-transfer system [181]. Sodium borohydride reacted regioselectively in the ring-opening reaction of epoxides in the presence of cyclodextrins [182]. Oxidation of secondary [183] and benzylic alcohols [184] and the haloform reaction [185] with hypochlorites were claimed to take place effectively in the presence of β -cyclodextrin. The latter, nonetheless, was found to be allied with the pH lowering effect of the cyclodextrin rather than to the inverse PTC mechanism [186].

The third mode of inverse PTC is based on water-soluble surfactants. These allow the transport of the lipophilic substrate into the aqueous phase via the formation of micellar aggregates. This concept was introduced by Roque *et al.*, who have demonstrated it in the sodium borohydride reduction of organophilic ketones [187] and in the hydrogen peroxide

epoxidation of unsaturated ketones under basic conditions [188]. Optimal reaction conditions were developed for the latter process [189]. Further research of the mechanism resolved that there are two competitive catalytic processes involved: an interfacial catalysis and an inverse PTC. The first process is predominant when a very low concentration of surfactant (dodecyltrimethylammonium bromide, DTAB) is used with rapid stirring and the second process prevails with high surfactant concentration and slow stirring. As expected, the rate of the interfacial catalysis process is less sensitive to the surfactant concentration and it reaches a maximum at 40 mM (when the interface is apparently saturated with DTAB), whereas in the inverse PTC process the rate still increases even at 500 mM [190]. The potential of applying a normal phase-transfer catalyst in a microemulsion system was examined by Hager *et al.* [191].

4 Three Liquid Phases and Triphase Catalysis

The formation of a third liquid phase has been observed in the past in several PTC systems [192]. In addition to unique catalytic effects observed upon the presence of the third liquid phase, this phenomenon can be utilised for simple separation and recycling of the catalyst. We have realised [193] that the formation of a third phase is unique to the TBAB/aqueous NaOH/apolar organic solvent mixture and it is not observed with tetraethyl-, tetrapropyl- or tetrapentylammonium bromides. In the toluene/water/NaOH/TBAB system the third liquid phase was assayed to be composed of (w/w) 44.4% toluene, 2.2% water, 52.6% TBAB and only 50 ppm OH^- . In the elimination reaction of phenethyl bromide to styrene in an aqueous NaOH/TBAB mixture, a fivefold increase in the reaction rate was observed at the point when the third phase was formed. Conversely, when the third phase disappeared, e.g. at higher temperature or with more concentrated base, a significant rate decrease was noticed. Microscopic examination of a stirred three-phase system revealed that the continuous phase is the organic phase with aqueous phase droplets as the dispersed phase surrounded by the third catalyst-rich phase.

The ternary phase diagram toluene/40% aqueous NaOH/toluene at 44°C is presented in Fig. 10.1

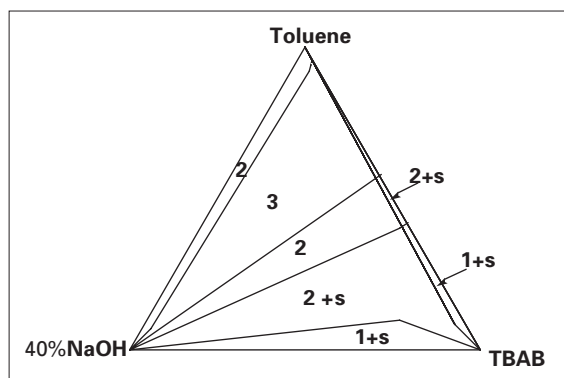


Fig. 10.1 Ternary Phase Diagram of TBAB/Toluene/40% NaOH Showing the Region of Three Liquid Phases.

[194]. The number of liquid phases in the seven distinct regions are shown within each section (S represents the presence of a solid precipitate).

Similar conclusions were derived by Ido *et al.*, who have studied the dehydrohalogenation of 2-bromooctane with various onium salt catalysts in the presence of aqueous KOH [195]. These authors report that with dodecane as organic solvent TBAB, THAB, TBPB and hexadecyltributylphosphonium bromide all easily formed the third catalyst-rich phase [196]. The same authors also examined the halogen exchange between benzyl chloride and KBr under the three-phase conditions. In this study it was confirmed that the TBAB phase could be recycled without any apparent loss in activity [197]. In another study this group examined the reaction of benzyl chloride with sodium sulfide catalysed by THAB [198]. The dramatic rate increase was monitored here as well upon the appearance of a third phase. In the presence of the third phase the reaction rate increased with temperature up to 60°C. At higher temperature the third phase dissolved in the organic phase and the rate sharply decreased.

Correia [199] found that the addition of TBAHS to a solution of NaBr in aqueous hypochlorite results in the formation of a third phase composed mainly of $\text{Bu}_4\text{N}^+\text{Br}_3^-$ and the organic solvent. This three-phase system was used for the bromination of olefins and acetylenes or for the oxidation of diphenylmethane to benzophenone. A similar system was used by Clark *et al.* for the side-chain oxidation of alkyl aromatic compounds [200].

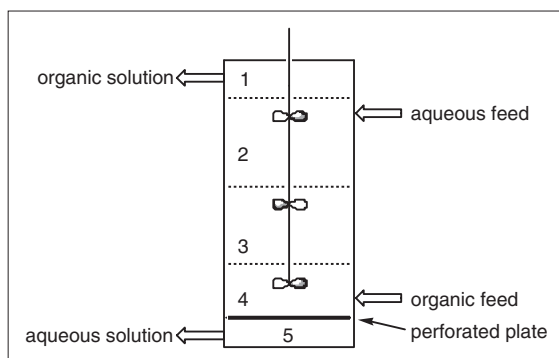


Fig. 10.2 Weng's Continuous Flow Mixer-Settler Reactor for Three Liquid Phase Processes.

Yadav recently has explored the aromatic nucleophilic substitution of *p*-nitrochlorobenzene with butoxide anion under liquid/liquid/liquid PTC conditions using the NaOH/TBAB combination. It was found that upon increasing the catalyst loading a third phase is observed when the catalyst amount reaches a certain critical mass. At this point a very sharp increase is observed in the reaction rate. Under standard conditions 95% of the reaction was determined to take place in the third catalyst-rich phase and only 5% in the organic phase. Other factors affecting the system, such as speed of agitation, *p*-chloronitrobenzene (PCNB) concentration, NaOH concentration and temperature, also were analysed. Experiments aimed at examining the reusability the catalyst layer indicated that a certain loss of catalyst takes place upon recycling. A kinetic model has been proposed. A theoretical model for the three-phase catalytic system also was proposed by Yang [201].

Wang & Weng have applied a similar three-phase system for the etherification of sodium phenolate with *n*-butyl bromide catalysed by TBAB [202] and concluded that the formation of the third phase results in a critical increase in the reaction rate. For the same reaction, Wang & Weng designed and tested a five-section, vertical, continuous-flow, stirred laboratory reactor of 163 cm³ total volume (5.45 cm i.d. and 22 cm height) shown in Fig. 10.2. The central third section is the main site of the reaction. The lighter organic phase was introduced to section 4 and the heavier aqueous phase was admitted to section 2. The counter-current system

created the third catalyst phase both in sections 2 and 4. This immiscible liquid phase resides in various forms in the central section of the apparatus where the reaction is taking place. Sections 1 and 5 are settlers, where the product aqueous and organic phases are separated and continuously withdrawn from the system. By feeding an aqueous solution containing 0.2 gml^{-1} of both NaOH and NaOPh \cdot 3H $_2$ O and an organic solution of 0.09 gml^{-1} *n*-butyl bromide with an initial TBAB concentration of 0.072 gml^{-1} , the authors measured a conversion of 87% at a residence time of 150 min with a stirring rate of 1200 rpm. This conversion dropped to 77% after 24 h, which was attributed to minor loss of catalyst in the effluent aqueous and organic phase and was solved by continuous catalyst make-up in the aqueous phase feed.

A PEG-based PTC system, particularly with aqueous KOH, also tends to form a third liquid phase upon saturation of the aqueous phase. The third phase is essentially a PEG–alkali hydroxide complex. Wang & Weng, who examined the above etherification reaction with the PEG-600/ NaOH system, concluded that the main factors affecting the formation and stability of the third phase are temperature, nature of the organic solvent and the amount of PEG, NaOH and NaOPh [203]. Synergy in third-phase formation between THAB and PEG200 has been reported by Ido [204], who studied the elimination reaction of 2-bromooctane by aqueous KOH.

The phase behaviour of phase-transfer agents could be modified greatly when the latter are attached to particular polymers. Nishikubo [205] used soluble polymers with pendant quaternary onium salts as catalyst in the reaction of CO $_2$ with oxirans. Grinberg [206] demonstrated that a soluble polymer-bound phase-transfer catalyst could be prepared from amido-terminated polyethylene. These materials have shown a unique temperature-dependent solubility that was utilised for facile separation of the catalyst from the reaction mixture. Poly(ethylene glycols) with molecular weight (M_w) higher than 2000 also were used as soluble carriers for quaternary ammonium salts. Such bifunctional adducts were shown to be highly effective and readily recycleable catalysts in numerous PTC reactions, evidently with clear advantage over insoluble polymer-supported catalysts [207]. Other researchers [208] studied PEG as solvent or support mainly in the synthesis of amino acid.

The alternative, more mature, three-phase system, namely polymer-bound PTC or ‘triphase catalysis’, lately has reached a certain level of saturation. A relatively small number of publications in the field were published in recent years [209] and no potentially promising new leads were identified. It seems that the triphase concept also does not enjoy industrial acceptance. Glatzer & Doraiswamy [210] presented a comparative study on the performance of the polymer-bound tributylmethylammonium chloride versus the homogeneous benzyltributylammonium chloride. The catalytic activity was studied in the formation and hydrolysis of benzyl, hexyl and octyl acetate. Based on kinetic analyses, the author concluded that the triphase catalyst performed better at low conversion but at higher conversion the two-phase system exhibited a unique autocatalytic effect resulting in higher rates. This autocatalysis was attributed to the build-up of the product in the organic phase, which enhanced the catalyst solubility in this phase and consequently the overall reaction rate.

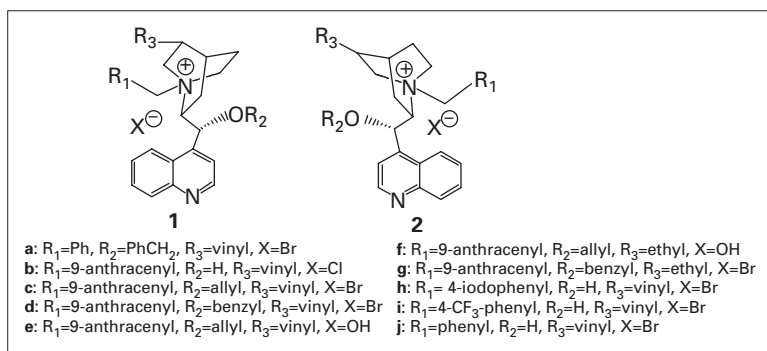
In a related area, clay-supported PTC was studied by Yadav [211] and by Varma [212] using triphase catalysts in the synthesis of benzoic anhydride and alkyl azides, respectively. It is well recognised that the slow diffusion of organic substrates in and out of the polymer matrix often limits the utility of triphase catalysts. Balakrishnan & Murugan [213] developed a novel method for the synthesis of copolymer beads containing active sites mostly on the surface. These materials were characterised by microscopic and spectroscopic techniques and applied for the C-alkylation of phenylacetone with *n*-butyl bromide.

5 Asymmetric PTC

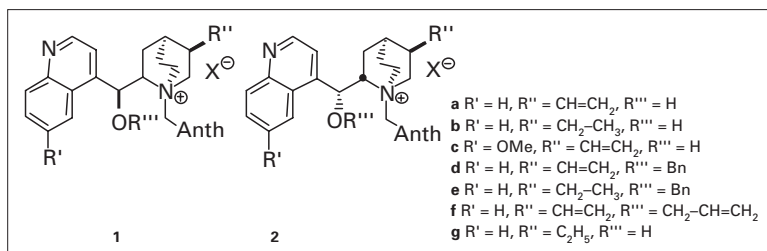
Major breakthroughs were made in recent years in the development of highly enantioselective phase-transfer catalysts [214]. A key milestone has been the simultaneous discovery by Corey [215] and by Lygo [216] that the size of the substituent R $_1$ in the quaternary salts of cinchonidinium and cinchoninium halides has a critical effect on the enantioselectivity of various phase-transfer processes. With R $_1$ = 9-anthracenyl, these authors were able to achieve >99% stereoselectivity in various reactions.

The attempted enantioselective synthesis of natural and unnatural amino acids was the aim of numerous studies. O’Donnell pioneered the use of

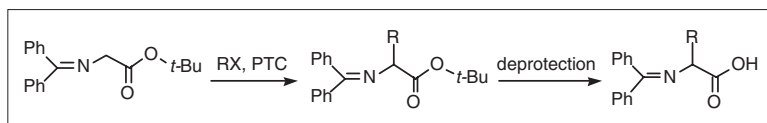
Fig. 10.3 Quaternary Cinchonine (1) and Cinchonidine (2) Based PTC.



Scheme 10.33



Scheme 10.34



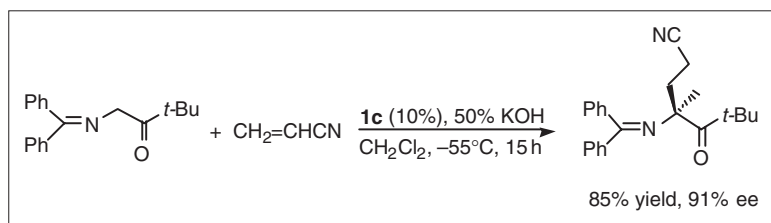
the Schiff base of glycine with benzophenone as a protected and activated building block. This substrate could be alkylated or dialkylated under PTC conditions to yield, after deprotection, a variety of amino acids (Scheme 10.33).

Using compound **1a** as catalyst (Fig. 10.3) and 50% NaOH at 5°C, up to 81% ee could be obtained (RX = benzyl bromide) [217]. In the same reaction 99.5% ee was reported by Corey [218], who applied solid caesium hydroxide hydrate as a base at -78°C in the presence of catalyst **1c** in methylene chloride. Lygo [219] with RX = benzyl bromide used catalysts **1b** and **2b** in an aqueous KOH/toluene system at 25°C to achieve high yields (89–91% ee) of the *R*- and *S*-isomers, respectively. Bis(α -amino acid) esters were prepared similarly (ee > 95%) using dibromoalkanes as alkylating agents. Dityrosine and isodityrosine likewise were prepared [220]. Intriguingly, similarly high enantiomeric excesses could be obtained in a homogeneous system using neutral

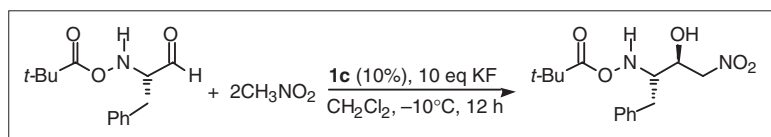
non-ionic, soluble phosphazene bases [221]. Chinchilla *et al.* [222] alkylated cinchonidine and cinchonine with Merrifield resin. The resulting materials were applied in the enantioselective alkylation according to Scheme 10.34. The cinchonidine-based catalyst yielded the *S*-isomer whereas the cinchonine analogue gave the *R*-isomer. Both were obtained in up to 90% ee.

Another strategy to functionalise amino acids using the Schiff base of glycine was developed via the Michael addition. This was demonstrated by Corey, who reacted the latter with acrylonitrile in the presence of catalyst **1c** to yield a precursor for the synthesis of (*S*)-ornithine (Scheme 10.35) [223].

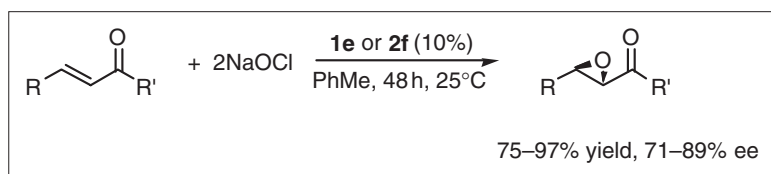
Catalyst **1c** was utilised also with similar Michael additions of cyclohexenone and chalcone and also in the aldol and nitroaldol reactions of aldehydes. A typical example (Scheme 10.36) was the stereoselective synthesis of an amprenavir (an HIV protease inhibitor) intermediate [224].



Scheme 10.35



Scheme 10.36



Scheme 10.37

Based on the crystal structure of the ammonium salt **1c**, Corey resolved that the high enantioselectivity obtained with this catalyst was due to the proximity between the nucleophilic site of the substrate and the quaternary ammonium cation. This resulted in optimal van der Waals attractive interaction between the two and, consequently, allowed the efficient transfer of stereochemical information from the catalyst to the substrate.

The PTC nucleophilic enantioselective epoxidation of α,β -unsaturated ketones was another example for the application of chiral Cinchona-derived quaternary catalysts [225].

Lygo [226] reported low enantiomeric excess in the epoxidation of chalcone using either NaOCl or H_2O_2 with **1b** as catalyst. The enantiomeric excesses were improved substantially in the hypochlorite epoxidation after switching to catalyst **1d**, particularly in apolar solvent (toluene). The opposite enantiomer was obtained in 86% ee using the cinchonidine-based catalyst **2g** (Scheme 10.37).

Applying catalyst **1d** in a similar system with KOCl as oxidant at -40°C , Corey [227] obtained up to 1:130 enantioselectivity. The structure in Fig. 10.4, comprising the substrate (4-fluoro-chalcone), the catalyst and the oxidant, was proposed as the transition state complex of this reaction to account for the remarkable stereoselectivity. In this model, the

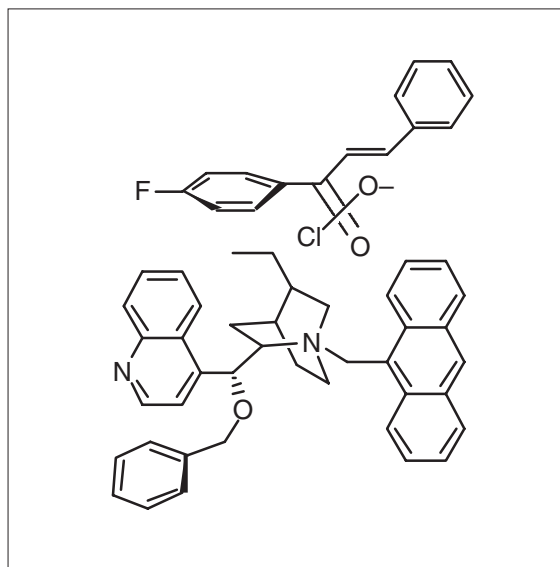
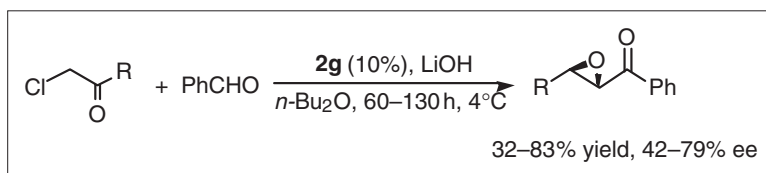
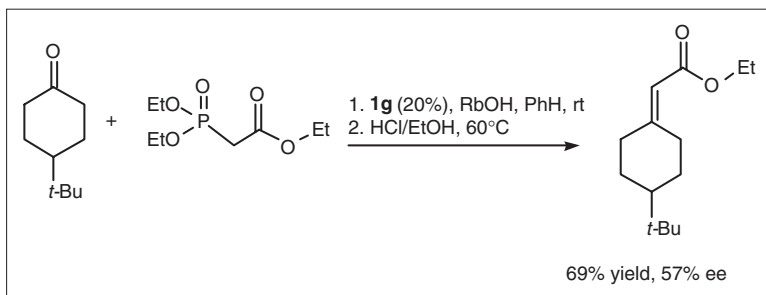


Fig. 10.4 Activated complex for KOCl epoxidation of 4-fluoro-chalcone using **1d** as catalyst.

hypochlorite anion is contact ion-paired with the positively charged catalyst nitrogen. The nucleophilic oxygen of the reagent is forced in position where only one face of the enone is accessible.



Scheme 10.38



Scheme 10.39

The kinetics and mechanistic study of the Jacobsen asymmetric epoxidation of indene using a chiral manganese–salen complex catalyst containing a pyridine *N*-oxide axial ligand was reported by Hughes *et al.* [228]. It was established that the axial *N*-oxide ligand enhances the transport of the HOCl oxidant from the aqueous to the organic phase in addition to its role in stabilising the metal catalyst. Indene oxide was obtained in 90% yield and 88% ee.

With hydrogen peroxide (10 equiv.) as oxidant in the presence of LiOH and catalyst **1g** at 4°C, Shioiri [229] was able to obtain up to 100% yield and 92% ee in the benzylation of α -fluorotetralone. Interestingly, catalyst **1g** induced the opposite stereoselectivity in comparison with **1f**. The same authors also reported the epoxidation of 2-alkyl-1,4-naphthoquinone using quinidine-based catalysts with 17–76% ee [230].

Chiral epoxides also were the product of an asymmetric Darzens condensation (Scheme 10.38). This was demonstrated by Shioiri *et al.* for cyclic and alicyclic α -chloro ketones [231]. These authors ascertained that the enantioselective step in this reaction was not the initial aldol formation but rather the cyclisation of the intermediate chlorohydrine derivative, which proceeded with kinetic resolution.

Additional enantioselective PTC reactions using cinchona-based phase-transfer catalysts were borohydride reduction of ketones [232], alkylation of α,β -unsaturated propionic acid [233], benzylation

of α -fluorotetralone [234] and the Horner–Wadsworth–Emmons reaction (Scheme 10.39) [235].

The two enantiomers of methyl dihydrojasmonate were prepared elegantly by Perrard *et al.* [236] via an asymmetric Michael addition of dimethylmalonate into α -*n*-pentylcyclopentenone followed by demethoxycarbonylation. The key enantioselective step involved a potassium-carbonate-promoted solid/liquid PTC without solvent. Enantioselectivity of up to 90% was achieved (Scheme 10.40).

Another novel and very active family of chiral phase-transfer catalysts has been introduced recently by Marouka [237]. These were fully synthetic compounds based on C_2 -symmetric spiro binaphthyl derivatives of the general formula shown in Fig. 10.5.

Catalyst **3b** at 1 mol.% was sufficient for alkylation or benzylation of benzophenone imine of glycine *t*-butyl ester (Equation 10.33), with yields of 41–95% and 90–96% ee. Furthermore, catalyst **3c** was found to catalyse the sequential double alkylation of glycine Schiff base to yield a chiral α,α -dialkyl- α -amino acid precursor (Scheme 10.41) [238].

It was found that the order of addition of the alkylating agents determined the absolute configuration of the product. Thus, for example, the *R*-enantiomer was obtained when allyl bromide preceded benzyl bromide in the alkylation sequence and the *S*-enantiomer was the product when the order was reversed.

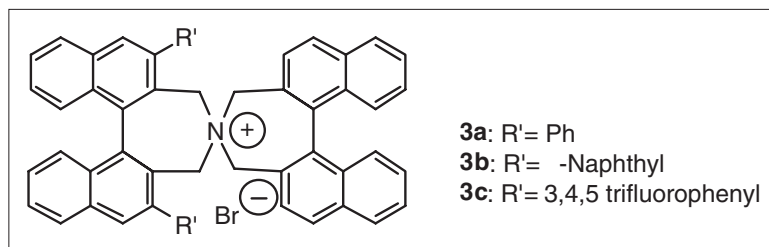
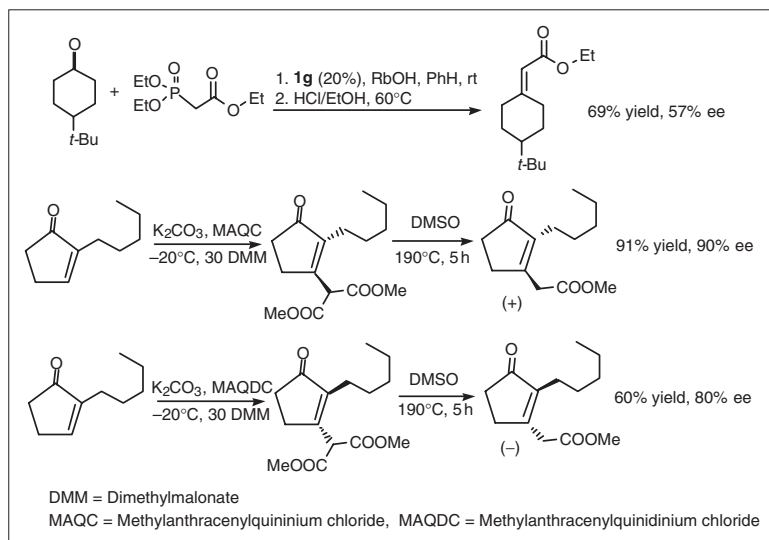
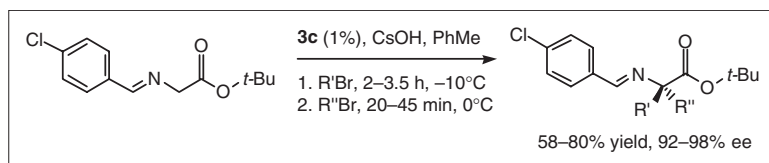


Fig. 10.5 Marouka's chiral phase transfer catalysts.



Scheme 10.40



Scheme 10.41

Other chiral phase-transfer catalysts (Fig. 10.6, compounds **4–6**) were examined in the benzylation or allylation of Schiff bases of alanine. The enantiomeric excesses obtained generally were lower than in the other systems presented in this chapter, reaching 82% with compound **4** [239], 68% with compound **5** [240] and up to 92% in the presence of compound **6** [241] as phase-transfer catalyst.

Carbohydrates of natural origin are an obvious source of chiral molecules that were potential enantioselective complexing agents and, consequently, phase-transfer catalysts. This concept was explored by Bako *et al.* [242]. These authors prepared novel

monoaza-15-crown-15 derivatives of glucose (**7**) and galactose with different side chains and studied their extraction capabilities and potential as chiral phase-transfer catalysts.

These catalysts have shown up to 87% ee (45% yield) in the Michael addition of 2-nitropropane to chalcone (with R=CH₃OCH₂CH₂—, 5% catalyst, solid/liquid conditions, sodium *t*-butoxide and dry toluene at 25°C, 40 h). In the Darzen condensation of phenacyl chloride with benzaldehyde a maximum of 71% ee (49% yield) was determined (R=HOCH₂CH₂CH₂—, 5% catalyst, toluene/30% NaOH, -20°C, 1 h).

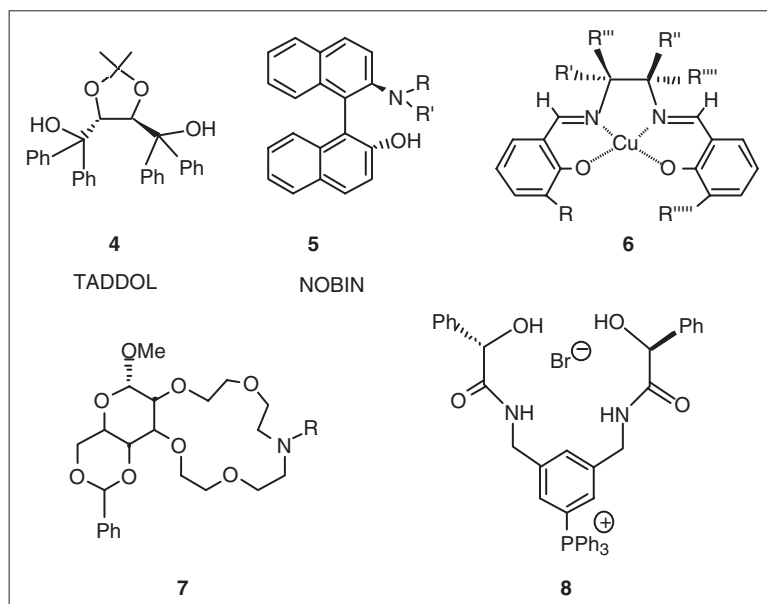


Fig. 10.6 Additional chiral phase transfer catalysts.

The phosphonium salt (**8**) reported by Manabe [243] exhibited moderate enantioselectivity (up to 50% ee) in the benzylation of alkyl-2-oxocyclopentanecarboxylates.

6 Phase-transfer Catalysis in Polymerisation Processes

Phase-transfer catalysis was used widely in macromolecular chemistry, particularly in condensation polymerisation [244]. Several applications in free-radical-initiated polymerisation by potassium or sodium peroxydisulfate [245] and in anionic polymerisation also are known [246].

Through latter years Tagle's group had continuously developed new novel classes of condensation polymers prepared via PTC methods. Some recent products were polycarbonates and thiocarbonates containing germanium or silicone in the main chain [247], polyhalodiphenol amides [248] poly(amide) esters [249] and poly(amide) carbonates [250]. Linear segmented polyesters containing soft perfluoropolyether and hard aromatic segments were prepared by PTC polycondensation of acyl-chloride-terminated fluorinated prepolymer with various diphenols [251].

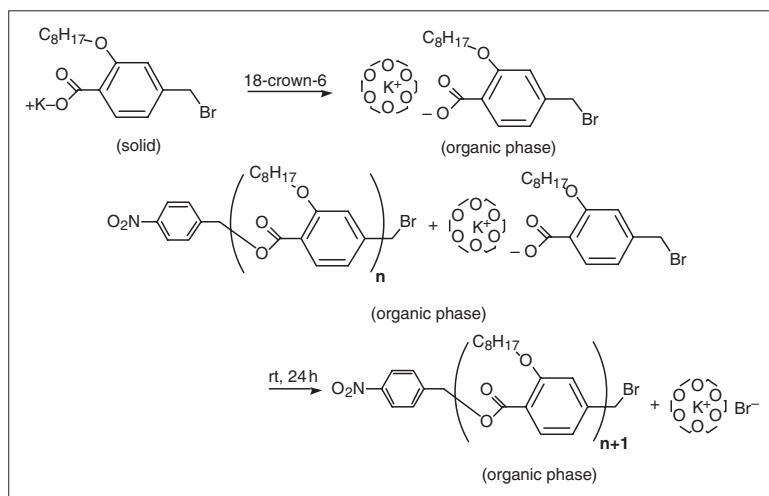
A major breakthrough was made by Yokozawa & Suzuki [252], who proposed a solid/liquid PTC-based

living condensation polymerisation that they termed 'condensative chain polymerisation'. This novel concept was based on the assumption that monomer molecules in the solid phase do not interfere with each other and that only after transport to the organic phase, complexed with the phase-transfer agent, can the activated monomer react with the polymer end group in this phase (Scheme 10.42).

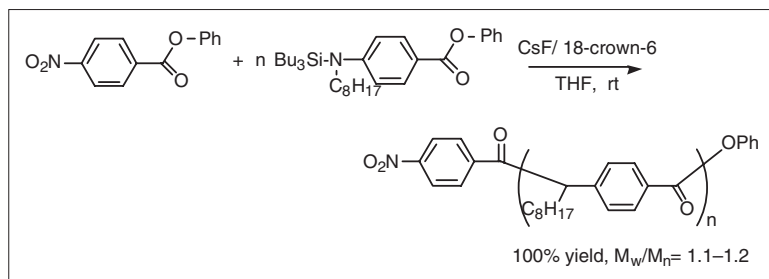
Using 4-nitrobenzylbromide as initiator (10 mol.%) with an identical amount of crown ether catalyst, a polymer with $M_w = 2400$ with a narrow molecular weight distribution ($M_w/M_n = 1.3$) was obtained, characterising a reasonable 'living polymerisation' mechanism.

A similar perception was utilised by the same group in the chain-growth polycondensation of a phenyl 4-aminobenzoate derivative (Scheme 10.43) [253]. The monomer was activated by the crown-CsF complex according to Scheme 10.44.

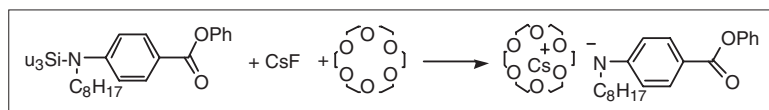
The highly reactive anilide anion reacted with the terminal ester function of the growing polymer to yield a new amide bond. The authors proved that the reaction of the monomer with itself was much slower than with the reactive polymer chain. Consequently, a true living polymerisation was apparent with a polydispersity as low as $M_w/M_n = 1.1$. Indeed, plotting M_n as a function of conversion or as a function of the monomer/initiator ratio resulted in



Scheme 10.42



Scheme 10.43



Scheme 10.44

a linear function typical to chain-growth polymerisation. Conversely, M_w/M_n remained essentially constant and very close to unity in these experiments. The authors anticipated that this novel technique would provide new approaches to the design of nanoarchitectures similar to the achievements made in living vinyl and cyclic monomer polymerisation.

In a study by Percec the free-radical polymerisation of styrenes, methacrylates and acrylates, initiated by sulfonyl chlorides and catalysed by $\text{Cu}_2\text{O}/\text{Cu}(0)$ -2,2'-bipyridine complexes, was improved significantly by modification with PEG phase-transfer catalysts [254]. This system gave faster and more effective living polymerisation than

the previous homogeneous and heterogeneous methods.

N-Cetylpyridinium thiocyanate (prepared in situ from *N*-cetylpyridinium chloride and KSCN) was used simultaneously as a phase-transfer catalyst and a photoinitiator in the polymerisation of methyl metacrylate [255].

The condensation of bisphenol A with *tert*- and *iso*-phthaloyl dichloride was studied by Wang [256]. The steady-state concentration of bisphenolate dianion in the organic phase was monitored by UV spectroscopy. The organic phase reaction between the bisphenolate and the phthaloyl chloride was found as rate determining. The polycondensation of 4,4'-

thiodiphenol with adipoyl dichloride was studied by Hirano *et al.* [257].

A unique interfacial polyesterification of tetrabromobisphenol A with trimesoylchloride was catalysed by tetra-*n*-hexylammonium bromide (THAB) in the preparation of membrane for gas separations that have shown a CO₂/CH₄ selectivity of 25 : 1 [258]. The PTC polyetherification of bis-phenols was accomplished with 3,3'-bis(chloromethyl)oxetane [259].

Poly(triaryl)amines were prepared via the Ullmann reaction between bis(*N,N*-diaryl)amines and diiodo aryls in the presence of 18-crown-6. These polymers proved to be effective hole transport materials in electroluminescent devices [260].

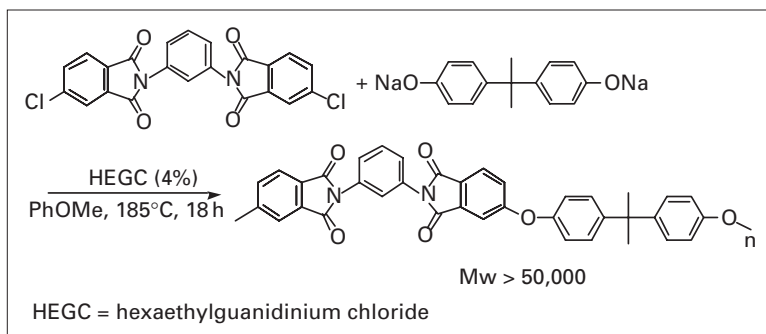
Hydridosiloxane and alkylhydridosiloxane resins were prepared effectively from trichlorosilane and alkylchlorosilane in a hexane/ethanol/water system in the presence of quaternary ammonium salts [261].

GE Plastics is one of the world pioneers in industrial application of PTC technology. Polycarbonate synthesis via phase-transfer catalysed interfacial condensation of bisphenol A with phosgene developed in GE Plastics was the first large-scale application of phase-transfer technology [262]. An improved catalytic system was patented recently. This novel system was based on a combination of quaternary ammonium phase-transfer catalyst and a tertiary amine nucleophilic catalyst. The main feature in this binary catalyst system is the efficient utilisation of phosgene. The former procedures necessitate up to 40% excess of phosgene for complete conversion of the bisphenol but this new methodology accedes the use of a stoichiometric amount of phosgene [263]. Copolyester carbonate was prepared by reaction of

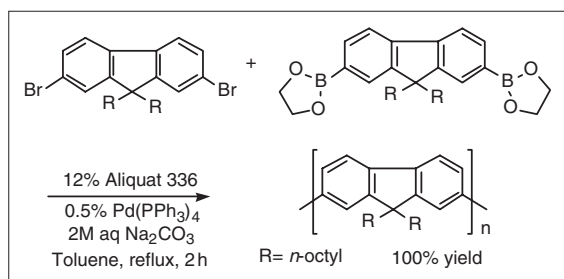
phosgene with a mixture of bisphenol and aliphatic dicarboxylic acid catalysed by a combination of hexaalkylguanidinium salt and a trialkylamine [264]. Similar binary catalyst systems (phase-transfer and nucleophilic catalysts) were reported by Freedman [265] in the early days of PTC. The TBAB-catalysed synthesis and properties of brominated and fluorinated flame-retardant polycarbonates were described by Liaw [266].

The main advantage of the guanidinium-based phase-transfer catalysts is their remarkable thermal stability. These materials are prepared [267] via the phosgenation of secondary amine to yield a tetraalkylurea. This was phosgenated further to make a 'Vilsmeier salt' followed by reaction with another dialkyl amine to generate the hexasubstituted guanidinium chloride salt. Because the latter is highly hygroscopic, a fourth step is advocated in which the chloride salt is converted into the bromide salt. The procedure was improved recently to a water-based synthesis [268]. GE Plastics patents claimed these catalysts to be stable up to 290°C [269]. This trait renders these materials suitable promoters in polyarylate synthesis. A typical example (Scheme 10.45) is the fabrication of the polyetherimide Ultem in a solid/liquid PTC system as disclosed in a recent GE Plastics patent [270]. In a similar fashion copolyetherimides with ether sulfones and ether ketones were prepared [271].

A unique family of polyaryls and a method to prepare them were patented recently by Dow [272]. Dihaloaryl monomers were reacted with bifunctional aromatic boronic acid or ester. The polymerisation was affected by a combination of palladium and phase-transfer catalyst (Scheme 10.46). These polymers provided exceptional electro-optical prop-



Scheme 10.45



Scheme 10.46

erties and are used in light-emitting diodes and in electroluminescent devices.

Siloxane-based resins are practicable materials in the electronic and semiconductor industries where they are used to coat silicon chips and related components, functioning both as protective lamination and a dielectric layer between electric conductors on integrated circuits. Hydridosiloxane and organohydridosiloxane resins were prepared [273] by copolymerisation of trichlorosilane and alkyltrichlorosilane in an aqueous/organic biphasic system in the presence of quaternary ammonium phase-transfer catalyst. The polymerisation proceeded smoothly at 25°C. Polymers with $M_w \leq 33\,500$ and a polydispersivity of 10–21 were obtained in 36–73% yield.

7 Applications of PTC in Analytical Chemistry

Significant progress was made in the PTC derivatisation of various target molecules for analytical purposes. Pentafluorobenzyl bromide has been proposed as an effective derivatisation reagent under PTC conditions [274]. This methodology allowed the simultaneous organic phase extraction, concentration and derivatisation of species in the aqueous phase. Thus, highly sensitive simultaneous determination of traces of azide, cyanide and thiocyanate in aqueous solutions was accomplished via pentafluorobenzyl bromide derivatisation in the presence of a polymer-bound phosphonium salt catalyst, followed by gas chromatography/mass spectrometry analysis of the organic phase. Sensitivity of up to 25 ng ml⁻¹ could be achieved using negative-ion chemical ionisation mass spectrometry [275]. Azide was analysed in blood and in urine [276]. In a similar manner, metabolites of organophosphorus nerve gas agents

(alkylmethylphosphonic acids) were assayed in biofluids such as urine, serum and saliva at detection limits of 60 pg ml⁻¹ [277]. Phenoxyacid herbicides also were detected by the same methodology [278].

Pentafluorobenzyl bromide was used also for the assay of hydrogen sulfide in blood [279]. Pentafluorobenzyl bromide PTC etherification combined with an electron-capture gas chromatography detector was used for the detection of leverphanol in human plasma in concentrations as low as 0.25 ng ml⁻¹ [280]. Aliphatic alcohols were derivatised to dithiocarbonates, which were analysed directly using capillary zone electrophoresis with a detection limit of 1.47 μg ml⁻¹ [281]. Methanol was assayed by high-performance liquid chromatography (HPLC) after derivatisation with 3-bromomethyl-7-methoxy-1,4-benzoxazin-2-one [282]. Phase-transfer catalysis extractive methylation was used for assay of dihydropyridine calcium channel blocker metabolites [283] and of ACE inhibitors and their metabolites [284], with detection limits of 10 ng ml⁻¹. Phenylacetic acid (a marker for 2-phenylethylamine) was determined in human plasma by reaction with Nile blue followed by HPLC analysis [285]. Phase-transfer catalysis has found applications also in analyses of various geological sediments [286].

An extraordinary PTC application was reported by Kaur *et al.* [287], who used phase-transfer techniques for the detection of latent fingerprints on surfaces such as paper, glass, stainless steel and various plastics.

8 Phase Transfer Combined with Metal Catalysis

Phase-transfer agents were applied in combination with homogeneous, heterogeneous and colloidal transition metal catalysts. Remarkable effects on rate and selectivity were recorded with PTC, along with improvements in catalyst recovery and reusability.

8.1 Phase transfer in homogeneous transition metal catalysis

Various phase-transfer methods were introduced through the last two decades into the realm of homogeneous transition metal catalysis. These can be classified according to the nature of the transfer process. Here we define phase transfer (usually of

the metal catalyst) from the aqueous to the organic phase or from the organic to the aqueous phase. Other options include transfer from the organic phase into other immiscible phase, e.g. fluoruous phase [288], supercritical CO₂ [289] or ionic liquids [290].

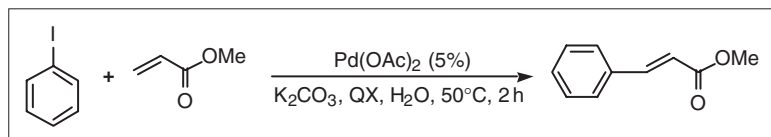
In the aqueous to organic transfer process the phase-transfer agents play a dual role, extracting both the metal complex anion *and* the reagent (either anion or neutral) into the organic phase where the reaction takes place. Numerous reactions, such as hydrogenation, oxidation, carbonylation, isomerisation, cyanation, desulfurisation and vinylation, were catalysed in this manner. The subject was surveyed thoroughly by Goldberg [291] and Amer [292]. The opposite phase-transfer process, namely organic to aqueous transfer (sometimes referred to as 'inverse PTC' or 'counter PTC' [293]), is based on water-soluble ligands that, upon coordination, solubilise a transition metal catalyst in water. This facilitates the separation of the catalyst from the reaction products. This concept was the basis of the Ruhrchemie/Rhone Poulenc propene hydroformylation process catalysed by HRh(CO)(TPPTS)₃ (TPPTS = triphenylphosphine trisulfonate) [294]. The area of aqueous biphasic catalysis has been reviewed extensively by Cornils [295], Joo [296], Kalck [297], Herrmann [298], Sinou [299], Hanson [300], Nomura [301], Bertoux [302] and Driessen-Holscher [303]. Sulfonated triphenylphosphines are the most common transfer agents/ligands [304] but other hydrophilic ligands also are reported. Typical examples are carbohydrate-substituted phosphines [305], β -cyclodextrin-modified phosphines [306], xanthene-based diphosphines [307], dibenzofuran-based phosphines [308], aminomethylated phosphines [309], carboxylated phosphines [310] and alkylated surface-active phosphines [311]. Other instances include polymeric hydrophilic ligands [312] such as polyethylene glycol [313], polyacrylic acid [314], PEG-polystyrene [315], polyethyleneimine [316], polypentenoic acid combined with bis[2-(diphenylphosphino)ethyl]amine [317] and even human serum albumin [318].

A major shortcoming of this aqueous biphasic catalysis was the low solubility of most organic substrates in the aqueous phase where the catalyst abides. The method therefore was particularly attractive to water-soluble or partially soluble substrates [319]. Numerous techniques were proposed in

the literature to enhance the mass transport of organophilic substrates into the aqueous phase or, alternatively, to force the catalyst to reside near the interface. For example, the addition of small amounts of triphenylphosphine ('promoter ligand') to the RhCl₃/TPPTS system maintained the active catalyst at the interface, enhancing the reaction rate by a factor of 10–50 [320]. Cyclodextrins [321], surfactants [322], or co-solvents such as ethanol [323], ethylene glycol [324], and others [325] affected the transport of organophilic substrates to the aqueous phase. Modification of the phosphane backbone by attaching it to various amphiphilic groups (as above) also was beneficial. Two typical recent examples were the phosphacalix[4] arene ligands [326] proposed by Shimizu and the surface-active xantphos derivatives introduced by van Leeuwen [327]. Both types of compounds functioned as inverse phase-transfer catalysts in addition to their role as ligands, the first via the formation of cage compounds and the second through the formation of vesicles that enhance the solubility of the substrate in the aqueous phase. Both papers reported high yields of the hydroformylation of 1-octene. Supporting the aqueous phase on a solid carrier such as silica [328] or glass beads [329] also had a beneficial effect on the reaction rate.

Of particular interest are the non-ionic amphiphilic phosphine ligands of the general formula P[*p*-C₆H₄O(CH₂CH₂O)_{*n*}H]₃ (PETPP), with *n* ~6, which were prepared by the ethoxylation of tris(*p*-hydroxyphenyl)phosphine. The complex PETPP/RhCl₃ was insoluble in solvents such as toluene at room temperature, but upon heating to a critical solution temperature the complex dissolved and the system became homogeneous. Upon cooling, the catalyst precipitated and was separated readily by decantation. This concept was termed by Fell [330] and Jin [331] as 'thermoregulated phase-transfer ligands and catalysis' (TRPTC). It was applied mainly in hydroformylation of higher olefins, which are insoluble in water [332]. In the hydroformylation of 1-dodecene a conversion of 95.8% and a yield of 93.7% were reported [333].

Note that each of the above methods introduced technical complications, which rendered it impractical for industrial applications. Currently, the only industrial application is the RC/RP hydroformylation of propene using Rh/TPPTS catalyst in a biphasic system.



Scheme 10.47

A further development in the field of transition metal biphasic catalysis was re-extraction of the hydrophilic metal complex from the aqueous to the organic phase using conventional PTC techniques. This idea originated at Ruhrchemie [334] for the separation of sulfonated phosphines from the sulfonation mixture using a fatty amine/toluene extraction system. It was realised later that the new multi-ion-paired phosphines could be the basis for a new family of organophilic trifunctional ligands. These ligands then could affect the hydroformylation of higher olefins [335]. An additional advantage of these large-size 're-immobilized ligands' was that they could be separated from the reaction mixture using membrane technology. A pilot experiment demonstrating the double hydroformylation of dicyclopentadiene using the Rh/TPPTS/distearylamine catalyst system followed by membrane separation of the catalyst has been described by Bahrman [336].

A natural extension of this technology is the development of chiral polysulfonated phosphines [337], which were applied in asymmetric hydroformylation [338] and hydrogenation [339] reactions. Phosphines modified with carbohydrates also were proposed as enantioselective catalysts [340].

Rhodium-catalysed hydroformylation is by far the major field where water-soluble metal catalysts were applied. Other aqueous catalytic reactions are the Wacker oxidation [341], cleavage of allylic substrates [342], hydrocarboxylation of higher α -olefins [343] catalysed by Pd/cyclodextrins and hydrogenation catalysed by Ru/cyclodextrins [344]. Some recent studies ascertained the molecular recognition between the cyclodextrins and the water-soluble phosphane ligand [345] and also between the cyclodextrins and the organic substrate. In the latter case, the deprotection of allyl carbonates was accelerated 300-fold when a specifically modified cyclodextrin was used as a co-catalyst [346].

One of the major contributions of PTC to organic synthesis is the dramatic effect that quaternary ammonium salts had on the Heck reaction. This phenomenon was reported first by Jeffery in 1984 [347].

A typical example can be found in the arylation of methyl acrylate by iodobenzene catalysed by $\text{Pd}(\text{OAc})_2$ under basic conditions (Scheme 10.47).

Although stoichiometric quantities of ammonium salts usually are needed, the impact is remarkable. The presence of phase-transfer agents allowed for the application of water as the sole solvent for the reaction and spares the need for phosphine ligands, which are otherwise critical for stabilisation of the palladium catalyst [348]. Thus, under the conditions described in Equation 10.47, yields of 92% of methyl cinnamate were obtained with TBAB or TBAC (70% yield with TBAHS).

This acceleration of Heck-type reactions was attributed by Jeffery to the assistance of tetraalkylammonium salts in the regeneration of the zerovalent palladium catalyst via reductive elimination of HX (a key step in the catalytic cycle in all the various routes suggested for the Heck reactions) [349]. Three possible PTC mechanisms were proposed for this dehydrochlorination in the presence of a base: extraction; interfacial; and nucleophilic, based on hydrogen bonding [350]. The appropriate selection of Pd/base/QX combination was found to direct the arylation of 2,3-dihydrofuran [351] and of vinyltrimethylsilane [352].

Jeffery's conditions were extended by Nguefack to an interesting modification of the Heck reaction—namely, the coupling of aryl halides with terminal acetylenes [353]. Arylation of thiophenes also was carried out using the same protocol [354,355]. Poly(ethylene glycols) also were used as phase-transfer agents in the Heck reaction [356].

A more reactive catalytic system was developed by Reetz [357], who combined $\text{Ph}_4\text{P}^+\text{Cl}^-$ with $\text{PdCl}_2(\text{MeCN})_2$ to affect the coupling of 4-chlorobenzaldehyde with styrene in very high yields. In a later work from the same group, phosphane-free palladium nanoparticles were stabilised by quaternary ammonium salts and applied in Heck and Suzuki type reactions [358]. The authors claimed that palladium colloids were the actual catalysts whenever Jeffery's conditions applied.

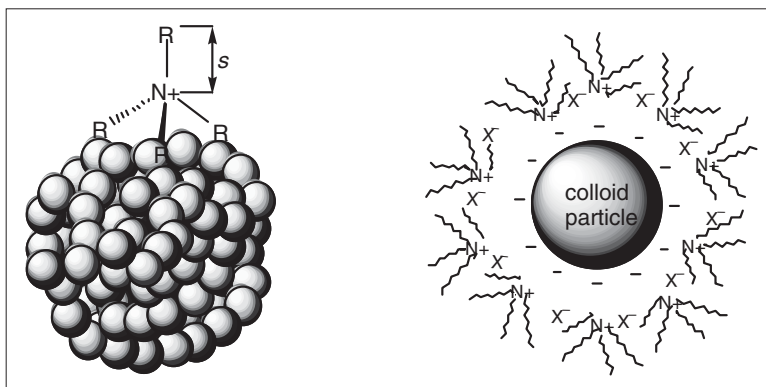


Fig. 10.7 Visualisation of Palladium Nanoparticles Stabilised with Quaternary Salts.

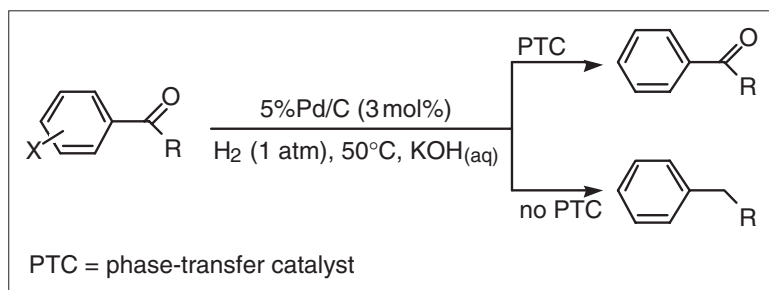
Gurtler & Buchwald reported another reactive phosphane-free system where PTC was combined with dicyclohexylamine to generate a very active Heck system that was utilised for the synthesis of trisubstituted alkenes [359]. Using a polymer-supported palladium(II) catalyst enhanced with TBAB, Buchmeiser was able to vinylate aryl chlorides in high yields [360].

8.2 Catalysis by onium-salt-stabilised transition metal nanoclusters

One of the most versatile catalytic ion pairs, $[(C_8H_{17})_3NMe]^+RhCl_4^-$, which was formed by extraction of $RhCl_3$ from aqueous to organic phase by Aliquat 336, eventually was discovered to be a heterogeneous catalyst. This combination catalyst, developed by Blum [361,362], was applied in single- or two-phase systems for the hydrogenation and transfer hydrogenation [363] of olefins [364], acetylenes and even arenes [365], and also for the oligomerisation [366], cyclooligomerisation [367] and carbonylation [368] of alkynes. The performance of this ion pair was improved further by encapsulation into sol-gel matrices [369]. The nature of the catalytic system in benzene hydrogenation reactions was re-investigated by Finke *et al.* [370], who presented convincing evidence that the true catalysts in this process are $Rh(0)$ nanoclusters stabilised by Aliquat 336. Apparently the $RhCl_4^-/Aliquat\ 336$ ion pair was not stable under reductive conditions and was reduced spontaneously to form soluble $Rh(0)$ nanoclusters. This conclusion suggests a new vision for PTC—the development of a ‘soluble heterogeneous catalysis’

that is based on nanoclusters of active metals stabilised by lipophilic quaternary ammonium salts. The role of the phase-transfer agents in these systems is dual: to extract the precursor metal anion into the organic phase; and to secure the stability of the metallic nanocrystals formed upon reduction. One of the earliest publications on the application of a stable organosol in catalysis was published by Narasimhan, who applied cetyltributylphosphonium bromide and platinum in the hydrogenation of nitrobenzene [371]. The formation of colloidal transition metals stabilised in organic media by lipophilic quaternary ammonium salts and its application in catalysis was studied by Bonnemenn [372]. Reetz has visualised the nanostructure of quaternary ammonium/Pd cluster complexes using scanning tunnelling microscopy, high-resolution transmission electron microscopy (TEM) [373], and surface Fourier transform infrared techniques [374] (Fig. 10.7). The same group applied tetra-*n*-octylammonium bromide (TOAB)-stabilised Ni clusters in [3 + 2] cycloaddition reactions [375] and entrapped Pd nanoclusters in sol-gel materials [376].

Nanocrystalline yttrium oxide was prepared using tetraalkylammonium hydroxides [377]. Stabilisation of nanoparticles in the aqueous phase was proposed by Schulz [378], who utilised water-soluble *N*-alkyl-*N*-(2-hydroxyethyl)ammonium salts to protect colloids of $Rh(0)$. This system proved to be highly effective for the biphasic hydrogenation of arenes at room temperature and one atmosphere of hydrogen gas. The preparation of transition metal nanoclusters and their application in catalysis was reviewed recently by Aiken & Finke [379].



Scheme 10.48

In another approach, palladium nanoparticles encapsulated in amino-terminated polyamidoamine dendrimers [380] were extracted into toluene as ion pairs with dodecanoic acid [381]. These self-assembled inverted micelles were shown to be catalytically active in a model hydrogenation reaction. The extraction could be reversed at pH 2.

A related PTC mechanism was concluded in the hydrogen peroxide oxidation of alcohols catalysed by combined RuCl_3 /dodecyldimethylammonium bromide (DDAB) catalysts [382]. Using TEM imaging we proved that the DDAB molecules formed an organised vesicular structure in the organic phase and that the Ru catalyst resided in the aqueous layer of these vesicles. The alcohol substrate and the hydrogen peroxide molecules reached the reaction site by diffusion, which was established as the rate-determining step in the overall process.

8.3 Phase transfer in heterogeneous catalysis

The utilisation of phase-transfer agents in solid transition-metal-catalysed reactions was demonstrated by Tundo. In a series of papers published between 1993 and 1999, his group studied the effects of phase-transfer agents on the heterogeneous Pd/C-catalysed hydro-dehalogenation by hydrogen and hydrogen donors. Thus 1,2,4,5-tetrachlorobenzene was reduced rapidly to benzene at 50°C in the presence of Pd/C using sodium phosphite as the hydrogen donor [383]. Aliquat 336 was found to enhance the reaction rate. Some intriguing observations were made in systems where dihydrogen was used as the reducing agent [384]. Chloroethylbenzenes (all three isomers) were reduced 50 times faster in the presence of phase-transfer catalysts. On the other hand, bromotoluenes reacted five times slower upon the addition of Aliquat 336 [385]. The selectivity also

was altered under phase-transfer conditions. Thus, *p*-dichlorobenzene reacted five times slower than the *ortho*-isomer when the phase-transfer catalyst was present, whereas the reduction rate of both isomers was identical in the absence of the phase-transfer catalyst. Interestingly, Raney nickel, which is normally inactive in hydrodehalogenation reactions, became active upon the addition of quaternary salts [386].

A unique phenomenon was noticed when chloroarylketones were hydrogenated in the above systems. Without PTC, the major product was the corresponding alkylbenzene (complete reduction of both the halide and the ketone). In the presence of Aliquat 336 reduction of the ketone was retarded, resulting in the selective formation of arylketones [387]. Similar results were obtained when Pt/C was used instead of Pd/C [388], with the formation of arylalkylcarbinol as the single product under alkaline conditions (pH > 13.5) and arylalkylketone at lower pH (Scheme 10.48) [389].

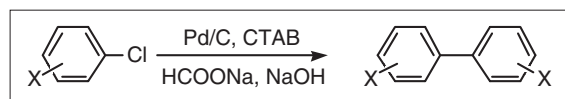
Tundo proposed three functions for the quaternary ammonium compounds in these systems: rapid removal of HX from the catalyst surface; formation of a lipophilic film at the catalyst surface, generating a unique microenvironment for the reaction; and Modification of the transition metal coordination sphere due to the proximity of the Q^+ cation. Interestingly, he also reported a visible change in the behaviour of the supported metal catalyst when the phase-transfer catalyst was added. Although initially the catalyst tended to distribute evenly in both the aqueous and the organic phases, when it was added all the catalyst was transported into the organic phase. Apparently the carbon particles actually were 'extracted' into the organic phase, possibly via interaction of the phase-transfer catalyst with carboxylic acid groups on the carbon surface.

Unfortunately the conclusions put forward by Tundo's group could not fully explain or predict the inconsistent role of phase-transfer catalyst in hydrodehalogenation reactions catalysed by Pd/C. No practical guidelines could be prompted for a rational selection of a phase-transfer catalyst for a given task in these systems. Regioselective hydrode-bromination was claimed by Sabahi [390], who converted 1,6-dibromo-2-methoxynaphthalene into 2-bromo-6-methoxynaphthalene using hydrogen with a tungsten carbide/phase-transfer catalyst system.

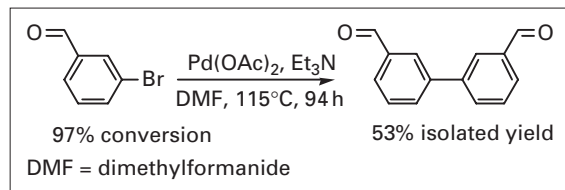
As early as 1978, Bamfield & Quan [391] reported a different reaction path for the hydrogenolysis of aryl halides catalysed by Pd/C upon the addition of various cationic surface-active agents. Using sodium formate as the reducing agent (Scheme 10.49) it was found that in the presence of CTAB an Ullmann-type reaction was the major process.

Quaternary ammonium salts likewise were endorsed for the homogeneous Pd(OAc)₂-catalysed homocoupling of aryl halides (Scheme 10.50). This system, developed by Lemaire *et al.* [392], has proved to be compatible with various sensitive functional groups. Biheterocycles such as bipyridines also were accessible using this methodology (Scheme 10.51). A major shortcoming of this system was that the palladium catalyst was reduced in the course of the reaction and could not be recycled.

We have observed recently that one of the key parameters controlling the selectivity of the reduction reaction of halobenzenes to homocoupling or hydrogenolysis was the reaction temperature. Thus, the activation energy of the Pd/C-catalysed homo-



Scheme 10.49



Scheme 10.50

coupling of chlorobenzene to biphenyl was measured to be 63 kJ mol⁻¹, whereas *E_a* for the hydrohalogenation of chlorobenzene to benzene under the same conditions was found to be an order of magnitude smaller (6 kJ mol⁻¹) [393]. These results characterise the hydrogenolysis reaction as a mass-transfer-controlled process and suggest that higher temperature would favour the coupling reaction. This was indeed the case: the selectivity of the homocoupling of chlorobenzene to biphenyl was increased from 45% at 90°C to 70% at 100°C and 85% at 110–120°C in the system containing Pd/C/CTAB/HCOONa/NaOH [394].

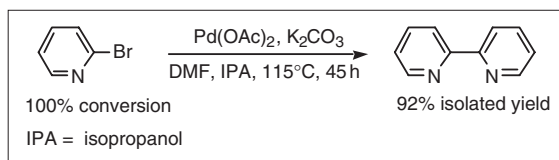
We also found that the reductive coupling reaction can be induced favourably with hydrogen gas as a reducing agent. The hydrogen can be supplied externally or generated in situ, for instance by reaction of zinc with water [395] or by decomposition of formate salts in water [396]. Both hydrogen-producing reactions were catalysed by Pd/C (Scheme 10.52).

Numerous phase-transfer agents were shown to improve the conversion, particularly the selectivity of the homocoupling reaction. Highest chemoselectivity was monitored with CTAB, TBAB and PEG-400. Crown ethers also were very effective [397].

Other parameters that increased the homocoupling selectivity were higher Pd/C loading, higher base amount and higher hydrogen pressure (or hydrogen donor concentration). It was demonstrated clearly that the Pd/C catalyst could be recycled in ten consecutive runs without any loss in activity.

We have shown evidence that the coupling of aryl halides was the result of one electron transfer from Pd(0) to the substrates to generate a radical anion that ejects a chloride anion with the formation of an aryl free radical that couples with a second aryl radical to yield the biaryl product (Fig. 10.8).

The oxidised palladium then is reduced by hydrogen to regenerate Pd(0) (Scheme 10.53).



Scheme 10.51

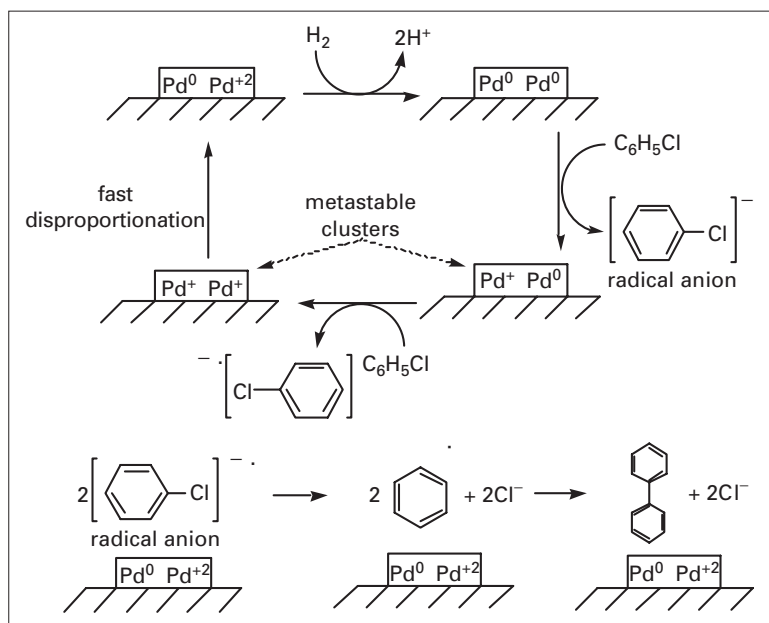
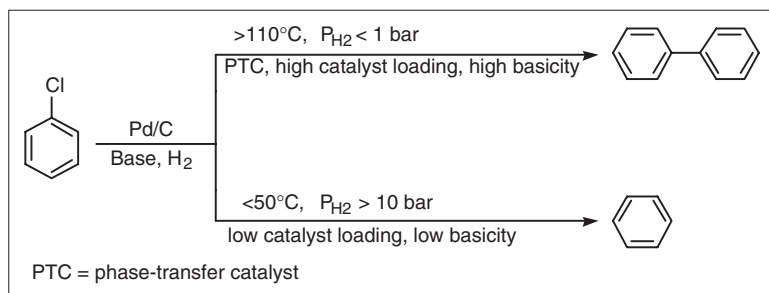
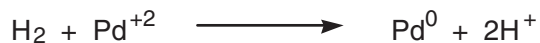


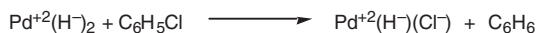
Fig. 10.8 Mechanism of Pd/C catalysed Biaryl Formation.



Scheme 10.52



Scheme 10.53

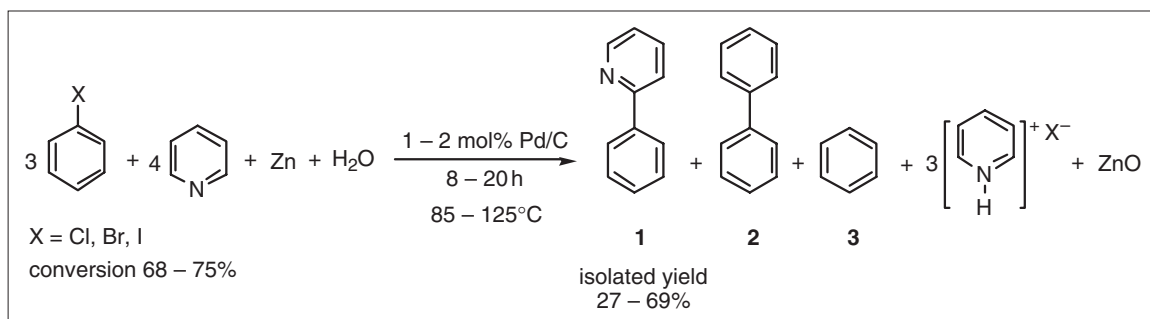


Scheme 10.54

However, hydrogen also can adsorb on the reduced palladium to form palladium hydride which in turn may reduce chlorobenzene to benzene (hydro-dehalogenation) (Scheme 10.54).

The resulting PdCl₂ may release HCl or reduce another chlorobenzene molecule. Addition of a base should enhance the reactions in which the products were Pd(0) and HCl. The significance of this lies in the greater sensitivity of the coupling reaction to the effective concentration of available Pd(0) sites. The

coordination of a single chlorobenzene molecule to one catalytic site should suffice for hydrogenolysis, whereas coordination of two chlorobenzene molecules to two neighbouring sites is required for the coupling reaction. The fact that higher Pd/C loading increased the coupling yield also supports this argument. Similarly, it could be asserted that although hydrogen is necessary for regeneration of the Pd(0)



Scheme 10.55

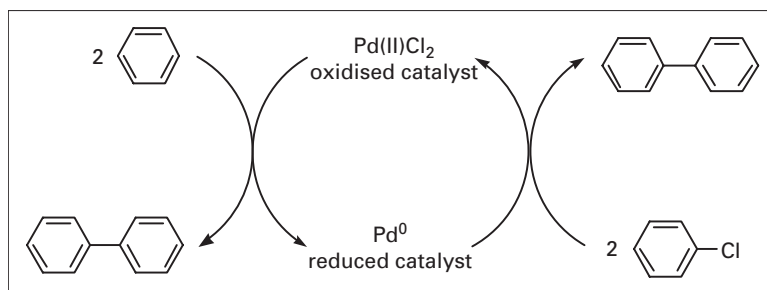


Fig. 10.9 Tandem Oxidative and Reductive Coupling of Benzene and chlorobenzene.

catalyst, higher hydrogen pressure would cause hydride formation to predominate, thus favouring the hydrogenolysis over coupling.

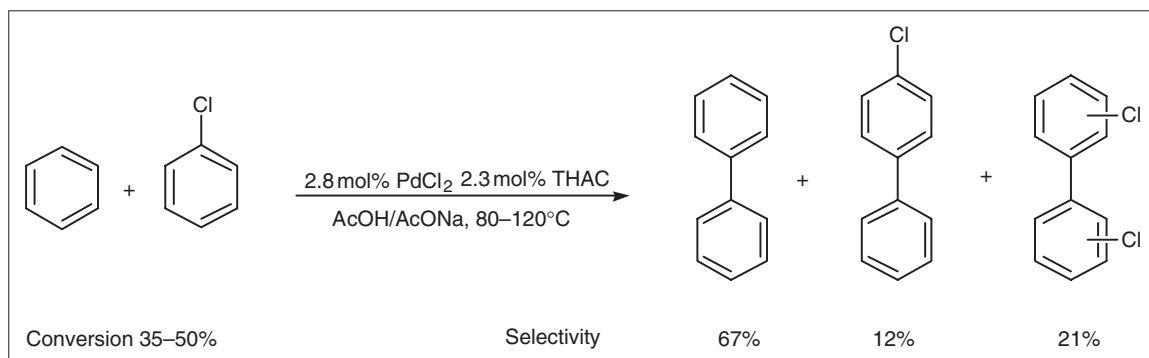
Phase-transfer agents may facilitate the removal of HCl from the catalyst surface and transport of the acid into the aqueous phase, where it is neutralised by the base. Another conceivable function is the consequence of the spontaneous adsorption of the quaternary ammonium or PEG derivatives to the carbon support surface. This phenomenon, which was noted by Tundo, creates an ionic (though lipophilic) thin layer covering the palladium catalyst, which regulates its microenvironment. This 'membrane' is permeable to electron flow but limits the access of substrates or solvent molecules (including hydrogen) to the palladium metal. Thus, hydride formation is avoided and, as a result, a higher coupling yield is observed. It is conspicuous that the coupling reaction is feasible only when the catalyst support is carbon (which is conductive). With insulators such as silica or alumina very poor yields were obtained. This unique role of the phase-transfer agent was made known to the authors recently by Professor C. Amatore.

Further support for this mechanism can be found in the fact that when the Pd/C catalyst was impreg-

nated with TBAB, prior to its addition to the reaction mixture, significantly higher selectivity to biaryl formation was observed [398].

Note that no monochlorobiphenyl was formed in the coupling process. This suggests that attack of phenyl radical on chlorobenzene is improbable and that the aryl radicals couple because they are formed on the catalyst surface. Again, this shows the importance of vacant Pd(0) sites. Remarkably, however, we found that when a strong electron acceptor such as pyridine is added to the system, cross-coupling products are obtained in significant yields [399]. Interestingly, 2-phenylpyridine (Scheme 10.55) was the only cross-coupling product obtained. As could be expected, addition of a phase-transfer catalyst to this system increased the conversion but lowered the cross-coupling/homocoupling ratio from 5:3 to 3:5.

Another important function of the phase-transfer catalyst on palladium-catalysed reactions was realised in exploring a related process where reductive coupling of chlorobenzene catalysed by Pd(0) was combined into a tandem reaction with the oxidative coupling of benzene catalysed by Pd(II) (Fig. 10.9) [400,401].



Scheme 10.56

We have examined the reaction of chlorobenzene with benzene in acetic acid at 80–120°C in the presence of PdCl₂ and tetra-*n*-hexylammonium chloride (THAC) catalysts (Scheme 10.56) [402]. The main function of the ammonium salt was claimed to be stabilisation of small palladium clusters and, consequently, retardation of catalyst deactivation caused by aggregation in the course of reduction of Pd(II) to Pd(0) (Fig. 10.10). Indeed, stabilisation of Rh(0) [403], Pd(0) [404] and Pd/Pt [405] nanoclusters by quaternary ammonium salts has been discussed at length and their role in regenerating PdCl₂ from Pd(0) complexes using 1,2-dichloroethane has been studied [406,407].

To summarise, the role of PTC in the Pd-catalysed arene coupling reactions may be threefold: rapid removal and neutralisation of HCl formed on the catalyst; formation of a lipophilic ionic membrane on the catalyst surface; stabilisation of catalytically active Pd(0) nanoparticles.

A stimulating family of reactions combining copper metal and cyclodextrin catalysis was reported by Hirai *et al.* These authors developed a regioselective carboxylation of aromatic systems using carbon tetrachloride and aqueous NaOH. A typical illustration was the selective double carboxylation of naphthalene (Scheme 10.57) to yield naphthalene 2,6-dicarboxylic acid [408].

The regioselectivity was ascribed to the conformation of the β-cyclodextrin complex with naphthalene and with the intermediate 2-naphthalenecarboxylic acid. The structure of the latter in aqueous alkaline solution was determined by nuclear magnetic reso-

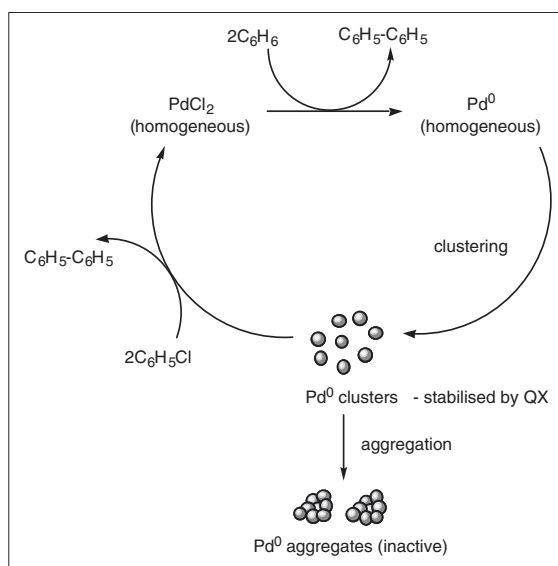
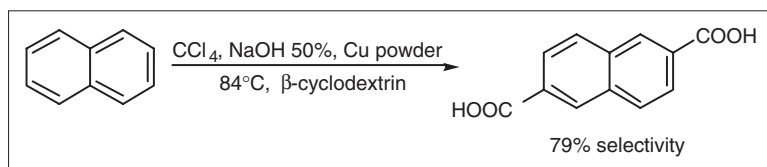


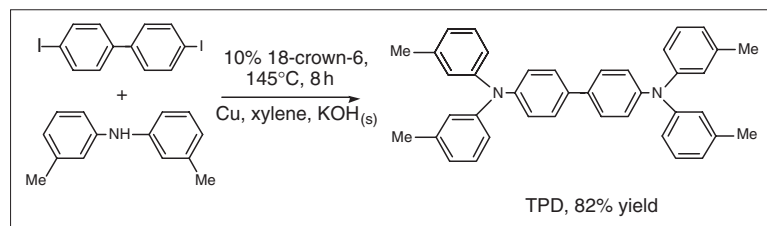
Fig. 10.10 Mechanism of the Palladium Catalyst Deactivation by Aggregation.

nance spectroscopy using homonuclear Overhauser enhancement. In a similar fashion, biphenyl was carboxylated to 4,4'-biphenyldicarboxylic acid [409]. Benzoic acid [410] and even benzene [411] were transformed into terephthalic acid.

Another copper-catalysed reaction, the Ullmann synthesis of triaryl amines, was improved substantially by employing a phase-transfer catalyst. Thus, 18-crown-6 was combined with copper powder and solid KOH in xylene to catalyse the reaction of 4,4'-diiodobiphenyl with bis(3-methylphenyl)amine (Scheme 10.58) [412]. The product *N,N'*-diphenyl-*N,N'*-di(3-tolyl)-*p*-benzidine (TPD) is a charge trans-



Scheme 10.57



Scheme 10.58

port agent in electrophotographic photoconductors. The PTC tandem N-alkylation of azo dyes to yield potential photorefractive molecules containing both a charge-transfer component and a non-linear optical chromophore was reported by Bu [413].

8.4 Phase-transfer catalysis activation of metallic and non-metallic reagents

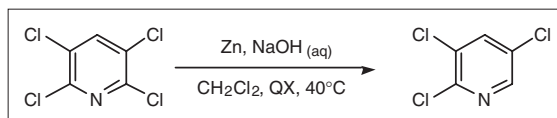
Another exciting development is the PTC activation of solid elements, both metallic and non-metallic. Thus, PTC was found to enhance the stoichiometric solid/liquid/liquid selective gradual dehalogenation of polychloropyridines by zinc metal in an aqueous NaOH/organic solvent system. A typical example (Scheme 10.59) is the regioselective dechlorination of 2,3,5,6-tetrachloropyridine (symtet) to 2,3,5-trichloropyridine [414].

Other examples are the direct synthesis of phosphonic acid esters from alkyl halides and elementary phosphorus, as disclosed in a patent from Clariant [415], and of selenium derivatives via PTC reaction of selenium powder [416].

9 Hydrogen Peroxide and Other PTC Oxidations and Halogenations

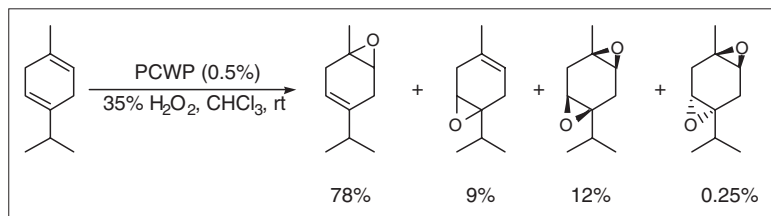
9.1 Hydrogen peroxide and alkyl hydroperoxide oxidations

The field of catalytic oxidations by dioxygen and hydrogen peroxide under PTC conditions was reviewed recently by Dehmlow [417].

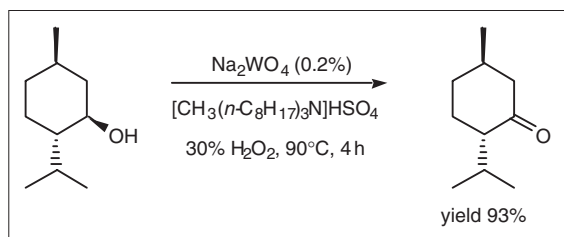


Scheme 10.59

Direct epoxidations of olefins with dilute hydrogen peroxide (as in many other applications of hydrogen peroxide) is a much sought-after synthetic method in terms of economy, safety and sustainability. The Ishii-Venturello [418] procedure is based on the catalytic combination of phosphate and tungstate anions under phase-transfer conditions. The original agenda as developed by Venturello was a true phase-transfer process where both hydrogen peroxide and tungstate anion were extracted by Aliquat 336 into the organic phase (1,2-dichloroethane) to react with 1-octene to yield the corresponding epoxide. Later, however, a modified procedure called for a pre-prepared catalyst made from a heteropolyacid such as dodecatungstophosphoric acid ($H_3PW_{12}O_{40}$) combined with an ammonium salt such as cetylpyridinium bromide. The resulting cetylpyridinium peroxotungstophosphate (PCWP) was applied in numerous two-phase oxidation processes using hydrogen peroxide as the primary oxidant. A detailed mechanistic study of this catalytic system, including some observations on the catalyst deactivation, was reported by Hill [419]; see also the study of Bregeault [420]. Some recent examples of PCWP catalysis are: epoxidation and di-epoxidation



Scheme 10.60



Scheme 10.61

of terpenes [421] (Scheme 10.60), oxidation of vinyl ethers and silyl enol ethers [422], epoxidation of undecylenic acid and its esters [423] and dehomologation of aldehydes via oxidative cleavage of silyl enol ethers [424]. The combination of Aliquat 336 with peroxotungstophosphate was used in the epoxidation of castor oil [425]. These catalytic ion pairs were claimed to be as active and selective as the stoichiometric reagent methyltrioxorhenium [426]. Other useful applications of the PTC-tungstate/H₂O₂ system are the synthesis of nitrones of *N*-alkyl- α -amino acids [427] and the oxidative desulfurisation of dibenzothiophene [428].

An apparent breakthrough in H₂O₂ oxidations was reported by Noyori *et al.* in 1996. These authors developed a *totally halide and solvent-free system* based on an Na₂WO₄ catalyst combined with trioctylmethylammonium hydrogen sulfate as phase-transfer agent. This system is claimed to be most effective relative to prior systems (in terms of turnover numbers) in the epoxidation of terminal olefins [429] or functional olefins [430] (including allylic alcohols, unsaturated esters, ketones and ethers) and in the oxidation of secondary alcohols to ketones (Scheme 10.61) [431] and of benzylic alcohols to benzaldehydes or benzoic acids [432].

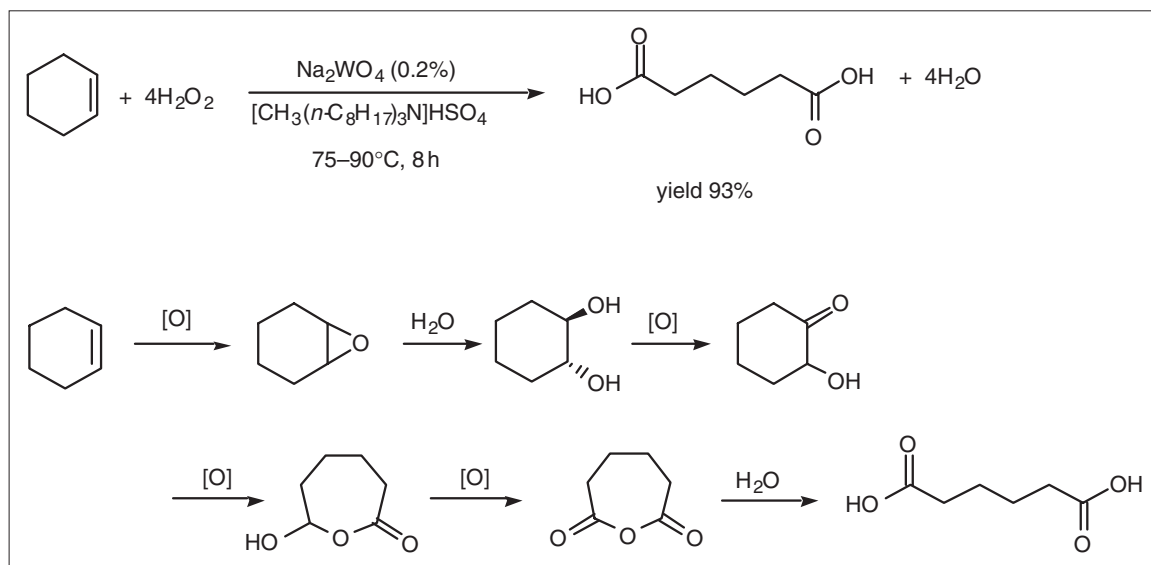
Aldehydes were oxidised selectively to carboxylic acids even in the absence of a metal due to the acidic properties of the hydrogen sulfate anion [433]. The Na₂WO₄/QHSO₄ system also has been applied effec-

tively in the conversion of cyclohexene to adipic acid [434]. This fascinating six-step reaction was achieved using 1 mol.% of catalyst and a 12% excess of hydrogen peroxide with gradual heating to 90°C for 6 h. A yield of 93% of pure product was obtained. The mechanism apparently involves an epoxidation step, two alcohol oxidation steps, one Baeyer–Villiger oxidation and two hydrolysis steps (Scheme 10.62). This synthesis is an excellent example of a ‘green’ chemical process, particularly when compared with the current industrial method for the fabrication of adipic acid. Noyori’s series of publications remarkably illustrate the potential of PTC in designing environmentally benign processes. In a further development, Noyori’s system was accelerated by an order of magnitude when it was carried out under microwave radiation [435].

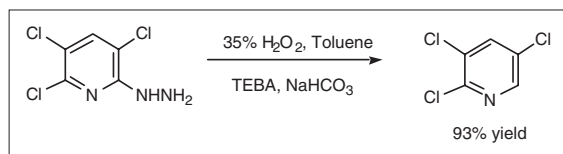
Although Noyori’s catalyst failed in the synthesis of styrene oxide, very recently Yadav [436] reported the efficient epoxidation of styrene using classical PTC methodology by applying a synergistic combination of cetyltrimethylbenzylammonium chloride and dodecatungstophosphoric acid at 50°C in a biphasic 30% H₂O₂/dichloroethane system.

Another significant hydrogen peroxide oxidation process is the Baeyer–Villiger oxidation of ketones. This has been reviewed recently by Ricci, with particular reference to PTC methods [437]. Oxychlorination and oxybromination of benzene by sodium perborate with HCl or HBr, respectively, was catalysed by TBAB [438]. The effect of tetraheptylammonium chloride on the rate of oxychlorination of *p*-cresol by HCl/H₂O₂ was studied by Mukhopadhyay *et al.* [439]. A sevenfold rate increase was measured in the oxidative chlorination system in comparison with the non-catalytic reaction. Hydrogen peroxide also was shown to be effective in the removal of the hydrazine group from a pyridine skeleton under mild conditions (Scheme 10.63) [440].

Alkyl hydroperoxides also are effectual oxidation reagents. Zawadiak [441] applied 1-methyl-1-



Scheme 10.62



Scheme 10.63

phenylethylhydroperoxide for the oxidation of cumene catalysed by copper combined with crown ether. We have converted tetralin to 1-(*t*-butylperoxy)tetralin by reaction with *t*-butylhydroperoxide/TBAB/CuCl₂ [442]. The same bi-functional catalytic system was studied also in the oxidation of alcohols (Scheme 10.64) [443].

9.2 Other oxidising agents

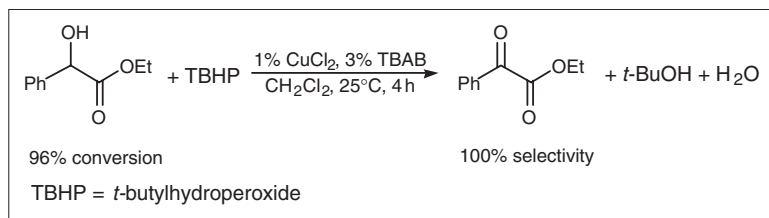
The application of quaternary ammonium salts as single-component auto-oxidation catalysts was extended to various substrates. In a patent from Osaka Gas (Scheme 10.65), the TBAB-catalysed peroxidation of isopropylbiphenyl followed by acid decomposition of the hydroperoxide to 4-phenylphenol was disclosed [444]. Hydroperoxides

of 2,6-diisopropyl-naphthalene were prepared similarly [445].

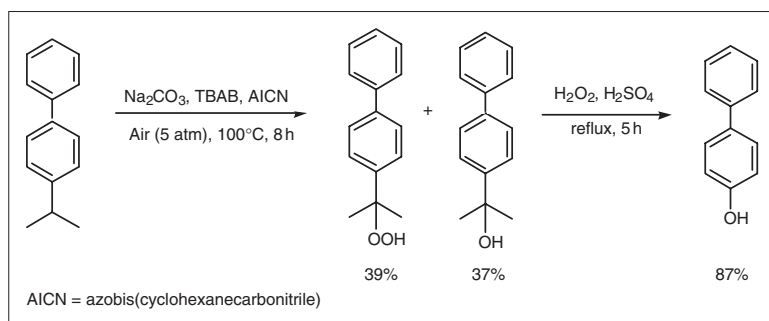
Similar auto-oxidations of cyclohexene, tetralin and cumene were studied by Csanyi & Jaky [446], who concluded that the role of the phase-transfer catalyst is to facilitate homolysis of the O–O bond of the hydroperoxide. Accordingly, Aliquat 336 was utilised for the selective decomposition of primary hydroperoxides in the presence of tertiary hydroperoxides with very high selectivity [447]. Auto-oxidation of γ -picoline to nicotinic acid was carried out by a combined Co/Mn/tetra-*n*-propylammonium bromide (TPAB) catalyst (Scheme 10.66) [448]. Anionic monomeric and oligomeric vanadium (V) species could be extracted into the *t*-butylhydroperoxide organic phase using Aliquat 336. These ion pairs influenced the decomposition rate of TBHP and catalysed the auto-oxidation of hydrocarbons [449].

In a patent from Dow Agrosciences [450] the oxidation by chlorine of the following disulfide to sulfonyl chloride is disclosed (Scheme 10.67).

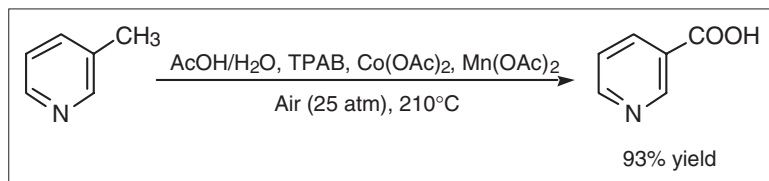
Disulfides could be prepared from thiols via bromination with tetrabromomethane in the presence of potassium carbonate and 18-crown-6 [451]. Phenylindenes were dimerized via chloro intermediates using tetrachloromethane or hexachloroethane in the presence of 50% aqueous KOH and TEBA [452]. Aliphatic hydrocarbons could be brominated



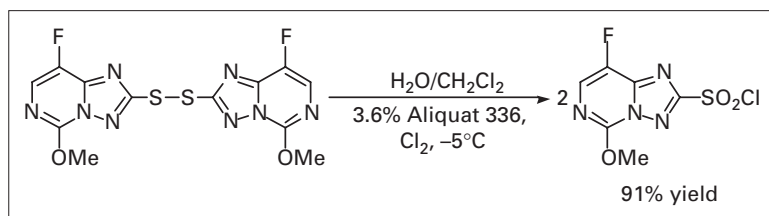
Scheme 10.64



Scheme 10.65



Scheme 10.66



Scheme 10.67

using CBr_4 in a 50% $\text{NaOH}/\text{CH}_2\text{Cl}_2/\text{TEBA}$ system [453] (Scheme 10.68). The regioselectivity of this reaction is much higher than in free-radical bromination. Thus, the ratio of 1-bromo-/2-bromo-adamantane was 0.96:1 in free-radical bromination and 8.3:1 in this method. Iodination similarly could be obtained (with even higher selectivity: (1-/2- = 40:1) when using solid NaOH and iodoform but a phase-transfer catalyst was not required [454].

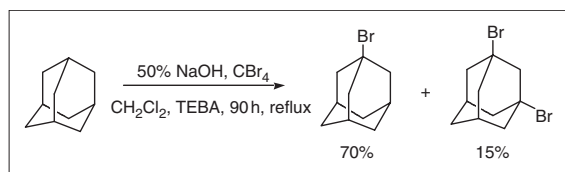
The reaction is initiated by a single electron transfer from hydroxide anion to CBr_4 . The latter ejects a

bromide anion to yield a tribromomethyl radical that starts a chain reaction with the hydrocarbon. This mechanism was supported by the significant H/D kinetic isotope effect of 4–5 [455].

Malonate esters could be iodinated directly with elementary iodine, solid potassium carbonate and Aliquat 336 [456].

The PTC oxidation of ethylbenzenes to acetophenones (Scheme 10.69) using elementary bromine under very mild conditions has been claimed by Mitsubishi [457].

Hypochlorite is a very effective oxidant in PTC systems and was applied in the oxidation of numerous substrates. A recent example is the β -scission of tertiary alcohols in the presence of TBAHS (Scheme 10.70) [458]. We have elucidated a sequential chlorination–hydrolysis mechanism for the oxidative cleavage of cycloalkanones by bleach solution in the presence of a phase-transfer catalyst. Thus, cyclohexanone was reacted with an aqueous NaOCl/Aliquat 336 mixture at 10°C and a constant pH of 12 to yield, at 100% conversion after 24 h,



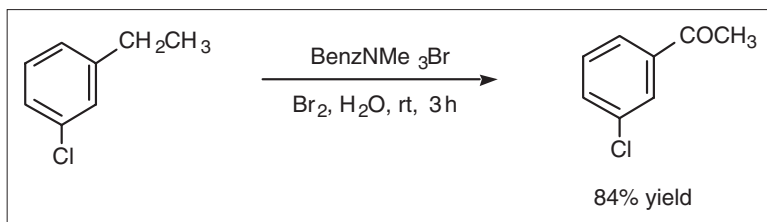
Scheme 10.68

63% adipic acid along with 17% glutaric acid and 9% succinic acid [459].

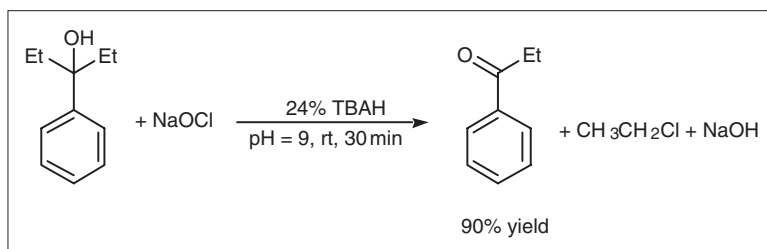
When combined with precious metal such as ruthenium, hypochlorite can readily oxidise methyl aromatic compounds to benzoic acids. The selective transformation of xylenes to toluic acids (Scheme 10.71) is a typical illustration [460].

10 Supercritical and Ionic Liquid PTC

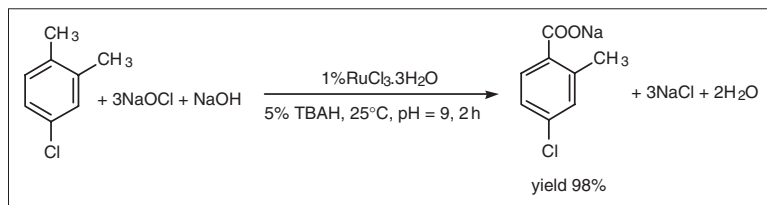
Supercritical fluid PTC offers several advantages over classical liquid/liquid or solid/liquid PTC. The most widely used supercritical fluid (SCF)—carbon dioxide—is easily available, non-flammable and non-toxic, environmentally benign (when compared with other solvents) and easy to separate from the reaction products. In addition, the molecular diffusivities of the substrate molecules in the SCF are much higher than in normal liquids. This property is particularly beneficial for PTC reactions that are, in numerous instances, mass transfer limited. Eckert *et al.* have demonstrated this novel PTC scheme in the



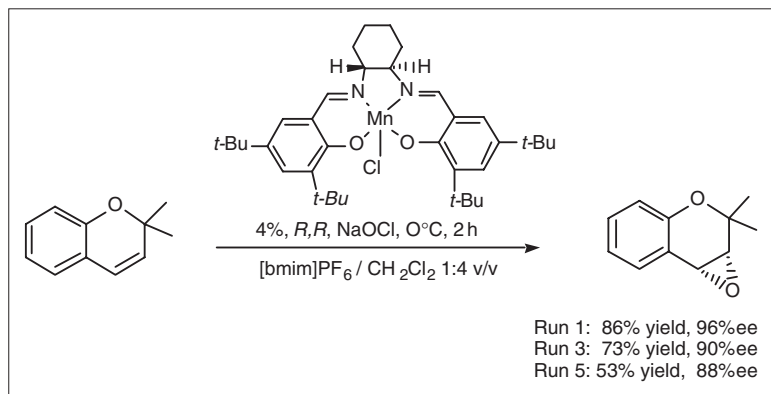
Scheme 10.69



Scheme 10.70



Scheme 10.71



Scheme 10.72

exchange reactions of KBr [461] and of KCN [462] with benzyl chloride, catalysed by tetraheptylammonium salts. The insolubility of the catalyst in the SCF (CO_2), along with the kinetic results, clearly suggest that the reactions are three-phase systems consisting of the SCF, the catalyst phase and the solid salt phase. The reaction was found to take place in the catalyst phase. Similar phase behaviour was observed when alternative phase-transfer catalysts such as PEG or 18-crown-6 were used instead of the ammonium salt. As expected, these processes have shown very weak dependence on the stirring rate, attaining a maximum rate at 100 rpm. Interestingly, addition of a co-solvent (acetone) resulted in lower reaction rates.

The idea of using quaternary onium salts as solvents is a new frontier in PTC exploration. The room-temperature ionic liquid 1-butyl-3-methylimidazolium hexafluorophosphate ($[\text{bmim}]^+[\text{PF}_6]^-$) developed by Huddleston [463] was applied by Seddon *et al.* [464] and by Howarth [465] as a solvent in the Pd-catalysed coupling reactions of aryl iodides or bromides with acrylate esters under mild conditions. The copper(I)-mediated living radical polymerisation of methyl methacrylate was accomplished likewise [466]. Similar ionic liquids were used as vinylation solvents [467] and for the Pd-catalysed Suzuki cross-coupling [468]. Larsen *et al.* [469] analysed the structure–activity relations of various potential ionic liquids based on imidazolium cations and carborane anions. The thermal properties of imidazolium salts were studied by Ngo [470],

who concluded that the latter are more stable thermally than tetraalkylammonium cations.

Aromatic aldehydes were auto-oxidized at room temperature using $\text{Ni}(\text{acac})_2$ catalyst in $[\text{bmim}]^+[\text{PF}_6]^-$ with effective recycling of the solvent and the catalyst [471]. In the same ionic liquid Dupont [472] accomplished the biphasic hydrogenation of dienes to monoenes catalysed by $\text{Pd}(\text{acac})_2$. Again, simple product separation and catalyst/solvent recycling was demonstrated. Song & Roh used $[\text{bmim}]^+[\text{PF}_6]^-$ as a solvent for asymmetric epoxidations with NaOCl based on Jacobsen's ($\text{salen})\text{Mn}(\text{III})$ catalyst [473] (Scheme 10.72) and for scandium(III) triflate-promoted Friedel–Crafts alkylations [474].

1-Ethyl-3-methylimidazolium tetrafluoroborate served as a green solvent for the methylrhenium-trioxide-catalysed epoxidation of various olefins with urea hydrogen peroxide [475]. Tributylhexylammonium bis(trifluoromethylsulfonyl)amide was used as solvent by Scott *et al.* [476] for the clean and safe syntheses of cyclotrimeratrylenes under mild conditions. Tetraalkyl/aryl phosphonium tosylate were reported by Comyns [477] as a medium for rhodium catalysed transfer hydrogenation reactions.

A novel resolution for the recovery of organic constituents from ionic liquids was accomplished by Blanchard via supercritical CO_2 extraction [478]. Cull *et al.* [479] examined a unique use of ionic liquids as solvents in biotechnological processes. Freemantle summarised the industrial potential of room-temperature ionic liquids in view of a recent NATO workshop [480].

11 New Experimental Tools and Modelling Techniques in PTC Research

The last couple of years have witnessed a step change in the refinement of the physical means available for visualisation and analysis of the phase-transfer phenomenon. Numerous exciting new instruments and methodologies brought about deeper and more accurate perception of the molecular dynamics of extraction and reaction in multiphase systems.

The dynamic interfacial behaviour of TBAB at the water/nitrobenzene interface was monitored by Swada *et al.* using time-resolved quasi-elastic laser scattering (QELS) measurements [481]. Analysing the capillary wave frequencies as a function of concentration of different surfactants the authors were able to determine the surface tension γ and the interfacial number density Γ . The TBAB-catalysed reaction between sodium phenolate and diphenylphosphoryl chloride (DPC) to yield triphenyl phosphate was selected as a model reaction. It was found that the capillary wave frequencies were independent of C_6H_5ONa and DPC concentrations, indicating that these substrates do not react in the absence of a phase-transfer catalyst. The authors concluded that the concentration ratio of TBAB/ C_6H_5ONa at the interface was unity when the bulk concentration of TBAB exceeded 50 mM. At lower bulk TBAB concentration this ratio was lower than unity. The authors concluded that the site of the reaction between the two species to form the ion pair $TBA^+C_6H_5O^-$ was changing with concentration. Above 50 mM it is an aqueous phase reaction, whereas below 50 mM it is an interfacial process.

By inspecting the time courses of the QELS spectrum [482] after injecting various phase-transfer catalysts to the interface, it was determined that the desorption rate of TBAB was very low in comparison with tetra-*n*-ethylammonium bromide (TEAB) and TPAB. As a result, a stationary state was quickly established with this catalyst at high interfacial molecular density, leading to a more effective catalysis. Evidently, the interface is the main reaction site in this process. Remarkably, with increasing TBAB concentration from 1 mM to 25 mM the amount of $TBA^+C_6H_5O^-$ transferred to the organic phase decreased [483]. The interfacial molecular number density of $TBA^+C_6H_5O^-$ for 1 mM TBAB was $8.2 \times 10^{-10} \text{ mol cm}^{-2}$ and with 25 mM TBAB it was only $11 \times 10^{-10} \text{ mol cm}^{-2}$. Therefore, the explicit conclusion

was that interfacial TBAB promotes the reaction via ion-pair formation but at the same time it disturbs the mass transfer across the interface. The optimal catalyst concentration therefore should be determined by taking into account the interfacial coverage while adjusting the conflicting processes of ion-pair formation and mass transfer.

Another novel physical method for analysis of surface properties is metastable-induced electron spectroscopy (MIES). This technique was applied by Oberbrodage for the measurement of surface activity of different onium salts and for determining the nature of their surface layer [484]. Spectroscopic properties in the second harmonic generation (SHG) were used for direct measurements of adsorption layers of 4-dimethylaminopyridine derivatives at liquid/liquid interfaces [485]. Another method—scanning electrochemical microscopy—was used to induce and follow the rate of charge-transfer coupling between two ion-transfer processes across liquid/liquid interfaces [486].

Transport of ionic species across interfaces could be driven also by potential differences between phases. This was demonstrated recently by Kakiuchi *et al.* [487], who carried out biphasic azo coupling reactions promoted by the phase boundary potential across the dichloroethane/water interface. The kinetics of the coupling reaction of the hydrophilic Fast Red TR (4-chloro-2-methylbenzene diazonium chloride, hemi zinc chloride) and other diazonium salts in water with *N,N*-dimethyl-1-naphthylamine and other coupling agents in dichloroethane was monitored using cyclic voltammetry and potential-step chronoamperometry. The value of the standard ion transfer potential of each diazonium salt could be a measure of its lipophilicity [488]. It was confirmed also that the transfer of arenediazonium ions from water to dichloroethane was diffusion controlled. However, contradicting the common perception by PTC researchers, this work concluded that adsorbed reactants did not play a role in this process. The authors advocated this method as being highly useful for the control of PTC processes by application of the phase boundary potential and also for the elucidation of complex PTC mechanisms. It should be noted that in an earlier publication Srivastava *et al.* observed the oscillations of electric potential differences across the liquid/liquid interface in phase-transfer systems and correlated it with the Starks extraction mechanism [489]. In a later work these

authors proposed to use the amplitude of the oscillations as a measure of catalytic efficacy [490].

Novel experimental techniques also were introduced to the PTC process research and development studies. In a recent publication Oxley *et al.* described the application of spinning disc reactor technology for a phase-transfer-catalysed Darzen reaction [491]. A rotating disk contactor was used also by Glatzer for measuring the mass transfer coefficients of polymer-supported tri-*n*-butylmethylammonium chloride (TBMAC)-catalysed esterification of benzyl chloride with sodium acetate. The external mass transfer coefficients were determined as a function of the bulk agitation speed. The values ranged from 1.4 to $2.0 \times 10^{-3} \text{ cm min}^{-1}$.

Juang & Liu [492] designed a glass stirred Lewis cell with a constant contact area of 43.2 cm^2 equipped with two symmetrically located stirrer blades with respect to the aqueous/organic interface. The stirrers were driven at the same rate in the opposite direction without disturbing the interface. Using this apparatus they monitored the TBAB-catalysed esterification reaction of 4-methoxyphenylacetic acid with *n*-butylbromide in the toluene/aqueous NaOH solvent system. They concluded that the reaction took place in the bulk of the organic-phase and that adsorption of intermediate species played a certain role in the overall process. Indeed, the empirically resolved rate equation was similar to equations observed in heterogeneous catalysis involving Langmuir-type isotherms. The rate of the interfacial ion-exchange processes was much less temperature sensitive in comparison with the organic-phase substitution reaction ($E_a = 9.1 - 10.9 \text{ kJ mol}^{-1}$ versus 64.6 kJ mol^{-1} , respectively). This also suggests an interfacial adsorption mechanism. Consequently, a combination interfacial/extraction mechanism was resolved and a theoretical rate equation was derived. The discrepancies between the empirical and theoretical rate equations (such as the fractional order of QBr and the substrate in the experimental equation) were attributed to the aggregation of the ion pairs. The latter rate law is far more rigorous than the pseudo-first-order kinetics model assumed for this and similar PTC reactions. The mechanism of the same reaction catalysed by a polymer-bound phase-transfer catalyst was addressed by Wu [493], who analysed also the consecutive diffusion-controlled catalytic hydrolysis reaction.

A useful tool for estimation of the interfacial area in laminar-flow liquid/liquid systems was put forward by Starks [494]. The equation derived is highly beneficial for simulation of PTC kinetics to determine the dependence of apparent rates and speed of agitation. The model fitted well with literature experimental data and also demonstrated the reciprocal relationship between the surface tension and rates in PTC mass-transfer-controlled reactions.

A mathematical model for triphase catalysis (including non-isothermal effects) [495] and for solid/liquid PTC reactions [496], which provided a rational basis for the scale-up of PTC reactions, was elaborated by Doraiswamy *et al.*

A molecular dynamics simulation of TBAI at the formamide/hexane interface was carried out by Oberbrodthage [497], who described the nature and thickness of the interface and the behaviour, orientation and movements of the ion pairs at the interface. Numerical simulation of simultaneous mass transfer and chemical reaction in a PTC system was reported by Wu [498], who also introduced the concept of catalyst effectiveness and analysed its contingency to physical reaction parameters.

References

1. Starks, C. M., Liotta, C. L., & Halpern, M. *Phase Transfer Catalysis: Fundamentals, Applications and Industrial Perspectives*. Chapman & Hall, New York, 1994; Dehmlow, E. V. & Dehmlow, S. S.: *Phase Transfer Catalysis*, 3rd edn. Verlag Chemie, Weinheim, 1993; Goldberg, Y. *Phase Transfer Catalysis, Selected Problems and Applications*. Gordon & Breach, Philadelphia, 1992.
2. Starks, C. M. *J. Am. Chem. Soc.*, 1971, **93**, 195.
3. Makosza, M., & Fedorynski, M., *Pol. J. Chem.*, 1996, **70**, 1093.
4. Conti, F. *Chim. Ind. (Milan)*, 1998, **80**, 74; Sharma, M. In *Handbook of Phase Transfer Catalysis* (Sasson, Y., & Neumann, R. eds). Blackie A&P, London, 1997, p. 168.
5. Vargha, V., Pozsgay, A. G., & Valentini, P. *Ferroelectrics*, 2000, **243**, 159.
6. Fishman, A., & Zviely, M. *Tetrahedron: Asymm.*, 1998, **9**, 107. Alston, W. C., & Ng, K. *Abstr. Pap. ACS Meet.*, 1999, **217**, BIOT 131.
7. Reetz, M.T., *Top. Catal.*, 1998, **4**, 187.
8. Yadav, G. D., *Chem. Ind. Dig.*, 1997, **10**, 148, 152.
9. Dutta, N. N., Borthakur, S., & Baruah, R. *Water Environ. Res.*, 1998, **70**, 4 [CA 128:144689]; Sherman, H. J., & Taylor, R. T. US 6007701 (to Miami

- University), 1999 [CAPLUS 1999:818209]; Williams, M. R., & Krzykawski, J. W. WO 9961565 (to Interline Hydrocarbon), 1999 [CA 132:13772].
10. Polk, M. B., Leboeuf, L. L., Shah, M., Won, C. Y., Hu, X., & Ding, W. *Polym-Plast. Technol. Eng.*, 1999, **38**, 459; Mizuide, F., Itaru, H., Sokolov, S. V., Zuravlev, M. V., Kokotin, I. V., & Blagodatova, O. JP 11322842 (to Nippon Mektron), 1999 [CA 131:352482].
 11. Park, D. W., Moon, J. Y., Yang, J. G., & Lee, J. K. *Energy Convers. Manag.*, 1997, **38**, S449 [CA 127:36190].
 12. Anderson, N. G. *Practical Process Research and Development*. Academic Press, San Diego, 2000, p. 119.
 13. Totten, G. E., Clinton, N. A., & Matlok, P. L. *J. Macromol. Sci., Rev. Macromol. Chem. Phys.*, 1998, **C38**, 77.
 14. Loupy, A., Petit, A., Hamelin, J., Texier-Boullet, F., Jackuault, P., & Mathe, D. *Synthesis*, 1998, 1213.
 15. Deshayes, S., Liagre, M., Loupy, A., Luche, J. L., & Petit, A. *Tetrahedron*, 1999, **55**, 19851.
 16. Loupy, A. *Top. Curr. Chem.*, 1999, **206**, 153.
 17. Cook, M. M., & Halpern, M. E. *Chim. Oggi*, 1998, **16**, 44.
 18. Yadav, V., Yadav, G.D., & Vyas, J.R. *Chim. Oggi*, 2000, **18**, 39.
 19. Abele, E., & Lukevics, E. *Org. Prep. Proc. Int.*, 1999, **31**, 359.
 20. Toader, V., & Bulacovschi, V. *Mater. Plast.*, 1997, **34**, 9.
 21. Naik, S. D., & Doraiswamy, L. K. *AIChE*, 1998, **44**, 612.
 22. Wolff, M. O., Alexander, K. M., & Belder, G. *Chim. Oggi*, 2000, **18**, 29.
 23. Halpern, M. E. *Proc. Chem. Pharm. Ind.*, 1999, 283 [CA 132:141737].
 24. Tavener, S., & Clark, J. H. *Chem. Ind.*, 1997, 22.
 25. Dupont, J., Consorti, C. S., & Spencer, J. *J. Braz. Chem. Soc.*, 2000, **11**, 337.
 26. Olivier, H. *J. Mol. Catal. A: Chem.*, 1999, **146**, 285.
 27. Welton, T. *Chem. Rev.*, 1999, **99**, 2071.
 28. Sasson, Y., & Neumann, R. *Handbook of Phase Transfer Catalysis*. Blackie A&P, London, 1997.
 29. Fukunaga, T., Oguro, K., Mitsui, O., & Ota, R. JP 10045769, 1996 [CA 128:217501].
 30. Varma, R. S., & Naicker, K. P. *Tetrahedron Lett.*, 1998, **39**, 1998; Varma, R. S., Naicker, K. P., & Aschberger, J. *Synth. Commun.*, 1999, **29**, 2823. Varma, R. S., Naicker, K. P., & Kumar, D. *J. Mol. Catal. A: Chem.*, 1999, **149**, 153.
 31. Varma, R. S., & Kumar, D. *Catal. Lett.*, 1998, **53**, 225.
 32. Singh, R. P., & Matteson, D. S. *J. Org. Chem.*, 2000, **65**, 6650.
 33. Jacobson, S. E. US 5726337 (to Du-Pont), 1996 [CA 128:193966].
 34. LeBlanc, W. B., & Jursic, B. S. *Synth. Commun.*, 1998, **28**, 3591.
 35. Allegrini, P., & Soriato, G. WO 9942438 (to Zambon Group), 1999 [CA 1999:549248].
 36. Zhao, H. WO 9965883 (to Cytec), 1999 [CA 1999:811220].
 37. Ohtani, N., Murakawa, S., Watanabe, K., Tsuchimoto, D., & Sato, D. *J. Chem. Soc., Perkin Trans. 2*, 2000, 1851.
 38. Markovic, R., Dimitrijevic, G., & Aleksic, V. *J. Chem. Res. (S)*, 1997, 66.
 39. Albanese, D., Landini, D., & Penso, M. *Tetrahedron*, 1997, **53**, 4687; Albanese, D., Landini, D., & Penso, M. *Chem. Commun.*, 1999, 2095.
 40. Oren, J. WO 9827047 (to Bromine Compounds), 1998 [CA 129:82063].
 41. Sakata, J., Inoue, S., & Kadono, S. WO 9928287 (to Manac), 1999 [CA 131:5693].
 42. Brunelle, D. J., & Guggenheim, T. L. US 6028203 (to GE Plastics), 2000 [CA 132:152311].
 43. Yadav, G. D., & Naik, S. S. *Org. Proc. Res. Dev.*, 1999, **3**, 83; Yadav, G. D., & Reddy, C. A. *Ind. Eng. Chem. Res.*, 1999, **38**, 2245.
 44. Gelmont, M., & Zilbermann, J. WO 9951561 (to Bromine Compounds), 1999 [CA 131:288003].
 45. Boaz, N.W. US 6100431 (to Eastman), 2000.
 46. Jiang, Y. L., Pang, J., & Yuan, Y. C. *Chin. Chem. Lett.*, 1994, **5**, 29 [CA 120:298160].
 47. De la Cruz, P., De la Hoz, A., Langa, F., Martin, N., Perez, M. C., & Sanchez, L. *Eur. J. Org. Chem.*, 1999, 3433.
 48. De la Cruz, P., de la Hoz, A., Font, L. M., Langa, F., & Perz-Rodriguez, M. C. *Tetrahedron Lett.*, 1998, **39**, 6053.
 49. Jiao, J., Zheng, X., & Hu, Z. *Huaxue Shijie*, 1996, **37**, 312 [CA 126:105744].
 50. Beletskaya, I. P., Davydov, D. V., Gorovoi, M. S., & Kardashov, S. V. *Russ. Chem. Bull.*, 1999, **48**, 1533.
 51. Sorokin, V. D., & Fertel, L. B. US 6025536 (to Occidental), 2000 [CA 132:137115].
 52. Tanaka, H., Sakamoto, J., & Itsuda, H. JP 10114736, 1996 [CA 129:4653].
 53. Wessel, T., & Koch, P. EP 758643 (to Hoechst), 1996 [CA 126:225114].
 54. Viauvy, A., & Casado, M. EP994099 (to Rhone Poulenc Agro), 2000 [CA 132:264976].
 55. Okano, T., Kiji, J., & Toyooka, Y. *Chem. Lett.*, 1998, 425.
 56. Tanaka, T. JP 09188639 (to Mitsubishi), 1996 [CA 127: 148994].
 57. Ratovelomanana, V., Commenil, M. G., Gillet, J. P., Drivon, G., & Caupin, H. J. WO 9818748 (to Elf Atochem), 1998 [CA 128:321380].
 58. Reed, D., & Snedecor, T. WO 9505352 (to Dow), 1995.
 59. Yamada, T., & Sugimoto, T. JP 11292807 (to Nippon Zeon), 1999 [CA 131:300787].

60. Ross, G. J., Watts, J. F., Hill, M. P., & Morrissey, P. *Polymer*, 2000, **42**, 403.
61. Nefedov, O. M., Volchkov, N. V., Lipkind, M. B., Lee, H. S., Park, Y. J., & Min, H. US 6008407 (to Samsung Chem. Comp.), 1999 [CA 132:51451].
62. Patra, P. K., Suresh, J. R., Lla, H., & Junjappa, H. *Tetrahedron*, 1998, **54**, 10167.
63. Jonczyk, A., & Gierczak, A. H. *Tetrahedron*, 2000, **56**, 6083.
64. Wu, S., Ming, L., Shi, G., & Guo, L. *J. Appl. Polym. Sci.*, 2000, **76**, 1510.
65. Guo, L., Shi, G., & Liang, Y. *Eur. Polym. J.*, 1998, **35**, 215.
66. Nazarov, S. I., & Magerramov, M. N. *Russ. J. Org. Chem.*, 1997, **33**, 66.
67. Bogdal, D. *Bull. Soc. Chim. Belg.*, 1997, **106**, 809.
68. Koch, E. C. DE 19806758, 1998 [CA 131:148618].
69. Boussand, B. FR 2785285 (to Elf Atochem), 2000 [CA133:30655].
70. Dehmlow, E.V., Thieser, R., Sasson, Y., & Neumann, R. *Tetrahedron*, 1986, **42**, 3569.
71. Sivorski, F. S. *Org. Proc. Res. Dev.*, 1999, **3**, 437.
72. Makosza, M., & Chesnokov, A. *Tetrahedron*, 2000, **56**, 3553.
73. Zahalka, H. A., & Sasson, Y. *Chem. Commun.*, 1984, 1581.
74. Rothenberg, G., Wiener, H., Lavie, Z., & Sasson, Y. *Chem. Commun.*, 2000, 1293.
75. Oku, M., Arai, S., Katayama, K., & Shioiri, T. *Synlett*, 2000, 493.
76. [a] Mizuno, K., Sugita, H., Nishioka, S., Otsuji, Y., & Isagawa, K. *Proc. 1997 PTC Conference*, 24–27 September 1997, Nagoya, Japan, p. 29; Isagawa, K., Mizuno, K., Sugita, H., & Otsuji, Y. *J. Chem. Soc., Perkin Trans. 1*, 1991, 2283.
77. Isagawa, K., Mizuno, K., & Majima, T. *Tetrahedron Lett.*, 1999, **40**, 9051.
78. Bernhard, K., & Giger, A. US 5780693 (to Roche), 1998 [CA 128:282120].
79. Alcaide, B., Aly, M. F., Rodriguez, C., & Rodriguez-Vicente, A. *J. Org. Chem.*, 2000, **65**, 3453.
80. Auerbach, J., Carolen, J., & Hoerrner, R. S. GB 2320926 (to Merck), 1998 [CA 129:316052].
81. Abele, E. M., Abele, R. N., Popelis, Y. Y., Gaukhman, A. P., & Lukevits, E. *Russ. J. Org. Chem.*, 1998, **34**, 1334.
82. Sasson, Y., Ovadia, D., & Sturkovich, R. WO 2000044703 (to Makhteshim), 2000 [CA 133:135107].
83. Beck, W. A., Herkes, F. E., & Higley, D. P. US 5834617 (to Du Pont), 1998 [CA 129:303989].
84. Van Beek, J. A. M., Gruter, M. J. G., & Green, R. EP 805133 (to DSM), 1997 [CA 128:13512].
85. Van Beek, J. A. M., Gruter, M. J. G., & Green, R. WO 9742159 (to DSM), 1997 [CA 127:347905].
86. Overby, J. S., Brady, E. D., Slate, S. C., & Hanusa, T. P. *J. Mol. Struct.*, 1999, **478**, 163.
87. Gobbi, A., Landini, D., Maia, A., & Petricci, S. *J. Org. Chem.*, 1998, **63**, 5356; Maia, A., Landini, D., & Petricci, S. *Supramol. Chem.*, 2000, **11**, 289.
88. Diez-Barra, E., De La Hoz, A., & Sanchez-Verdu, P. *An. Quim. Int. Ed.*, 1997, **93**, 145.
89. Sauvagnat, B., Kulig, K., Lamaty, F., Lazaro, R., & Martinez, J. *J. Comb. Chem.*, 2000, **2**, 134.
90. Varray, S., Gauzy, C., Lamaty, F., Lazaro, R., & Martinez, J. *J. Org. Chem.*, 2000, **65**, 6787.
91. Kroger, S., & Haufe, G. *Amino Acids*, 1997, **12**, 363.
92. Miyabe, H., Fujii, K., & Naito, T. *Org. Lett.*, 1999, **1**, 569.
93. Guillena, G., & Najera, C. *J. Org. Chem.*, 2000, **65**, 7310.
94. Hoffmaa, P., Doucet, J. B., Li, W., Vergnes, L., & Labidalle, S. *J. Chem. Res. (S)*, 1997, 218.
95. De Knaep, A. G. M., Vandendriessche, A. M., Daemen, D. J. E., Dingenen, J. J. *et al. Org. Proc. Res. Dev.*, 2000, **4**, 162.
96. Yang, H. M., Yu, P. I., & Li, C. M. *Appl. Catal. A: Gen.*, 2000, **193**, 129; Yang, H. M., Yu, C. M., & Yu, H. E. *J. Chem. Technol. Biot.*, 2000, **75**, 387.
97. Yang, H. M., & Wu, C. M. *J. Mol. Catal. A: Chem.*, 2000, **153**, 83.
98. Wang, M. L., & Hsu, S. L. *J. Mol. Catal. A: Chem.*, 1999, **150**, 11.
99. Wang, M. L., & Yang, C. Y. *Tetrahedron*, 1999, **55**, 6275.
100. Joshi, S. R., Sawant, S. B., & Joshi, J. B. *Org. Proc. Res. Dev.*, 1999, **3**, 17.
101. Wingert, H., & Keil, M. DE 4442730 (to BASF), 1996 [CA 125:114307].
102. Isak, H., Keil, M., Wolf, B., & Wingert, H. EP 554767 (to BASF), 1993 [CA 119:270809].
103. Nakagawa, H., Endo, Y., Murakami, M., Gonodo, T., Endo, Y., & Abe, M. WO 9846561 (to Otsuka), 1998 [CA 129:316136].
104. Touma, T., & Asai, T., JP 11071319 (to Asahi Glass), 1999 [CA 130:209500].
105. Naepfli, A., Roduit, J. P., & Wellig, A. EP 820992 (to Lonza), 1998 [CA 128:140725].
106. Yang, H. M., & Wu, H. E. *Ind. Eng. Chem. Res.*, 1998, **37**, 4536.
107. Pilipauskas, D. R. *Ind. Eng. Chem. Res.*, 1999, **38**, 4130.
108. Zahalka, H. A., & Sasson, Y. *J. Mol. Catal.*, 1983, **18**, 57; Zahalka, H. A., & Sasson, Y. *Synthesis*, 1986, 763.
109. Joshi, S. R., & Sawant, S. B. *Org. Proc. Res. Dev.*, 2000, **4**, 23.
110. Prasad, V. A., Applegate, J. M., Erdman, D. T., & Newallis, P. E. US 5808152 (to Bayer), 1998.
111. Oda, K., Aiba, K., & Ohara, T. JP 11228626 (to Tonen), 1999 [CAPLUS 1999:531053].
112. Taniguchi, H., Nomura, E., Uchida, M., Nasaka, N., Doi, A., & Kawashima, S. JP 09208510 (to Wakayama Prefecture), 1997 [CA 127:205340].

113. Guo, C., Wei, P., Jin, H., & Chen, Y. *Huaxue Shijie*, 1997, **38**, 30 [CA 127:190041].
114. Miyasawa, S., Kitamura, A., & Kobayashi, N. JP 10036484 (to Dainippon Ink), 1998 [CA 128:154848].
115. Corrigan, J. P., & Howie, J. K. WO 9821219 (to Proctor & Gamble), 1998 [CA 129:29321].
116. Limousina, C., Cleophaxa, J., Loupy, A., & Petit, A. *Tetrahedron*, 1998, **54**, 13567.
117. Hara, T., & Momota, J. JP 2000095731 (to Tokuyama Corp.), 2000 [CA 132:237518].
118. Baj, S., & Chrobok, A. *Pol. J. Chem.*, 1999, **73**, 1185.
119. Bentley, T. W., Jones, R. V. H., Larder, A. H., & Lock, S. J. *J. Chem. Soc., Perkin Trans. 2*, 1998, 89.
120. Kueber, F., Riedel, M., & Michael, S. B. DE 19637669 (to Hoechst), 1998 [CA 128:230518].
121. Jayachandran, J. P., Balakrishnan, T., & Wang, M. L. *J. Mol. Catal. A: Chem.*, 2000, **152**, 91.
122. de la Hoz, A., Diaz-Barra, E., Langa, F., Merino, S., Rodriguez, A., & Sanchez-Verdu, P. *Tetrahedron*, 1997, **53**, 11693; Diez-Barra, E., de la Hoz, A., Merino, S., & Sanchez-Verdu, P. *Tetrahedron Lett.*, 1997, **38**, 2359; Diez-Barra, E., de la Hoz, A., Merino, S., Rodriguez, A., & Sanchez-Verdu, P. *Tetrahedron*, 1998, **54**, 1835.
123. Fedorynski, M., Kubicka-Prusik, M., Kurska, M., & Jonczyk, A. *Tetrahedron*, 1999, **55**, 1053; Fedorynski, M. *Tetrahedron*, 1999, **55**, 6329.
124. Hwang, J. J., Lin, R. L., Shieh, R. L., & Jwo, J. J. *J. Mol. Catal. A: Chem.*, 1999, **142**, 125.
125. Daubresse, N., Francesch, C., & Rolando, C. *Tetrahedron*, 1998, **54**, 10761.
126. Song, J., & Hansen, H. J. *Helv. Chim. Acta*, 1999, **82**, 1690.
127. Koldobskii, G. I. *Russ. Chem. Bull.*, 1995, **44**, 2019; Diez-Barra, E., & de la Hoz, A. In *Handbook of Phase Transfer Catalysis* (Sasson, Y., & Neumann, R., eds). Blackie A&P, London, 1997, p. 276.
128. Percec, V., Asandei, A. D., & Zhao, M. *Chem. Mater.*, 1996, **8**, 301; Percec, V., Asandei, A. D., & Chu, P. *Macromolecules*, 1996, **29**, 3736; Zniber, R., Regragui, M., Achour, R., Cherkaoui, O., ElHajji, A. J., & Cherkaoui, M. *Z. Bull. Soc. Chim. Belg.*, 1996, **105**, 457; Bazavova, I. M., Esipenko, A. N., Neplyuev, V. M., & Lozinskii, M. O. *Russ. J. Org. Chem.*, 1998, **34**, 478.
129. Kumar, S., Hundal, G., Bhalla, V., Hundal, M. S., & Singh, H. *J. Chem. Res. (S)*, 1998, 794.
130. Kumar, S., Hundal, M. S., Hundal, G., Singh, P., Bhalla, V., & Singh, H. *J. Chem. Soc., Perkin Trans. 2*, 1998, 925.
131. Chellini, A., Pagliarin, R., Giovencana, G. B., Palmisano, G., & Sisti, M. *Helv. Chim. Acta*, 2000, **83**, 793.
132. Makosza, M. *Pure Appl. Chem.*, 1975, **43**, 439.
133. Diez-Barra, E., de la Hoz, A., Moreno, A., & Sanchez-Verdu, P. *J. Chem. Soc., Perkin Trans. 1*, 1991, 2593.
134. Barker, S. J., & Clark, S. M. WO 9720810 (to Knoll), 1996.
135. Jayachandran, J. P., & Wang, M. L. *Appl. Catal.*, 2000, **198**, 127.
136. Cohen, S., & Sasson, Y. unpublished results.
137. Kim, S., Kwon, T., Park, B., & Kim, S. *Korean Patent* 9501406 (to Lucky), 1995 [CA 133:60387].
138. Metz J., & Osterholt, C. DE 19752041 (to Huels), 1997 [CA 1999:343724].
139. Lizuka, H., & Nagase, H. JP11180899 (to Mitsui), 1999 [CA 131:44429].
140. Kotha, S., & Brahmachary, E. *Bioorg. Med. Chem. Lett.*, 1997, **7**, 2719 [CA 127:359066]; Kotha, S., & Brahmachary, E. *J. Org. Chem.*, 2000, **65**, 1359.
141. Gronet, S., Azizian K., & Friedman, M. A. *J. Am. Chem. Soc.*, 1998, **120**, 3220.
142. Fedorynski, M., & Jonczyk, A. *Org. Prep. Proc. Int.*, 1995, **27**, 355.
143. Kim, D. Y., & Suh, K. H. *Synth. Commun.*, 1998, **28**, 83.
144. Ciba-Geigy, GB 1570319, 1980.
145. Cohen, S., Zoran, A., & Sasson, Y. *Tetrahedron Lett.*, 1998, **39**, 9815.
146. Cohen, S., & Sasson, Y. unpublished results.
147. Cohen, S., Rothenberg, G., & Sasson, Y. *Tetrahedron Lett.*, 1998, **39**, 3093.
148. Cohen, S., Rothenberg, G., & Sasson, Y. *Tetrahedron Lett.*, 1999, **40**, 1612.
149. Cohen, S., PhD Thesis, The Hebrew University of Jerusalem, 1999.
150. Arai, S., Nakayama, K., Hatano, K. I., & Shioiri, T. *J. Org. Chem.*, 1998, **63**, 9572.
151. Arai, S., Nakayama, K., Ishida, T., & Shioiri, T. *Tetrahedron Lett.*, 1999, **40**, 4215.
152. Hell, Z., Finta, Z., Grunvald, T., Bocskei, Z. *Tetrahedron*, 1999, **55**, 1367.
153. Ennis, D. S., McManus, J., Wood-Kaczmar, W., Richardson, J., Smith, G. E., & Carstairs, A. *Org. Proc. Res. Dev.*, 1999, **3**, 248.
154. Abrecht, S. EP 864564 (to Hoffmann La Roche), 1998 [CA 129:216517].
155. Keller, W. E. *Phase Transfer Reactions, Fluka Compendium*, Vols 1-3. Georg Thieme, Stuttgart, 1986, 1987, 1992.
156. Dehmlow, E. V. In *Houben-Weyl: Methoden der Organischen Chemie*, Vol. E19b. Georg Thieme, Stuttgart, 1989, p. 1521.
157. Makosza, M. *Pure Appl. Chem.*, 1975, **43**, 439.
158. Maskoza, M., & Krylowa, I. *Tetrahedron*, 1999, **55**, 6395.
159. Novikov, M. S., Khelbnykov, A. F., Sidorina, E. S., & Kostikov, R. R. *J. Chem. Soc. Perkin Trans. 1*, 2000, 231.
160. Campbell, C. J., & Rusling, J. F. *Langmuir*, 1999, **15**, 7416.
161. Mathias, L. T., & Vaidya, R. A. *J. Am. Chem. Soc.*, 1986, **108**, 1093.

162. Fife, W. K., & Xin, Y. *J. Am. Chem. Soc.*, 1987, **109**, 1278.
163. Kuo, C. S., & Jwo, J. J. *J. Org. Chem.*, 1992, **57**, 1991.
164. Wang, M. L., Ou, C. C., & Jwo, J. J. *Ind. Eng. Chem. Res.*, 1994, **33**, 2034.
165. Wang, M. L., Ou, C. C., & Jwo, J. J. *Bull. Chem. Soc. Jpn.*, 1994, **67**, 2949.
166. Wang, M. L., Ou, C. C., & Jwo, J. J. *J. Mol. Catal.*, 1995, **99**, 153.
167. Wang, M. L., Ou, C. C., & Jwo, J. J. *Bull. Chem. Soc. Jpn.*, 1995, **68**, 2165.
168. Ou, J. S., Chen, R. H., & Jwo, J. J. *J. Mol. Catal. A: Chem.*, 1996, **110**, 95.
169. Chang, Y. S., & Jwo, J. J. *J. Mol. Catal.*, 2000, **160**, 357.
170. Liou, Y. M., & Jwo, J. J. *J. Chin. Inst. Chem. Eng.*, 1996, **27**, 405.
171. Hung, S. M., & Jwo, J. J. *J. Mol. Catal. A: Chem.*, 2000, **154**, 55.
172. Wang, M. L., Ou, C. C., & Jwo, J. J. *Chem. Eng. Commun.*, 1998, **165**, 151.
173. Wong, J. Y., & Jwo, J. J. *J. Mol. Catal. A: Chem.*, 1998, **132**, 155.
174. Asai, S., Nakamura, H., Okada, W., & Yamada, M. *Chem. Eng. Sci.*, 1995, **50**, 943.
175. Nakamura, H., Asai, S., & Yamada, M. *Chem. Eng. Sci.*, 1996, **51**, 1343.
176. Wang, M. L., Ou, C. C., & Jwo, J. J. *Chem. Eng. Commun.*, 2000, **179**, 233.
177. Wang, M. L., Ou, C. C., & Jwo, J. J. *J. Chin. Inst. Eng.*, 2000, **23**, 171.
178. Shaffer, T. D., & Kramer, M. C. *Makromol. Chem.*, 1990, **191**, 3157.
179. Takeishi, M., Se, K., Umetsu, N., & Sato, R. *Nipp. Kagaku Kaishi*, 1992, 824.
180. Trifonov, A. Z., & Nikiforov, T. T. *J. Mol. Catal.*, 1984, **24**, 15; Tanaka, N., Yamaguchi, A., Araki, Y., & Araki, M. *Chem. Lett.*, 1987, 715; Deratani, A., Lelievre, G., Maraldo, T., & Seville, B. *Carbohydr. Res.*, 1989, **192**, 215.
181. Trotta, F., Moraglio, G., & Rapposelli, A. *J. Inclus. Phenom. Mol. Recog. Chem.*, 1994, **20**, 353.
182. Hu, Y., Uno, M., Harada, A., & Takahashi, S. *Bull. Chem. Soc. Jpn.*, 1991, **64**, 1884.
183. Ravichandran, R., & Divakar, S. *J. Mol. Catal.*, 1994, **88**, L117.
184. Hu, Y., Harada, A., & Takahashi, S. *J. Mol. Catal.*, 1990, **60**, L13.
185. Trotta, F., Cantamessa, D., & Zanetti, M. *J. Inclus. Phenom. Mol. Recog. Chem.*, 2000, **37**, 83.
186. Hays, R. S., Hobbs, G. P., Kourouma, M., Ries, J. J. *et al. J. Mol. Catal. A: Chem.*, 1998, **129**, L123.
187. Boyer, B., Betzer, J. F., Lamaty, G., Leydet, A., & Roque, J. P. *New J. Chem.*, 1995, **19**, 807.
188. Boyer, B., Hamabardzoumian, A., Lamaty, G., Leydet, A., Roque, J. P., & Bouchet, P. *New J. Chem.*, 1996, **20**, 985.
189. Boyer, B., Hamabardzoumian, A., Roque, J. P., & Beylerian, N. *Tetrahedron*, 1999, **55**, 6147.
190. Boyer, B., Hamabardzoumian, A., Roque, J. P., & Beylerian, N. *Tetrahedron*, 2000, **56**, 303.
191. Hager, M., & Holmberg, K. *Tetrahedron Lett.*, 2000, **41**, 1245.
192. Neumann, R., & Sasson, Y. *J. Org. Chem.*, 1984, **49**, 3448; Wang, D. H., & Weng, H. S. *Chem. Eng. Sci.*, 1988, **43**, 2019; Nougouier, R., & Mchich, M. *Tetrahedron*, 1988, **44**, 2477; Corria, J. A. *J. Org. Chem.*, 1992, **57**, 4555.
193. Mason, D., Magdassi, S., & Sasson, Y. *J. Org. Chem.*, 1991, **56**, 7229.
194. Mason, D., PhD Thesis, The Hebrew University of Jerusalem, 1992.
195. Jin, G., Ido, T., & Goto, S. *J. Chem. Eng. Jpn.*, 1998, **31**, 741.
196. Ido, T., Kitamura, Y., & Goto, S. *Kagaku Kogaku Ronbunshu*, 1990, **16**, 388 [CA113:8361r].
197. Ido, T., Yamamoto, T., Jin, G., & Goto, S. *Chem. Eng. Sci.*, 1997, **52**, 3511.
198. Ido, T., Susaki, T., Jin, G., & Goto, S. *Appl. Catal. A: Gen.*, 2000, **201**, 139.
199. Correia, J. *J. Org. Chem.*, 1992, **57**, 4555.
200. Clark, J. H., Grigoropoulou, G., & Scott, K. *Synth. Commun.*, 2000, **30**, 3731.
201. Yang, H. M. *J. Chin. Inst. Eng.*, 1998, **21**, 399 [CA129:207741].
202. Wang, D. H., & Weng, H. S. *J. Chin. Inst. Chem. Eng.*, 1995, **26**, 147; Wang, D. H., & Weng, H. S. *Chem. Eng. Sci.*, 1995, **50**, 3477; Wang, D. H., & Weng, H. S. *J. Chin. Inst. Chem. Eng.*, 1996, **27**, 129; Wang, D. H., & Weng, H. S. *J. Chin. Inst. Chem. Eng.*, 1996, **27**, 419.
203. Hsiao, H. C., Kao, S. M., & Weng, H. S. *Ind. Eng. Chem. Res.*, 2000, **39**, 2772.
204. Jin, G., Ido, T., & Goto, S. *J. Chem. Eng. Jpn.*, 1999, **32**, 417.
205. Nishikubo, T., Kameyama, A., Yamashita, J., Fukumitsu, T., Maejima, C., & Tomoi, M. *J. Polym. Sci. A: Polym. Chem.*, 1995, **33**, 1011.
206. Grinberg, S., Kasyanov, V., & Srinivas, B. *React. Funct. Polym.*, 1997, **34**, 53.
207. Annunziata, R., Benaglia, M., Cinquini, M., Cozzi, F., & Tocco, G. *Org. Lett.*, 2000, **2**, 1737.
208. Sauvagnat, B., Lamaty, F., Lazaro, R., & Martinez, J. *Tetrahedron Lett.*, 1998, **39**, 821; Sauvagnat, B., Kulig, K., Lamaty, F., Lazaro, R., & Martinez, J. *J. Comb. Chem.*, 2000, **2**, 134; Sauvagnat, B., Lamaty, F., Lazaro, R., & Martinez, J. *Tetrahedron Lett.*, 2000, **41**, 6371.
209. Tomoi, M. In *Handbook of Phase Transfer Catalysis* (Sasson, Y., & Neumann, R., eds). Blackie A&P, London 1997, p. 424.
210. Glatzer, H. J., & Doraiswamy, L. K. *Chem. Eng. Sci.*, 2000, **55**, 5149.
211. Yadav, G. D., & Naik, S. S. *Org. Proc. Res. Dev.*, 2000, **4**, 807.

212. Varma, R. S., Naicker, K. P., & Aschberger, J. *Synthet. Commun.*, 1999, **29**, 2823; Varma, R. S., & Kumar, D. *Catal. Lett.*, 1998, **178**, 225; Varma, R. S., & Naicker, K. P. *Tetrahedron Lett.*, 1998, **39**, 2915; Varma, R. S., Naicker, K. P., & Kumar, D. *J. Mol. Catal. A: Chem.*, 1999, **149**, 153.
213. Balakrishnan, T., & Murugan, E. *J. Appl. Polym. Sci.*, 2000, **76**, 408.
214. Nelson, A. *Angew. Chem. Int. Ed.*, 1999, **38**, 1583.
215. Corey, E. J., Xu, F., & Noe, M. C. *J. Am. Chem. Soc.*, 1997, **119**, 12414.
216. Lygo, B., & Wainwright, P. G. *Tetrahedron Lett.*, 1997, **38**, 8595.
217. O'Donnell, M. J., Esikova, L. A., Mi, A., Shullenberger, D. F., & Wu, S. In *Phase Transfer Catalysis*, (Halpern, M., ed.), ACS Symp. 659. ACS, Washington, DC, 1997, p. 124.
218. Corey, E. J., Noe, M. C., & Xu, F. *Tetrahedron Lett.*, 1998, **39**, 5347.
219. Lygo, B., Crosby, J., & Peterson, J. A. *Tetrahedron Lett.*, 1999, **40**, 1385.
220. Lygo, B. *Tetrahedron Lett.*, 1999, **40**, 1389.
221. O'Donnell, M. J., Delgado, F., Hostettler, C., & Schwesinger, R. *Tetrahedron Lett.*, 1998, **39**, 8775.
222. Chinchilla, R., Mazon, P., & Najera, C. *Tetrahedron: Asymm.*, 2000, **11**, 3277.
223. Zhang, F. Y., & Corey, E. J. *Org. Lett.*, 2000, **2**, 1097.
224. Corey, E. J., & Zhang, F. Y. *Angew. Chem. Int. Ed.*, 1999, **38**, 1931.
225. Porter, M. J., & Skidmore, J. *Chem. Commun.*, 2000, 1215.
226. Lygo, B., & Wainwright, P. G. *Tetrahedron Lett.*, 1998, **39**, 1599; Lygo, B., & Wainwright, P. G. *Tetrahedron*, 1999, **55**, 6289.
227. Corey, E. J., & Zhang, F. Y. *Org. Lett.*, 1999, **1**, 1287.
228. Hughes, D. L., Smith, G. B., Liu, J., Dezeny, G. C., et al. *J. Org. Chem.*, 1997, **62**, 2222.
229. Arai, S., Tsuge, H., & Shioiri, T. *Tetrahedron Lett.*, 1998, **39**, 7563.
230. Arai, S., Oku, M., Miura, M., & Shioiri, T. *Synlett.*, 1998, 1201.
231. Arai, S., & Shioiri, T. *Tetrahedron Lett.*, 1998, **39**, 2145; Arai, S., Shirai, Y., Ishida, T., & Shioiri, T. *Tetrahedron*, 1999, **55**, 6375.
232. Hofstetter, C., Wilkinson, P. S., & Pochapsky, T. C. *J. Org. Chem.*, 1999, **64**, 8794.
233. Corey, E. J., Bo, Y., & Busch-Petersen, J. *J. Am. Chem. Soc.*, 1998, **120**, 13000.
234. Arai, S., Oku, M., Ishida, T., & Shioiri, T. *Tetrahedron Lett.*, 1999, **40**, 6785.
235. Arai, S., Hamaguchi, S., & Shioiri, T. *Tetrahedron Lett.*, 1998, **39**, 2997.
236. Perrard, T., Plaquevent, J. C., Desmurs, J. R., & Hebrault, D. *Org. Lett.*, 2000, **2**, 2959.
237. Ooi, T., Kameda, M., & Maruoka, K. *J. Am. Chem. Soc.*, 1999, **121**, 6915.
238. Ooi, T., Kameda, M., & Maruoka, K. *J. Am. Chem. Soc.*, 2000, **122**, 5228.
239. Belokon, Y. N., Kochetkov, K. A., Churkina, T. D., Ikonnikov, N. S., et al. *Tetrahedron: Asymm.*, 1998, **9**, 851.
240. Belokon, Y. N., Kochetkov, K. A., Churkina, T. D., Ikonnikov, N. S., Vysocil, S., & Kagan, H. B. *Tetrahedron: Asymm.*, 1999, **10**, 1723.
241. Belokon, Y. N., North, M., Kublitski, V. S., Ikonnikov, N. S., Krasik, P. E., & Maleev, V. I. *Tetrahedron Lett.*, 1999, **40**, 6105.
242. Bako, P., Kiss, T., & Toke, L. *Tetrahedron Lett.*, 1997, **38**, 7259; Bako, P., Vizvardi, K., Toppet, S., Van der Eycken, E., Hoornaret, G. J., & Toke, L. *Tetrahedron*, 1998, **54**, 14975; Bako, P., Novak, T., Ludanyi, K., Pete, B., Toke, L., & Keglevich, G. *Tetrahedron: Asymm.*, 1999, **10**, 2373; Bako, P., Czinege, E., Bako, T., Czugler, M., & Toke, L. *Tetrahedron: Asymm.*, 1999, **10**, 4539.
243. Manabe, K. *Tetrahedron*, 1998, **54**, 14465.
244. Tagle, L. H. In *Handbook of Phase Transfer Catalysis* (Sasson, Y., & Neumann, R., eds). Blackie A&P, London 1997, p. 200.
245. Balakrishnan, T., & Kumar, S. D. *J. Macromol. Sci. Pure*, 2000, **37**, 719; Balakrishnan, T., & Damodarkumar, S. *J. Appl. Polym. Sci.*, 2000, **76**, 1564; Park, S. W., Yang, S., & Park, S. H. *J. Polym. Sci. Polym. Chem. Ed.*, 1999, **37**, 3504; Park, S. W., Park, S. H., Kim, W., Suh, S. D., & Sohn, I. *J. Polym. Sci. Polym. Chem. Ed.*, 2000, **38**, 3543.
246. Reetz, M. T., & Ostarek, R. *Chem. Commun.*, 1988, 213.
247. Tagle, L. H., Vega, J. C., Diaz, F. R., Radic, D., Gargallo, L., & Valenzuela, P. *J. Macromol. Sci. Pure Appl. Chem.*, 2000, **37**, 997.
248. Tagle, L. H., Diaz, F. R., Cares, C., & Brito, A. *Polym. Bull.*, 1999, **42**, 627.
249. Tagle, L. H., Diaz, F. R., Cerda, G., Oyarzo, M., & Penafiel, G. *Polym. Bull.*, 1998, **40**, 35.
250. Tagle, L. H., Diaz, F. R., Cerda, G., Oyarzo, M., & Penafiel, G. *Polym. Bull.*, 1997, **39**, 9.
251. Levy, M., & Turri, S. *J. Polym. Sci. Polym. Chem. Ed.*, 1998, **36**, 939.
252. Yokozawa, T., & Suzuki, H. *J. Am. Chem. Soc.*, 1999, **121**, 11573.
253. Yokozawa, Y., Asai, T., Sugi, R., Ishigooka, S., & Hiroka, S. *J. Am. Chem. Soc.*, 2000, **122**, 8313.
254. Percec, V., Barboiu, B., & Van der Sluis, M. *Macromolecules*, 1998, **31**, 4053.
255. Shimada, S., Tabuchi, K., & Tsunooka, M. *J. Photopolym. Sci. Technol.*, 1999, **12**, 307.
256. Wang, C. Y., Wang, D. C., Chiu, W. Y., & Chen, L. W. *Angew. Makromol. Chem.*, 1997, **248**, 123.
257. Hirano, H., & Tanaka, M. *Angew. Makromol. Chem.*, 1999, **267**, 57.
258. Glula, G. P., Rickle, G. K., Smith, B. L., & Bales, S. E. US 5650479 (to Cyanara), 1997 [CA 127:162833].

259. Liaw, D. J., Liang, W. J., & Liaw, B. Y. *J. Polym. Sci. Polym. Chem. Ed.*, 1998, **36**, 103; Daudi, A., Buisine, J. M., Hurduc, N., & Simionescu, C. I. *J. Macromol. Sci., Pure Appl. Chem.*, 1998, **A35**, 151; Simionescu, C. I., Hurduc, N., Barboiu, V., Stoleru, A., & Scutaru, D. *Rev. Roum. Chim.*, 1997, **42**, 525 [CA 128:154467].
260. Thelakkat, M., Hagen, J., Haarer, D., & Schmidt, H. W. *Synth. Met.*, 1999, **102**, 1125.
261. Hacker, N. P., Figge, L. K., & Lefferts, S. WO 9847941 (to Allied Signal), 1998 [CA 129:316734].
262. Campbell, J. R., & Thackeray, J. W. US 4471105 (to GE Plastics), 1984; Boden, E. P., Phelps, P. D., Ramsey, D. L., Flowers, L. I., & Odle, R. R. US 5391692 (to GE Plastics), 1995.
263. Boden, E. P., Flowers, L. I., Odle, R. R., Phelps, P. D., Ramsey, D. L., & Sybert, P. D. US 5519105 (to GE Plastics), 1996; Boden, E. P., Flowers, L. I., Odle, R. R., Phelps, P. D., Ramsey, D. L., & Sybert, P. D. US 5739257 (to GE Plastics), 1998; [CA 128:257814]; Flowers, L. L., Sybert, P. D., & Ramsey, D. L. US 5744416 (to GE Plastics), 1998; Boden, E. P., Flowers, L. I., Odle, R. R., Phelps, P. D., Ramsey, D. L., & Sybert, P. D. US 5804525 (to GE Plastics), 1998.
264. Davis, G. C. US 5807965 (to GE Plastics), 1998 [CA 129:231175].
265. Ridgway, R. W., Greenside, H. S., & Freedman, H. H. *J. Am. Chem. Soc.*, 1976, **98**, 1979.
266. Liaw, D. J., & Chang, P. *J. Appl. Polym. Sci.*, 1997, **63**, 195; Liaw, D. J., & Chang, P. *Polymer*, 1997, **38**, 5545.
267. Brunelle, D. J. US 5229482 (to GE Plastics) 1993.
268. Caringi, J. J., Falor, G. R., Phelps, P. D., Guggenheim, T. L., Flowers, L. I., Brunelle, D. J., & Odle, R. R. US 5872294 (to GE Plastics), 1999 [CA 127:135560].
269. Brunelle, D. J. *Book of Abstracts, 214th ACS National Meeting*, Las Vegas, 1997, ORGN-131.
270. Schmidhauser, J. C., & Brunelle, D. J. US 5830974 (to GE Plastics), 1998.
271. Brunelle, D. J. EP 908485 (to GE Plastics), 1999 [CA 130:282532].
272. Inbasekaran, M., Wu, W., & Woo, E. P. US 5777070 (to Dow), 1998 [CA 129:123010].
273. Hacker, N. P., Lefferts, S., & Figge, L. K. WO 9847944 (to Allied Signal), 1998 [CA 129:316735]; Hacker, N. P., Figge, L. K., & Lefferts, S. WO 9847941 (to Allied Signal), 1998 [CA 129:316734].
274. Miki, A., Tsuchihashi, H., Yamano, H., & Yamashita, M. *Anal. Chim. Acta*, 1997, **356**, 165.
275. Miki, A., Nishikawa, M., & Tsuchihashi, H. *J. Health Sci.*, 2000, **46**, 81 [CA 132:261452].
276. Kage, S., Kudo, K., & Ikeda, N. *J. Anal. Toxicol.*, 2000, **24**, 429.
277. Miki, A., Katagi, M., Tsuchihashi, H., & Yamashita, M. *J. Anal. Toxicol.*, 1999, **23**, 86.
278. Miki, A., Tsuchihashi, H., & Yamashita, M. *J. Anal. Toxicol.*, 1998, **22**, 237.
279. Miki, A., & Tsuchihashi, H. *Jpn. J. Forens. Toxicol.*, 1999, **17**, 14 [CAPLUS 1999:416934].
280. Everhart, E. T., Shwonek, P., Jacob, P., Rowbotham, M. C., & Jones, R. T. *J. Chromatog. B.*, 1999, **729**, 173.
281. Lee, A. W. M., Liu, L., Lau, D., & Chan, R. *Anal. Lett.*, 1999, **32**, 1235.
282. Chen, S. H., Wu, H. L., Yen, C. H., Wu, S. M., Lin, S. J., & Kou, H. S. *J. Chromatogr. A*, 1998, **799**, 93.
283. Maurer, H. H., & Arlt, J. W. *J. Anal. Toxicol.*, 1999, **23**, 73.
284. Maurer, H. H., Kraemer, T., & Arlt, J. W. *Ther. Drug. Monit.*, 1998, **20**, 706 [CAPLUS 1998:805694].
285. Rahavendran, S. V., & Karnes, H. T. *Anal. Chem.*, 1997, **69**, 3022.
286. Grasset, L., & Ambles, A. *Org. Geochem.*, 1998, **29**, 881.
287. Kaur, J., Sodhi, G. S., & Nath, S. *Sci. Justice*, 1996, **36**, 267 [CA 126:208276].
288. Horvath, I. T., Kiss, G., Cook, R. A., Bond, J. E., et al. *J. Am. Chem. Soc.*, 1998, **120**, 3133; Hope, E. G., & Stuart, A. M., *J. Fluor. Chem.*, 1999, **100**, 75; Fish, R. H. *Chem. Eur. J.*, 1999, **5**, 1677; Horvath, I. T. *Acc. Chem. Res.*, 1998, **31**, 641; Richter, B., de Wolf, E., van, Koten, G., & Deelman, B. J. *J. Org. Chem.*, 2000, **65**, 3885; Cavazzini, M., Montanari, F., Pozzi, G., & Quici, S. *J. Fluor. Chem.*, 1999, **94**, 183.
289. Jacobson, G. B., Lee, C. T., Johnston, K. P., & Tumas, W. *J. Am. Chem. Soc.*, 1999, **121**, 11902; Jacobson, G. B., Lee, C. T., & Johnston, K. P. *J. Org. Chem.*, 1999, **64**, 1201; Jacobson, G. B., Lee, C. T., daRocha, S. R. P., & Johnston, K. P. *J. Org. Chem.*, 1999, **64**, 1207; Bonilla, R. J., James, B. R., & Jessop, P. G. *Chem. Commun.*, 2000, 941.
290. Mathews, C. J., Smith, P. J., & Welton, T. *Chem. Commun.*, 2000, 1249; de Bellefon, C., Pollet, E., & Grenouillet, P. *J. Mol. Catal. A: Chem.*, 1999, **145**, 121; Dullius, J. E. L., Suarez, P. A. Z., Einloft, S., de Souza, R. F., *Organometallics*, 1998, **17**, 815.
291. Goldberg, Y., & Alper, H. In *Applied Homogeneous Catalysis* (Cornils, B., & Herrmann, W. A., eds). Verlag Chemie, Weinheim, 1996, p. 844.
292. Amer, I. In *Handbook of Phase Transfer Catalysis* (Sasson, Y., & Neumann, R., eds). Blackie A&P, London, 1997, p. 336.
293. Okano, T. In *Aqueous Phase Organometallic Catalysis* (Cornils, B., & Herrmann, W. A., eds). Wiley-VCH, Weinheim, 1998, p. 221.
294. Kuntz, E. G. *Chem. Tech.*, 1987, **17**, 570; Cornils, B., & Kuntz, E. G. *J. Organomet. Chem.*, 1995, **502**, 177.
295. Cornils, B. *Org. Proc. Res. Dev.*, 1998, **2**, 121; Cornils, B. *J. Mol. Catal. A: Chem.*, 1999, **143**, 1; Cornils, B., & Herrmann, W. A. *Applied Homogeneous Catalysis*. VCH, Weinheim, 1996, p. 575; Wachsen, O., Himmler, K., & Cornils, B. *Catal. Today*, 1998, **42**, 373; Cornils, B., & Wiebus, E. *Chemtech*, 1995, **25**, 33; Cornils, B., Herrmann, W. A., & Eckl, R. W. *J. Mol. Catal. A: Chem.*, 1997, **116**, 27.
296. Joo, F., & Katho, A. *J. Mol. Catal. A: Chem.*, 1997, **116**, 3; Joo, F., Papp, E., & Katho, A. *Top. Catal.*, 1998, **5**,

- 113; Joo, F., Kovacas, J., Katho, A., Benyei, A. C., Decuir, T., & Darensbourg, D. J. *Inorg. Synth.*, 1998, **32**, 1.
297. Kalck, P., & Monteil, F., *Adv. Organomet. Chem.*, 1992, **34**, 219.
298. Herrmann, W. A., & Kohlpaintner, C. W. *Angew. Chem. Int. Ed.*, 1993, **32**, 1524.
299. Sinou, D. *Top. Curr. Chem.*, 1999, **206**, 41.
300. Henson, B. E. *Coord. Chem. Rev.*, 1999, **186**, 795.
301. Nomura, K. *J. Mol. Catal. A: Chem.*, 1998, **130**, 1.
302. Bertoux, F., Monflier, E., Castanet, Y., & Mortreux, A. *J. Mol. Catal. A: Chem.*, 1999, **143**, 11.
303. Driessen-Holscher, B. *Adv. Catal.*, 1998, **42**, 473.
304. Herrmann, W. A., Kellner, J., & Riepl, H. J. *Organomet. Chem.*, 1990, **389**, 103.
305. Beller, M., Krauter, J. G. E., Zapf, A., & Bogdanovic, S. *Catal. Today*, 1999, **48**, 279; Yan, Y. Y., & RajanBabu, T. V. *J. Org. Chem.*, 2000, **65**, 900; Shin, S., & RajanBabu, T. V. *Org. Lett.*, 1999, **1**, 1229.
306. Reetz, M. T. *J. Heterocyc. Chem.*, 1998, **35**, 1065; Reetz, M. T., & Frombgen, C. *Synthesis*, 1999, 1555.
307. Goedheijt, M. S., Reek, J. N. H., Kamer, P. C. J., & van Leeuwen, P. W. N. M. *Chem. Commun.*, 1998, 2431; Goedheijt, M. S., Kamer, P. C. J., & van Leeuwen, P. W. N. M. *J. Mol. Catal. A: Chem.*, 1999, **134**, 243.
308. Gelpke, A. E. S., Veerman, J. J. N., Goedheijt, M. S., Kamer, P. C. J., van Leeuwen, P. W. N. M., & Hiemstra, H. *Tetrahedron*, 1999, **55**, 6657.
309. Krauter, J. G. E., & Beller, M. *Tetrahedron*, 2000, **56**, 771.
310. Mudalige, D. C., & Rempel, G. L. *J. Mol. Catal. A: Chem.*, 1997, **116**, 309; Mudalige, D. C., & Rempel, G. L. *J. Mol. Catal.*, 1997, **123**, 15.
311. Hanson, B. E., Ding, H., & Kohlpaintner, C. W. *Catal. Today*, 1998, **42**, 421.
312. Bergbreiter, D. E. *Catal. Today*, 1998, **42**, 389.
313. Borrmann, T., Roesky, H. W., & Ritter, U. *J. Mol. Catal. A: Chem.*, 2000, **153**, 31.
314. Malmstrom, T., & Andersson, C. *J. Mol. Catal. A: Chem.*, 2000, **157**, 79.
315. Danjo, H., Tanaka, D., Hayashi, T., & Uozumi, Y. *Tetrahedron*, 1999, **55**, 14341.
316. Malmstrom, T., Andersson, C., & Hjortkjaer, J. *J. Mol. Catal. A: Chem.*, 1999, **139**, 139.
317. Näit-Ajjou, A., & Alper, H. *J. Am. Chem. Soc.*, 1998, **120**, 1466.
318. Marchetti, M., Mangano, G., Paganelli, S., & Botteghi, C. *Tetrahedron Lett.*, 2000, **41**, 3717.
319. Fermy, G., Monflier, E., Carpentier, J. F., Castanet, Y., & Mortreux, A. *J. Mol. Catal. A: Chem.*, 1998, **129**, 35.
320. Chaudhari, R. V., Bhanage, B. M., Deshpande, R. M., & Delmas, H. *Nature*, 1995, **373**, 501; Kalck, P., Dessoudeix, M., & Schwartz, S. *J. Mol. Catal. A: Chem.*, 1999, **143**, 41.
321. Kalck, P., Miquel, L., & Dessoudeix, M. *Catal. Today*, 1998, **42**, 431; Tilloy, S., Bertoux, F., Mortreux, A., & Monflier, E. *Catal. Today*, 1999, **48**, 245; Monflier, E., Fermy, G., Castanet, Y., & Mortreux, A. *Angew. Chem. Int. Ed.*, 1995, **34**, 2269; Monflier, E., Tilloy, S., Fermy, G., Castanet, Y., & Mortreux, A. *Tetrahedron Lett.*, 1995, **36**, 9481.
322. Zhong, Y. P., Godfrey, V. M., Lim, P. K., & Brown, P. A., *Chem. Eng. Sci.*, 1996, **51**, 757; Chen, H., Li, Y. Z., Chen, J. R., Cheng, P. M., He, Y. E., & Li, H. J. *J. Mol. Catal. A: Chem.*, 1999, **149**, 1.
323. Deshpande, R. M., Purwanto, P., Delmas, H., & Chaudhari, R. V. *Ind. Eng. Chem. Res.*, 1996, **35**, 3927; Purwanto, P., & Delmas, H. *Catal. Today*, 1995, **24**, 135.
324. Nair, V. S., Bhanage, B. M., Deshpande, R. M., & Chaudhari, R. V. *Stud. Surf. Sci. Catal.*, 1998, **113**, 529.
325. Kalke, P., Escaffre, P., Serein-Spriau, F., Thorez, A., et al. *New J. Chem.*, 1988, **12**, 687.
326. Shimizu, S., Shirakawa, S., Sasaki, S., & Hirai, C. *Angew. Chem. Int. Ed.*, 2000, **39**, 1256.
327. Goedheijt, M. S., Hanson, B. E., Reek, J. N. H., Kamer, P. C. J., & van Leeuwen, P. W. N. M. *J. Am. Chem. Soc.*, 2000, **122**, 1650.
328. Kalck, P., & Dessoudeix, M. *Coord. Chem. Rev.*, 1999, **192**, 1185.
329. Leese, M. P., & Williams, J. M. J. *Synlett*, 1999, 1645.
330. Jin, Z. L., Yan, Y. Y., Zuo, H. P., & Fell, B. *J. Prakt. Chem.—Chem. Zeit.*, 1996, **338**, 124; Jin, Z. L., Zheng, X. L., & Fell, B. *J. Mol. Catal. A: Chem.*, 1997, **116**, 55.
331. Zheng, X. L., Jiang, J. Y., Liu, X. Z., & Jin, Z. L. *Catal. Today*, 1998, **44**, 175.
332. Chen, R. F., Jiang, J. Y., Wang, W. H., & Jin, Z. L. *J. Mol. Catal. A: Chem.*, 1999, **149**, 113.
333. Yang, Y. H., Jiang, J. Y., Zhang, R., Liu, H. X., & Jin, Z. L. *J. Mol. Catal. A: Chem.*, 2000, **157**, 111.
334. Gartner, R., Cornils, B., Springer, H., & Lappe, P. EP 0107006 (to Ruhrchemie), 1982.
335. Fell, B., Papadogianakis, G., Konkol, W., Weber, J., & Bahrmann, H. *J. Prakt. Chem.—Chem. Zeit.*, 1993, **335**, 75.
336. Bahrmann, H. In *Applied Homogeneous Catalysis* (Cornils, B., & Herrmann, W. A., eds). Verlag Chemie, Weinheim, 1996, p. 644.
337. Trinkhaus, S., Holz, J., Selke, R., & Borner, A. *Tetrahedron Lett.*, 1997, **38**, 807.
338. Miquel-Serrano, M. D., Masdeu-Bulto, A. M., Claver, C., & Sinou, D. *J. Mol. Catal. A: Chem.*, 1999, **143**, 49; Miquel-Serrano, M. D., Aghmiz, A., Dieguez, M., Masdeu-Bulto, A. M., Claver, C., & Sinou, D. *Tetrahedron: Asymm.*, 1999, **10**, 4463; Gelpke, A. E. S., Kooijman, H., Spek, A. L., & Hiemstra, H. *Chem. Eur. J.*, 1999, **5**, 2472; Eckl, R. W., Priermeier, T., & Herrmann, W. A. *J. Organomet. Chem.*, 1997, **532**, 243.
339. Trinkhaus, S., Kadyrov, R., Selke, R., Holt, J., Gotze, G., & Borner, A. *J. Mol. Catal. A: Chem.*, 1999, **144**, 15.

340. Yonehara, K., Hashizume, T., Mori, K., Ohe, K., & Uemura, S. *J. Org. Chem.*, 1999, **64**, 5593; Yonehara, K., Ohe, K., & Uemura, S. *J. Org. Chem.*, 1999, **64**, 9381; Holz, J., Heller, D., Sturmer, R., & Borner, A. *Tetrahedron Lett.*, 1999, **40**, 7059.
341. Karakhanov, E., Maximov, A., & Krillov, A. *J. Mol. Catal. A: Chem.*, 2000, **157**, 25.
342. Widehem, R., Lacroix, T., Bricout, H., & Monflier, E. *Synlett*, 2000, 722.
343. Monflier, E., Tilloy, S., Bertoux, F., Castanet, Y., & Morteux, A. *New J. Chem.*, 1997, **21**, 857.
344. Monflier, E., Tilloy, S., Castanet, Y., & Morteux, A. *Tetrahedron Lett.*, 1998, **39**, 2959.
345. Monflier, E., Tilloy, S., Meliet, C., Morteux, A., et al. *New J. Chem.*, 1999, **23**, 469.
346. Lacroix, T., Bricout, H., Tilloy, S., & Monflier, E. *Eur. J. Org. Chem.*, 1999, **5**, 3127.
347. Jeffery, T. *J. Chem. Soc., Chem. Commun.*, 1984, 1287.
348. Jeffery, T. *Tetrahedron Lett.*, 1994, **35**, 3051; Gron, L. U., & Tinsley, A. S. *Tetrahedron Lett.*, 1999, **40**, 227.
349. Amatore, C., & Jutand, A. *Acc. Chem. Res.*, 2000, **33**, 314; Shaw, B. L. *New J. Chem.*, 1998, **22**, 77.
350. Jeffery, T. *Tetrahedron*, 1996, **52**, 10113.
351. Jeffery, T., & David, M. *Tetrahedron Lett.*, 1998, **39**, 5751.
352. Jeffery, T. *Tetrahedron Lett.*, 1999, **40**, 1673.
353. Nguéfacq, J. F., Bolitt, V., & Sinou, D. *Tetrahedron Lett.*, 1996, **37**, 5527.
354. Lavenot, L., Gozzi, C., Ilg, K., Orlova, I., Penalva, V., & Lemaire, M. *J. Organomet. Chem.*, 1998, **567**, 49.
355. Penalava, V., Lavenot, L., Gozzi, C., & Lemaire, M. *Appl. Catal. A: Gen.*, 1999, **182**, 399.
356. Sauvagant, B., Lamaty, F., Lazaro, R., & Martinez, J. *C.R. Acad. Sci. II CI*, 1998, 777.
357. Reetz, M. T., Lohmer, G., & Schwickardi, R. *Angew. Chem. Int. Ed.*, 1998, **37**, 481.
358. Reetz, M. T., & Wastermann, E. *Angew. Chem. Int. Ed.*, 2000, **39**, 165.
359. Gurtler, C., & Buchwald, S. L. *Chem. Eur. J.*, 1999, **5**, 3107.
360. Buchmeiser, M. R., & Wurst, K. *J. Am. Chem. Soc.*, 1999, **121**, 11101.
361. Blum, J., Amer, I., Zoran, A., & Sasson, Y. *Tetrahedron Lett.*, 1983, **24**, 4139.
362. Blum, J. *Izv. Akad. Nauk. Ser. Khim.*, 1993, 1697.
363. Blum, J., Pri-Bar, I., & Alper, H. *J. Mol. Catal.*, 1986, **37**, 359; Blum, J., Bitan, G., Marx, S., & Vollhardt, K. P. C. *J. Mol. Catal.*, 1991, **66**, 313.
364. Azran, J., Buchman, O., Amer, I., & Blum, J. *J. Mol. Catal.*, 1986, **34**, 229; Amer, I., Bravdo, T., Blum, J., & Vollhardt, K. P. C. *Tetrahedron Lett.*, 1987, **28**, 1321.
365. Amer, I., Amer, H., & Blum, J. *J. Mol. Catal.*, 1986, **34**, 221; Blum, J., Amer, I., Vollhardt, K. P. C., Schwarz, H., & Hoehne, G. *J. Org. Chem.*, 1987, **52**, 2804; Amer, I., Amer, H., Ascher, R., Blum, J., Sasson, Y., & Vollhardt, K. P. C. *J. Mol. Catal.*, 1987, **39**, 185.
366. Amer, I., Bernstein, T., Eisen, M., Blum, J., & Vollhardt, K. P. C. *J. Mol. Catal.*, 1990, **60**, 313.
367. Badrieh, Y., Blum, J., Amer, I., & Vollhardt, K. P. C. *J. Mol. Catal.*, 1991, **66**, 295; Badrieh, Y., Greenwald, A., Schumann, H., & Blum, J. *Chem. Ber.*, 1992, **125**, 667; Baidossi, W., Schumann, H., & Blum, J. *Tetrahedron*, 1996, **52**, 8349.
368. Badrieh, Y., Blum, J., & Schumann, H. *J. Mol. Catal.*, 1994, **90**, 231.
369. Blum, J., Rosenfeld, A., Polak, N., Israelson, O., Scumann, H., & Avnir, D. *J. Mol. Catal.*, 1996, **107**, 217; Rosenfeld, A., Blum, J., & Avnir, D. *J. Catal.*, 1996, **164**, 363; Blum, J., Rosenfeld, A., Gelman, F., Schumann, H., & Avnir, D. *J. Mol. Catal. A: Chem.*, 1999, **146**, 117.
370. Weddle, K. S., Aiken III, J. D., & Finke, R. G. *J. Am. Chem. Soc.*, 1998, **120**, 5653.
371. Deshpande, V. M., Singh, P., & Narasimhan, C. S. *Chem. Commun.*, 1990, 1181.
372. Bonnemann, H., Brijoux, W., Brinkmann, R., Dinjus, E., Jousen, T., & Korall, B. *Angew. Chem. Int. Ed.*, 1991, **30**, 1312; Bonnemann, H., Brinkmann, R., Koppler, R., Neiteler, P., & Richter, J. *Adv. Mater.*, 1992, **4**, 804; Bonnemann, H., Brijoux, W., Brinkmann, R., Fretzen, R. et al. *J. Mol. Catal.*, 1994, **86**, 129.
373. Reetz, M. T., Helbig, W., Quaiser, S. A., Stimming, U., Breuer, N., & Vogel, R. *Science*, 1995, **267**, 367.
374. Bradley, J. S., Tesche, B., Busser, W., Masse, M., & Reetz, M. T. *J. Am. Chem. Soc.*, 2000, **122**, 4631.
375. Reetz, M. T., Breinbauer, R., Wedemann, P., & Binger, P. *Tetrahedron*, 1998, **54**, 1233.
376. Reetz, M. T., & Dugal, M. *Catal. Lett.*, 1999, **58**, 207.
377. Fokema, M. D., Chiu, E., & Ying, J. Y. *Langmuir*, 2000, **16**, 3145.
378. Schulz, J., Roucoux, A., & Patin, H. *Chem. Eur. J.*, 2000, **6**, 618.
379. Aiken III, J. D., & Finke, R. G. *J. Mol. Catal. A: Chem.*, 1999, **145**, 1.
380. Zhao, M., Sun, L., & Crooks, R. M. *J. Am. Chem. Soc.*, 1998, **120**, 4877.
381. Chechik, V., Zhao, M., & Crooks, R. M. *J. Am. Chem. Soc.*, 1999, **121**, 4910.
382. Rothenberg, G., Barak, G., & Sasson, Y. *Tetrahedron*, 1999, **55**, 6301.
383. Marques, C. A., Selva, M., & Tundo, P. *J. Chem. Soc., Perkin Trans. I*, 1993, 529.
384. Marques, C. A., Selva, M., & Tundo, P. *J. Org. Chem.*, 1993, **58**, 5256.
385. Marques, C. A., Selva, M., & Tundo, P. *J. Org. Chem.*, 1994, **59**, 3830.
386. Marques, C. A., Rogozhnikova, O., Selva, M., & Tundo, P. *J. Mol. Catal. A: Chem.*, 1995, **96**, 301.
387. Marques, C. A., Selva, M., & Tundo, P. *J. Org. Chem.*, 1995, **60**, 2430.
388. Selva, M., Tundo, P., & Perosa, A. *J. Org. Chem.*, 1998, **63**, 3266.

389. Perosa, A., Selva, M., & Tundo, P. *J. Org. Chem.*, 1999, **64**, 3934.
390. Sabahi, M. WO 9850334 (to Albemarle), 1998 [CA 129:316051].
391. Bamfield, P., & Quan, P. M. *Synthesis*, 1978, 537.
392. Hassan, J., Penalva, V., Lavenot, L., Gozzi, C., & Lemaire, M. *Tetrahedron*, 1998, **54**, 13793.
393. Mukhopadhyay, S., Rothenberg, Wiener, H., & Sasson, Y. *Tetrahedron*, 1999, **55**, 14763.
394. Mukhopadhyay, S., Rothenberg, G., Gitis, D., Wiener, H., & Sasson, Y. *J. Chem. Soc., Perkin Trans. 2*, 1999, 2481.
395. Mukhopadhyay, S., Rothenberg, G., Wiener, H., & Sasson, Y. *New J. Chem.*, 2000, **24**, 305.
396. Wiener, H., Sasson, Y., & Blum, J. *J. Mol. Catal.*, 1986, **35**, 377.
397. Venkatraman, S., & Li, C.-J. *Tetrahedron Lett.*, 2000, **41**, 4831.
398. Mukhopadhyay, S., Rothenberg, G., & Sasson, Y. *Adv. Synth. Catal.*, 2001, **343**, 274.
399. Mukhopadhyay, S., Rothenberg, G., Gitis, D., Baidossi, M., Ponde, D. E., & Sasson, Y. *J. Chem. Soc., Perkin Trans. 2*, 2000, 1809.
400. Shiotani, A., Itatani, H., & Inagaki, T. *J. Mol. Catal.*, 1986, **34**, 57.
401. Sherman, S. C., Iretskii, A. V., White, M. G., & Schiraldi, D. A. *Chem. Innov.*, 2000, **July**, 25.
402. Mukhopadhyay, S., Rothenberg, G., Gitis, D., & Sasson, Y. *J. Org. Chem.*, 2000, **65**, 3107.
403. Yonezawa, T., Tominaga, T., & Richard, D. *J. Chem. Soc., Dalton Trans.*, 1996, 783.
404. Reetz, M. T., Winter, M., & Tesche, B. *Chem. Commun.*, 1997, 147.
405. Kolb, U., Quaiser, S. A., Winter, M., & Reetz, M. T. *Chem. Mater.*, 1996, **8**, 1889.
406. Ait-Mohand, S., Henin, F., & Muzart, J. *Tetrahedron Lett.*, 1995, **36**, 2473.
407. Bouquillon, S., du Moulinet d'Hardemare, A., Averbuch-Pouchot, M. T., Henin, F., & Muzart, J. *Polyhedron*, 1999, **18**, 3511.
408. Shiraishi, Y., Toshima, N., Kawamura, T., Mihori, H., Shirai, H., & Hirai, H. *J. Mol. Catal. A: Chem.*, 1999, **139**, 149.
409. Shiraishi, Y., Tomita, H., Fujiki, K., & Hirai, H. *React. Funct. Polym.*, 1998, **36**, 99.
410. Hirai, H. *Polym. Adv. Technol.*, 1997, **8**, 666; Shiraishi, Y., Kojima, S., Tomita, H., Ohsuka, H. *et al. Polym. J.*, 1996, **28**, 619.
411. Shiraishi, Y., Tashiro, S., & Toshima, N. *Chem. Lett.*, 2000, 828.
412. Bellino, M. T., Levin, R. H., Luo, W., & Mosier, S. T. US 6114583 (to Lexmark), 2000 [CAPLUS 2000:622488].
413. Li, X., Mintz, E. A., Bu, X. R., Zehnder, O., Bosshard, C., & Gunter, P. *Tetrahedron*, 2000, **56**, 5785; Li, X., Santos, J., & Bu, X. R. *Tetrahedron Lett.*, 2000, **41**, 4057.
414. Lawin, P. B., Yang, Z. J., Hillstrom, G. F., Gregory, F., & Cruskie, M. P. Jr. US 6051714 (to Rilley), 2000 [CA 132:266774].
415. Hoerold, S., Weferling, N., & Breuer, H. P. DE 19828861 (to Clariant), 1998 [CA 132:12410].
416. Hu, X., Tian, Z., Chen, Y., & Lu, X. *Synth. Commun.*, 2000, **30**, 523; Wang, J. X., Bai, L., & Liu, Z. *Synth. Commun.*, 2000, **30**, 971.
417. Schrader, S., & Dehmlow, E. V. *Org. Prep. Proc. Int.*, 2000, **32**, 123.
418. Venturello, C., Alneri, E., & Ricci, M. *J. Org. Chem.*, 1983, **48**, 3831; Venturello, C., & Ricci, M. *J. Org. Chem.*, 1986, **51**, 1599; Ishii, Y., Yamawaki, T., Ura, H., Yamada, H., & Ogawa, M. *J. Org. Chem.*, 1988, **53**, 3587.
419. Duncan, D. C., Chambers, R. C., Hecht, E., & Hill, C. L. *J. Am. Chem. Soc.*, 1995, **117**, 681.
420. Salles, L., Piquemal, J. Y., Thouvenot, R., Minot, C., & Bregeault, J. M. *J. Mol. Catal. A: Chem.*, 1997, **117**, 375.
421. Sakaguchi, S., Nishiyama, Y., & Ishii, Y. *J. Org. Chem.*, 1996, **61**, 5307.
422. Yamamoto, H., Tsuda, M., Sakaguchi, S., & Ishii, Y. *J. Org. Chem.*, 1997, **62**, 7174.
423. Yadav, G. D., & Satoskar, D. V. *J. Am. Oil Chem. Soc.*, 1997, **74**, 397.
424. Sakaguchi, S., Yamamoto, Y., Sugimoto, T., Yamamoto, H., & Ishii, Y. *J. Org. Chem.*, 1999, **64**, 5954.
425. Crivello, J. V., & Chakrapani, S. US 6051725 (to Caschem), 2000 [CA 132:265441].
426. Salles, L., Bregeault, J. M., & Thouvenot, R. *C.R. Acad. Sci. Ser. Iic: Chim*, 2000, **3**, 183.
427. Ohtake, H., Imada, Y., & Murahashi, S.-I. *Bull. Chem. Soc. Jpn.*, 1999, **72**, 2737.
428. Colloins, F. M., Lucy, A. R., & Sharp, C. *J. Mol. Catal. A: Chem.*, 1997, **117**, 397.
429. Sato, K., Aoki, M., Ogawa, M., Hashimoto, T., & Noyori, R. *J. Org. Chem.*, 1996, **61**, 8310.
430. Sato, K., Aoki, M., Ogawa, M., Hashimoto, T., Panyella, D., & Noyori, R. *Bull. Chem. Soc. Jpn.*, 1997, **70**, 905.
431. Sato, K., Aoki, M., Takagi, J., & Noyori, R. *J. Am. Chem. Soc.*, 1997, **117**, 12386; Sato, K., Aoki, M., Takagi, J., Zimmermann, K., & Noyori, R. *Bull. Chem. Soc. Jpn.*, 1999, **72**, 2287.
432. Sato, K., Takagi, J., Aoki, M., & Noyori, R. *Tetrahedron Lett.*, 1998, **39**, 7549.
433. Sato, K., Hyodo, M., Takagi, J., Akoi, M., & Noyori, R. *Tetrahedron Lett.*, 2000, **41**, 1439.
434. Sato, K., Aoki, M., & Noyori, R. *Science*, 1998, **281**, 1646.
435. Nuchter, M., Ondruschka, B., Jungnickel, A., & Muller, U. *J. Phys. Org. Chem.*, 2000, **13**, 579.
436. Yadav, G. D., & Pujari, A. A. *Org. Proc. Res. Dev.*, 2000, **4**, 88.

437. Ricci, M., & Battistel, E. *Chim. Ind. (Milan)*, 1997, **79**, 879.
438. Deshmukh, A. P., Kamlesh, J., Jadhav, V. K., Vidyadhar, K., & Salunhke, M. M. *J. Chem. Res. (S)*, 1998, 828.
439. Mukhopadhyay, S., Mukhopadhyaya, K. J., Ponde, D. E., Cohen, S., & Kurkalli, B. G. S. *Org. Proc. Res. Dev.*, 2000, **4**, 509.
440. Ikura, K., & Katsumata, N. JP 11180956 (to Daciel), 1999 [CA 131:44737].
441. Zawadiak, J., Gilner, D., & Mazurkiewicz, R. *Tetrahedron Lett.*, 1999, **40**, 4059.
442. Feldberg, L., & Sasson, Y. *Tetrahedron Lett.*, 1996, **37**, 2063.
443. Rothenberg, G., Feldberg, L., Wiener, H., & Sasson, Y. *J. Chem. Soc., Perkin Trans. 2*, 1998, 2429.
444. Shimokawadoko, T., Yutsu, S., & Ogata, K. JP 08245462 (to Osaka Gas), 1996 [CA 126:7811].
445. Shimokawadoko, T., & Okimi, K. JP 07267923 (to Osaka Gas), 1995 [CA 124:201800].
446. Csanyi, L. J., & Jaky, K. *J. Mol. Catal. A: Chem.*, 1997, **120**, 125; Csanyi, L. J., Jaky, K., Karoly, P., Istvan, R. A., & Korecz, L. *Phys. Chem. Chem. Phys.*, 2000, **2**, 3801.
447. Takshira, A., Masaki, S., & Maruyama, O. US 5166451 (to Sumitomo Chemicals), 1994 [CA 118:212669].
448. Hashimoto, T., Nakamura, K., & Takagawa, M. JP 08311031 (to Mitsubishi Gas), 1996 [CA126:89272].
449. Csanyi, L. J., & Jaky, K. *J. Mol. Catal. A: Chem.*, 1999, **145**, 229.
450. Pearson, D. L., Tai, J. J., & Adaway, T. J. WO 9900392 (to Dow Agrosiences), 1999 [CA 130:81524].
451. Abele, E., Abele, R., & Lukevics, E. *J. Chem. Res. (S)*, 1999, 624.
452. Jonczyk, A., Szymanek, P., & Juszczuk, C. *Pol. J. Chem.*, 2000, **74**, 985.
453. Schreiner, P. R., Lauenstein, O., Kolomitsyn, I. V., Ndi, S., & Fokin, A. A. *Angew. Chem. Int. Ed.*, 1998, **37**, 1895.
454. Schreiner, P. R., Lauenstein, O., Butova, E. D., & Fokin, A. A. *Angew. Chem. Int. Ed.*, 1999, **38**, 2786.
455. Lauenstein, O., Fokin, A. A., & Schreiner, P. R. *Org. Lett.*, 2000, **2**, 2201.
456. Hell, Z., Finta, Z., & Toke, L. *Synth. Commun.*, 1997, **27**, 405.
457. Tanaka, T. JP 09188647 (to Mitsubishi Chemical), 1997 [CA 127:161593].
458. Dailey, J. I., Hays, R. S., Lee, H., Mitchell, R. M., Ries, J. J., & Landolt, R. G. *J. Org. Chem.*, 2000, **65**, 2568.
459. Rothenberg, G., & Sasson, Y. *Tetrahedron*, 1996, **52**, 13641.
460. Sasson, Y., El Aziz El Quantar, A., & Zoran, A. *Chem. Commun.*, 1998, 73.
461. Dillow, A. K., Yun, S. L. J., Suleiman, D., Boatright, D. L., Liotta, C. L., & Eckert, C. A. *Ind. Eng. Chem. Res.*, 1996, **35**, 1801.
462. Chandler, K., Culp, C. W., Lamb, D. R., Liotta, C. L., & Eckert, C. A. *Ind. Eng. Chem. Res.*, 1998, **37**, 3252.
463. Huddleston, J. G., & Rogers, R. D. *J. Chem. Soc., Chem. Commun.*, 1998, 1765.
464. Carmichael, A. J., Earle, M. J., Holbrey, J. D., McCormac, P. B., & Seddon, K. R. *Org. Lett.*, 1999, **1**, 997.
465. Howarth, J., & Dallas, A. *Molecules*, 2000, **5**, 851.
466. Carmichael, A. J., Haddleton, D. M., Bon, S. A. F., & Seddon, K. R. *Chem. Commun.*, 2000, 1237.
467. Bohm, V. P. W., & Herrmann, W. A. *Chem. Eur. J.*, 2000, **6**, 1017.
468. Mathews, C. J., Smith, P. J., & Welton, T. *Chem. Commun.*, 2000, 1249.
469. Larsen, A. S., Holbrey, J. D., Tham, F. S., & Reed, C. A. *J. Am. Chem. Soc.*, 2000, **122**, 7264.
470. Ngo, H. L., LeCompte, K., Hargens, L., & McEwen, A. B. *Thermochim. Acta*, 2000, **357**, 97.
471. Howarth, J. *Tetrahedron Lett.*, 2000, **41**, 6627.
472. Dupont, J., Suarez, P. A. Z., Umpierre, P., & de Souza, R. F. *J. Braz. Chem. Soc.*, 2000, **11**, 293.
473. Song, C. E., & Roh, E. J. *Chem. Commun.*, 2000, 837.
474. Song, C. E., Shim, W. H., Roh, E. J., & Choi, J. H. *Chem. Commun.*, 2000, 1695.
475. Owens, G. S., & Abu-Omar, M. M. *Chem. Commun.*, 2000, 1165.
476. Scott, J. L., MacFarlane, D. R., Raston, C. L., & Teoh, M. C. *Green Chem.*, 2000, **2**, 123.
477. Comyns, C., Karodia, N., Zeler, S., & Andersen, J. A. *Catal. Lett.*, 2000, **67**, 113.
478. Blanchard, L. A., Hancu, D., Beckman, E. J., & Brennecke, J. F. *Nature*, 1999, **399**, 28.
479. Cull, S. G., Holbrey, J. D., Vargas-Mora, V., Seddon, K. R., & Lye, G. J. *Biotech. Bioeng.*, 2000, **69**, 227.
480. Freemantle, M. *Chem. Eng. News*, 2000, **78**, 37.
481. Uchiyama, Y., Tsuyumoto, I., Kitamori, T., & Swada, T. *J. Phys. Chem. B*, 1999, **103**, 4663.
482. Uchiyama, Y., Fujinami, M., Swada, T., & Tsuyumoto, I. *J. Phys. Chem. B*, 2000, **104**, 4699.
483. Uchiyama, Y., Kitamori, T., & Swada, T. *Langmuir*, 2000, **16**, 6597.
484. Oberbrodthage, J. J. *Electron Spectrosc. Relat. Phenom.*, 1998, **95**, 171.
485. Hagge, K., Hintz, W., Bae, S. M., Motschmann, H., & Mohwald, H. *Book of Abstracts, 217th ACS National Meeting*, Anaheim, CA, March 1999, COLL-189.
486. Selzer, Y., & Mandler, D. *J. Phys. Chem. B*, 2000, **104**, 4903.
487. Kong, Y. T., Imabayashi, S. I., & Kakiuchi, T. *J. Am. Chem. Soc.*, 2000, **122**, 8215.
488. Kong, Y. T., & Kakiuchi, T. *J. Electroanal. Chem.*, 2000, **483**, 22.
489. Strivasata, R. C., Agarwala, V., Upahyay, S., Varghese, V. A., & Sahney, R. *J. Phys. Org. Chem.*, 1995, **8**, 341.
490. Strivasata, R. C., Sahney, R., Upadhyay, S., & Gupta, R. L. *J. Phys. Org. Chem.*, 1999, **12**, 308.

491. Oxley, P., Brechtelsbauer, C., Richard, F., Lewis, N., & Ramshaw, C. *Ind. Eng. Chem. Res.*, 2000, **39**, 2175.
492. Juang, R. S., & Liu, S. C. *Ind. Eng. Chem. Res.*, 1998, **37**, 4625.
493. Wu, H. S., & Tang, J. F. *J. Mol. Catal. A: Chem.*, 1999, **145**, 1381.
494. Starks, C. M. *Tetrahedron*, 1999, **55**, 6261.
495. Desikan, S., & Doraiswamy, L. K. *Ind. Eng. Chem. Res.*, 1999, **38**, 2634; Desikan, S., & Doraiswamy, L. K. *Ind. Eng. Chem. Res.*, 1995, **34**, 3524.
496. Naik, S. D., & Doraiswamy, L. K. *Chem. Eng. Sci.*, 1997, **52**, 4533.
497. Oberbrodthage, J. *Phys. Chem. Chem. Phys.*, 2000, **2**, 129.
498. Wu, H. S. *Chem. Eng. Technol.*, 1997, **20**, 17.

Chapter 11: Hydrogen Peroxide in Waste Minimisation—Current and Potential Contributions

WILLIAM R. SANDERSON

1 Introduction

1.1 Factors in the introduction of new technology

A former colleague once said to me that almost all the chemistry that people really use was at least 50 years old. This comment was made in the context of an R&D Department tasked with demonstrating the possibilities for new process chemistry and facing an uphill struggle to get this adopted commercially. However, one must face reality, and the exploitation of fundamentally new technology in the chemical industry as a whole has turned out to be considerably slower than its most enthusiastic protagonists have suggested. Hence, although this chapter celebrates the existing contribution of hydrogen peroxide to clean processes, it also often reaches into the future—the realm of ‘not yet’—in discussing many opportunities that remain to be realised fully.

The reasons for slow adoption of new technology are several. In general, significant cost is incurred in process development and plant construction, and in many countries the last two decades have been marked by a risk- and investment-averse business climate, owing to high interest rates and pressure for short-term shareholder returns. On the whole, these factors direct businesses towards incremental rather than fundamental change. Of course, one can find many case histories where new processes have been implemented successfully without excessive up-front cost, and also where a courageous investment has paid for itself within a short time, owing to much lower operating and effluent disposal costs. Such cases challenge the traditional assumptions of managers, but the argument is being won only slowly.

Without doubt, the costs of energy and of waste have risen sharply in industrialised countries, putting pressure on many conventional processes, as a

result of more stringent environmental legislation, fuel prices and taxation policy. However, the chemical industry is highly resourceful and often has been able to treat waste more effectively on site (the ‘end-of-pipe’ solution) and make other incremental improvements to alleviate the problem in order to prolong the life of its existing assets in production plant. Furthermore, considerations such as BATNEEC (Best Available Technology Not Entailing Excessive Cost), BPEO (Best Practicable Environmental Option), IPC (Integrated Pollution Control) and IPPC (Integrated Pollution Prevention Control) shine their searchlights most brightly upon proposed new plants, which ironically can increase the ‘activation barrier’ for replacing existing processes.

As we stand at the junction of two centuries, the adoption of chemical technology that minimises waste at source is only one of several valid responses that the chemical industry has made to the ‘clean technology’ imperative. We are on a journey from waste management to waste avoidance—from cure to prevention—and from a factory-level to a plant-level approach.

1.2 Scope of this chapter

In reflection of the above, the remainder of this chapter addresses:

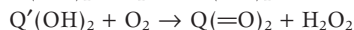
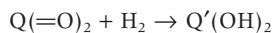
- An overview of how the uses of hydrogen peroxide have developed (Sections 1.3–1.4)
- The variety of ways in which it can be activated towards a range of valuable chemical oxidations (Sections 2–3)
- The applications of this in chemical synthesis (Section 4)
- Its applications in effluent treatment (Section 5)

Regarding the broader picture, whole books have been written on the chemistry and applications of

hydrogen peroxide, including a particularly valuable recent work [1] and other general accounts that cover the subject well [2–4]. This chapter does not aim to cover the same ground but rather to focus particularly on recent developments in catalytic chemistry. It seeks to strike a balance between technology already in successful use and potentially valuable systems still at the research stage. It is intended, however, to give sufficient background to the chemistry to make it useful on a ‘stand alone’ basis.

1.3 Manufacture of hydrogen peroxide

It is pertinent to consider the ‘clean chemistry’ credentials of hydrogen peroxide (H_2O_2). The manufacturing process in almost universal use is based on auto-oxidation of 2-alkylanthraquinols ($\text{Q}'(\text{OH})_2$) in a mixed organic solvent (‘working solution’) [4]. These are generated by hydrogenation of the corresponding anthraquinone $\text{Q}(=\text{O})_2$ with hydrogen over a supported palladium or nickel catalyst. The quinol solution then is exposed to oxygen, forming H_2O_2 and regenerating the quinone. The H_2O_2 is extracted into water and can be purified further and/or concentrated, the working solution then being returned to the reduction stage. The formation of H_2O_2 is exothermic and does not require external input.



The efficiency of the process in hydrogen is more than 99%. A very small amount of organic waste (C,H,O only) is generated (fractions of a per cent of product weight) owing to side reactions in the quinone/quinol cycle, and this continues to reduce in response to progressive process improvement.

As a compound, H_2O_2 can be seen as a source of activated oxygen plus water. In all of its reactions, the active oxygen goes into the product, forms additional water or is liberated as a gas. Hence, no significant waste is generated from the compound itself: high ‘atom utilisation’ can be expected. Naturally, to realise the full benefits of this depends on other process factors:

- Selective reaction of substrate to desired product, free from by-product formation
- Confinement of any catalyst within the process

(easier to achieve for heterogeneous than for homogeneous catalysts)

- Absence of solvent, or other process, waste
- Efficient use of water and energy

As will be seen, these factors are well understood and taken very much into account in the development of H_2O_2 application technology.

1.4 Uses of hydrogen peroxide

History and evolution of commercial applications

Over half a century elapsed between the discovery of H_2O_2 in 1818 [5] and the earliest commercial production. In the later 1800s it began to be in demand for the bleaching of wool and straw, and this property was applied later to cotton and other natural materials. In 1909 the first use of sodium perborate (manufactured from H_2O_2), in washing powders was recorded [6], again exploiting the oxidising ability of H_2O_2 to destroy natural-coloured compounds. All of these applications remain today, in increasing order of significance. A larger use in the bleaching of pulp and paper has been added recently, which now leads the table in volume terms.

Regarding specific oxidations, the application of peracetic acid—also derived from H_2O_2 —in epoxidation was discovered in 1909 [7] and again continues to be important. However, the ability to use H_2O_2 itself to carry out controlled oxidations in chemical synthesis probably was mastered only in the mid-twentieth century, since when there has been a progressive increase in the knowledge of stabilisation, activation and process safety. From this time a number of applications have grown up that are now considered to be mature:

- Organic peroxide manufacture (acid- or alkali-activated H_2O_2)
- Epoxidation of soybean and other natural oils (in-situ-generated peracetic or performic acid)
- Amine oxide manufacture (aqueous H_2O_2 , sometimes with further activation)
- S–S and S–N coupling for rubber vulcanisation accelerators (alkaline H_2O_2)
- Hydroxylation of phenol to catechol and quinol (acid-activated H_2O_2)
- Hydrazine manufacture (indirect ammonia oxidation)

All of the above processes are carried out mainly in the liquid phase. However, processes now have been commercialised for phenol hydroxylation [8] and caprolactam manufacture (via ammonia oxidation to hydroxylamine) [9] using H_2O_2 with a heterogeneous catalyst—the Ti-substituted zeolite TS-1. This has been disclosed [10] as an effective catalyst for epoxidation, raising the possibilities of large-scale use in the manufacture of epichlorhydrin and propylene oxide, neither of which currently is manufactured using H_2O_2 . What is of more fundamental significance is that the technology for large-scale use of H_2O_2 in the liquid phase with a heterogeneous catalyst is now available, paving the way for many future developments of this nature.

Processes using H_2O_2 with a homogeneous catalyst, often in two-phase liquid systems with a phase-transfer agent, have been commercialised but on a smaller scale. In these cases too, the attributes of H_2O_2 as a waste-avoiding reagent have been demonstrated in practice.

Recent trends in H_2O_2 application [11a]

Global production of H_2O_2 now is probably over 2 million tonnes, of which about 75% is made in North America, Western Europe and Japan. Fig. 11.1 shows the rapid rise in production since the late 1980s, roughly doubling inside 10 years.

By far the major driving force has been the growth in its use for pulp and paper processing. It is used both to bleach and to delignify wood fibres and is applied to mechanical, chemical and recycled pulps. A number of factors have contributed to this growth. Development of the technology has been driven by the desire to move away from elemental chlorine—traditionally used in the industry—for environmental reasons. This has been accompanied by big improvements in the performance of H_2O_2 , owing to better understanding and control of the role of metals and chelating agents (both natural and artificial) in the processes, and by improvements in the use of oxygen for primary ‘cooking’ of the pulp.

To show the effect of the pulp and paper usage on overall H_2O_2 consumption, Fig. 11.2 gives a breakdown of the percentage of H_2O_2 devoted to the main application areas. Production devoted to persalt manufacture for laundry use is conventionally omitted from this breakdown—it is of similar size to

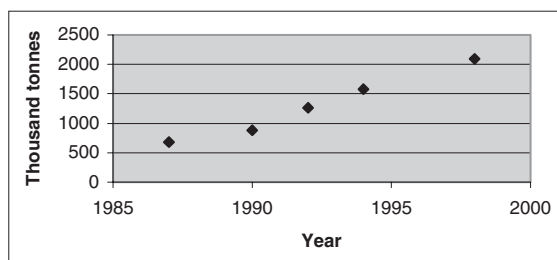


Fig. 11.1 Global production of hydrogen peroxide.

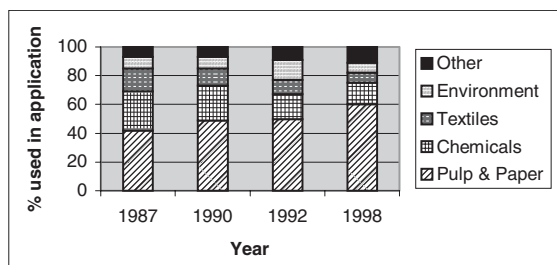


Fig. 11.2 Breakdown of hydrogen peroxide usage by application.

the chemicals application. During the period 1990–1998, usage in chemicals grew by 16% and in environmental applications by 63%, but such was the dominance of pulp and paper (which more than doubled in the same period) that the contribution of both of these important uses actually fell in percentage terms.

The rapidly growing pulp and paper application has changed the face of the H_2O_2 market, causing a sharp reduction in prices and a move towards commodity character. Manufacturers, although continuing to give advice on safe handling and use, can no longer afford to maintain the previous high levels of R&D applications, and the onus for process discovery and development has passed to the user. However, one beneficial effect of this price reduction has been to bring H_2O_2 in range for a series of applications for which it was ruled out previously on economic grounds. This has, in fact, given new impetus to the development of new technology for chemical synthesis and environmental uses, which should lead to an increased growth rate in the chemicals area and sustained progress in the environment in years to come.

2 Peroxygen Systems and their Reactivity

Hydrogen peroxide on its own is a relatively weak oxidant under mild conditions but it can be activated in a large variety of ways, as summarised by the often-quoted (in some form) sunburst diagram in Fig. 11.3. The low intrinsic reactivity of H₂O₂ is actually an advantage, in that a method can be chosen that selectively activates it to perform a given oxidation: many examples of this will be discussed later. As will be apparent, the focus of this chapter is on catalytic activation methods, and hence most of this account will be concerned with the shaded area of Fig. 11.3.

In the remainder of this section, each type of activation is described briefly, and then the main classes of catalytic system will be discussed in more detail.

2.1 Effect of acids and bases

Neutral hydrogen peroxide

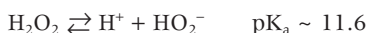
Although neutral H₂O₂ is a weak oxidant, it does have both electrophilic and nucleophilic properties. As an electrophile, H₂O₂ will oxidise electron-rich nitrogen and sulfur centres such as aliphatic tertiary amines and thiolates, and is used in both of these cases on a large scale (see Section 4).

Undissociated H₂O₂ also behaves as a nucleophile to some extent, being about 10⁴ times more nucleophilic than water. For example, H₂O₂ readily adds

to many carbonyl double bonds, giving hydroxyhydroperoxides (peracetals and perketals). Compounds thus prepared are used as polymerisation initiators on account of their radical decomposition at moderate temperatures (O–O bond homolysis). They can be hazardous if formed accidentally in other synthesis reactions, for which ketones therefore are not recommended solvents. Neutral H₂O₂ also can react with activated acyl compounds such as anhydrides to give peracids—under some conditions, diacyl peroxides can be formed as side products, which are hazardous and should be avoided.

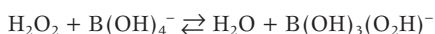
Base activation

In alkaline solution, hydrogen peroxide dissociates:



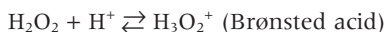
The perhydroxyl anion, HO₂[−], is a powerful nucleophile that attacks substrates such as electron-deficient olefins (e.g. α,β-unsaturated ketones) and aldehydes—reactions with some synthetic utility and also of value in bleaching and product purification, particularly of natural materials. In addition, HO₂[−] can be used to generate more powerful oxidants by mixing with electron-deficient acyl compounds (giving peracids) or with nitriles (Payne system; see later).

Hydrogen peroxide is somewhat activated towards nucleophilic oxidation in aqueous borate solutions, such as may be formed by dissolving sodium perborate, owing to a coordinated form of HO₂[−] [12]:



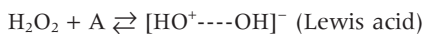
Acid activation

In very strongly acidic conditions (usually non-aqueous) H₂O₂ can be protonated:



or converted to the equivalent of the hydroxyl cation:

A



The resulting strong electrophile is used in some oxidations, notably phenol hydroxylation. However, the extreme acidic conditions often used limit the applicability of this oxidant species: many products tend to

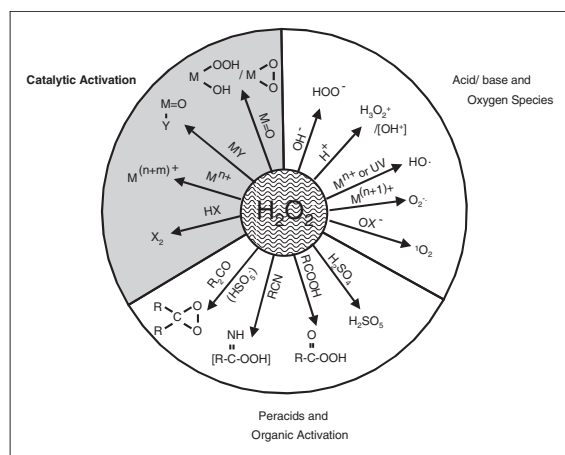
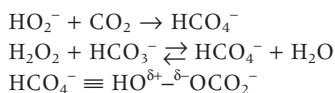


Fig. 11.3 Activation of hydrogen peroxide.

react further by oxidation or acid-catalysed condensation or rearrangement.

Some newer heterogeneous catalysts that have been found to be effective with H₂O₂ work at least partly by general acid catalysis. These include layered metal phosphates (e.g. Zr,Sn) used for aromatic hydroxylation (see later).

Some activation of H₂O₂ towards electrophilic oxidations at alkaline pH can be provided by carbon dioxide [13] or bicarbonate [14]. In both cases the active species is a percarbonate, where a pseudo-HO⁺ species can be formed and the carbonate acts as a leaving group:



Note that the 'sodium percarbonate' of commerce is not NaHCO₄, but a compound of sodium carbonate and hydrogen peroxide: 2Na₂CO₃·3H₂O₂.

2.2 Oxygen species

Hydroxyl radical

The O–O bond in H₂O₂ is relatively weak [15] and thus susceptible to homolysis by a variety of methods, including thermal, photolytic/radiolytic and metal redox. The active species produced is the hydroxyl radical and generation by UV irradiation at 254 nm gives two radicals per mole of H₂O₂:

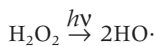


Table 11.1 compares the oxidising power of several oxidant species, and from this it can be seen that HO· is second only to fluorine. This high power corresponds to a relative lack of selectivity as an oxidant and the hydroxyl radical has limited use in synthesis. The use of H₂O₂/UV systems is known in water disinfection (particularly ultrapure systems) and is growing in effluent treatment, where the ability to remove colour and to degrade refractory organics to products treatable by biological processes is valuable.

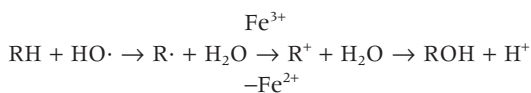
Hydroxyl radical can be generated also from several one-electron reducing metal ions [16], of which the most useful is Fe²⁺; such a combination is commonly known as Fenton's reagent [17]:



Table 11.1 Oxidation potentials of various oxidants

Oxidant species	Potential (volts)
F ₂	3.00
HO·	2.72
¹ O ₂	2.42
O ₃	2.01
H ₂ SO ₅	1.81
H ₂ O ₂	1.78
KMnO ₄	1.70
HO ₂ [·]	1.70
HOCl	1.49
Cl ₂	1.27
ClO ₂	1.27
O ₂	1.20
HO ₂ ⁻	0.87

The Fe(III) co-product often plays a role in oxidising the intermediate organic radicals produced by the HO· to eventual products:



A Fenton system was used for industrial phenol hydroxylation for some years [18] and has been used also to generate organic radicals for nucleophilic substitution of nitrogen heterocycles—the Minisci reaction [19]. Its use for effluent treatment is enhanced by the ferric iron acting as a flocculant to remove additional organics.

Superoxide

Superoxide (O₂^{·-}) and the corresponding perhydroxyl radical (HO₂[·]) (pK_a 4.6–4.8) are little more than a 'footnote' to the useful chemistry of H₂O₂. By comparison with hydroxyl radical these are very weak oxidants and are not used appreciably in synthesis. Their main significance is in the metal-catalysed decomposition pathways for H₂O₂ shown above.

Singlet oxygen

This is an excited form of oxygen that can be produced by photoactivation of (ground-state) triplet O₂ or by chemical methods involving H₂O₂, notably its reaction with hypochlorite [20] and with other two-electron oxidants. More recently, two additional

peroxygen-based generation methods have been developed to provide convenient sources of singlet oxygen for synthetic reactions: one is based on a calcium peroxide decomposition [21] and the other on catalysis of H_2O_2 decomposition by molybdate or tungstate, at alkaline pH and large oxidant excess [22]. Singlet oxygen has a very short lifetime in water and its use in synthesis is not widespread. Its chemistry with organic molecules has been reviewed elsewhere [23]. Chief among reactions of possible synthetic interest are: the formation of dioxetanes (leading to cleavage) or allylic hydroperoxides (the 'ene' reaction) with olefins; Diels–Alder reactions with dienes; and endoperoxide formation with some aromatics and cyclic polyolefins.

2.3 Peracids and organic activation

This category contains much of the classical chemistry of peroxygens in chemical synthesis. For the most part it involves the stoichiometric generation of a peroxygen compound that is more active than H_2O_2 , and this clearly raises the 'atom utilisation' question. However, significant progress has been made in recent years in internal recycling systems, such that the agent used to convert the H_2O_2 into the more active peroxygen can be recovered and reused within the overall plant. This approach will become clear in the following sections.

Caro's acid

When strong sulfuric acid and aqueous hydrogen peroxide are mixed, 'Caro's acid' is formed. The active constituent is permonosulfuric acid: H_2SO_5 . Equilibration is rapid at concentrations in the g l^{-1} region or greater, and the reaction of strong solutions is exothermic (largely due to heat of dilution of H_2SO_4 in water). The amount of H_2SO_5 present in any mixture can be predicted readily from the initial composition.

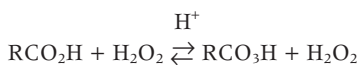
Permonosulfate for synthesis can be derived from the triple salt $2\text{KHSO}_5 \cdot \text{KHSO}_4 \cdot \text{K}_2\text{SO}_4$. Although this remains a convenient (but relatively expensive), solid source for small-scale use, technology for controlled generation of Caro's acid on a large scale is now available [24]. In general, the properties of permonosulfate systems in synthesis are similar to a mixture of percarboxylic acid and mineral acid, as one might expect. However, an important recent use

is in the generation of dioxiranes, where they are uniquely suitable. A limitation of permonosulfate systems is the co-production of sulfate when it is used. This sulfate may, however, be recycled by electrolysis in large-scale uses.

Percarboxylic acids

Percarboxylic acids, often simply called peracids, are the main means used to date of activating H_2O_2 towards electrophilic oxidations, such as epoxidation, Baeyer–Villiger oxidation and heterocyclic N-oxidation.

Peracids usually are prepared by the equilibrium reaction:



For most carboxylic acids, a strong acid catalyst must be added in order to achieve an acceptable rate of reaction: sulfuric and sulfonic acids, the latter in resin-bound form, or phosphonic acids. A few acids are strong enough to catalyse their own peracid formation, notably formic and trifluoroacetic. The reaction may be speeded up by increasing the temperature, subject to safety considerations.

Peracids themselves are very weakly acidic, with most pK_a values in the range 7.5–8.5 (cf most parent acids at 2–5) [25]. For example, peracetic acid has a pK_a of 8.2, compared with acetic acid at 4.8.

The two peracids most relevant to industry are performic and peracetic. Performic acid always is generated in situ by the above reaction, because it is neither sufficiently stable nor safe to isolate as an equilibrium mixture. Peracetic acid, however, can be used in a variety of forms, including in situ generation, pre-formed equilibrium mixtures, distilled aqueous solution and solvent-extracted products.

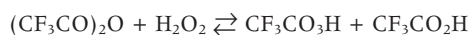
In situ generation is a convenient method for substrates that tolerate the acidity required to catalyse the equilibrium. If a faster reaction is required, this can be achieved by using the strongest pre-formed products, which typically contain 35–40% peracetic acid with about 45% acetic acid, <15% water, <5% residual H_2O_2 and $\leq 1\%$ sulfuric acid. In the latter case, the mineral acidity can be suppressed by the addition of sodium acetate to the reaction mixtures, and the effects of the free acetic acid can be moderated by the addition of bases such as sodium carbonate, Na_2HPO_4 or magnesium hydroxide.

For highly acid-sensitive reactions (such as epoxidations, where the epoxide product is very prone to ring-opening), distilled peracetic acid may be used. Under a range of controlled conditions, equilibrium mixtures can be distilled to give a product containing essentially only peracetic acid ($\geq 30\%$) and water. This technology has been proved on the plant scale [26] and lends itself to the recycling of acetic acid. Finally, on peracetic acid, such distillates can be extracted with organic solvents such as ethyl or isopropyl acetates to give organic solutions containing $>20\%$ peracid. These solutions are useful in the oxidation of water-sensitive substrates. Potential users should obtain expert advice before distilling or extracting peracids.

In situ generation of performic and peracetic acids has an important application in producing epoxidised soybean oil (ESBO), a plasticiser and stabiliser. Acetic acid often is recycled. Technology for the manufacture of propylene oxide [27] and epichlorhydrin [28] using internal recycling systems for peracetic or perpropionic acids has been developed.

It has been shown recently [29] that peracids can be generated in situ from acids or esters and H_2O_2 using lipase (esterase) enzymes as catalysts, some of which themselves are robust to oxidation. Although applicable to peracetic acid generation, this is especially suited to making higher aliphatic (fatty) peracids.

Peracids can be formed also from H_2O_2 and acid anhydrides without a catalyst. This method is used in the laboratory to prepare trifluoroperacetic acid in organic solvent:



and can be used also for monopero-phthalic or mono-permaleic acids. It is important to keep the H_2O_2 in excess in this reaction in order to avoid the formation of diacyl peroxides, which are hazardous. Reactions with anhydrides or other acylating agents commonly require very concentrated H_2O_2 (85–90%): alternatives for small-scale use include the (essentially anhydrous) H_2O_2 adducts sodium carbonate perhydrate and urea perhydrate. Pre-formed peracids used in the laboratory include *m*-chloroperbenzoic acid, which is long-established in synthesis [30], and magnesium monopero-phthalate, a more recent addition [31].

Nitriles/Payne system

When alkaline aqueous H_2O_2 is mixed with nitriles, the H_2O_2 is decomposed: this is known as the Radziszewski reaction [32]. However, the initial product of the reaction is believed to be a percarboximidic acid (Fig. 11.4), which can either react with further H_2O_2 to liberate oxygen or oxidise a substrate, such as an olefin, in a similar way to a percarboxylic acid. The system, discovered around 1960 [33] and known as Payne's reagent, works best in mildly alkaline aqueous solution or alcoholic aqueous solution, and is a powerful and specific method for the epoxidation of olefins, being free from acid-induced side reactions. Nitriles used are usually acetonitrile (cheapest) or benzonitrile (more powerful). Substrates containing carbonyl groups will not undergo Baeyer–Villiger oxidation with Payne's reagent [34].

The by-product of these reactions is an amide, which usually precipitates and is easily separated. However, the stoichiometric production of this is a disadvantage that has limited the industrial use of the system. In principle, acetamide can be dehydrated back to acetonitrile using acid catalysts, but this is relatively difficult. In spite of this drawback, it is believed that an H_2O_2 /acetonitrile process for epoxidation has been used on a full scale [35].

Ketones/dioxiranes

These organic peroxygen compounds are relative newcomers to synthetic chemistry, but in the last 10 years it has been shown that they are among the most powerful and versatile non-metal oxidants available to the organic chemist, with the ability to oxidise amines to nitro compounds, to epoxidise very unreactive double bonds and to hydroxylate alkanes and aromatic side chains [36].

Dioxiranes are prepared from permonosulfate and ketones under mildly alkaline conditions, as shown

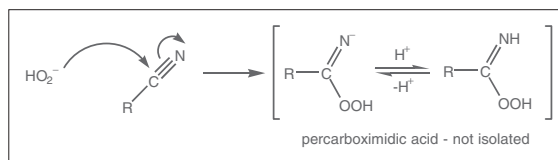


Fig. 11.4 Active species in the Payne system.

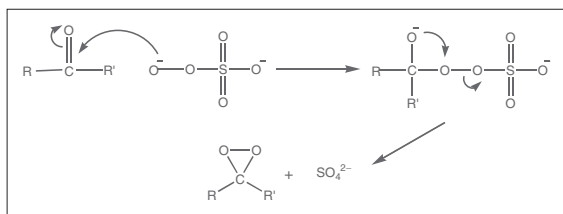


Fig. 11.5 Generation of dioxiranes.

in Fig. 11.5. The ketone used is most often acetone, although a more powerful alternative is methyl trifluoromethyl ketone [37]. The source of permonosulfate is either the triple salt $2\text{KHSO}_5\cdot\text{KHSO}_4\cdot\text{K}_2\text{SO}_4$ or neutralised Caro's acid [38]. The scope of the method is limited by the tendency of many ketones to undergo Baeyer–Villiger oxidation in preference to dioxirane formation.

Dioxiranes from the two ketones mentioned can be recovered from the mixtures as a solution in the ketone, by nitrogen entrainment or, in the case of methyl trifluoromethyl ketone, by solvent extraction. Also, they can be generated and used in situ. Because permonosulfate is used to generate the dioxiranes, at least a stoichiometric amount of sulfate is formed as a by-product, and the question of recycling or disposing of this is clearly important. Dioxiranes were considered, however, as selective delignification agents for pulp and paper, and it was claimed that the sulfate recycling problem in this very-large-scale use could be solved [39].

2.4 Catalytic activation

As indicated earlier, this category is of central importance because of its special value in waste minimisation. Much of the chemistry has been developed relatively recently: many oxidation systems are destined for widespread use in the future because they satisfy the 'atom utilisation' principle and enable the use of simple processes without serious effluent problems.

Hypervalent metals

Hydrogen peroxide and other peroxides can function as primary or stoichiometric oxidants in combination with other elements present in catalytic quantities to

form hypervalent states of the elements that are the active species in the system.

Some of these oxidations are long-established, e.g. the use of $\text{H}_2\text{O}_2/\text{OsO}_4$ for olefin hydroxylation [40]. More recently, H_2O_2 has been used with ruthenium compounds in phase-transfer systems for alcohol oxidation and olefin cleavage [41]. Again recently, it has been found that the use of H_2O_2 with cobalt or cerium compounds for side-chain oxidation offers advantages over air/ O_2 as an oxidant in giving better control over selectivity [42].

One of the limitations of H_2O_2 in driving oxidations with hypervalent metals is its ability to act as a reducing agent as well as an oxidising agent. The titration methods for H_2O_2 using cerium(IV), permanganate or dichromate are well-known examples of this, in which the H_2O_2 is oxidised to O_2 , but two of them also illustrate the pH dependence of this behaviour: in alkaline solution, H_2O_2 oxidises Cr(III) to Cr(VI) and Ce(III) to Ce(IV), which is the reverse of the acid reactions. Because permonosulfates and percarboxylic acids do not exhibit reducing properties to the same extent, generally they are able to oxidise a wider range of elements: Caro's acid in particular is used in the metals industry to recover or separate metals using redox chemistry. It can oxidise Mn(II) to Mn(III) or Mn(VII), depending on the pH. Peracetic acid can be used to generate lead(IV) and iodine(III) reagents for synthesis.

A very recent field of research is that of transition-metal-substituted polyoxometallates. Some papers are beginning to appear referring to catalytic oxidation with these compounds (based on transition-metal redox) using various primary oxidants, including H_2O_2 [43]. Being completely inorganic, their inherent robustness to oxidative degradation offers good prospects for eventual industrial use and they are discussed further in Section 3.

Metal oxenes

Here, the reaction consists of a two-electron formal oxidation of a metal centre by a peroxygen through mono-oxygen transfer:



The 'oxene' species formed can itself be a much more powerful oxygen-transfer agent than H_2O_2 , or indeed some peracids. There is a link between this system

and Fenton's reagent chemistry in that both go through an intermediate in which H_2O_2 or its anion is ligated to the metal. In fact, in scrupulously anhydrous conditions, iron salts with H_2O_2 exhibit epoxidation and regioselective hydroxylation typical of oxenes but inconsistent with hydroxyl radical chemistry [44].

The most important oxene chemistry driven by peroxygens is that of the metalloporphyrins, especially iron and manganese. The latter group function with a co-catalyst such as imidazole to carry out oxygen-transfer and insertion reactions, notably epoxidation [45], tertiary amine oxidation [46] and hydroxylation [47]. The reactions can be carried out in two-phase systems with a phase-transfer catalyst or in single phase with a co-solvent for the H_2O_2 , catalyst and substrate. These systems are mimics of peroxidase enzymes, including cytochrome P-450, which use iron porphyrin oxene chemistry [48]. Although metal catalysts are involved, the levels of these catalysts are often very small and recovery can be simple. Unfortunately, the catalyst lifetime often is limited owing to self-attack by the oxene and to some radical side reactions. Appreciable work has been directed towards supported forms of metalloporphyrins, where site isolation is expected to improve the stability to oxidation.

Metal-peroxo and hydroperoxo systems

This is the largest and most important of the oxidant classes within this category. Metal-peroxo complexes are formed rapidly in water over a wide pH range from a range of d^0 metal compounds, mainly of groups IVb, Vb and VIb, and notably Ti(IV), V(V), Mo(VI) and W(VI). These complexes are electrophilic in nature and many of them have oxygen transfer properties. Their re-formation from the parent compound and H_2O_2 is rapid enough for them to be used catalytically in oxidation systems. As such, they can be regarded as inorganic catalytic analogues of peracids, which immediately implies a large number of potential applications in oxidation [49].

Titanium complexes in aqueous solution are used to determine H_2O_2 in analytical chemistry but are not very active as oxidants. There is, however, a very important heterogeneous catalyst system believed to be based on Ti-peroxo chemistry. This is titanium silicalite or TS-1, discovered by Enichem [50]—a silicalite with the ZSM-5 structure containing

small amounts (typically about 2%) of titanium substituted for silicon in the zeolite framework. The resulting material catalyses a wide range of oxidations, including hydroxylation of alkanes [51] and of phenol [52], oxidation of ammonia to hydroxylamine [53] (itself usable as an intermediate in ϵ -caprolactam production [54]), epoxidation of alkenes [55] and some other olefin oxidations involving further reaction of the initial epoxide product [56,57]. Applications are, however, limited by the size of the zeolite channels (5.5 Å), in that substrate must pass down these in order to reach the active sites. Intense work on analogues of TS-1 using larger pore zeolites is currently in progress [58], which will be discussed in more detail in Sections 3 and 4. This heterogeneous system is an outstanding example of technology leading to relatively simple process plant and conforming to the 'atom utilisation' principle.

The peroxo complexes of vanadium have not, by comparison with the other three elements cited, been used extensively. The ease of the redox step, V(V)–V(IV), introduces a mixture of two-electron and one-electron character into vanadium-peroxo chemistry, which in the case of epoxidation leads to side reactions of substrate and products [26,49].

The reported peroxo chemistry of molybdenum and tungsten is extensive [59]. Many of the peroxo complexes can be isolated and used stoichiometrically as oxidants in organic solvents. However, such isolation can be hazardous and the stoichiometric use on a large scale would require a high metal inventory, even though recycling is relatively easy. Of more industrial relevance is the catalytic use of these complexes, usually in a two-phase system with a phase-transfer catalyst. In such a system, the peroxo complex is formed in the aqueous phase using H_2O_2 and a catalytic amount of the metal(VI) compound and then the peroxo complex is taken by the phase-transfer agent into the organic phase in which the substrate is dissolved. After oxidation, the oxo complex is regenerated in the aqueous phase. Such systems epoxidise olefins and oxidise organic nitrogen and sulfur centres. Simple molybdate and tungstate salts can be the metal source in these reactions. However, more powerful systems can be formed by the addition of phosphate or arsenate, or by the use of pre-formed polyoxometallate species such as the 'Keggin' dodeca-tungstophosphate ion (Fig. 11.6) [60].

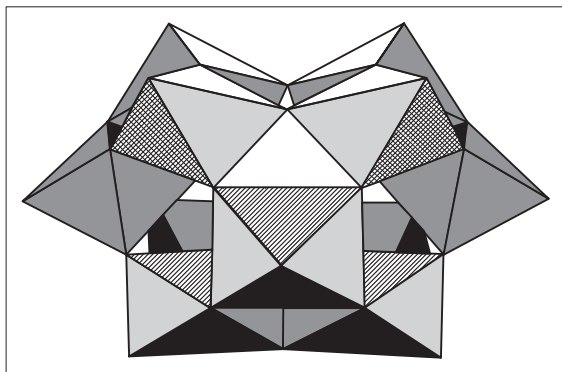


Fig. 11.6 Keggin structure (central atom not shown).

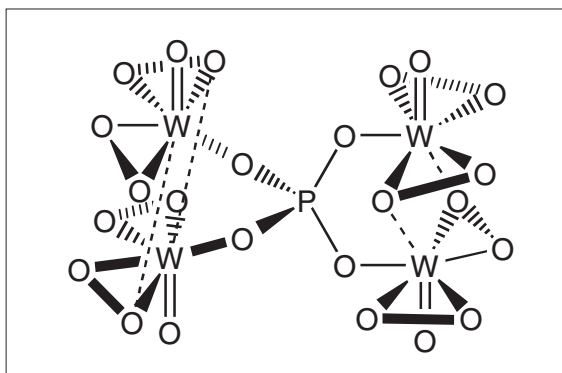
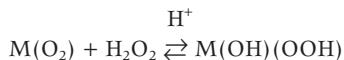


Fig. 11.7 Venturello complex.

Both of these systems are believed to function through an intermediate known as the Venturello complex (Fig. 11.7) [61], where one of the peroxy oxygens is activated towards electrophilic transfer by the non-bonded interaction with an adjacent metal centre.

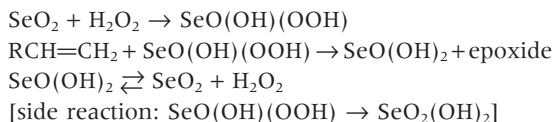
The above metal-peroxy complexes are equivalent, via the addition of water across the O–O bond, to hydroxo-hydroperoxy species:



In the case of tungsten and molybdenum, these forms of the complex are believed to be intermediates in the oxidation of alcohols to carbonyl compounds (a hydride abstraction reaction) [62].

Certain other non-metal oxides react with H_2O_2 to form similar compounds, which also can be viewed

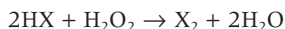
as inorganic peracids. Chief of these are B(III), As(III) and Se(IV). For example, SeO_2 can be used as a catalyst for epoxidations or amine oxidations [63], via a perselenous acid intermediate:



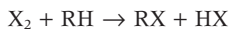
These catalytic oxidations, unlike those with Mo and W, require the continuous removal of water by azeotrope to regenerate the active oxidant. Also, selenium and arsenic are highly toxic, and their total containment within the process presents some difficulties. Organic resin-bound analogues have been reported [64] but it is believed that the molybdenum and tungsten catalytic chemistry is much more amenable to current and future use in clean industrial processes.

Halogens

In strong acidic aqueous solution, halogen acids other than HF are converted stoichiometrically to the free halogen by H_2O_2 :



In halogen substitution reactions using free halogen, only half of this goes into the product, the remainder appearing as the halogen acid:

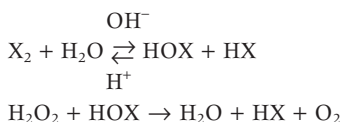


The recycling of the HX by-product using H_2O_2 as above has three benefits:

- (1) Avoidance of acid/salt effluent from the process.
- (2) Protection of acid-sensitive products.
- (3) Cost saving for bromine and iodine.

In addition, the use of H_2O_2 and the halogen acid as primary reactants avoids the need for free halogen storage on site, which is not always allowed or desirable.

The system must be operated at low pH for greatest efficiency because of the following side reactions:



Technology exists both for the generation of halogens in situ and for ex situ halogen recovery [65].

3 State of Progress on Main Catalytic Systems [11b]

3.1 Redox metal and oxo-metal complexes

Most work in this area has been done with iron and manganese porphyrins [66], aimed largely at oxygen transfer to form $M^{(n+2)+}O$ oxene intermediates (see Fig. 11.8). These were not thought at all relevant as commercial catalysts until relatively recently, when the relative robustness of Mn(III) tetrakis(*meso*-2,6-

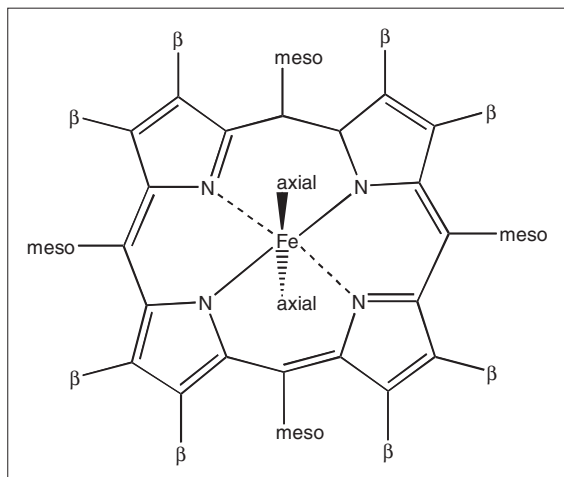


Fig. 11.8 Metalloporphyrin structure.

dichlorophenyl) porphyrin (MnTDCPP) was found, along with high-yielding preparative methods. Whenever organic ligands are present in oxidation catalysts, some degradation over long time periods almost invariably occurs. However, in the case of porphyrins, this has been mitigated by electron-withdrawing *meso*-substituents such as are present in TDCPP, and in later generations by β -substitution also [67]. With H_2O_2 as the oxidant, homolytic rather than heterolytic cleavage of the $M-O-O-H$ intermediate can occur (Fig. 11.9).

Free hydroxyl radical is an indiscriminate oxidant that will attack even the most unreactive ligands, which is why H_2O_2 often is found to be more aggressive to porphyrins than hypochlorite, even though the latter is a more powerful oxidant *per se*. The electron-withdrawing substituents used to stabilise porphyrins (and to make the oxene a more powerful electrophile) also make heterolytic cleavage less favourable and hence actually encourage the formation of oxidising radicals.

Manganese porphyrins mainly depend on a co-catalyst to assist heterolytic O–O cleavage by donating electrons as an axial ligand below the porphyrin plane and by assisting in proton transfer to the OH group to create O^+H_2 as the leaving group. Imidazoles are the traditional choice, reflecting the role of histidine in natural peroxidases. However, in ‘free’ systems these are degraded rapidly. Alternatives such as ammonium acetate [68] and aliphatic amine N-oxides [69] appear more practicable. The porphyrin MnTDCPP oxidises terminal *n*-olefins such as non-1-ene with high turnover and little loss of catalyst—in fact, catalyst doses are so small as to make disposal

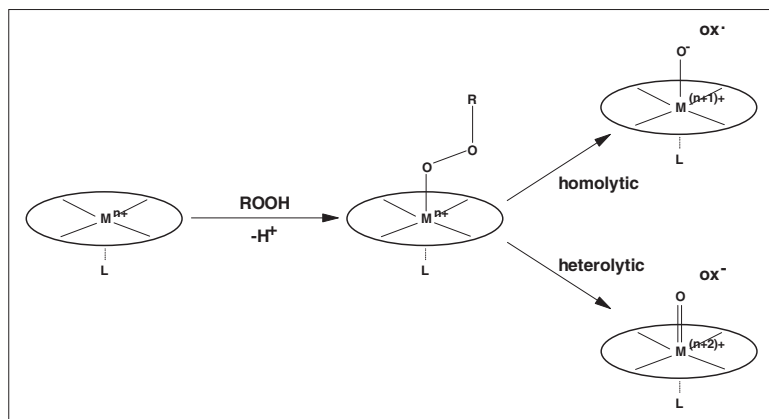
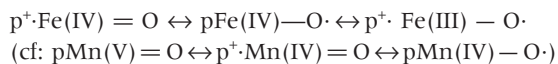


Fig. 11.9 The O–O cleavage pathways in metalloporphyrins.

after a single batch reaction potentially economic for fine chemicals. There is always, however, some competition between substrate oxidation and catalyst degradation, which is more serious for less-reactive substrates and masked in much literature work by the use of large excesses of substrate to H_2O_2 . In very electron-deficient Mn porphyrins (such as poly- β -nitro [70] or poly- β -chloro [71]), the role of the axial ligand is diminished and it may be that the $\text{M}-\text{O}-\text{O}-\text{H}$ species acts directly on the substrate, as has been shown for similar iron systems. The catalytic potential of such systems remains to be established.

For iron porphyrins, imidazole is not very useful in homogeneous systems because the inactive *trans*-disubstituted complex is readily formed. Accordingly, homolytic O–O cleavage is more of a factor. Moreover, it appears that when oxygen transfer from the oxene does occur, it is in two discrete one-electron steps, as shown, for example, by isomerisation of *cis*-stilbene to the *trans*-epoxide, and by the greater tendency to hydroxylate aryl-substituted olefins along with the epoxidation. This is likely to be due to the absence of Fe(V) in the resonance equilibria:



allowing significant radical character arising from the single-bonded species. Recent mechanistic work also has shown, however, that O–O cleavage is not necessary to obtain a catalytic system—the $\text{Fe}-\text{O}-\text{O}-\text{H}$ intermediate can transfer oxygen directly to substrates [72]. Where the oxene is formed, iron porphyrins have been shown to exhibit ‘oxo–hydroxo tautomerism’ in the presence of water, which is a favoured axial ligand. All in all, iron porphyrins may have the same catalytic potential as manganese, with less dependence on co-catalysts, but fewer studies on relevant substrates have been reported. Water-soluble Mn [73] and Fe [72a,b,74] porphyrins have been prepared, mainly by substitution of *meso*-phenyl substituents with charged groups such as quaternary ammonium or sulfonate.

Attempts to immobilise porphyrins on solid supports [75], whether by physical or chemical attachment, have met with limited success to date. Although site isolation should improve catalyst life by preventing face to edge contact, this is counterbalanced by the loss of activity usually seen. A likely

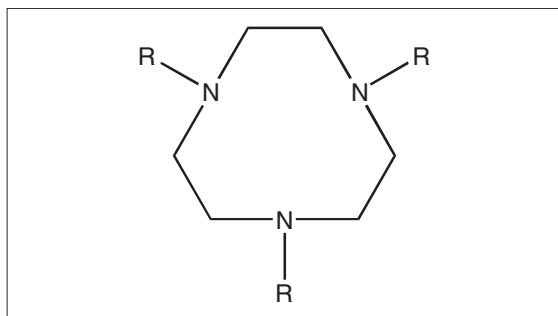


Fig. 11.10 Tri-*N*-alkyl triazacyclononane.

major factor is lack of control over the relative surface affinity for reactants (and products). In Mn systems, co-catalyst access also often is needed—tethering of the co-factor is not a promising approach owing to its own degradation and to the dual role of axial ligand and proton donor required (although these functions can be performed by different molecules).

Recent work with phthalocyanines [76] has revealed new catalytic potential, a key advantage being their cheap and simple preparation by incorporating transition metals from all three rows of the periodic table. They can be prepared readily in zeolite cavities and on other supports [77]. Indeed, complexes thus encapsulated can have a longer lifetime with H_2O_2 than they do in solution: e.g. Fe phthalocyanine in zeolite Y, which catalyses cyclohexene epoxidation [78]. They appear on the whole, however, to be more suited to C–H oxidation reactions than to epoxidation.

Another relative newcomer as a ligand is sym-triazacyclononane (tacn) and its *N,N',N''*-trimethyl analogue (tmtacn) (see Fig. 11.10). These form stable complexes with all first-row transition metals, and the manganese complexes in particular offer electrophilic oxygen-transfer catalysis with H_2O_2 [79] and radical hydroxylation of saturated hydrocarbons in acetic acid solution [80]. Once again, ligand degradation is not negligible over long periods, and leads to a loss of selectivity as Mn is liberated in different forms. The consequences of this for catalysis of stain bleaching in domestic laundry are well known. Salen (Schiff-base type) ligands are another class that have not achieved much success with H_2O_2 owing to their easy oxidisability. By contrast, hypervalent metal complexes with tetragonal amide ligands can be

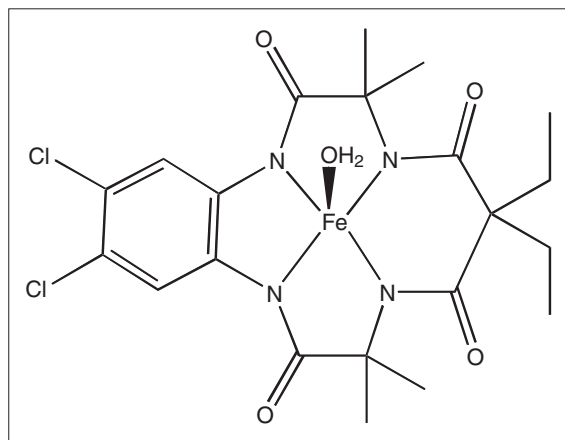


Fig. 11.11 Iron tetra-amide complex (Collins).

much more robust to oxidation, and recent reports suggest significant potential of iron amide complexes [81] as catalysts for H_2O_2 oxidations (Fig. 11.11).

Hydrogen peroxide can be used for aromatic side-chain oxidations, catalysed by cobalt and/or manganese compounds in acetic acid, in the presence of a bromide co-catalyst: this is discussed later.

There have been several attempts at encapsulation [82] of some of the above types of complex (and others such as $\text{Mn}(\text{bpy})_3$) in zeolite cavities (e.g. zeolite Y) [83], smectite interlayers (e.g. montmorillonite, layered double hydroxide) [84], mesopore channels (e.g. MCM-41) [85], amorphous silica [86] or membranes (e.g. polydimethylsiloxane) [87], all using many synthetic approaches. So far, moderately good catalysts have resulted in a few cases. Transport of reactants and products within the support and space around the active site are common limitations for 'ship in a bottle' catalysts [88], which are more difficult to solve than for framework-substituted catalysts. Only quite low loadings can be tolerated, to ensure adequate mobility. Smectites have the option of pillaring to increase interlayer volume, and are thought generally to be under-explored.

3.2 Peroxo-metal systems

This section refers to electrophilic peroxo complexes of d^0 metals, which are formed by several elements under Ti, V, Cr and Mn in the Periodic Table, the relevant oxidation state being favoured as one moves

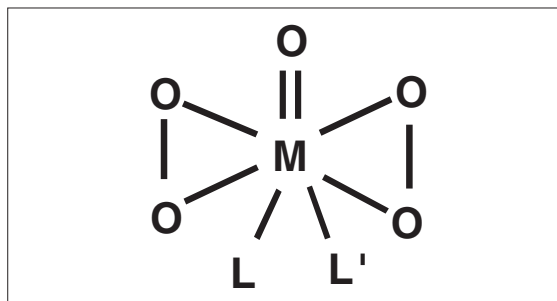


Fig. 11.12 Metal-di- $(\eta_2\text{-peroxo})$ complex (Mimoun).

to the left and down each row. Nucleophilic d^8 peroxo complexes, which are also catalytic, are not believed to compare with these in commercial potential.

Catalysis using tungsten(VI) and molybdenum(VI) complexes via the formation of peroxo-metal intermediates has been known for over 50 years, but important advances continue to be made in understanding and improving this mode of H_2O_2 activation. Peroxo chemistry based on vanadium, molybdenum and tungsten complexes has been surveyed [49]. It is, in fact, one of the most versatile systems and comes closest to classical organic peracids in its range of applications. The key catalytic intermediate is an $\eta_2\text{-peroxometal}$ species (one or two peroxo groups usually are attached in this way) that acts on the substrate either directly or via protonation to give the M-O-O-H species (Fig. 11.12). Substrates may be coordinated to the metal centre (e.g. in alcohol oxidation, by hydride abstraction) or un-coordinated (e.g. in epoxidation, according to the consensus of opinion).

Both molybdenum and tungsten work effectively in aqueous systems, unlike many catalysts, owing to their high affinity for H_2O_2 . If the substrate is hydrophobic, two-phase systems are commonly used, the peroxo complex being taken into the organic phase by suitable ligands and/or cationic phase-transfer agents. The simple complexes are moderately active in epoxidation [89], N-oxidation [90], alcohol oxidation [91], etc., with tungsten being better except for alcohol oxidation. Activity sometimes can be raised by increasing temperature

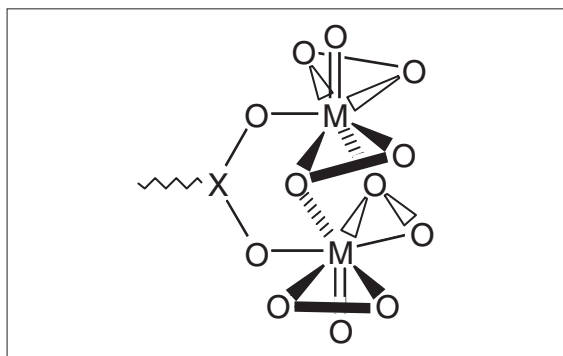


Fig. 11.13 Likely active function in Venturello and similar complexes.

(to reflux in water), but this is not a good option for epoxidation owing to hydrolytic ring-opening. A key discovery by Venturello [61a] was the use of phosphate/tungstate mixtures that epoxidised terminal olefins at moderate temperatures (Figs 11.7 and 11.13). This boosts activity by making the peroxo intermediate asymmetric via non-bonded tungsten–oxygen interaction, facilitating oxygen transfer [92]. Industrial use of this system is certainly feasible [93].

Since the discovery of this structural feature it has been reproduced in many other complexes, including XM_2 and XM_3 types ($\text{X}=\text{P}, \text{As}, \text{S}, \text{Si}$) [94]. There are drawbacks, however. The non-bonded interaction is the basis for the stability of the complex, which therefore dissociates after the peroxo group is lost, suggesting that a significant excess of H_2O_2 be maintained. This can lead to further oxidation by Hock reaction with the epoxide, giving C–C cleavage (although this itself can be a desirable transformation [95]). Hydrolytic ring-opening can be a problem for sensitive epoxides, owing to acidity of the medium and/or Lewis acid character of the d^0 metal centre.

Excess H_2O_2 with tungsten, and particularly molybdenum, complexes can lead to the liberation of singlet oxygen under some conditions, which is a particularly convenient and controllable source of oxygen [22,96].

Simple immobilisation of molybdenum or tungsten complexes on solids gives materials that oxidise

‘easy’ substrates such as sulfides or electron-rich olefins [97] but, as noted earlier, these are not of much interest for industrial chemical synthesis. In principle, it should be possible to attach XW_2 complexes covalently to solid supports. This remains a serious and worthwhile research target, but successful catalysts based on this feature have yet to be reported.

A much more recently discovered (by Herrmann *et al.*) catalyst based on peroxo–metal chemistry is methylrhenium(VII) oxide (MeReO_3 , MTO) [98]. The alkyl substitution is critical to catalytic activity, which is mainly lost on degradation owing to formation of the unreactive rhenate ion ReO_4^- . The MTO is a stronger Lewis acid than molybdenum or tungsten complexes, and catalyses many reactions as such, including olefin metathesis. Its strong electrophilic nature makes the peroxo complexes good oxygen-transfer species to olefins, etc. but the acidity also increases ring-opening, giving diol rather than epoxide as the product. However, unusual effects of azine ligands, including pyridines, bipyridines, etc., have been found, which appear to accelerate epoxidation but inhibit acid-catalysed ring-opening [99]. The system is complicated further by gradual oxidation of these ligands to N-oxides [100], which is a common reaction of peroxo–metal oxidants. A full explanation is still lacking but a lot of good information has been generated [99,101].

The MTO is less tolerant of water than Mo and W systems and requires strong to anhydrous H_2O_2 for best results. The ratio of H_2O_2 to H_2O and catalyst influences the equilibria between mono and diperoxo complexes, which can exhibit different activities—more so than molybdenum, for example, where the monoperoxo tends to disproportionate. Degradation probably occurs via loss of a proton from the methyl group and then electrophilic attack on the $\text{H}_2\text{C}=\text{Re}$ bond.

In addition to forming a fibrous solid polymer itself, monomeric MTO has been supported successfully on a range of solid surfaces, retaining its catalytic properties [102]. None of these catalysts has been developed for industrial use to date and gradual degradation of MTO is obviously a concern if long lifetimes are to be reached, but there remains scope for further research to this end.

Somewhat different properties to the above are offered by vanadium(V) complexes [103], which

also readily form peroxo complexes with H_2O_2 but are generally more selective catalysts with *t*-butyl hydroperoxide (TBHP) than with hydrogen peroxide (although, for example, enantioselective *S*-oxidation can be achieved with chiral vanadium-complexes and H_2O_2). Indeed, the η_2 -peroxo complexes of vanadium and molybdenum are themselves good catalysts for TBHP oxidations.

With H_2O_2 , vanadium exhibits some one-electron (V(V)–(IV)) redox chemistry, introducing free-radical character into its reactions. This makes epoxidation non-stereoselective and also can change chemoselectivity. For example, when substituted in silicalites (see later), titanium (TS-1 and -2) oxidises toluene mainly at the nucleus to give cresols, whereas vanadium (VS-1 and -2) oxidises more at the side chain to give benzylic products—taken as evidence of parallel electrophilic and radical mechanisms [104]. This radical character can be useful, e.g. in alcohol oxidations where vanadium systems are more active than molybdenum, especially towards primary alcohols. Another chemoselectivity effect in silicalites concerns allylic alcohols, which are epoxidised mainly by TS-1 but with VS-1 undergo mainly alcohol oxidation [105].

Oxygen can be used as co-oxidant because the radical intermediates can capture oxygen from the atmosphere, even to the extent where H_2O_2 is acting more as a radical initiator than a stoichiometric oxidant. The Fenton-like activity of vanadium complexes with azine carboxylic acids (2-picolinic acid, 4-heptyl-2-picolinic acid and pyrazinecarboxylic acid) has been explored quite thoroughly [106], even extending to attack on methane [107].

A great deal of work has been reported recently on mimics of vanadium bromoperoxidase enzymes. Bromide with V/ H_2O_2 systems can provide an effective system for halogenation and for hydride abstractions such as alcohol oxidation at moderate pH (uncatalysed bromide and H_2O_2 only work in strong acid) [108]; molybdenum behaves similarly [109], as does MTO [110]. There is evidence for a bound active halogen species in both enzyme and mimics.

A final practical note is that, owing to the one-electron chemistry, much more decomposition of excess H_2O_2 is caused in vanadium systems than in W, Mo and Re. This requires either better control of addition rates or the effective capture and use of the oxygen generated, with regard for safety issues.

3.3 Polyoxometallates and heteropolyanions

This is a group of polynuclear oxoanion complexes usually based on tungsten or molybdenum. They often include structural heteroatoms, which may be di- to pentavalent, and one or more main atoms can be substituted by transition metals, giving additional one- or two-electron redox chemistry. Common structure types are Keggin (XM_{12}) (Fig. 11.14), Wells–Dawson (X_2M_{18}) and ‘sandwich’ ($\text{M}_9\text{X}\cdot\text{Y}_4\cdot\text{XM}_9$). They have the attraction of being fully inorganic and therefore not prone to oxidative degradation, although the equilibria involved in their formation are subtle and intricate. A bewildering range of structure options exists, where unit size, main and heteroatom, substituent, degree of substitution and topomerism can be varied. The catalysis is based mainly on metal redox/oxo–metal chemistry, but peroxo–metal chemistry sometimes can also be involved.

Adding the Keggin complex $[\text{PW}_{12}\text{O}_{40}]^{3-}$ catalyses epoxidations with H_2O_2 . However, it has been shown that the active species are the same as in the Venturello system (see earlier), arising from breakdown of the Keggin structure [111]. This illustrates two factors involved with polyoxometallate dissociation: addition of H_2O_2 itself promotes dissociation because it is a strong ‘ligand’ for W and Mo; and dissociation is a nucleophilic process that occurs readily when the complex has a relatively low charge. In fact, the silicon analogue $[\text{SiW}_{12}\text{O}_{40}]^{4-}$ is much more stable

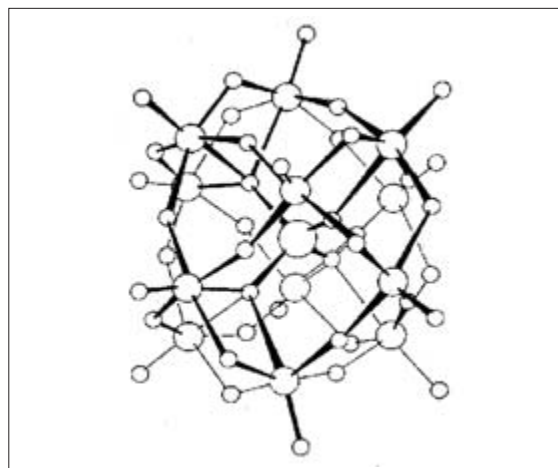


Fig. 11.14 Ball-and-stick representation of Keggin XM_{12} heteropolyacid.

and does not catalyse epoxidation. Hydrolytic stability therefore is enhanced by high negative charges and lower-valent heteroatoms or substituents. Trivalent heteroatoms include B and Al, but the divalent Zn and Co are very much more robust. As usual there is a cost—higher negative charge inhibits catalysis of electrophilic oxidations.

Since the early work, catalytic activity has been shown for a variety of polyoxometallates, at least some of which appear to act in the undissociated form. Several substituted 'lacunary' Keggin complexes have been studied [112], although the activity in epoxidations usually has been low for terminal olefins. The 'sandwich' type has shown the greatest promise for epoxidations in the form of the two complexes $[\text{WZnMn}^{\text{II}}_2(\text{ZnW}_9\text{O}_{34})_2]^{12-}$ [113] and $[(\text{WZnRh}^{\text{III}}_2)(\text{ZnW}_9\text{O}_{34})_2]^{10-}$ [114], the latter offering lower H_2O_2 decomposition and greater stability.

Keggin complexes with a single transition metal substituent can give both radical and electrophilic reactions, depending on the substituent, but reported activities are not of great interest industrially. A W-peroxo derivative of an intact singly substituted Keggin structure has been discovered now: $\beta_3\text{-}[\text{Co}^{\text{II}}\text{O}_4]\text{W}_{11}\text{O}_{31}(\text{O}_2)_4]^{10-}$ [115]. This appears, from cyclohexenol oxidation results, to be a relatively nucleophilic oxidant, as expected. Hydroxylations of alkanes are catalysed by the substituted Keggin structure $[\gamma\text{-SiW}_{10}(\text{Fe}(\text{OH})_2)_2\text{O}_{38}]^{6-}$ [116] and it is established by nuclear magnetic resonance (NMR) that the 1,2-Fe topomer (with vicinal Fe atoms) is the main active component. Similar results are reported for oxygen oxidations with $\text{H}_5\text{PV}_2\text{Mo}_{10}\text{O}_{40}$, with the 1,2-V topomer being the best catalyst of phenol and alcohol oxidation, among others [117]. Both of these catalysts seem to involve cooperation between two one-electron oxidising species, as may others with this feature [118]. Mixed Mo–V complexes up to PV_6Mo_6 catalyse phenol hydroxylation by H_2O_2 [119], and the dependence of *o*-/*p*- ratio on V/Mo ratio may well be related to topomer interactions. This phenomenon will be revisited in Section 4.

An important development in the practical use of polyoxometallates, aimed thus far at paper pulp bleaching, is successful self-assembly—including self-repair and self-reassembly after reaction, even if dissociation occurs at an intermediate stage [120]. This makes use of the thermodynamic stability of the complexes under given conditions once an

effective catalytic structure can be matched to those conditions. A lot of laborious research is needed to achieve this match, but it is ultimately one of the most valuable properties of polyoxometallates and should ensure their adoption for many catalytic processes in future. This same feature suggests enormous potential in immobilised systems, as yet largely untapped. A limitation of polyoxometallates is their high equivalent weight as oxidising intermediates. For this reason, true catalytic cycles, rather than stoichiometric generation/use/regeneration loops, remain a key target.

3.4 Zeolitic and smectitic materials

This section addresses heterogeneous catalysts with no homogeneous analogue, as distinct from immobilised homogeneous catalysts. Some excellent critical reviews covering one or both areas have been published recently [121]. For the most part, the catalysts are based on peroxo–metal chemistry.

Titanium and other silicalites

The titanium-substituted aluminium-free silicalite TS-1 with 5.5 Å channels (MFI structure, analogous to ZSM-5), was found to catalyse many H_2O_2 oxidations [52–55,122]. After the first reports of titanium silicalite in the early 1980s there was a huge research effort worldwide to find the many analogous materials believed to be waiting to be discovered. However, as time has progressed, TS-1 itself seems more and more unusual. Hence, this effort has not abated, but a large amount of it has been applied to finding out why TS-1 works so well, before being in a position to make new breakthroughs [123–125]. This in itself has fuelled progress on the characterisation techniques for such materials [126,127].

From the beginning at least three features potentially were important: hydrophobic environment, tetrahedral geometry and constrained reaction site. All of these have turned out to be relevant. Work on solvent dependence and on Ti/Si xerogels with varying hydrophobicity [128] confirms the importance of the active site environment, while not achieving comparable catalysis by the latter route. In fact, TS-1 has been commercialised for the oxidation of phenol to catechol/quinol and for in situ oxidation of ammonia to hydroxylamine in the production of caprolactam from cyclohexanone (via the

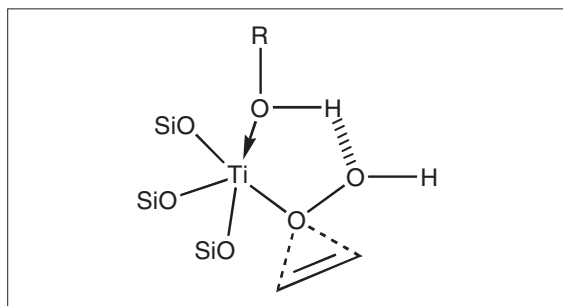


Fig. 11.15 Proposed intermediate in olefin epoxidation by TS-1 in methanol.

oxime). It is likely also to be used for epoxidation of olefins in the future, an application made more attractive by the reduction in price of H_2O_2 during the 1990s; methanol and water are the usual solvents (see Fig. 11.15). (Acetone has been advocated by some, pointing out that the hydroperoxides it forms with H_2O_2 are useful secondary oxidants. However, there is the risk of build-up of condensed organic peroxides, which are highly dangerous, and the use of acetone therefore is strongly discouraged.) For many applications, including phenol hydroxylation and epoxidation, residual acidity must be suppressed because it leads to fouling of the catalyst by over-oxidised or hydrolysed products. Post-addition of alkali metal or other cations helps, without much impact on activity, implying that acid sites are mainly at the surface [129]: the use of other additives with similar effect is described in Section 4. Site isolation of the titanium atoms appears important, and the lower limit of 40:1 Si/Ti excess for good catalysts agrees well with this criterion—otherwise increased H_2O_2 decomposition and less substrate oxidation are seen.

Regeneration of TS-1 can be done effectively in the liquid phase, without recourse to recalcination, by use of H_2O_2 in the absence of substrate [130]—presumably this helps to degrade ‘heavies’ fouling the channels into smaller molecules that can be desorbed. The physical form of the catalyst is critical, as in all industrial process, and the very small TS-1 crystallites required for high activity must themselves be supported securely on a suitable substrate [131].

Other elements have been used in place of titanium in making silicalite catalysts and many of these

probably are not true framework-substituted structures: ZrS-1 [132], SnS-1 [121c,133] and MoS-1 [134] all show some catalytic activity but fail to improve upon TS-1 for any particular oxidation [135]; VS-1 shows some useful additional chemistry, as noted earlier [104,105]; CrS-1 shows activity in alcohol oxidations but this has been shown to arise from homogeneous catalysis from Cr leaching [121c,147]; and TS-2 is based on the MEL (ZSM-11) structure and exhibits the same range of chemistry as TS-1, with some variations (these are not large enough to have caused its industrial exploitation to date).

In summary, TS-1 is a valuable and versatile catalyst but with an important drawback of substrate size limitation. The zeolite channels will not accept *o*- or *m*-disubstituted aromatics, alicyclic terpenes or tertiary aliphatic compounds, and simple alicyclics or branched aliphatics pass with difficulty, restricting desorption of product and therefore the reaction rate. For this reason alone, the search for alternatives is bound to continue.

Other titanium catalysts

The vigorous quest for larger pore analogues of TS-1 has been in progress for some years and even recent reviews of the field [125,136–138] will not stay up to date for long.

The most useful such material found to date is Ti- β , which is a large-pore zeolite (6.4–7.6 Å) [138] containing framework Ti (although the cavity size also accommodates other forms of Ti). By comparison with TS-1, it certainly accepts large substrate molecules but it is not as hydrophobic and does not exclude solvent from the reaction site—hence, solvent effects are very significant [139]. The lower hydrophobicity favours acid-catalysed ring-opening of epoxides, giving diols or their monoethers as the main products from olefins [140]. The acidity can be suppressed by working in the mildly basic acetonitrile as solvent (selectivity is more solvent-dependent for Ti- β ; trifluoroethanol also is a good choice) and by the addition of cations [141]. In the latter case activity is reduced, which confirms that the acidity is in the cavities, adjacent to active sites. Presence of solvent in the cavities also reduces activity, and Ti- β is slower than TS-1 at oxidising small substrates: in fact, it is a better catalyst for TBHP reactions, the

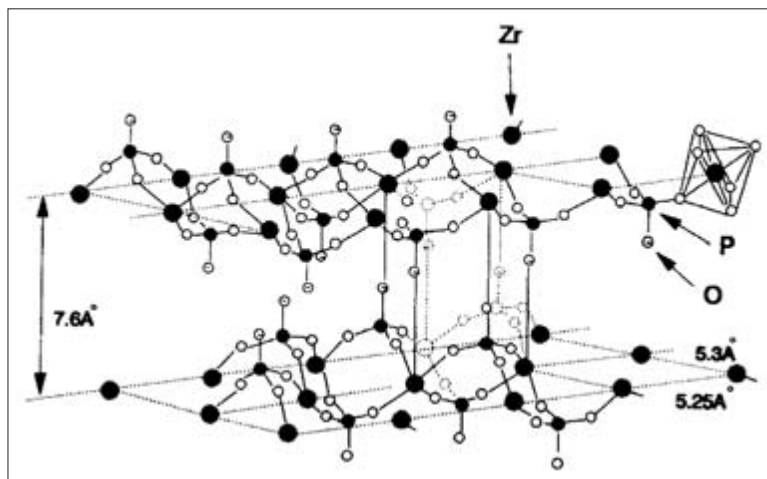


Fig. 11.16 Zirconium phosphate—a smectitic material.

latter being more hydrophobic than H_2O_2 . However, $\text{Ti-}\beta$ now is quite well understood to find application in fine chemistry as a convenient catalyst for larger molecule oxidations, etc. [142]. Furthermore, the cavities are large enough to allow some surface modification, to increase hydrophobicity or attach other functional groups, while maintaining a viable volume. One drawback is that the active Ti sites in $\text{Ti-}\beta$ are less stable than those in TS-1, leading to the formation of defects, extra-framework Ti during calcination and inferior catalyst life [143]. This might be mitigated by treatments to make $\text{Ti-}\beta$ more hydrophobic, which should help to protect from hydrolysis.

The incorporation of titanium into even larger cavities [144,145], such as the mesomorphous MCM/HMS series made using liquid-crystal templates, yields materials that, according to reports to date, are still less good with H_2O_2 and better with TBHP than $\text{Ti-}\beta$, for reasons similar to those discussed. The same options for modifying the surface [146] and spatial properties exist. The subject of design of large-pore materials has been reviewed [70,75,148] and several catalysts based on them have been investigated [149], the results being largely consistent with the picture presented here. Kaliaguine [150] has tested a range of titanium aluminium phosphates (APOs) for hydroxylation, epoxidation and alcohol oxidation, with some encouraging results (but note the comments in the next section).

Other metals and supports

Zeotypes APO and silicon aluminium phosphate (SAPO) have been explored to some extent as supports for liquid-phase oxidation catalysts. Aluminium phosphates such as VPI-5 can incorporate a variety of transition metals such as vanadium (phosphorus substitution) cobalt (aluminium substitution or cation exchange) or chromium and are large-pore materials. However, the structures are not particularly robust and rely for their integrity on a large amount of coordinated water. Overall, published results do not demonstrate any advantage over zeolitic supports. Chromium APO suffers Cr leaching in use with H_2O_2 , just as CrS-1 [121c,147].

A rather more encouraging theme is that of metal(IV,V) phosphates such as zirconium, tin, cerium and vanadium. Taking zirconium phosphate as an example, this readily forms a layered (smectitic) structure in which the interlayer spaces (7.6 Å spacing) contain strong Brønsted acid sites, corresponding to the protons in the empirical formula $\text{ZrPO}_4(\text{OH})$ (Fig. 11.16).

Such materials, whether overtly crystalline or amorphous according to x-ray diffraction, activate H_2O_2 towards electrophilic oxidations. Examples include phenol hydroxylation [151], where performance compares well with TS-1, olefin oxidations and Baeyer–Villiger reactions [152]. In some cases acetic acid is found to be the best solvent and there

is evidence that peracetic acid is formed in the interlayers and reacts directly with the substrate there. In other cases, acetonitrile is a good solvent and the chemistry appears to arise from protonated H_2O_2 itself. The interlayer spaces are relatively hydrophilic and acidic, so olefins are more likely to give diols than epoxides in this system. However, these spaces can be modified by pillaring (organic or inorganic) to give a range of heights and polarities. Some variation also is possible by templating with non-ionic or cationic surfactants. Like polyoxometallates, there is enormous scope for structure manipulation. Combinations of major and minor elements, crystallinities, etc. can be made, but the potential of this type of catalyst for use with H_2O_2 has been explored much less to date. One of their chief attractions compared with TS-1 is the greater mobility and size of substrates achievable.

A chromium-pillared zirconium phenylphosphonate has been described recently with ca. 2-nm mesopores [153]. No catalysis results are yet to hand.

Other smectitic materials include clays, e.g. montmorillonite (acid sites), and layered double hydroxides, e.g. gibsonite (base sites). These have been employed as supports for other catalysts, the former for cationic species such as bipyridine and triazacyclononane complexes, and the latter (which are only stable over a narrow neutral to alkaline pH range) for anionic species such as polyoxometallates and metal-peroxo complexes [161].

3.5 Enzymes

There has been enormous progress in biotechnology and in the receptiveness of much of the chemical industry towards it. Also, oxidoreductase enzymes are plentiful and many are well characterised and readily isolated. However, they have significant drawbacks as industrial oxidation catalysts.

Firstly, most enzymes are not designed to withstand significant concentrations ($\geq 1\%$) of H_2O_2 because these are not encountered in nature. Hydrogen peroxide often is generated naturally from dioxygen reduction by oxygenases, but invariably there is co-production of catalase, which destroys the H_2O_2 very efficiently without release of other active oxidants. Peroxidase enzymes do exist, of course, using H_2O_2 itself to carry out organic oxidations, but again these work naturally with small peroxide con-

centrations and are not very robust to oxidation—supported or immobilised catalysts have a strictly limited life. In some cases, such as ligninases, self-destruction is even a normal part of the mode of action. This drawback could be overcome by using whole-cell systems rather than isolated enzymes: such expertise is not widespread in the chemical industry at present.

Secondly, the low concentration limit and high catalyst molecular weight mean that space yield is poor and recovery/recycling of the enzyme is awkward. Hence, peroxidases as such are not particularly attractive as catalysts in industrial oxidation. This applies particularly to haem-based systems. Vanadium and molybdenum enzymes are somewhat more robust but also less active towards substrates of industrial interest. Peroxidases do have other applications in synthesis [154].

Of distinct interest, however, are hydrolase (lipase, esterase) enzymes—not for catalysing H_2O_2 reactions directly but for forming more electrophilic intermediates via acylation of H_2O_2 (or ‘esterification’ of acids with H_2O_2 to give peracids) [155]. These enzymes are much more robust, and one in particular, *Candida antarctica* lipase, is outstandingly so, such that it has a long lifetime in immobilised form (Novozym™ 435). A range of peracids have been generated this way, either from their acids or from lower alkyl esters. Peracetic acid works reasonably well but longer chain analogues suit the enzyme better, especially C_8 and greater. Methyl oleate reacts in two stages, with the intermediate peracid epoxidising itself to form 9,10-epoxystearic acid [156]. Furthermore, acid-sensitive substrates can be oxidised by a percarbonic acid intermediate generated from dialkyl (e.g. dimethyl) carbonates and H_2O_2 : after reaction, only alcohol and CO_2 are left [157].

4 Developments in Catalysed Oxidations for Chemical Synthesis

In each of the following sections, the aptitude of H_2O_2 for the given application will be considered, major existing uses will be highlighted and chemistry available for future exploitation will be reviewed. There have been some general surveys of the catalysed oxidation area, including H_2O_2 reactions [158–160].

4.1 Oxidations at carbon

Epoxidation

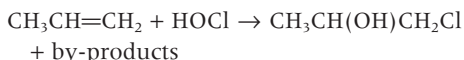
Epoxidation of olefins is a single oxygen transfer reaction to which peroxygen systems ideally—perhaps uniquely—are suited. The reactivity of olefins varies widely: for example, the trisubstituted 2-methylbut-2-ene is 6000 times more reactive than ethylene. It is very important to bear this in mind when assessing published work. Many results are reported for cyclooctene, which not only is probably the easiest common olefin to epoxidise but also forms epoxides readily with dioxygen and other oxidants that do not usually transfer single oxygen atoms. Industrial demand, on the other hand, is most often for epoxidation of substrates at the very far end of the reactivity series—terminal olefins and allylic compounds—and no conclusions on this can be drawn from cyclooctene results. An indicative order of reactivity is cyclooctene > methylcyclohexene > cyclohexene > 2-octene > 1-octene > allyl chloride (~other allylics, propylene). Cyclohexene is a useful selectivity probe because it readily undergoes allylic oxidation to give cyclohex-2-en-1-ol/one (Fig. 11.17).

Historically, organic peracids have been used to prepare epoxides on small to medium scale, and processes have even been worked out for such preparations on the large commodity scale for propylene oxide and epichlorhydrin [27,28]. The peracid

(peracetic or perpropionic) was prepared and contained in a recycling loop such that only H_2O_2 itself was consumed stoichiometrically (Fig. 11.18).

These processes were not adopted at the time (late 1970s) for a combination of reasons including cost and complexity of plant and cost of H_2O_2 . In current industrial use, olefins that do not have active allylic hydrogen can be epoxidised with oxygen, commonly with a silver-containing catalyst. Ethylene oxide is the prime example. Quite recently, a process also has been introduced for mono-epoxidation of butadiene using oxygen. Like most oxidations with air/oxygen, it is carried out at elevated temperature and pressure to achieve acceptable activity and at low conversion per pass to achieve acceptable selectivity.

Propylene oxide is currently manufactured by one of two types of process. In the chlorhydrin route, olefin is reacted with hypochlorous acid (from chlorine) followed by ring closure of the chlorhydrin with lime:



This route produces both organic and inorganic effluent and measures up poorly against the 'atom utilisation' principle. The other major route is the (Halcon) co-oxidation of propylene with either isobutane (giving *t*-butanol co-product) or ethylbenzene (leading to styrene co-product). The co-

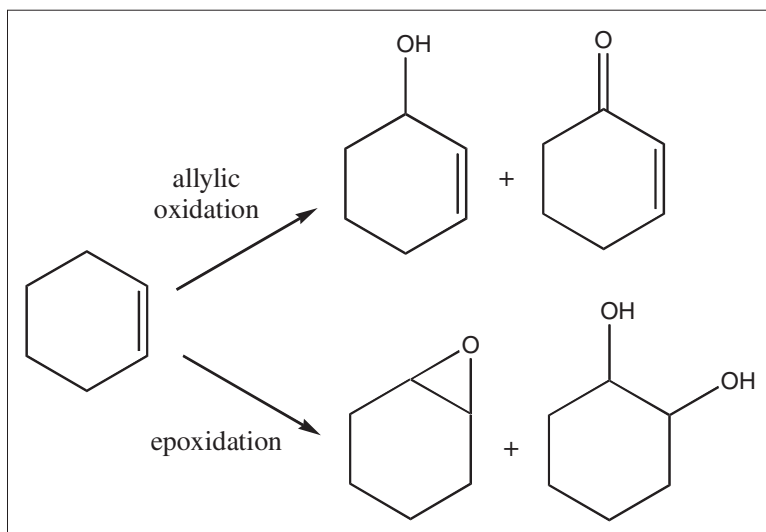


Fig. 11.17 Oxidation products of cyclohexene.

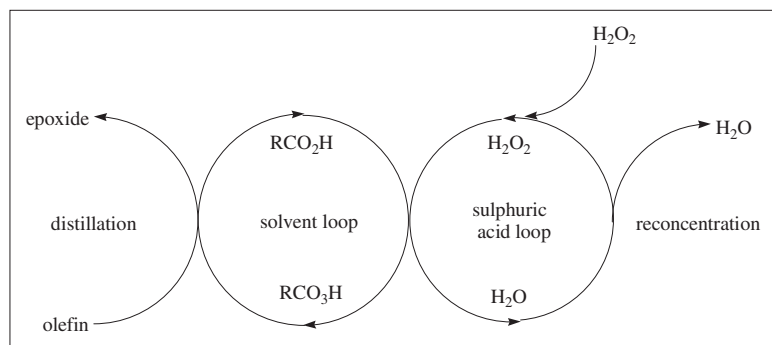
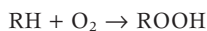


Fig. 11.18 Peracid-based continuous epoxidation process.

substrate is auto-oxidised by oxygen to a hydroperoxide, which then epoxidises the propylene in the presence of a molybdenum- or titanium-based catalyst:



Matching demand for the co-product with that for propylene oxide is a continuing challenge.

Despite their drawbacks, there has been investment in both routes recently to raise capacity. Epichlorhydrin is produced mainly from allyl chloride by the chlorhydrin route. As shown below, however, small molecules can be epoxidised effectively by H_2O_2 and titanium silicalite, and there is keen interest at present in the prospective manufacture of propylene oxide and epichlorhydrin in this way.

The largest established application for H_2O_2 in epoxidation is for unsaturated natural oils such as soybean, the epoxidised forms (ESBO, etc.) being used chiefly as stabilising plasticisers for poly(vinyl chloride) (ca. 100kt year⁻¹). The oil itself acts as solvent, although a volatile hydrocarbon such as hexane may be added to facilitate processing. An amount of carboxylic acid is added (typically 0.14 units per unit of oil for formic and 0.2 for acetic, the latter also requiring about 0.01 units of H_2SO_4 catalyst) and the H_2O_2 , typically at 70% strength, is added gradually to this mixture at 60°C. Complete reaction to ESBO takes 10–15 h, giving an oxirane content of 6.5–7.1% (80–85% of theory). Small amounts of olefin remain unreacted and some undergoes ring-opening to the diol or its monoester. This process produces very little waste: residual carboxylic acid is separated by washing and can, in the case of acetic acid, be recycled. Formic acid is oxi-

dised partly to CO_2 and water, and the target here is to minimise the amount needed for the reaction rather than to recycle the residue.

Replacement of organic peracids by catalytic methods is not easy to achieve here. The size of the substrate molecules and the viscosity of the oils do not lend themselves to heterogeneous liquid-phase catalysis. The oils often are used for food contact applications, so homogeneous metal-catalysed systems must avoid any introduction of metals into the product. In fact, there is no great driving force to change on waste minimisation grounds. It is, however, noteworthy that another sizeable application—the production of epoxysuccinic (and tartaric) acid from maleic anhydride [162]—does use tungstate catalysis successfully to make products with food-related applications (Fig. 11.19). In one disclosure [163], epoxysuccinic acid is produced from maleic acid and H_2O_2 , using Na_2WO_4 at pH 4.8, for 6 h at 90°C. A glucamine chelating resin is used to remove and recycle the tungstate, with 99% efficiency.

There are currently many smaller epoxidation applications using a variety of methods, but information on these is often not made public. Certainly metal-peroxo catalytic chemistry, including the Ishii–Venturello system, is now in routine use alongside traditional peracid technology. A recent practical method from Noyori's group embodies much of what has been learned to date about the 'simple' tungstate system [89b,164].

Homogeneous catalytic methods typically use two-phase liquid systems with a phase-transfer catalyst. The organic phase used to be a chlorinated hydrocarbon, but solvents such as toluene and propylene carbonate are now established in this role. Single-

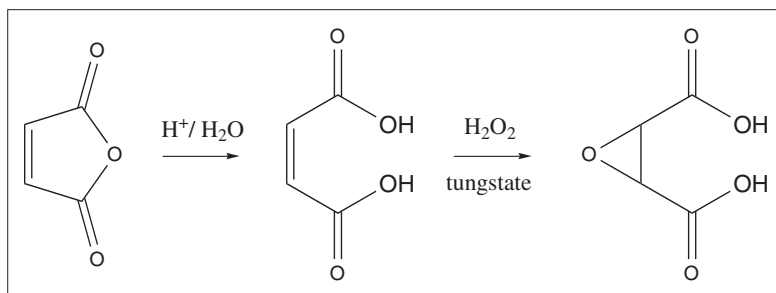


Fig. 11.19 Production of epoxysuccinic acid.

phase systems sometimes can be achieved by the use of lower alcohols (if these are not attacked) and acetonitrile (in the absence of base). Acetone is sometimes proposed, but there are severe safety issues related to ketone peroxide build-up that are often apparently neglected.

Sheldon [165] recently has described the use of trifluoroethanol as a solvent for methyltrioxorhenium (MTO) catalysis of epoxidation. The solvent helps water tolerance by the catalyst and is proposed as a good 'partner' for H_2O_2 . In this case, the reaction is apparently quite slow for some terminal olefins but high yields are obtained. The Ishii–Venturello system has been mentioned already and continues to be understood and developed further [94,97]. An industrially relevant example [166] is the mono-epoxidation of cyclododecatriene using phosphotungstic acid and a phase-transfer catalyst, with solvent-free continuous reaction.

Berkessel [167] has shown that the Mn/tmtacn/ascorbic acid complex (Fig. 11.20) is an efficient catalyst for epoxidation of methyl acrylate (97% yield) and of 1-octene (83% yield) in water/MeCN. The ascorbic acid is, not surprisingly, oxidised significantly in the system but is necessary to the function of the Mn catalyst.

Polyoxometallate catalysis also has been developing in recent years as the ability to probe structure and reactivity has advanced. Mizuno [168] has described $\gamma\text{-[SiW}_{10}\text{(Fe(OH)}_2\text{)}_2\text{O}_{38}]^{6-}$ for epoxidation of many olefins. Excess substrate is used throughout and although epoxidation predominated, some allylic oxidation also is seen for 1- and 2-octene, and much more for cyclohexene. When 1:1 substrate/ H_2O_2 is used with cyclohexene, more diol than epoxide formed and there was less allylic oxidation, which suggests acid-catalysed ring-opening. The two Fe sites may be cooperating in the oxidation, in

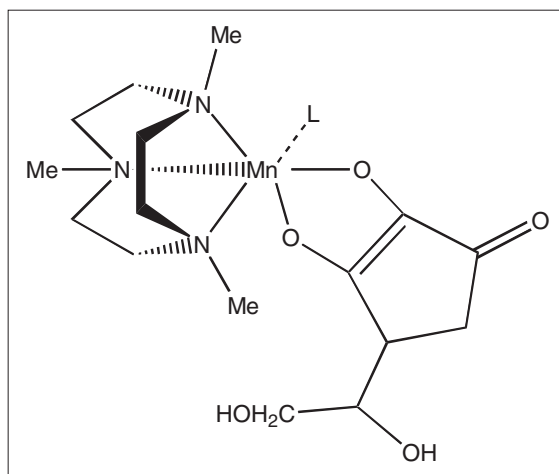


Fig. 11.20 The Mn/tmtacn/ascorbate complex.

line with an emerging pattern for many transition-metal-substituted polyoxometallates. For example Ishikawa [169] epoxidised cyclooctene in aqueous acetonitrile with $\alpha\text{-[PTi}_2\text{W}_{10}\text{O}_{38}(\text{O}_2)_2]^{7-}$, which is said to occur via a di-Ti- η_2 -peroxo intermediate, where each of these interacts with neighbouring tungsten sites. The olefin is not of interest, but cooperation of adjacent metal centres now appears widespread in intact polyoxometallate catalysis. Hydrogen peroxide decomposition was also catalysed—about 3:1 excess was needed to get a high epoxide yield, even with this very reactive olefin.

For the most part epoxidation is electrophilic, but some homogeneous nucleophilic oxidations are of importance, most notably those of enones. Such oxidations can be achieved by alkaline H_2O_2 [170] using various bases, from simple caustic alkali to milder bases including tertiary amines. Effective stabilisation of H_2O_2 at high pH is important, to avoid waste-

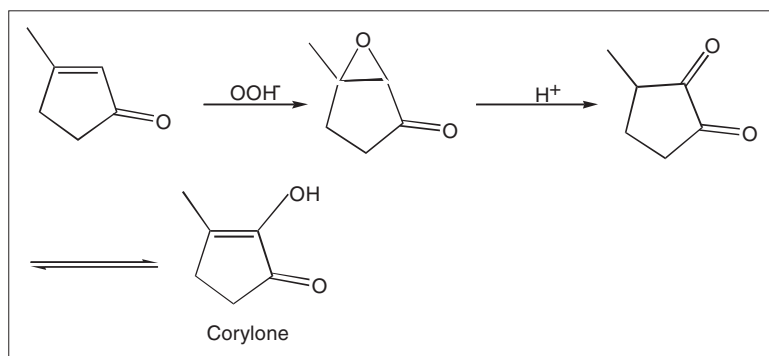


Fig. 11.21 Nucleophilic epoxidation in the preparation of Corylone.

ful decomposition and possibly uncontrolled exotherms. Where chiral bases are used (including poly-leucine), it is possible to perform asymmetric epoxidations, and this area has been explored extensively [171]. Some flavour and fragrance intermediates can be prepared by nucleophilic epoxidation [172] (Fig. 11.21). Although the pK_a of H_2O_2 is about 11.6, decomposition is too rapid at this pH for practical use and control at about pH 10 gives the best results. Reactivity may be increased by the addition of tetraalkylammonium fluorides [173].

Also in a recent review [174] on the synthesis and properties of 1,2-epoxyalkyl phosphonates, alkaline H_2O_2 was shown to be better than peracids in this epoxidation because of excessive ring-opening with the latter. Alcoholic aqueous solutions of carbonate/bicarbonate were used. The production of Fosfomycin is a valuable application of the method.

For the obvious reasons there has been greater recent activity in the field of heterogeneous catalysis, including the immobilisation of homogeneous systems. It has been reported [175] that Fe phthalocyanine in zeolite Y gives highly selective cyclohexene epoxidation—the experiments used a large excess of H_2O_2 , indicating that decomposition also may be catalysed, perhaps by other forms of iron present. Metalloporphyrins continue to attract some attention: Jacobs [176] immobilised MnTDCPP in polydimethylsiloxane (PDMS) membranes and used the allylic alcohol 3-penten-2-ol as substrate in water (the same catalyst needs dichloromethane plus cyanomethane or methanol mixtures for homogeneous catalysis)—imidazoles were co-catalysts. Epoxide was the sole product with the supported catalyst but ketone predominated in the homogeneous system. The porphyrin appears intact after the reac-

tion but catalytic activity drops, possibly due to blockage of the support.

The same group covalently attached a tmtacn analogue to a silica support [177] to make a manganese catalyst for olefin conversion to epoxides and diols. Diol formation was much increased in the supported, compared with the homogeneous form of the catalyst, and some loss of stereoselectivity also occurred. However, less H_2O_2 decomposition was caused by the supported catalyst because bimolecular Mn interactions were very low. Oxalic acid was used as a co-ligand in the homogeneous system only, and this may be preventing the ring-opening of epoxide to diol.

In another study involving groups covalently attached to supports, Neumann [178] used a polyoxometallate ‘sandwich’-type catalyst $[(ZnWMn_2(ZnW_9)_{34})_2]^{12-}$ tethered via Q^+ (quaternary ammonium) and poly(ethylene oxide)/poly(pupylylene oxide) spacers to silica. A key feature was the tuning of the hydrophobic/hydrophilic balance by varying the ethoxylate/propoxylate ratio to ensure contact of all the reactants, as studied by wetting angle measurement. Good activity and recycling was seen with 30% H_2O_2 using cyclooctene, but no other olefins were reported.

Regarding fully organic supports, this field has been surveyed recently by Sherrington [179]: the review covers polymer-supported catalysts for epoxidation, including asymmetric systems. There is more on *t*-butyl hydroperoxide than on H_2O_2 as oxidant, but W(VI) catalysts with H_2O_2 are discussed. The work of Gelbard’s group is prominent, usually with cyclohexene as substrate. Good support types include polystyrenephosphonamide and polybenzimidazole/phosphonamide, the latter giving no

detectable metal leakage. Polymethacrylate/phosphonamide catalyst is very selective with cyclohexene and 65% H_2O_2 —very little allylic product is formed compared with the homogeneous analogue.

Titanium silicalite TS-1 continues to occupy a central position in the research and development of heterogeneous epoxidation catalysts, the aim being either to improve its own performance further or to reproduce its key features in other structures, as noted earlier. Early work [122] established the scope of the catalyst, which performs most strongly with small substrates such as lower alkenes [10,55], allyl chloride [180], allyl methacrylate [181] and, interestingly, butadiene [182] (to monoepoxide)—all at high conversion and selectivity. Hydrogen-peroxide-based processes competitive with existing technology can be envisaged in all these cases.

The purity and crystallite size are both critical to epoxidation: the former because of selectivity and the latter because of activity. Many patents and publications refer to the addition of mildly basic buffering agents to suppress any acid sites present at the start or developing during use. Although deleterious during TS-1 formation, the addition of alkali metal cations in use can improve selectivity [129]. Amides such as dimethylformamide recently have been claimed [183], as has the addition of heavier cations including zinc [184] and of amines or amine oxides such as 2,6-lutidine, which clearly only reaches external surfaces. The need for small crystallites but tough catalyst bodies has led to many studies aimed at supporting TS-1 on more robust (and cheaper) solid substrates [185,186]. Many groups have confirmed that there is a maximum loading of Ti in TS-1, which appears to correspond to the limit for effective site isolation. However, the conventional way of achieving this distribution (co-precipitation of Ti and Si from esters) has been challenged by a recent paper [187], claiming that post-substitution of TiCl_4 into silanol nests in silicalite (high-silica ZSM-5) formed from *n*-butylamine, tetraethylammonium bromide or hexamethylenediamine templates gives higher catalytic activity for propylene epoxidation because of higher concentrations of isolated framework Ti.

Jacobs' group [188] has attempted to improve understanding of epoxidation by Ti zeolites through quantitative sorption experiments including substrate, solvent and product. For TS-1, methanol allowed the biggest concentration of olefin inside the

pores, corresponding to the biggest initial rates of reaction. Longer chain olefins epoxidise faster initially but the epoxide is very slow to desorb—acetone is said to be a better solvent for these—and deactivation therefore is fast in methanol. Larger pore materials do not adsorb olefins as strongly, corresponding to lower reactivity. Regarding solvents, an interesting recent patent from Exxon [189] employs methanol and CO_2 for carrying out propylene epoxidation under supercritical conditions. Examples also are given with 1-octene, and improved selectivities on both olefin and H_2O_2 are shown. It has been claimed recently [190] that vanadium incorporation into the TS-1 framework improves activity for propylene epoxidation, even though VS materials alone are worse than TS-1. For the Ti- β zeolite, a sharp dependence of 1-hexene conversion on crystallite size is shown, as in other results for TS-1, which seems to confirm the product desorption limitation for larger molecules. Addition of thallium fluoride has been claimed to promote the epoxidation of methallyl chloride by H_2O_2 and TS-1 [191], e.g. at 40°C for 2 h a selectivity of 93.2% at a conversion of 52.3% is obtained.

As noted in Section 3, Ti- β is the best-characterised large-pore analogue of TS-1 to date but the larger cavities always accommodate solvent along with the substrate. This increases the tendency for epoxide ring-opening and means that the slightly basic acetonitrile gives better results than the slightly acidic methanol. The influence of zeolite hydrophobicity is highlighted by studies on the epoxidation of unsaturated fatty esters [192]. Elimination of residual aluminium (Brønsted acid) sites and of extra-framework TiO_2 in Ti- β is also difficult, both contributing to side reactions. Recent work by van Hooff [193] has made Ti- β for epoxidation by post-synthesis: dealuminisation is followed by TiCl_4 treatment. For 1-octene, results in acetonitrile are comparable with TS-1 (accepting that this is not the best solvent for TS-1 reactions).

It is probably fair to say that other microporous materials such as UTD-1 [194] and SSZ-33 have not shown any advantages over Ti- β as hosts for framework titanium. A recent addition by Corma's group [195] is ITQ-6, prepared by delamination of ferrierite. This offers a very high *external* surface area and Ti framework substitution is readily achieved, the product being active and selective in 1-hexene and norbornene epoxidation—comparable with Ti-

β . It remains stable and active upon reaction/calcination cycles.

Other work has taken up the themes of surface hydrophobicity and site isolation in the search for effective epoxidation catalysts using mesoporous or amorphous supports. High-surface-area alcohols have been made from $\text{Si}(\text{OEt})_4/\text{Me}_2\text{Si}(\text{OMe})_2$ mixtures [196]—there is a transition from glass to rubber at approximately 2:3 ratio. The hydrophobic products may offer longer life because there is less tendency for silanol groups to continue cross-linking than all-tetraethyl-orthosilicate preparations, bearing in mind that the structure is not fixed. Cyclooctene was the only substrate tested in this work. Other workers [197] investigated the effect of hydrophobic ‘end capping’ before Ti grafting for a system where $\text{Ti}(\text{OiPr})_4$ was supported on silica. Using cyclooctene and cyclohexene as substrates, this capping improved the H_2O_2 efficiency and reduced epoxide ring-opening, but did not change the epoxidation/allylic product ratio. As well as giving the catalysts greater affinity for organic substrates, silylation appears to reduce H_2O_2 decomposition in larger pore materials [198].

Improved site isolation apparently has been obtained by using the organometallic tetra-nepentyl titanium (and its zirconium analogue) in attaching Ti sites to silica gel [199]. The remaining alkyl groups are rapidly solvolysed in use. With diglyme as solvent, these catalysts give better yield and selectivity (including lower H_2O_2 decomposition) in cyclohexene epoxidation than conventional Ti ester-based materials. The zirconium analogue is more acidic and hence more resistant to activity loss through hydrolysis, but also catalyses epoxide ring-opening better. Apparently, diglyme itself also is hydrolysed to an extent.

Other olefin oxidations

Diol formation has been highlighted many times as a side reaction during epoxidation and diol easily can

be made the predominant product by increasing acidity in the presence of sufficient water. With alcohol solvents the monoalkyl ether is formed, whereas in the presence of carboxylic acids (as for unbuffered peracid epoxidations) the monoester is found. Epoxides vary in their sensitivity to acid, protonation being easier in the presence of electron-donating substituents. A good practical example is the tungstate-catalysed formation of tartaric acid from maleic acid, where the tungstate indeed catalyses the ring-opening as well as the epoxidation itself [200]. In this case, the product inhibits the reaction by coordinating the catalyst.

Epoxides are well known as versatile intermediates in synthesis. An interesting *in situ* rearrangement recently reported by Tatsumi [201] occurs with hydroxyepoxides. Intramolecular rearrangement of glycidols to hydroxytetrahydrofurans/homoglycidols to hydroxytetrahydropyrans occurs after their formation from $\text{H}_2\text{O}_2/\text{TS-1}$ or $\text{H}_2\text{O}_2/\text{Ti-}\beta$: examples with TS-1 include 3-buten-1-ol (Fig. 11.22), 4-penten-2-ol, 4-penten-1-ol, *cis*-4-hexen-1-ol and 5-hexen-1-ol, with product yields of 60–95%. Solvents were water, acetone or 2-butanol. Some bulky terpene alcohols were tried with Ti- β , giving generally lower conversions but still quite good selectivity.

An important olefin reaction involving further oxidation is that of $>\text{C}=\text{C}<$ cleavage. Commercially, oleic acid is cleaved by ozonation to give nonanoic (pelargonic) and azelaic acids [202]. This reaction can be performed by peroxygen systems, including one based on a mixture of Ru and Mo catalysis, and carried out in *t*-butanol solvent with a minor amount of carboxylic acid added [203]. In the case of olefin groups bearing hydrogen, this acid is conveniently that obtained from the cleavage itself. A mixed $\text{H}_2\text{O}_2/\text{oxygen}$ system also has been described [204] for cleavage of fatty acids such as oleic and erucic using $\text{H}_2\text{O}_2/\text{tungstate}$ for the dihydroxylation and then *N*-hydroxyphthalimide (NHPI)/ $\text{Co}(\text{acac})_3$ (or the Mn analogue) with O_2 for the cleavage (Fig. 11.23).

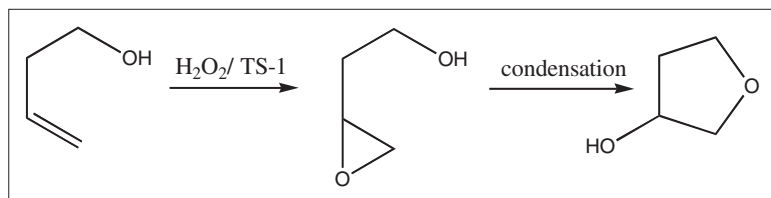


Fig. 11.22 3-Hydroxytetrahydrofuran from 3-buten-1-ol via the epoxy alcohol.

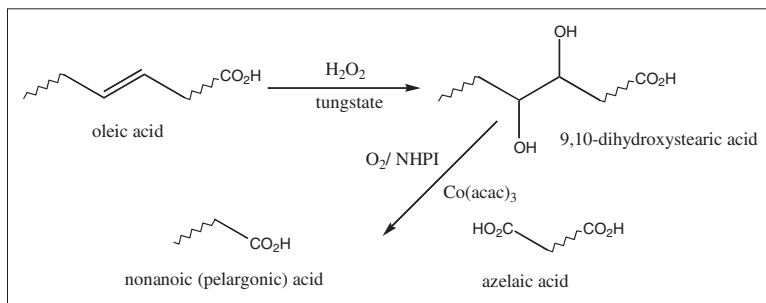


Fig. 11.23 Oxidative cleavage of oleic acid using hydrogen peroxide and oxygen.

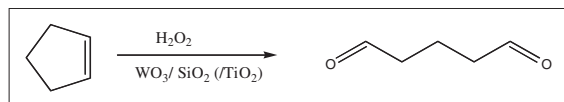


Fig. 11.24 Oxidative cleavage of cyclopentene to glutaraldehyde.

In a lot of cases, metal–peroxo catalysts alone can be sufficient to cleave olefins if the appropriate excess of H_2O_2 is used [205]. Cleavage of cyclopentene to glutaraldehyde can be achieved with H_2O_2 in *t*-butanol solvent over heterogeneous catalysts comprising tungstic oxide (WO_3), supported on sol-gel-prepared silica [206] or on mixed $\text{TiO}_2/\text{SiO}_2$ [207] (Fig. 11.24). In both cases the support was post-impregnated with ammonium tungstate. It seems possible that at least some of the tungsten may be solubilised as a peroxo complex at some stage during the reaction, although it may reprecipitate if all the peroxide is consumed.

Heteropolyacids catalyse this and other olefin cleavage reactions [208]. Polyoxometallates have been reported for olefin cleavage: for example, the Keggin structures Mo_{12}P , W_{12}P and $\text{W}_6\text{Mo}_6\text{P}$ have been used with H_2O_2 , 2,3-dimethylbut-2-ene gives acetone, cyclohexene gives adipic acid, 1-octene gives heptanoic acid, styrene and stilbene both give benzoic acid and 1-methylcyclohexene gives 6-ketoheptanoic acid, all in at least 90% yields [209]. Once again, there are doubts that the intact complex is the active catalyst. This reaction has been reviewed recently with respect to oleic acid cleavage [210]. Not surprisingly, because diols are common intermedi-

ates in the oxidation, they themselves are cleaved by much the same range of catalysts [211].

Aliphatic hydrocarbon oxidations

Saturated aliphatic hydrocarbons are oxidised to alcohols (predominantly secondary and tertiary) and ketones by a variety of catalysed peroxygen systems, although the reactions are rarely selective enough to be useful commercially. Activity and product patterns often are investigated in the course of characterising catalysts such as TS-1 and its ‘offshoots’ already encountered. For example, a kinetic and product study of *n*-hexane oxidation over Ti catalysts, includes a literature review on partial oxidation [212].

The use of membranes for this reaction is worthy of note as a means of solving a common problem in H_2O_2 oxidations—lack of mutual solubility between hydrophobic substrate and hydrophilic oxidant. Kaliaguine’s group has studied *n*-hexane oxyfunctionalisation over TS-1-containing catalytic PDMS membranes [213], avoiding the use of a co-solvent to bring H_2O_2 and alkane into solution by contacting on opposite sides of the membrane. Products are alcohols and ketones, with generally low conversions in the experiments quoted.

A mixed oxygen/ H_2O_2 system that has received much attention recently comprises vanadium(V) and heterocyclic acids such as pyrazinecarboxylic acid in carboxylic acid solvent [106,107]. Mizuno also has reported [214] a system comprising trifluoroacetic anhydride and H_2O_2 with the polyoxometallate $\text{H}_4\text{PVMo}_{11}\text{O}_{40}$ as catalyst precursor. The activity of these systems appears comparable with Fenton’s reagent, with even methane being attacked—once again, selectivity can be the main issue.

Aromatic ring oxidations

By far the biggest application in this category is the hydroxylation of phenol to catechol and quinol, with H_2O_2 and an acid catalyst. This process is always carried out at limited conversion, usually 25% or less, because the products are oxidised more easily than phenol itself and hence conditions must be used that allow the phenol to compete effectively for the oxidant. The traditional process uses homogeneous catalysis by phosphoric and sulfuric acids (Fig. 11.25). However, a range of other acid catalysts now has been shown to perform at least as well, including the ubiquitous TS-1 [8]. A process based on this was commercialised some years ago [122].

The purity of TS-1 is of paramount importance. The presence of alkali metal ions during preparation gives extra-framework Ti compounds, leading to H_2O_2 decomposition and a drastic decrease in catalyst performance, possibly due to channel blockage and/or rapid fouling with over-oxidised products. It has been found also that catalyst pretreatment with fluoride and H_2O_2 improves performance for benzene hydroxylation, possibly by washing off surface TiO_2 [215].

Phenol hydroxylation can be carried out effectively with zirconium phosphate and related materials as catalysts in acetic acid solvent [216]. There is evidence of formation of peracetic acid within the layer structure of the catalyst, where it reacts with the phenol.

A number of polyoxometallate catalysts have been disclosed for phenol hydroxylation in homogeneous and heterogeneous systems. As in all processes making two or more products, balancing demand is an issue. The ability to vary the ratio of catechol to quinol is valuable but is usually limited for any particular catalyst: however, polyoxometallates appear to offer more flexibility in this respect. Variation of the V/Mo ratio in PM_{12} Keggin complexes varies the

substitution ratio [217]. Phenol hydroxylation over the complex oxide $\text{H}_x\text{V}_2\text{Zr}_2\text{O}_9 \cdot \text{H}_2\text{O}$, with $\text{V}^{\text{IV-V}}$ mixed valence, has been described [218]. Conversions quoted are lower than current manufacturing processes (but ca 95% overall selectivity is quoted) to catechol (57–60%)/quinol (38–35%). No loss of activity is seen over four recycles, with intermediate calcination at 550°C. Benzene hydroxylation with α - or β -1,2,3- $[\text{SiW}_9\text{V}_3\text{O}_{40}]^{7-}$ has been studied [219]. The α -complex catalyses directly after an induction period, but the β -complex catalyses by vanadium release almost immediately. The induction period is seen at neutral pH, not acidic. Active peroxygen species are of the type $[\text{VO}(\text{O}_2)]^+$ and $[\text{VO}(\text{O}_2)_2]^-$ for free vanadium in solution. There appears to be a genuine cooperative effect between the 1,2- V_2 moiety as shown by this study and the references therein.

A very active catalyst for phenol hydroxylation based on α - Fe_2O_3 particles in a macroporous resin has been reported [220]. Copper complexes encapsulated in zeolites also have been shown to catalyse this reaction [221], as have metal-substituted APOs [222].

Oxidation of the aromatic ring to *p*-quinone is valuable in a few well-known cases. Vitamin K_3 (menadione) is thus prepared from 2-methylnaphthalene (Fig. 11.26). A range of peroxygen systems can achieve this oxidation. A recent addition [223] uses encapsulated metal complexes in the mesoporous support MCM-41 or in zeolite Y. 2,3,6-Trimethylphenol is oxidised to 2,3,5-benzo-1,4-quinone in the course of vitamin E synthesis. This oxidation can be achieved in two stages: using H_2O_2 and HCl for 4-chlorination, followed by H_2O_2 /acetic acid to oxidise to the quinone [224].

Aromatic side-chain oxidations

Hydrogen peroxide can be used as an oxidant in aromatic side-chain oxidations in acetic acid, catalysed by cobalt and bromide salts [225] with or without manganese, or with cerium and bromide [226]. Toluenes are oxidised to benzaldehydes or benzoic acids, ethylbenzenes to acetophenones, and diphenylmethanes to benzophenones. The first of these systems is analogous to dioxygen oxidations carried out at high pressure on a very large scale to make terephthalic and isophthalic acids from the corresponding xylenes. The ability to use ambient

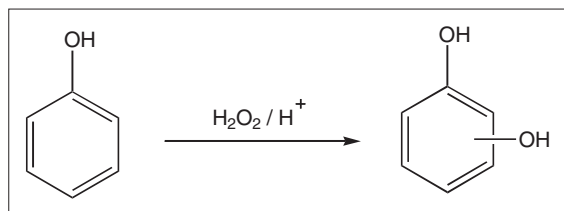


Fig. 11.25 Hydroxylation of phenol—the traditional route.

Fig. 11.26 Preparation of menadione by the oxidation of an arene to a quinone.

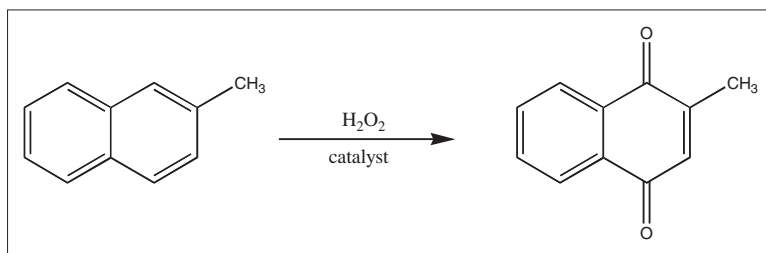
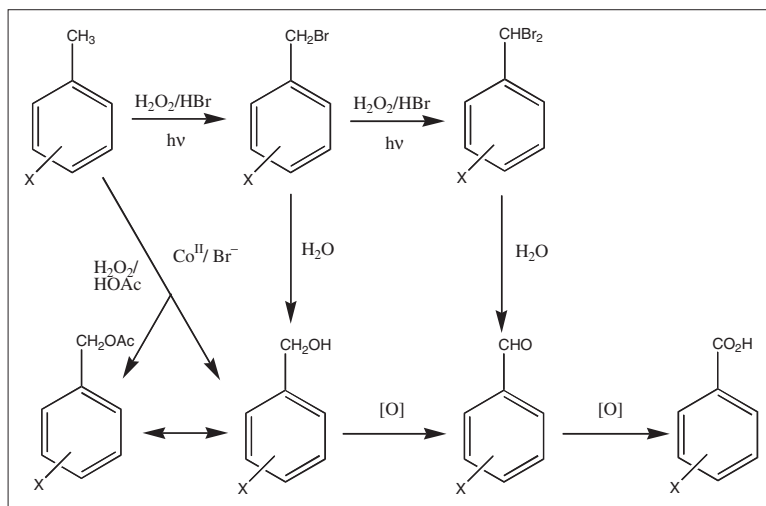


Fig. 11.27 Range of useful products from aromatic side-chain oxidation.



pressure in general-purpose plant with H_2O_2 as oxidant is useful for fine chemicals. In this case, the second oxidation on a side chain is faster than the first, tending to give toluic acid or aldehyde intermediates if a low excess of oxidant is used. Another side-chain oxidation system uses H_2O_2 and hydrogen bromide irradiated with visible light [227,228], the active species being atomic bromine. Here, the second oxidation is slower than the first, offering a selective route to dialcohols from xylenes, for example. Also, although acetophenones and benzophenones can be oxidised to the intermediate carbinol by control of H_2O_2 stoichiometry, the ketones can be produced directly by using excess H_2O_2 with only catalytic levels of HBr.

Many useful intermediates can be obtained via these benzylic oxidations, as shown in Fig. 11.27. Benzylic oxidation of ethylbenzene over Ti-, V- and Sn-containing MFI zeolites has been reported [229] and *p*-chlorotoluene is oxidised to the benzaldehyde over vanadium zeolites [230].

Alcohol oxidations

A recent review [231] describes methods for alcohol oxidation with both H_2O_2 and O_2 . It is becoming increasingly difficult to sustain the use of traditional methods involving stoichiometric oxidation with chromium(VI). Peroxo-metal and peroxygen-driven metal redox systems both now figure strongly.

Regarding the peroxo-metal systems, the combination of H_2O_2 with simple molybdate salts is a very effective catalytic system for oxidising secondary alcohols to ketones, and benzylic alcohols to aldehydes [91] (Fig. 11.28). Unlike epoxidation, molybdenum(VI) generally catalyses alcohol oxidation as well as tungsten(VI). However, there have been a couple of salient recent papers about the tungsten system. One of these, from Noyori [232], describes a practical method for alcohol oxidation using 3–30% H_2O_2 without solvent: sodium tungstate is the catalyst and the phase-transfer agent is methyltriethyl ammonium bisulfate. A similar method assisted by

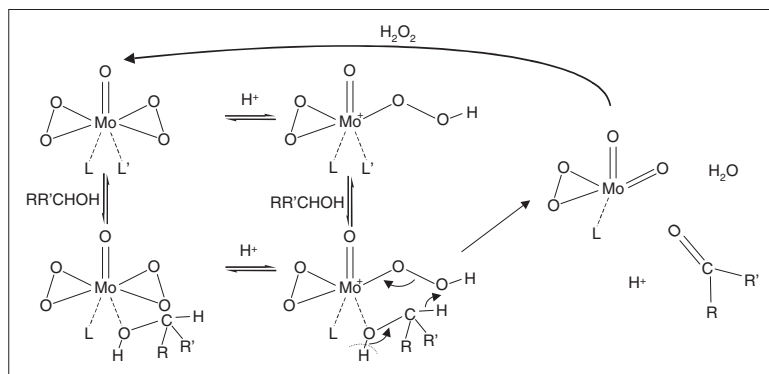
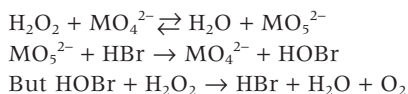


Fig. 11.28 Metal-peroxo-catalysed alcohol oxidation.

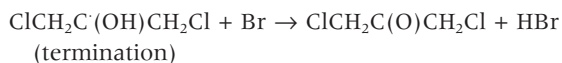
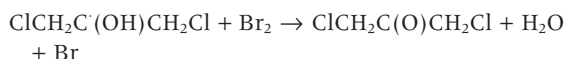
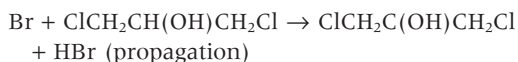
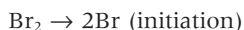
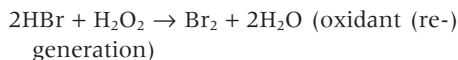
microwave irradiation [233], with $\text{Bu}_4\text{N}^+\text{HSO}_4^-$ as phase-transfer agent, claims good yields of acids from primary aliphatic alcohols (60–80%) as well as ketones from secondary alcohols (77–94%)—the latter groups react faster and can be oxidised selectively in the presence of primary hydroxyl. Niobium compounds also catalyse alcohol oxidation via a peroxo mechanism [238].

Again referring to peroxo-metal systems, methyltrioxorhenium (MTO) is an effective catalyst for alcohol oxidation [110]. Generally, peroxo-metal systems are substantially speeded up in alcohol oxidation by the addition of bromide, owing to in situ generation of hypobromous acid, this formation itself being catalysed by the peroxo-metal species (see Section 2). However, there may be an increase in the decomposition of H_2O_2 , e.g.:



Note also that HOBr is a less selective oxidant than peroxotungstate and may oxidise or halogenate other functional groups if present.

On the other hand, the deliberate generation of active halogen can be useful in some cases. Ethyl lactate can be oxidised to the pyruvate using bromine and H_2O_2 , without metal catalyst, in dichloroethane [234]. The HBr co-product of oxidation by bromine is re-oxidised by the H_2O_2 at high acidity. A still more powerful system arises from H_2O_2 and HBr irradiated by visible light, which dissociates Br_2 into atomic bromine, resulting in a free-radical chain oxidation. This is excellent for alcohols such as 1,3-dichloropropanol that are very difficult to oxidise [235]:



Turning to metal redox systems, the Mn/tmtacn/ascorbic acid combination described earlier for epoxidation is also an efficient catalyst for oxidation of pentan-2-ol to ketone (97% yield) and of pentan-1-ol to *n*-valeric acid (90% yield) in water/MeCN [167]. Excess H_2O_2 is required. There are also many references to ruthenium-catalysed alcohol oxidation using H_2O_2 [236], and to chromium systems with persalts [237], where the important point is that Cr^{III} is oxidised to Cr^{VI} in neutral to alkaline solution but the reverse takes place in acid. In general, the redox systems are not as efficient as peroxo-metal in the use of H_2O_2 .

Regarding solid catalysts, alcohol oxidations are among the reactions catalysed by titanium zeolites: some of this work is reviewed in [212,231]. Some other solids also are reported, including vanadium-pillared clay (VPILC) for benzylic alcohol oxidation using 30% H_2O_2 [239]: *p*-substituted alcohols are oxidised faster than the *o*-isomers. Note that it is especially difficult to rule out a homogeneous contribution in the case of V and Cr solid catalysts because of their amphoteric nature in the redox cycle and their activity at very low levels in solution.

Finally, attention is drawn to an excellent review

[240] of carbohydrate and related oxidations with O_2 or H_2O_2 —this is related more to alcohol oxidation than the other categories herein, and includes two summarising schemes.

Carbonyl oxidations

Unlike alcohols, aldehydes often can be oxidised by H_2O_2 alone under suitable conditions. In the presence of mineral alkali or organic bases, H_2O_2 will convert a range of aldehydes to their corresponding acids [26,241]. For example, furoic acid can be made in high yield from furfural, and even the sulfur analogue 2-carbonyl thiophene undergoes aldehyde oxidation in preference to S-oxidation [242].

A recent general method has been published by Noyori [243]: using a quaternary ammonium salt under phase-transfer conditions without solvent, halide or metals, which is especially valuable from a waste minimisation viewpoint. Rather more spe-

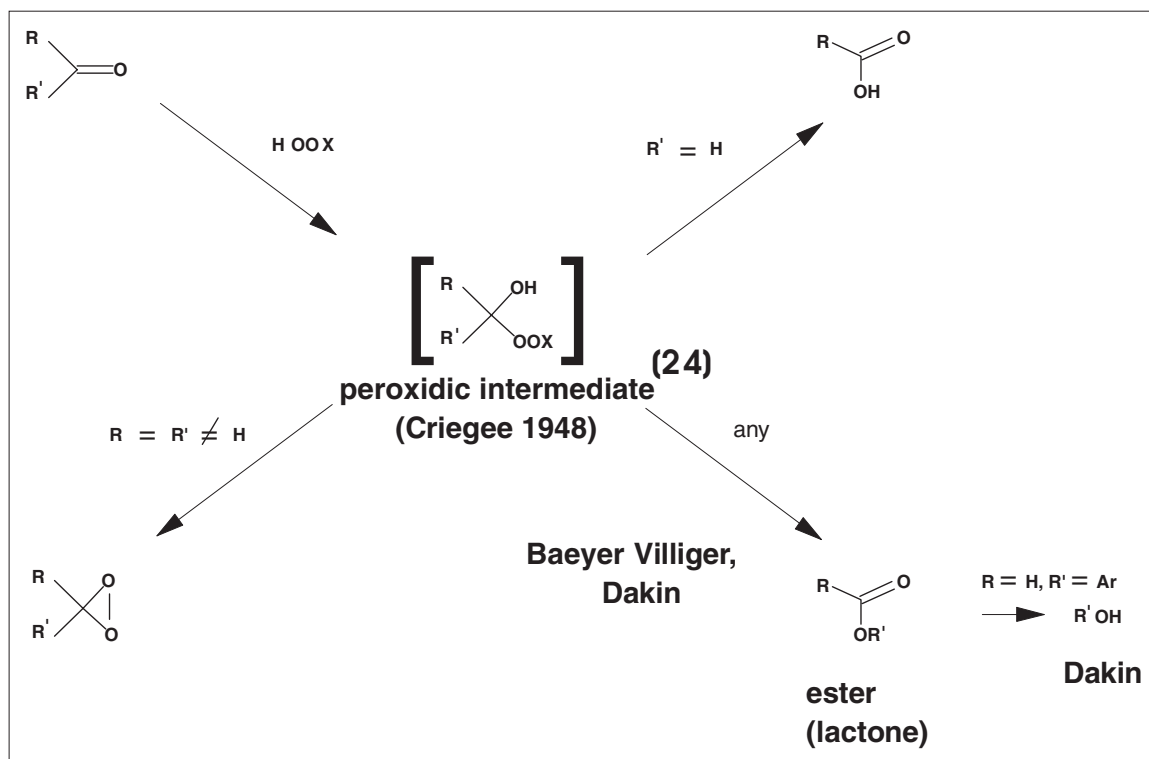
cialised is a patented method [244] for the oxidation of dimethylolbutanal to dimethylolbutanoic acid using 50% H_2O_2 at 60°C for 5 h: note that the primary alcohol groups are much less reactive than the aldehyde.

The most common reaction of ketones, also given by certain activated aromatic aldehydes, is the Baeyer–Villiger reaction shown in Fig. 11.29. This results in oxygen insertion between the carbonyl group and one of its substituents, normally leading to an ester or lactone. The ease with which different substituents migrate is roughly in the order:

tert-alkyl > cyclohexyl > *sec*-alkyl > benzyl > phenyl > prim-alkyl > methyl > haloalkyl

Caprolactone is manufactured by the Baeyer–Villiger oxidation of cyclohexanone using peracetic acid, which in the Solvay process is made, used and regenerated in an internal recycling loop (Fig. 11.30). The product, like many epoxides, is very sensitive to ring-opening by traces of acid, which necessitates the use of very strong H_2O_2 and distillation of the peracetic acid prior to use and limits the conversion achievable at acceptable selectivity.

Fig. 11.29 Baeyer–Villiger and other peroxide reactions with carbonyl groups.



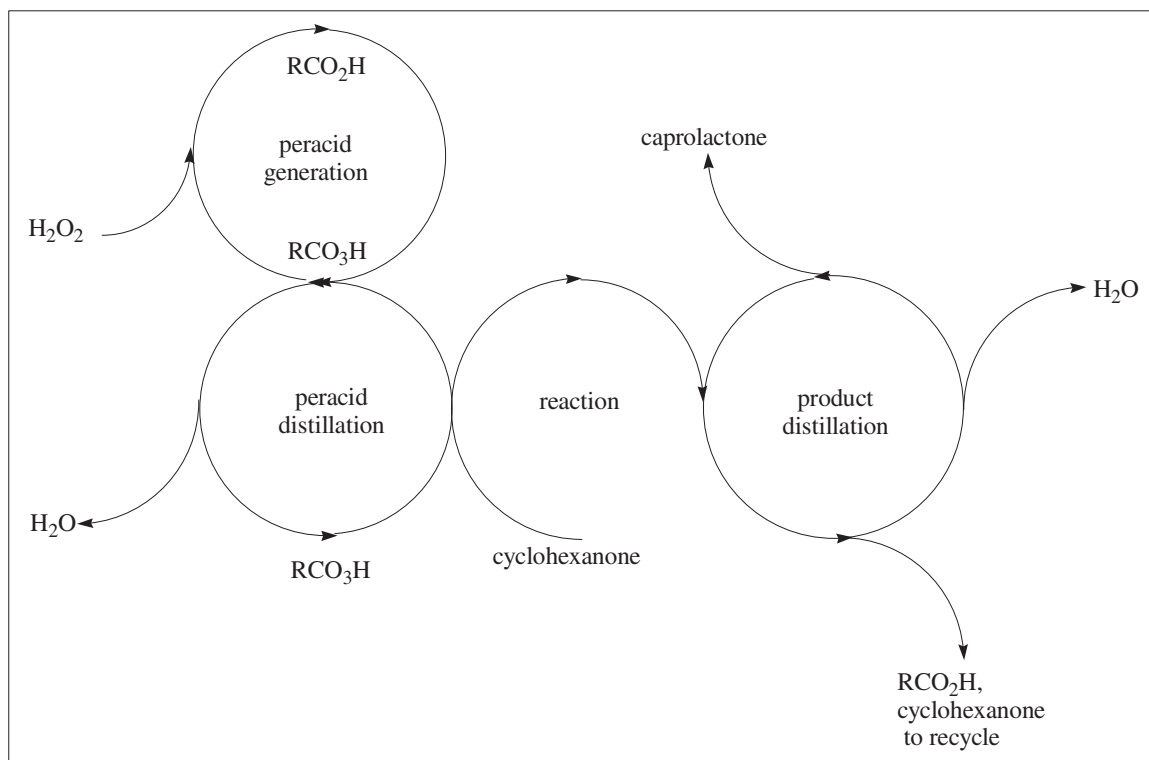


Fig. 11.30 Caprolactone manufacture using the peracid process.

The Baeyer–Villiger reaction and reagent systems have been reviewed comprehensively [245]. Most systems described to date are based either on peracids or on electrophilic activation of peroxide by various acid catalysts. Many Lewis acids are effective [246] but tend to suffer deactivation sooner or later owing to the water contained in or liberated from the H_2O_2 .

Inorganic peracid analogues such as perseleninic acids, often derived from diselenides, have been studied quite extensively [247]. Also, solid catalysts including heteropolyacids [248], zirconium and similar phosphates [249] and even uranium phosphate [250] have been described. Caprolactone is particularly easy to hydrolyse but most other substrates do give esters or lactones that are stable under the reaction conditions.

The Baeyer–Villiger reaction can be a useful way of making phenols from aldehydes or from ketones

via Friedel–Crafts alkylation, in order to access particular substitution patterns. Aldehyde to phenol (the Dakin reaction) occurs only with strongly activating *o*- and/or *p*-substituents [241a,251]. Ketone to phenol is common, owing to the ease of migration of phenyl groups relative to alkyl. A recent system has employed H_2O_2 in the presence of boric and sulfuric acids [252].

4.2 Oxidations at nitrogen

There is a diverse range of specific oxidations at nitrogen; a complete description of these, as they relate to peroxygens, can be found elsewhere [1–4]. The ability to activate peroxygens selectively for a given oxidation type is, as expected, very valuable in such circumstances.

Oxidation of ammonia itself by peroxygens is of importance in two industrial processes. One of the main routes to hydrazine [253] involves reaction of ammonia, hydrogen peroxide and 2-butanone (MEK) to give an azine intermediate, which is then hydrolysed to hydrazine, liberating the ketone for

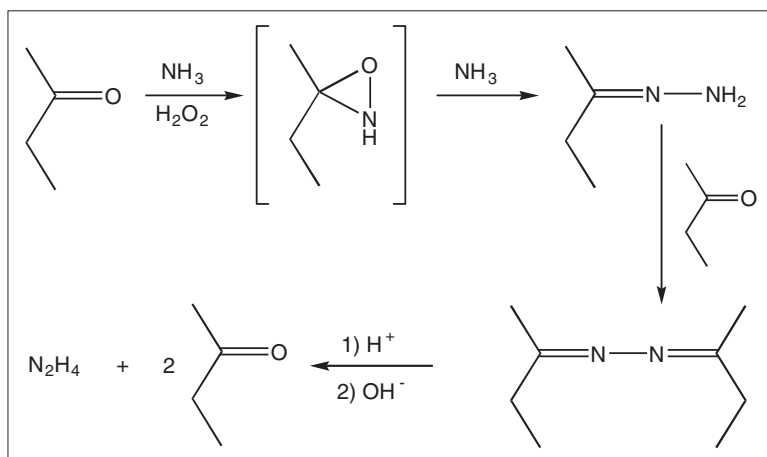


Fig. 11.31 Hydrazine manufacture using hydrogen peroxide.

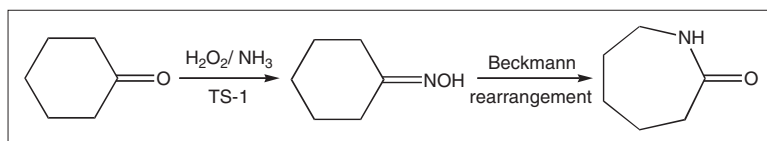


Fig. 11.32 Caprolactam manufacture with $\text{H}_2\text{O}_2/\text{TS-1}$.

recycling (Fig. 11.31). This has been operated for over 20 years and accounts for 20–25% of world N_2H_4 production. Much more recently, the oxidation of ammonia to hydroxylamine by TS-1 has been commercialised within a new catalytic process for caprolactam manufacture from cyclohexanone [254] (Fig. 11.32). This process generates much less waste than the conventional one, which can give rise to as much as 4 t of ammonium sulfate per tonne of caprolactam. A patent has been issued on the preparation of MEK oxime in a similar fashion [255]. It would seem feasible to employ TS-1 in hydrazine manufacture also [256].

4.2.1 Amine oxidations

One of the biggest current applications for H_2O_2 is in the manufacture of tertiary amine oxides from tertiary amines [257]. Like epoxidation, this is a single oxygen transfer reaction for which peroxygens are the natural choice. The products are mainly of the surfactant type, for use in a large number of household and personal care products, although another industrially significant product is *N*-methylmorpholine *N*-oxide, now used as a solvent in rayon manufacture [258]. The reaction will proceed simply by

mixing amine and aqueous H_2O_2 without a catalyst, but is speeded up in the presence of tungstate or, most notably, carbon dioxide or bicarbonate (forming electrophilic percarbonate species as shown in Section 2). Because the system is alkaline, addition of stabilisers is important to prevent uncontrolled side reactions. Among the by-products, small amounts of nitrosamines tend to be formed. Because these are harmful, they must be kept down to parts-per-billion levels for most applications. This can be done by a combination of measures: limiting reaction temperature; using a catalyst for the main reaction; and adding a stabiliser to suppress metal-catalysed decompositions.

For surfactant production, manufacturing technology continues to be refined. One recent patent [259] deals with completing the reaction in the shipping containers, to reduce plant residence time and/or temperature and hence improve throughput. Another patent [260] discloses that adiabatic temperature rise can be allowed during the (exothermic) reaction while maintaining very low nitrosamine levels through the use of CO_2 catalyst and a chelating agent. Regarding the latter, organophosphonates such as diethylenetriamine-*N,N,N',N'',N'''*-pentakis-methylenephosphonate can be used.

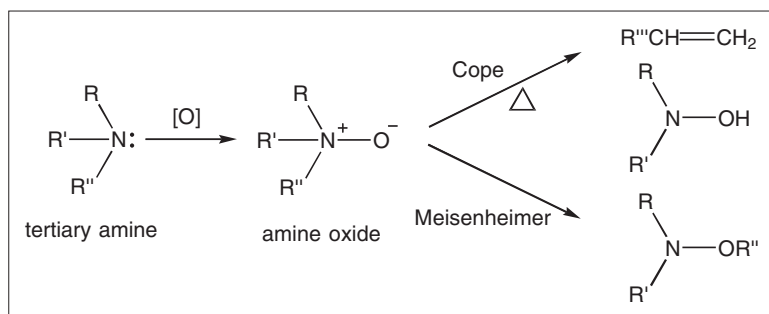


Fig. 11.33 Other products via tertiary amine oxides.

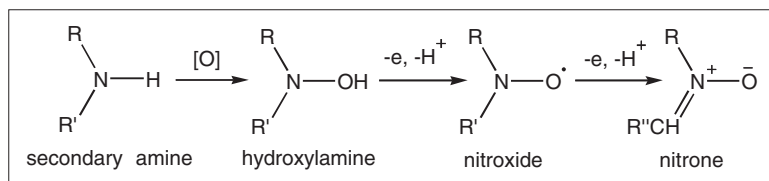


Fig. 11.34 Oxidation products from secondary amines.

The most important secondary amine oxidation product is *N,N*-diethylhydroxylamine (DEHA), a radical scavenger and polymerisation chain stopper. This can be made by direct oxidation of diethylamine with H₂O₂, in alcoholic/aqueous solution with added stabiliser [261]. The process usually is carried out to limited conversion (~60%) to avoid over-oxidation. It has been shown by Tuel that TS-1 will catalyse the formation of DEHA [262]. An alternative, however, is the thermal decomposition (Cope elimination) of triethylamine *N*-oxide [261a,b] (Fig. 11.33). This is probably the more convenient in terms of product separation and recovery, even though it is less good from the 'atom utilisation' viewpoint. Further oxidation of hydroxylamines proceeds via nitroxides (which can be isolated if no α -hydrogen is present) to nitrones, the latter being valuable intermediates in heterocyclic chemistry (Fig. 11.34).

In comparison to the above, no single primary amine oxidations by H₂O₂ are as significant, although many may be carried out on a small scale.

N(-)N oxidations

Hydrogen peroxide can be used in the manufacture of azo compounds such as azobisisobutyronitrile (AIBN, a radical reaction/polymerisation initiator) and azodicarbonamide (a blowing agent for various foam materials) by oxidation of the hydrazo intermediate [263] (Fig. 11.35).

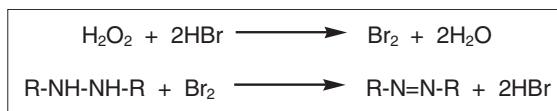


Fig. 11.35 Hydrogen peroxide in azo compound production.

Electrophilic peroxygens oxidise azo compounds to azoxy compounds [264], which are relatively stable. Only under forcing conditions can they be oxidised further, resulting in —N=N— cleavage and nitroso/ nitro products (Fig. 11.36)

C(-)N oxidations

Formation of these bonds more usually is achieved by elimination (e.g. alkyl halide + amine) or condensation (e.g. carbonyl + amine) reactions rather than oxidation, and no single such reaction using H₂O₂ is industrially important at present. Destruction of C=N bonds can, on the other hand, be performed by a number of electrophilic peroxygens, as in oxidative deprotection of hydrazones [265]. It is possible also to oxidise hydrazones without cleavage [247a], forming mono-oxaziridines and *N*-oxides, using e.g. selenium catalysis or peracids. Nitrones, nitriles and oxadiazoles also are accessible. These bonds in Schiff bases also can be 'epoxidised' by similar systems to form oxaziridines [266], which have attracted some interest as oxidants in their own right.

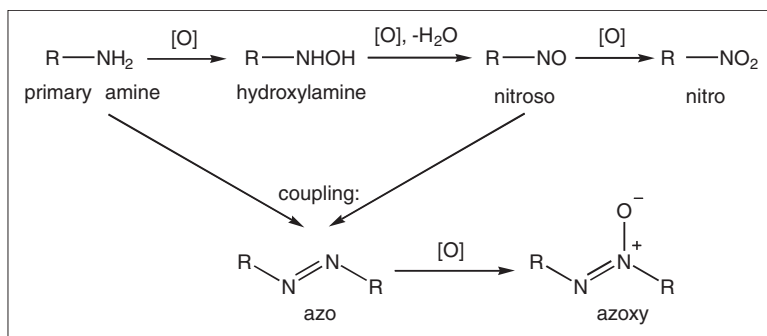


Fig. 11.36 Azo and azoxy compounds in peroxide reactions.

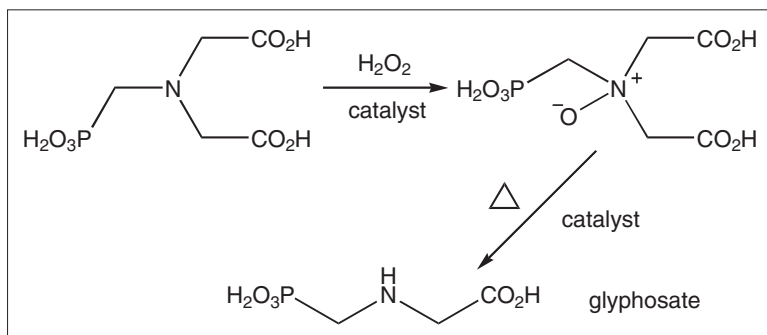


Fig. 11.37 Peroxide process to glyphosate.

An important industrial application of C–N cleavage has been ‘dealkylation’ of *N*-phosphonomethyl iminodiacetic acid used during production of the pesticide glyphosate (*N*-phosphonomethyl glycine) [274] (Fig. 11.37). Hydrogen peroxide oxidation remains significant, although some methods based on oxygen also now are available.

Reports of new chemistry arise from time to time, such as the recent cyanation reaction of *N,N*-dimethylaniline catalysed by Ru^{III} [267] (Fig. 11.38) and the aromatisation of 2,3-dihydropyridazines [268] (Fig. 11.39).

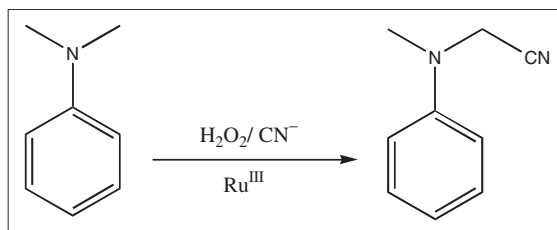


Fig. 11.38 Cyanation of *N,N*-dimethylaniline.

4.3 Oxidations at sulfur

The analogue of ammonia oxidation in sulfur chemistry would be the oxidation of H₂S. However, this oxidation does not add value and the corresponding use of H₂O₂ is confined to the abatement of H₂S in gaseous and liquid effluents, in which it performs extremely well. At acidic to neutral pH the product is sulfur, whereas in alkaline solution oxidation can proceed through to sulfate.

Sulfide oxidations

Organic sulfides can be oxidised to sulfoxides and further to sulfones, both steps involving single oxygen transfer (Fig. 11.40). The first oxidation is essentially electrophilic, but the second is nucleophilic and this, along with control of stoichiometry, permits selective preparation of either product. Many systems for this are long established: as noted for nitrogen chemistry, it is not the purpose of this chapter to catalogue all the available chemistry.

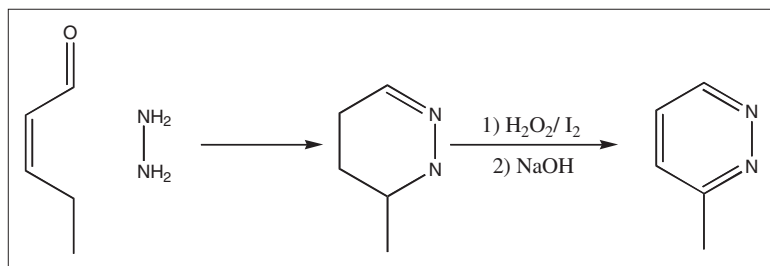


Fig. 11.39 Aromatisation of a heterocyclic intermediate.

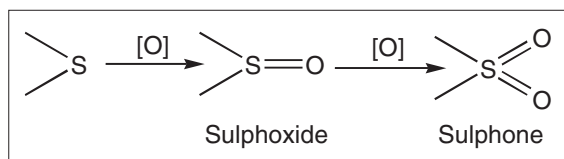


Fig. 11.40 Oxidation of sulfides.

It has been found recently [269] that sulfide oxidation, like tertiary amine oxidation, can be catalysed by bicarbonate: ethyl phenyl sulfide is oxidised primarily to sulfoxide, with some sulfone at higher molar ratios, in water/ethanol or *t*-butanol mixtures. The study was used in part to model the detoxification of mustard gas (bis-2-chloroethyl sulfide) and related chemical warfare agents. This application has driven studies on molybdate- and tungstate-doped porous carbons for sulfide oxidation [270].

Reactive sulfides can be oxidised to sulfoxides using peroxyntrous acid generated in situ from nitrous acid and H_2O_2 [271]. The oxidant system decomposes rapidly and a relatively low H_2O_2 efficiency is to be expected for many substrates.

Oxidation of penicillins to sulfoxides, although on a relatively small scale, is an important intermediate reaction in cephalosporin manufacture. This has been performed traditionally with peracetic acid on a stoichiometric basis. A catalytic system using H_2O_2 and phosphotungstic acid on alumina has been disclosed [272].

Dimethyl sulfoxide can be oxidised to the sulfones using H_2O_2 and TS-1 [273].

Thiol oxidations

The oxidation scheme for thiols is quite complex (Fig. 11.41). The first stage is always the formation of disulfides (S–S coupling), and this represents the

biggest current industrial use of H_2O_2 in sulfur oxidation, many of the products being used as rubber vulcanisation accelerators and other chemical intermediates. Tetraalkyl thiuram disulfides are a good example [275] (Fig. 11.42). The reaction can be carried out under either acidic or alkaline conditions, but the latter are chosen because of the ease of separation of the hydrophobic product from the thiol, which is in solution as its anion. Careful control of pH is necessary to avoid side reactions.

Hydrogen peroxide and sodium hypochlorite are both used industrially at present for these oxidations, but catalysed air oxidation methods are now available and are likely to become more widespread in the future.

There are still, however, new reports of the use of H_2O_2 for this reaction. A process has been patented [276] for the manufacture of dimethyl disulfide by reacting 70% H_2O_2 and sodium methanethiolate under reduced pressure, such that the product vaporises and is then distilled and recovered. In another patent [277], dithiodipropionic acid is prepared from 2-thiopropionic acid with H_2O_2 at 50°C without catalyst.

Exhaustive oxidation of thiols to sulfonic acids can be carried out by Fenton's reagent [278] or by other catalysed H_2O_2 systems, including phosphotungstic acid on alumina [272], which gives 94% yield of benzenesulfonic acid from thiophenol in 45 min at 80°C . Simple homogeneous tungstate catalysis also can be effective, e.g. in preparing isethionic acid from 2-thioethanol [279] (Fig. 11.43).

S–S Oxidations

By careful choice of oxidant and conditions it is possible to access many of the intermediates shown on the thiol oxidation scheme, although some are fairly unstable to reactions such as disproportionation, as shown.

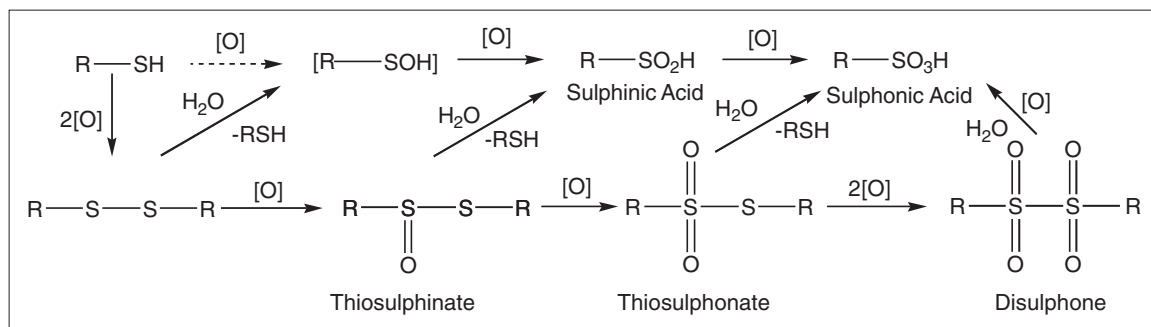


Fig. 11.41 Oxidation of thiols.

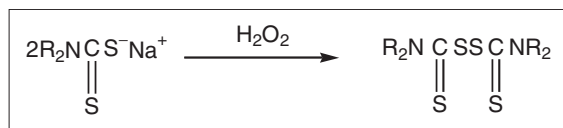


Fig. 11.42 Dithiocarbamate oxidation to thiuram disulfide.

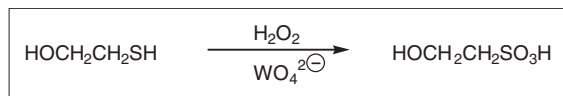


Fig. 11.43 Isethionic acid production from 2-thioethanol.

In a recent careful study, Espenson [280] oxidised symmetric disulfides by $\text{H}_2\text{O}_2/\text{MTO}$ in acetonitrile/water. Thiosulfonates RS(O)SR can be made in near-quantum yield, or oxidised via thiosulfonate $\text{RS(O)}_2\text{SR}$ to the sulfonic acid. The thiosulfonate also can disproportionate to disulfide and thiosulfonate. In this study, the mono-Re and diperoxo-Re species were found to make similar contributions to the catalysis. This chemistry also should be accessible via other peroxy-metal systems (V, Mo, W).

S-X Oxidations

In addition to disulfides, sulfenamides are made commercially as rubber vulcanisation accelerators, and these arise from oxidative coupling of thiols and (usually secondary) amines [281] (Fig. 11.44). Again, this is currently an important industrial use of H_2O_2 in chemical synthesis.

Carbon-sulphur bonds are cleaved oxidatively by peroxides. For example, thioketones ($>\text{C}=\text{S}$) and

sulphines ($>\text{C}=\text{S}=\text{O}$) are oxidised by $\text{MTO}/\text{H}_2\text{O}_2$ to ketones and SO_2 [282]. Sulfur monoxide is a transient intermediate in the latter reaction, formed by fragmentation of sulfine (the 'epoxide' of the sulfine). The sulfine itself can be produced in high yield in a few minutes at 25°C .

4.4 Halogenations

The general utility of hydrogen peroxide for the controllable in situ generation of halogens other than fluorine from the corresponding halogen acid has been discussed in Section 2 and earlier in this section. Bromine probably offers the most advantages when generated in this way, from both cost and convenience viewpoints: from the atom utilisation standpoint, complete incorporation of Br in the product scores heavily over generation of HBr by-product for external recycling. Halogenation also provides a means of side-chain oxidation of aromatics, as outlined earlier. Sometimes the benzylic halides themselves are the desired products, as in the example shown in Fig. 11.45, where 4'-bromomethyl-biphenyl-2-carbonitrile is made from 4'-methyl-biphenyl-2-carbonitrile by side-chain bromination with $\text{H}_2\text{O}_2/\text{HBr}$, activated by light or the radical initiator AIBN, refluxing in cyclohexane for 1.5 h [283].

Nuclear bromination is exemplified by the production of tetrabromo-bisphenol A using $\text{H}_2\text{O}_2/\text{HBr}$ [284], one of a number of flame-retardant additives that can be made in this way. In halogen substitutions such as these, essentially all of the halogen can be put into the product, instead of generating a stoichiometric amount of HX that must be treated externally.

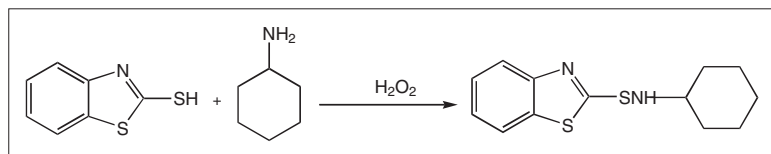


Fig. 11.44 Production of sulfenamides by S–N coupling.

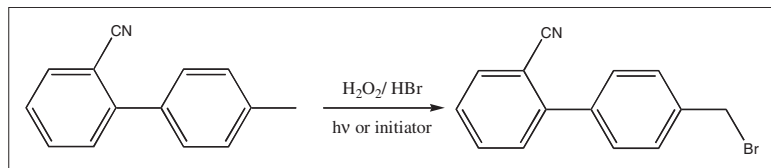


Fig. 11.45 Aromatic side-chain bromination with $\text{H}_2\text{O}_2/\text{HBr}$.

5 Developments in Catalysed Oxidations for Effluent Treatment

Although the thrust of this book is towards waste minimisation, it is clear that end-of-pipe treatment of effluents will remain important for many years as one means used by industry to maintain and improve environmental quality. The inherent advantage of H_2O_2 itself, in generating no significant waste during use, is especially valuable in effluent treatment. Increasingly, chemical techniques will be applied not to the bulk of waste streams, but either as a pretreatment—to ‘soften’ refractory effluents before natural purification—or as a post-treatment (‘polishing’) stage—to make low residual pollutant levels even lower and to remove environmentally persistent compounds such as AOX compounds (adsorbable organic halogens) and some pesticides.

A great amount of R&D has been devoted already to combinations of treatment elements, known as ‘advanced oxidation processes’ (AOPs)—many chemists would think of them as ‘hyphenated techniques’—and these now are becoming applied widely to real effluents. As will be seen, H_2O_2 is a key element in many such treatment combinations.

5.1 Catalysed H_2O_2 systems

The Fenton system described in Section 2 has been used over many decades for the treatment of refractory organics in wastewater. It is ideal, for example, for the degradation of phenolic compounds to non-toxic products [285], as summarised in Fig. 11.46. This has been applied, for example, to aminophenols in photographic effluent [286]. A characteristic of this system is that Fe^{III} salts are produced, often

leading to precipitation of a sludge containing organic residues that itself requires disposal. Although the removal of some products by flocculation into the sludge helps to reduce the H_2O_2 consumption, it may not be possible always to dispose of this waste. In such cases, the Fe^{III} can be reduced to Fe^{II} , using SO_2 or electrolysis, and recycled [287]. In an anaerobic/aerobic sequence, ferric can be reduced to ferrous by some microorganisms [288]. Also recently, a ‘photo-Fenton’s’ system has been used successfully, where the waste is treated with H_2O_2 /ferrous salt (e.g. oxalate) in a holding lagoon under the action of sunlight [289].

An extensive study has been made of the effects of complexing agents on the Fenton system [290]. Although relatively high $\text{Fe}/\text{H}_2\text{O}_2$ ratios were employed (so re-reduction of Fe^{III} was less of an issue), a general conclusion was that uncomplexed Fe only works at pH 3–4, whereas complexed forms can work at pH 2–10.

A number of proprietary solid catalysts are offered now in order to obtain Fenton-like chemistry without adding metals to the wastewater [291,292]. Hydrogen peroxide/goethite ($\alpha\text{-Fe}(\text{O})\text{OH}$) was investigated as a catalyst for organics destruction in wastewater [293], using 1-chlorobutane as model. The oxidation rate was found, surprisingly, to be independent of solution pH/alkalinity. For this compound, the system compared favourably with O_3/UV , $\text{H}_2\text{O}_2/\text{O}_3$, $\text{H}_2\text{O}_2/\text{UV}$ and $\text{H}_2\text{O}_2/\text{Fe}^{2+}$.

The HO^\bullet active species produced by the Fenton system can be generated also using H_2O_2 and UV radiation [294]. This is particularly suitable for very dilute effluents (‘polishing’) where UV absorption by other constituents is small.

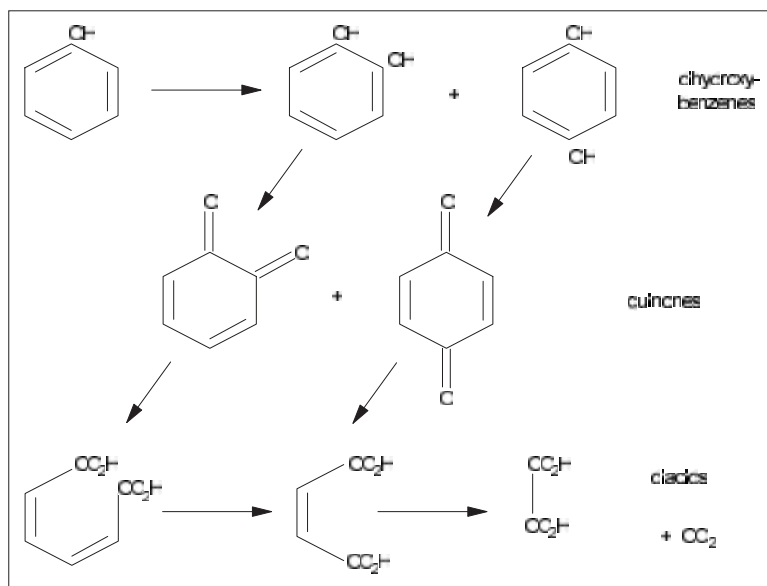


Fig. 11.46 Phenol oxidative degradation scheme.

A variety of industries produce phenolic or similar aromatic wastestreams, mainly as by-products of specific chemical manufacture but also associated with coking, refinery, tar distillery and foundry operations. Use of phenolic disinfectants ultimately leads to these compounds appearing in effluents.

Essentially, the hydroxyl radical produced by Fenton's reagent [295] or by H₂O₂/UV systems (or O₃/H₂O₂, as described below) is one of very few chemical species capable of attacking refractory halo-organic compounds. The treatment of halo-organics before release from current processes, and the retrospective treatment of previous accumulations of industrial waste containing them, is an important issue because of their environmental persistence and both the acute and chronic toxicity. Compounds involved vary from volatile aliphatics such as chloroform or 1,1,1-trichloroethane to heavy aromatics such as polychlorinated biphenyls (PCBs) and dioxins (e.g. 2,3,6,7-tetrachloro-dibenzo-*p*-dioxan).

5.2 Advanced oxidation processes (AOPs)

This title embraces a large number of treatment combinations, of which the individual elements include:

- Sonolysis
- Photolysis (including UV)
- Electrolysis

- H₂O₂
- O₃
- Adsorption on active carbon or other solids, etc.

Within these permutations, pairs of H₂O₂, ozone and UV are in common use and can be used effectively on concentrated or dilute effluents. The combination of ozone and H₂O₂ is covered to some extent in a recent ozone review [296]. Ozone/H₂O₂ [297] is becoming a standard treatment in the USA: there is evidence that H₂O₂ also enhances the degradation of organics by ozone [298]. Although hydroxyl radical and H₂O₂ itself are both generated to an extent in aqueous ozone reactions, the two oxidants do tend to sustain different, and often complementary, reaction pathways. For example, O₃ and HO[•] (from H₂O₂/UV) were compared in glycine oxidation [299]. Molecular ozone attacks the nitrogen centre first and gives nitrites/nitrates, but hydroxyl radical only gives ammonia nitrogen. In the presence of oxygen, hydroxyl radical products include oxalic acid, along with some formic and oxamic. Trace organochlorine and pesticide compounds are removed using O₃/H₂O₂ in California [300]. The scope and utility of the H₂O₂/UV treatment system has been reviewed [301]: this has benefited greatly from improvements in lamp efficiency and reactor design over the last two decades.

A more unusual technique is the use of H₂O₂ with

low-frequency-power ultrasound, which can also produce hydroxyl radicals, along with very high local temperatures and pressures in the cavitation bubbles formed. A patent [302] describes its use in simple or complex cyanide removal, including complexes with Au, Ag, Ni, Fe, Cu and Zn.

Some processes produce concentrated organic effluents (high chemical oxygen demand) that cannot be discharged directly and are difficult to treat on-site using conventional biological methods. In addition to the peroxygen methods noted above, there is a technique involving the use of H_2O_2 and air under moderately elevated temperature and pressure—typically 150°C and 10 bar. This is known as wet peroxide oxidation (WPO) [303–304] and operates under much milder conditions than the now-established wet air oxidation (WAO)—the latter involves temperatures over 200°C and pressures up to 200 bar and can result in severe corrosion of the plant. In general, running costs are somewhat higher with WPO but capital costs are lower than WAO. Both achieve a similar performance, removing 65–90% total organic carbon, depending on the nature of the effluent [305].

5.3 Treatment of refractory effluents

Phenols and halo-organics have been mentioned already as types of compound that are often important in effluent treatment. Further to this, refractory effluent types of common concern include:

- Dyes
- Explosives (TNT and other polynitro compounds)
- Pulp and paper (although some of the industry is moving towards totally effluent free technology, working in a closed loop)
- Pesticides
- Methyl *t*-butyl ether (and related gasoline additives)
- Chemical warfare agents (usually waste disposal rather than effluent as such, although some pesticides have similar structures)
- Landfill leachate

The manufacture of dyestuffs and, more particularly, their use by very many different textile dyers and finishers leads to the production of effluents that, although often very dilute, are highly coloured, to the extent of being noticeable even when further diluted by discharge into watercourses. The increase

in monitoring of water quality has led to a corresponding demand for colour removal treatments. Absorbents such as clays or active carbon can perform such a function for some types of dyes but not all are strongly absorbed. The use of oxidants is a good alternative because this disrupts the chromophoric groups (usually electron-rich) in the dye molecules, leading to smaller fragments that are not as highly coloured and often also are more amenable to biological treatment. As discussed above, the generation of oxygen radicals, via the Fenton system or $\text{UV}/\text{O}_3/\text{H}_2\text{O}_2$ combinations, provides an efficient way of degrading coloured compounds in effluents and of reducing the total oxygen demand of the effluent [306].

Explosives are predominantly poly-nitro compounds that are highly electron-deficient and chemically quite unreactive. A system like Fenton's reagent, however, is powerful enough to destroy intramine explosive compounds such as TNT, RDX and HMX in effluent [307,308].

The origins of effluent chemicals and toxicity in pulp and paper manufacture are considered [309] in terms of recent research and future directions, one conclusion being that there is not yet enough information of the impact of changing bleach technology (although this is generally positive).

The chemical oxidation of pesticide-containing effluents [310] and the removal of pesticides from drinking water [311] have been reviewed very recently. Hydroxyl radical again gives different oxidation pathways to, for example, ozone, direct electron abstraction (such as is achieved by photo-activated TiO_2), etc. Photo-Fenton systems turned out to be among the best choices, along with TiO_2 . The technique also has been evaluated specifically for pesticides [312].

Judging by the number of papers addressing it, methyl *t*-butyl ether has become a very important issue in groundwater contamination, judging by the number of recent papers addressing it. Solutions include the use of the $\text{H}_2\text{O}_2/\text{UV}$ system [313] and $\text{H}_2\text{O}_2/\text{solid catalysts}$ [292]. This topic is somewhat related to soil remediation, for which a number of solutions involving peroxygens have been described (see Section 5.5).

Landfill leachate can contain phenolics and other organics, along with harmful inorganic pollutants, especially sulfide. The system $\text{H}_2\text{O}_2/\text{UV}$ has been applied successfully [314].

An evaluation of wastewater disinfection systems alternative to chlorine [315] recently has considered peracetic acid along with chlorine dioxide, ozone and UV, including cost comparisons. Regarding investment, peracetic acid compared favourably with all the others for all plant sizes. Regarding operating costs, peracetic acid was rated best for small-size re-operating costs and second only to UV for larger installations.

5.4 Gaseous effluent treatment

There is extensive literature on this area, which can be accessed best through more comprehensive works than this chapter [1a,3a].

Essentially, H_2O_2 is among the most effective methods for treatment of hydrogen-sulfide-containing gases, as shown, for example, in a recent comparison of odour control methods available to pulp and paper plants [316]. Contrasting applications involve suppression of ammonia and sulfide odours from dairy manure storage by surface spraying of 0.5% H_2O_2 [317] and the use of H_2O_2 and nitrate for odour removal from sewage and sludge [318].

Another major strength arises in the area of NO_x treatment, where H_2O_2 offers the great benefit of producing nitric acid as the product, which almost always can be recovered and reused [322]. Absorption models are available [316,319,320]. Sometimes, there is the option either of scrubbing NO_x vapour or of preventing its formation by adding H_2O_2 to the 'reaction' (which may, for example, be metal pickling) [321]. It is claimed that paper mill recovery boiler flue gases can be treated for NO_x by direct injection of H_2O_2 at 400–600°C [323].

Sulfur-dioxide-containing gases also can be scrubbed effectively to produce dilute sulfuric acid solutions [324].

5.5 Soil remediation

With pressure both on environmental clean-up and on reuse of land formerly associated with industrial operations, soil remediation is an active area. Contaminants arise from former gas and coke works, refuse tips, chemical factories and refineries, abattoirs and animal rendering and some retail operations such as fuel-filling stations. Pollutants cover the whole spectrum from inorganics such as cyanide, sulfide, thiocyanate, nitrite, etc. through inert or-

ganics such as saturated hydrocarbons, to noxious organics such as phenols, PCBs, etc. Hydrogen peroxide is involved in a number of systems used to treat such contaminated soil. These range from excavation and intense chemical treatment, using high doses of H_2O_2 and catalyst, to the injection of H_2O_2 in situ to provide aerobic conditions for biological processes to work (using either organisms naturally present or a suitable inoculated culture). Concerning the slow release of oxygen, many studies report the usefulness of calcium and magnesium peroxides as soil additives for land remediation.

The use of H_2O_2 in this area has been reviewed critically in a balanced article [325].

References

- (a) Jones, C. W. *Applications of Hydrogen Peroxide and Derivatives*. Clean Technology Monograph Series (Clark, J. H., ed.). RSC, Cambridge, UK, 1999; (b) Schirmann, J., & Delavarenne, S. Y. *Hydrogen Peroxide in Organic Chemistry*. EDI, Paris, 1979.
- Hess, W. T. In *Kirk Othmer Encyclopaedia of Chemical Technology* (Kroschwitz, J. I., & Howe-Grant, M., eds). Vol. 13. John Wiley, New York, 1995, pp. 961–995.
- (a) Sanderson, W. R. In *Chemistry of Waste Minimization* (Clark, J. H., ed.). Blackie, Glasgow, 1995, pp. 247–327; (b) Strukul, G. *Catalytic Oxidations with Hydrogen Peroxide as Oxidant*. Kluwer Academic, Dordrecht, 1992.
- Goor, G., & Kunkel, W. In *Ullmanns Encyclopaedia of Chemical Technology* (Elvers, B., ed.). Vol. A13. VCH, New York, 1989, pp. 443–466.
- Thénard, L. J. *Ann. Chim. Phys.*, 1818, **8**, 306.
- (a) Gilbert, A. H. *Detergent Age*, 1967, **June**, 18–20; **July**, 30–33; **Aug.**, 26–27; (b) Fagandini, D. *Chem. Ind.*, 1983, 158–161.
- Prilezhaev, N. *Chem. Ber.*, 1909, **42**, 4811.
- (a) European Patent 200260, Enichem; (b,c) German Patent Applications 3135559, 3309669, Anic SpA.
- (a–d) European Patents 208311, 267362, 299430, 384390, Montedipe SpA; (e,f) European Patent Applications 496385, 564040, Enichem Anic SpA; (g) Roffia, P., Leofanti, G., Cesana, A., Mantegazza, M., et al. *Chim. Ind. (Milan)*, 1990, **72**(7), 598.
- European Patent Application 230949, Eniricerche SpA.
- (a) *Chemical Economics Handbook*. SRI International, CA, 2000, and other sources; (b) Sanderson, W. R. *Pure Appl. Chem.*, 2000, **72**(7), 1289.
- (a) Flanagan, J., Griffith, W. P., Powell, R. D., & West, A. P. *J. Chem. Soc. Dalton Trans.*, 1989, 1651; (b) Pfizer, R., & Tihal, C. *Inorg. Chem.*, 1987, **26**, 3639; (c) Thompson, K. M., Griffith, W. P., & Spiro, M. *J. Chem. Soc. Faraday Trans.*, 1993, **89**, 4035.

13. Jones, D. P., & Griffith, W. P. *J. Chem. Soc. Dalton Trans.*, 1980, 2526.
14. Flanagan, J., Jones, D. P., Griffith, W. R., Skapski, A. C., & West, A. P. *Chem. Commun.*, 1986, 20; (b) Richardson, D. E., Yao, H., Frank, K. M., & Bennett, D. A. *J. Am. Chem. Soc.*, 2000, **122**(8), 1729 and references therein.
15. McMillen, D. F., & Golden, D. M. *Ann. Rev. Phys. Chem.*, 1982, **33**, 493.
16. Samuni, A., Meisel, D., & Czapski, G. *J. Chem. Soc. (Dalton)*, 1972, 1273.
17. Fenton, H. J. H. *Proc. Chem. Soc., London*, 1893, **9**, 113; Fenton, H. J. H. *J. Chem. Soc.*, 1894, **65**, 899.
18. (a) Maggioni, P., & Minisci, F. *Chim. Ind.*, 1977, **59**, 239; (b) Minisci, F. *Chim. Ind.*, 1983, **65**, 487.
19. (a) Minisci, F., Citterio, A., & Vismara, E. *Tetrahedron*, 1985, **41**(19), 4157; (b) Minisci, F., Vismara, E., & Fontana, F. *Heterocycles*, 1989, **28**(1), 489.
20. (a) Khan, A. U., & Kasha, M. *J. Am. Chem. Soc.*, 1970, **92**, 3293; (b) Foote, C. S., Wexler, S., Ando, W., & Higgins, R. *J. Am. Chem. Soc.*, 1968, **90**, 975.
21. Nardello, V., Briviba, K., & Aubry, J. M. *Chem. Commun.*, 1998, 599.
22. (a) Nardello, V., Marko, J., Vermeersch, G., & Aubry, J.-M. *Inorg. Chem.*, 1998, **37**(21), 5418; (b) Nardello, V., Marko, J., Vermeersch, G., & Aubry, J.-M. *Inorg. Chem.*, 1995, **34**, 4950; (c) Niu, Q. J., & Foote, C. S. *Inorg. Chem.*, 1992, **31**, 3472.
23. Wasserman, H. H., & Murray, R. W. *Organic Chemistry Monographs*, Vol. 40. Academic Press, New York, 1979, Chapt. 6-9.
24. (a) European Patent Application 463304, Degussa AG; (b) International Patent Application 93/08144, Solvay Interox.
25. (a) Everett, A. J., & Minkoff, G. J. *Trans. Faraday Soc.*, 1953, **49**, 410; (b) Goodman, J. F., Robson, P., & Wilson, E. R. *Trans. Faraday Soc.*, 1962, **58**, 1846.
26. Solvay Interox, unpublished information.
27. US Patents 4160778, 4193929, 4267124, 4294776, Propylox SA.
28. US Patents 4304639, 4325888, 4358609, Propylox SA.
29. (a) International Patent Application 91/04333, Novo Nordisk A/S; (b) Björkling, F., Godtfriedson, S. E., & Kirk, O. *Chem. Commun.*, 1990, 1301.
30. Fieser, L. F. M. *Reagents for Organic Synthesis*, Vol. 1. Wiley Interscience, New York 1967, p. 135, and subsequent volumes.
31. Brougham, P., Cooper, M. S., Cummerson, D. A., Heaney, H., & Thompson, N. *Synthesis*, 1987, **11**, 1015.
32. (a) Radziszewski, B. *Chem. Ber.*, 1884, **17**, 1289; (b) Wiberg, K. B. *J. Am. Chem. Soc.*, 1953, **75**, 3961.
33. Payne, G. B., Williams, P. H., & Deming, P. H. *J. Org. Chem.*, 1961, **26**, 659.
34. Payne, G. B. *Tetrahedron*, 1962, **18**, 763.
35. European Patent 161234, Monsanto Co.
36. (a) Murray, R. W. *Chem. Rev.*, 1989, **89**, 1187; (b) Adam, W., Curci, R., & Edwards, J. O. *Acc. Chem. Res.*, 1989, **22**, 205; (c) Adam, W., Hadjiarapoglou, L., Curci, R., & Mello, R. In *Organic Peroxides* (Ando, W., ed.). Wiley Interscience, New York, 1992, Chapt. 4.
37. Mello, R., Fiorentino, M., Sciacovelli, O., & Curci, R. *J. Org. Chem.*, 1988, **53**, 3890.
38. Jones, C. W., Sankey, J. P., Sanderson, W. R., Rocca, M. C., & Wilson, S. L. *J. Chem. Res. (S)*, 1994, 114.
39. (a) Lee, C.-L., Hunt, K., & Murray, R. W. *TAPPI J.*, 1993, **76**(11), 137; (b) Lee, C. L., Hogikyan, R., Skothos, A., Sacciadis, G., et al. *Pulp. Pap. Can.*, 1996, **97**(7), 43.
40. (a) Milas, N. A., & Suismann, S. *J. Am. Chem. Soc.*, 1936, **58**, 1302; (b) Milas, N. A., & Suismann, S. *J. Am. Chem. Soc.*, 1937, **59**, 2345.
41. (a) Barak, G., Dakka, J., & Sasson, Y. *J. Org. Chem.*, 1988, **53**, 3553; (b) Barak, G., & Sasson, Y. *Chem. Commun.*, 1987, 1266.
42. (a) International Patent Application 93/00319; (b) International Patent Application PCT/GB 94/02080, Solvay Interox.
43. (a) Khenkin, A. M., & Hill, C. L. *Mendeleev Commun.*, 1993, **4**, 140; (b) Neumann, R., & Gara, M. *J. Am. Chem. Soc.*, 1994, **116**, 5509.
44. (a) Groves, J. T., & McClusky, G. A. *J. Am. Chem. Soc.*, 1976, **98**(3), 859; (b) Groves, J. T., & Swanson, W. W. *Tetrahedron Lett.*, 1975, **24**, 1953; (c) Sugimoto, H., & Sawyer, D. T. *J. Am. Chem. Soc.*, 1985, **107**, 5712; (d) *J. Org. Chem.*, 1985, **50**, 1784.
45. Renaud, J.-P., Battioni, P., Bartoli, J. F., & Mansuy, D. *Chem. Commun.*, 1985, 888.
46. Thellend, A., Battioni, P., Sanderson, W., & Mansuy, D. *Synthesis*, 1997, **12**, 1387.
47. Battioni, P., Renaud, J.-P., Bartoli, J. F., & Mansuy, D. *Chem. Commun.*, 1986, 341.
48. Mansuy, D. *Pure Appl. Chem.*, 1987, **59**(6), 759.
49. Conte, V., Di Furia, F., & Moro, S. *J. Phys. Org. Chem.*, 1996, **9**(6), 329.
50. (a) Notari, B. In *Structure Activity and Selectivity Relationships in Heterogeneous Catalysis* (Grasselli, R. K., & Sleight, A. W., eds). Elsevier, Amsterdam, 1991, p. 243; (b) Belgian Patent 886812, Snamprogetti; (c,d) European Patents 200260, 226257, Enichem Sintesi; (e) European Patent 311983, Montedipe.
51. International Patent Applications WO90/05126, WO94/02245, Exxon Chemical.
52. German Patent Application 3309669, Belgian Patent 890290, Anic SpA.
53. European Patent Application 522634, Enichem Anic.
54. European Patents 208311, 267362, 310486, Montedipe SpA.
55. (a) European Patent 100119, Anic SpA; (b) European Patents 190609, 230949, Enichem Sintesi.
56. European Patent 100118, Anic SpA.
57. European Patent 102097, Anic SpA.

58. (a) Camblor, M. A., Corma, A., Martinez, A., & Pérez-Pariente, J. *J. Chem. Soc. Chem. Commun.*, 1992, 589; (b) Camblor, M. A., Corma, A., & Pérez-Pariente, J. *Zeolites*, 1993, **13**, 83.
59. Dickman, M. H., & Pope, M. T. *Chem. Rev.*, 1994, **94**, 569.
60. Hill, C. L. In *Catalytic Oxidations with Hydrogen Peroxide as Oxidant* (Strukul, G., ed.). Kluwer Academic, Dordrecht, 1992, Chapt. 8.
61. (a) Venturello, C., & D'Aloisio, R. *J. Org. Chem.*, 1988, **53**, 1553; (b) Ishii, Y., Yamawaki, K., Ura, T., Yamada, H., Yoshida, T., & Ogata, M. *J. Org. Chem.*, 1988, **53**, 3587.
62. Jacobsen, S. E., Muccigrosso, D. A., & Mares, F. *J. Org. Chem.*, 1979, **44**(6), 921.
63. (a,b) US Patents 5086189, 4925941; (c) European Patent 224662, Interlox SA.
64. (a) Taylor, R. T., & Flood, L. A. *J. Org. Chem.*, 1983, **48**, 5160; (b) Brill, W. F. *J. Org. Chem.*, 1986, **51**, 1149.
65. Reeve, K. M. In *OrgaBrom '93, 2nd Int. Symp. on Chemistry of Brominated Compounds and their Uses*, Jerusalem, 27 June–2 July 1993.
66. (a) d'A Rocha Gonsalves, A. M., & Pereira, M. M. *J. Mol. Catal. A: Chem.*, 1996, **113**, 209; (b) Sheldon, R. A. *Metalloporphyrins in Catalytic Oxidations*. Marcel Dekker, New York, 1994.
67. (a) Traylor, T. G., & Tsuchiya, S. *Inorg. Chem.*, 1987, **26**, 1338; (b) Carrier, M.-N., Scheer, C., Gouvine, P., Bartoli, J.-F., Battioni, P., & Mansuy, D. *Tetrahedron Lett.*, 1990, **31**, 6445.
68. Thellend, A., Battioni, P., & Mansuy, D. *J. Chem. Soc. Chem. Commun.*, 1994, 1035.
69. d'A Rocha Gonsalves, A. M., Johnstone, R. A. W., Pereira, M. M., & Shaw, J. *J. Chem. Soc. Perkin. Trans. 1*, 1991, 645.
70. Ozette, K., Battioni, P., Leduc, P., Bartoli, J.-F., & Mansuy, D. *Inorg. Chim. Acta*, 1998, **272**, 4.
71. d'A Rocha Gonsalves, A. M., Johnstone, R. A. W., Pereira, M. M., Shaw, J., & Sobral, A. J. F. N. *Tetrahedron Lett.*, 1991, **32**, 1355.
72. (a) Lee, K. A., & Nam, W. *J. Am. Chem. Soc.*, 1997, **119**(8), 1916; (b) Lee, Y. J., Goh, Y. M., Han, S.-Y., Kim, C., & Nam, W. *Chem. Lett.*, 1998, 837; (c) Bernadou, J., & Meunier, B. *Chem. Commun.*, 1998, 2167.
73. (a) Barloy, L., Lallier, J. P., Battioni, P., & Mansuy, D. *New J. Chem.*, 1992, **16**, 71; (b) Campestrini, S., & Meunier, B. *Inorg. Chem.*, 1992, **31**, 1999.
74. (a) Song, R., Robert, A., Bernadou, J., & Meunier, B. *Inorg. Chim. Acta*, 1998, **272**, 228; (b) Yang, S. J., & Nam, W. *Inorg. Chem.*, 1998, **37**(4), 606; (c) Goh, Y. M., & Nam, W. *Inorg. Chem.*, 1999, **38**(5), 914; (d) Nam, W., Goh, Y. M., Lee, Y. J., Lim, M. H., & Kim, C. *Inorg. Chem.*, 1999, **38**(13), 3238.
75. Martinez-Lorente, M. A., Battioni, P., Kleemiss, W., Bartoli, J.-F., & Mansuy, D. *J. Mol. Catal. A: Chem.*, 1996, **113**, 343.
76. Larsen, E., & Jorgensen, K. A. *Adv. Chem. Ser.*, 1989, **43**, 259.
77. (a) Hadasch, A., Sorokin, A., Rabion, A., Fraisse, L., & Meunier, B. *Bull. Soc. Chim. Fr.*, 1998, **134**, 1025; (b) Hadasch, A., Sorokin, A., Rabion, A., Fraisse, L., & Meunier, B. *New J. Chem.*, 1998, **22**, 45; (c) Armengol, E., Corma, A., Fornes, V., Garcia, H., & Primo, J. *Appl. Catal. A: Gen.*, 1999, **181**(2), 305; (d) Zefirov, N. S., & Zakharov, A. N. *Can. J. Chem.*, 1998, **76**(6), 955.
78. Gaigneau, E. M., Nand, J., Knoden, J. L., Maggi, R., Ruiz, P., & Delmon, B. *Bulg. Chem. Commun.*, 1998, **30**(1–4), 69.
79. (a) De Vos, D. E., & Bein, T. J., *Chem. Commun.*, 1996, 917; (b) De Vos, D. E., & Bein, T. J. *J. Organomet. Chem.*, 1996, **520**(1–2), 195; (c) Zondervan, C., Hage, R., & Feringa, B. L., *Chem. Commun.*, 1997, 687.
80. (a) Shul'pin, G. B., Süß-Fink, G., & Lindsay-Smith, J. R. *Tetrahedron*, 1999, **55**, 5345; (b) Lindsay-Smith, J. R., & Shul'pin, G. B. *Tetrahedron Lett.*, 1998, **39**, 4909.
81. (a) Horwitz, C. P., Fooksman, D. R., Vuocolo, L. D., Gordon-Wylie, S. W., Cox, N. J., & Collins, T. J. *J. Am. Chem. Soc.*, 1998, **120**, 4867; (b) Miller, C. G., Gordon-Wylie, S. W., Strazisar, S. A., Peraino, D. K., et al. *J. Am. Chem. Soc.*, 1998, **120**, 11540; (c) US Patent 5847120 (1998).
82. For critical reviews see (a) De Vos, D. E., Thibault-Starzyk, F., Knops-Gerrits, P. P., Parton, R. F., & Jacobs, P. A. *Macromol. Symp.*, 1994, **80**, 157–84; (b) Tuel, A. *Stud. Surf. Sci. Catal.*, 1998, **117**, 159–70.
83. Armengol, E., Corma, A., Fornes, V., Garcia, H., & Primo, J. *Appl. Catal. A: Gen.*, 1999, **181**(2), 305; (b) Raja, R., & Ratnasamy, P. *Appl. Catal. A: Gen.*, 1996, **143**, 145; (c) Ernst, S., & Jean, B. *Progr. Zeol. Microp. Mater.*, 1997, **105**, 747; (d) Kozlov, A., Asakura, K., & Iwasawa, Y. *J. Chem. Soc. Faraday Trans.*, 1998, **94**(6), 809.
84. (a) Xiao, J. Xu, J., & Gao, Z. *Catal Lett.*, 1999, **57**, 37; (b) Sels, B. F., De Vos, D. E., & Jacobs, P. A. *Tetrahedron Lett.*, 1996, **37**(47), 8557.
85. (a) Khim, S.-S., Zhang, W., & Pinnavaia, T. J. *Catal. Lett.*, 1997, **43**, 149; (b) Luan, Z., Xu, J., & Kevan, L. *Chem. Mater.*, 1998, 3699.
86. De Vos, D. E., De Wildeman, S., Sels, B. F., Grobet, P. J., & Jacobs, P. A. *Angew Chem. Int. Ed. Engl.*, 1999, **38**(7), 980.
87. Knops-Gerrits, P. P., Vankelecom, I. F. J., Beatse, E., & Jacobs, P. A. *Catal. Today*, 1996, **32**(1–4), 63.
88. Balkus, K. J., & Gabrielov, A. G. *J. Inclusion Phenom. Mol. Recogn. Chem.*, 1995, **21**, 159.
89. (a) Sato, K., Aoki, M., Ogawa, M., Hashimoto, T., & Noyori, R. *J. Org. Chem.*, 1996, **61**(23), 8310; (b) Sato, K., Aoki, M., Ogawa, M., Hashimoto, T., Panyella, D., & Noyori, R. *Bull. Chem. Soc. Jpn.*, 1997, **70**, 905.
90. Syper, L., Kloc, K., Mlochowski, J., & Szulc, Z. *Synthesis*, 1979, 521.
91. (a) Trost, B. M., & Masuyama, Y. *Tetrahedron Lett.*, 1984, **25**, 173; (b) Trost, B. M., & Masuyama, Y. *Israel*

- J. Chem.*, 1984, **24**, 134; Bortolini, O., Conte, V., Di Furia, F., & Modena, G. *J. Org. Chem.*, 1986, **51**, 2661; (c) Bortolini, O., Conte, V., Di Furia, F., & Modena, G. *Stud. Org. Chem. (Amsterdam)*, 1988, **33**, 301.
92. Salles, L., Robert, F., Semmer, V., Jeannin, Y., & Brégeault, J.-M. *Bull. Soc. Chim. Fr.*, 1996, **133**, 319.
93. (a) US Patent 5763629 (Sartomer, Mingxin, F., et al); (b) US Patent 5780655 (1998, Shum, W. P., ARCO); (c) Solvay Interlox, unpublished information.
94. (a) Piquemal, J.-Y., Bois, C., & Brégeault, J.-M. *Chem. Commun.*, 1997, 473; (b) Piquemal, J.-Y., Salles, L., Bois, C., Robert, F., & Brégeault, J.-M. *C. R. Acad. Sci. Paris*, 1994, **319**(II), 1481; (c) Piquemal, J.-Y., Bois, C., & Brégeault, J.-M. *Chem. Commun.*, 1997, 473.
95. Antonelli, E., D'Aloisio, R., Gambaro, M., Fiorani, T., & Venturello, C. *J. Org. Chem.*, 1998, **63**, 7190.
96. Aubry, J.-M., & Bouttemy, S. *J. Am. Chem. Soc.*, 1997, **119**(23), 5286.
97. (a) Brégeault, J.-M., Thouvenot, R., Zhougebi, S., Salles, L., et al. *New Developments in Selective Oxidation II* (Cortés-Corberán, V., & Vic Bellón, S., eds). Elsevier, Amsterdam, 1994, pp. 571–581; (b) Drago, R. S., & Burns, D. S. *J. Catal.*, 1997, **166**(2), 177; (c) Gelbard, G., Breton, F., Quenard, M., & Sherrington, D. C. *J. Mol. Catal. A: Chem.*, 1999, 2457; (d) Gelbard, G., Sherrington, D. C., Breton, F., Benelmoudeni, M., Charreyre, M.-T., & Dong, D. *Metal-containing Polymeric Materials*. Plenum Press, New York, 1996, pp. 265–275; (e) Gelbard, G., Breton, F., Benelmoudeni, M., & Quenard, M. *React. Funct. Polym.*, 1997, **33**, 117.
98. (a) Owens, G. S., Arias, J., & Abu-Omar, M. M. *Catal. Today*, 2000, **55**(4), 317; (b) Espenson, J. H., & Abu-Omar, M. M. *Adv. Chem. Ser.*, 1997, **253**, 99; (c) Espenson, J. H. *Chem. Commun.*, 1999, 479.
99. (a) Rudolph, J., Reddy, K. L., Chiang, J. P., & Sharpless, K. B. *J. Am. Chem. Soc.*, 1997, **119**, 6189; (b) Copéret, C., Adolffson, H., & Sharpless, K. B. *Chem. Commun.*, 1997, 1565; (c) Herrmann, W. A., Fischer, R. W., Rauch, M. U., & Scherer, W. *J. Mol. Catal. A: Chem.*, 1994, **86**(1–3), 243; (d) Wang, W.-D., & Espenson, J. H. *J. Am. Chem. Soc.*, 1998, **120**, 11335; (e) Nakajima, M., Sasaki, Y., Iwamoto, H., & Hashimoto, S. *Tetrahedron Lett.*, 1998, **39**(1–2), 87; (f) Deloffre, A., Halut, S., Salles, L., Brégeault, J.-M., et al. *J. Chem. Soc. Dalton Trans.*, 1999, 2897; (g) Rudler, H., Gregorio, J. R., Denise, B., Brégeault, J.-M., & Deloffre, A. *J. Mol. Catal. A: Chem.*, 1998, **133**, 255.
100. (a) Murray, R. W., Iyanar, K., Chen, J., & Wearing, J. T. *Tetrahedron Lett.*, 1996, **37**(6), 805; (b) Copéret, C., Adolffson, H., Chiang, J. P., Yudin, A. K., & Sharpless, K. B. *Tetrahedron Lett.*, 1998, **39**, 761.
101. Kuhn, F. E., Santos, A. M., Roesky, R. W., Herdtweck, E., et al. *Chem. Eur. J.*, 1999, **5**(12), 3603.
102. Zhu, Z., & Espenson, J. H. *J. Mol. Catal. A: Chem.*, 1997, **121**, 139.
103. Conte, V., Di Furia, F., & Licini, G. *Appl. Catal. A: Gen.*, 1997, **157**, 335.
104. Ramaswamy, A. V., Sivasanker, S., & Ratnasamy, P. *Div. Petr. Chem. Symp., 106th National Meeting*, ACS, Chicago, 1993, p. 765.
105. Bhaumik, A., Kumar, R., & Ratnasamy, P. *Stud. Surf. Sci. Catal.*, 1994, **84**, 1883.
106. (a) Shul'pin, G. B., Attanasio, D., & Suber, L. *J. Catal.*, 1993, **142**, 147; (b) Shul'pin, G. B., Guerreiro, M. C., & Schuchardt, U. *Tetrahedron*, 1996, **52**(41), 13051; (c) Schuchardt, U., Guerreiro, M. C., & Shul'pin, G. B. *Russ. Chem. Bull.*, 1998, **47**(2), 247.
107. (a) Nizova, G. V., Süß-Fink, G., & Shul'pin, G. B. *Chem. Commun.*, 1997, 397; (b) Nizova, G. V., Süß-Fink, G., & Shul'pin, G. B. *Tetrahedron*, 1997, **53**(10), 3603.
108. Conte, V., Di Furia, F., Moro, S., & Rabbolini, S. *J. Mol. Catal. A: Chem.*, 1996, **113**, 175.
109. Bhattharcharjee, M., & Mukherjee, J. *J. Chem. Res. (S)*, 1995, 238.
110. (a) Espenson, J. H., Zhu, Z., & Zauche, T. H. *J. Org. Chem.*, 1999, **64**, 1191; (b) Zauche, T. H., & Espenson, J. H. *Inorg. Chem.*, 1998, **37**(26), 6827.
111. (a) Aubry, C., Chottart, G., Platzer, N., Brégeault, J.-M., et al. *Inorg. Chem.*, 1991, **30**, 4409; (b) Salles, L., Aubry, C., Thouvenot, R., Robert, F., et al. *Inorg. Chem.*, 1994, **33**, 871; (c) Salles, L., Piquemal, J.-Y., Thouvenot, R., Minot, C., & Brégeault, J.-M. *J. Mol. Catal. A: Chem.*, 1997, **117**(1–3), 375.
112. (a) Yamase, T., Ishikawa, E., Asai, Y., & Kanai, S. *J. Mol. Catal. A: Chem.*, 1996, **114**(1–3), 237; (b) Kuznetsova, L. I., Detusheva, L. G., Kuznetsova, N. I., Fedotov, M. A., & Likholobov, V. A. *J. Mol. Catal. A: Chem.*, 1997, **117**, 389; (c) Kuznetsova, N. I., Kuznetsova, L. I., & Likholobov, V. A. *J. Mol. Catal. A: Chem.*, 1996, **108**, 135; (d) Simões, M. M. Q., Conceição, C. M. M., Gamelas, J. A. F., Domingues, P. M. D. N., et al. *J. Mol. Catal. A: Chem.*, 1999, **144**, 461; (e) Kuznetsova, L. I., Maksimov, G. M., & Likholobov, V. A. *Kinet. Catal.*, 1999, **40**(5), 622.
113. Neumann, R., & Juwiler, D. *Tetrahedron*, 1996, **52**(26), 8781.
114. Neumann, R., & Khenkin, A. M. *J. Mol. Catal. A: Chem.*, 1996, **114**, 169.
115. Server-Carrió, J., Bas-Serra, J., Gonzáles-Núñez, M. E., García-Gastaldi, A., et al. *J. Am. Chem. Soc.*, 1999, **121**, 977.
116. (a) Mizuno, N., Nozaki, C., Kiyoto, I., & Misono, M. *J. Am. Chem. Soc.*, 1998, **120**, 9267; (b) Mizuno, N., Kiyoto, I., Nozaki, C., & Misono, M. *J. Catal.*, 1999, **181**, 171.
117. Khenkin, A. M., & Neumann, R. *Activation of Dioxygen and Homogeneous Oxidation Conference (ADHOC-99)*, York, UK, 1999.
118. (a) Atlamsani, A., Ziyad, M., & Brégeault, J.-M. *J. Chem. Phys.*, 1995, **92**, 1344; (b) Zhang, X., & Hill, C. L. *Chem. Ind. (Dekker)*, 1998, **75**, 519.
119. (a) International Patent Application 92/14691, Solvay Interlox; (b) Brown, S. W., Hackett, A., Johnstone, A., King, A. M., et al. *Tagungsbericht*

- 9204 Proc DGMK Conference, *Selective Oxidation in Petrochemistry* (Baerns, M., & Weitkamp, I., eds). Goslar, Germany, 1992, p. 339.
120. (a–e) US Patents 5 302 248, 5 549 789, 5 552 019, 5 695 605, 5 824 189 (Weinstock, I. A., & Hill, C. L.); (f) Hill, C. L., & Zhang, X. *Nature*, 1995, **373**, 324; (g) Weinstock, I. A., Atalla, R. H., Reiner, R. S., Moen, M. A., *et al.* *J. Mol. Catal. A: Chem.*, 1997, **116**, 59.
121. (a) Dumitriu, D., Angelescu, E., & Parvulescu, V. I. *Roum. Chem. Quart. Rev.*, 1998, **6**(2), 113; (b) Clark, J. H., & Macquarrie, D. J. *Org. Process. Res. Dev.*, 1997, **1**, 149; (c) Sheldon, R. A., Arends, I. W. C. E., & Lempers, H. E. B. *Catal. Today*, 1998, **41**, 387; (d) Sheldon, R. A., Arends, I. W. C. E., & Lempers, H. E. B. *Collect. Czech. Chem. Commun.*, 1998, **63**, 1724; (e) Wilson, S. L., & Jones, C. W. *Stud. Surf. Sci. Catal.*, 1997, **110**, 603; (f) Arends, I. W. C. E., Sheldon, R. A., Wallau, M., & Schuchardt, U. *Angew. Chem. Int. Ed. Engl.*, 1997, **36**, 1144; (g) Tatsumi, T. *Curr. Opin. Solid. State. Mater. Sci.*, 1997, **2**(1), 76.
122. (a) Notari, B. *Catal. Today*, 1993, **18**, 163; (b) Clerici, M. G., & Ingallina, P. *J. Catal.*, 1993, **140**(1), 71.
123. (a) Tatsumi, T., Yanagisawa, K., Asano, K., Nakamura, M., & Tominaga, H. *Stud. Surf. Sci. Catal.*, 1994, **83**, 417; (b) Zhidomirov, G. M., Arbuzyukov, A. V., Yudanov, I. V., & Kachurovskaya, N. A. *React. Kinet. Catal. Lett.*, 1996, **57**(2), 263; (c) Hoelt, E., Kosslick, H., Fricke, R., & Hamann, H.-J. *J. Prakt. Chem.*, 1996, **338**(1), 1; (d) Duprey, E., Beaunier, P., Springuel-Huet, M.-A., Bozon-Verduraz, F., *et al.* *J. Catal.*, 1997, **165**, 22; (e) Karlsen, E., & Schöffel, K. *Catal. Today*, 1996, **32**, 107.
124. Yudanov, I. V., Gisdakis, P., Di Valentin, C., & Rosch, N. *Eur. J. Inorg. Chem.*, 1999, **12**, 2135.
125. Popova, Z., Vayssilov, G., & Genov, K. *Khim. Fak.*, 1998, **90**, 221.
126. Talsi, E. P. *New J. Chem.*, 1997, **21**(6–7), 709.
127. Thomas, J. M., & Vaughan, D. E. W. *J. Phys. Chem. Solids*, 1989, **50**(5), 449.
128. Maier, W. F. *Prepr. Symp., Am. Chem. Soc., Div. Fuel Chem.*, 1998, **43**(3), 534.
129. European Patent 230949 (Clerici, M. G., & Romano, U., Enichem).
130. (a) German Patent DE 19528220 (Thiele, G. Degussa); (b) Thiele, G. F., & Roland, E. *J. Mol. Catal. A: Chem.*, 1997, **117**(1–3), 351.
131. International Patent Applications WO 99/28035 A1, WO 99/28029 A1 (Strebelle, M., & Catinat, J.-P., Solvay Interox).
132. UK Patent GB 2332364 A (Mathys, G. M. K., Dakka, J. M., *et al.*, Exxon); Ko, Y. S., & Ahn, W. S. *Korean J. Chem. Eng.*, 1998, **15**(4), 423.
133. US Patents 5780654, 5354875 (Nemeth, L., *et al.*, UOP).
134. Ranghavan, P. S., Ramaswamy, V., Upadhyaya, T. T., Sudalai, A., Ramaswamy, A. V., & Sivasanker, S. *J. Mol. Catal. A: Chem.*, 1997, **122**, 75.
135. Ratnasamy, P., & Kumar, R. *Stud. Surf. Sci. Catal.*, 1995, **97**, 367.
136. Saxton, R. J. *Topics Catal.*, 1999, **9**(1–2), 43.
137. Popova, Z., Vayssilov, G., & Genov, K. *Godsh. Sofisk. Univ. Klim. Okhrid. Khim. Fak.*, 1998, **90**, 221.
138. (a) Camblor, M. A., Costantini, M., Corma, A., Gilbert, L., & Esteve, P. *Chem. Commun.*, 1996, 1339; (b) Camblor, M. A., Costantini, M., Corma, A., Esteve, P., Gilbert, L., & Martínez, A. *Roots Org. Dev.*, 1996, **8**, 391.
139. (a) Corma, A., Esteve, P., & Martínez, A. *J. Catal.*, 1996, **161**(1), 11; (b) Camblor, M. A., Corma, A., Esteve, P., Martínez, A., & Valencia, S. *Chem. Commun.*, 1997, 795.
140. Derouane, E. G., Hutchings, G. J., Mbafor, W. F., & Roberts, S. M. *New J. Chem.*, 1998, **22**(8), 797.
141. Sato, T., Dakka, J., & Sheldon, R. A. *Stud. Surf. Sci. Catal.*, 1994, **84**, 1853.
142. (a) van der Waal, J. C., Rigutto, M. S., & van Bekkum, H. *Appl. Catal. A: Gen.*, 1998, **167**, 331; (b) Corma, A., Esteve, P., & Martínez, A. *Appl. Catal. A: Gen.*, 1996, **143**, 87.
143. Carati, A., Flego, C., Massara, E. P., Millini, R., *et al.* *Micro. Mesop. Mater.*, 1999, **30**(1), 137.
144. Corma, A., & Kumar, D. *Stud. Surf. Sci. Catal.*, 1998, **117**, 201.
145. Morey, M. S., O'Brien, S., Schwarz, S., & Stucky, G. D. *Chem. Mater.*, 2000, **12**(4), 898.
146. D'Amore, M. D., & Schwarz, S. *Chem. Commun.*, 1999, 121.
147. Sheldon, R. A., Wallau, M., Arends, I. W. C. E., & Schuchardt, U. *Acc. Chem. Res.*, 1998, **31**, 485.
148. (a) Davis, M. E. *ACS Symp. Ser.*, 1994, **561**, 27; (b) Casci, J. L. *Stud. Surf. Sci. Catal.*, 1994, **85**, 329.
149. (a) Parvulescu, V. I., Dumitriu, D., & Poncelet, G. *J. Mol. Catal. A: Chem.*, 1999, **140**(1), 91; (b) Mal, N. K., Bhaumik, A., Kumar, R., & Ramaswamy, A. V. *Catal. Lett.*, 1995, **33**, 387; (c) Belhekar, A. A., Das, T. K., Chaudhuri, K., Hegde, S. G., & Chandwekar, A. J. *Stud. Surf. Sci. Catal.*, 1998, **113**, 195; (d) Akolekar, D. B., & Ryoo, R. *J. Chem. Soc. Faraday Trans.*, 1996, **92**(22), 4617; (e) Tuel, A., & Ben Taârit, Y. *Zeolites*, 1994, **14**(1), 18; (f) Gontier, S., & Tuel, A. *Appl. Catal. A: Gen.*, 1996, **143**(1), 125.
150. Zahedi-Niaki, M. H., Kapoor, M. P., & Kaliaguine, S. *Proc. Int. Zeolite Conf., 12th Meet.*, 1998, **V2**, 1221.
151. (a) Johnstone, A., Middleton, P. J., Wasson, R. C., Johnstone, R. A. W., Pires, P. J. C., & Rocha, G. O. In *The Activation of Dioxygen and Homogeneous Catalytic Oxidation* (Barton, D. H. R., *et al.*, eds). Plenum Press, New York, 1993, p. 45; (b) International Patent Applications 92/18449, 94/14740, Solvay Interox.
152. International Patent Application 97/44129 A1, Solvay Interox.
153. Xiao, J. B., Xu, J. S., & Gao, Z. *Huaxue Xuebao (Hua Hsueh Pao)*, 1999, **57**(6), 609.

154. Adam, W., Lazarus, M., Saha-Möller, C. R., Weichold, O., *et al.* *Adv. Biochem. Eng. Biotechnol.*, 1999, **63**, 73.
155. Rüschen Klaas, M., & Warwel, S. *J. Mol. Catal. A: Chem.*, 1997, **117**, 311.
156. Rüschen Klaas, M., & Warwel, S. *Recent Developments in the Synthesis of Fatty Acid Derivatives* (Knothe, G., & Derksen, J. T. P., eds). AOCS Press, Illinois, 1999, pp. 157–181.
157. (a) Rüschen Klaas, M., & Warwel, S. *Org. Lett.*, 1999, **1**(7), 1025; (b) German Patent DE 19738442 (Warwel, S., & Rüschen Klaas, M.).
158. Mlochowski, J., & Said, S. B. *Polish J. Chem.*, 1997, **71**, 149.
159. (a) Rafelt, J. S., & Clark, J. H. *Catal. Today*, 2000, **57**, 33; (b) Clark, J. H., & Macquarrie, D. J. *Org. Process. Res. Dev.*, 1997, **1**, 149.
160. Hronec, M. *Handbook of Phase Transfer Catalysis* (Sasson, Y., & Neumann, R., eds). Blackie, Glasgow, 1997, pp. 317–325.
161. Sels, B. F., De Vos, D. E., & Jacobs, P. A. *Tetrahedron Lett.*, 1996, **37**(47), 8557.
162. Japanese Patent 76 08216, French Patent 2320946, Toray Industries.
163. JP 11/130762, Mitsubishi Gas Chemical.
164. JP 11/158107, corresponding to system described in Ref. 89b.
165. Van Vliet, M. C. A., Arends, I. W. C. E., & Sheldon, R. A. *Chem. Commun.*, 1999, 821.
166. (a) EP 950659, Ube Industries; (b) JP 11/349579, Ube Industries.
167. Berkessel, A., & Sklorz, C. A. *Tetrahedron Lett.*, 1999, **40**(45), 7965.
168. Mizuno, N., Nozaki, C., Kiyoto, I., & Misono, M. *J. Catal.*, 1999, **182**(1), 285.
169. (a) Ishikawa, E., & Yamase, T. *J. Mol. Catal. A: Chem.*, 1999, **142**(1), 61; (b) Yamase, T., Ishikawa, E., Asai, Y., & Kanai, S. *J. Mol. Catal. A*, 1996, **114**(1–3), 237.
170. Cativiela, C. *Tetrahedron Lett.*, 1995, **35**, 4125.
171. (a) Porter, M. J., Roberts, S. M., & Skidmore, J. *Bioorg. Med. Chem.*, 1999, **7**(10), 2145; (b) Ray, P. C., & Roberts, S. M. *Tetrahedron Lett.*, 1999, **40**(9), 1779.
172. (a) Ho, T. L., & Liu, S. O. *Synth. Commun.*, 1983, **13**, 685; (b) European Patent 181475, Firmenich SA.
173. Miyashita, M., Suzuki, T., & Yoshikoshi, A. *Chem. Lett.*, 1987, 285.
174. Iorga, B., Eymery, F., & Sauvignac, P. *Synthesis*, 1999, **99**(2), 207.
175. Gaigneau, E. M., Nand, J., Knoden, J. L., Maggi, R., Ruiz, P., & Delmon, B. *Bulg. Chem. Commun.*, 1998, **30**(1–4), 69.
176. Neys, P. E. F., Severyns, A., Vankelecom, I. F. J., Ceulemans, E., Dehaen, W., & Jacobs, P. A. *J. Mol. Catal. A*, 1999, **144**(2), 373.
177. De Vos, D. E., De Wildeman, S., Sels, B. F., Grobet, P. J., & Jacobs, P. A. *Angew. Chem. Int. Ed. Engl.*, 1999, **38**(7), 980.
178. Cohen, M., & Neumann, R. *J. Mol. Catal. A*, 1999, **146**(1–2), 291.
179. (a) Sherrington, D. C. *Catal. Today*, 2000, **57**(1–2), 87; (b) Gelbard, G., Sherrington, D. C., Breton, F., Benelmoudeni, M., Charreyre, M.-T., & Dong, D. *Metal-containing Polymeric Materials*, Plenum Press, New York, 1996, pp. 265–275.
180. Early Enichem/Anic patents; EP 919551, Solvay SA.
181. Early Enichem/Anic patents; JP 11/165074, Mitsubishi Gas Chem.
182. EP 190609, Enichem Sintesi.
183. EP 940393, Enichem.
184. EP 930308, Enichem.
185. International Patent Applications 99/28029, 99/28030, 99/28035, Solvay SA.
186. DE 19815879; International Patent Application 99/52626, BASF AG.
187. Zhang, F. Z., Wuo, X., Wang, X. S., Li, G. Y., *et al.* *Mater. Chem. Phys.*, 1999, **60**(3), 215.
188. Langhendries, G., De Vos, D. E., Baron, G. V., & Jacobs, P. A. *J. Catal.*, 1999, **187**(2), 453.
189. International Patent Application 99/64376, Exxon.
190. (a) Nemeth, L., McCulloch, B., Jensen, R., Wilson, S., & Moscoso, J. *Stud. Surf. Sci. Catal.*, 1999, **125**, 473; (b) US Patent 5466835, Nemeth *et al.*
191. JP 11080144 A2, Daiso Co.
192. Camblor, M. A., Corma, A., Esteve, P., Martinez, A., & Valencia, S. *Chem. Commun.*, 1997, 795.
193. Krunen, S., Sanchez, P., Jacobs, B. T. F., & Van Hooff, J. H. C. *Microp. Mesop. Mater.*, 1999, **31**(1–2), 163.
194. Balkus, K. J., Khanmamedova, A. K., Scott, A., & Hoefelmeyer, J. *Proc. Int. Zeolite Conf., 12th Meet.*, 1998, **V2**, 1403.
195. Corma, A., Diaz, U., Domine, M. E., & Fornes, V. *J. Am. Chem. Soc.*, 2000, **122**(12), 2804.
196. Buechler-Skoda, M., Gill, R., Vu, D., Nguyen, C., & Larsen, G. *Appl. Catal. A*, 1999, **185**(2), 301.
197. Fraile, J. M., Garcia, J. I., Mayoral, J. A., & Vispe, E. *J. Catal.*, 2000, **189**(1), 40.
198. Tatsumi, T., Koyano, K. A., & Igarashi, N. *Stud. Surf. Sci. Catal.*, 1999, **121**, 221.
199. Holmes, S. A., Quignard, F., Choplin, A., Teissier, R., & Kervennal, J. *J. Catal.*, 1998, **176**(1), 173, 182.
200. Oludipe, J. O. *J. Chem. Tech. Biotech.*, 1999, **74**(8), 785.
201. Bhaumik, A., & Tatsumi, T. *J. Catal.*, 1999, **182**(2), 349.
202. (a) US Patent 2813113, Emery Industries; Heins, A., & Witthaus, M. *Henkel-Referate*, 1984, **20**, 42; (b) Pryde, E. H., & Cowan, J. C. In *Topics in Lipid Chemistry*, (Gunstone, F. D., ed.). Vol. 2 Logos Press, London, 1970, p. 1.
203. (a) Johnstone, A., Middleton, P. J., Sanderson, W. R., Service, M., & Harrison, P. R. In *New Developments in Selective Oxidation II* (Cortés Corberán, V., & Vic Bellón, S., eds). Elsevier Science, Amsterdam 1994,

- p. 609; (b) US Patent 5731460, International Patent Application 95/00243, Solvay Interlox.
204. Oakley, M. A., Woodward, S., Coupland, K., Parker, D., & Temple Heald, C. *J. Mol. Catal. A*, 1999, **150**(1–2), 105.
205. (a) Oguchi, T., Ura, T., Ishii, Y., & Ogawa, M. *Chem. Lett.*, 1989, 857; (b) US Patent 5157152, Ortec Inc.
206. Jin, R., Xia, X., Xue, D., & Deng, J. *F. Chem. Lett.*, 1999, 371.
207. Jin, R., Xia, X., Dai, W., Deng, J. F., & Li, H. *Catal. Lett.*, 1999, **62**(2–4), 201.
208. (a) Furukawa, H., Nakamura, T., Inagaki, H., Wishikawa, E., *et al.* *Chem. Lett.*, 1988, 877; (b) German Patent 3610718, *Ind. Sci. Tech.*; (c) Ishii, Y., Yamawaki, K., Ura, T., Yamada, H., *et al.* *J. Org. Chem.*, 1988, **53**(15), 3587.
209. Brooks, C. D., Huang, L., McCarron, M., & Johnstone, R. A. W. *Chem. Commun.*, 1999, 37.
210. Turnwald, S. E., Lorier, M. A., Wright, L. J., & Mucalo, M. R. *J. Mater. Sci. Lett.*, 1998, **17**(15), 1305.
211. (a) Oda, R. *Kagaku (Kyoto)*, 1986, **41**(11), 760; (b) Venturello, C., & Ricci, M. *J. Org. Chem.*, 1986, **51**(9), 1599; (c) Shimizu, M., Orita, H., Suzuki, K., Hayakawa, T., Hamakawa, S., & Takehira, K. *J. Mol. Catal. A*, 1996, **114**, 217.
212. (a) Gallot, J. E., & Kaliaguine, S. *Can. J. Chem. Eng.*, 1998, **76**(5), 833; (b) Gallot, J. E., Fu, H., Kapoor, M. P., & Kaliaguine, S. *J. Catal.*, 1996, **161**, 798.
213. Wu, S. Q., Bouchard, C., & Kaliaguine, S. *Proc. Int. Zeolite Conf., 12th Meet.*, Mtg date 1998, **V2**, 1399.
214. Seki, Y., Mizuno, N., & Misono, M. *Appl. Catal. A*, 2000, **194**(5), 13.
215. EP 958861, Enichem, 1998.
216. (a) Johnstone, A., Middleton, P. J., Wasson, R. C., Johnstone, R. A. W., Pires, P. J. C., & Rocha, G. O. In *Activation of Dioxygen and Homogeneous Catalytic Oxidation* (Barton, D. H. R., *et al.*, eds). Plenum Press, New York, 1993, p. 45; (b) International Patent Applications 92/18449, 94/14740, Solvay Interlox.
217. (a) Brown, S. W., Hackett, A., Johnstone, A., King, A. M., *et al.* *Tagungsbericht 9204 Proc DGMK Conference, Selective Oxidation in Petrochemistry* (Baerns, M., & Weitkamp, I., eds). Goslar, Germany, 1992; (b) PCT Patent Application WO 92/14691, Solvay Interlox; (c) GB Patent 2269588, Solvay Interlox.
218. Yu, R., Xiao, F.-S., Wang, D., Sun, J., *et al.* *Catal. Today*, 1999, **51**(1), 39.
219. Nomiya, K., Nemoto, Y., Hasegawa, T., & Matsuoka, S. *J. Mol. Catal. A: Chem.*, 2000, **152**(1–2), 55.
220. Wang, D., Liu, Z., Liu, F., Zhang, X., *et al.* *React. Kinet. Catal. Lett.*, 1998, **2**, 233.
221. Raja, R., & Ratnasamy, P. *Appl. Catal. A*, 1996, **143**, 145.
222. Dai, S. E., Petty, R. H., Ingram, C. W., & Szostak, R. *Appl. Catal. A*, 1996, **143**, 101.
223. Murthy, K. V. S. B. S. R., Srinivas, N., Kulkarni, S. J., & Raghavan, K. V. *Proc. Int. Zeolite Conf., 12th Meet.*, 1998, **V2**, 893.
224. German Patent DE 2460361, Merck GmbH.
225. International Patent Application 93/00319, Solvay Interlox.
226. International Patent Application 94/02080, Solvay Interlox.
227. Wilson, S. L. *Performance Chemicals*, 1993, **Oct/Nov**, 39.
228. (a–d) European Patents 334511, 336057, 336567, 336568, Interlox Chemicals; (e) International Patent Application 94/00407, Solvay Interlox; (f) French Patent 2274586, Ugine Kuhlmann.
229. Mal, N. K., & Ramaswamy, A. V. *Appl. Catal. A*, 1996, **143**, 75.
230. Singh, A. P., & Selvam, T. *Appl. Catal. A*, 1996, **143**, 111.
231. Sheldon, R. A., Arends, I. W. C. E., & Duksman, A. *Catal. Today*, 2000, **57**(1–2), 157.
232. Sato, K., Aoki, M., Takagi, J., Zimmerman, K., & Noyori, R. *Bull. Chem. Soc. Jpn.*, 1999, **72**(10), 2287.
233. Bogdal, D., & Lucasiwicz, M. *Synlett*, 2000, 143.
234. (a,b) European Patents 102655, 326470, Hoechst; (c) JP 11/246482, Toray Industries.
235. European Patent 260054, Solvay Interlox.
236. Barak, G., Dakka, J., & Sasson, Y. *J. Org. Chem.*, 1988, **53**, 3553; (b) Behr, A., & Eusterwiemann, K. *Organomet. Chem.*, 1991, **403**(1), 215; (c) Lu, X., Lanteri, P., & Longeray, R. *Inform. Chem.*, 1990, **May**, 180.
237. (a) Muzart, J., & Ait-Mohand, S. *Tetrahedron Lett.*, 1995, **36**(32), 5735; (b) Maignien, S., Ait-Mohand, S., & Muzart, J. *Synlett* 1996, 439.
238. Batista, C. M. S., Melo, S. C. S., Gelbard, G., & Lachter, E. R. *J. Chem. Res. (S)*, 1997, 92.
239. Choudary, B. M., & Vali, V. L. K. *Chem. Commun.*, 1990, 1115.
240. Arts, S. J. H. F., Mombarg, E. J. M., & Van Bekkum, H. *Synthesis*, 1997, 597.
241. (a) Hassall, C. H. *Org. React.*, 1957, **9**, 73; (b) A Dobrowsky, *Monatsh. Chem.*, 1955, **86**, 325.
242. UK Patent 2188927, Interlox Chemicals.
243. Sato, K., Hyodo, M., Takagi, J., Aoki, M., & Noyori, R. *Tetrahedron Lett.*, 2000, **41**(9), 1439.
244. JP 11/217351, Nippon Kasei/Mitsubishi Gas Chemical, 1997.
245. Krow, G. R. *Org. React.*, 1993, **43**, 251.
246. (a) McClure, J. D., & Williams, P. H. *J. Org. Chem.*, 1962, **27**, 24; (b) US Patent 4353832, Interlox SA; (c,d) US Patent 4213906, European Patent 008496, Allied Chemicals.
247. (a) Mlochowski, J. *Chem. Pap.*, 1998, **52**(1), 45; (b) Grieco, P. A., Yokoyama, Y., Gilman, S., & Ohfuné, Y. *J. Chem. Soc. Chem. Commun.*, 1977, 870; (c) Taylor, R. T., & Flood, L. A. *J. Org. Chem.*, 1983, **48**, 5160; (d) Syper, L. *Synthesis*, 1989, 167; (e) US Patent 4160769, Union Carbide.

248. International Patent Application 94/21624, Solvay Intertox.
249. International Patent Application 97/44129, Solvay Intertox.
250. International Patent Application 99/55691 A1, BNFL.
251. Dakin, H. D. *Org. Synth. Coll.*, 1941, **1**, 149.
252. Roy, A., Reddy, K. R., Mohanta, P. K., Ila, H., & Junjappa, H. *Synth. Commun.*, 1999, **29**(21), 3781.
253. (a) PC Ugine Kuhlmann, US Patent 3972878, Atochem; European Patent 399866; (b) Schirmann, J. P., & Weiss, F. *Tetrahedron Lett.*, 1972, 635.
254. (a-d) European Patents 208311, 267362, 299430, 384390, Montedipe SpA; (e,f) European Patents 496385, 564040, Enichem Anic SpA; (g) Roffia, P., Leofanti, G., Cesana, A., Mantegazza, A., *et al. Chim. Ind. (Milan)*, 1990, **72**(7), 598.
255. JP 2000/063342, Mitsubishi Gas Chemical.
256. Hayashi, H. *Res. Chem. Intermed.*, 1998, **24**(2), 183.
257. (a) Albini, A. *Synthesis*, 1993, 263; (b) Lindner, K. *Tenside*, 1964, **1**, 112; (c) Sauer, J. D. *Surfact. Sci. Ser.*, 1990, **34**, 275.
258. (a) German Patent 3618352, Hüls AG; (b) Austrian Patent 89/02373, Lenzing AG; (c) US Patent 5216154, Texaco Chem Co.
259. US 6037497A, Albemarle.
260. WO 99/50236 A1, Albemarle.
261. (a) Wawzonak, S., & Kempf, J. V. *Org. Prepr. Proc. Int.*, 1972, **4**(3), 135; (b) Wang, K. *Hecheng Xiangjiao Gongye*, 1985, **8**(6), 408; (c) US Patent 5013510, Ciba-Geigy Corp; (d) European Patent 289596, Ciba-Geigy AG; (e) European Patent 233622, Intertox SA.
262. (a) Jorda, E., Tuel, A., Teissier, R., & Kervannal, J. *Proc. Int. Zeolite Conf., 12th Meet., Mtg 1998*, **V2**, 1269; (b,c) European Patent 314147, US Patent 4918194, Montedipe SpA.
263. (a) British Patent 1410446, Eiwa; (b) Czechoslovakian Patent 232350 (V. Macho); (c) Romanian Patents 89763, 90607, 90608, 91258, Combinatul Chimic.
264. Brough, J. N., & Lythgoe, B. *J. Chem. Soc.*, 1954, 4069.
265. (a) Enders, D., & Plant, A. *Synlett*, 1990, 725; (b) Enders, D., & Bhushan, V. Z. *Naturforsch. B: Chem. Sci.*, 1987, **42**(12), 1595.
266. (a) Kloc, K., Kubicz, E., Mlochowski, J., & Syper, L. *Synthesis*, 1987, 1084; (b) Emmons, W. D. *J. Am. Chem. Soc.*, 1957, **79**, 5739; (c) Boyd, D. R., Coulter, P. B., & Sharma, N. D. *Tetrahedron Lett.*, 1985, **26**(13), 1673.
267. JP 11/255729, Sumitomo.
268. DE 19826669, VEB Stickstoffwerke.
269. Richardson, D. E., Yao, H., Frank, K. M., & Bennett, D. A. *J. Am. Chem. Soc.*, 2000, **122**(8), 1729.
270. Drago, R. S., & Burns, D. S. *J. Catal.*, 1997, **166**, 377.
271. Vayssie, S., & Elias, H. *Angew. Chem. Int. Ed.*, 1998, **37**(15), 2088.
272. EP 710647, Solvay Intertox.
273. Hulea, V., Ropot, R., & Dumitriu, E. CA 132:194029 (Romanian article).
274. (a) European Patent Application 541333, Du Pont; (b-d) US Patents 5023369, 5061820, 5072033, Monsanto; (e-g) US Patents 5043475, 5095140, 5077430, Monsanto.
275. German Patent 2725166, Goodyear Tire Co.
276. WO 99/41234, Albemarle.
277. JP 11/116550, Nippon Peroxide.
278. German Patent 604016, Schoberl.
279. French Patent 2616786, Intertox SA.
280. Wang, Y., & Espenson, J. H. *J. Org. Chem.*, 2000, **65**(1), 104.
281. (a) UK Patent 655668, Monsanto; (b) Belgian Patent 883703, Pennwalt.
282. Huang, T., & Espenson, J. H. *J. Org. Chem.*, 1999, **64**(17), 6374.
283. DE 19757995, Great Lakes Chemical.
284. Romanian Patent 00109327, Inst Cerc Prod Auxiliare Organice.
285. (a) Sims, A. F. E. *Effluent Water Treat. J.*, 1981, **21**(3), 109; (b) Eisenhauer, H. R. *J. Water Pollut. Control Fed.*, 1964, **36**(9), 1116; (c) Bowers, A. R., Gaddipati, P., Eckenfelder Jr, W. W., & Monsen, R. M. *Water Sci. Technol.*, 1989, **21**, 477; (d) Goldstein, S., Meyerstein, D., & Czapski, G. *Free Rad. Biol. Med.*, 1993, **15**, 435.
286. Lumar, L., Sicilia, D., Rubio, S., Perez-Bendito, D., & Nickel, U. *Water Res.*, 2000, **34**(6), 1791.
287. (a,b) International Patent Application 94/22772, EP 609272 A1, Solvay Intertox; (c) JP 83-034197 B, Toa Gosei Chemical Industries.
288. Bucek, J. *Wasser Luft Boden*, 1999, **43**(5), 42.
289. (a) Cater, S. R., Bircher, K. G., Stevens, R. D. S., & Amiri, A. S. *Water Pollut. Res. J. Can.*, 1992, **27**(1), 151; (b) Buckley, J. A., Brown, P. M., Cater, S. R., Luang, C. V., *et al. Int. Conf. Physicochem. Biol. Detoxif. Hazard Wastes*, 1988, **1**, 369; (c) US Patent 5266214, Solarchem Environment Systems; (d) Ruppert, G., Bauer, R., Heisler, G., & Novalic, S. *Chemosphere*, 1992, **27**(8), 1339; (e) 1993, **28**(8), 1447.
290. Tachiev, G. I. Vanderbilt University 1998, 240 pp.; *Dissert. Abstr. Int. B*, 1999, **59**(12), 6436.
291. Parker, J. *Textiles Mag.*, 1994, 23.
292. Hofmann, J., Ondruschka, B., Tauchnitz, H., & Vanselow, H. *Chem. Tech. (Leipzig)*, 1998, **58**(4), 198.
293. Lin, S.-S., & Gurol, M. D. *Water Sci. Technol.*, 1996, **34**(9), 57.
294. (a) Borup, M., & Middlebrooks, J. E. *Water Sci. Technol.*, 1986, **19**(3-4), 381; (b) Sundstrom, D. W., Weir, B. A., Barber, T. A., & Klei, H. E. *Water Pollut. Res. J. Can.*, 1992, **27**(1), 57; (c) Froelich, E. M. *Water Pollut. Res. J. Can.*, 1992, **27**(1), 169.
295. (a) Sedlak, D. L., & Andren, A. W. *Environ. Sci. Technol.*, 1991, **25**(4), 777; (b) Tang, W. Z., & Tassos, S. *Water Res.*, 1997, **31**(5), 1117.
296. Hoigne, J. *Handb. Environ. Chem.*, 1998, **5**, 83.

297. (a) Masten, S. J., & Davies, S. H. R. *Environ. Sci. Technol.*, 1994, **28**(4), 180A; (b) Brunet, R., Bourbigot, M. M., & Dore, M. *Ozone. Sci. Eng.*, 1984, **6**, 163.
298. (a) Duguet, J. P., Bruchet, A., & Mallevialle, J. *Water Supply*, 1989, **7**, 115; (b) Ferguson, D. W., McGuire, M. J., Koch, B., Wolfe, R. L., & Aieta, E. M. *J. Am. Water Works Assoc.*, 1990, **April**, 181.
299. Berger, P., Karpel, N., Leitner, V., Dore, M., & Legube, B. *Water Res.*, 1998, **33**(2), 433.
300. (a) McGuire, M. J., & Davis, M. K. *Water*, 1988, **May**, 42; (b) Aieta, E. M., Reagan, K. M., Lang, J. S., McReynolds, L., Kang, J. W., & Glaze, W. H. *J. Am. Water Works Assoc.*, 1988, **May**, 64.
301. Sapach, R., & Viraraghavan, T. *J. Environ. Sci. Health*, 1997, **A32**(8), 1077.
302. EP 968966, Euro Hydrotechn Galvanoplastie.
303. (a) Sanger, A. R., Lee, T. T. K., & Chuang, K. T. *Progr. Catal.*, 1992, 197; (b) Debellefontaine, H., Striolo, P., Chakchouk, M., Foussard, J. N., & Besombes-Vailhes, J. *Rev. Sci. Eau.*, 1992, **5**(4), 555; (c) Striolo, P., Pech, J. L., & Debellefontaine, H. *1st International Conference on Advanced Oxidation Technology and Water/Air Remediation*, Ontario, 1994, p. 184.
304. (a) Oliver, J. M. *Ing. Quim.*, 1999, **31**(361), 373; (b) Todo, F., Sasaki, T., & Suzuki, K. *Proc. Int. Conf. Radioact. Waste Manage Environ. Rem.*, 1995, **V2**, 1099.
305. Debellefontaine, H., Chakchouk, M., Foussard, J. N., Tissot, D., & Striolo, P. *Environ. Pollut.*, 1996, **92**(2), 155.
306. (a) Kuo, W. G. *Water Res.*, 1992, **26**(7), 881; Huang, C. R., Lin, Y. K., & Shu, H. Y. *Am. Dyestuff Rep.*, 1994, **Oct.**, 15; (b) Pittroff, M., & Gregor, K. H. *Melliand Engl.*, 1992, E244; (c) Gregor, K. H. *Melliand Engl.*, 1990, E435.
307. Li, Z. M., Comfort, S. D., & Shea, P. J. *J. Environ. Qual.*, 1997, **26**, 480.
308. Zoh, K. D., & Stenstrom, M. K. *WEFTEC 99, 72nd Annu. Conf. Expo.*, 1999, pp. 2732–2747.
309. Servos, M. R. 2nd Int. Conf. on *Environ. Fate Eff. Pulp. Pap. Mill. Effluents*, 1996, pp. 159–166.
310. Chiron, S., Fernandez-Alba, A., Rodriguez, A., & Garcia Calero, E. *Water Res.*, 1999, **34**(2), 366.
311. Croll, B. T. *Spec. Publ. R. Soc. Chem.*, 1995, **174**, 124.
312. Fallmann, H., Krutzler, T., Bauer, R., Malato, S., & Blanco, J. *Catal. Today*, 1999, **54**(2–3), 309.
313. Stefan, M. I., Mack, J., & Bolton, J. R. *Environ. Sci. Technol.*, 2000, **34**(4), 650.
314. Chen-Hamacher, X. L., Hicke, K., & Thiemann, W. *Entsorgungspraxis*, 1999, **17**(6), 31.
315. Collivignarelli, C., Bertanza, G., & Pedrazzani, R. *Environ. Technol.*, 2000, **21**(1), 1.
316. Goddard, C. F., & Shack, P. A. *Ind. Wastew.*, 1999, **7**(3), 27.
317. Xue, S. K., & Chen, S. *Trans. ASAE*, 1999, **42**(5), 1401.
318. JP 2000/5772, 5774, 5775, Mitsubishi Gas Chemical.
319. (a) Shilov, E. A. *Zh. Fiz. Khim.*, 1953, **27**, 1103; (b) Kuznetsov, J. E., Ganz, S. N., & Shoak, N. P. *Khim. Tekh.*, 1968, **12**, 77; (c) Baveja, K. K., Subba Rao, D., & Sarkar, M. K. *J. Chem. Eng. Jpn.*, 1978, 322; (d) Il'chenko, A. F., Kucha, M. I., Egorov, B. F., & Shchemer, M. N. *Izv. Vuzov. Khim. Khim. Tekh.*, 1983, **26**(7), 835; (e) Gray, D., Lissi, E., & Heicklen, J. J. *Phys. Chem.*, 1972, **76**, 1919.
320. Solvay Interlox, unpublished data.
321. (a) Rossi, N. J., & Unfried, K. *Met. Finish.*, 1997, **95**(4), 16; (b) Woods, S., Wyborn, P., McIntyre, G., & Colgan, S. *Case Stud. Environ. Technol.*, 1996, 103.
322. Guenther, L. *Chem. Anlag. Verf.*, 2000, **33**(4), 50.
323. DE 19921854, Ahlstroem Oy.
324. (a) Hoffmann, M. R., & Edwards, J. O. *J. Phys. Chem.*, 1975, **79**, 2096; (b) McArdle, J. V., & Hoffmann, M. R. *J. Phys. Chem.*, 1983, **87**, 5425.
325. Nyer, E. K., & Vance, D. *Ground Water Monit. Rev.*, 1999, **17**(3), 54.

Chapter 12: Waste Minimisation in Pharmaceutical Process Development: Principles, Practice and Challenges

TONY Y. ZHANG

1 Introduction

From the launching of aspirin in 1899 to the decoding of the human genome at the turn of the new millennium, the last century has witnessed the birth and exploding growth of medicinal chemistry and the modern pharmaceutical industry. Although there are still many unmet medical needs, great strides have been accomplished in chemistry and biology that have made pharmaceuticals one of the most cost-effective means for maintaining human health. Table 12.1 offers a glimpse of the structures, biological functions and targeted disease areas for the best selling prescription medicines in 1999 [1].

As seen from Table 12.1, pharmaceuticals encompass a wide array of molecules of different complexities. Except for the proteins, they tend to have a molecule weight of 200–800 Da and on average the synthesis of these compounds might take 8–12 steps. With the exception of metformin, which is not much more complicated than urea (the first organic molecule ever synthesised), virtually all of the top-selling pharmaceuticals contain one or more cyclic components. Among these 23 active pharmaceutical ingredients, 21 contain at least one nitrogen atom, 13 have at least one chiral centre, 5 are natural or side-chain-modified products and 2 are produced by recombinant DNA technology. Although protein therapeutics will likely account for an even larger share due to the advent of genomic research and breakthroughs in drug delivery technologies, small molecules are expected to maintain their dominance in the near future. This means that chemical synthesis will continue to be the mainstay of the pharmaceutical industry. Even though the total sales figure is a useful indication of the market demand for a particular drug, the unit selling price is governed by a group of factors, including cost for manufacturing the active pharmaceutical ingredients,

formulation, marketing, competition, R&D risk and profit. The quality of synthetic routes for the manufacture of active pharmaceutical ingredients directly affects the availability of these products to the world population.

The annual production of bulk active ingredient ranges between a few kilograms for some protein drugs to thousands of tonnes for antibiotics (veterinary use accounting for a major share), with the general trend moving towards highly potent, lower volume compounds. The regulatory environment of pharmaceutical industry dictates that strict control over product quality and consistency must be in place for bulk drug manufacturing. Any changes in synthetic route must be validated and approved vigorously to ensure the quality and safety of the drug products. At the same time, the need for innovative products to address emerging epidemics such as AIDS and hepatitis, the escalating cost of pharmaceutical R&D and fierce competition within the industry creates a great sense of urgency to reduce the development time from discovery to launching. Designing a high-quality process within a short time frame that will withstand the test of time during the product life-cycle is the ultimate challenge for the process chemist. As a result, incorporation of waste minimisation and pollution controls in the designing phase of process research and development is not only good environmental practice but also makes sound business sense for an industry that strongly endorses the triple bottom line of social benefits, environmental protection and profitability.

The use of chemistry for pollution prevention is referred to generally as green or sustainable chemistry [2–4]. The general public usually interprets the word 'green' as good for the environment, and may even conjure up a certain political philosophy. Although the term 'green chemistry' was coined in the late 1980s, the fundamental principles were

Table 12.1 Top 23 prescription drug sales in 1999

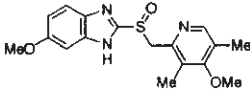
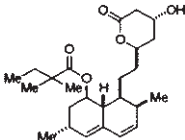
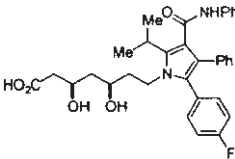
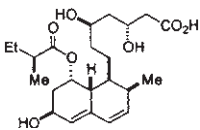
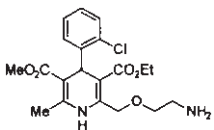
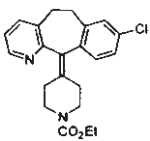
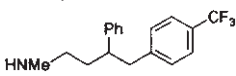
Rank	Product	Product category	Company	Molecular weight (Da)
1	Losec/Prilosec (omeprazole)	Gastrointestinal proton pump inhibitor	AstraZeneca	909
				
2	Zocor (simvastatin)	Hypolipidaemic	Merck & Co.	495
				
3	Procrit/Epogen (epoetin alpha)	Anti-anaemic proteins	Johnson & Johnson/Amagen	790
4	Lipitor (atorvastatin)	Hypolipidaemic	Pfizer	732
				
5	Mevalotin/ Pravachol (pravastatin)	Hypolipidaemic	Sankyo/ Bristol-Myers Squibb	504
				
6	Norvasc (amlodipine)	Calcium antagonist	Pfizer	991
				
7	Insulins of various forms	Antidiabetic proteins	Eli Lilly/Novo Nordisk	754
8	Claritin (loratadine)	Antihistamine	Schering-Plough	673
				
9	Prozac (fluoxetine)	Antidepressant	Eli Lilly	613
				

Table 12.1 Continued

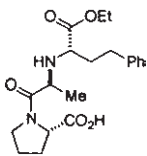
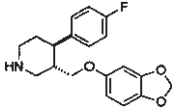
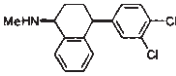
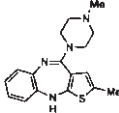
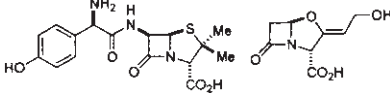
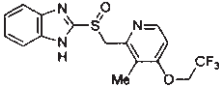
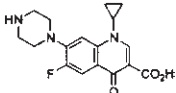
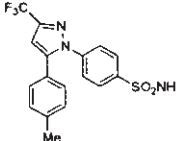
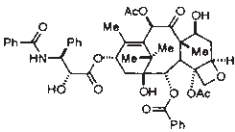
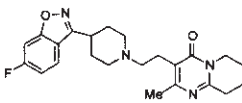
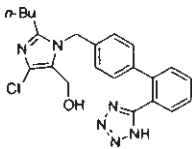
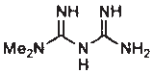
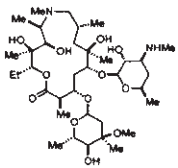
Rank	Product	Product category	Company	Molecular weight (Da)
10	Vasotec (enalapril)	ACE inhibitor	Merck & Co.	305
				
11	Seroxat/Paxil (paroxetine)	Antidepressant	SmithKline Beecham	100
				
12	Zoloft (sertraline)	Anti-depressant	Pfizer	997
				
13	Zyprexa (olanzapine)	Antipsychotic	Eli Lilly	885
				
14	Augmentin (amoxicillin + clavulanic acid)	Penicillin antibiotic	SmithKline Beecham	811
				
15	Prevacid (lansoprazole)	Proton pump inhibitor	TAP	800
				
16	Premarin (conjugated oestrogens)	Hormonal product mixture	American Home Products	776
17	Ciprobay (ciprofloxacin)	Antibiotic	Bayer	534
				
18	Celebrex (celecoxib)	Cox-2 inhibitor, analgesic	Pharmacia Corporation	501
				

Table 12.1 Continued

Rank	Product	Product category	Company	Molecular weight (Da)
19	Taxol (paclitaxel)	Anti-cancer	Bristol-Myers Squibb	481
				
20	Risperdal (risperidone)	Antipsychotic	Johnson & Johnson	474
				
21	Cozaar /Hyzaar (losartan)	Angiotensin II antagonist	Merck & Co.	385
				
22	Glucophage (metformin)	Anti-diabetic	Bristol-Myers Squibb	317
				
23	Zithromax, (azithromycin)	Macrolide antibiotic	Pfizer	309
				

embraced by many forward-looking chemical practitioners around the world many years ago in designing chemical products and processes that are more environmentally benign. However, in the past two decades the topic has been examined with unprecedented interest and intensity from different perspectives by chemists, engineers, government regulators, ecologists and entrepreneurs. Several new concepts have been introduced to elevate the level of awareness among chemists in this front. Most notably among them are 'atom economy' by Trost [5,6] and 'E factor' or 'environmental quotient' by Sheldon [7–10].

Atom economy emphasises the maximum incorporation of reactant atoms into the product at a particular step, whereas the E-factor notion approaches

the question with a comprehensive look at the transformation to include other reaction components that do not necessarily end up in the product, such as solvents, by-products, etc. Recognition and incorporation of these concepts early in the process development often has a profound positive effect on the environmental friendliness of the manufacturing process. Delineating these principles of overall process design has not been addressed extensively in a systematic fashion [11–14].

Although it is common and effective for academic researchers to showcase and popularise one's favourite key transformation in the context of total synthesis of a molecule of biological importance, industrial practitioners have a different objective that requires a more practical approach to the same syn-

thetic target. Incorporation of waste minimisation principles and scientific innovation in the design of pharmaceutical manufacturing processes to offer the most cost-effective solutions for disease management with minimum environmental impact is the current mandate for process chemists. Rather than considering one reaction (step) at a time, a global examination of the interwoven issues of the overall process (total synthesis) must be carried out in an industrial setting. Chemical processes, especially those employed in the production of pharmaceuticals, are often the culmination of several iterations of optimisations, with considerations given to an array of confounding issues along different stages of the drug development pipeline. Because the criteria along the path change with the business reality, a process suitable for making kilograms of material for Phase I clinical trial may not be suitable for commercial-scale manufacture at a multi-tonne level.

2 Focus of Process Chemistry

Although each one of these drugs commands billions of annual sales, behind every one of these molecular entities are tens of thousands made by medicinal chemists or isolated from natural products that did not meet the critical success factors. A medicinal chemist's focus is on hunting down the molecules with the best efficacy and high therapeutic index. The most effective strategy to achieve this goal is a divergent approach where a large structure–activity relationship space can be explored with minimum effort. This is usually achieved by introducing molecular diversity in a hierarchical fashion and minimising the number of post-diversification reactions, as illustrated in Fig. 12.1.

When the target molecule is identified and subjected for scale-up, the focus would shift to the efficiency of a synthesis for this particular molecule, e.g. AB^2C^2 , which demands a different strategy, whereas the ability to make other molecules is of little concern. This affords the process chemists a great degree of flexibility in choosing the starting material and chemistry for the target molecule, and the end result might be totally different from the way the compound was made in the first place (Fig. 12.2). A number of interrelated factors, such as overall yields, number of steps, process safety and ecological consequences, have to be considered and their interaction evaluated to achieve the maximum efficiency.

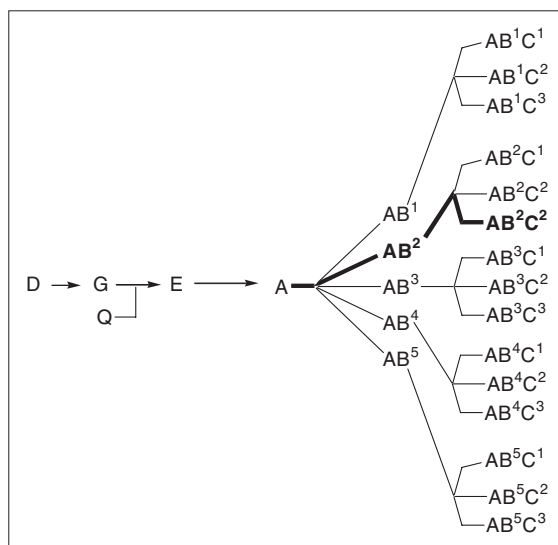


Fig. 12.1 Structure–activity relationship: focus on diversity.

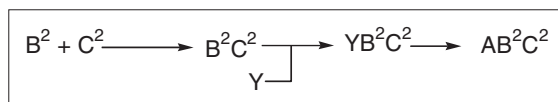


Fig. 12.2 Process chemistry: focus on efficiency.

For early stage testing purposes, the routes used by the medicinal chemists often are adopted to prepare up to a few hundred grams of compound for the benefits of expediency. As the drug candidate moves further along the development process and the attrition rate becomes smaller, serious consideration is given to process development for scale-up. The synthetic route employed by the medicinal chemist in the first place may not be suitable due to cost, efficiency or environmental concerns at a larger scale. At the same time, the process chemists are not bound by consideration for making analogous compounds, and have a great deal of freedom in designing a totally new process using their own set of criteria around the synthetic efficiency for one single compound.

2.1 Safety

The environmental consequence of a runaway reaction can be very grave. Usually the problems are caused by the building up of high-energy species and

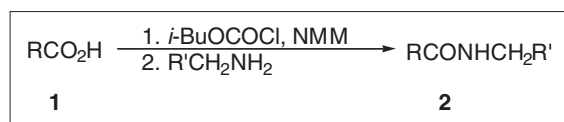
an inadvertent trigger, such as adding catalyst last to reaction mixtures or adding initiators to polymerisable monomers. Such mishaps can be avoided easily by running the reaction at higher temperature to consume and to avoid the accumulation of reactive intermediates, running at lower temperature to increase heat transfer efficiency and to lower the reaction rate, and controlling the exotherm by the reagent addition rate or by having a continuous process. Safety is the primary concern when a process is being scaled up and it is not negotiable because no waste is greater than that of human lives.

2.2 Increasing complexity

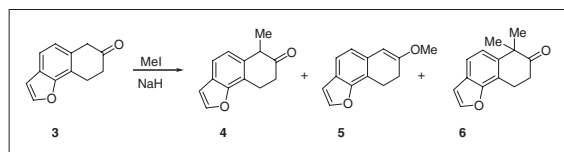
To minimise waste, an efficient synthesis should have increasing complexity and increasing molecular weight as the synthesis evolves from starting material to product (see Schemes 12.1 and 12.2). This translates into the maximum use of chemoselective reactions and the minimum use of protecting groups. The virtue of convergent synthesis is emphasised in every synthetic text for the precise reason that it is more effective at increasing molecular complexity than a linear synthesis.

2.3 Means of purification

To ensure product quality and synthetic efficiency, various checkpoints must be built into the synthesis to remove impurities. Crystalline intermediates are highly desirable and may even be worth an extra step or two to obtain. Process optimisation often leads to the best way to remove an impurity, which



Scheme 12.1



Scheme 12.2

is not to make it in the first place. Given a choice, the impurity that displays the greatest difference in chemical or physical behaviour compared with the product is usually easier to remove. As a general rule, the synthesis should be designed in such a way that maximum difference between starting material and product is maintained in the steps comprising it. For example, coupling of a carboxylic acid with an amine base (Scheme 12.1) would fulfil this criterion because the product amide differs significantly from both starting materials, whereas methylation of tetralone (Scheme 12.2) does not because the product, impurities and precursor are similar in both composition and physical properties.

2.4 Choice of starting material

As a general rule, commercial sources of starting material should be considered first for reasons of speed, economy and quality. This not only saves development time and frees R&D and manufacturing capacity, but also has the added benefits of waste reduction. Pollution also is easier to prevent at a dedicated manufacturing site than at a diversified site. One should try to incorporate as many carbon atoms from the purchased starting material as possible. A caveat in purchasing raw material is the long-term stability of a particular source. For example, a by-product from an agrochemical company may serve as an ideal and cheap source for a new synthetic route but this source can dry up quickly when the suppliers improve their process and no longer offer the by-product. Also, an ecologically acceptable material today may face some serious questioning in future years. An integral part of the sourcing strategy is the examination of sustainability of the chemistry used to make the starting material by the vendor.

2.5 Yields

Although the overall yields have been used extensively as a measure for total synthesis elegance, it is but one aspect in evaluating the overall efficiency in an industrial setting. Factors such as reagent cost, solvent usage, ease of separations, process safety and waste treatment concerns are not usually displayed conspicuously in a synthetic scheme. Often, when a starting material is cheap and separation is facile, a low-yielding step may fit well in the early stages of

a process in preference to a few more, albeit high-yielding, steps. Percentage yield for a particular transformation only measures how efficiently the major starting material (limiting agent) is converted into the product. In practice, other implicit factors such as reaction kinetics, impurity profile and throughput often outweigh concerns over this sacred number. A balanced perspective can be obtained by taking into consideration the possible improvement in yields during later stage of development. This often results in the selection of a new process with fewer steps, albeit of lower overall yield, over a longer and higher yielding process. Risk tolerance at different stages of drug development plays an essential role in the decision process.

2.6 Number and order of steps

Whereas many fine chemicals and reagents are quite expensive and appear as the first order of concern to the chemists, processing time and solvent usage often account for a bigger proportion of the production cost. Reduction of the number of bond forming/breaking events and minimising the use of protecting groups often will have a profound effect on the overall efficiency. In addition, work-up in-between steps usually involves extensive usage of solvents and prolonged processing time. Moreover, extra steps not only cause physical losses of material but also introduce additional impurities along the way. Combining compatible steps (telescoping) together not only reduces waste and processing time but also cuts down product losses during separation and transfer. Unnecessary drying, solvent exchange and chromatography should be eliminated whenever possible. The common practice in small-scale laboratories of evaporating everything to dryness is not only impractical on an industrial scale but is also wasteful and sometimes hazardous.

However, carrying forward impurities often can lead to new ones that are difficult to remove, jeopardising the whole process. Thus, acceptable purification means must be available to avoid the common pitfall of piling junk over junk when such measures are taken. This can be modulated by designing a reaction sequence to achieve a maximum difference in physical properties (solubility, partition, crystallinity, etc.) between the desired product and everything else.

On the other hand, although a shorter synthesis is

usually the more elegant one, questions must be asked about what starting materials are used and how available they are. Moreover, for scale-up it is not uncommon for a longer sequence to be preferred over a shorter one just for the existence of a crystalline intermediate as a purification point.

The order of steps generally falls into the category of synthetic strategy. However, even within a defined synthetic scheme, juxtaposing the order of transformations often can bring about an unexpected improvement in the economy of the process and waste reduction, even if the overall yield remains the same. Generally, low-yielding processes, e.g. resolution of enantiomers, should be carried out as early as possible for the throughput and efficiency. However, the advantage of doing so is often overlooked when one focuses only at the overall yield. For similar reasons, solvents and time-intensive procedures should be deferred to the last stage of the process because volumes become smaller due to attrition towards the end.

2.7 Robustness

A good chemical process should not only be efficient but also robust. The ability to be carried out consistently, and at a different scale, is crucial in pilot and production settings. Quality deviations can be extremely wasteful in drug product manufacture. Simplicity often is synonymous to robustness in these cases. An elaborate green process can turn grey very quickly when it becomes too sensitive to minor aberrations in operating parameters. In general, simplicity is the primary criterion when a process is judged for its elegance. The reason is a rather obvious one in that the more complex a process is, the more chances there are of errors and waste being generated. This is not to downplay the importance of innovative technologies, because the most creative solutions to chemical problems usually are the simple ones derived by sophisticated thinking. When getting deeply involved in overcoming a particular obstacle one must keep in mind that solutions cannot be more complicated than the problems.

2.8 Solvents

With the exception of forming the desired solvate in the final product, processing solvents do not contribute to the effectiveness of the drug and their use

should be minimised or completely eliminated. Solvents also are the key contributors to the low E values in pharmaceutical manufacture and overall cost. However, solvents play an essential role in chemical processing for controlling the reaction rate, facilitating heat and mass transfer and enabling product separation and purification, which cannot be replaced easily with other alternatives. Nonetheless, many processes were conducted unnecessarily too dilute and the possibility of carrying out the reaction without any solvent was seldom given a serious consideration. One of the major reasons contributing to low throughput of a particular process is the use of too much solvent. The following questions have to be answered in earnest to minimise the use and release of solvents into the environment:

- Can the transformation be carried out with little or no solvent (neat)? Doing so will not only reduce pollution and cost associated with solvent purchase and recovery, but also reduce cycle time as a result of enhanced reaction rate for intermolecular reactions, and increase reactor throughput because more products can be obtained from a concentrated solution.
- Is the solvent toxic, a mutagen or a suspected carcinogen?
- Is the solvent of choice inert to the reagents, reactants and products?
- Can the solvents be separated efficiently from the product, recovered and reused?
- Is the solvent readily available at reasonable cost?
- Are effective measures in place to control evaporation of solvents?
- Can the number of solvents used in the process be reduced to a minimum? Solvent exchange is an energy-intensive and time-consuming endeavour that increases the prospect of emission of volatile chemicals.
- Do the solvents pose a thermal hazard under processing conditions within a foreseeable deviation?
- What are the boiling and melting points of the solvent? A low-boiling solvent is easier to evaporate and remove but may escape to the atmosphere more easily during processing and recovery operations. A higher boiling solvent tends to have a bigger thermal operation range and to possess better recovering efficiency, but may be difficult to separate by distillation. A low freezing point is generally desired for flexibility in unit operation.
- What are the flashing points and auto-ignition temperatures of the solvents under consideration?
- Do the solvents of choice have the desired solubility characteristics for the compound of interest? Ideally all the reactants should be soluble to ensure the maximum reaction rate, whereas the product should have minimum solubility for facile separation.
- Is the solvent water-miscible? What is the density of the solvent? These are very important points to consider when separation and recovery are concerned.
- Have solvent mixtures been considered to have achieved the desired property? This may be counter-intuitive to the pollution control principle of avoiding mixing but it has been successful to replace an undesirable solvent by two or more solvents that are more environmentally benign in order to achieve similar properties, such as flammability, volatility, polarity and solubility.
- Can water be used in place of other solvents? This is often possible with the help of additives such as phase-transfer catalysts. For all the right reasons, water has been touted as an ideal solvent and much attention has been given in the green chemistry community. However, organic compounds tend to have very limited aqueous solubility and many reagents are not compatible with water, limiting the usefulness of this most abundant and innocuous liquid as a processing medium. Additionally, aqueous wastewater contaminated with soluble organic compound is difficult to treat by thermal oxidation methods such as incineration. Future research should be directed at addressing these gaps. Supercritical CO₂ has attracted the attention of many academic researchers in recent years because of its environmental friendliness, thermal stability and wide availability. Again, the major obstacle is limited solubility, especially for polar compounds in this medium. Fluorinated solvents sometimes have been touted as green solvents. Although perfluorinated hydrocarbons do have low flammability and toxicity, their low biodegradability also means that anything leaked to the environment will be lingering there for a long time. In general, it is better to approach new solvents cautiously because limited data are available on their biological impact.

2.9 Reagents

For intermolecular reactions, excess reagents often are used to drive the reactions to completion because the reaction rate diminishes at higher conversion when the stoichiometry is 1:1. However, unspent reagents can cause separation problems and decisions must be made on whether to have residual starting material or excess reagent in the crude reaction mixture. The choice should be the cheaper and the one that displays the greatest difference compared with the desired product for purification feasibility. Judicious choice must be made on peripheral reagents, such as oxidants, reducing agents and hydroxyl and carboxyl activating agents. These reagents themselves do not contribute to the product skeleton and can have a profound impact on the overall E value of the process. Change of oxidation states often can be avoided by juxtaposing steps in a reaction sequence, and greener agents (H_2 , O_2 , O_3 and H_2O_2) should be given priority consideration when feasible. Utilising enzymatic hydrolysis often has provided a vastly improved E factor over conventional caustic conditions. Unlike synthetic strategy, changes in reagents and reaction conditions (indicated above and below the arrows in a synthetic scheme) often can be made in the later stage of product development and are always targets for perpetual improvement.

2.10 Reaction temperature

Increasing temperature can often bring about a vast improvement in reaction kinetics. This must be balanced by considering the effect of temperature on side reactions, thermal hazards and solvent losses. Although cryogenic conditions often afford better selectivity for some anionic chemistry, energy consumption is high for such operations and more solvent usually is needed to compensate for the decreased solubility at lower temperature.

2.11 Heavy metals

Transition metals such as palladium and rhodium play a major role in reducing waste by improving the atom economy through catalysis, but effective measures must be installed to prevent these heavy metals from contaminating the product stream and the environment. Recycling is the best means for min-

imising heavy metal pollution. Immobilising homogeneous catalysts onto a solid support holds much promise in this area because normally tedious separation processes can be reduced to a simple filtration when the reaction is done and the recovered catalysts can be reused. This also makes strong economical sense, because the price of palladium has nearly quadrupled in the last decade. The use of some highly toxic metals, such as mercury and thallium, even in catalytic amounts, should be avoided altogether at scale. Fortunately, there are usually alternatives to applications involving such metals.

2.12 Endurance

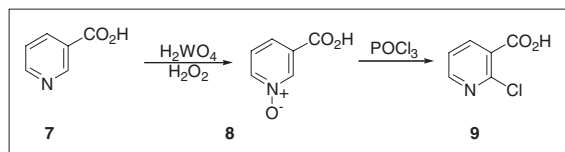
New reactions and catalysts with better selectivities are continuously being discovered and refined. Advances in organometallic chemistry in the last two decades have expanded significantly the repertoire of tools for organic chemists. Although it is not acceptable to rely on the emergence of a future miracle to cure the ills of a problematic step, a process should be designed with vision and diligent efforts so that it will not become obsolete during the product's lifetime. When a short-term fix is applied to a particular process to produce enough material quickly for a pivotal study, one should also keep an eye on the long-term solutions to the problem when the drug candidate proceeds forward and a more practical route is needed. *Getting it right the first time* would obviate all the troubles associated with switching a manufacturing process for active pharmaceutical ingredients. The staying power of a process relies on its safety, environmental impact, economy and reproducibility. Aesthetic elegance of the synthetic scheme is an added bonus when all these are factored in.

3 Example 1

An example [15] of the global approach to the design of a green process is the synthesis of 2-chloronicotinic acid (**9**), a versatile intermediate for a number of agrochemical and pharmaceuticals, including the anti-HIV drug nevarapine [16,17]. There have been several reported synthetic routes to this rather simple compound. The most notable one involves chlorination of nicotinic acid *N*-oxide (**8**) using $POCl_3$ [18]. This route is quite competitive in that nicotinic acid (**7**) is a large-volume chemical pro-

duced in amounts of thousands of metric tonnes by fairly efficient processes. Oxidation to the *N*-oxide also generates very little waste because this was done by hydrogen peroxide and a tungsten catalyst (see Scheme 12.3).

The problematic step is the conversion of compound **8** to compound **9**, where a 5:1 mixture of 2- and 6-chloro isomers usually was obtained owing to low regioselectivity. Separation of the desired 2-chlorinated compound (**9**) from the 6-isomer involved a tedious and solvent-intensive procedure. This is a case where the waste is not apparent just from looking at the equation. One can approach this problem in three ways. The first is to look for a highly regioselective chlorination methodology to obviate the separation step. Alternatively, one can find a more efficient separation technology to curtail solvent usage. This may well be the case where lower yield can be tolerated due to the low cost of the starting material. Yet another approach is a regiospecific synthesis, as reported by Bryson *et al.* [19], where cyanoacetate **11** was allowed to condense with the bisacetal of malonaldehyde (**10**). Hydrochlorination of the diene **12** gave rise to the desired ester **13** in a regiospecific manner (see Scheme 12.4). This is an excellent synthesis from yield and selectivity points of view. However, the problems manifest when one examines the synthesis from a waste minimisation perspective: the atom economy of this synthesis is fairly low, primarily due to the use of protecting groups, and the bisacetal acts as a malonaldehyde surrogate that is unstable in its native form. For this three-carbon building block, only 25% of the mo-



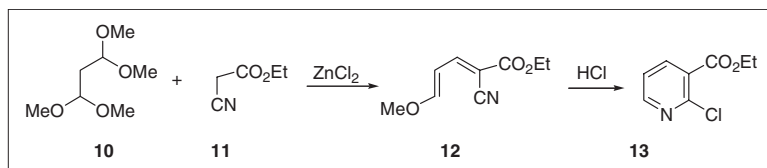
Scheme 12.3

lecular weight is incorporated into the final structure. An even more serious problem is the stoichiometric use of zinc chloride as a Lewis acid promoter for the condensation reaction, which led to a large amount of inorganic solid waste that caused emulsion during work-up and proved hard to treat.

If we examine the synthesis from an idealistic point of view, Scheme 12.5 appears to be optimum. However, we cannot be oblivious to the thermodynamics of this proposed sequence, in addition to the fact that malonaldehyde is not available owing to its stability. If we were to stick with the use of compound **11**, a readily available material that provides the backbone for all of the functional groups in the molecule, a better surrogate has to be found. To this end, acrolein (**16**) was considered because it is made from one of the cheapest organic chemicals, propylene, in a very efficient manner by catalytic air oxidation.

However, we have to recognise the difference in the oxidation state of acrolein compared with that of malonaldehyde. The consequence is that an adjustment in oxidation state has to be made for the sequence of Scheme 12.6 to bear out. Moreover, it turned out that the Michael reaction of compound **4** to acrolein (**16**) under base catalysis was laden with problems. In addition to the polymerisation of acrolein (**16**), a double Michael adduct (**18**) appeared to be the major product due to the superior activity of the monoadduct (**17**) towards acrolein (**16**) over that of compound **11**.

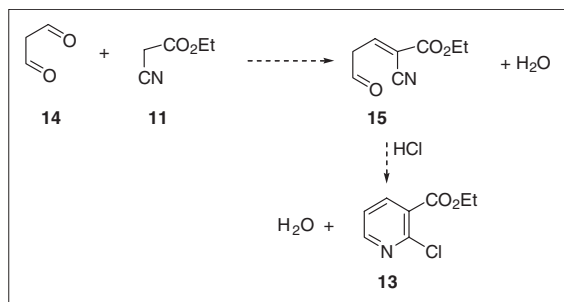
Apparently, three tasks have to be accomplished in order to make the synthesis work: the double Michael adduct has to be curtailed, possibly by a blocking group; reactivity of compound **11** has to be enhanced to obviate the need for a strong base in order to avoid polymerisation of acrolein; and a suitable oxidation or dehydrogenation method has to be found to aromatise the heterocyclic ring (**19** → **13**). Towards this end it was recognised that the oxidation burden could be shifted from the Michael acceptor to the Michael donor, giving rise to a new pair of



Scheme 12.4

Michael reactants, namely acrolein (**16**) and chloroacetoacetate (**20**). This would achieve the three goals, i.e. blockage for the double Michael addition, activation of the C-2 centre and oxidation state adjustment, all in one shot. The hypothesis was soon borne out because compound **20** proved to be an excellent Michael donor to acrolein (**16**). The resulting adduct (**21**) was found to cyclise efficiently to give the aromatised product **13** regioselectively via a one-pot consecutive hydrochlorination, cyclodehydration and dehydrochlorination sequence (see Scheme 12.7).

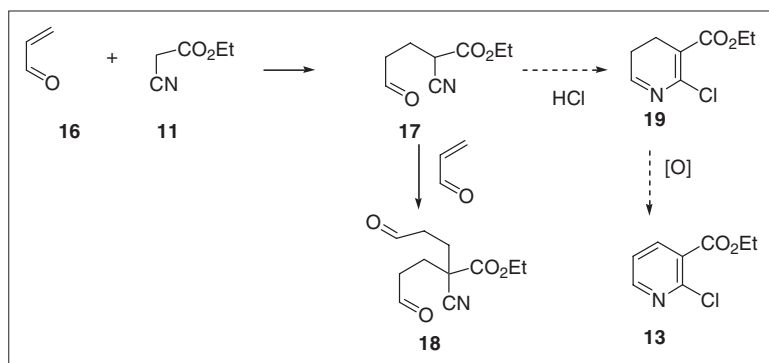
However, a new problem emerged: the availability of compound **20**. For the initial proof of concept



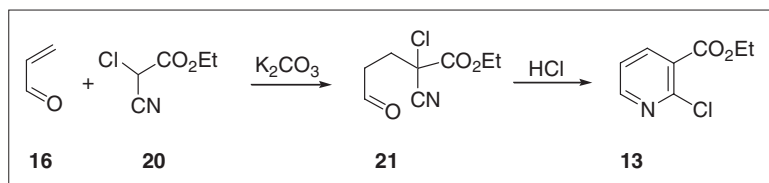
Scheme 12.5

it was made by reacting the anion of compound **11** with carbon tetrachloride [20]. Not only did the process lack robustness but the product also was unstable, disproportionating into the dichloride (**22**) and the parent compound **11** (Scheme 12.8). Additionally, the E factor was appalling. Direct chlorination, even under carefully controlled conditions, led to the dichloride **22** exclusively (see Scheme 12.9), reflecting the weakened and active nature of the C–H bond on the C2 of compound **20**, which contributed to the effectiveness in the Michael addition as shown in Scheme 12.7. However, the tendency for compound **20** to disproportionate has shed some light on the reversibility of this reaction.

Further examination of the synthesis revealed the possibility of moving the reaction equilibrium by coupling steps together (see Scheme 12.10). Although the equilibrium disfavors the formation of compound **20**, one can shift the equilibrium by selectively removing it from the reaction system. The best way to remove the compound appeared to be turning it into the product of the next step. This was made possible by the fact compound **20** is a much better Michael donor than compound **11**. Indeed, when a 1:1:1 mixture of compounds **22**, **11** and **16** was mixed with a catalytic amount of sodium carbonate, the desired Michael adduct was isolated in 82% yield (Scheme 12.10). Better yet, the 1:1



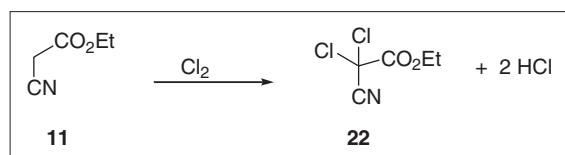
Scheme 12.6



Scheme 12.7

mixture of compounds **22** and **11** can be obtained conveniently by introducing gaseous chlorine into neat compound **11** to exact constitution. Moreover, the only by-product from the chlorination step, HCl, can be trapped and used in the final hydrochlorinating step to effect cyclisation (see Scheme 12.11).

Now if we take a look at the whole synthesis, we can see that every carbon and nitrogen atom in the starting material was incorporated into the final product. The only by-products were one mole each of water and HCl, even though the use of solvent (tetrahydrofuran) and dehydration agent (PCl₃) in the last step could not be avoided totally.

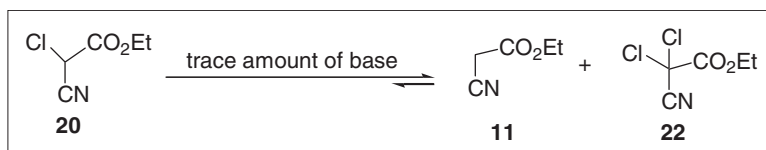


Scheme 12.8

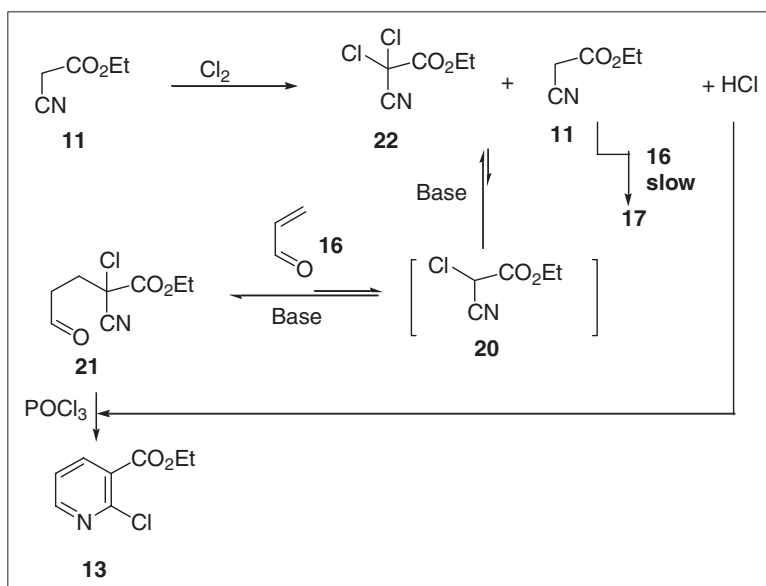
Although this example illustrates process design by systematic consideration of all steps and factors in a synthesis, a great majority of processes are more complicated and cannot be integrated into one closed system as far as waste minimisation goes. Although measures taken to eliminate waste in one step should not lead to more of it in another, we should search carefully for the possibility of turning one step's problem into a blessing for another step in the same process. A seamless merging of green chemistry ideals with thermodynamic principles, mechanistic understanding and technological innovation usually will provide a simple solution for complicated problems.

4 Example 2

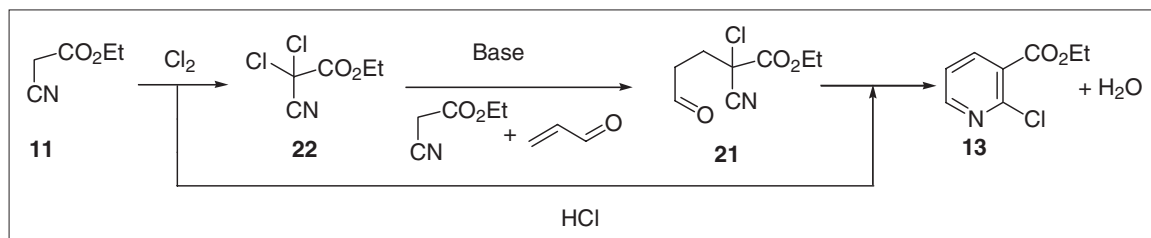
Compounds represented by formula **23** are a new class of 5Ht1a antagonists with significant central nervous system activities [21] and the medicinal chemists chose a very expedient approach to carry out the SAR study (see Scheme 12.12). The strategy



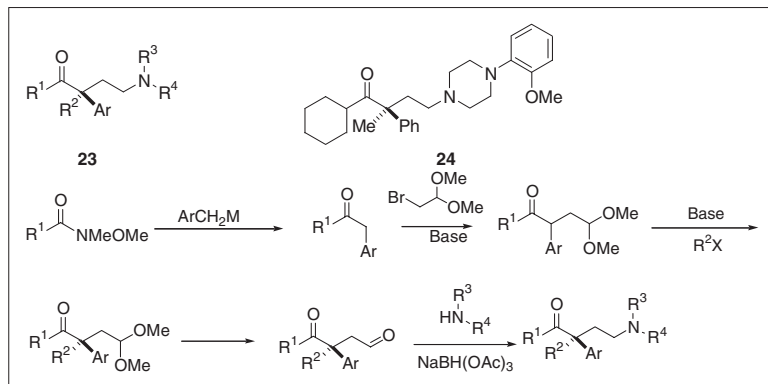
Scheme 12.9



Scheme 12.10



Scheme 12.11

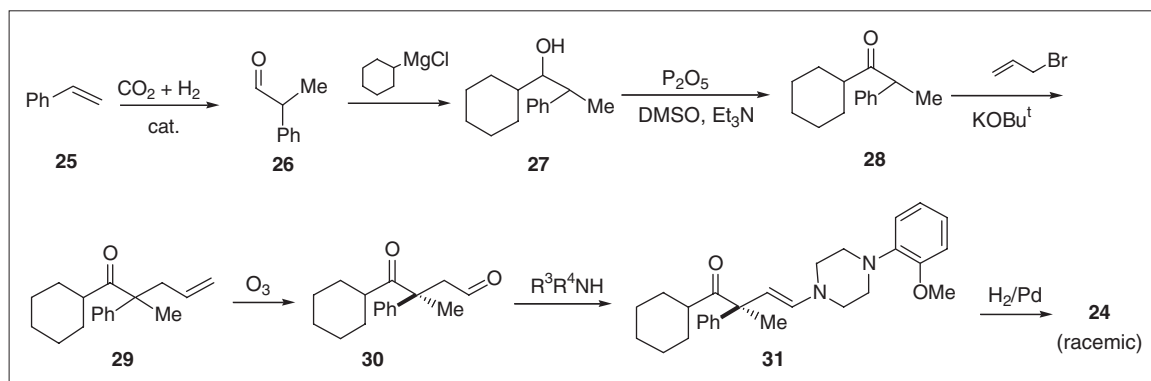


Scheme 12.12

was laid out such that diversification occurs at every step of the synthesis as the molecule gained complexity, and compound **24** was identified quickly as having the most desirable therapeutic index. However, when this molecule was selected for further testing and a large amount of the material was required, process chemists chose a very different approach to the synthesis.

First, the original route was given a serious consideration for scale-up. However, several issues needed to be addressed. These included the use of rather expensive alkoxyamine, the availability of benzylic metal species, an incomplete alkylation step leading to impurities that were too similar to the products and a high-molecular-weight reducing agent in the final step. Most importantly, the lack of crystalline intermediate made quality control a formidable task. For comparison, the process synthesis after a couple of iterations is shown in Scheme 12.13. As starting material we have chosen dihydrotropaldehyde (**26**), commercially available in large amounts and easily accessible from hydroformylation of styrene (**25**), one of the most abundant organic chemicals produced. The cyclohexyl

Grignard reagent also was readily available and was added to the aldehyde in high yield. Oxidation of the resultant alcohol (**27**) activated the benzylic carbon for alkylation. Ozonolysis across the double bond generated aldehyde **30** and formaldehyde, a one-carbon by-product that was removed easily. Condensation of compound **30** with arylpiperazine gave a crystalline enamine (**31**) that provided a very desirable purification point. Catalytic hydrogenation of compound **31** then yielded the desired compound. Although there is still some waste generated (CH_2O , MgCl_2 , KCl , $t\text{-BuOH}$, phosphates and spent solvents) and oxidation and reduction were present in the same process, the overall process is quite efficient in terms of carbon utilisation and overall yield. A salient feature of the synthesis is the built-in check points for impurities along the way. For example, a slight excess of Grignard reagent was used to ensure complete consumption of compound **26**, whereas the residual Grignard gave rise to easily separable cyclohexane upon work-up. Conversion of compound **27** into compound **28** was about 98%, but the residual 2% of compound **27** did not participate in the alkylation step under the reaction conditions,



Scheme 12.13

preventing it from contaminating the downstream intermediate. For the same reason, any residual compound **28** in the processing stream of compound **29** resulting from incomplete alkylation would not have the eventual aldehyde moiety and thus was unable to participate in the amine formation step. This controlling mechanism, in combination with the fact that every step gave >90% yield, makes the overall process quite efficient. In this particular case, selection of the appropriate starting material with the key attributes is critical. Understanding the commodity and speciality chemical supply chains also was helpful.

5 Conclusion

Although much progress has been made by generations of chemists in the search for reaction efficiency and selectivity, we are still far from matching nature's ability at accomplishing sophisticated transformations in water with graceful ease and amazing accuracy. For example, it is always a sobering reminder when we compare the E factor differences in enzymatic and chemical-based peptide coupling procedures. As we ponder about the sustainability of a particular process, *balance*—whether in an ecological sense or from a mere material inventory perspective—is the primary question we have to answer. To put it simply, whatever we put into a reactor or a plant we have to get out, either as a product, with all the promises to improve the quality of human life, or as waste, which does just the opposite.

In summary, waste minimisation in pharmaceutical manufacture is most effective if implemented at the design phase of the process, with a balanced approach after careful consideration of related issues. The few principles in the process development can be summarised by the acronym **SEERS**: Safety, Ecology (or Environment), Efficiency (or Economy), Robustness (or Reproducibility) and Speed. Striving for creative and simple solutions to address all these concerns is the responsibility for all forward-looking scientists and engineers.

References

1. Wood McKenzie's PharmaQuant™ on-line at <http://www.woodmac.com/pharma.htm>.
2. Anastas, P. T., & Williamson, T. C. *ACS Symp. Ser.*, 1996, **626**, 1.
3. Anastas, P. T., & Williamson, T. C. *Green Chemistry: Frontiers in Benign Chemical Syntheses and Processes*. Oxford University Press, Oxford, 1998.
4. Tundo, P., Anastas, P., Black, D. S., Breen, J., et al. *Pure Appl. Chem.*, 2000, **72**, 1207.
5. Trost, B. M. *Science*, 1991, **254**, 1471.
6. Trost, B. M. *Angew. Chem., Int. Ed. Engl.*, 1995, **34**, 259.
7. Sheldon, R. A. *Chemtech*, 1994, **24**, 38.
8. Sheldon, R. A. *J. Mol. Catal. A: Chem.*, 1996, **107**, 75.
9. Sheldon, R. A. *J. Chem. Technol. Biotechnol.*, 1997, **68**, 381.
10. Sheldon, R. A. *C. R. Acad. Sci., Ser. IIc: Chim.*, 2000, **3**, 541.
11. Repic, O. *Process Research and Chemical Development in the Pharmaceutical Industry*. John Wiley, New York, 1998.
12. Lee, S., & Robinson, G. *Process Development: Fine Chemicals from Grams to Kilograms*. Oxford University Press, Oxford, 1995.
13. Jones, D. G. *Chemistry and Industry. Applications of Basic*

- Principles in Research and Process Development*. Oxford University Press, Oxford, 1967.
14. Anderson, N. G. *Practical Process Research and Development*. Academic Press, San Diego, CA, 2000.
 15. Zhang, T. Y., Stout, J. R., Keay, J. G., Scriven, E. F. V., Toomey, J. E., & Goe, G. L. *Tetrahedron*, 1995, **51**, 13177.
 16. Merluzzi, V. J., Hargrave, K. D., Labadia, M., Grozinger, K., *et al. Science*, **250**, 1411.
 17. Wu, J. C., Warren, T. C., Adams, J., Proudfoot, J., *et al. Biochemistry*, **30**, 2022.
 18. Taylor, J. E. C., & Croveti, A. *J. Org. Chem.*, 1954, **19**, 1633.
 19. Bryson, T. A., Donelson, D. M., Dunlap, R. B., Fisher, R. R., & Ellis, P. D. *J. Org. Chem.*, 1976, **41**, 2066.
 20. Terpigorev, A. N., Shcherbinin, M. B., Bazanov, A. G., & Tselinskii, I. V. *Zh. Org. Khim.*, 1980, **16**, 2545.
 21. Kohlman, T. D., Xu, Y., Godfrey, A. G., O'Toole, J. C., & Zhang, T. Y. EP 924205, 1999.

Chapter 13: Green Catalysts for Industry

KEITH MARTIN

1 Introduction

There are a wealth of highly active reagents and catalysts that can be used to promote Friedel–Crafts, oxidation and acid-catalysed reactions. They are highly active and can be used in a wide variety of applications. Unfortunately, operating these processes has resulted in the production of high levels of toxic and corrosive aqueous effluent and unwanted organic side products. During the 1800s and well into the 1900s there was minimal environmental legislation, and therefore effluent from these processes was fed into local water courses, vented to the atmosphere and landfilled with little/no pretreatment. The impact on the environment was profound: waterways very quickly became sterile and highly noxious, rainfall became increasingly acidic on a global scale and landfill sites became very hazardous and unusable due to seepage of chemicals into the soil and to the atmosphere.

From the latter part of the 1960s environmental legislation steadily was introduced, forcing companies to consider ways of minimising the impact of effluent on the environment. Chemical companies understandably were reluctant to invest either time or money on finding alternative ways of performing their processes to reduce effluent production at source. Therefore, their efforts were directed at ‘end-of-pipe’ minimisation [1,2]: solvent recycling, using ‘scrambling’ reactions to recover product from polyalkylated side products, recovery of water-soluble products and reactants from aqueous wastestreams [3], etc. However, increasing pressure from environmental groups and the increasing awareness of the public on environmental issues forced the chemical companies to start looking at methods of reducing the effluent from the process at source. This meant some significant investment in process optimisation: reduction of catalyst concentration, operating in solvent-free systems and operating at lower temperatures to increase selectivity. However, companies very quickly discovered that all

these measures not only minimised their impact on the environment but also led to increased profits because their processes had become more efficient and high-yielding.

Over the last 20–30 years there have been considerable advances in catalyst and solvent technologies. Zeolites, for example, now are used widely throughout the petrochemical industry, often resulting in processes that give 100% atom utilisation and are virtually effluent-free. Fine chemical, agrochemical and pharmaceutical industries, however, are still using traditional catalysts (AlCl_3 , BF_3 , $\text{Co}(\text{OAc})_2/\text{AcOH}$, stannous oxalate, methanesulfonic acid, *p*-toluenesulfonic acid) and methodologies to achieve the required transformations in their existing processes. Companies who manufacture in these areas of the chemical industry are very reluctant to use new technology in existing processes unless it can be demonstrated that there would be significant cost, process and environmental advantage. Technology that offers a reduced impact on the environment has not been an incentive for a company to change a process that has operated for years and provides a steady source of income. Pharmaceutical companies are ‘disadvantaged’ further because none of their processes can be changed without millions of pounds of expenditure to prove that the process changes do not change the purity profile of a drug and hence the properties of the drug itself.

The situation is very different where chemical companies are developing new processes. When considering a synthetic route to a target molecule, the potential impact of any effluent on the economics of the process and its impact on the environment must be considered. The emphasis is to design and develop a process that gives a high yield, with high purity that produces little or no effluent. Any effluent produced must *not* have any environmental impact. This directive has given companies the incentive to consider the new and exciting advances made in chemistry. For example, companies are seriously considering supercritical fluids. Here is the

ability to exploit a phenomenon where organic substrates are soluble in supercritical water or carbon dioxide, and reactions performed under these conditions have shown remarkable yields and selectivities and effluent can be virtually eliminated [4–6].

Another area of chemistry that currently is being considered seriously by chemical companies is ionic liquids [7]. These materials are ionic compounds that are liquids over a wide range of temperature (from –20 to 300°C). They possess no vapour pressure and are highly stable. Like supercritical fluids, they have the ability to solubilise a wide range of organic compounds and inorganic reagents, and in some cases act as the catalyst for the reaction, e.g. Friedel–Crafts reactions [8,9].

However, the majority of investment centres on the area of catalysis, with increasing emphasis on heterogeneous catalysis. There are many types of heterogeneous catalysts but the intention here is to focus on supported reagents and their use and application in the fine chemical, agrochemical and pharmaceutical industries.

2 Supported Reagents

Although the first supported reagent was discovered over 100 years ago [10], in-depth investigations into their preparation, physical properties and applications have occurred only over the last 30 years. The concept of a supported reagent is very simple: take an active reagent that is normally used under homogeneous conditions and ‘fix it’ to an inactive solid support.

The support can be organic (e.g. ion-exchange resins) or inorganic (e.g. silica, alumina, aluminosilicates, activated carbon). Ideally it should possess a high surface area ($>100\text{m}^2\text{g}^{-1}$) and the loading of the reagent should be sufficient to form no more than a monolayer on the surface of the support. Some of the best results in this area of heterogeneous catalysis have been obtained when a mesoporous solid has been used as the support, where the size of the pore can vary between 20 and 150 Å [11,12].

There are a wide variety of active reagents that can be supported successfully: from finely divided precious metals for hydrogenation [13] and simple metal salts [14] to transition metal complexes [15] and organometallics [16] that are chemically bonded to the surface of the support.

3 Envirocats™

Envirocats are a range of commercially available supported reagent catalysts, manufactured by Contract Chemicals Ltd (CCL), that catalyse Friedel–Crafts, Brønsted acid and oxidation reactions [17]. There are five commercially available catalysts in the range: EPZG, EPZ10, EPZE, EPIC and EPAD. Although each has been designed for a particular reaction type, various customers and researchers have found that they are equally effective in a variety of other applications (see later).

All of these catalysts are ‘simple’ supported reagents, i.e. they are produced by the deposition of a metal salt onto a high-surface-area inorganic support. Although they may be termed ‘simple’, it is not known for certain how the reagent interacts with the support and it is very likely that these interactions are, in reality, quite complex. However, various methods of surface analysis has given us very valuable information about the nature of the active sites that reside within these supported reagents.

3.1 Envirocat EPZ10

This was the first of the Envirocats to be developed as a result of the collaboration between the University of York and CCL. Its more familiar name is ‘CLAYZIC’ and there are many reports in the literature describing a range of applications [1,11,18–23]. As the name suggests, this catalyst is prepared by supporting ZnCl_2 on an acid-treated Montmorillonite, e.g. Süd Chemie’s K10. Envirocat EPZ10 was designed to catalyse Friedel–Crafts alkylation of aromatics. Fourier transform infrared spectroscopy (FTIR) studies have shown this catalyst to contain predominantly strong Lewis acid sites as well as weak Brønsted acid sites [20]. In fact, the Lewis acid sites are considerably stronger than those found in homogeneous ZnCl_2 . This means that both alkyl halide and olefins can be used to alkylate an aromatic.

3.2 Envirocat EPZG

This is an iron, clay-based reagent. Here, FTIR studies have shown that this catalyst contains a mixture of strong Brønsted and Lewis acid sites. This supported reagent was designed as a Friedel–Crafts benzoylation catalyst [24]. It will also catalyse some acylation

reactions and some Brønsted acid catalysed reactions, e.g. etherifications (see later).

3.3 Envirocat EPZE

This catalyst is also a 'CLAYZIC' type of supported reagent but the method of preparation is radically different to that used for Envirocat EPZ10. This results in the formation of not only strong Lewis acid sites but also some strong Brønsted acid sites. Thus, this catalyst possesses a wider range of applications than EPZ10, e.g. Friedel–Crafts sulfonylations and, to a lesser extent, benzoylations.

3.4 Envirocat EPIC

This catalyst is a phosphoric acid, clay-based reagent. As expected, the active sites display exclusively strong Brønsted acid characteristics. This supported reagent was designed primarily to catalyse high-temperature esterifications, e.g. polyols with fatty acids. However, it is possible also to catalyse other reaction types that require Brønsted acid catalysis.

3.5 Envirocat EPAD

This catalyst is a Cr(VI), alumina-based reagent. It has been designed as a catalyst for the promotion of aromatic side-chain oxidation to ketones and benzoic acids. Studies have shown that it can be used for the oxidation of aliphatic alcohols to their respective aldehydes, ketones and carboxylic acids [25]. It should be noted, however, that Envirocat EPAD is not suitable for oxidations using peroxide. Under these conditions virtually all of the chromium is leached from the support as Cr(III).

4 Advantages of Envirocats

4.1 Friedel–Crafts reactions

Aluminium chloride is an extremely powerful and versatile reagent for the promotion of Friedel–Crafts reactions. However, it is far from being a green catalyst for chemistry. It is a toxic and corrosive solid and the only way to remove it from the reaction mixture is by aqueous quenching. This has a severe impact on the environment and, as a result of public pressure and legislation, its use is becoming increasingly unacceptable.

The Envirocats that are used to catalyse Friedel–Crafts reactions—EPZG, EPZ10 and EPZE—are classed as non-toxic and non-corrosive materials [26]. Unlike homogeneous aluminium chloride, they are true catalysts. When using Envirocat EPZG in a benzoylation, for example, there is a tenfold reduction in the amount of catalyst required (cf. aluminium chloride). These catalysts also are totally inert in water.

They often show improved selectivity in aromatic substitution and sometimes they can be reused, although this will depend on the reaction and reaction conditions. They are used normally with a neat substrate or, if a solvent is required, inert hydrocarbon solvents (cf. chlorinated solvents for AlCl_3). Once the reaction is complete, the catalyst is filtered from the reaction mixture, thus eliminating the aqueous effluent that normally is associated with these processes. Provided that the spent catalyst has been washed free of organics, the catalyst can be safely landfilled.

4.2 Esterifications

High-temperature esterifications traditionally are catalysed with an organic acid, e.g. methanesulfonic acid (MSA)/*p*-toluenesulfonic acid (PTSA) or metal salts (stannous oxalate). Although these catalysts are very efficient, they are highly corrosive and toxic and can be removed from the crude ester only by aqueous washes. Their use also results in highly coloured crude products, which must undergo numerous treatments with a bleaching agent to remove the colour.

Envirocat EPIC is a non-toxic and non-corrosive powder. Once the esterification is complete, it can be filtered from the reaction mixture, negating the need for aqueous washes and therefore eliminating aqueous effluent. Also, unlike its homogeneous counterparts, using Envirocat EPIC often can produce a crude material that does not require any decolourising treatments.

Figure 13.1 shows the typical colour of the crude product when PTSA is used to catalyse the esterification of pentaerythritol with a fatty acid. Extensive treatments with activated carbon would be required to remove the colour from this crude material. In comparison, the same reaction when catalysed by Envirocat EPIC produces a white crude solid, thus

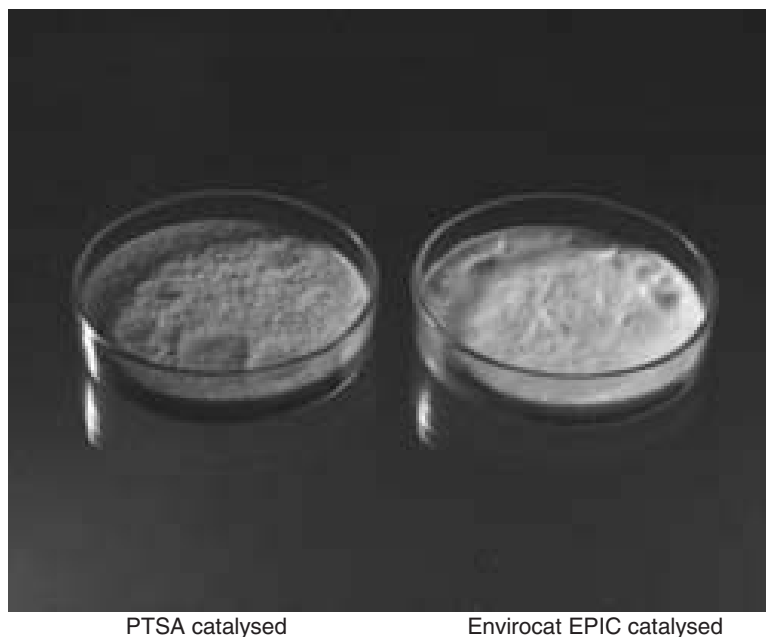


Fig. 13.1 The crude products obtained after esterification of pentaerythritol with a fatty acid, catalysed by PTSA (*left*) and Envirocat EPIC (*right*).

eliminating the effluent that results from decolourising treatments.

4.3 Oxidations

The oxidation of aromatic methyl and methylene groups traditionally is performed using homogenous cobalt salts in acetic acid, usually at high temperature and pressure [27]. Although air is used as the oxidant, the resulting reaction mixture is highly toxic and corrosive. The plants that perform these reactions are built from expensive alloys and require many safety features to be incorporated into the system.

There are alternative methods of performing oxidation that are highly efficient and can be performed under very mild conditions. However, these processes use high oxidation-state transition metals (permanganate, dichromate) [28]. Even when these metal salts are used catalytically, the secondary oxidant (e.g. *t*-butyl hydroperoxide, 4-methylmorpholine-*N*-oxide) [29,30] is very expensive and toxic and, when spent, an extensive work-up is required to isolate the product from the reaction mixture.

Envirocat EPAD is a non-toxic and non-corrosive powder. When launched onto the market it was

believed to be the first example of a true heterogeneous catalyst for aerobic oxidations [25]. It is a highly efficient catalyst, typically using a 1% suspension in the neat substrate to achieve catalysis of the oxidation. The use of air or O₂ results in water being produced as a by-product. Once the oxidation is complete, the catalyst is removed from the reaction mixture by filtration and the product can be purified easily by distillation or crystallisation.

5 Activation of Envirocats

The clay-based Envirocats (EPZG, EPZ10, EPZE and EPIC) are supplied in an *inactive* form. This is because all clays and clay-based catalysts equilibrate with the atmospheric humidity and typically contain 10% (w/w) water. Activation of these catalysts is simply a matter of removing the loosely bound water associated with the catalyst. The most convenient method of activation is via azeotropic drying of a suspension of the Envirocat either in the neat substrate and/or in an inert hydrocarbon solvent for 2–3 h. Should the activated catalyst become exposed to moisture, azeotropic drying reactivates the catalyst. Where this method of activation is not possible, there is an alternative: thermal activation.

Temperature and time of activation will depend on the Envirocat: EPZ10, and EPZE can be activated at 280–300°C for 18h but, EPZG can be activated at 300°C for 5–10min under N₂. However, these conditions can be used only rarely in an industrial process and therefore it is possible to activate these catalysts at 100–120°C for 1h under a vacuum, releasing the vacuum with dry N₂. It should be noted that thermal activation usually leads to active sites that are highly sensitive to moisture. Exposure to the atmosphere will result in permanent deactivation of the catalyst.

When using Envirocat EPIC in an esterification it is not necessary to use these methods of activation prior to use. Simply suspend the catalyst in the reaction mixture and begin azeotropic drying.

In general, failure to activate the Envirocat will result in little or no activity. Envirocat EPAD, however, does not require activation prior to use.

6 General Methods for Using Envirocats

6.1 Catalyst concentration

For Envirocats EPZG, EPZE, EPZ10 and EPIC there is a very simple rule of thumb: 10g catalyst mol⁻¹ reagent. In the esterification of benzoic acid, for example, 10g of EPIC would be used to catalyse the esterification. However, the esterification of adipic acid would require 20g of EPIC. Envirocat EPAD requires significantly lower catalyst concentrations, typically 1% (w/w) suspension in the neat substrate.

6.2 Reaction temperature

This will vary depending on the reaction type and substrates used. Benzoylations and sulfonylations require a minimum reaction temperature of 80°C but more usually 130–160°C. The reason for these high temperatures is to make sure that any complex formed between the product and the active site can be broken down, allowing the catalytic cycle to continue. Alkylations are performed over a very wide temperature range of 20–140°C. Typically, benzoylations can be performed at ambient temperatures, whereas some olefin alkylations require temperatures of up to 140°C. Oxidations catalysed by Envirocat EPAD usually are performed at the boiling point of the substrate.

7 Commercial Applications of Envirocats

7.1 Benzoylations

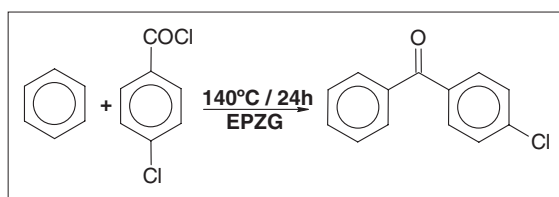
This catalyst can be used to catalyse the production of benzophenones, which are used as starting materials for pharmaceuticals, flavours, fragrances and sunscreens. As a general rule, EPZG will not catalyse the benzoylation of deactivated substrates, e.g. nitrobenzene, and cannot activate benzoyl chlorides that contain electron-donating groups, e.g. 4-methoxybenzoyl chloride. Envirocat EPZG will not catalyse Fries rearrangements to form hydroxybenzophenones.

4-Chlorobenzophenone is an intermediate for a variety of pharmaceutical products [31] and this product was produced successfully using Envirocat technology at CCL (see Scheme 13.1). Typically, the yields for this process were 70% and no scrambling of the aromatic chlorine was observed (cf. anhydrous AlCl₃).

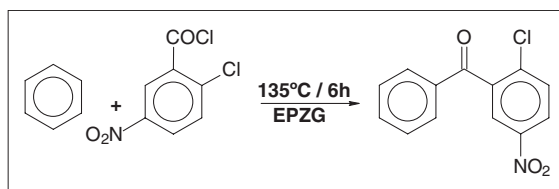
Another application of EPZG is in the production of 2-chloro-5-nitrobenzophenone (see Scheme 13.2), which is a precursor to the benzodiazepine drugs. In this particular example, an isolated yield of 85% was attained with a gas chromatography (GC) assay of >99%.

7.2 Acylations

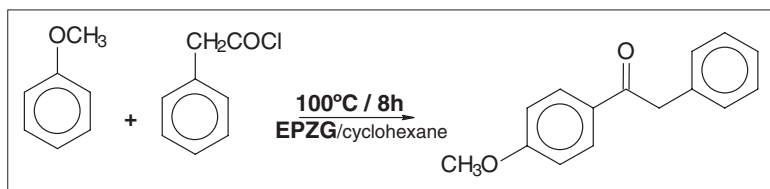
Although it is possible to use EPZG to catalyse the production of alkylphenones, the number of appli-



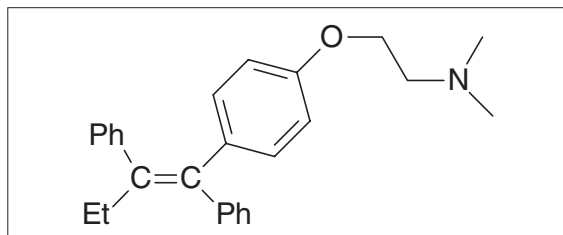
Scheme 13.1



Scheme 13.2



Scheme 13.3

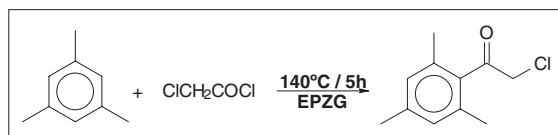


Scheme 13.4

cations is limited to activated aromatics and/or activated alkyl chlorides. The most commonly used aromatics are anisole and mesitylene. Acylation of less-activated aromatic substrates, e.g. xylene, toluene, etc. with acetyl chloride cannot be catalysed by EPZG. However, if the aliphatic chloride is activated by the presence of an electron-releasing group, e.g. alkyl chain or phenyl, some very useful intermediates can be produced using Envirocat technology.

The acylation of anisole with phenylacetyl chloride to produce 4-methoxydeoxybenzoin is a reaction that is catalysed efficiently and selectively by EPZG (see Scheme 13.3). This particular ketone is the intermediate to the anti-cancer drug Tamoxifen [32] (see Scheme 13.4). The reaction is performed at 100°C in the presence of cyclohexane in an excess of anisole over 8 h to give 100% conversion of the acid chloride. Once the catalyst has been filtered off and unreacted anisole recovered, the product is purified by treating the crude with cyclohexane to give a yield of 85%, with a GC assay of >99% for the *para* isomer.

α -Chloroacetophenones are very useful intermediates in the production of agrochemicals. With 2,4,6-trimethyl- α -chloroacetophenone, the reaction is performed at 140°C in the presence of cyclohexane and 100% conversion is achieved over 5 h. Again, treatment of the isolated crude with cyclohexane results in an isolated yield of 85% (see Scheme 13.5).



Scheme 13.5

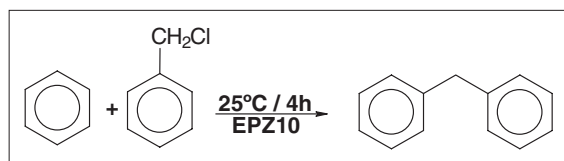
7.3 Benzylations

Diphenylmethanes are the basic building block for a wide variety of pharmaceutical products. Although anhydrous AlCl₃ can be used in catalytic quantities (provided that there are no functional groups that can complex with this reagent), it is unselective, giving rise to a high concentration of polybenzylated products. It will scramble substituents that may be present already in the molecule, further reducing the selectivity of the reaction. Furthermore, the catalyst must be washed out of the reaction mixture prior to isolation of the product, so AlCl₃ cannot be reused.

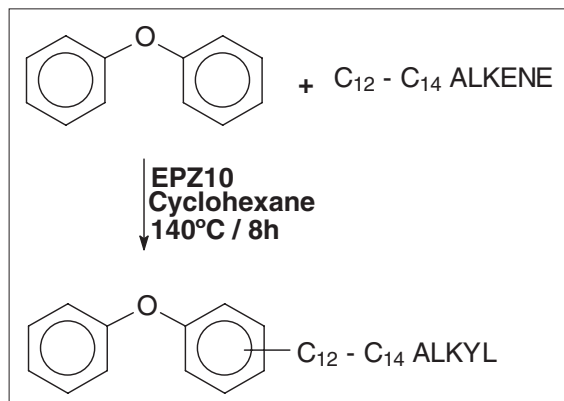
Envirocat EPZ10, however, can be used under very similar conditions to those used for AlCl₃. Unlike the homogeneous reagent, it will not scramble substituents, it can give lower concentrations of unwanted polybenzylated products and it can be reused. This has been demonstrated in the benzylation of benzene (see Scheme 13.6), where four uses were obtained from the catalyst. The reactions were performed using a 10:1 molar ratio of benzene to benzyl chloride (BzCl) and the reaction time reflects the rate of addition of BzCl to the suspension. At the end of each reaction the catalyst was filtered off and, washed with and resuspended in benzene. With each use, little or no decrease in activity was observed and the isolated yields of diphenyl methane remained at 70–75%.

7.4 Olefin alkylation

Olefin alkylation of aromatics results in a range of intermediates that are used to produce surfactants.



Scheme 13.6

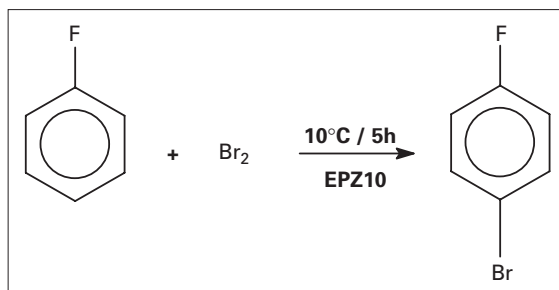


Scheme 13.7

The use of AlCl_3 , however, also catalyses the oligomerisation of the olefin. Envirocat EPZ10 was found to be superior to AlCl_3 in the alkylation of diphenyl ether (see Scheme 13.7). Using a substrate/olefin molar ratio of 5:1, >98% conversion was achieved over 8 h, with a selectivity of >85% monoalkylates and no oligomers detected by GC. On filtration of the catalyst and distillation of unreacted substrate an isolated yield of 93% was obtained from this process.

7.5 Aromatic bromination

Aromatic bromine compounds are used as intermediates to pharmaceutical and agrochemical products. The desired product is usually the *para* isomer. Although AlCl_3 is used in catalytic quantities, it produces significant amounts of the *ortho* isomer. However, the rate of bromination of the *ortho* isomer is greater than that of the *para* isomer. Therefore, by using an excess of bromine, the *ortho* isomer can be removed from the reaction mixture. Unfortunately, some of the *para* isomer is also consumed and this



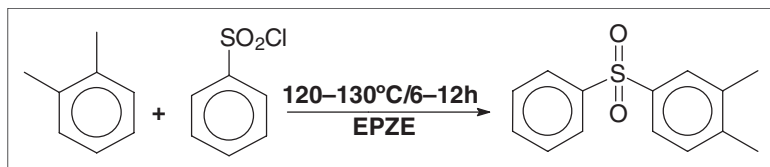
Scheme 13.8

results in low yields and large volumes of dibrominated aromatic waste.

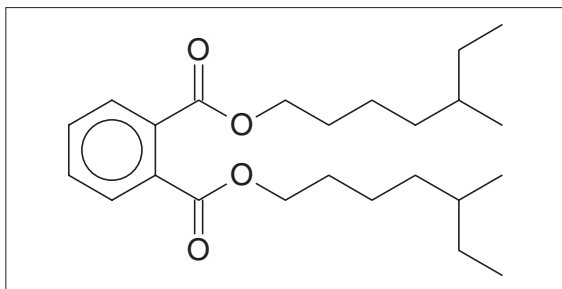
4-Bromofluorobenzene is an intermediate to agrochemical and some pharmaceutical products [33] and currently is prepared using AlCl_3 . The selectivity for the *para* isomer is typically 90%. However, the assay of the final product must be >98% *para* with little contamination of dibrominated products, therefore a significant amount of over-bromination is required to increase the concentration of the *para* isomer to the required specification. Replacing AlCl_3 with EPZ10 resulted in some remarkable selectivity for this bromination (see Scheme 13.8). The reaction was performed neat using a slight excess of Br_2 . Gas chromatography analysis of the reaction mixture showed that 98% conversion had occurred, with a selectivity of ca.99% for the *para* isomer and no dibrominated products detected. On work-up, an isolated yield of 90% was achieved for 4-bromofluorobenzene.

7.6 Sulfonylation

Diphenylsulfones are usually intermediates to agrochemicals and their formation using AlCl_3 results in the production of about 3 tonnes of effluent per tonne of product. Envirocat EPZE was used successfully as a replacement for AlCl_3 in the production of 3,4-dimethyldiphenylsulfone—an intermediate to a polyimide—by SNPE, France (see Scheme 13.9). SNPE observed an 80% conversion and obtained a 60% yield of the 3,4-dimethyl isomer. SNPE were very impressed, not only with the efficiency of the sulfonylation but also with the selectivity for the required isomer. By using Envirocat technology, they reduced their effluent production compared to the AlCl_3 process by >80%.



Scheme 13.9



Scheme 13.10

7.7 Esterifications

Esters are used in a wide variety of applications, either as an intermediate or as the final product. Commercially, esters are used as flavours and fragrances, sunscreens, plasticisers and transformer fluids. Plasticisers and transformer fluids are of particular interest because they also have an environmental impact.

One of the most widely used plasticisers is dioctyl phthalate (see Scheme 13.10). However, over the last 2 years there have been a considerable number of reports in the literature [34] on the use of these compounds in children's toys. It appears that dioctyl phthalates leach from the plastic when sucked by children and these esters are toxic. In view of such adverse publicity, the industry has been looking for a non-toxic alternative and has come up with tributyl citrate. This class of esters is prepared at high temperature using catalysts such as methanesulfonic acid. However, these organic acids are toxic and their use results in a highly coloured product. However, EPIC can be used successfully to replace these acid catalysts. The reaction conditions shown in Scheme 13.11 are not developed in any way, but over 10h at 150°C 100% conversion is achieved with an isolated yield of 95%. This demonstrates the effectiveness of Envirocat EPIC to replace

organic and mineral acids in high-temperature esterifications.

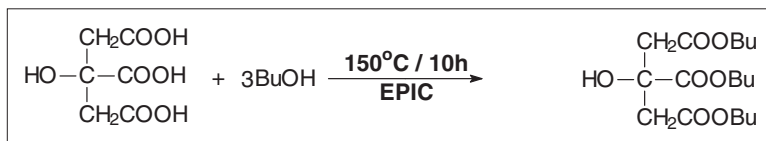
Transformer fluids need to exhibit very low electrical conductance and possess a particular viscosity. Silicone oils can be manufactured to meet these criteria. However, with time they degrade, lose their low conductance and become coloured. Unfortunately, silicones are not biodegradable and therefore the disposal has an impact on the environment. A commercial alternative to silicone oils has been found: the fatty acid ester of pentaerythritol. The esterification is performed with a mixture of C8–C12 fatty acids, where the proportion of acids used is critical to obtaining the required viscosity. As in the previous example, organic acids can be used to catalyse this process. However, a successful trial using Envirocat EPIC at $200\text{--}250^\circ\text{C}$ for 6h gave a >90% yield of the tetra-ester, showing that EPIC can be used as a commercial replacement for the homogeneous catalyst, eliminating the need for aqueous washes and decolourising procedures (see Scheme 13.12).

7.8 Aerobic oxidations

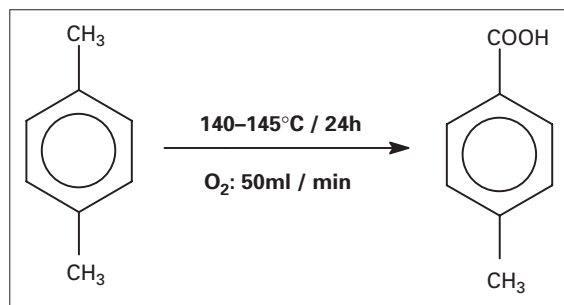
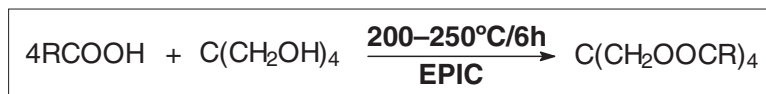
Of all the transformations discussed so far, oxidations possess the potential to have the greatest impact on the environment. Traditionally, reagents such as permanganate, dichromate, MnO_2 , OsO_4 , etc. have been used to oxidise selectively a particular functional group within a molecule. These reagents are highly toxic and corrosive and the resulting wastestreams are composed of large volumes of toxic, aqueous, low-oxidation-state transition metal salts [28,30]. Even when used catalytically, the secondary oxidants (e.g. *t*-butylhydroperoxide, 4-methylmorpholine-*N*-oxide) result in the production of a large volume of toxic waste.

The commercial process used to oxidise an aromatic methyl, for example, is a classic case of an environmentally hostile process. The reaction conditions used to achieve this oxidation involve the use of cobalt acetate in acetic acid, usually at $>250^\circ\text{C}$

Scheme 13.11



Scheme 13.12



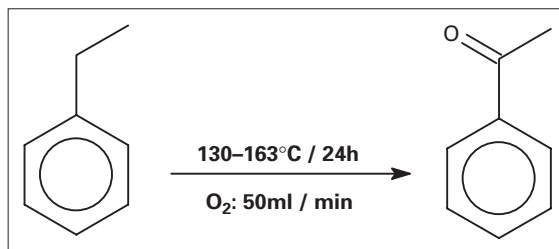
Scheme 13.13

under an atmosphere of O_2 and several atmospheres of pressure [27]. To operate a commercial process using these reaction conditions requires highly expensive plant equipment that is inert under these highly corrosive reaction conditions. Large volumes of corrosive, toxic waste are produced in isolating the benzoic acid from the reaction mixture.

Envirocat EPAD was one of the first true heterogeneous catalysts for performing aerobic oxidations. The oxidation is performed in a solvent-free environment at atmospheric pressure, using O_2 as the oxidant. This means that the only wastestream produced during the reaction is water. *p*-Toluic acid, an agrochemical intermediate, can be prepared selectively using Envirocat EPAD. The reaction is performed at 140–145°C over 24 h, using O_2 as the oxidant. Typical yields for this process are around 30%, with a selectivity of 93% for the toluic acid (see Scheme 13.13).

This catalyst also will catalyse the oxidation of chloro- and bromotoluenes to their respective benzoic acids.

Similar reaction conditions also can be used to oxidise aromatic methylenes to produce acetophenones and benzophenones [14,35,36], and this is an



Scheme 13.14

alternative to Friedel–Crafts acylation/benzoylation (see Scheme 13.14).

Envirocat EPAD can be used also in the oxidation of aliphatic alcohols. The oxidation of the terminal OH group of a polyethylene glycol chain to the corresponding aldehyde and acid is used in the manufacture of shampoo. This oxidation can be achieved using conventional methods but results in large volumes of toxic, acidic wastestreams. Envirocat EPAD can catalyse this oxidation under mild reaction conditions in the absence of solvent. The catalyst is suspended in the neat substrate and warmed to 110°C with air. Over approximately 30 h, 80% conversion to a 50:50 mixture of the corresponding aldehyde and carboxylic acid is observed (see Scheme 13.15).

8 Other Applications of Envirocat Catalysts

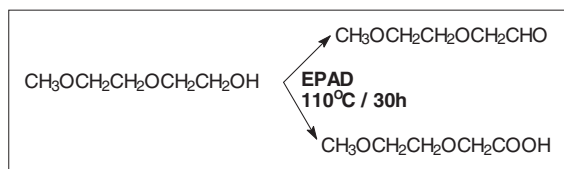
The Envirocat range of catalysts was designed initially for a particular application, e.g. EPZG for benzoylation, EPIC for high-temperature esterification, etc. However, the clay-based reagents possess Brønsted and Lewis acid sites to various degrees. Over the last 10 years other researchers and compa-

nies besides the University of York and CCL have found some very interesting new applications for Envirocats.

8.1 Envirocat EPZG

One of the first commercial applications of an Envirocat was using EPZG in an etherification. The UK-based company found that EPZG was a highly active and selective catalyst, giving high yields and high purity of an intermediate to a yellow dye, giving them an advantage over their competitors.

Protective group chemistry is not a particularly environmentally benign approach to a target molecule. Incorporation of this chemistry into a synthetic strategy ultimately can lead to the production of large volumes of organic and aqueous effluent. However, pharmaceutical products often are complex organic molecules containing numerous functional groups, and protective group chemistry is the only way to incorporate a new functional group without destroying any of the functionalities already present in the molecule. Researchers in India have been investigating the application of Envirocat EPZG



Scheme 13.15

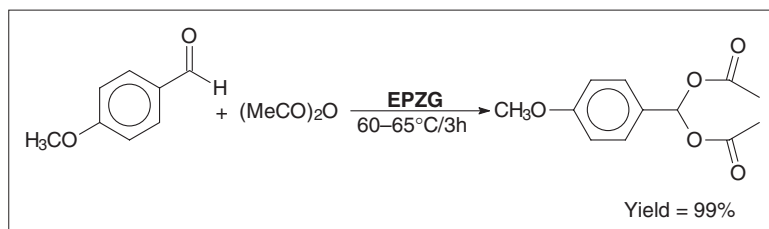
in this area of chemistry, utilising the strong Brønsted acid sites that are present in this supported reagent.

One of the most common functional groups to be protected is the aldehyde. The usual strategy is to convert the carbonyl to either the acetal or the 1,1-diacetate. The conditions normally used to effect this transformation are via Brønsted mineral or organic acids [37]. Bandgar *et al.* found that Envirocat EPZG is a very efficient catalyst for the formation of acetals and 1,1-diacetates of aldehydes. The reaction is performed simply by suspending the catalyst in a solution of the substrate and reagent in toluene and azeotroping dry for about 1–2 h [38–40]. Once the reaction is complete, the catalyst is filtered from the reaction mixture and the solvent is recovered by distillation (for reuse) to leave a highly pure product that requires no further purification (see Scheme 13.16).

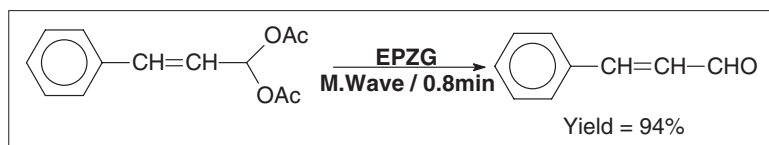
The hydrolysis of these protecting groups to return to the aldehyde is also acid catalysed and the researchers have found that EPZG can be used to replace conventional homogeneous acids (see Scheme 13.17) [41].

Bandgar *et al.* also have successfully applied EPZG as a catalyst for the formation of tetrahydropyrans, thioacetals and silyl ethers [42–44] (see Schemes 18–20).

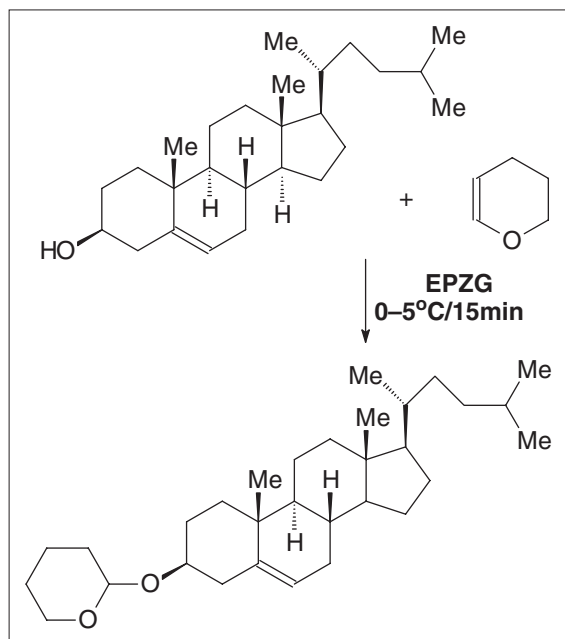
It is possible also to exploit the strong Brønsted acid sites of EPZG to effect a variety of acid-catalysed dehydration reactions. A Knoevenagel reaction normally is catalysed by a strong base, and this is a very useful methodology for producing substituted



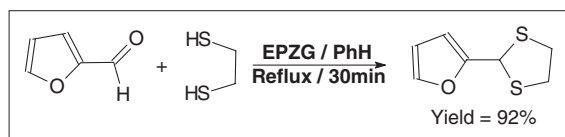
Scheme 13.16



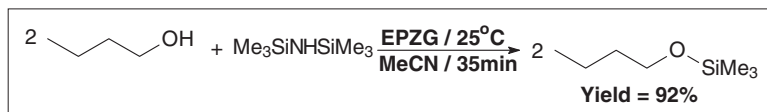
Scheme 13.17



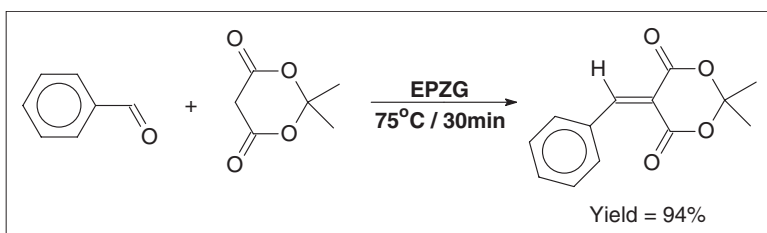
Scheme 13.18



Scheme 13.19



Scheme 13.20



Scheme 13.21

alkenes [45]. These reactions are performed as a two-phase reaction with a strong inorganic base, and often can result in a mixture of *E*- and *Z*-isomers, leading to the production of basic aqueous waste and extensive purification procedures to obtain the required isomer. There have been some reports in the literature where researchers have used a heterogeneous basic catalyst that has proved to be highly efficient and selective [46,47]. However, these reactions also can be acid catalysed and Envirocat EPZG has been shown to be a highly active and selective catalyst for the Knoevenagel condensation [48] (see Scheme 13.21).

A very similar procedure can be used for the production of nitro olefins [49], which are intermediates for the production of insecticides and fungicides [50–52]. This report demonstrates the activity and selectivity that can be obtained with EPZG. In all the examples quoted, only the *E*-isomers are produced (see Scheme 13.22).

8.2 Envirocat EPIC

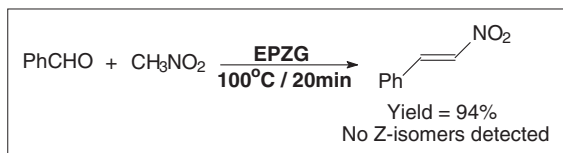
This Envirocat was designed originally to catalyse high-temperature esterifications. However, the presence of strong Brønsted acid sites means that this catalyst can be used potentially in a wide variety of applications, particularly, in Friedel–Crafts acylations and benzoylations. It is possible, in a number of limited cases, to use EPIC to catalyse the formation of a benzophenone via dehydration of a benzoic acid. However, this method of benzoylation will work

only with activated aromatics, e.g. anisole, mesitylene, etc. [53] (Schemes 13.23 and 13.24).

Envirocat EPIC also proved to be highly active and selective in an acylation of anisole to produce an intermediate to the drug tamoxifen and its analogues. In this example, the acylation is performed using two equivalents of anisole. Complete acylation is observed by GC over 14.5 h and an almost quantitative crude yield of the ketone is obtained with >96% selectivity for the *para* isomer (see Scheme 13.25). In fact, the R&D team at CCL went on to develop a novel laboratory process to produce the intermediate shown in Scheme 13.26, which is two steps away from tamoxifen or its analogues.

8.3 Envirocat EPZ10

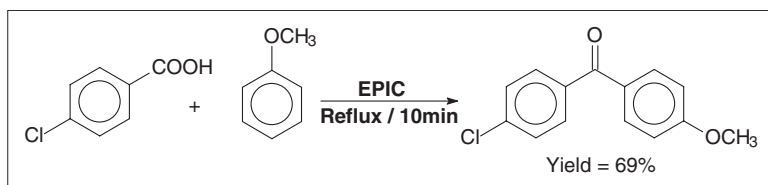
This supported reagent can be used to replace mild Lewis acid catalysts (e.g. ZnCl_2). For example, tetraalkoxypropanes are agrochemical intermediates that are formed via an addition reaction between a trialkyl orthoformate and a vinyl ether. Traditionally, this reaction is catalysed by homogeneous ZnCl_2 and, although it is an efficient catalyst, it must be washed from the reaction mixture before the product can be isolated, resulting in toxic acidic waste. The team at CCL developed a process that replaced homogeneous ZnCl_2 with Envirocat EPZ10, which was translated successfully to a pilot trial (see Scheme 13.27). Not only was the aqueous waste normally associated with this process eliminated, but also a second use of the catalyst was achieved without loss of activity or selectivity.



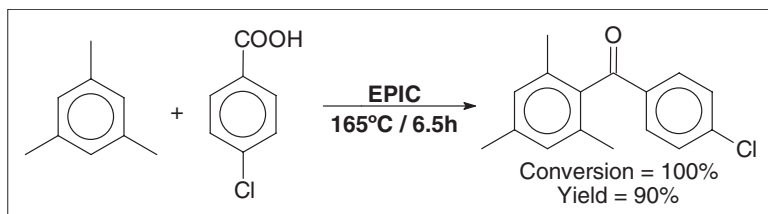
Scheme 13.22

9 The Second Generation of Envirocats

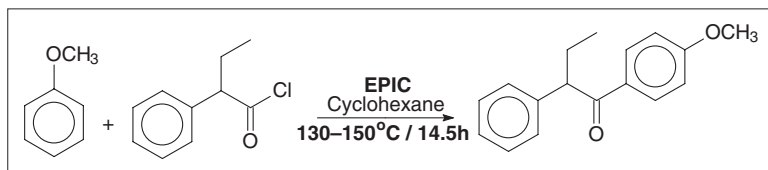
It has been 10 years since Envirocats were launched onto the market and during that time only Envirocat EPZG currently is being used in a commercial process. However, it must be remembered that Envirocats represent a radical innovation in catalysis for



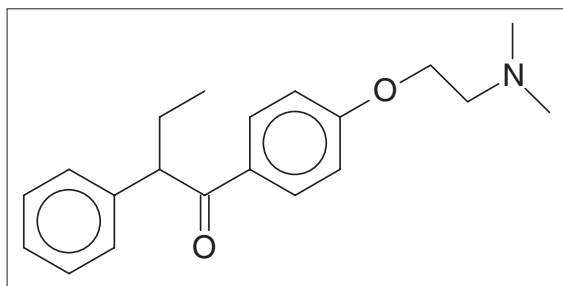
Scheme 13.23



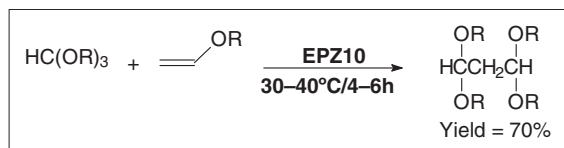
Scheme 13.24



Scheme 13.25



Scheme 13.26



Scheme 13.27

the pharmaceutical, fine and agrochemical industries and it takes a considerable amount of time for a company to test, develop and implement new technology into their plant processes. There have been a number of occasions where an Envirocat has been used successfully in one part of a multistage synthesis but the final product, usually a drug, fails in its trials. However, the future of the current range of Envirocats is looking very promising, with companies within Europe and India about to start using Envirocats in pilot trials.

Inevitably, companies are constantly looking for more active and selective catalysts. Ideally, they should possess the same or better activity as their homogeneous counterparts. Since the launch of Envirocats, CCL and the University of York have been developing not only the range of applications for the current range of catalysts but also the next generation of Envirocats, particularly Friedel–Crafts and oxidation catalysts. Although the catalysts described below are not available commercially yet, there are samples available that can be obtained from CCL for laboratory trials.

9.1 Envirocat EPA10

Despite the advances made in the preparation of supported reagent catalysts, one of the most difficult to

immobilise has been anhydrous AlCl_3 . The main reason has been due to its reactivity towards water and free OH groups that are present at high concentrations in the materials normally used as a support (e.g. silicas, aluminas, aluminosilicates, zeolites etc.). However, over the last 5 years various research groups have reported the successful preparation of a supported AlCl_3 that possesses the same activity as its homogeneous counterpart [11,54,55].

Contract Chemicals Limited, in collaboration with the University of York, has developed its version of this catalyst: EPA10 [55]. It is a supported and immobilised version of homogeneous AlCl_3 that possesses the same activity as the homogeneous reagent but is significantly more selective. Analysis of reaction mixtures has shown that no leaching of the reagent occurs. Therefore, once the reaction is complete, the catalyst can be filtered from the reaction mixture, eliminating the aqueous effluent associated with the homogeneous process. Studies on this catalyst have shown that it is possible also to reuse the catalyst.

Unlike the other Envirocats, this catalyst is supplied in its active form. However, like homogeneous AlCl_3 , it is very sensitive to the presence of moisture.

Envirocat EPA10 has been designed primarily as an alkylation catalyst, particularly in the olefin alkylation of benzene to form linear alkylbenzenes [11] (it is not an acylation catalyst). Linear alkylbenzenes are intermediates to surfactants and detergents. However, the commercial process uses conventional homogeneous catalysts (AlCl_3 , BF_3) and therefore suffers from the production of large volumes of toxic acidic waste, oligomers and polyalkylated aromatics. The aqueous waste can be reduced greatly and the alkylation made more selective by using HF. Unfortunately, use of HF requires very expensive plant equipment and safety features to prevent any loss of HF to the environment.

Envirocat EPA10 has been shown to be highly selective in the production of linear alkylbenzenes, which has been demonstrated in the alkylation of benzene with oct-1-ene. The reaction is performed at room temperature using a benzene/octene molar ratio of 2:1. The olefin is added to the suspension of EPA10 in benzene over 2 h. The rate of alkylation is virtually instantaneous and 100% conversion is observed. The crude reaction mixture contains <1% oligomers and a selectivity of 75% for monoalkylation is observed (see Scheme 13.28).

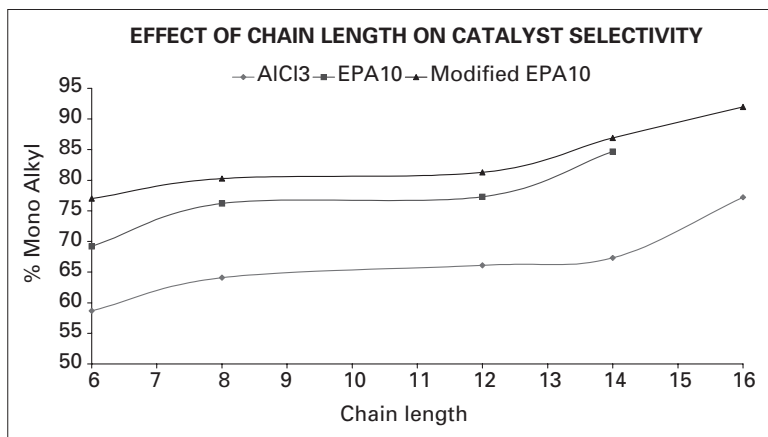
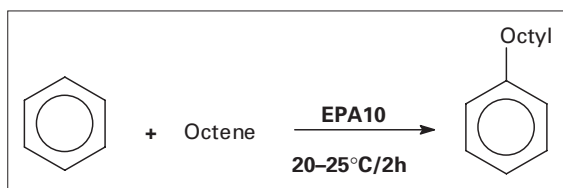


Fig. 13.2 Effect of chain length on catalyst selectivity.



Scheme 13.28

In a study that compared EPA10 with homogeneous AlCl₃, a determination of the effect of olefin chain length on the selectivity was performed. In all cases, EPA10 was approximately 10% more selective than AlCl₃ with respect to monoalkylation. (Fig. 13.2). The graph in Fig. 13.2 also shows the selectivity of a modified version of EPA10. This version of the catalyst has been prepared from hexagonal mesoporous silica [56–58] and exhibits a further 5% selectivity for monoalkylation over EPA10.

Other aromatic substrates that have been olefin alkylated using Envirocat EPA10 include diphenyl ether. Alkylated diphenyl ether is a monomer. Studies have shown that when using EPA10, higher reaction temperatures are required, presumably to break up the complex formed between the active site and the ether linkage. Again, by using a 4:1 substrate/olefin molar ratio, remarkable selectivity is observed (see Scheme 13.29).

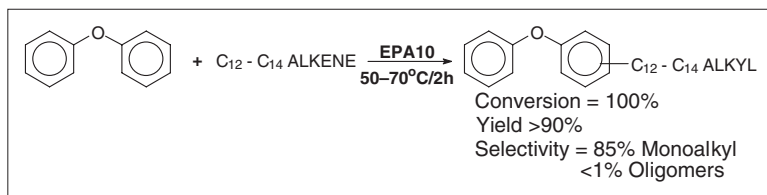
One other important feature of EPA10 that distinguishes it from its homogeneous counterpart is that it will not perform scrambling reactions. For example, in the alkylation of benzene with benzyl chlo-

ride to form diphenyl methane, di- and tri-alkylated products also are produced. If these by-products are isolated, dissolved in benzene and treated with AlCl₃, transalkylation or scrambling occurs to form more diphenyl methane (see Scheme 13.30). Envirocat EPA10 will not perform this reaction. Once the alkyl group has been attached to the aromatic, the active sites in the catalyst will not remove the alkyl group. This demonstrates that EPA10 possesses some different properties to homogeneous AlCl₃, and, along with the leaching studies, shows that EPA10 is a true heterogeneous version of AlCl₃.

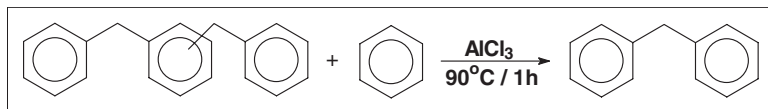
9.2 Envirocat EPCS

The supported reagents described above make use of the physical and chemical properties of inorganic materials that are already available. However, the emphasis has moved towards either modification of the surface of existing materials or preparing a support that will possess the desired properties, e.g. hexagonal mesoporous silicas, the ultimate aim being the engineering of a supported reagent that can be fine-tuned to a particular application.

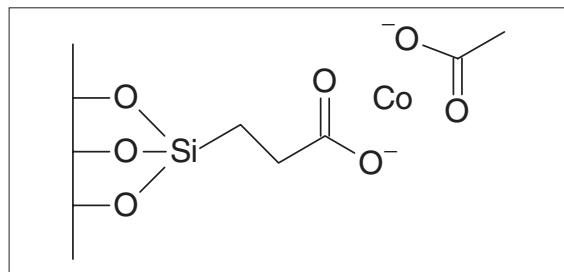
Envirocat EPCS is a cobalt-based catalyst that has been prepared from modified mesoporous silica [59]. The metal centre is chemically bound to the support via a ligand that is attached to the surface OH groups found on the surface of the silica (see Scheme 13.31). It has been designed to catalyse selectively the formation of epoxides. Epoxide functionalities are found in a wide variety of fine chemical, agrochemical and pharmaceutical products [60]. The classical



Scheme 13.29



Scheme 13.30



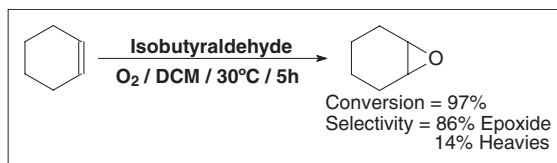
Scheme 13.31

method of preparation of epoxides involves the use of highly toxic and corrosive peracids, e.g. *m*-chloroperbenzoic acid [61]. Unfortunately, owing to the sensitivity of the epoxide function to nucleophilic attack, the benzoic acid liberated from the formation of the epoxide attacks the molecule, resulting in the production of large volumes of unwanted by-products.

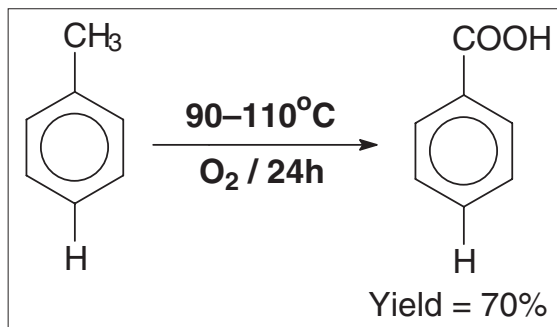
Envirocat EPCS is not only an efficient catalyst for epoxidation but it is also highly selective, resulting in high yields of the epoxide. The reaction is performed under an atmosphere of O₂ at near-ambient temperatures. The oxidation is achieved using a sacrificial aldehyde (see Scheme 13.32). Surprisingly, the corresponding carboxylic acid formed only has a limited effect on by-product formation [62].

10 Future Envirocats

The R&D team at CCL is still very active in the design and development of new catalysts. A new oxidation catalyst and reaction conditions currently are being developed that are showing some very promising results. So far, toluene has been oxidised successfully



Scheme 13.32



Scheme 13.33

to benzoic acid at atmospheric pressure at the reflux temperature of toluene (see Scheme 13.33).

Further work has shown that it may be possible to use the same system to achieve a Baeyer-Villiger oxidation, replacing organic peracids with O₂. It is hoped that if this project comes to a successful conclusion, customers will be informed of this advance in oxidation chemistry some time during 2001.

11 Conclusions

It is evident that national and international legislation and public pressure and opinion will continue

to be the driving force behind the design, development and implementation of new environmentally benign technology. Even with the advances seen with ionic liquids and supercritical fluids, the emphasis will continue with catalysis.

The design and preparation of heterogeneous catalysts has advanced considerably from the days of simply depositing a metal salt onto a high-surface-area solid. It is now possible to prepare high-surface-area supports with a specific pore size, to derivatise or chemically modify the support to incorporate the active reagent into the support. Indeed, the situation is fast approaching where a catalyst can be designed that is not only highly active but also highly selective towards the required target molecule.

The Envirocat range of catalysts offers many advantages over conventional homogeneous catalysts: waste minimisation at source, existing plant equipment can be used, non-toxic powders and a wide range of applications. The development of a heterogeneous version of AlCl_3 is a very exciting advance in catalysis. However, as the understanding of heterogeneous catalysis increases, it will be possible to continue to rise to the challenge of producing new catalysts for the fine chemical, agrochemical and pharmaceutical industries that will represent an environmentally benign, commercially viable alternative to conventional Friedel–Crafts, Brønsted acid and oxidation catalysts.

References

- Martin, K., & Bastock, T. W. *Waste Minimisation: a Chemist's Approach*, Special Publication No. 140. Royal Society of Chemistry, London, 1994, pp. 141–145.
- Clark, J. H. *Chemistry of Waste Minimisation*. Chapman and Hall, London, 1995.
- Petty, J. D., Orazio, C. E., Huckins, J. N., Gale, R. W., et al. *J. Chromatogr. A*, 2000, **879**(1), 83.
- Sheldon, R. A. In *Current Topics in Flavours and Fragrances* (Swift, K. A. D., ed.). Kluwer Academic, Dordrecht, 1999, pp. 59–78.
- Swan, T. M., Ross, S. K., Poliakoff, M., Hitzler, M. G., et al. WO 9815509, 1998.
- Hitzler, M. G., Smail, F. R., Ross, S. K., & Poliakoff, M. *Chem. Commun.*, 1998, 359.
- Holbrey, J. D., Rooney, D., & Seddon, K. R. *Book of Abstracts of 218th ACS National Meeting*, New Orleans, 22–26 August 1999. American Chemical Society, Washington, DC, 1999.
- Davey, P. N., Newman, C. P., Seddon, K. R., & Earle, M. J. WO 9919288, 1999.
- Earle, M. J., Seddon, K. R., Adams, C. J., & Roberts, G. *Chem. Commun.*, 1998, 2097.
- Fetizon, M., & Golfier, M. *C. R. Acad. Sci. Paris, Ser. C.*, 1968, **267**, 900.
- Clark, J. H., Martin, K., Teasdale, A. J., & Barlow, S. J. *J. Chem. Soc., Chem. Commun.*, 1995, 2037.
- Clark, J. H., Butterworth, A. J., Tavener, S. J., Teasdale, A. J., et al. *J. Chem. Tech. Biotechnol.*, 1997, **68**, 367.
- Rylander, P. N. *Catalytic Hydrogenation over Platinum Metals*. Academic Press, New York, 1967.
- Clark, J. H., Kybett, A. P., Macquarrie, D. J., Barlow, S. J., & Landon, P. *J. Chem. Soc., Chem. Commun.*, 1989, 1353.
- Clark, J. H., & Macquarrie, D. J. *Chem. Commun.*, 1998, 853.
- Basset, J. M., Candy, J. P., Choplin, A., Didillon, B., Quignard, F., & Theolier, A. In *Perspectives on Catalysis* (Thomas, J. M., & Zamarayev, K. I., eds). Blackwell, Oxford, 1992, pp. 125–145.
- Contract Chemicals Limited. *Envirocats: Supported Reagent Catalysts*. CCL, Prescot, 1994.
- Bastock, T. W., & Clark, J. H. *Speciality Chemicals* (Pearson, B., ed.). Elsevier, London, 1991, pp. 383–396.
- Clark, J. H., Kybett, A. P., & Macquarrie, D. J. *Supported Reagents: Preparation, Analysis and Applications*. VCH, New York, 1992, pp. 59–66.
- Barlow, S. J., Bastock, T. W., Clark, J. H., & Cullen, S. R. *Tetrahedron Lett.*, 1993, **34**(20), 3339.
- Barlow, S. J., Bastock, T. W., Clark, J. H., & Cullen, S. R. *J. Chem. Soc. Perkin Trans. 2*, 1994, 411.
- Clark, J. H., Cullen, S. R., Barlow, S. J., & Bastock, T. W. *J. Chem. Soc. Perkin Trans. 2* 1994, 1117.
- Brown, C. M., Barlow, S. J., Macquarrie, D. J., Clark, J. H., & Kybett, A. P. European Patent EP 0 352 878 A1, 1990.
- Bastock, T. W., Clark, J. H., Landon, P., & Martin, K. *J. Chem. Res.*, 1994, 104.
- Brown, C. M., Macquarrie, D. J., Clark, J. H., & Kybett, A. P. European Patent EP 0 336 768 B1, 1990.
- Full EEC Material Safety Data Sheets for EPZ10, EPZG, EPZE, EPIC and EPAD are available from Contract Chemicals Limited, Penrhyn Road, Knowsley Business Park, Prescot, Merseyside L34 9HY, UK.
- Ager Jr, J. W. US Patent 3 683 017, 1972.
- House, H. O. *Modern Synthetic Reactions*, 2nd edn. Benjamin/Cummings Publishing, Menlo Park, CA, 1972, pp. 257–291.
- House, H. O. *Modern Synthetic Reactions*, 2nd edn. Benjamin/Cummings Publishing, Menlo Park, CA, 1972, pp. 292–352.
- Jacobsen, E. N., Marko, I., Mungall, W. S., Schroder, G., & Sharpless, K. B. *J. Am. Chem. Soc.*, 1988, **110**(6), 1968.
- Kleemann, A., & Engel, J. *Pharmaceutical Substances*,

- 3rd edn. Thieme Publishing, Stuttgart, 1999, pp. 414–415, 463–464, 1132–1133, 1721–1722.
32. Brittain, D. R. GB Patent 1345939, 1974.
33. Kleemann, A., & Engel, J. *Pharmaceutical Substances*, 3rd edn. Thieme Publishing, Stuttgart, 1999, pp. 854–855, 1099–1100, 1460–1461, 1523; Budavari, S., O'Neil, M. J., Smith, A., & Heckelman, P. E. *The Merck Index*, 11th edn. Merck, Rahway, NJ, 1989, nos 4130, 4135.
34. Anon. *Chem. Week.*, 2000, **162**(25), 47.
35. Clark, J. H., Landon, P., Barlow, S. J., Duke, C. V. A., & Martin, K. *Chem. Ind.*, 1991, **Nov.**, 800.
36. Clark, J. H., Kybett, A. P., Barlow, S. J., Trenbith, B. W., & Butterworth, A. J. *J. Chem. Res.*, 1994, 102.
37. Olah, G. A., & Mehrotra, A. K. *Synthesis*, 1982, 962.
38. Bandgar, B. P., Mahajan, N. P., Mulay, D. P., Thote, J. L., & Wadgaonkar, P. P. *J. Chem. Res.*, (S), 1995, 470.
39. Bandgar, B. P., Kulkarni, M. M., & Wadgaonkar, P. P. *Synth. Commun.*, 1997, **27**(4), 627.
40. Bandgar, B. P., & Gaikwad, N. B. *Monatsh. Chem.*, 1998, **129**(6/7), 719.
41. Bandgar, B. P., Kasture, S. P., Tidke, K., & Makone, S. S. *Green Chem.*, 2000, **2**(4), 152.
42. Bandgar, B. P., Jagtap, S. R., Aghade, B. B., & Wadgaonkar, P. P. *Synth. Commun.*, 1995, **25**(15), 2211.
43. Kasture, S. P., Bandgar, B. P., Sarkar, A., & Wadgaonkar, P. P. *Synth. Commun.*, 1996, **26**(8), 1579.
44. Bandgar, P., & Wadgaonkar, P. P. *Synth. Commun.*, 1997, **27**(12), 2069.
45. House, H. O. *Modern Synthetic Reactions*, 2nd edn. Benjamin/Cummings Publishing, Menlo Park, CA, 1972, p. 646.
46. Chalais, S., Laszlo, P., & Mathy, A. *Tetrahedron Lett.*, 1985, **26**(37), 4453.
47. Macquarrie, D. J., Brunel, D., Mdoe, J. E. G., Renard, G., & Blanc, A. In *Proceedings of the 4th International Symposium on Supported Reagents and Catalysts in Chemistry* (Sherrington, D. C., & Kybett, A. P., eds), RSC Special Publication No. 266. Royal Society of Chemistry, London, 2001, pp. 196–202.
48. Bandgar, B. P., Roopali, G., Shahapurkar, G. R., & Wadgaonkar, P. P. In *Catalysis: Modern Trends* (Gupta, N. M., & Chakrabatty, D. K., eds). Narosa Publishing House, New Delhi, India, 1995, pp. 463–465.
49. Bandgar, B. P., Zirange, M. B., & Wadgaonkar, P. P. *Synlett*, 1996, **Feb.**, 149.
50. Bousquet, E. W., Kirby, J. E., & Searle, N. E. US Patent 2335384 to Seattle, 1944.
51. Brian, P. W., Grove, J. F., & McGowan, J. C. *Nature*, 1946, **158**, 876.
52. Brown, A. W., Robinson, D. B. W., Hurtig, H., & Wenner, B. J. *Can. J. Res.*, 1948, **26D**, 177.
53. Bandgar, B. P., & Sadavarte, V. S. *Synth. Commun.*, 1999, **29**(15), 2587.
54. Drago, R. S., Petrosius, S. C., & Kaufman, P. B. *J. Mol. Catal.*, 1994, **89**, 317.
55. Bastock, T. W., Trenbith, B. W., Clark, J. H., & Ross, J. *European Patent Application* EP 866046, 1998, 19980319.
56. Clark, J. H., Macquarrie, D. J., Bastock, T. W., Martin, K., & Price, P. *J. Chem. Res. (S)*, 1997, 430.
57. Price, P. M., Clark, J. H., Martin, K., Macquarrie, D. J., & Bastock, T. W. *Supported Reagents and Catalysts in Chemistry*, RSC Special Publication No.2. Royal Society of Chemistry, London, 1998, pp. 229–230.
58. Price, P., Clark, J. H., Martin, K., Macquarrie, D. J., & Bastock, T. W. *Org. Process Res. Dev.*, 1998, **2**(4), 221.
59. Clark, J. H., Butterworth, A., Bastock, T. W., & Barlow, S. J. GB Patent Application GB2314517, 1998.
60. Kleemann, A., & Engel, J. *Pharmaceutical Substances*, 3rd edn. Thieme Publishing, Stuttgart, 1999, pp. 874, 880–881, 1282–1283, 1310–1311.
61. Itoh, T., Jitsukawa, K., Kaneda, K., & Teranishi, S. *J. Am. Chem. Soc.*, 1979, **101**(1), 159.
62. Butterworth, A. J., Clark, J. H., Walton, P. H., & Barlow, S. J. *J. Chem. Soc. Commun.*, 1996, 1859.

Chapter 14: Green Chemistry in Practice

JOSEPH J. BOZELL

1 Introduction

Realisation of the goals of green chemistry will not occur without their widespread, concerted adoption by the chemical industry. The industry is the logical interface between promising laboratory-scale technologies described in earlier chapters and benefit to society at large because of its pre-existing infrastructure for manufacture, isolation and distribution of products. However, this will not be an easy task. Many of these new approaches are foreign to the chemical industry, and will be met with considerable reluctance and scepticism. The challenge, of course, is to demonstrate to the industry that these technologies will simultaneously address their economic needs as well as the environmental needs of the world.

The chemical industry has played a key role in the development of the international economy and is still a vital part of the world's industrialised nations. In the USA the impact of the chemical industry can be seen from its statistics: in 1994, the industry supported almost a million jobs and shipped 70 000 products at a value of \$341.3 billion, which is equivalent to about 1.9% of the gross domestic product. Moreover, the industry possesses one of the few trade surpluses in the US economy, which was about \$20.5 billion in 1997 [1].

However, the public's perception of huge smokestacks and sprawling industrial complexes as being a source of pride in a nation's strength have given way to those images being representative of ecological despoilment and environmental havoc, with every use of the term 'chemical' being preceded by the adjective 'toxic'. The terms 'black chemistry' and 'red chemistry' were coined to describe how the public now views and fears much of the conventional manufacturing carried out by the chemical industry. Black chemistry refers to waste as pollution. Red chemistry refers to the toxic aspects of production, and disasters such as those experienced by Union Carbide at Bhopal [2]. Certainly a lot of this imagery

is hyperbole, but the perception is real in society and the media.

2 What is the Impact of Green Process Technology on the Chemical Industry?

Implementing new, environmentally friendly technology in practice will go a long way towards changing the black and red imagery to green. But evaluation of the impact of process change, and thus determination of whether the technology will be adopted, is an exceedingly complicated issue!

A starting point for qualitative industrial assessment of new technology could be the 12 principles of green chemistry suggested by Anastas [3]. Developing a manufacturing route that embodies many of these elements likely would be perceived as environmentally benign. Yet the context of these principles may not align well with that of the industry. Pereira has defined 10 qualitative environmental process objectives that would be important from an industrial viewpoint [1].

Regardless of qualitative principles, the primary quantitative issue from an industrial perspective is that of economics. The chemical industry exists to make profits and products, in that order. If a process is no longer profitable, it is jettisoned, either by elimination from the product line or by improvement through modifications designed to return it to profitability. This is a reality that must be understood whenever any new green approach is proposed. The chemical industry has been very successful in developing high-yield economical routes for the manufacture of a wide range of chemical building blocks and intermediates. It understands and can manipulate existing technologies and primary feedstocks with amazing control, even at incredibly high annual production levels [4]. Some of these processes have been in place for decades. Any new methodology designed to displace them will be subjected first to a stringent economic screen and will (in the absence of legislation *forcing* replacement) be discarded if

the cost is too high, *regardless* of the environmental benefits.

More frequently, the argument is being made that a 'green' approach is also the more economical approach. The industry is facing increasing regulatory and cost pressures regarding environmental issues that are driving the industry to more environmentally friendly processes. The cost for environmental controls has been estimated at about 3% of sales revenue, or about \$10 billion each year [1]. Deeper evaluation of these numbers by industry has revealed that there might be generally unrecognised and positive economic drivers beyond simple raw material and capital costs to encourage green chemistry growth in the industry. This is certainly the case in the evaluation of new projects. For example, the cost of safety issues in the design of a new plant is always evaluated. Safety costs are found to have a relative factor of unity at the research stage but a factor of 10^4 if an incident occurs [5]. It would be reasonable to assume that similar factors also apply to the environmental impact of a new process. Other analyses have pointed out where positive economic benefits accrue through waste minimisation and capital expenditures on green process technology rather than end-of-pipe treatments [6].

Reduction of waste and elimination of toxic by-products can be translated directly into economic benefit. A useful quantitative measure of the impact of a technology based on the amount of waste it generates was developed by Sheldon, and measures the ratio of the weight of by-products in a process to the weight of product formed [7a]. This E value has been cited in many subsequent papers and is summarised in Table 14.1.

Table 14.1 indicates that the industry segment handling the largest amount of chemical products also generates the smallest amount of waste, at least as a function of product tonnage. The pharmaceuti-

cal industry with its reliance on multistep syntheses and somewhat exotic reagents and solvents is, by this evaluation, 'dirtiest' [7b]. However, in absolute terms, the oil refining industry still generates the biggest pile of material to dispose. To address this component of the issue, Sheldon also has tried to incorporate an 'unfriendliness factor' into the evaluation. Fairly innocuous waste products (such as NaCl), which are more common in large-scale commodity manufacture, could be given an unfriendliness factor of 1, whereas the generation of heavy metal waste (e.g. Cr waste from an oxidation step) might be given a factor of 100 or 1000. This factor is multiplied by the E value to give an environmental quotient (EQ), which would be a measure of the overall impact of the waste. Evaluation of the EQ could indicate that small-scale processes have a very large impact. A goal for green technology would be to direct all manufacturing routes, large and small, to the lowest possible EQ.

Quantitative evaluations of the relative greenness of a process can be debated. If an improvement results in less waste, but not zero waste, is it acceptable? If a process or product is renewables-based, is it automatically green? Some evaluations have projected that routes employing renewable feedstocks actually may consume more energy and generate more waste than those currently used [8]. If an industry decides to use a biotechnological step for production, are the cell waste or metabolic by-products less damaging to the environment than some of those generated by the fine chemical or pharmaceutical industries, i.e. what is a reasonable unfriendliness factor for newly developing technology? If one uses catalysis, how many additional manufacturing steps can be included before the effectiveness is lost? For example, a BASF procedure uses a catalytic hydroformylation step in the production of vitamin A [9]. However, the process also uses a very atom-*uneconomical* Wittig coupling in a subsequent step. What is the overall impact?

From a broader viewpoint, should separate technology for the manufacture of reagents needed for a particular transformation also be evaluated? Reagents H_2O_2 , O_2 and O_3 are widely considered as benign oxidants, but the production of H_2O_2 or O_3 is energy intensive. What is the environmental impact of their production? [10]. Electrochemistry frequently is suggested as a very clean method for the production of new compounds, and a large-scale

Table 14.1 The E values for different chemical industry segments

Industry segment	Product tonnage	E value
Refining	10^6 – 10^8	~0.1
Bulk chemicals	10^4 – 10^6	<1–5
Fine chemicals	10^2 – 10^4	5–50
Pharmaceutical	10^1 – 10^3	25 to >100

electrochemical process for the production of adiponitrile ($2.7 \times 10^5 \text{ t year}^{-1}$) by electrohydrodimerisation of acrylonitrile was developed and commercialised by Monsanto [11]. How much energy is required to run the operation? Is the source of that energy a coal-fired power plant or a hydroelectric facility? Manufacture of the acrylonitrile used as a starting material also generates large amounts of a salt as a by-product that must be disposed of. Each of these questions again links directly to the overall economics and the resulting cost to the industry. Long term, the clearest quantitative goal for green technology in the chemical industry may be that of Pereira: develop processes having 100% raw materials utilisation or zero waste [1].

Questions such as these surrounding industrial adoption of green process technology clearly highlight the need to incorporate more life-cycle analysis [12] (see also Chapter 5) for the evaluation of any supposed 'environmentally friendly' routes [13]. In the context of life-cycle analysis, some have proposed that green technology eventually must provide a cradle to grave service for a product, e.g. in the photocopier industry where the makers of toner cartridges are also their primary recyclers [14]. Research also provides answers. Improvements in the synthesis of H_2O_2 have been developed that could lower its cost and make it more attractive as a green oxidant from an energy viewpoint [15].

3 Overview

Against this backdrop, this chapter will attempt to review green technologies that, apparently, have surmounted all the life-cycle and economic barriers and currently are being practiced by industry for the commercial manufacture of products. The green technologies that have been employed most widely by the industry comprise three major categories. It is interesting to note that over 85% of the technologies described in a recent review of winners of the EPA Presidential Green Chemistry award also fall into these categories [3]:

(1) *Catalysis*. Catalysis is proving to be a most powerful technology for the greening of the chemical industry. Most simply, catalysis is employed because of its ability to promote reactions by adding one molecular fragment to another, with incorporation of most or all of the atoms in both

fragments in the final product. Catalysis thus embodies the goal of eliminating the stoichiometric reagent and its associated waste from chemical manufacturing. Catalysis also encompasses efficient organic synthesis as a subset, because conversions of high atom economy frequently employ catalytic steps to carry out given transformations [16]. This field of research continues to develop within the chemical industry, with 80–90% of all chemical processes involving at least one catalytic step [17].

(2) *Biocatalysis/bioprocessing*. Biocatalysis is closely related to non-biological catalysis and possesses many of the same features and benefits. In addition, bioprocesses proceed under very mild conditions, frequently in aqueous reaction media, and can use renewable feedstocks as starting materials. However, issues of separation, expense, productivity, maintenance of organisms and new capital investment so far have limited the use of bioprocesses in the chemical industry, except where no other alternatives are available [18].

(3) *Renewables as chemical feedstocks*. The USA possesses sufficient renewable resources to supply all domestic organic chemical needs without sacrificing traditional applications of renewables in the production of food, feed and fibre. Yet, apart from a few exceptions, the chemical industry has not embraced renewables on a large scale. Renewables will play an important role in the future evolution of the chemical industry. Progress in the use of conventional chemical processing and catalysis for the conversion of renewables to products are areas that will see significant growth as the world turns its attention to new carbon sources as non-renewable crude oil feedstocks diminish.

A review of this size cannot be exhaustive. The chapter will not discuss reactor, separation or engineering technology. Although widespread in the industry [1], there will be no description of end-of-pipe strategies. Where possible, the examples are limited to newer technologies reported in the last few years, with well-known industrial processes mentioned only briefly. Moreover, an attempt has been made to limit coverage to those processes currently being used in industry at a reasonable production scale (e.g. bulk and commodity chemicals),

or on products of fairly broad importance (e.g. certain pharmaceuticals). Promising non-commercial pilot- or laboratory-scale research is included where appropriate. The reference list will direct the reader to additional examples of reactions that are applicable to industrial use but are still in the developmental stage or are being applied in specialised or low-volume applications.

4 Catalysis

Only recently has catalysis, either heterogeneous or homogeneous, become green. In the absence of attention now focused on the environmental impact of a chemical process, catalysis was seen simply as a highly efficient and economical way to make chemical products. Catalysis has been practiced widely for many years in the oil refining and bulk chemical industry, even before green technology was recognised. Catalysts offer a number of advantages, including [19]:

- The elimination of stoichiometric reagents and the resulting large amounts of waste associated with these reagents.
- The ability to carry out transformations that are difficult or impossible using conventional stoichiometric technology (from transformations as simple as catalytic hydrogenation to more complex C–C bond-forming reactions such as Suzuki, Stille or Heck couplings).
- The ability to combine several transformations into a single step by acting as a ‘template’ for the assembly of different molecular fragments.
- The replacement of toxic or problematic reagents.

Heterogeneous catalysis is by far the major player in the chemical industry. However, more industrial uses of homogeneously catalysed reactions are appearing. A comparison of the strengths and weaknesses of both are shown in Table 14.2 [9]. The choice of one over the other obviously will be determined by the needs of the process. It is interesting that homo- and heterogeneous catalysis frequently are viewed as competing, even when both offer a unique set of properties for chemical processing. The following sections will highlight recent examples where significant benefits have been or might be realised by the use of catalysis as part of green technology.

Table 14.2 Comparison of homogeneous and heterogeneous catalysts

	Homogeneous catalyst	Heterogeneous catalyst
Activity (relative to metal content)	High	Variable
Selectivity	High	Variable
Service life	Variable	Long
Reaction conditions	Mild	Harsh
Sensitivity toward poisons	Low	High
Catalyst recycling	Expensive	Not necessary
Diffusion problems	None	May be important
Variability of steric and electronic properties	Possible	Not possible
Mechanistic understanding	Relatively good	Relatively poor

4.1 Examples of heterogeneous catalysis in practice

Heterogeneous systems are the cornerstones of industrial catalysis. Many large-scale examples exist, such as catalytic cracking or isomerisation, and Fischer–Tropsch synthesis in the Sasol hydrocarbon process [20]. Heterogeneous catalysts are key in the selective Ag-catalysed oxidation of ethylene with oxygen to give ethylene oxide and the direct ethylation of benzene and subsequent dehydrogenation of ethylbenzene for the production of styrene (3.3×10^6 and 5.2×10^6 t, respectively, in 1995 in the USA) [21]. A wide range of materials have been used as heterogeneous catalysts, including clays, both acidic and basic zeolites, ion-exchange resins and metals on various support materials [22]. These species have led to new catalytic oxidations and reductions, or replacement of stoichiometric reagents such as AlCl_3 or mineral acids, notorious for the production of large amounts of waste salts.

A significant breakthrough in industrial heterogeneous catalysis has been achieved with the development of the TS-1 family of titanium silicalite zeolites; TS-1 is the first example of a ‘redox molecular sieve’ [23]. In general, use of a zeolite to support an active metal centre has the advantage of inhibiting both leaching of the metal into the bulk solution and preventing deactivation of the metal centres via oligomerisation. The pore size can be defined by

proper synthesis, leading to shape-selective catalysts able to induce reaction selectivity on the basis of molecular size. These materials have proven useful for the promotion of several industrially important oxidations in the liquid phase using aqueous H_2O_2 as the oxidant. A new process using TS-1 catalysts offers a route to caprolactam, a component of Nylon-6. In 1995, the world capacity for caprolactam was 3.7×10^6 t, mostly produced by the Beckmann rearrangement of cyclohexanone oxime [24]. Recent developments have greatly improved this route for the synthesis of both caprolactam and its precursors by using several sequential catalytic steps (Fig. 14.1).

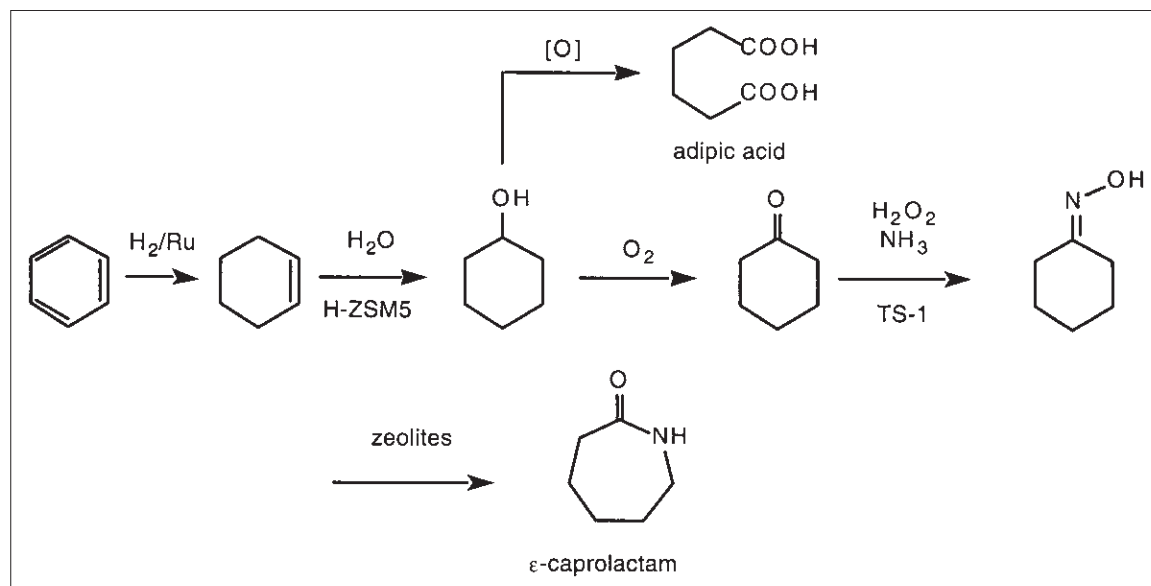
Partial hydrogenation of benzene to cyclohexene, followed by hydration over an H-ZSM-5 zeolite, gives a new process for cyclohexanol synthesis now being carried out at a scale of 6×10^4 t year⁻¹ by Asahi [17]. Cyclohexanol is oxidised with O_2 to cyclohexanone, which is treated with NH_3 and H_2O_2 over TS-1 to form cyclohexanone oxime. Enichem operates this conversion at a demonstration scale of 1.2×10^4 t year⁻¹. Conventional manufacture of cyclohexanone oxime requires the use of stoichiometric amounts of H_2SO_4 , resulting in the generation of a large amount of waste salt. Vapour-phase Beckmann rearrangement over a zeolite can be used to prepare

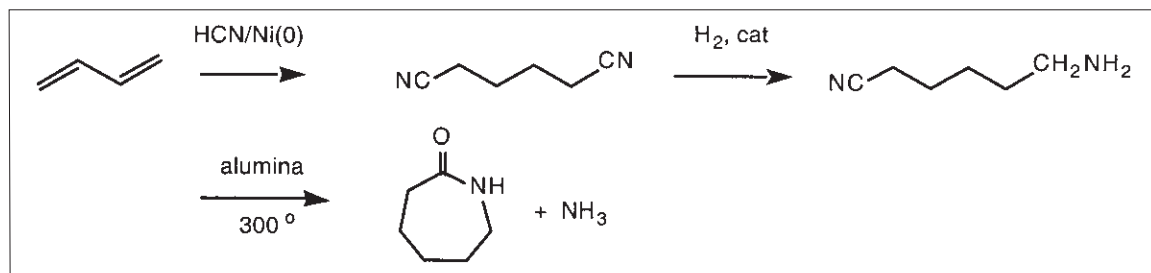
the caprolactam [25] but it is not yet commercialised, so the final step in practice still generates $(\text{NH}_4)_2\text{SO}_4$ as a waste. A recent report indicates that caprolactam could be produced from a completely catalytic route, ultimately starting from butadiene (Scheme 14.1) [2].

Adiponitrile, produced by the Ni(0)-catalysed hydrocyanation of butadiene, can be reduced selectively to the monoamine. Caprolactam is formed in the vapour phase by heating of the monoamine over an alumina catalyst. Rhodia is planning a 1×10^5 t year⁻¹ plant based on this technology by 2003. The zeolite-catalysed cyclohexanol process also provides a new route to adipic acid, because commercial production of adipic acid occurs by oxidation of cyclohexanol with HNO_3 or O_2 in the presence of a catalyst (NH_4 -metavanadate/Cu-nitrate or Cu-Mn-acetate) [26].

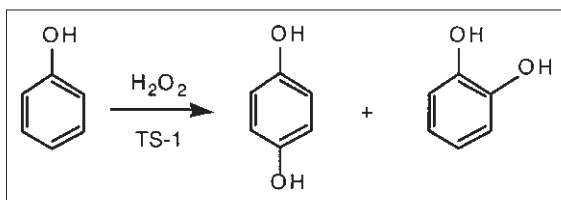
Zeolite TS-1 has proven to be remarkably versatile in its ability to promote clean oxidation technology. Hydroquinone is produced at an annual level of about 5×10^4 t. The classic approach oxidises aniline in the presence of acidic MnO_2 , followed by a reduction over Fe/HCl, generating large amounts of waste salt. In contrast, reaction of phenol with H_2O_2 in the presence of TS-1 gives a very clean route to hydroquinone via direct hydroxylation of the aromatic ring. The only by-product is catechol, which is also an item of commercial interest. Currently, about half

Fig. 14.1 New routes to caprolactam and adipic acid.

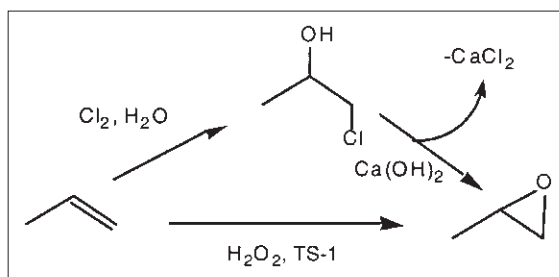




Scheme 14.1



Scheme 14.2



Scheme 14.3

of the world's production has shifted to this H_2O_2 /zeolite-based approach (Scheme 14.2) [22].

Zeolite TS-1 also has been reported as being useful in a new manufacturing route for propylene oxide. Over 3×10^6 t of this material are produced annually, primarily by the reaction of base with propylene chlorohydrin, which again generates considerable amounts of salt. In contrast, treatment of propylene in aqueous methanol with H_2O_2 under mild conditions ($<60^\circ\text{C}$ and 4 bar) produces propylene oxide with selectivities as high as 97% (Scheme 14.3) [22].

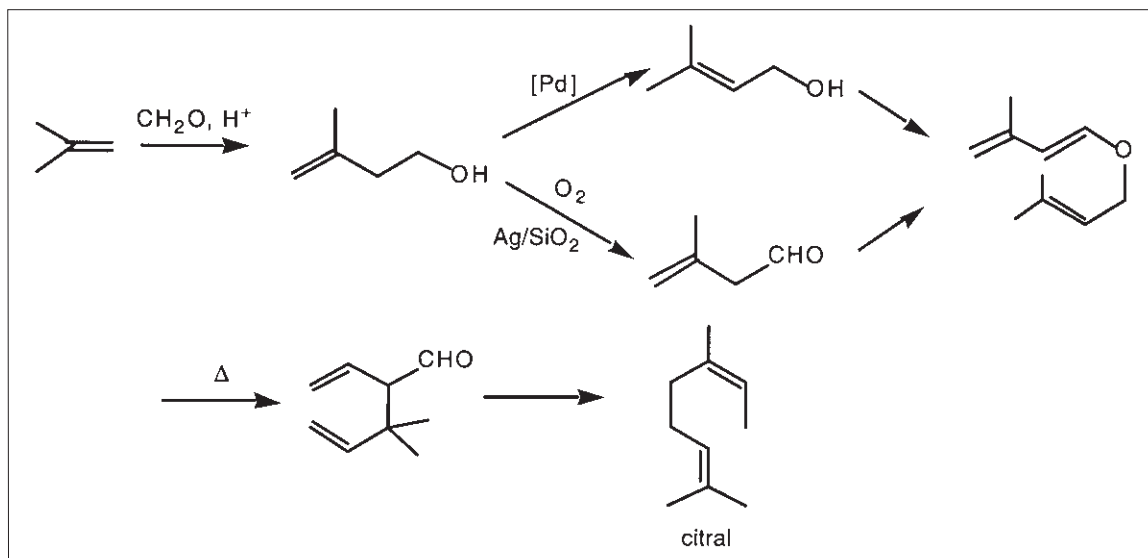
Traditionally, the commercial use of heterogeneous catalysis has been limited to the production of large-scale commodity chemicals. More recently, the technology is being used in the production of fine chemicals and pharmaceuticals. Sheldon and Downing describe several examples of heterogeneously catalysed pilot plant and demonstration operations reported by industry [27]. The BASF production of citral (Scheme 14.4) [28,29] and Eastman's method for manufacturing 3,4-epoxy-1-butene (Scheme 14.5) are illustrative [30].

Citral manufacture starts from the reaction of isobutylene and formaldehyde to give 3-methyl-3-butenol, which serves as the starting material for two

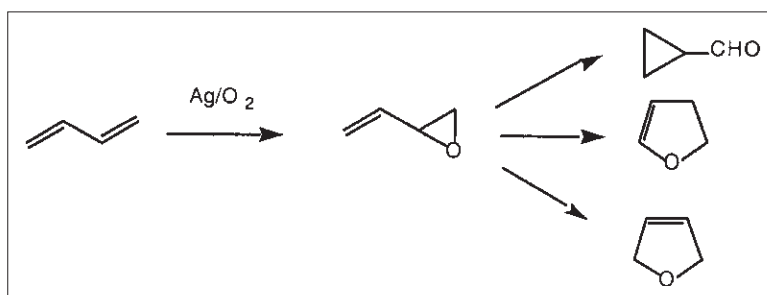
components: 3-methyl-2-butenol via Pd-catalysed isomerisation of the double bond to the more highly substituted position; and 3-methyl-3-butenol via oxidation of the hydroxyl group over a silica-supported silver catalyst. Addition of these two materials gives an ether, which in two thermal steps rearranges to form citral.

The Eastman process (Scheme 14.5) for the selective oxidation of only one of the double bonds in butadiene is carried out over a silver catalyst with oxygen. Epoxybutene is being positioned by Eastman as a fine chemical platform that can be converted to a number of different intermediates, including cyclopropanes and dihydrofurans.

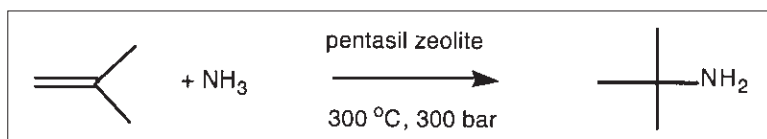
Direct amination of olefins can be catalysed by heterogeneous systems. Workers at BASF have found that treatment of isobutylene with ammonia under supercritical conditions gives a 99% selectivity to *t*-butylamine at 12–15% conversion. This direct formation of *t*-butylamine is a marked improvement over the conventional three-step Ritter route [30]. The conventional route requires 4.5 kg of raw material to generate 1 kg of product, and results in the formation of about 3 kg of Na_2SO_4 as a waste product (Scheme 14.6).



Scheme 14.4



Scheme 14.5



Scheme 14.6

4.2 Examples of homogeneous catalysis in practice

Homogeneous catalysis is being employed more widely for industrial production. In many cases, catalysis will involve the use of transition metal complexes to promote reactions. However, a particularly elegant example of catalysis not involving a transition metal intermediate is the route adopted by Solutia (formerly Monsanto) for the production of

4-ADPA, an intermediate for the manufacture of antioxidants in the rubber chemicals industry (Fig. 14.2). This process takes advantage of the ability of nitroaromatics to undergo nucleophilic substitution, in this case for hydrogen. Attack of aniline on nitrobenzene promoted by $\text{Me}_4\text{N}^+\text{OH}^-$ results in the formation of an intermediate Meisenheimer complex. The complex loses OH^- , regenerating the catalyst and giving a nitroso compound. Catalytic hydrogenation gives 4-ADPA. This approach elimi-

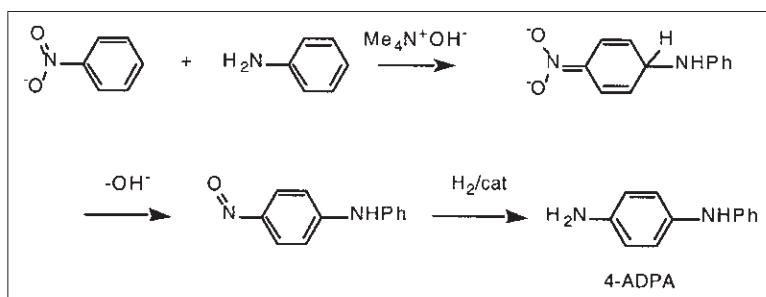


Fig. 14.2 New process for manufacturing 4-ADPA.

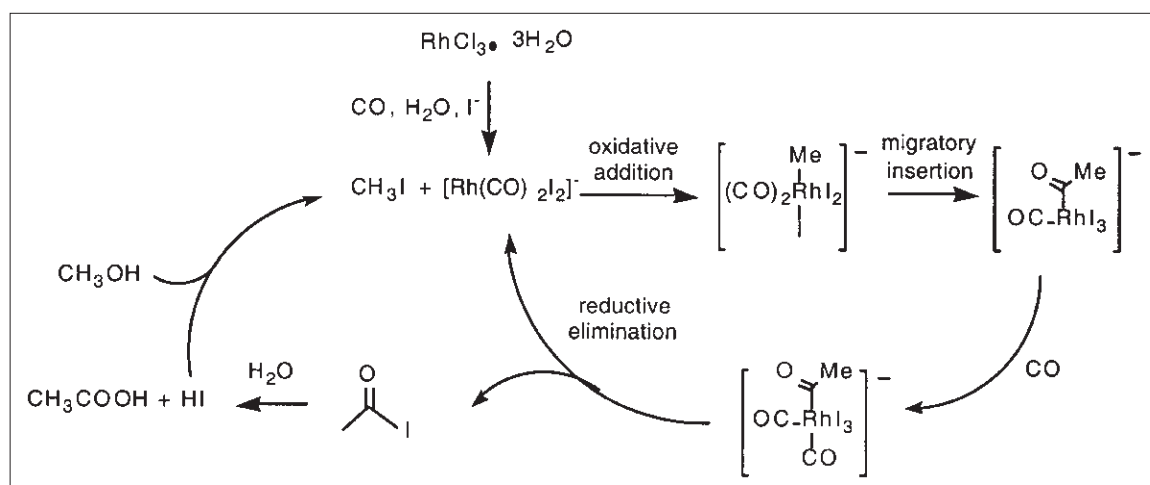


Fig. 14.3 Mechanism of Rh-catalysed methanol carbonylation.

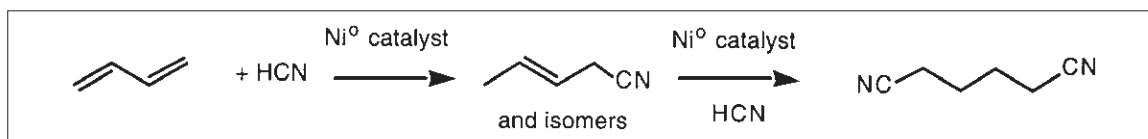
nated a much longer route to the same compound and has become Solutia's manufacturing method for 4-ADPA [31].

Early examples of more traditional transition-metal-mediated homogeneous catalysis are still relevant today with regard to their high efficiency. For example, more than 50% of the world's acetic acid is produced by $[\text{Rh}(\text{CO})_2\text{I}_2]^-$ -catalysed methanol carbonylation, a route developed by Monsanto in the late 1960s [32]. Third-generation processes have been developed that replace the original Rh catalyst with an Ir complex [33], and results from Japan describe a new technique employing a Pd/heteropolyacid catalyst supported on silica [34]. The mechanism of the carbonylation is shown in Fig. 14.3 [35].

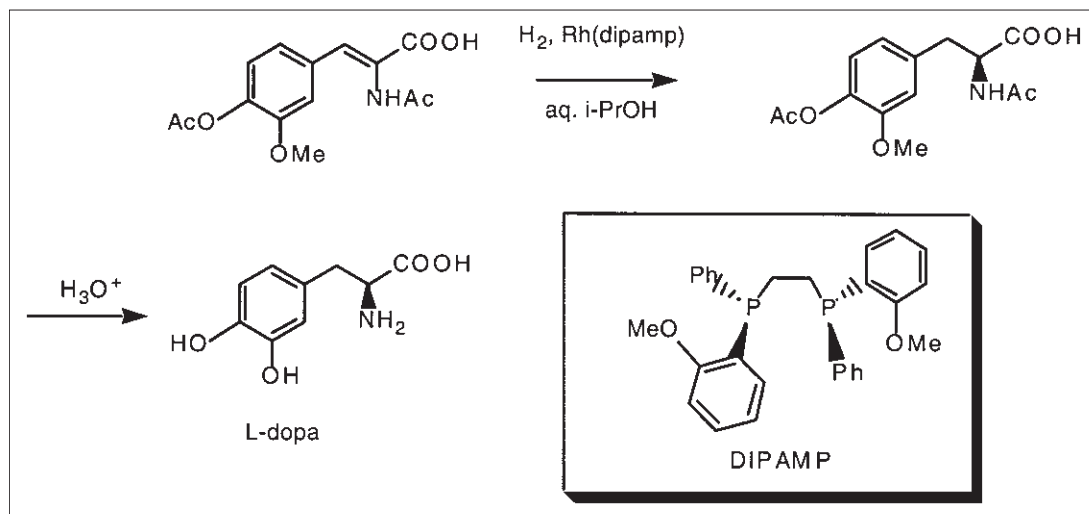
A Rh(III) salt is converted to $[\text{Rh}(\text{CO})_2\text{I}_2]^-$ by treatment with an iodide promoter (MeI , HI , I_2) and CO .

Through a textbook series of organometallic transformations, the Rh catalyst oxidatively adds MeI , inserts a molecule of CO and reductively eliminates acetyl iodide, which is converted under the reaction conditions to acetic acid and HI . The HI reacts with a molecule of methanol to generate MeI for the next cycle. The mechanism demonstrates the level of detail to which homogeneously catalysed processes can be understood and illustrates one of the differences between heterogeneous and homogeneous catalysis. Homogeneously catalysed reactions generally proceed via discrete, structurally well-defined intermediate complexes. Thus, it is generally easier to control the reaction, and hence determine product distributions, reaction rates, etc., using simple modifications such as changing the nature of the ligand around the metal. This control also could be used as a tool to minimise the E value of an industrial process.

The DuPont Ni-catalysed hydrocyanation of butadiene is also notable as a route for the production of



Scheme 14.7



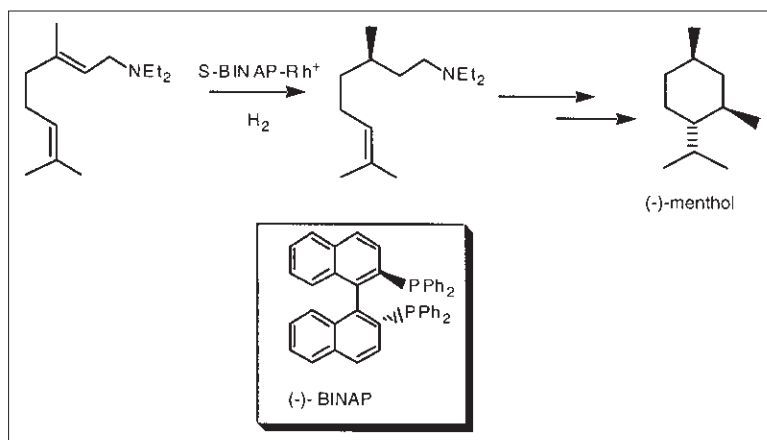
Scheme 14.8

adiponitrile [36], a material with a worldwide production capacity of 1×10^6 t year⁻¹ in 1990 [37]. In this process, two moles of HCN add sequentially to butadiene in the presence of an Ni(0) phosphite catalyst via intermediate cyanopentenes to give adiponitrile with high selectivity (Scheme 14.7). The mechanism is understood in detail to be equivalent to methanol carbonylation [38].

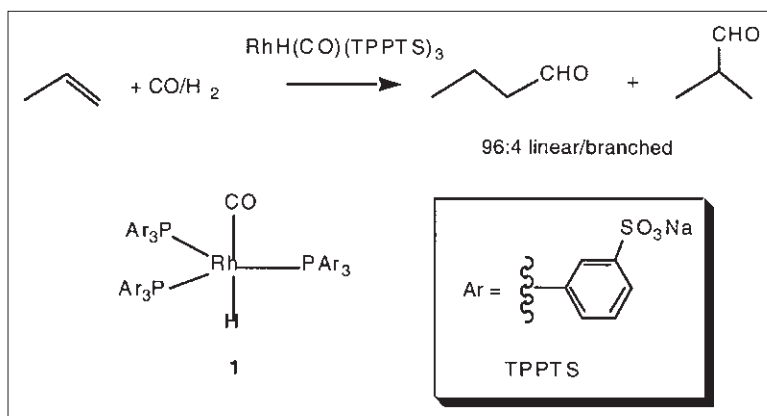
The ability to control homogeneously catalysed reactions has been used extensively in catalytic asymmetric hydrogenation. The nature of the environment around the metal centre, and therefore the catalyst's reactivity, is strongly influenced by the choice of ligand. A large number of chiral ligands have been developed to provide routes to optically active products. A key step in the Monsanto process for the production of L-dopa uses a Rh(DIPAMP) catalyst to introduce optical activity into the molecule (Scheme 14.8). L-Dopa is produced in 100% enantiomeric excess (ee) after recrystallisation [39].

(-)-Menthol is also produced by asymmetric hydrogenation by Takasago in Japan [40]. Between 1983 and 1996, 2.6×10^4 t of menthol were manufactured using only 250 kg of the chiral ligand (Scheme 14.9) [41].

Despite the success of these well-known examples, homogeneous catalysis is used infrequently in industry because of the difficulty of separating the product from the catalyst in a single-phase reaction. More recently, aqueous biphasic catalysis has been developed as a way of retaining the catalyst in an aqueous phase while keeping the organic product in the organic phase. A wide number of catalysts have been rendered water-soluble through incorporation of polar groups on the metal ligands, in a sense 'immobilizing' the catalyst in the aqueous phase. This approach is applicable to a number of well-known industrial processes. For example, the Ni-catalysed production of adiponitrile described in Scheme 14.7, which is normally carried out in organic solvent, can be carried out also in a biphasic system in the presence of a water-soluble ligand [36]. However, the most important commercial example of this



Scheme 14.9



Scheme 14.10

approach has been the development of a process for the hydroformylation of propene to give *n*-butyraldehyde (Scheme 14.10).

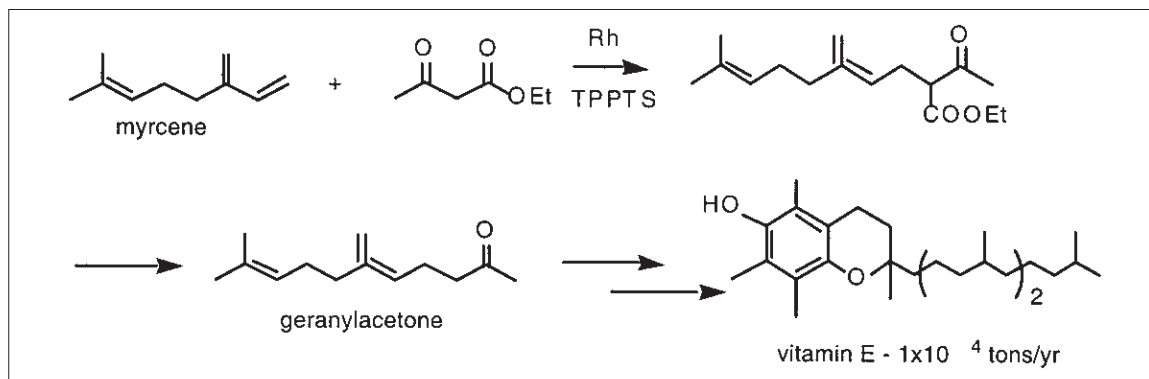
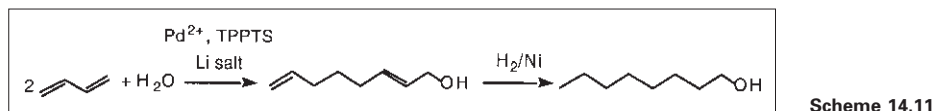
Hydroformylation, another mechanistically well-understood reaction, occurs via complex **1** as the active catalyst to give a 96:4 ratio of *n*-butyraldehyde/isobutyraldehyde. The TPPTS ligand is formed by direct sulfonation of triphenylphosphine [42] and gives the catalyst high (1.1 kg l^{-1}) solubility in water. Of particular note is that the commercial development of this route was extremely rapid. Scale-up proceeded in only two steps, from a 5-l laboratory reactor to a 50-l pilot plant, and then to a 120-m^3 commercial production facility (overall, a scaling of 1:24000 in only two steps) [43]. Biphasic catalysis is now the primary method used for the production of butyraldehyde (over $6 \times 10^5 \text{ t year}^{-1}$). This method also has been investigated for the production of

valeraldehyde, a material produced at a scale of $1.4 \times 10^4 \text{ t year}^{-1}$ [44].

Biphasic catalysis also is being used for the production of 1-octanol as a plasticiser at a scale of $4.5 \times 10^3 \text{ t year}^{-1}$. In a variation on the well-known butadiene telomerisation reaction, butadiene undergoes dimerisation followed by the addition of a molecule of water in the presence of a Pd catalyst and the Li salt of the TPPTS ligand. The resulting unsaturated alcohol then is reduced catalytically to give 1-octanol (Scheme 14.11).

Fine chemical synthesis also has benefited from the use of biphasic catalysis. Vitamin E (worldwide production of $1 \times 10^4 \text{ t}$) [45] is produced via Rh(TPPTS)-catalysed alkylation of myrcene with ethyl acetoacetate (Scheme 14.12).

The success of these reactions under biphasic conditions is due to sufficient solubility of the reaction



Scheme 14.12

components in water, but many organic compounds exhibit low or zero water solubility, limiting the use of aqueous systems. Efforts have been made to overcome this problem through the design of new ligands for the metal catalyst. Immobilisation of Rh catalysts in a sol-gel matrix has been shown to promote propene hydroformylation with yields and selectivities similar to the commercial system [46]. Modification of the Rh catalyst by replacement of a TPPTS ligand with PPh₃ has been used to increase the solubility of the catalyst in the organic phase and improve the reactivity of those substrates exhibiting only slight water miscibility [47].

Heteropolymetallates (HPMs) have seen increasing interest as robust, homogeneous catalysts for the activation of oxidants such as O₂ or H₂O₂ [48]. A new route for the production of adipic acid is based on homogeneous catalysis. Adipic acid is a material produced in huge amounts (2.2 × 10⁶ t year⁻¹) via nitric acid oxidation of cyclohexanol or cyclohexanone, both of which come from benzene [49]. It is a primary constituent in the production of Nylon-6,6, used in carpets, upholstery, tyres and other materials [50], a new adipic acid process would have a significant environmental impact. The current production emits 4 × 10⁵ t year⁻¹ of N₂O into the atmosphere, which is approximately 5–8% of the

worldwide total. Cyclohexene is oxidised by H₂O₂ in the presence of NaWO₄ and a phase-transfer catalyst ([CH₃(*n*-C₈H₁₇)₃N]HSO₄) to give adipic acid in 90% isolated yield upon heating at 75–90°C for 8 h [51]. The proposed mechanism, based on extensive investigation of the reaction of HPM-catalysed oxidation of olefins, is shown in Fig. 14.4. The catalytically active species is probably the peroxytungstate complex **2** (Scheme 14.13). The process is not limited to cyclohexene. Substituted cyclohexenes and cyclopentene also underwent catalytic oxidation in similar yields.

More recently, the process was improved by eliminating the phase-transfer agent and adding a bidentate organic acid. This modification forms adipic acid with 97% selectivity at 100% conversion [52]. The most effective organic acid appears to be oxalic acid, which forms complex **3** (Scheme 14.13).

Related oxidations also have been reported. An oxidation of cyclohexane to a mixture of cyclohexanol and cyclohexanone using oxygen in the presence of an HPM has been described [53]. Direct catalytic oxidation of cyclohexane using *N*-hydroxyphthalimide, Mn(acac)₂ and Co(OAc)₂ as a catalyst mixture also has been reported to form adipic acid in 73% selectivity at 73% conversion [54].

Dimethylcarbonate is receiving attention as a new green chemical intermediate. A wide range of applications for dimethylcarbonate is known [55] but the primary interest in this material for the chemical

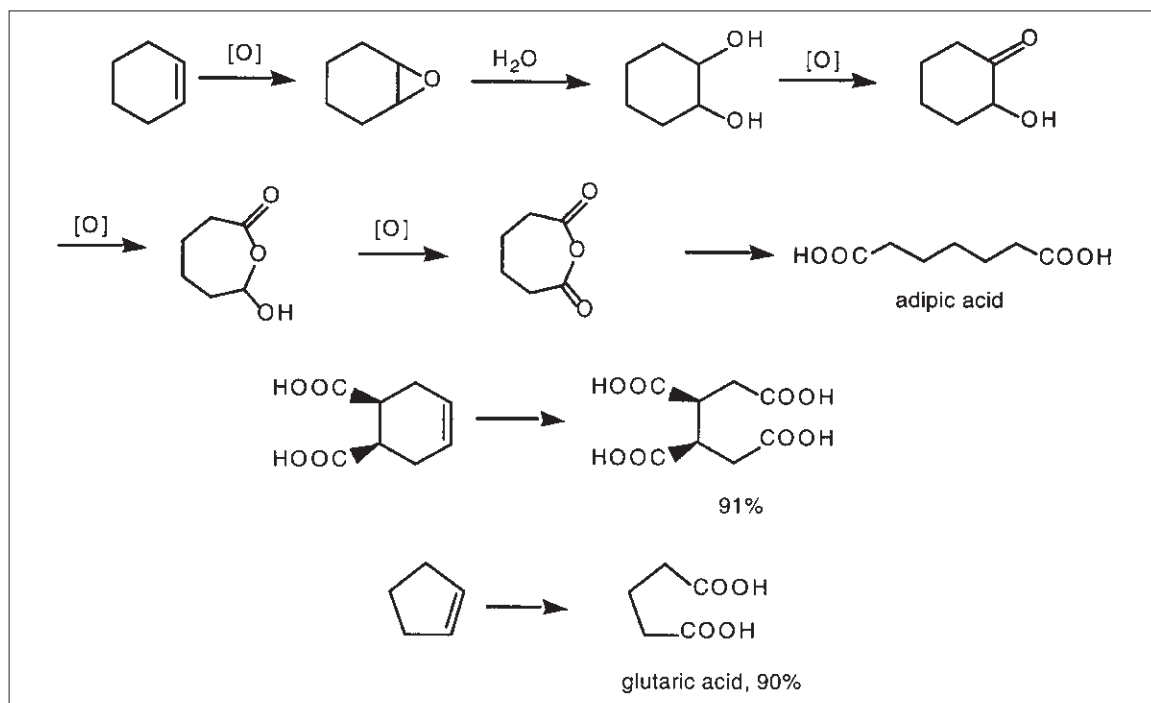
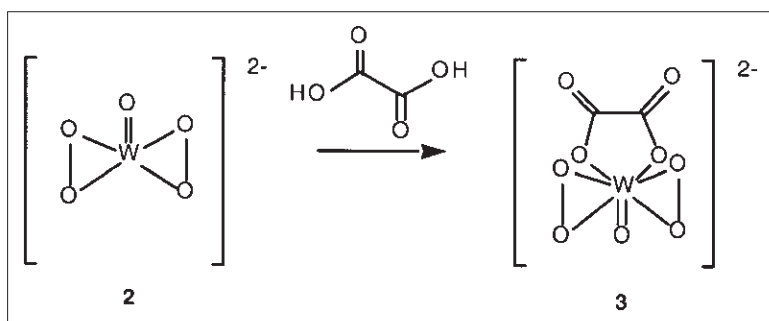


Fig. 14.4 Heteropolymetallate-catalysed production of adipic and other diacids.



Scheme 14.13

industry has been as a replacement for phosgene in the production of polyurethanes, which is a very large market ($4.7 \times 10^6 \text{ t year}^{-1}$ in 1990 growing to $7.7 \times 10^6 \text{ t year}^{-1}$ in 2000) [56]. However, replacement of phosgene with dimethylcarbonate has been considered too expensive.

A new, less-expensive commercial process for dimethylcarbonate has been developed that proceeds via CuCl-catalysed oxidative carbonylation of methanol. Carbonylation is carried out at 120°C and

27 atm with oxygen as the terminal oxidant. The selectivity for dimethylcarbonate production is high, with CO₂ from CO combustion being the only side product (Fig. 14.5) [57].

A disadvantage of this process is that it must be run as a slurry and is highly corrosive, requiring specialised equipment. Some recent attempts to improve the reaction have been reported [58]. Other reports indicate that dimethylcarbonate can be made directly from the reaction of CO₂ and methanol [59]

as part of an overall effort to mitigate CO₂ build-up in the atmosphere [60].

Homogeneous catalysis also has been used in the synthesis of profens. Ibuprofen and naproxen are examples of these 2-arylpropionic acids, which are widely used as pain relievers. These compounds are large-volume pharmaceuticals, with about 7.2×10^3 t of ibuprofen being produced each year. A widely cited example of green chemistry in industry is the current commercial route for ibuprofen manufacture (Scheme 14.14). Acetylation of isobutylbenzene in the *para* position gives a ketone. Reduction of the ketone to the alcohol and then carbonylation over a Pd²⁺ catalyst gives ibuprofen. The elegance of this approach is more striking when compared with the original route, which used several stoichiometric waste-generating steps, including a Friedel–Crafts acylation. The current route, which is operating commercially in Texas, is almost completely catalytic, almost 100% atom efficient and generates very little waste [61]. This route is an excellent example of how a fine

chemical/pharmaceutical manufacturing route, originally with a very high E value, can be made much cleaner through implementation of green process technology.

Conventional synthesis of profens gives racemic mixtures, but in the case of naproxen, the *S*-form is 28 times more active than the *R*-form [62]. Normally, a simple resolution is used industrially for the preparation of optically active naproxen [40,63], but direct synthesis of single enantiomers has been accomplished using asymmetric catalytic hydrogenation. Chemical yields as high as 92% with enantiomeric excesses as high as 97% have been observed. The use of water-soluble Ru hydrogenation catalysts also has been reported (Scheme 14.15) [64]. To improve the ability to recover and reuse the homogeneous catalyst, new solvent systems such as molten salts (ionic liquids) have been tried [65].

(*S*)-Naproxen methyl ester can be made asymmetrically in up to 81% ee in the presence of a chiral phosphorus ligand (Scheme 14.16) [66]. Commercial implementation of these various hydrogenation schemes will depend on the availability and long-term stability of the necessary chiral ligands.

Naproxen also has been manufactured commercially using a Heck reaction to introduce the necessary side chain on 3-bromo-7-methoxynaphthalene (Scheme 14.17) [67]. Relatively inexpensive methoxynaphthalene was brominated and then treated with ethylene in the presence of a Pd catalyst to give vinylmethoxynaphthalene as an intermediate. Catalytic carbonylation gave racemic naproxen. The key to improving the E value of this process is the ability to minimise waste by recycling the NaBr by-product to Br₂.

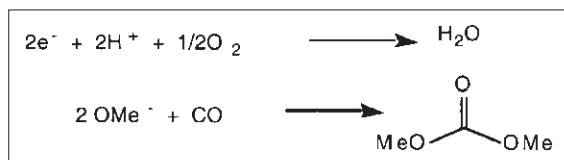
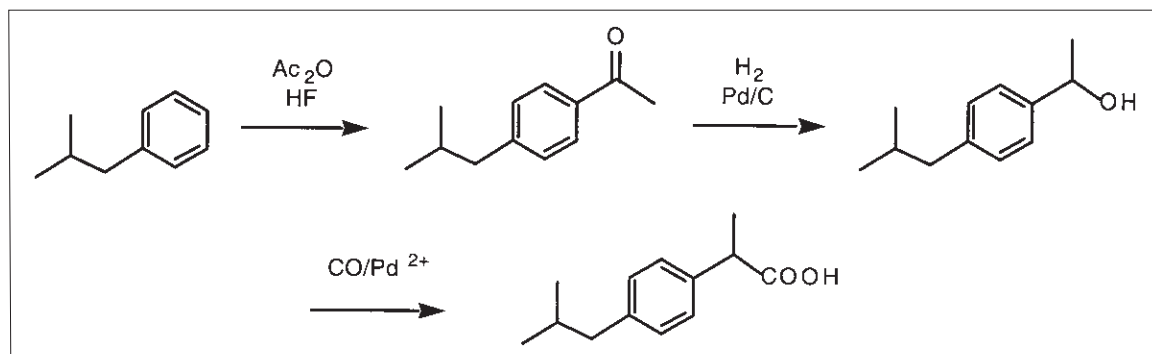
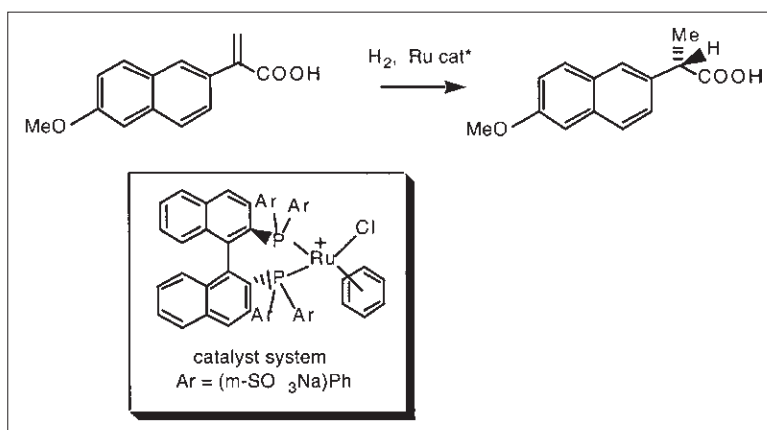


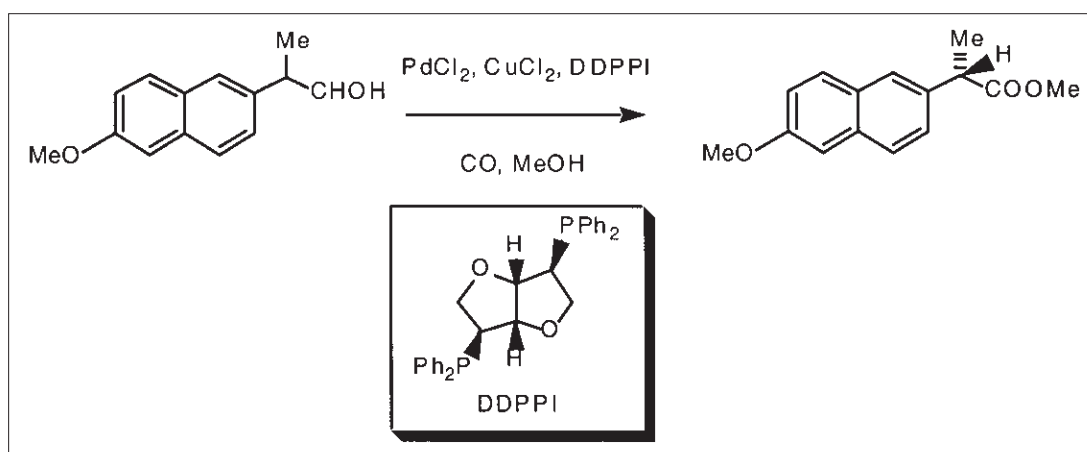
Fig. 14.5 Dimethylcarbonate production by oxidative carbonylation.

Scheme 14.14

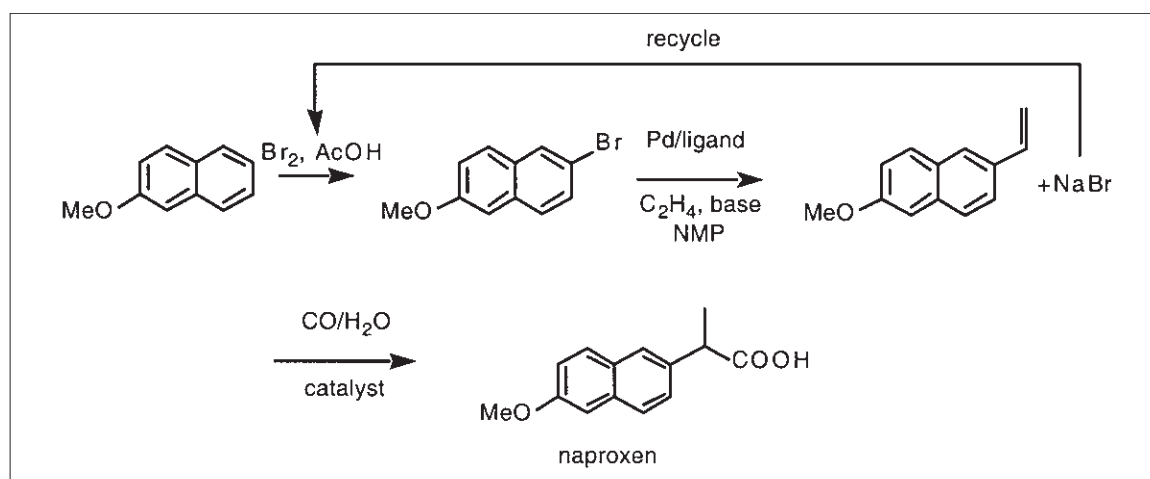




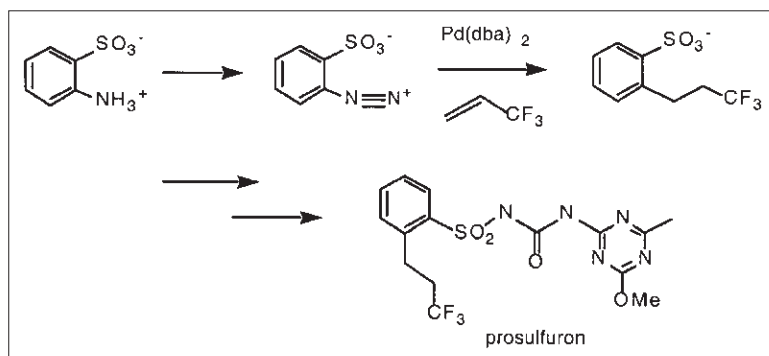
Scheme 14.15



Scheme 14.16



Scheme 14.17



Scheme 14.18

Regardless of the ability to recycle halide salts, use of the Heck reaction has been limited because the necessary bromides and iodides are expensive. Recently, aryl diazonium salts, available from less expensive nitroaromatics, have been demonstrated as being useful in the Heck reaction and form the basis of a new small-scale process for the production of Novartis' herbicide Prosulfuron. The production is currently 100 t year^{-1} (Scheme 14.18) [68]. The intermediate trifluoromethylethyl-substituted arene is formed in one pot, minimising waste in its synthesis.

Metachlor, an important herbicide marketed as Dual, has been sold as a racemic mixture. However, a more recent approach based on asymmetric hydrogenation produces a single enantiomer of the material. The difference in herbicidal activity is striking. Identical performance was observed at only 65% of the previous application rate, which has a significant impact on the environmental issue of run-off from agricultural operations. The process proceeds via asymmetric hydrogenation of an intermediate imine over a chiral Ir ferrocenyl complex in 80% ee. The catalyst system is extremely active and exhibits a turnover number of 1×10^6 with a frequency of $2 \times 10^5\text{ h}^{-1}$. About $1 \times 10^4\text{ t year}^{-1}$ of optically pure Dual are produced using this route (Scheme 14.19) [69].

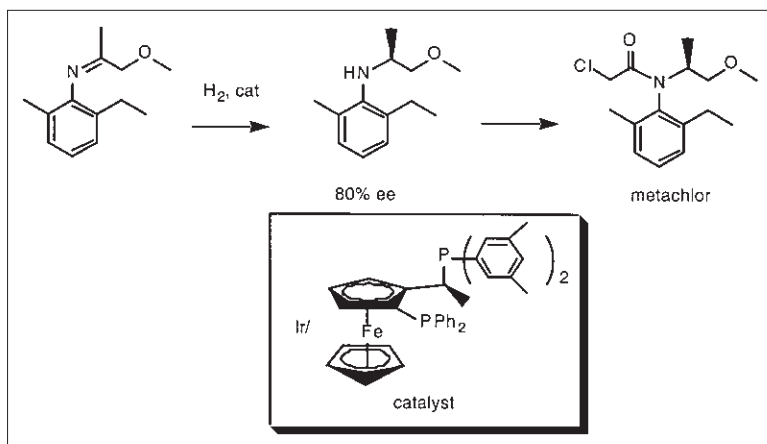
Longer term, continued use of homogeneous catalysis will rely on the ability to design highly active transition metal species that exhibit both high turnover number and turnover frequency. For example, recent work has revealed new Pd catalysts for the Heck reaction that exhibit turnover numbers as high as 196 000 000 and a turnover frequency of 12 000 000. An air-stable Pd complex reported by Milstein exhibits turnover numbers as high as 10^6

and a frequency of $8 \times 10^4\text{ h}^{-1}$. These reactions are fairly substrate specific but demonstrate that extremely high activity can be realised [70]. Further research areas important to catalysis, and hence to implementation of green process technology, have been reported [9,27,71].

5 Renewables as Chemical Feedstocks and Biocatalysis

Catalysis has proven to be a key contributor to green chemical processes by virtue of its role in synthetically efficient manufacture of chemical products. However, green process technology must not only address the methodology used for chemical production but also the starting materials employed. A truly green chemical industry eventually will evolve from non-sustainable feedstocks to renewable building blocks. The unfamiliarity of renewables to the industry has hindered their adoption. This situation has started to change in recent years because of the symbiosis between biocatalysis and renewable feedstocks, particularly carbohydrates. Biocatalysis is expanding rapidly, with an increasing number of organisms able to convert sugars to a wide array of products. As a result, renewables as chemical feedstocks are also receiving increased attention.

It is important to realise that the use of renewable feedstocks does not *require* biotechnology, or vice versa. Lichtenthaler has written extensively about the use of conventional chemical technology to convert carbohydrates to new products [72]. Examples of industrial use of biotechnology for the conversion of non-renewable starting materials also have appeared. As industrial biotechnology expands, the use of renewables will grow, as will the comfort



Scheme 14.19

level of the chemical industry with these, as yet, unfamiliar materials. New, non-biological methodology for the use of renewables will grow in parallel.

5.1 The case for renewables

Well into the twentieth century, renewable feedstocks supplied a significant portion of the nation's chemical needs. It is only in the period of time between 1920 and 1950 that we have witnessed the transition to a non-renewables-based economy [73].

A vast amount of renewable carbon is produced in the biosphere; about 71×10^9 t is fixed annually, an amount that could supply almost all domestic organic chemical needs, which is currently about 7–8% of our total non-renewables consumption [74]. (In 1995, the USA consumed 5.6 EJ (10^{18} joules) of energy for the production of synthetic organic chemicals. This corresponds to about 7% of the fossil fuel feedstocks used in the USA.) When measured in energy terms, the amount of carbon synthesised is equivalent to about ten times the world consumption [75]. Cellulose, the most abundant organic chemical on earth, has an annual production of about 90×10^9 t [76]. These values correspond to the production of 171×10^9 total tonnes of biomass and assumes that biomass is 45% carbon.

The yearly availability of renewables is most important, because it makes this resource almost unlimited if used in a sustainable manner. This contrasts with world supplies of petrochemicals. Recent

work [77] projects that world oil production could peak and then begin to decline in the next 5–10 years. It is unlikely that demand will decrease in line with production. In the USA, energy consumption has increased by more than 28% (about 21 EJ) during the last 25 years, but more than half of this energy growth (about 11 EJ) has occurred during the last 6 years, indicating that other feedstock sources will be needed [78]. Of course, a wider use of renewables always begs the question: is there enough to fulfil the traditional biomass needs in food, feed and fibre and still use the material for the production of chemicals? Several analyses indicate that there should be little problem [79].

Yet our chemical feedstock supply is overwhelmingly dominated by non-renewable carbon. Only about 2% comes from renewable sources [80], thus relatively few examples exist of large-scale industrial processes based on renewables. Two notable examples are the pulp and paper and the corn wet milling industries. Both convert huge amounts of renewable feedstocks into market products. The corn industry alone produces 8–10 ($\times 10^9$) bushels of corn per year. Each bushel contains 33 lb of renewable carbon as glucose, and a corn harvest of 10×10^9 bushels is equivalent to 500×10^6 barrels of crude oil [81]. Over 1×10^9 bushels of this supply is converted to ethanol and high-fructose corn syrup. The pulp and paper industry consumes over 100×10^6 t year⁻¹ of wood [82]. Some of this production is used for the manufacture of chemicals. Speciality dissolving-grade celluloses are used for the production of over 1.4×10^6 t year⁻¹ of cellulose esters, ethers and related

Material	US\$kg ⁻¹	US\$lb ⁻¹	Type of cost	Source
<i>Polymers</i>				
Cellulose	0.44–1.10	0.20–0.50	Production	^a
Lignin	0.07–0.13	0.03–0.06	Production	Fuel value
<i>Carbohydrates</i>				
Glucose	0.60–1.10	0.27–0.50	Sales	^b
	0.13–0.26	0.06–0.12	Production	^a
Xylose/arabinose	0.07–0.13	0.03–0.06	Production	^a
Sucrose	0.40	0.18	Sales	^c
Lactose	0.65	0.30	Sales	^c
	0.50–1.50	0.23–0.68	Sales	^b
Maltose	2.69	1.23	Sales	^c
Fructose	0.90	0.41	Sales	^b
Sorbitol	1.60	0.73	Sales	^b
<i>Other</i>				
Levulinic acid	0.18–0.26	0.08–0.12	Production	^a

^a Range of estimates from discussions with various industrial sources.

^b Bols, M. *Carbohydrate Building Blocks*. Wiley-Interscience, New York, 1996.

^c Cichenthaler, F. & Mondel, S. *Pure Appl. Chem.*, 1997, **69**, 1853.

materials. Lignin production by the pulp and paper industry is 30–50 ($\times 10^6$) t year⁻¹ [83]. The experience of these industries would seem to indicate that renewables hold considerable promise as a feedstock complementary to those used by the chemical industry. However, the scope of renewables-based chemicals production is narrow.

The necessary economic comparison reveals that a number of polymeric (cellulose, lignin) and monomeric (carbohydrates such as glucose, xylose; other materials such as levulinic acid) materials compete favourably with non-renewables [84]. Table 14.3 summarises some sales or production costs of a few typical renewable building blocks. Other evaluations show that two of the most basic renewable feedstocks—corn and cellulose—are competitive with several fossil feedstocks on both a mass and energy basis (Table 14.4) [85]. This evaluation also determined that the break-even price for oil when compared with cellulosic biomass at \$40 t⁻¹ is \$12.7 per barrel on an energy basis and \$6 per barrel on a mass basis, a projection that takes on more significance because oil prices are currently above \$30 per barrel at this writing (late 2000).

Although the economic issues are small, one finds that the technological barriers to a renewables-based green chemical industry are significant. A stark contrast exists between renewables and non-renewables

Table 14.3 Costs of some selected renewable feedstocks

in terms of the range of methodology available for their conversion into products (e.g. the ‘recalcitrance of cellulose’ referred to by Lynd) [85]. A green chemical industry based on renewables currently suffers from a much narrower range of discrete building blocks, fewer methods to convert those building blocks to other materials, a lack of fundamental understanding of how to convert starting raw materials (lignin, carbohydrates, oil crops, protein, biomass polymers, etc.) into single products in high yield and a lack of information about the properties and performance available from the final products. We are faced with the puzzle of possessing an almost limitless source of raw material, while being unable effectively to convert it to a wide range of useful products. This technology gap is not the result of an inherently greater level of difficulty in the processing of biomass. Instead, it is the result of technology to date being focused almost exclusively on highly reduced oil-based hydrocarbons, rather than on highly oxygenated carbohydrate-based materials.

Increased use of renewables as chemical feedstocks will grow in parallel with molecular-level understanding of their reactivity. The past and continuing success in catalyst design and product control in the petrochemical industry indicates that defining phenomena at a molecular level leads to control of reactions and practical applications. Process control and

Table 14.4 Cost comparison of renewables and non-renewables on a mass and energy basis

Feedstock	US\$t ⁻¹	US\$GJ ⁻¹
Oil (\$17.5 per barrel)	129	3.1
Oil (\$12.7 per barrel)	94	2.3
Oil (\$6 per barrel)	44	1.2
Natural gas (\$2.50 per 1000scf)	122	2.3
Coal	33	1.0
Corn kernels (\$2.50 per bushel)	98	5.0
Corn stover	19	1.0
Cellulosics (\$40t ⁻¹)	44	2.3

understanding also allow the effective design of molecular structure for function, e.g. the production of a new polymeric material or new commodity chemicals with new properties. Bioprocessing has initiated the use of renewables as a feedstock and greater numbers of chemical transformations will follow closely as the benefits of sustainable feedstocks are recognised [86].

5.2 Examples of the use of renewable feedstocks for the production of chemicals

Conventional transformation of renewable feedstocks to products is not common in the chemical industry. In many cases, the products are those that can be isolated from existing renewable resources without further structural transformation. Examples include extractives from the pulp and paper industry used in the production of turpentine, tall oils and rosins [87], the production of oils from corn or other oil crops [88] or starch-based polymers [89]. Other products are made by simple derivatisation of the materials found naturally occurring in biomass. The pulp and paper industry produces a number of chemicals, including a wide range of cellulose derivatives such as cellulose esters and ethers, rayons, cellophane, etc. A few well-known routes exist for the conversion of renewables to low-molecular-weight monomeric products. Glucose is converted to sorbitol by catalytic hydrogenation (US production of about 1.8×10^5 t in 1990) [90] and to gluconic acid by oxidation (US production of about 6.8×10^3 t in 1989) [90]. Xylitol also is produced from xylose by hydrogenation [91]. Furfural is manufactured by the acidic dehydration of corn by-products (3.5×10^4 t in 1989) [90]. Vanillin (1.2×10^7 kg year⁻¹ demand

worldwide) [92] and dimethylsulfoxide have been produced commercially from lignin.

There are some renewables-based materials under development that have promise but whose production is not yet commercialised. Levulinic acid is an example of a platform chemical, one that could serve as a starting material for many other products if it were inexpensive enough [93]. The production of levulinic acid from waste paper currently is being demonstrated at a 1 t day⁻¹ pilot facility, showing that the material can be made available at low cost. Additional work has indicated that inexpensive levulinic acid can be converted to other items that are potentially valuable in industry (Fig. 14.6).

Laboratory scale work shows that levulinic acid can be converted to methyltetrahydrofuran—an automobile fuel extender [94]—in 83% yield [95]. Because the USA uses about 100 billion gallons of gasoline per year, replacement of as little as 1% (similar in volume to the usage of ethanol in gasohol) would result in a yearly demand of 1 billion gallons of methyltetrahydrofuran, which is equivalent to over 10 billion pounds of levulinic acid.

Levulinic acid also can be converted into δ -aminolevulinic acid (DALA), a broad-spectrum herbicide that is completely biodegradable [96]. More recently, DALA has been found to be useful as an insecticide [97] and as a component in photodynamic therapy for the treatment of cancer [98]. A new approach to DALA starting from levulinic acid affords DALA (as the hydrochloride salt) in greater than 90% purity, giving a process that could be viable commercially [99].

Diphenolic acid (DPA) is a material that has found wide application in the production of polymers and other materials. It is prepared easily from the reaction of levulinic acid with two moles of phenol [100] and can serve in many of the same applications as bisphenol A but the lower cost of the latter has reduced the DPA market. Because the Biofine process offers levulinic acid at a much lower cost, it is reasonable again to consider DPA as a renewables-based polymer precursor.

Levogluconan and levogluconenone (Fig. 14.7, compounds **4** and **5**) are products of sugar pyrolysis. Hydroxymethylfurfural (**6**) is made by acid treatment of sugars. Levogluconan has been produced on a small pilot scale by RTI in Canada. All three materials have been touted as important, renewables-based platform chemicals, but to date no

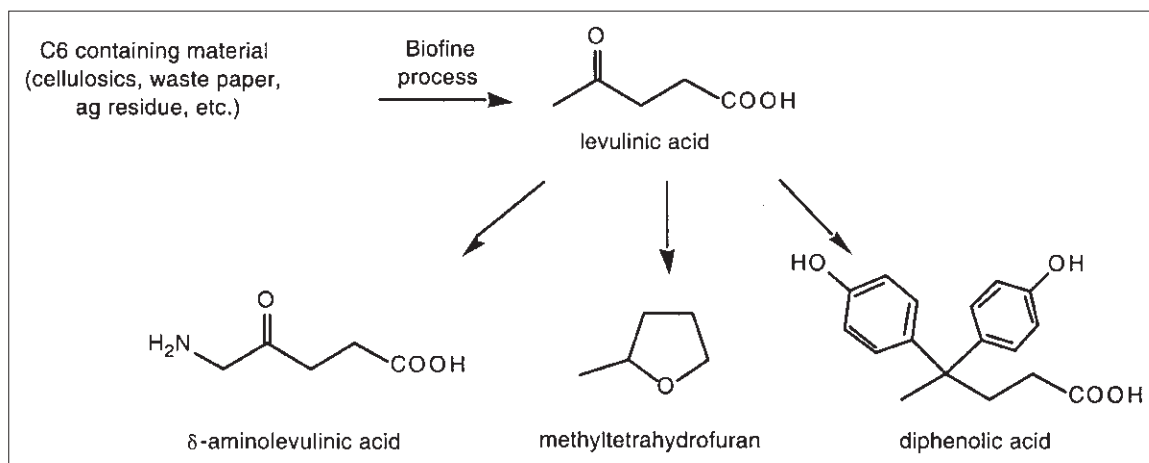


Fig. 14.6 Levulinic acid as a platform chemical.

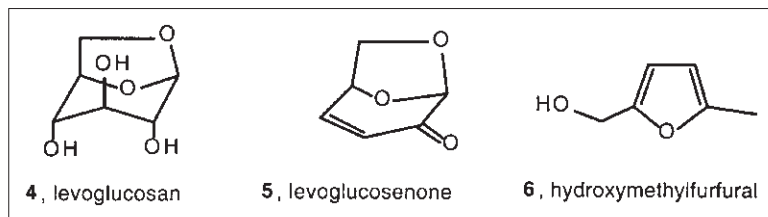


Fig. 14.7 Chemical building blocks available from carbohydrates.

commercially viable applications have appeared [101]. Recently, Iowa State University and RTI began an investigation of levoglucosan hydrolysis to give simple sugars that can be fermented to organic acids or ethanol [102].

Lignin also has been investigated as a chemical feedstock, e.g. in the production of quinones [103], and has been suggested widely as a component in graft copolymers or polymer blends [104]. The use of lignin in the chemical industry is limited mostly to very low value applications, such as drilling muds, asphalt additives and fillers in concrete [87]. The highly heterogeneous structure of lignin and the resulting difficulty in converting it to a single product have hindered its use as a chemical feedstock.

5.3 Bioproduction of chemicals in industry

The most successful route so far for introducing renewables to the chemical industry has been through biotechnology, although its use for the green production of large-volume chemicals is only

starting to be realised. Most examples of the use of organisms or enzymatic steps in the production of chemicals has been limited to low-volume, high-value fine chemicals and pharmaceuticals such as oligosaccharides, amino acids, purines, vitamins, nicotine or indigo [40,105]. This is a sensible first application, given the strict structural requirements of many of these speciality materials. Biocatalysts are generally unchallenged in their ability to provide the stereo-, regio- and enantioselectivity required by these speciality products. However, bioprocesses also possess some attractive features that suggest they would be useful for the greening of larger scale operations [106]. The utility of biotechnology in the production of bulk chemicals has been reviewed and an economic evaluation of the necessary technology has been presented [91]. The development of more robust biological systems that can operate in extreme conditions (temperature, low water levels, in organic solvents, high hydrostatic pressure) also will broaden their applicability [107].

The industry is not without examples of reason-

Table 14.5 Current industrial-scale use of bioprocessing [108]

	10 ³ t year ⁻¹	US\$t ⁻¹
Glucose	15000	600
Ethanol	13000	400
Fructose	1000	800
Citric acid	800	1700
Monosodium glutamate	800	1900
L-Lysine	350	2200
L-Lactic acid	70	2100
L-Ascorbic acid	60	1000
Gluconic acid	40	1700
Xanthan	30	8000
Penicillin G	25	20000
Aspartame	15	40000

ably large-scale biotechnology processes (Table 14.5) [108]. In some of the cases, the operations have been used for many years because there is no equivalent non-biological route. Ethanol and lactic acid are of particular interest because they represent chemicals whose original non-biological production has been replaced almost totally by biochemical manufacture. In addition, the pulp and paper industry has started to incorporate enzyme treatments into their pulping and bleaching sequences [109] and low-lactose milk is produced by treating milk with β -galactosidase. Up to 250 000 l are converted daily [110].

Lactic acid is a good example of a platform chemical available from bioprocessing [111]. Factors affecting the fermentation of lactic acid have been reviewed [112]. The primary interest in lactic acid today is for the production of poly(lactic acid) as a 'green' polymer that undergoes decomposition upon disposal [113]. It is being positioned as a biodegradable replacement for use in markets now dominated by polyolefins. A 1.4×10^5 t year⁻¹ production facility currently is being built by Cargill-Dow polymers. Lactic acid self-polymerises poorly, so it is converted initially to the dilactide, a material that readily forms a polyester with high molecular weight (Fig. 14.8) upon ring opening. In addition, lactic acid can serve as a starting material for several other compounds of industrial interest, including acetaldehyde, propylene glycol, acrylic acid and 2,3-pentanedione [114].

Bioproduction of other polymers is also an emerging area of growth, although apart from the work on polylactic acid there are few commercial examples.

Much of the work tries to focus attention on the green nature of the polymers, but that aspect yet has to be proven conclusively, and life-cycle analysis will need to be carried out [115]. Other papers describe some criteria for new polymers with regard to composting and recycling [116]. The most publicised class of biopolymers are the poly(hydroxyalkanoates) [117], but other materials that have been reported include poly(γ -glutamic acid) [118], poly(aspartic acid) [119], polycarbonates and polyesters [120].

An important new example of industrial biotechnology is the Mitsubishi Rayon process for acrylamide, currently operating on a 3×10^4 t year⁻¹ basis by the treatment of acrylonitrile with nitrile hydratase from *Rhodococcus rhodochrous* [121]. This methodology is unique because a non-sugar starting material is treated with an enzyme to generate a well-known and high-volume commodity chemical. The same enzyme is being used for the production of nicotinamide on a scale of 3×10^3 t year⁻¹ [122] and also has been reported as part of a new route to acrylic acid [123].

New demonstrations of biotechnology are appearing in the production of herbicides and agrochemicals, materials that have a larger production volume and market than many fine chemicals [124]. (In 1987, the synthetic herbicide market in the USA was 4.4×10^5 t.) DuPont has reported a biochemical route to glyphosate, the principal component of the broad-spectrum herbicide Roundup (Scheme 14.20) [125].

The investigation revealed that the ability to oxidise glycolic acid to glyoxylic acid with oxygen was improved by the presence of an aminomethylphosphonic acid buffer. Hydrogenation and acidification of the reaction mixture, which contained an equilibrium concentration of several intermediate species, eventually afforded glyphosate as the final product. Proper adjustment of conditions gave a 98% conversion of aminomethylphosphonic acid to glyphosate.

A significant advantage for biocatalysis is seen clearly in the manufacture of optically active materials. For example, BASF currently is investigating the use of a lipase from *Pseudomonas* for the production of optically active amines. The technology is being investigated on a scale of 100 t year⁻¹ and is being directed at the production of a herbicide called Frontier X2. Successful commercial production of

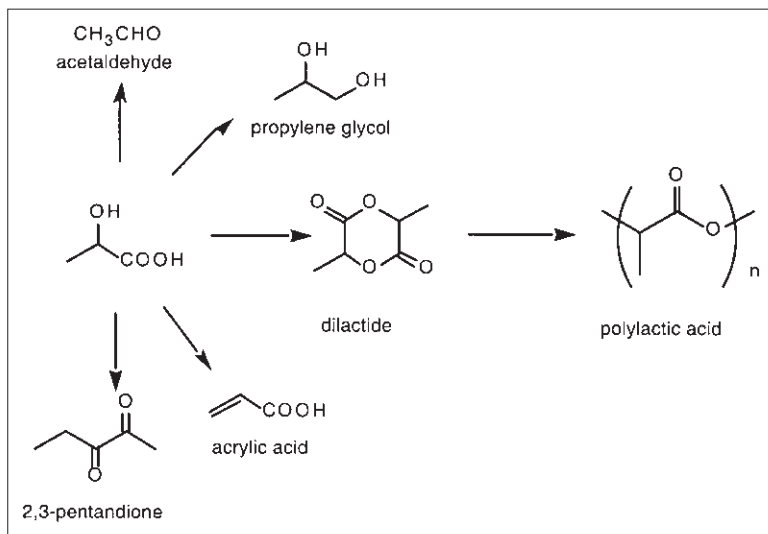
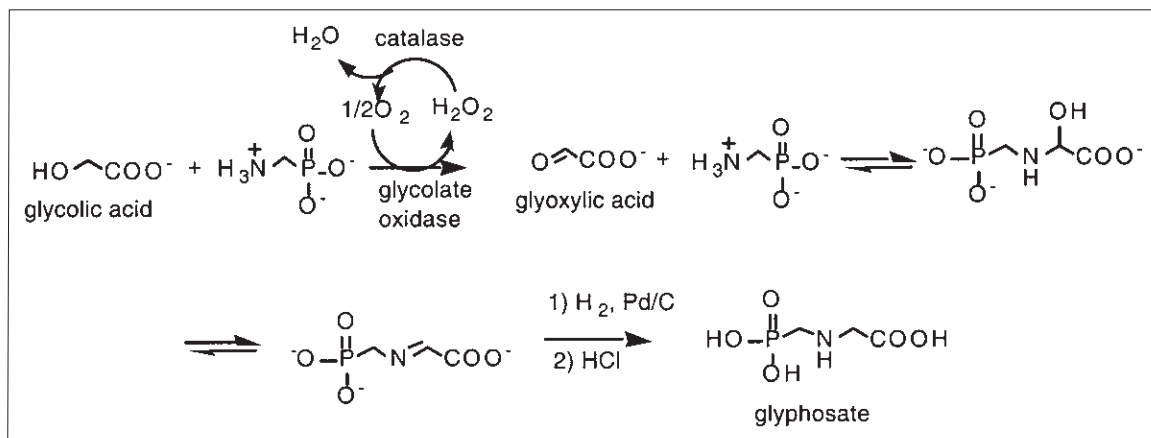


Fig. 14.8 Uses for lactic acid.



Scheme 14.20

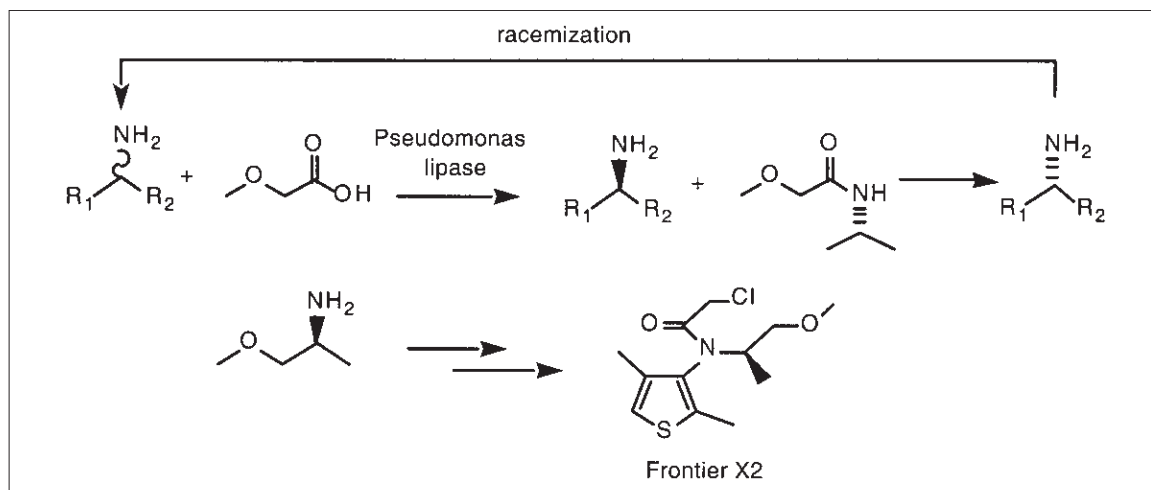
this herbicide will be one of the largest scale examples of a biocatalytic process (Scheme 14.21) [126].

Reaction of a racemic amine with methoxyacetic acid in the presence of the lipase gives a selective amidation of the unwanted enantiomer. The remaining optically pure amine then is converted to the herbicide. Hydrolysis of the amide gives a free amine that can be racemised and recycled to the initial biochemical step. Eventually, very high conversions of the starting amine are realised.

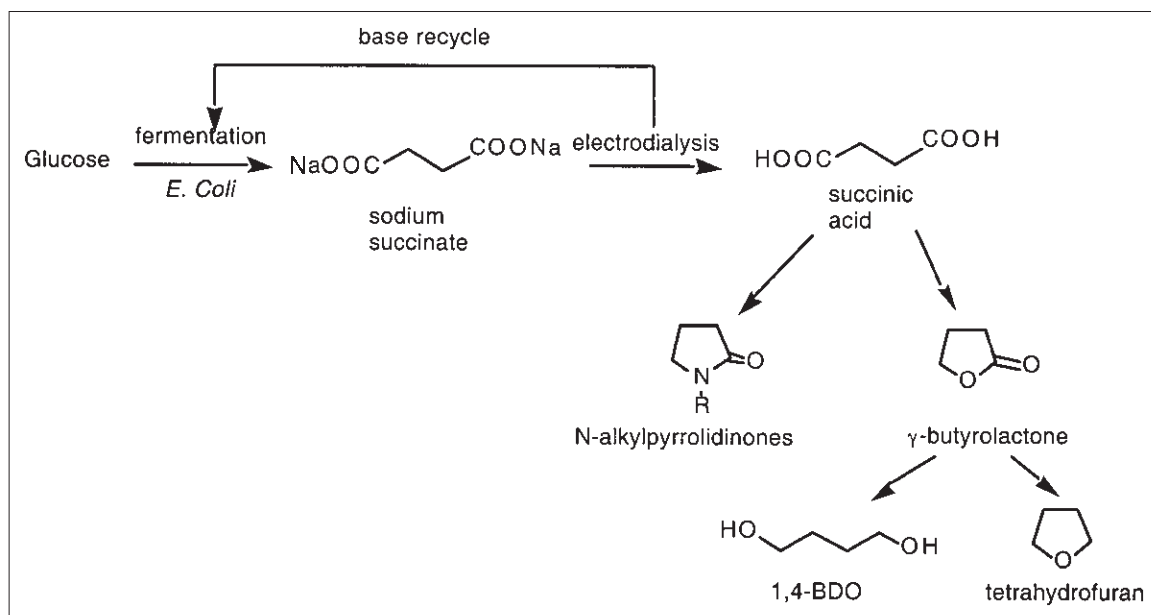
Succinic acid has been recognised as a possible

commercial building block from biotechnology [127]. Like levulinic acid, succinic acid is another example of a platform chemical. Succinic acid has been used traditionally in speciality applications [128] and is produced at a level of $1.5 \times 10^4 \text{ t year}^{-1}$. New process technology currently being scaled up suggests that it would be useful for the production of much larger volume materials such as 1,4-butanediol (BDO), tetrahydrofuran, γ -butyrolactone and *N*-methyl pyrrolidinone [129]. These products have a combined market of over $2.75 \times 10^5 \text{ t year}^{-1}$.

Many attempts have been made to develop a fermentation for the production of succinic acid from renewable feedstocks [130] but none of these have



Scheme 14.21



Scheme 14.22

been applied towards commercial production. More recently, an approach based on the use of an engineered *E. coli* bacterium has been shown to be effective on a commercial scale (Scheme 14.22) [131]. The process is being commercialized currently by Applied CarboChemicals, Inc. In this new process,

glucose is fermented to form the intermediate sodium succinate. The salt is converted to succinic acid and base by water-splitting electrolysis, followed by recycling of the base to the fermentation step. Concentrations of succinic acid as high as 54g l^{-1} have been observed at glucose conversion levels of $0.7\text{g succinic acid g}^{-1}$ glucose consumed. Production of BDO based on bioderived succinic

acid has been projected to have the lowest cost in comparison with other routes currently being used industrially.

Both 1,2-propanediol and 1,3-propanediol can be derived from the common biological intermediate dihydroxyacetone phosphate, a product of sugar metabolism. Over 4.5×10^5 t of 1,2-propanediol (propylene glycol) currently is produced from propene. Cameron has developed a biochemical process for the production of 1,2-propanediol from glucose by engineering a new metabolic path in *E. coli* [132]. 1,2-Propanediol is a particularly interesting target for green process technology because commercial production proceeds by hydration of propylene oxide, derived from the corresponding chlorohydrin or via a hydroperoxide [133]. Both commercial routes generate waste salt.

1,3-Propanediol is being developed as a component of new polyesters, specifically, poly(propylene terephthalate). The market for this material is beginning to develop with DuPont and Genencor's announced intent to make a polymer based on 1,3-propanediol commercially [134]. This material would be related to other polyesters such as poly(butylene terephthalate), from 1,4-butanediol, and poly(ethylene terephthalate), from ethylene glycol. The resulting polyester family could have a broad range of uses because variation of chain length in the diol component of polyesters imparts unique properties to the resulting polymer [135]. The current bioprocessing route uses glycerol as a start-

ing material, which is relatively expensive, thus recent work on 1,3-propanediol production has been directed at sugar fermentation. Interest in biodiesel also could reduce the price of glycerol. Production of 10 kg of biodiesel gives 1 kg of glycerol as a by-product that could be used for lower cost production of 1,3-propanediol [136].

Frost has reported several biochemical transformations that could be useful in the future for commodity chemical manufacture (Fig. 14.9). A new approach to adipic acid eliminates all toxic, non-renewable components by replacing them with an elegant biosynthetic pathway. Starting from glucose, adipic acid was produced by an engineered *E. coli* organism via *cis,cis*-muconic acid as an intermediate [137]. Additional research has revealed routes to catechol [138] and vanillin [139]. These transformations provide another example of reaction control through understanding of mechanism. The different biochemical paths by which glucose is metabolised are well characterised. Hence, the product distribution could be changed by altering the mechanism towards production of the materials of interest.

As with non-biological catalysis, bioprocessing has found utility in the production of the more active optically pure forms of ibuprofen and naproxen. The conventional biochemical approach uses kinetic resolution via asymmetric enzymatic hydrolysis of precursor esters in an aqueous system [140]. Other organisms have been studied for hydrolysis of the racemic acid or amide derivative [141]. For highest

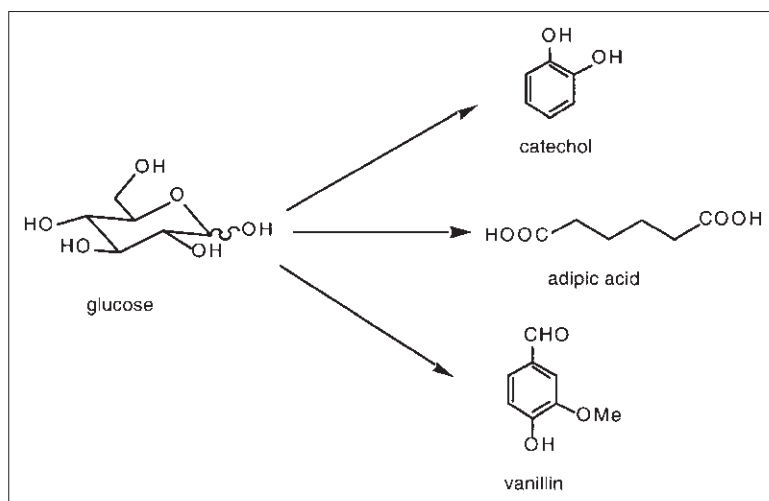
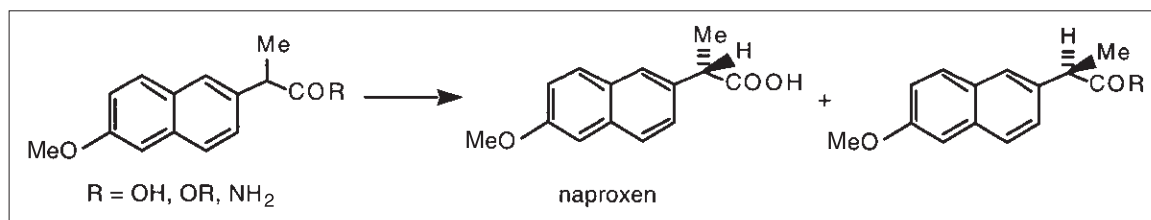


Fig. 14.9 Biochemical transformations of glucose to industrial chemicals.



Scheme 14.23

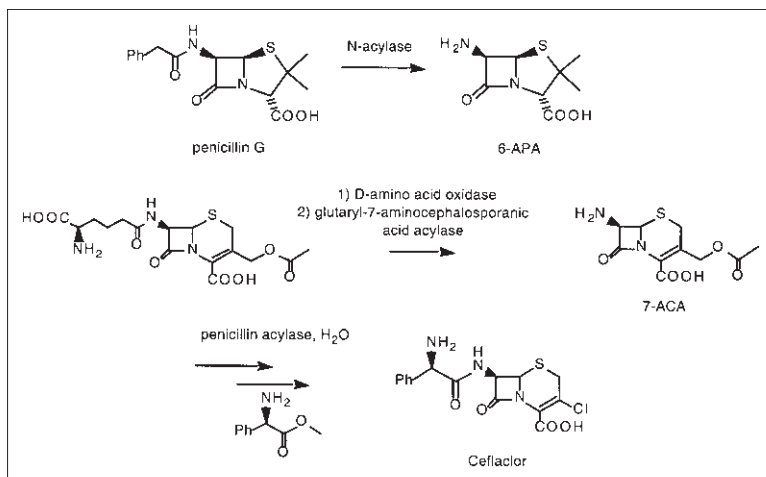


Fig. 14.10 Biochemical approaches to industrial antibiotics.

efficiency, a route needs to include a recycle step for the non-hydrolysed product, otherwise the final yield is limited to 50% (Scheme 14.23).

Lipase-based asymmetric esterifications of profens [142] has been used industrially for the synthesis of profen-based prodrugs because of the known gastrointestinal side effects that occur upon administration of the pure acid. Derivatisation of the acid as an ester lowers these side effects by allowing the ester hydrolysis to occur *in vivo*. Under these conditions, one enantiomer of racemic ibuprofen is esterified by *Rhizomucor miehei* lipase in enantiomeric excesses as high as 97%. In the case of the profens, many different types of prodrugs have been suggested and could be produced by similar technology [143].

One of the largest pharmaceutical uses for bioprocessing is in the production of semi-synthetic penicillins and cephalosporins. Key starting materials in this industry include the fermentatively produced penicillins G and V and cephalosporin C. New analogues are prepared by the enzymatic deacylation of

the starting material to give 6-aminopenicillanic acid or 7-aminocephalosporanic acid [144]. Semi-synthetic antibiotics are formed by reaction of the free amine with different acylating agents. Formation of 7-ACA is a step in the manufacture of the commercial antibiotic Cefaclor (Fig. 14.10).

6 Conclusions

The chemical industry is becoming more sensitised to the perception of black and red manufacturing and its effect on the environment and society. In recent years, the industry has been working to address these issues, especially as a compelling case is being made that a green approach also can be a profitable approach. The impact of green technology will be felt gradually as greater numbers of processes are improved. Catalysis has earned the right to be included as a key component of atom-economical low-waste manufacturing, and will continue to lead the drive to streamline multistep industrial process.

Renewable feedstocks are inherently green and will play an important role in future process technology but will require a different infrastructure for their collection and conversion for industrial use and development of a much broader range of technologies and tools for their efficient conversion to marketplace products. Bioprocessing stands as the first example of a successful wedding of renewable feedstocks and catalysis, and could spur the development of a much wider array of non-biological processes for biomass conversion. The industry is evolving and green process technology will continue to play a key role in this evolution.

References

- Pereira, C. J. *Chem. Eng. Sci.*, 1999, **54**, 1959.
- Sheldon, R. A. *Green Chem.*, 2000, **2**, G1.
- Anastas, P. T., Bartlett, L. B., Kirchoff, M. M., & Williamson, T. C. *Catal. Today*, 2000, **55**, 11.
- Weissermel, K., & Arpe, H.-J. *Industrial Organic Chemistry*, 3rd edn. VCH, Weinheim, 1997.
- Crowl, D. A. *Inherently Safer Processes: a Life Cycle Approach*. Center for Chemical Process Safety, American Institute of Chemical Engineers, New York, 1996.
- Lancaster, M. *Green Chem.*, 2000, **3**, G65.
- (a) Sheldon, R. A. *Chemtech*, 1994, **24**(3), 38; (b) In one of the more stinging indictments of organic synthesis, Sheldon writes: 'In short, organic synthesis is going through a rough patch. It has lost its direction because it is no longer in touch with the needs of industry, which are derived from those of society. Organic synthesis has become a primarily intellectual exercise, much like playing chess.'
- Gerngross, T. In *Chemicals and Materials from Renewable Resources* (Bozell, J. J., ed.), ACS Symposium Series. American Chemical Society, Washington, DC, 2001, p. 10. Gerngross, T.U., & Slater, S. *Sci. Am.*, 2000, **Aug.**, 36.
- Herrmann, W. A., & Cornils, B. *Angew. Chem. Int. Ed.*, 1997, **36**, 1048.
- Armor, J. N. *Appl. Catal. A*, 1999, **189**, 153.
- Pletcher, D., & Walsh, F. C. *Industrial Electrochemistry*, 2nd edn. Chapman and Hall, London, 1990, p. 298.
- Graedel, T. *Green Chem.*, 1999, **1**, G126.
- Yadav, G. D., & Krishnan, M. S. *Org. Process Res. Dev.*, 1998, **2**, 86; Turner, K. *Org. Proc. Res. Dev.*, 1998, **2**, 431; Yadav, G. D., & Krishnan, M. S. *Org. Process Res. Dev.*, 1998, **2**, 432.
- Clift, R. J. *Chem. Tech. Biotech.*, 1997, **68**, 347.
- Iwahama, T., Sakaguchi, S., & Ishii, Y. *Org. Process Res. Dev.*, 2000, **4**, 94; Bianchi, D., Bortolo, R., D'Aloisio, R., & Ricci, M. *Angew. Chem. Int. Ed.*, 1999, **38**, 706.
- Trost, B. M. *Science*, 1991, **254**, 1471; Trost, B. M. *Angew. Chem. Int. Ed.*, 1995, **34**, 259.
- Holderich, W. F., Roseler, J., Heitmann, G., & Liebens, A. T. *Catal. Today*, 1997, **37**, 353.
- Rozzell, J. D. *Bioorg. Med. Chem.*, 1999, **7**, 2253.
- Blaser, H.-U., & Studer, M. *Appl. Catal. A*, 1999, **189**, 191.
- Malonowski, S., & Marczewski, M. In *Catalysis* (Bond, G. C., ed.), Vol. 8. RSC, Cambridge, 1989, Chapt. 4.
- Weissermel, K., & Arpe, H.-J. *Industrial Organic Chemistry*, 3rd edn. VCH, Weinheim, 1997, pp. 335–339.
- Clark, J. H., & Macquarrie, D. J. *Org. Process Res. Dev.* 1997, **1**, 149; Vaccari, A. *Catal. Today*, 1998, **41**, 53; Ono, Y., & Baba, T. *Catal. Today*, 1997, **38**, 321.
- Sheldon, R. A., & Dakka, J. *Catal. Today*, 1994, **19**, 215.
- Weissermel, K., & Arpe, H.-J. *Industrial Organic Chemistry*, 3rd edn. VCH, Weinheim, 1997, p. 251.
- Sato, H., Hirose, K., Kitamura, M., & Nakamura, Y. *Stud. Surf. Sci. Catal.*, 1989, **49**, 1213.
- Weissermel, K., & Arpe, H.-J. *Industrial Organic Chemistry*, 3rd edn. VCH, Weinheim, 1997, p. 241.
- Sheldon, R. A., & Downing, R. S. *Appl. Catal. A*, 1999, **189**, 163.
- Chauvel, A., Delmon, A., & Holderich, W. F. *Appl. Catal. A*, 1994, **115**, 173.
- Notari, B. *Stud. Surf. Sci. Catal.*, 1988, **37**, 413.
- Holderich, W. F., & Heitmann, G. *Catal. Today*, 1997, **38**, 227.
- Bashkin, J., Rains, R., & Stern, M. *Green Chem.*, 1999, **1**, G41; Stern, M. K., Cheng, B. K., Hileman, F. D., & Allman, J. M. *J. Org. Chem.*, 1994, **59**, 5627.
- Roth, J. F., Craddock, J. H., Hershman, A., & Paulik, F. E. *Chemtech*, 1971, **1**(10), 600.
- Blaser, H.-U., Indolese, A., & Schnyder, A. *Curr. Sci.*, 2000, **78**, 1336.
- Otake, M. *Chemtech*, 1995, **25**(9), 36.
- Forster, D. *Adv. Organomet. Chem.*, 1979, **17**, 255.
- Cornils, B., & Herrmann, W. A. *Aqueous-Phase Organometallic Catalysis—Concepts and Applications*. Wiley-VCH, Weinheim, 1998.
- Weissermel, K., & Arpe, H.-J. *Industrial Organic Chemistry*, 3rd edn. VCH, Weinheim, 1997, p. 245.
- Tolman, C. A. *J. Chem. Educ.*, 1986, **63**, 199.
- Knowles, W. S. *J. Chem. Educ.*, 1986, **63**, 222.
- Bommarius, A. S., Schwarm, M., & Drauz, K. *J. Mol. Catal. B*, 1998, **5**, 1.
- Akutagawa, S. *Top. Catal.*, 1997, **4**, 271.
- Cornils, B. *J. Mol. Catal. A*, 1999, **143**, 1; Sheldon, R. A. *J. Mol. Catal. A*, 1996, **107**, 75.
- Cornils, B. *Org. Process Res. Dev.*, 1998, **2**, 121.
- Cornils, B., Herrmann, W. A., & Eckl, R. W. *J. Mol. Catal. A*, 1997, **116**, 27.
- Ullmann's Encyclopedia of Industrial Chemistry*, Vol. A27. VCH, Weinheim, 1996, p. 478.

46. Sandee, A. J., van der Veen, L. A., Reek, J. N. H., Kamer, P. C. J., et al. *Angew. Chem. Int. Ed.*, 1999, **38**, 3231.
47. Chaudhari, R. V., Bhanage, B. M., Deshpande, R. M., & Delmas, H. *Nature*, 1995, **373**, 501.
48. Bozell, J. J., Hoberg, J. O., & Dimmel, D. R. *J. Wood Chem. Technol.*, 2000, **20**, 19, and references therein.
49. Davis, D. D., & Kemp, D. R. *Kirk Othmer Encyclopedia of Chemical Technology*, 4th edn, Vol. 1. Wiley, New York, 1991, p. 466.
50. Bolm, C., Beckmann, O., & Dabard, O. A. G. *Angew. Chem. Int. Ed.*, 1999, **38**, 907.
51. Sato, K., Aoki, M., & Noyori, R. *Science*, 1998, **281**, 1646.
52. Deng, Y., Ma, Z., Wang, K., & Chen, J. *Green Chem.*, 1999, **1**, 275.
53. Hayashi, T., Kishida, A., & Mizuno, N. *Chem. Commun.*, 2000, 381.
54. Iwahama, T., Syojo, K., Skakguchi, S., & Ishii, Y. *Org. Process Res. Dev.*, 1998, **2**, 255.
55. Ono, Y. *Appl. Catal. A*, 1997, **155**, 133.
56. Feldman, D., & Barbalata, A. *Synthetic Polymers, Technology, Properties, Applications*. Chapman and Hall, London, 1996, p. 273.
57. Pacheco, M. A., & Marshall, C. L. *Energy Fuels*, 1997, **11**, 2.
58. Kricsfalussy, Z., Waldmann, H., & Traenckner, H.-J. *Ind. Eng. Chem. Res.*, 1998, **37**, 865; Sato, Y., Kagotani, M., & Souma, Y. *J. Mol. Catal. A*, 2000, **151**, 79.
59. Sakakura, T., Choi, J.-C., Saito, Y., & Sako, T. *Polyhedron*, 2000, **19**, 573.
60. Xiaoding, X., & Mouljin, J. A. *Energy Fuels*, 1996, **10**, 305.
61. Lindley, D. D., Curtis, T. A., Ryan, T. R., de la Graza, E. M., Hilton, C. B., & Kenesson, T. M. US Patent 5068448 to Hoechst-Celanese, 1991; Elango, N., Murphy, M. A., Smith, B. L., Davenport, K. G., Mott, G. N., & Moss, G. L. European Patent Application 0284310 to Hoechst-Celanese, 1988.
62. Margolin, A. L. *Enzyme Microb. Technol.*, 1993, **15**, 266.
63. Harrington, P. J., & Lodewijk, E. *Org. Process Res. Dev.*, 1997, **1**, 72.
64. Ohta, T., Takaya, H., Kitamura, M., Nagai, K., & Noyori, R. *J. Org. Chem.*, 1988, **52**, 3174; Wan, K. T., & Davis, M. E. *Nature*, 1994, **370**, 449.
65. Monteiro, A. L., Zinn, F. K., deSouza, R. F., & Dupont, J. *Tetrahedron: Asymm.*, 1997, **8**, 177.
66. Zhou, H., Cheng, J., Lu, S., Fu, H., & Wang, H. *J. Organomet. Chem.*, 1998, **556**, 239; Xie, B.-H., Xia, C.-G., Lu, S.-J., Chen, K.-J., Kou, Y., & Yin, Y.-Q. *Tetrahedron Lett.*, 1998, **39**, 7365.
67. Wu, T.-C. US Patent 5536870 to Albemarle, 1996.
68. Baumeister, P., Meyer, W., Oertle, K., Seifert, G., Siegrist, U., & Steiner, H. *Stud. Surf. Sci. Catal.*, 1997, **108**, 37.
69. Spindler, F., Pugin, B., Jalett, H. P., Buser, H. P., Pittelkow, U., & Blaser, H.-U. *Chem. Ind.*, 1996, **68**, 153.
70. Brunel, J. M., Heumann, A., & Buono, G. *Angew. Chem. Int. Ed.*, 2000, **39**, 1946; Ohff, M., Ohff, A., & Milstein, D. *Chem. Commun.*, 1999, 295.
71. Mills, P. L., & Chaudhari, R. V. *Catal. Today*, 1997, **37**, 367.
72. Lichtenthaler, F. W. *Carb. Res.*, 1998, **313**, 69.
73. Morris, D., & Ahmed, I. *The Carbohydrate Economy: Making Chemicals and Industrial Materials from Plant Matter*. Institute for Local Self Reliance, Washington, DC, 1992.
74. Bender, M. H. *Resour. Conserv. Recycl.*, 2000, **30**, 49; *US Department of Energy Annual Energy Review 1997*. Energy Information Agency, Washington, DC, 1998, available at <http://www.eia.gov/pub/energy/overview/>; Donaldson, T. L., & Culberson, O. L. *Energy*, 1984, **9**, 693; Lipinsky, E. S. *Science*, 1981, **212**, 1465; Hanselmann, K. W. *Experientia*, 1982, **38**, 176; Goheen, D. W. *J. Chem. Educ.*, 1981, **58**, 544; Kovaly, K. A. *Chemtech*, 1982, **12**(8), 487; Kleinhanss, W. *Zuckerindustrie*, 1988, **113**, 939; Kennedy, J. F., & Melo, E. H. M. *Br. Polym. J.*, 1990, **23**, 193.
75. Indergaard, M., Johansson, A., & Crawford, Jr., B. *Chimia*, 1989, **43**, 230.
76. *Kirk-Othmer Encyclopedia of Chemical Technology*, 4th edn, Vol. 12. John Wiley, New York, 1994, p. 16; Goldstein, I. S. *Organic Chemicals from Biomass*. CRC Press, Boca Raton, FL, 1981, Chapt. 1; Goldstein, I. S. *Forest Prod. J.*, 1981, **31**, 63.
77. Anon. *Science*, 1998, **281**, 1128.
78. *Energy Information Administration, Annual Energy Review 1997*, DOE/EIA-0384(97). (Washington, DC, July 1998); information also available at <http://www.eia.doe.gov>.
79. Okkerse, C., & van Bekkum, H. *Green Chem.*, 1999, **1**, 107.
80. McLaren, J. S. *J. Chem. Tech. Biotech.*, 2000, **75**, 927.
81. Varadarajan, S., & Miller, D. J. *Biotechnol. Prog.*, 1999, **15**, 845.
82. *North American Pulp and Paper Factbook*. Miller Freeman, San Francisco.
83. Kuhad, R. C., & Singh, A. *Crit. Rev. Biotech.*, 1993, **13**, 151.
84. Bols, M. *Carbohydrate Building Blocks*. Wiley-Interscience, New York, 1996; Lichtenthaler, F., & Mondel, S. *Pure Appl. Chem.*, 1997, **68**, 1853; Chemical Market Reporter; National Corn Growers Association.
85. Lynd, L. R., Wyman, C. E., & Gerngross, T. U. *Biotechnol. Prog.*, 1998, **15**, 777.
86. Andrews, M. In *Green Chemistry. Frontiers in Benign Chemical Syntheses and Processes* (Anastas, P. T., & Williamson, T. C., eds). Oxford University Press, Oxford, 1998, Chapt. 7.

87. Fengel, D., & Wegener, G. *Wood: Chemistry, Ultrastructure and Reactions*. Walter DeGruyter, New York, 1984.
88. Murphy, D. J. *Designer Oil Crops. Breeding, Processing and Biotechnology*. VCH, Weinheim, 1994.
89. Bastioli, C. In *Carbohydrates as Organic Raw Material IV* (Praznik, W., & Huber, A., eds). WUV, Vienna, 1998, p. 218.
90. Bozell, J. J., & Landucci, R. *Alternative Feedstocks Program Technical and Economic Assessment: Thermal/Chemical and Bioprocessing Components*. US Department of Energy Office of Industrial Technologies, Washington, DC, 1993.
91. Melaja, A., & Hemalainen, L. US Patent 4008285, 1977.
92. Clark, G. S. *Perfum. Flavor.*, 1990, **15**, 45.
93. Bozell, J. J., Moens, L., Elliott, D. C., Wang, Y., et al. *Resour. Conserv. Recycl.*, 2000, **28**, 227.
94. Thomas, J. J., & Barile, R. G. *Energy Biomass Wastes*, 1984, **8**, 1461.
95. Elliott, D. C., & Frye, Jr., J. G. US Patent 5883266 to Battelle Memorial Institute, 1999.
96. Rebeiz, C. A., Montazer-Zouhoor, A., Hopen, H. J., & Wu, S. M. *Enzyme Microb. Technol.*, 1984, **6**, 390; Rebeiz, C. A., Amindari, S., Reddy, K. N., Nandihalli, U. B., Moubarak, M. B., & Velu, J. A. In *Porphyric Pesticides: Chemistry, Toxicology, and Pharmaceutical Applications*, ACS Symposium Series 559. American Chemical Society, Washington, DC, 1994.
97. Rebeiz, C. A., Juvik, J. A., & Rebeiz, C. C. *Pestic. Biochem. Physiol.*, 1988, **30**, 11.
98. Rebeiz, N., Arkins, S., Rebeiz, C. A., Simon, J., Zachary, J. F., & Kelley, K. W. *Cancer Res.*, 1996, **56**, 339.
99. Moens, L. US Patent 5907058, to Midwest Research Institute, 1999.
100. Isoda, Y., & Azuma, M. Japanese Patent 08053390 to Honshu Chemical Industries, 1996.
101. Witzcak, Z. J. *Levoglucosone and Levoglucosans. Chemistry and Applications*. ATL Press, Mount Prospect, IL, 1994; Schiweck, H., Munir, M., Rapp, K. M., Schneider, B., & Vogel, M. In *Carbohydrates as Organic Raw Materials* (Lichtenthaler, F. W., ed.). VCH, Weinheim, 1991, Chapt. 3.
102. So, K., & Brown, R. C. *Appl. Biochem. Biotechnol.*, 1999, **77-79**, 633.
103. Bozell, J. J., Hames, B. R., & Dimmel, D. R. *J. Org. Chem.*, 1995, **60**, 2398.
104. Mai, C., Majcherzyk, A., & Hutterman, A. *Enzyme Microb. Technol.*, 2000, **27**, 167, and references therein.
105. Wandrey, C., Liese, A., & Kihumbu, D. *Org. Process Res. Dev.*, 2000, **4**, 286; Liese, A., & Filho, M. V. *Curr. Opin. Biotechnol.*, 1999, **10**, 595; Schulze, B., & Wubbolts, M. G. *Curr. Opin. Biotechnol.*, 1999, **10**, 609; Petersen, M., & Kiener, A. *Green Chem.*, 1999, **1**, 99.
106. Wackett, L. P. *Trends Biotechnol.*, 2000, **18**, 19.
107. Sellek, G. A., & Chaudhuri, J. B. *Enzyme Microb. Technol.*, 1999, **25**, 471; Adams, M. W. W., Perler, F. B., & Kelly, R. M. *Biotechnology*, 1995, **13**, 662; Niehaus, F., Bertoldo, C., Kahler, M., & Antranikian, G. *Appl. Microbiol. Biotechnol.*, 1999, **51**, 711; Gerday, C., Aittaleb, M., Bentahir, M., Chessa, J.-P., et al. *Trends Biotechnol.*, 2000, **18**, 103.
108. Wilke, D. *Appl. Microbiol. Biotechnol.*, 1999, **52**, 135.
109. Bajpai, P. *Biotechnol. Prog.*, 1999, **15**, 147.
110. Liese, A., & Filho, M. V. *Curr. Opin. Biotechnol.*, 1999, **10**, 595.
111. Van Velthuisen, J. A. In *Carbohydrates as Organic Raw Materials III* (Van Bekkum, H., Roper, H., & Voragen, A. G. J., eds). VCH, Weinheim, 1996, Chapt. 7; Lipinsky, E. S., & Sinclair, R. G. *Chem. Eng. Prog.*, 1986, **82**, 26.
112. Hofvendahl, K., & Hahn-Hagerdal, B. *Enzyme Microb. Technol.*, 2000, **26**, 87.
113. Ghorpade, V. M., Gennadios, A., & Hanna, M. A. *Biores. Technol.*, 2000, **76**, 57.
114. Varadarajan, S., & Miller, D. J. *Biotechnol. Prog.*, 1999, **15**, 845; Lunt, J. *Polym. Degrad. Stabil.*, 1998, **59**, 145; Danner, H., Urmos, M., Gartner, M., & Braun, R. *Appl. Biochem. Biotechnol.*, 1998, **70-72**, 887.
115. Scott, G. *Polym. Degrad. Stabil.*, 2000, **68**, 1.
116. De Wilde, B., & Boelens, J. *Polym. Degrad. Stabil.*, 1998, **59**, 7; Swift, G. *Polym. Degrad. Stabil.*, 1998, **59**, 19; Heyde, M. *Polym. Degrad. Stabil.*, 1998, **59**, 3.
117. Pool, R. *Science*, 1989, **245**, 1187; Williams, S. F., & Peoples, O. P. *Chemtech*, 1996, **26**(9), 38; Lee, S. Y. *Nature-Biotechnol.*, 1997, **15**, 17.
118. Perez-Camero, G., Congregado, F., Bou, J. J., & Munoz-Guerra, S. *Biotech. Bioeng.*, 1999, **63**, 110.
119. Larson, R. J., Bookland, E. A., Williams, R. T., Yocom, K. M., et al. *J. Environ. Polym. Degrad.*, 1997, **5**, 41; Schwamborn, M. *Polym. Degrad. Stabil.*, 1998, **59**, 39.
120. Rodney, R. L., Allinson, B. T., Beckman, E. J., & Russell, A. J. *Biotechnol. Bioeng.*, 1999, **65**, 485; Chaudhary, A. K., Lopez, J., Beckman, E. J., & Russell, A. J. *Biotechnol. Prog.*, 1997, **13**, 318.
121. Ogawa, J., & Shimizu, S. *Trends Biotechnol.*, 1999, **17**, 13; Shimizu, S., Ogawa, J., Kataoka, M., & Kobayashi, M. In *New Enzymes for Organic Synthesis* (Scheper, T., ed.). Springer, New York, 1997, p. 45.
122. Meyer, H.-P., Kiener, A., Imwinkelried, R., & Shaw, N. *Chimia*, 1997, **51**, 287.
123. Kobayashi, M., Nagasawa, T., & Yamada, H. *Trends Biotechnol.*, 1992, **10**, 402.
124. Cremlyn, R. J. *Agrochemicals: Preparation and Mode of Action*. John Wiley, New York, 1991, p. 10.
125. Gavagan, J. E., Fager, S. K., Seip, J. E., Clark, D. S., et al. *J. Org. Chem.*, 1997, **62**, 5419.
126. Balkenhohl, F., Ditrich, K., Hauer, B., & Ladner, W. E. *J. Prakt. Chem.*, 1997, **339**, 381; Ladner, W. E., & Ditrich, K. *Chim. Oggi*, 1999, **7/8**, 51.

127. Zeikus, J. G., Jain, M. K., & Elankovan, P. *Appl. Microbiol. Biotechnol.*, 1999, **51**, 545; Nghiem, N. P., Davison, B. H., Donnelly, M. I., Tsai, S.-P., & Frye, J. G. In *Chemicals and Materials from Renewable Resources* (J. J. Bozell, ed.), ACS Symposium Series. American Chemical Society, Washington, DC, 2001, p. 160.
128. Fumagalli, C. In *Kirk-Othmer Encyclopedia of Chemical Technology*, 4th edn, Vol. 22. John Wiley, New York, 1997, p. 1072.
129. Rao, V. N. M. US Patent 4782167 to DuPont, 1988; Mabry, M. A. US Patent 4550185 to DuPont, 1985.
130. Ling, L. B. US Patent 4877731 to DuPont, 1989; Datta, R. US Patent 5143833, 1992; Glassner, D. A. US Patent 5143834, 1992; Guettler, M. V. US Patent 5573931 to Michigan Biotechnology Institute, 1996.
131. Donnelly, M. I., Millard, C. S., Clark, D. P., Chen, M. J., & Rathke, J. W. *Appl. Biochem. Biotechnol.*, 1998, **70/72**, 187; Wang, X., Gong, C. S., & Tsao, G. T. *Appl. Biochem. Biotechnol.*, 1998, **70/72**, 919.
132. Altaras, N. E., & Cameron, D. C. *Appl. Environ. Microbiol.*, 1999, **65**, 1180; Cameron, D. C., Altaras, N. E., Hoffman, M. L., & Shaw, A. J. *Biotechnol. Prog.*, 1998, **14**, 116.
133. Martin, A. E., & Murphy, F. H. In *Kirk-Othmer Encyclopedia of Chemical Technology*, 4th edn, Vol. 17. John Wiley, New York, 1994, p. 715; Trent D. T. In *Kirk-Othmer Encyclopedia of Chemical Technology*, 4th edn, Vol. 20. John Wiley, New York, 1996, p. 271.
134. Anon. *Genet. Eng. News*, 1997, **17**(11), 17.
135. Witt, U., Muller, R. J., Augusta, J., Widdecke, H., & Deckwer, W. D. *Macromol. Chem. Phys.*, 1994, **195**, 793; Smith, J. G., Kibler, C. J., & Sublett, B. J. *J. Polym. Sci. A1*, 1966, **4**, 1851.
136. Papanikolaou, S., Ruiz-Sanchez, P., Pariset, B., Blanchard, F., & Fick, M. *J. Biotechnol.*, 2000, **77**, 191; Meesters, P. A. E. P., Huijberts, G. N. M., & Iggink, G. *Appl. Microbiol. Biotechnol.*, 1996, **45**, 575.
137. Draths, K. M., & Frost, J. W. *J. Am. Chem. Soc.*, 1994, **116**, 399.
138. Draths, K. M., & Frost, J. W. In *Green Chemistry. Frontiers in Benign Chemical Syntheses and Processes* (Anastas, P. T., & Williamson, T. C., eds). Oxford University Press, Oxford, 1998, Chapt. 9.
139. Li, K., & Frost, J. W. *J. Am. Chem. Soc.*, 1998, **120**, 10545.
140. Akita, H., Enoki, Y., Yamada, H., & Oishi, T. *Chem. Pharm. Bull.*, 1989, **37**, 2876.
141. Snell, D., & Colby, J. *Enzyme Microb. Technol.*, 1999, **24**, 160; Effenberger, F., Graef, B. W., & Oßwald, S. *Tetrahedron: Asymm.*, 1997, **8**, 2749.
142. Sanchez, A., Valero, F., Lafuente, J., & Sola, C. *Enzyme Microb. Technol.*, 2000, **27**, 157.
143. Chang, C.-S., & Tsai, S.-W. *Enzyme Microb. Technol.*, 1997, **20**, 635, and references therein.
144. Burgink, A., Roos, E. C., & deVroom, E. *Org. Process Res. Dev.*, 1998, **2**, 128.

Chapter 15: Process Intensification for Green Chemistry

ROSHAN JACHUCK

1 Introduction

The chemicals industry worldwide is facing the challenges of stringent environmental regulations amidst severe market competitiveness. There is a growing demand for processes that are clean, energy efficient, intrinsically safe and responsive to market needs. In order to meet these objectives it is essential to rethink the process design philosophy and adopt a multidisciplinary approach towards problem solving. It is essential that chemists, material scientists, mathematicians and engineers work together as a team and discuss process issues at the outset.

In order to exploit the advances made in the field of green chemistry, it is essential to develop process technology based on the concepts of process intensification. Process intensification was pioneered by Ramshaw [1] in the 1980s and may be defined as a strategy that aims to achieve process miniaturisation, reduction in capital cost, improved inherent safety and energy efficiency and often improved product quality. In recent times process intensification has been seen to provide processing flexibility, just-in-time (JIT) manufacturing capabilities and the opportunity for distributed manufacturing. In order to develop an intensified process plant, it is essential that all the unit operation systems are intensified, i.e. reactors, heat exchangers, distillation columns, separators, etc. Wherever possible, the aim should be to develop and use multifunctional modules for performing heat transfer, mass transfer and separation duties. Process intensification encompasses [2] not only the development of novel, more compact equipment but also the development of intensified methods of processing, such as the use of ultrasonic and radiation as energy sources.

Additional benefits of process intensification are improved intrinsic safety, easier scale-up and increased energy efficiency. Adopting the process intensification approach can improve substantially the intrinsic safety of a process by having a significantly reduced volume of potentially hazardous

chemical at any time in a smaller intensified unit. In addition, one of the objectives of process intensification is to move away from batch processing to small continuous reactors, the latter giving more efficient overall operation, especially in the case of hugely exothermic reactions whereby the heat can be removed continuously as it is being released. The inherent safety aspect of process-intensification-based technologies and its role in minimising hazards in the chemical and process Industries have been discussed in a recent article [3]. Design considerations that may be taken into account for intensifying a process are presented in Table 15.1.

2 Relevance to Green Chemistry

Process intensification may be seen as an ideal vehicle for performing chemical reactions based on green chemistry. It can provide appropriate reactor technologies for utilising opportunities offered by heterogeneous catalysis, phase-transfer catalysis, supercritical chemistry and ionic liquids. It allows the use of more intense chemistry for a given process by using intensified reactors, such as the spinning disc reactors, HEX reactors, oscillatory baffle reactors, microwave reactors, microreactors, cross-corrugated membrane reactors and catalytic plate reactors. For instance, an intensified reactor may permit the use of higher reactant concentrations, which significantly influence the kinetics, selectivity and inventory. Often, due to the heat/mass transfer and mixing limitations of the reactor, the reactant concentrations are compromised resulting in slow speed, poor selectivity and extensive downstream separation process. Process intensification presents a range of exciting processing tools/opportunities for chemists to try out chemistry that could not be considered in the past, as seen in Table 15.2.

On the aesthetic side, because intensified process plants will have smaller footprints it is likely that they will be below the tree line, making it far less of an eyesore for the general public than the unsightly

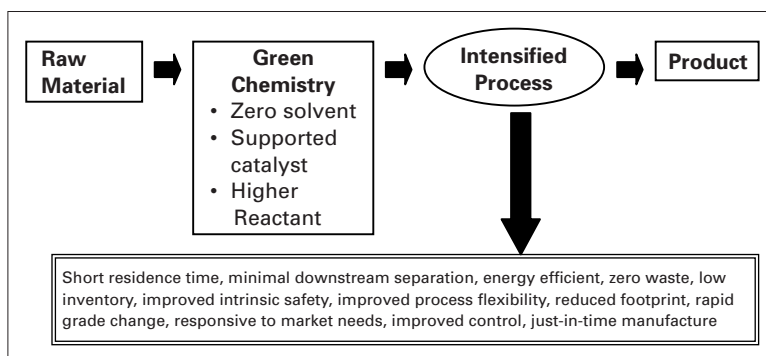


Fig. 15.1 Process characteristics of an intensified plant using green chemistry.



Fig. 15.2 View of sheared thin films on the SDR.

and massive steel works characterising our present chemical plants. In some cases the plant may be mobile, thereby offering opportunity for distributed manufacturing of chemicals. This will reduce the quantities of chemicals currently being transported by road and rail, thereby improving safety. The improved energy efficiency foreseeable in intensified unit operations constitutes yet another highly attractive benefit of process intensification in a world where there is overwhelming concern over the ever-growing demand on non-renewable energy resources and the release of greenhouse gases such as carbon dioxide. In this respect, there is a great and urgent need for the development of new process technologies that will utilise energy in an efficient manner. Process intensification is a positive step in the right direction for the chemical industry. Large enhancements in heat and mass transfer—two of the most fundamental and frequently encountered operations in chemical engineering processes—can

Table 15.1 Design considerations for process intensification

- Is the process based on batch or continuous technology?
- Identify the rate-limiting step (heat transfer, mass transfer, mixing, etc.)
- Identify appropriate intensification tools/modules/concepts
- Eliminate solvents if possible
- Use supported catalysts wherever possible
- Reduce pressure/temperature gradients
- Reduce the number of processing steps by using multifunctional modules
- Ultimate aim is to achieve significant (orders of magnitude) enhancements in transport rates

Table 15.2 Characteristics of an intensified process

- Gives every molecule the same processing experience
- Matches the mixing and transport rates with the reaction rate
- Offers significant enhancements in heat and mass transfer rates
- Allows the reaction to run at the speed at which it wants to run and not at the speed at which the equipment permits it to run
- Improves selectivity and yield
- Improves product quality and validation
- Rapid grade change through easy cleaning
- Rapid response to set points
- For certain processes, the laboratory scale may be the full scale

be achieved in intensified units. Such improvements give reason to believe that process times and therefore the associated energy consumption can be reduced dramatically for a given operation.

Case studies of intensified processes have been presented for nitration in a compact heat exchanger: a gas–liquid reaction using static mixers and

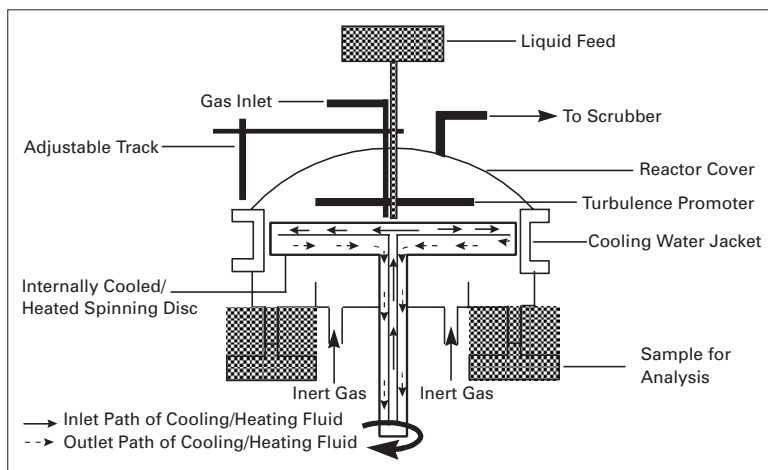


Fig. 15.3 Schematic of an SDR.

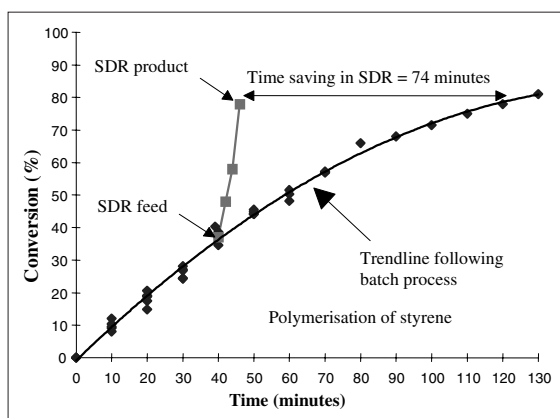


Fig. 15.4 Process time saving with a large disc of 1.08 m diameter rotating at 400 rpm.

hypochlorous production in a rotating packed bed [4]. The case studies clearly illustrate the benefits of process intensification achieved in real process situations. It has been suggested recently [5] that process intensification will dictate the future advancement of the chemicals and process industries. The process benefits that can be achieved by using an intensified process plant based on green chemistry are shown in Fig. 15.1.

3 Spinning Disc Reactor

The spinning disc reactor (SDR) technology utilises the effects of centrifugal force and is capable of producing highly sheared thin films (Fig. 15.2) on the

Table 15.3 Performance of catalysed SDR

Rearrangement of α -pinene oxide to campholenic aldehyde	Batch reactor	Catalysed SDR
Feed	100 ml	100 ml
Conversion	50%	95%
Yield	42%	71%
Processing time	900 s	17 s

surfaces of rotating discs/cones. Extensive heat- and mass-transfer studies using SDRs have shown that convective heat-transfer coefficients [6] as high as $14 \text{ kW m}^{-2} \text{ K}$ and mass-transfer coefficient K_L values as high as $30 \times 10^{-5} \text{ m s}^{-1}$ and K_G values as high as $12 \times 10^{-8} \text{ m s}^{-1}$ can be achieved while providing micro-mixing and an appropriate fluid dynamic environment for achieving faster reaction kinetics. The size of the disc may range from 60 to 500 mm in diameter and the surface characteristic may be smooth, grooved or meshed, depending on the application and the throughput requirement. The rotational speeds may range from 100 to about 6000 rpm (typically around 1500 rpm). The SDR, which has the following characteristics, has been used successfully to perform free-radical [7] as well as condensation [8] polymerisations—fast precipitation reactions for the production of monodispersed particles and catalysed organic reactions:

- Intense mixing in the thin liquid film
- Short liquid residence time (may allow the use of higher processing temperatures)

Fig. 15.5 Improved slug distribution observed in a PTFE capillary reactor used for organic nitration.

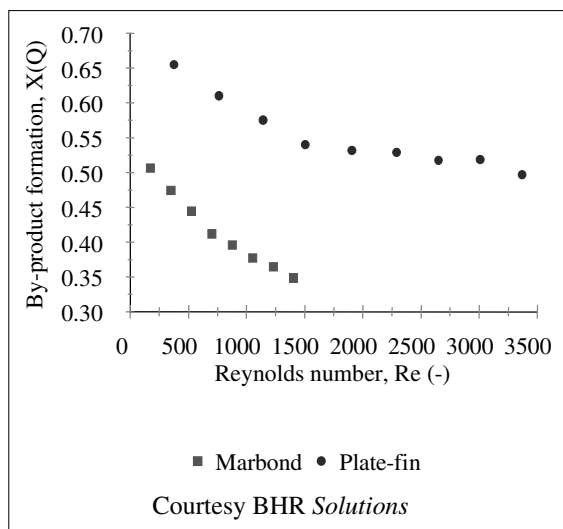
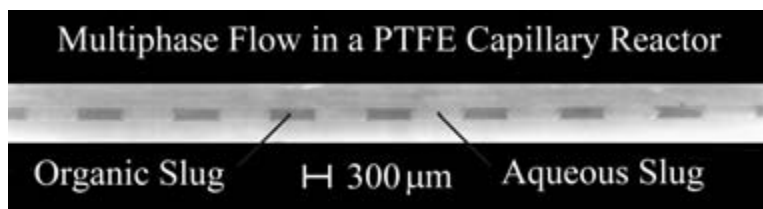


Fig. 15.6 Use of HEX reactors for reducing by-product formation. (Courtesy of BHR Solutions.)

- Plug flow characteristics
- High solid/liquid heat or mass transfer
- High liquid/vapour heat or mass transfer

A schematic view of an SDR is shown in Fig. 15.3. Figure 15.4 highlights the time saving that may be achieved by carrying out the polymerisation of styrene on an SDR. More recently, the SDR technology has been used to perform catalytic reactions using supported zinc triflate catalyst [9] for the rearrangement of α -pinene oxide to campholenic aldehyde. The results of this study, as presented in Table 15.3, suggest that by using a supported catalyst on an SDR it is possible to achieve faster reaction rates, improved yield and elimination of the downstream separation process for catalyst recovery.

4 Microreactors

Improved methods of manufacturing at the micro-scale are opening up new avenues for the development of compact devices for performing a range of chemical processes, from reactions to extraction and separation. Equipment utilising rapid heat and mass transfer within submillimetre-scale channels offers a low inventory environment with a high degree of control over the chemical process. Microreactors [10] based on this concept can provide intrinsically safe environments for catalysed and non-catalysed fluid processing. One such example of this is organic nitration in a poly (tetrafluoroethylene) (PTFE) capillary reactor where rapid heat-transfer rates allow stronger acid concentrations to be used at lower temperatures, resulting in decreased organic oxidation by-products.

The HEX reactor developed by BHR Solutions is another example of intensified process equipment that allows the heat of reaction to be removed at source almost as rapidly as it is generated [11]. This technology has been used successfully to demonstrate the reduction in by-product formation for an exothermic organic reaction, as shown in Fig. 15.6. The use of high-intensity gas-liquid mixers [12], rotor/stator mixers [13] and tubular reactors with static mixers [14] for performing chemical reactions with improved selectivity also have been demonstrated successfully. The catalysed plate reactor concept [15] is yet another innovative process intensification technology for achieving efficient heat transfer for performing exo- and endothermic reactions on opposite sides of a catalysed plate. A schematic diagram representing the coupling of methane steam reforming and the combustion of methane can be seen in Fig. 15.7. This technology enables a reduction in size of equipment by several orders of magnitude and eliminates NO_x emissions because the process is operated at lower temperatures.

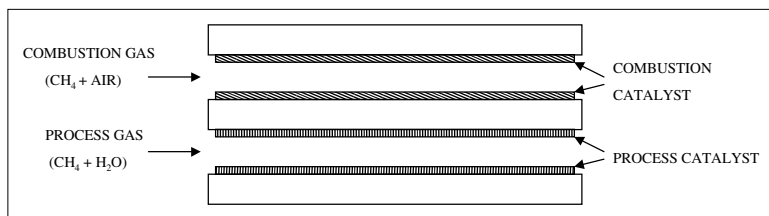


Fig. 15.7 Exo- and endothermic reactions using a catalysed plate reactor.

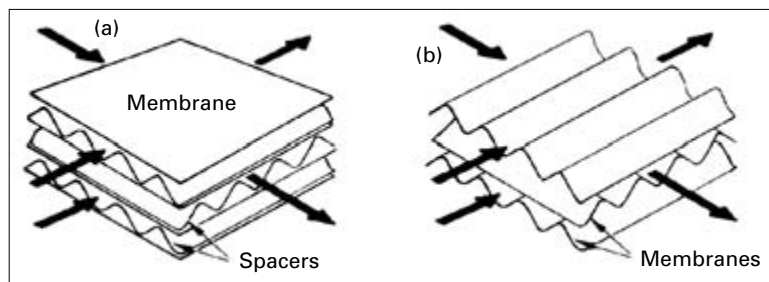


Fig. 15.8 (a) Flat sheet membrane flow cell and (b) cross-corrugated membrane flow cell.

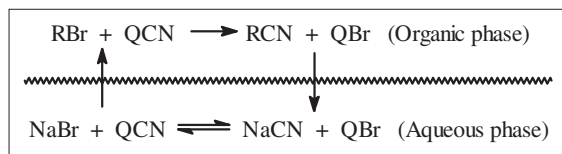


Fig. 15.9 Phase-transfer-catalysed cyanide displacement.

5 Intensified Cross-corrugated Multifunctional Membrane

Cross-corrugated membrane modules as shown in Fig. 15.8 offer the potential of developing multifunctional units for performing reaction as well as product separation in one miniaturised module [16]. The use of a microporous membrane in a reaction system is a relatively new method of solving various reaction/separation problems. Miscible fluids may be kept apart to control the rate of transport of reactant or product, thereby controlling the overall reaction rate. Alternatively, the membrane may be designed to be permselective; i.e. it will allow a desired species to pass through it, say the product of an organic synthesis, while holding back another, say a by-product

or unreacted feed. This type of application can be applied successfully for performing organic reactions in pharmaceuticals, cosmetics, agricultural chemicals, dyes and flavouring industries by using phase-transfer catalysis [17]. Figure 15.9 shows a representation of Starks' [18] early phase-transfer work, reacting 1-chlorooctane with aqueous cyanide to produce 1-cyanooctane. With no phase-transfer agent present, there is no reaction. But with the addition of a small amount of quaternary ammonium salt, the reaction goes to completion in just a few hours.

Currently in industry these reactions are carried out in stirred tanks, the resulting mixture being separated downstream for product and catalyst recovery, resulting in significant energy consumption. Tests carried out in a cross-corrugated membrane module using phase-transfer catalysts such as tetrabutylammonium salts for the oxidation reaction of benzyl alcohol have produced encouraging results. The results, as seen in Fig. 15.10, suggest that this technology may be applied for a host of other reactions such as alkylations, esterifications, oxidations/reductions, epoxidations, condensation reactions, polymerisations, etc.

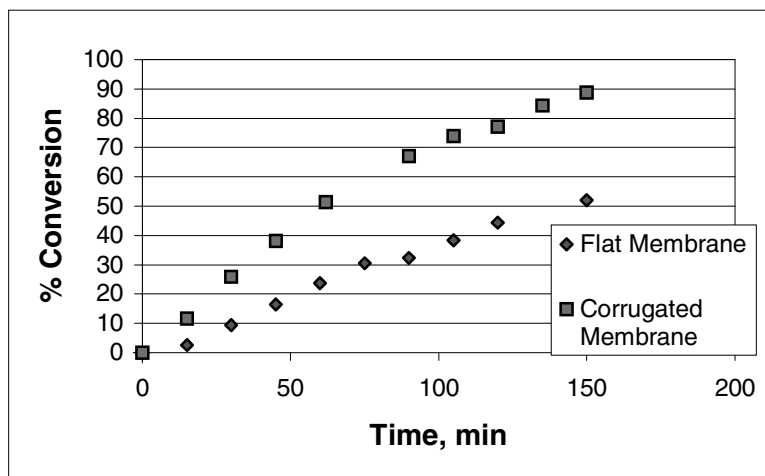


Fig. 15.10 Effect of corrugated membranes on oxidation reaction rate.

6 Conclusions

Advances in green chemistry often will demand more efficient process equipment based on step change concepts arising from the process intensification philosophy. In order to promote this novel concept for achieving a sustainable environment, both businesses as well as process drivers have to be addressed [19].

References

- Ramshaw, C. *Chem. Eng.*, 1985, **415**, 30.
- Stankiewicz, A. I., & Moulijn, J. A. *Chem. Eng. Prog.*, 2000, **96**(1), 22.
- Hendershot, D. C. *Chem. Eng. Prog.*, 2000, **96**(1), 35.
- Green, A., Johnson, B., & John, A. *Chem. Eng.*, 1999, **106**(13), 66.
- Keller, G. E., & Bryan, P. F. *Chem. Eng. Prog.*, 2000, **96**(1), 41.
- Jachuck, R. J., & Ramshaw, C. *Heat Recovery Syst. CHP*, 1994, **14**(5), 475.
- Boodhoo, K. V. K., & Jachuck, R. J. *Appl. Therm. Eng.*, 2000, **20**, 1127.
- Boodhoo, K. V. K., & Jachuck, R. J. *Green Chem.*, 2000, **4**, 235.
- Wilson, K., Renson, A., & Clark, J. H. *Catal. Lett.*, 1999, **61**(1/2), 51.
- Burns, J. R., & Ramshaw, C. *Proc. 4th International Conference on Microreaction Technology*, Atlanta, GA, 2000, pp. 133–140.
- Phillips, C. H., & Edge, A. M. Paper at the 6th Heat Exchanger Action Group (HEXAG) Meeting, Leatherhead, UK, 31st October 1996.
- Zhu, Z. M., Hannon, J., & Green, A. *Chem. Eng. Sci.*, 1992, **47**, 2847.
- Sparks, T. G., Brown, D. E., & Green, A. *Chemical Reactions using Overall Power Characteristics*, BHR Conference Series Publication No. 18. Mechanical Engineering Publications, London, 1995.
- Schutz, J. *Chem. Eng. Sci.*, 1988, **43**(8), 1975.
- Charlesworth, R. J. PhD Thesis, Chemical and Process Engineering, University of Newcastle upon Tyne, 1996.
- Hall, K., Scott, R., & Jachuck, J. Paper presented at ICoM '99, Toronto, June 1999.
- Reuben, B., & Sjoberg, K. *Chemtech*, 1981, **May**, 315.
- Starks, C. M. *J. Am. Chem. Soc.*, 1971, **93**, 195.
- Green, A. J., Hearn, S., & Wood, M. *Methodologies for Process Intensification*, BHR Conference Series Publication No. 28, Mechanical Engineering Publications, London, 1997, pp. 25–36.

Chapter 16: Sonochemistry

TIMOTHY J. MASON AND P. CINTAS

1 Introduction

1.1 Sonochemistry

The first commercial application of ultrasound dates back to 1917 with the echo sounding technique developed by Langevin for estimation of the depth of water. From this has developed a whole range of sophisticated techniques for non-destructive testing and medical imaging, all essentially based on the pulse-echo technique. Such diagnostic uses of ultrasound use low powers and very high frequencies (in the MHz range) and do not affect the physical or chemical character of the medium that is probed. If, on the other hand, a lower frequency (generally in the 20–40 kHz range) and a higher power are applied to a fluid, it is possible to produce significant physical and chemical changes in the medium through the generation and subsequent collapse of cavitation bubbles. It is acoustic cavitation produced by power ultrasound that is the basis of sonochemistry and a number of processing techniques.

The history of this use of power ultrasound is shorter than that for diagnostic ultrasound and began in the years preceding World War II, when it was being developed for a range of processing including emulsification and surface cleaning. By the 1960s the industrial uses of power ultrasound were well accepted [1,2] and have since continued [3].

Paralleling these developments in processing there were a growing number of chemists interested in the chemical effects of power ultrasound, which became known as sonochemistry. It was not until 1986, however, that the first ever international symposium on a subject identified as sonochemistry was held at Warwick University, UK, as part of the Autumn Meeting of the Royal Society of Chemistry and signified the beginning of serious interest in the uses of cavitation in chemistry as a study in itself [4]. Since then, the subject has developed to generate an ever-expanding number of applications [5–9] and a growing interest in the underlying driving force—

acoustic cavitation [9]. There is an argument that the term sonochemistry should refer only to those reactions that are influenced chemically by cavitation but it is often difficult to separate the chemical from the physical consequences of cavitation and so both aspects will be considered in this contribution.

Sonochemistry is the term used to describe the effect of ultrasonic sound waves on chemical reactions. This terminology is in keeping with that of the longer established techniques, which use light (photochemistry) and electricity (electrochemistry) to achieve chemical activation. Unlike these, however, sonochemistry does not require some special attribute of the system being activated, e.g. the presence of a chromophore or a conducting medium, respectively. For chemical applications, ultrasound requires only the presence of a liquid in which to generate cavitation in order to transmit its power.

Increasingly, sonochemistry is being seen as one of the first options when looking at new technology in a number of fields as a processing aid in terms of energy conservation and waste minimisation (Table 16.1). Not only has the subject broadened in scope and gained acceptance in chemical engineering for scale-up, but it has also been found particularly beneficial when applied jointly with other techniques. Such joint applications have resulted in major advances in these specialisms, some examples being ultrasound with electrochemistry, biotechnology and extraction processes.

The interest in sonochemistry has been accompanied by a surge in the development of new equipment for the generation of ultrasound. In recent years a number of studies have been taking place using frequencies outside of those that are normally associated with sonochemistry (the most common frequencies used are 20 kHz for probe systems and 40 kHz for ultrasonic baths). In essence, any sound frequency that can generate cavitation in a liquid can be used in sonochemistry. This would encompass all sound frequencies, from infrasound (below 16 Hz) through the audible sound range and all the way up

Table 16.1 Some industrial uses of power ultrasound

Field	Application
Plastic welding	Fabrication of thermoplastic articles
Cleaning	Cleaning in aqueous media of engineering items, medical instruments and jewellery
Cutting	Accurate drilling and cutting of all forms of material, from ceramics to frozen food products
Therapeutic medicine	Destruction of cancerous tissue (high-intensity focused ultrasound, HIFU), dissolution of blood clots, enhanced chemotherapy
Processing	Pigments and solid dispersion in liquid media, crystallisation, filtration, drying, degassing, defoaming, homogenisation, emulsification, dissolution, deaggregation, extraction
Sonochemistry	Electrochemistry, environmental protection, catalysis, benign synthesis

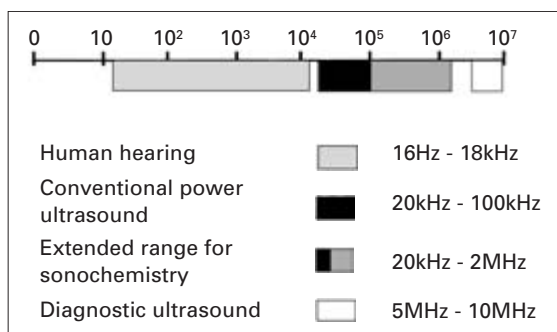
to diagnostic ultrasound (above 1 MHz), reaching a limit defined as the frequency above which cavitation is no longer possible (at about 3 MHz). This will mean that a new and wider definition of sonochemistry will be required for the uses of *sound* in chemistry.

In this chapter we will explore the range of applications of sonochemistry in clean technology and waste minimisation and try to relate this to the underlying principles.

1.2 Power ultrasound

Ultrasound is defined as sound of a frequency beyond that to which the human ear can respond and generally is considered to lie between 20 kHz and 500 MHz. The normal range of human hearing is between 16 Hz (Hz = Hertz = cycle per second) and about 18 kHz. For younger people 20 kHz is audible but the frequency response limit reduces with age. The full range of sound and its subdivisions is shown in Fig. 16.1.

Power ultrasound enhances chemical reactivity in a liquid medium through the generation and destruction of cavitation bubbles. Like any sound wave, ultrasound is propagated via a series of compression and rarefaction waves induced in the molecules of the medium through which it passes. At sufficiently high power the rarefaction cycle may

**Fig. 16.1** Sound frequencies associated with sonochemistry.

exceed the attractive forces of the molecules of the liquid, and cavitation bubbles will form. It is the fate of these cavities when they collapse in succeeding compression cycles that generates the energy for chemical and mechanical effects. The collapse is thought to generate very high local temperatures (around 5000°C) and pressures (in excess of 1000 atmospheres). Sonication of a liquid medium therefore can be thought of as generating high-energy ‘hot spots’ throughout the system.

Transducers

The first requirement for research in sonochemistry is a source of ultrasound, and whatever type of commercial instrument is used the energy will be generated via an ultrasonic transducer—a device by which mechanical or electrical energy can be converted to sound energy. There are three main types of ultrasonic transducer used in sonochemistry.

Liquid-driven transducers. These are effectively liquid whistles where a liquid is forced out of an orifice and across a thin steel blade (Fig. 16.2). Cavitation is generated from two sources: the vibration of the blade induced by liquid flow and a Venturi effect as the liquid emerges as a jet. This style of transducer is very effective in mixing and dispersion but is not used generally for sonochemical reactions requiring high energies.

Magnetostrictive transducers. These are electro-mechanical devices that use magnetostriction, an effect found in some ferromagnetic materials, e.g. nickel. Such materials reduce in size when placed in

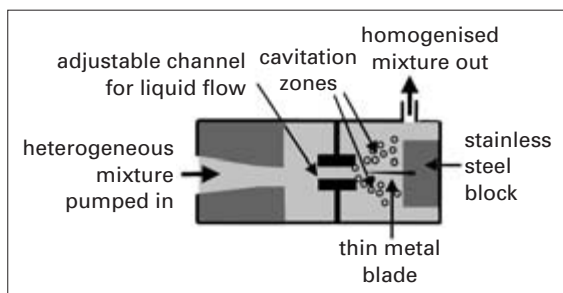


Fig. 16.2 Schematic diagram of a liquid whistle.

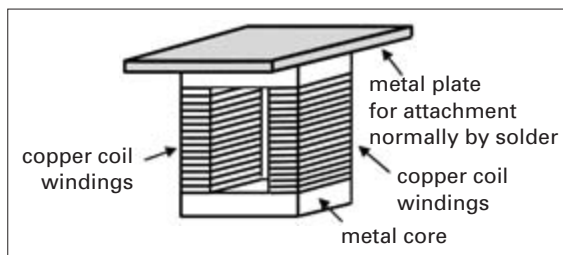


Fig. 16.3 Schematic diagram of a magnetostrictive transducer.

a magnetic field and return to normal dimensions when the field is removed. This type of transducer is constructed using laminated nickel as the core of a solenoid (Fig. 16.3). There are two major disadvantages of this type of transducer: the useful frequency range is restricted to below 100 kHz and the system is only about 60% electrically efficient, with considerable energy loss through heating. As a result of the latter problem, all magnetostrictive transducers must be cooled. The major advantages are that the system is of extremely robust construction and produces very large driving forces.

Piezoelectric transducers. These are the most common devices employed for the generation of ultrasound and they utilise ceramics containing piezoelectric materials such as barium titanate or lead metaniobate. The piezoceramic element commonly used in ultrasonic cleaners and for probe systems is produced in the form of a disc with a central hole. Ceramic transducers are potentially brittle and so it is normal practise to clamp them between metal blocks. This serves both to protect the delicate crystalline material and to prevent it from overheating by acting as a heat sink. Usually two ele-

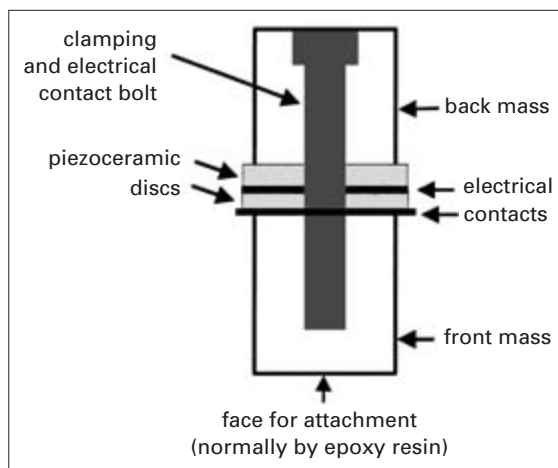


Fig. 16.4 Schematic diagram of a piezoelectric sandwich transducer.

Table 16.2 Methods of introducing ultrasound into a system

- Immerse reactor in a tank of sonicated liquid (e.g. flask dipped into a cleaning bath)
- Immerse an ultrasonic source directly into the reaction medium (e.g. probe placed in a reaction vessel)
- Use a reactor constructed with ultrasonically vibrating walls (e.g. a tube operating through radial vibrations)

ments are combined so that their overall mechanical motion is additive (Fig. 16.4). Piezoelectric transducers are better than 95% electrically efficient and can operate over the whole ultrasonic range.

1.3 Apparatus available for sonochemistry

There are essentially three methods for the introduction of ultrasound into a reacting system (Table 16.2), and of those listed only the first two have received any extensive use in the chemical laboratory. The majority of these systems rely upon the piezoelectric transducer as a source of power ultrasound and all three suffer from the disadvantage that optimum performance is obtained at a fixed frequency that depends upon the particular transducer employed. For most commercial probe systems this frequency is 20 kHz, and for baths it is around 40 kHz.

The ultrasonic cleaning bath

The ultrasonic cleaning bath is by far the most widely available and cheapest source of ultrasonic irradiation for the chemical laboratory. Although it is possible to use the bath itself as a reaction vessel, this is seldom done because of the problems involved with chemical attack of the bath walls and with the containment of any evolved vapours and gases. Normal usage therefore involves the immersion of standard glass reaction vessels into the bath (Fig. 16.5). This is important because conventional apparatus can be transferred directly into the bath and so an inert atmosphere or a static pressure can be achieved readily and maintained throughout a sonochemical reaction.

It is important to establish the optimum position for the reaction vessel in the bath both vertically (due to the discrete wavelength of sound in water) and horizontally (in terms of the position of the vessel with respect to the transducers on the base). The simplest method of establishing this point is to locate the vessel such that maximum disturbance is observed on the surface of the liquid contained in that vessel. Once this position is found, a template can be used to ensure that future reactions are carried out in the same region of the bath. Naturally, in order to attain reproducible results, the same glass vessel should be used each time because differences in the thickness of the glass bases of vessels will affect ultrasonic power transfer into the reacting system.

The amount of energy that reaches the reaction is low—normally between 1 and 5 W cm⁻². This is so low that, for heterogeneous systems, it is almost

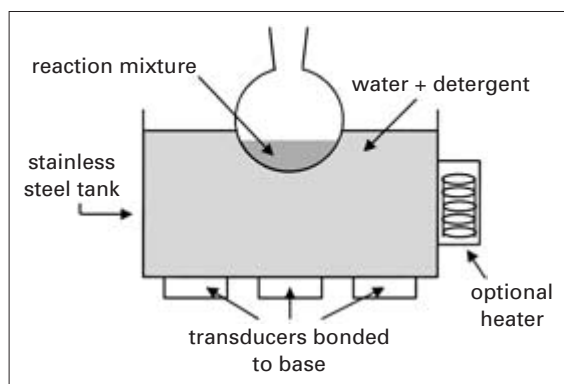


Fig. 16.5 The ultrasonic cleaning bath for sonochemistry.

always necessary to agitate mechanically the reaction mixture during sonication. A further complication in trying to reproduce work reported in the literature is that all baths operate at frequencies and powers that depend upon the transducers used, and with bath geometries peculiar to the particular manufacturer.

Water (containing a little surfactant) normally is used as the coupling medium in the bath and this will limit the upper temperatures of operation to a maximum of just below 100°C. Factory-fitted thermostatic control in baths normally is available for temperatures above that reached under its normal working conditions (generally about 40°C). Below this temperature a cooling system (cooling coil or circulating bath liquid) is required, although this can interfere with the clear passage of ultrasound through the bath. It is important to record the temperature inside the reaction vessel because this will be always a few degrees above that of the bath itself due to localised ultrasonic heating.

The ultrasonic probe

In order to increase the amount of ultrasonic power available to a reaction it is desirable to introduce the energy directly into the system rather than rely on its transfer through the water of a tank and the reaction vessel walls. The simplest method to achieve this is to introduce the ultrasonically vibrating tip of a sonic probe into the reaction itself (Fig. 16.6). The

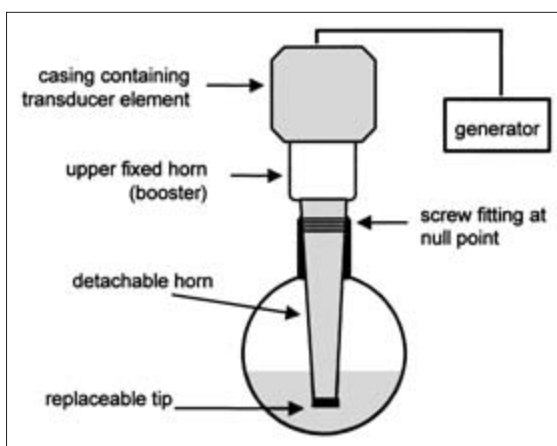


Fig. 16.6 The ultrasonic probe system for sonochemistry.

part of the probe system that conducts and amplifies the vibrational energy from the transducer into the reaction is the acoustic horn.

The probe system has several major advantages over a bath, including control of ultrasonic power delivered to the reaction. Maximum powers of several hundred watts per square centimetre can be achieved easily (depending on the size of the unit). One side benefit of such high powers is that ultrasonic streaming from the tip of the probe often is sufficiently powerful to provide bulk mixing without the need for additional stirring. Most modern units have a pulse facility, allowing the operator to sonicate reactions repeatedly for fractions of a second. This gives adequate time for bulk cooling between sonic pulses.

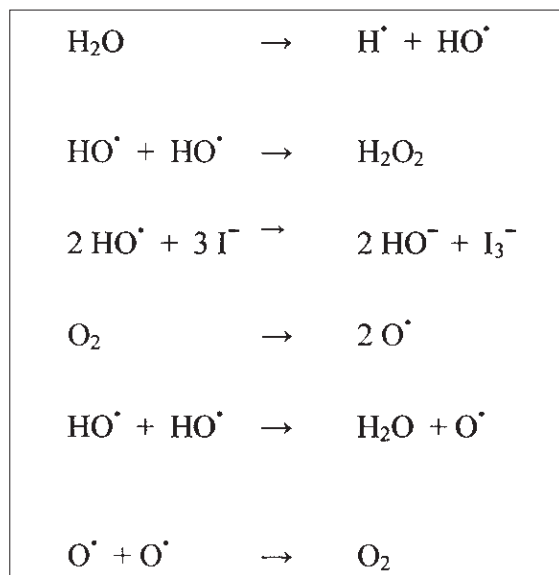
Although so much extra power is available using the probe system, it is more expensive than the bath and it is significantly less convenient in use, especially in terms of the glassware required. Special seals will be needed if the horn is to be used in any reactions that involve reflux, inert atmospheres or the use of pressures above (or below) ambient. The cavitation, which is the source of chemical activation, is also the source of a common problem with probe systems—tip erosion—which occurs despite the fact that most probes are fabricated of titanium alloy, which is very hard. There are two unwanted side effects associated with erosion: metal particles may erode from the tip and contaminate the reaction mixture; and the physical shortening of the horn causes a loss of efficiency (eventually it will become too short to be tuned to the ultrasonic frequency used). The latter problem is avoided by the use of screw-on tips for the probe in the form of studs, which eliminates the need for a costly replacement of the whole horn.

2 Sonochemistry in Chemical Synthesis

As mentioned before, most physical and chemical effects of ultrasound arise from cavitation. In fact, ultrasonic frequencies do not even alter the rotational or vibrational states of molecules. It is only the cavitation collapse that releases sufficient kinetic energy to drive the chemical transformation. However, unlike photochemical or electrochemical reactions, for which a series of well-known mechanistic pathways (e.g. molecular fragmentations, intermediacy of excited species, radical intermedi-

ates, etc.) have been identified, a comparable and self-consistent background cannot be found in sonochemistry. This simply evidences our modest understanding of cavitation and related phenomena such as sonoluminescence—the weak emission of light in the UV–VIS window after ultrasonic irradiation of liquids—which are the subject of both theoretical and experimental studies [9–11]. Fortunately, it is equally possible to anticipate the formation of reactive intermediates, although the chemical outcome will be dependent largely on the nature of the reacting partners and the experimental conditions.

The cavitation implosion leads to the production of solvent radicals, which in the case of water are H^\bullet and OH^\bullet radical species [12] that can react with each other to give hydrogen and hydrogen peroxide (Scheme 16.1). They can also react with other substances to induce secondary reduction and oxidation reactions. For example, iodide can be oxidised sonochemically to triiodide by OH^\bullet radicals or H_2O_2 produced during cavitation (see Scheme 16.1, Equation 1). This so-called Weissler reaction constitutes a standard dosimetric method in sonochemistry because the rate of triiodide formation can be determined spectrophotometrically [13]. If the aqueous solutions contain chlorocarbons (e.g. CCl_4), then Cl^\bullet



Scheme 16.1 Sonolytic production and recombination of radical species.

and Cl_2 also are liberated in high yields and this fact increases the rates of iodide oxidation. Molecular oxygen, if present, can decompose [14] and the subsequent radical pathways are analogous to those found in flame chemistry, particularly those leading to oxygen production (Scheme 16.1, Equations 5 and 6). Although yields of these short-lived species are smaller than those of radiolysis experiments, it has been demonstrated that H_2O_2 resulting from recombination of hydroxyl radicals is always formed in larger amounts at 514 kHz than at 20 kHz, and efficiency is better under oxygen at high frequency than under argon at low frequency [15].

Research into reactions that take place in aqueous media hold an important place in sonochemistry in relation to the effects of sound waves on biomolecules and polymers [16]. Degradation of sugars [17] and base damage in DNA solutions [18] may be induced by ultrasonic cavitation. These studies also are of paramount importance in determining the influence of high-frequency waves on biological fluids and tissues, which is the domain of medical ultrasonics.

A model of the cavitation bubble presented in Fig. 16.7 highlights three different temperature domains in which a particular chemistry will take place. A salient feature of this simple picture is that it provides an intuitive rationale for understanding how sonochemical reactions occur and why sonication potentially can yield reaction products that are inaccessible by other methods. Volatile molecules will be inside the cavitation bubbles and the high temperatures and pressures produced during cavitation are sufficient to break chemical bonds, sending charged species into the bulk liquid at room temperature, this gradient taking place over less than 500 Å. Further-

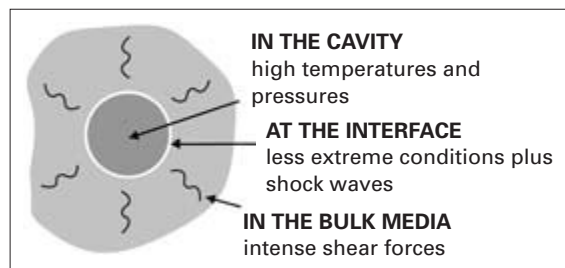


Fig. 16.7 The cavitation bubble.

more, substances of small vapour pressure, which most probably have no possibility to penetrate a bubble and thus have no possibility to undergo these extreme conditions directly, will still experience a high-energy environment resulting from the pressure waves associated with propagation of the acoustic wave or with bubble collapse (shock waves), or from a reaction with radical species generated by sonolysis of the solvent. As we shall see, even though thermal effects should be prevalent, some experimental results do not support the hot-spot cavitation theory. Moreover, reactions susceptible to the influence of high pressures and temperatures often are inert under ultrasound.

2.1 The nature of sonochemical reactions

For decades the accelerating effect of ultrasonic irradiation has been a useful reactivity paradigm. In what way, if any, does ultrasound affect chemical reactions? The analysis of numerous experiments reveals that ultrasound has no effect on the chemical pathway and often reaction rates are comparable to those of non-irradiated (or silent) processes. Thus, in many heterogeneous reactions the application of ultrasonic waves has the same *physical* effect as a high-speed agitator or a homogeniser in which fluids do not cavitate. Enhanced yields and rates can be observed owing to the mechanical effects of shock waves. *Chemical* effects of ultrasound will occur only if an elemental process is the sonication-sensitive step or when the high-energy species released after cavitation collapse do indeed participate as reaction intermediates. In this context, one speaks appropriately of ultrasonic activation and sonocatalysis. Changes in product distribution upon irradiation, switching of mechanisms and in some instances alterations of regio- and diastereoselectivity [19] suggest that chemical modifications are occurring. Accordingly, it has been possible to establish a set of empirical rules [20] that represent the first logical approach to sonochemical reactions and can provide some clues for future work.

(I) In *homogeneous reactions*, chemical effects can be rationalised by assuming that sequential electron transfers are favoured by ultrasonic irradiation [21]. Transition metal complexes will undergo ligand–metal bond cleavage under such conditions, producing coordinatively unsaturated

species. However, homogeneous ionic reactions should not be affected by sonication.

- (2) In *heterogeneous liquid–liquid* or *liquid–solid* ionic reactions, mechanical effects associated with sound waves can affect both rates and yields to an extent depending on the characteristics of the system, such as surface tension, density, temperature or nature of the solids. In the former reactions, cavitation collapse at or near the interface will cause disruption and mixing, resulting in the formation of fine emulsions. Such systems require little or no surfactant to maintain stability and are particularly beneficial in the enhancement of phase-transfer catalysis. Collapse on the surface, especially of powders, produces enough energy to cause fragmentation, even for finely divided metals, thereby increasing surface area for reaction and providing activation through efficient mixing and enhanced mass transport. For very fine powders the particles are accelerated to high velocity by cavitation collapse and may collide to cause surface abrasion. For some metal powders these collisions generate sufficient heat to cause particle fusion.
- (3) In *heterogeneous reactions*, which can follow either an ionic or an electron transfer path, the latter will be induced preferentially under ultrasonic irradiation. These biphasic systems also will be subjected to the mechanical component of shock waves, in addition to the chemical activation.

In the following paragraphs we shall illustrate the above types in detail with examples taken from the recent literature. The application of this focused irradiation has important *environmental* connotations. Thus, the accelerating effect of sound waves often impedes the formation of side products (*waste minimisation*) and the enhanced activation of catalysts and reagents enables the replacement or control of hazardous, highly reactive substances. Overall, this results in simplified and milder procedures accompanied by *energy savings*. Even though, in many cases, the immediate conclusion is that one can achieve the same effect by heating or stirring, ultrasound offers a cheaper ‘green’ route.

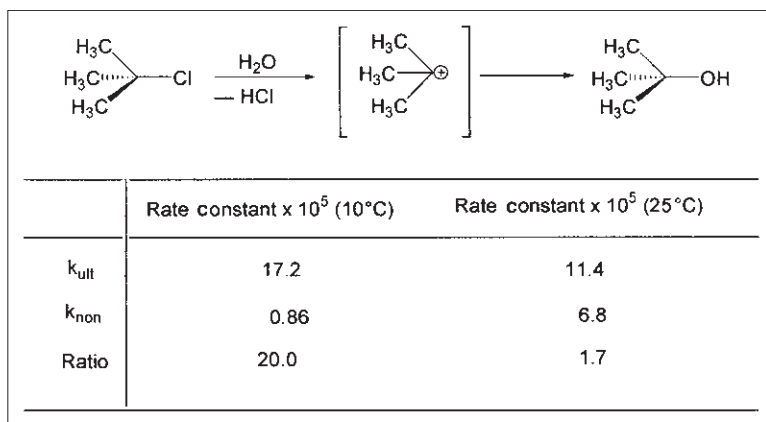
Homogeneous reactions

The above classification states that homogeneous sonochemical reactions preferentially follow a

sequential electron transfer (SET) mechanism. However, homogeneous ionic reactions are not, at least not significantly, influenced by ultrasound. One of the first examples of this type of reaction is the acid-catalysed hydrolysis of saccharose at frequencies as high as 2 MHz [22]. Under ultrasonic irradiation, an increase in the reaction rate with respect to the silent experiment is observed. The accelerated degradation was attributed to the lower pH of the sonicated solution because some formic acid was produced, presumably via oxidation of saccharose by the hydroxyl radicals that are generated by ultrasonic irradiation [12a]. This is consistent with the fact that hydrolysis conducted under sonication or mechanical stirring in the presence of formic acid exhibits similar rates. Similarly, the basic catalysis of 4-nitrophenyl esters shows a modest rate enhancement (about 1.1-fold) under sonication [23], and in a further study the acid-catalysed acetalisation of acetophenone in methanol, which should involve a purely ionic pathway, shows the same rates both with or without sonication [24].

An important result emerges from the sonochemical solvolysis of 2-chloro-2-methylpropane in aqueous ethanol [25], where the ratio of the first-order rate constants k_{ult} (in the presence of ultrasound) and k_{non} (under conventional conditions) are compared (see Scheme 16.2). Remarkably, the process displays the paradoxical temperature effect by which the sonochemical process is more efficient on lowering the temperature: about a 20-fold increase in the reaction rate from 25°C to 10°C. The explanation is that any reduction in vapour pressure by the lowering of the reaction temperature will increase the cavitation bubble collapse energy and hence the sonochemical effect. Nevertheless, the primary process is unlikely to occur inside the cavitation bubbles and a radical pathway should be discarded. Probably, the shock waves can disrupt the weak intermolecular forces of solvents, thereby altering solvation of the reactive species present.

Bimolecular nucleophilic substitutions have been studied largely by sonochemists and, perhaps by chance, it is now well established that a classical concerted pathway and a radical mechanism are equally possible [26]. The *S*-alkylation of thiocarbamates by alkyl halides in ethanol is greatly accelerated by ultrasound: as the non-irradiated reaction proceeds 75 times slower at the same temperature [27]. A direct cavitation effect cannot be invoked in view



Scheme 16.2 Solvolysis of 2-chloro-2-methyl propane at different temperatures.

of the non-volatility of the salts. Alternatively, the reaction would occur via free-radical species from the alkyl halide formed by electron transfers. Involvement of a SET pathway has been demonstrated in the reaction of lithium thiolates with a series of one-electron acceptors, including organic halides [28].

One of the most salient cases of switching provided by sonication involves the reaction of aqueous nitric acid with alcohols [29]. Although the process is dependent on the type of alcohol, the application of ultrasound gives a quantitative yield of the carboxylic acid in ca. 20 min, whereas under mechanical stirring the reaction proceeds slowly at room temperature, affording a quantitative yield of nitrate esters after 12 h. In close analogy to the sololysis of water, the reaction should proceed via a radical pathway in which the cleavage of nitric acid to the nitrogen dioxide radical or its protonated form (a radical cation) is involved.

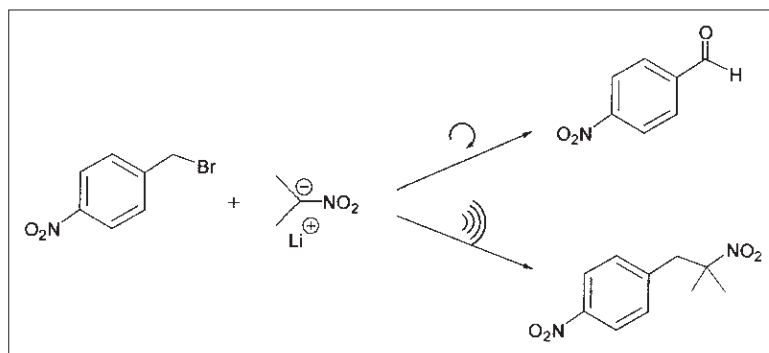
A further extension to the Kornblum–Russell reaction—the alkylation of nitronate anions by 4-nitrobenzyl bromide [30]—reveals sonochemical switching as well. It has been known that the reaction can proceed either through $S_{\text{N}}2$ or $S_{\text{RN}}1$ mechanisms, leading to O-alkylated or C-alkylated products, respectively. When sonication was applied, the ratio of C- versus O-alkylation was practically reversed, with sonication favouring the radical mechanism (see Scheme 16.3). As observed in other sonochemical experiments, an optimum intensity was detected with the exception of standing waves using a large probe [31].

A similar case of switching was found by French

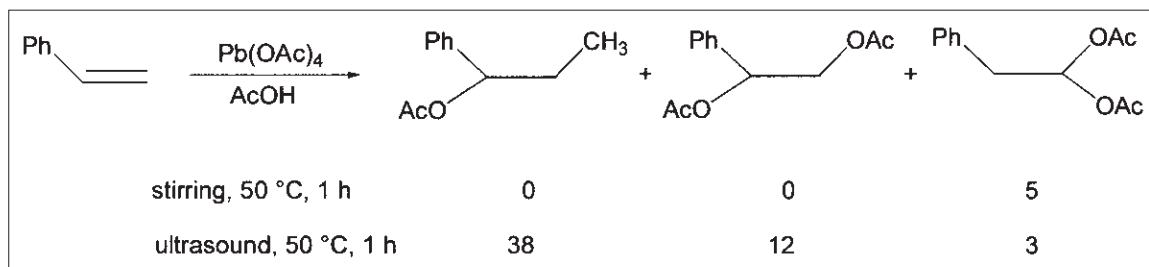
and Japanese authors describing the reaction of lead tetraacetate with styrene [32]. Again, the addition may follow either an ionic or a radical pathway, affording the products depicted in Scheme 16.4. In the former case, the lead reagent adds to styrene to give a *gem*-diacetate via a carbocation, whereas the first stage of the radical pathway likely consists of the decomposition of lead tetraacetate to give the methyl radical, which reacts further with styrene [33]. The use of an ultrasonic horn produces an enhanced yield of products resulting from homolytic processes, whereas these substances cannot be obtained at all under mechanical stirring.

Manganese acetate mediates intermolecular carbon–carbon bond-forming radical reactions, which also have been conducted under sonication [34]. A recent paper describes the milder preparation of alkenes substituted with electron acceptors by ultrasound-mediated oxidation of dialkyl malonates [35] (see Scheme 16.5). Such alkenes are important precursors in Diels–Alder reactions, Michael additions and polymerisations, but they are not easy to make. The new protocol involves irradiation of a solution of dialkyl malonate and $\text{Mn}(\text{OAc})_3$ to give the hydroxyethanetetracarboxylate, which is then converted to the alkene. Moreover, reactions can be accomplished with catalytic amounts of oxidant (0.1 equiv), because $\text{Mn}(\text{II})$ can be reoxidised to $\text{Mn}(\text{III})$ in acetic acid under sonication.

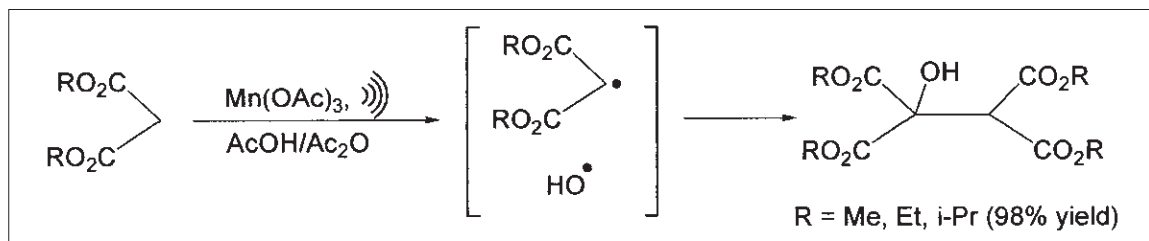
A limiting case among homogeneous reactions is offered by the Diels–Alder and other thermal symmetry-allowed cycloadditions, which are a current challenge for sonochemists [36]. Surprisingly, Diels–Alder reactions have found little or no success



Scheme 16.3 The Kornblum–Russell reaction under mechanical stirring and sonication.



Scheme 16.4 Effects of stirring and sonication on the composite pathway of the reaction of lead tetraacetate with styrene.

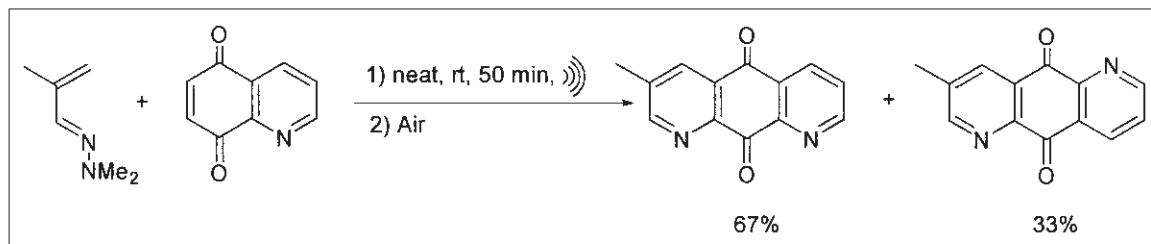


Scheme 16.5 The Mn(III)-induced generation of malonate radicals.

under ultrasonic irradiation, despite being very sensitive to heat and pressure. Some exceptions to this rule were found by Snyder and his group in the preparation of quinonoid natural products [37]. The application of pressures of 10 kbar produces equivalent results, in terms of yields and selectivities, to those obtained during ultrasonic irradiation, even with a simple cleaning bath. Accordingly, the pressure effects of cavitation might be invoked in this case, although the pressures reached in the cavitational

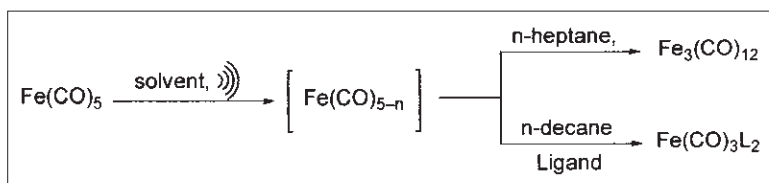
collapse are estimated to be lower than those employed in high-pressure chemistry. Anyway, these results are difficult to interpret because most experiments were partially heterogeneous.

An alternative explanation could be based on the existence of a SET mechanism, which would be favoured by sonication, involving radical cation species [38]. The hetero-Diels–Alder cycloaddition of a monoazadiene with quinoline-1,4-dione gives the [3 + 2] furan adduct as the major product under mechanical stirring, whereas sonication leads to the expected, though non-spontaneous, [4 + 2] cycloadduct [39]. Probably, ultrasound promotes an electron transfer from the diene, leading to its radical

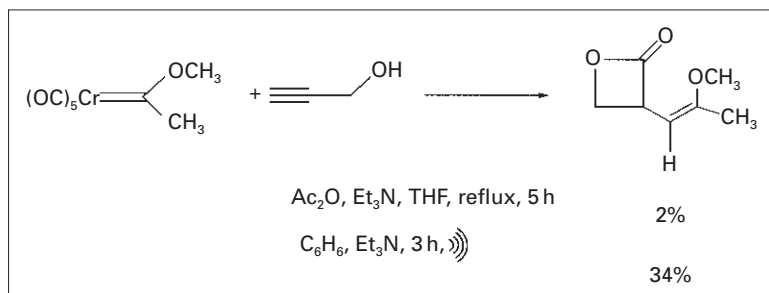


Scheme 16.6 Switching of a hetero-Diels-Alder reaction.

Scheme 16.7 Sonolysis of iron pentacarbonyl and trapping reactions.



Scheme 16.8 Enhanced formation of β -lactones by sonolysis of metal carbenes.



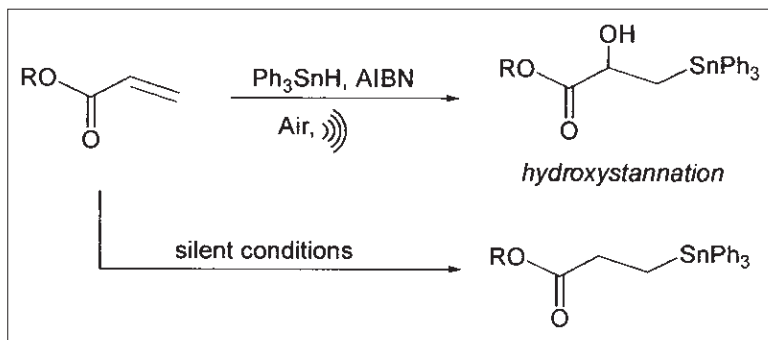
cation, or the removal of dissolved gases is made easier by sonication. In fact, when the reaction was stirred mechanically after careful oxygen exclusion, the [4 + 2] cycloadduct was obtained in good yields (see Scheme 16.6).

Both yields and *endo/exo* selectivities in the Diels-Alder reactions of cyclopentadiene with methyl vinyl ketone in halogenated solvents are enhanced largely by sonication [40]. However, these results are presumably due to the catalytic effect of Lewis acids (TiCl_4 , TiBr_4) generated in situ by the interaction of halogen radicals, resulting from solvent pyrolysis, with the titanium horn.

As noted before, the sonolysis of metal complexes and organometallics should give rise to coordinatively unsaturated transient species; mechanistic switching also can occur. Well-documented examples were reported by Suslick and his associates in the sonolysis of iron pentacarbonyl, leading to

cluster formation; remarkably, photo- and thermolysis produce different products [41]. The selective formation of the cluster $\text{Fe}_3(\text{CO})_{12}$ is increased by decreasing the cavitation energy, i.e., increasing the solvent vapour pressure. The coordinated intermediate species, which are generated in the cavitation bubble and in the superheated liquid shell surrounding it, can be trapped by external ligands such as alkenes, and reaction rates are about 10^5 higher than the silent process (see Scheme 16.7) [42].

Condensation of chromium alkyl(alkoxy)carbene complexes with propargylic alcohols gives rise to functionalised β -lactones [43]. Sonication provides a more effective procedure, particularly in terms of accessing the less heavily substituted β -lactones, for which the non-irradiated reaction gives poor yields (see Scheme 16.8). This can be attributed to the rapid reaction with the less-stable alkyl carbene



Scheme 16.9 Hydroxystannation of olefins induced by sonication.

complexes, thereby avoiding the possibility of decomposition.

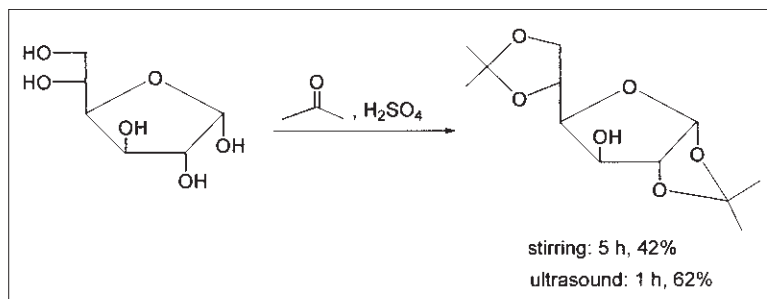
Results of a chemical activation induced by ultrasound have been reported recently by Nakamura *et al.* in the initiation of radical chain reactions with tin radicals [44]. When an aerated solution of R_3SnH and an olefin is sonicated at low temperatures (0–10°C), *hydroxystannation* of the double bond occurs and not the conventional hydrostannation achieved under silent conditions (see Scheme 16.9). This point evidences the differences between radical sonochemistry and the classical free-radical chemistry. The result was interpreted on the basis of the generation of tin and peroxy radicals in the region of hot cavities, which then undergo synthetic reactions in the bulk liquid phase. These findings also enable the sonochemical synthesis of alkyl hydroperoxides by aerobic reductive oxygenation of alkyl halides [45], and the aerobic catalytic conversion of alkyl halides into alcohols by trialkyltin halides [46].

It is obvious that in order to make predictions, the chemistry induced by cavitation will depend on the lifetimes of primary radicals compared with the lifetime of bubbles [47]. According to theory, ultrasonic frequency will influence the time taken for the collapse of a cavitation bubble, although most synthetic studies do not take into account this important parameter. At high frequencies of, say, 500 kHz the collapse occurs in 4×10^{-7} s, a period shorter than the lifetime of most radicals. These species, after the collapse, will migrate into the liquid phase and interact with other species or substrates. At a frequency of 20 kHz, however, the bubble collapse occurs in $\sim 10^{-5}$ s and this is a long enough period for $\cdot OH$ radicals to be able to undergo recombination reactions to give hydrogen peroxide, superoxides, excited

water molecules or other reactions in which dissolved gases also may participate. This suggests that 'primary' sonochemistry will be observed only at high frequencies, whereas the chemistry of low frequencies will be a consequence of sequential transformations of radicals.

To test the above considerations, the sono-oxidation of 2,2,6,6-tetramethylpiperidin-4-one was investigated at 520 and 20 kHz and the formation of its stable nitoxide was monitored by electron spin resonance [15]. The reaction requires the presence of $\cdot OH$ and either molecular oxygen or superoxide radical anion. A higher rate for nitoxide formation was observed at 520 kHz with the oxygen saturated solution, but no formation occurred under argon. In contrast, the same experiment run at 20 kHz proceeded slowly under oxygen but at a higher rate under argon. Because oxygen is necessary for this transformation, it must be produced at low frequency under argon by reaction pathways involving $\cdot OH$ recombination (see Scheme 16.1).

It is noteworthy to mention a homogeneous process involving C_{60} solutions, because the sonochemistry of fullerenes is still underexploited [48]. The ultrasonic irradiation (at 20 kHz) of a solution of C_{60} in decahydronaphthalene results in the formation of $C_{60}H_2$ [49]. Owing to its low vapour pressure at room temperature, no C_{60} will be inside the cavitation bubbles, although it will experience secondary reactions in the liquid phase. The dihydrofullerene results from the reaction with atomic hydrogen generated by sonolysis of the solvent. Although there are already many studies on hydrogenated fullerenes, it is remarkable that sonication does not produce more highly hydrogenated derivatives. Moreover, continued sonication results in the disappearance of both C_{60} and $C_{60}H_2$ from the solution,



Scheme 16.10 Ultrasound-mediated acetalisation of carbohydrates.

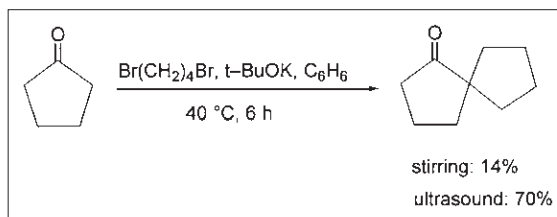
presumably by fragmentation into smaller hydrocarbons or by the formation of polymeric structures, although the latter points have not yet been confirmed.

Heterogeneous ionic reactions

In heterogeneous ionic reactions only the mechanical role of ultrasonic waves should be expected, which eventually may lead to enhanced reaction rates and yields. A typical example is the acid-catalysed acetalisation of sugars [50]. With mechanical stirring, the reaction is slow and side products resulting from acid catalysis accompany the process. These ionic side reactions, which take place in the solution, remain unaffected by sonication but the heterogeneous ketalisation is accelerated due to an efficient agitation process, the result being a cleaner and high-yielding reaction (see Scheme 16.10).

Oxymercuration of olefins, heterogeneous in nature, benefits from the application of sound waves [51]. Conventionally, the reaction is performed with mercury(II) acetate or trifluoroacetate. However, almost any mercuric salt can be prepared from mercury(II) oxide and an organic acid under sonication. Moreover, the salt preparation and the subsequent oxymercuration now can be conducted in a one-pot procedure.

In any event, certain cases of 'ionic' reactions may be problematic. Thus, the spiroannulation of ketones with α,ω -dihaloalkanes is effected in excellent yields, and the advantage of sonication is noticeable in the case of cyclopentanone, which undergoes self-condensation when the reaction is run under stirring only (see Scheme 16.11) [52]. Because a SET pathway also has been identified in certain cases of enolate alkylation [53], it is unclear if a radical step is being accelerated by ultrasound.

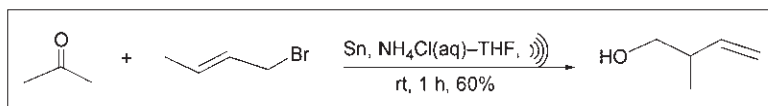


Scheme 16.11 Synthesis of spiroketones from cycloalkanones.

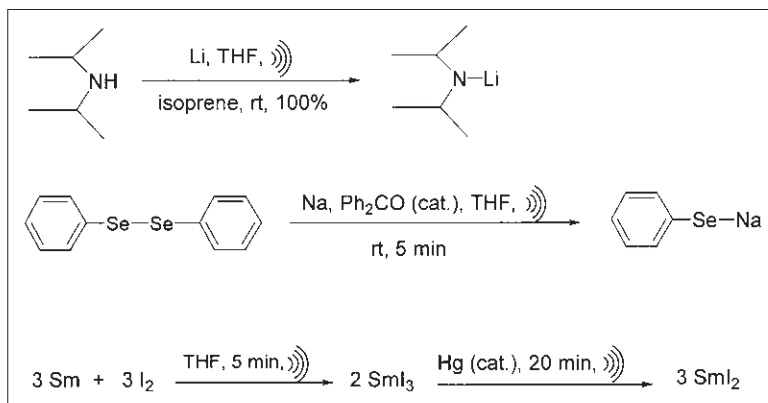
More intriguing is the isomerisation of polycyclic hydrocarbons to diamandoid cage compounds in superacid media, which would proceed by carbonium ions; this isomerisation has been found to be sensitive to sonication [54]. Hydrocarbons are dissolved in Freon-113 or CH_2Cl_2 and, after the addition of $\text{CF}_3\text{SO}_3\text{H-SbF}_5$ a heterogeneous system is obtained. Quantitative yields of cage hydrocarbons are obtained in less than 2 h by sonication, whereas without ultrasound the same superacid brought about these rearrangements in much longer reaction times. In this case ultrasound could serve not only as a synthetic tool but also as a probe capable of identifying a hidden component of a widely accepted mechanism.

Heterogeneous radical reactions

The study of heterogeneous reactions, which can follow either an ionic or SET pathway, represent one of the favourite domains of sonochemistry because such reactions are influenced by sonication and in some cases switching of the reaction pathway is observed. Most studies have been focused on reactions involving metals [55] and, although the sonochemical effects have been attributed mainly to a 'cleaning' or mechanical depassivation of metal sur-



Scheme 16.12 The sonochemical Barbier reaction.



Scheme 16.13 Sonochemical preparation of metal reagents.

faces, the studies on the Barbier reaction clearly evidence that electron transfer from the metal to the halide is easier under sonication [56] (see Scheme 16.12).

The Barbier reaction with lithium works very well and starts almost immediately under sonication, whereas Barbier and Barbier–Grignard reactions with magnesium often require long induction periods. This metal undergoes fractures and surface erosion before chemical reaction occurs, the role of ultrasound being the creation of lattice-defect sites where reaction takes place preferentially [57]. Recently, it has been demonstrated that Grignard reagent formation involves diffusion steps—reactions of radicals that diffuse in solution (the D model)—rather than adsorption steps in which the radicals remain adsorbed at the magnesium surface until they react [58]. In other words, the reaction would be more homogeneous than once thought and this could explain why sonication activates the reaction.

A direct consequence of the ultrasound-promoted electron transfer is the facile preparation of radical anions and their propagation reactions, as illustrated here in the preparation of lithium amides. It is noteworthy to point out the beneficial effect of an electron carrier like isoprene [59]. Similarly, a series of useful organometallic reagents such as sodium phenylselenide, the important hydride [(Ph₃P)CuH]

and the versatile lanthanide SmI₂ can be prepared easily by sonication upon addition of sodium/benzophenone [60] (see Scheme 16.13). Because the rate-limiting step of these processes is the transfer of electrons from the metal surface, the set-up of the reaction is due to the presence of the ketyl radical anion, a fact that reinforces again the chemical role of ultrasound. Thus, the sonochemical preparation of SmI₂ can be conducted starting from samarium metal and iodine in tetrahydrofuran (THF) using a simple cleaning bath, which affords a yellow triiodide within 5 min. Further addition of a catalytic amount of mercury to the sonicated reaction leads to the desired reagent in quantitative yield. The overall process is complete in less than 30 min, which contrasts with the classical protocols performed under an inert atmosphere, in dried solvents and requiring longer reaction times [61].

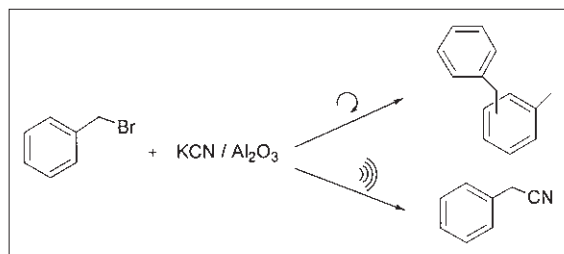
Other interesting examples of heterogeneous sonochemistry do not involve metals but inorganic solids. Thus, Ando and co-workers reported one of the first cases of sonochemical switching in the reaction of benzyl bromide, potassium cyanide and alumina, which when stirred mechanically in toluene at 50°C gives rise to a mixture of *o*- and *p*-benzyltoluene in 75% yield. In contrast, irradiation with ultrasound (45 kHz) of the same reaction mixture at 50°C yielded also benzyl cyanide in 71% yield (see Scheme 16.14) [62].

It has been suggested that ultrasound switches the reaction course from the Friedel–Crafts reaction to nucleophilic substitution due to sonochemical acceleration of a specific poisoning of the catalytically active sites of alumina by potassium cyanide [63]. However, a plausible explanation is that benzyl cyanide might be formed through a SET pathway because sonication should yield a higher density of free-radical species than mechanical stirring [64].

The Wittig–Horner olefination reaction on barium hydroxide as the catalyst represents the other model case in which the chemical effects of ultrasound are evident. Sonication cleaves the water molecules (present in small amounts in the mixture) to give hydroxyl radicals, which initiate a catalytic cycle with the phosphonate radical anion at the surface of barium hydroxide [65] (see Scheme 16.15). This is probably the first example in which the small amounts of radicals generated by water sonolysis do induce a high-yielding synthetic process.

2.2 Ultrasonic preparation of micro- and nanostructured materials

The high temperatures and pressures created during the cavitation event on a microsecond time scale



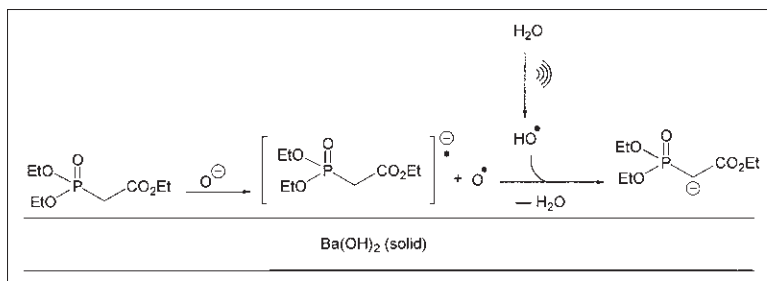
Scheme 16.14 Divergent pathways in the reaction of benzyl bromide with KCN/Al₂O₃.

along with the rapid cavitation cooling rate ($<10^9 \text{ K s}^{-1}$), which is much greater than that obtained by conventional melting techniques (10^5 – 10^6 K s^{-1}) [66], enable the preparation of nanosized amorphous particles. Furthermore, because the thermal conductivities of metal oxides are generally much lower than those of the metals, faster cooling rates are required to prepare amorphous metal oxides.

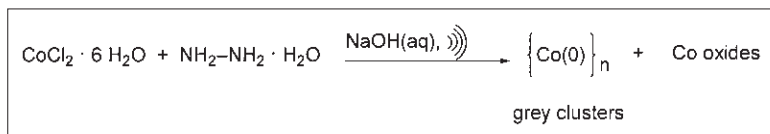
Several groups have prepared nanosized amorphous powders of transition metals and their alloys by sonochemical decomposition of volatile organometallic compounds [67–73]. Thus, nanostructured metals and alloys are formed from Fe(CO)₅ and Co(CO)₃(NO); the metal carbide Mo₂C is produced from Mo(CO)₆ and the process is suitable also for a wide range of transition metals. Reactions are performed in alkane solvents having low volatility (e.g. decane) and irradiated by ultrasound at 20 kHz. The Fe powder prepared contains ca. 3% carbon and ca. 1% oxygen as residual impurities and possesses a high surface area ($\sim 120 \text{ m}^2 \text{ g}^{-1}$). The amorphous powder undergoes crystallisation at $\sim 350^\circ \text{C}$ to the α -Fe phase when heated in N₂ [68,69]. The Fe, Co and Fe–Co alloys have high activity for cyclohexane dehydrogenation and hydrogenolysis, and supported Fe on SiO₂ is an active Fischer–Tropsch catalyst [68a]. Ultrasound irradiation of Mo(CO)₆ gives nanometre-sized clusters (ca. 2 nm) of Mo₂C having a dehydrogenation activity comparable to that of ultrafine powdered platinum [67,69].

Irradiation of a slurry of Mo(CO)₆ and sulfur in 1,2,3,5-tetramethylbenzene gives rise to amorphous MoS₂ [73]. It was converted to the crystalline state—hexagonal MoS₂—by heating. The particles were examined for their catalytic activity for hydrodesulfurisation, a key process in petrochemistry. It was found to be superior to that of commercially available ReS₂, RuS₂ and MoS₂.

Amorphous nickel powder has been prepared



Scheme 16.15 Sonocatalytic effect on the Wittig–Horner olefination.



Scheme 16.16 Sonochemical formation of cobalt nanoclusters.

equally by sonochemical decomposition of $\text{Ni}(\text{CO})_4$ as neat liquid or in decalin solution [74] and nanophase amorphous nickel supported on silica microspheres also has been obtained [75].

Nanosized amorphous oxides such as NiFe_2O_4 powder can be prepared equally by sonochemical decomposition of $\text{Fe}(\text{CO})_5$ and $\text{Ni}(\text{CO})_4$ in decalin solutions under an oxygen pressure of 100–150 kPa [76]. Microscopic characterisation gives no evidence of crystalline formation and the material is an agglomerate of nanoparticles with diameters of >10 nm. Magnetic measurements also indicate that NiFe_2O_4 particles are superparamagnetic.

Ultrafine powders of Cr_2O_3 and Mn_2O_3 have been prepared by sonochemical reduction of aqueous solutions of ammonium dichromate and potassium permanganate, respectively [77]. The powders are nanosized (50–200 nm) and crystallisation may be induced by heating. A continuous process based on *hydrodynamic cavitation* can be employed to prepare a wide variety of metal oxides in grain sizes of 1–10 nm, such as iron oxide, bismuth molybdate, perovskites, platinum-loaded zeolite and other ceramics and superconductors [78]. The method uses a microfluidiser for mechanically generating hydrodynamic cavitation and the internal pressure of the liquid media is elevated from ambient pressure to between 1000 to 25 000 psi. Nanocrystalline oxides (Y_2O_3 , TiO_2 , ZrO_2 , Cr_2O_3 , Fe_2O_3 , Co_3O_4 , NiO , CeO_2) also have been prepared by hydrodynamic cavitation [79].

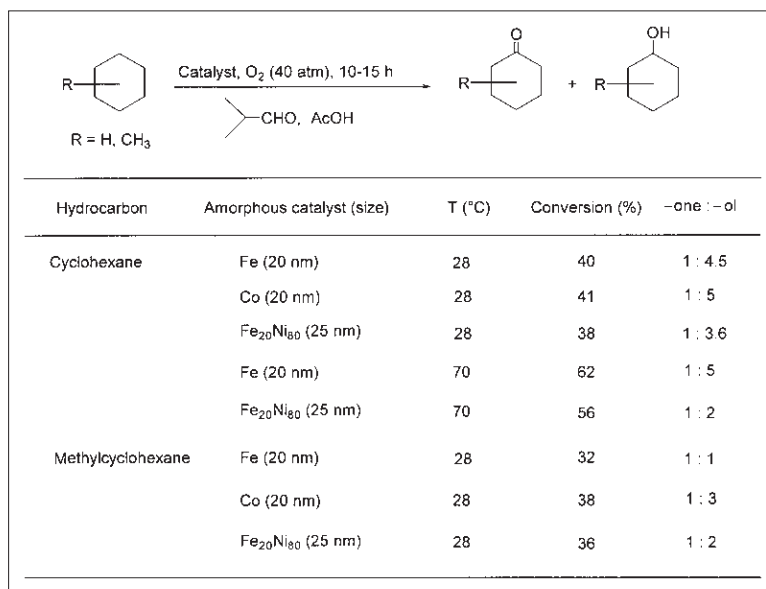
A recent investigation has demonstrated the usefulness of ultrasonic irradiation in the preparation of delaminated zeolites, which are a particular type of modified oxides—microporous crystalline aluminosilicates with three-dimensional structures—having a greater catalytic activity than the layered structures (clays) and mesoporous catalysts. In an attempt to increase the pore size of zeolites, a layered zeolite precursor was delaminated in an ultrasonic bath operating at 40 kHz for 1 h [80]. This layered aluminosilicate and a typical zeolite have similar activities for *n*-decane cracking. In addition, delami-

nation provides greater site accessibility for larger molecules, catalysing the formation of more liquid (gasoline) and less gaseous products and coke.

The preparation of cobalt nanoclusters has been performed by sonicating basic solutions of $\text{Co}(\text{II})$ and hydrazine [81] (see Scheme 16.16). The colloidal cobalt nanoclusters consist primarily of cobalt, although a small amount of oxygen, possibly as a very thin oxide coating, also is present. The cobalt nanoclusters are ferromagnetic and may be useful in the construction of high-density recording media or permanent magnets.

Recently, the amorphous magnetic metals (Fe, Ni, and Co), and some amorphous magnetic alloys have been used as catalysts in the aerobic oxidation of hydrocarbons such as cyclohexane, methyl cyclohexane, and adamantane [82]. Thus, the oxidation of cyclohexane is carried out up to 40% conversion with 80% selectivity for cyclohexanone and cyclohexanol using nanostructured amorphous metals like Fe and Co, and amorphous alloy like $\text{Fe}_{20}\text{Ni}_{80}$ with oxygen (40 atm) at 25–28°C in the absence of any solvent. In the aerobic oxidation isobutyraldehyde as co-reductant and a catalytic amount of acetic acid are used. Such oxidations can be accomplished at room temperature under 1 atm of oxygen, albeit oxygen at 40 atm gives better conversion (see Scheme 16.17).

Noble metal particles and bimetallic nanoparticles in aqueous solutions can also be obtained by sonochemical procedures. Palladium metallic clusters have been prepared at room temperature by sonochemical reduction of $\text{Pd}(\text{OAc})_2$ and a surfactant, myristyltrimethylammonium bromide, in THF or methanol [83]. It is noteworthy that nanosized amorphous Pd is obtained in THF but it is obtained in crystalline form in methanol. In this solvent, and in higher homologous alcohols, sonolysis of tetrachloropalladate(II) leads to Pd nanoclusters in which carbon atoms, formed by complete decomposition of the solvent, can diffuse. This results in an interstitial solid having the formula PdC_x ($0 < x < 0.15$) [84]. Noble metal nanoparticles of Au, Pd and Ag are



Scheme 16.17 Aerobic oxidation of hydrocarbons by sonochemically prepared catalysts.

obtained by sonicating aqueous solutions of the corresponding salts in the presence of a surfactant, which largely stabilises the naked colloid [85]. Freshly prepared Pd embedded in amorphous carbon exhibits catalytic properties for the Heck reaction [83,86].

Elongated copper nanoparticles have been prepared by sonicating copper hydrazine carboxylate in an aqueous solution containing a zwitterionic surfactant [87]. The dimensions of these copper nanoparticles are approximately 500 nm in length and 50 nm in width. In the absence of surfactant, nanoparticles are spherical with a diameter of approximately 50 nm. These sonochemically prepared Cu nanoparticles have been examined as catalysts for the Ullmann reaction [88].

Although the topic of sonoelectrochemistry will be treated in the subsequent section, it should be mentioned that sonoelectroreduction of metallic salts gives rise to reactive metals that can be employed in organometallic synthesis [89].

3 Ultrasound in Electrochemistry: Sonoelectrochemistry

Recent studies have demonstrated that there are several aspects of ultrasound that recommend its use in conjunction with electrochemical processes

Table 16.3 The possible benefits of sonication during an electrochemical process

- Ultrasonic degassing limits gas bubble accumulation at the electrode
- Ultrasonic agitation (via cavitation) disturbs the diffusion layer and stops the depletion of electroactive species
- Ultrasonic agitation provides more even transport of ions across the electrode double layer
- Ultrasonic irradiation continuously cleans and activates the electrode surfaces

(Table 16.3) [89,90]. These improvements include enhanced diffusion processes, increased yields, increased current efficiencies, increased limiting currents [91,92], lower overpotentials and improved electrodeposition rates [93]. Although there may be different origins for the variety of these effects, one well-characterised effect of ultrasonic irradiation is the generation and subsequent collapse of cavitation bubbles within the electrolyte medium and near to the electrode surface of the electrochemical cell. The electrode surface causes asymmetrical collapse of a bubble, which in turn leads to the formation of a high-velocity jet of liquid that is directed towards the surface. This jetting is thought to lead to the destruction of the mass transfer boundary layer [94] at the electrode. This improves the overall mass transfer of

the system and, as a consequence, the reaction rates at the electrodes.

Such advantages were not recognised until relatively recently but now are rapidly making the subject of ultrasonically enhanced electrochemistry (sonoelectrochemistry) a major research and applications domain [95,96].

3.1 Electroplating

Early research into the field of sonoelectrochemistry seems to have been carried out mainly by metallurgists concerned with improving the efficiency of electroplating [93]. Using the simple method of directly sonicating the plating bath, considerable savings are possible in processing costs through improvements via a shortening in process time, an increase in the deposition rate and a reduction in the plating current that occurs in conventional electroplating due to polarisation [97]. In the case of nickel plating, ultrasonic irradiation alleviated the need for rigorous control of bath temperature in order to obtain acceptable deposits [98]. Improvements in the efficiency of chromium plating also have been reported [99]. Electrodeposited copper had a brighter finish and better properties [100]. Research in this domain continues towards improvements in both electroplating [101] and electroless plating [102].

3.2 Electrosynthesis

Investigations into the influence of ultrasound on electrode reactions and electrosynthesis are of more recent origin. For the reasons outlined in Table 16.3, the interfacing of ultrasound with electrochemistry appears to hold a lot of potential and the field of sonoelectrochemistry is set to make new strides. For example, the electrochemical oxidations of Fe^{2+} to Fe^{3+} , $\text{Fe}(\text{CN})_6^{4-}$ to $\text{Fe}(\text{CN})_6^{3-}$ and Cr^{3+} to Cr^{4+} have been investigated [103]. The yields and current efficiencies for the reactions were studied at a current density of 0.25 A mm^{-2} without ultrasound and at three ultrasonic frequencies 15, 25 and 200 kHz. It was found that ultrasound accelerates the process and increases the current efficiency, with the greatest effect observed at 25 kHz. It was found that the application of ultrasound raises the limiting current density considerably, thus causing a reduction of the diffusion layer thickness and thus an increased efficiency of the process.

The application of ultrasound in electrochemical polymerisation of conducting polymers also has been studied. In particular, the electrochemical polymerisation of thiophene has been carried out both in the presence and absence of ultrasonic waves [104,105]. In the absence of ultrasound the anode potential increased with increasing current density. However, polymerisation at high potential gave a low polymer yield and produced macroscopically heterogeneous films. Ultrasonic irradiation resulted in an improvement of the polymer yield and a lowering of the anode potential during polymerisation. Polythiophene films produced using sonoelectrochemistry have been shown to be flexible and tough, in contrast to the more brittle forms produced using conventional technology.

Some unusual compounds have been synthesised efficiently through sonoelectrochemistry. The compound digermane $[\text{Ge}(\text{R}^1\text{R}^2\text{R}^3)]_2$ has been manufactured by the electrode reaction of $\text{Ge}(\text{R}^1\text{R}^2\text{R}^3)\text{X}$ ($\text{R}^{1-3}=\text{H}$, alkyl, aryl, alkoxy or amino group) in an aprotic solvent containing Mg, Cu or Al as an anode and perchlorate as a supporting electrolyte with ultrasound. This methodology is claimed to be safe and non-toxic with minimal pollution [106].

The effects of ultrasound on electrochemical processes suggest significant benefits. These include modifications to the chemistry of reactions at the electrode and greatly increased current efficiencies. One major result of these studies could be that, in the future, industrial electrochemistry might become a more attractive proposition.

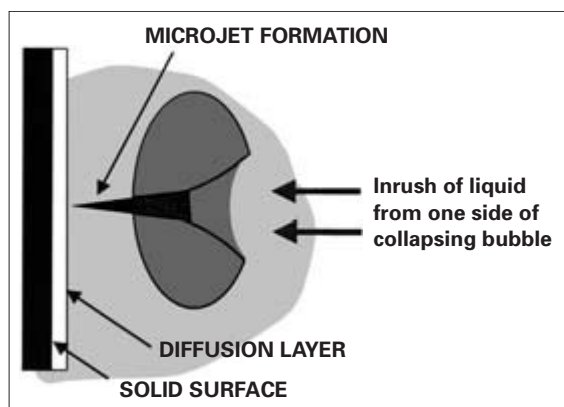
4 Ultrasound in Environmental Protection and Waste Control

At the time of writing this is one of the expanding areas of research in sonochemistry, with the majority of investigations focusing on the harnessing of cavitation effects for the destruction of chemical and biological pollutants (Table 16.4).

There are three zones associated with the collapsing cavitation bubble that can be involved in the decontamination process (Fig. 16.7). Inside the bubble is a localised microreactor; any material entering this zone will be subjected to temperatures of several thousand degrees and pressures in excess of 1000 atm and will be degraded. Some chemicals that become associated with the interface will experience less forcing conditions but also could suffer

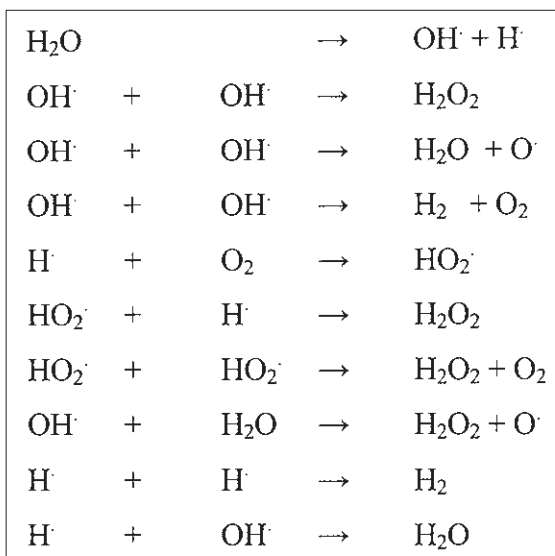
Table 16.4 Uses of ultrasound in environmental protection

Biological decontamination	Chemical decontamination
Surface cleaning sterilisation of water and food materials	Surface cleaning Destruction of organic compounds in water and sewage Removal of pollutants in soil

**Fig. 16.8** Collapse of a cavitation bubble close to the surface.

degradation. The violent collapse also will produce large shear forces in the bulk medium immediately surrounding the bubble. It is these forces that are mainly responsible for the efficient mixing and particle dispersion effects that can also assist in decontamination processes [107–110].

In a heterogeneous solid–liquid system the collapse of the cavitation bubble will have significant mechanical effects. Collapse near to a surface generates a liquid jet, targeted at the surface, with speeds in excess of 100 m s^{-1} (Fig. 16.8). The effect is equivalent to high-pressure jetting and is the reason why ultrasound has been used for many years in surface cleaning from delicate applications such as micro-components under clean-room conditions to large-scale items such as engine blocks in factories. It is particularly effective in the removal of biological contamination because the jets are easily capable of dislodging bacteria that may be adhering to surfaces. The particular advantage of ultrasonic cleaning in this context is that it can reach into crevices that are not cleaned easily by conventional methods. For this reason biological decontamination is used for a range

**Scheme 16.18** Sonochemical decomposition of water.

of items, from large crates used for food packaging and transportation to delicate surgical implements such as endoscopes.

There are three main thrusts to the work on decontamination:

- (1) To use cavitation alone as a clean energy source.
- (2) To use cavitation to improve other treatments (e.g. advanced oxidation).
- (3) To reduce the amounts of chemicals required for conventional treatments (e.g. reduction in biocide levels).

4.1 Chemical decontamination

The mechanical effects of cavitation collapse together with the production of radical species combine to provide the essential elements for water decontamination. The primary radicals produced during the sonication of water are OH^\bullet and H^\bullet and the fate of these is quite complex (see Scheme 16.18). The HO^\bullet radical is extremely reactive and is capable of oxidising most chemical compounds dissolved in the water. This oxidation is mainly responsible for the degradation of organic pollutants in sonicated aqueous media. The efficient generation of HO^\bullet is therefore an important goal in waste treatment.

The use of ultrasound for the destruction of dilute aqueous solutions of low-molecular-weight organic compounds (alcohols, ketones and aldehydes) at ambient temperature has been reported. An aqueous flow cell system was assembled to measure the oxidatively degraded formate and acetate products by on-line ion chromatography [111].

Ultrasonic irradiation of aqueous solutions results in the formation of free radicals due to the homogeneous sonolysis of water. These radicals attack and degrade numerous organic compounds. A study of sonochemical treatment of chlorinated hydrocarbons in water demonstrated the homogeneous destruction of CH_2Cl_2 , CCl_4 , MeCCl_3 and $\text{ClCH}:\text{CCl}_2$ in solution at concentrations of 100–1000 ppm by volume [112]. The method appears to be quite powerful potentially for the purification of contaminated water. In a separate study, when saturated aqueous solutions of CH_2Cl_4 (110 ppm) and MeCCl_3 (1300 ppm) were sonicated for 20 min some 75% of the contaminant was degraded [113].

The sonochemical removal of chlorinated aromatic compounds from water is attracting considerable attention. By using phenol itself as a model substrate, Berlan *et al.* have shown that degradation takes place via sequential oxidation and the intermediate formation of hydroquinone and catechol [114]. The final products of the degradation at 541 kHz are low-molecular-weight carboxylic acids. The process for the degradation of phenol (100 mg l^{-1}) requires long reaction times of 1–3 h, depending on the entrained gas used.

The degradation of a number of 2-, 3- and 4-chlorophenols has been examined under pulsed sonolytic conditions (20 kHz, power = 50 W cm^{-2}) in air-equilibrated aqueous media [115]. These phenols are totally transformed to dechlorinated and hydroxylated intermediate products via first-order kinetics in a time of 10–15 h. The process involves hydroxyl radical attack and at low concentrations of chlorophenol the reaction takes place in the bulk solution, whereas at the higher concentrations the reaction occurs predominantly at the gas bubble/liquid interface.

Up to a few years ago the majority of sonochemistry research used a narrow range of frequencies (generally 40 kHz using a bath and 20 kHz for a probe). Only a few studies have been performed at higher frequencies (around 1 MHz) [116]. Recently it has been shown that the insonation frequency

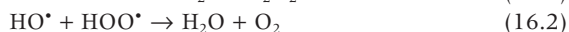
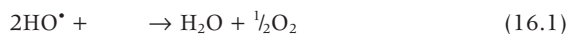
Table 16.5 Comparison between H_2O_2 production and the rates of phenol and carbon tetrachloride disappearance at different frequencies ($\mu\text{M min}^{-1}$)

	Frequency (kHz)			
	20	200	500	800
H_2O_2 formation	0.7	5.0	2.1	1.4
Phenol degradation	0.5	4.9	1.9	1.0
CCl_4 degradation	19	33	37	50

employed affects radical production, with higher frequencies generating more radicals for the same power input [14,117,118].

The question as to where the sonochemical degradation of chemicals occurs with relation to the collapsing bubble has been investigated. In a comparative study of the decomposition of phenol (to carboxylic acids) and carbon tetrachloride (to CO_2 and Cl^-) in water saturated with oxygen at different frequencies (Table 16.5) [119], the results clearly show a difference in the behaviour of the chemical contaminants (original concentration 10^{-3} M), with the phenol degradation mirroring the peroxide formation, indicating that this reaction is proceeding at the bubble interface or outside of the bubble. The volatile CCl_4 , however, is decomposed within the bubble and increased frequency slightly accelerates the process. An intriguing calculation for these reactions shows that the efficiency for each of these processes over one ultrasonic cycle decreases as the frequency increases.

The occurrence of an optimum frequency at 200 kHz was explained through a two-step reaction pathway. In the first step, water sonolysis produces radicals within the bubble. In the second step the radicals must migrate to the bubble interface or into the bulk aqueous medium to form peroxide or react with the phenolic substrate. The authors suggest that the lower frequencies are the most efficient for the decomposition of molecules inside the bubble, but a proportion of the radicals recombine inside the bubble at high temperature to form water, thereby reducing the overall yield of H_2O_2 (Equations 16.1 and 16.2):



As the frequency increases, the pulsation and collapse of the bubble occur more rapidly and more radicals escape from the bubble. However, as the frequency increases, the cavitation intensity decreases and this reduces the yield of radicals and consequently the number that reach the interface and bulk solution.

4.2 Biological decontamination

Power ultrasound currently is under investigation for use in the biological decontamination of water [120]. Conventional methods of disinfection involve the use of a bactericide, which for the large-scale water industry may be chlorine, chlorine dioxide or ozone. Current trends are towards the reduction in quantity of the biocide used in sterilisation, but some bacteria are capable of building up resistant strains that may require more concentrated biocide. Power ultrasound affords the opportunity of increasing the efficiency of a biocide such as chlorine. The improvement in the biocidal effect of chlorine is thought to be the result of two major effects: a mechanical breakdown of bacterial clumps or the material in which the bacteria adhere, which will remove the protection afforded to live bacteria in the centre of the clumps and directly expose them to the biocide; and ultrasound can increase the permeability of the cell walls of the bacteria to the biocide and thus increase its rate of uptake.

Although bacteria are difficult to kill with ultrasound in the absence of a bactericide, larger biological contaminants such as plankton and algae can be destroyed using low-power ultrasound without the need for additional chemicals. This does provide a real possibility for future development, with several technologies approaching realisation.

Zooplankton often accidentally pass through the purification cycle of a water treatment plant, leading to re-germination and a clogging of filters located in the water distribution system. It is important therefore to eliminate the plankton before the water reaches the flocculation process. Such inactivation can be achieved using power ultrasound through the purely mechanical effects of acoustic cavitation, which have been discussed above [121]. In order to inactivate plankton a sound intensity of approximately 1 W cm^{-2} and a high air content in the water are especially effective. The economic viability of a system for plankton treatment has been tested using

a flow-through system with a capacity of $300 \text{ m}^3 \text{ h}^{-1}$. The actual volume of treatment in the system was 2 m^3 , with an active acoustic area of 2 m^2 . To inactivate a large number of real types of plankton such as Nauplii, Copopods and Rotifers, a specific power of 0.05 kWh m^{-3} proved to be satisfactory.

A continuing problem in water treatment is the occurrence of algal blooms. Algae may be killed relatively easily on exposure to ultrasound and with a lightly 'polluted' system, which provides very little attenuation to sound transmission, there is the possibility of using high-frequency ultrasound (low power emission and consumption). Such high frequencies have been shown to give maximum activity, as shown through sonoluminescence, at the interface between liquids and gases. Logically, then, if a large number of small bubbles were introduced into a field of high-frequency ultrasound there would be a very large gas/liquid surface area for cavitation activity and the bubbles themselves also should provide 'seeds' for cavitation events. This is the basis of an approach to algae removal and control proposed by the Belgian company Undatim. In a trial involving the monocellular algae species *Scenedesmus Capricornutum*, some spectacular results were obtained. A cell was constructed to treat water at a rate of $2 \text{ m}^3 \text{ h}^{-1}$ using an acoustic power of 450 W . At a temperature of 25°C and for a deep-green, highly concentrated solution of the algae containing some 4×10^6 algal cells cm^{-3} , a single pass through the cell reduced the recovery threshold of the microorganism by some 60%. This indicates that this treatment, even operating at algal concentrations that are far higher than might be encountered in normal treatments, offers the potential not only to kill the microorganism but also to severely restrict its reproductive ability.

This ultrasonic anti-algae methodology has been combined with an electromagnetic treatment to provide a new water remediation technology for cooling towers, known as Sonoxide [122]. This process tackles two major problems of cooling circuits: the build-up of algae (see above) and the removal of hard-water scaling. The latter is affected by changing the crystalline form of calcium carbonate and causing it to precipitate out for easy removal. In terms of chemical consumption, the process removes the problem of heavy biocide dosage during the irregular blooming conditions. It also means a large saving in the continuous injection of the

incoming water with conventional chemical additives (anti-scaling, anti-corrosion, anti-redeposition, anti-algae and biocidal agents).

5 Enhanced Extraction of Raw Materials from Plants

The use of plants not only as food but also as flavouring, colouring or in medicine has a long history. The interest in aromatic and medicinal plants has declined over the last half-century, mainly due to the tremendous developments in the production of synthetic substitutes. Nowadays, however, there is a resurgence of interest in natural remedies, which is in part due to some disillusionment with modern medicines and the hope that new treatments can be resurrected from ancient remedies.

Medicinal and aromatic plants provide an inexhaustible resource of raw materials for the pharmaceutical, cosmetic and food industries and, more recently, in agriculture for pest control. People have learned to increase the power or usefulness of herbs by preparing medicinal compounds from them, by preserving them so that they are always available and by finding new ways to release their active constituents.

Increased efficiency in extraction leads directly to a reduction in material wastage and power ultrasound has been shown to improve extraction from plant materials. The classical techniques for extraction are mainly liquid–solid extraction by means of steam and/or organic solvents. All such techniques use relatively high temperatures and thus the energy consumption is very high and decomposition of some compounds also may occur. The use of ultrasound avoids these high temperatures and can result in enhanced component extraction at lower temperatures and in a faster time [123–125].

Plants are a source of raw chemicals and there are real possibilities for the growing of crops for specific extracts. One of the best-known examples is the rubber tree. It is also well known that oil plants like sunflower, rape and castor could be not only a source of food material but also a bulk source of chemicals for the cosmetic and chemical industries. Some examples are: linalool from coriander, limonene and carvone from dill seeds, anethole from fennel seeds and α -pinene that can be separated from turpentine oil extracted from coniferous trees in quite large amounts.

6 Large-scale Sonochemistry

The progress of sonochemistry in green and sustainable chemistry is dependent upon the possibility of scaling up the excellent laboratory results for industrial use. There are currently several systems available commercially, with configurations to suit most applications [7,126–129].

The first step in the progression of a sonochemical process from laboratory to large scale is to determine whether the ultrasonic enhancement is the result of a mechanical or a truly chemical effect. If it is mechanical then ultrasonic pretreatment of slurry may be all that is required before the reacting system is subjected to a subsequent conventional type of reaction. If the effect is truly sonochemical, however, then sonication must be provided during the reaction itself. The second decision to be made is whether the reactor should be of the batch or flow type. Whichever type is to be used, there are only three basic ways in which ultrasonic energy can be introduced to the reacting medium (Table 16.3). Several different types of ultrasonic reactors are currently available.

6.1 Batch systems

The obvious batch treatment processor is the ultrasonic cleaning bath, which is a readily available source of low-intensity ultrasonic irradiation, generally at a frequency of around 40 kHz. A reactor based on this design might require adaptation to provide chemically resistant walls, a sealed lid for work under an inert atmosphere and mechanical stirring. Using this system for large-volume treatment, the acoustic energy entering the reaction would be quite small and any stirrer and fittings in the bath would cause attenuation of the sound energy.

An alternative configuration would involve using a submersible transducer assembly, which has been used for many years in the cleaning industry. It consists of a sealed unit within which transducers are bonded to the inside of one face and can be designed to fit into any existing reaction vessel.

6.2 Flow systems

Flow systems are generally regarded as the best approach to industrial-scale sonochemistry. The general arrangement would consist of a flow loop

outside a normal batch reactor, which acts as a reservoir within which conventional chemistry can occur. Such an arrangement allows the ultrasonic dose of energy entering the reaction to be controlled by the transducer power input and flow rate (residence time). Temperature control is achieved through heat exchange in the circulating reaction mixture.

Pipes of various cross-sectional geometry can be converted to flow processors by generating ultrasonic vibrations through their walls. The length of pipe must be designed accurately so that a null point exists at each end and then it can be retro-fitted to existing pipework. Such systems are capable of handling high flow rates and viscous materials. There are four common cross-sectional geometries: rectangular, pentagonal, hexagonal and circular. The pentagonal pipe provides a fairly uniform ultrasonic field because the energy from each irradiating face is reflected at an angle from the two opposite faces. The other configurations provide a 'focus' of energy in the centre, where direct energy and that reflected from the opposite wall meet.

7 Conclusions

Through the cavitation energy provided by power ultrasound, sonochemistry is finding a niche as a clean technology for the future. Trends that are now evident include chemical synthesis, sonocatalysis, environmental remediation and the use of ultrasound to enhance electrochemistry, biotechnology and photochemistry. The future prospects are likely to encompass a much wider range of applications as the frequency effects are exploited and more studies of sonochemical reaction mechanisms are embarked upon. Equipment design is coming on apace both in the laboratory and in development work for the scale-up of sonochemistry and processing.

Sonochemistry is an expanding field of study that continues to thrive on outstanding laboratory results that have even more significance now that scale-up systems are available.

References

1. Brown, B., & Goodman, J. E. *High Intensity Ultrasonics*. Iliffe Books, London, 1965.
2. Frederick, J. R. *Ultrasonic Engineering*. John Wiley, Chichester, 1965.

3. Abramov, O. V. *High-intensity Ultrasound: Theory and Industrial Applications*. Gordon and Breach, London, 1998.
4. Mason, T. J. *Ultrasonics*, 1987, **25** (special issue).
5. Suslick, K. S. *Ultrasound: its Chemical, Physical and Biological Effects*. VCH, Weinheim, 1988.
6. Mason, T. J. *Sonochemistry: the Uses of Ultrasound in Chemistry*. Royal Society of Chemistry, London, 1990.
7. Mason, T. J. *Sonochemistry*, Oxford University Primer Series No. 70. Oxford Science Publications, Oxford, 1999.
8. Povey, M., & Mason, T. J. *Ultrasound in Food Processing*. Blackie Academic and Professional, London, 1998.
9. Crum, L. A., Mason, T. J., Reisse, J. L., & Suslick, K. S. *Sonochemistry and Sonoluminescence*, NATO ASI Series. Kluwer Academic, Dordrecht, 1999.
10. Leighton, T. G. *The Acoustic Bubble*. Academic Press, London, 1994.
11. Didenko, Y. T., McNamara III, W. B., & Suslick, K. S. *J. Am. Chem. Soc.*, 1999, **121**, 5817.
12. (a) Makino, K., Mossoba, M. M., & Riesz, P. *J. Am. Chem. Soc.*, 1982, **104**, 3537; (b) Makino, K., Mossoba, M. M., & Riesz, P. *J. Phys. Chem.*, 1983, **87**, 1369.
13. (a) Weissler, A., Cooper, H. W., & Snyder, S. *J. Am. Chem. Soc.*, 1950, **72**, 1769; (b) Weissler, A. *J. Am. Chem. Soc.*, 1959, **81**, 1077; (c) Hart, E. J., & Henglein, A. *J. Phys. Chem.*, 1987, **91**, 3654; (d) Gutiérrez, M., Henglein, A., & Ibañez, F. *J. Phys. Chem.*, 1991, **95**, 6044.
14. Fisher, C.-H., Hart, E. J., & Henglein, A. *J. Phys. Chem.*, 1986, **90**, 1954.
15. Petrier, C., Jeunet, A., Luche, J.-L., & Reverdy, G. *J. Am. Chem. Soc.*, 1992, **114**, 3148.
16. Bremner, D. In *Advances in Sonochemistry* (Mason, T. J., ed.), Vol. 1. JAI Press, Greenwich, CT, 1990, pp. 1-38 and references therein.
17. (a) Paul, D., Fink, H. P., & Philipp, B. *Acta Polym.*, 1986, **37**, 496; (b) Heusinger, H. *Carbohydr. Res.*, 1988, **181**, 67; (c) Portlaenger, G., & Heusinger, H. *Carbohydr. Res.*, 1992, **232**, 291.
18. (a) Sehgal, C. M., & Wang, S. Y. *J. Am. Chem. Soc.*, 1981, **103**, 6606; (b) Fuciarelli, A. F., Sisk, E. C., Thomas, R. M., & Miller, D. L. *Free Radical Biol. Med.*, 1995, **18**, 231.
19. Luche, J.-L., & Cintas, P. In *Advances in Sonochemistry* (Mason, T. J. ed.), Vol. 5. JAI Press, 1998, Greenwich, CT, pp. 147-174.
20. Luche, J.-L. In *Advances in Sonochemistry* (Mason, T. J., ed.), Vol. 3. JAI Press, Greenwich, CT, 1993, pp. 85-124.
21. Luche, J.-L., Einhorn, C., Einhorn, J., & Sinisterra-Gago, J. V. *Tetrahedron Lett.*, 1990, **31**, 4125.
22. Griffing, V. *J. Chem. Phys.*, 1952, **20**, 939.
23. Kristol, D. S., Klotz, H., & Parker, R. C. *Tetrahedron Lett.*, 1981, **22**, 907.

24. Einhorn, C., & Luche, J.-L. Personal communication.
25. Lorimer, J. P., Mason, T. J., & Mistry, B. P. *Ultrasonics*, 1987, **25**, 23.
26. Speiser, B. *Angew. Chem., Int. Ed. Engl.*, 1996, **35**, 2471.
27. Galiakhmetov, R. N., Valitov, R. B., Kurochkin, A. K., & Margulis, M. A. *Zh. Fiz. Khim.*, 1986, **60**, 1024.
28. Ashby, E. C., Park, W. S., Goel, A. B., & Su, W.-Y. *J. Org. Chem.*, 1985, **50**, 5184.
29. Einhorn, C., Einhorn, J., Dickens, M. J., & Luche, J.-L. *Tetrahedron Lett.*, 1990, **31**, 4129.
30. (a) Kornblum, N., Michel, R. E., & Kerber, R. C. *J. Am. Chem. Soc.*, 1966, **88**, 5662; (b) Russell, G. A., & Danen, W. C. *J. Am. Chem. Soc.*, 1966, **88**, 5663.
31. (a) Dickens, M. J., & Luche, J.-L. *Tetrahedron Lett.*, 1991, **32**, 4709; (b) Luche, J.-L. *Ultrasonics*, 1992, **30**, 156.
32. Ando, T., Bauchat, P., Foucaud, A., Fujita, M., Kimura, T., & Sohmiya, H. *Tetrahedron Lett.*, 1991, **32**, 6379.
33. House, H. O. *Modern Synthetic Reactions*. Benjamin, Menlo Park, CA, 1972, pp. 379–380.
34. (a) Allegretti, M., D'Annibale, A., & Trogolo, C. *Tetrahedron*, 1993, **49**, 10705; (b) Bosman, C., D'Annibale, A., Resta, S., & Trogolo, C. *Tetrahedron*, 1994, **50**, 13847.
35. Linker, T., & Linker, U. *Angew. Chem. Int. Ed.*, 2000, **39**, 902.
36. Fillion, H., & Luche, J.-L. *Synthetic Organic Sonochemistry* (Luche, J.-L., ed.). Plenum Press, New York, 1998, pp. 91–106.
37. (a) Lee, J., & Snyder, J. K., *J. Org. Chem.*, 1990, **55**, 4995; (b) Hainza, M., Lee, J., & Snyder, J. K. *J. Org. Chem.*, 1990, **55**, 5008; (c) Lee, J., Mei, H. S., & Snyder, J. K. *J. Org. Chem.*, 1990, **55**, 5013; (d) Lee, J., Li, J.-H., Oya, S., & Snyder, J. K. *J. Org. Chem.*, 1992, **57**, 5301.
38. (a) Ebersson, L. *Electron Transfers in Organic Chemistry*. Springer, Berlin, 1987, pp. 179–182; (b) Bauld, N. L., Bellville, D. J., Harirchian, B., Lorenz, K. T., et al. *Acc. Chem. Res.*, 1987, **20**, 371; (c) Baumgarten, M., & Müllen, K. *Top. Curr. Chem.*, 1994, **169**, 1.
39. (a) Nebois, P., Bouaziz, Z., Fillion, H., Moeini, L., et al. *Ultrason. Sonochem.*, 1996, **3**, 7; (b) Fillion, H., Moeini, L., Aurel-Piquier, M. J., & Luche, J.-L. *Bull. Soc. Chim. Fr.*, 1997, **134**, 375.
40. Caulier, T. P., & Reisse, J. *J. Org. Chem.*, 1996, **61**, 2547.
41. Suslick, K. S., Schubert, P. F., & Goodale, J. W. *J. Am. Chem. Soc.*, 1981, **103**, 7324.
42. Suslick, K. S., Goodale, J. W., Schubert, P. F., & Wang, H. H. *J. Am. Chem. Soc.*, 1983, **105**, 5781.
43. Caldwell, J. J., Kerr, W. J., & McKendry, S. *Tetrahedron Lett.*, 1999, **40**, 3485.
44. Nakamura, E., Imanishi, Y., & Machii, D. *J. Org. Chem.*, 1994, **59**, 8178.
45. Nakamura, E., Sato, K., & Imanishi, Y. *Synlett*, 1995, 525.
46. Sawamura, M., Kawaguchi, Y., Sato, K., & Nakamura, E. *Chem. Lett.*, 1997, 705.
47. Luche, J.-L. *Synthetic Organic Sonochemistry*. Plenum Press, New York, 1998, pp. 51–90, 107–166 and 167–234.
48. (a) Hucho, C., Kraus, M., & Maurer, D. *Physica B*, 1994, **194/196**, 415; (b) Andrievsky, G. V., Kosevich, M. V., Vovk, O. M., Shelkovsky, V. S., & Vashchenko, L. A. *J. Chem. Soc., Chem. Commun.*, 1985, 1281.
49. Mandrus, D., Kele, M., Hettich, R. L., Guiochon, G., Sales, B. C., & Boatner, L. A. *J. Phys. Chem. B*, 1997, **101**, 123.
50. Einhorn, C., & Luche, J.-L. *Carbohydr. Res.*, 1986, **155**, 258.
51. Einhorn, J., Einhorn, C., & Luche, J.-L. *J. Org. Chem.*, 1989, **54**, 4479.
52. Fujita, T., Watanabe, S., Sakamoto, M., & Hashimoto, H. *Chem. Ind. (London)*, 1986, 427.
53. Ashby, E. C., & Argyropoulos, J. N. *J. Org. Chem.*, 1985, **50**, 3274.
54. Farooq, O., Morteza, S., Farnia, F., Stephenson, M., & Olah, G. A. *J. Org. Chem.*, 1988, **53**, 2840.
55. Luche, J.-L., & Cintas, P. In *Active Metals, Preparation, Characterization, Applications* (Fürstner, A., ed.). VCH, Weinheim, 1996, pp. 133–190, and references therein.
56. (a) De Souza-Barboza, J. C., Luche, J.-L., & Petrier, C. *Tetrahedron Lett.*, 1987, **28**, 2013; (b) De Souza-Barboza, J. C., Petrier, C., & Luche, J.-L. *J. Org. Chem.*, 1988, **53**, 1212; (c) Moyano, A., Pericas, M., Riera, A., & Luche, J.-L. *Tetrahedron Lett.*, 1990, **31**, 7619.
57. Hill, C. L., Van der Sande, J. B., & Whitesides, G. M. *J. Org. Chem.*, 1980, **45**, 1020.
58. Garst, J. F., Ungváry, F., & Baxter, J. T. *J. Am. Chem. Soc.*, 1997, **119**, 253.
59. De Nicola, A., Einhorn, J., & Luche, J.-L. *J. Chem. Res.(S)*, 1991, 278.
60. Low, C. M. R. *Ultrason. Sonochem.*, 1995, **2**, S153.
61. Imamoto, T. *Lanthanides in Organic Synthesis*. Academic Press, New York, 1994, pp. 21–23.
62. Ando, T., Sumi, S., Kawate, T., Ichihara, J., & Hanofusa, T. *J. Chem. Soc., Chem. Commun.*, 1984, 439.
63. Ando, T., & Kimura, T. *Ultrasonics*, 1990, **28**, 326.
64. Luche, J.-L., Einhorn, C., & Einhorn, J. *Tetrahedron Lett.*, 1990, **31**, 4125.
65. Sinisterra, J. V., Fuentes, A., & Marinas, J. M. *J. Org. Chem.*, 1987, **52**, 3875.
66. Greer, A. L. *Science*, 1995, **267**, 1947.
67. Suslick, K. S., Hyeon, T., & Fang, M. *Chem. Mater.*, 1996, **8**, 2172.
68. (a) Suslick, K. S., Choe, S. B., Cichowlas, A. A., & Grinstaff, M. W. *Nature*, 1991, **353**, 414; (b) Suslick, K. S., Flint, E. B., Grinstaff, M. W., & Kemper, K. A. *J. Phys. Chem.*, 1993, **97**, 3098.

69. Suslick, K. S., Grinstaff, M. W., Cichowlas, A. A., & Choe, S. B. US Patent Application 765,647, 1991; CA **119**, P13608e, 1993.
70. Gonsalves, K. E., Rangarajan, S. P., García-Ruiz, A., & Law, C. C. *J. Mater. Sci. Lett.*, 1996, **15**, 1261.
71. Suslick, K. S., Fang, M., & Hyeon, T. *J. Am. Chem. Soc.*, 1996, **118**, 11960.
72. Shafi, K. V. P. M., Gedanken, A., Goldfarb, R. B., & Felner, I. *J. Appl. Phys.*, 1997, **81**, 6901.
73. Mdleleni, M. M., Hyeon, T., & Suslick, K. S. *J. Am. Chem. Soc.*, 1998, **120**, 6189.
74. Koltypin, Y., Katabi, G., Cao, X., Prozorov, R., & Gedanken, A. *J. Non-Cryst. Solids*, 1996, **201**, 159.
75. Ramesh, S., Koltypin, Y., Prozorov, R., & Gedanken, A. *Chem. Mater.*, 1997, **9**, 546.
76. Shafi, K. V. P. M., Koltypin, Y., Gedanken, A., Prozorov, R., et al. *J. Phys. Chem. B*, 1997, **101**, 6409.
77. Dhas, N. A., Koltypin, Y., & Gedanken, A. *Chem. Mater.*, 1997, **9**, 3159.
78. Moser, W. R., Marshik, B. J., Kingsley, J., Lemberger, M., et al. *J. Mater. Res.*, 1995, **10**, 2322.
79. Sunstrom, J. E., Moser, W. R., & Marshik-Guerts, B. *Chem. Mater.*, 1996, **8**, 2061.
80. Corma, A., Fornes, V., Pergher, S. B., Maesen, T. L. M., & Buglass, J. G. *Nature*, 1998, **396**, 353.
81. Gibson, C. P., & Putzer, K. J. *Science*, 1995, **267**, 1338.
82. Kesavan, V., Sivanand, P. S., Chandrasekaran, S., Koltypin, Y., & Gedanken, A. *Angew. Chem. Int. Ed.*, 1999, **38**, 3521.
83. Dhas, N. A., & Gedanken, A. *J. Mater. Chem.*, 1998, **8**, 445.
84. Okitsu, K., Mizukoshi, Y., Bandow, H., Yamamoto, T. A., Nagata, Y., & Maeda, Y. *J. Phys. Chem. B*, 1997, **101**, 5470.
85. Mizukoshi, Y., Okitsu, K., Maeda, Y., Yamamoto, T. A., Oshima, R., & Nagata, Y. *J. Phys. Chem. B*, 1997, **101**, 7033.
86. Dhas, N. A., Cohen, H., & Gedanken, A. *J. Phys. Chem. B*, 1997, **101**, 6834.
87. Salkar, R. A., Jeevanandam, P., Kataby, G., Aruna, S. T. et al. *J. Phys. Chem. B*, 2000, **104**, 893.
88. Dhas, N. A., Raj, C. P., & Gedanken, A. *Chem. Mater.*, 1998, **10**, 1446.
89. (a) Durant, A., Delplancke, J.-L., Winand, R., & Reisse, J. *Tetrahedron Lett.*, 1995, **36**, 4257; (b) Durant, A., Delplancke, J.-L., Libert, V., & Reisse, J. *Eur. J. Org. Chem.*, 1999, 2845.
90. Mason, T. J., Lorimer, J. P., & Walton, D. J. *Ultrasonics*, 1990, **28**, 333.
91. Lorimer, J. P., Pollet, B., Phull, S. S., Mason, T. J., Walton, D. J., & Geissler, U. *Electrochim. Acta*, 1996, **41**, 2737.
92. Lorimer, J. P., Pollet, B., Phull, S. S., Mason, T. J., & Walton, D. J. *Electrochim. Acta*, 1998, **43**, 449.
93. Walker, R. *Chem. Britain*, 1990, **26**, 251.
94. Klima, J. K., Bernard, C., & Degrand, C. *J. Electroanal. Chem.*, 1994, **367**, 297.
95. Walton, D. J., & Phull, S. S. In *Advances in Sonochemistry* (Mason, T. J., ed.), Vol. 4. JAI Press, Greenwich, CT, 1996, pp. 205–284.
96. Walton, D. J., & Mason, T. J. In *Synthetic Organic Sonochemistry* (Luche, J.-L., ed.). Plenum Press, New York, 1998, pp. 263–297.
97. Rich, S. R. *Plating*, 1955, **42**, 1407.
98. Dereska, J., Yeager, E., & Hovorka, F. *J. Acoust. Soc. Am.*, 1957, **29**, 769.
99. Walker, R., & Walker, C. T. *Ultrasonics*, 1975, **13**, 79.
100. Namgoong, E., & Chun, J. S. *Thin Solid Films*, 1984, **120**, 153.
101. Lorimer, J. P., & Mason, T. J. *Electrochemistry*, 1999, **67**, 924.
102. Zhao, Y., Bao, C., Feng, R., & Mason, T. J. *J. Appl. Poly. Sci.*, 1998, **68**, 1411.
103. Kowalskei, E., & Mizera, J. *Ultrasonics*, 1971, **9**, 81.
104. Osawa, S., Ito, M., Tanaka, K., & Kuwano, J. *Synthe. Met.*, 1987, **18**, 145.
105. Osawa, S., Ito, M., Tanaka, K., & Kuwano, J. *J. Polym. Sci. B: Polym. Phys.*, 1992, **30**, 19.
106. Shono, T., Nashida, R., Murase, H. *Jpn. Kokai Tokkyo Koho.*, 1993, 6.
107. Mason, T. J., Newman, A. P., & Phull, S. S. In *Advances in Water Treatment* (White, M. J. D., ed.), BHR Conference Series Publication No. 8. MEP, London, 1993, p. 243.
108. Mason, T. J. In *Sonochemistry and Sonoluminescence* (Crum, L. A., Mason, T. J., Reisse, J. L., & Suslick, K. S., eds), NATO ASI Series. Kluwer Academic, Dordrecht, 1999, pp. 363–370.
109. Mason, T. J. In *TUHH Reports on Sanitary Engineering* (Tiehm, A., & Neis, U., eds), Vol. 25, GFEU/TUHH, Hamburg, 1999, pp. 1–9.
110. Mason, T. J., & Tiehm, A. *Advances in Sonochemistry*, Vol. 6. Elsevier, Amsterdam, 2000.
111. Toy, M. S., Stringham, R. S., & Woodward, S. S. *Environ. Technol.*, 1992, **14**, 657.
112. Cheung, H. M., Bhatnagar, A., & Jansen, G. *Environ. Sci. Technol.*, 1991, **25**, 1510.
113. Nagata, Y., Kurosaki, Y., Nakagawa, M., & Maeda, Y. *Chem. Express*, 1993, **8**, 657.
114. Berlan, J., Trabelsi, F., Delmas, H., Wilhelm, A.-M., & Petrignani, J. F. *Ultrason. Sonochem.*, 1994, **1**, S97.
115. Serpone, N., Terzian, R., Hidehe, H., & Pelizzetti, E. *J. Phys. Chem.*, 1994, **98**, 2634.
116. Henglein, A. In *Advances in Sonochemistry* (Mason, T. J., ed.), Vol. 3. JAI Press, Greenwich, CT, 1993, pp. 17–84.
117. Mason, T. J., Lorimer, J. P., Bates, D. M., & Zhao, Y. *Ultrason. Sonochem.*, 1994, **1**, S91.
118. Entezari, M. H., & Kruus, P. *Ultrason. Sonochem.*, 1994, **1**, S75.
119. Petrier, C., & Francony, A. *Ultrason. Sonochem.*, 1997, **4**, 295.
120. Phull, S. S., Newman, A. P., Lorimer, J. P., Pollet, B., & Mason, T. J. *Ultrason. Sonochem.*, 1997, **4**, 157.

121. Mues, A. *Proceedings of 6th Meeting of European Society of Sonochemistry*, University of Rostock, Rostock-Warnemünde, 1998, p. 53.
122. Cordemans, E., & Hannecart, B. WO 98/01394.
123. Vinatoru, M., Toma, M., Radu, O., Filip, P. I., Lazurca, D., & Mason, T. J. *Ultrason. Sonochem.*, 1997, **4**, 135.
124. Salisova, M., Toma, S., & Mason, T. J. *Ultrason. Sonochem.*, 1997, **4**, 131.
125. Vinatoru, M., Toma, M., & Mason, T. J. In *Advances in Sonochemistry* (Mason, T. J., ed.), Vol. 5. JAI Press, Greenwich, CT, 1999, pp. 209–248.
126. Mason, T. J. *Sonochemistry: the Uses of Ultrasound in Chemistry*. Royal Society of Chemistry, London, 1990, p. 157.
127. Mason, T. J. *Ultrasonics*, 1992, **30**, 192.
128. Berlan, J., & Mason, T. J. *Ultrasonics*, 1992, **30**, 203.
129. Keil, F. J., & Swamy, K. M. In *Rev. Chem. Eng.*, 1999, **15**, 85.

Chapter 17: Applications of Microwaves for Environmentally Benign Organic Chemistry

CHRISTOPHER R. STRAUSS

1 Background

In 1986, the groups of Gedye and Giguere independently reported that organic reactions could be accelerated in domestic microwave ovens [1,2]. Their equipment comprised domestic microwave ovens and rudimentary reaction vessels. Although significant rate enhancements were obtained, hazards also were apparent, including explosions. Recommendations were made regarding the scale of reactions, containment of samples and conditions that could be expected to be relatively safe. These studies indicated that microwave heating for organic reactions was beneficial through increased rates but yet potentially dangerous owing to the flammability of organic solvents and the lack of facilities for control and monitoring.

Others began to investigate the microwave technique. Different approaches evolved, with common aims being to explore the advantages and minimise the risks. The diversity of these approaches stimulated further growth of the field. As a result, there are now more than 700 refereed papers on microwave-assisted organic and organometallic chemistry, including many reviews [3–20].

This chapter summarises the properties of microwaves and their influence on organic chemical reactions, and discusses these developments in the context of environmentally benign synthesis. The intention was not to produce yet another review, but more to discuss trends and opportunities for microwave technology in 'green' chemistry.

2 Properties of Microwaves

The microwave region of the electromagnetic spectrum corresponds to wavelengths of 1 cm to 1 m and frequencies of 30 GHz to 300 MHz [3]. This places it between infrared radiation, which has shorter wavelengths, and radio frequencies. Within the microwave band, some specific wavelengths in the 1–25 cm range are employed for radar, whereas

remaining sections are devoted to telecommunications. To ensure that these uses are not compromised, by international convention it has been agreed that the following frequencies are assigned to industrial and scientific microwave heating and drying: 915 ± 25 MHz; 2450 ± 13 MHz; 5800 ± 75 MHz; and $22\,125 \pm 125$ MHz [21,22]. The entire microwave region therefore is not readily available for heating applications. For microwave chemistry, 2450 MHz (corresponding to a wavelength of 12.2 cm) has been used almost exclusively.

3 Influence of Microwave Heating on Chemical Reactions

Microwave energy is not transferred primarily by conduction or convection as with conventional heating, but by dielectric loss [21]. The dielectric loss factor (ϵ'') and the dielectric constant (ϵ') of a material are two determinants of the efficiency of heat transfer to the sample. Their quotient (ϵ''/ϵ') is the dissipation factor ($\tan \delta$), high values of which indicate ready susceptibility to microwave energy [21]. Important parameters relevant to microwave dielectric heating have been discussed and reviewed [23].

Briefly, there are two main mechanisms by which materials dissipate microwave energy, namely dipole rotation and ionic conduction [22]. Dipole rotation refers to the alignment of molecules that have permanent or induced dipoles, with the electric field component of the radiation. At 2450 MHz, the field oscillates 4.9×10^9 times per second. Sympathetic agitation of the molecules generates heat. The efficacy of heat production through dipole rotation depends upon the characteristic dielectric relaxation time of the sample, which in turn is dependent on temperature and viscosity. The second main dissipation mechanism—ionic conduction—is the migration of dissolved ions with the oscillating electric field. Heat generation is due to frictional losses that depend on the size, charge and conductivity

of the ions as well as on their interactions with the solvent.

Compounds with high dielectric constants, such as water, ethanol and acetonitrile, tend to heat readily under microwave irradiation. Less polar substances like aromatic and aliphatic hydrocarbons or compounds with no net dipole moment (e.g. carbon dioxide, dioxan and carbon tetrachloride) and highly ordered crystalline materials are poorly absorbing.

Changes to the physical properties of a compound or material can have a dramatic influence on the susceptibility to microwave radiation. For example, ice has dielectric properties ($\epsilon' = 3.2$; $\tan \delta = 0.0009$; $\epsilon'' = 0.0029$) that differ significantly from those of liquid water at 25°C ($\epsilon' = 78$; $\tan \delta = 0.16$; $\epsilon'' = 12.48$) [24] and render it essentially microwave-transparent. Although liquid water absorbs microwave energy efficiently, the dielectric constant decreases with increasing temperature, and supercritical water ($T_c = 374^\circ\text{C}$) also is microwave-transparent.

With microwaves, high rates of heating usually are sought. A difficulty can arise, however, when a material possesses a dissipation factor that increases with temperature. In contrast with conventional heating, microwave energy is then absorbed more efficiently and the rate of temperature rise increases. This phenomenon could be useful for specific applications, but thermal runaway can result unless the temperature is monitored carefully and the power is controlled.

Differences in sample size, shape and composition also can affect heating rates [20]. The last case particularly applies when ionic conduction becomes possible through the addition or formation of salts [25]. For compounds of low molecular weight, the dielectric loss contributed by dipole rotation decreases with rising temperature but that due to ionic conduction increases. Therefore, because an ionic sample is microwave-irradiated, the heating results predominantly from dielectric loss by dipole rotation initially, but the contribution from ionic conduction becomes more significant with temperature rise [22].

Excess input microwave energy can lead to arcing [26]. For this to occur, the build-up of an intense electrical field is necessary. With microwave-assisted organic reactions, this possibility exists when low-loss samples are irradiated, when salt solutions suffer dielectric breakdown [21] or when suspended metallic materials or sharp edges are present [26]. For

metal powders in liquid systems, factors important to arcing were identified recently by Whittacker & Mingos [27].

4 Rate Studies and Investigations into 'Microwave Effects'

Microwave absorption depends on several factors and can vary with both sample and temperature. This can make the interpretation of results from microwave-heated reactions difficult. The problem is exacerbated if heterogeneous systems are studied and/or if the reaction temperature is not monitored or measured precisely. Claims of reactions, including enzymatic processes [7], proceeding faster in a microwave environment than under conventional conditions at the same temperature have led to speculation about the influence of microwaves [11,13,14]. In much of that work, the reaction kinetics were not determined. Rather, yields were quoted after a given time under apparently comparable conditions. This approach can produce misleading data about rates, particularly if conventionally heated reactions proceed rapidly and in high yield.

Cundy [10] has suggested that differential heating [9] could account for many of the 'microwave effects' reported for zeolite synthesis and modification, as well as for microwave-assisted organic reactions on supports. This explanation could account for the products obtained when microwave-transparent alkenes were hydrogenated to the corresponding alkanes by irradiation of strongly absorbing CaNi_5H_2 in static and flow-through systems [28].

Other investigations have dismissed the theory of specific activation at a controlled temperature in homogeneous media. These aspects have been discussed in several reviews [9–11,13,14]. The introduction of dedicated microwave reactors has allowed some earlier claims of non-thermal 'microwave effects' to be refuted. For example, specific effects reported by Gupta *et al.* [29] and Dandia *et al.* [30] for Biginelli reactions recently have been shown to be unjustified [31]. Similarly, Vidal *et al.* [32] reinvestigated and reinterpreted 'microwave effects' previously proposed by others for the syntheses of phthalimides [33,34].

Superheating arises through inefficient nucleation and appears to be responsible for some reported accelerations under microwave conditions [35,36]. Mingos estimated that it can lead to 10–50-fold

reductions in reaction times in comparison with conventional reflux conditions, but that rate enhancements of 100–1000-fold at atmospheric pressure would be required before specific microwave effects could be invoked [37].

For kinetics studies, the temperature must be known and the reaction solution must be either thermally homogeneous or possess thermal gradients that are known or can be modelled [38,39]. In 1992, a microwave unit was reported that could conduct reactions under these circumstances [40]. Reaction kinetics were determined with that system and a conventionally heated oil bath. Rates were the same within experimental error, regardless of the heating method [38,39].

Some of the discussion about non-thermal ‘microwave effects’ appears to have stemmed from a misconception that microwave radiation at 2.45 GHz can excite rotational transitions. The frequencies at which molecules undergo rotational transitions are higher, however. Internal bond rotations also require higher frequencies for excitation. These ‘rotations’ should be referred to as torsional vibrations and are excited by infrared radiation at ca. 100–400 cm^{-1} or 3000–12 000 GHz [39].

Heterogeneous systems are difficult to study. The influence of microwave radiation on the catalytic transfer hydrogenation of soybean oil from an aqueous sodium formate solution in the presence of Pd/C has been reported [41]. Reaction rates were up to eight times greater with microwave irradiation compared with conventional heating at the same temperature. This was attributed to microwave assistance in transport processes at the catalyst and oil/water interfaces. In support of this rationale, microwave extraction of plants, foods and soils also can be rapid and efficient [20,42–44]. In some cases, the extracted material absorbs the energy preferentially and the cellular structure becomes disrupted and readily releases components into the solvent.

Heating rate will be important in reactions that can proceed to more than one product by separate reaction pathways, especially if the reaction that pro-

ceeds first (i.e. that with the lower activation energy) is undesired [26]. In such circumstances rapid microwave heating can be advantageous, as demonstrated by Stuerger *et al.* [45] for the sulfonation of naphthalene to give 1- and 2-naphthalenesulfonic acids. At 130°C, the 2-substituted isomer was produced almost exclusively, whereas at lower heating rates a mixture of both regioisomers was obtained. Similarly, Bose *et al.* [46] controlled the steric course of β -lactam formation by varying the microwave power input. In the example illustrated in Scheme 17.1, after heating for 1 min the *trans* to *cis* isomeric ratio was 16:84, but after 4 min the *cis* isomer predominated, with the ratio being 55:45.

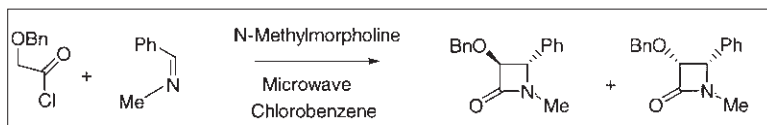
To summarise, when reaction kinetics have been determined in homogeneous systems, the rates of microwave- and conventionally heated reactions were found to be the same, within experimental error. In cases where the reaction kinetics were not determined, rate enhancements probably resulted from superheating, non-uniform heating, differential heating and/or transport processes, rather than from ‘specific microwave effects.’

5 Approaches to Microwave-assisted Organic Chemistry

Because, for the majority of applications, the rates of microwave-heated reactions will be comparable with those from conventional heating, what advantages do microwaves offer for clean processing? Briefly, there are general advantages, others that are more specific and some that are relevant to particular methods.

The main general advantages include:

- (1) Microwave energy can be introduced remotely, without contact between the source and the chemicals.
- (2) Energy input to the sample starts and stops immediately when the power is turned on or off.
- (3) Heating rates are higher than can be achieved conventionally if at least one of the components can couple strongly with microwaves.



Scheme 17.1 β -Lactam formation [46].

As outlined below, a major difference among the respective methods is the presence or absence of solvents. Solvent-free conditions can be employed using neat reactants only: reactants adsorbed onto solid supports or reactants in the presence of phase-transfer catalysts [7,15]. Methods employing solvents (including some that are environmentally benign, such as water) use either pressurised systems [9] or open vessels for superheating [37], reflux and microwave oven reaction enhanced (MORE) [19] chemistry.

5.1 Solvent-free methods

Applications involving solvent-free conditions have been the subject of the greatest activity and have been reviewed extensively [7,12,13,15]. Besides the apparent potential benefits in minimising solvent usage, reactions can be conducted conveniently and rapidly without temperature measurement in domestic microwave ovens. A dedicated commercial reactor for applications at atmospheric pressure also has been used [7].

Neat reactants in an open container

The simplest solvent-free method involves irradiation of neat reactants in an open container. In the absence of reagents or supports, the scope for such processes appears to be limited to relatively straightforward condensations that can be conducted without added catalysts, or to intramolecular thermolytic processes such as rearrangement or elimination. As with the thermolysis of starch, which afforded 1,6-anhydroglucose in yields of only about 2% [47], outcomes can be highly dependent upon sample size. Other examples include amidation of carboxylic acids (see Scheme 17.2) [48], the reaction of 4-chloroazaine derivatives with benzotriazoles [49] and 1,3-dipolar cycloaddition of pyridinium ylides [50] and nitrones to acrylates, methacrylates and fluorinated dipolarophiles [7].

Loupy *et al.* have argued that if the mixture of neat starting materials is heterogeneous (comprising a

solid and a liquid), reaction could occur by dissolution of the solid in the liquid or by adsorption of the liquid onto the solid, and in either case a diluting solvent would slow the reaction [7].

'Dry media' reactions

For 'dry media' reactions the organic reactants are adsorbed onto acidic or basic supports such as alumina, silica, bentonite, montmorillonite K10 or KSF clays and zeolites and subjected to irradiation, often in domestic microwave ovens without temperature measurement [7,9,10,12,15]. The supports also can be doped with inorganic reagents [7,15]. If a strong base is required, KF on alumina can ionise carbon-containing acids up to pK_a 35, whereas clays like montmorillonite K10 offer acidities comparable with those of nitric or sulfuric acids [7]. Two examples are presented in Scheme 17.3. 'Dry media' seem well suited to transformations involving a single organic species, e.g. as in deprotection, rearrangement, oxidation and dehydration. Condensations, including alkylation of carboxylates and acetalisation, also have been reported [7,9,10,12,15].

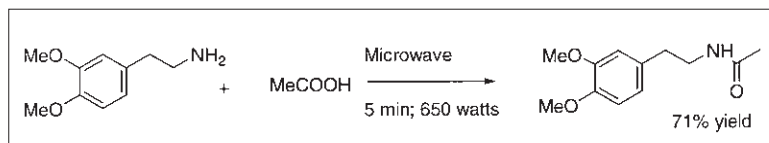
Phase-transfer-catalysed reactions

Solid-liquid solvent-free phase-transfer catalysis (PTC) is specific for anionic reactions, including base-catalysed isomerisation as shown in Scheme 17.4 [7]. Usually, a catalyst (typically a tetraalkylammonium salt or a cationic complexing agent) is added to an equimolar mixture of an electrophile and a nucleophile, one of which serves as both a reactant and the organic phase.

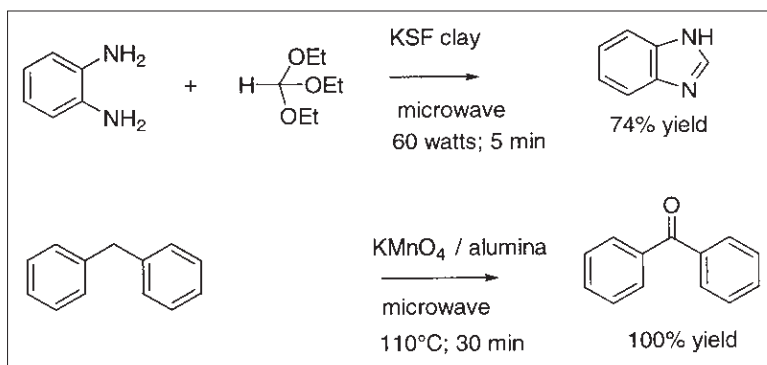
In a recent extension, a support of polyethylene glycol (MW = 3400) also acted as the organic phase [51].

Advantages and disadvantages of solvent-free methods

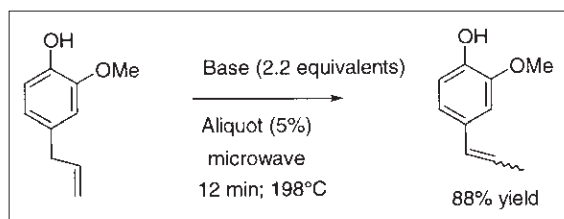
The following environmental benefits have been reported for microwave-heated reactions under solvent-free conditions:



Scheme 17.2 Direct amidation [48].



Scheme 17.3 Examples of 'dry media' reactions [7].



Scheme 17.4 Isomerisation of eugenol [7].

- (1) Avoidance of large volumes of solvent reduces emissions and the need for redistillation
- (2) Work-up is simple by extraction, distillation or sublimation.
- (3) Recyclable solid supports can be used instead of polluting mineral acids and oxidants.
- (4) The absence of solvent facilitates scale-up.
- (5) Safety is enhanced by reducing the risks of over-pressure and explosions [7,17].

The technique could be improved by overcoming deficiencies that include a low ratio of organic reactants to solid support and the lack of facilities for measuring reaction conditions. If the reaction temperature is not known and/or not uniform throughout the sample, reactions may not be reproducible between microwave systems. Given the variability in operation and performance of domestic microwave ovens, perhaps it is not surprising that few, specific, literature syntheses have been reproduced by others and occasionally such attempts have resulted in alternative outcomes or failure [5,31,32]. Unfortunately, these shortcomings demand technical improvements that may place the equipment beyond the financial reach of a large group of users.

It is not always acknowledged that solvents are used for 'dry media' reactions, both to load the reactants onto the support and to elute the products after reaction. If the supports are polar materials such as alumina or silica gel, which are commonly used in liquid chromatography, substantial quantities of solvent may be required to remove the organics. For clean processing, recycling of the solvent and the support would be essential. The latter has not been demonstrated in many instances and may prove difficult if residual organic reactants and/or products are retained strongly. The advent of generally applicable protocols for recycling spent supports would minimise waste and significantly advance the scope of the technique.

A potential hazard, particularly for scale-up, concerns the toxic effects of mineral dusts [52]. Chemical composition and active surface states are critical determinants of biological response, so minerals doped with inorganic or organic oxidants such as MnO_2 , CrO_3 , iodobenzene diacetate and sodium periodate, or reductants like NaBH_4 and catalysts including KF and CsF , which have been employed as 'dry media' [15], could have severe biological side effects if inhaled. Strict safety precautions should be taken when handling such materials.

5.2 Methods with solvents

MORE chemistry

An approach termed 'microwave-induced organic reaction enhancement' (MORE) chemistry was developed by Bose *et al.* [19,53–55]. Polar, high-boiling solvents are employed with open vessels in unmodified domestic microwave ovens. The solvents

have dielectric properties suitable for efficient coupling of microwave energy and rapid heating to temperatures that, although high, are typically some 20–30°C below boiling [55]. With this technique, reactions (on the milligram to several hundred gram scale) have been performed within minutes. A disadvantage is the limitation to high-boiling polar solvents such as dimethylsulfoxide, ethylene glycol, diglyme, triglyme, *N*-methylmorpholine, *N,N*-dimethylformamide and 1,2-dichlorobenzene, which have relatively similar boiling points and can present difficulties for recycling and for isolation of products.

Superheated solvents and reactions at reflux

Enhancements in rates of reaction also have been exploited through superheating of solvents under microwave irradiation [35–37]. Baghurst & Mingos obtained boiling points up to 26°C above equilibrium values at atmospheric pressure and suggested that nucleation-limited boiling (superheating) was responsible [35]. Solvents with relaxation times greater than 65 ps (corresponding to 2450 MHz) will have loss tangents that increase with temperature and will be prone to superheating [23].

For reactions at reflux [56–63], domestic microwave ovens have been modified by making a shielded opening to prevent microwave leakage and through which the reaction vessel has been connected to a condenser. Alternatively, microwave-transparent coolants, including CO₂, have been used within the microwave cavity. Preparations carried

out at reflux include various organometallic and Diels–Alder reactions, as well as arylsulfonation [9].

Reactions under pressure with solvents

Dedicated microwave reactors have been developed that are capable of reliable and safe operation with volatile, organic solvents at elevated temperatures and pressures [9,64]. Independent investigations into optimal parameters for microwave chemistry support this approach [23,27].

The continuous microwave reactor (CMR) The continuous microwave reactor (CMR) was the first microwave system designed for reactions in organic solvents [9,65]. The microwave cavity (see Fig. 17.1) is fitted with a vessel of microwave-transparent, inert material. Plumbing in the microwave zone is attached to a metering pump and pressure gauge at the inlet end and a heat exchanger and pressure-regulating valve at the effluent end. The heat exchanger enables rapid cooling of the effluent, under pressure, immediately after it exits the irradiation zone. Temperature is monitored immediately before and after cooling. Variables such as volume of the vessel within the microwave zone, flow rate and control of the applied microwave power allow flexible operation. The plumbing was designed to withstand corrosive acids and bases and to minimise contact between metal surfaces and reaction mixtures. Feedback microprocessor control allows the setting of pump rates and temperatures for heating and cooling of reactions. Fail-safe measures ensure

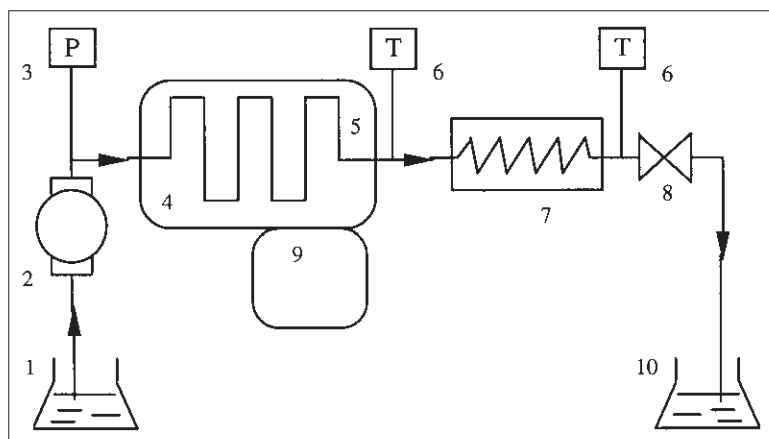


Fig. 17.1 Schematic diagram of the CMR: 1, reactants for processing; 2, metering pump; 3, pressure transducer; 4, microwave cavity; 5, reaction coil; 6, temperature sensor; 7, heat exchanger; 8, pressure regulator; 9, microprocessor controller; 10, product vessel. (Reproduced with permission from Ref. 9.)

that the system shuts down if the temperature exceeds the maximum allowable by 10°C, or in the event of blockages or ruptures in the plumbing.

A commercially available embodiment has a volume of 120 ml within the microwave zone, 80 ml within the cooling zone and a pump that can produce flow rates up to 100 ml min⁻¹. With this arrangement, residence times in the microwave zone (which, for convenience, are also defined as reaction times) are typically 2–10 min [66,67].

The microwave batch reactor (MBR) A complementary laboratory-scale microwave batch reactor (MBR) was developed for synthesis or kinetics studies [9,68]. The MBR has a capacity of 25–200 ml and is capable of operating at up to 260°C and 10 MPa (100 atm). Pressures in excess of 5 MPa are seldom used. The main features (see Fig. 17.2) include: rapid heating capability (1.2-kW microwave output); infinitely variable control of microwave power; measurement of absorbed and reflected microwave energy; a load-matching device to maximise heating efficiency; direct measurement of the reaction temperature and pressure; a stirrer for mixing and to ensure uniform temperature within the sample; valving and plumbing to facilitate sample introduction and withdrawal during the heating period; chemically inert wettable surfaces and fittings; rapid cooling post-reaction; and a facility for conducting reactions under an atmosphere of inert gas.

Microwave power input is computer controlled and enables heating to be conducted at high or low

rates and designated temperatures to be retained for lengthy periods if desired. The safety features have been described and discussed [9,68]. A robotically operated MBR (manufactured by Personal Chemistry, Uppsala, Sweden) designed along the lines of the MBR and an earlier prototype [40] but with a lower capacity (2–3 ml) has been developed for rapid synthesis of candidates for drug discovery. Advantages of the CMR and MBR for synthetic organic chemistry are discussed below.

6 Advantages of the Pressurised Microwave Systems

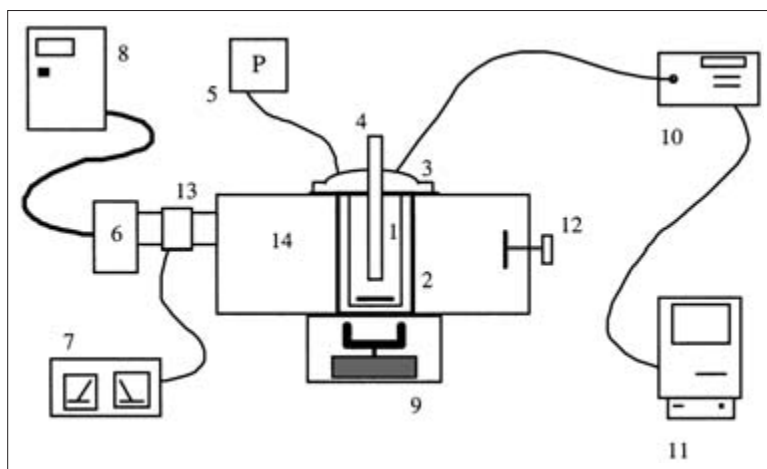
6.1 Elevated temperature

An approximation often applied by chemists is that an increase of 10°C in reaction temperature can lead to a halving of the requisite time. If a reaction taking 16 h at 100°C could be performed at 200°C, the time expected would be about 1 min, i.e. of the order of 2¹⁰ faster! This indicates that higher temperatures than normal offer opportunities for efficiencies in time and energy. It also suggests that if reaction mixtures are sufficiently mobile, it should be possible to transform lengthy batch processes into continuous operations merely by changing the reaction temperature.

For reaction temperatures of 200°C or above at atmospheric pressure, the choice of solvents is limited and high-boiling solvents are inconvenient to remove and to repurify. These disadvantages can be avoided by heating low-boiling solvents in closed

Fig. 17.2 Schematic diagram and photograph of the MBR: 1, reaction vessel; 2, retaining cylinder; 3, top flange; 4, cold-finger; 5, pressure meter; 6, magnetron; 7, microwave forward/reverse power meters; 8, variable power supply to magnetron; 9, stirrer unit; 10, optic-fibre thermometer; 11, computer; 12, load-matching device; 13, waveguide; 14, microwave cavity (applicator).

(Reproduced with permission from Ref. 9.)



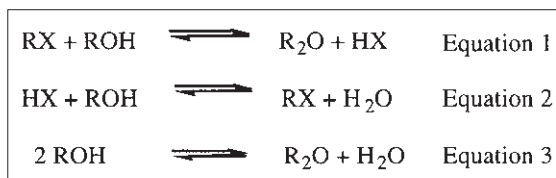
systems. Increases in boiling points of many commonly used solvents are significant with modest rises in pressure [69], and at 2–3 MPa relatively high temperatures can be attained safely for a variety of solvents. Such conditions can be obtained with the microwave reactors but not readily with typical glassware. Higher temperatures have led to reaction times up to three orders of magnitude shorter than those for the same preparations carried out conventionally [9,65,68].

Benefits of high temperature also can be gained with traditional autoclaves but the energy usually is applied to the reaction mixture conductively, by external heating. Consequently, the rate of temperature increase usually is low, thermal gradients develop and even by stirring batch reactions not all of the sample will be at the temperature of the applied heat. With microwaves, the whole sample can be irradiated and the energy input can be adjusted readily to match that required. Bulk heating combined with efficient stirring diminishes the temperature gradients.

Etherification

Conditions employing elevated temperatures with less catalyst, a milder catalyst or without the addition of catalyst can be an attractive alternative to those utilising aggressive reagents at lower temperatures. A recent example concerns a catalytic, thermal etherification that produces minimal waste and can be carried out near neutrality [70]. This represents a cleaner alternative to the 150-year-old Williamson procedure, in which the ether is produced through substitution of an alkyl halide by a strongly basic alkoxide or phenoxide. The Williamson synthesis generates a stoichiometric amount of waste salt, and sometimes base-catalysed elimination of hydrogen halide can compete.

The new process is suited to production by MBR or CMR and is shown in Scheme 17.5 for a symmetrical ether. An excess of alcohol (ROH) and a catalytic amount of RX are heated. A solvolytic displacement reaction between RX and ROH affords R₂O along with HX or its elements (hereafter referred to as HX; Equation 1). The liberated HX attacks another molecule of ROH to form water and to regenerate RX (Equation 2). If the rates of both reactions are comparable, the concentration of HX will be low throughout and that of RX will remain rela-



Scheme 17.5 Pathway for catalytic ether synthesis [71].

tively constant. Although HX and RX are stoichiometric reactants or products in Equations 1 and 2, they do not appear in the sum (Equation 3). The net procedure involves condensation of two molecules of ROH to give R₂O plus water. The process has been demonstrated with primary and secondary alcohols, including base- and acid-labile compounds. Advantages for clean production are the high atom economy, salts are not formed, RX often is recoverable, the reaction does not require the addition of strong acids or bases and water is the major by-product.

6.2 Rapid heating, cooling and ease of use for high-temperature reactions

Vessels for microwave-assisted chemistry usually are made from thermal insulators and, as indicated by a temperature profile communicated recently [71], the benefits of rapid heating can be diminished if the opportunity for work-up is delayed by slow cooling. Decomposition of thermally unstable products also can occur.

In the CMR, rapid cooling takes place through an in-line heat exchanger adjacent to the microwave heating zone [65]. Mixtures can be cooled immediately, while still under pressure, to prevent losses of volatiles and to minimise decomposition of thermally labile products.

The MBR has an incorporated cold-finger that offers advantages for cooling microwave reactions in pressure vessels [68]. Because the cold-finger contacts the reaction mixture directly, cooling can be initiated at any time during operation and is efficient because it is not *via* the container. Temperature and pressure monitoring, as well as stirring, can be maintained during the cooling process, allowing access to the vessel at the earliest opportunity.

As discussed for the following four examples, the CMR and MBR have been useful for reactions that

are known to require high temperatures and/or in which thermally labile products are formed.

Aryl vinyl ketones

Aryl vinyl ketones can be produced thermally from the corresponding quaternary ammonium salts *via* Hofmann elimination. However, the conjugated ketones generated are heat sensitive and polymerisation of these products is difficult to avoid. Traditionally they have been prepared in only moderate yields, by vacuum distillation. Microwave conditions were established under which Hofmann eliminations were easier to carry out, essentially quantitatively, by batch or continuous processes [9]. With the CMR, phenyl vinyl ketone was prepared by passage of a 5% aqueous slurry of *N*-(2-benzoyl)ethyl-*N,N,N*-trimethylammonium iodide through the microwave zone (see Scheme 17.6) [65]. The product was extracted immediately from the cooled aqueous effluent into chilled Et₂O, thereby avoiding polymerisation of the monomer and giving near-quantitative yields.

Alkyl 2-(hydroxymethyl)acrylates

Alkyl 2-(hydroxymethyl)acrylates are versatile multifunctional monomers and synthetic building blocks [72–77]. However, their availability was limited owing to their high reactivity, and consequently established preparative procedures required days at ambient temperature. A microwave method with the CMR [65] employed a Baylis–Hillman reaction, which involved addition of formaldehyde to the parent acrylate derivative, catalysed by 1,4-diazabicyclo[2.2.2]octane (DABCO). Syntheses from starting acrylates were achieved within minutes at temperatures in the range 160–180°C (see Scheme 17.7). Rapid cooling limited hydrolysis, dimerisation and polymerisation. Formalin required for the reaction was obtained conveniently in the CMR by acid-

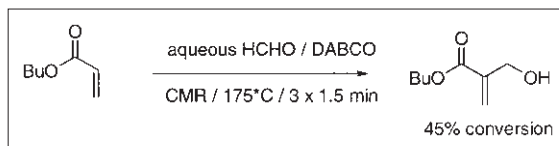
catalysed depolymerisation of an aqueous slurry of paraformaldehyde.

Hydrolysis of cellulose

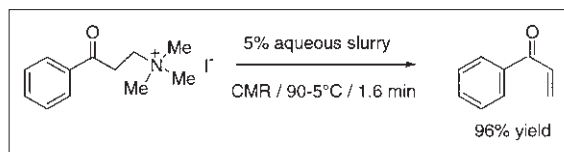
Strategies for sustainability and reduction of CO₂ emissions include exploration of technologies based on renewable resources. Key challenges include the depolymerisation of cellulose to produce glucose or its oligomers from biomass, for use as feedstock for fermentation to ethanol, acetic acid and lactic acid [78]. High temperatures and acidic conditions are required to cleave the glycosidic bonds. However, the monosaccharide and oligosaccharides are more labile than the starting material, necessitating rapid heating and cooling. With 1% sulfuric acid, a useful method involved raising the temperature from ambient to 215°C within 2 min in the MBR, maintaining this temperature for 30 s and then cooling. The entire operation was completed within 4 min and afforded glucose in nearly 40% yield, along with oligomeric materials [9].

Willgerodt reactions

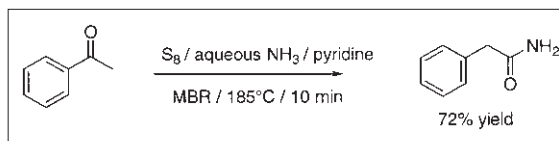
Phenylacetamides were prepared in the MBR from the corresponding styrene or acetophenone derivatives by Willgerodt reactions (see Scheme 17.8) [64,79]. Yields were comparable with those obtained previously by conventional heating [80]. At similar temperatures the microwave-heated reactions were completed within minutes rather than hours. The



Scheme 17.7 Synthesis of *n*-butyl 2-(hydroxymethyl) acrylate by CMR [65].



Scheme 17.6 Hofmann elimination by CMR [65].



Scheme 17.8 Willgerodt reaction by MBR [64,79].

conditions were optimised readily through the capabilities of the MBR for rapid heating and cooling. The substantially shorter reaction times probably resulted from the convenience in the operation of the reactor in comparison with a standard autoclave, indicating broader opportunities for microwave heating to improve the conditions for established reactions that require high temperatures.

6.3 Control of heating

With conventionally heated reactions, a constant temperature can be attained under reflux conditions. For temperatures below boiling though, a feedback system normally is employed but adjustments can be slow to take effect owing to the thermal inertia of associated vessels, oil baths and heating mantles. With microwave irradiation, the response to changes in energy input is immediate. This makes heating at high or low rates possible in the MBR, with periods at temperature plateaux if so desired. Because the system can operate under pressure, this control can be applied at temperatures above the normal boiling point of the solvent.

To illustrate, temperature profiles were obtained for two comparable aqueous reactions (100-ml scale; Fig. 17.3). In the experiment depicted by the unbroken line, the reaction was heated rapidly from ambient to 100°C and held for 2 h. The temperature then was increased at ca. 60°C min⁻¹ to 250°C, held for 10 min, and rapidly decreased. In the other experiment, after 2 h at 100°C the temperature was

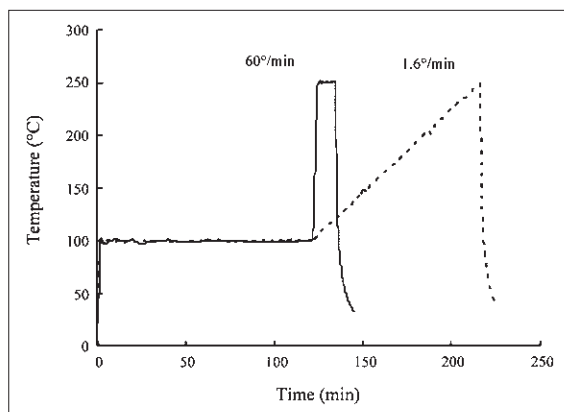


Fig. 17.3 Heating profiles for two aqueous reactions. (Reproduced with permission from Ref. 9.)

increased at 1.6°C min⁻¹ to 250°C and then lowered [9]. The temperature response was rapid when required and the low thermal inertia of the system facilitated subsequent cooling.

6.4 Exothermic reactions, differential heating and viscous reaction mixtures

In the MBR, heating and cooling can be performed concurrently, thereby helping to control reactions that require heat for induction but then develop exotherms that could result in unwanted by-products or decomposition [9,68].

The individual phases in two-phase systems can be heated at different rates owing to differences in the dielectric properties. In some cases a sizeable temperature difference can be maintained for several minutes. This technique also was useful for preparing aryl vinyl ketones batchwise by Hofmann elimination in a two-phase system comprising water and chloroform [9,68]. Reactions took place in the aqueous phase and the thermally unstable products were extracted simultaneously and diluted into the cooler organic phase, which could be recycled. Yields were nearly quantitative and twice those obtained by the traditional method of pyrolysis under vacuum with distillation (see Section 6.2 for discussion of an alternative method employing the CMR).

Typically, viscous materials transfer energy poorly. With conductively heated vessels, pyrolytic degradation on the walls can co-occur with incomplete reaction towards the centre of the container. Large thermal gradients can result in suboptimal conversions, loss of product and laborious clean-up procedures. Also, when high temperatures are required, heat losses increase and conductive heating becomes inefficient. Under microwave conditions these problems are diminished.

6.5 Reaction vessels

Because the reaction vessels are microwave-transparent, they will be no hotter than their contents. They usually are made from insulating polymeric materials such as polytetrafluoroethene (PTFE), which have inherent advantages for cleaner processing. In contrast with glass, PTFE is resistant to attack by strong bases or HF. In contrast with stainless steel, it is not corroded by halide ions [81]. Also, conductive heat loss by PTFE is minimal and the

low adhesivity can help to minimise detergent and organic solvent usage during cleaning operations that otherwise would generate considerable effluent [82–85].

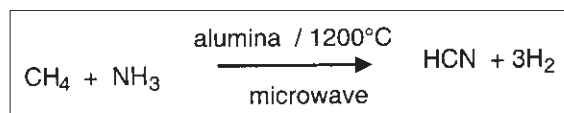
6.6 Reactions with a distillation step

With conductive heating, several factors are detrimental for distillation. Transferral of heat to the sample usually occurs from the inner surfaces of the vessel. Owing to vaporisation at the surface of the liquid and to a thermal gradient established by convection, not all of the sample will be at the same temperature. Significantly higher temperatures are required for the pot than for the distillate. With microwaves, energy is absorbed more uniformly, a larger volume of the sample in the pot is heated simultaneously, convection is reduced and distillation is more rapid.

The MBR can facilitate distillation through an outlet tube connected to a port on the top flange. With that arrangement, a monodehydrobromination of a dibromoalkane was performed in which the product, monobromo-olefin, was removed from the mixture before further HBr could be eliminated [9,68].

6.7 Flexible operation

Economic and safety considerations encourage minimisation in the stockpiling of chemicals and transportation of hazardous substances. Industrially, reactor size is now important, with miniaturisation becoming an attribute [86,87]. These factors suggest that, in future, individual chemical reactors will be required for diverse tasks and may need to be relocatable readily. Indicative of this trend is the DuPont HCN process [88–90], involving catalysed condensation of methane and ammonia at 1200°C under microwave heating (see Scheme 17.9). Advantages include quick start-up and shut-down, high yield, low holding capacity and almost complete elimination of waste. The potential for accidents during



Scheme 17.9 The DuPont HCN process [88–90].

transportation and storage is avoided by just-in-time, point-of-use production.

The MBR and CMR are portable, multi-purpose and self-contained advantages that could become increasingly important for industrial chemical reactors. Their capabilities for rapid throughput and the materials of construction enable easy cleaning for reuse and promote short turnaround times. Safety advantages include control and method of energy input, low volumes undergoing reaction at one time and opportunities for remote, programmable operation.

The microwave systems have facilitated thermal processes for cleaner production, including applications of water as a solvent and reactions that require elevated temperatures, and also have been useful components of tandem processes, including coupling with membrane techniques [64,91].

7 High-temperature Water as a Medium or Solvent for Microwave-assisted Organic Synthesis

Priorities for safety, the environment and economy of operation emphasise the need for decreased usage of many organic solvents in chemical laboratories and in industrial processes. The phasing out of some halogenated solvents, particularly chlorofluorocarbons and CCl_4 , and the search for suitable replacement media are indicative [64].

Since the pioneering work of Grieco & Breslow in the late 1980s, water has been investigated more intensively as a medium for non-enzymatic organic reactions [92–98]. Temperatures below boiling have been employed, mainly to exploit hydrophobic effects brought about by the tendency of non-polar species to aggregate and decrease the hydrocarbon/water interfacial area. Conditions at and near supercritical, where hydrophobic effects are less important, also have attracted increasing interest [99–105].

At ambient temperature, water is a poor solvent for most organic compounds. However, its ionic product increases 1000-fold between 25°C and 240°C, so it becomes a stronger acid and base [101]. The dielectric constant decreases from 78 at 25°C to 20 at 300°C, indicating that the polarity is lowered with temperature increase [101]. These apparently anomalous properties suggest that as a medium for organic reactions water could have a complex role

that may vary with temperature. If this variable behaviour were understood better, it would be more predictable and new clean methods could result. Investigations into organic synthesis in high-temperature water, carried out with the MBR and CMR, have gone some way towards such outcomes [9,64,102].

7.1 Reactions in high-temperature water

Biomimetic reactions

As suggested by the lower dielectric constant, high-temperature water behaves somewhat like an organic solvent, dissolving organic compounds that are much less soluble at ambient temperature. This property was exploited for the hydrolysis of naturally occurring monoterpene alcohols without the need for prior derivatisation with typical water-solubilising groups such as phosphates or glycosidic units [106]. Because of the enhanced dissociation of high-temperature water, biomimetic reactions that normally would be acid-catalysed proceeded on the underivatised compounds in the absence of added acidulant. Cooling of the mixtures rendered the products insoluble, readily isolatable and the aqueous phase did not require neutralisation before work-up. This approach should be beneficial in the flavour and fragrance industry, where products derived by clean processing can command a premium.

For example, geraniol, nerol and linalool are practically insoluble in water at ambient temperature. Although acid labile, they do not react readily in water at moderate temperature and neutral pH. In unacidified water at 220°C in the MBR they reacted within minutes [106]. Geraniol rearranged to α -terpineol and linalool predominantly and gave lesser amounts of the monoterpene hydrocarbons,

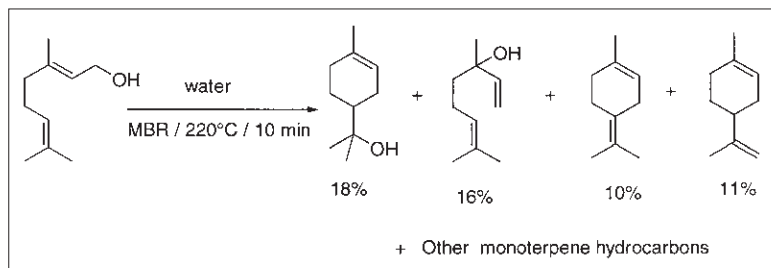
myrcene, α -terpinene, limonene, γ -terpinene, the ocimenes, α -terpinolene and alloocimenes (see Scheme 17.10).

Nerol and linalool both underwent considerably more elimination than did geraniol, to give the same array of hydrocarbons. The major products and their relative proportions were consistent with those for carbocationic rearrangement of derivatives of linalool, nerol and geraniol under acidic conditions [107,108]. At first glance, an aqueous environment may seem inappropriate for dehydration reactions. However, dehydration often proceeds readily under such conditions, by E1 mechanisms and *via* carbocation intermediates [109,110].

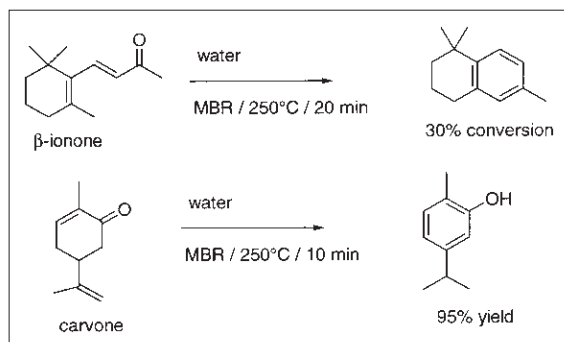
Established methods for the conversion of α - and β -ionones to ionene have involved catalysis by hydriodic acid along with small amounts of phosphorus, or distillative heating in the presence of 0.5% iodine [111]. The latter procedure is known to co-produce about 10% 1,1,6-trimethyl-1,2-dihydronaphthalene [112]. The cyclisation also occurred by heating β -ionone in water at 250°C in the MBR (see Scheme 17.11). Work-up did not require the usual exhaustive washing procedures [106]. Similarly, carvacrol was prepared almost quantitatively, by isomerisation of carvone in water at 250°C for 10 min (Scheme 17.11) [102]. A literature method utilised acidic conditions, took a longer time and proceeded in lower conversion [113]. The microwave reactions showed that elevated temperatures under neutral pH conditions can offer advantages over acidic (or basic) reagents at lower temperatures.

Indoles

In research into indole preparation and transformations, 2,3-dimethylindole was obtained in 67% yield from phenylhydrazine and butan-2-one by a one-pot



Scheme 17.10 Reaction of geraniol in water at 220°C [106].



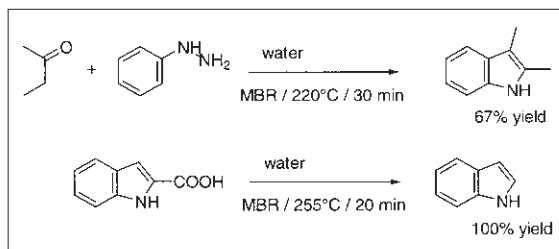
Scheme 17.11 Treatment of β -ionone and carvone in water at 250°C [106].

reaction in water at 220°C for 30 min (see Scheme 17.12) [9]. That was the first example of water as the reaction medium for Fischer indole synthesis and, significantly, neither a preformed hydrazone nor addition of acid was required.

Also, decarboxylation of indole-2-carboxylic acid to form indole is not trivial [114]. Published methods include pyrolysis or heating with copper-bronze powder, copper(I) chloride, 'copper' chromite, 'copper' acetate or copper(II) oxide in, for example, heat-transfer oils, glycerol, quinoline or 2-benzylpyridine. Decomposition of the product during lengthy thermolysis or purification affects the yields. However, in water at 255°C, decarboxylation of indole-2-carboxylic acid was quantitative within 20 min (Scheme 17.12) [9].

Rupe and Meyer-Schuster rearrangements

Organic substrates possessing more than one potentially reactive function were investigated through Rupe and Meyer-Schuster rearrangements in a conventionally heated autoclave and in the MBR. At 290°C for 1 h (autoclave), 1-ethynyl-1-cyclohexanol underwent Rupe rearrangement [102], affording 1-acetylcyclohex-1-ene in moderate yield. By contrast, a conventional method used refluxing 90% formic acid to give the product in comparable yield [115]. 2-Phenyl-3-butyln-2-ol underwent Meyer-Schuster rearrangement [102] at 200°C in water to give the 3-phenylbut-2-enaldehydes predominantly. By a literature method, a mixture of the aldehydes was obtained at sub-ambient temperatures under acidic conditions, but even at room temperature the reac-



Scheme 17.12 Indole reactions in water [9].

tion was uncontrollably exothermic and only gave resin [116].

Addition of water to olefins

At elevated temperature, addition of water to some olefins occurs readily, without the addition of catalyst. Equilibria can be established rapidly but conversions usually are low. Treatment of (*S*)-(+)-carvone in water for 10 min at temperatures between 180 and 250°C afforded 8-hydroxy-*p*-6-menthen-2-one as an intermediate on the pathway to carvacrol. Hydration of the 8,9-double bond of carvone proceeded at lower temperature than did aromatisation, was regioselective and occurred by Markovnikov addition.

Racemisation did not occur during the hydration, consistent with literature results for the acid-catalysed hydration [117]. In high-temperature water [102] the conversion was lower than had been obtained in concentrated acid at ambient temperature [117] but the reaction time was much shorter (i.e. 10 min instead of 43 h). The product was isolated readily by differential extraction from the recyclable starting ketone, so the reaction of carvone with water was a clean and practical synthetic route to 8-hydroxy-*p*-6-menthen-2-one, despite the low conversion.

The diversity of applicable reactions, the high selectivities often obtained with seemingly minor variations in the conditions and the demonstrated scale-up, including to continuous operation with the CMR, indicate that aqueous high-temperature media will become more important for the development of clean processes. Underpinning this are the obvious additional advantages of water, including low-waste work-up, low cost, negligible toxicity and safe handling and disposal.

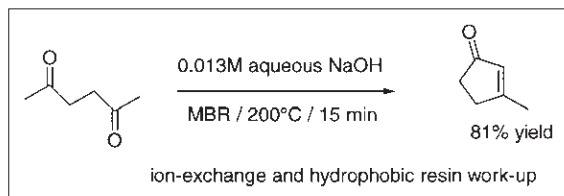
7.2 Reactions in aqueous acid and base

In some instances improved yields and lower levels of by-product can more than compensate for waste generated if dilute acids or bases are used instead of neat water. For example, phenylacetylene in high-temperature water at 250°C gave acetophenone in 51% conversion after 5 days, along with significant amounts of dimeric and trimeric by-products [118]. At 280°C in dilute aqueous acid (in a conventionally heated autoclave), however, acetophenone was obtained in 90% yield within 1 h [102]. In a less clearcut case discussed above (see Scheme 17.12), 2,3-dimethylindole was obtained in 67% yield from phenylhydrazine and butanone in water at 222°C for 30 min [9]. With 1 M H₂SO₄ instead of water, the yield was comparable but the reaction time was only 1 min [9].

By the literature method, the preparation of 3-methylcyclopent-2-enone from 2,5-hexanedione employed strong aqueous base in 2–3% concentration at reflux [119]. Substantial amounts of salt were produced in the work-up and the product was contaminated with polymeric and starting materials. A method developed with microwave heating at 200°C employed a two orders of magnitude less concentrated base (see Scheme 17.13). Competing reactions were suppressed, salt formation was lowered and the enone was obtained in conversions of over 90% and isolated yields of about 85%. The preparation was scaled-up readily by conversion to a continuous process with the CMR [66].

7.3 Limiting salt formation

Sheldon has estimated that the manufacture of fine chemicals and pharmaceuticals generates of the order of 25–100 times more waste than product and is approximately 1000 times more profligate than bulk chemicals production and oil refining



Scheme 17.13 Preparation of 3-methylcyclopent-2-enone [66].

[120,121]. Inorganic salts account for the bulk of the waste and are produced most often by neutralisation of acidic or basic solutions [120–122]. Apart from polluting soil and ground water, salts can lower the pH of atmospheric moisture and may contribute to acid-dew or acid-rain [64,123]. For cleaner production, their minimisation is essential.

Significantly, the use of high-temperature water as a reaction medium can lead to lower production of salt. For reactions necessitating the addition of acid or base, less agent usually was required for high-temperature processes than for those at and below 100°C, and the reactions often proceeded more selectively [102]. In some instances the requirement was several orders of magnitude lower and was reflected in the subsequent neutralisation.

7.4 Avoiding solvent extraction through resin-based adsorption processes

From the above discussion, microwave heating in pressurised systems can facilitate organic reactions in aqueous media. However, customarily the products would be recovered by extraction with organic solvent. This would saturate the aqueous phase with the solvent (and the solvent with water), thereby complicating disposal and offsetting environmental benefits gained through using water as the reaction medium in the first place. To avoid solvent extraction, hydrophobic resins can be employed for concentration and isolation of the products from aqueous media [66]. Organics are retained on the resin and subsequently can be desorbed with a solvent such as ethanol, which is a useful solvent for ‘green’ chemistry because it is readily recyclable and is both renewable and biodegradable [78]. It is produced fermentatively on the industrial scale and can be readily removed and recycled. Advantages of non-extractive processes include convenience, high throughput and low waste, owing to ready disposal of the spent water, recyclability of the resin and the solvent used for desorption.

8 Metal-catalysed Processes

The first reports of the use of microwave heating to accelerate Heck, Suzuki and Stille reactions on solid phase [124] and in solution did not appear until 1996 [125]. Now, many metal-catalysed reactions can be performed almost routinely, within minutes

by microwave techniques [126] and sometimes with high regio- and enantioselectivities [127,128].

Palladium and its complexes and salts can catalyse a range of transformations, including oxidation, hydrogenation and rearrangement, but one of the most useful applications of the metal is for activation of C–H bonds towards coupling reactions. The Heck reaction, which involves C–C coupling of an aryl or vinyl halide with an alkene in the presence of palladium derivatives, has been the subject of intensive study [129]. Synthetic transformations of terminal alkynes via homo- or heterocouplings of the Glaser, Eglinton or Chodkiewicz–Cadiot type have attracted interest as well [130–136].

Stille coupling involves the use of tin reactants. Tin is both toxic and difficult to remove. In an elegant extension of the pioneering work of Horvath, which has been reviewed [137], Curran and co-workers prepared fluorinated tin reactants that facilitated Stille reactions and enabled the convenient isolation and separation of products afterwards [138]. Probably owing to the low solubility of fluorine-containing compounds in organic solvents, the reactions normally required about 1 day at 80°C. However, with microwave heating they were completed within minutes [139].

Typically, the Pd species for Heck couplings are homogeneous catalysts that are stabilised by air-sensitive ligands and present economic and environmental problems regarding separation, regeneration and reuse [140,141]. These difficulties can be minimised with heterogeneous catalysts that are more easily recoverable from the reaction mixture. A catalyst consisting of palladium metal deposited on porous glass tubing was developed for C–C coupling reactions [91]. It was used for reactions conducted continuously or batchwise and could be reused several times for repeat or different reactions. Reactions were performed in the presence of air, with either conventional heating or under microwave irradiation in the MBR [64,91].

Coupling of aryl halides with terminal acetylenes affords internal alkynes [130–136]. Typically, high amounts of catalyst (1–5 mol.% Pd) and co-addition of copper salts (also 1–5 mol.% in Cu) are needed, thus diminishing the industrial viability of such procedures [140,141]. With palladium on porous glass, copper salts or activating ligands were not necessary and direct coupling of terminal acetylenes occurred readily. In contrast with Heck reactions involving

halogen-containing reactants (usually aryl bromides or iodides), homocoupling of terminal acetylenes occurred readily [91] and with excellent atom economy [142,143].

Advantages of palladium on porous glass included ease of manufacture, mechanical strength and obviation of air- and temperature-sensitive ligands. Depending on the specific application, the catalyst also showed thermal stability and resistance to organic solvents. On occasions it was reused for repeat or different reactions. Turnover numbers of the order of 15 000 were achieved for Heck reactions in high-temperature water (with either Et₃N or NaOAc as base). However, some of the support dissolved and an alternative material may be advantageous for such conditions.

Other workers have explored analogous catalysts, although not in microwave systems. Tonks *et al.* investigated Heck reactions with palladium complexes in ethylene glycol on porous glass beads [144]. More recently, Clark and co-workers developed a Pd catalyst supported on a chemically modified mesoporous silica gel [145]. The metal did not leach out and the catalyst could be reused at least five times without a significant decrease in activity. Turnover numbers were in excess of 2000. These studies indicate the scope for further linking of microwave technology and catalysis to develop new clean processes.

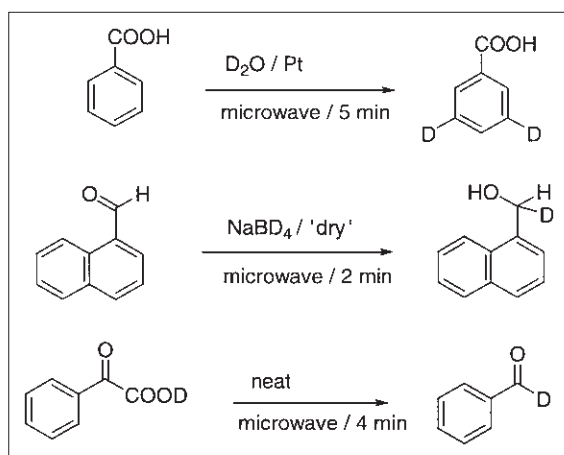
9 Enzymatic Processes

Enzymes now are used widely in organic synthesis to effect enantioselective chemical transformations at moderate temperatures under relatively neutral conditions. Microwave heating is attractive in that regard, particularly with thermally stable enzymes available through recombinant DNA technology and immobilised on solid supports [7]. Carillo-Munoz *et al.* resolved racemic 1-phenylethanol by selective transesterification of isopropenyl acetate to leave the *S*-isomer. They also transesterified racemic 1-phenylethyl valerate enantioselectively to liberate the *R*-isomer [146]. Model reactions of natural hydrolytic processes brought about by phosphodiesterases and cellulases also have been investigated and it was concluded that there was no particular rate enhancement under microwave conditions [147]. Parker *et al.* studied the rate of an enzyme-catalysed esterification in organic solvent and found

that the reaction rate depended upon the extent of hydration of the enzyme [148]. Although further work will be required to determine more fully the advantages and disadvantages of microwave heating for enzymatic reactions, completed studies have demonstrated the feasibility of combining both techniques.

10 Deuteration and Tritiation

Deuterium (^2H)- and tritium (^3H)-labelled compounds have important roles in the physical and life sciences [18]. Tritiation usually is performed on a much smaller (milligram) scale than deuteration (gram) and attention must be paid to the radioactive waste produced. Hence, there is a need for environmentally friendly procedures. Jones & Lu have employed microwave dielectric heating to facilitate catalysis for radiosynthesis [149]. Their work (see Scheme 17.14) has embraced a wide range of reactions, including hydrogenations, borohydride reductions, aromatic dehalogenations, decarboxylations and hydrogen isotope exchange processes. In addition to accelerated rates of reaction, new environmentally friendly routes have been developed, particularly solventless reactions that minimise waste production and facilitate containment [150–152].



Scheme 17.14 Examples of microwave-assisted deuterium exchange [149].

11 Tandem Technologies

Reactors have been constructed that combine microwave heating with other technologies including sonication [153], ultraviolet radiation [154] and electrochemistry [155]. With the microwave–ultrasound reactor, the esterification of acetic acid with *n*-propanol was studied along with the pyrolysis of urea to afford a mixture of cyanuric acid, ameline and amelide [153]. Improved results were claimed compared with those from conventional and microwave heating. Ultrasound is propagated through a series of compression and rarefaction waves induced within the medium. At sufficiently high power, cavitation bubbles form and grow over a few cycles, accruing vapour or gas from the medium. The acoustic field associated with the bubbles is unstable, leading to sudden expansion and violent collapse that generates energy for chemical and mechanical effects [156]. The reported outcome from the microwave–ultrasound reactor is somewhat surprising because ultrasonic reactions usually are favoured at low temperatures and microwave heating could be expected to inhibit cavitation.

The efficacy of the microwave–UV reactor was demonstrated through the rearrangement of 2-benzoyloxyacetophenone to 1-(2'-hydroxyphenyl)-3-phenylpropan-1,3-dione.

In 1997, electrochemical processes and devices that can contribute to a cleaner environment were reviewed [157]. The first report of microwave-activated voltammetry has since appeared [155]. The technique involves the focusing of microwave energy at the electrode/solution (electrolyte) interface of an electrode immersed in a solution and placed in a microwave cavity. Either superheating or a stable high temperature of the solution near the electrode can be accommodated [158]. So far, microwave-activated voltammetry has been applied to metallic complexes, including the ferrocyanide/ferricyanide redox couple [156] and to the reduction of a ruthenium complex [158] and it will be interesting to discover whether or not it could benefit organic reactions involving oxidation or reduction.

12 Conclusion

From tentative beginnings in 1986, microwave-assisted organic chemistry has emerged as a field

experiencing exponential growth and commanding its own, dedicated international conferences [159]. Commercial microwave reactors have been introduced for laboratory-scale and pilot-scale preparations, with scale-up apparently a formality. Fundamental studies have provided the basis for an understanding of the principles of microwave chemistry. As a result, the focus of research has shifted toward applications, with an increasing emphasis on environmentally benign methods, including those utilising tandem processes and multidisciplinary activities. Several of these aspects have been discussed briefly herein and, in many instances, references to more extensive reviews and comprehensive studies have been provided within the various sections. Also, microwave technology has found applications in other new areas not discussed here, including combinatorial chemistry, the use of tethered reagents and ionic liquids. Reports dealing with such areas could be expected to appear within the near future. Microwave technology already is used for commercial synthesis of high-value, low-volume chemicals and one reasonably could expect the continued development of new equipment and niche chemical applications.

References

- Gedye, R., Smith, F., Westaway, K., Ali, H., *et al.* *Tetrahedron Lett.*, 1986, **27**, 279.
- Giguere, R. J., Bray, T. L., Duncan, S. M., & Majetich, G. *Tetrahedron Lett.*, 1986, **27**, 4945.
- Mingos, D. M. P., & Baghurst, D. R. *Chem. Soc. Rev.*, 1991, **20**, 1.
- Gedye, R., Smith, F., & Westaway, K. *J. Microwave Power Electromag. Energy*, 1991, **26**, 3.
- Abramovitch, R. A. *Org. Prep. Proced. Int.*, 1991, **23**, 683.
- Loupy, A., Bram, G., & Sansoulet, J. *New J. Chem.*, 1992, **16**, 233.
- Loupy, A., Petit, A., Hamelin, J., Texier-Boullet, F., Jacquault, P., & Mathé, D. *Synthesis*, 1998, 1213.
- Toma, Š. *Chem. Listy*, 1993, **87**, 627.
- Strauss, C. R., & Trainor, R. W. *Aust. J. Chem.*, 1995, **48**, 1665.
- Cundy, C. S. *Collect. Czech. Chem. Commun.*, 1998, **63**, 1699.
- Galema, S. A. *Chem. Soc. Rev.*, 1997, **26**, 233.
- Caddick, S. *Tetrahedron*, 1995, **51**, 10403.
- Langa, F., De la Cruz, P., De la Hoz, A., Diaz-Ortiz, A., & Diez-Barra, E. *Contemp. Org. Synth.*, 1997, **4**, 373.
- Jacob, J., Chia, L. H. L., & Boey, F. Y. C. *J. Mat. Sci.*, 1995, **30**, 5321.
- Varma, R. S. *Green Chem.*, 1999, **1**, 43.
- Varma, R. S. *Heterocycles*, 1999, **36**, 1565.
- Diaz-Ortiz, A., De la Hoz, A., & Langa, F. *Green Chem.*, 2000, **2**, 165.
- Elander, N., Jones, J. R., Lu, S. Y., & Stone-Elander, S. *Chem. Soc. Rev.*, 2000, **29**, 239.
- Bose, A. K., Manhas, M. S., Banik, B. K., & Robb, E. W. *Res. Chem. Intermed.*, 1994, **20**, 1.
- Zlotorzynski, A. *Crit. Rev. Anal. Chem.*, 1995, **25**, 43.
- Metaxis, A. C., & Meredith, R. J. *Industrial Microwave Heating*. Peregrinus, London, 1988.
- Neas, E. D., & Collins, M. J. In *Introduction to Microwave Sample Preparation* Kingston, H. M., & Jassie, L. B., (eds). American Chemical Society, Washington, DC, 1988, pp. 7–32.
- Gabriel, C., Gabriel, S., Grant, E. H., Halstead, B. S. J., & Mingos, D. M. P. *Chem. Soc. Rev.*, 1998, **27**, 213.
- Schiffmann, R. F. In *Encyclopedia of Chemical Processing and Design* McKetta, J. J., & Cunningham, W. A., (eds), Vol. 30. Marcel Dekker, New York, 1989, p. 220.
- Zijlstra, S., De Groot, T. J., Kok, L. P., Visser, G. M., & Vaalburg, W. J. *Org. Chem.*, 1993, **58**, 1643.
- Peterson, E. R. *Proc. 28th Microwave Symposium*. International Microwave Power Institute, Manassas, VA, 1993, p. 89.
- Whittacker, A. G., & Mingos, D. M. P. *J. Chem. Soc., Dalton Trans.*, 2000, 1521.
- Wan, J. K. S., Wolf, K., & Heyding, R. D. In *Catalysis on the Energy Scene* Kaliaguine S., & Mahay, A. H., (eds). Elsevier, Amsterdam, 1984, p. 561.
- Gupta, R., Gupta, A. K., Paul, S., & Kachroo, P. L. *Ind. J. Chem.*, 1995, **34B**, 151.
- Dandia, A., Saha, M., & Taneja, H. *J. Fluorine Chem.*, 1998, **90**, 17.
- Stadler A., & Kappe, C. O. *J. Chem. Soc., Perkin Trans. 2*, 2000, 1363.
- Vidal, T., Petit, A., Loupy, A., & Gedye, R. N. *Tetrahedron*, 2000, **56**, 5473.
- Bose, A. K., Manhas, M. S., Ghosh, M., Raju, V. S., Tabei, K., & Urbanczyk-Lipkowska, Z. *Heterocycles*, 1990, **30**, 741.
- Borah, N. H., Boruah, R. C., & Sandhu, J. S. *J. Chem. Res. (S)*, 1998, 272.
- Baghurst, D. R., & Mingos, D. M. P. *Chem. Commun.*, 1992, 674.
- Armstrong, B. F., & Neas, E. D. *Sep. Sci. Tech.*, 1990, **25**, 2007.
- Mingos, D. M. P. *Res. Chem. Intermed.*, 1994, **20**, 85.
- Raner, K. D., & Strauss, C. R. *J. Org. Chem.*, 1992, **57**, 6231.
- Raner, K. D., Strauss, C. R., Vyskoc, F., & Mokbel, L. *J. Org. Chem.*, 1993, **58**, 950.

40. Constable, D., Raner, K., Somlo, P., & Strauss, C. J. *Microwave Power Electromag. Energy*, 1992, **26**, 195.
41. Leskovšek, S., Šmidovnik, A., & Koloini, T. *J. Org. Chem.*, 1994, **59**, 7433.
42. Ganzler, K., Salgo, A., & Valko, K. *J. Chromatogr.*, 1986, **371**, 299.
43. Ganzler, K., Szinai, I., & Salgo, A. *J. Chromatogr.*, 1990, **520**, 257.
44. Paré, J. R. J., Belanger, J. M. R., & Stafford, S. S. *Trends Anal. Chem.*, 1994, **13**(4), 176.
45. Stuerge, D., Gonon, K., & Lallemand, M. *Tetrahedron*, 1993, **49**, 6229.
46. Bose, A. K., Banik, B. K., & Manhas, M. S. *Tetrahedron Lett.*, 1995, **36**, 213.
47. Straathof, A. J. J., van Bekkum, H., & Kieboom, A. P. G. *Rec. Trav. Chim. Pays-Bas*, 1988, **107**, 647.
48. Vázquez-Tato, M. P. *Synlett*, 1993, 506.
49. Molina, A., Vaquero, J. J., García-Navio, J. L., & Alvarez-Builla, J. *Tetrahedron Lett.*, 1993, **34**, 2673.
50. Diaz-Ortiz, A., Diez-Barra, E., De La Hoz, A., Loupy, A., Petit, A., & Sanchez, L. *Heterocycles*, 1994, **38**, 785.
51. Sauvagnat B., Lamaty, F., Lazaro, R., & Martinez, J. *Tetrahedron Lett.*, 2000, **41**, 6371.
52. Fubini, B., & Otero Arean, C. *Chem. Soc. Rev.*, 1999, **28**, 373.
53. Banik, B. K., Manhas, M. S., Kaluza, Z., Barakat, K. J., & Bose, A. K. *Tetrahedron Lett.*, 1992, **33**, 3603.
54. Bose, A. K., Manhas, M. S., Ghosh, M., Shah, M., *et al.* *J. Org. Chem.*, 1991, **56**, 6968.
55. Banik, B. K., Manhas, M. S., Newaz, S. N., & Bose, A. K. *Bioorg. Med. Chem. Lett.*, 1993, **3**, 2363.
56. Linders, J. T. M., Kokje, J. P., Overhand, M., Lie, T. S., & Maat, L. *Rec. Trav. Chim. Pays-Bas*, 1988, **107**, 449.
57. Baghurst, D. R., & Mingos, D. M. P. *J. Organomet. Chem.*, 1990, **384**, C57.
58. Woudenberg, R. H., Oosterhoff, B. E., Lie, T. S., & Maat, L. *Rec. Trav. Chim. Pays-Bas*, 1992, **111**, 119.
59. Linders, J. T. M., Briel, P., Fog, E., Lie, T. S., & Maat, L. *Rec. Trav. Chim. Pays-Bas*, 1989, **108**, 268.
60. Puciová, M., & Toma, Š. *Coll. Czech. Chem. Commun.*, 1992, **57**, 2407.
61. Puciová, M., Ertl, P., & Toma, Š. *Coll. Czech. Chem. Commun.*, 1994, **59**, 175.
62. Zhang, Y.-W., Shen, Z.-X., Pan, B., Lu, X.-H., & Chen, M.-H. *Synth. Commun.*, 1995, **25**, 857.
63. Matsumura-Inoue, T., Tanabe, M., Minami, T., & Ohashi, T. *Chem. Lett.*, 1994, 2443.
64. Strauss, C. R. *Aust. J. Chem.*, 1999, **52**, 83.
65. Cablewski, T., Faux, A. F., & Strauss, C. R. *J. Org. Chem.*, 1994, **59**, 3408.
66. Bagnell, L., Bliese, M., Cablewski, T., Strauss, C. R., & Tsanaktsidis, J. *Aust. J. Chem.*, 1997, **50**, 921.
67. Braun, I., Schulz-Ekloff, G., Wohrle, D., & Lautenschlager, W. *Microp. Mesop. Mater.*, 1998, **23**, 79.
68. Raner, K. D., Strauss, C. R., Trainor, R. W., & Thorn, J. S. *J. Org. Chem.*, 1995, **60**, 2456.
69. Stull, D. R. *Ind. Eng. Chem.*, 1947, **39**, 517.
70. Bagnell, L., Cablewski, T., & Strauss, C. R. *Chem. Commun.*, 1999, 283.
71. Zara, C. L., Jin, T., & Giguere, R. J. *Synth. Commun.*, 2000, **30**, 2099.
72. Kress, A. O., Mathias, L. J., & Cei, G. *Macromolecules*, 1989, **22**, 537.
73. Kusefoglu, S. H., Kress, A. O., & Mathias, L. J. *Macromolecules*, 1987, **20**, 2326.
74. Ueda, M., Koyama, T., Mano, M., & Yazawa, M. *J. Polym. Sci., Part A*, 1989, **27**, 751.
75. Mathias, L. J., Warren, R. M., & Huang, S. *Macromolecules*, 1991, **24**, 2036.
76. Avci, D., & Kusefoglu, S. H. *J. Polym. Sci., Part A*, 1993, **31**, 2941.
77. Avci, D., Kusefoglu, S. H., Thompson, R. D., & Mathias, L. J. *J. Polym. Sci., Part A*, 1994, **32**, 2937.
78. Danner, H., & Braun, R. *Chem. Soc. Rev.*, 1999, **28**, 395.
79. Strauss, C. R., & Trainor, R. W. *Org. Prep. Proc. Int.*, 1995, **27**, 449.
80. Brown, E. V. *Synthesis*, 1958, 358.
81. Schillmoller, C. M. In *Encyclopedia of Chemical Processing and Design* McKetta, J. J., & Cunningham, W. A., eds, Vol. 31. Marcel Dekker, New York, 1990, pp. 80–87.
82. Kirschner, E. M. *Chem. Eng. News*, 1994, **72**(25), 13.
83. Willis, L. *Chemtech*, 1998, **28**(8), 18.
84. Kanegsberg, B. *Chem. Ind. (London)*, 1996, 787.
85. DeVito, S. C. *Chemtech*, 1996, **26**(11), 34.
86. Haggin, J. *Chem. Eng. News*, 1996, **74**(23), 38.
87. Eigenmann, K. *Chimia*, 1997, **51**, 169.
88. Haggin, J. *Chem. Eng. News*, 1994, **72**(2), 22.
89. Wan, J. K. S., & Koch, T. A. *Res. Chem. Intermed.*, 1994, **20**, 29.
90. Mehdizadeh, M. *Res. Chem. Intermed.*, 1994, **20**, 79.
91. Li, J., Mau, A. W.-H., & Strauss, C. R. *Chem. Commun.*, 1997, 1275.
92. Breslow, R. *Acc. Chem. Res.*, 1991, **24**, 159.
93. Grieco, P. A. *Aldrichim. Acta*, 1991, **24**, 59.
94. Lubineau, A., Augé, J., & Queneau, Y. *Synthesis*, 1994, 741.
95. Grieco, P. A., Brandes, E. B., McCann, S., & Clark, J. D. *J. Org. Chem.*, 1989, **54**, 5849.
96. Li, C.-J. *Chem. Rev.*, 1993, **93**, 2023.
97. Blokzijl, W., & Engberts, J. B. F. N. *Angew. Chem. Int. Ed. Engl.*, 1993, **32**, 1545.
98. Lubineau, A., & Augé, J. In *Modern Solvents in Organic Synthesis*, (Knochel, P., ed.), Topics in Current Chemistry Vol. 206, Springer, Berlin, 1999, pp. 1–39.
99. Bröll, D., Kaul, C., Krämer, A., Krammer, P., *et al.* *Angew. Chem. Int. Ed. Engl.*, 1999, **38**, 2998.
100. Savage, P. E. *Chem. Rev.*, 1999, **99**, 603.
101. Siskin, M., & Katritzky, A. R. *Science*, 1991, **254**, 231.
102. An, J., Bagnell, L., Cablewski, T., Strauss, C. R., & Trainor, R. W. *J. Org. Chem.*, 1997, **62**, 2505.
103. Jennings, J. M., Bryson, T. A., & Gibson, J. M. *Green Chem.*, 2000, **2**, 87.

104. Ikushima, Y., Hatakeda, K., Sato, O., Yokoyama, T., & Arai, M. *Angew. Chem. Int. Ed. Engl.*, 1999, **38**, 2910.
105. Katritzky, A. R., Allin, S. M., & Siskin, M. *Acc. Chem. Res.*, 1996, **29**, 399.
106. Strauss, C. R., & Trainor, R. W. In *Biotechnology for Improved Foods and Flavors* Takeoka, G. R., Teranishi, R., Williams, P. J., and Kobayashi, A., eds, ACS Symposium Series 637. American Chemical Society, Washington, DC, 1996, pp. 272–281.
107. Stevens, K. L., Jurd, L., & Manners, G. *Tetrahedron*, 1972, **28**, 1939.
108. Bunton, C. A., Cori, O., Hachey, D., & Leresche, J.-P. *J. Org. Chem.*, 1979, **44**, 3238.
109. Manassen, J., & Klein, F. S. *J. Chem. Soc.*, 1960, 4203.
110. Cram, D. J. *J. Am. Chem. Soc.*, 1952, **74**, 2137.
111. Bogert, M. T., & Fourman, V. G. *J. Am. Chem. Soc.*, 1933, **55**, 4670.
112. Strauss, C. R., & Williams, P. J. *J. Inst. Brew.*, 1978, **84**, 148.
113. Sattar, A., Ahmad, R., & Khan, S. A. *Pak. J. Sci. Res.*, 1980, **23**, 177.
114. Strauss, C. R., & Trainor, R. W. *Aust. J. Chem.*, 1998, **51**, 703.
115. Hassner, A., & Stumer, C. *Organic Syntheses based on Named Reactions and Unnamed Reactions*. Elsevier, Oxford, 1994, p. 328.
116. Apparu, M., & Glenat, R. *Bull. Soc. Chim. Fr.*, 1968, 1106.
117. Buchi, G., & Wuerst, H. *J. Org. Chem.*, 1979, **44**, 546.
118. Katritzky, A. R., Luxem, F. J., & Siskin, M. *Energy Fuels*, 1990, **4**, 518.
119. Karpinski, M. L., Nicholas, D., & Gilbert, J. C. *Org. Prep. Proc. Int.*, 1995, **27**, 569.
120. Sheldon, R. A. *Chemtech*, 1994, **24**(3), 38.
121. Sheldon, R. A. *Chem. Ind. (London)*, 1992, 903.
122. Hanson, D. J. *Chem. Eng. News*, 1998, **76**(27), 19.
123. Okochi, H., Kajimoto, T., Arai, Y., & Igawa, M. *Bull. Chem. Soc. Jpn.*, 1996, **69**, 3355.
124. Larhed, M., Lindeberg, G., & Hallberg, A. *Tetrahedron Lett.*, 1996, **37**, 8219.
125. Larhed, M., & Hallberg, A. *J. Org. Chem.*, 1996, **61**, 9582.
126. Kabalka, G. W., Pagni, R. M., Wang, L., Namboodiri, V., & Hair, C. M. *Green Chem.*, 2000, **2**, 120.
127. Vallin, K. S. A., Larhed, M., Johansson, K., & Hallberg, A. *J. Org. Chem.*, 2000, **65**, 4537.
128. Bremberg, U., Larhed, M., Moberg, C., & Hallberg, A. *J. Org. Chem.*, 1999, **64**, 1082.
129. Beletskaya, I. P., & Cheprakov, A. V. *Chem. Rev.*, 2000, **100**, 3009.
130. Sonogashira, K. In *Comprehensive Organic Synthesis* Trost, B. M., & Fleming, I., eds, vol. 3. Pergamon, Oxford, 1993, p. 551.
131. Sakamoto, T., Nagata, H., Kondo, Y., Shiraiwa, M., & Yamanaka, H. *Chem. Pharm. Bull.*, 1987, **35**, 823.
132. Vidal-Ferran, A., Muller, C. M., & Sanders, J. K. M. *J. Chem. Soc., Chem. Commun.*, 1994, 2657.
133. Cho, S. Y., Kim, S. S., Park, K.-H., Kang, S. K., *et al.* *Heterocycles*, 1996, **43**, 1641.
134. Okita, T., & Isobe, M. *Synlett*, 1994, 589.
135. Melissaris, A. P., & Litt, M. H. *J. Org. Chem.*, 1994, **59**, 5818.
136. Cassar, L. *J. Organomet. Chem.*, 1975, **93**, 253.
137. Horvath, I. T. *Acc. Chem. Res.*, 1998, **31**, 641.
138. Curran, D. P., & Hoshino, M. *J. Org. Chem.*, 1996, **61**, 6480.
139. Larhed, M., Hoshino, M., Hadida, S., Curran, D. P., & Hallberg, A. *J. Org. Chem.*, 1997, **62**, 5583.
140. Herrmann, W. A., Reisinger, C.-P., Ofele, K., Brossmer, C., Beller, M., & Fischer, H. *J. Mol. Catal. A: Chem.*, 1996, **108**, 51.
141. Beller, M., & Riermeier, T. H. *Tetrahedron Lett.*, 1996, **37**, 6535.
142. Trost, B. M. *Science*, 1991, **254**, 1471.
143. Trost, B. M. *Angew. Chem., Int. Ed. Engl.*, 1995, **34**, 259.
144. Tonks, L., Anson, M. S., Hellgardt, K., Mirza, A. R., Thompson, D. F., & Williams, J. M. *J. Tetrahedron Lett.*, 1997, **38**, 4319.
145. Clark, J. H., Macquarrie, D. J., & Mubofu, E. B. *Green Chem.*, 2000, **2**, 53.
146. Carillo-Munoz, J.-R., Bouvet, D., Guibé-Jampel, E., Loupy, A., & Pettit, A. *J. Org. Chem.*, 1996, **61**, 7746.
147. Kalba, K. G., Gestwicki, J. E., McGrath, J. L., & Terassi, H. M. *J. Org. Chem.*, 1996, **61**, 9599.
148. Parker, M.-C., Besson, T., Lamare, S., & Legoy, M.-D. *Tetrahedron Lett.*, 1996, **37**, 8383.
149. Jones, J. R., & Lu, S. Y. *Proc. Int. Conf. on Microwave Chemistry*, 4–7 September, 2000, Institut National Polytechnique de Toulouse, p. 51.
150. Barthez, J. M., Filikov, A. V., Frederiksen, L. B., Hugué, M. L., Jones, J. R., & Lu, S. Y. *Can. J. Chem.*, 1998, **76**, 726.
151. Erb, W. Th., Jones, J. R., & Lu, S. Y. *J. Chem. Res. (S)*, 1999, 728.
152. Frederiksen, L. B., Grobosch, T. H., Jones, J. R., Lu, S. Y., & Zhao, C. C. *J. Chem. Res. (S)*, 1999, 42.
153. Chemat, F., Poux, M., Di Martino, J.-L., & Berlan, J. *J. Microwave Power Electromag. Energy*, 1996, **31**, 19.
154. Chemat, S., Aouabed, A., Bartels, P. V., Esveld, D. C., & Chemat, F. *J. Microwave Power Electromag. Energy*, 1999, **34**, 55.
155. Compton, R. G., Coles, B. A., & Marken, F. *Chem. Commun.*, 1998, 2595.
156. Mason, T. J. *Chem. Soc. Rev.*, 1997, **26**, 443.
157. Simonsson, D. *Chem. Soc. Rev.*, 1997, **26**, 181.
158. Marken, F., Tsai, Y.-C., Coles, B. A., Matthews, S. L., & Compton, R. G. *New J. Chem.*, 2000, 653.
159. Microwave chemistry conferences have been held at venues including: Breukelen, The Netherlands (1992); Honolulu, Hawaii (1995; a symposium within Pacificchem); Ottawa, Canada, (1997); Prague, the Czech Republic (1998); and Antibes, France (2000).

Chapter 18: Photochemistry

IAN R. DUNKIN

Curiously, previous publications dealing with the clean technology of chemicals manufacturing [1] have neglected photochemistry as a method of initiating synthetic reactions. Techniques such as electrochemistry, microwave irradiation and sonochemistry all have their advocates. The potential of photochemistry, on the other hand, seems to be recognised only for the clean-up of effluents. Indeed, recent books on environmental photochemistry [2] and heterogeneous photocatalysis [3] are devoted almost exclusively to the role of photochemistry in producing atmospheric pollution and to the photocatalytic destruction of pollutants.

Why has synthetic photochemistry thus been neglected? Certainly not because it is intrinsically uneconomic. In books on industrial organic chemistry [4] and photochemical technology [5] examples can be found of established industrial photochemical processes, e.g. in the production of caprolactam—the precursor for Nylon 6 (see Fig. 18.1)—which demonstrate that photoreactions can be viable even for commodity chemicals. Figure 18.1 also shows two other examples of commercialised photochemical synthesis. In this chapter we shall review the advantages of photochemistry as a clean technology, discuss why it has been overlooked so far and explore whether its shortcomings can be overcome or accommodated. In Section 5, at the end, there is a brief review of those basic principles of photochemistry that are most relevant to the technological exploitation of photochemical reactions in chemicals manufacturing.

1 Photons as Clean Reagents

Within the context of cleaner chemicals manufacturing there are three general benefits that can be expected from photochemical reactions:

- (1) Reduced usage of reagents.
- (2) Lower reaction temperatures.
- (3) Control of selectivity.

The ways in which these benefits should arise are explained in the next few sections.

1.1 Reduced usage of reagents

A photochemical reaction is initiated by the absorption of light, rather than by heat or the action of conventional reagents. The activation energy needed is provided by photons, which are non-material and disappear in the process. Photons therefore can be regarded as ideal reagents: they activate reactions without directly generating any by-products.

Waste production should be reduced whenever a process employing conventional reagents can be replaced by a purely photochemical process. The benefits will be greatest when one-shot reagents are eliminated (i.e. those that, unlike catalysts, cannot be reused). Moreover, such reagents often give rise to toxic or otherwise harmful by-products and, especially in these cases, avoiding the need for recovery and disposal of harmful waste will reduce overall processing costs.

Light sources can be switched on and off at will. In contrast, conventional reagents must be kept in storage and then sometimes are hazardous or prone to deterioration. Whenever photochemical processes supersede reagent-activated processes, stocks of reagents can be reduced. For example, peroxide radical initiators, which can be used in the halogenation of organic compounds, are potentially explosive and need to be kept refrigerated. Alternatively, such halogenations can be initiated by light (cf. the bromination in Fig. 18.1), thus avoiding the need to store peroxides.

1.2 Lower reaction temperatures

In a photochemical reaction, the activation energy is supplied by the photons directly to the molecules that absorb the light. If a solvent is needed for the reaction, the choice normally will fall on one that does not absorb light in the wavelength range of the

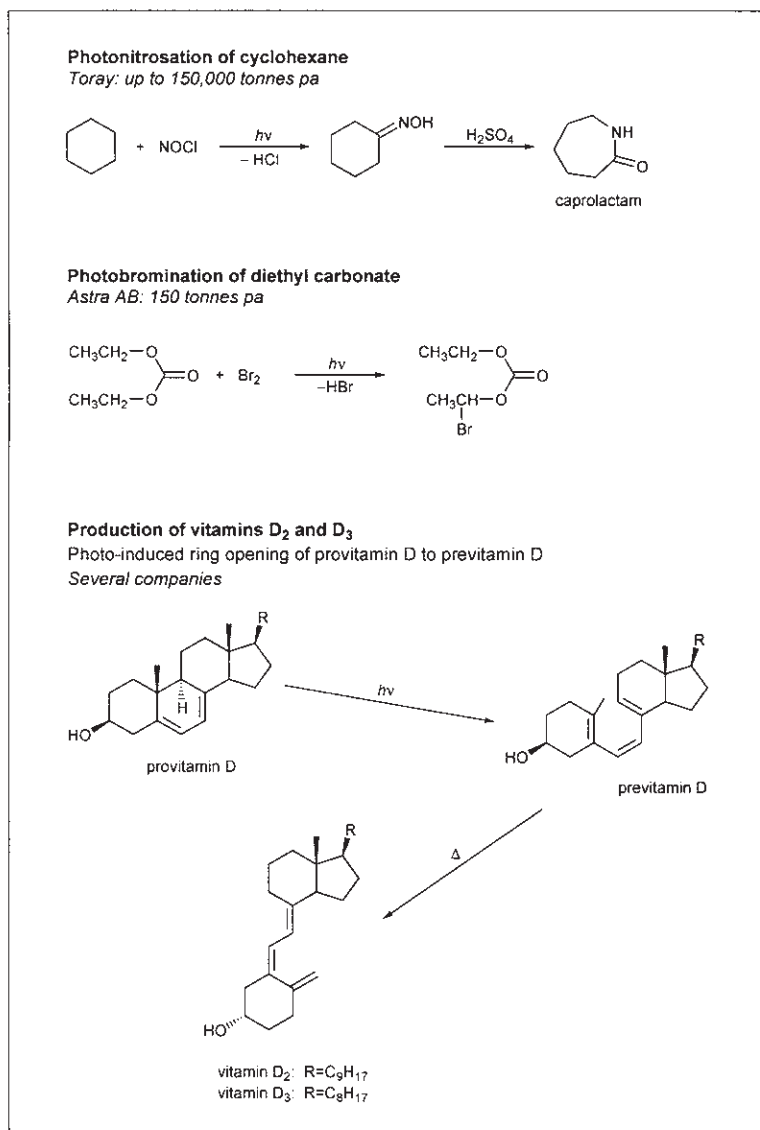


Fig. 18.1 Three examples of industrial photoprocesses in chemicals manufacturing. (Data from Refs 4 and 5.)

light source in use. Therefore, all the energy supplied to the reaction system goes into the reacting molecules. Photoreactions often can be carried out without heating the reaction mixture and the reaction vessel, thus saving energy and reducing thermal decomposition of the products.

1.3 Control of selectivity

It is well known that certain synthetic reactions can be accomplished only by electronic excitation of a

reactant. Familiar examples are: $2\pi + 2\pi$ cycloadditions, e.g. the key construction of a strained cyclobutane ring in the synthesis of cubane [6] (Fig. 18.2); reactions involving singlet oxygen, e.g. the synthesis of ascaridole from α -terpinene [7,8] (Fig. 18.3); and the di- π -methane reaction—a method for producing cyclopropane derivatives—an example of which [9] is given in Fig. 18.4. In all these cases the photochemical products are not generated at all if the reaction mixtures are merely heated. In these and numerous other examples of the photochemical syn-

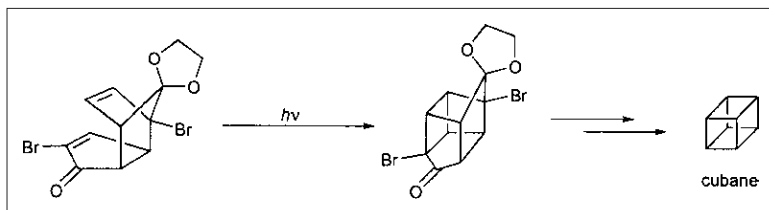


Fig. 18.2 Photochemical intramolecular $2\pi + 2\pi$ cycloaddition as a key step in the synthesis of cubane.

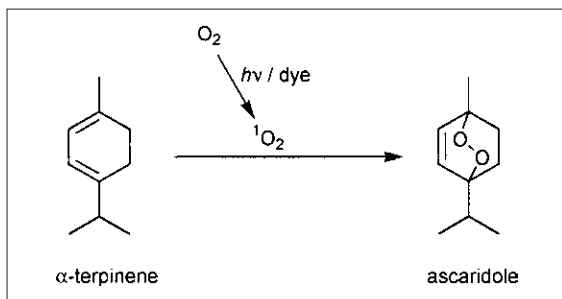


Fig. 18.3 Synthesis of ascaridole, a naturally occurring cyclic peroxide, from α -terpinene by $4\pi + 2\pi$ cycloaddition of singlet oxygen. Singlet oxygen is generated from the ground-state triplet by the action of a photosensitising dye such as Rose Bengal.

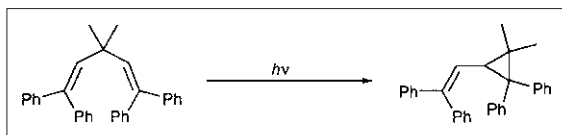


Fig. 18.4 A cyclopropane derivative formed in a di- π -methane reaction.

thesis of strained or unstable molecules, the products often are unobtainable by conventional thermal reactions. This type of photochemistry thus is highly selective. Figure 18.5 illustrates the principle behind such selectivity. Obviously, if a reaction of this type is needed in a process, photochemistry is the only option. Indeed, in the synthesis of vitamins D_2 and D_3 (Fig. 18.1), the photochemical ring opening of provitamin D to give previtamin D is an example of just such a selective reaction that has been commercialised.

There is, however, another, more subtle, way in which photochemistry can offer enhanced selectivity, which may, in the long run, be more widely beneficial. This is a result of the greater freedom to

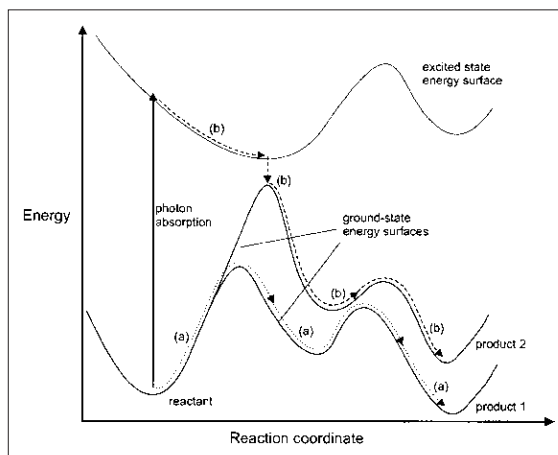


Fig. 18.5 Energy diagram showing two ground-state energy surfaces and an excited-state surface for a reactant molecule. The dotted line (a) shows the most probable reaction pathway for a reactant molecule undergoing a thermal reaction, i.e. passing over the lower initial activation barrier and yielding the lower energy product. Only a negligible proportion of the reacting molecules will pass over the much higher initial activation barrier leading to product 2. The dashed line (b) shows a possible photochemical reaction pathway for the same molecule. From the excited state attained by photon absorption, the higher energy ground-state surface becomes accessible and the higher energy product is formed.

choose the reaction temperature that photochemical initiation allows the process developer.

In non-equilibrium reactions, the proportions of the various products are determined by the kinetics of each of the competing pathways involved. In general, higher temperatures lead to increased proportions of minor, usually unwanted, products. In thermal reactions, the temperature must be chosen to provide an acceptably high rate of initiation. In a photochemical reaction, however, this is no longer the case. The reaction temperature instead can be chosen to minimise the yields of by-products. With a photoreaction, the activation energy is supplied

right at the start by the photon, and the competition between the various subsequent thermal pathways can, to some extent, be controlled by varying the temperature.

The relationship between the rate constant k for a unimolecular reaction and the activation energy E_a is given by the well-known Arrhenius equation:

$$k = Ae^{-E_a/RT}$$

where A is the pre-exponential factor, R is the gas constant and T is the temperature. When there are two competing reactions—let us say a major pathway with Arrhenius parameters $k(1)$ and $E_a(1)$ and a minor pathway with $k(2)$ and $E_a(2)$ —the ratio of the yields of minor and major products is given by

$$\frac{k(2)}{k(1)} = \frac{A(2)}{A(1)} e^{-\Delta E_a/RT}$$

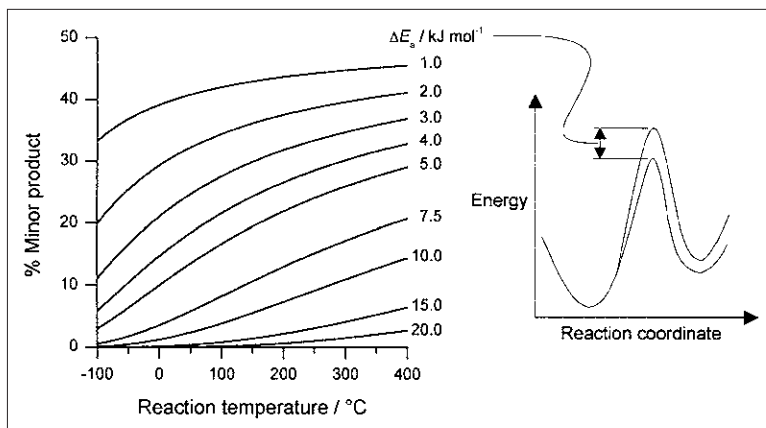
where $\Delta E_a = E_a(2) - E_a(1)$. Figure 18.6 shows how the percentage of the minor product formed is expected to vary with temperature in the range -100 to $+400^\circ\text{C}$ for values of ΔE_a from 1.0 to 20.0kJ mol^{-1} , and on the assumption that the pre-exponential factors for the two reactions, $A(1)$ and $A(2)$, are identical.

The point with regard to photochemistry is well illustrated by the hypothetical reaction energy profiles shown in Fig. 18.7. On the electronic ground-state surface, the reaction proceeds via a high-energy transition state to an intermediate from which two reaction pathways lead to two products, both via transition states with considerably lower energy than the first transition state. If the reaction

is activated thermally, the temperature has to be high enough for the reactant molecules to surmount the energy barrier of the first transition state. This temperature, however, is much larger than is needed for the reaction to proceed over the subsequent transition states to the products. Therefore, a higher proportion of the minor product will be formed than if the reaction could be carried out at a lower temperature. If, on the other hand, the activation energy required for the first step is supplied photochemically (path (b) in Fig. 18.7), the reaction can be carried out at a considerably lower temperature, thus reducing the proportion of the minor product.

Real reactions are likely to be more complicated than the hypothetical case illustrated in Fig. 18.7. For example, there may be several competing reactions, not just two, and each pathway may involve more than one intermediate. A product that can be isolated at low temperatures may, when the temperature is raised, become only an intermediate on the path to another product. In any case, studies of the effects of temperature on product distributions in photoreactions can yield quite dramatic results. An example comes from the reactions of sulfuryl chloride (SO_2Cl_2) with aliphatic carboxylic acids, which have been subjected to detailed studies in the author's laboratory [10]. The thermal reaction of propionic acid with sulfuryl chloride, initiated by benzoyl peroxide, must be carried out at temperatures above 80°C to achieve a reasonable rate of homolysis of the initiator. Under these conditions, a roughly equal mixture of 2- and 3-chloropropionic acids is obtained (Fig. 18.8). In contrast, the photo-

Fig. 18.6 Curves showing the expected percentage of the minor product from kinetically controlled competition between two reaction pathways as a function of temperature (over the range -100 to $+400^\circ\text{C}$) and the difference in activation energies of the two processes ΔE_a (in the range 1 – 20kJ mol^{-1}). It is assumed that the two pathways have identical values of the Arrhenius pre-exponential factor.



chemical reaction between propionic acid and SO_2Cl_2 requires no peroxide initiator and can be carried out at temperatures down to 0°C . At low temperatures, products from 3-chlorosulfonation predominate (the products actually isolated vary with the work-up procedure) and no 3-chloropropionic acid is obtained. When the photoreaction is carried out at $80\text{--}100^\circ\text{C}$, however, 2- and 3-chloropropionic acids but no chlorosulfonation products are obtained.

This type of temperature dependence of the product distribution may prove to be fairly common in photoinitiated processes, and could become one of

the main driving forces for a greater utilisation of photochemistry in chemicals manufacturing.

1.4 Photochemical reactions for industry

The general advantages of photochemistry as a clean technology, which have been outlined above, will not of course provide the solutions to every problem in chemicals manufacturing. Nevertheless, there is enough evidence to suggest that a photochemical approach could prove optimum in a significant minority of cases. In short, photochemistry should not be neglected by process development chemists and engineers.

It would be easy to conclude from the vast literature on laboratory photochemical reactions that the main obstacle to exploiting photochemistry industrially is the lack of well-developed technologies rather than a lack of known photoreactions. To some extent this is true. Nevertheless, photochemical research has, naturally enough, been concentrated largely on those photoreactions that have no thermal counterparts. There is still a need for studies of photoreactions that could serve as substitutes for well-established thermal processes, especially those with recognised problems of waste generation, e.g. Friedel–Crafts acylation. There have been very few reports of investigations of the effect of temperature on product distributions in photoreactions, so little is known about the temperature sensitivity of the majority of photoprocesses. It is likely, therefore, that future progress in the exploitation of photochemistry in chemicals manufacturing will depend on a combination of new or more fully researched photochemistry as well as new technology. The remainder of this chapter will, however, deal mainly with the latter, because it is in the technological area that most of the perceived drawbacks of photochemistry lie.

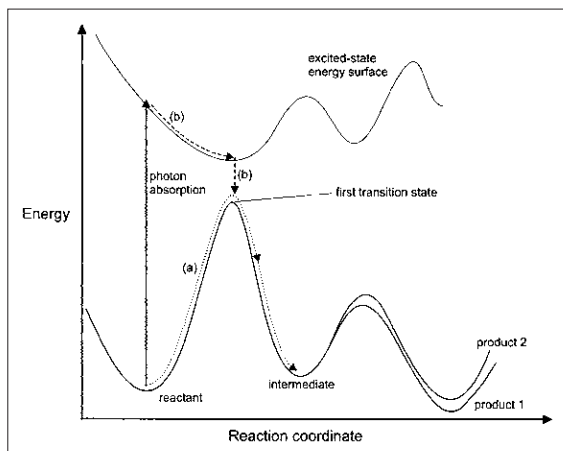


Fig. 18.7 Energy diagram for a reaction that, in the electronic ground state, has a high-energy first transition state leading to an intermediate from which two pathways diverge, both with lower energy transition states. The intermediate can be reached by thermal activation (a) or by photochemical activation (b).

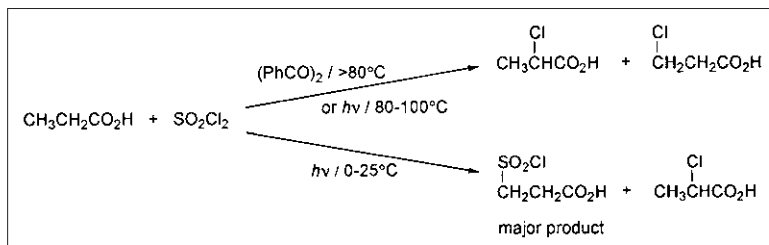


Fig. 18.8 Thermal (peroxide initiated) and photochemical reactions of sulfuryl chloride with propionic acid.

2 General Problems with Photochemical Processes

The benefits that can be derived from the exploitation of photochemistry in cleaner chemicals manufacturing can be realised only when they are not outweighed by serious disadvantages. There are several generic problems that frequently are cited as the underlying reasons why photochemistry is not utilised more widely. These are

- The need for specialised processing plant
- Unfamiliar process technology
- Window fouling
- The high cost of photons

Clearly, where photochemical processes already have been commercialised successfully, these problems have been overcome. Whether they can be overcome more generally is discussed in the next few sections.

2.1 Specialised photochemical reactors and process technology

It is all very well to regard the photon as an ideal, non-material reagent, but the differences between photons and conventional reagents become apparent when one considers how they are introduced into a reaction mixture. Many organisations have general-purpose batch reactors in which it is quite feasible to carry out almost any chemical reaction that requires only the straightforward addition of solid or liquid reagents and the heating and mechanical stirring of the reaction mixture. Photons, on the other hand, require one or more lamps to be added to the configuration, preferably in a manner to allow maximum utilisation of the light output. In this respect, specialised plant is needed for photochemistry, but there are ways in which standard batch reactors can be adapted fairly easily.

The most common adaptation of a batch reactor for photochemical reactions is to enclose the lamps in immersion wells (Fig. 18.9). The resulting facility is a scaled-up version of the familiar immersion-well reactor—probably the most widely used type of reactor for laboratory photochemical syntheses—in which the light source is surrounded completely by the reaction mixture. Immersion wells have to be made of quartz if UV light with wavelengths of less than about 300 nm is to be utilised, but they can be

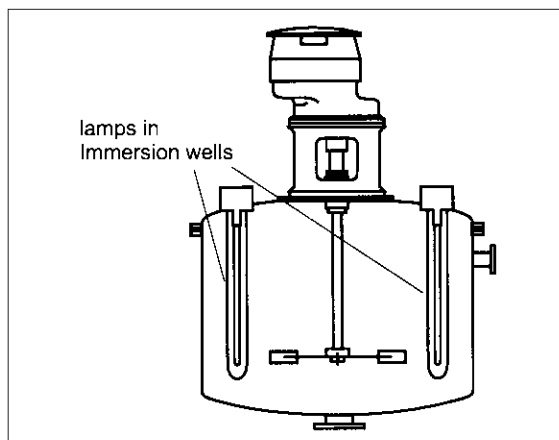


Fig. 18.9 A stirred batch reactor adapted for photochemical reactions by incorporation of two lamps in immersion wells.

made of much cheaper glass for reactions initiated by longer wavelength UV or visible light.

Other ways of incorporating the necessary lamps into a set-up based on a standard batch reactor also can be envisaged. For example, the liquid reaction mixture contained in the main vessel can be circulated through a second chamber containing the lamp.

Reaction conditions in the various types of adapted batch reactor can differ markedly. This can lead to surprising results when seemingly the same reaction is carried out in reactors of different designs. In the author's laboratory, for example [10], the chlorination of propionyl chloride by light-induced reaction with suluryl chloride (SO_2Cl_2) has been investigated in various glass reactors based on the industrial stirred batch reactor. In an immersion-well reactor similar to that shown in Fig. 18.9, the results were comparable to those derived from parallel studies with propionic acid (Fig. 18.8): mixtures of 2- and 3-chloro and 3-chlorosulfonylpropionyl chloride were obtained, the proportions varying with temperature. In contrast, photolysis of propionyl chloride and SO_2Cl_2 in a reactor involving circulation to a second chamber gave almost exclusively 2-chloropropionyl chloride. The greatly different product distributions obtained with the two reactor types suggest that a different reaction mechanism may be operating in each case.

The main point about Fig. 18.9 is that standard batch reactors can be adapted relatively easily for

photochemistry. The simplest designs have serious disadvantages, however. In particular, they are both prone to window fouling—the build-up of opaque deposits on the lamp enclosures.

2.2 Window fouling

A problem that arises with many photochemical reactions is the formation of by-products that are deposited as coatings on the lamp enclosures. In many cases these coatings appear to be quite hard polymers and difficult to remove. Over time, the build-up of such deposits can significantly reduce the intensity of the available light and thus the efficiency of the process. This is termed *window fouling*. As well as the cost of wasting light, window fouling results in undesirable variability in a crucial operating parameter, namely the light intensity.

Window fouling does not occur with every photochemical process, but it is a sufficiently serious and widespread problem to require a generic solution. In their valuable book on photochemical technology [5], Braun *et al.* discuss the design of photoreactors in depth, including provisions for reducing or eliminating window fouling. A number of potential solutions are highlighted. For example, in falling film reactors, the liquid reaction mixture is irradiated as a thin film passing down the walls of the reaction vessel, and in some designs (see Fig. 18.10) the film has no contact with the lamp enclosure, thus minimising the chance of window fouling. Even in these reactors, however, the vapour above the liquid phase is in contact with the lamp enclosure, and so a chance of window fouling from gas-phase photolyses remains. In jet injection reactors, the feed mixture is directed in jets against a quartz or glass plate that is irradiated from the other side. The formation of deposits is prevented by the strong turbulence at the inner surface of the irradiated plate.

2.3 The cost of photons

The ideal light source for photochemistry would convert all the electrical energy taken in by the power supply into a monochromatic light beam of the desired wavelength. No available sources can achieve this, but some come much nearer than others. At one extreme, tungsten lamps, for example, produce a continuum of wavelengths over a wide range, with most of the output energy in the

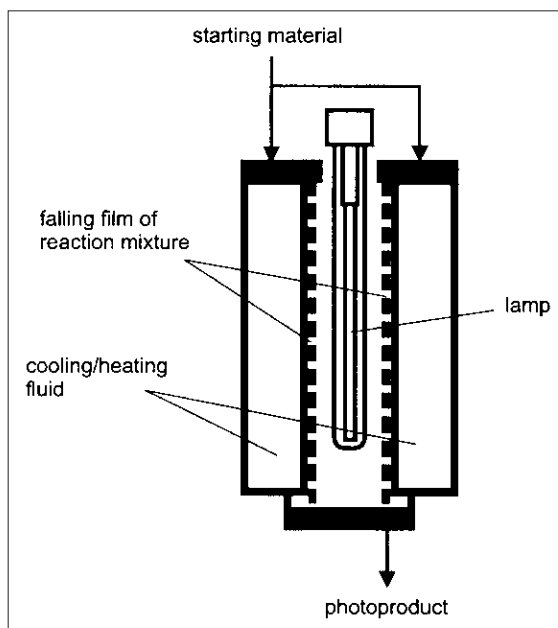


Fig. 18.10 Schematic diagram of a photochemical falling-film reactor.

form of infrared irradiation and heat. Low-pressure mercury arc lamps, on the other hand, produce 254-nm radiation almost exclusively, with little heat output and a high energy efficiency. Lasers tend to be highly monochromatic but energy inefficient. Solar light is free, but variable and intermittent.

Most photoreactions require light with wavelengths that fall in a fairly narrow range. Wide-range continuum sources are therefore wasteful of energy, because much of their output will be unused. High-efficiency monochromatic sources are much preferred. Solar light has a very broad wavelength range and, because it is free, any unused wavelengths do not present an unacceptable cost. The utilisation of solar light for chemicals manufacturing is being researched at a number of institutions [11] and one day may become economic in countries with reliable, high-intensity sunshine. However, the potential viability of purpose-built chemical plants sited away from the established infrastructure of the chemicals industry, e.g. in desert areas, is far from clear.

Superimposed on the technological question of lamp efficiency is the fundamental photochemical question of the quantum yield. This is defined as the number of molecules undergoing a particular

photon-induced process per photon absorbed. The quantum yield of product formation is of critical importance to the economic viability of a synthetic photoreaction. Quantum yields vary enormously. Many quite useful laboratory photoreactions have quantum yields well below unity. This may not be of much concern for small-scale synthesis but would render a manufacturing process uneconomic. Different sectors of the chemicals industry have different sensitivities to the cost of reagents but, generally speaking, photoreactions with low quantum yields are unlikely to be attractive, except where there is really no alternative or where a photochemical reaction has overwhelming advantages compared with any available thermal process. For large-tonnage photochemical production to be viable, e.g. the nitrosation of cyclohexane (Fig. 18.1), it is probably necessary for the reaction to be a chain process, with many product molecules formed as the result of each photon absorbed.

Quantum yields tend to be inconvenient to measure and, for this reason, a high proportion of papers on synthetic photochemistry give no quantum yield data. In assessing the economic viability of a photochemical process, however, the overall energy efficiency of the whole reactor and reaction system is a better indicator than the quantum yield of formation of the desired product. The overall energy efficiency can be defined as the amount of desired product derived from a given input of electrical energy. This takes into account energy losses in converting electrical energy into light, light wasted by scattering or absorption by materials other than the reactant and the energy wastage due to unproductive photophysical processes of the excited reactant or the generation of by-products. Determination of the overall energy efficiency of a process normally is relatively straightforward and much easier than measuring quantum yields. Nevertheless, sometimes still it will be worthwhile to dissect the overall energy efficiency into its components, including the quantum yield of product formation, e.g. when the feasibility of improving a process is being considered in detail.

3 The Light Ahead

The future development of photochemistry for cleaner chemicals manufacturing requires progress on several fronts. The most important needs are:

- Versatile photoreactors
- Efficient light sources for a variety of wavelengths
- Greater knowledge of the effect of operating parameters on product distributions

Thus, contributions from chemical engineers, physicists, electronic and electrical engineers and photochemists are likely to play a part in what is clearly a multidisciplinary field. Collaborations between photochemists and chemical engineers are particularly important.

So far, very few reports of photochemical studies devoted to cleaner manufacturing have appeared in the literature. Nevertheless, many of the necessary elements for progress in this area are being investigated, sometimes for quite different reasons. Recent developments of novel photoreactor designs and light sources, in particular, have been very timely and have increased significantly the potential of photochemistry as a clean technology.

3.1 Photochemical reactors

The photochemical bell reactor

The problem of window fouling has been tackled by Shama *et al.* at Loughborough University [12] in the development of a photochemical forced-jet bell reactor (Fig. 18.11). Bell photoreactors originally were designed for photosterilising liquids of high UV absorptivities [12–14], e.g. in controlling the microbial colonisation of cutting fluids. In this type of reactor, window fouling is reduced greatly because there is no contact between the reaction medium and the quartz or glass enclosures surrounding the lamps (Fig. 18.11). The liquid reaction mixture is fed from a constant-head reservoir to a nozzle, from which the liquid impinges on a horizontal circular plate. This causes it to spread out in a bell-shaped envelope, i.e. an unsupported, enclosed, thin liquid sheet. The dimensions of the envelope can be adjusted by controlling nozzle parameters, such as gap opening and liquid flow rate. Because the sheet is unsupported, it can be irradiated with light sources that do not make physical contact with the reaction medium, thus minimising window fouling. For maximum light *efficiency*, a single lamp can be located within the bell so that all the photons are absorbed by the flowing reaction mixture. For maximum light *intensity*, several lamps also can be placed around the

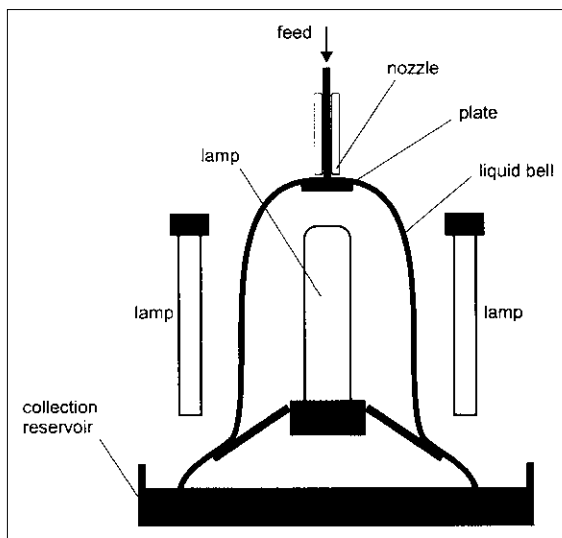


Fig. 18.11 Schematic diagram of a photochemical forced-jet bell reactor.

outside of the bell. The irradiated reaction mixture is collected at the bottom of the bell, from where it can be recirculated or transferred to the next step of a process.

Although the bell reactor greatly reduces window fouling, experience gained with the disinfection of cutting fluids (G. Shama, personal communication) has shown that some fouling still occurs, apparently caused by droplets of liquid created by the falling liquid sheet as it impinges on a liquid or solid surface, becoming deposited on the lamp enclosures. It is hoped that in further refinements of the design this fouling can be substantially reduced or even eliminated, e.g. by incorporating splash shields and by carefully selecting the location of the light sources.

In addition to a reduction in window fouling compared with conventional immersion-well reactors, the bell reactor has the following advantages:

- (1) It has a high ratio of surface area to reacting volume, favouring gas-liquid reactions and reactions producing off-gases.
- (2) It works well with mixtures containing suspended solids, e.g. in heterogeneous photocatalytic systems.
- (3) It could be incorporated readily into either batch or continuous processes.

- (4) It is suitable for concentrated solutions because a relatively thin liquid film is irradiated.
- (5) It is relatively simple to construct and operate.

To date, bell reactors have been used almost exclusively in the photosterilisation of aqueous media, and there has been little endeavour to assess their suitability for chemicals manufacturing. There is clearly a potential for this design, however.

The photochemical oscillatory flow reactor

An attractive way of utilising photochemistry in manufacturing processes would be in heterocatalytic systems. In this type of process, light is absorbed by an insoluble photosensitiser and the excitation energy subsequently is transferred to the reactant molecules. The photosensitiser returns to its original ground state and then is available for another light-absorption and energy-transfer cycle. At the end of the reaction, the insoluble photosensitiser can be removed readily by filtration and ideally used again. Photosensitisers can be immobilised by adsorption on silica or alumina surfaces, by complexation with ion-exchange resins, by incorporation into zeolite cages or by covalent bonding to organic polymers.

The processing advantages of reactions activated by reagents or catalysts immobilised on polymer supports, for example, have long been recognised [15]. Within this field, however, the immobilisation of photosensitisers has received relatively little attention, although there have been some studies of immobilised dyes, such as Rose Bengal and Methylene Blue [16,17] for singlet oxygen generation.

The practical implementation of heterogeneous photocatalytic reactions for chemical synthesis on a large scale presents significant difficulties. Firstly, there is the problem of achieving efficient mixing and mass transfer in a heterogeneous reaction mixture, with the additional requirement of getting light into the system to initiate the reaction. Secondly, there is the question of optimising the design of the immobilised photosensitisers.

The general problems encountered in the design of suitable reactors for heterogeneous photocatalysis have been discussed by Augugliaro *et al.* [18] and include both modelling difficulties (non-ideal fluidodynamics and complex kinetics) and practical considerations such as the opacity and light-scattering properties of suspended photosensitiser particles,

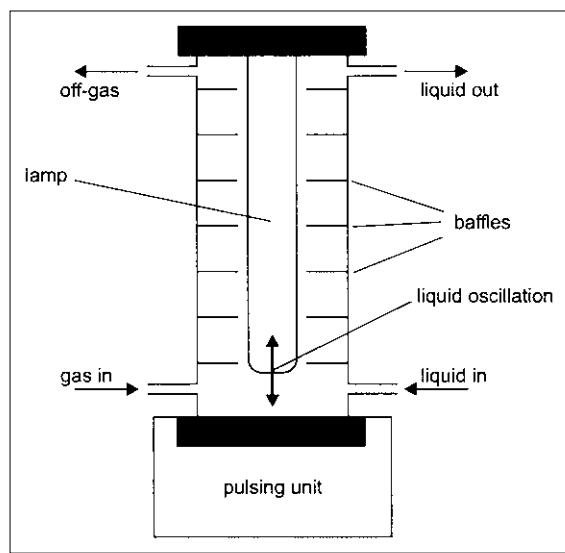


Fig. 18.12 Schematic diagram of a photochemical reactor with oscillatory flow mixing.

choice of construction materials and the avoidance of window fouling. Research on UV-assisted wet oxidation and parallel research on oscillatory flow mixing (OFM) [19] has led to the development, by Skelton's group at Cambridge University, of a photochemical reactor with oscillatory flow mixing of the reactants [20,21], which seems highly promising for heterogeneous photocatalytic synthesis (Fig. 18.12).

In OFM reactors, the mixing of phases is accomplished by the application of a vertical oscillation to the reaction liquid, by means of a pulsing unit, which causes vortexing around and between the baffles (see Fig. 18.12). The oscillations can be varied in amplitude and frequency to optimise mixing. The OFM reactor therefore is specially suitable for two- and three-phase reaction systems, e.g. the combination of heterogeneous photocatalysts and gaseous reagents. The reactor can be operated in either batch or continuous modes, but in the latter it is important that a sufficient settling volume is provided, above the top baffle, to ensure that the solid photocatalyst is not carried over.

The OFM reactors originally were designed for the photocatalytic destruction of pollutants, e.g. using supported TiO_2 , but their potential for photochemical synthesis now is being investigated in a col-

laboration between the author's group at Strathclyde University and Skelton's group at Cambridge. In this project it is hoped to develop the photochemical OFM reactor for use with a wide range of reagent and solvent systems and to increase the scope of immobilised photosensitisers.

Continuous flow reactors and process intensification

There is much current interest in process intensification through the development of small continuous-flow reactors. Major advantages are the lower capital costs and space requirements of the smaller reaction vessels needed for any given throughput. Photochemical reactions should, in the main, be quite amenable to this approach.

In an immersion-well batch reactor like that shown in Fig. 18.9, the light output from each lamp usually will be absorbed completely within a short distance of the lamp enclosure, unless the reaction solution is very dilute. Thus, most of the volume of the reaction vessel effectively is shielded from the light. The reaction can proceed to completion because, through stirring of the solution, all the reactant molecules at some stage will come close enough to a lamp to be irradiated. This, however, may be achieved just as easily in a flow system. Indeed, the flow system has the advantage that, once the reactant molecules have been irradiated, the resulting product molecules are removed from the reaction chamber and therefore are not exposed to further prolonged irradiation and the possibility of secondary photolysis. All the designs mentioned in this chapter—immersion-well, falling-film, jet-injection, bell and OFM reactors—are capable of adaptation to continuous-flow processes.

3.2 Light sources

In view of the need for highly efficient monochromatic light sources, the development of a range of so-called excimer lamps has been a welcome advance [22,23]. These silent discharge sources are driven by high-voltage power supplies operating at frequencies from 50Hz to several megahertz and have narrow spectral bandwidths, readily variable geometry—allowing flexibility in reactor design—and relatively low operating temperatures. Table 18.1 lists some of the available systems, together with their peak wavelengths. The two varieties of

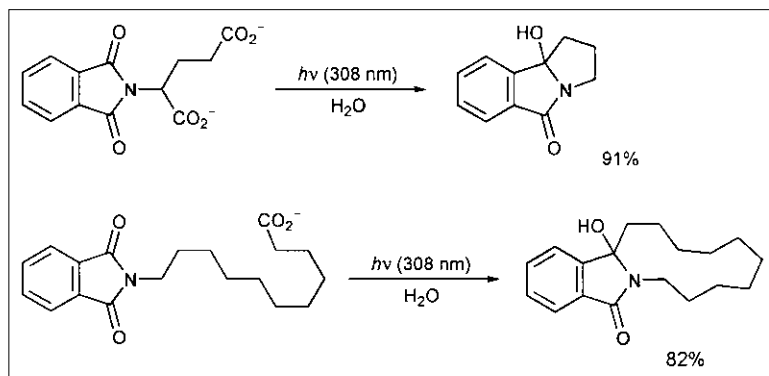


Fig. 18.13 Decarboxylative ring-closure reactions carried out in aqueous solution and initiated by 308-nm light from an XeCl* excimer lamp.

Table 18.1 Excimer light sources with peak output wavelengths in the range 100–400 nm^a

Gas mixture	Emitting species	Peak wavelength (nm)
Ar	Ar ₂ *	128
Kr	Kr ₂ *	148
Xe	Xe ₂ *	172
Ar + Cl ₂	ArCl*	175
Ar + F ₂ + SF ₆ (trace)	ArF*	193
Kr + Cl ₂	KrCl*	222
Kr + F ₂ + SF ₆ (trace)	KrF*	248
Xe + Cl ₂	XeCl*	308
Xe + F ₂ + SF ₆ (trace)	XeF*	352

^a Data from Ref. 24.

excimer sources that have been most studied generate either noble gas excimers (excited dimers), e.g. Xe₂*, which give out light in the vacuum-UV region of the spectrum (wavelengths below 200 nm), or exciplexes (excited complexes) of noble gases with halogens, e.g. XeCl*, which tend to give out longer wavelengths. Both types are referred to as excimer sources, even though true excimers are involved only with the unmixed gases. It seems probable that other excimer systems, offering an even wider range of output wavelengths, should be relatively easy to develop.

As with many advances in photochemical technology, these new light sources so far have found applications primarily in the photo-oxidative degradation of organic materials [24–30], but synthetic applications are beginning to appear.

In one of the few published papers on photochemistry for clean synthesis, Griesbeck *et al.* [31]

have described a falling-film reactor incorporating a 308-nm excimer lamp (XeCl*). In this reactor they have carried out some interesting decarboxylative ring-closures (see Fig. 18.13) using water as the solvent. Because these reactions use light as the activating agent and an environmentally benign solvent, they are good examples of what can be achieved in cleaner synthesis utilising photochemistry.

4 Conclusions

Several reasons for regarding photochemistry as a viable clean technology for chemicals manufacturing have been put forward and elaborated in this chapter. Although thermal reactions will continue to provide the largest proportion of synthetically useful procedures, photochemical reactions can have significant advantages and should not be neglected out of hand. The current unpopularity of photochemistry may be traced to various influences, such as the exclusion of preparative photochemistry from many, if not most, chemistry courses, the need for specialised reactors and the admittedly high cost of photons. Technological problems, such as window fouling, also contribute to the lack of enthusiasm for photochemistry, but such problems can be overcome given sufficient incentive to develop novel reactors.

Adaptations of the widely available stirred batch reactors can be accomplished relatively easily and inexpensively and may prove sufficient for some photoreactions, but they will not yield all the potential benefits of photochemical processing. There are, however, several designs of reactor that could be developed for synthesis and that promise much

improved performance. The advent of efficient excimer lamps, offering essentially monochromatic light at a variety of wavelengths, has provided an additional technological advance to aid reactor design. Photochemistry also seems well adapted to process intensification through the development of small-scale continuous reactors.

Photochemical reactions can become competitive when at least one of the following conditions prevails:

- (1) There is no economical conventional reaction as an alternative.
- (2) High selectivity in the production of a high-value fine chemical or pharmaceutical negates the extra costs involved in photochemical processing.
- (3) A photochemical reaction accomplishes in one stage what would require a sequence of several thermal reactions.
- (4) A photochemical reaction avoids the generation of a by-product, the presence of which would result in costly purification or disposal procedures.
- (5) A chain reaction results in high quantum yields.

How many such processes actually will emerge and be commercialised will depend on the direction and emphasis of future research and development in clean technology. In an age when whatever is natural or 'organic' is so highly esteemed, we should reflect that nature's synthetic methodology is photosynthetic.

5 The Basics of Photochemistry

There are many excellent texts on photochemistry [32]. The reader is referred to these for detailed treatments of the theory of light, excited states of atoms and molecules, photophysical processes, mechanisms of photochemical reactions and synthetic applications. There are, however, a few important principles that should be kept in mind when considering the technological exploitation of photochemistry. This section has been included, really as an appendix, to serve as a reminder of these principles for some or a brief introduction for others, but it may be neglected by any reader who is reasonably familiar with the subject.

5.1 Light and energy

Light is an everyday phenomenon, but trying to understand it in terms of quantum and relativity theories takes us into territory still beset with many mysteries. Fortunately, for most photochemical purposes, a pragmatic mix of particle and wave models serves well enough as a conceptual basis.

In the *wave model*, light is simply an oscillating electrical field, with an associated oscillating magnetic field, propagating as a wave through space. A light wave has both a frequency and a wavelength. For visible and ultraviolet (UV) light the frequencies are very high (in the region of 10^{15} Hz) and the wavelengths are short (100–700 nm). The UV–visible light lies in the middle of a continuum of *electromagnetic radiation*, in which infrared light, microwaves and radio waves have longer wavelengths and lower frequencies, whereas x-rays and gamma rays have shorter wavelengths and higher frequencies.

The oscillating electric fields of light waves can interact with the electrically charged particles in matter (electrons and nuclei), inducing motion in the particles and increasing the energy of the matter. It has been known for a long time, however, that such transfer of energy from light to matter can occur only in discrete packets, termed *quanta* or *photons*. The energy of each photon E_p is related to the frequency ν of the light wave:

$$E_p = h\nu$$

where h is Planck's constant ($6.6260755 \times 10^{-34}$ J·s). Thus, for light of a given frequency, energy can be transferred to matter only in integral multiples of the photon energy E_p .

When we consider this aspect of energy transfer, light seems to behave more like a stream of particles than a wave. Energy can be abstracted from the light beam by removing individual photons in any integral number, but energy corresponding to a fraction of a photon cannot be abstracted. Nevertheless, in this *particle model*, photons differ significantly from more familiar particles such as billiard balls. The latter can transfer part of their energy in collisions, losing some of their speed and generally changing direction as a result. Photons, on the other hand, transfer energy only by being absorbed. A photon therefore must lose all its energy or none. (A possible exception is found in the inelastic scattering of light, e.g. in vibrational Raman scattering. Here the

incident and scattered photons have slightly differing energies, whereas vibrational energy is transferred either from the light beam to the scattering molecule or *vice versa*. Whether it is proper to regard the scattered and incident photons as the same or different, however, is a debate outside the scope of this chapter.)

If we can regard a single photon as comparable to a reagent molecule, we can similarly regard Avogadro's number of photons as being equivalent to a mole of photons. This quantity of light is known as the *einstein*.

5.2 Absorption of light by molecules

Excited states

When a molecule absorbs a photon it is promoted to a higher energy state—an *excited state*—that may have excess electronic, vibrational or rotational energy, depending on the energy of the photon. The absorption process can occur only when the photon energy precisely matches the difference in energy ΔE between this higher level state and the original state of the molecule:

$$\Delta E = E_p = h\nu$$

For electronic excitation, the most common case occurs when a molecule in its electronic *ground state* is promoted to an electronic excited state. This is illustrated diagrammatically by the upward arrow **A** in Fig. 18.14. For most molecules, transition from the electronic ground state to the lowest energy excited state requires energy corresponding to light in the UV-visible region of the spectrum. Therefore, the UV-visible absorption spectrum of a molecule yields information about the energies of its electronic excited states. The energy gaps between these excited states and the ground state are typically so large that, at equilibrium at normal temperatures, only a negligible proportion of molecules will exist in an electronic excited state.

Energy diagrams in which the various electronic and vibrational energy levels are indicated by short horizontal lines are known as *Jabłoński diagrams*. Figure 18.14 is a Jabłoński diagram for a molecule with no unpaired electrons in the electronic ground state, i.e. a non-paramagnetic *singlet state* (denoted S_0). The majority of organic and many inorganic molecules are of this type. In the familiar molecular

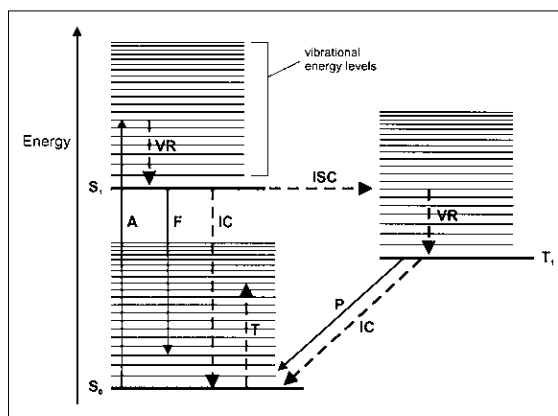


Fig. 18.14 A typical Jabłoński diagram, showing photophysical processes involving a singlet electronic ground state (S_0) and both singlet (S_1) and triplet (T_1) electronic excited states. Processes not accompanied by the absorption or emission of a photon are indicated by means of dashed arrows. Key: **A**, absorption of a photon; **F**, fluorescence (emission); **IC**, internal conversion; **ISC**, intersystem crossing; **P**, phosphorescence (emission); **T**, thermal activation (heating); **VR**, vibrational relaxation.

orbital theory, when a photon is absorbed by a singlet ground-state molecule an electron is promoted from a filled orbital into a higher energy vacant orbital, thus generating an electronic excited state with two unpaired electrons (Fig. 18.15). If these unpaired electrons retain their antiparallel spins, the excited state produced is also a singlet (denoted S_1 for the lowest excited singlet state, and S_2, S_3 , etc. for higher singlet states) (cf. Fig. 18.15(b)). If the unpaired electron spins become parallel, however, a paramagnetic *triplet excited state* results (denoted T_1 for the lowest excited triplet, and T_2, T_3 , etc. for higher triplets) (cf. Fig. 18.15(c)). There is no triplet state corresponding to the singlet ground state. The two complete sets of singlet and triplet electronic states are referred to as the singlet and triplet *manifolds*, respectively. Each triplet has a lower energy than the corresponding singlet, as indicated for T_1 and S_1 in Fig. 18.14. (This is a consequence of Hund's rule of maximum multiplicity.) Molecules with unpaired electrons in their ground states, e.g. free-radical species, O_2 and many transition metal complexes, will have additional types of electronic states at relatively low energies (doublets, quadruplets, quintuplets, etc.) and frequently will have

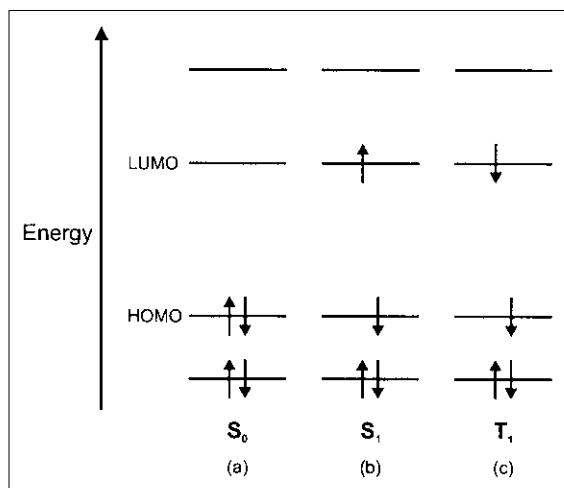


Fig. 18.15 Energy diagram showing the two highest energy occupied and two lowest energy unoccupied orbitals of a molecule with a singlet ground state: (a) ground state with all electrons paired; (b) first excited singlet state attained by promotion of an electron from the highest occupied molecular orbital (HOMO) to the lowest unoccupied molecular orbital (LUMO); (c) first excited triplet state attained by promotion of an electron as in (b) but with intersystem crossing, resulting in electrons with parallel spins in the HOMO and LUMO.

non-singlet ground states. Nonetheless, similar principles apply in constructing appropriate Jabłoński diagrams.

Each electronic state of a molecule has its own *vibrational energy levels*, which are shown schematically in Fig. 18.14. The lowest vibrational level in each electronic state corresponds to the situation in which each of the fundamental vibrations of the molecule has its minimum amplitude and energy. The energy separation between vibrational levels is much smaller than that between electronic states, typically corresponding to light in the infrared region of the spectrum. Even at room temperature, a significant proportion of molecules will exist in the lower excited vibrational levels of the electronic ground state. Heating a sample will further increase this proportion and push significant numbers of molecules into higher vibrational levels, as indicated by the upward arrow **T** in Fig. 18.14. Generally speaking, heat and infrared radiation will excite molecules to higher vibrational levels of the electronic ground state, whereas UV-visible light will promote molecules to electronic excited states. The combined

electronic and vibrational state of a molecule is known as its *vibronic state*. Each vibronic state has many *rotational energy levels* with even closer spacing than the vibrational levels. These will not be considered further in this chapter, but they are of considerable importance in studies of gas-phase photoprocesses.

Selection rules

The probability of photon absorption is governed in theory by *selection rules*, which depend on the symmetries of the molecular orbitals involved when an electron is promoted from one orbital to another, and also on the electron spins. Transitions that are *forbidden* by the selection rules are expected to have a low probability, whereas *allowed transitions* should occur with high probability. As a result, we expect weak absorptions (small extinction coefficients) in the UV-visible spectrum of a molecule for forbidden transitions and strong absorptions (large extinction coefficients) for allowed transitions. Detailed discussion of selection rules is beyond the scope of this chapter, but in practice the most important restraint is that inversion of the spin of an electron is formally forbidden. Thus, photon absorption by a singlet ground state initially generates a singlet excited state; $S_0 \rightarrow S_1$ is the lowest energy of these *spin-allowed* transitions. Although the T_1 state has lower energy than the S_1 state, $S_0 \rightarrow T_1$ is a *spin-forbidden* transition, examples of which are observed only rarely.

One further constraint on the absorption process is worth mentioning. Because the distribution of electrons in an electronically excited state is different from that of the ground state, the equilibrium molecular geometries of the two states also will differ. Photon absorption occurs much more quickly than readjustment of the molecular framework. Thus, in general, the $S_0 \rightarrow S_1$ transition produces the excited state initially with the same geometry as the ground state, significantly distorted from equilibrium, i.e. in a vibrationally excited state. This is called *vertical excitation* or the *Franck-Condon principle*, and is shown schematically for excitation **A** in Fig. 18.14. Vertical excitation is illustrated more clearly in Figs 18.5 and 18.6, where the ground and excited states are depicted in more detail as energy surfaces with minima and maxima, rather than as the short horizontal lines of a Jabłoński diagram. In reality, mo-

lecules in their electronic ground state will exist in a range of geometries with varying probabilities, and thus a range of wavelengths can be absorbed, matching transitions from the lowest vibrational level of S_0 to particular vibrational levels of S_1 . The result is an absorption spectrum with many bands, or more usually a broad absorption comprising numerous unresolved bands.

5.3 Excited-state processes

After a ground-state molecule has absorbed a photon, the resulting excited state can undergo a variety of processes. In some cases the molecule will return to its electronic ground state via *photophysical* processes, in which no chemical change occurs. On the other hand, a photochemical reaction occurs when there is some chemical change, such as bond cleavage or transfer of an electron.

Photophysical processes

Figure 18.14 illustrates the most common types of photophysical processes. After initial excitation by photon absorption (**A**), the excited state generally is produced with excess vibrational energy. In the liquid or solid phase, where collisions between molecules are very frequent, loss of this vibrational energy usually is very rapid and is termed *vibrational relaxation* (**VR**). The electronically excited molecule, now at its lowest vibrational level, then can return to its electronic ground state either by emitting a photon or by non-radiative energy loss.

Emission of a photon where there is no change of electron spin, e.g. $S_1 \rightarrow S_0$, is termed *fluorescence* (**FL**). It is normally a very rapid process, taking place within nanoseconds. As discussed above for the absorption process, the equilibrium geometries of the ground- and excited-state molecules usually will be different, and the ground state therefore will be produced (via a vertical transition) in a geometry distorted from equilibrium, i.e. in a vibrationally excited state. The sequence of vibrational relaxation in the excited state followed by production of the ground state with excess vibrational energy means that there is a smaller energy gap for fluorescence than for the initial absorption (see Fig. 18.14). For a given molecule, therefore, fluorescence occurs at longer wavelengths than absorption.

As an alternative to emission, an electronically excited molecule may return to the electronic

ground state by collisional transfer of energy to surrounding molecules. This is an example of a non-radiative transition and is termed *internal conversion* (**IC**).

Another type of non-radiative photophysical process is *intersystem crossing* (**ISC**), in which there is an inversion of an electron spin. In Fig. 18.14, the case for $S_1 \rightarrow T_1$ is shown. Although intersystem crossing is formally forbidden by the selection rules, it is the predominant process for some classes of molecules, e.g. aromatic ketones such as benzophenone. As with the singlet excited states, triplet-excited-state molecules can return to their electronic ground states either by emission of a photon or by non-radiative internal conversion. When photon emission is accompanied by the inversion of an electron spin, as with $T_1 \rightarrow S_0$, it is termed phosphorescence (**P**). Phosphorescence, because it is a spin-forbidden process, usually occurs much more slowly than fluorescence, often taking place with a half-life of many seconds.

Photochemical processes

All the energy-loss processes shown in Fig. 18.14 are photophysical processes, which in various combinations return the excited molecule back to its electronic ground state. In competition with these processes is the possibility of photoinduced chemical reaction, which may be either unimolecular, involving only the initially excited molecule, or bimolecular, in which case the excited species interacts with a second molecule.

Typical unimolecular photoreactions include the reactions shown in Figs 18.2 and 18.4. In a bimolecular photoreaction, the initially generated excited-state molecule can interact with a second species in a number of different ways, of which the most common are energy transfer, electron transfer or chemical reaction involving bond-breaking, e.g. atom transfer.

Energy transfer from an excited-state molecule to another molecule in its electronic ground state is the basis for *photosensitised reactions*. In these processes, a light-absorbing molecule known as the *photosensitiser* undergoes the initial excitation and then transfers its electronic excitation to a second, non-absorbing species. In so doing, the photosensitised molecule returns to its electronic ground state, whereas the energy-accepting species is excited and may undergo

a sequence of photophysical processes or photochemical reactions, just as if it had been excited directly by photon absorption. One of the main values of photosensitisation is that it can give access to the excited states of molecules that absorb only weakly or in inconvenient regions of the spectrum. The generation of singlet oxygen from triplet ground-state O₂ (see Fig. 18.3) provides a good example. Singlet oxygen is an interesting reagent with unique properties, but it cannot be generated in useful quantities by irradiating the ground-state molecule in its extremely weak (spin-forbidden) absorption band. Fortunately, it can be generated readily by means of photosensitising dyes, such as Rose Bengal, Methylene Blue or Eosin Y.

Quantum yields

From the preceding discussion, it is clear that an excited-state molecule, once it is generated by photon absorption or sensitisation, can undergo any one of a number of photophysical or photochemical processes. In general, there will be competition between these pathways. The number of moles of reactant undergoing a particular process *i* per einstein of light absorbed is termed the *quantum yield* of that process ϕ_i . In chain processes, such as frequently occur in radical reactions, where many product molecules can result from a single photon absorption, quantum yields can exceed unity. In all other cases, the sum of the quantum yields of all competing pathways will be equal to unity:

$$\sum_i \phi_i = 1$$

From the standpoint of photochemical synthesis, the photophysical processes illustrated in Fig. 18.14 are unproductive and thus are referred to as *energy-wasting* processes. Fluorescence, for example, may be very useful in analytical applications but it is unwanted if it competes efficiently with an intended photochemical reaction. The quantum yield of formation of the desired product therefore is an important quantity in assessing the potential utility of any photoreaction. Unfortunately, the measurement of quantum yields usually is inconvenient, especially if quantum yields for a particular design of reactor are needed. For this reason, the measurement of quantum yields often is not carried out in photochemical studies.

In determining the economic viability of a prospective photochemical process, however, the overall energy efficiency of the system is of more practical significance than the quantum yield of product formation. We can define the overall energy efficiency as the amount of desired product derived from a given input of electrical energy. This takes into account inefficiencies in converting electrical energy into light, and light wasted by scattering or absorption by materials other than the reactant, as well as the energy wastage due to photophysical processes or the generation of by-products following excitation of the reactant. Estimation of the overall energy efficiency of a process normally is straightforward and provides information that is directly relevant to the reactor actually employed for the process.

Acknowledgements

The author wishes to thank the EPSRC and the Royal Academy of Engineering for the award of a Clean Technology Fellowship, which provided him with the opportunity to begin research into the exploitation of photochemistry for cleaner manufacturing processes, as well as other aspects of clean technology. As a consequence of this original award, the author has been able to develop industrial collaborations with A. H. Marks and Co. Ltd and Air Products, Inc., linked to academic collaborations with chemical engineers and chemists, especially with C. M. Gordon, D. C. Sherrington, S. J. Shilton, R. L. Skelton and R. Withnall. The author thanks all these collaborators and the members of his research group for continuing stimulation.

References

1. (a) Anastas, P. T., & Williamson, T. C. *Green Chemistry: Frontiers in Benign Chemical Syntheses and Processes*. Oxford University Press, Oxford, 1998; (b) Clark, J. H. *Chemistry and Waste Minimization*. Blackie, London, 1995; (c) Kirkwood, R. C., & Longley, A. J. *Clean Technology and the Environment*. Blackie, London, 1995.
2. Boule, P. *Environmental Photochemistry*. Springer, Berlin, 1999.
3. Schiavello, M. *Heterogeneous Photocatalysis*. John Wiley, Chichester, 1997.
4. Weissermel, K., & Arpe, H.-J. *Industrial Organic Chemistry* (Lindley, C. R., trans.), 3rd edn. VCH, Weinheim, 1997.

5. Braun, A. M., Maurette, M.-T., & Oliveros, E. *Photochemical Technology* (Ollis, D. F., & Serpone, N. trans.). John Wiley, Chichester, 1991.
6. Eaton, P. E., & Cole, Jr., T. W. *J. Am. Chem. Soc.*, 1964, **86**, 3157.
7. Schenck, G. O., & Ziegler, K. *Naturwissenschaften*, 1944, **32**, 157.
8. Adam, W., & Griesbeck, A. G. In *CRC Handbook of Organic Photochemistry and Photobiology* (Horspool, W. M., & Song, P.-S. eds). CRC Press, Boca Raton, FL, 1995, pp. 311–324.
9. Zimmerman, H. E., & Mariano, P. S. *J. Am. Chem. Soc.*, 1969, **91**, 1718.
10. Dunkin, I. R., Sanín-Leira, D., Balmforth, B., & McRobbie, I. Unpublished results based on earlier work of Kharasch, M. S., & Brown, H. C. *J. Am. Chem. Soc.*, 1940, **62**, 925.
11. Esser, P., Pohlman, B., & Scharf, H.-D. *Angew. Chem., Int. Ed. Engl.*, 1994, **33**, 2009; *Angew. Chem.*, 1994, **106**, 2085.
12. Shama, G., Peppiatt, C., & Biguzzi, M. *J. Chem. Technol. Biotechnol.*, 1996, **65**, 56.
13. Shama, G. *Lett. Appl. Microbiol.*, 1992, **15**, 69.
14. Shama, G. *Lett. Appl. Microbiol.*, 1992, **15**, 259.
15. Blossey, E. C., & Neckers, D. C. *Solid-phase Synthesis*. Dowden, Hutchinson and Ross, Stroudsburg, Pennsylvania, 1975; Hodge, P., & Sherrington, D. C. *Polymer-supported Reactions in Organic Synthesis*. John Wiley, Chichester, 1980; Sherrington, D. C., & Hodge, P. *Syntheses and Separations using Functional Polymers*. John Wiley, Chichester, 1988; *React. Funct. Polym.*, published by Elsevier, is devoted to this and related areas.
16. Blossey, E. C., Neckers, D. C., Thayer, A. L., & Schaap, A. P. *J. Am. Chem. Soc.*, 1973, **95**, 5820.
17. Juillard, M. In *Homogeneous Photocatalysis* (Chanon, M. ed.). John Wiley, Chichester, 1997, pp. 221–261.
18. Augugliaro, V., Loddo, V., & Schiavello, M. In *Heterogeneous Photocatalysis* (Schiavello, M. ed.). John Wiley, Chichester, 1997, pp. 169–189.
19. Mackley, M. R., Smith, K. B., & Wise, N. P. *Chem. Eng. Res. Des.*, 1993, **71A**, 649.
20. Fabiyi, M. E., & Skelton, R. L. *J. Photochem. Photobiol. A: Chem.*, 1999, **129**, 17.
21. Fabiyi, M. E., & Skelton, R. L. *J. Photochem. Photobiol. A: Chem.*, 2000, **135**, 121.
22. Eliasson, B., & Kogelschatz, U. *Appl. Phys. B*, 1988, **46**, 299.
23. Kogelschatz, U. *Pure Appl. Chem.*, 1990, **62**, 1667.
24. Jakob, L., Hashem, T. M., Bürki, S., Guindy, N. M., & Braun, A. M. *J. Photochem. Photobiol. A: Chem.*, 1993, **75**, 97.
25. Gonzalez, M. C., Braun, A. M., Bianco Prevot, A., & Pelizzetti, E. *Chemosphere*, 1994, **28**, 2121.
26. Gonzalez, M. C., Hashem, T. M., Jakob, L., & Braun, A. M. *Fresenius' J. Anal. Chem.*, 1995, **351**, 9.
27. Gonzalez, M. C., & Braun, A. M. *Res. Chem. Intermed.*, 1995, **21**, 837.
28. Gonzalez, M. C., & Braun, A. M. *J. Photochem. Photobiol. A: Chem.*, 1996, **95**, 67.
29. Gonzalez, M. C., & Braun, A. M. *J. Photochem. Photobiol. A: Chem.*, 1996, **93**, 7.
30. Benoit-Marquie, F., Wilkenhoner, U., Braun, A. M., Oliveros, E., & Maurette, M. T. *J. Phys. IV*, 1999, **9**, 113.
31. Griesbeck, A. G., Kramer, W., & Oelgemöller, M. *Green Chem.*, 1999, **1**, 205.
32. (a) Gilbert, A., & Baggott, J. *Essentials of Molecular Photochemistry*. Blackwell, Oxford, 1991; (b) Horspool, W., & Armeto, D. *Organic Photochemistry: a Comprehensive Treatment*. Ellis Horwood/PTR Prentice Hall, London, 1992; (c) Kagan, J. *Organic Photochemistry: Principles and Applications*. Academic Press, London, 1993; (d) Roundhill, D. M. *Photochemistry and Photophysics of Metal Complexes*. Plenum Press, New York, 1994; (e) Suppan, P. *Chemistry and Light*. The Royal Society of Chemistry, Cambridge, 1994; (f) Wayne, C. E., & Wayne, R. P. *Photochemistry*. Oxford University Press, Oxford, 1996.

Chapter 19: Electrochemistry and Sustainability

K. SCOTT

1 Introduction

Electrochemistry plays an important role in the commercial world and is established in a range of technologies in industry. Electrochemistry is concerned with the transfer of charge, by the movement of ions, in liquid or solid (or gaseous) phases through which electrochemical transformation of species is achieved. Thus electrochemistry can be used to synthesise materials and chemicals, to generate power and to analyse and detect compounds and components. In general the applications of electrochemistry are diverse and can be summarised as follows:

- Synthesis of chemicals and materials
- Extraction and production of metals
- Metal and materials finishing and processing
- Recycling, water purification and effluent treatment
- Energy storage and generation
- Corrosion protection
- Analysis, sensors and monitors
- Semiconductor technology

The field of electrosynthesis is well established for the production of a range of bulk/commodity chemicals, fine chemicals, speciality products and materials. Many of the processes have a high profile, e.g. in excess of 4000 t h⁻¹ of chlorine is produced by the chloralkali industry worldwide, in conjunction with sodium hydroxide and hydrogen. This high-tonnage bulk chemical manufacture has changed radically over recent decades and has resulted in many advances and improvements in cell design, electrodes and materials. These developments have had an overall positive effect on electrochemical process technology in general.

Many other inorganic and organic synthesis processes are in operation and currently there is somewhat of a revival in this technology due, for example, to: demand for on-site production of relatively small quantities of inorganic chemicals as reagents, etc.; attraction of electrochemistry in the

synthesis of speciality chemicals and materials; and the current emphasis on reducing effluent emissions and on recycling materials.

An expanding area for electrochemical technology is in the treatment of effluents and process streams for recovery, recycling and reuse of a range of species [1,2]. The importance of electrochemistry is well appreciated for removal and recovery of dissolved metals, the destruction of dissolved organic and inorganic chemicals, the treatment of flue gases and the regeneration of chemicals. Electrochemical methods are widely used commercially; notably, metal electrodeposition has several thousand applications worldwide.

The attraction of electrochemistry lies in the ability to supply the reducing or oxidising agent in a non-obtrusive form, i.e. by electron transfer at an appropriate electrode. Thus, in many applications electrochemistry can be used as a truly green technology.

2 Green Electrochemistry

Electrochemistry can be seen as a branch of green chemistry that is 'concerned with the utilisation of a set of principles that can reduce or eliminate the use of hazardous substances in the design, manufacture and application of chemical products'. Thus, electrochemistry covers processes that relate to a reduction in the environmental impact of chemicals (and fuels), whether from improved production methods, formulation of delivery systems, the use of sustainable resources or product substitution. Green electrochemistry solutions include bioelectrochemistry and improved process engineering.

Electrochemistry has an important role to play in the development of cleaner/greener and more efficient processes in all industries that manufacture or use chemicals. Electrolysis can provide a selective and environmentally friendly procedure for synthesis. Electrochemistry offers approaches to the recycling of chemicals and remediation of effluents. This

is because electrochemistry presents a powerful method for promoting reactions—within a potential scan of approximately 6.0V it offers a vast range of opportunities—and powerful oxidants (such as ozone) and reductants (e.g. solvated electrons, alkali metals), as indicated in Table 19.1 of standard electrode potentials E° .

The benefits in the use of electrochemistry for greener and more sustainable processes include:

- Mild chemical conditions
- Ease of control
- High process selectivity
- Novel chemistry available
- Mild process conditions
- Safer operation
- The electron is an inexpensive reagent

The cost of the electron (£0.08kWh⁻¹, 3.5V; 8–10 kJmol⁻¹) compares extremely favourably with the cheapest oxidants and reductants. Approximate costs (kJmol⁻¹) of other commonly used reagents are: hydrogen peroxide, 50; sodium metal, 100; magne-

sium, 106; zinc metal, 114; sodium borohydride, 230; hydrazine, 190; sodium dichromate, 505; and potassium permanganate, 570. Electrons are the cheapest, purest and most versatile redox agents able to perform clean and fast reactions. Overall, electrochemistry can make a significant contribution to sustainability by satisfying a range of targets for green chemistry:

- **Clean synthesis** by direct oxidation and reduction
- **Enhanced atom utilisation**
- **Replacement of stoichiometric reagents:** regeneration of a wide range of redox oxidants and reductants
- **New solvents and reaction media:** solid polymers, ionic liquids, supercritical fluids, etc.
- **Water-based processes and products:** predominate in electrochemistry
- **Replacements for hazardous reagents:** solution-phase oxidants and reductants can be generated in situ
- **Intensive processing:** electrochemical processes can be intensified using ultrasonics, centrifugal fields, etc.
- **Novel separation technologies:** electrochemical enhancement of ion exchange, adsorption, gas-phase separation and water filtration
- **Alternative Feedstocks:** electrochemistry in many cases allows alternative feedstocks
- **New, safer chemicals and materials:** in situ, on-demand reagent can be generated
- **Waste minimisation/reduction:** achieved by reagent regeneration and material recycling.

Table 19.1 Standard electrochemical potentials

Electrode reaction	E° (V) @ 25°C
$\text{S}_2\text{O}_8^{2-} + 2\text{e}^- \rightarrow 2\text{SO}_4^{2-}$	+2.01
$\text{H}_2\text{O}_2 + 2\text{H}^+ + 2\text{e}^- \rightarrow 2\text{H}_2\text{O}$	+1.78
$\text{Au}^+ + \text{e}^- \rightarrow \text{Au}$	+1.69
$2\text{Cl} + 2\text{e}^- \rightarrow 2\text{Cl}^-$	+1.36
$\frac{1}{2}\text{O}_2 + 2\text{H}^+ + 2\text{e}^- \rightarrow \text{H}_2\text{O}$	+1.23
$\text{Pd}^{2+} + 2\text{e}^- \rightarrow \text{Pd}$	+0.99
$\text{Ag}^+ + \text{e}^- \rightarrow \text{Ag}$	+0.80
$\text{Fe}^{3+} + \text{e}^- \rightarrow \text{Fe}^{2+}$	+0.77
$\text{Cu}^+ + \text{e}^- \rightarrow \text{Cu}$	+0.52
$\text{Cu}^{2+} + 2\text{e}^- \rightarrow \text{Cu}$	+0.34
$2\text{H}^+ + 2\text{e}^- \rightarrow \text{H}_2$	+0.00
$\text{Pb}^{2+} + 2\text{e}^- \rightarrow \text{Pb}$	-0.13
$\text{Sn}^{2+} + 2\text{e}^- \rightarrow \text{Sn}$	-0.14
$\text{Mo}^{2+} + 2\text{e}^- \rightarrow \text{Mo}$	-0.20
$\text{Ni}^{2+} + 2\text{e}^- \rightarrow \text{Ni}$	-0.25
$\text{Co}^{2+} + 2\text{e}^- \rightarrow \text{Co}$	-0.28
$\text{Cd}^{2+} + 2\text{e}^- \rightarrow \text{Cd}$	-0.40
$\text{Fe}^{2+} + 2\text{e}^- \rightarrow \text{Fe}$	-0.44
$\text{Zn}^{2+} + 2\text{e}^- \rightarrow \text{Zn}$	-0.76
$\text{Mn}^{2+} + 2\text{e}^- \rightarrow \text{Mn}$	-1.19
$\text{Al}^{3+} + 3\text{e}^- \rightarrow \text{Al}$	-1.66
$\text{Mg}^{2+} + 2\text{e}^- \rightarrow \text{Mg}$	-2.36
$\text{Na}^+ + \text{e}^- \rightarrow \text{Na}$	-2.71

3 Electrochemistry Fundamentals

An understanding of the chemistry and the electrochemistry occurring in the cell is essential for the successful adoption of any electrochemical process. This understanding is embodied in the knowledge of the reaction mechanisms, thermodynamics and kinetics of the electrode processes. Electrode reactions are heterogeneous multistep processes and can involve several species and phases: liquid, solid and gases. The tendency for a particular species to release or accept electrons is determined by the magnitude of an electrode potential. The standard electrode potential, $E_{\text{O/R}}$, of a redox system involving dissolved oxidised (O) and reduced (R) species is a measure of

the relative oxidation and reduction capabilities of the particular species. Redox systems with positive potentials will oxidise hydrogen to protons and thus increasing positive potentials correspond to increasing oxidation conditions. The converse is true for increasing negative potentials: reductants (electron donors) will reduce protons to hydrogen. For example, increasing positive potentials equate to oxidation of metals to solution species or to passivation, e.g. oxide films, whereas increasing negative potentials equate to stable metal species. Thus, generally for two redox couples (denoted as 1 and 2) with values of standard potentials $E1$ and $E2$ the reduced form of couple 1 can be oxidised by the oxidised form of couple 2 when $E2 > E1$. Thus the thermodynamic driving force is positive and the reaction is spontaneous with species O_2 as the oxidant. In aqueous solution the pH can be a significant factor and reaction equilibria commonly are expressed in terms of potential–pH (Pourbaix) diagrams [3] that incorporate both chemical and electrochemical (redox) reactions. A typical Pourbaix diagram is shown in Fig. 19.1 for copper. The broken lines are used to signify the equilibrium between solution species and the solid lines define equilibria between solid phases or between solid and solution phases. Figure 19.1 shows only the predominant phases under specified conditions of temperature, pressure and solution species activity and also the region of stability of water. Equations 19.1–19.4 are the basis of two important technological applications of electrochemistry, i.e. the production of hydrogen by electrolysis and the generation of electrical energy from fuel cells:



$$E_{O_2/H_2O} = 1.2291 - 0.0591 \text{pH} + 0.0148 \log(p_{O_2}) \quad (19.2)$$



$$E_{H_2/H^+} = 0.0591 \text{pH} - 0.0296 \log(p_{H_2}) \quad (19.4)$$

In the case of the copper system, with $E^0 = 0.34 \text{V}$, corrosion of the copper can occur only by the reduction of dissolved oxygen and not by proton reduction.

Although Pourbaix diagrams give useful information on the behaviour of many electrochemical systems from purely thermodynamic considerations, in practice electrolytic systems are driven by an overpotential.

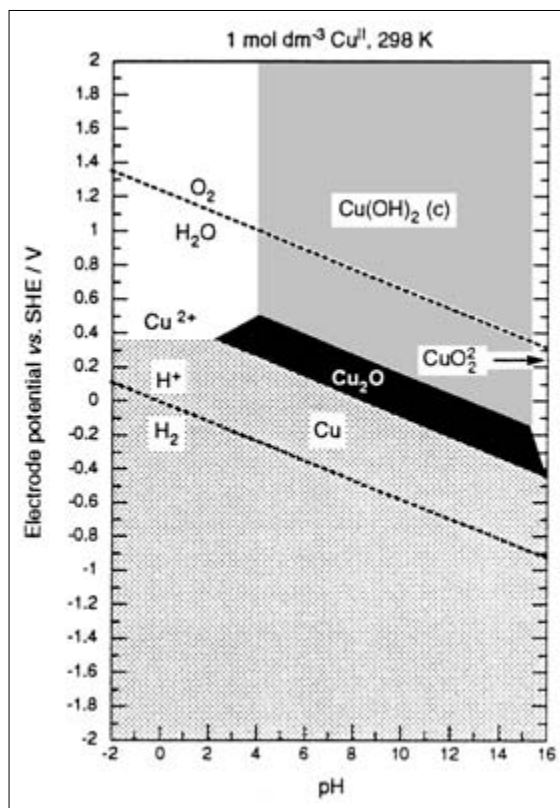


Fig. 19.1 Potential pH diagram for copper.

3.1 Electrode potential, kinetics and mass transport

Electrochemical processes are driven by the application of a potential field, the magnitude of which generally will determine the rate of the relevant process: charge transfer and ionic flux. Electrochemical reactions are surface processes that are instigated by a suitable charge transfer at a fluid/solid interface. When two electrodes are placed in an ionic conducting solution and are connected externally they become charged. Thus, locally, at the solution/electrode interface there is a large potential difference over a molecular scale of a few nanometres. A simple model of this situation [4] consists of a double layer comprising a plane of closest approach (ihp) and a diffuse layer or outer layer. The equilibrium established at the interface is electrostatic and somewhat analogous to that in a capacitor. The electrostatic interactions determine the distribution of the poten-

tial and the potential difference, which constitutes the driving force for electrochemical (Faradaic) reaction when a current flows through the circuit. An increase in magnitude of the potential applied between the two electrodes increases this potential difference at the interface. The mathematical description of the relationship between the electrode–solution potential difference (measured as the electrode potential) and the current density (current per unit area of electrode) is the basis of electrode kinetics. The types of electrochemical reaction that occur at the electrode/solution interface can be a simple electrochemical reaction, heterogeneous electrocatalysis, heterogeneous redox electrocatalysis or homogeneous redox catalysis.

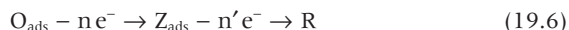
A simple electrochemical process is when a reactant undergoes a transformation to a product by the transfer of an electron from the electrode to the species in solution, without contacting or interacting with the surface in any significant way. Thus the model of the process is that of an electron hopping from the electrode to the reactant species while it is within the molecular dimensions of the surface. The role of the electrode is essentially that of a source or sink for electrons, and it does not influence the type of final product species. The nature of the product species thus is determined by the chemistry between the species, which have undergone charge transfer, and the electrolyte solution. In practice, the role of the electrode is through its influence on the structure of the interfacial double layer. This structure will depend on the way in which solvent, ionic and neutral species in solution interact with the surface and thus on the local distribution of potential in the double layer. In addition, a charged reactant species will be at a different concentration at the double layer than in bulk solution because of the potential field. This is referred to as the double layer effect. Overall, therefore, these factors result in the variation of the standard rate constants for simple reactions at different electrode materials.

In heterogeneous catalysis the strong adsorption of starting material(s) at the surface reduces the activation barrier for the reaction to proceed via an intermediate species (Equation 19.5):



Partial charge transfer may occur as part of the process, but it is recycled completely on the formation of the product R. In electrocatalysis a similar principle holds, but there is a net flow of electronic

charge. The charge transfer is an inner Helmholtz plane process between the adsorbed species and the surface (Equation 19.6):



The chemical steps in the process, rather than the electrochemical steps, are catalysed by interaction with the surface. This interaction therefore distinguishes between electrochemical reaction, which is affected by adsorbed species, and electrocatalytic reaction, where adsorbed electroactive intermediates are directly involved. The rate constants of electrocatalytic reactions will exhibit a wide variation with the type of electrode (electrocatalyst) used. The performance of electrochemical processes can be affected significantly if the electrode surface is modified by a layer, at least a monolayer, of a redox system. This redox system can serve as a mediator for the reactants S, as well as a new surface for adsorbed interactions with reagents and other molecules (Equations 19.7 and 19.8):



The mediator, R, exhibits typical catalytic behaviour and is regenerated continuously as the reaction occurs. This type of catalysis is termed redox catalysis and is an inner Helmholtz plane process between the adsorbed reactant and the immobilised redox mediator. The behaviour of heterogeneous redox catalysis is analogous to the case of homogeneous redox catalysis. In the latter, reaction between the redox mediator and the reagent is not at the surface but somewhere in the bulk solution.

From a mechanistic view heterogeneous redox catalysis is an electrochemical process, deriving chemical transformation directly at the surface by the charge-transfer process. It has inherent advantages over homogeneous redox catalysis in that the reaction mixture is not contaminated by the redox reagent and thus product separation potentially is less troublesome. In practice, this requires the redox agent to have the required stability in the electrolytes.

A simple model of electrode kinetics [4,5]

For the simple reversible electron transfer between two ions in solution and an electrode (Equation 19.9):



the rate constants of reaction for the cathodic and anodic processes are usually written as shown in Equations 19.10 and 19.11:

$$k_- = k^0 \exp[-\alpha n F / R T (E - E^0)] \quad (19.10)$$

$$k_+ = k^0 \exp[(1 - \alpha) n F / R T (E - E^0)] \quad (19.11)$$

where k^0 is the standard rate constant and α is the transfer coefficient for the reaction.

These expressions are obtained on the basis of the absolute rate theory with the assumption that the free energy of activation of the electrode reaction varies linearly with the electrode potential. The overall rate of reaction, or current density, is made up of the sum of the anodic and cathodic contributions, expressed according to Equation 19.12:

$$j = n F (k_+ C_R - k_- C_O) \quad (19.12)$$

For the equilibrium condition of zero net rate, Equation 19.12 gives the partial current density at equilibrium, called the exchange current density j^0 ($= j_- = j_+$), when the potential E is equal to the equilibrium potential E_c . Thus, from Equations 19.10 and 19.11 the exchange current density is given by Equation 19.13:

$$\begin{aligned} j_0 &= n F k_0 C_O \exp[-\alpha n F / R T (E_c - E^0)] \\ &= n F k_0 C_R \exp[(-\alpha) n F / R T (E_c - E^0)] \end{aligned} \quad (19.13)$$

Simplification of Equation 19.13 gives a Nernst equation (Equation 19.14), with activity replaced by concentration:

$$E_c = E^0 + (R T / n F) \ln(C_O / C_R) \quad (19.14)$$

Thus the kinetic model of the electrode process is consistent with the thermodynamic model for the equilibrium situation. It is often convenient in experiments to choose the equilibrium potential as a reference point and to write kinetic expressions in terms of the overpotential $\eta = E - E_c$ (Equation 19.15):

$$j = j^0 + \{ \exp[(-\alpha) n F \eta / R T] - \exp(-\alpha n F \eta / R T) \} \quad (19.15)$$

This equation is known as the Butler–Volmer expression for simple reversible electrode kinetics. Its characteristics are determined by the value of the transfer

coefficient and the exchange current density. The value of the exchange current density depends on the standard rate constant for the reaction and the concentrations C_O and C_R . The form of the relationship is represented typically (Fig. 19.2) by an initial slow increase in j with potential, followed by an exponential rise in j that levels off to a plateau (limiting current density), at which point mass transport of ionic species to the electrode controls the rate of the reaction. At even greater potentials away from equilibrium, other reactions then can occur. These can be seen typically in additional j versus E waves if there is a significant difference in the standard potentials. If not, then the kinetic curves will be a more complicated representation of several reactions occurring simultaneously. The value of j at any particular potential is then a measure of the total rates of all the reactions occurring.

The Butler–Volmer equation (Equation 19.15) has analogous forms for multistep, fast, electrochemical reactions. In these cases the equation will not exhibit symmetry, i.e. $\alpha = 0.5$, and the reaction order may not be equal to unity [5]. Generally, high values of exchange current density shift the curves to lower overpotentials at the same values of current density. This is the desired effect when electrocatalysts are used. An increase in the value of the transfer coefficient increases the magnitude of the anodic current density, at a fixed potential, while decreasing the magnitude of the cathodic current density.

The experimental determination of the kinetic parameters of the Butler–Volmer equation (Equation 19.15) can be achieved conveniently from data obtained at relatively high overpotentials. Inspection of Equation 19.15 shows that at overpotentials of

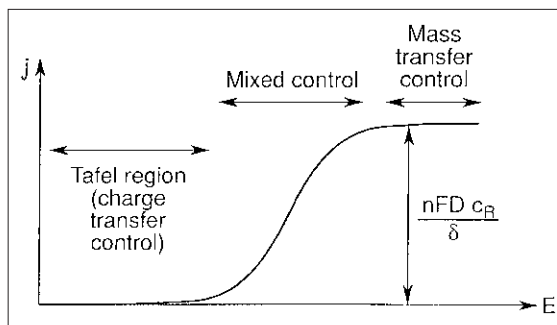


Fig. 19.2 Schematic representation of the overpotential–current density relationship.

>70/n (mV) the equation reduces to the form of Equation 19.16 for a cathodic reaction:

$$j = j^0 \exp(-\alpha f \eta) \quad (19.16)$$

where $f = nF/RT$. Thus a graphical plot of overpotential against the log of the current density will give a slope of $d[\log(j)]/d\eta = -\alpha f/2.3 = 1/b$, where b is referred to as the Tafel slope. The value of the Tafel slope often can be used as a diagnostic tool. A value of approximately 120 mV per decade gives a transfer coefficient of 0.5.

Electrode kinetics and mass transport

The consumption of a species at an electrode must be initiated by application of the current and thus will instigate the development of concentration profiles of species in the electrolyte solution near the electrode. A condition of steady convection introduced into the system by, say, mechanical stirring or the flow of electrolyte adjacent to the electrode surface and, in the absence of turbulence, the flux of an ionic species in the electrolyte is attributed to the sum of three effects:

- (1) Migration: transport of charged species under the influence of a potential gradient.
- (2) Diffusion: the transport of species due to a concentration gradient.
- (3) Convection: transport of species by bulk movement, i.e. mass flow of the electrolyte.

An important situation is when an excess of supporting electrolyte is present in the solution [6]. Near an electrode surface, where convection is eliminated, the flux is given by Fick's first law of diffusion (Equation 19.17):

$$N_j = -D_j dC_j/dx \quad (19.17)$$

In a region close to the electrode surface where convection and migration are effectively absent—the diffusion layer—the concentration near the electrode surface is assumed to be linear. The diffusion layer thus offers the sole resistance to mass transfer and, with a linear approximation, the current density is written in terms of a mass-transfer coefficient k_j ($k_j = D_j/\delta$), according to Equation 19.18:

$$j_j/njF = k_j(C_j - C_{j_s}) \quad (19.18)$$

The mass-transfer coefficient depends upon the flow conditions, the cell geometry, the diffusion coefficient

and the electrolyte solution. Through experimental and theoretical developments, mass-transfer coefficients can be based on expressions such as Equation 19.19 [6]:

$$Sh = \text{function}(Re, Sc) = K Re^a Sc^b \quad (19.19)$$

where $Sh = k_l l/D$ is the Sherwood number, $Re = \rho u l/\mu$ is the Reynold's number and $Sc = \mu/\rho D$ is the Schmidt number, with ρ = density, μ = viscosity, u = velocity and l = characteristic length for the system geometry, and K is a constant.

At an electrode surface, at steady state, the supply of reacting species to the surface is equal to the total rate of reaction of that species at the surface. Thus, in the case of diffusion alone the rates of mass transport and electrochemical reaction for Tafel high-field conditions are equal, giving Equation 19.20:

$$j = j^0 \exp(-\alpha n f \eta) / [1 + j^0 \exp(-\alpha n f \eta) / n F C k_l] \quad (19.20)$$

At high potentials the system comes under mass transport control, as depicted in Fig. 19.2, and the 'mass-transport-limited' current density is given by Equation 19.21:

$$j_l = n F k_l C \quad (19.21)$$

The role of adsorption

Adsorption of ionic or neutral species onto electrode surfaces can have a significant impact on the progression and direction of electrochemical processes. These species may be electroreactive reagents, intermediates or solvent molecules that form some type of bond with the surface and thereby accelerate, decelerate or alter the pathway that the reaction(s) takes to form products. The adsorption bond may be covalent or electrostatic or the molecule may have a preferred affinity for the surface. The role of adsorption in electrochemical processes generally will result in a modification of the kinetic pathway by avoiding a slow step in the process, i.e. electrocatalysis, and a change in the interfacial environment at the electrode, which may induce depletion of particular species, thereby altering reaction pathways. These factors are influenced by the degree of surface coverage, which depends on the type and concentration of adsorbate, solution composition, temperature, electrode material and electrode potential and is described by an adsorption isotherm. Rate models for

reactions influenced by adsorption generally are developed on the basis of the stationary-state approximation or on the assumption of a rate-determining step [5].

3.2 Electrochemical cells

For the effective application of electrochemistry in synthesis, energy generation, effluent remediation and recycling, the design of the appropriate cell or reactor is of prime importance. Over the years a large number of electrochemical cell designs have been used in industry, usually the result of R&D programmes focused on specific reactions with specific materials. Many of these designs have been improved significantly to give greater versatility and enhanced performance in terms of energy consumption and throughput. Several commercial general-purpose electrochemical cells now are available that can meet the requirements of many reactions for recycling and synthesis. The selection of an appropriate electrochemical cell depends upon many factors, but notably the concentration of the active species, the phase of the species and whether the electrochemical reaction occurs directly at the electrode or indirectly through an electrochemically generated mediator. As a general guide, a good cell design must attempt to satisfy a number of requirements, which include:

- High productivity to minimise cell costs
- Good mass transport to maximise reaction rate and efficiency
- Good temperature control
- Low electrical resistance to maximise energy consumption
- Ease and safety of operation
- Provision of cell separators to give flexibility in operation
- Ability to deal with gaseous products and reactants

Commercial cells in most cases have been designed to meet these criteria, although the cost is largely dictated by selection of the cell materials. Commercial electrochemical cells can be put into two categories based on either a tank electrolyser concept or a flow electrolyser concept. Tank electrolysers are, conceptually, the simplest of the two types where the electrodes, in the form of sheet, mesh or gauze, are immersed vertically in the tank and arranged as alternate anode and cathodes. Electrowinning cells

are classic examples of tank electrolysers where the increase in size of the cathodes and their eventual removal and replacement make operation in any other form difficult. The inter-electrode gap generally is as small as possible but is governed by practical limitations. The electrolyte in tank cells generally is not flowing and mass transport thus can be limited, although electrogenerated gas bubbles can cause a large amount of electrolyte agitation.

Flow electrolysers frequently are based on the parallel plate arrangement. The common design, shown schematically in Fig. 19.3, uses vertically mounted electrodes in a plate and frame configuration mounted on a mechanical press. The multicell module, in a monopolar form, consists of alternating anodes and cathodes separated electrically by a cell frame or spacers, with suitable gaskets/seals and provision for the use of membranes. Electrolyte is pumped through each cell compartment to provide good mass transport and to facilitate gas removal from the electrolyte. The inter-electrode gap can vary in the range 1–20 mm, depending upon the application, and is determined largely by the conductivity of the electrolyte and thus the IR (current \times resistance) and pressure losses and the requirement to manifold external pipework for fluid flow.

Developments in electrochemical reactor design have resulted in a number of commercially available general-purpose flow electrolysers [2] that are available in a range of sizes. The cells can be adapted to operate with a wide range of electrode materials. In addition, a number of electrochemical cell designs have been commercially successful and include undivided parallel plate reactors as used in the electrochemical synthesis of adiponitrile (Fig. 19.4) [7], rotating cylinder electrode cells and three-dimensional electrode cells.

Three-dimensional electrodes

Three-dimensional electrodes are used in cell designs where a high surface area per unit volume is required, thus providing acceptable rates of reaction per unit cross-sectioned area of cell when either the reactant concentrations or the current density is low. The term three-dimensional electrode is used to indicate that the electroactivity is distributed in three dimensions. The high surface area in the three-dimensional electrode can be achieved using particulate, porous or fibrous media. Depending upon the material, surface

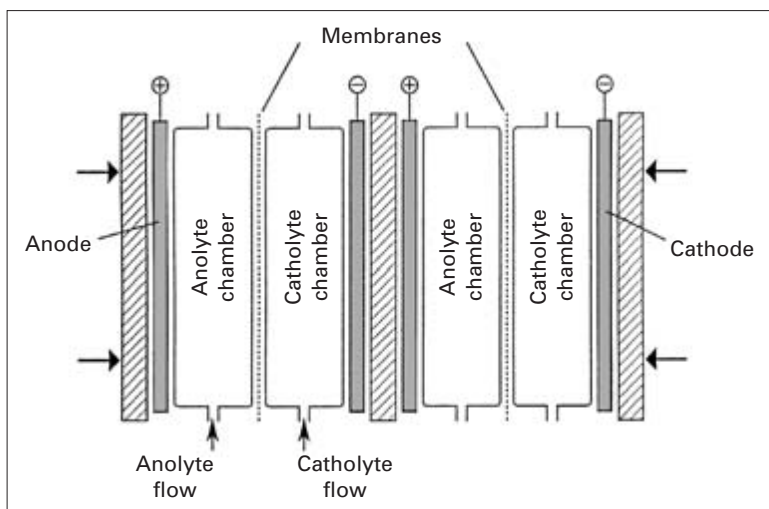


Fig. 19.3 Schematic diagram of a flow electrolyser.

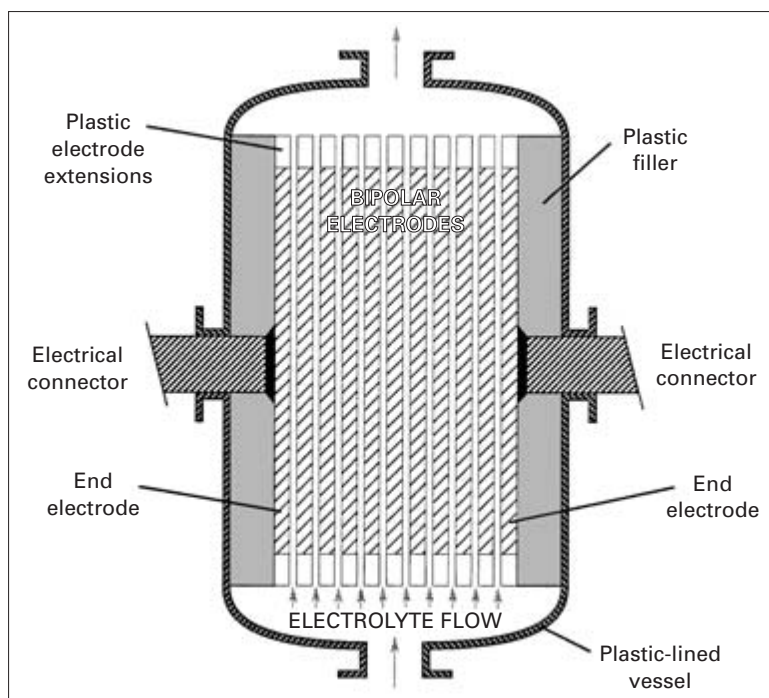


Fig. 19.4 Undivided parallel plate cell design.

areas of the order of $1000\text{--}10000\text{ m}^2\text{ m}^{-3}$ are possible, which is at least an order of magnitude greater than for parallel plate cells. With sufficient flow of electrolyte through this media, good mass-transfer rates usually can be achieved.

In the production of electrocatalytic electrodes, nanometre-size particles often are deposited onto

suitable substrates, such as carbon powder, to produce very active electrode structures. Such structures currently are used in the design of fuel cell electrodes, where the size of the electrocatalyst means that localised diffusion-limiting currents are very high and mass-transport limitations in 'solution' do not arise.

In the structure of a three-dimensional electrode, current flows in both electrolyte and electrode phases. The respective conductivities of the phases determine the associated distribution of electrode potential or reaction rate. An adverse effect of poor electrolyte conductivity is that current will tend to favour the electronic pathway provided by the electrode material rather than the ionic path through the solution. Thus, as shown in Fig. 19.5, the distribution of potential (and current) is not uniform and the 'penetration' of current into the structure is incomplete, thus the reaction may not fully use the available surface area. Thus generally the thickness of the

electrode in the direction of current flow is limited to less than a few centimetres.

Three-dimensional electrodes can be divided into two general categories, depending upon whether the electrode material is stationary or in motion. The former are either porous, where the electrode material is in the form of a continuous matrix, or packed, where the bed is constructed from 'loosely' contacting material. The 'moving beds' cover a range of designs where the particulate electrode itself is in motion, either by mechanical means or hydraulically due to electrolyte flow: fluidised, circulating or moving beds, slurries, rotating and tumbling beds,

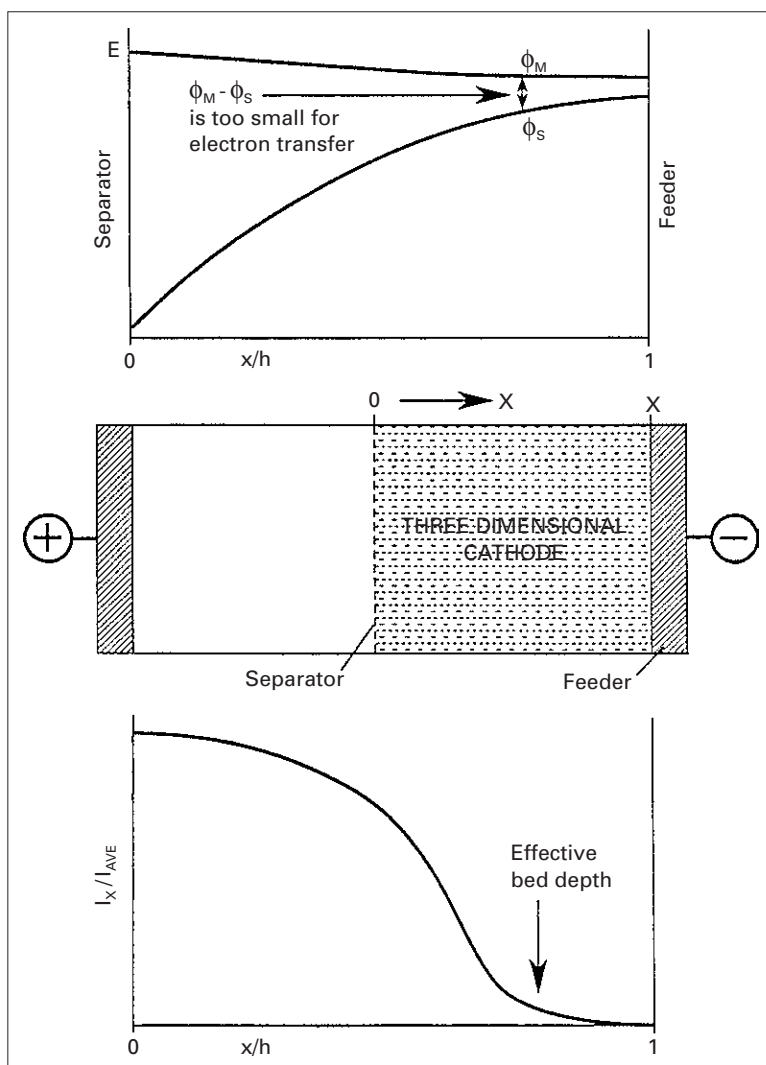


Fig. 19.5 Schematic diagram of current distribution in three-dimensional electrodes.

vibrated beds and pulsed beds [2]. The general trend today is to produce simple, low-cost cells that offer flexibility in materials and operation.

Three-dimensional electrodes can be operated either in a flow-through or flow-by configuration where the electrolyte and overall current flow are parallel or perpendicular, respectively. The latter offers the means of independently varying the length of the electrodes in the direction of fluid flow and the thickness of the electrode in the direction of current flow. Therefore, in the case of limiting current operation, the design in principle can ensure a uniform current, subject to restrictions and limitations in fluid flow and mass transport.

Reactor design for multiphase reactions

In some applications the reactor must contend with more than one fluid phase. As a multiphase reactor, the electrochemical unit must couple together an interphase mass-transfer process between, for example, a liquid and a gas. Probably the simplest of procedures for carrying out electrochemical reactions involving gaseous reactants is to feed the gas directly into the cell as a dispersed two-phase mixture or to sparge the gas directly into the cell. The presence of gas reduces the effective conductivity of the electrolyte and thus optimisation of performance is required. Several processes have considered using the packed bed as a two-phase electrochemical reactor in which the packing is the active electrode material. Examples of this include the removal of chlorine by reduction, the oxidation of SO_2 directly on a carbon bed electrode and the production of hydrogen peroxide [8]. In the latter case, peroxide is produced by oxygen reduction on carbon electrodes and the cell is operated in a trickle flow regime (see Fig. 19.6).

4 Electrochemistry and Energy Sustainability

Human demand for energy puts increasing pressure on the world carbon sources. Although the trend, historically, has been to use fuels with lower carbon content, e.g. natural gas, rather than those with higher carbon content, e.g. coal, this cannot be sustained indefinitely unless there is developed effective technology to recover and reuse carbon dioxide, the combustion product. Methods proposed for this

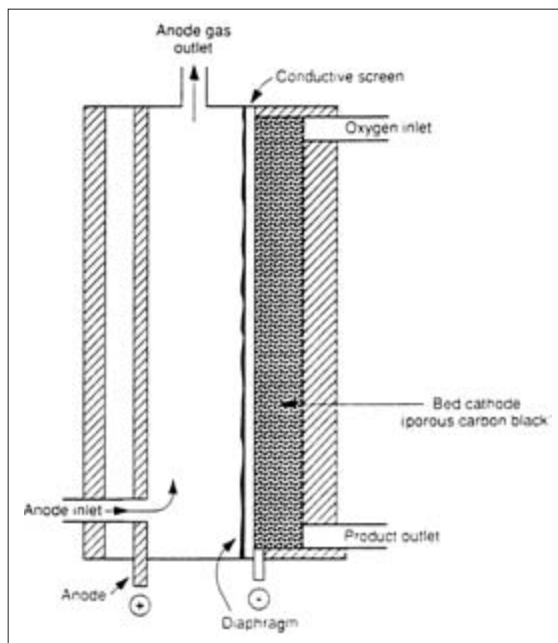


Fig. 19.6 Electrochemical cell for the production of hydrogen peroxide.

reuse include the production of methanol, either catalytically from carbon dioxide and hydrogen and formic acid, catalytically or electrochemically from carbon dioxide and water. Thus 'energy cycles' are envisaged in which hydrocarbon-based fuels (methanol, formic acid) are used to produce, for example, electric power by fuel cells and the carbon dioxide generated is reconverted back to fuel. These cycles are net energy inefficient and thus are not sustainable unless the fuel is produced by, for example, fermentation, e.g. ethanol or wood alcohol (methanol). Thus a potential fuel cycle based on methanol could be developed in which, for example, methanol is used directly in the fuel cell.

A similar concept called 'hydrogen economy' was put forward in the 1970s, where hydrogen is used as the major energy vector. In practice this could mean that water is used to generate hydrogen and oxygen, by electrolysis, which are used in fuel cells to generate power. Thus we have an energy system based on water or a 'water energy economy' (Fig. 19.7). Although the majority of electricity is generated by fossil fuel combustion, the future generation would need to be based on 'renewable' sources

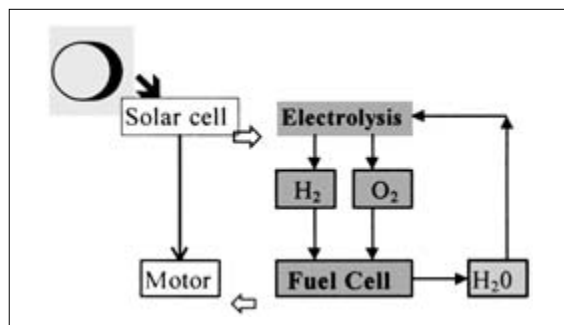


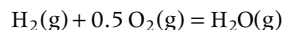
Fig. 19.7 Generation and use of hydrogen as part of a water energy economy.

(hydropower, solar, wind and wave) or on photochemical or photobiological methods.

Hence, overall, electrochemistry is set to play a major role in energy production and generation in the future. This role covers the areas of storage batteries, super-capacitors, redox batteries, solar cells and fuel cells, the latter being a key technological factor. The function of the battery for energy store in portable devices is well established in many markets for medium- and small-scale power generation. Exciting new battery couples continue to be developed, including metal hydride, e.g. nickel/lithium polymer, sodium/nickel chloride, etc. [9]. For sustainability of battery technology, methods are required to recycle and reuse, particularly the active battery components in primary cells. Recycling of lead acid batteries is well established whereas other processes for nickel cells, etc. are developing, in some cases using electrochemical technology.

4.1 Fuel cells

The principal type of fuel cell uses hydrogen as the fuel and in conjunction with oxygen produces electrical energy by virtue of the favourable thermodynamics of the overall cell reaction:



which at 80°C has a Gibbs free energy ΔG of $-226.1 \text{ kJ mol}^{-1}$. If the system is reversible, the overall electrical work done (in the absence of losses) is equal to the Gibb's free energy of formation, i.e. $\Delta G_f = -nFE$, where E is the electromotive force (EMF) or reversible, open-circuit cell potential and F is the Faraday constant or charge on 1 mol of electrons.

Table 19.2 Types of fuel cells and characteristics

Fuel cell type and mobile ion	Applications
Alkaline (AFC) OH ⁻ ion	Space vehicles
Proton exchange membrane (PEM) H ⁺ ion	Vehicle and mobile low-power CHP systems
Phosphoric acid (PAFC) H ⁺ ion	200-kW CHP systems
Molten carbonate (MAFC) CO ₃ ²⁻ ion	Medium- and large-scale CHP systems
Solid oxide (SOFC) O ²⁻ ion	All sizes of CHP systems

Thus, at 80°C the potential for a hydrogen oxygen fuel cell is given by $E = 226\,100/2 \times 96\,485 = 1.15 \text{ V}$.

Since the first demonstration of a fuel cell by William Grove in 1839, five principal types of fuel cells have been developed, according to the electrolyte in the cell (see Table 19.2). The characteristics of a fuel cell are:

- Electrochemical device to convert directly a fuel (hydrogen) plus oxygen to electricity (heat +H₂O)
- Potential to operate with other hydrogen-rich fuels: alcohols, natural gas, petrol, NH₃?
- Solid state and silent
- Compact electrical power generation
- Low emissions

Until recent years the technological success of the fuel cell has been limited. Polymer electrolyte membrane (PEM) cells were used in the first manned spacecraft, alkaline fuel cells were used in the Apollo mission and then PEM cells returned to the space shuttle Orbiter vehicles. Many 200-kW combined heat and power (CHP) phosphoric acid fuel cells have been installed in the USA, Europe and Japan. In the last decade the interest in the PEM cell has gained momentum rapidly for use in transportation and portable electronic equipment. The attraction of the fuel cell (Table 19.2), particularly in the latter applications, lies in its good efficiency, simplicity in construction, low emissions and low noise.

The issue of efficiency is of particular interest because the fuel cell is not Carnot cycle limited. The maximum fuel cell efficiency usually is defined as the electrical energy produced per mole divided by the enthalpy of formation, i.e. $-\Delta G_f / -\Delta H_f$. At temperatures of <750°C the fuel cell efficiency can be greater than that of a heat engine. For example, at 25°C for liquid water as the product ($\Delta G_f = -327.2 \text{ kJ mol}^{-1}$) the efficiency maximum is 0.83 or 83%. Although

the maximum efficiency of a fuel cell falls with increase in temperature, most fuel cells operate at temperatures significantly higher than ambient temperature because of two principal factors:

- (1) Waste heat generated at higher temperatures is much more useful than from lower temperature cells and leads to highly efficient combined heat and power systems
- (2) Voltage losses, i.e. cell polarisation factors, are typically lower at higher temperatures, so higher temperatures ultimately can lead to higher fuel cell efficiencies (and power densities, i.e. watts per kilogram)

Fuel cell operating voltage

The actual operating voltage of a fuel cell is affected by many factors, including the fuel and oxidant supply and the type and characteristics of the cell materials and components [10]. High pressures of hydrogen and oxygen generally are attractive for better fuel cell performance, although of course this has to be considered in the overall cost of supply and performance of the system. In practice, one of the attractions of fuel cells is the high power density that can be achieved, certainly in comparison with batteries. High power densities require significant current or current density to be drained from the cell, with the typical resultant effect on the cell voltage—current density characteristics as shown in

Fig. 19.8 for a low-temperature cell. The factors identifiable from the curve of Fig. 19.8 include:

- (1) *Electrode activation losses.* These losses are due to the inherent slow reaction kinetics (electrode polarisation), particularly at the cathode (oxygen reduction), in low-temperature cells. They appear as an initial relatively rapid fall in voltage with applied current. They can be reduced by using more effective catalysts with higher exchange current densities (j^0), operating at higher temperatures, increasing the catalyst roughness or surface area and increasing the available reactant concentration.
- (2) *Ohmic losses.* These losses essentially are due to resistance to the flow of electrons in various connections and materials in the cell and the flow of ions in the electrolyte(s). They appear as an approximately linear variation of voltage with current density in the mid-range of Fig. 19.8. Highly conducting electrodes and electrolytes and thin electrolyte regions reduce the effect.
- (3) *Mass transport.* The losses associated with mass-transport limitations or concentration polarisation appear at high current densities as a typical rapid loss in cell voltage. The electrocatalyst becomes starved of fuel or oxidant and thus limits the associated electrode reaction. The effect may be due to changes in bulk compositions of reactants, e.g. influence of nitrogen in air on oxygen supply, or may be due to interfa-

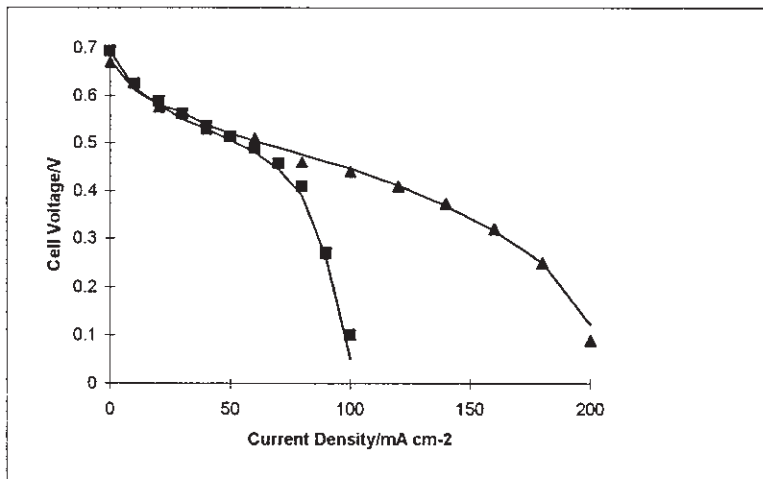


Fig. 19.8 Typical current-voltage characteristics of a low-temperature fuel cell.

cial mass transport effects at the electrocatalyst/electrolyte/electrode interface. For example, a water film may form over the electrocatalyst surface, which may inhibit diffusion of oxygen to the catalyst.

- (4) *Open-circuit losses.* Here, particularly for low-temperature cells, a significant loss in voltage below the thermodynamic theoretical value at open circuit (zero current flow) is seen, which can be several hundred millivolts. The losses are associated with fuel crossover and internal currents. Fuel crossover is the diffusion of hydrogen through the electrolyte to the cathode catalyst, where it reacts with oxygen to waste electrons. This is essentially an internal current production that serves to polarise the cathode and does not appear as an external current. The effect is influenced by the nature of the electrocatalyst, its structure and the dispersion of catalyst in the electrode matrix. The internal currents generated are typically low, probably $<2 \text{ mA cm}^{-2}$, but are sufficient to cause local cell polarisation. A similar effect is produced also at the anode due to oxygen crossover but, due to faster anode kinetics, the effect on cell voltage is not as pronounced as at the cathode.

Fuel cell structure

The development of any particular fuel cell system is complex, requiring detailed science and engineering of the cell components and stack system [11]. If, as an example, we consider the PEM fuel cell, shown schematically in Fig. 19.9, the factors that can be identified include:

- (1) *Electrode and electrode structure.* Platinum is acknowledged as the best catalyst for anode and cathode. This catalyst typically is supported on small (2–10 nm) particles of carbon to produce highly active material with a high surface area. The supported catalyst often is bound with poly(tetrafluoroethene) (PTFE) to repel water from the porous matrix, to facilitate evaporation and to prevent flooding of electrode pores. The catalyst region must be in intimate contact with the polymer electrolyte to enable efficient ion (H^+) transfer from anode to cathode. To this end, dispersed polymer electrolyte also can be introduced into the electrode matrix. Furthermore, the catalyst particles must maintain good electronic contact with each other through effective contact of the carbon supports. In addition, the whole catalyst matrix must be connected electrically to adjacent cells or the external circuit and load. This is one function of the ‘gas diffusion layer’ that serves a dual role as a gas distributor and current collector. The gas diffusion layer is typically carbon cloth or paper.
- (2) *Polymer electrolyte and humidification.* The basic polymer electrolyte membrane used in PEM cells is a perfluorosulfonic acid/PFTE copolymer. A typical ‘ionomer’ structure, shown in Fig. 19.10, is referred to under the tradename Nafion, made by DuPont. The SO_3^- ion group is highly hydrophilic and creates regions (clusters of side chains) that absorb large quantities of water, even though the polymer backbone is very hydrophobic, in which the H^+ ions are able to move by attraction to the fixed sulfonate groups.

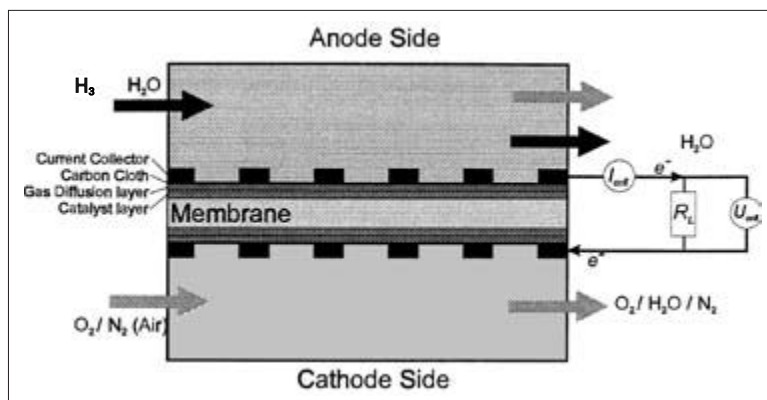


Fig. 19.9 Schematic diagram of a polymer electrolyte fuel cell.

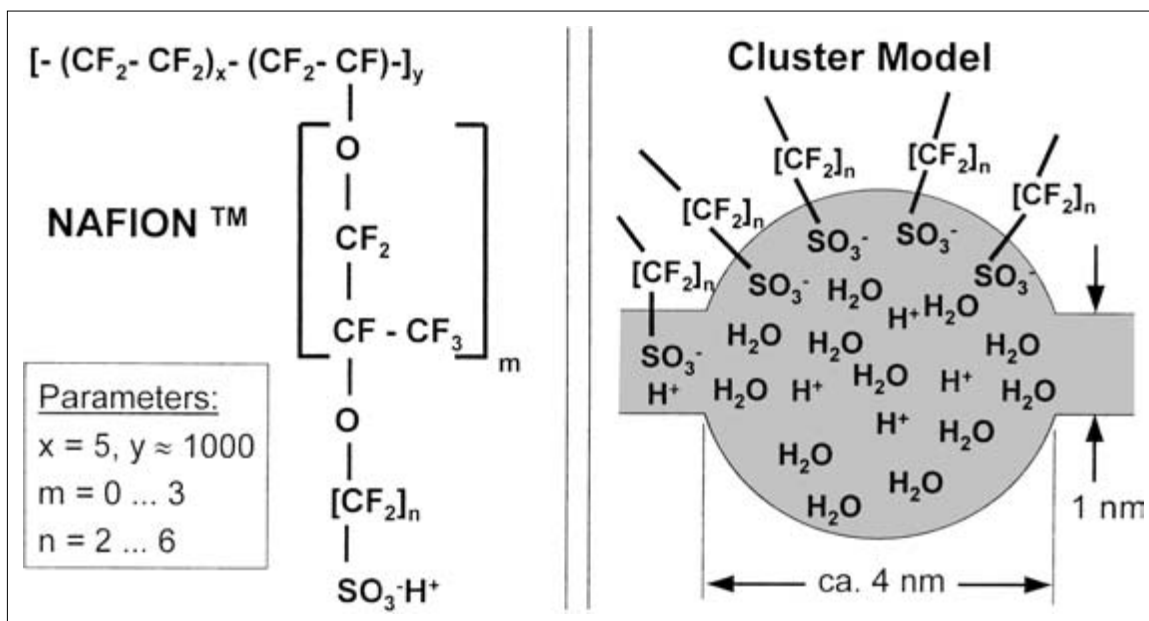


Fig. 19.10 Schematic diagram of the structure of Nafion perfluorosulfonic acid polymer.

For the PEM cell, the ionomer membrane possesses the required characteristics of:

- High chemical resistance
- Physically robust when absorbing relatively large quantities of water
- Mechanically strong, especially when prepared as thin films (50 μm) to minimise electrical resistance
- Good proton conductivity

The issue of proton conductivity is closely related to that of water absorption and membrane hydration in practical operation. The movement of water and a correct water balance in the membrane and catalyst regions is crucial to the operation of effective PEM cells:

- Water is produced by reaction at the cathode
- Water present in the membrane will be transported from anode to cathode, by electro-osmotic drag, with protons
- Water can diffuse through the membrane from regions of high concentration at the cathode to regions of low concentrations at the anode
- Water can be removed by evaporation in the anode fuel and air streams

Removal of water from the cathode region is important to prevent flooding of pores and a resultant loss

in performance. Thus as well as supplying the oxidant, the air flow, always supplied in excess of stoichiometry requirements to avoid oxygen starvation and mass-transport limitations, serves to maintain the water balance. However, at relatively high temperatures the air can dry out the membrane faster than the water can be produced and thus frequently the air stream is humidified. In addition, to maintain membrane hydration, it may be necessary to humidify the anode air stream. Procedures vary for maintaining water balance in PEM fuel cells and include [11]:

- The use of internal hydration
- External hydration in a membrane contactor using, for example, the humidified air exhaust to provide water for the incoming air stream
- Interdigitated flow fields
- Counter-current flow of air and oxidant streams in the cell

Bipolar plates

Bipolar plates in a PEM cell system provide the electrical connection between cells in a cell stack and form the flow field, i.e. the path for reactant gases, for distribution of hydrogen and air to the membrane electrode assembly (MEA), i.e. the combined struc-

ture of gas diffusion layers, electrocatalyst and membrane. The flow field typically consists of narrow channels machined into the plate material. In addition, the bipolar plate also may contain channels for coolant to be used to control the cell stack temperature because heat is generated by the inherent inefficiency of the electrochemical reactions. The bipolar plate is required to be resistant to corrosion in the fuel cell environment and thus typically graphite and carbon composites are used. Graphite is, however, expensive to machine, is brittle and porous and thus has to be relatively thick. Therefore, alternative materials such as compression-moulded graphite-polymer resin mixtures and metals such as stainless steel are used.

Stack operating factors

To produce the final fuel cell system a range of factors relating to auxiliary equipment operating conditions and control have to be considered. In any fuel cell system due regard has to be made to the source and quality of fuel used. Hydrogen therefore has to be stored appropriately or produced from a hydrocarbon-based fuel by partial oxidation or steam reforming. Thus an important issue is the influence of impurities in the fuel on cell and electrocatalyst performance over extended periods of operation.

The hydrogen and air must be supplied (pumped) under some pressure (depending on cell size and application) to the cell stack, which involves the use of compressors or air blowers and regulating valves. The air must be free of contaminants and requires filtration.

Cell stacks have to be maintained at specified operating temperatures, as well as the required humidity, to ensure target power performance. Thus the compressed air is cooled and cell stacks are cooled. Consequently, energy is expended in supplying compressed air, fuel and cooling medium and for the electronic controllers for the system. This energy has to be obtained from the fuel cell and reduces the efficiency of the complete system. The overall operation of a fuel cell system thus requires a detailed optimisation of all factors to maximise power output while minimising system cost.

Regenerative fuel cells

A regenerative fuel cell, currently being developed for utility applications, uses hydrogen and oxygen

(or air) to produce electricity, water and waste heat, as in a conventional fuel cell. However a 'regenerative' fuel cell also performs the reverse of the cell reaction, using electricity to form hydrogen and oxygen from the dissociation of water by electrolysis. In principle, the 'closed' system of the regenerative fuel cell has significant attraction because it could enable the operation of the power system without requiring a significant hydrogen infrastructure. A major concern about the regenerative fuel cell is the cost of making the fuel cell reversible, as well as achieving long-term operational performance over many cycles.

An indication of the increasing importance that electrochemistry plays in the energy sector is the development of a large-scale energy storage facility for load levelling, based on a redox fuel cell or battery called *Regensys* [12]. The Regensys system is envisaged for use at large-scale power generation sites or at smaller scale close to the point of use. The technology is based on two soluble redox couples $\text{Br}^-/\text{Br}_3^-$ and $\text{S}^{2-}/\text{S}_2^{2-}$ in aqueous solution. The process uses as the basis a bipolar stack of approximately 200 cells, with the charged and discharged electrolytes stored external to the stacks. The electrodes are carbon/polymer mixtures made by an extrusion technique and are divided by cation-permeable membranes. Mass transport is enhanced by the use of turbulence promoters. The overall energy efficiency of the system is claimed to be 70%.

5 Electrochemical Synthesis

Electrosynthesis has been long established as a method of manufacturing a range of materials and chemicals—gases, solids and liquids—and in many cases is the only viable method (see Table 19.3). Electrochemistry can play a strategic part in the minimisation of waste and sustainability in synthesis in that the oxidation or reduction is via electron exchange and is not chemical. The benefits to be gained from the application of electrochemistry in electrosynthesis is due to its many inherent characteristics:

- Mild conditions of operation, e.g. low temperature and pressure
- Improved selectivity and yield of existing reactions
- Availability of novel chemical transformations to new molecules and new routes to known molecules
- Reduction in the number of synthesis steps
- Improved management of potential pollutants

Table 19.3 Electrochemical synthesis processes

Al, Na, Mg, Li	Molten salt electrowinning
Cu, Zn, Cu, Ni, Cr, Pb	Hydrometallurgy
Cd, Mn, Ti, Ga, In, Ag, Au	Electrowinning or refining
Chlorine/caustic	Noble metal oxide anode, brine electrolyte
Chlorate	Noble metal oxide anode, brine electrolyte
Perchlorate	Pt/Ti, PbO ₂ anodes, chlorate electrolyte
Persulfate	Pt/Ti anode, conc. H ₂ SO ₄
Hypochlorite	DSA®, aqueous NaCl
Permanganate	Ni, monel anode, KMnO ₄ electrolyte
Fluorine	Carbon anode, KF/2HF eutectic
Manganese oxide	C, Pb, Ti anodes, MnSO ₄
Water electrolysis (H ₂ , O ₂)	Ni on steel, KOH
Hydrogen peroxide	Carbon cathodes, NaOH
Ozone	Vitreous carbon anode, conc. aq. HBF ₄
Bromate	C, Pt/Ti, PbO ₂ aq. NaBr
Chromic acid	Lead anode, Cr(III) in H ₂ SO ₄
Cuprous oxide	Copper, aq. NaCl
Potassium stannate	Anodic dissolution
Chlorine dioxide	DSA®, carbon cathode, sodium chlorate and HCl

- Avoidance of aggressive and hazardous reagents
- Use of alternative feedstocks
- Decrease processing costs

It is important to stress that electrochemistry is not an expensive process in terms of energy use and, with appropriate cell design, when operating at high current densities the processes are very competitive.

Electrochemical synthesis covers the production of inorganic and organic chemicals, metals and alloys, semiconductors, conductive polymers and composites. Many electrochemical syntheses involve a change of phase in forming the product, thus simplifying product recovery and separation and reducing the tendency to generate waste streams in downstream processing. Good examples are the production, by reduction, of solid metals from electrolytes, the production of gases from aqueous solutions or eutectics, e.g. oxidative generation of chlorine and fluorine, and the production of metal salts by anodic oxidation. In addition, several of these species are non-chlorinated bleaching, sterilising or oxidising solutions (peroxide, ozone, persulfate) used to a small extent as alternatives to chlorine, which itself is produced electrochemically.

Interestingly the use of sulfur dioxide (possibly as a waste gas) to produce dithionite—widely used in the pulp and paper industry—is now commercialised (Olin). The process is based on a three-dimensional, carbon electrode (graphite felt) and achieves current efficiencies of near 100% [13].

5.1 Metal salt preparation

There are several small-scale processes in operation for the manufacture of metal salts by anodisation. The electrochemical method offers the feature of controlled purity and is based on the overall ‘simple’ formation of a soluble metal ion. The following are examples of metal salt production [14,15], which are typically formed by anodic dissolution of the base metal in the appropriate acid or alkali solution:

- (1) Potassium gold cyanide solutions from gold.
- (2) Silver nitrate liquors by the anodic dissolution of Ag in nitric acid.
- (3) Titanium(III) chloride.
- (4) Nickel acetate, carbonate, chloride, etc.
- (5) Potassium and sodium stannate (from tin/lead solder).
- (6) Cuppra-ammonium nitrate from copper scrap dissolution in ammonium hydroxide.
- (7) Copper acetate and pyrophosphate.

The current efficiencies for these salt productions are typically greater than 98%. Cathodic reduction also can be used for the production of metal salts, e.g. vanadium(II) formate by the cathodic reduction of vanadium.

5.2 In situ generation of reagents

The production of chemical reagents that are hazardous to transport and store, both on site and on demand, is becoming an increasingly important area for electrochemistry. The production of hydrogen by electrolysis using, for example, solid polymer electrolyte (SPE) cells for use in chromatography analysis is well established. Processes also exist for the production of hypochlorous acid, chlorine, hydrogen peroxide, ozone and arsine. Notably the production of ozone essentially uses SPE cell technology (Fig. 19.11), generating the gas (O₃) at the anode (with oxygen) from pure water. The process requires high anode potentials ($E^0 = -1.5\text{ V}$) to produce an approximate 30% by volume ozone concentration.

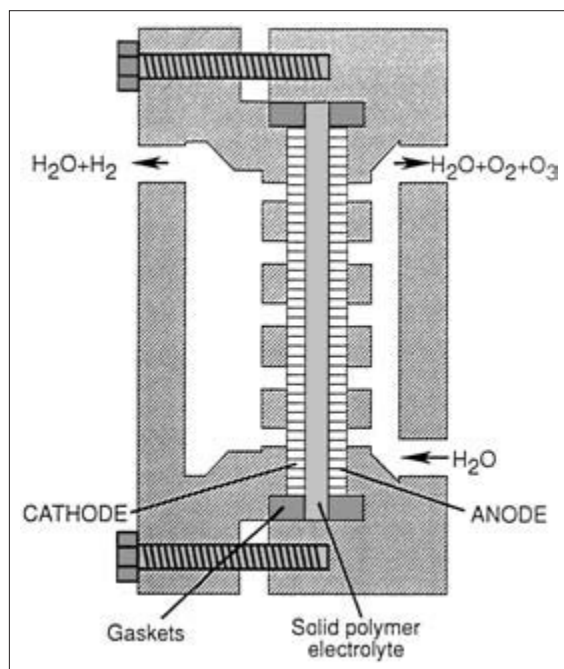
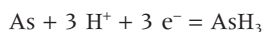


Fig. 19.11 Electrochemical cell for the generation of ozone.

The use of arsine gas (AsH_3) is essential in several applications in the electronics industry. Arsine is an extremely toxic material and stringent safety requirements are needed in its storage and use. These concerns have promoted the use of on-site, on-demand supply of arsine to eliminate the need for storage. One recently developed method [16] is based on the electrochemical reduction of arsenic to arsine:



The generation of arsine in alkaline solution (1 mol dm^{-3} NaOH) from high-purity (99.999%) arsenic cathodes can be carried out with current efficiencies in the range of 95–97%. The only other product is hydrogen gas. This production can be achieved over two orders of magnitude of current density and thus high arsine gas concentrations are produced at variable rates for use in the manufacture of InGaAs materials.

5.3 Influence of counter-electrode

The reduction of waste can be brought about generally by the improvement in efficiency in the use of electrical energy by, for example, the use of thermo-

dynamically favourable reactions. This can be achieved in many cases by the appropriate choice of the counter-electrode reaction, e.g. the reduction of oxygen and the oxidation of hydrogen gas. The application of these reactions reduces potential by-products at the counter-electrode and reduces energy consumption for the cell, thereby reducing the waste generation at the power plant. The reduction of potential waste products can be achieved by utilising both reactions in the cell in what are called paired syntheses.

5.4 Paired synthesis

Paired electrochemical syntheses are processes in which both the anode and cathode reactions simultaneously contribute to the formation of the final products. The classic example is the simultaneous production of chlorine and sodium hydroxide in the chloralkali industry. Paired electrochemical synthesis can be classified generally in terms of:

- (1) The generation of two distinct products from two reagents.
- (2) The generation of one product by coupling of anode and cathode reactions.
- (3) The generation of one common product from the anodic and cathodic reactions of two reagents, e.g. glyoxylic acid from glyoxal and oxalic acid [17].
- (4) The generation of one product in which the intermediate species is formed by reaction at the counter-electrode, e.g. the formation 1,2-butanone from 2,3-butanediol [18].
- (5) The generation of two products from one reagent, e.g. sorbitol and gluconate from glucose [19].

It is interesting to consider examples of type 1 and type 2 paired electrochemical syntheses.

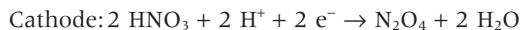
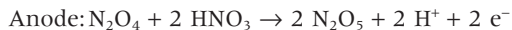
Organic chemical production

Paired synthesis can play a potential role in organic chemical production. A recent example is the synthesis of phthalide and 4-*t*-butyl-benzaldehyde at BASF (Germany) using their capillary gap cell technology [20].

The manufacture of dinitrogen pentoxide

An electrochemical process for the production of dinitrogen pentoxide (N_2O_5) from nitric acid has

been developed [21] by the UK Ministry of Defence. Both electrode reactions are utilised effectively in the following reactions:

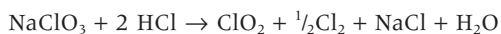


The N_2O_4 generated at the cathode assists in the splitting of nitric acid into N_2O_5 and water. The water formed is separated from the anolyte by the membrane.

The N_2O_5 generated by this system (in HNO_3) is seen as a replacement to sulfuric acid/nitric acid and oleum/nitric acid mixtures for the synthesis of nitro compounds used as intermediates in the manufacture of pharmaceuticals, dyestuffs, pesticides and explosives. Dinitrogen pentoxide offers reduced reaction time, increased product yield and a simplified process time, although these must be offset against higher reagent costs.

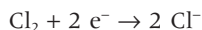
Chlorine dioxide

Chlorine dioxide is a major chemical used in the pulp and paper industry. It is used in conjunction with sodium hydroxide for purifying pulp and typically is produced on site from the reaction of sodium chlorate with hydrochloric acid:

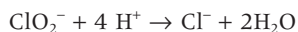
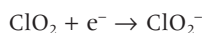


The current and future imbalance in caustic soda and chlorine requirements has seen, due to environmental limitations on the latter, the development of a new electrochemical route for ClO_2 generation [21].

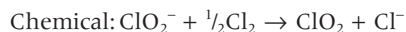
The electrochemical behaviour of the chlorine dioxide/chlorine redox couple in acidic media depends upon the cathode material. Materials with low overpotential, e.g. platinum, will reduce chlorine close to the thermodynamic potential of 1.36 V vs. normal hydrogen electrode (NHE):



and reduce ClO_2 at overpotentials of approximately 0.95 V, followed by ClO_2^- ion reduction:



At high overpotential electrodes, e.g. vitreous carbon, chlorine reduction is at more negative potentials (0.85 V vs. NHE). In the presence of ClO_2 , the reduction wave for chlorine is not observed. This is explained by an electrochemical catalytic mechanism in which the ClO_2^- , formed electrochemically, is re-oxidised near the electrode by chlorine in solution:

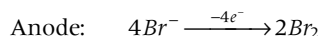
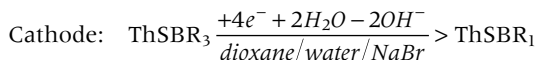
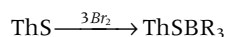


This reaction scheme therefore offers a method for electrochemically purifying ClO_2 . The electrochemical cell for this synthesis has five compartments overall, with a central anode and two different cathodes providing two separate cell processes. Overall, the cell (see Fig. 19.12) has three functions:

- (1) Acid generation at a DSA- O_2 (Dimensional Stable Anode) evolution anode.
- (2) Chlorine reduction at a fixed flow-by carbon bed cathode, for electrochemical chlorine scrubbing.
- (3) Sodium hydroxide generation by virtue of the hydroxide ion generation at an Ni cathode and Na^+ ion transport through an adjacent cation-exchange membrane.

5.5 Organic electrosynthesis

There are many electro-organic syntheses in commercial operation, mainly on a small scale. These have been successful because of several factors, but typically through the reduction in complexity in the overall production steps and the improvements in product yields. It is not appropriate to give vast details of these syntheses but it is informative to cite examples of electrochemical syntheses that illustrate the potentially cleaner, more sustainable technology of electrochemistry. One example is the synthesis of 3-bromothiophen from thiophene (ThS). The chemical reduction uses Zn in acetic acid at high temperature and produces a large amount of a difficult waste (Zn(II) in acetic acid). The electrochemical reduction is much cleaner and, in addition, can operate with an anode reaction that produces bromine used in the chemical production of the tri-bromo species:



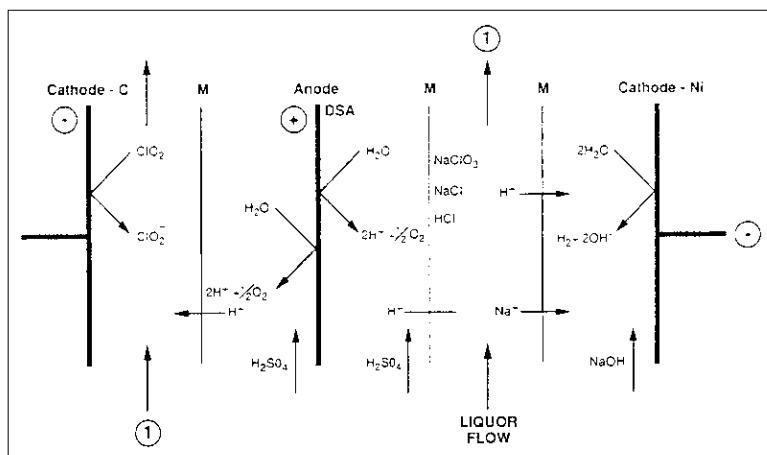


Fig. 19.12 Cell for the production of chlorine dioxide.

Table 19.4 Indirect electrochemical processes

Oxidation with metal salts	<ul style="list-style-type: none"> • Oxidation of aromatics with side chain, e.g. synthesis of substituted benzaldehydes with Mn^{3+} and Ce^{4+} • Oxidation at the aromatic nucleus, e.g. benzene to phenol with Fe^{2+}/H_2O_2 • Olefin oxidations with Ti^{3+}, Pd^{2+} and Os^{8+}
Oxidation with inorganic anions	<ul style="list-style-type: none"> • Oxidation of alkenes to epoxides and secondary alcohols to ketones with halogens • Dialdehyde starch production from starch by periodate
Reductions with metal salts and base metals	<ul style="list-style-type: none"> • Ti^{3+}, V^{3+}, Sn^{2+}, Cr^{2+}, Zn, Cu, Fe and Sn powder reduction of nitro compounds and halogenated hydrocarbons
Reductions with metal complexes and metal salts	<ul style="list-style-type: none"> • Ni^0, Ni^A, Co^+, Sn^0, Pd^0 and Ph' complexes, e.g. reaction with alkylating agents via oxidative addition
Synthesis with organic redox catalysts	<ul style="list-style-type: none"> • Electrochemical reduction of alkyl complex cleaves the metal-carbon bond • Reductions with radical anions and dianions of mainly aromatics for cleavage of alkyl (e.g. perylene), biphenyl, anthracene and aryl halides, sulfonates, sulfides and, epoxides • Dehalogenation of polychlorinated biphenyls with 1,9-diphenylanthracene • NAD to NADH and NADPH with methyl viologen • Selective oxidations of arylalkanes to benzaldehyde dimethyl acetals • <i>N</i>-Hydroxy phthalamide for oxidation of arylalkanes, benzylethers and olefins
Reduction by viologen radical cations	
Oxidation with triarylamine radical cations	
Oxidation with electrochemically regenerable hydride or hydrogen-abstrating reagents	

The range of syntheses performed in the laboratory is vast and many (of the order of 100) have reached industrial scale. This includes a range of reductive and oxidative processes, cathodic and anodic cleavages, cyclisations and couplings [22]. An important developing area is the use of indirect electrochemical processes.

Indirect electrosynthesis

Common methods of carrying out oxidation and reduction in organic synthesis is by homogeneous reaction with conventional oxidants or reductants.

Many of these reagents can be prepared electrochemically and the appropriate regeneration of these agents by electrochemical oxidation or reduction can lead to simplifications in the process operation, a reduction in any problems of effluent treatment and can eliminate, or reduce, the need for bulk storage of hazardous or toxic chemicals on site. There is considerable commercial interest in the use of these routes for the small-scale manufacture of high-value and speciality chemicals [2,23]. Table 19.4 lists a selection of the processes typically performed as ex-cell processes.

Generally, in both the in-cell and ex-cell cases, if reaction is slow then the cell must include a separator between the anode and cathode to prevent the counter-electrode from causing an electrochemical back-reaction of the redox agent. A strategy that has been used to try to eliminate the need for a cell separator (and thus reduce the cost) is to introduce a phase-transfer agent into the emulsion phase, which selectively removes the active redox agent after regeneration.

Redox catalysts

The ability, in terms of reaction rate and selectivity, of a redox agent to carry out a particular indirect synthesis will depend largely on the required oxidation or reduction power of the agent, which is effectively measured by the standard potential of the redox couple. Although inorganic mediators often involve slow electron transfer in regeneration, often they can offer the advantage of moderating the reactivity of intermediates to enable selective reaction. Typical inorganic species used to carry out oxidations include several metal ions, e.g. Fe(III), Co(II), Mn(III), Ce(IV) and Cr(VI). The use of mediated electrochemical reduction of organic compounds is not as popular in industry as that of oxidations. The use of alkali-metal amalgams in the reduction of organics, notably nitro compounds, is practised. The use of homogeneous reducing agents such as Eu(II), Cr(II), Ti(II), Sn(II) and V(II) also could be considered [24].

The wide variety of indirect mediated electro-organic reactions has been reviewed by Steckhan [25]. There has been significant research on the oxidation of toluenes using electrochemically generated mediators. The method is particularly useful due to the low solubilities of the organic species in the aqueous electrolyte. For the electrosynthesis of benzaldehydes, the mediators frequently used are Ce(IV) and Mn(III). An important example (adopted by W. R. Grace and Co.) of mediated synthesis is the oxidation of aromatic precursors to aldehydes, ketones and quinones. The products of the oxidation are used as intermediates, flavours, fragrances and dyes. The non-electrochemical processes, using sodium dichromate, MnO₂ or oxygen in air, have limitations in terms of disposal of spent metal oxidants or poor selectivity in the case of air oxidation. The Grace process [22] uses Ce(IV) in a solution of

methane sulfonic acid for the oxidation because of its high selectivity to many of the desired products, high solubility, low cost and fast reaction.

Another interesting example is the Electricité de France process for the conversion of sugar beet extract to mucic acid using indirect oxidation with bromine, i.e. bromine-mediated oxidation of galacturonic acid to galactaric acid. The strategy adopted here was to base the process around a modified Grignard reactor, familiar to the industry to which electrochemistry was being introduced, and achieve simple cell design and installation and low cost. Another bromine-mediated synthesis approaching commercialisation at BASF (Germany) is the conversion of hydroxypivalic aldehyde to methyl hydroxypivalate, which subsequently is converted to hydroxypivalic acid using an electrodiolysis step.

Non-aqueous electrosynthesis

Electrosynthesis can be carried out in non-aqueous solution by methods that include the use of organic solvents, micelles and solid polymer electrolytes.

Solid polymer electrolyte. Solid polymer electrolytes, or proton-conducting membranes, can be used to perform hydrogenations. One example is the partial hydrogenation of the unsaturated fatty acid constituent of edible oil—triglyceride—at palladium (or platinum) catalyst supported on carbon:



where $\text{--RH}_2\text{C-CH}_2\text{=R--}$ is an unsaturated fatty acid. The catalyst is bonded to the membrane (Nafion) to produce a PEM fuel cell type of structure [26].

Electrosynthesis as a means of organic chemical and intermediates manufacture is an area that has fulfilled its promise. It is being seen widely as a cleaner alternative to wet chemistry and catalysis. Innovative electrochemical syntheses can be performed, which reduce the number of reaction steps, say, in the multistep routes to pharmaceuticals. One such example is in the electrocarboxylation of chlorodiphenylether as part of the route to fenpropfen [22]. The process is an example of synthesis in non-aqueous media, i.e. dimethylformamide (DMF), and uses a novel cell design based on a consumable

Mg anode in the shape of a pencil (Fig. 19.13) surrounded by a conical steel cathode.

The following is a list of examples of other syntheses based on consumable anodes (see Fig. 19.14):

- (1) Nozaki-Hiyama reaction (Fig. 19.14a). In the electrochemical version of this reaction only catalytic quantities of the transition metal ions are required. The reaction involved regeneration of Cr(II) intermediate and can be performed in an undivided cell with an Al anode in DMF. The chemical process produces large volumes of toxic chromous chloride effluent [27].
- (2) Cathodic reduction of ethyl trifluoroacetate with an Al anode in an undivided cell. With a steel cathode good yields of fluorinated acetylacetate,

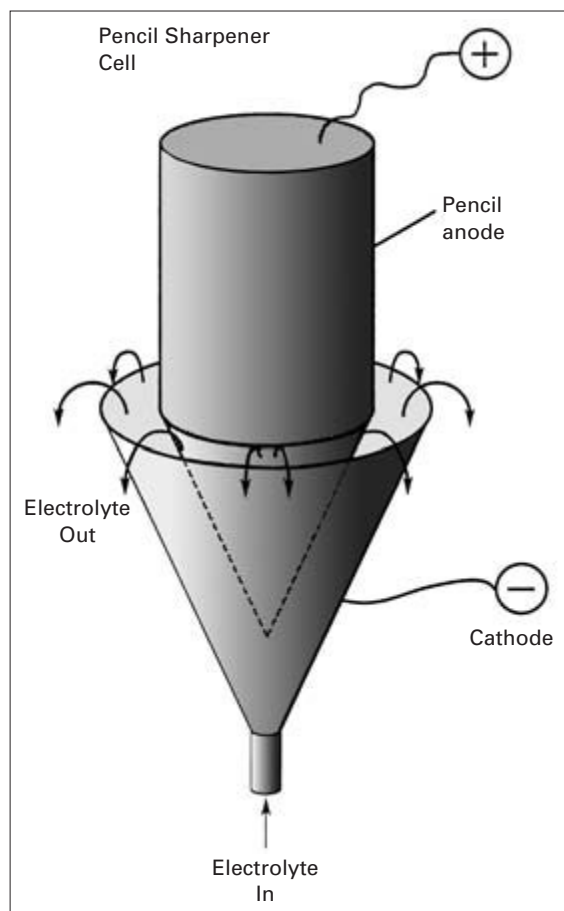


Fig. 19.13 Schematic diagram of the pencil sharpener cell.

after acid hydrolysis, are obtained in an aprotic solvent containing trimethylsilyl chloride [28].

- (3) Jubault *et al.* have used an Mg anode for synthesis (Fig. 19.14b). As well as an improvement in yield, the Mg anode also enabled production rates greater than those expected from the stoichiometric consumption of charge, because the Mg becomes activated and acts as a reducing agent [29].
- (4) Manufacture of the anti-inflammatory drug Naproxen (Fig. 19.14c) with an Al anode and lead cathode in dry DMF under a carbon dioxide atmosphere [30].

The cathodic generation of active metals is another approach that has attractions for synthesis. Electro-generated Ni powder, formed by reduction at a Pd cathode as a black suspension in DMF, has been used to reduce 4-substituted nitrobenzenes [31]. Electro-generated Zn has been used to prepare organo-zinc compounds as useful intermediates in the coupling of alkyl and aryl halides [32].

6 Electrochemical Waste Minimisation

The process industries in their consumption and production of materials and chemicals deal with a wide range of liquors containing toxic and hazardous materials. These materials, if not a direct product of the plant, must be recycled or treated. In many cases large quantities of effluents and dilute wastewaters containing toxic (and non-biodegradable) compounds can be produced. These compounds include toxic metals, organic compounds, inorganic compounds and waste and flue gases. The importance of electrochemistry in recycling is now well appreciated. The use of electrochemical techniques is increasing rapidly for the treatment of a wide range of process streams, both liquid and gaseous. Several of the electrochemical methods described are used commercially, notably metal deposition, whereas many more are at the prototype stage. Methods described are not always stand-alone techniques but often are used in conjunction with other non-electrochemical methods. For example, electrodeposition is an effective technique for the recovery of metal ions at relatively high concentrations. At low concentrations (< 1 ppm) the efficiency and cost effectiveness start to fall and thus a method such as ion exchange, which can deal effectively with lower metal ion concentra-

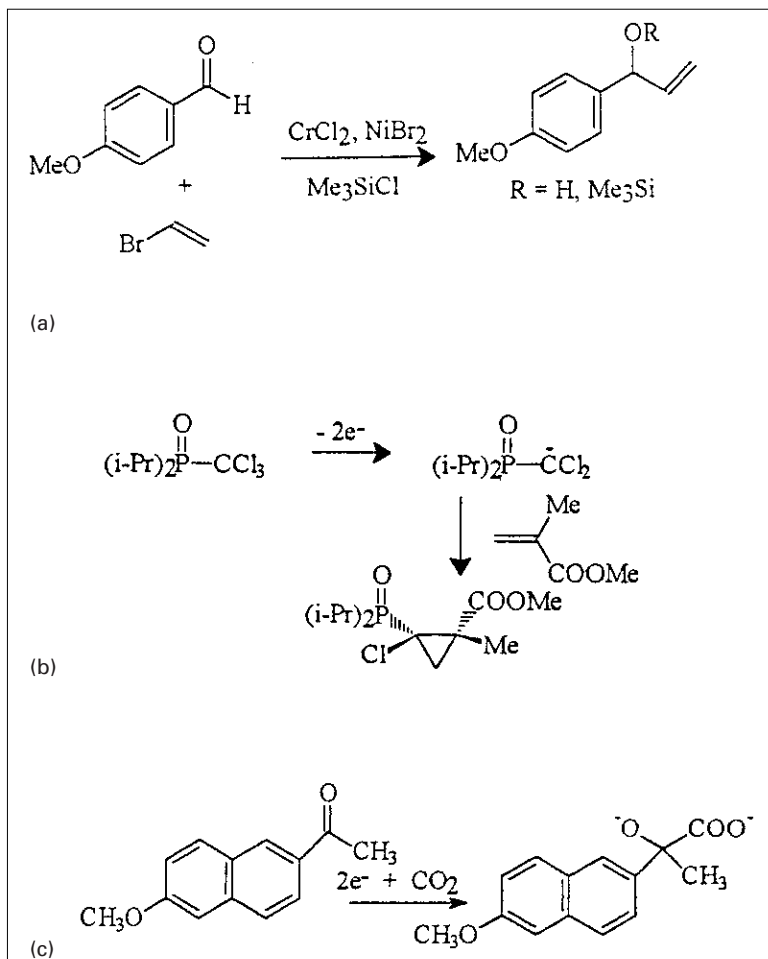


Fig. 19.14 Examples of electro-organic synthesis using a consumable anode.

tions, can be utilised to recover and recycle the metal ions back to the electrodeposition.

Under the general umbrella of electrochemical technologies for waste minimisation, there are three broad categories of processes: direct electrochemical, indirect electrochemical and electrochemically driven separations. The scope of electrochemistry in waste minimisation is outlined in Table 19.5. The processes are varied and are used for:

- Recovery and recycling of valuable components from wastewaters, e.g. metal ions such as Ni, Cu, Pb, Hg, etc.
- Separation and recycling of salts via electrochemical membrane processes
- Treatment of process waters containing cyanide, chromium species, phenols, PCBs etc.

- Removal of acid gases such as SO_2 , HCl, NO_x and H_2S from process and combustion gas
- Purification of water using with Cl_2 , OCl^- , OH^- and O_3
- Recycling of constituents in plating operations and reagents for oxidation and reduction reactions, e.g. Cr(VI) and Ce(IV) ions
- Separation processes for solid/liquid and liquid/liquid dispersions

6.1 Recovery and recycling of metal ions

Electrodeposition functions typically in aqueous solution, but not exclusively. Processing of solid 'waste' material to recover metal by electrodeposition frequently will involve a dissolution step of a metal or metal salt. The removal and recycling of dis-

Table 19.5 The scope of electrochemistry in waste minimisation

	Direct	Indirect	Phase separations and membrane separations
<i>Metals</i>			
Reduction	Electrodeposition of metals and oxides Dissolution of scrap	Cementation, e.g. Cu with Fe	
Oxidation		Electro-cementation Electro-precipitation	
<i>Liquids</i>			
Oxidation	Phenols, CN ⁻ , etc.	Organics with Ag(III), Co(II)	Electrodialysis Electrohydrolysis Electrochemical ion exchange
Reduction	Chlorinated organics	Photochemical	Electrosorption
<i>Gases (vapours)</i>			
Oxidation	SO ₂ , H ₂ S, organics	SO ₂ with Br ₂ , SO ₂ , etc. by Ag(III)	SO ₂ and H ₂ S with eutectic membrane
Reduction	NO _x , HCl, Cl ₂ , SO ₂	SO ₂ with Ti(III)	NO ₂ with eutectic membrane
<i>Solids and particulates</i>			
	Sulfide oxidation: FeS ₂ by air	Sulfide oxidation	Electroflotation Electrofiltration Electro-osmosis Electrophoresis

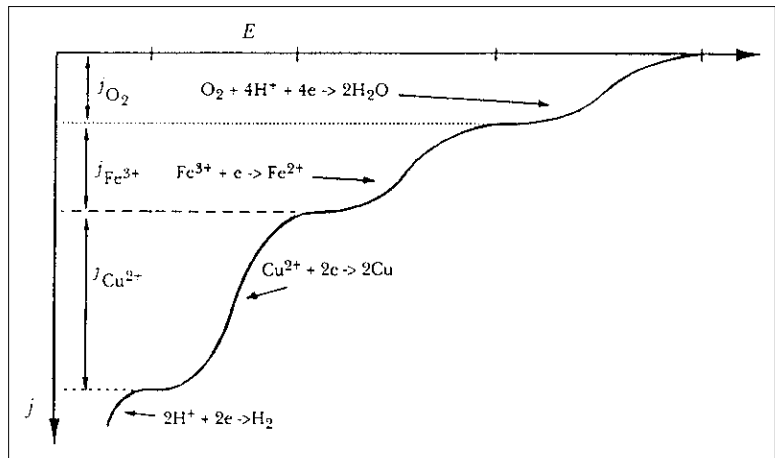
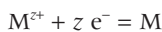


Fig. 19.15 Schematic polarisation curves of metal deposition reaction.

solved metals from process solutions by electrodeposition at source is seen to be attractive due to the potential for a ‘one-step cleaning’ method of metal recycling [2].

Electrochemistry of deposition

Let us consider the case of a metal deposition reaction:



where, at electrode potentials more cathodic than the equilibrium potential, the rate of metal deposition will depend upon the electrode kinetics of the particular reaction as shown in Fig. 19.16. Ideally the rate of deposition will be at the maximum Faradaic efficiency up to values of the limiting current density. The efficiency will depend largely on the relative

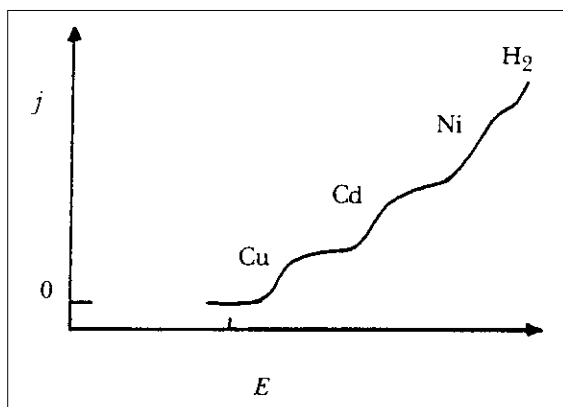


Fig. 19.16 Schematic diagram of polarisation curves for multi-deposition reactions.

values of overpotential for competing reactions at the electrode surface, e.g. the reduction of protons to hydrogen gas.

In aqueous solution containing dissolved oxygen, reduction of oxygen may occur. This is more significant when dealing with low concentrations of the metal ions with well-oxygenated solutions, especially those systems where the anodic reaction is the evolution of oxygen gas. Here the concentration of oxygen can be supersaturated, although the actual value depends significantly on the pH, the electrolyte composition, etc. Current efficiency also can be lowered by other reactions in addition to the hydrogen evolution and oxygen reduction reactions, such as:

- (1) The presence of other ionic (non-metallic) species that may be cathodically active in the potential range of operation. For example, Fe(III) ions will result in the cathodic reduction of Fe(III) to Fe(II) at potentials more anodic than for most metal ions, e.g. Cd(II), and thus generally it will be under mass-transport control.
- (2) The presence of redox species that may be chemically reactive with other dissolved ionic and solid species. For example, metals that have been electrodeposited and are not cathodically protected are free to corrode by reactions such as oxygen reduction or Fe(III) ion reduction.
- (3) The presence of other metal ions that also can be cathodically electrodeposited.

In the above cases, the performance of the system with a mixture of metal and other cations can be pre-

dicted initially from thermodynamics, i.e. the relative potential of the species in the electrochemical series. These data can indicate only the possibility of selective metal recovery, because in practice this is affected also by the cathode substrate and the electrolyte composition. Thus, it is usual to carry out experimental tests to obtain appropriate current/voltage responses of the complete system. These data (polarisation curves), when obtained under well-defined hydrodynamics, enable the identification of conditions for selective (or otherwise) metal deposition in the absence of other competing reactions. A typical curve that is representative of a system with a neutral electrolyte containing a mixture of Cu(II), Ni(II) and Cd(II) ions is shown schematically in Fig. 19.16. It is seen in Fig. 19.16 that selective Cu deposition is possible in the absence of hydrogen evolution, but that for selective cadmium deposition the copper ion concentration will need to be reduced to very low values.

In many cases the system can be more complicated than suggested by the curves of Fig. 19.16 due to several factors, such as:

- (1) The nature and actual material form of the metal deposit will change during the course of the electrode reactions.
- (2) The evolution of hydrogen (and of oxygen) and the reduction of oxygen can cause pH changes at the electrode surface, which can lead to changes in the chemical form of the deposit. This, for example, could be the formation of metal hydroxides, which also could lead to passivation of the cathode surface:

$$M^{n+} + n OH^- \rightarrow M(OH)_n$$
- (3) The possibility of the deposition of metal alloys.
- (4) A complex metal deposition reaction involving adsorbed intermediates, etc.

Many solution species, particularly metal ions, exhibit a tendency to complex with other species in solution. The metal then is not present as a free ion but as a complex with an inorganic or organic ligand, e.g. cyanide, chloride, EDTA. Changes in the standard reduction potential of a metal ion occur if the metal ion is complexed. Metal deposition will occur less easily when complexation occurs and this is seen in a more negative reduction potential by as much as 0.6–0.8 V for the complexed metal ion.

6.2 Cell technology and applications

The recovery of metals from solution by electrodeposition can be divided conveniently into the following two areas, depending upon the metal ion concentration:

- (1) Metal ion concentration $>1\text{gdm}^{-3}$ of solution feed; two-dimensional cathodes generally are used to maintain effluent concentration levels in the range of $0.1\text{--}0.5\text{gdm}^{-3}$. The removal of a metal from a process stream, to a predetermined concentration, enables recycling of either solution or metal to the process.
- (2) At approximate low concentrations up to 100mg dm^{-3} (100 ppm), three-dimensional electrodes preferably are used, especially if effluent levels of $<1\text{mg dm}^{-3}$ (1 ppm) are required. The removal of metal to very low concentrations enables the resulting spent liquor to be recycled, discharged or passed to further treatment stages for other species.

Available cell designs for recovery of metal ions from dilute solutions can be put into the two general categories of direct metal recovery or indirect recovery as a metal ion concentrate. In both of these categories two- and three-dimensional electrodes are used.

Two-dimensional electrodes

Two-dimensional electrodes appropriate for metal recycling typically are based on the tank electrolyser to enable ready removal of metal-plated electrodes. The simplest cells are the vertical, plate or mesh electrode-in-tank units, where turbulence is provided by using either inert fluidised beds [33] (Chemelec Cell, BEWT Water Engineers Ltd) or air agitation (Reconwin cell), in conjunction with electrolyte pumping.

In the Reconwin cell [34] a uniform curtain of fine air bubbles is directed across the face of the cathode to increase the mass-transfer coefficient in comparison with unagitated or recirculated electrolyte systems. Typically, at a concentration of 1gdm^{-3} the limiting current for, say, copper deposition is approximately 100Am^{-2} . The cathode material is a metal (stainless steel) blank of approximate size 0.6m by 0.6m , from which the electrodeposited metal is recovered as foil. The Chemelec unit uses mesh or expanded metal electrodes from which

metal can be recovered by dissolution or an electrorefining process. The cell benefits from the good mass transfer arising from the turbulence caused by the inert fluidised bed of ceramic (glass) beads. Typical applications of the Chemelec and Reconwin cells are in the metal finishing, electronic, mining, photographic and electroplating industries, to recover metals such as Cu, Ni, Zn, Cd, Rh, Pt, Sn, Au, Ag and brass.

Rotating electrode cells. Cells for industrial applications utilise rotation of a cylindrical electrode (RCE). The RCE can produce the metal deposit as a powder or a particulate that enables the cell to be operated in a continuous mode when the powder is displaced freely from the electrode surface. Notably amongst two-dimensional electrode cells, the RCE can reduce metal ion concentrations to the single ppm level. The performance of a 500-A reactor is discussed in some detail in Ref. 35. The cell is operated with the inner cathode cylinder rotating with tip velocities in the range of $0.6\text{--}20\text{ms}^{-1}$. This results in the formation of Taylor vortices in the electrolyte flow that produce a high degree of agitation and high mass-transfer rates. The concentric anode is arranged to give an inter-electrode gap of $1\text{--}2\text{cm}$. The deposited metal is in the form of flakes or powder and serves to increase the effective electrode area for electrodeposition and causes a significant enhancement in the rate of mass transport over and above that for smooth rotating cylinder electrodes.

Three-dimensional electrodes

The trend in three-dimensional electrodes is to use high surface areas achieved with cheap carbon materials such as particles, fibre or foam. Cathodes based on carbon fibres or woven cloth offer high surface area and good mass-transfer rates for electrodeposition.

A packed bed cell called the Enviro-Cell has been developed by Deutsche Carbone [36]. The cell is employed mainly in the plating and photographic industries to treat rinse tank effluents such as the rinse water after the fixer tank for silver removal. The cell originally used a tapered cathode compartment filled with electro-graphite granules, specially impregnated and screened to produce a definite particle size. The design since has been simplified to a simple cylindrical configuration to reduce the operating costs.

Although carbon is a cheap and relatively stable substrate for cathodes in three-dimensional electrodes, metal electrodes (e.g. stainless steel, Ti) are used in other cell designs [37,38]. Wastewater treatment with this cell is highly competitive with ion-exchange technology. Typical applications for metal ion removal are the recovery of Cu, Hg and Ag. General-purpose flow electrolyzers can be modified readily to act as packed-bed electrolyzers for metal recovery. Active packing materials that have been used are porous graphite, reticulated or felt metals and carbons and regular or irregular packing. Typical electrochemical performance of a cell [39] showed that several metals such as Cu, Zn and Ag could be removed from solution to below the 1 ppm level with reasonable current efficiencies and energy consumption, cell voltage being typically in the range 2–3 V.

A recent cell design based on carbon fibres is the PoroCell, which uses an annular cartridge of fibre to recover the metal [40]. The carbon fibres typically are between 5 and 10 μm and 1 g of fibre typically has a surface area of $2.6 \times 10^6 \text{ cm}^2$, providing an effective electrode surface area approximately 12 000 times the geometric cross-sectional area. The carbon fibre electrode (cartridge) has a porosity of 90–97%, depending upon the compression of the material and the corresponding specific surface area. The metal is recovered from the cartridge, which is easily removed, by furnace refining, electro-refining or chemical dissolution. The carbon fibre electrode has been used effectively for the recovery of a wide range of metals (or oxide/hydroxide), with the final metal ion concentrations achieved typically below 1 ppm.

Potential high-surface-area materials for three-dimensional electrodes are reticulated or foam carbon, or foam metal. This material has been used in the Retec cell, which is an undivided monopolar connected reactor utilising a bank of vertical foam cathodes (60 \times 50 cm) with interspersed DSA anodes. It has been demonstrated [41], using a 0.4-m long cathode, that the concentration of Cu(II) (in sodium sulfate, pH 2) can be reduced from 10 ppm to approximately 0.1 ppm in a single pass even in the presence of air-saturated solutions.

Fluidised bed electrolysis. The fluidised bed electrode (FBE) is used to produce a solid metal deposit by continuous addition and withdrawal of particu-

late substrate. The cell design and technology, developed by AKZO in the 1970s [42], gives uniform fluidisation, uses stable cylindrical ceramic separators and has improved potential distribution due to strategic positioning of the cathode feeders. The reported performance of the system has been compared favourably economically against non-electrodeposition processes in the recovery of Cu, Hg, Zn, Cd, etc. The fluidised bed electrode is capable of removing metal ions to concentrations below 1 ppm and thus is very attractive for effluent treatment.

6.3 Integration of electrodeposition with other separations

The previous systems for recovery of metal ions have been concerned mainly with solutions containing only one metal ion. With mixed-metal ion solutions there are thermodynamic and kinetic limitations that can affect the selectivity of the system and the quality of the final metal deposit. With some mixed-metal ion solutions the difference in equilibrium potentials for the reactions can indicate that selective electrodeposition is probable, e.g. with solutions of zinc or cadmium and copper in dilute sulfuric acid solutions, as used in fluidised bed electrolysis. Another example is the use of a flow-by carbon felt electrode in the extraction of Cu, Pb and Hg in a batch recirculating reactor [43]. By fixing the initial electrode potential to a low value of -300 mV (vs. SCE), the selective deposition of copper occurs without lead deposition. When the residual copper concentration reaches the prescribed level the potential is increased to -600 mV to remove the lead ion. Overall, the system reduced the concentration of copper from an initial 50 ppm value to 0.05 ppm and reduced the concentration of lead from 100 ppm to 1 ppm (see Fig. 19.17).

The effectiveness of metal deposition can be impeded in the presence of other ionic species, organic or neutral species and also when relevant ionic species are in low concentrations. To improve the efficiency a combined or 'integrated' approach to metal recycling can be used that incorporates other chemical and physical separation processes in conjunction with electrodeposition. This approach is used in several recycling processes, e.g. electrodeposition bath residues, sludge [44], treatment of etching solutions [45], recycling of lead acid batteries

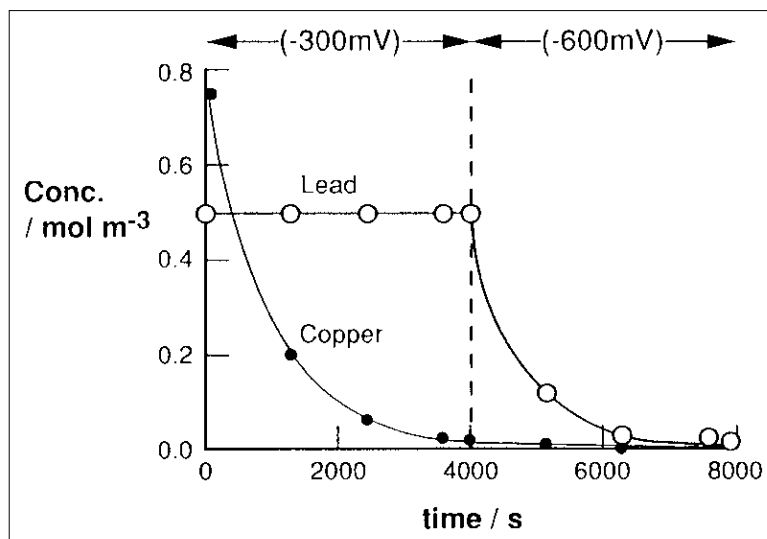


Fig. 19.17 Recovery of copper and lead by successive deposition.

[46,47], processing of nickel cadmium and alkaline batteries [48] and recovery of metals from used catalysts [49].

Combined electrodeposition and ion-exchange systems

The integration of electrochemical recovery and ion-exchange systems to treat the various metal pollutants at point of source or end of pipe is a potentially useful method. With the use of chelating ion-exchange resins, e.g. iminodiacetate, an even greater potential for metal ion separation is possible because these resins are particularly selective for metals such as Cu, Ni and Zn. The combined use of electrodeposition and ion exchange can give the appropriate levelling control in individual metal finishing and plating applications [50]. Each metal recovered generally will require a separate electrowinner because of requirements of different bath conditions (pH, temperature) and varying removal rates. For several metals electrodeposition becomes impractical below certain concentrations, and thus the cell effluent electrolyte can be recycled back to the ion-exchange system.

6.4 Electrochemical ion exchange

Electrochemical ion-exchange systems have been developed by the Atomic Energy Authority, Harwell, UK, in which an electrochemical potential is applied to the ion exchanger. The process is a method of

separation of ionic species in which a potential field is used to enhance the normal operation of standard ion exchange. In this enhanced ion-exchange operation, an ion-exchange material is attached to an electrode structure (typically platinised titanium) [51] using a suitable binder (see Fig. 19.18). The adsorption and elution properties are controlled by the external applied potential.

Suggested applications are in the removal of toxic metal ions, precious metals, nitrates and corrosive anions and in the deionisation of water. The technique has been demonstrated in the removal of chloride and sulfate in the presence of borate/boric acid and for the removal of Co from feeds, from concentrations of 100 ppb to undetectable levels. The feasibility of removing Mo and V polyanions arising from the treatment of hydrodesulfurisation waste catalysts and slags from oil-fired boilers has been examined [52].

6.5 Electrochemical membrane processes

Electrochemical membrane separations have applications in the areas of effluent treatment and recycling [2,53]. Electrodialysis is a process in which electrolyte solutions are either concentrated or diluted (or deionised). Over the years the process has been the dominant technique for the desalination of brackish water. Electrodialysis has many applications for the removal or recovery of ionic species and gen-

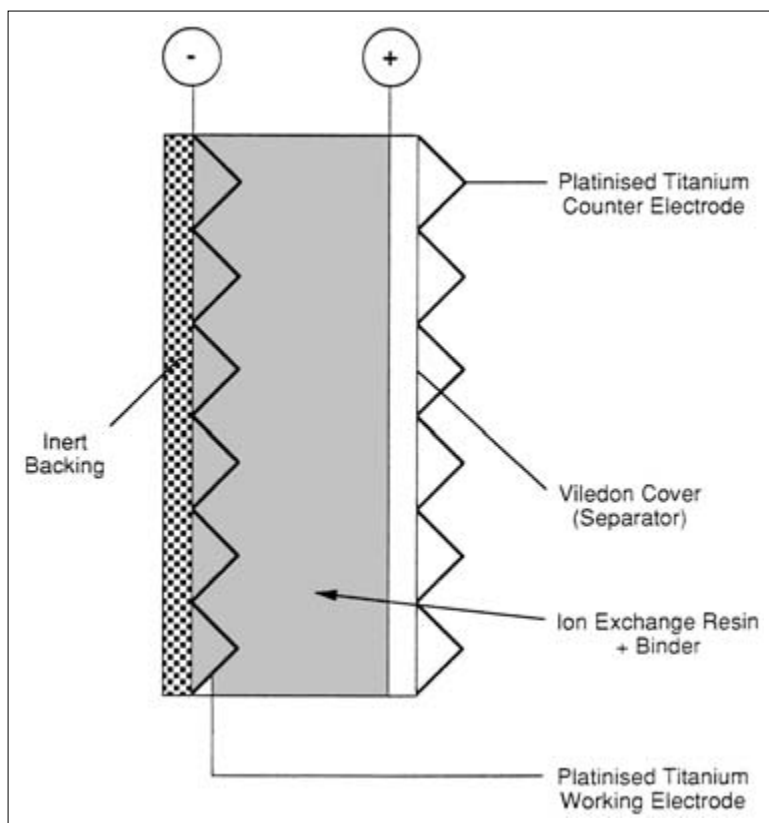


Fig. 19.18 Electrochemical ion exchange.

erally the process can be used to perform a number of functions, such as:

- (1) The separation of salts, acids and bases from aqueous solutions.
- (2) The separation of ionic compounds from neutral molecules.
- (3) The separation of monovalent ions from ions with multiple charges.
- (4) The introduction of ionic moieties to generate new species.

Electrodialysis competes with other separation processes, such as reverse osmosis, ion exchange, dialysis, etc., and can offer advantages of high selectivity for charged components, lower energy costs and investment costs, continuous operation, high product recovery rates and minimal change of feed water constituents due to chemical or thermal degradation.

The process of electrodialysis uses a direct electrical current to transport ions through ion-selective membranes. There are two types of membranes:

anionic, which are permeable to anions; and cationic, which are permeable to cations. The membranes are effectively impermeable to the hydraulic transport of water and other non-charged species. In practical applications the membranes are arranged alternately in a stack, as shown in Fig. 19.19, between two electrodes. The membranes in the stack are separated from one another by thin plastic spacers 0.5–2.0 mm in thickness, which creates discrete compartments known as cells. The application of a potential difference (direct electrical current) between the two electrodes induces the transport of ionic species. Anions migrate towards the anode, passing through the anion-exchange membrane, and then are blocked by the cation-exchange membrane. The cations behave in a similar manner but move in the opposite direction and are retained by the anion-exchange membrane. Thus one type of cell will become ion enriched, forming the concentrate stream, and the other cell will become ion depleted, forming the diluate stream. The main variable for controlling the quantities of ions transferred through

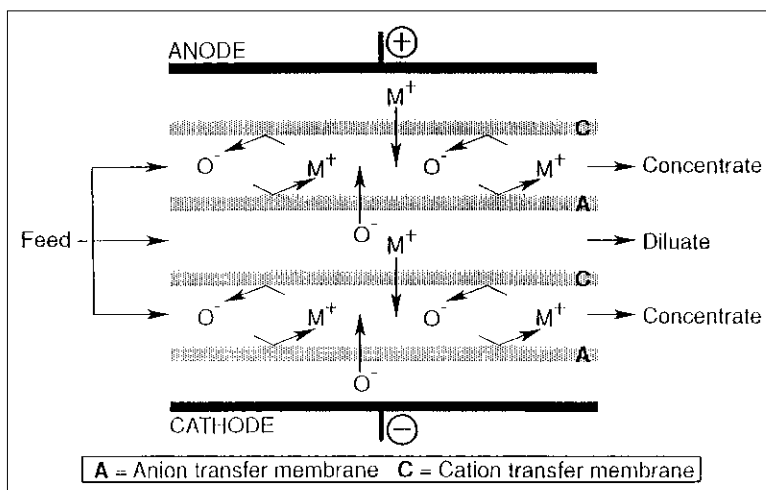


Fig. 19.19 Electrodiagnosis stack.

the respective membranes is the cell current. In addition to the many concentrate and diluate streams in the stack, there are two other streams: the electrode rinse streams adjacent to the anode and the cathode.

There are several applications of electrodiagnosis in industry that are well established and include water desalination, salt production and a variety of applications in the food, dairy and pulp and paper industries [54]. Other applications of electrodiagnosis are in the de-salting of organic solutions and dye stuffs that are contaminated with salt solutions. Typical application are the treatment of pulping spent liquors to recover pulping chemicals, sugars and low-molecular-weight organic and lignosulfonic acids and the desalination of wastewater from low-waste viscose manufacturing technology. A major application is in the processing of rinse waters from the electroplating industry, where in principle complete recycling of the water and metal ions can be achieved. The recovery of HF and H₂SO₄ from pickle rinse solutions and the removal of heavy metals from electroplating rinse waters and contaminants, by electrodiagnosis, is especially attractive. Treatment of the rinse solution using electrodiagnosis removes and concentrates the salts, which are recycled directly to the plating bath. The diluate is fed back to the still-rinse, keeping the salt concentration in the still-rinse at a low level [53]. Electrodiagnosis is being used successfully on several plating baths for metals such as Au, Pt, Ni, Cu, Ag, Pd, Cd, Cr, Zn and Sn/Pb [54].

6.6 Electrohydrolysis

Electrohydrolysis is a process that uses the ionic products formed during the production of hydrogen and oxygen gases, i.e. hydroxide and hydrogen ions, respectively, to regenerate acids and bases from salts. The electrohydrolysis of aqueous streams of sodium sulfate to regenerate sulfuric acid and caustic soda can be operated in a three-compartment cell (see Fig. 19.20), fitted with a cationic membrane and an anionic membrane, in which the stream containing sodium sulfate is fed to the central compartment. On electrolysis the ionic components transfer across the ion-exchange membranes; the sodium ions across the cation-exchange membrane combine with the hydroxide ion, and the sulfate ions across the anion-exchange membrane combine with the hydrogen ions, to produce the sulfuric acid. This process has a number of limitations: the current efficiency falls off significantly with the formation of higher concentrations of sulfuric acid and the selectivity of the anion-exchange membrane is not sufficiently good to eliminate sodium ions from the anode compartment.

An alternative process, based on a two-compartment cell, has been developed by ICI [56] to carry out the electrohydrolysis of sodium sulfate. The process gives a lower cell voltage than the three-compartment unit, avoids the limitations of the anion-exchange membranes and gives high current efficiencies at sulfuric acid product concentrations of 15% and greater. Although the sulfuric acid contains

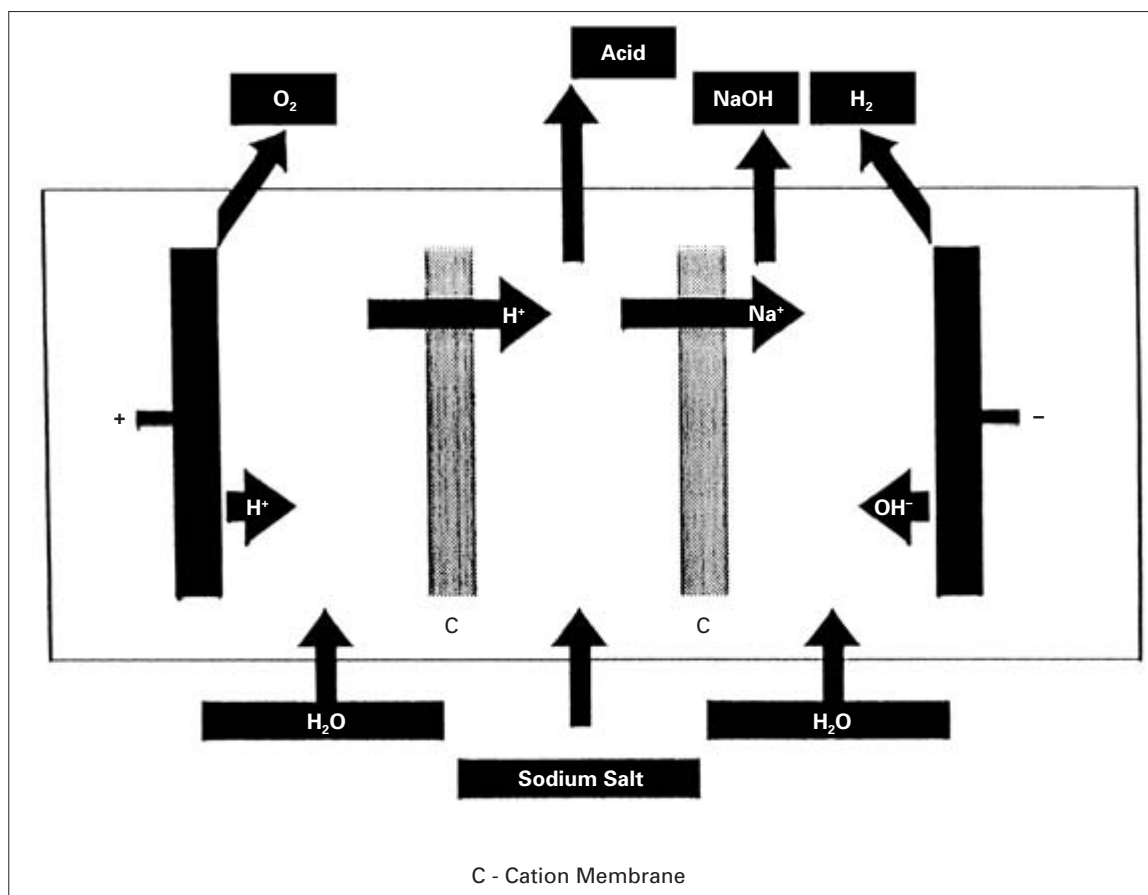


Fig. 19.20 The electrohydrolysis process.

sodium sulfate, this can be removed by crystallisation. Importantly the catholyte product, typically 20% w/w NaOH, is pure.

Electrohydrolysis has been applied to many inorganic and organic species [2]:

- (1) The isolation and purification of iminodiacetic acid from its sodium salt.
- (2) The separation of organic acids from Kraft Black liquors.
- (3) The recovery of ammonium sulfate (and some sulfite) from a wastewater.
- (4) The recovery and reuse of sodium hydroxide from industrial effluents. The typical applications are in ion-exchange resin generation, pulp and paper, textile and various industries.
- (5) The recycling of sodium sulfate as ammonium sulfate and sodium hydroxide.

Bipolar membranes

A recent process for the electrohydrolysis of salts is based on the use of bipolar membranes [55]. A bipolar membrane is a polymeric material consisting of two homopolar ion-exchange membranes, one cationic and one anionic. When placed in an electrochemical cell, with the cationic layer in contact with catholyte, current is carried by protons moving through this layer and by hydroxyl ions moving through the opposite anionic layer (see Fig. 19.21). Water diffuses through these layers to an interfacial region where it dissociates into the constituent hydrogen and hydroxide ions, which diffuse back into the adjacent compartments in opposite directions. Because of this property, bipolar membranes often are referred to as 'water-splitting' membranes. For efficient operation the membrane should have a

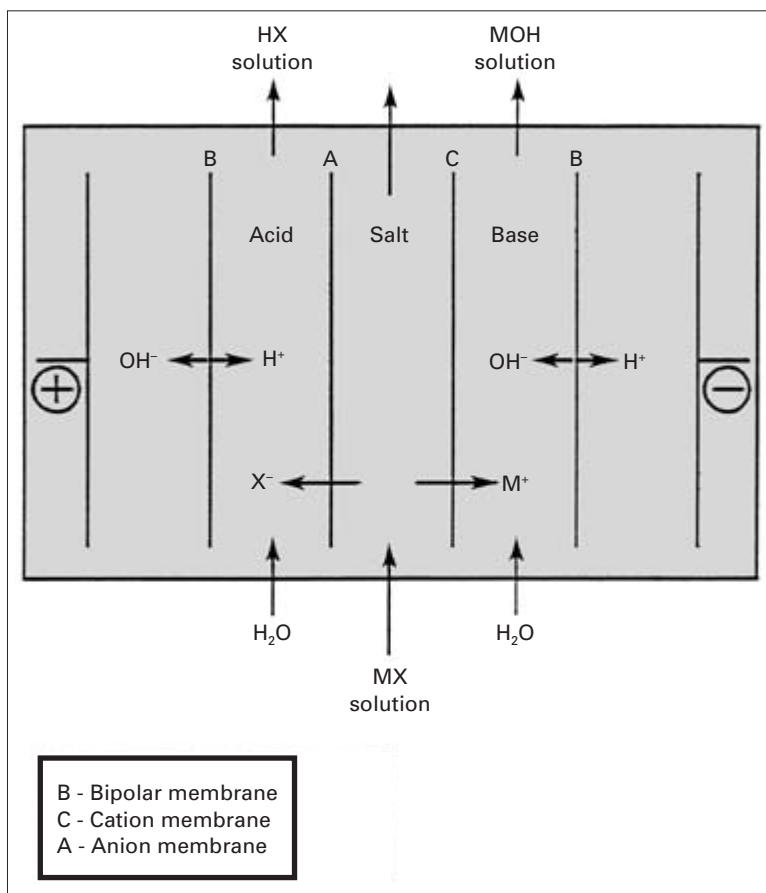


Fig. 19.21 Bipolar membrane separation.

good water permeability from the external solution to the interface and have a thin interface between the cation and anion layers to give efficient, low-resistant transport of hydrogen and hydroxide ions.

The attractions of bipolar membranes are that they avoid the production of excess quantities of by-product gases and also reduce the energy costs associated with electrode polarisation in the more conventional electrohydrolysis approach. Bipolar membranes are used with either two- or three-compartment cells. The basic three-compartment cell, shown in Fig. 19.21, for a typical sodium sulfate treatment consists of a cation-exchange, an anion-exchange and a bipolar membrane. In operation, positive and negative ions migrate through the respective monopolar membranes and concentrate in compartments on opposite sides of the bipolar membranes. The hydrogen and hydroxide ions gen-

erated by the bipolar membrane diffuse back into the adjacent compartments, in opposite directions, to produce the alkali and acid solutions.

Bipolar membranes also can be used in a two-cell configuration, regenerating only one base or acid. For example, in an anion/bipolar membrane configuration the anions move through the anion-exchange membrane and combine with the H^+ ions arising from the bipolar membrane to form the acid product. This type of cell is useful for converting salts of weak bases (e.g. ammonium nitrate) to a salt/base mixture and a relatively pure acid. Conversely, the cation/bipolar membrane two-compartment cell is useful for the processing of the salts of weak acids (of organic acids) to give a relatively pure base stream and a mixed acid/salt stream. Potential applications of bipolar membranes in recycling or effluent control [55] are numerous.

References

- Rajeshwar, K., & Ibanez, J. *Environmental Electrochemistry. Fundamentals and Applications in Pollution Abatement*. Academic Press, London, 1997.
- Scott, K. *Electrochemical Processes for Clean Technology*. Royal Society of Chemistry, Cambridge, 1995.
- Bard, A. J., Parsons, R., & Jordan, J. *Standard Potentials in Aqueous Solutions*. Dekker, NJ, 1986.
- Southampton Electrochemistry Group. *Instrumental Methods in Electrochemistry*. Ellis Horwood, Chichester, 1985.
- Scott, K. *Electrochemical Reaction Engineering*. Academic Press, London, 1991.
- Goodridge, F., & Scott, K. *Electrochemical Process Engineering*. Plenum Press, New York, 1995.
- Danly, D. L., & Cambell, C. R. In: *Technique of Electroorganic Chemistry*. (Weinberg, N. L. & Tilak, B. V., eds), Part III. John Wiley, Chichester, 1982: 283–340.
- Clifford, A., Dorg, D., Giziewicz, E., & Rogers, D. In *Proceedings of the Symposium on Electrochemical Engineering and Small Scale Electrolytic Processes*, Vol. 90-10. Electrochemical Society NJ, 1990.
- Vincent, C. A., & Scrosati, H. B. *Modern Batteries*, 2nd edn. Arnold, London, 1997.
- Appleby, A. J., & Foulkes, F. R. *A Fuel Cell Handbook*, 2nd edn. Kreiger Publishing, Malabar, FL, 1993.
- Larminie, J., & Dicks, A. *Fuel Cell Systems Explained*. John Wiley, Chichester, 2000.
- 5th European Conference on Electrochemical Processing*, 12–16 April 1999, Capenhurst, Chester, UK.
- Scott, L. L., Kohl, P., Winnick, J., & Bottomley, L. A. *J. Electrochem. Soc.*, 1998, **145**, 4062.
- Pletcher, D., & Walsh, F. C. *Industrial Electrochemistry*, 2nd edn. Chapman and Hall, London, 1990, p. 34.
- Dalrymple, I. *Electrochemical Engineering Course*, July 1994, Newcastle upon Tyne.
- Valdes, J. L., Cadet, G., & Mitchell, J. W. *J. Electrochem. Soc.* 1991, **138**(6), 1654.
- Scott, K. *Electrochim. Acta*, 1991, **36**, 1447.
- Yu, J. C., Baizer, M. M., & Nobe, K. *J. Electrochem. Soc.*, 1988, **135**, 1400.
- Yu, J. C., Baizer, M. M., & Nobe, K. *J. Electrochem. Soc.*, 1988, **135**(6), 1392.
- Putter, H. *13th International Forum on Electrolysis in the Chemical Industry*, November 1999, Florida, USA.
- Genders, J. D., & Pletcher, D. *Electrosynthesis, From Pilot, To Plant, To Production*. The Electrosynthesis Co. New York, 1990, Chapt. 10: 197–206.
- Top. Curr. Chem.*, **185**. In: Steckham E., ed *Electrochemistry VI: Electroorganic Synthesis Bond Formation at Anode and Cathode*. Berlin: Springer-Verlag, 1997: 183–206.
- Degner, D. *Top. Curr. Chem.*, 1988, **148**, 1–95.
- Weinberg, N. L., & Tilak, B. V. *Technique of Electroorganic Synthesis. Part III Scale-up and Engineering Aspects*. John Wiley, New York, 1982.
- Steckhan, E. *Angew. Chem. Int. Ed. Engl.*, 1986, **25**, 683.
- An, W., Hong, J. K., & Pintauro, P. N. *J. Appl. Electrochem.*, 1998, **28**, 947.
- Kuroboshi, M., Tanaka, M., Kishimoto, S., Tanaka, H., & Torii, S. *Synlett*, 1999, 69.
- Stepanov, A. A., Minyaeva, T. V., & Martynov, B. I. *Tetrahedron Lett.*, 1999, **40**, 2203.
- Jubault, P., Goumain, S., Feasson, C., & Coobnon, N. *Synthesis*, 1999, 981.
- Datta, A. K., Marron, P. A., Wagenknecht, J. H., & King, C. J. H. *J. Appl. Electrochem.*, 1998, **28**, 569.
- Yasuhara, A., Kasano, A., & Sakamoto, T. *J. Org. Chem.*, 1999, **64**, 2301.
- Kurono, N., Sugita, K., Takasuji, S., & Tokuda, M. *Tetrahedron*, 1999, **55**, 6097.
- Bewt (Water Engineers) Ltd. *Technical Brochure, Profit from Effluent*. Tything Road, Alcester, Warwickshire, UK.
- Brown, C. J. *Electrochemistry for a cleaner environment*. In Genders, J. D. & Weinberg, N. L., (eds). The Electrosynthesis Co., New York, 1992, Chapt. 7.
- Robinson, D., & Walsh, F. C. *Hydrometallurgy*, 1991, **26**, 93–114, 115, 133.
- Muller, K. J. *Electrochemical Cell Design and Optimisation Procedures*. Dechema Monograph, Vol. 123. Dechema, Germany: Frankfurt am Main, 1991, 199.
- Keating, K. B., & Williams, J. M. *Resource Conserv. Conserv.*, 1976, **2**, 39.
- Robertson, P. M., Scholder, B., Theis, G., & Ibl, N. *Chem. Ind.*, 1978, 459.
- Simmons, D. *J. Appl. Electrochem.*, 1984, **14**, 595.
- Sunderland, J. G. E. A. Technology, Capenhurst, Chester, CHI 6ES.
- Pletcher, D., Whyte, I., Walsh, F. C., & Millington, J. P. *J. Appl. Electrochem.*, 1993, **23**, 82.
- Raats, C. M. S., Boon, H. F., & van der Heiden, G. *Chem. Ind.*, 1978, 465.
- Polcaro, A. M., & Palmas, S. *Electrochemical Engineering and the Environment*, Institute of Chemical Engineering Symp. Ser. No. 127. Oxford: Pergamon Press, 1992, p. 85.
- Stefanowicz, T., Golik, T., Napieralska, S., & Osinska, M. *Resources, Conserv. Recycl.*, 1991, **6**, 61.
- Clean Technology Bulletin*, Environmental Protection Technology Scheme, November 1989, DoE, UK, D119NJ.
- Maja, M., Pinazzi, N., Spinelli, P. *Electrochemical Engineering*, Institute of Chemical Engineering Symp. Ser. No. 98, Oxford: Pergamon Press, 1986, pp. 155–172.
- Ducati, U. Italian Patent 23745 AA/81.
- Div. Tech. Soc. *Recycling of Spent Batteries*, TNO Report 89-127/R.22/CAP. Netherlands: TNO, 1989.
- Dalrymple, I. *Electrochemical Engineering Course*, July 1994, Newcastle upon Tyne.

50. Brown, C. J. *Separation Processes in Hydrometallurgy* (Davies, G. A., ed.). Ellis Horwood, Chichester, 1987, p. 379.
51. Bridgewater, N. J., Jones, C. P., & Neville, M. D. *J. Chem. Tech. Biotech.*, 1991, 469.
52. Henry, P., & van Lierde, A. *Hydrometallurgy*, 1998, **48**, 73.
53. Davies, T. A., Genders, J. D., & Pletcher, D. *Ion Permeable Membranes*. The Electrochemical Consultancy, London, 1997.
54. Scott, K. *Handbook of Industrial Membranes*, 2nd edn. Elsevier, Oxford, 1998.
55. *Handbook on Bipolar Membrane Technology*. University of Twente, The Netherlands, 2000.
56. Martin, A. D. *I. Chem. E. Symp. Ser. No. 127*, 1992, p. 153.

Chapter 20: Fuel Cells: a Clean Energy Technology for the Future

BRIAN GRIEVSON

1 Introduction

Global electricity consumption has been predicted to approximately double from 12 trillion kWh in 1996 to 22 trillion kWh by 2020, with the strongest growth expected in the developing world [1]. The generation of this electricity will be subject to increasingly stringent emission regulations to prevent environmental damage. Fuel cell technology has been developed as a means of increasing the efficiency of electricity generation from existing petroleum- and natural-gas-based fuels. In addition, fuel cells are able to utilise both hydrogen and methanol, potentially from regenerative biomass sources, as a long-term alternative to petroleum fuels.

Fuel cells were first described in 1839 by the British scientist William Grove, who was experimenting with the electrolysis of water and collecting the hydrogen and oxygen generated in inverted test tubes. He observed that after removing the battery power from the electrolysis cell current continued to flow from the cell, making use of the collected gases as the fuel. In 1889 Ludwig Mond, later to become a co-founder of ICI, used porous non-conducting substances such as plaster of Paris and earthenware to contain the electrolyte and platinum electrodes to make an improved fuel cell [2]. However, fuel cell technology was not generally developed and used until the space exploration programmes in the 1960s and for military submarine applications. The fuel cells were used to generate electricity for power and water for consumption from hydrogen fuel in a clean, efficient and reliable way. In these cases cost was of little concern, hence fuel cell systems for commercial and consumer applications generally were too expensive. The financial incentive also was low for individual companies to make the huge investments necessary to develop a feasible commercial fuel cell system. In these circumstances the proactive nature of government-based investment, especially in Japan and the USA, was crucial to commercial fuel

cell development. A number of excellent and comprehensive reviews of recent fuel cell technology are available [3–8].

2 Fuel Cell Electrochemistry

Fuel cells are electrochemical devices that convert the chemical energy of a fuel directly into electrical energy. Like battery systems, they are composed of an anode, cathode and electrolyte (see Fig. 20.1). Unlike battery systems, they are not exhausted when the cell reaction has reached equilibrium and fuel cells are able, in theory, to continue operation as long as fuel is supplied to them, although in practice degradation of cell components will limit lifetime. The fuel is supplied to the anode and oxygen or air to the cathode. The overall chemical reaction is the oxidation of the fuel to carbon dioxide and water.

A range of fuels may be used, including hydrogen, natural gas and methanol. The electrochemical reactions taking place within the fuel cell also will depend on the type of fuel cell used, because each type uses a different charge carrier through the electrolyte, as shown in Table 20.1. There are five main types of fuel cell currently under development, namely alkaline (AFC), solid polymer (or polymer electrolyte or proton-exchange membrane) (SPFC), phosphoric acid (PAFC), molten carbonate (MCFC) and solid oxide (SOFC). Each type uses a different electrolyte system and they operate under different regimes of conditions, especially temperature, giving them advantages for particular application areas. In this review hydrogen is used as the fuel to describe the electrochemistry of the fuel cell system. In practice hydrogen often is generated from other fuels, such as from carbon monoxide by water gas shift reactions or from hydrocarbons by steam reforming reactions. These reactions can occur either within the fuel cell or in an external processing unit. In fact these two reactions may be more favourable than the direct oxidation of the fuels, especially at high

Fig. 20.1 Schematic diagram of a fuel cell system. Fuel cell processes: [a] diffusion of fuel through anode, [b] electron transfer at anode/electrolyte interface, [c] diffusion of charge carrier through electrolyte, [d] electron transfer at cathode/electrolyte interface, [e] diffusion of oxygen through cathode, [f] diffusion of water through electrodes, [g] ohmic loss in anode, [h] ohmic loss in cathode and [i] electronic conductivity of electrolyte.

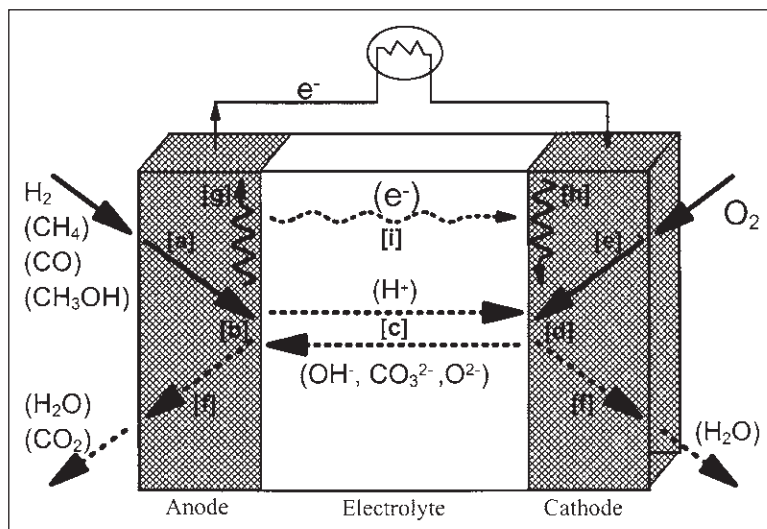


Table 20.1 Electrochemical half-reactions within fuel cells

Fuel cell type	Anode reaction	Charge carrier	Cathode reaction
Alkaline	$\text{H}_2 + 2\text{OH}^- \rightleftharpoons 2\text{H}_2\text{O} + 2\text{e}^-$	OH^-	$0.5\text{O}_2 + 2\text{H}_2\text{O} + 2\text{e}^- \rightleftharpoons 2\text{OH}^-$
Solid polymer	$\text{H}_2 \rightleftharpoons 2\text{H}^+ + 2\text{e}^-$	H^+	$0.5\text{O}_2 + 2\text{H}^+ + 2\text{e}^- \rightleftharpoons \text{H}_2\text{O}$
Phosphoric acid	$\text{H}_2 \rightleftharpoons 2\text{H}^+ + 2\text{e}^-$	H^+	$0.5\text{O}_2 + 2\text{H}^+ + 2\text{e}^- \rightleftharpoons \text{H}_2\text{O}$
Molten carbonate	$\text{H}_2 + \text{CO}_3^{2-} \rightleftharpoons \text{H}_2\text{O} + \text{CO}_2 + 2\text{e}^-$ $\text{CO} + \text{CO}_3^{2-} \rightleftharpoons 2\text{CO}_2 + 2\text{e}^-$	CO_3^{2-}	$0.5\text{O}_2 + \text{CO}_2 + 2\text{e}^- \rightleftharpoons \text{CO}_3^{2-}$
Solid oxide	$\text{H}_2 + \text{O}^{2-} \rightleftharpoons \text{H}_2\text{O} + 2\text{e}^-$ $\text{CO} + \text{O}^{2-} \rightleftharpoons \text{CO}_2 + 2\text{e}^-$ $\text{CH}_4 + 4\text{O}^{2-} \rightleftharpoons 2\text{H}_2\text{O} + \text{CO}_2 + 8\text{e}^-$	O^{2-}	$0.5\text{O}_2 + 2\text{e}^- \rightleftharpoons \text{O}^{2-}$
Shift reaction	$\text{CO} + \text{H}_2\text{O} \rightleftharpoons \text{CO}_2 + \text{H}_2$	—	—
Reforming reaction	$\text{CH}_4 + \text{H}_2\text{O} \rightleftharpoons \text{CO} + 3\text{H}_2$ $\text{CH}_4 + \text{CO}_2 \rightleftharpoons 2\text{CO} + 2\text{H}_2$	—	—

operating temperatures. Because fuel mixtures typically are used, reference often is made to equivalent hydrogen as the basis for calculating the energy input, and hence the efficiency, of fuel cells.

For a hydrogen/oxygen fuel cell the maximum electrical work that can be obtained is given by the change in Gibbs free energy (ΔG) for the reaction of hydrogen and oxygen. The ideal cell potential (E^0) may be calculated from the ideal Gibbs free energy (ΔG^0) and has a value of 1.23 V when the water product is in the liquid state, or 1.18 V when the water is in the gaseous state:

$$\Delta G^0 = -n F E^0$$

where n is the number of electrons per molecule participating in the electrochemical reaction ($n = 2$ for H_2/O_2 ; $n = 8$ for CH_4/O_2), F is Faraday's constant ($= 96487 \text{ C mol}^{-1}$) and E^0 is the cell potential at ideal conditions of 298 K and 1 atm.

The theoretical efficiency of a fuel cell is given by the ratio between the Gibbs free energy and the enthalpy (ΔH) of the fuel:

$$\text{Efficiency of a fuel cell} = \frac{\Delta G}{\Delta H}$$

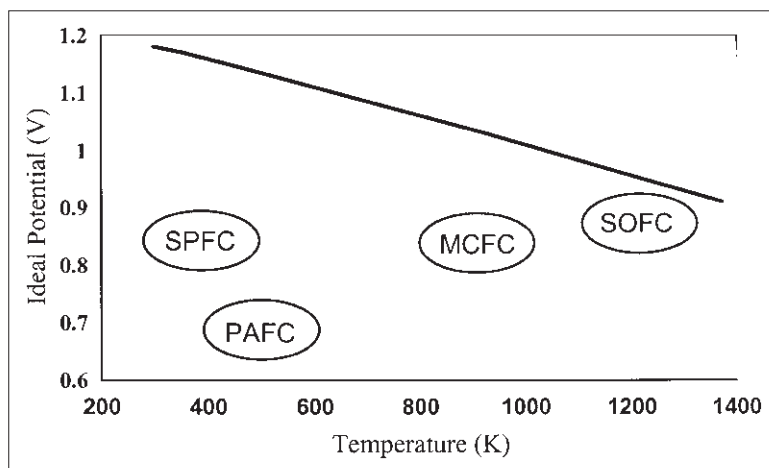


Fig. 20.2 Graph of the ideal potential for a hydrogen/oxygen fuel cell as a function of temperature.

As temperature increases, ΔG also increases and hence the ideal fuel cell potential will decrease as shown in Fig. 20.2. Because the different fuel cell types operate under different temperature regimes, they will have different ideal cell potentials.

In comparison, the theoretical efficiency of a conventional heat engine is limited by the Carnot efficiency, which is a function of the upper temperature (T_U) and the lower temperature (T_L) of the thermal cycle:

$$\text{Carnot efficiency of a heat engine} = \frac{T_U - T_L}{T_U}$$

At lower operating temperatures the fuel cell efficiency is significantly higher than the heat engine. The efficiency of a heat engine increases with operating temperature and at approximately 1200K may actually be higher than a fuel cell. However, the need for motion within a heat engine at such high temperatures will present serious material problems. The relaxing of the temperature requirement enables greater flexibility in fuel cell design to achieve higher efficiency.

The fuel cell potential also will be altered by the reaction kinetics of the chemical process involved, according to the Nernst equation:

$$E = E^0 - \frac{RT}{nF} \ln \left[\frac{P_{\text{water}}}{P_{\text{hydrogen}} \times (P_{\text{oxygen}})^{0.5}} \right]$$

where R is the gas constant, T is the temperature, and P is the partial pressure. The voltage obtained from the fuel cell when a current is drawn is lower

than the ideal potential due to losses within the cell. Three main sources contribute to these losses, namely activation polarisation, ohmic polarisation and concentration polarisation, as shown in Fig. 20.3.

Activation polarisation arises due to slow kinetics of the electrochemical reaction at the electrode surface and typically may be in the region of 50–100 mV. Ohmic polarisation arises due to resistance of the electrolyte to the flow of ions and resistance of the electrodes to the flow of electrons. Concentration polarisation arises due to the formation of concentration gradients close to the electrode surfaces as a result of slow diffusion, solution or dissolution of reaction products away from the electrodes. The overall result of these polarisation losses is to increase the anode potential and decrease the cathode potential, and hence to reduce the cell voltage. The polarisation can be reduced by modifying the cell design, e.g. by using better electrocatalysts or thinner cell components, and by changing the temperature or pressure. A compromise often is required between operating at a higher temperature and/or pressure and causing unacceptable stability or durability problems to the cell components.

3 Fuel Cell Technology

Over the last 40 years each of the main types of fuel cell have been developed and improved to give higher electrical efficiency, longer operating lives and lower cost of components and supporting systems.

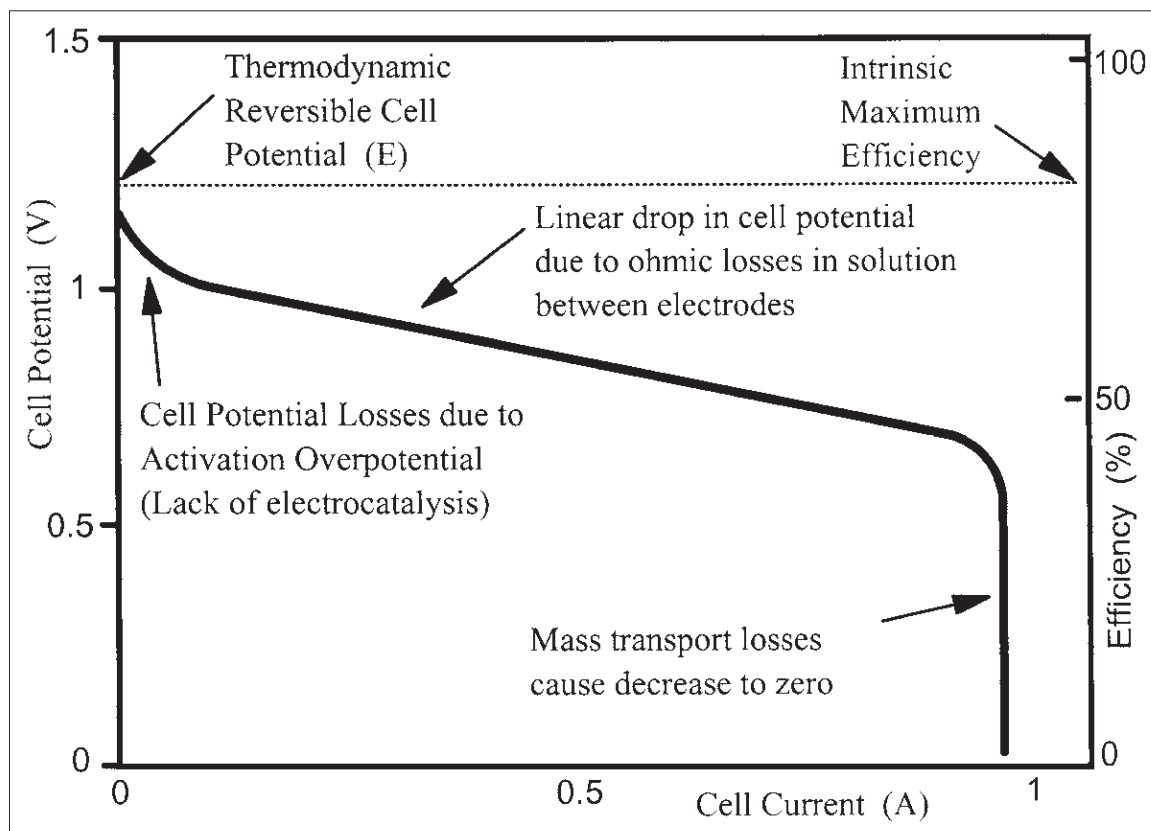


Fig. 20.3 Graph of the reduction in voltage of a hydrogen/oxygen fuel cell as current is drawn.

Typical recent technologies for each component of the main fuel cell types are summarised in Table 20.2.

In order to achieve acceptable reaction rates at the electrodes, the low-temperature fuel cells need to use electrocatalysts, which are usually noble metal based. Also, hydrogen tends to be the only fuel that can be processed. In contrast, the high-temperature fuel cells do not need to use electrocatalysts and can operate using a wider range of fuels, including hydrocarbons and carbon monoxide.

3.1 Alkaline fuel cell

The alkaline fuel cell (AFC) was the first type of fuel cell to be developed and although it has been used

successfully in space exploration programmes and military applications, such as in submarines, it has tended to be superseded by the other types of fuel cell in commercial applications. The AFC may be operated at room temperature or up to 523K using concentrated KOH (85%) as the electrolyte. A number of electrocatalyst materials can be used, such as nickel, metal oxides and noble metals. A limitation of AFCs is that their fuel must be very pure with respect to reactive contaminants, such as carbon monoxide and carbon dioxide. Carbon dioxide will react with the electrolyte to give potassium carbonate, which will cause the efficiency of the AFC to deteriorate rapidly. The cost of removal of carbon dioxide from the air source will render an AFC uneconomical for normal commercial applications.

International Fuel Cells Inc. in the USA have developed a commercial AFC system for use in space and military applications.

Table 20.2 Summary of recent technology used for the main types of fuel cells

Property	AFC	SPFC	PAFC	MCFC	SOFC
Operating temperature	333–363K	353–373K	473K	923K	1073–1273K
Anode	Pt (80%) Pd (20%)	Pt/C, 4 mg Pt cm ⁻²	Pt/C on PTFE, 0.1 mg Pt cm ⁻²	Ni–Cr/Ni–Al	Ni/ZrO ₂
Cathode	Au (90%) Pt (10%)	Pt/C, 4 mg Pt cm ⁻²	Pt/C on PTFE, 0.5 mg Pt cm ⁻²	NiO–Li	LaMnO ₃ (doped)
Electrode support	Graphite	Graphite	Carbon paper	LiAlO ₂	—
Electrolyte	KOH (35–45%)	Perfluorinated sulfonic acid polymers	H ₃ PO ₄ , 100%	Li ₂ CO ₃ (62%) K ₂ CO ₃ (38%)	ZrO ₂ with Y ₂ O ₃ (8 mol.%)
Electrolyte support	Metals	—	SiC on PTFE	c-LiAlO ₂ , a-LiAlO ₂	—
Cell interconnect	Graphite	Graphite	Graphite	Ni on Incoloy	LaCrO ₃ (doped)
Charge carrier	OH ⁻	H ⁺	H ⁺	CO ₃ ²⁻	O ²⁻

3.2 Solid polymer fuel cell

The solid polymer fuel cell (SPFC) is typified by high power density, low weight and volume, low cost, low corrosion, low operating temperature and relative ease of achieving gas-tight seals. An SPFC may be started up quickly and reach full power within a short time. It can also respond very fast to changes in demand for power. These properties make an SPFC the preferred fuel cell for vehicle power. The disadvantages of an SPFC result from the low operating temperature, which means that the electrode kinetics are slow and that expensive noble metal catalysts are required. These catalysts are poisoned by carbon monoxide, which means that certain fuels, such as reformed hydrocarbon fuels, must be pretreated to lower the carbon monoxide, carbon dioxide and hydrocarbons to acceptable levels. This may be achieved by membrane separation, methanation, pressure swing adsorption or selective oxidation. Another disadvantage of the low operating temperature of an SPFC is that no heat is available for external use in combined heat and power applications, in contrast to the MCFC and SOFC types. Methanol would be a useful fuel for vehicular use [9] although hydrogen, despite the logistical and safety issues, has been developed extensively and the partial oxidation of gasoline also has been investigated.

A cation-exchange membrane was introduced into fuel cells by Grubbs in 1959 to function as an ion-conductive gas barrier [10]. Initially aqueous acids

were used as the electrolyte, however it was found that hydrated membranes also could act as the electrolyte [11]. Perfluorinated sulfonic acid polymers are used as the membrane due to their relatively high thermal tolerance and high chemical stability towards strong acids and alkalis. The membrane is sandwiched between two platinum-impregnated porous electrodes backed with a coating of polytetrafluorethene to provide a path for gas diffusion to the catalyst layer. A critical issue for the successful operation of an SPFC is water management within the membrane. The ionic conductivity of the membrane depends on the water content and is highest when the membrane is fully saturated. Water is produced from the cell reactions as liquid and it will have to be removed from the cell. Too much water in the cell will result in flooding of the electrodes and a reduction in the gas diffusion to the electrodes. Too little water in the cell will result in dehydration of the membrane and a reduction in ionic conductivity. The membrane also will shrink on dehydration, causing it to lose contact with the electrodes and because there is no liquid electrolyte to fill the gap electrical contact will be lost. Dehydration can be caused by a range of factors such as high reactant flow and low humidity of the reactants. Operating the SPFC at higher temperatures, such as approaching 373 K, and lower pressure also will contribute to dehydration. Another factor to take into account in the water balance is the effect of water drag through the cell as the ion species are transported across the cell, which is represented more

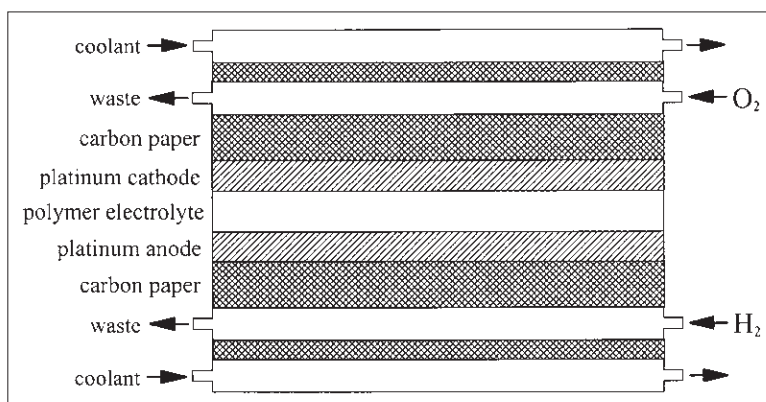


Fig. 20.4 Schematic diagram of a solid polymer fuel cell (not to scale).

accurately as a hydrated proton. Diffusion of water can occur from the reactant gases through both the anode and cathode, which will be a function of cell current, membrane characteristics and the electrode structures. The water balance may be controlled by humidifying the reactant gases. The electrodes are cast as thin films and bonded to the membrane. Machined graphite plates are used to collect the current from each cell and distribute it to the terminals. Channels within the graphite enable good gas distribution and efficient thermal management, often by using a heat transfer fluid, typically water. A soluble form of the polymer is incorporated into the porosity of the carbon support to increase the interface between the electrocatalyst and the electrolyte. Figure 20.4 shows the layout of the main features of an SPFC.

Recent developments in the cell components have concentrated on improving the cell performance and lowering the overall cost. Cell membranes have been improved by using lower molecular weight polymers with shorter distances between the sulfonic acid groups. This results in higher conductivity and better water retention capacity. Lower cost membranes have been made using trifluorostyrene and substituted trifluorostyrene co-polymers [12]. The platinum loading on the electrode has been reduced to a level of 0.1 mg cm^{-2} of platinum [13]. Low-cost, lightweight graphite has replaced expensive high-purity graphite for the bipolar plates. The use of conductive plastics for bipolar plates has been investigated, although to date they have not been as good as graphite [12]. Extending the capability of an SPFC to function using the direct methanol and formaldehyde electro-oxidation reactions has been possible

using platinum/tin and platinum/ruthenium bimetallic catalysts [14].

The performance of SPFCs has increased markedly from a current density of 37 mA cm^{-2} at 0.78 V , provided by the cells used in the Gemini space programme, to a current density of about 200 mA cm^{-2} today [15] and the best cells are able to supply a power density of $180\text{--}250 \text{ mW cm}^{-2}$. Using higher operating temperatures has lowered the internal resistance of the cell and improved cell performance. This improvement is limited by the resultant higher vapour pressure of the water. Employing a higher oxygen operating pressure has reduced the polarisation of the cathode and hence improved the performance. However, this must be balanced against the increased difficulty of operating under pressure. This improvement is more suitable for stationary applications rather than transport.

A number of companies have developed full-scale commercial SPFC systems or prototypes, including: Advanced Power Sources in the UK; Ballard Power Systems in Canada; Avista Laboratories, Energy Partners, H-Power Corporation and Plug Power L.L.C. in the USA; Siemens AG in Germany; and Fuji Electric, Mitsubishi Electric and Toyota Motor Corporation in Japan.

3.3 Phosphoric acid fuel cell

A phosphoric acid fuel cell (PAFC) uses phosphoric acid as the electrolyte and improvements have resulted in an increase in concentration of the acid from 85% in the 1960s, to 95% in the 1970s and to 100% at present. This has allowed the operating temperature of the cell to be increased to about

200°C and the operating pressure to be increased above 8 atm to give greater cell performance. The electrolyte is supported by polytetrafluoroethene-bonded silicon carbide. The electrodes are polytetrafluoroethene-bonded platinum/carbon black with a metal level of 0.1 mg cm⁻² platinum for the anode and 0.5 mg cm⁻² platinum for the cathode. This is a considerable reduction from the earlier levels of 9 mg cm⁻² and lowers the costs significantly. This reduction was made possible by the development of high-surface-area carbon blacks [5]. Unfortunately, carbon corrosion and platinum dissolution become unacceptably high when the cell voltage is above 0.8 V, and hence the PAFC should be operated in regimes below this voltage. The electrodes are supported on carbon paper, which is a much cheaper alternative than the earlier tantalum mesh. A bipolar plate of carbonised graphite/resin mixtures separates the individual cells, makes electrical connections and provides gas channels to the electrodes. The graphite/resin mixtures are heat treated at 2700°C to make them sufficiently corrosion resistant within the PAFC environment to survive 40 000 h of operation, but they are costly to produce.

Recent developments have been aimed at increasing the power density of the PAFC while reducing costs to a level that is competitive with other energy generation technologies. A power density of up to 310 mW cm⁻² has been achieved with the latest PAFC systems.

A number of companies have developed full-scale commercial PAFC systems or prototypes, including International Fuel Cells Inc. in the USA and Toyota in Japan.

3.4 Molten carbonate fuel cell

A molten carbonate fuel cell (MCFC) uses molten carbonate salts as the electrolyte and therefore must operate at about 650°C to maintain the molten state. The charge-transfer species is the carbonate ion, which means that there is an effective transfer of carbon dioxide from the cathode gas stream to the anode gas stream. As a result, the cell potential will depend on the relative partial pressures of carbon dioxide at the cathode and anode, as well as the partial pressures of oxygen and fuel. The carbon dioxide balance can be maintained either by recycling carbon dioxide from the anode to the cathode or by producing carbon dioxide during combustion

of the anode exhaust gas then mixing it with the cathode stream, or by supplying carbon dioxide from an external source. The higher operating temperature will give a higher overall system efficiency and a greater flexibility in the choice of fuels. However, corrosion problems can be severe in the aggressive molten carbonate salts. This imposes restrictions on cell construction materials and their operating life. A stable electrolyte/gas interface is achieved by balancing capillary pressures within the porous electrodes, which depends on the relative pore size [16]. Larger pores in the electrode materials and smaller pores in the electrolyte material, if chosen correctly, ensure that the electrolyte matrix is completely filled with electrolyte and that the electrodes are partially filled. The correct distribution is critical for high cell performance. Redistribution of the electrolyte can occur via corrosion reactions, potential driven migration, creepage and salt vaporisation [17]. The electrolyte has consisted of mixtures of lithium, sodium and potassium carbonates, with the most recent composition being lithium carbonate (62%) and potassium carbonate (38%). The richer the electrolyte is in lithium carbonate, the higher will be the ionic conductivity and hence the lower the ohmic polarisation. However, the gas solubility and diffusivity will be lower and corrosion will be more rapid.

Traditional electrodes based on precious metals have been replaced with nickel alloys for the anode and lithium oxides for the cathode. The most important developments recently have been concerned with the fabrication of more efficient electrolyte structures. Hot pressing techniques tend to give structures that are thick (1–2 mm) and exhibit poor uniformity of microstructure with many voids. In consequence, the structures tend to have poor mechanical strength, making it difficult to scale them up into larger areas. They also exhibit higher than expected resistance [18]. Improvements in processing techniques, such as the use of tape casting and electrophoretic deposition, have enabled much thinner (0.5 mm) and stronger structures to be manufactured. The electrolyte structure also has a tendency to increase in resistance during the lifetime of the cell, resulting in ohmic losses from 65 mV initially to 145 mV after 40 000 h of operation.

A number of companies have developed full-scale commercial MCFC systems or prototypes, including Energy Research Corporation and MC-Power in the

USA, Hitachi, Ishikawajima Harima, Mitsubishi Electric and Toshiba in Japan and Brandstafel Nederland, Deutsche Aerospace and Ansaldo in Europe.

3.5 Solid oxide fuel cell

There are a number of advantages of operating fuel cells at high temperatures. One advantage highlighted already is that the choice of fuel is much greater because the electrode kinetics are much faster. Reforming and shift reactions become favourable within the fuel cell itself, resulting in a higher efficiency. A further advantage is that high-grade heat is generated during operation of the fuel cell, which can be used either to power conventional turbines or as external heat in combined heat and power installations. This also will increase the overall efficiency of the fuel cell system. However, operating at a high temperature means that appropriate materials must be used for the electrodes and other internal components. Ceramic materials have to be used because metals are effectively ruled out. A major problem with operating at high temperatures is achieving gas-tight seals between the ceramic components. Yttria-doped (8 mol.%) zirconia has the ability to conduct oxygen ions due to oxygen ion vacancies in the cubic crystal lattice. Consequently, yttria-doped zirconia is a good material to use as the electrolyte of the solid oxide fuel cell (SOFC), using oxide ions as the charge-transporting species. This process is negligible at room temperature but increases rapidly with temperature to reach a conductivity of approximately 30 S m^{-1} at 1000°C , with a relatively low electronic conductivity. The zirconia should be thin to minimise ohmic losses and have no porosity in order to prevent gas diffusion. The anode is composed of nickel (30%) / zirconia (70%) cermet, with the nickel providing high conductivity and the zirconia preventing sintering of the nickel. An anode porosity of 20–40% is used to facilitate the mass transport of reactants and products.

A major problem during the operation of a SOFC is maintaining the distribution of small nickel particles within the zirconia matrix, because agglomeration tends to occur at high temperatures. The cathode is composed of doped lanthanum manganite ceramic and has a similar porosity to the anode. The electronically conducting ceramic, lanthanum chromite, is used as the cell interconnect material because it is impervious to gases and has good

thermal stability in oxygen atmospheres at 1000°C . The ceramic components must not just have the appropriate electric properties but must also have compatible thermomechanical properties. A thermal expansion coefficient mismatch can result in catastrophic stress-induced cracking on warming up the fuel cell. Also, the materials must be able to withstand rapid thermal cycling to ensure that the cell can be started up and closed down in a reasonable time. The latest ceramic processing technology has been used extensively to manufacture SOFC components. Individual cells may be fabricated by using thin-film techniques to deposit electrode, electrolyte and interconnect layers together. They are then sintered to form a fully dense cell structure. Electrochemical vapour deposition, plasma spraying, tape casting, screen printing and calendaring processes have been used as fabrication techniques [19].

Because all the components are solid state there will be lower material corrosion or electrolyte management problems and a range of cell configurations are possible. Two main configurations have been developed extensively, namely the tubular and the flat plate design.

The tubular design consists of a cylinder of porous ceramic material, usually calcia-stabilised zirconia, to ensure thermomechanical compatibility with the electrodes; the cylinder is up to 1.5 m long and 2.2 cm in diameter and is sealed at one end, as shown in Fig. 20.5. Onto the surface of this tube is deposited the cathode layer by extrusion, followed by the electrolyte using electrochemical vapour deposition (EVD), the cell interconnects by plasma spraying and finally the anode by slurry deposition, all typically 10–50 μm thick. Air is passed through an alumina injection tube in the centre of the support tube and fuel is circulated on the outside of the tube. Careful manifolding at the open end of the tubes ensures that the two gases do not mix. Each tube is a separate cell and they are electrically connected in series by bridges of the interconnect. The advantages of the tubular design are that large-surface-area thin ceramic plates, which would be very susceptible to breakage, are not required and gas sealing between cells is much easier.

Full-scale commercial SOFC systems or prototypes based on the tubular concept have been developed by various companies, including Siemens-Westinghouse in the USA and Mitsubishi Heavy Industries in Japan. The planar design for a SOFC

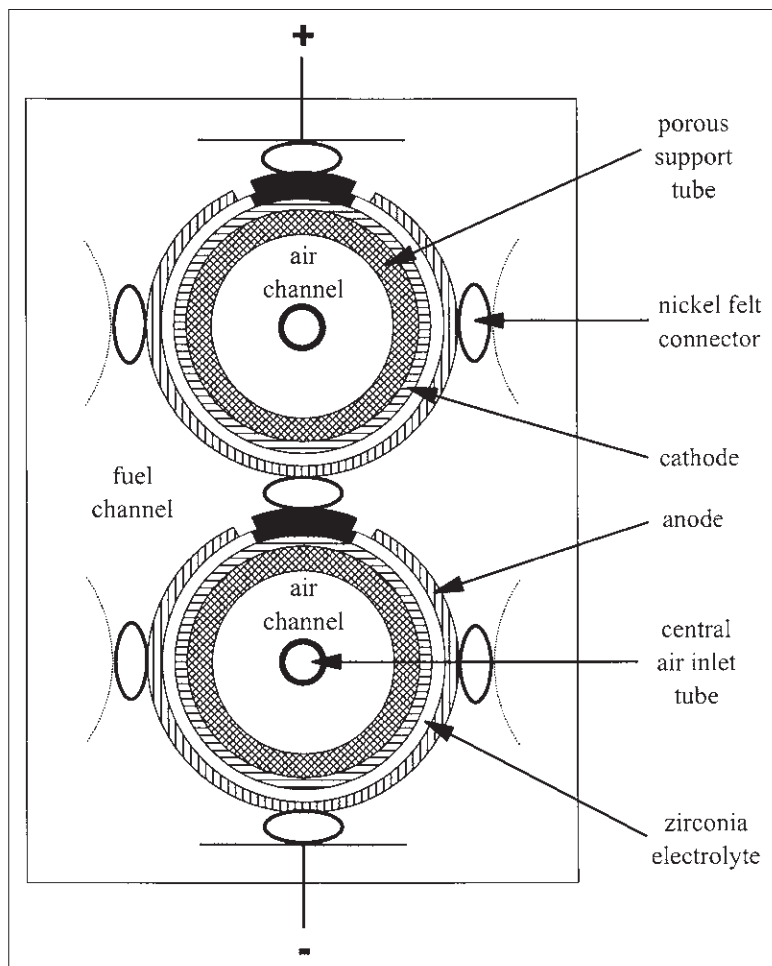


Fig. 20.5 Schematic diagram of a tubular solid oxide fuel cell (not to scale): Siemens Westinghouse design, plan view.

is analogous to the planar designs for an SPFC and a MCFC. This design permits the easy electrical connections between cells. A perpendicular current collection system within the cell allows a lower ohmic polarisation and hence a higher efficiency compared with a tubular design. However, gas-tight seals are more difficult to achieve and thermomechanical stresses are higher. The basic design consists of a flat plate of electrolyte up to 400cm^2 in area and 0.25 mm thick, usually manufactured by tape casting (see Fig. 20.6).

The electrolytes are deposited by plasma spraying or screen printing as thin films onto either side of the electrolyte (see Fig. 20.7). The interconnect, or bipolar plate, is manufactured by tape casting and grooves are added to both sides, perpendicular in

direction to each other, which provide channels for the fuel and air to pass over the electrodes. High-temperature gas seals are required at the edges of the plates, which usually are made of ceramic glasses. A compressive seal can lead to non-uniform stress distribution and cracking of the plates, especially during thermal cycling.

Full-scale commercial SOFC systems or prototypes based on the planar concept have been developed by various companies, including Rolls Royce, Ceram Research and British Gas in the UK, Allied Signal, SOFCo and Ceramic Fuel Cells Inc. in the USA and Mitsubishi Heavy Industries and Tokyo Gas in Japan.

Recent developments in SOFCs have had the objective of reducing the cost of cell components,

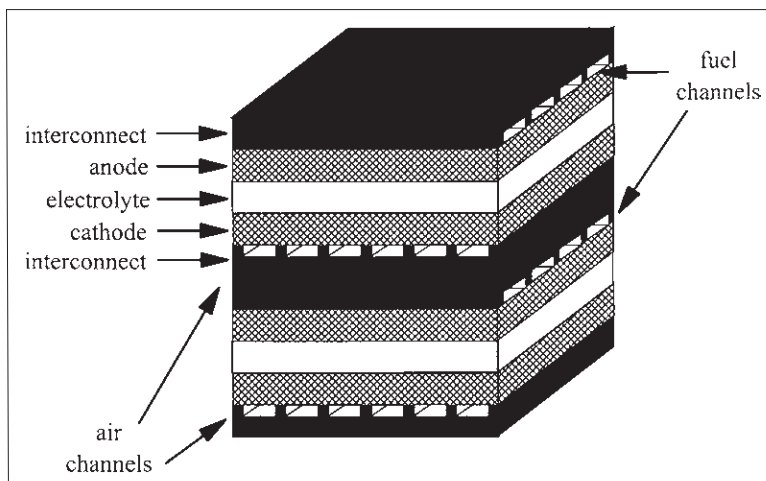


Fig. 20.6 Schematic diagram of a planar solid oxide fuel cell stack (two cells, not to scale).



Fig. 20.7 Photograph of planar zirconia electrolyte plates: black cathode, white electrolyte, green anode (grey in picture). (Courtesy of Ceramic Fuel Cells Inc.)

simplifying the manufacturing processes and improving material properties [19]. Much research has been conducted into making the thinnest possible ceramic components while maintaining

mechanical strength. The thinner the components, the lower the ohmic resistance within the cell, but ceramics are very brittle and thin sheets may not survive under the operating conditions. One approach has been to deposit the active ceramic layers onto thicker, porous ceramic supports. Another approach has employed novel processing methods to improve the basic strength of the ceramics. One such new technique—viscous polymer processing—uses high-shear mixing to break down the agglomerates present within the unsintered ceramic formulations [20,21]. This results in smaller voids within the ceramic matrix, which are the inherent cause of the low sintered strength. The strength of a ceramic is related to the size of the largest pore, or critical flaw length, according to the Griffiths relationship [22]. Another approach has increased the strength of cubic zirconia by the addition of alumina or a tetragonal zirconia phase [23]. Jet vapour deposition (JVD) and chemical vapour deposition (CVD) techniques also have been investigated as alternatives to the capital-intensive EVD fabrication [24]. The JVD technique produces thin films of ceramic material that are dense and gas tight. Plasma spray techniques have been shown to have the ability to produce multilayer coatings [25], which would be beneficial in manufacturing cell structures. A problem experienced during fabrication is the interfacial changes between the various layers, including diffusion, volatilisation and segregation of trace components. A major area of research is to develop an alternative electrolyte material to zirconia that

would have a similar or greater ionic conductivity but at a lower temperature (800–1000K). Electrolytes based on LaSrGaMgO [26] and zinc-doped LaBiAlO₃ [27] have been investigated.

4 Fuel Cell Applications

Fuel cells exhibit a number of advantages over alternative techniques for the generation of electricity from chemical fuels. These advantages can be summarised as follows:

- (1) High theoretical efficiency, especially at low operation temperatures and low load levels.
- (2) Low levels of pollutant emissions due to clean fuels, e.g. methanol or desulfurised natural gas, and because they operate at temperatures below that required for NO_x formation.
- (3) No moving parts, hence fuel cells tend to be quiet during operation and require less on-site maintenance than generators with moving parts.
- (4) Fuel flexibility and internal reforming is possible, especially with the high-temperature fuel cells.
- (5) Modular construction, hence the size of the fuel cell unit can be tailored to local energy needs.
- (6) Waste heat can be used, transforming the fuel cell into a combined heat and power unit. The ratio of heat to electrical power can be altered by adjusting the efficiency of the fuel cell.

4.1 General economics

The widespread use and commercial viability of fuel cells as electricity-generating devices will depend on achieving a sustainable competitive advantage over alternative energy technologies. A wide range of factors can be brought into play and these may be summarised using the business environment model (STEEP) of Fahey & Narayanan [28].

Social factors

Social acceptance of commercial products and services is becoming increasingly important in society. It is less acceptable to build large and polluting power stations and to distribute the electricity through high-visual-impact power lines. Fuel cells offer the opportunity of low emissions from existing and future biomass-based fuels as well as the local generation of both power and heat with low visual impact.

Technological factors

Fuel cells have been shown to exhibit a number of technical advantages over alternative methods of generating power and any one could give rise to a sustainable competitive advantage. The main technical advantage is that a fuel cell has a higher theoretical efficiency compared with heat engines. In addition, there is an increase in efficiency of fuel cells at low loads, which is the opposite of heat engines. There is flexibility in the type of fuel that can be used in a fuel cell including hydrogen, petroleum and alcohols. A fuel cell is a modular device, which means that the individual modules potentially can be mass manufactured with lower production costs. Extra modules could be added to increase the capacity of the system without having to replace the existing fuel cell and it can be done while the existing unit remains on-line. This advantage will continue into the operating phase of the fuel cell, when maintenance on one part of the fuel cell stack could be undertaken without closing down the rest of the power unit.

Environmental factors

Environmental concerns increasingly are becoming a major factor in the future of energy generation. The higher efficiency of fuel cells means that less fuel is required to give a unit of power and therefore less carbon dioxide will be released into the atmosphere. Reformed fuels will have little overall benefit in reducing greenhouse gases because the same amount of carbon dioxide will still be generated. However, it has been estimated that methanol fuels will reduce greenhouse gas emission by 25% and hydrogen from natural gases by 40%. To use hydrogen from biomass would be a zero 'net carbon dioxide emission' fuel. Sulfur gases have to be removed in advance to enable the fuel cell to function on low-sulfur fuels, which will generate aqueous effluent rather than gaseous pollution. The operating temperatures of fuel cells, even SOFC, are below the temperature required for the thermal formation of nitrogen oxides during the combustion of fuels, which means that nitrogen oxide emissions are negligible.

Economic factors

Although fuel cells are not currently economic, a reduction in unit costs on mass production will make

fuel cells competitive with heat engines. Currently energy is produced from fuel cells at a cost of US\$500–10 000 kW⁻¹, however it is predicted that this cost will reduce as follows: from \$2000 to \$100 kW⁻¹ for AFC, from \$500 to \$30 kW⁻¹ for SPFC, from \$3000 to \$1000 kW⁻¹ for PAFC, from \$5000 to \$600 kW⁻¹ for MCFC and from \$10 000 to \$600 kW⁻¹ for SOFC [4]. Large-scale power generation must be competitive with conventional power generation at approximately \$1500 kW⁻¹ and transport power must be competitive with an internal combustion engine at approximately \$50 kW⁻¹. However, these comparisons are made using current crude oil prices, which may rise in future due to political reasons or as the cost of extraction of dwindling reserves increases.

Political factors

Global energy policy is affected by a myriad of political issues, such as the possible introduction of a carbon tax, and fuel cells can offer attractive options to governments. For example, the State of California in the USA has passed the tightest emissions legislation in the world, even though obtaining planning approval for new power-based projects is a very expensive and long process. Fuel cells have been considered as zero-emission power devices and are exempt from certain stages of the planning process. This exemption may be a significant cost advantage in itself over conventional power generation in California. Over the long term, fuel cells may provide a means of using fuels from biomass sources from politically sensitive regions of the world as an alternative to petroleum fuel sources.

General fuel cell commercialisation

The history of fuel cell development has been typified by the push of the new technology into application areas that are price insensitive. In the case of space exploration, fuel cells were able to provide the most attractive and reliable method of power generation. The fuel cell system used within the US Space Shuttle is shown in Fig. 20.8. To enter a mainstream commercial market with fuel cells will require taking technical and financial risks. A 'technical push' rather than a 'market pull' technology environment has been the case for fuel cells and the

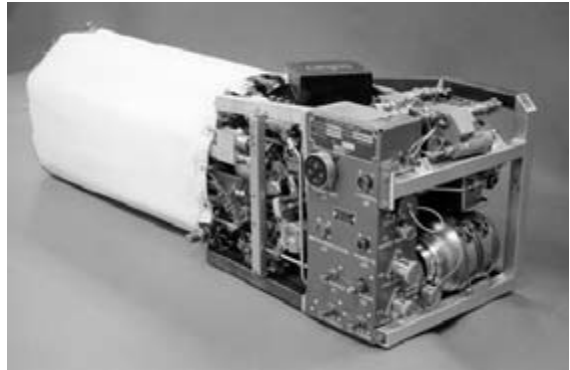


Fig. 20.8 Photograph of fuel cell unit used within the US Space Shuttle. (Courtesy of International Fuel Cells Inc.)

high risks and large financial investments necessary have discouraged many commercial companies from developing fuel cell technology. Hence, investment into fuel cell technology from government sources has been critical to prove the feasibility of fuel cell systems. Only in the last few years have prototypes of fuel cell systems been available from commercial companies. The first decade of the 21st century will see fuel cell systems available on a commercial basis. The first applications to appear are likely to be in market niches that can exploit the technical advantages of fuel cells together with lower price restrictions. Such conditions exist in markets for stationary power sources with no access to central-grid-supplied electricity, public transport within environmentally sensitive city centre areas and to replace expensive batteries for mobile computing and telecommunications.

4.2 Transport applications

Fuel cells for transport applications are available already within demonstration vehicles. To be competitive with conventional petrol/diesel/electric power units, mass production will be needed to bring down the price of a fuel cell. A Daimler Benz/General Motors/Toyota consortium is aiming for a fully commercial fuel cell vehicle by 2003. Major investments in fuel cell technology have been made by vehicle automobile manufacturers. A major issue to consider is the nature of the fuel. The use of pure hydrogen will give a true zero-emission vehicle but

has major safety issues and problems with storage both on board the vehicle and within the distribution system. The early demonstration vehicles have tended to use pure hydrogen. Over the long term the use of methanol within a direct methanol fuel cell would be a particularly attractive option. As a liquid it would be easy to distribute via the existing fuel infrastructure and easy to store on board the vehicle. It could be reformed easily to give hydrogen or used directly within a direct methanol fuel cell. The major criteria used to determine the suitability of a fuel cell for a transport application are those of size, weight, cost and performance. Rapid start-up, high power density and a good dynamic response are desired, and hence the SPFC is preferred.

Demonstration vehicles have been manufactured and tested by various automobile companies. Daimler Benz introduced the NECAR 1 in 1994, which was powered by twelve Ballard SPFC stacks and used hydrogen fuel to deliver 50kW of power. The fuel cell unit was large and required a Mercedes Benz 190 van to contain it. In 1996, the NECAR 2 was developed with a much smaller SPFC unit and it could be housed within a Mercedes Benz V-class vehicle. A methanol-fuelled NECAR 3 was introduced in 1997 based on a Mercedes Benz A-class vehicle. The methanol capacity was 40l, giving a range of 400km that is comparable with equivalent petrol vehicles. The NECAR 4 is the latest demonstration vehicle and is also hydrogen fuelled. Daimler Benz and Ballard have operated a fleet of fuel-cell-powered buses (NEBUS) in the Chicago and Vancouver regions since 1997.

Toyota has developed a demonstration fuel vehicle, the RAV4, that uses methanol fuel and on-board hydrogen generation. The RAV4 has a maximum speed of 120 km h^{-1} and a range of 480km, although it also uses some battery power.

Ford introduced a P2000 vehicle in 1999, which uses a 50-kW SPFC from International Fuel Cells Inc. and hydrogen fuel. A THiNK FC5 prototype fuel cell vehicle was unveiled during 2000.

Seimens has operated an SPFC-powered fork-lift truck in Neunburg since 1997 and a consortium of Seimens/MAN/Linde/Ludwig-Bolkow Foundation have developed a bus.

Such activity illustrates the high level of interest in using fuel cells to power vehicles of the future. A photograph of a fuel cell bus is shown in Fig. 20.9.



Fig. 20.9 Photograph of a fuel-cell-powered bus. (Courtesy of International Fuel Cells Inc.)

4.3 Stationary power generation applications

To use fuel cells for stationary power generation has many advantages over conventional thermal generators. The technology of thermal generators such as gas turbines has been developed to increase efficiency and has tended to mean increasingly larger units. These large power stations deliver their power to customers through extensive distribution grids. The World Bank has estimated that 300 billion kWh of power is lost globally during transmission and distribution. Such losses could be reduced significantly by using smaller local power plants. Unlike a thermal power unit, the efficiency of a fuel cell is much less dependent on capacity. The small physical size and low level of emissions also would ensure low local environmental impact. A variety of fuels could be used, such as natural gas and methanol, including locally generated gases from landfill sites and sewerage plants. A local fuel cell system would be particularly attractive to remote sites for which connection to a grid distribution network would be prohibitively expensive. Such locations have been used as testing grounds for fuel cell systems. Another main advantage for local fuel cell systems is that they would have the ability to produce heat together with power. Combined heat and power (CHP) units are capable of producing low-grade heat at approximately 353 K for local space heating and hot water. Alternatively, high-grade heat could be produced at greater than 773 K for steam raising or gas turbine operation, to increase further the efficiency of the system and reduce the unit cost of power. The high-

Fig. 20.10 Photograph of PC25 fuel cell unit at South County Hospital, Wakefield, RI, USA. (Courtesy of International Fuel Cells Inc.)



temperature fuel cells (MCFC and SOFC) are preferred for CHP applications, e.g. for large buildings like hospitals or for district power schemes. The low-temperature fuel cells (SPFC and PAFC) could be used for small-scale applications, such as 250-kW units for leisure centres or 5-kW units for individual houses. In all cases, a lifetime of at least 40 000 h of continuous use is the target needed for commercial viability. Maintenance downtime is also important and because a fuel cell contains fewer moving parts than a thermal generator this would be expected to be lower for a fuel cell. This attribute is a valuable advantage for remote applications.

A number of organisations have manufactured fuel cell stationary power units and tested them on extensive field trials to gather long-term performance data and to assess reliability. Such systems are available for purchase now and full-scale fully commercial systems probably will be available by 2005–2010. International Fuel Cell Inc. have developed 200-kW PC25 PAFC stationary co-generation plants and up to 200 have been installed in hospitals, military facilities and leisure centres. A PC25 fuel cell unit installed at the South County Hospital in Wakefield, Rhode Island, USA is shown in Fig. 20.10. Five PC25 fuel cell units have been installed at the Regional USPS Mail Sorting Centre in Anchorage, Alaska and they can be seen in the foreground of the photograph in Fig. 20.11.

4.4 Battery replacement applications

The recent rapid developments in mobile communications and computing relies heavily on portable battery power. Batteries are expensive per unit of power, tend to be large and heavy compared with the electronic components and require a power point to recharge that can take a number of hours. Fuel cells can avoid all of these problems and represent an attractive alternative. A small fuel cell with a small fuel chamber could be recharged with gaseous or liquid fuel rapidly. An SPFC is the lightest and has the highest power density of the fuel cells, so is preferred for battery replacement.

Energy Related Devices, the Fraunhofer Institute, Motorola and Sanyo all aim to have commercial fuel cell battery replacements on the market by the end of 2001.

5 The Future of Fuel Cells

After a slow start, fuel cell development and commercialisation are now receiving significant investment by major industrial corporations [29–31]. The large investments required and high risks involved have encouraged the formation of global consortia. For example, Ballard has joined forces with Daimler Chrysler, Ford, GPU, Alstom and EBARA to develop fuel cells in transport applications.



Fig. 20.11 Photograph of five PC25 fuel cell units installed at Anchorage, Alaska. (Courtesy of International Fuel Cells Inc.)

It is likely that by 2010 fuel cells will be established as commercial products in all areas of their application. Although thermal generators are unlikely to be replaced in the foreseeable future, increasing environmental concerns will provide a strong incentive for a customer to purchase a fuel cell power unit.

References

1. US Energy Information Administration. *International Energy Outlook 1999*. US Energy Information Administration, Washington, DC, 1999.
2. Mond, L., & Langer, C. *Proc. R. Soc. London*, 1889, **46**, 296.
3. Appleby, A. J., & Foulkes, F. R. *Fuel Cell Handbook*. Van Nostrand Reinhold, New York, 1993.
4. Brandon, N., & Hart, D. *An Introduction to Fuel Cell Technology and Economics*, Occasional Paper 1. Centre for Energy Policy and Technology, Imperial College, London, 1999.
5. Kordesch, K., & Simader, G. *Fuel Cells and Their Applications*. VCH, New York, 1996.
6. Bossel, U. G. *Facts and Figures*, an International Energy Agency SOFC Task Report. IEA, Berne, 1992.
7. Federal Energy Technology Center. *Fuel Cells; Opening New Frontiers in Power Generation*. US Department of Energy, Morgantown, WV, 1999.
8. Bos, P. B. *Commercializing Fuel Cells—Managing Risks*, Fourth Grove Fuel Cell Symposium. Commonwealth Institute, London, 1995.
9. Gottesfeld, S. *Polymer Electrolyte Fuel Cells: Potential Transportation and Stationary Application Number 10*, an EPRI/GRI Fuel Cell Workshop on Technology Research and Development. Stonehart Associates, Madison, CT, 1993.
10. Grubb, W. T. In *Proceedings of the 11th Annual Battery Research and Development Conference*. PSC Publication Committee, Red Bank, NJ, 1959, p. 59; US Patent 2,913,511, 1959.
11. Grune, H. In *1992 Fuel Cell Seminar Program and Abstracts*. The Fuel Cell Seminar Organisation Committee, Tucson, AZ, 1992, p. 138.
12. Wilkinson, D., & Steck, A. In *Proceedings of the Second International Symposium on New Materials for Fuel Cell and Modern Battery Systems*, Montreal, Quebec, Canada, July 6–10 1997, p. 186.
13. Wilson, M. S., Springer, T. E., Zawodzinski, T. A., & Gottesfeld, S. In *26th Intersociety Energy Conversion Engineering Conference Proceedings*, Vol. 3. Conversion Technologies / Electrochemical Conversion, Boston, Massachusetts, 1991, p. 74.
14. Naylor, P. J., Mitchell, P. J., & Adcock, P. L. In *1992 Fuel Cell Seminar Program and Abstracts*. The Fuel Cell Seminar Organisation Committee, Tucson, AZ, 1992, p. 9.
15. Watkins, D., Dircks, K., Epp, E., & Harkness, A. In *Proceedings of the 32nd International Power Sources Symposium*. The Electrochemical Society Inc., Pennington, NJ, 1986, p. 590.
16. Mitteldorf, J., & Wilemski, G. *J. Electrochem. Soc.*, 1984, **131**, 1784.
17. Kunz, H. R. *J. Electrochem. Soc.*, 1987, **134**, 105.
18. Maru, H. C., Paetsch, L., & Pigeaud, A. In *Proceedings of the Symposium in Molten Carbonate Fuel Cell Technology* (Selman, R. J., & Claar, T. D., eds). The Electrochemical Society Inc., Pennington, NJ, 1984, p. 20.
19. Minh, N. Q. *J. Am. Ceram. Soc.*, 1993, 563.
20. Kendall, K. *Powder Technol.*, 1989, **58**, 151.

21. Bate, L. D., Grievson, B., Hall, R. G., & Jones, A. G. *Ceram. Trans.*, 1995, **51**, 315.
22. Griffith, A. A. *Philos. Trans. R. Soc. London*, 1920, **A221**, 163.
23. Yamamoto, O. In *The International Fuel Cell Conference Proceedings*, NEDO/MITI, Tokyo, Japan, 1992, p. 348.
24. Halpern, B. L., Golz, J. W., & Di, Y. In *Proceedings of the Fourth Annual Fuel Cells Contractors Review Meeting*. US DOE/METC, Washington, DC, 1992, p. 205.
25. Uchiyama, F. In *The International Fuel Cell Conference Proceedings*, NEDO/MITI, Tokyo, Japan, 1992, p. 183.
26. Goodenough, J., & Huang, K. In *Proceedings of the Fuel Cell '97 Review Meeting*, Morgantown, WV, 1997, p. 96.
27. Bloom, I., & Krumpelt, M. In *Proceedings of the Fourth Annual Fuel Cells Contractors Review Meeting*. US DOE/METC, Washington, DC, 1992, p. 148.
28. Fahey, L., & Narayanan, V. K. *Macroenvironmental Analysis for Strategic Management*. West Publishing, St Paul, 1986.
29. Ralph, T. R., & Hards, G. A. *Chem. Ind.*, 1998, 337.
30. Hart, D. *Chem. Ind.*, 1998, 344.
31. Hoogers, G., & Thompsett, D. *Chem. Ind.*, 1999, 796.

Chapter 21: Supercritical Carbon Dioxide as an Environmentally Benign Reaction Medium for Chemical Synthesis

NATHALIE TANCHOUX AND WALTER LEITNER

1 Introduction

Increasing efforts are being made to develop chemical processes with minimised ecological impact, leading, for example, to reduced production of waste or avoiding the use of hazardous or toxic organic chemicals. One important aspect in this area is the quest for replacement of organic solvents by alternative reaction media. The majority of chemical processes in fine chemical synthesis are carried out in solution and organic solvents usually are the first choice. These solvents often bear considerable potential risk owing to their toxicity, flammability or environmental hazards. Furthermore, they have to be separated from the products completely and recycled or disposed of at the end of the process, adding to the overall costs of production. In the present paper we will discuss supercritical carbon dioxide (scCO₂) as an alternative solvent providing an environmentally benign reaction medium with unique properties for solution-phase chemistry [1].

Supercritical fluids have been known since the discovery of the critical temperature more than 175 years ago [2]. Their chemical reactivity has raised interest since the very beginning, even though they have been studied mainly from a physical point of view for a long time [3]. The technology to utilise scCO₂ as a solvent for selective extraction processes is well established nowadays in the food industry and commercial applications include the production of decaffeinated coffee and hops aroma [4]. These applications have originated from the pioneering work of Kurt Zosel at the Max-Planck-Institut für Kohlenforschung in the middle of the twentieth century [5]. The commercial success of these processes has stimulated a number of efforts to use scCO₂ in areas as diverse as dry cleaning, dyeing of fabrics and polymers, metal degreasing and materials processing. A broad and general interest in the use of supercritical fluids as reaction media for organic

syntheses, however, has emerged only during the last 10–15 years [1].

The critical point of a pure compound marks the end point of the evaporation line in the phase diagram. This point is characterised for CO₂ by the critical temperature $T_c = 31.0^\circ\text{C}$, the critical pressure $P_c = 73.8$ bar and the corresponding critical density $d_c = 0.466\text{ g ml}^{-1}$ (Fig. 21.1). Beyond this point, no distinct liquid or vapour phase can exist and the new supercritical phase exhibits properties that are reminiscent of both states.

The physicochemical properties of scCO₂ as a solvent for chemical synthesis are described in detail elsewhere and will be summarised here only briefly [1,4,6–8]. Like gases, scCO₂ exhibits a very low surface tension, low viscosity and high diffusion rates. It is completely miscible with many reaction gases over a wide range of composition. This provides an ideal situation for reactions involving gaseous reactants, because the availability of the gas in the supercritical fluid is higher than in a liquid solvent at comparable partial pressures. Without losing these gas-like properties, the density of scCO₂ can be tuned to liquid-like values with relatively small variations of temperature and/or pressure. At densities around and above the critical density, many liquid or even solid materials become reasonably soluble in scCO₂, whereby the solubility of individual materials depends strongly on the exact value of the bulk density of the medium. This last property forms the basis for the selective purification processes in natural product extraction and may apply equally to isolate products from reaction mixtures and/or to recover catalytic systems. The density variations also affect other properties of the supercritical fluid and sometimes can directly influence the course of chemical reactions.

In the following parts of this chapter we will use recent examples to highlight the potential of scCO₂ as an attractive and environmentally benign reaction

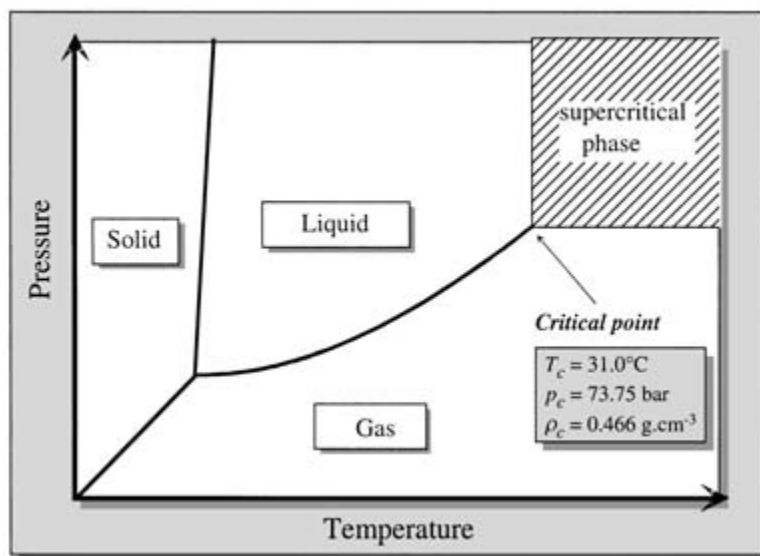


Fig. 21.1 Schematic phase diagram of pure carbon dioxide.

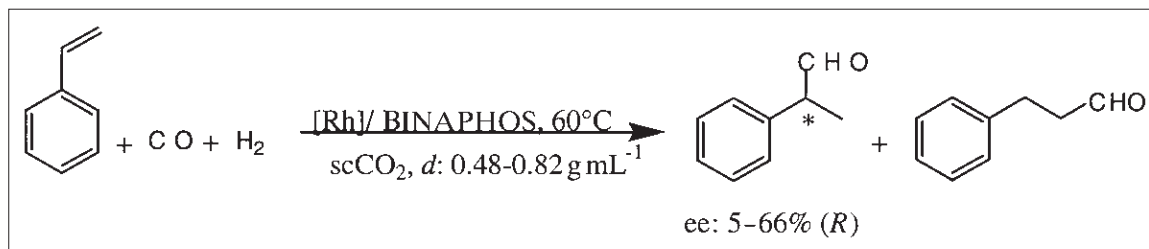
medium for chemical synthesis, with a strong emphasis on homogeneous and heterogeneous metal catalysis. The material is organised according to the impact that CO_2 has on a synthetic process in the context of 'green chemistry'. It ranges from the replacement of organic solvents to the simultaneous use of CO_2 as a reagent and solvent, including a discussion of some unique effects based on the specific properties of the supercritical state. In this approach, we found it appropriate to select examples that we find most illustrative for the individual effects. Arguably, such an organisation and selection must remain arbitrary and therefore we refer the interested reader to some recent reviews with other emphasis for further reading [1,7,8].

2 Phase Behaviour and Solubility in Supercritical Reaction Mixtures

The phase behaviour of a reaction mixture is an important parameter for chemistry in scCO_2 . In order to use the properties of a supercritical phase during a reaction, one generally will try to find conditions where a single homogeneous phase is present. On the other hand, it could be interesting to establish a two-phase system to achieve a separation after the reaction. The phase behaviour of mixtures is much more complex than that shown in Fig. 21.1 for pure CO_2 and it is not sufficient to work at temperatures

and pressures above the critical values to obtain a homogeneous mixture in the presence of other components. Although a large body of data on the phase behaviour of CO_2 with various other components is available, much less is known about systems that are related directly to synthetic procedures. Model calculations based on various equations of state can help to give first estimates about the phase behaviour but become rather challenging for multicomponent systems, with varying concentrations as encountered in typical reaction mixtures.

The phase behaviour of the system $\text{CO}_2/\text{H}_2/\text{cyclohexane}$ was studied in the context of heterogeneous hydrogenation of organic compounds in a continuous flow reactor (see Section 5.1) [9]. As expected, the miscibility of the system decreases with increasing partial pressures of H_2 under otherwise identical conditions. At higher temperatures, relatively small amounts of CO_2 were found to be sufficient to ensure high miscibility. The phase behaviour of $\text{H}_2/\text{CO}_2/\text{amine}$ systems was investigated as part of a study devoted to the homogeneously catalysed hydrogenation of scCO_2 to formic acid and its derivatives (see Section 7) [10]. In the case of triethylamine, a large amount of amine is totally miscible with scCO_2 in the absence of hydrogen, but the amount of amine soluble in a single phase is reduced by a factor of five when H_2 is present at partial pressures typically used in the reaction. If the secondary



Scheme 21.1 Asymmetric hydroformylation of styrene in scCO₂: the large variation in the enantiomeric excess (ee) results from the complex phase behaviour of the reaction mixture.

amine dimethylamine is used, the phase behaviour is entirely different because CO₂ and dimethylamine form the liquid adduct dimethylammonium carbamate (dimcarb) under the reaction conditions. A liquid phase then is present at any stage of the reaction, whereas single phase conditions can be achieved at least initially with the tertiary amine. Such investigations are very important for determination of the optimal reaction conditions and for understanding the reaction systems.

The catalytic asymmetric hydroformylation of styrene (see Scheme 21.1) provides an illustrative example of the dramatic effects that can result from the phase behaviour of reaction mixtures, especially when presumably homogeneous organometallic catalysts are involved. Catalysts for asymmetric hydroformylation often are formed in situ from an achiral rhodium complex and a chiral diphosphine, and the compatibility of such procedures with scCO₂ was investigated for the BINAPHOS ligand [11]. High CO₂ densities (0.70–0.82 g mL⁻¹) resulted in single-phase reaction mixtures, but very low enantioselectivities (5–35%) were obtained for the aldehyde under these conditions. When the densities were lowered towards the critical density of pure CO₂ (0.47 g mL⁻¹), the enantioselectivity improved up to 66% but a coloured liquid phase was observed during the reaction. This striking density dependence results from the poor solubility of the chiral ligand in scCO₂: the ligand-containing species inducing enantioselectivity can operate only when a liquid phase is formed at lower densities, whereas the catalytic reaction occurs mainly via ligand-free rhodium species in the supercritical phase.

The solubility of reactants, products and catalyst in the supercritical phase obviously is a decisive factor for the reaction design. The situation described above

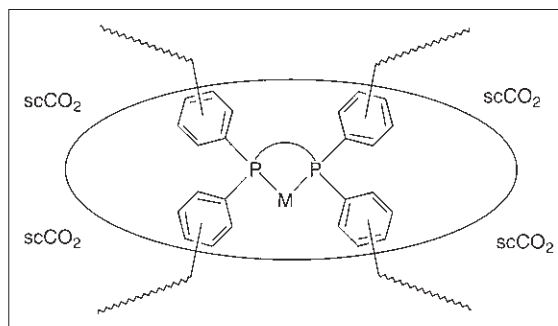


Fig. 21.2 Fixation of fluorinated chains (wavy lines) to the aromatic rings of an aryldiphosphine enhances the solubility of the ligand and its metal (M) complexes in scCO₂.

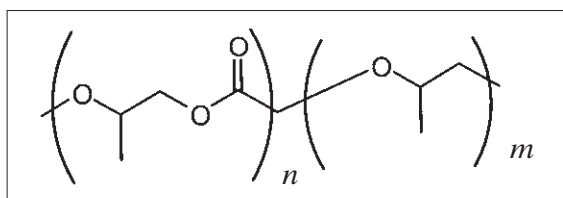
results from the fact that aryldiphosphine ligands and their metal complexes—an important class of homogeneous catalysts for chemical synthesis—do not exhibit sufficient solubility for catalysis under homogeneous supercritical conditions. One general approach to overcome this limitation consists of fixation of perfluoroalkyl groups to the aromatic rings of these ligands (Fig. 21.2) [12]. Applying this methodology to the BINAPHOS ligand used for enantioselective hydroformylation resulted in a catalytic system that provided over 90% enantiomeric excess (ee) regardless of the phase behaviour of the reaction mixture [13,14]. Other possibilities to enhance the solubility of organometallic catalysts in scCO₂ include the use of ‘CO₂-philic’ (mainly fluorinated) counter-ions [15] or the addition of co-solvents such as fluorinated alcohols [16].

The use of fluorinated groups to render organic or inorganic materials ‘CO₂-philic’ is not restricted to transition metal catalysts. Other applications include

extraction of metal ions from aqueous wastestreams [17] or the design of CO₂-soluble polymers [18] and surfactants [19]. A fluoroalkyl-substituted tin hydride reagent has been prepared and used for radical reactions such as reductive dehalogenation in scCO₂ [20]. The 'CO₂-philic' anthraquinones required for the generation of hydrogen peroxide in scCO₂ were based also on the introduction of perfluoroalkyl chains (see Section 5.1 for more details) [21,22]. Very recently, a non-fluorous polyether/polycarbonate copolymer was designed and synthesised that exhibits an outstandingly high solubility in scCO₂ (see Scheme 21.2) [23]. These materials may provide an entirely new approach to non-fluorous 'CO₂-philic molecules' from cheap and even more benign building blocks.

3 Supercritical CO₂ as a Replacement for Organic Solvents

Many processes use organic solvents that are classified as volatile organic chemicals (VOCs), i.e. organic compounds that participate in atmospheric photoreactions. The advantage of replacing such solvents by scCO₂ as a reaction medium is obvious, because CO₂ is not regulated as a VOC and is not detrimental to the atmospheric ozone layer. Its application as a solvent also would not generate any additional CO₂ and thus would not increase the anthropogenic greenhouse gas emission. Even in large-scale appli-

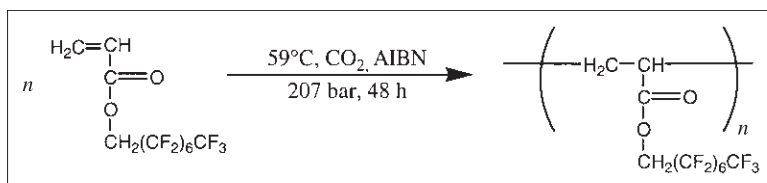


Scheme 21.2 A highly CO₂-soluble ether-carbonate copolymer structure that may find application for the design of 'CO₂-philic' materials.

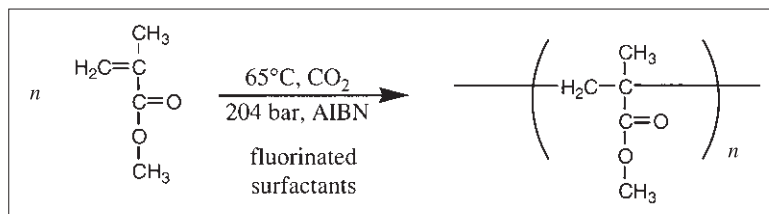
cations, no environmental risk would arise in the case of accidental contamination of the immediate environment with the non-toxic and innocuous solvent CO₂.

Fluoropolymers have many technical applications in the form of lubricants or coatings. They are generally insoluble in most conventional organic solvents and traditionally their synthesis and processing have relied on the use of chlorofluorocarbon (CFC) solvents, which have been identified as one of the main causes of depletion of the ozone layer. In 1992, the use of scCO₂ as a possible solvent replacement for the synthesis of fluoropolymers was reported [18]. This pioneering work demonstrated the very efficient homogeneous radical polymerisation of 1,1-dihydroperfluorooctyl acrylate (FOA) initiated by azobisisobutyronitrile (AIBN) in scCO₂ (see Scheme 21.3). Radical copolymerisation reactions between fluorinated monomers and hydrocarbon-based substrates such as methylmethacrylate or styrene lead to the formation of statistical copolymers.

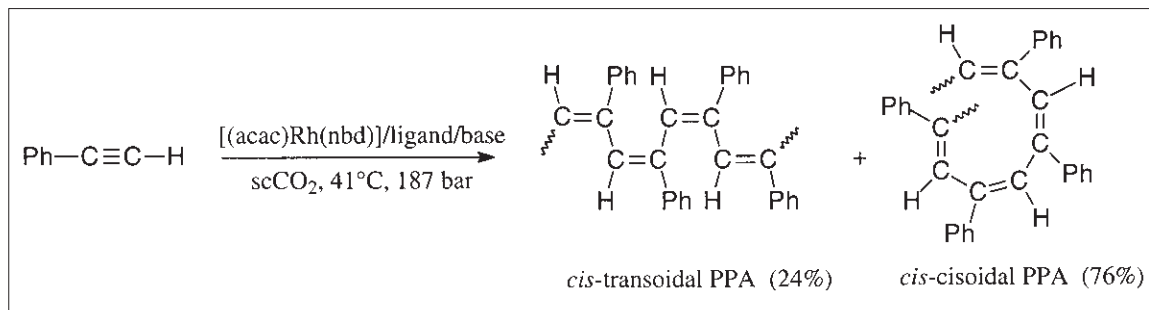
In contrast to the fluoropolymers, purely hydrocarbon-based polymers generally are insoluble in scCO₂, leading to precipitation polymerisation conditions with difficulties in controlling molecular weights and their distribution. This problem can be ameliorated by the use of surfactants containing a 'CO₂-philic' and a polymer-related part. Such amphiphilic additives allow the production of CO₂-insoluble polymeric materials such as poly(methyl methacrylate) in scCO₂ with a dispersion polymerisation method (see Scheme 21.4) [24]. In a dispersion polymerisation process, the polymerisation is initiated homogeneously and particles of the resulting polymer are stabilised by the amphiphilic molecules to prevent coagulation and precipitation. Supercritical CO₂ is an attractive dispersing medium for such polymerisation processes that could reduce the aqueous and organic wastes usually generated by conventional procedures. Furthermore, the residual monomer along with the initiator may be extracted very easily from the polymer by supercritical fluid



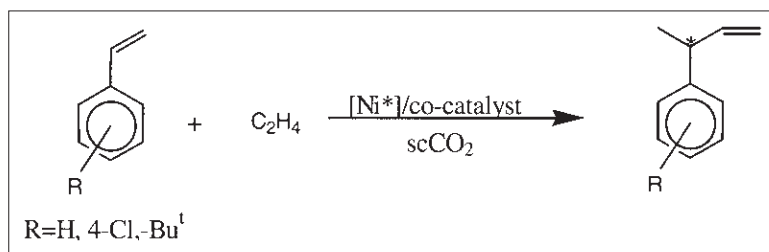
Scheme 21.3 Homopolymerisation of FOA in scCO₂.



Scheme 21.4 Synthesis of poly(methyl methacrylate) via dispersion polymerisation in $sc\text{CO}_2$.



Scheme 21.5 Rhodium-catalysed synthesis of poly(phenylacetylene)(PPA) in $sc\text{CO}_2$.



Scheme 21.6 Hydrovinylation of styrenes in $sc\text{CO}_2$.

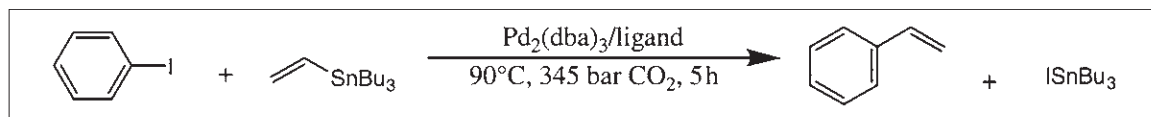
extraction without involving any additional organic solvent.

Organic solvents can be replaced by compressed CO_2 also in metal-catalysed polymerisation reactions such as the ring-opening metathesis polymerisation (ROMP) [25], olefin copolymerisation [26], olefin/ CO copolymerisation [27] or the formation of polyphenylacetylene (PPA) [28]. The microstructure of the PPA formed in CO_2 was markedly different from that obtained with similar catalysts in organic solvents under related conditions (see Scheme 21.5).

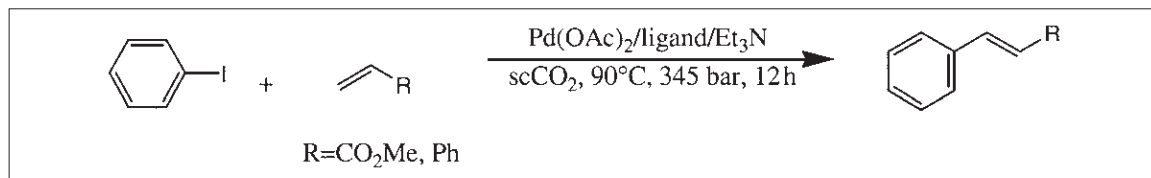
The replacement of organic and especially chlorinated solvents by CO_2 is not restricted to polymerisation, and often is feasible in C–C coupling reactions for the synthesis of small organic molecules. The enantioselective nickel-catalysed hydrovinylation of

styrenes exhibits slightly better asymmetric induction in CO_2 than in CH_2Cl_2 at comparable temperatures (see Scheme 21.6) [29]. The choice of the proper co-catalyst as activator was found to be essential for the chiral nickel catalyst to operate in the new reaction medium. Palladium-catalysed cross-coupling reactions using the Stille or Heck procedures also occur efficiently in $sc\text{CO}_2$ [30–32]. The reactions of phenyl iodide shown in Schemes 21.7 and 21.8 afforded high conversions and selectivities that were fully comparable with those observed in toluene.

Another large class of C–C bond-forming reactions that have been studied intensively in $sc\text{CO}_2$ are carbonylation reactions. Successful examples include the carbonylation of methanol [33], Pd-catalysed carbonylations of aryl halides [34] and the Pauson–Khand reaction [35]. The industrially

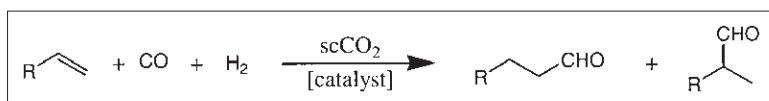


Scheme 21.7 Stille cross-coupling of PhI in $scCO_2$.



Scheme 21.8 Heck cross-coupling of PhI in $scCO_2$.

Scheme 21.9 Hydroformylation of alkenes in $scCO_2$.



important hydroformylation in particular has been investigated intensively, and catalytic systems compatible with the use of compressed CO_2 include unmodified cobalt [36,37] or rhodium [38] catalysts, phosphine-modified rhodium catalysts [12,38–42], heterogenised rhodium systems [43] and even chiral catalysts for asymmetric synthesis [13,14]. The hydroformylation of long-chain terminal and internal olefins using unmodified rhodium catalysts occurs with significantly higher rates in $scCO_2$ as compared with toluene (see Scheme 21.9) [38]. We will come back to this reaction in more detail on several occasions throughout this chapter.

From the few selected examples discussed above, it can be seen already that a large variety of synthetically useful reactions can be performed in $scCO_2$ with similar and sometimes even better results than in conventional organic solvents. The use of CO_2 in industrial-scale synthesis would imply continuous processes where the products recovered at the outlet of the reactor are free of organic solvents and the gas used as reaction medium would be recycled and recompressed. In addition to providing a 'green' alternative to VOCs without producing hazardous or toxic organic wastes, the use of $scCO_2$ can increase the inherent safety of a process, as discussed in the next section.

4 Use of Supercritical CO_2 for Safer Processes

The use of non-explosive and non-flammable $scCO_2$ as a solvent (i.e. in a large excess compared with all other components) can reduce potential risks and hazards in many reaction types involving highly reactive reactants or gases. The inert solvent, which is used, for example, in fire extinguishers, allows pressurised gases such as hydrogen, carbon monoxide or oxygen to be manipulated under much safer conditions than applying these reagents in neat form. Furthermore, the excellent heat transport capacities of $scCO_2$ relative to low-density gaseous mixtures can be very advantageous for the removal of heat from highly exothermic reactions, thus avoiding hot spots in reactors.

Following these considerations, $scCO_2$ provides a highly attractive medium for oxidation reactions. In addition, CO_2 itself is of course inert towards oxidation, thus excluding the formation of any by-products from oxidation of the solvent. Several studies have focused on metal-catalysed oxidation of olefins using organic or inorganic oxidants. The oxidative cleavage of $C=C$ double bonds using catalytic amounts of ruthenium tetroxide was performed in a biphasic water/ $scCO_2$ system [44]. The actual

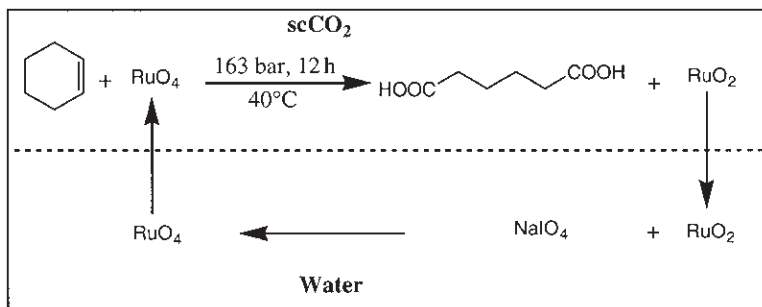
oxygen source NaIO_4 was located in the aqueous phase, whereas the ruthenium catalyst migrated between the two phases (see Scheme 21.10). The selectivity for adipic acid was very high (99%) but rapid deactivation of the ruthenium catalyst occurred.

The metal-catalysed oxidation of alkenes with organic peroxides occurs readily in scCO_2 as the solvent [45–47]. Three studies showed almost simultaneously that good to excellent yields of epoxides could be obtained with anhydrous $^t\text{BuOOH}$ as the oxidant using molybdenum-based catalysts. Diols were obtained as the major products with aqueous $^t\text{BuOOH}$, most probably due to the in situ hydrolysis of the epoxide (see Scheme 21.11). Typical yields of diols often were better in scCO_2 than in conventional solvents and the products generally were cleaner. Organic hydroperoxides also were employed for enantioselective epoxidations using a titanium catalyst in the presence of chiral tartrate ligands [46].

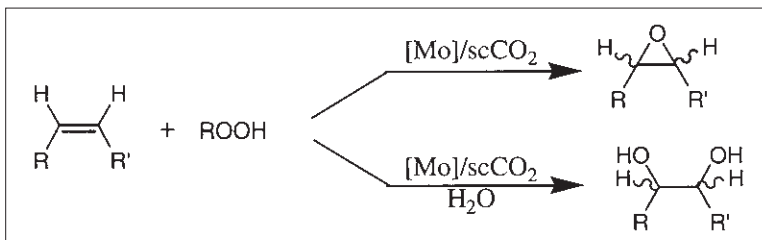
The selective oxidation of organic compounds with molecular oxygen is still a major challenge for chemical synthesis and the use of scCO_2 seems to open very promising new directions in this area. As mentioned previously, scCO_2 is largely miscible with oxygen, thus allowing the oxidant/substrate ratio to increase while considerably improving the safety of

the process due to expanded explosion limits. The rhodium-catalysed aerobic oxidation of tetrahydrofuran to γ -butyrolactone has been achieved in scCO_2 with moderate turnovers and selectivities [48]. Several studies on catalytic [49] and non-catalytic [50] free-radical aerobic oxidations of alkanes have been conducted and the partial oxidation of propane catalysed by metals impregnated on solid supports demonstrates the potential of scCO_2 for these reactions [51]. The aerobic oxidation of cyclohexane to cyclohexanol and cyclohexanone catalysed by an iron complex bearing perfluorinated porphyrin ligands has been studied in sub- and supercritical CO_2 [52]. The results seemed to indicate that the reaction rate reaches a maximum around the critical pressure of CO_2 .

Related iron-based catalysts were found to enable the epoxidation of cyclohexene with molecular oxygen as the sole oxidant, but yields and selectivities were moderate [53]. A frequently used method to activate molecular oxygen for selective epoxidations is the addition of an aldehyde as a sacrificial co-oxidant. Under these conditions, the oxidation of alkenes was found to be very efficient in scCO_2 , the reaction being initiated by the stainless steel of the reactor walls (see Scheme 21.12) [54]. A large variety of substrates could be converted with good



Scheme 21.10 Oxidation of cyclohexene to adipic acid in an scCO_2 /water biphasic medium.



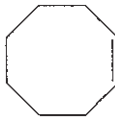
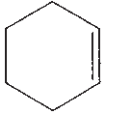
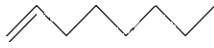
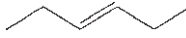

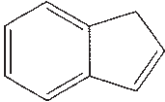
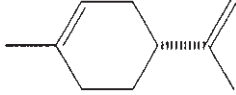
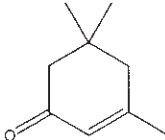
Scheme 21.11 Molybdenum-catalysed oxidation of alkenes to form epoxides or diols using scCO_2 as reaction medium.

yields into their corresponding oxidation products (Table 21.1). This epoxidation is particularly efficient in the case of linear or cyclic substrates containing internal double bonds. The presence of the steel walls initiates a radical chain process and no additional catalyst is required.

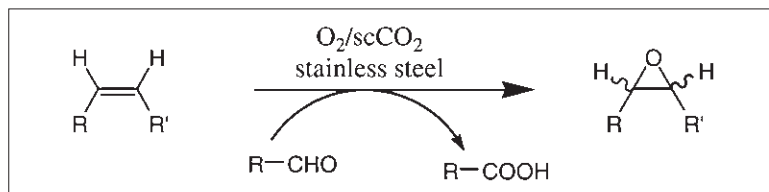
In general, the synthetic utility of oxidations with molecular oxygen in scCO_2 is still limited, but some of the advantages associated with the use of this medium have become apparent. The potential of scCO_2 for modern synthetic chemistry already is

more elaborated in hydrogenation processes, where similar safety arguments apply as for oxidations. In addition to the catalytic hydrogenation processes discussed in Section 5, several highly enantioselective hydrogenation reactions of $\text{C}=\text{C}$ double bonds were reported [15,16,55]. The asymmetric homogeneous hydrogenation of dehydroamino acid derivatives could be achieved using cationic rhodium/phosphine complexes with lipophilic counter-ions such as the BARF anion (BARF = tetrakis[3,5 bis(trifluoromethyl)phenyl]borate) to solubilise the catalyst in

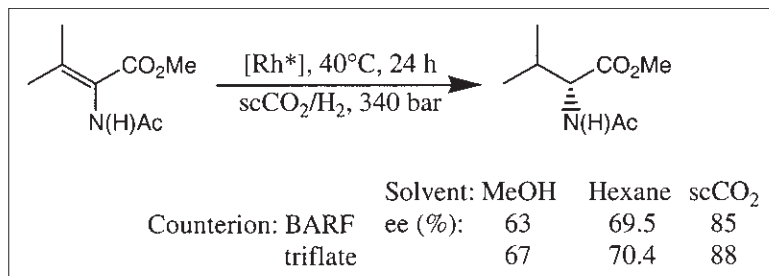
Table 21.1 Epoxidation of various olefins with molecular oxygen and 2-methyl-propionaldehyde in scCO_2 ($T = 55^\circ\text{C}$, $d_{\text{CO}_2} = 0.75 \text{ g ml}^{-1}$, $[\text{S}]/[\text{Ald}] = 1/2$, $[\text{S}]/\text{O}_2 = 1/10$, $t = 18 \text{ h}$)

Substrate	Conversion (%)	Product(s)	Selectivity (%)
	>99	Epoxycyclooctane	>99
	95	Epoxycyclohexane	91
	46	1,2-Epoxyoctane 3,4-Epoxyoctane	87 5
	96	<i>trans</i> -3,4-Epoxyhexane	>98
	73	Propylene oxide Acetone	14 67
	32	2-(2-Oxoethyl)-benzaldehyde 2-Indanone 1,2-Indandiol	59 21 11
	51	<i>cis</i> -1,2-Epoxyde <i>trans</i> -1,2-Epoxyde 8,9-Epoxydes	59 30 9
	16	Epoxyisophorone	30

Data taken from Ref. 54.



Scheme 21.12 Oxidation of alkenes using molecular oxygen in scCO_2 .



Scheme 21.13 Enantioselective hydrogenation of a β,β -disubstituted α -enamide ester in scCO_2 .

scCO_2 . The reaction was very efficient, especially in the case of β,β -disubstituted α -enamide esters, where the enantioselectivities in scCO_2 were by far the best observed for this substrate with any of the tested reaction media (see Scheme 21.13) [15].

The use of scCO_2 as solvent for the hydrovinylation of styrenes (see Scheme 21.6) was accompanied by the replacement of the potentially hazardous co-catalyst $\text{Et}_3\text{Al}_2\text{Cl}_3$ with the sodium salt of BARF, which is much easier and safer to handle [29]. The co-catalyst $\text{Et}_3\text{Al}_2\text{Cl}_3$ used under previously developed conditions is highly flammable and ignites spontaneously upon contact with moisture or air. Although the aluminum-based co-catalyst can be applied more safely in scCO_2 , it was found to give disappointingly low asymmetric induction in this medium and to lead to corrosion problems when handled in standard stainless-steel reactors. The BARF anion proved much more efficient as a co-catalyst, easier to handle and non-corrosive under the reaction conditions. Performing the hydrovinylation in scCO_2 results therefore in replacement of the organic solvent CH_2Cl_2 as well as a potentially hazardous co-catalyst, making this process inherently safer under the supercritical conditions.

5 Improvement of Process Performance

The transfer of a reaction from organic solvents to supercritical media generally leads to changes in the

overall performance, sometimes for worse but often for better. Some of these effects can be rationalised on the basis of the physicochemical properties of the supercritical state. The reduced number of phase boundaries can lead to enhanced reaction rates, especially in heterogeneously catalysed reactions, where the gas-like transport properties of supercritical fluids are clearly superior to liquid systems. Similar arguments may be used to explain at least partly enhanced reaction rates and changes of regio-, chemo- or enantioselectivities in homogeneously catalysed processes in scCO_2 . In addition, the chemical reactivity of CO_2 can change the course of a reaction, but these effects will be discussed separately in Section 7.

5.1 Process intensification

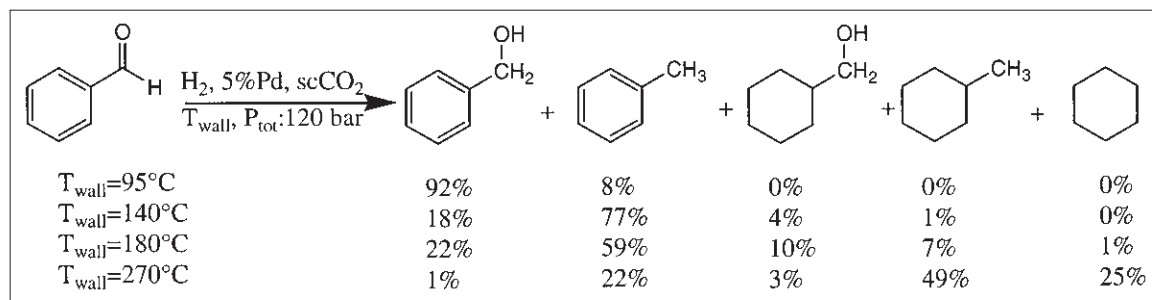
Several studies have focused on the selective and complete hydrogenation of fatty acids and oils in continuous fixed-bed reactors over heterogeneous catalysts using scCO_2 or supercritical alkanes as the reaction phase [56–58]. The hydrogenation of fats and oils is used to increase their melting point and oxidation stability ('hardening'). Processes using nickel-based catalysts are long established on a commercial scale but have several severe disadvantages. The hydrogenations are carried out discontinuously as three-phase reactions (gas/liquid/solid) resulting in strong mass-transfer limitations. Furthermore,

high costs are associated with purification of the products and disposal of nickel residues. The better mass transfer properties of scCO_2 result in continuous processing with higher space-time yields along with less formation of undesirable by-products. Furthermore, improved catalyst lifetimes were noticed in scCO_2 compared with conventional organic solvents, and the products could be obtained in solvent-free form.

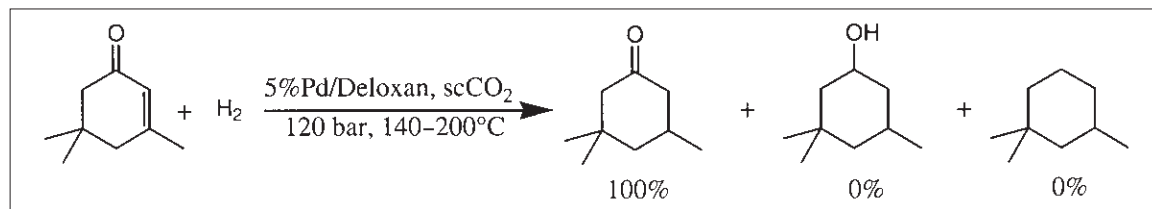
These promising results have stimulated the investigation of hydrogenation processes using heterogeneous catalysts in various fields of fine chemicals synthesis. Additional impetus is provided by the consideration that reaction parameters in a supercritical flow reactor can be controlled more or less independently and that pressure effects may be utilised in supercritical fluids at much lower pressures than those required for traditional liquid-phase 'high pressure' reactions. The hydrogenation of α,β -unsaturated aldehydes using a $\text{Pt}/\text{Al}_2\text{O}_3$ catalyst in scCO_2 occurred with very high rates in a batch reactor, with high selectivity towards $\text{C}=\text{O}$ bond reduction producing almost exclusively the unsaturated alcohols [59]. The combination of high rate and selectivity is very hard to achieve in this process with conventional solvents.

An exploratory study of continuous-flow hydrogenations was performed with very small reactors of 5- or 10-ml volume using fixed-bed noble metal catalysts on aminosiloxane supports (Deloxan) [9]. The hydrogenation of a very wide range of substrates, including alkenes, alkynes, ketones, aldehydes and epoxides, occurred efficiently in scCO_2 . The hydrogenation of nitro compounds was performed in supercritical propane to avoid the formation of insoluble carbamic salts from the amines and CO_2 . Enhanced reaction rates were found in almost all cases and the chemoselectivity during hydrogenation of multifunctional substrates could be changed drastically by small variations in the reaction parameters (see Scheme 21.14).

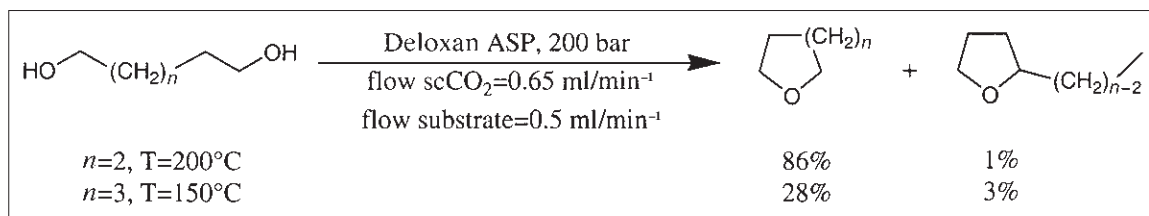
The hydrogenation of isophorone, which is of commercial interest in the fine chemical industry, was found to exhibit high conversion and high selectivity towards the desired product dihydroisophorone in scCO_2 (see Scheme 21.15). The product could be isolated in sufficient purity and in solvent-free form with a remarkably high throughput of material in the small flow-reactor system: 7.5 kg of isophorone could be hydrogenated continuously using only 2 g of 5% Pd on Deloxan in a 10-ml reactor with a substrate flow rate of 7 ml min^{-1} . The results indicate also that



Scheme 21.14 Hydrogenation of benzaldehyde in scCO_2 .



Scheme 21.15 Hydrogenation of isophorone in a continuous-flow reactor in scCO_2 .



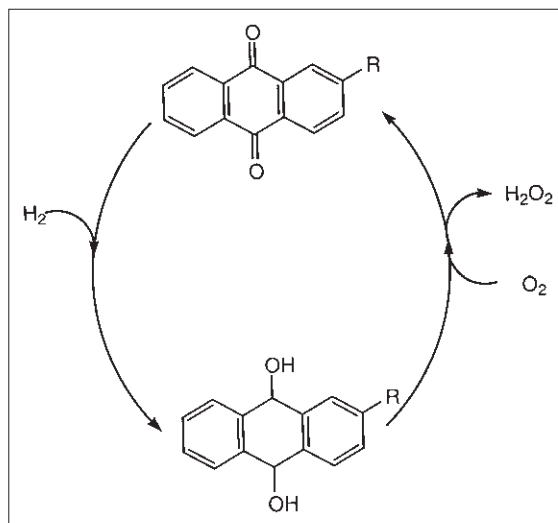
Scheme 21.16 Cyclisation of 1,5-pentandiol and 1,6-hexandiol in scCO_2 .

high flow rates of substrates do not necessarily require high flow rates of scCO_2 , which could be very interesting for future scale-up of such continuous and solvent-free syntheses.

The dehydration of alcohols to ethers with solid acid catalysts was studied in the same continuous-flow reactor system [60]. The results on the formation of cyclic ethers from α,ω -diols showed that the yield of the desired product could be adjusted nicely by very small variations in the reaction parameters. Optimised conditions led to high selectivity for the cyclic alkyl ethers with very little rearrangement to branched ethers, which is a typical side reaction in classical syntheses (see Scheme 21.16).

Another promising example for the successful transposition of a process from conventional solvents to scCO_2 is the heterogeneously catalysed synthesis of hydrogen peroxide [21,22]. The actual generation of H_2O_2 occurs via a sequential hydrogenation/oxidation cycle of anthraquinones as a redox relay (see Scheme 21.17).

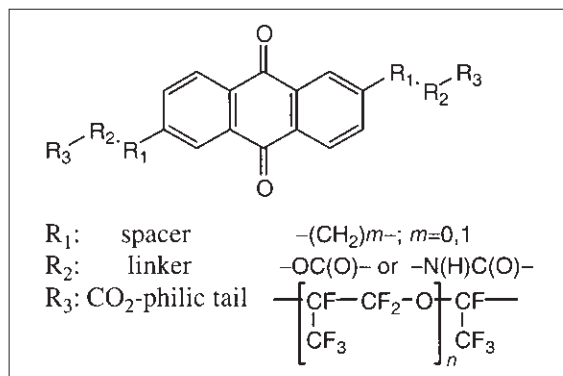
In the present technology, the anthraquinones are dissolved in an organic solvent and first hydrogenated over a palladium catalyst at 30–50°C in a three-phase reactor. The anthrahydroquinone then is fed to a second two-phase reactor, where it is oxidised back to the anthraquinone under production of H_2O_2 . The process is carried out continuously and is inherently safe because hydrogen and oxygen are not mixed directly and mild temperatures are used. Nevertheless, it also has some severe solvent constraints because it is mass transfer limited during the hydrogenation step and deep hydrogenation of the aromatic ring leads to by-products that are resistant to the back oxidation. The work-up procedure requires a tedious liquid–liquid extraction step to isolate the H_2O_2 . A transposition of this process in scCO_2 thus seems very attractive but is hampered by the very low solubility of the anthraquinones in



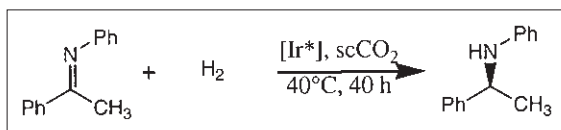
Scheme 21.17 The anthraquinone-based hydrogenation/oxidation process for the production of H_2O_2 .

scCO_2 ($<0.1 \text{ mmol l}^{-1}$). To overcome this limitation, specially functionalised anthraquinones containing CO_2 -philic fluorinated ponytails were designed (see Scheme 21.18) [21] and tested as substrates for the hydrogenation step in scCO_2 [22]. Indeed, enhanced and kinetically controlled reaction rates were observed and deep hydrogenation leading to undesirable by-products was reduced, resulting in clean formation of the fluorinated anthrahydroquinones.

A remarkable 20-fold increase in catalytic efficiency was observed when the hydrogenation of *N*-(1-phenylethylidene)aniline to *N*-phenyl-1-phenylethylamine was carried out in scCO_2 instead of CH_2Cl_2 (see Scheme 21.19) [61]. The best results were obtained with BARF as the counter-ion for the chiral iridium catalyst and enantioselectivities were fully comparable with those obtained in CH_2Cl_2 . The



Scheme 21.18 Design of 'CO₂-philic' anthraquinones.



Scheme 21.19 Enantioselective hydrogenation of *N*-(1-phenylethylidene)aniline in *scCO*₂.

reaction profiles were strongly different in the two media: the turnover rate was largely independent of conversion in *scCO*₂ whereas the reaction slowed down considerably as it proceeded in the organic solvent.

It has been mentioned already that the high compressibility of *scCO*₂ allows its bulk density to be changed continuously from gas- to liquid-like values with small variations of pressure and/or temperature. For example, the density of *scCO*₂ at 37°C is 0.33 g ml⁻¹ at 80 bar, but it increases to 0.80 g ml⁻¹ at 150 bar. Such density variations can have a strong impact on chemical equilibria and reaction rates, providing sometimes additional control over yield and/or selectivity that is not available in conventional liquids. For example, the product distribution of the ring-closing metathesis (RCM) in *scCO*₂ catalysed by ruthenium complexes could be controlled entirely by adjusting the density of the supercritical medium (see Scheme 21.20) [25]. The desired macrocyclic product was produced with excellent yields at densities above 0.65 g ml⁻¹, whereas at lower densities only oligomer products resulted from acyclic diene metathesis (ADMET). Increasing the density of the medium leads to an increased number of solvent molecules, thus mimicking the dilution

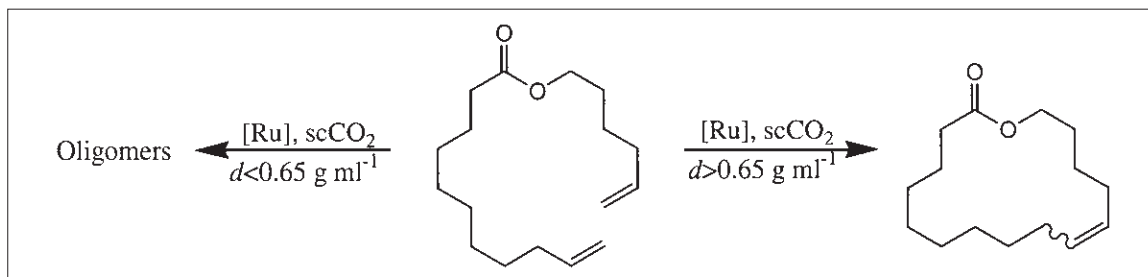
effect of conventional solvents and favouring the intramolecular pathway. Using density instead of concentration has the big advantage that 'dilution' can be achieved at constant volume, making the reaction rate the only decisive parameter for the space-time yield.

5.2 Improvement of changes in stereoselectivity

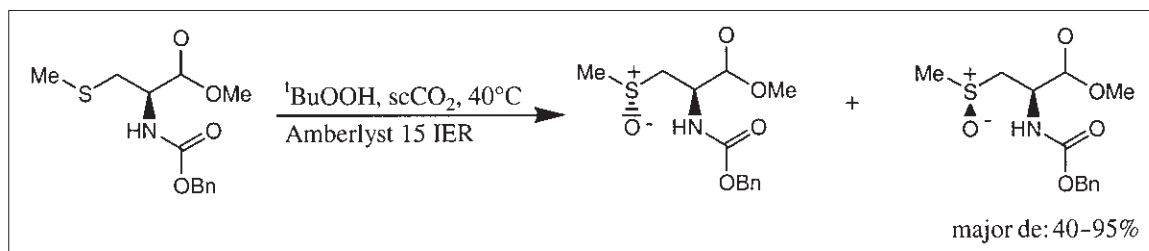
One of the earliest examples of a homogeneously metal-catalysed reaction in *scCO*₂ was the hydroformylation of propene using [Co₂(CO)₈] (Scheme 21.9) [36]. In the original work, a significant improvement in regioselectivity for the desired linear aldehyde was noted at rates comparable with those obtained in classical solvents. The results of a later study suggest that the selectivity can be affected further by the CO₂ pressure (or density) of the reaction medium [62]. The linear/branched ratio was reported to increase from 2.7:1 to 4.3:1 as the pressure doubled from 92 to 184 bar. A higher linear/branched ratio also was reported for the hydroformylation of hex-1-ene in *scCO*₂ using rhodium trialkylphosphine [41]. Moreover, different chemoselectivities from those observed in organic solvents were obtained in this case.

The enantioselective hydroformylation using rhodium catalysts bearing 'CO₂-philic' chiral phosphine ligands gave unprecedented high regioselectivities towards the branched isomers for several substrates in *scCO*₂ [13]. Taking into account the regio- and enantioselectivity, the overall selectivity towards the desired single stereoisomer was significantly higher than with the optimised system in conventional solvents (Fig. 21.3). In this particular case, detailed control experiments revealed that the high regioselectivity originated mainly from the introduction of the perfluoroalkyl side chains into the ligand framework rather than from the specific properties of the reaction medium.

A remarkable effect of *scCO*₂ was observed in the heterogeneously catalysed diastereoselective oxidation of cysteine derivatives (see Scheme 21.21) [63]. The reaction, which proceeds without any stereoselective differentiation in conventional solvents, could be optimised to reach up to 95% of diastereoselectivity in *scCO*₂. Under conditions well beyond the critical data of CO₂, the selectivity exhibited a dramatic dependence on pressure (density) of the



Scheme 21.20 Density effect on the product formation for RCM in scCO_2 .



Scheme 21.21 Diastereoselective oxidation of cysteine derivative in scCO_2 .

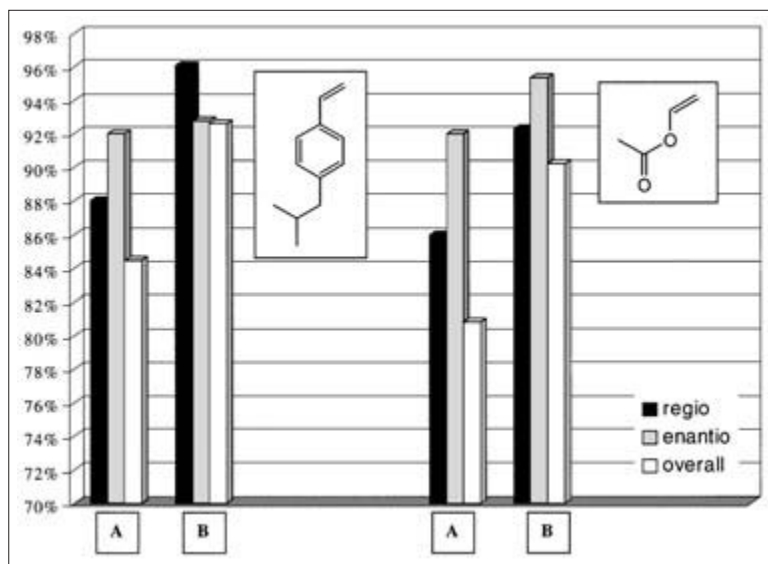


Fig. 21.3 Enhancement of stereoselectivity for asymmetric hydroformylation of two representative substrates using the chiral ligand BINAPHOS in benzene (A) or its 'CO₂-philic' analogue in scCO_2 (B). (Data taken from Ref. 13.)

medium. The diastereoselectivity showed a maximum at 175 bar and declined at both higher and lower pressures at a constant temperature of 40°C. Even though no plainly satisfactory explanation has

been found yet for this phenomenon, it seems to substantiate further the fact that density can be used as an additional parameter for the optimisation of organic syntheses in SCFs.

5.3 Enhanced catalyst lifetime

In heterogeneous catalysis, the use of supercritical reaction media can lead to increased catalyst lifetimes owing to in situ extraction of coke or other low-volatile products that would block the pores, preventing access to the active centres under classical gas-phase conditions [64,65]. For example, the use of scCO_2 allowed catalyst deactivation to be suppressed during Friedel–Crafts alkylation in a continuous-flow reactor using a heterogeneous polysiloxane-supported solid acid catalyst [66]. In the highly selective alkylation of mesitylene with propan-2-ol (see Scheme 21.22), catalyst activity was fully maintained after 16 h of operation in scCO_2 , even though Friedel–Crafts catalysts are known to show much shorter lifetimes under conventional conditions.

The phase behaviour of supercritical reaction mixtures was exploited in a judicious way to extend the lifetime of microporous and mesoporous solid acid catalysts used in 1-butene/isobutene alkylation converting light refinery gases (C_3 – C_5) into gasoline-range compounds (C_7 – C_9) [67]. To exploit the properties of the supercritical state, it was first attempted to perform the reaction using isobutane above its critical point ($T_c = 135^\circ\text{C}$, $P_c = 36.5$ bar) in a continuous-flow reactor. However, the high temperatures required to reach the supercritical state lead to an increase of undesired side reactions such as oligomerisation or cracking, resulting in unacceptable product quality. Operating at subcritical temperatures (50°C) favoured the C_8 alkylate selectivity, but rapid catalyst deactivation occurred due to coke deposition. The problem was solved finally by using CO_2 as a diluent gas, which lowers the critical temperature of the mixture while still providing the transport properties of a supercritical fluid. The addition of 90 mol.% CO_2 to the reaction mixture led to

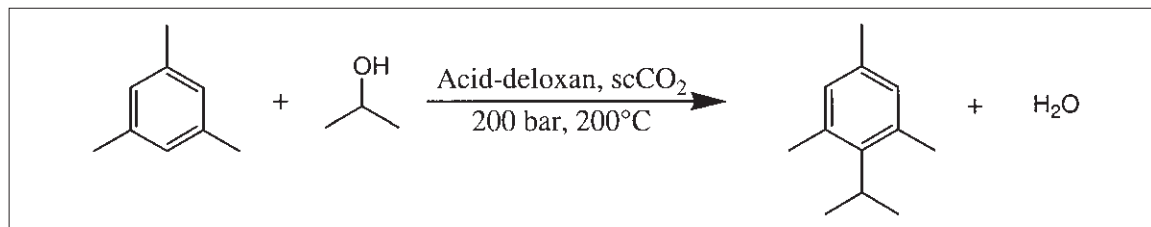
steady and highly selective alkylate production for a reaction time of 2 days at 50°C .

6 Use of Supercritical CO_2 for Product Separation and Catalyst Recycling

Efficient methods for the isolation of pure and solvent-free products from the reaction mixture are required to utilise a chemical synthesis for a practical process. In the case of very sophisticated (and often expensive) homogeneous catalysts, the recovering and recycling of metal and/or ligand is frequently a limiting step for industrial application. The well-known extracting properties of scCO_2 and its density-tuneable solvent power open up new and innovative approaches to this problem. Two different methods can be envisaged, where the reaction occurs either in a single homogeneous phase or under multiphase conditions.

6.1 Multiphase processes using supercritical CO_2 as a reaction and separation phase

One attractive concept for the use of scCO_2 in multiphase catalysis is the design of biphasic water/ scCO_2 systems. The hydrogenation of cinnamaldehyde in such a biphasic medium was investigated with a rhodium catalyst bearing the well-known water-soluble TPPTS ligand [68]. This system exhibited enhanced reaction rates (11% conversion in toluene/water and 38% in scCO_2 /water) as well as better selectivities towards the unsaturated alcohol (see Scheme 21.23). The better performance may be related to enhanced mass-transfer properties in the two-phase (water/ scCO_2) system compared with the conventional ‘biphasic’ catalysis, which actually comprises three reaction phases (water/toluene/gas). The mass transfer between the two reaction phases can be enhanced further using additional surfactants



Scheme 21.22 Alkylation of mesitylene with isopropanol in scCO_2 .

to form scCO_2 /water emulsions, as demonstrated for the hydrogenation of styrene (see Scheme 21.24) [69]. The formation of these emulsions increases the interfacial surface area and can lead to enhanced reaction rates also in non-catalytic reactions [70,71].

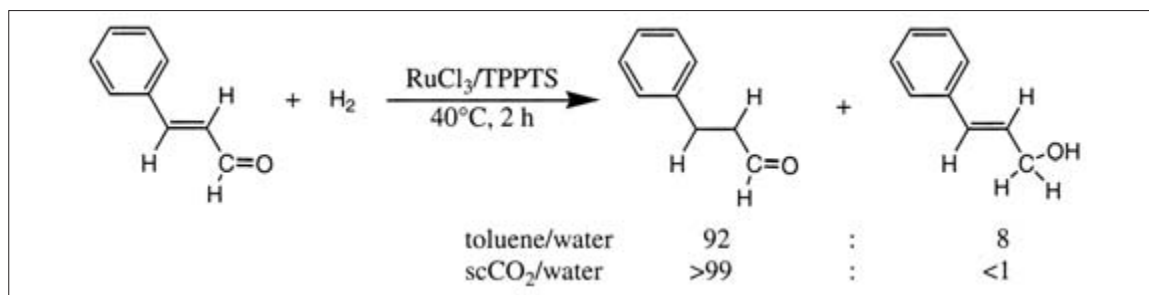
These new systems eliminate the use of organic solvents in aqueous multiphase catalysis but still allow for very easy catalyst/product separation and catalyst recycling. In the simple scCO_2 /water mixture, the catalyst remains trapped in the aqueous phase while the organic product can be removed with the supercritical phase. In the systems involving the surfactants, a simple decrease in pressure is sufficient to break the emulsion down and complete phase separation occurs between water and CO_2 , the surfactant forming a third phase below the two others. The product is recovered from the CO_2 phase during venting and the gas stream is recycled to the catalyst-containing water phase, whereby it is charged with new substrate. The catalyst activity remained constant over three cycles in a first pioneering test of this concept [69].

In principle, liquids other than water can be utilised in a similar way for catalyst immobilisation in multiphase systems. The hydroformylation of olefins was studied under conditions where the

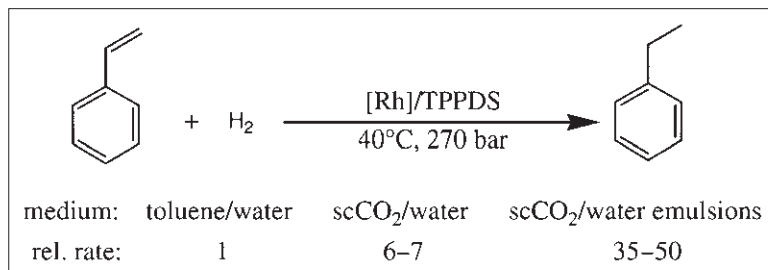
substrate itself formed a second phase containing the catalyst [42]. The immobilisation of the organometallic catalyst in a solid matrix or on a solid support is another intriguing option, resulting in a situation largely identical to classical heterogeneous catalysis [43,72,73]. The possibility of purifying the product stream from such multiphase reactions by controlled changes in temperature and/or pressure seems as yet a largely unexplored area. This is in sharp contrast to polymer synthesis, where the advantage of supercritical processing to remove unreacted monomers or other low-molecular-weight impurities has long been recognised.

6.2 Single-phase reactions with subsequent separation using supercritical CO_2 as the reaction and separation phase

Although the multiphase reactions described above have many attractive features, the remaining phase boundaries still add to the complexity of the reaction system and can lead to difficulties in reaction control compared with fully homogeneous mixtures. A scenario where the reaction occurs in a single homogeneous phase and phase separation is introduced only for the separation step seems, therefore, a highly



Scheme 21.23 Hydrogenation of cinnamaldehyde in a biphasic scCO_2 /water medium.



Scheme 21.24 Hydrogenation of styrene using water/ CO_2 emulsions and other biphasic media.

attractive alternative. We refer to such procedures in organometallic catalysis as CESS (catalysis and extraction using supercritical solutions) processes. After changing from homogeneous to multiphase conditions by small changes of the process parameters, the product is removed selectively from the reaction system with CO₂ by methods closely related to supercritical fluid extraction (SFE), leaving the catalyst in the reactor in its active form.

The first example of a combination of homogeneous organometallic catalysis and SFE was described for ring-closing olefin metathesis (RCM) reactions in scCO₂ using ruthenium carbene catalysts (Scheme 21.20) [25]. These catalysts showed a very limited solubility in scCO₂, the bulk of material remaining undissolved under the reaction conditions. Simple extraction of the reactor content with scCO₂ allowed the products to be removed selectively and the residue in the reactor was still active for RCM in subsequent runs. Similar observations were made for palladium-catalysed Heck (Scheme 21.8), Suzuki and Sonogashira C–C coupling reactions in scCO₂ [31]. In the enantioselective hydrovinylation shown in Scheme 21.6, the extraction of the volatile products resulted not only in separation from the catalyst but also in purification from less-volatile by-products formed via secondary reactions of the product olefin [29].

A special situation is encountered for the iridium-catalysed enantioselective hydrogenation of imines

in scCO₂ using cationic iridium catalysts (Scheme 21.19) [61]. Detailed control experiments revealed that the catalyst showed sufficient solubility when the substrate was present in the reaction mixture but it was almost insoluble in mixtures with only the product. Thus, it was possible to remove the reaction product selectively from the catalyst simply by purging the reactor with compressed CO₂ after complete conversion and no change of conditions between the reaction and extraction stage was necessary. The catalyst remaining in the reactor was recycled seven times, exhibiting a certain loss of activity but no decrease of enantioselectivity (Fig. 21.4).

Another intriguing example for the CESS process was described for the homogeneous hydroformylation of long-chain terminal alkenes in scCO₂ (Scheme 21.9) [38]. In the currently used conventional industrial processes, the high-boiling aldehydes obtained from these reactions have to be separated from the catalysts by tedious distillation and extraction procedures. In scCO₂, the reaction can be performed with high rates and selectivities using rhodium catalysts modified with perfluoroalkyl-substituted phosphorus ligands. The solubility properties of these ligands ensure homogeneous single-phase reaction mixtures for a wide range of substrates at various temperatures and pressures, but still allow for the identification of efficient separation conditions even with very-high-boiling products.

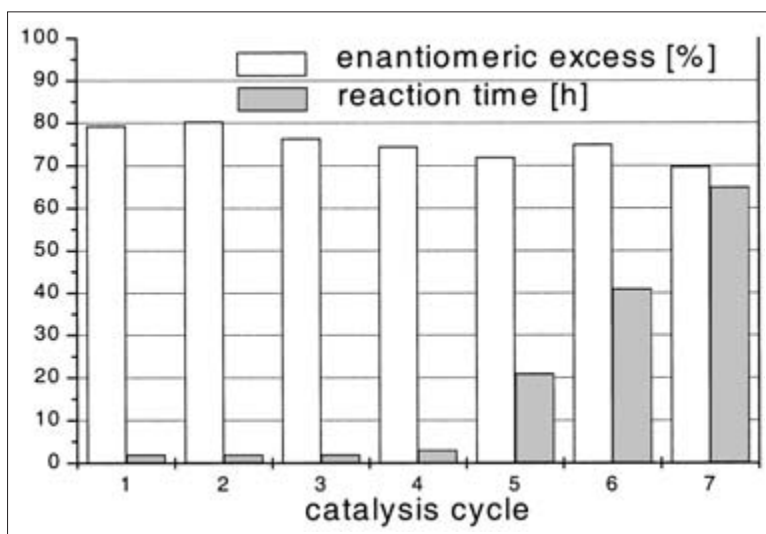


Fig. 21.4 Catalyst recycling in the enantioselective hydrogenation of imines (Scheme 21.19) using the CESS procedure.

The aldehydes collected by the CESS approach contained less than 1 ppm of rhodium and the catalysts were recycled five times without any noticeable change in activity and selectivity. Most recently, this approach was extended also to enantioselective hydroformylation reactions [14].

7 Simultaneous Use of Supercritical CO₂ as Reaction Medium and Reagent

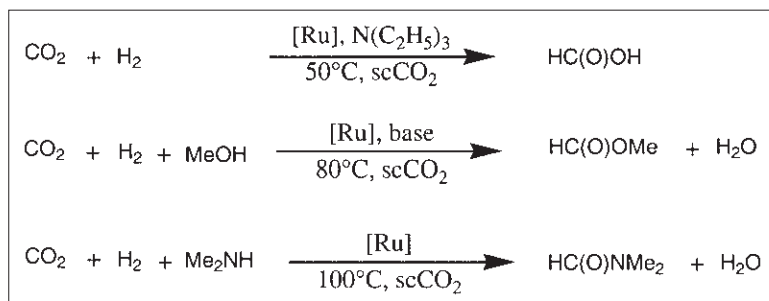
The use of CO₂ as a cheap, non-toxic and readily available C₁-building block seems especially desirable within the context of 'green chemistry', because it would allow the use of a small portion of a major waste material of human activities to replace considerably less benign reagents such as carbon monoxide or phosgene. Despite its reputation of being 'unreactive', CO₂ undergoes a variety of synthetically useful transformations, especially in the presence of transition metal catalysts [74].

The hydrogenation of CO₂ to formic acid and its derivatives is an interesting approach to use CO₂ as a raw material for commodity products, but efficient catalysts were not available until the early 1990s [75,76]. At that time, highly active catalysts for the hydrogenation of CO₂ to formic acid were developed on the basis of rhodium complexes soluble in polar organic [77,78] or aqueous [79] solvents. These catalysts, however, proved not to be compatible with scCO₂ [76]. The first system operating efficiently in scCO₂ was based on a ruthenium-alkylphosphine complex, leading to turnover frequencies (TOFs) of up to 1400 h⁻¹ compared with a TOF of 80 h⁻¹ with the same catalytic system in tetrahydrofuran [80]. The addition of methanol or dimethylamine to the system allowed the formation of formic acid to be coupled to subsequent condensation to methyl formate [81] or dimethylformamide (DMF) [82] (see

Scheme 21.25). The production of DMF with this system occurs with outstanding efficiency, providing quantitative conversion at almost perfect selectivity, and up to 420 000 mol DMF mol⁻¹ catalyst could be obtained. The molecular ruthenium catalysts could be anchored to silica supports by a sol-gel process and then were recyclable with negligible leaching [72,73].

The use of CO₂ as a solvent and a reagent also has been considered in the synthesis of organic carbonates [83] and particularly polycarbonates using epoxides as the other starting material. The copolymerisation of propylene and CO₂ in scCO₂ was effected using a heterogeneous zinc catalyst [84]. A CO₂-soluble zinc catalyst was used to achieve the copolymerisation with 1,2-epoxycyclohexane, with polymer yields up to 69%. Up to 400 g of polymer were formed per gram of zinc and the product contained more than 90% carbonate linkages (see Scheme 21.26) [85]. Soluble chromium porphyrin catalyst proved even more effective (3.9 kg polymer g⁻¹ chromium) [86], giving copolymers containing more than 95% carbonate linkages and narrow molecular weight distributions.

In an early example for C-C coupling reactions, CO₂ was used beyond its critical data as a reactant in the nickel-catalysed synthesis of tetraethyl-2-pyrone from hex-3-yne (see Scheme 21.27) [87]. A side reaction of the nickel complexes with CO₂ was identified as a major deactivation pathway, in this case with fully soluble catalytic systems [47]. On the other hand, the reactivity of CO₂ also can help to protect catalytically active centres by chemical interaction with functional groups of the substrate that otherwise would deactivate the catalyst. This principle was demonstrated first with ruthenium catalysts used for RCM in scCO₂ [25]. These catalysts are deactivated by basic N-H groups and substrates



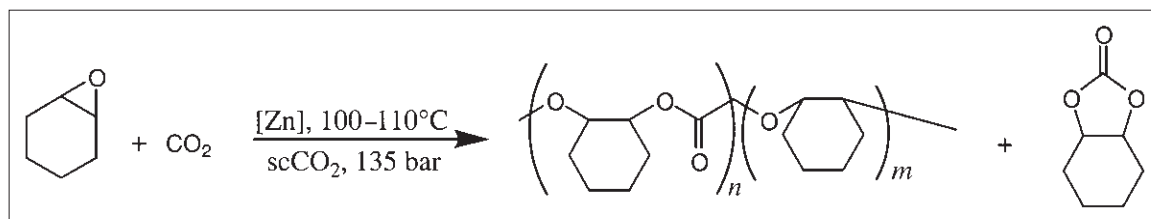
Scheme 21.25 Hydrogenation of scCO₂ to formic acid, methyl formate or DMF.

containing this type of functional group can be cyclised in conventional solvents in protected form only. The conventional synthesis to obtain cyclic amines by this route therefore involves three steps (protection/cyclisation/deprotection) and has a low atom efficiency due to the protecting group manipulation. In scCO_2 , however, the cyclisation is readily achieved without the need for an additional protecting group (see Scheme 21.28), because the reversible formation of the carbamic acid results in a temporary protection of the amine in the solvent scCO_2 . Upon pressure release, the carbamic acid is converted back spontaneously to the free amine, which is isolated directly in one step.

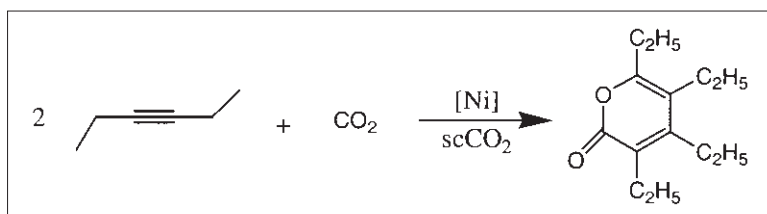
8 Conclusion

Supercritical carbon dioxide is a highly promising reaction medium for environmentally benign chemical synthesis and can be applied widely in

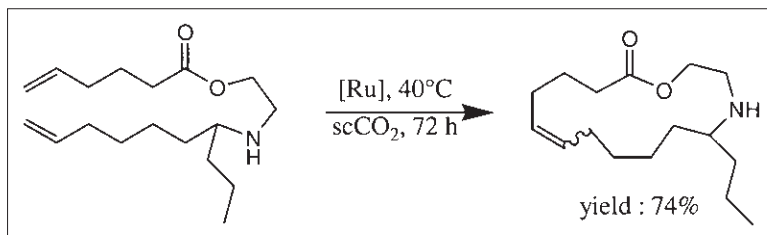
combination with homogeneous or heterogeneous catalysts. Additional benefits such as increased reaction rates, tuning of product selectivity, enhanced catalyst lifetime and the combination of reaction and extraction often can result from the choice of scCO_2 instead of an organic solvent. Although scCO_2 is far from being a universal solvent, the design of 'CO₂-philic' materials and surfactants is making rapid progress and will help to broaden the scope of possible applications in the near future. At present, the economic evaluation of CO₂-based catalytic processes is still difficult because many important parameters are not yet known with sufficient certainty. Obviously, working with scCO_2 means significant capital investment in costly high-pressure equipment and benefits such as simplified work-up procedures, enhanced reaction rates and selectivities, or savings through elimination of organic and hazardous wastes, must help to counterbalance these costs. There is, however, increasing evidence that



Scheme 21.26 Copolymerisation of 1,2-epoxycyclohexane with scCO_2 .



Scheme 21.27 Coupling of hex-3-yne with scCO_2 .



Scheme 21.28 Use of scCO_2 as solvent and temporary protecting group during ring-closing metathesis (RCM) of amines.

this balance may well be on the side of scCO₂ in certain cases: the polymerisation of fluorinated monomers, leading to polymers of the Teflon brand, is currently conducted by DuPont on a demonstration plant using scCO₂ technology and world-scale production is planned if these studies are successful [88]. The British company Thomas Swan Ltd has announced plans to build a multipurpose facility using supercritical fluids to replace conventional solvents for continuous-flow heterogeneously catalysed processes such as hydrogenations, alkylations, acylations and etherifications [89]. If these processes prove to be economically viable, they substantiate once again that 'green chemistry' can help to achieve sustainable industrial synthesis.

References

- Jessop, P. G., & Leitner, W. *Chemical Synthesis Using Supercritical Fluids*. Wiley-VCH, Weinheim, 1999.
- Cagniard de la Tour, C. *Ann. Chim. Phys.*, 1822, **21**, 127.
- Jessop, P. G., & Leitner, W. *Chemical Synthesis Using Supercritical Fluids*. Wiley-VCH, Weinheim, 1999, p. 13.
- McHugh, M., & Krukonis, V. J. *Supercritical Fluid Extraction*, 2nd edn. Butterworth-Heinemann, Boston, 1994.
- Zosel, K. *Angew. Chem. Int. Ed. Eng.*, 1978, **17**, 702.
- Jessop, P. G., Ikariya, T., & Noyori, R. *Science*, 1995, **269**, 1065.
- Leitner, W. *Top. Curr. Chem.*, 1999, **206**, 107, and references therein.
- Noyori, R. *Chem. Rev.*, 1999, 99.
- Hitzler, M. G., Smail, F., Ross, S. K., & Poliakov, M. *Org. Process Res. Dev.*, 1998, **2**, 137.
- Jessop, P. G., Hsiao, Y., Ikariya, T., & Noyori, R. *J. Am. Chem. Soc.*, 1996, **118**, 344.
- Kainz, S., & Leitner, W. *Catal. Lett.*, 1998, **55**, 223.
- Kainz, S., Koch, D., Baumann, W., & Leitner, W. *Angew. Chem. Int. Ed. Engl.*, 1997, **36**, 1628.
- Franciò, G., & Leitner, W. *Chem. Commun.*, 1999, 1663.
- Franciò, G., Wittmann, K., & Leitner, W. *J. Organomet. Chem.*, 2000, **621**, 130.
- Burk, M. J., Feng, S., Gross, M. F., & Tumas, W. *J. Am. Chem. Soc.*, 1995, **117**, 8277.
- Xiao, J., Neffkens, S. C. A., Jessop, P. G., Ikariya, T., & Noyori, R. *Tetrahedron Lett.*, 1996, **37**, 2813.
- Smart, N. G., Carleson, T., Kast, T., Clifford, A. A., Burford, M. D., & Wai, C. M. *Talanta*, 1997, **44**, 137.
- DeSimone, J. M., Guan, Z., & Elsbernd, C. S. *Science*, 1992, **257**, 945.
- Harrison, K., Goveas, J., Johnston, K. P., & O'Rear, E. A. *Langmuir*, 1994, **10**, 3536.
- Hadida, S., Super, M. S., Beckman, E. J., & Curran, D. P. *J. Am. Chem. Soc.*, 1997, **119**, 7406.
- Hâncu, D., & Beckman, E. J. *Ind. Eng. Chem. Res.*, 1999, **38**, 2824.
- Hâncu, D., & Beckman, E. J. *Ind. Eng. Chem. Res.*, 1999, **38**, 2833.
- Sarbu, T., Styrane, T., & Beckman, E. J. *Nature*, 2000, **405**, 165.
- DeSimone, J. M., Maury, E. E., Menciloglu, Y. Z., McClain, J. B., Romack, T. J., & Combes, J. R. *Science*, 1995, **265**, 356.
- Fürstner, A., Koch, D., Langemann, K., Leitner, W., & Six, C. *Angew. Chem. Int. Ed. Eng.*, 1997, **36**, 2466.
- de Vries, T. J., Duchateau, R., Vorstman, M. A. G., & Keurentjes, J. T. F. *Chem. Commun.*, 2000, 263.
- Wegner, A. *PhD Thesis*, Universität Jena/MPI für Kohlenforschung, 2000.
- Hori, H., Six, C., & Leitner, W. *Macromolecules*, 1999, **32**, 3178.
- Wegner, A., & Leitner, W. *Chem. Commun.*, 1999, 1583.
- Morita, D. K., Pesiri, D. R., David, S. A., Glaze, W. H., & Tumas, W. *Chem. Commun.*, 1998, 1397.
- Carroll, M. A., & Holmes, A. B. *Chem. Commun.*, 1998, 1395.
- Shezad, N., Oakes, R. S., Clifford, A. A., & Rayner, C. M. *Tetrahedron Lett.*, 1999, **40**, 2221.
- Sowden, R. J., Sellin, M. F., DeBlasio, N., & Cole-Hamilton, D. J. *Chem. Commun.*, 2000, 2511.
- Kayaki, Y., Noguchi, Y., Iwasa, S., Ikariya, T., & Noyori, R. *Chem. Commun.*, 2000, 1235.
- Jeong, N., Hwang, S. H., Lee, Y. W., & Lim, J. S. *J. Am. Chem. Soc.*, 1997, **119**, 10549.
- Rathke, J. W., Klingler, R. J., & Krause, T. R. *Organometallics*, 1991, **10**, 1350.
- Guo, Y., & Akgerman, A. *J. Supercrit. Fluids*, 1999, **15**, 63.
- Koch, D., & Leitner, W. *J. Am. Chem. Soc.*, 1998, **120**, 13398.
- Palo, D. R., & Erkey, C. *Ind. Eng. Chem. Res.*, 1998, **37**, 4203.
- Palo, D. R., & Erkey, C. *Organometallics*, 2000, **19**, 81.
- Bach, I., & Cole-Hamilton, D. J. *Chem. Commun.*, 1998, 1463.
- Sellin, M. F., & Cole-Hamilton, D. J. *J. Chem. Soc. Dalton Trans.*, 2000, 1681.
- Meehan, N. J., Sandee, A. J., Reek, J. N. H., Kamer, P. C. J., van Leeuwen, P. W. N. M., & Poliakov, M. *Chem. Commun.*, 2000, 1497.
- Morgenstern, D. A., LeLacheur, R. M., Morita, D. K., Borkowsky, S. L., et al. In *Green Chemistry* (Anastas, P. T., & Williamson, T. C., eds). *ACS Symp. Ser.* No. 626. American Chemical Society, Washington DC, 1996, p. 132.
- Haas, G. R., & Kolis, J. W. *Organometallics*, 1998, **17**, 4454.
- Perisis, D. R., Morita, D. K., Glaze, W., & Tumas, W. *Chem. Commun.*, 1998, 1015.

47. Kreher, U., Schebesta, S., & Walther, D. *Z. Anorg. Allg. Chem.*, 1998, **624**, 602.
48. Loeker, F., Koch, D., & Leitner, W. In *Selective Oxidations in Petrochemistry* (Emig, G., Kohlpaintner, C., & Lücke, B., eds). DGMK, Hamburg, 1998, p. 209.
49. Dooley, K. M., & Knopf, F. C. *Ind. Eng. Chem. Res.*, 1987, **26**, 1910.
50. Ochiogrosso, R. N., & McHugh, M. A. *Chem. Eng. Sci.*, 1987, **42**, 2478.
51. Martin, A., & Kerler, B. *Chem. Ing. Tech.*, 2000, **72**, 382.
52. Wu, X. W., Oshima, Y., & Koda, S. *Chem. Lett.*, 1997, 1045.
53. Birnbaum, E. R., Le Lacheur, R. M., Horton, A. C., & Tumas, W. *J. Mol. Catal. A: Chem.*, 1999, **139**, 11.
54. Loeker, F., & Leitner, W. *Chem. Eur. J.*, 2000, **6**, 2011.
55. Lange, S., Brinkmann, A., Trautner, P., Woelk, K., Bargon, J., & Leitner, W. *Chirality*, 2000, **12**, 450.
56. Tacke, T., Wieland, S., & Panster, P. *High Press. Chem. Eng.*, 1996, 17.
57. Tacke, T., Wieland, S., & Panster, P. *Proceedings of the 4th International Symposium on Supercritical Fluids*, Sendai, Japan, 11–14 May 1997.
58. Tacke, T., Rehren, C., Wieland, S., Panster, P., et al. In *Catalysis of Organic Reactions* (Herkes, F. E., ed.). Marcel Dekker, New York, 1998, p. 345.
59. Bhanage, B. M., Ikushima, Y., Shirai, M., & Arai, M. *Catal. Lett.*, 1999, **62**, 175.
60. Gray, W. K., Small, F. R., Hitzler, M. G., Ross, S. K., & Poliakov, M. *J. Am. Chem. Soc.*, 1999, **121**, 10711.
61. Kainz, S., Brinkmann, A., Leitner, W., & Pfaltz, A. *J. Am. Chem. Soc.*, 1999, **121**, 6421.
62. Guo, Y., & Akgerman, A. *Ind. Eng. Chem. Res.*, 1997, **36**, 4581.
63. Oakes, R. S., Clifford, A. A., Bartle, K. D., Thornton Pett, M., & Rayner, C. M. *Chem. Commun.*, 1999, 247.
64. Baiker, A. *Chem. Rev.*, 1999, **99**, 453.
65. Ikushima, Y., & Arai, M. In *Chemical Synthesis Using Supercritical Fluids* (Jessop, P. G., & Leitner, W., eds). Wiley-VCH, Weinheim, 1999, p. 259.
66. Hitzler, M. G., Small, F. R., Ross, S. K., & Poliakov, M. *Chem. Commun.*, 1998, 359.
67. Clark, M. C., & Subramaniam, B. *Ind. Eng. Chem. Res.*, 1998, **37**, 1243.
68. Bahnage, B. M., Ikushima, Y., Shirai, M., & Arai, M. *Chem. Commun.*, 1999, 1277.
69. Jacobson, G. B., Lee Jr., C. T., Johnston, K. P., & Tumas, W. *J. Am. Chem. Soc.*, 1999, **121**, 11902.
70. Jacobsen, G. B., Lee, C. T., daRocha, S. R. P., & Johnston, K. P. *J. Org. Chem.*, 1999, **64**, 1201.
71. Jacobsen, G. B., Lee, C. T., & Johnston, K. P. *J. Org. Chem.*, 1999, **64**, 1207.
72. Kröcher, O., Köppel, R. A., & Baiker, A. *Chem. Commun.*, 1996, 1497.
73. Kröcher, O., Köppel, R. A., Fröba, M., & Baiker, A. *J. Catal.*, 1998, **178**, 284.
74. Leitner, W. *Coord. Chem. Rev.*, 1996, **153**, 257.
75. Jessop, P. G., Ikariya, T., & Noyori, R. *Chem. Rev.*, 1995, **95**, 259.
76. Leitner, W. *Angew. Chem. Int. Ed. Engl.*, 1995, **34**, 2207.
77. Graf, E., & Leitner, W. *J. Chem. Soc. Chem. Commun.*, 1992, 623.
78. Leitner, W., Dinjus, E., & Gaßner, F. *J. Organomet. Chem.*, 1994, **475**, 257.
79. Gaßner, F., & Leitner, W. *J. Chem. Soc. Chem. Commun.*, 1993, 1465.
80. Jessop, P. G., Ikariya, T., & Noyori, R. *Nature*, 1994, **368**, 231.
81. Jessop, P. G., Hsiao, Y., Ikariya, T., & Noyori, R. *J. Am. Chem. Soc.*, 1996, **118**, 344.
82. Jessop, P. G., Hsiao, Y., Ikariya, T., & Noyori, R. *J. Am. Chem. Soc.*, 1994, **116**, 8851.
83. Sakakura, T., Saito, Y., Okano, M., Choi, J. C., & Sako, T. *J. Org. Chem.*, 1998, **63**, 7095.
84. Darensbourg, D. J., Stafford, N. W., & Katsurao, T. *J. Mol. Catal. A: Chem.*, 1995, **104**, L1.
85. Super, M., Berluche, E., Costello, C., & Beckman, E. *Macromolecules*, 1997, **30**, 368.
86. Mang, S., Cooper, A. I., Colclough, M. E., Chauhan, N., & Holmes, A. B. *Macromolecules*, 2000, **33**, 303.
87. Reetz, M. T., Könen, W., & Strack, T. *Chimia*, 1993, **47**, 493.
88. McCoy, M. *Chem. Eng. News*, 1999, **June**, 11.
89. Anon. *Chem. Eng. News*, 2000, **78**, 16.

Chapter 22: Chemistry in Fluorous Biphasic Systems

JÓZSEF RÁBAI, ZOLTÁN SZLÁVIK AND ISTVÁN T. HORVÁTH

1 Introduction

One of the most vigorously studied areas of green chemistry is the development of selective reagents and catalysts with facile and complete separation from the products [1]. Although solid reagents and catalysts could provide easy separation from gaseous and liquid products, the presence of various active centres on the surface frequently leads to different reactivity and thus low selectivity. Although the selectivity of carefully designed soluble reagents and catalysts could be extremely high because the active centre(s) could be controlled at the molecular level, the separation of the products could be a major limiting factor for commercial developments. One of the most promising approaches for the separation of liquid products from soluble reagents and catalysts is the application of liquid–liquid biphasic chemistry. An effective biphasic system consists of a reagent or a catalyst phase, containing a preferentially soluble reagent or catalyst, and a second product phase that should have limited solubility in the reagent or catalyst phase (Fig. 22.1). The selection of the reagent or the catalyst phase is governed by the solubility characteristics of the product. For example, the Hildebrand solubility parameter scale (Fig. 22.2) could be used to assess the solubility and miscibility of the product with various solvents and to identify a well-separable reagent or catalyst phase [2–5]. In general, if the product is apolar then the reagent or the catalyst phase should be polar, and if the product is polar then the reagent or the catalyst phase should be apolar. Reagents and catalysts can be made preferentially soluble in the reagent or the catalyst phase by attaching solubilising groups to reagents or catalysts in appropriate size and number. Although reagents and catalysts soluble in water [6] and ionic liquid [7] can be used for the synthesis and separation of products with lower polarity, the most apolar media for biphasic systems are fluoruous solvents such as perfluoroalkanes, perfluorodialkyl ethers, per-

fluorotrialkyl amines [8,9] and supercritical carbon dioxide [10].

2 The Fluorous Biphasic Concept

The fluoruous biphasic concept is based on the limited miscibility of perfluoroalkanes, perfluorodialkyl ethers and perfluorotrialkyl amines with common organic solvents such as toluene, tetrahydrofuran (THF) and acetone [8,9]. A fluoruous biphasic reagent or catalyst consists of a fluoruous phase containing a preferentially fluoruous soluble reagent or catalyst and a second product phase that may be any organic or non-organic solvent with limited solubility in the fluoruous phase. Reagents and catalysts can be made fluoruous soluble by attaching fluorocarbon moieties to ligands in the appropriate size and number. The most effective fluorocarbon moieties are linear or branched perfluoroalkyl chains with high carbon number that may contain other heteroatoms (the ‘fluorous ponytails’). Because of the electron-withdrawing properties of the fluorine atom, the attachment of fluoruous ponytails could change significantly the electronic properties and consequently the reactivity of fluoruous reagents and catalysts. Therefore, the insertion of insulating groups before the fluoruous ponytail may be necessary to decrease the electron-withdrawing effects [11–13].

Fluorous biphasic systems are well suited for converting apolar reactants to products of higher polarity, because the partition coefficients of the reactants and products will be higher and lower, respectively, in the fluoruous phase. The net results are no or little solubility limitation on the reactants and easy separation of the products. Furthermore, as the conversion level increases, the amount of polar products increases, further enhancing product separation.

It should be emphasised that some fluoruous biphasic systems can become a single phase at increased temperatures. Thus, a fluoruous biphasic system could combine the advantages of one phase reaction with

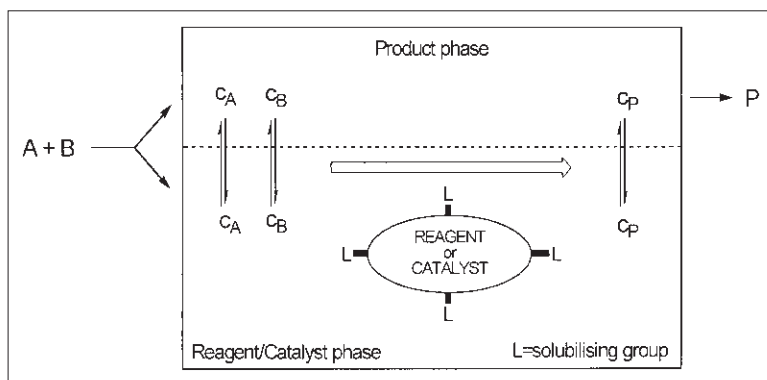


Fig. 22.1 Biphasic system consisting of a reagent/catalyst phase, containing a preferentially soluble reagent or catalyst, and a product phase that has limited solubility in the reagent/catalyst phase.

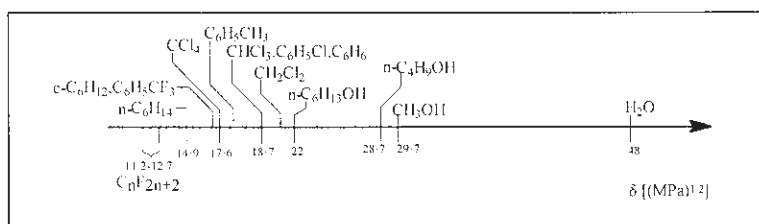


Fig. 22.2 Typical solvents and their Hildebrand solubility parameters δ . (From Ref. 3.)

biphasic product separation by running the reaction at higher temperatures and separating the products at lower temperatures [5,8,9,14–19].

3 Fluorous Solvents

Perfluorocarbon liquids have unique properties making them suitable for a wide range of applications in medicine, biotechnology, electronics and the oil and gas industries. It should be emphasised that only perfluoroalkanes, perfluorodialkyl ethers and perfluorotrialkyl amines are considered here as fluorous solvents. Many of their applications rely on properties such as hydrophobicity, non-toxicity, high oxygen solubility, inertness, high thermal stability, non-flammability and efficient heat-transfer capacity. These characteristics are due to the remarkably high stability of the C–F bonds [20,21]. Fluorous solvents are used in degreasing technologies (replacing toxic, chlorinated and ozone-depleting solvents), non-toxic fire-extinguishers, gas-tracers, plasticisers of poly(tetrafluoroethylene) and medical applications [22]. A recently developed fluorocarbon emulsion called *Oxygent*TM is now in the final stages of clinical evaluation for use as a therapeutic oxygen delivery system [23]. Its main ingredient, the bio-

compatible perfluorooctyl bromide, like other fluorous solvents, is non-toxic and manufactured at an industrial scale. However, some perfluorinated olefins are toxic, e.g. $\text{CF}_2=\text{C}(\text{CF}_3)_2$ [24].

The unique solvent behaviour of fluorous solvents was clearly recognised and described by Hildebrand and co-workers in the 1940s: ‘*The large molal volumes of the fluorocarbons compared with the corresponding hydrocarbons lead to unusually low internal pressures or cohesive energy densities, while their high weights aid in maintaining them in the liquid state, the net result of which is to make many of their solutions with ordinary liquid hydrocarbons deviate from Raoult’s law to such an extent as to form two liquid phases, a state of affairs comparatively rare among non-polar liquids*’ [25]. Both the experimental data and the explanations for the anomalous solution behaviour of two-component systems involving fluorocarbons have been critically reviewed [26].

In general, fluorophilic, organophilic or hydrophilic solvents can be identified by their Hildebrand solubility parameters: $\delta_{(\text{fluorous})} < \delta_{(\text{organic})} \ll \delta_{(\text{water})}$. These values are known for several compounds or can be estimated by a group contribution method [3]. Solvents having higher Hildebrand parameter values than $18 \text{MPa}^{1/2}$ (or located right from

Table 22.1 Critical solution temperatures (°C) for binary mixtures with perfluoro-(methylcyclohexane) and perfluoro-*n*-heptane

	<i>n</i> -Heptane	Carbon tetrachloride	Chloroform	Benzene	Toluene	Chlorobenzene
CF ₃ C ₆ F ₁₁	—	26.8	50.3	85.3	88.8	126.8
<i>n</i> -C ₇ F ₁₆	50	58.7	78.5	113.5	—	—

Data taken from Refs 25 and 27.

CCl₄ on Fig. 22.2) will form two phases with fluorine solvents at ambient conditions (Table 22.1) [28].

The temperature-dependent miscibility (i.e. the formation of one phase at higher and two phases at lower temperatures) of perfluorocyclohexane with acetone, chloroform, benzene, carbon tetrachloride and trichloroethylene, along with its unlimited solubility in benzotrifluoride and ether, has been observed already during wartime activities [29,30].

It is important to note that fluorine solvents are essentially inert to atmospheric OH, O and H radicals and atoms, and the only significant destruction process is photolysis at wavelengths shorter than 130 nm. The release of gases such as CF₄ and C₂F₆ (formed during the electrolysis of Al₂O₃ dissolved in cryolite) could be a concern for their high global warming potential [31,32].

4 Synthesis of Fluorous Compounds

The successful development of fluorine biphasic chemistry requires an easy access to reagents and catalysts with appropriate (absolute and/or relative) fluorine solubility. Their relative solubility can be quantified with fluorine partition coefficients or related terms such as fluorophilicity or specific fluorophilicity [33]. In order to avoid significant leaching of fluorine reagents and catalysts, the partition properties of all fluorine intermediates involved should be tuned for high fluorine phase affinity. Some empirical rules of designing fluorophilic reagents and catalysts have been summarised [12,14].

In a qualitative treatment the 'like dissolves like' principle can be applied, and the likelihood of the reagents or the catalysts and the solvent molecules can be estimated by using their calculated Hildebrand solubility parameters, provided that their molecular volumes are approximately the same [5]. In a general protocol, solubilising groups rich in

fluorine atoms (e.g. fluorine ponytails R_{fn} = F(CF₂)_n) of appropriate number, length and shape are appended to molecules to give them high fluorine phase preference. In order to preserve the reactivity of the fluorine version of reagents and catalysts, the strong electron-withdrawing effect of the R_{fn} groups must be insulated from the reaction centre by inserting hydrocarbon spacers between them, e.g. (CH₂)_n or (CH₂)₂Si(R₂) [8,34,35]. Another important design element is that the number of functional groups capable of attractive interaction with each other or with the molecules of the product phase should be minimised.

Because the application of fluorine biphasic chemistry is highly dependent on easy access to fluorine ligands, catalysts, labels and reagents, we provide a collection of potential as well as demonstrated fluorine precursors, ligands and complexes (Table 22.2 and Figs. 22.3–22.6).

Perfluoroalkyl halides (F(CF₂)_nX, where X = Cl, Br, I) can be used as perfluoroalkyl radical, anion or cation precursors. Perfluoroalkyl iodides can be activated either by heat or by electron transfers to initiate radical substitution or addition reactions, whereas perfluoroalkyl silanes (R_{fn}-SiMe₃) in the presence of fluoride ions behave as perfluoroalkyl anion equivalents. The aryl(perfluoroalkyl)iodonium triflates (Yagupolskii–Umamoto's reagent) act as electrophilic perfluoroalkylation reagents. Although perfluoroalkyl lithium reagents have very limited synthetic value due to the loss of LiF above -90°C, perfluoroalkyl copper derivatives have been used frequently in high-yield procedures [36,85,86].

There are many examples capitalising on the phase separation of fluorine compounds from other reaction components. Some selected examples are: the reduction of R_{fn}CH₂CH(I)R with Bu₃SnH [47]; the oxidation of fluorine Schiff bases with *m*-chloroperbenzoic acid in CH₃CN affords easily separable di(perfluoroalkyl)oxaziridines [79]; pure fluorine aldehydes can be obtained by reduction of the

Table 22.2 Selected fluorous precursors, intermediates and ligands

Precursor (educt)	Product [Ref.]
$R_{fn}-I$ [36]	<p>Ar-R_{fn} [37]</p> <p>Het-R_{fn} [37]</p> <p>Ar-R_{fn} [33, 38, 39]</p> <p>$R_{fn}R_2C_6H_2OH$, $(R_{fn}R_2C_6H_2O)_3P$ [40]</p> <p><i>p</i>-$R_{fn}C_6H_4OH$, $(p-R_{fn}C_6H_4O)_3P$ [41]</p> <p><i>p</i>-$R_{fn}C_6H_4Br$, $(p-R_{fn}C_6H_4)_3P$ [41]</p> <p>2,4-$(R_{fn})_2ArOH$, [2,4-$(R_{fn})_2ArO$]$_3P$ [42]</p> <p>$[R_{fn}CH=CH-(CH_2)_m]_2$-bipy [43]</p> <p>ArS-R_{fn}, AlkS-R_{fn} [33]</p> <p>2,4-$(R_{18})C_6H_3SeC_4H_9$ [44]</p> <p>$R_{fn}CH_2CH_2I$ [45]</p> <p>$[R_{fn}CH_2CHISi(CH_3)_3, R_{fn}CH=CH_2]$ [46]</p> <p>$R_{fn}CH_2CH(I)CH_2OH$ [47]</p> <p>$R_{fn}CH_2CH_2CH_2OH$, $n = 6$ [47]</p> <p>$n = 8$ [48]; $n = 6, 8, 10$ [49]</p> <p>$R_{fn}CH_2CH_2(CH_2)_mOH$, $n = 8, m = 1, 2, 3$ [50]</p> <p>$R_{fn}CH_2CHIOAc$, $R_{fn}CH_2CH=O$ [51]</p>
$R_{fn}-Br$	$R_{fn}-S-R$, R = alkyl, aryl [52]
$R_{fn}-Cl$	<p>$R_{fn}CH_2CH_2R$, R = alkyl, $CH_2Si(CH_3)_3$ [53]</p> <p>$R_{fn}CH_2CH_2R$, $R_{fn}SO_2Cl$ [54]</p>
$R_{fn}-CO_2H$	$R_{17}C(O)CH_2C(O)R_{17}$ [55]
$R_{fn}CH_2CH_2I$	<p>$R_{fn}CH=CH_2$ [56]</p> <p>(Ferrocene)$(CH_2CH_2R_{fn})_2$ [57]</p> <p>$(R_{fn}CH_2CH_2)_2P((-)$menthyl) [58]</p> <p>$(R_{fn}C_6H_4)_2PCH_2CH_2P(C_6H_4R_{fn})_2$ [41]</p> <p>$(m-R_{fn}CH_2CH_2C_6H_4)_3P$ [59]</p> <p>$[(R_{fn}CH_2CH_2C_6H_4)_2PCH_2]_2$ [59]</p> <p>$[(R_{fn}CH_2CH_2)_2P(BH_3)CH_2]_2$ [60]</p> <p>$(R_{fn}CH_2CH_2)_{3-n}SiMe_nCl$, $n = 0, 1, 2$ [35]</p> <p>$[(R_{fn}CH_2CH_2)_{3-n}SiMe_nC_6H_4]_3P$, $n = 0, 1, 2$ [35]</p> <p>$(R_{fn}CH_2CH_2)_3SiBr$ [61]</p> <p>$(R_{fn}CH_2CH_2)_3SnR$, R = Ph, Br, H [62]</p> <p>$[(R_{16}CH_2CH_2)_2SnO]_n$ [63]</p>
$R_{18}CH_2CH_2OC(O)CH=CH_2^-$	$-[(Ph_2PC_6H_4)CHCH_2]_1- [CH(CO_2CH_2CH_2R_{18})CH_2]_{n-}$, fluorous polymer-supported arylphosphine [64]
$[R_{fn}CH_2CH_2P(C_6H_5)_3]^+I^-$	Ar $(CH=CHCH_2R_{fn})_x$, Ar $(CH_2CH_2CH_2R_{fn})_x$ [65]
$R_{18}(CH_2)_mI$, $m = 2-4$	$R_{18}(CH_2)_mPH_2$, $m = 2-4$; $R_{18}(CH_2)_mP[(CH_2)_mR_{18}]_2$, $m/m' = 3/2, 2/3, 4/3, 3/4$ [66]
$R_{fn}CH_2CH_2CH_2I$	<p>$(R_{fn}CH_2CH_2CH_2OAr)_3P(O)_{x'}$, $x = 0, 1$ [67]</p> <p>$[-N(CH_2CH_2CH_2R_{fn})CH_2CH_2-]_3$ [48]</p> <p>$(R_{18}CH_2CH_2CH_2)_2NCH_3$ [13]</p> <p>$[R_{17}CH_2CH_2CH_2CH_2]_2$bipy [68]</p>
$R_{fn}CH_2CH_2CH_2OTs$	$N(CH_2CH_2N(CH_2CH_2CH_2R_{16})_2)_3$ [69]
$R_{17}CH_2OH$	$[R_{17}CH_2OCH_2]_2$ bipy [68]
$R_{fn}(CH_2)_nOH$	$R_{fn}(CH_2)_nOP(O)[N(CH_2CH_2)_2O]_2$, $n = 1, 3$ [70]
$R_{fn}CH_2OSO_2C_4F_9$	$(R_{fn}CH_2OAr)_3P(O)_{x'}$, $x = 0, 1$ [67]
$R_{fn}CH_2CH_2OH$	$(R_{fn}CH_2CH_2O)_3P$ [9]

Table 22.2 Continued

Precursor (educt)	Product [Ref.]
$R_{17}CH_2CH_2CH_2OH$	$R_{17}CH_2CH_2CH_2I$ [48] $R_{17}CH_2CH_2CH_2OAr$ [17] $[R_{17}CH_2CH_2CH_2OCH_2]_2bipy$ [68]
$R_{17}CH=CH_2$	$ArCH_2CH_2CF_3$ [71] $(R_{17}CH_2CH_2)_2P(-)menthyl$ [58] $[(R_{17}CH_2CH_2)_3P]$ [8, 34] $(O)_xP(C_6H_4CH=CHR_{17})_3, x = 0, 1$ [72]
$R_{17}(CH_2)_xCH=CH_2, x = 0, 1, 2$	$[R_{17}(CH_2)_x]_2]_3P$ [34]
$R_{16}(CH_2)_{m-1}CH=O, m = 3-5$	$NH_{3-x}[(CH_2)_m(CF_2)_7CF_3]_x, x = 1-3$ [73]
$R_{17}CH_2CH_2CO_2H$	$[R_{17}CH_2CH_2CO_2]_2M, M = Mn^{2+}, CO^{2+}$ [48]
$(CF_3)_2C=CF_2CF_3$	$ArCH_2C(CF_3)_2CF_2CF_2CF_3$ [74] $P(C_6H_4CH_2C(CF_3)_2CF_2CF_2CF_{3-p})_3$ [75]
$(R_1)_2N(CF_2)_nCOF$	$(R_1)_2N(CF_2)_n, n = 1, 2$ [76]
$CF_3CF_2CF_2OCF_2CF_2COF$	$CF_3CF_2CF_2OCF_2CF_2I, (LiI/180^\circ C)$ [76]
$R_iOR_jOCH_2OCH_2CH_2OT_s$	$[CF_3O(CF_2)_p(CF_2CF(CF_3)O)_qCF_2CH_2OCH_2CH_2OAr]_3P(O)_x, x = 0, 1, q = 3.38, p = 0.11$ [67] $N,N,N,N-(CH_2CH_2OCH_2R_iOR_j)_4-cyclam$ [77]
$F(CF(CF_3)CF_2O)_nCF(CF_3)COF$	$F(CF(CF_3)CF_2O)_nCF(CF_3)CO-R, n = 1, 2, 3, 4$ [78]
$CF_3CF_2CF_2CF = NCF_2CF_2CF_2CF_3$	Fluorous oxaziridine [79]
$R_{17}C(S)OCH_3$	$R_{17}CH_2NR_2$ [80]
$(Pd@PAMAM)[poly(amidoamine)](NH_2)_x$	$(Pd@PAMAM)(NH_2HO_2CR_iOR_j)_x$ [81]
$(R_{16}CH_2CH_2)_3SiH$	$[(R_{16}CH_2CH_2)_3SiCH_2CH_2CH_2]_2NH$ [82]

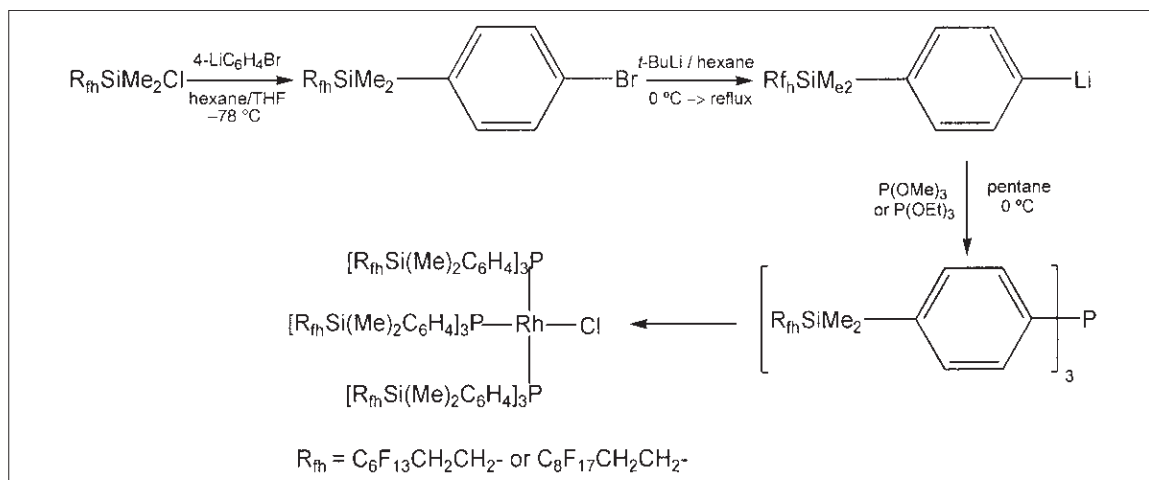


Fig. 22.3 Synthesis of fluororous triphenylphosphine derivatives and the corresponding fluororous-soluble Wilkinson's catalysts. (From Ref. 124.)

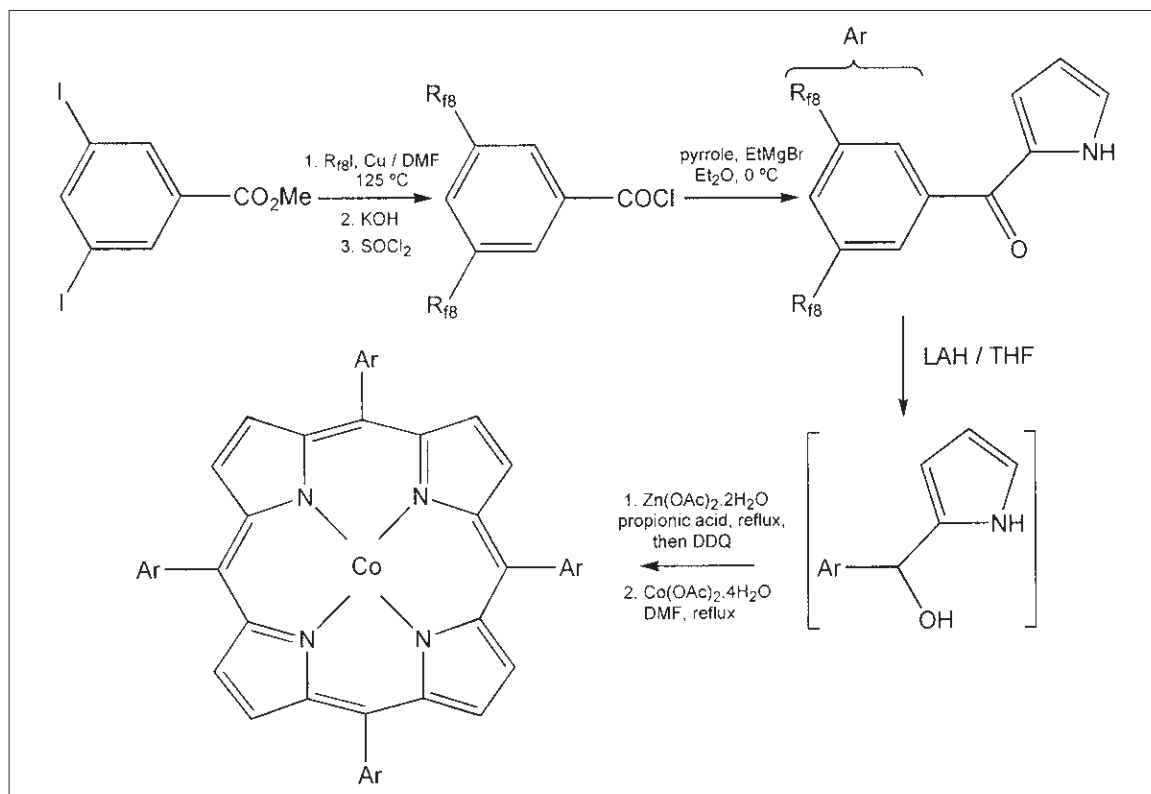


Fig. 22.4 Synthesis of a fluorinated porphyrin derivative. (From Ref. 119.)

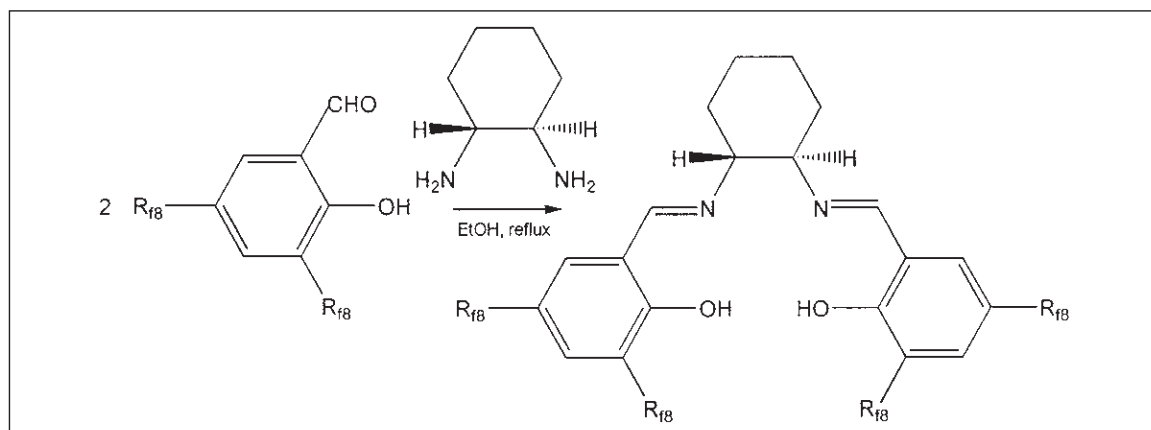


Fig. 22.5 Synthesis of a chiral fluorinated SALEN ligand. (From Ref. 39.)

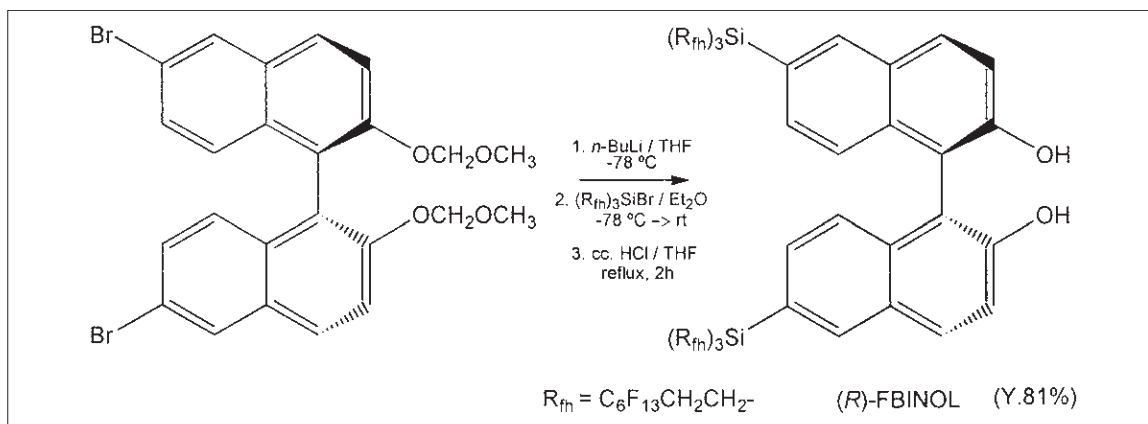


Fig. 22.6 Synthesis of a chiral BINOL derivative. (From Ref. 84.)

precursor acid chlorides with $i\text{-Pr}_3\text{SiH}$, followed by phase separation at -20°C from the side product $i\text{-Pr}_3\text{SiCl}$ [87]; and the reaction of difluorotris(perfluoroalkyl)phosphoranes, $F_2P(R_{fn})_3$, with excess of $P(\text{SiMe}_3)_3$ leads to the formation of the corresponding tris(perfluoroalkyl)-phosphines, $P(R_{fn})_3$, in high yield [88]. Fluorous crown ethers can be obtained under cryogenic conditions by elemental fluorination of the corresponding hydrocarbon crown ethers supported on NaF. These fluorous macrocycles are very weak bases and not soluble in common organic solvents [89].

Owing to the great importance of alkyl and aryl phosphines in homogeneous transition metal catalysis, it is not surprising that their fluorous analogues are among the most studied ligands in fluorous biphasic catalysis [90].

It is important to note that the reactivity of $R_f(\text{CH}_2)_n\text{X}$ ($n = 0, 1, 2$; $\text{X} = \text{Cl}, \text{Br}, \text{I}$) derivatives appears to be anomalous when compared with the parent hydrocarbon derivatives. For example, perfluoroalkyl iodides ($n = 0$) are attacked at the iodine atom when reacted with organolithium anions (LiR) [91]. The rather low reactivity of $\text{CF}_3\text{CH}_2\text{X}$ ($\text{X} = \text{Cl}, \text{Br}, \text{I}$) compounds [92] as well as the easy HX elimination from perfluoroalkylethyl halides, $R_f(\text{CH}_2)_2\text{X}$, are well documented [56]. Practically, compounds having $(\text{CH}_2)_3$ or higher spacers between the perfluoroalkyl groups (R_{fn}) and the reaction centre will show normal reactivities but these can be coupled with solubility problems when longer perfluoroalkyl chains are involved.

5 Fluorous Extraction

Generally a large number of longer fluorous ponytails are necessary to achieve high fluorous phase separation by liquid–liquid extraction. The attachment of longer fluorous ponytails, however, will increase the molecular weight so much that commercial applicability is beyond reality. Because a trifluoromethyl group could serve as a superdense fluorophilic moiety, replacement of some of the longer fluorous ponytails with trifluoromethyl groups could significantly lower the molecular weight and maintain fluorous solubility [33].

Extraction processes can be classified as simple or reactive. In the former type every entity partitions according to its phase behaviour, which is determined by the composition and structure. Simple fluorous extractions are involved in fluorous catalyst recovery processes [11] and fluorous syntheses [19,93]. Examples for reactive extractions are the synthesis of various fluorous catalysts by the reaction of organic-soluble metal precursors and fluorous ligands such as phosphines [9] and the synthesis of fluorous fullerene adducts [94]. The preparation of *trans*- $\text{Pt}[\text{P}(\text{CH}_2\text{CH}_2\text{R}_{f6})_3]_2\text{Cl}_2$ complex is a typical example for reactive extraction. A suspension of *cis*- $\text{Pt}(\text{C}_6\text{H}_5\text{CN})_2\text{Cl}_2$ in CH_3CN and a solution of $\text{P}(\text{CH}_2\text{CH}_2\text{R}_{f6})_3$ in $\text{CF}_3\text{C}_6\text{F}_{11}$ was stirred overnight. As a result, a biphasic mixture was obtained consisting of a colourless CH_3CN phase and a very pale yellow $\text{CF}_3\text{C}_6\text{F}_{11}$ phase. The phases then were separated and the $\text{CF}_3\text{C}_6\text{F}_{11}$ was removed *in*

vacuo to yield *trans*-Pt[P(CH₂CH₂R₁₆)₃]₂Cl₂ as a pale yellow solid [95].

6 Fluorous Synthesis

The unique solvent properties of fluorous solvents led to the development of novel phase separation techniques. The limited miscibility of these perfluorinated solvents with water and most organic solvents has rarely been utilized in organic synthetic methods. In an early study Zhu has applied a fluorous solvent in transesterification reactions separating esters and alcohols from each other and from the reaction media by liquid–liquid extraction [96]. Inspired by the fluorous biphasic concept [8], Curran and co-workers have developed a series of synthetic and purification methods, proposing the collective name ‘fluorous synthesis’ for them. These fluorous methodologies have been adopted already by others [97–99] and reviewed recently [15,19,100].

From a practical point of view, Curran has introduced the fluorous liquid as the fifth orthogonal phase, to extend the applicability of simple work-up purification techniques using gas, organic, aqueous and solid phases (Fig. 22.7).

Preferential solubility of a target molecule in a fluorous solvent can be achieved by attaching fluorous phase labels (or ponytails) into appropriate positions. The fluorous reagents, intermediates or products can

be isolated from other components of the reaction mixture by liquid–liquid or special solid-phase extraction. The application of both organic and aqueous phases against the fluorous phase extends the applicability of classical liquid–liquid extraction techniques, providing the possibility of both biphasic and triphasic conditions at the purification stage of the fluorous synthesis (Fig. 22.8). As an alternative method, a solid-phase extraction procedure was developed and used successfully to separate highly fluorinated compounds with a novel perfluoroalkyl-coated reverse-phase silica gel [101,102].

The fluorous synthetic methods can be classified according to the role of the fluorous labels at the reaction or separation stages. In the case of the fluorous procedures, the fluorous module can be attached permanently to different substrates, forming the so-called ‘fluorous reagents,’ or temporarily, functioning as special phase labels or phase switches called ‘fluorous tags’. In both synthetic strategies, the immobilisation of reactants or substrates in fluorous solvents appears to be an attractive alternative for polymer-supported combinatorial chemistry. This approach has been demonstrated in several cases through the evaluation of small product libraries under fluorous synthesis conditions, highlighting the advantages and also the technical difficulties of this special liquid-phase automated synthesis concept.

Fig. 22.7 Immiscible phases in synthetic practice; separation techniques and appropriate labels to immobilise organic molecules in different phases—a simplified view. (From Ref. 100.)

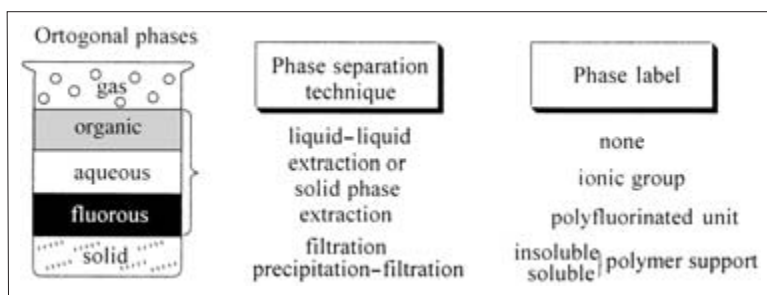
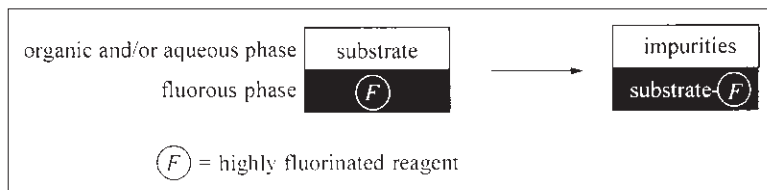


Fig. 22.8 A general scheme of rendering a substrate fluorous soluble at any stage of the reaction.



7 Fluorous Reagents

The first class of fluorous synthesis methodologies has been evaluated for the application of permanently fluorous-soluble reagents in organic synthesis (Fig. 22.9). In fact, this is an extension of the fluorous biphasic concept to non-catalytic systems, with the modification that the reaction itself is conducted under homogeneous conditions using appropriate non-fluorous solvents, and a fluorous liquid (or a fluorous solid-phase support) is used only during the purification procedure to separate the fluorous and non-fluorous components [19,62,101, 103–109].

The first examples of these fluorous reagents described by Curran and co-workers were different

organotin reagents, the fluorous-soluble equivalents of the well-known tin compounds used in a wide range of radical and ionic reactions. One of the reasons for the selection of these compounds was to eliminate the problems associated with the toxicity of the classical organotin reagents and the separation difficulties during syntheses (Fig. 22.10).

The first paper on a fluorous reagent for use in traditional organic synthesis describes the preparation of tris[2-(perfluorohexyl)ethyl]tin hydride $[(C_6F_{13}CH_2CH_2)_3SnH$ or $(R_f^6CH_2CH_2)_3SnH]$ and its application through the example of the reduction of 1-bromo-adamantane. The attempts to carry out the reaction in fluorous media—like those used by Zhu—or under biphasic conditions, and even in benzene, were unsuccessful. The authors assumed

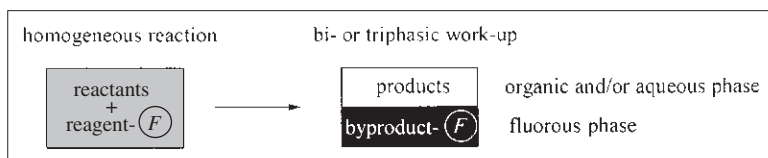


Fig. 22.9 A simplified scheme for the application of a fluorous reagent in organic synthesis.

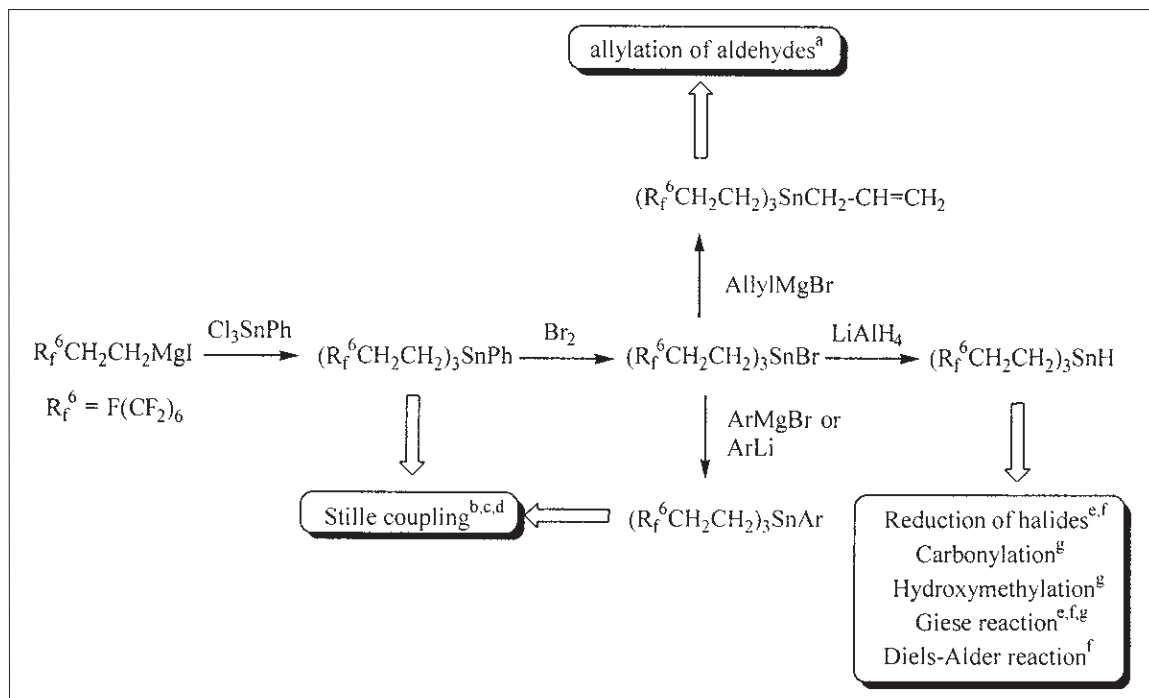


Fig. 22.10 Application of fluorous organotin reagents in fluorous synthesis. (From Refs 62, 101, 103–106 and 109.)

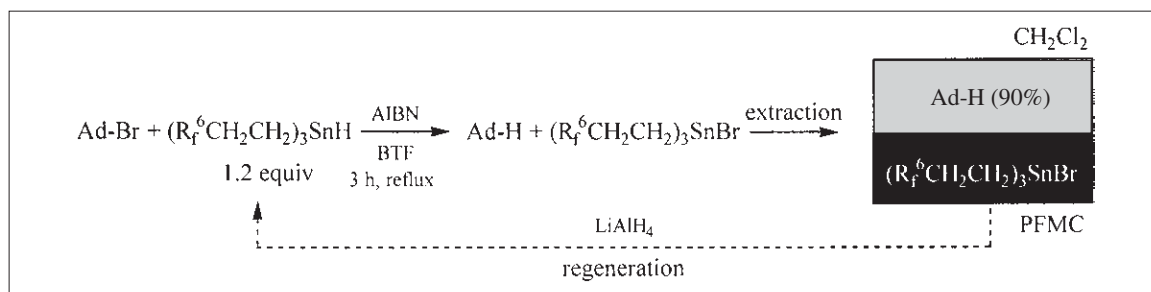


Fig. 22.11 The first application of the fluorinated organotin hydride reagent in a stoichiometric reduction procedure.

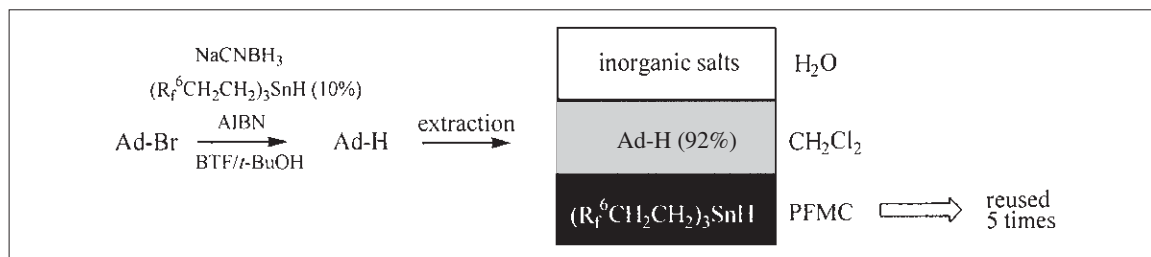


Fig. 22.12 The first application of the fluorinated organotin hydride reagent in a catalytic reduction procedure.

that these observations could be explained by the necessity of homogeneous conditions during the radical chain propagation process. Instead of a mixture of fluorinated and organic solvents they have selected a partially fluorinated liquid, benzotrifluoride (BTF), to dissolve both components. Thus, 1-bromo-adamantane was reduced cleanly in the presence of a slight excess of the $(\text{R}_f^6\text{CH}_2\text{CH}_2)_3\text{SnH}$. After evaporation of BTF, adamantane was isolated in 90% yield by liquid–liquid extraction using perfluoro(methylcyclohexane) and CH_2Cl_2 (Fig. 22.11) [62,109]. Using this procedure a number of other functional groups, such as NO_2 , SePh and OCS_2CH_3 , can be reduced.

The catalytic equivalent of this procedure was developed also by applying 10% $(\text{R}_f^6\text{CH}_2\text{CH}_2)_3\text{SnH}$ and 1.3 equivalents of NaCNBH_3 in a 1:1 mixture of BTF and *t*-butyl alcohol. During the work-up, BTF was evaporated and the products were partitioned among three liquid phases: the aqueous phase contained the inorganic salts, perfluoro(methylcyclohexane) removed the tin reagent and CH_2Cl_2 extracted selectively the adamantane (isolated in 92% yield). The organic and fluorinated phases were analysed by ^1H - and ^{19}F -NMR and above the detec-

tion limit of 1–2% there was no fluorinated compound observable in the dichloromethane phase; likewise, the fluorinated extract contained no adamantane (Fig. 22.12). It should be noted that in the case of a cyclisation reaction of an important spirocyclic indoline intermediate of an autoreceptor antagonist developed for pharmaceutical purposes, Mulholland tested Curran's $(\text{R}_f^6\text{CH}_2\text{CH}_2)_3\text{SnH}$ reagent and no residual tin was detected in the spirocycle product using ICP-AES (detection limit is at 7 ppm) [110].

Inspired by this successful work-up procedure, the possibility of using the fluorinated synthesis in liquid-phase combinatorial synthesis also was illustrated in this pioneering study [62]. As a simulation of an automated synthesis, a series of Giese-type radical additions were conducted in parallel, in the presence of a catalytic amount of the $(\text{R}_f^6\text{CH}_2\text{CH}_2)_3\text{SnH}$ reagent, and the products were 'purified' simply by three-phase extraction, resulting in satisfactory yields and purities (Fig. 22.13). As the authors state, the omission of chromatographic purification is advantageous for both the polymer-based solid-phase parallel synthesis and the described fluorinated liquid–liquid extractive method. The great advantage

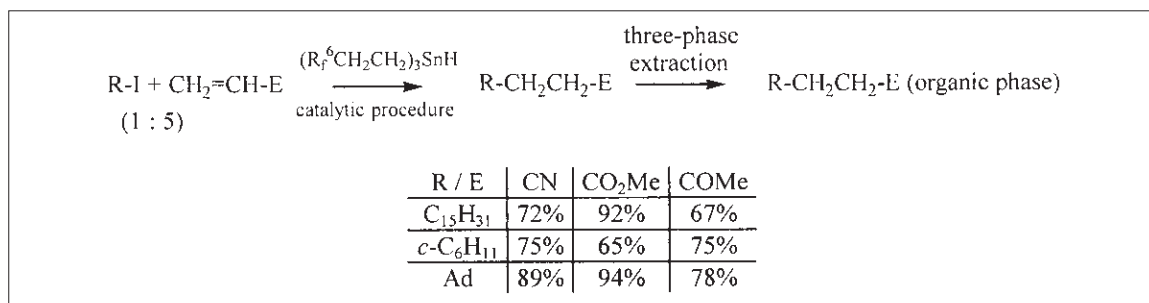


Fig. 22.13 The first application of the fluoros organotin hydride reagent in a model parallel synthetic procedure.

of the latter one is that a range of traditional reactions can be conducted only under homogeneous liquid-phase conditions.

The reactivity of the $(\text{R}_f^6\text{CH}_2\text{CH}_2)_3\text{SnH}$ reagent was compared with the traditional tributyltin hydride reagent Bu_3SnH in a study during the evaluation of a catalytic fluoros system for radical carbonylation and hydroxymethylation [106]. In the case of the carbonylation reactions of organic halides, the hydrogen-donating ability of different tin hydride reactants was compared by examining the formylation/reduction ratio under identical experimental conditions (concentration of reactants, pressure of CO, etc.). The results have shown that $(\text{R}_f^6\text{CH}_2\text{CH}_2)_3\text{SnH}$ could be characterised by a smaller ratio, indicating enhanced reducing power compared with the classical Bu_3SnH reagent. Therefore, in a successful formylation reaction a higher CO pressure and/or lower concentration of the $(\text{R}_f^6\text{CH}_2\text{CH}_2)_3\text{SnH}$ would be required to obtain results identical to those with tributyltin hydride. A similar tendency in the reactivity order was observed in a cyclisation–formylation reaction (Fig. 22.14). In this paper [106], a procedure for the transformation of organic bromides into the corresponding hydroxymethyl derivatives is described using a catalytic amount of $(\text{R}_f^6\text{CH}_2\text{CH}_2)_3\text{SnH}$ reagent in a mixed solvent (BTF/*t*-BuOH) and NaCNBH_3 reducing agent, similar to the previously discussed dehalogenation method [62], and the alcohol products were purified again by three-phase liquid–liquid extraction (in 42–81% yields).

Recently, a general work [109] on fluoros tin hydride chemistry described the preparation and

comparative properties of a series of reagents: $[\text{R}_f^n(\text{CH}_2)_m]_3\text{SnH}$ and $[\text{R}_f^n(\text{CH}_2)_m]\text{Me}_2\text{SnH}$ ($n = 4, 6, 8, 10$; $m = 2, 3$). The measured partition coefficients of these tin compounds in FC-72/ CH_3CN and FC-72/ C_6H_6 have established clearly that the fluorine content of a molecule is not the only factor of the fluoros phase preference, but it is also strongly influenced by the primary structure. By introducing one more methylene unit into the $(\text{R}_f^6\text{CH}_2\text{CH}_2)_3\text{SnH}$ reagent, e.g. $(\text{R}_f^6\text{CH}_2\text{CH}_2\text{CH}_2)_3\text{SnH}$, the fluorine content decreases only slightly (from 64% to 62%) and the partition coefficient diminishes drastically from 160 to 6.4. On the other hand, sufficient partitioning can be achieved for fluoros synthetic purposes if three perfluorinated units are attached to the tin reagent. The presence of three perfluorodecylethyl chains causes extremely high fluorophilicity, but the applicability of this reagent—due to its extremely large molecular weight—is strongly limited because it is practically insoluble in organic solvents and is not very soluble in fluoros liquids. All things considered, the original $(\text{R}_f^6\text{CH}_2\text{CH}_2)_3\text{SnH}$ fluoros reagent seems to be the best alternative owing to its optimal solubility and partitioning behaviour. In this study it was concluded also that the length of the insulator $-(\text{CH}_2)_n-$ is a very sensitive factor for the reactivity of this tin series due to the strong electron-withdrawing effect of the perfluorinated units. Reagents such as $(\text{R}_f^6\text{CH}_2\text{CH}_2)_3\text{SnH}$ bearing three fluoros chains and short ethylene spacers can be used in radical tin hydride chemistry, but they do not work well in radical allylation procedures or ionic reactions. The propylene-spaced derivatives are much more effective for these types of transformations.

Another obvious application of the fluoros tin strategy is the development of highly fluorinated aryl tin reagents for Stille coupling reactions [103–105].

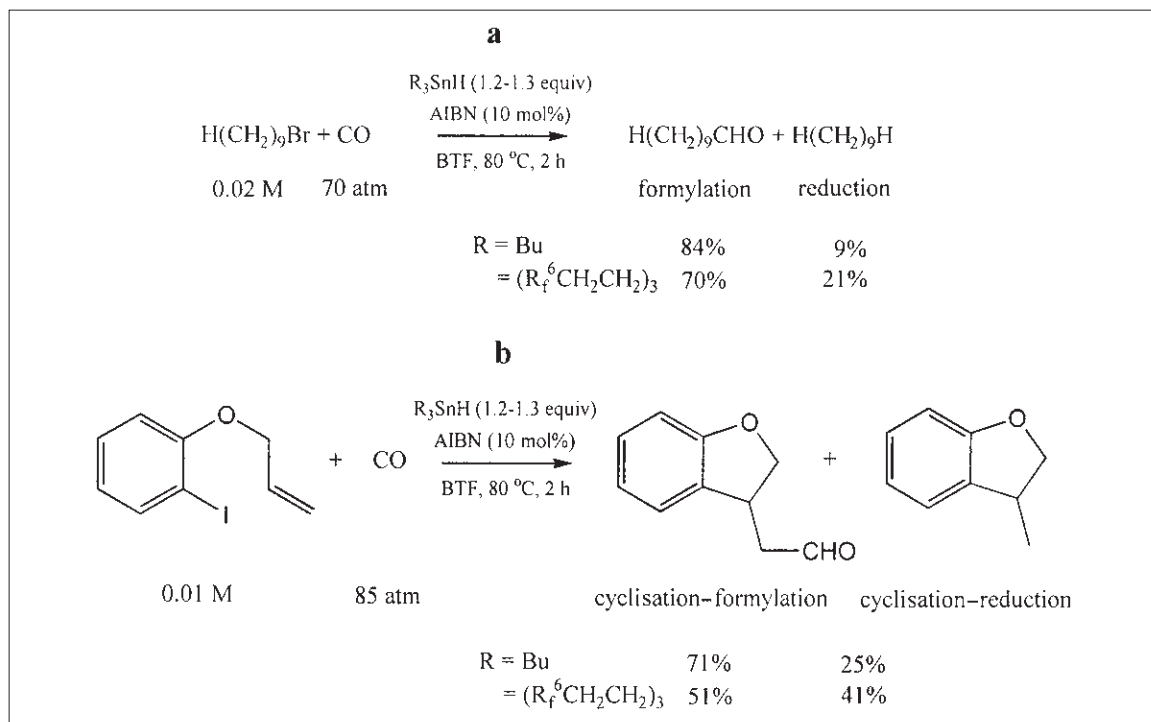


Fig. 22.14 Comparison of the reactivity of tributyltin hydride and the fluorous analogue in (a) formylation and (b) cyclisation-formylation reactions.

The Grignard reaction of *F*-hexylethyl magnesium iodide with phenyltrichlorotin resulted directly in the phenyl reagent $(\text{R}_f^6\text{CH}_2\text{CH}_2)_3\text{SnPh}$, whereas other derivatives (4-methoxyphenyl, 2-furyl, 2-pyridyl) could be obtained from the tin bromide intermediate (Fig. 22.10) [103]. The first Stille reactions were carried out under standard conditions using lithium chloride additive. The efficiency of the aromatic coupling process was demonstrated by the parallel syntheses of each tin reactant with four different aryl halogenides and a triflate (Fig. 22.15). The coupled biaryls were extracted to the organic layer by the three-phase distribution method and purified further using preparative thin-layer chromatography.

The advantages of this liquid-phase combinatorial process in comparison with the solid-phase equivalent are as follows: the reaction could be conducted in homogeneous phase; the application of a large excess of the tin reagents was unnecessary, which

could cause an undesired increase of homocoupled by-products ($\text{Ar}^1\text{-Ar}^1$); and in the absence of a common functional group in substrates **d-h** in Fig. 22.15, a solid-phase approach would require the development of a suitable linking strategy. On the other hand, it was also pointed out that when a by-product from the reactant is formed with concomitant detachment of the fluorous unit ($\text{Ar}^1\text{-Ar}^1$), simple extractive work-up is not sufficient to separate this component from the desired product ($\text{Ar}^1\text{-Ar}^2$). This problem probably would not appear in the polymer-supported solid-phase method, and the final chromatographic separation could be avoided.

Because the relatively long reaction time of the Stille reaction is undesirable for rapid parallel synthesis applications, Curran and co-workers have developed a microwave-assisted equivalent of the original thermal method [104]. A series of coupling products were synthesised using different halides and triflates (39–96% yields) and the reactions required only 90–120 s for completion. The reaction components were distributed in the triphasic mixture (water–dichloromethane–FC-84) and

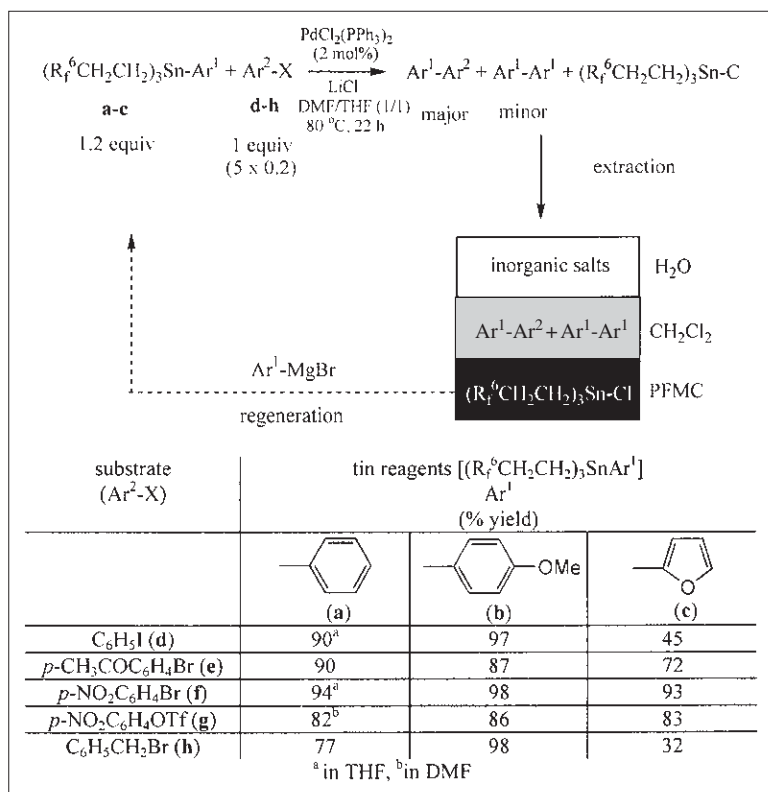


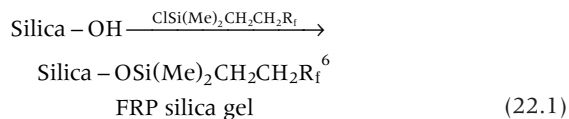
Fig. 22.15 Application of the fluorous Stille coupling reaction in liquid-phase parallel synthesis.

finally were purified by chromatography. The source of by-products under microwave irradiation was not a simple homocoupling reaction, but rather a coupling process followed by ligand migration of the intermediate oxidative addition complex [ArPd(PPh₃)₂X → PhPd(PArPh₃)(PPh₃)X].

The advantages and properties of different fluorous Stille reagents were described by Curran *et al.* [105], where also optimisation of the reaction conditions and the role of the LiCl additive were studied in detail.

The fluorous allylstannane, (R_f⁶CH₂CH₂)₃SnCH₂CH=CH₂, was readily synthesised by the reaction of allylmagnesium bromide and the tin bromide R_f⁶CH₂CH₂)₃SnBr (Fig. 22.10). Under thermal conditions the reactivity of the (R_f⁶CH₂CH₂)₃SnCH₂CH=CH₂ reagent with different aldehydes was found to be comparable with the reactivity of the parent compound Bu₃SnCH₂CH=CH₂. The experiments were carried out using a large excess of the tin reagent without solvent. The crude reaction mixture then was purified efficiently by partitioning between FC-

72/CH₃CN solvents, or by reverse-phase flash chromatography using a modified, highly fluorinated silica support (Fig. 22.16). This special fluorous reverse-phase (FRP) column was prepared from standard 'flash chromatography'-grade silica gel silylated by the commercially available dimethyl[2-(perfluorohexyl)ethyl]silyl chloride reagent (Equation 22.1):



The purification of the allylation products with FRP silica gel was carried out on a dry-packed column, eluting the components first with acetonitrile (organic components) and then with hexane (fluorous components). The authors have noted that the hexane solvent was effective to elute the fluorous products but, according to their other preliminary observations, in some other cases more powerfully eluting fluorinated solvents were needed.

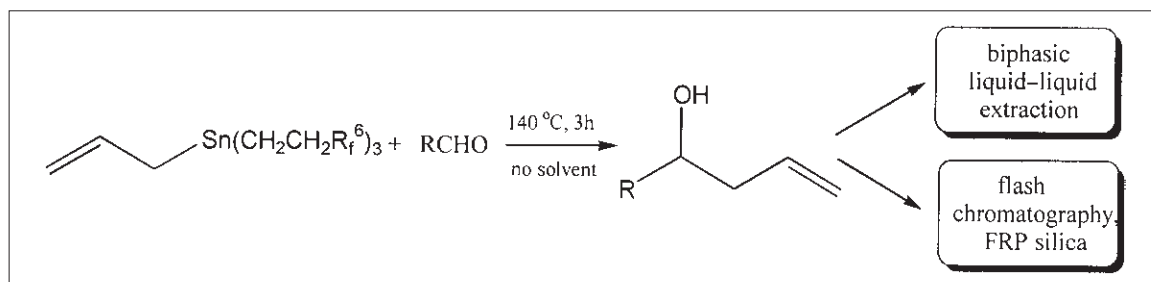


Fig. 22.16 Fluorous thermal allylation reaction using extractive and chromatographic work-up.

In a control experiment it was shown that a normal C_{18} reverse silica gel could not separate efficiently the fluorinated and non-fluorinated components, indicating an important role of fluorine–fluorine interactions between the FRP silica support and the fluorous compounds.

8 Fluorous Tags

The temporary attachment of highly fluorinated units to different substrates, introduced also by Curran, opens large perspectives in the field of separation techniques in organic synthesis [111]. Owing to the role of the so-called ‘fluorous tags’ applied at appropriate stages of the reaction, a number of novel fluorous techniques have been introduced [61,82,112,113], such as the application of fluorous phase labels in multistep syntheses—the name ‘fluorous synthesis’ referred originally to this method, and the meaning of the concept was extended to all fluorous techniques only later [100]—or fluorous phase switches (or scavengers) (Fig. 22.17).

The key idea of all these tagging procedures is that the connection of a highly fluorinated module renders selectively one component (or one class of components in the case of parallel synthesis) fluorous soluble, leading to facile separation from other organic and inorganic components by simple extractive work-up, or by fluorous reverse-phase chromatography. At a later point of the synthesis or purification, the fluorous tag is cleaved and the product can be extracted to the organic phase while the fluorous compound remains in the fluorous liquid. When FRP chromatography is used at this

stage, the organic solvent elutes the products and the fluorous eluent contains the fluorous molecule, which usually can be recovered for further tagging processes.

The strategy of fluorous labelling was demonstrated through the parallel synthesis of a small isoxazoline library, as an alternative to solid-phase combinatorial chemistry (Fig. 22.18) [61,111]. The selected labelling reagent for this application was a highly fluorinated bromosilane derivative $(R_f^6CH_2CH_2)_3SiBr$ that contained three perfluoro-hexylethyl units, similar to the previously described tin reagent. Allyl alcohols were rendered fluorous upon attachment to this label in typical silylation reactions (Fig. 22.18, 1. labelling). The cycloaddition reactions of these fluorinated allyl derivatives with in-situ-generated nitrile oxide, following standard Huisgen or Mukaiyama procedures, were performed under homogeneous reaction conditions in CH_2Cl_2 or BTF solvent (Fig. 22.18, 2. reaction). The fluorous isoxazoline compounds were obtained in high yields and purities, which could allow further reaction steps, if desired, for other automated synthesis purposes. The fluorosilyl tags were removed from the cycloadducts under mild conditions with HF–pyridine reagent in diethyl ether (Fig. 22.18, 3. detachment). At all stages of the reaction, the components were separated by simple three-phase liquid–liquid extractions (fluorous: FC-72/organic: CH_2Cl_2 or benzene/aqueous).

The suitability of fluorous phase labelling methods for combinatorial synthesis of organic molecules with pharmaceutical potential was evaluated for Ugi- and Biginelli-type multicomponent condensations [112]. Because the technical development of these two reactions is very similar, here we consider only the Ugi-type four-component condensation (Fig. 22.19). The labelling is based on silane chemistry, as

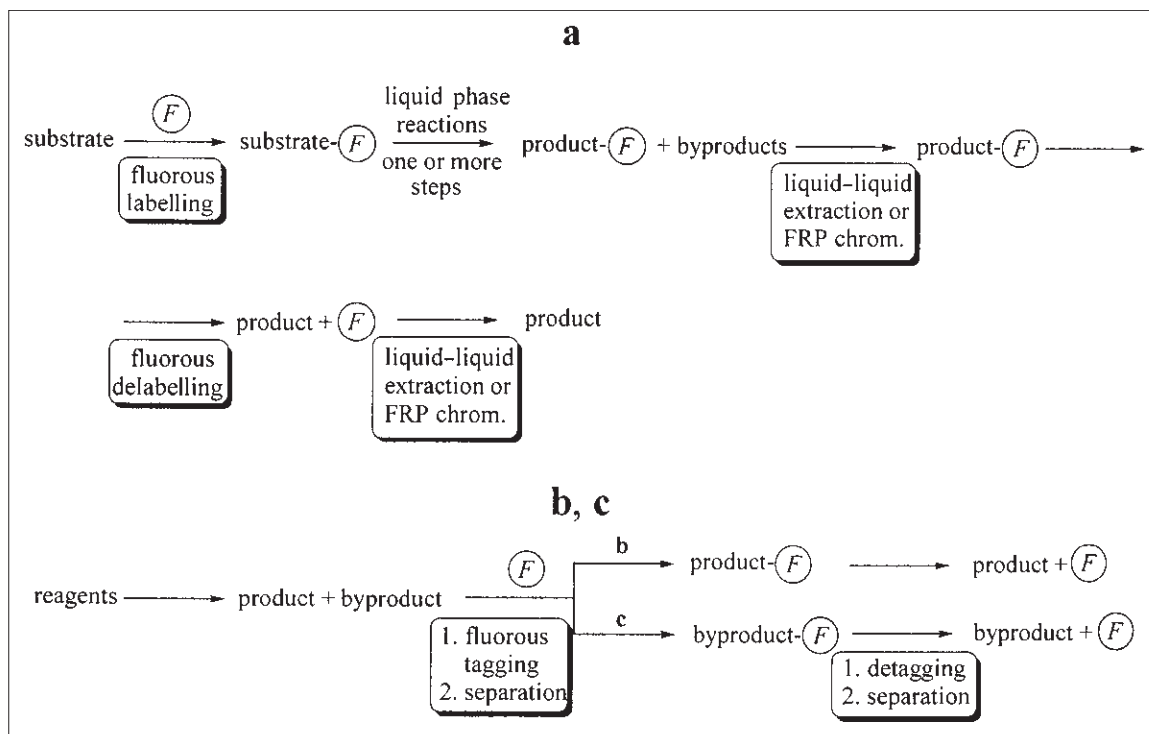


Fig. 22.17 Summary of the fluorine tagging methods according to the role of the fluorine unit: (a) labels; (b) switches; (c) scavengers.

in the previous case, but the synthesis and application of the longer chain C_{10} derivative with 63 fluorine atoms $[(R_f^{10}CH_2CH_2)_3SiBr]$ also was necessary to achieve sufficient extractive separation of these larger organic substrates (with molecular weights of up to almost 500). The fluorine bromosilanes were coupled in the *para* position of orthothiobenzoate in a lithiation process, and further routine transformations resulted in the desired silylated benzoic acid derivatives (Fig. 22.19, 1. labelling). The parallel condensations of the labelled acid, aldehyde, amine and isonitrile components were carried out in trifluoroethanol, a 'hybrid organic/fluorous' solvent like BTF, with the ability to dissolve both organic and fluorine compounds (Fig. 22.19, 2. reaction). Finally, the tags were removed by tetrabutylammonium fluoride treatment in THF at room temperature to obtain a series of the desired benzoylated amino acid amide derivatives (Fig. 22.19, 3. detachment).

The yield and purity data were suitable for standard combinatorial chemistry purposes.

The fluorine labelling concept also was introduced to the field of carbohydrate chemistry [113] using a novel silylated benzyl-type tagging reagent (Bn_fBr) (Fig. 22.20), which provided a fluorine tribenzyl glucal derivative (1. labelling). In this case the label functioned also as a protecting group, where the enhanced fluorine phase preference was ensured, instead of increasing the size of the fluorinated chain, by the attachment of more than one label to the substrate. The labelled glucal reagent was purified using triphasic extraction (water- CH_2Cl_2 -FC-72) followed by standard silica-gel chromatography. This reagent then was coupled in two different ways with diacetone galactose (10 equiv.) to the corresponding disaccharide under homogeneous conditions (Fig. 22.20, 2. reaction). The fluorine disaccharide then was debenzylated by catalytic hydrogenation (50 psi) with $Pd(OH)_2$ in FC-72 solvent (Fig. 22.20, 3. detachment). It was noted that heterogeneous catalysis usually is not considered for solid-phase chemistry, and the success of this reaction suggests that a range of standard supported metal transformations might

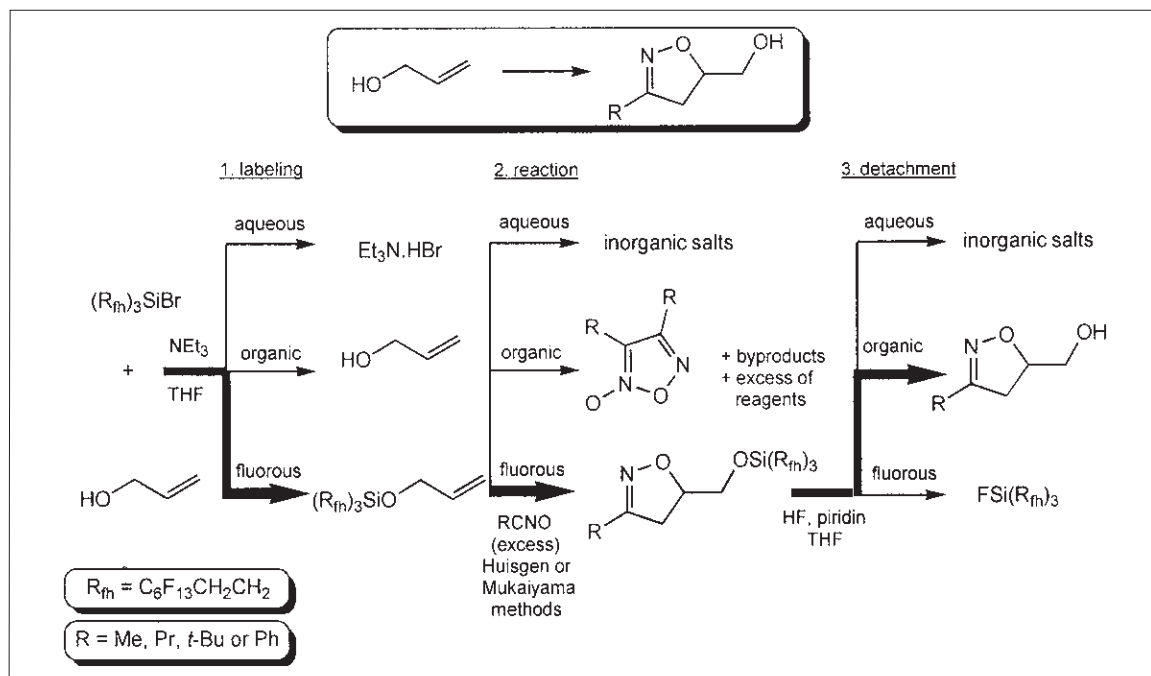


Fig. 22.18 Fluorous phase labeling approach for the parallel synthesis of a small isoxazoline library.

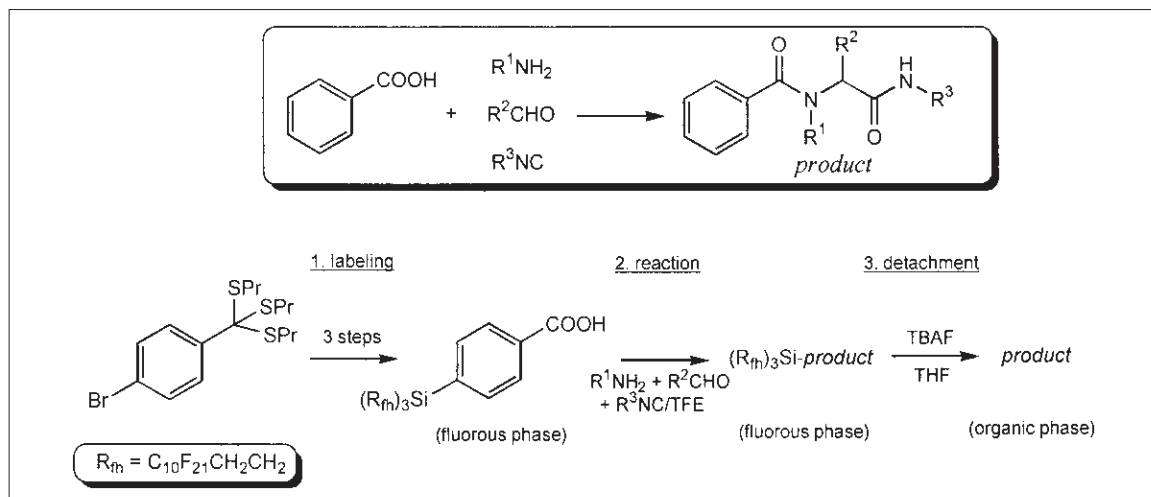


Fig. 22.19 Fluorous phase labeling approach for the parallel Ugi-type multicomponent condensation reactions.

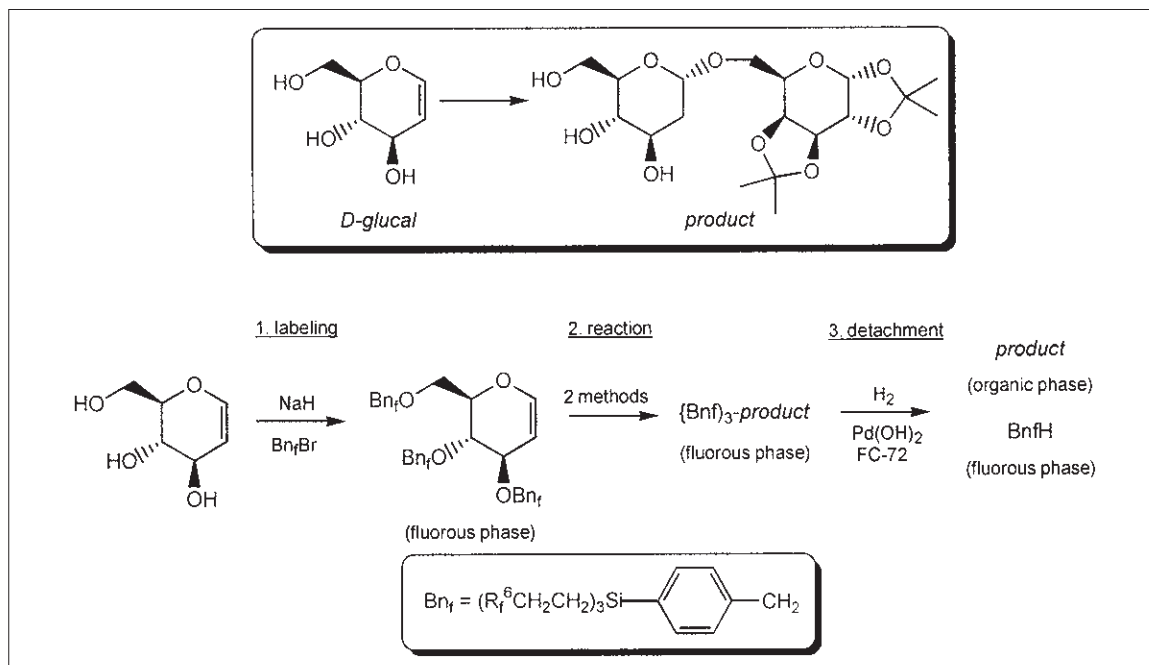


Fig. 22.20 Fluorous phase labelling approach for disaccharide synthesis.

be applicable to fluororous synthesis conditions. The fluorinated tagging reagent was recovered after extractive work-up of the products.

Wipf and co-workers developed other fluororous labelling groups for the protection of the hydroxyl functional group (Fig. 22.21). The fluororous tetrahydropyranyl (THP_F) tag provides increased stability to basic and nucleophilic conditions and can be removed easily by acidic treatment [97]. As the organic mass and polarity of the THP_F-labelled substrate became larger, simple liquid-liquid extraction proved to be inefficient for the purification process, and solid-phase extraction by filtration through FRP silica gel was found to be effective for these cases. For example, the THP_F-protected cholesterol was purified successfully on a CH₃CN-wetted FRP column, eluted first with CH₃CN (organic components) and then with FC-72 solvent (desired labelled product). Curran named this type of purification method, which required less fluorine content of the tagged substrates, 'light fluororous synthesis' [102]. As an alternative solution to alcoholic protection, a highly fluorinated alkoxy ethyl ether protective group (AE_F) was developed, which provided the

applicability of simple extractive purifications of small- to medium-sized molecules [98]. Finally, Wipf and co-workers introduced a fluororous alkoxyethyl protecting group (BPFOS) with improved acid stability [99]. In this case a parallel automated synthesis of the protection-deprotection reaction of a small alcohol library was performed. The detachment of the fluororous labels required nucleophilic conditions: a mild tetrabutylammonium fluoride treatment of the fluorinated silyl ethers.

Another solution of the fluororous tagging concept to ensure both homogeneous reaction conditions and simple phase separation at the purification stage is provided by the introduction of fluororous phase switches in organic synthesis. Following this approach, the reaction can be conducted under standard synthetic conditions using traditional components, and the fluororous tagging reagent is used only to quench the reaction and to render the product selectively fluorocarbon soluble. The first example on this strategy was a Grignard reaction, and the product was switched to the fluorocarbon phase with the bromosilane (R_f⁶CH₂CH₂)₃SiBr quenching reagent (Fig. 22.22a) [111]. If the by-

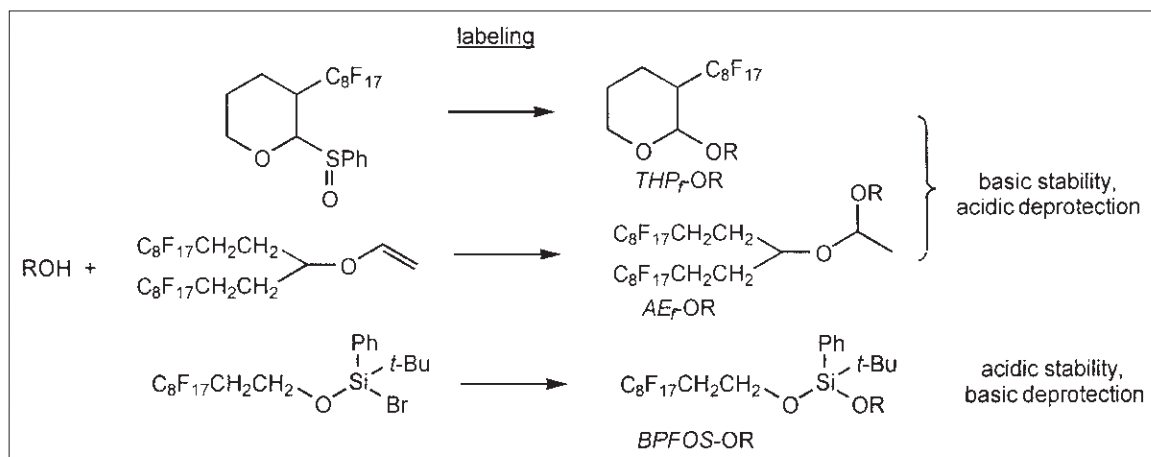


Fig. 22.21 Fluorous phase labelling approach for the protection of the hydroxyl functional group.

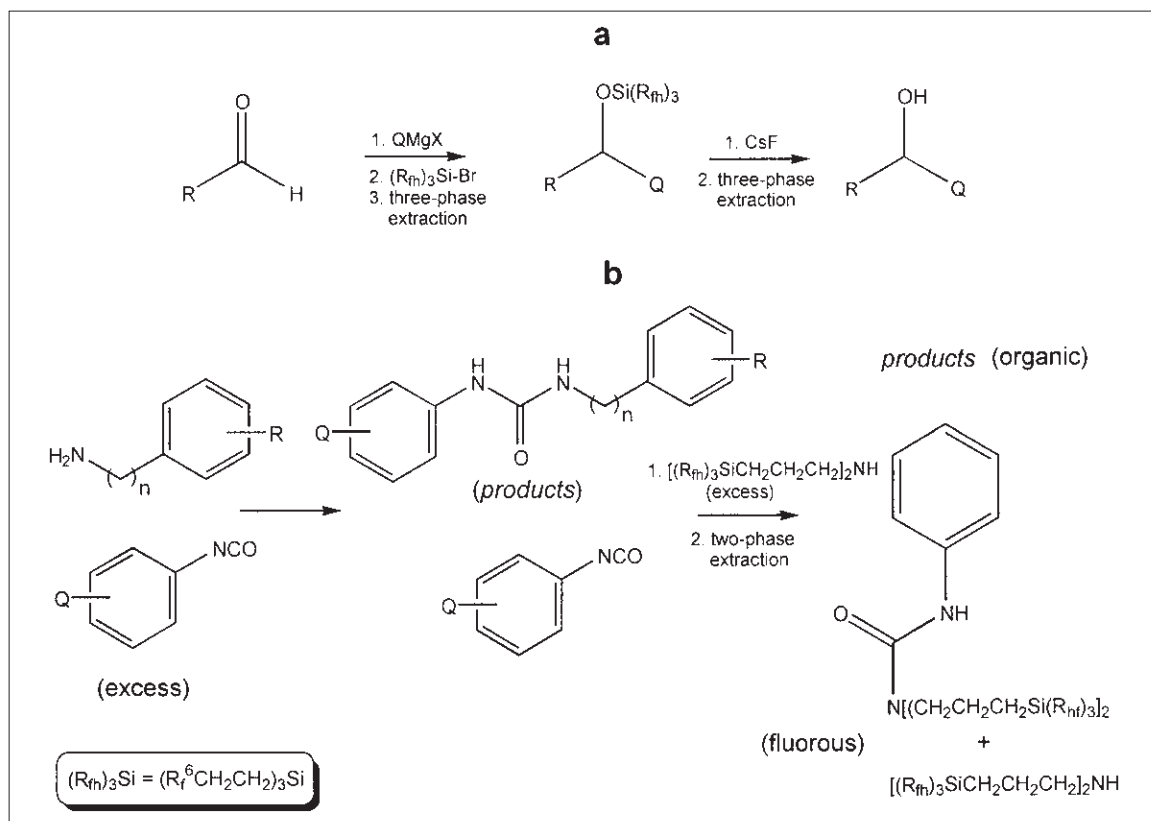


Fig. 22.22 The applications of (a) fluorine phase switches and (b) fluorine phase scavengers.

product (or the excess of a reagent) is tagged, then the switches are called scavengers, and in this case the product preserves the organic character (Fig. 22.22b) [82]. The components can be separated similarly to the previous attempts by two- or three-phase liquid–liquid extraction or by fluorosolid-phase extraction. The detachment of the fluorinated tagging unit is followed by simple phase separation.

9 Fluorous Biphasic Catalysis

Simple and efficient separation of products from the catalyst under mild conditions is crucial to the application of homogeneous catalysts in industrial processes. The use of biphasic systems, in which one of the phases contains the dissolved catalyst, could allow particularly easy separation of the products (Fig. 22.1). A biphasic catalyst is designed to dissolve preferentially in the *catalyst phase*, although having a large partition towards the catalyst phase also could be appropriate for some applications. The required solubility can be achieved by attaching *solubilising groups* to the catalyst. If the products (**P**) have limited solubility in the catalyst phase, a second, *product phase* could form during conversion of the reactants (**A** and **B**), which can be separated easily.

The fluorosoluble biphasic catalysis concept was originally developed during the search for a novel catalytic system for the selective oxidation of methane to methanol, utilising molecular oxygen [9,14]. The fluorosoluble medium is especially suitable for oxidation reactions because the solubility of dioxygen is very high and the fluorosolvents are remarkably resistant to oxidation. Furthermore, as the conversion level of an oxidation reaction increases, the amount of polar products increases, thus enhancing product separation. Because fluorosolvents readily dissolve methane and have limited miscibility with methanol, the over-oxidation of the product methanol could be avoided provided that a catalyst could be designed to dissolve preferentially in the fluorosoluble phase. The attachment of fluorosoluble ponytails ($L=R_{in}=F(CF_2)_n$) to oxidation catalysts, such as phthalocyanines or porphyrins, was shown [9] to provide high fluorosolubility and facile catalyst separation. Although this approach has not resulted in a new methane oxidation catalyst yet, it has led to the development of a wide range of fluorosoluble biphasic catalysts.

Although most soluble homogeneous catalysts

could be made fluorosoluble by attaching fluorosoluble ponytails to the catalyst core in appropriate size and number [114], mostly transition metal complexes have been converted to fluorosoluble through ligand modification. Fluorosoluble-ligand-modified biphasic catalysts [4,14,15] have been used successfully in allylic nucleophilic substitutions [115], cross-coupling reactions [116], Diels–Alder reaction [117], epoxidation of olefins [44,48,68,83,118–120], Friedel–Crafts acylation [117], Heck heterocoupling [121], hydrogenation [35,81,122–124], hydroformylation [8,9,64], hydroboration [125], hydrosilylation [126], intramolecular cyclisation of unsaturated esters [69], Kharasch addition reaction [127], living radical polymerisation [128], oligomerisation [78], oxidation of alcohols [129], oxidation of aldehydes [120], oxidation of alkanes [48,77], oxidation of sulfides [9,120], Stille couplings [103,130], and Wacker oxidation of alkenes [55]. In addition, several chiral catalysts have been developed recently for alkylation of aromatic aldehydes [131,132] and epoxidation of olefins [39]. The common feature of these catalytic systems is the easy separation of the product(s) and the facile recycling of the fluorosoluble catalyst.

10 Relationship between Fluorous and Supercritical Carbon Dioxide Media

Supercritical carbon dioxide (scCO₂) has a pressure- and temperature-dependent solubility parameter ($\delta = 18.2 \times \rho_{sc}/\rho_{liq}$ MPa^{1/2}) and will be miscible either with low-polarity organic solvents or fluorocarbons under appropriate conditions [133,134]. In general, fluorosoluble reagents and catalysts also are soluble in supercritical carbon dioxide. Consequently, a fluorosoluble reagent or catalyst could be tested in fluorosolvents at much lower operating pressure and the most promising one developed further in supercritical carbon dioxide for commercial applications. It should be noted that perfluoroaryl-containing reagents and catalysts soluble in supercritical carbon dioxide might not dissolve in fluorosolvents.

11 Economical Feasibility of Fluorous Biphasic Chemistry

Fluorosolvents generally are considered to be too expensive for large-scale commercial processes. However, their non-toxic nature and the significant

simplification of the separation step could make fluororous technology very attractive for the production of fine chemicals and pharmaceuticals. One should consider also the fact that a simple separation technology could result in significant savings on initial investments in hardware and energy savings during separation. In addition, successful investment of the savings during the plant construction period could result in enough earnings that a state-of-the-art fluororous technology could be beneficial financially over technologies using a hardware intensive separation method, such as distillation.

References

- Anastas, P. T., & Warner, C. J. *Green Chemistry: Theory and Practice*. Oxford University Press, Oxford, 1998.
- Barton, A. F. M. *Chem. Rev.*, 1975, **75**, 731.
- Barton, A. F. M. *CRC Handbook of Solubility Parameters and Other Cohesion Parameters*. CRC Press, Boca Raton, FL, 1983.
- Lo Nostro, P. *Adv. Colloid Interface Sci.*, 1995, **56**, 245.
- De Wolf, E., van Koten, G., & Deelman, B.-J. *Chem. Soc. Rev.*, 1999, **28**, 37.
- Cornils, B., & Herrmann, W. A. *Aqueous-phase Organometallic Catalysis*. Wiley-VCH, Weinheim, 1998.
- Welton, T. *Chem. Rev.*, 1999, **99**, 2071.
- Horváth, I. T., & Rábai, J. *Science*, 1994, **266**, 72.
- Horváth, I. T., & Rábai, J. US Patent 5,463,082, 1995.
- Fink, R., Hancu, D., Valentine, R., & Beckman, E. J. *J. Phys. Chem. B*, 1999, **103**, 6441.
- Horváth, I. T., Kiss, G., Cook, R. A., Bond, J. E., et al. *J. Am. Chem. Soc.*, 1998, **120**, 3133.
- Barthel-Rosa, L. P., & Gladysz, J. A. *Coord. Chem. Rev.*, 1999, **190–192**, 587.
- Szlávik, Z., Tárkányi, G., Gömöry, Á., Tarczay, G., & Rábai, J. *J. Fluorine Chem.*, 2001, **108**, 7.
- Horváth, I. T. *Acc. Chem. Res.*, 1998, **31**, 641.
- Cavazzini, M., Montanari, F., Pozzi, G., & Quici, S. *J. Fluorine Chem.*, 1999, **94**, 183.
- Diederichsen, U. *Nachr. Chem. Tech. Lab.*, 1999, **47**, 805.
- Fish, R. H. *Chem. Eur. J.*, 1999, **5**, 1677.
- Baker, T. R., & Tumas, W. *Science*, 1999, **284**, 1477.
- Curran, D. P., & Luo, Z. *Fluorous Technologies Primer: a Short Introduction to Fluorous Techniques for the Synthesis and Separation of Organic Molecules*, pp. 1–10. <http://www.fluorous.com/img/FTIprimer.pdf>
- Smart, B. E. In *Organofluorine Chemistry, Principles and Commercial Applications* (Banks, R. E., Smart, B. E., & Tatlow, J. C., eds). Plenum Press, New York, 1994, pp. 57–88.
- Green, S. W., Slinn, D. S. L., Simpson, R. N. E., & Woytek, A. J. In *Organofluorine Chemistry, Principles and Commercial Applications* (Banks, R. E., Smart, B. E., & Tatlow, J. C., eds). Plenum Press, New York, 1994, pp. 57–88.
- May, G. *Chem. Br.*, 1997, 34.
- Riess, J. G. In *Fluorine Chemistry at the Millenium. Fascinated by Fluorine* (Banks, R. E., ed.). Elsevier, Amsterdam, 2000, pp. 385–431.
- Clayton Jr., J. W. *Fluorine Chem. Rev.*, 1967, **1**, 197.
- Hildebrand, J. H., & Cochran, D. R. F. *J. Am. Chem. Soc.*, 1949, **71**, 22.
- Scott, R. L. *J. Phys. Chem.*, 1958, **62**, 136.
- Hildebrand, J. H., Fisher, B. B., & Benesi, H. A. *J. Am. Chem. Soc.*, 1950, **72**, 4348.
- Scott, R. L. *J. Am. Chem. Soc.*, 1948, **70**, 4090.
- Grosse, A. V., & Cady, G. H. *Ind. Eng. Chem.*, 1947, **39**, 367.
- Brice, T. J. In *Fluorine Chemistry* (Simmons, J. H., ed.), Vol. I. Academic Press, New York, 1950, pp. 423–462.
- Ravishankara, A. R., Solomon, S., Turnipseed, A. A., & Warren, R. F. *Science*, 1993, **259**, 194.
- Zurer, P. *Chem. Eng. News*, 1993, **Aug.**, 16.
- Kiss, L. E., Kövesdi, I., & Rábai, J. *J. Fluorine Chem.*, 2001, **108**, 95.
- Alvey, L. J., Rutherford, D., Juliette, J. J. J., & Gladysz, J. A. *J. Org. Chem.*, 1998, **63**, 6302.
- Richter, B., de Wolf, E., van Koten, G., & Deelman, B.-J. *J. Org. Chem.*, 2000, **65**, 3885.
- Deev, L. E., Nazarenko, T. I., Pashkevich, K. I., & V Ponomarev, V. G. *Russ. Chem. Rev.*, 1992, **61**, 40.
- Tiers, G. V. D. US Patent 3,281,426, 1966.
- Brace, N. O. US Patent 3,271,441, 1966.
- Pozzi, G., Cavazzini, M., Cinato, F., Montanari, F., & Quici, S. *Eur. J. Org. Chem.*, 1999, 1947.
- Mathivet, T., Monflier, E., Castanet, Y., Mortreaux, A., & Couturier, J.-L. *Tetrahedron Lett.*, 1998, **39**, 9411.
- Bhattacharyya, P., Gudmunsen, D., Hope, E. G., Kemmitt, R. D. W., Paige, D. R., & Stuart, A. M. *J. Chem. Soc., Perkin Trans. 1.*, 1997, 3609.
- Mathivet, T., Monflier, E., Castanet, Y., Mortreaux, A., & Couturier, J.-L. *Tetrahedron Lett.*, 1999, **40**, 3885.
- Garelli, N., & Vierling, P. *J. Org. Chem.*, 1992, **57**, 3046.
- Betzemeier, B., Lhermitte, F., & Knochel, P. *Synlett*, 1999, 489.
- Brace, N. O. US Patent 3016406, 1962.
- Szlávik, Z., Tárkányi, G., Gömöry, Á., & Rábai, J. *Org. Lett.*, 2000, **2**, 2347.
- Kotora, M., Hájek, M., Ameduri, B., & Boutevin, B. *J. Fluorine Chem.*, 1994, **68**, 49.
- Vincent, J.-M., Rabion, A., Yachandra, V. K., & Fish, R. H. *Angew. Chem. Int. Ed. Engl.*, 1997, **36**, 2346.
- Szlávik, Z., Tárkányi, G., Tarczay, G., & Rábai, J. *J. Fluorine Chem.*, 1999, **98**, 83.
- Metzger, J. O., Mahler, R., & Schmidt, A. *Liebigs Ann.*, 1996, **1996**, 693.

51. Laurent, P., Blancou, H., & Commeyras, A. *Tetrahedron Lett.*, 1992, **33**, 2489.
52. Ignat'ev, N. V., Boiko, V. N., & Yagupolskii, L. M. *Russ. Zh. Org. Khim.*, 1985, **21**, 653.
53. Hu, C.-M., & Qing, F.-L. *J. Org. Chem.*, 1991, **56**, 6348.
54. Long, Z.-Y., & Chen, Q.-Y. *J. Org. Chem.*, 1999, **64**, 4775.
55. Betzemeier, B., Lhermitte, F., & Knochel, P. *Tetrahedron Lett.*, 1998, **39**, 6667.
56. Brace, N. O., Marshall, L. W., Pinson, C. J., & Wingerden, G. *J. Org. Chem.*, 1984, **49**, 2361.
57. Hughes, R. P., & Trujillo, H. A. *Organometallics*, 1996, **15**, 286.
58. Klose, A., & Gladysz, J. A. *Tetrahedron: Asymm.*, 1999, **10**, 2665.
59. Kainz, S., Koch, D., Baumann, W., & Leitner, W. *Angew. Chem. Int. Ed. Engl.*, 1997, **36**, 1628.
60. Langer, F., Puentener, K., Stuermer, R., & Knochel, P. *Tetrahedron: Asymm.*, 1997, **8**, 715.
61. Studer, A., & Curran, D. P. *Tetrahedron*, 1997, **53**, 6681.
62. Curran, D. P., & Hadida, S. *J. Am. Chem. Soc.*, 1996, **118**, 2531.
63. Bucher, B., & Curran, D. P. *Tetrahedron Lett.*, 2000, **41**, 9617.
64. Chen, W., Xu, L., & Xiao, J. *Chem. Commun.*, 2000, 839.
65. Rocaboy, C., Rutherford, D., Bennett, B. L., & Gladysz, J. A. *J. Phys. Org. Chem.*, 2000, **13**, 1.
66. Alvey, L. J., Meier, R., Soós, T., Bernatis, P., & Gladysz, J. A. *Eur. J. Inorg. Chem.*, 2000, 1975.
67. Sinou, D., Pozzi, G., Hope, E. G., & Stuart, A. M. *Tetrahedron Lett.*, 1999, **40**, 849.
68. Quici, S., Cavazzini, M., Ceragioli, S., Montanari, F., & Pozzi, G. *Tetrahedron Lett.*, 1999, **40**, 3647.
69. De Campo, F., Lastécoueres, D., Vincent, J.-M., & Verlhac, J.-P. *J. Org. Chem.*, 1999, **64**, 4969.
70. Sadtler, V. M., Jeaneaux, F., Krafft, M. P., Rábai, J., & Riess, J. G. *New J. Chem.*, 1998, 609.
71. Kobayashi, Y., Nagai, T., Kumadaki, I., Takahashi, M., & Yamauchi, T. *Chem. Pharm. Bull.*, 1984, **32**, 4382.
72. Chen, W., Xu, L., & Xiao, J. *Org. Lett.*, 2000, **2**, 2675.
73. Rocaboy, C., Bauer, W., & Gladysz, J. A. *Eur. J. Org. Chem.*, 2000, 2621.
74. Chambers, R. D., Magron, C., & Sanford, G. *J. Chem. Soc., Perkin Trans. 1.*, 1999, 283.
75. Zhang, Q., Luo, Z., & Curran, D. P. *J. Org. Chem.*, 2000, **65**, 8866–8873.
76. Fukaya, H., Hayashi, E., Hayakawa, Y., & Abe, T. *J. Fluorine Chem.*, 1997, **83**, 117.
77. Pozzi, G., Cavazzini, M., & Quici, S. *Tetrahedron Lett.*, 1997, **38**, 7605.
78. Vogt, M. *DPhil Thesis*, RWTH, Aachen, 1991.
79. Desmarteau, D. D., Donadelli, A., Montanari, V., Petrov, V. A., & Resnati, G. *J. Am. Chem. Soc.*, 1993, **115**, 4897.
80. Kiss, L. E., Rábai, J., Varga, L., & Kövesdi, I. *Synlett*, 1998, 1243.
81. Chechik, V., & Crooks, R. M. *J. Am. Chem. Soc.*, 2000, **122**, 1243.
82. Linclau, B., Singh, A. K., & Curran, D. P. *J. Org. Chem.*, 1999, **64**, 2835.
83. Pozzi, G., Colombani, I., Miglioli, M., Montanari, F., & Quici, S. *Tetrahedron*, 1997, **53**, 6145.
84. Nakamura, Y., Takeuchi, S., Ohgo, Y., & Curran, D. P. *Tetrahedron*, 2000, **56**, 351.
85. Prakash, G. K. S., & Yudin, A. K. *Chem. Rev.*, 1997, **97**, 757.
86. Uno, H., & Suzukib, H. *Synlett*, 1993, 91.
87. Farnham, W. R., & Zane, S. G. In *Inorganic Fluorine Chemistry Toward the 21st Century* (Trasher, J. S., & Strauss, S. H., eds). ACS Symp. Ser. No. 555. American Chemical Society, Washington, DC, 1994, pp. 209–215.
88. Kampa, J. J., Nail, J. W., & Lagow, R. J. *Angew. Chem. Int. Ed. Engl.*, 1995, **35**, 1241.
89. Lin, T.-Y., Lin, W.-H., Clark, W. D., Lagow, R. D., et al. *J. Am. Chem. Soc.*, 1994, **116**, 5172.
90. Bhattacharyya, P., Croxtall, B., Fawcett, J., Gudmunsen, D., et al. *J. Fluorine Chem.*, 2000, **101**, 247.
91. Blackmore, I. J., Boa, A. N., Murray, E. J., Dennis, M., & Woodward, S. *Tetrahedron Lett.*, 1999, **40**, 6671.
92. Bodor, N., Huang, M.-J., Szántay Jr., C., & Szántay, C. *Tetrahedron*, 1992, **48**, 5823.
93. Spetsers, N., Hadida, S., Curran, D. P., & Meyer, T. Y. *Organometallics*, 1998, **17**, 1458.
94. Wilson, S. R., Yurchenko, M. E., & Schuster, D. I. *J. Org. Chem.*, 2000, **65**, 2619.
95. Stibrany, R. T., & Gorun, S. M. *J. Organomet. Chem.*, 1999, **579**, 217.
96. Zhu, D.-W. *Synthesis*, 1993, 953.
97. Wipf, P., & Reeves, J. T. *Tetrahedron Lett.*, 1999, **40**, 4649.
98. Wipf, P., & Reeves, J. T. *Tetrahedron Lett.*, 1999, **40**, 5139.
99. Röver, S., & Wipf, P. *Tetrahedron Lett.*, 1999, **40**, 5667.
100. Curran, D. P. *Angew. Chem. Int. Ed.*, 1998, **37**, 1174.
101. Curran, D. P., Hadida, S., & He, M. *J. Org. Chem.*, 1997, **62**, 6714.
102. Curran, D. P., & Luo, Z. *J. Am. Chem. Soc.*, 1999, **121**, 9069.
103. Curran, D. P., & Hoshino, M. *J. Org. Chem.*, 1996, **61**, 6480.
104. Larhed, M., Hoshino, M., Hadida, S., Curran, D. P., & Hallberg, A. *J. Org. Chem.*, 1997, **62**, 5583.
105. Hoshino, M., Degenkolb, P., & Curran, D. P. *J. Org. Chem.*, 1997, **62**, 8341.
106. Ryu, I., Niguma, T., Minakata, S., Komatsu, M., Hadida, S., & Curran, D. P. *Tetrahedron Lett.*, 1997, **38**, 7883.
107. Ryu, I., Niguma, T., Minakata, S., Komatsu, M., Luo, Z., & Curran, D. P. *Tetrahedron Lett.*, 1999, **40**, 2367.

108. Oloffson, K., Kim, S.-Y., Larhed, M., Curran, D. P., & Hallberg, A. *J. Org. Chem.*, 1999, **64**, 4539.
109. Curran, D. P., Hadida, S., Kim, S.-Y., & Luo, Z. *J. Am. Chem. Soc.*, 1999, **121**, 6607.
110. Mulholland, K. *16th Process Development Symposium*, SCI, London, 1998.
111. Studer, A., Hadida, S., Ferritto, R., Kim, S.-Y., *et al. Science*, 1997, **275**, 823.
112. Studer, A., Jeger, P., Wipf, P., & Curran, D. P. *J. Org. Chem.*, 1997, **62**, 2917.
113. Curran, D. P., Ferritto, R., & Hua, Y. *Tetrahedron Lett.*, 1998, **39**, 4937.
114. Van Vliet, M. C. A., Arends, W. C. E., & Sheldon, R. A. *Chem. Commun.*, 1999, 263.
115. Kling, R., Sinou, D., Pozzi, G., Choplin, A., *et al. Tetrahedron Lett.*, 1998, **39**, 9439.
116. Betzemeier, B., & Knochel, P. *Angew. Chem. Int. Ed. Engl.*, 1997, **36**, 2623.
117. Nishikido, J., Nakajima, H., Saeki, T., Ishii, A., & Mikami, K. *Synlett*, 1998, 1347.
118. Pozzi, G., Banfi, S., Manfredi, A., Montanari, F., & Quici, S. *Tetrahedron*, 1996, **52**, 11879.
119. Pozzi, G., Montanari, F., & Quici, S. *Chem. Commun.*, 1997, 69.
120. Klement, I., Lütjens, H., & Knochel, P. *Angew. Chem. Int. Ed. Engl.*, 1997, **36**, 1454.
121. Yeung, L. K., & Crooks, R. M. *Nano Lett.*, 2001, **1**, 14.
122. Rutherford, D., Juliette, J. J. J., Rocaboy, C., Horváth, I. T., & Gladysz, J. A. *Catal. Today*, 1998, **42**, 381.
123. Hope, E. G., Kemmitt, R. D. W., Paige, D. R., & Stuart, A. M. *J. Fluorine Chem.*, 1999, **95**, 125.
124. Richter, B., Deelman, B.-J., & van Koten, G. *J. Mol. Catal. A: Chem.*, 1999, **145**, 317.
125. Juliette, J. J. J., Rutherford, D., Horváth, I. T., & Gladysz, J. A. *J. Am. Chem. Soc.*, 1999, **121**, 2696.
126. Dinh, L. V., & Gladysz, J. A. *Tetrahedron Lett.* 1999, **40**, 8995.
127. Kleijn, H., Jastrzebski, J. T. B. H., Gossage, R. A., Kooijman, H., Spek, A. L., & van Koten, G. *Tetrahedron*, 1998, **54**, 1145.
128. Haddleton, D. M., Jackson, S. G., & Bon, S. A. *J. Am. Chem. Soc.*, 2000, **122**, 1542.
129. Betzemeier, B., Cavazzini, M., Quici, S., & Knochel, P. *Tetrahedron Lett.*, 2000, **41**, 4343.
130. Schneider, S., & Bannwarth, W. *Angew. Chem. Int. Ed. Engl.*, 2000, **39**, 4142.
131. Kleijn, H., Rijnberg, E., Jastrzebski, J. T. B. H., & van Koten, G. *Org. Lett.*, 2000, **1**, 853.
132. Nakamura, Y., Takeuchi, S., Ohgo, Y., & Curran, D. P. *Tetrahedron Lett.*, 2000, **41**, 57.
133. Giddings, J. C. *Unified Separation Science*. John Wiley, New York, 1991, pp. 16–36.
134. DeSimone, J. M., Guan, Y., & Elsbernd, C. S. *Science*, 1992, **257**, 945.

Chapter 23: Extraction of Natural Products with Superheated Water

A. A. CLIFFORD

1 Introduction

In recent years there has been a search for methods to replace the use of organic solvents in the extraction of natural products, especially plant materials, and in the subsequent processing of the extract. The purpose has been to reduce pollution in the workplace and environment generally and to avoid residues of undesirable organic solvents in the products, which often are used in foods and fragrances. One of these methods that has been studied in the last few years is the use of superheated (sometimes called subcritical) water, which is liquid water above its boiling point at atmospheric pressure (100°C) under pressure. Under these conditions, liquid water is less polar than at ambient temperature and has an increased capability of dissolving organic compounds, thus giving it to some extent the character of a polar organic solvent. It has been used, therefore, to extract compounds from soil, e.g. for the purpose of environmental analysis and decontamination.

In the last few years attention has been turned to the use of water for the extraction of natural products. A number of studies have been made on a small scale, often with the objective of providing a method of sample preparation for subsequent analysis to identify and quantify the components in a particular plant material. There is also considerable interest in developing processes from these small-scale experiments that would satisfy the aims described in the first paragraph. However, process development is at an early stage. The problems to be solved are the separation of the desired components at the end of the process from water and from highly water-soluble material also present in the plants.

During extraction, some of the components undergo reactions such as oxidation and hydrolysis to a minor extent. To reduce oxidation, the water to be used may be deoxygenated. Reactions also happen in other forms of extraction and may be acceptable and even improve the product. In other

cases, the reactions may be an important part of the process, as will be described at the end of the chapter.

2 Properties of Superheated Water

The term superheated water (or subcritical water) refers to liquid water under pressure between 100°C and its critical temperature of 374°C. Above its critical temperature, where the distinction between liquid water and gas (steam) disappears, it is known as supercritical water. For natural product extraction the temperature cannot be too high because of thermal sensitivity and so the range 100–200°C or a little more is typically used. At these lower temperatures, water is not highly compressible and the pressure of the medium does not have much effect, as long as it is high enough to maintain the water in the liquid phase. Both subcritical water [1] and supercritical water [2] have been used in recent years for the oxidative destruction of organic compounds with molecular oxygen. These processes are not described here, and oxygen in the water used for these experiments is mostly removed beforehand in a stream of nitrogen.

The physical properties of water and steam are well known over a wide range of temperature and pressure, owing to their importance in power generation. They have been compiled in what are known as steam tables, such as the recent NBS/NRC Steam Tables [3]. However, in the context of plant extraction, almost any edition of steam tables will provide data of sufficient accuracy. An important property is the vapour pressure of water, and at 200°C this is around 12 bar. The pressure in a system used for plant extraction usually is higher than the vapour pressure of water, however, because of the presence of volatile organics. The extent of this effect is difficult to predict, but it can be estimated by adding the vapour pressure of a principal volatile component present. Another important property is enthalpy, from which the heating and cooling requirements of a process can be calculated.

Water changes dramatically when its temperature rises, owing to the breakdown in its hydrogen-bonded structure with temperature. The high degree of association in the liquid causes its relative permittivity (more commonly called its dielectric constant) to be very high, around 80 under ambient conditions, but as the temperature rises this value falls, as shown in Fig. 23.1. By 205°C its dielectric constant is equal to that for methanol (i.e. 33) at ambient temperature. Thus, between 100°C and 200°C superheated water is behaving like a water–methanol mixture.

The solubility of an organic compound in superheated water is often many orders of magnitude higher than its solubility in water at ambient temperature for two reasons. The first is the change in dielectric constant, described above. The second is that a compound with low solubility at ambient temperature will have a high positive enthalpy of solution and thus a large increase in solubility with temperature. Compounds that show high solubility in superheated water are often polarisable, such as aromatic compounds, or have some polar character. Thus oxygenates in plant extracts, which are usually the valuable compounds, show good solubility.

It is not appropriate in this chapter to do a full review of solubility measurements, but an outline will be given. An early measurement [4] showed that naphthalene forms a 10 mass% solution in water at 270°C. The same group of Professor Schnei-

der in Karlsruhe carried out a range of detailed studies. It was shown later [5] that the heavy hydrocarbons benz[*e*]pyrene and nonadecylbenzene reach the same concentration at 350°C. In recent years many more studies have been made. In one of these [6], an attempt has been made to rationalise solubility behaviour in a simple way on a range of compounds, including polyaromatic compounds and pesticides, between 25°C and 200°C. These data have been analysed to obtain a method of roughly estimating high-temperature solubilities. The analysis first takes into account the effect of temperature thermodynamically and then adds in the effect of the change in dielectric constant empirically. The analysis shows clearly that solubility increases more than would be expected by the temperature increase. For example, the solubility of anthracene, in terms of mole fraction, increases from 8.1×10^{-9} at 25°C to 2.1×10^{-4} at 200°C, whereas the effect of temperature alone would predict a solubility at 200°C of only 8.0×10^{-6} . Studies of the solubility of the components of essential oils have been made [7] that also show large increases in solubility with temperature.

The change of the properties of water with increase in temperature allows a range of processes to be possible, such as extraction from solids and liquids and soil and general environmental decontamination. The manipulation of water properties with temperature to achieve various ends has been made the subject of a patent [8].

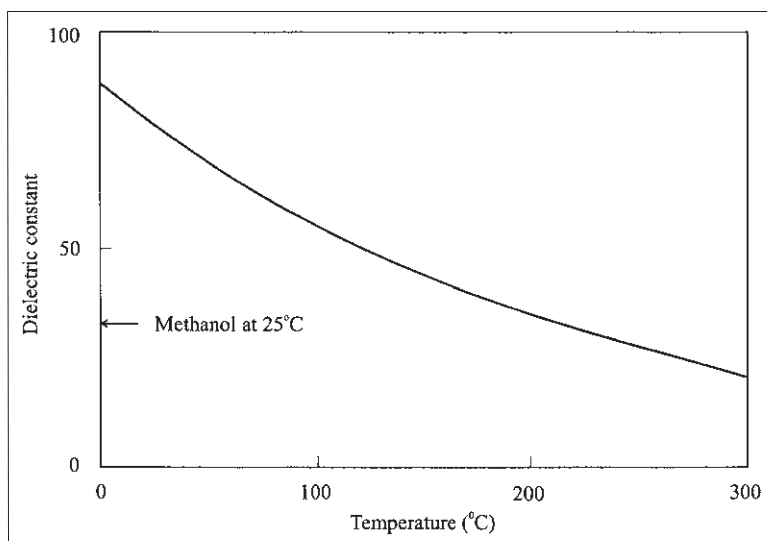


Fig. 23.1 The dielectric constant (relative permittivity) of water as a function of temperature at its vapour pressure [3]. The value for methanol at ambient temperature is shown for comparison.

3 Extraction of Materials Other Than Natural Products

The higher solubilities described in the previous section has made water a candidate for carrying out extractions. Initially the compounds to be extracted were environmental pollutants for the purposes of monitoring and decontamination. For example, superheated water was used to extract polynuclear hydrocarbons and polychlorinated biphenyls from soil and sediment [9,10] and extraction was found to be quantitative at around 250°C. Since this work, a number of other studies have been published, but again a comprehensive review of this subject is not required here. However, it has been shown recently that decontamination with superheated water can be carried out in situ with a device that can be hammered into the soil or a contaminated site [11]. Because of the higher solubility of aromatic compared with saturated compounds, it has been shown also that aromatic compounds can be extracted from petroleum products [12], which could provide a way of removing benzene from gasoline, for example.

4 Chromatography with Superheated Water

Superheated water also has been used for reverse-phase chromatography [13,14] and this is referred to briefly here because of the possibility of including chromatography into a process for natural product extraction with water. Water up to 210°C was used with a polymer stationary phase to separate a wide variety of compounds, giving chromatograms comparable with those obtained using solvent mixtures at ambient conditions. Some of the compounds used were natural products, e.g. a chromatogram of caffeine was obtained at 150°C.

5 Extraction of Rosemary

The first extraction of a natural product with superheated water was an experiment carried out by Hawthorne and co-workers [8]. They extracted rosemary (*Rosmarinus officinalis*) with water at 100°C and 200°C and found that the extracts contained the oxygenated compounds in the essential oil, such as 1,8-cineol, camphor, borneol and linalyl propanoate. The extract at 200°C contained small quantities of the monoterpene hydrocarbons α -pinene and camphene, but the extract at 100°C did not contain traceable amounts of the monoterpenes. In essential oils, the valuable components that give the flavour and fragrance of the essential oil are the oxygenated compounds, whereas the monoterpenes are the less valuable components. Most conventional processes, such as steam distillation, give essential oils that consist mainly of terpenes (often in high proportion) and there are many processes operated worldwide for the 'deterpenation' of essential oils. Thus, the experiments showed that extraction with superheated water not only had environmental advantages but could produce a more valuable extract of higher quality.

In Leeds we carried out a more detailed study of the extraction of rosemary [15]. The apparatus used is shown schematically in Fig. 23.2. Water is deoxygenated by sparging with helium for half an hour. It is then pumped at around 1 ml min⁻¹ into the extraction cell in an oven at the required temperature through a long tube, which acts as a heat exchanger to bring the water up to temperature. On exiting the oven, the water stream is cooled using a coil of tubing in air and then passes through a narrow tube into a collection vial. The narrow tube acts as a restrictor to maintain the pressure in the system above the vapour pressure, typically at 50 bar. Minor

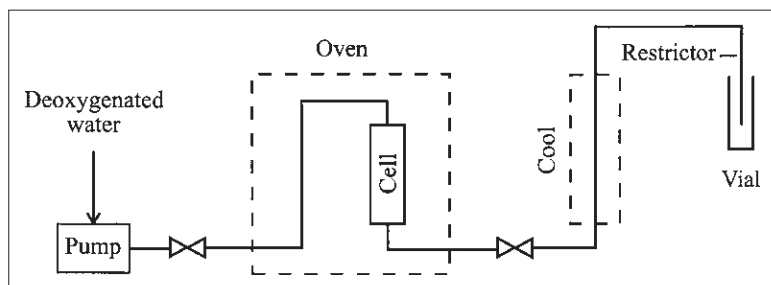


Fig. 23.2 Schematic diagram of a small laboratory system for the study of the superheated water extraction of plants. (From Ref. 15.)

refinements are not shown here. Other studies referred to below use very similar experimental systems. For kinetic experiments, to study extraction rates, the vial is replaced at known intervals. The extract then is back-extracted into a solvent such as pentane and analysed and quantified by gas chromatography.

Figure 23.3 shows the results obtained at 150°C for the extraction of rosemary with liquid water, presented in the form of the percentage of each of eight compounds of interest obtained after a given time compared with the amount that can be obtained after a long extraction. The monoterpenes extracted are camphene and limonene, whose extraction profiles are indistinguishable (shown as filled circles), and α -pinene (shown as open circles). These extract relatively slowly. The ester isobornyl acetate is extracted a little more quickly. A more rapidly extracted group is formed by the cyclic ether 1,8-cineole (open inverted triangles) and the alcohol borneol (closed inverted triangles). The ketones are removed most rapidly. Of the latter, verbenone (closed triangles), which has a double carbon-carbon bond conjugated with the ketone bond, is extracted more rapidly than camphor (open triangles). Very small and unquantifiable amounts of heavier hydrocarbons were extracted.

All the extraction curves are found to be exponential in form. This indicates that the extraction

rate is controlled by partitioning the compounds between the water and the plant material. Release from the plant material and diffusion through it appear to be very rapid in this extraction process, in contrast to extraction by liquids and supercritical carbon dioxide. Other experiments showed that the total amount of compounds obtained by superheated water extraction was greater than that obtained by steam distillation. This could be because penetration of the plant material is better with hot water under pressure. Analysis of the rate curves obtained showed that if extraction was stopped after 70% of the total material had been extracted, then 90% of the essential oil extract would be oxygenated flavour and fragrance compounds.

6 Extraction of Other Plant Materials

A number of studies now have been made on a small scale, including work on laurel [16,21], marjoram [17], clove buds [18], peppermint [19] and various medicinal herbs [20]. These reach similar conclusions to those given in the previous section and in some cases comparisons with steam distillation and other methods have been made [15, 17–20]. As an example of these comparisons, the work on marjoram (*Thymus mastichina*) will be outlined briefly [17]. Steam distillation was carried out over 3 h, whereas superheated water extraction at 150°C was com-

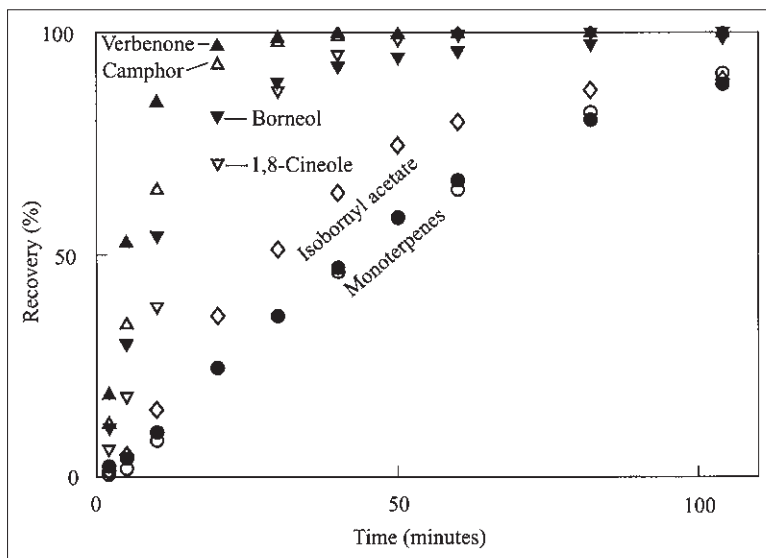


Fig. 23.3 Recovery curves for compounds extracted from rosemary with liquid water at 150°C. (From Ref. 15.)

pleted in 15 min. The authors used about 10.5 times more water per gram of plant material in superheated water extraction than in steam distillation and stated that steam distillation seemed to have gone to completion. The yield from superheated water extraction was 5.1 times that obtained by steam distillation. This is in accord with results from our laboratory and others, although the ratio of yields is larger than obtained elsewhere. Table 23.1 shows the percentages of selected compounds in the oils obtained by both methods. The major component, eucalyptol, is present in roughly the same proportion in both oils, but the monoterpenes (the first three compounds listed) are much less prominent in the oil obtained by superheated water extraction. However, the superheated water extract contains a higher proportion of most other oxygenated compounds, except for geranyl acetate. These compounds will give the oil its particular fragrance. The results agree in general with those reported in other studies.

Using an experimental system modified from, but similar to, that shown in Fig. 23.2, plant essential oils also have been extracted at Leeds, although the work has not been published yet. The cell was filled with packing material and the oil pumped through a tube so that it entered 20 mm above the bottom of the cell. It then trickled up over the packing material and collected at the top of the cell. The flow rate of oil was one-tenth of that of water. Initial experiments were carried out on cold-pressed lemon oil, which consisted largely of terpenes, mainly limonene, with about 1% of oxygenated compounds. The extract,

however, consisted only of the oxygenated flavour and fragrance compounds. Similar results were obtained with other oils. These experiments could form the basis of a method for deterring essential oils, as discussed below.

7 Process Development

The advantages in yield and quality, as well as the environmental and clean-product benefits, give rise to interest in developing processes from these small-scale experiments. There are also energy savings in principle. A greater mass of superheated water for a given mass of plant material is required than for steam distillation. However, only 505 kJ kg^{-1} is required to heat liquid water from 30°C to 150°C , compared with the 2550 kJ kg^{-1} required to convert water at 30°C to steam at 100°C [3]. Moreover, it is relatively easy to recycle the heat in a superheated water process by passing the water leaving the extraction cell through a heat exchanger to heat the water flowing to the cell. About 80% of the energy realistically can be recovered in this way. By contrast, it is difficult to recover heat in steam distillation, because a relatively large amount of cooling water is needed to condense the steam and only part of this can pass into the boiler. The amount of heat that can be recovered in steam distillation is of the order of 5%. These advantages mean that in a well-designed process, in spite of the greater amount of water required, less energy is needed. Extraction by superheated water, therefore, has the potential advantages over steam distillation (an equally environmentally friendly process) of better yields, a higher quality product and less energy use.

Process development is, however, at an early stage. Not much work is published yet but the challenges are being tackled. The main problems to be solved are separation of the desired components at the end of the process from both the extracting water and from highly water-soluble material also present in the plant material and therefore water extract. The extract often is coloured brown, like tea, and often contains a precipitate in which the oxygenated compounds are absorbed. On a small scale these are back-extracted using an organic solvent such as pentane for analysis, but this would not be acceptable in an environmentally friendly process.

One suggestion is to back-extract with supercritical carbon dioxide, which also is a clean solvent.

Table 23.1 Comparison of percentages of selected components in the essential oil obtained from marjoram by steam distillation and superheated water extraction at 150°C

	Steam distillation	Superheated water extraction
α -Pinene	2.5	0.1
β -Pinene	4.4	0.5
β -Myrcene	5.0	0.3
Eucalyptol	67	65.0
Linalool	2.1	4.7
α -Terpineol	6.0	10.1
Geraniol	3.6	6.1
Geranyl acetate	3.6	2.6

Data taken from Ref. 17.

Another alternative is to do the reverse, i.e. extract the plant material first with carbon dioxide to obtain a 'concrete' or 'oleoresin', which contains heavy materials such as plant waxes. The concrete then can be treated with superheated water as described below. However, the use of supercritical carbon dioxide probably is not economically viable for most products.

In some cases there is not a problem. For example, the extraction of flowers such as rose petals leads to a white precipitate containing the fragrance compounds. This may be a product that can be accepted as an additive to soaps and other cosmetics and could be described as a solid fragrance. Another situation is the production of flavour materials such as spices, which normally are obtained by hot-water infusion. The use of superheated water seems to give a more concentrated extract and thus may be more cost effective.

Another approach to this problem is to extract essential oils that have been obtained previously without the use of organic solvents by procedures such as steam distillation, cold pressing or supercritical carbon dioxide extraction. As described above, experiments show that the oxygenated flavour and fragrance compounds are extracted preferentially and the extraction amounts to a method for deterring oils. A typical conventional process for this purpose would be an extraction using hexane and ethanol-water streams flowing counter-currently, with the oxygenates being removed in the ethanolic stream and the terpenes in the hexane stream. A method using superheated water would avoid the use of hexane and hexane residues in the product.

Again there are separation problems, because the concentration of oxygenates in the water extract is typically less than 1% by mass, due to the low concentration of oxygenates in the original oil. The extract is a cloudy emulsion that is difficult to separate. It is possible that continuous centrifuging would produce an oil consisting primarily of the oxygenates, but this has not been achieved yet. Various other possibilities currently are being pursued.

The first is to dilute the extract with more water until it becomes clear, to produce a fragrant 'water' as a possible product. Waters such as lavender water and rose water currently are obtained as the water layer in the condensate following steam distillation. This is rich in the oxygenated flavour and fragrance

compounds and is one of the reasons why the essential oil obtained by steam distillation is weak in these compounds. Fragrant waters obtained by dilution from a superheated water extract are of high quality and have been described as 'punchier' by a commercial expert. The demand for these waters exceeds the production as a by-product from steam distillation.

Another possibility being pursued is back-extraction of the oxygenates into some of the original oil to produce an enhanced oil of higher quality and value. A third method being studied is to trap the oxygenates on to a solid-phase material such as a cross-linked polystyrene, used in the chromatographic work described earlier. The oxygenates then are concentrated in a column and can be washed off with ethanol. The resulting solution of the flavour and fragrance compounds in ethanol containing some water is a possible product for high-value materials and is similar to the 'absolutes' produced traditionally in the fragrance industry.

Thus there are a number of routes to products being investigated and these are summarised in Fig. 23.4. Work is being carried out on a laboratory and pilot scale. Figure 23.5 shows a pilot plant at Express Separations Ltd in North Yorkshire. The main feature visible is the extraction column of 30-l volume. It can be used for solids or liquids and the water can be recirculated, or not, as desired. There are also facilities for trapping on a column filled with a solid phase (not visible). It is capable of operating up to 175°C. Work for scale-up is at a preliminary stage, but there are a number of products that appear to be of interest. Because superheated water extraction is a relatively inexpensive process and easy to operate, it would be viable to install small production plants at the point of agricultural production, to increase the value of materials being sold from a farm.

8 Extraction with Reaction

During extraction, some of the components undergo reactions such as oxidation and hydrolysis, to a minor extent. Reactions also happen in other forms of extraction and may be acceptable and even improve the product. The monoterpene terpinene is oxidised to terpineol, and linaloyl acetate is hydrolysed to linalool during steam distillation, increasing the fragrance of the oils. The beautiful blue colour of

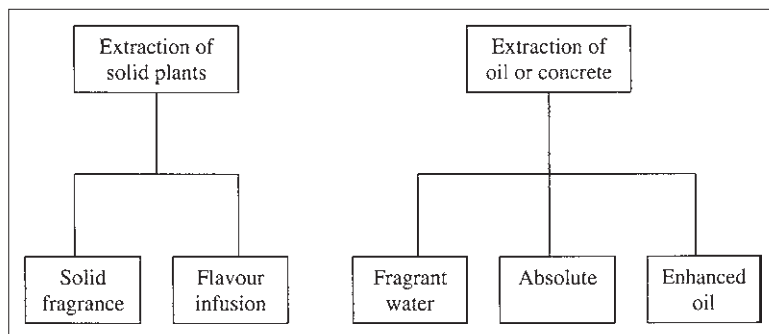


Fig. 23.4 Routes for exploring processes for the use of superheated water in natural product extraction.



Fig. 23.5 Superheated water extraction pilot plant.

the valuable chamomile oil is formed by oxidation during its production.

Reactions in superheated water are well characterised [22]. In relation to plant materials, the hydrolysis of starch and cellulose to sugars has been studied widely up to the present [23]. Superheated water has been used as a solvent and reagent for the hydrolysis of triglycerides, some containing unsaturated acids, in the temperature range 260–280°C,

although higher temperatures resulted in degradation [24]. This opens up the possibility of extraction of lipids from natural products, followed by separation of the fatty acids.

In an attempt to produce sugars directly from barley seeds, these were extracted with superheated water in our laboratory. Unfortunately, at the temperature required for hydrolysis a dark-brown extract was obtained that smelled of burning. At a lower temperature, however, a pleasant cooking aroma was obtained, due to the Mailliard reaction. Similar results were obtained with other vegetable materials and superheated water could be used to manufacture food flavours.

The most interesting results were obtained with green Java coffee beans. Extraction at around 200°C produced a brown liquid that had the aroma of coffee. The apparatus is shown in Fig. 23.6, with the cell and preheating coil shown in the oven and the ‘coffee’ produced on the left side of the picture. The stainless-steel vessel to the right-hand side of the pump is used to pressurise water with oxygen in some experiments. Extractions were carried out using both deoxygenated water and water oxygenated by air at atmospheric pressure and by oxygen at 5 bar, although the product was not much affected by the presence of oxygen. Following extraction, the cell contents were examined. After all the experiments the beans were found to be whole. Water appeared to have permeated throughout the individual beans and all the beans were homogeneously dark brown. They had expanded to about double their initial size and the strong smell from the beans was bitter and burnt.

The extracts were analysed by head-space gas chromatography coupled to mass spectrometry. In



Fig. 23.6 Laboratory-scale production of coffee flavour.

some cases the effluent from the chromatograph was split so that the separated compounds could be sniffed, to aid identification. The chromatograms obtained were compared with those from filter coffee obtained from the same beans after roasting and grinding (i.e. in the normal way). The 'coffee' obtained from superheated water gave a much more concentrated extract but the components and their proportions were very similar to conventional coffee. Thus, a process similar to roasting is occurring for the green beans. These experiments may give rise to a process for producing coffee flavours for the food industry.

References

1. Zimmernam, F. J. *US Patent 2 665 249*, 1954.
2. Modell, M. *US Patent 4 338 199*, 1982.
3. Haar, L., Gallagher, J. S., & Kell, G. S. *NBS/NRC Steam Tables*. Hemisphere, Washington, 1984.
4. Alwani, Z. *Dissertation*, Karlsruhe, Germany, 1969.
5. Sanders, N. D. *Ind. Eng. Chem. Fundam.*, 1984, **25**, 169.
6. Miller, D. J., Hawthorne, S. B., Gizir, A. M., & Clifford, A. A. *J. Chem. Eng. Data*, 1998, **43**, 1043.
7. Miller, D. J., & Hawthorne, S. B. *J. Chem. Eng. Data*, 2000, **45**, 315.
8. Lagadec, A. J.-M., Yang, Y., Miller, D. J., & Hawthorne, S. B. *US Patent 6 001 256*, 1999.
9. Hawthorne, S. B., Yang, Y., & Miller, D. J. *Anal. Chem.*, 1994, **66**, 2912.
10. Yang, Y., Bøwolt, S., Hawthorne, S. B., & Miller, D. J. *Anal. Chem.*, 1995, **67**, 4571.
11. Hammond, P. J. *UK Patent 2 343 890A*, 2000.
12. Yang, Y., Miller, D. J., & Hawthorne, S. B. *J. Chem. Eng. Data*, 1997, **42**, 908.
13. Smith, R. M., & Burgess, R. J. *J. Chromatogr. A*, 1997, **785**, 49.
14. Miller, D. J., & Hawthorne, S. B. *Anal. Chem.*, 1997, **69**, 623.
15. Basile, A. Jimenez-Carmona, M. M., & Clifford, A. A. *J. Agric. Food Chem.*, 1998, **46**, 5205.
16. Jimenez-Carmona, M. M., & de Castro, M. D. L. *Chromatographia*, 1999, **50**, 578.
17. Jimenez-Carmona, M. M., Ubera, J. L., & de Castro, M. D. L. *J. Chromatogr. A*, 1999, **855**, 625.
18. Clifford, A. A., Basile, A., & Al-Saidi, S. H. R. *Fresenius J. Anal. Chem.*, 1999, **364**, 635.
19. Ammann, A., Hinz, D. C., Addleman, R. S., Wai, C. M., & Wenclawiak, B. W. *Fresenius J. Anal. Chem.*, 1999, **364**, 650.
20. Gamiz-Gracia, L., & de Castro, M. D. L. *Talanta*, 2000, **51**, 1179.
21. Fernandez-Perez, V., Jimenez-Carmona, M. M., & de Castro, M. D. L. *Analyst*, 2000, **125**, 481.
22. Siskin, M., & Katritzky, A. R. *Abstr. Pap. Am. Chem. Soc.*, 1999, **217**.
23. Sasaki, M., Fang, Z., Fukushima, Y., Adschiri, T., & Arai, K. *Ind. Eng. Chem. Res.*, 2000, **38**, 2883.
24. Holliday, R. L., King, J. W., & List, G. R. *Ind. Eng. Chem. Res.*, 1998, **36**, 932.

Index

- 1,3-dimethylbenzene, 16
1,4-dimethoxybut-2-ene, 24
2-ketogulonic acid, 193
2-methyl 1,3-cyclopentadione, 14
3-dehydroshikimic acid, 194
6-aminopenicillanic 2-ketogulonic acid, 7
6-APA, 188, 190
- acetic anhydride, 93, 97, 100, 283
acetobacter, 188
 suboxydans, 193
acetone, 13, 89, 128, 137, 142, 161, 173,
 213, 222, 244, 265, 279, 281,
 282–3, 360, 502, 504, 516
acid anhydride, 16, 106, 161, 264
acid chloride, 112, 156, 161–2, 167, 326,
 508
acid deposition, 31, 45, 81–2
acid plants, 23
acidovorax facilis, 190
acrolein, 14, 35, 315–16
acrylamide, 35, 101, 188–9, 202–3, 357
acrylonitrile, 35, 153, 156, 165, 171,
 188–9, 199, 223, 339–40, 357
activation polarisation, 468
acylation, 16, 86, 92–3, 100–101, 103–4,
 108, 112–13, 125–6, 141, 156, 168,
 215, 219–20, 276, 322, 325–6, 329,
 331–3, 350, 361, 420, 500, 520
adipic acid, 23–4, 31, 194, 240, 243, 283,
 325, 342, 348, 360, 488
adiponitrile production, 340, 342, 346
adoption of new technology, factors in, 73,
 258, 321, 333, 338
advanced oxidation processes (AOPs),
 294–5
agaricus bisporus, 198
alcaligenes faecalis, 199
alcohols, 161, 386
 acetal formation, 93, 125
 adipic acid manufacture, 23
 carbonylation of, 350
 chiral, from renewable resources, 195
 co-catalysts in phase transfer catalysis,
 209
 epoxides, from, 207, 220
 esterification, 98, 100, 168–9, 173,
 323
 etherification, 104, 175–7, 404, 492
 fluorinated, as co-catalysts in fluorous
 biphasic systems, 484
 fluorous labelling of, 515, 518
 formation of alkyl halides, 176
 Friedel-Crafts reactions, in, 495
 fuel cells, in, 476
 hydration, by, 104
 hydrolysis, via, 161–3, 213
 life cycle analysis of whisky, 77
 oxidation of, 4, 137, 163–6, 220, 234,
 241, 243, 267, 270, 272, 274, 280,
 282, 285–7, 318, 379, 520
 oxidation of hydrocarbons, via, 138–9,
 370
 reduction, by, 491
 transesterification, 143, 509
aldehyde, 15, 34, 36, 82, 95, 108, 133,
 137, 142, 162–8, 173, 183, 214–15,
 223, 240, 244, 261, 284–5, 287–8,
 315, 318–19, 323, 329, 330, 335,
 343, 357, 368–9, 386, 390, 405,
 409, 449, 452, 471, 484, 488–9,
 491, 493, 495–8, 504, 514, 516, 520
aldol condensation, 25, 143
alkene, 14, 104, 126, 130–33, 135, 166,
 172–3, 175–6, 178, 182–3, 210,
 218, 233, 266, 281, 331, 379, 381,
 398, 411, 487–8, 490–91, 497,
 520
alkyl 2-(hydroxymethyl)acrylates, 405
alkylation, 16–17, 48, 104–5, 113, 114,
 211–12, 215–18, 318, 347–8, 500,
 520
 acetone, with, 128
 acidic X-H bonds, 211–18, 222–3, 225,
 319, 378, 383
 alcohols, of, 101, 103
 alcohols, with, 95, 495
 alkenes, with, 94–7, 108–11, 114–16,
 126, 327, 333
 alkyl halides, with, 326, 379
 amines, 169
 carboxylates, 400
 dialkylzinc, with, 144–5
 Friedel-Crafts, 16–17, 96, 99
 membrane reactors, in, 370
 phenols, 103
 polymers, 156, 166–7
 preparation of phosphonate esters, 239
 transesterification, 96
alkyne, 173, 175, 210, 233, 411, 491
allene, 173, 210
alternative energy, 6, 22, 476
alternative solvents, 25, 482
aluminium chloride, 13, 16, 86, 127, 323
aluminous waste, 16
alicyclic synthesis, 215
amide, *see also* acrylamide *and*
 nicotinamide, 13, 101, 133, 141,
 156, 161, 164, 167–8, 180, 197–8,
 202, 207, 214, 227, 244, 246, 264,
 269–70, 280–81, 290, 293, 311,
 358, 360, 384, 402, 405, 490, 498,
 516
amine
 acylation of, with or on polymer
 supported reagents, 167
 alkylation of, 172, 211, 215
 dendrimeric, in catalysis, 234
 external site blockers in porous catalysts,
 125
 fluorous tagging, 516
 formation of polymeric carbamoyl
 chlorides and ureas, 181
 Heck reactions, 237
 HF complexes, 175
 interaction with peroxy species, 261,
 266–7, 290
 iodination of, using polymer supported
 polyhalides, 172
 methyl, from methanol and ammonia,
 101
 optically active, from lipase catalysis,
 357–8
 oxides, 259, 268, 281
 from fatty tertiary amines, 289
 from n-methylmorpholine, 289
 nitrosamines in, 289
 penicillin and cephalosporin syntheses,
 361
 perfluorinated, 502
 polymeric amine borane complexes, 163
 polymeric, in electrochemical devices,
 229
 PTC system, 210, 232

- reduction of imines, 169
 scCO₂, 483, 491, 498
 separation processes, 311
 sewage sludge, 42
 supported, 126, 133, 139–45, 158, 167, 491
 templates in materials synthesis, 121, 123–4, 130, 137
 triarylamine, synthesis, 238
- ammonia, 17, 21, 79, 88, 101, 199, 259–60, 266, 273, 288–9, 291, 295, 297, 343, 407
- anhydride, 13, 16–17, 35, 93, 97, 100, 106, 108, 125, 156, 161, 165, 168, 207, 219–20, 222, 261, 264, 278, 283
- anode, 388, 439, 445–6, 448–50, 452–4, 458, 460–61, 466, 468, 471–3, 475
 consumable, 453–4
 materials, 473
 oxidation, 445, 448
- anthropogenic chemicals, 28
- antifungal, 13
- aqueous-media, 377, 389–90, 410, 424
- aromatic acylations, 16, 94, 322, 326
- aromatic nitration, 17
- arsenic, oxidation catalysis, 267
- arsine, 448–9
- arthrobacter*, 190, 199
- aryl halides, 208, 214, 232, 235, 411, 453, 486
- aryl vinyl ketone, 405–6
- asbestos, 34–5, 39
- aspartame, 192–3
- asymmetric PTC, 222
- atmosphere, 20, 23, 28–32, 34, 36, 40–41, 43, 50, 138, 272, 313, 321, 325, 329, 335, 350, 373, 375–6, 384, 388, 392, 403, 453, 473, 476
- atom
 economy, 4, 10, 12–13, 309, 314–15, 340, 404, 411
 efficiency, 5–6, 12–13, 15, 28, 135, 499
 utilisation, 259, 263, 265–6, 277, 290, 293, 321, 434
- azelaic acid, from oleic acid, 282
- azide, 169–71, 207, 222, 230
- azo dye, 170, 239
- azobis(isobutyronitrile) (AIBN), 485
- azodicarbonamide, 290
- baeyer-villiger oxidation, 240, 265, 335
 using peracids, 263, 335
- baker's yeast, 190–91
- Ballard Power Systems, 471, 478–9
- batch reactor, 368, 393, 403, 421, 425–6, 491
- batteries, 41, 443–4, 447, 459, 464, 466, 477–80
- benzaldehydes, 36, 132, 139–41, 143–4, 163, 208, 213, 215, 226, 232, 240, 284–5, 449, 452, 491
- benzene
 acylation of, 325
 air, in, 32
 alkylation of using alcohols, 95, 110
 alkylation of using alkenes, 16, 86, 104, 108–10, 116, 126, 326, 333, 341
 coupling reactions, 238
 enzymatic oxidation in
 decontamination, 202
 hydrodechlorination, 234–6
 hydrogenation of, 233, 342
 indoor environments, 39
 oxidation to phenol, 138, 284
 raw material in adipic acid synthesis, 24–5, 348
 solvent, 163, 181, 211, 493–4, 504, 510
- benzoic acids, 112, 163, 172, 238, 240, 243, 264, 283–4, 323, 325, 329, 331, 335, 504, 516
- benzophenones, 325, 329, 331
- benzoylation, 100, 104, 325, 329, 331–3
- benzyl
 alcohols, 110, 209
 halides, 170, 176, 181
- beta-galactosidase, 188–9, 357
- Bhopal, 22–3, 27, 338
- biocatalysis, 188, 190–94, 198, 203, 357, 340, 352
- biocatalytic process, 17, 188, 190, 197, 199, 200–201, 203
- biogeochemical cycling, 28, 50–51
- biomimetic, 408
- biopol, 195
- bioprocessing, 340, 355–7, 360–61, 364
- biotechnology, 202–4, 206, 276, 339, 356–8, 362, 364–5, 372, 393, 503
 feedstocks, 57–8, 60
- bipolar, 446–7, 471, 474
 membranes, 462–3
- BOD, 44
- borohydride, 163, 173, 176, 206, 220, 225, 412, 434
- BPEO, 73–4, 76, 258
- bromination, 165, 171–2, 209, 221, 235, 240–42, 293, 327, 407, 416
- bromine, 39, 50, 166, 171–2, 175–6, 183, 207, 243, 267, 285–6, 293, 327, 450, 452
- bromoacrylamide, 165, 171
- bromoaromatics, 170
- Brønsted acidity, 89, 102–4, 108, 128
- Bruntland Commission, 10
- built environment, 39
- bulk chemical production, 13, 188, 341, 356, 433
- business environment, 476
- butadiene, 13, 24, 35, 45, 277, 281, 342–3, 345–7
- butler-volmer equation, 437
- butyrolactone, 174, 196, 358, 488
- cabodiimides, 172
- candida antarctica*, 196, 198, 276
- candida tropicalis*, 198
- caprolactam, 35, 93, 260, 266, 273, 289, 342, 416
- caprolactone, 138, 287–8
- Captan, 13, 35, 42
- carbaryl, 22, 35
- carboalkoxylation, 24
- carbohydrate oxidations, with hydrogen peroxide, 287
- carbohydrates, 2, 192–3, 214, 226, 231–2, 287, 352, 354, 364, 383, 516
- carbon acids, 139, 211
- carbon dioxide, 23–5, 29–31, 36–8, 43–4, 77, 197, 199, 243–4, 262, 289, 322, 367, 398, 442, 453, 466, 469, 470, 472, 476, 482–95, 499, 502, 520, 527–9
 emissions, 18, 405, 476
- carbon fibre electrode, 458
- carbon fibres, 458
- carnitine, 192–3
- Caro's acid, 263, 265
 dioxiranes from, 265
 from hydrogen peroxide, 263
- catalysis, *see also* biocatalysis *and* electrocatalysis, ix, xi, xiv, 86, 151, 206–245
 acid catalysis
 acylation, 93, 100, 125, 325, 332
 alkylation, 91, 94, 103–4, 110, 114, 126–7, 326, 333, 495
 isomerisation, 91, 93, 96, 111–12
 rearrangement, 93
 aryl couplings, 235–8
 base catalysis, 139–44
 biocatalytic hydrolysis, 188, condensation, 125, 139–42, 214
 design of fluoros catalyts, 504
 enantioselective catalysis, 144–6, 190, 197–8, 346–7, 350–51, 353, 484
 energy conservation, in, 21
 esterification, 92, 107, 126, 132, 328
 Heck, 232
 heteropolyacids in ethyl acetate production, 101
 hydroformylation, 231–2

- hydrolysis, 100, 213–14,
ion exchange resins in ether formation,
106
Nafion-silica composites, 108–14
nucleophilic alkylation, 215–18
nylon chemistry, in, 342
membrane reactors, in, 370
oxidation, 128–39, 239–43, 328, 334,
342, 343
polymerisation, 227
remediation, in, 22
transesterification, 143, 214,
zeolites, by, 115–17
- catechol, 24, 138, 194, 259, 273, 284, 342,
360, 390
- cathode, 430, 444–6, 449–50, 452–3,
456–8, 461, 466, 468, 471–3, 475
cleavages, 451
reactions, 445–6, 449–50
- cell membranes, 53, 370, 471
- cells, 18–19, 47, 54, 191, 195, 198, 199,
200, 246, 276, 339, 387, 390–91,
399, 433–4, 438–40, 442–53,
457–61, 463–4, 526–8, 530
- cellulose, 31, 353–5, 405, 530
- Ceramic Fuel Cells Inc., 474–5
- CFCs, 28, 36–8, 81, 485
- charge carrier, 466
- cheletropic additions, 13
- Chemelec Cell, 457
- chemical warfare agents, destruction, 242
- chemicals from renewables, 340, 352, 354,
355–6
- chitosan, 199
- chloride process, 21–2
- chlorinated compounds, 315
- chlorine, 22, 33, 35, 38–9, 41–2, 50, 52,
133, 140, 158, 172, 176, 200, 208,
214, 241, 260, 277, 295, 297, 317,
325, 391, 433, 442, 448–9, 450
comparison with hydrogen peroxide,
260
- chlorine dioxide, 291, 450
- chlorochromate, 163–4
- chlorofluoropolymer, 158
- chloromaleimide, 171
- chromate, 5, 163–5, 265, 324, 328, 386,
434, 452
- chromium, 4, 34–5, 39, 44, 49, 276,
285–6, 323, 386, 388, 454, 498
- Claisen rearrangements, 14
- clays, 40, 43, 53, 86, 90, 100–101, 104,
107–8, 222, 276, 286, 296, 322–4,
329, 341, 386, 400
- coal-gas conversion, 199, 202
- cobalt catalysts, 334
for side-chain oxidation, 265
- cobalt naphthenate, 23
- coffee, 482, 530–31
- combined heat and power, 443–4, 470,
473, 476, 478
- competitive advantage, 11, 476
- complexation, 53, 134, 139, 145, 219,
424, 456
- concentration polarisation, 444, 468
- Concord grape, 192
- contaminated land, 41, 43
- continuous reactors, 366, 427
- Cope elimination, 290
- copolymerisation, 152–3, 155–6, 498–9
- copper corrosion, 435
- cordiachromene, 14
- coriolic acid, 195
- corrosion problems, 23, 30, 296, 472, 490
- corticosteroid, 203
- cost
electrons for electrochemistry, 434
photons for photochemistry, 422–3
processing, 12, 19, 116–17, 277, 388,
416, 427, 448, 476, 482
raw materials, 313, 315, 339, 355, 434,
439, 442, 468
reduction concepts, 19, 43, 471, 475,
waste, 2, 3, 11, 13, 258, 339, 422
- coupling reactions, 170, 192, 235–8,
244–5, 411, 449, 453, 486–7,
497–9, 512–14, 520
- Crambe abyssinica*, 195
- cross-linker, 156
- crude oil, 17, 52, 57, 202, 340, 353, 477
- cumene
hydroperoxide, 13
process, 13, 86, 94, 115–16
- Cunninghamella elegans*, 200–201
- current, 221, 387–8, 436, 441–2, 444–6,
448–9, 455–7, 460–62, 466, 468–9,
471, 474
distribution, 435, 441
efficiency, 218, 387–8, 448–9, 456, 458,
461
potential curves, 437
- cyanide, 22, 35, 44–5, 180, 199, 207–8,
217, 230, 296–7, 370, 384–5, 412,
448, 454, 456
oxidation with hydrogen peroxide,
296
- cyclisation, 132, 168, 174, 317, 451, 492,
499
- cyclododecatriene, monoepoxide, 279
- cyclohexane, 23–4, 42, 45, 138–9, 141,
209, 293, 318, 326, 348, 385–6,
423, 483, 488, 498–9, 504, 511
- cyclohexanol, 23–4, 342, 348, 386, 488
- cyclopropanation, 216, 218
- D- and L-lactic acids, 19
- dakin reaction, 288
- DCCI, 165
- decontamination, 43, 388–9, 391, 524–6
- dehalogenation, 176, 179–80, 199, 200,
209, 234–6, 239, 412, 485, 512
- dehydration, 21, 86, 90, 95, 100–101,
103–6, 161, 172–3, 180, 316–17,
330–31, 355, 400, 408, 470,
492
- deposition of metals, 322, 453, 455–6,
458–9
- desalination, 459–61
- Deutsche-Enviro cell, 457
- devising a chemical synthesis, 13
- dextrose, 19
- diazonon, 200
- dibenzothiophene, 202, 240
- Diels-Alder reaction, 13, 17, 263, 379–81,
402, 520
- diffusion, 88, 90, 93, 95–6, 124, 138, 151,
153, 155, 222, 234, 245–6, 384,
387, 438, 440, 445, 468, 470–71,
473, 475, 482
in mass transport, 438
layer, 388, 438, 445–6
- Difoltan, 13
- dimethyl
acetophenone, 16
disulfide, 292
- dinitrogen pentoxide, 449
- dioxins, 33, 47, 52, 295
- dioxiranes, 263–5
- dioxygenase, 190, 199, 201
- dispersion, 3, 32, 52, 113, 139, 373, 389,
445, 454, 485–6
- distannane, 174
- dithiodipropionic acid, 292
- dithionite, 166, 448
- divinylbenzene, 105, 153
- DMSO, 140, 165, 206, 355
- double layer, 435–6
- DVB, 153, 155, 158, 164, 171
- dye effluent, destruction, 296
- EDC, 168
- E-factor, 12–13, 309, 314, 316, 319
- Efavirenza, 15
- EGDMA, 153, 164
- electrocatalysis, 436, 438
heterogeneous, 436
homogeneous, 436
- electrochemical, 22, 206, 218, 340, 387–8,
412, 433–9, 442–54, 456, 458–9,
464, 466–8, 473, 480
- cell, 387, 439, 442, 450, 462
ion exchange, 434, 455, 459–60

- kinetics, 372
 synthesis, 439, 447–50, 452
- electrochemistry, 22, 339, 372, 387–8,
 393, 412, 416, 433–5, 439, 442–3,
 447–8, 450, 452–5, 464, 466
- electrode kinetics and potential, 434–8,
 455, 458, 470, 473
- electrodeposition, 387, 433, 453–5, 457–9
- electrodialysis, 359, 452, 455, 459–61
- electrohydrolysis, 455, 461–3
- electrolysis, 263, 294–5, 433, 435, 442,
 447–8, 458, 461, 464, 466, 504
- electrolyte, 387–8, 412, 436, 438–45,
 447–8, 452, 456–7, 459, 466,
 468–76, 480
- electron transfer, 235, 242, 377–80, 384,
 430, 433, 436, 452, 504
- electro-osmosis, 455
- electrophilic additions, 14
- electroplating, 22, 388, 457, 461
- electrosorption, 455
- electrosynthesis, 388, 433, 447, 449,
 451–2, 464
 organics, 450
- elimination, 34, 79, 176, 183, 209–10,
 232, 281, 290, 338–9, 341, 369,
 400, 404–8, 499, 508
 reactions, 15, 208, 220, 222
- emulsification, 52, 372
- end-of-pipe, 11, 22, 24, 28–30, 32, 34, 36,
 38, 56, 59–61, 74, 258, 294
 expenditure, 11
- endocrine system, 46
- energy, 20–22, 427–8, 476
 cavitation, 381, 388–9, 412
 climate change, 37–8
 cohesive density, 503
 consumption in the production of
 chemicals, 353
 efficiency, in biodesulfurisation, 202
 efficient production of hydrogen
 peroxide, 259
 electrochemical, 435, 437, 439, 447
 life cycle assessment, 73–4, 77
 light, 427–8
 microwave, 397
 overall process efficiency, 3, 5, 25, 353
 photochemistry, 416–19, 422
 process intensification, 19–20, 366–7,
 370
 production via renewable resources,
 18–19
 savings, 17, 21–2, 38, 59–60, 70–71, 79,
 188, 366–7, 372, 378, 521, 528
 sonochemistry, 375–8
 sources of, 7, 22, 29, 30, 354
 sustainability, 56–7, 59, 63, 354, 442
 use, minimisation, 11–12, 20–22
- Envirocats, 322–66
- environmental, impacts on, 62–3, 68–9,
 73, 77, 78, 81, 310, 314, 321, 323,
 328, 339, 341, 352
- environmentally benign processing, 240
- enzymatic, 142, 189, 193, 196, 198, 314,
 319, 356, 360, 361, 398, 407,
 411–12
- enzymes, 77, 79, 150–51, 188, 190, 192–3,
 195–202, 204, 272, 276, 357, 365,
 411–12
 lipase/esterase, 197, 264, 276
 peroxidase, 196, 266, 276
- epichlorohydrin, 35, 174, 260, 263, 277–8
- epi-goitrin*, 195
- epi-progoitrin*, 195–6
- epoxidation, 128–37, 139, 145–6, 172,
 174, 488–9, 220, 224–5, 239–40,
 244, 259–60, 263–4, 266–7, 269–75,
 277–82, 285–6, 289, 335, 370
 by Michael addition of perhydroxyl
 anion, 261
 catalysed, 143
 halcon routes, 277
 nucleophilic, 280
 olefin reactivity, 489, 520
 with peracids, 263
- epoxysuccinic acid, 278
- erwinia herbicola*, 193
- ESBO, 264, 278
- Escherichia coli*, 193, 195, 200
- essential oils, 525–9
- esterification, *see also* transesterification,
 86–7, 90, 98, 100–101, 103, 105–9,
 112, 127–30, 142, 173, 211, 213,
 229, 246, 276, 323, 325, 328–31,
 361, 370, 411–12
- esters, *see also* polyester
 cyclisation of, 174
 extraction of, 527
 formation of, 143, 173, 192, 197, 216,
 225, 315, 323, 328, 350, 360
 from ketones (baeyer-villiger reaction),
 174
 hydrolysis of, 104
 LCA for, 82
- estuaries, viii, 50–51, 53
- ether
 alkylation of, 327
 cyclisation of, 114, 174
 fluorous, 506
 formation of, 128, 282, 343, 356, 404,
 492
 LCA classification of, 82
 polymeric, 485
- etherification, 86, 90, 100, 103–4, 108–9,
 209, 211, 213, 215, 220–21, 222,
 230, 330, 404, 500
- ethyleneglycol, 153, 156, 158
- ethylidene norbornene (ENB), 17
- etoposide, 191
- eutrophication, 42, 44, 46, 68, 78–9, 81
- exchange current density, 437
- excimer lamp, 425–7
- excited state, 427–31
- exothermic reactions, 33, 263, 289, 366,
 369, 406, 409, 487
- expenditure on environmental protection,
 11
- exposure, 23, 30, 33, 42–3, 47, 52, 55,
 325, 391
- extraction, 392, 508
 acidification, 45
 analytical chemistry, 230
 crude oil over next 100 years, 57
 differential, in product isolation, 409
 electrochemistry, 433
 fluorous, 508–9, 515–16, 518
 microreactors in, 369
 processes, in phase transfer catalysis,
 209–11, 217–19, 232–4
 remediation, 43
 renewable raw materials, 19, 62–5, 70,
 77, 195, 392, 399
 solvent, in 'dry media' reactions, 401
 supercritical, 482, 485–6, 499
 template, in materials synthesis, 123
- FAR, 175
- Faraday, 443
- fenopropfen synthesis, 452
- Fenton's reagent, 262, 283, 292, 295–6
- ferulic acid, 192
- Fick's law of diffusion, 438
- fine chemical production, 312, 321, 343,
 433, 521
- fine chemicals, 13, 269, 285, 312, 321–2,
 334, 336, 339, 343, 347, 350,
 356–5, 410, 427, 482, 491
- flavobacterium*, 199
- flavours, 191–2, 195, 203, 280, 325, 328,
 370, 392, 408, 452, 526–31
- Flixborough, 23–4
- flow electrolyzers, 439–40, 458
- fluidised bed, 21, 457–8
 electrode, 458
- fluorous biphasic, 25, 502, 504, 509–10,
 520
 catalysis, 508, 520
- fluorous extraction, 508
- fluorous label, 504, 509, 515–19
- fluorous reagent, 502, 504, 509–10, 512,
 514, 518, 520–21

- fluorous reverse phase chromatography, 515
- fluorous scavenger, 519
- fluorous switch, 515, 518–19
- fluorous synthesis, 508–11, 515, 518, 521
- fluorous tag, 509, 515, 519
- flux in mass transport, 435, 438
- Folpet, 13
- fossil fuels, 7, 18–21, 32, 37, 41, 46, 59–60, 65, 81, 202
- fragrances, 191, 206, 280, 325, 328, 408, 452, 524, 526–30
- free energy (Gibbs), 443, 467
- freshwaters, 43–4, 46, 50–51
- Friedel-Crafts, 16, 100, 126, 128, 158, 244, 288, 321–3, 329, 331, 333, 336, 353, 420, 495, 520
- reactions, 16, 126, 321–3, 385
- fructose, 188, 202, 353
- fuel cells, 18, 443, 466–80
- alkaline, 469
- molten carbonate, 472
- phosphoric acid, 471
- solid oxide, 473
- solid polymer, 470
- fungicides, 13, 331
- galactose, 188–9, 226, 516
- gas liquid mixing, 20
- gemini space programme, 471
- germanium*, 176, 178, 180
- global warming, 31–2, 36–7, 59, 68–9, 70, 78–9, 81, 504
- gluconobacter oxydans*, 193
- glucose, 24, 137, 188–9, 193–4, 203, 226, 353–5, 359–60, 364, 400, 405, 449
- isomerase, 188–9
- glutaraldehyde, from cyclopentene, 283
- glycerol, 18, 107, 127, 167, 360, 409
- graphite, 447–8, 457–8, 471–2
- green and sustainable chemistry, 25, 392
- green chemistry
- as a reduction process, 11
- definition, 6, 10
- journal, 9
- principles, 6, 10, 21, 23
- greenhouse effect, 24, 28, 36
- greenhouse gas, 18, 23, 36–7, 81, 476, 485
- Haber process, 21
- halides, x, 34, 104, 127, 162, 167, 169–70, 172–4, 176, 178, 180–81, 183, 200, 206–8, 214, 219–20, 222, 232, 234, 239, 240, 287, 290, 293, 322, 352, 378–9, 382, 384, 404, 406, 411, 449, 504, 508, 512–13
- halogen addition, 14, 176
- halogen substitution, 267, 293, 407
- halogens, xi, 39, 44, 50, 52, 158, 164–5, 170–73, 176, 178–9, 199, 208, 221, 234–5, 239, 267–8, 272, 286, 293, 381, 411, 416, 426, 508, 513
- halohydrin, x, 178
- halo-organics, destruction, 295
- hazard, vii, 3, 6, 10, 13, 15–16, 18, 22–6, 28, 34–5, 39, 41–2, 86, 93, 109, 114, 117, 261, 264, 266, 304, 312–14, 321, 366, 378, 397, 401, 407, 416, 433–4, 448, 451, 453, 482, 487, 490, 499
- H-beta-zeolite, 16, 93
- heavy metals, xiii, 22–3, 33, 41, 44, 47, 53, 314, 339, 461
- heterocyclic synthesis, xi, 215
- heterogeneous catalysis and catalysts, xiv, 98, 107, 109, 115, 151, 206, 230, 233–4, 246, 259–60, 262, 266, 273, 278, 280–81, 283, 322, 331, 336, 341, 343–6, 348, 350, 352, 366, 411, 416, 424–5, 431, 436, 483, 490–92, 495–6, 498–9, 516
- high-fructose syrup, 188
- high temperature water, xv, 408
- Hildebrand solubility parameter, 502–4
- HOBT, 168
- homogeneous catalysis, xiv, 274, 280, 284, 436, 483, 497, 508, 520
- hormone disruptors, 42
- horseradish peroxidase, 196
- HWE, 183
- hydrazine, 35, 169, 240, 288, 386–7, 408, 434
- manufacture, 259, 289
- hydrazones, 169, 409
- oxidative cleavage, 290
- hydride, *see also* borohydride *and* anhydride, 163, 176, 178–80, 190, 236–7, 267, 270, 272, 384, 443, 485, 510, 512
- hydrocarbons, 24, 31–2, 34, 36, 39, 41–4, 52, 94, 101, 109, 115, 117, 119, 120, 125, 139, 199, 201, 208–9, 241–2, 269, 278, 283, 297, 313, 323–4, 341, 354, 383, 386–7, 390, 398, 407–8, 442, 447, 466, 469–70, 485, 503–4, 508, 525–7
- hydrogen, 29–31, 34–5, 40, 43–4, 88–9, 90, 96, 98, 103, 115, 144, 164, 175–6, 178, 202, 230, 232–7, 240, 277, 285, 290, 297, 344, 376, 382, 385, 398, 404, 412, 433–5, 442–9, 456, 461–3, 466–70, 476–8, 483, 487, 512, 525
- hydrogen cyanide, 22
- hydrogen economy, 442
- hydrogen peroxide, 120, 128–34, 136–8, 166, 172, 192, 196, 206, 220, 225, 239–40, 244, 258, 260–66, 270, 275–6, 282, 284–5, 287–8, 290, 292–3, 297, 299, 376–7, 434, 442, 448, 485, 492
- applications, 258
- economic factors, 260
- history, 259
- in effluent treatment, 258, 294
- in laundry bleaching, 269
- manufacture, xii, 259, 448
- ozone, with, 295
- phase transfer catalysts with, 279
- pKa value, 280
- safety considerations, 260
- stabilisation, 259, 279
- textile bleaching, 259
- with ultrasound, 296
- with uv radiation, 294
- hydrogen production, 466
- hydrogenation, 97, 108–9, 144, 190, 231–4, 244, 259, 315, 318, 322, 336, 341–2, 344, 346, 350, 352, 355, 357, 399, 411–12, 452, 483, 489–93, 495–8, 500, 516, 520
- of phenol, 24, 137
- hydrolysis, 15, 22, 93, 100, 104–5, 120–21, 123, 143, 161–2, 166, 195, 212–14, 216–17, 220, 222, 240, 243, 246, 275, 282, 314, 330, 356, 358, 360–61, 378, 405, 408, 453, 461–2, 488, 524, 529–30
- hydroxamic acids, 212
- hydroxyl cation, 261
- hydroxyl radical, 31, 262, 266, 268, 295–6, 377–8, 385
- hydroxylamine, 178, 212, 260, 266, 273, 289, 290
- intermediate in caprolactam manufacture, 260, 273
- hydroxylation, 137, 190, 192, 259–62, 266, 269, 273, 275, 282, 284, 342
- of aliphatic hydrocarbons, 283
- of alkanes, 266, 273
- of aromatics, 137
- of olefins, 265
- hypobromite, 165, 171
- H-ZMS-5, 24
- ibuprofen, 16, 86, 90, 350, 360–61
- imine, 35, 140–41, 168–9, 218, 225, 352, 497
- indirect electrosynthesis, 451–2
- indirect oxidation and reduction, 452
- indoles, 408–9, 410

- industrial ecology, goals for, 8
 industrial processes, 5, 13, 17, 60, 86, 188, 214, 267, 288, 407, 497, 520
 inherently atom economic reactions, 13
 inherently safe design, 22
 inorganics, 39, 106, 108, 120–21, 123, 133, 139, 150, 183, 198–9, 202, 265–7, 272, 276–7, 288, 297, 315, 322, 331, 334, 384, 400–401, 410, 428, 433, 448, 452–3, 456, 462, 484, 487, 511, 515
 intensified process plant, 366–8
 intramolecular alkylation, 215–18
 inverse PTC, 208, 218–20, 231
 ion exchange, 23, 39, 95, 98, 103–7, 109–10, 112, 118, 213, 218, 246, 275, 322, 341, 434, 459–60
 membranes, 461
 ionic liquids, 25, 86, 207, 231, 243–4, 350, 366, 413, 434, 502
 ionic product, 407, 461
 isobutylbenzene, 16, 350
 isomerisation, 86, 89, 90, 92–6, 98, 100–104, 108–9, 111–13, 116–17, 203, 208, 210, 231, 341, 343, 383

 Keggin structure, 98, 272–3
 ketones, 16, 23, 35, 82, 117, 138–40, 161, 163–8, 172–4, 176, 179, 183, 188, 207–9, 211, 213–14, 220, 224–5, 229, 234, 240, 261, 264–5, 278, 280, 283, 285–8, 323, 326, 332, 350, 381, 383, 390, 405–6, 409, 430, 527
 kinetic resolution, 198, 225, 360

 lactams, 35, 93, 167–8, 190, 399
 lactidess, 19, 357
 lactones, 35, 142, 173–5, 195–6, 287–8, 381
 lamp, 295, 421–6
 landfill leachate, treatment with hydrogen peroxide, 296
 lanthanide (III) triflates, 17
 lanthanum chromite, 473
 lead, 31, 33–4, 36, 39, 44, 48, 53, 265, 374, 379–80, 443, 448, 453, 458–9
 lewis acids, 13, 16–17, 102–4, 156, 246, 261, 271, 288, 315, 322–3, 329, 332, 381
 life cycle assessment, 7–8, 25, 62–81, 306
 application, 69–70, 73, 76, 78–80, 83–5, 340
 case studies, 69, 357
 methodology, 62–9, 79–80, 84
 light, 19, 38, 46, 230, 258, 285–6, 293–4, 372, 376, 416–17, 421–31

 lignin, 44, 196, 276, 354–6
 limiting current, 387–8, 437, 440, 442, 455, 457
 lipases, 18, 196–8, 264, 276, 357–8, 361
 lipoygenase, 195–6
 lost work, 5
 Ludwig Mond, 466

 macroporous, 104–7, 153–5, 284
 magnesium monopero-phthalate, 264
 magnetite, 21
 maleic anhydride, 13, 35, 108, 278
 manganese porphyrins, 268
 manganese TMTACN complex, 279, 286
 mass transfer, 20, 235, 243, 245–6, 313, 366–9, 387, 424, 438, 440, 442, 457, 490–92, 495
 m-chloroperbenzoic acid, 264, 335
 membrane separations, 232, 455, 459, 463, 470
 membranes, 30, 53, 198, 229, 232, 237–8, 270, 280, 283, 366, 370–71, 407, 439, 443, 445–7, 450, 452, 454–5, 459–63, 465–6, 470–71
 menadione, 284
 menthol, 193, 346
 Mercedes Benz, 478
 mercury, 13, 34, 36, 44–5, 48, 53, 314, 383–4, 422
 metal deposition, 453, 455–6, 458
 metal recovery, 456–8
 metalloporphyrins, 266, 280, 299
 metaperiodate, 165
 methacrylate, 35, 48, 130, 153, 156–7, 159–60, 164, 214, 228, 281, 400, 485–6
 methanol, 18, 35, 94–5, 101, 103, 106–9, 123, 132, 137, 143, 209, 230, 274, 281, 378, 442, 466, 470–71, 476, 478, 486, 498, 520
 methylisocyanate, 22
 methylparathion, 201
 metolachlor, 199, 201
 Meyer-Schuster rearrangement, 409
 Michael additions, 14, 126, 140, 143–4, 218, 223, 225–6, 379
 micro reactors, 366, 369
 microwave reactors, 22, 366, 402–4
 microwaves, 22, 206, 208, 214, 240, 286, 397–408, 410–14, 416, 427, 513
 middle distillate, 202
 milk, 83–4, 188, 357
 mono-perphthalic acid, 264
 moving bed electrodes, 441
 MTBE, 296
 MTO (methyreneum trioxide), 244, 271–2, 279, 293

 as oxidation catalyst, 286
 peroxo complexes from, 271
 muconic acid, 194, 360
mycobacterium, 199
 myrosinase, 195–6

 N₂O abatement, 24
 Na/NaOH on gamma alumina, 17
 nafion membranes, 442, 452
 nanoclusters, 233, 238, 286
 NCS, 171
 nernst equation, 437, 468
 networks for promoting green chemistry, 8
 nickel, 34, 36, 39, 44, 163, 169, 259, 373–4, 385–6, 388, 443, 448, 459, 469, 472–3, 486, 490–91, 498
 nicotinamide, 188–9, 357
 nicotinic acid, 188–9, 241, 314
 nitration, 17, 93, 97, 103–4, 208, 210, 367, 369
 nitric acid, 17, 23–4, 29, 31, 93, 297, 348, 379, 400, 448–50
 nitrile hydratase, 188–9, 357
 nitriles, 35, 132–3, 143, 153, 180–81, 183, 188–9, 207–8, 211–17, 261, 264, 274, 276, 279, 281, 290, 293, 357, 398, 439, 485, 514–16
 with hydrogen peroxide, 132, 264
 nitro compounds, 264
 nitrogen oxides (NO_x), 28, 31, 476
 nitrones, 178, 240, 290, 400
 nitrotoleues, 21
 nitrous oxide, 23, 29
 nitroxides, 290, 382
 n-methylmorpholine-n-oxide, 289
 n,n-diethylhydroxylamine (DEHA), 290
 non-metallic reagents, 239
 n-phosphonomethylglycine (glyphosate), 291
 production using hydrogen peroxide, 291
 nucleophilic additions, 14
 nucleophilic aliphatic substitution, 206–7
 nucleophilic aromatic substitution, 207, 221
 nylon, 93, 138, 164–5, 342, 416
 nylon 6:6, 23

 oceans, 29, 50, 52–3, 59
 ohmic polarisation, 468, 472, 474
 olefin cleavage, 265, 283
 olefin oligomerisation, 93, 97
 oleic acid, cleavage, 194, 196
 organophosphate, 41–2, 44, 50, 52, 200
 oxadiazole, 290
 oxaziridines, 504
 oxenes, 265–6, 268–9

- oxidants, 36, 68, 78, 81, 83, 135–9, 314, 324, 328–9, 339–40, 342, 344, 348–9, 434–5, 444, 446, 451–2, 487–8
- oxidation, 4–5, 21, 23–4, 30–31, 33, 36, 40, 43, 45, 51–2, 74–5, 117, 120, 128, 130–34, 136–9, 146, 164–7, 181, 193, 198–9, 201, 206, 213, 221, 231–2, 234, 239–43, 258–79, 282–96, 314–16, 318, 321–5, 324, 328–9, 333, 335, 339, 341–3, 348, 355, 370–71, 376–9, 382, 386, 388–90, 400, 411–12, 425, 434–5, 442, 447–9, 451–2, 454, 466, 470–71, 487–90, 492–4, 504, 520, 524, 529
- alcohols, 163, 165, 220, 240–41, 243, 265, 267, 270, 272–5, 285–7, 318, 323, 329, 370, 520
- aldehydes, 164, 520
- alkenes, 241, 277, 282, 488
- amines, 266–7, 289–90, 292
- arenes, 201, 221, 243, 329, 335
- atmosphere, in the, 36, 51
- atom accounts for, 4–5
- biocatalysis for, 198–9
- catalysis for, 128, 130–34, 136–9, 193, 198–9, 323–4, 328, 335
- cleaning, 389
- cyclohexane, 138–9, 241, 342, 348, 488
- electrosynthesis, 447–9, 451–2
- greener methods, 23–4, 348
- hydrogen peroxide in, 239–43, 258–79, 348
- ketones, 174, 240
- membrane reaction for, 370
- phase transfer catalysis for, 221, 234, 239–43
- phenols, 130, 137–8, 273
- polymer supported reagents for, 164–7, 181
- sulphides, 451, 455, 520
- supercritical CO₂, 487–90, 492–4
- superheated water, 529
- thiols, 183
- oximes, 93, 166, 169, 180, 213, 274, 289, 342
- ozone, 28–9, 31–2, 34, 36, 38–9, 81, 166, 295–7, 305, 391, 433, 448, 485, 503
- depletion, 38–9, 68, 78, 81
- packaging, 7, 19, 25, 47, 64, 69, 70, 116, 389
- packed bed electrodes, 441
- packed beds, 368, 442, 457–8
- PAHs, 32, 39, 41–2, 52
- paired synthesis, 449
- palladium, 145, 170, 229, 232–8, 259, 314, 386, 411, 452, 486, 492, 497
- PAN, 36, 216
- paraoxon, 200
- partition coefficients, 502, 504, 512
- Payne's reagent, 264
- PCDDs, 33, 41
- PCDFs, 33, 41
- pen-G, 188, 190
- penicillin, 188, 190, 203, 292, 361
- acylase, 190
- amidase, 17
- G, 17, 188, 361
- peracetic acid, 259, 263–5, 275–6, 284, 287, 292, 297
- from hydrogen peroxide, 259
- peracids (*see also individual compounds*), 172, 261, 263–7, 270, 276–8, 280, 282, 288, 290
- percarbonic acids, 276
- percarboximidic acid, 264
- perfluorinated sulphonic acid polymer, 470
- performic acid, 263
- from hydrogen peroxide, 259
- perhydroxyl anion, 261
- pericyclic reactions, 13–14, 27
- periodate, 181, 401
- permanganate, 163–5, 265, 324, 328, 386, 434
- peroxide, *see also* hydrogen peroxide, 13, 36, 104, 113, 130–32, 137, 192, 196, 214, 239–41, 259, 261, 263–5, 272, 276, 278, 279–80, 283, 288, 293, 296–7, 323–4, 328, 360, 382, 390, 416, 419–20, 434, 442, 448, 485, 488, 492
- peroxodisulfate, 166
- perseleninic acids, in oxidation, 288
- pesticides, 15, 41–2, 47, 49–50, 52, 79, 200, 291, 294–6, 450, 525
- petrochemical feedstocks, 57
- petroleum, 2, 18–19, 41, 49, 57, 59–60, 110, 114, 198, 202, 466, 476–7, 526
- pharmaceuticals sector, 1, 5, 8–9, 13, 26, 86, 112, 188, 190–91, 207, 306, 321–2, 333, 336, 339, 392, 511, 515, 521
- phenol, 35, 42, 45, 47–9, 94–5, 103–6, 111–12, 121, 130, 137–8, 156–7, 170–72, 175, 190, 196–200, 207, 208, 210, 213–14, 221, 227, 228–9, 241, 245, 273, 284, 288, 292–7, 342, 355, 390, 454, 455
- halogenation, 24
- hydroxylation, 137, 259–62, 266, 273–5, 284
- phenylalanine, 107, 192, 194
- phenyllactic acid, 194
- phosgene, 15, 22–3, 35, 176, 181, 229, 349, 498
- phosphine, 15, 35, 145, 161, 173, 231–2, 484, 487, 489, 493, 498, 508
- phosphine oxide, 15, 161, 183
- phosphonate, 183, 216, 276, 280, 289, 385
- phosphonium, 183, 207, 215, 221, 227, 230, 233, 244
- photocatalysis, 22, 416, 424, 431–2
- photochemical, 22, 30, 32, 36, 52, 416–27, 430–32
- reactors, 421, 423, 425
- smog, 28, 31–2, 68, 78, 81, 83
- photochemistry, 22, 36, 372, 393, 416, 418–24, 426–7, 431–2
- Photo-Fenton's system, 294, 296
- photolysis, 39, 43, 295, 421, 425, 504
- photophysics, 432
- picolinic acid, 190, 272
- planar design, 473–4
- plant cell cultures, 191
- plants, 41, 46–7, 56, 65, 79, 191, 194–5, 392, 398, 524–5, 527–30
- plate reactor, 366–9, 370–71, 439
- platinum, 102, 233, 336, 385–6, 445, 451–2, 466, 470–72
- PM₁₀, 33
- podophyllotoxin, 191–2
- podophyllum peltatum*, 192
- pollution, 18, 25–6, 28–30, 32–3, 35, 38–41, 43–5, 47, 50, 52–5, 86, 306, 311, 313–14, 338, 388, 416, 524
- prevention, 7, 8, 10, 311
- polyacrylate, 156–7, 229
- polybenzimidazole, 158, 160, 183, 280
- polychlorinated biphenyls (PCBs), 32, 35, 295, 526
- polyclar, 199
- polyester, 157, 159, 173, 183, 196–7, 227, 229, 357, 360
- polyethyleneimine, 164, 231
- polylactic acid, 19, 357
- polymer electrolyte, 443, 445, 448, 452, 466, 480
- polymerisation, 19, 111, 152–6, 158, 178, 196–7, 199, 206, 227–30, 244, 261, 290, 315, 368–70, 379, 388, 405, 485–6, 498–500, 520
- polyoxometallates, 266, 272–3, 276, 279–80, 283–4
- as oxidation catalysts, 265
- transition-metal substituted, 265
- polyphenol oxidase, 198
- polyphosphazene, 158, 161
- polystyrene, 19, 104, 106–7, 150, 153–7,

- 161, 165, 167–9, 172, 174–6, 178, 180, 183, 280, 529
- polyvinylpyridine, 158, 163, 172–3, 175–6, 183–4
- POPs, 33
- porous electrodes, 470, 472
- porous glass, 411
- potassium permonosulphate (triple salt), 263–4
- pourbaix diagram, 435
- power ultrasound, 296, 372–4, 391–3
- primary pollutants, 30
- process intensification, 15, 19, 366–8, 371, 425, 427, 490
- progesterone, 190
- propene, 16, 36, 45, 86, 94–5, 100, 104, 231, 347–8, 360, 493
- propylene oxide, 35, 360
- protecting groups, 15, 17, 153, 167, 260, 264, 277, 311–2, 315, 330, 499, 516, 518
- protective equipment, 23, 25
- protective group chemistry, 330
- Pseudomonas cepacia*, 196
- Pseudomonas putida*, 198–9
- Pseudomonas savastanoi*, 201
- public image of the chemical industry, 1, 9, 26
- pulp and paper, 70, 260, 265, 297, 353–5, 357, 363, 448–9, 462
- bleaching, 259
- PVP, 163
- Pycnoporus cinnabarinus*, 192
- pyrazinecarboxylic acid, 272, 283
- quantum yield, 422–3, 427, 431
- quinic acid, 194
- quinol, 259, 273, 284
- quinoline, 35, 89, 202, 380, 409
- quinones, from phenols, 130, 137–8
- radical flow converters, 21
- radicals, 31, 34, 36, 38, 227–8, 235, 237, 242, 244, 261–2, 266, 268–9, 272–3, 286, 290, 293, 295–6, 376–85, 389–91, 416, 428, 431, 504
- radon, 36, 39
- Ralstonia eutropha*, 195
- reactors, 15, 41, 87, 102, 109, 114–16, 147, 198, 221, 246, 295, 313, 319, 340, 347, 366–70, 388, 392–3, 398, 400, 402–4, 406–7, 412–13, 421–7, 431, 439, 442, 452, 457–8, 483, 487–8, 490–92, 495, 497
- red list, 45
- redox, 120, 196, 268, 341, 434–6, 443, 447, 450, 452, 456
- catalyst, 452, 492
- fuel cells, 447
- potentials, 435
- reduction
- azides, 170
- carbonyls, 163, 405, 454, 491
- heterogeneous catalysis for, 341
- imines, 169
- materials used, 15, 17–19, 21, 25, 79, 295, 323
- polymer supported reagents for, 163, 169, 170
- scale, 19–20
- supercritical CO₂, 491
- waste, 4, 11, 339
- remediation, 22, 41, 43, 199, 201, 296–7, 391, 393, 433, 439
- renewable feedstocks, 2, 10, 18, 28, 339–40, 352–5, 358, 362
- responsible care, 10–11
- Rhodococcus*, 188, 199, 202
- Rhodococcus* IGTS8, 202
- risk, 4, 11, 22–6, 30, 41–2, 52, 143, 258, 306, 312, 397, 401, 477, 479–80, 482, 485, 487
- rosemary, 526–7, 531
- rotary kilns, 21
- rotating electrodes, 457
- RU 27987, 190
- rubber accelerators, 259, 292
- Rupe rearrangement, 409
- ruthenium catalysts, 488, 498
- for alcohol oxidation, 286
- rutile, 22
- safflower seed oil, 195
- salts
- concentrations in the ocean, 50
- pollutants, 45
- preparation of, 448, 461
- separation of, 460, 462
- use in reactions, 206–11, 224, 232, 241–4, 383
- waste, 12, 322, 340, 410
- scale-up, 310, 312, 318, 372, 393, 401, 409, 413, 469, 529
- scandium triflate, 17
- Scotch whisky, 77, 79
- secondary pollutants, 33–4
- selectivity
- alkylation, 94, 109, 111, 215, 323, 326
- enantioselective, 144–6, 222–7, 493–4
- oxidation, 130, 132–9, 163–7, 241, 277, 280, 342, 344, 488
- photochemistry, 417
- reductions, 491, 498
- supercritical CO₂, 493–5
- zeolites for, 93–7
- sewage, 41–2, 45–7, 52
- deodorisation with hydrogen peroxide, 297
- shikimic acid, 194
- side-chain oxidation, 323
- with hydrogen peroxide, 265, 284–5
- sigmatropic rearrangements, 13
- silylation, 17, 131, 135–6, 140, 143, 282, 515, 520
- singlet oxygen, 31, 262–3, 271, 417, 424, 431
- sodium benzene sulfonate, 12
- sodium perborate, 259, 261
- in acetic acid, 240
- sodium percarbonate, 262
- sodium/potassium amalgam, 17
- soil, 31, 39–43, 45–6, 49, 52, 81, 83, 199, 201, 321, 399, 410, 524–6
- remediation, 296–7
- solar light, 422
- solid acid, 16, 86–93, 95, 97–101, 103–12, 114–15, 117, 492, 495
- sorbitol, 128, 193, 355, 449
- soya bean oil, 143, 264
- soybean peroxidase, 192
- space shuttle, 443, 477
- spinning disc reactor, 246, 366–9, 371
- static mixer, 20, 367, 369
- steam distribution networks, 21
- steroid, 166–7, 178, 190, 191, 203
- stratosphere, 38–9
- subcritical, 495, 524
- sulfate process, 21–2
- sulfenamides, 13, 293
- sulfones, 181, 229, 291, 327
- sulfonic acids, 127–9, 169, 172, 174, 323, 328, 399, 452, 455, 461, 470–71
- sulfonium, 172
- sulfonylation, 323, 325, 327
- sulfoxide, 165–6, 181, 291–2, 402
- sulfur dioxide, 21, 28, 65, 448
- sulfuric acid, 17, 21, 31, 45, 87, 93, 97, 99, 101–2, 107–9, 114–15, 126–7, 263, 284, 288, 297, 400, 405, 450, 458, 461
- supercritical carbon dioxide, i, xvii, xviii, 18, 25, 197–8, 244, 313, 322, 482–99, 502, 520, 527–9
- supercritical fluids, 123, 322, 336, 434, 482, 490–91, 500–501
- supercritical PTC, 243
- superheated, 381, 402, 524–31
- superoxide, 262, 382
- supported reagents, 150–51, 153, 155, 159, 161, 183–4, 322–3, 329, 332–4, 336

- sustainable development, 3, 10, 12, 26, 56, 62, 80
- sustainable processing, 202
- sustainable products, 62, 69, 70, 80
- synthesis
- atom efficiency in, 13
 - biomass, 6, 17, 352
 - catalysts, 120–24
 - electrochemistry, 450–53
 - fluorous compounds, 504–6
 - modern reactors, 19
 - pharmaceuticals, 190, 306
 - photochemistry, 416–20
 - polymer supported reagents, 150, 152–9
 - sonochemistry, 376–93
 - supercritical CO₂, 485–95, 498–9
- system optimisation, 69, 77, 80
- tandem, 207, 209, 217, 237, 239, 407, 412–13
- tartaric acid, 282
- technology assessment, 73–4
- TEMPO, 136–7
- thermolysin, 192
- thiazole, 166
- thiiranes, 181
- thiocyanate, 181, 207, 228, 230, 297
- thiol, 166, 181, 183, 241, 261, 292–3, 379
- thiosulfates, 293
- three dimensional electrodes, 439, 441, 457–8
- tin, 120, 174, 176, 179, 275, 382, 411, 448, 485, 510–15
- titanium dioxide, 21, 23, 120
- titanium silicalite catalyst, 266, 273, 281
- titanium zeolites, 281, 286
- large pore materials, 281
 - silicalite, 341
- TMTACN (N,N',N"-trimethyl-1,4,7-triazacyclononane), 279–80, 286
- TNT, 296
- toluene, 25, 32, 35–6, 45, 48, 88, 93, 103, 107–8, 111–12, 116, 123–4, 132, 141, 171, 190, 201–2, 220, 223–4, 226, 231–2, 234, 272, 278, 284–5, 323, 326, 329–30, 335, 384, 452, 486–7, 495, 502
- toxic metals, 33, 41–2, 45, 47, 52–3, 188, 314, 453
- toxicity, 4, 13, 32–3, 44, 48–50, 52–3, 56, 60, 68–9, 78–9, 83, 86, 198, 295–6, 313, 409, 482, 503, 510
- transducers, 373–6, 392–3, 402
- transesterification, 18, 107, 143, 198, 211, 214, 411, 509
- trifluoroacetic acid, 264
- triglycerides, 18, 452, 530
- trimegestrone, 190–91
- triphasic catalysis, 220, 222, 246
- triphenylphosphine, 161, 163, 166–7, 172–3, 175–6, 178, 180, 231, 347
- triple bottom line, 12, 306
- troposphere, 28–9, 30, 33, 39
- TS-1, titanium silicalite zeolite, 120, 128–30, 132, 137, 260, 266, 272–6, 281–4, 289–90, 292, 341–3
- two-dimensional electrodes, 457
- tyrosinase, 199
- ultrasonic, 22, 366, 372–80, 382–3, 385–93, 412, 434
- urea, 42, 161, 172–3, 181, 229, 264, 412
- urea-hydrogen peroxide adduct, 244
- uv light, 19, 38, 421
- vanillic acid 192
- vanillin, 192, 355, 360
- vegetable-based diesel oils, 18
- venturello system, 272, 278–9
- vinblastine, 191
- vincristine, 191
- vinylidene norbornene (VNB), 17
- VOC, 25, 32, 68, 74–6, 81–2, 485, 487
- abatement, 74
- vulcanisation of rubber, 22
- waste management, 4, 258
- waste minimisation, 1, 4, 9, 12, 25, 28, 85–7, 258, 265, 278, 287, 294, 306–19, 336, 372–3, 377, 434, 453–4
- water
- as an alternative solvent, 25, 313, 356, 407–10, 524–31
 - chemistry of the oceans, 50–54
 - high temperature, 407–10
 - oxidation of, 259
 - phase transfer catalysis, 218–20
 - pollution of, 44–50
 - quality, 44–7, 49–50, 95, 104, 321
 - quench using, 23
 - sonolytic reaction of, 376, 389
 - treatment, 27, 433, 453–4, 458
 - wet peroxide oxidation, 296
- Willgerodt reactions, 405
- William Grove, 443, 466
- window fouling, 421–6
- Wittig reaction, 15, 183, 214–15, 339
- xanthobacter*, 199
- xanthomonas campestris*, 193–4
- xylene, 32, 35–6, 74, 76, 93, 96, 100, 110, 112, 116, 202, 213, 238, 243, 284–5, 326
- ylide, 172–3, 183, 208, 210, 400, 493
- zeolites, 16–17, 89–90, 92–8, 107–8, 110, 112, 115–18, 120, 125, 128–30, 138, 144, 260, 266, 269–70, 273, 280–81, 284–6, 302–4, 321, 341–3, 386, 398, 400, 424
- zirconia, 86–7, 90, 99–104, 110, 120, 473, 475
- ZMS-5, 16

Handbook of Green Chemistry & Technology

Sustainable development is now accepted as a necessary goal for achieving societal, economic and environmental objectives. Chemistry has a vital role to play. The chemical industry is successful but traditionally success has come at a heavy cost to the environment. The challenge for chemists and others is to develop new products, processes and services that achieve societal, economic and environmental benefits. This requires an approach that reduces the materials and energy intensity of chemical processes and products; minimises the dispersion of harmful chemicals in the environment; maximises the use of renewable resources; and extends the durability and recyclability of products in a way that increases industrial competitiveness as well as improve its tarnished image.

This highly practical and rigorous book brings together reviews on the important aspects of green chemistry and technology, and is written by a team of world-renowned chemists spearheaded by leaders in the field.

THE EDITORS

James Clark is Professor of Chemistry and Director of the Green Chemistry Network and former industrialist.

Duncan Macquarrie is now a Royal Society University Research Fellow at the University of York.

ALSO AVAILABLE

Chemical Speciation in the Environment

Second Edition

A.M. Ure & C.M. Davidson
0 632 05848 X

Environmental Analytical Chemistry

Second Edition

F.W. Fifield & P.J. Haines
0 632 05383 6

Principles and Practice of Analytical Chemistry

Fifth Edition

F.W. Fifield & D. Kealey
0 632 05384 4

Integrated Solid Waste Management

Second Edition

F. R. McDougall, P.R. White,
M. Franke & P. Hindle
0 632 05889 7



**Blackwell
Publishing**

ISBN 0-632-05715-7



9 780632 057153