

The
WORST-CASE SCENARIO
Survival Handbook

By Joshua Piven and David Borgenicht



CHRONICLE BOOKS
SAN FRANCISCO

The authors wish to thank all the experts who contributed to the making of this book, as well as Jay Schaefer, Laura Lovett, Steve Mockus, and the entire team at Chronicle Books.

Copyright © 1999 by Quirk Productions.
All rights reserved. No part of this book may be reproduced in any form without written permission from the publisher.

Worst-Case Scenario and The Worst-Case Scenario Survival Handbook are trademarks of Quirk Productions.

Library of Congress Cataloging-in-Publication Data available.

ISBN 0-8118-2555-8

Manufactured in Singapore

Designed by Frances J. Soo Ping Chow

Typeset in Adobe Caslon, Bundesbahn Pi, and Zapf Dingbats

Illustrations by Brenda Brown

A Quirk Book

Distributed in Canada by Raincoast Books
9050 Shaughnessy Street
Vancouver, British Columbia V6P 6E5

40 39 38 37 36 35 34 33 32 31

Chronicle Books LLC
85 Second Street
San Francisco, California 94105

www.chroniclebooks.com

© 1999-2007 by Quirk Productions, Inc. All rights reserved.

WARNING

When a life is imperiled or a dire situation is at hand, safe alternatives may not exist. To deal with the worst-case scenarios presented in this book, we highly recommend—in~~st~~ist, actually—that the best course of action is to consult a professionally trained expert. **DO NOT ATTEMPT TO UNDERTAKE ANY OF THE ACTIVITIES DESCRIBED IN THIS BOOK YOURSELF.** But because highly trained professionals may not always be available when the safety of individuals is at risk, we have asked experts on various subjects to describe the techniques they might employ in those emergency situations. **THE PUBLISHER, AUTHORS, AND EXPERTS DISCLAIM ANY LIABILITY** from any injury that may result from the use, proper or improper, of the information contained in this book. All the information in this book comes directly from experts in the situation at hand, but we do not guarantee that the information contained herein is complete, safe, or accurate, nor should it be considered a substitute for your good judgment and common sense. And finally, nothing in this book should be construed or interpreted to infringe on the rights of other persons or to violate criminal statutes: we urge you to obey all laws and respect all rights, including property rights, of others.

—The Authors

ABOUT THE AUTHORS

JOSHUA PIVEN is a computer journalist and freelance writer, and is a former editor at Ziff-Davis Publishing. He has been chased by knife-wielding motorcycle bandits, stuck in subway tunnels, been robbed and mugged, has had to break down doors and pick locks, and his computer crashes regularly. This is his first book. He currently makes his home in Philadelphia.

DAVID BORGENICHT is a writer and editor who has written several nonfiction books, including *The Action Hero's Handbook* (Quirk Books). He has ridden in heavily-armored vehicles in Pakistan, stowed away on Amtrak, been conned by a grifter, broken into several houses (each for good reason), and has “borrowed” mini-bottles from the drink cart on Delta. He lives in Philadelphia with his wife—his best-case scenario.

Also available: **The Worst-Case Scenario Survival Handbook: Travel** by Joshua Piven and David Borgenicht, authors of the international best-seller *The Worst-Case Scenario Survival Handbook*.

And check out www.worstcasescenarios.com for updates, new scenarios, and more! Because you just never know . . .

How to Treat Frostbite...103
How to Treat a Leg Fracture...106
How to Treat a Bullet or Knife Wound...109

5 **Adventure Survival...113**

How to Land a Plane...114
How to Survive an Earthquake...120
How to Survive Adrift at Sea...125
How to Survive When Lost in the Desert...129
How to Survive If Your Parachute
Fails to Open...137
How to Survive an Avalanche...140
How to Survive If You Are in the Line
of Gunfire...143
How to Survive When Lost
in the Mountains...146
How to Make Fire Without Matches...150
How to Avoid Being Struck by Lightning...155
How to Get to the Surface
If Your Scuba Tank Runs Out of Air...160

The Experts...163

About the Authors...176

FOREWORD

THE RULES OF SURVIVAL

By “Mountain” Mel Deweese

I am a Survival Evasion Resistance Escape Instructor. I have developed, written, attended, and taught courses around the world to more than 100,000 students—civilians, naval aviators, and elite Navy SEAL teams. I have more than 30 years of survival training experience, from the Arctic Circle to the Canadian wilderness, from the jungles of the Philippines to the Australian desert.

Let’s just say that I’ve learned a few things about survival over the years.

Whatever the situation, whether you’re out in the mountains, on board a plane, or driving cross-country, to “survive” means “To outlive, to remain alive or in existence; live on. To continue to exist or live after.” After all, that’s what it’s really all about—about continuing to exist, no matter how dire the circumstances.

- You have to be prepared—mentally, physically, and equipment-wise.

I would have to call my training in the

Arctic Circle the ultimate survival adventure. The Arctic is an extremely harsh and unforgiving environment, and yet the Inuit people (Eskimos) not only survive, they live here at the top of the world. Most of the items you need for Arctic survival must come with you when you go—the Arctic offers little for improvisation.

One morning, as we huddled inside our igloo drinking tea to warm up, I noticed that our senior Inuit guide drank several more cups of tea than the rest of us. “He must be thirsty,” I thought. We then proceeded outside for our morning trek across the frozen landscape. After we reached our camp, the senior instructor walked over to a small knoll. Our young Inuit guide interpreted his words: “This is where the fox will come to seek a high lookout point. This is a good place to set a trap.” The older man then took out his steel trap, set it, laid out the chain, and to my surprise, urinated upon the end of the chain!

The younger instructor explained: “That’s why he drank all that tea this morning—to anchor it!” Indeed, the chain had frozen securely to the ground.

The lesson: Resources and improvisation equals survival.

- You must not ignore the importance of the mental aspects of survival; in particular, you must stay calm and you must not panic. And remember that willpower is the most crucial survival skill of all—don’t catch that terrible disease of “Give-up-itis.” All these mental strengths especially come into play when someone makes a mistake—which is inevitable.

One trip into the jungles of the Philippines, our old guide Gunny selected and gathered various plants while we were trekking. Upon arrival at the camp, Gunny skillfully prepared bamboo to use for cooking tubes. To these he added leaves, snails (he claimed only the old men catch snails because they are slow—young men catch fast shrimp), and a few slices of green mango. He also added a few things I could not discern. Topping this off with leaves from the taro plant, he added water and placed the bamboo cooking tube on the fire.

After the jungle feast, we settled into the darkness for sleep. During the night, I experienced pain, contraction, and itching in my throat. We were in pitch darkness, far from civilization, and my airways were progressively closing. The following morning, the condition worsened and my breathing was becoming restricted. I questioned the instructor, and he agreed he

had the same problem. That we shared our distress was reassuring and it led to our determining the source of the problem. It turned out we had not boiled the taro leaves long enough. Recovering hours later, I mentally logged this as a lesson learned the hard way: Even the old man of the jungle can make mistakes.

We all make mistakes. Overcoming them is survival as well.

- You must have a survival plan. And your plan should consider the following essential elements: food, fire, water, and shelter, as well as signals and first aid.

I remember a military survival training course I took in another jungle. A tropical environment is one of the easiest to survive, if you know where to look. It offers all of the needs for survival—food, fire, water, shelter. We needed water badly but could not head for the major streams, rivers, or bodies of water to quench our thirst, as the “enemy” was tracking us. The enemy knew our dire need for water, and he would be watching those areas. Looking into the jungle foliage, our guide Pepe pulled his jungle bolo (a large knife) from its wooden case and pointed to a thick, grapelike vine, 3-4 inches in diameter. He cut the

vine at the top, then sliced off a 2-3 foot section, motioned to me, and held it above my parched lips. Excellent! In total, it produced almost a large glass of water. Then he cut into a rattan vine that provided nearly the same amount.

That evening we tapped into the trunk of a *taboy* tree, placed bamboo tube reservoirs we had constructed beneath the tap, and left them overnight. Early the next morning, I was surprised to find 6-8 quarts of water in our reservoirs.

The next morning in the rain, Pepe stopped to cut a tall bundle of grass. He selected a smooth-barked tree and wrapped the grass around the tree to form a spigot. He then placed his bamboo drinking cup under the grass spigot. I was not convinced about the quality of his filter, but it was a good way for us to gather rainwater. That night, after we had reached the safe area, the jungle darkness fell upon us and we sat in the flicker of the bamboo fire. Pepe smiled at me and said, “Once again we’ve evaded the enemy and learned to return.”

That simple phrase became our motto—and in fact, is the motto of every survival trainer, whether or not they know it. “Learn to return.”

This guide might help you do just that.

PREFACE

Anything that can go wrong will.

—Murphy's Law

Be prepared.

—Boy Scout motto

The principle behind this book is a simple one:
You just never know.

You never really know what curves life will throw at you, what is lurking around the corner, what is hovering above, what is swimming beneath the surface. You never know when you might to be called upon to perform an act of extreme bravery and to choose life or death with your own actions.

But when you are called, we want to be sure that you know what to do. And that is why we wrote this book. We want you to know what to do when the pilots pass out and you have to land the plane. We want you to know what to do when you see that shark fin heading toward you. We want you to know how to make fire in the wilderness without any matches. We want you to know what to do in these and in dozens of other life-threatening situations, from being forced to

jump from a bridge to being forced to jump from a car, from taking a punch correctly to outsmarting a charging bull, and from escaping a sniper to treating a bullet wound.

We were not survival experts ourselves when we undertook this project—just regular, everyday folk like you. Joshua grew up in the East—a street-smart city boy. David grew up in the West and spent his youth hiking and camping and fishing (even though his family used a Volkswagen van most of the time). We were just a couple of inquisitive journalists from different backgrounds who worried a lot and were interested in knowing how to survive a variety of crisis situations, likely or unlikely (mostly the latter). Together, we consulted experts in a variety of fields to compile the handbook you have before you. The information in this book comes directly from dozens of expert sources—stuntmen, physicians, EMT instructors, bomb squad officers, bullfighters, survival experts, scuba instructors, demolition derby drivers, locksmiths, sky divers, alligator farmers, marine biologists, and avalanche rescue patrol members, to name a few.

Within this book, you will find simple, step-by-step instructions for dealing with 40 life- and limb-threatening situations, with instructive

illustrations throughout. We've also provided other essential tips and information—marked with red bullets—that you must know. Any and each of them could save your life. Ever wonder how you would deal with the kinds of situations that usually only come up when you are a movie action hero? Now you can find out. And then, like the Boy Scouts, you too will be prepared.

So keep this book on hand at all times. It is informative and entertaining, but useful, too. Get a copy and keep it in your glove compartment. Take it with you when you travel. Give a copy to your friends and loved ones. Because the Boy Scouts know what they're talking about.

And you just never know.

—Joshua Piven and David Borgenicht

CHAPTER I

GREAT ESCAPES AND ENTRANCES

**WORST-CASE
SCENARIO.**

HOW TO AVOID BEING STRUCK BY LIGHTNING

Lightning causes more casualties annually in the U.S. than any other storm-related phenomenon except floods. No place is completely safe from lightning. However, some places are more dangerous than others.

1 Loud or frequent thunder indicates that lightning activity is approaching.

If you can see lightning and/or hear thunder, you are at risk. High winds, rainfall, and cloud cover often act as precursors to actual cloud-to-ground strikes. Thunderstorms generally move west to east and occur late in the day or in early evening when humidity is highest.

2 When you see lightning, count the number of seconds until thunder is heard and then divide by five.

This will indicate how far the storm is from you in miles. (Sound travels at 1,100 feet per second.)

3 If the time delay between seeing the flash (lightning) and hearing the boom (thunder) is fewer than thirty seconds, seek a safer location immediately.

- Avoid high places, open fields, and ridges above the timberline. If in an open area, do not lie flat—kneel with your hands on the ground and your head low. If you are on a technical climb, sit on a rock

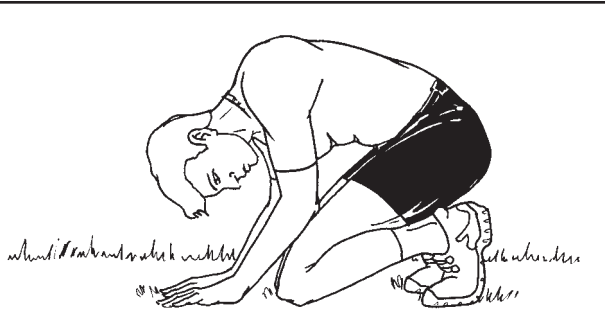

*In an open area, DO NOT lean on your knees and hands.
Squat to minimize contact with the ground.*

DO NOT stand under a tree.

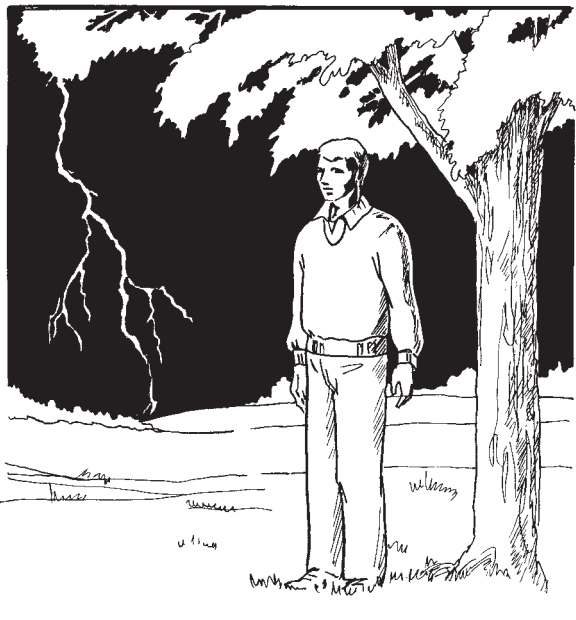

or on nonmetallic equipment. Tie a rope around your ankle; this will anchor you if a strike occurs and you are knocked off balance.

- Avoid isolated trees, unprotected gazebos, and rain or picnic shelters, as well as shallow depressions in the earth—current traveling through the ground may use you to bridge the depression.
- Avoid baseball dugouts, communications towers, flagpoles, light poles, metal and wood bleachers, and metal fences. If you are camping, avoid your tent if it is in an open area or under a large tree.
- Avoid golf carts and convertibles.
- Avoid bodies of water: oceans, lakes, swimming pools, and rivers.

4 Wait for the storm to pass.

The lightning threat generally diminishes with time after the last sound of thunder, but may persist for more than 30 minutes. When thunderstorms are in the area but not overhead, the lightning threat can exist even when it is sunny, not raining, or when clear sky is visible.

Be Aware

- Large enclosed buildings tend to be much safer than smaller or open structures. The risk for lightning injury depends on whether the structure incorporates lightning protection, the construction materials used, and the size of the structure.
- Fully enclosed metal vehicles such as cars, trucks, buses, vans, and fully enclosed farm vehicles with

the windows rolled up provide good shelter from lightning. Avoid contact with metal or conducting surfaces outside or inside the vehicle.

- When inside, avoid contact with conductive surfaces with exposure to the outside, including the shower, sink, plumbing fixtures, and metal door and window frames.
- Avoid outlets, electrical cords, and wired electrical devices, including telephones, computers, and televisions (particularly cable TVs).

HOW TO TREAT SOMEONE STRUCK BY LIGHTNING

1 Call 911 to report the strike and give directions to emergency personnel.

With immediate medical treatment, victims can survive an encounter with lightning. If multiple people have been struck, treat the apparently “dead” first. People who are unconscious but still breathing will probably recover on their own.

2 Move to a safer location to avoid getting struck yourself.

It is unusual for victims who survive a lightning strike to have major fractures that would cause paralysis or major bleeding complications unless they have suffered a fall or been thrown a distance. Do not be afraid to move the victim rapidly if necessary; individuals struck by lightning do not carry a charge and it is safe to touch them to give medical treatment.

3 In cold and wet environments, put a protective layer between the victim and the ground to decrease the chance of hypothermia, which can further complicate resuscitation.

Check for burns, especially around jewelry and watches.

4 If the victim is not breathing, start mouth-to-mouth resuscitation.

Give one breath every five seconds. If moving the victim, give a few quick breaths prior to moving.

5 Determine if the victim has a pulse.

Check the pulse at the carotid artery (side of the neck) or femoral artery (groin) for at least twenty to thirty seconds.

6 If no pulse is detected, start cardiac compressions.

7 If the pulse returns, continue ventilation with rescue breathing as needed for as long as practical in a wilderness situation.

8 If a pulse does not return after twenty to thirty minutes of good effort, stop resuscitation efforts.

In wilderness areas far from medical care, prolonged basic CPR is of little use—the victim is unlikely to recover if they do not respond within the first few minutes.

HOW TO BREAK DOWN A DOOR

INTERIOR DOORS

- 1 Give the door a well-placed kick or two to the lock area to break it down.**

Running at the door and slamming against it with your shoulder or body is not usually as effective as kicking with your foot. Your foot exerts more force than your shoulder, and you will be able to direct this force toward the area of the locking mechanism more succinctly with your foot.

Alternate Method (if you have a screwdriver)

- ★ Look on the front of the doorknob for a small hole or keyhole.**

Most interior doors have what are called privacy sets. These locks are usually installed on bedrooms and bathrooms and can be locked from the inside when the door is shut, but have an emergency access hole in the center of the door handle which allows entry to the locking mechanism inside. Insert the screwdriver or probe into the handle and push the locking mechanism, or turn the mechanism to open the lock.

EXTERIOR DOORS

If you are trying to break down an exterior door, you will need more force. Exterior doors are of sturdier construction and are designed with security in mind, for obvious reasons. In general, you can expect to see two kinds of latches on outside doors: a passage- or entry-lock set for latching and a dead-bolt lock for security. The passage set is used for keeping the door from swinging open and does not lock. The entry-lock set utilizes a dead latch and can be locked before closing the door.

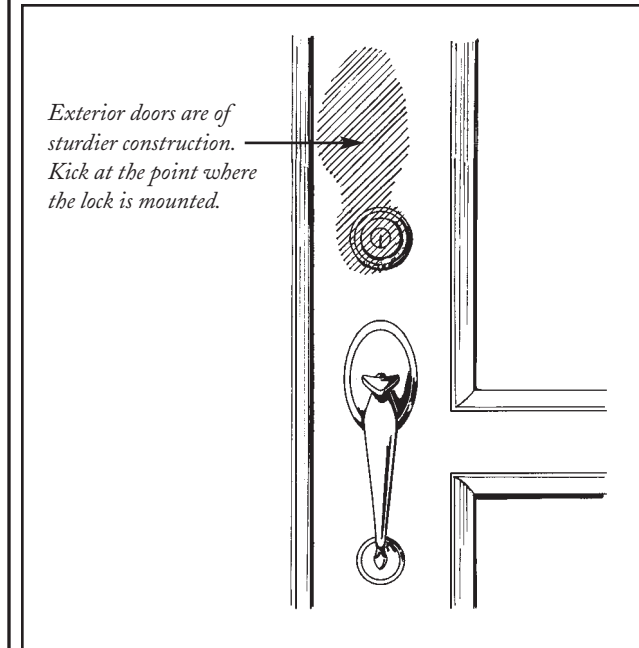

- 1 Give the door several well-placed kicks at the point where the lock is mounted.**

An exterior door usually takes several tries to break down this way, so keep at it.

Alternate Method (if you have a sturdy piece of steel)

- ★ **Wrench or pry the lock off the door by inserting the tool between the lock and the door and prying back and forth.**

Alternate Method (if you have a screwdriver, hammer, and awl)

- ★ **Remove the pins from the hinges (if the door opens toward you) and then force the door open from the hinge side.**

Get a screwdriver or an awl and a hammer. Place the awl or screwdriver underneath the hinge, with the pointy end touching the end of the bolt or screw. Using the hammer, strike the other end of the awl or screwdriver until the hinge comes out.

ASSESSING AMOUNT OF FORCE REQUIRED

Interior doors in general are of a lighter construction than exterior doors and usually are thinner— $1\frac{3}{8}$ " thick to $1\frac{5}{8}$ " thick—than exterior doors, which generally are $1\frac{3}{4}$ " thick. In general, older homes will be more likely to have solid wood doors, while newer ones will have the cheaper, hollow core models. Knowing what type of door you are dealing with will

help you determine how to break it down. You can usually determine the construction and solidity of a door by tapping on it.

HOLLOW CORE. This type is generally used for interior doors, since it provides no insulation or security, and requires minimal force. These doors can often be opened with a screwdriver.

SOLID WOOD. These are usually oak or some other hardwood, and require an average amount of force and a crowbar or other similar tool.

SOLID CORE. These have a softwood inner frame with a laminate on each side and a chipped or shaved wood core, and require an average amount of force and a screwdriver.

METAL CLAD. These are usually softwood with a thin metal covering, and require average or above average force and a crowbar.

HOLLOW METAL. These doors are of a heavier gauge metal that usually has a reinforcing channel around the edges and the lock mounting area, and are sometimes filled with some type of insulating material. These require maximum force and a crowbar.

HOW TO BREAK INTO A CAR

Most cars that are more than ten years old have vertical, push-button locks. These are locks that come straight out of the top of the car door and have rods that are set vertically inside the door. These locks can be easily opened with a wire hanger or a SlimJim, or picked, as described below. Newer cars have horizontal locks, which emerge from the side of the car door and are attached to horizontal lock rods. These are more difficult to manipulate without a special tool but can also be picked.

HOW TO BREAK INTO A CAR WITH A HANGER

- 1** Take a wire hanger and bend it into a long J.
- 2** Square off the bottom of the J so the square is 1½ to 2 inches wide (see illustration).
- 3** Slide the hanger into the door, between the window and the weather stripping. Open the door by feel and by trial and error. Feel for the end of the button rod and, when you have it, pull it up to open the lock.

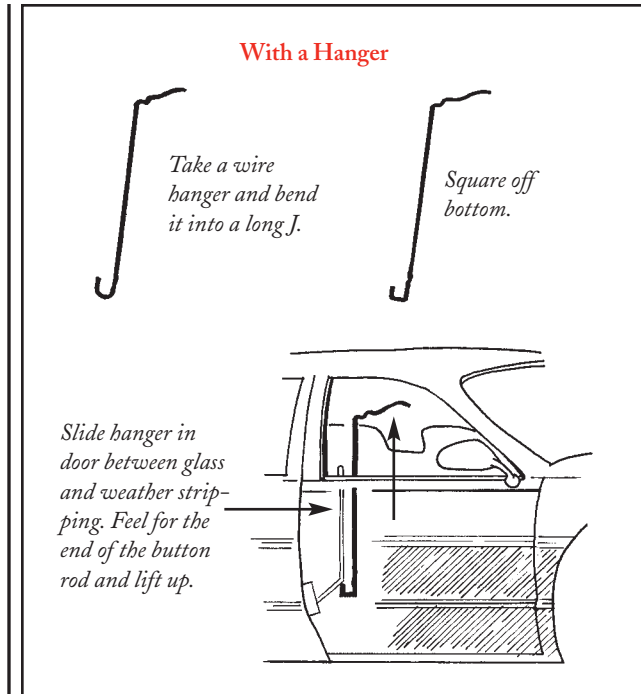

HOW TO BREAK INTO A CAR WITH A SLIMJIM

- 1** A SlimJim is a thin piece of spring steel with a notch in one side, which makes it easy to pull the lock rod up. They can be purchased at most automotive supply stores.

Slide the tool gently between the window and the weather stripping.

Some cars will give you only a quarter of an inch of access to the lock linkage, so go slowly and be patient.

- 2 Do not jerk the tool trying to find the lock rod.**
This can break the lock linkage, and on auto-locks it can easily rip the wires in the door.
- 3 Move the tool back and forth until it grabs the lock rod and then gently move it until the lock flips over.**

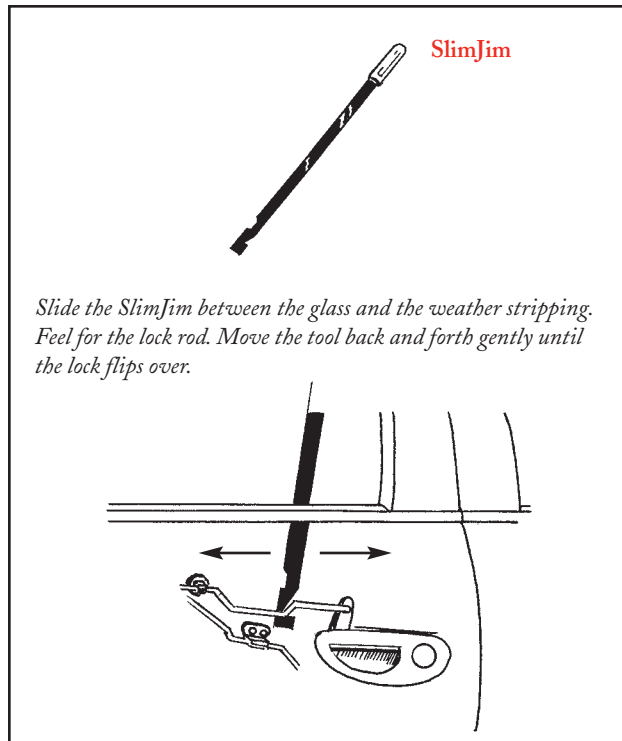

HOW TO PICK A CAR LOCK

- 1 You will need two tools—one to manipulate the pins or wafers inside the lock core and one to turn the cylinder.**

You can use a small Allen wrench to turn the lock and a long bobby pin to move the pins and wafers. Keep in mind that many car locks are harder to pick than door locks. They often have a small shutter that covers and protects the lock, and this can make the process more difficult.

- 2 While the bobby pin is in the lock, exert constant and light turning pressure with the wrench.**
This is the only way to discern if the pins or wafers—which line up with the notches and grooves in a key—are lined up correctly. Most locks have five pins.
- 3 Move the bobby pin to manipulate the pins or wafers until you feel the lock turn smoothly.**

Alternate Method

- ★ Use a key from a different car from the same manufacturer.**

There are surprisingly few lock variations, and the alien key may just work.

Be Aware

We of course assume you are seeking to enter your own car.

HOW TO DEAL WITH A CHARGING BULL

- 1 Do not antagonize the bull, and do not move.**
Bulls will generally leave humans alone unless they become angry.
- 2 Look around for a safe haven—an escape route, cover, or high ground.**
Running away is not likely to help unless you find an open door, a fence to jump, or another safe haven—bulls can easily outrun humans. If you can reach a safe spot, make a run for it.
- 3 If a safe haven is not available, remove your shirt, hat, or another article of clothing.**
Use this to distract the bull. It does not matter what color the clothing is. Despite the colors bullfighters traditionally use, bulls do not naturally head for red—they react to and move toward movement, not color.
- 4 If the bull charges, remain still and then throw your shirt or hat away from you.**
The bull should head toward the object you've thrown.

If you cannot find safe cover from a charging bull, remove articles of clothing and throw them away from your body. The bull will veer and head toward the moving objects.

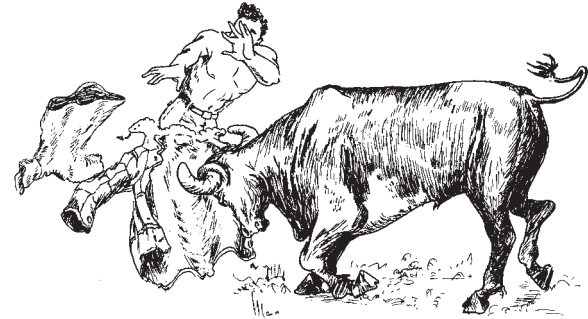

IF YOU ENCOUNTER A STAMPEDE

If you encounter a stampede of bulls or cattle, do not try to distract them. Try to determine where they are headed, and then get out of the way. If you cannot escape, your only option is to run alongside the stampede to avoid getting trampled. Bulls are not like horses, and will not avoid you if you lie down—so keep moving.

WORST-CASE SCENARIO.

HOW TO DEAL WITH A DOWNED POWER LINE

High-voltage power lines, which carry power from plants and transformers to customers, can come crashing down during severe storms. If you are in a car when a pole or line falls, you are much safer remaining inside a grounded vehicle than being on foot. If the wire falls on the car, do not touch anything—wait for help.

1 Assume that all power lines, whether sparking or not, are live.

2 Stay far away from downed lines.

Current can travel through any conductive material, and water on the ground can provide a “channel” from the power line to you. An electrical shock can also occur when one comes in contact with the charged particles near a high-voltage line; direct contact is not necessary for electrocution to occur. Never touch a vehicle that has come in contact with a live wire—it may still retain a charge.

3 Do not assume that a nonsparking wire is safe.

Often, power may be restored by automated equipment, causing a “dead” wire to become dangerous. Stay away from downed lines even if you know they are not electric lines—the line could have come in contact with an electric line when it fell, causing the downed line to be “hot.”

- 4** If a person comes into contact with a live wire, use a nonconductive material to separate the person from the electrical source.

Use a wooden broom handle, a wooden chair, or a dry towel or sheet. Rubber or insulated gloves offer no protection.

- 5** Avoid direct contact with the skin of the victim or any conducting material touching it until he or she is disconnected; you may be shocked also.

- 6** Check the pulse and begin rescue breathing and CPR if necessary.

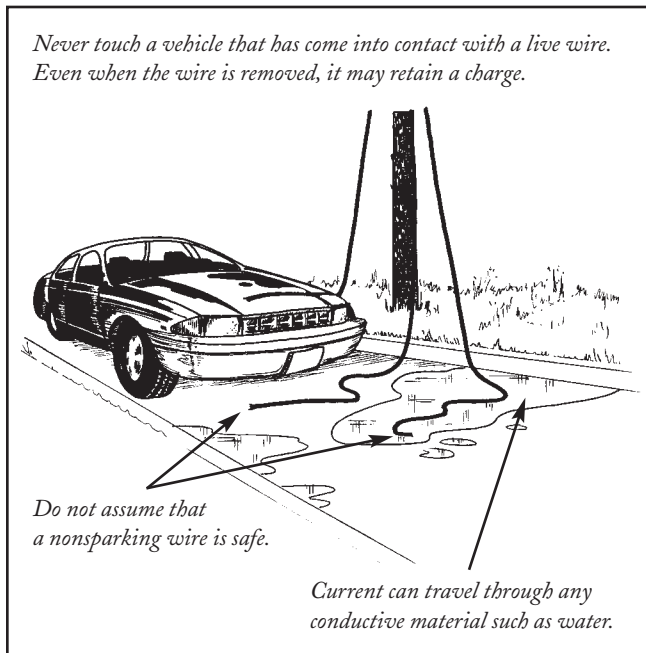

**WORST-CASE
SCENARIO.**

WORST-CASE SCENARIO.

HOW TO DELIVER A BABY IN A TAXICAB

Before you attempt to deliver a baby, use your best efforts to get to a hospital first. There really is no way to know exactly when the baby is ready to emerge, so even if you think you may not have time to get to the hospital, you probably do. Even the “water breaking” is not a sure sign that birth will happen immediately. The water is actually the amniotic fluid and the membrane that the baby floats in; birth can occur many hours after the mother’s water breaks. However, if you leave too late or get stuck in crosstown traffic and you must deliver the baby on your own, here are the basic concepts.

1 Time the uterine contractions.

For first-time mothers, when contractions are about three to five minutes apart and last forty to ninety seconds—and increase in strength and frequency—for at least an hour, the labor is most likely real and not false (though it can be). Babies basically deliver themselves, and they will not come out of the womb until they are ready. Have clean, dry towels, a clean shirt, or something similar on hand.

As the baby moves through the birth canal, guide it out by supporting the head.



Support the body as it moves out. Do not slap its behind to make it cry; the baby will breathe on its own.

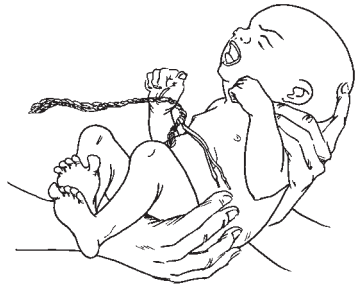
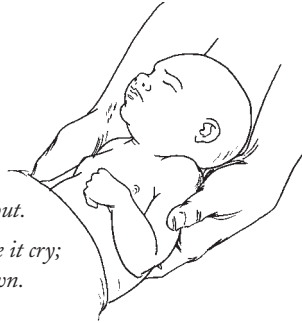

After you have dried off the baby, tie the umbilical cord with a shoelace or a piece of string several inches from the body.

Leave the cord alone until the baby gets to the hospital.

- 2** As the baby moves out of the womb, its head—the biggest part of its body—will open the cervix so the rest of it can pass through.

(If feet are coming out first, see next page.) As the baby moves through the birth canal and out of the mother's body, guide it out by supporting the head and then the body.

- 3** When the baby is out of the mother, dry it off and keep it warm.

Do not slap its behind to make it cry; the baby will breathe on its own. If necessary, clear any fluid out of the baby's mouth with your fingers.

- 4** Tie off the umbilical cord.

Take a piece of string—a shoelace works well—and tie off the cord several inches from the baby.

- 5** It is not necessary to cut the umbilical cord, unless you are hours away from the hospital.

In that event, you can safely cut the cord by tying it in another place a few inches closer to the mother and cutting it between the knots. Leave the cord alone until you get to a hospital. The piece of the cord attached to the baby will fall off by itself. The placenta will follow the baby in as few as three or as many as thirty minutes.

IF THE FEET COME FIRST

The most common complication during pregnancy is a breech baby, or one that is positioned so the feet, and not the head, will come out of the uterus first. Since the head is the largest part of the baby, the danger is that, if the feet come out first, the cervix may not be dilated enough to get the head out afterward. Today, most breech babies are delivered through cesarean sections, a surgical procedure that you will not be able to perform. If you have absolutely no alternatives (no hospital or doctors or midwives are available) when the baby begins to emerge, you can try to deliver the baby feet first. A breech birth does not necessarily mean that the head won't be able to get through the cervix; there is simply a higher possibility that this will occur. Deliver the baby as you would in the manner prescribed above.

**WORST-CASE
SCENARIO.**

HOW TO ESCAPE FROM A BEAR

1 Lie still and quiet.

Documented attacks show that an attack by a mother black bear often ends when the person stops fighting.

2 Stay where you are and do not climb a tree to escape a bear.

Black bears can climb trees quickly and easily and will come after you. The odds are that the bear will leave you alone if you stay put.

3 If you are lying still and the bear attacks, strike back with anything you can.

Go for the bear's eyes or its snout.

WHAT TO DO IF YOU SEE A BEAR

- Make your presence known by talking loudly, clapping, singing, or occasionally calling out. (Some people prefer to wear bells.) Whatever you do, be heard—it does not pay to surprise a bear. Remember, bears can run much faster than humans.
- Keep children close at hand and within sight.
- There is no guaranteed minimum safe distance from a bear: the farther, the better.
- If you are in a car, remain in your vehicle. Do not get out, even for a quick photo. Keep your windows up. Do not impede the bear from crossing the road.

While all bears are dangerous, these three situations render even more of a threat.



Females protecting cubs



Bears habituated to human food.



Bears defending a fresh kill.

HOW TO AVOID AN ATTACK

- Reduce or eliminate food odors from yourself, your camp, your clothes, and your vehicle.
- Do not sleep in the same clothes you cook in.
- Store food so that bears cannot smell or reach it.
- Do not keep food in your tent—not even a chocolate bar.
- Properly store and bring out all garbage.
- Handle and store pet food with as much care as your own.
- While all bears should be considered dangerous and should be avoided, three types should be regarded as more dangerous than the average bear. These are:
 - Females defending cubs.
 - Bears habituated to human food.
 - Bears defending a fresh kill.

Be Aware

There are about 650,000 black bears in North America, and only one person every three years is killed by a bear—although there are hundreds of thousands of encounters. Most bears in the continental U.S. are black bears, but black bears are not always black in color: sometimes their fur is brown or blond. Males are generally bigger than females (125 to 500 pounds for males, 90 to 300 pounds for females).

- Bears can run as fast as horses, uphill or downhill.
- Bears can climb trees, although black bears are better tree-climbers than grizzly bears.
- Bears have excellent senses of smell and hearing.
- Bears are extremely strong. They can tear cars apart looking for food.
- Every bear defends a “personal space.” The extent of this space will vary with each bear and each situation; it may be a few meters or a few hundred meters. Intrusion into this space is considered a threat and may provoke an attack.
- Bears aggressively defend their food.
- All female bears defend their cubs. If a female with cubs is surprised at close range or is separated from her cubs, she may attack.
- An aggressive reaction to any danger to her cubs is the mother grizzly’s natural defense.
- A female black bear’s natural defense is to chase her cubs up a tree and defend them from the base.
- Stay away from dead animals. Bears may attack to defend such food.
- It is best not to hike with dogs, as dogs can antagonize bears and cause an attack. An unleashed dog may even bring a bear back to you.

HOW TO ESCAPE FROM A MOUNTAIN LION

- 1 Do not run.**
The animal most likely will have seen and smelled you already, and running will simply cause it to pay more attention.
- 2 Try to make yourself appear bigger by opening your coat wide.**
The mountain lion is less likely to attack a larger animal.
- 3 Do not crouch down.**
Hold your ground, wave your hands, and shout. Show it that you are not defenseless.
- 4 If you have small children with you, pick them up—do all you can to appear larger.**
Children, who move quickly and have high-pitched voices, are at higher risk than adults.
- 5 Back away slowly or wait until the animal moves away.**
Report any lion sightings to authorities as soon as possible.



Upon sighting a mountain lion, do not run. Do not crouch down. Try to make yourself appear larger by opening wide your coat.



6 **If the lion still behaves aggressively, throw stones.**
Convince the lion that you are not prey and that you may be dangerous yourself.

7 **Fight back if you are attacked.**
Most mountain lions are small enough that an average size human will be able to ward off an attack by fighting back aggressively. Hit the mountain lion in the head, especially around the eyes and mouth. Use sticks, fists, or whatever is at hand. Do not curl up and play dead. Mountain lions generally leap down upon prey from above and deliver a “killing bite” to the back of the neck. Their technique is to break the neck and knock down the prey, and they also will rush and lunge up at the neck of prey, dragging the victim down while holding the neck in a crushing grip. Protect your neck and throat at all costs.

HOW TO AVOID AN ATTACK

Mountain lions, also called cougars, have been known to attack people without provocation; aggressive ones have attacked hikers and especially small children, resulting in serious injury. Still, most mountain lions will avoid people. To minimize your contact with cougars in an area inhabited by them, avoid hiking alone and at dusk and dawn, when mountain lions are more active.

**WORST-CASE
SCENARIO.**

HOW TO ESCAPE FROM A SINKING CAR

1 As soon as you hit the water, open your window.

This is your best chance of escape, because opening the door will be very difficult given the outside water pressure. (To be safe, you should drive with the windows and doors slightly open whenever you are near water or are driving on ice.) Opening the windows allows water to come in and equalize the pressure. Once the water pressure inside and outside the car is equal, you'll be able to open the door.

2 If your power windows won't work or you cannot roll your windows down all the way, attempt to break the glass with your foot or shoulder or a heavy object such as an antitheft steering wheel lock.

3 Get out.

Do not worry about leaving anything behind unless it is another person. Vehicles with engines in front will sink at a steep angle. If the water is fifteen feet or deeper, the vehicle may end up on its roof, upside down. For this reason, you must get out as soon as possible, while the car is still afloat. Depending on the vehicle, floating time will range from a few seconds to a few minutes. The more airtight the car, the longer it floats. Air in the car will quickly be forced out

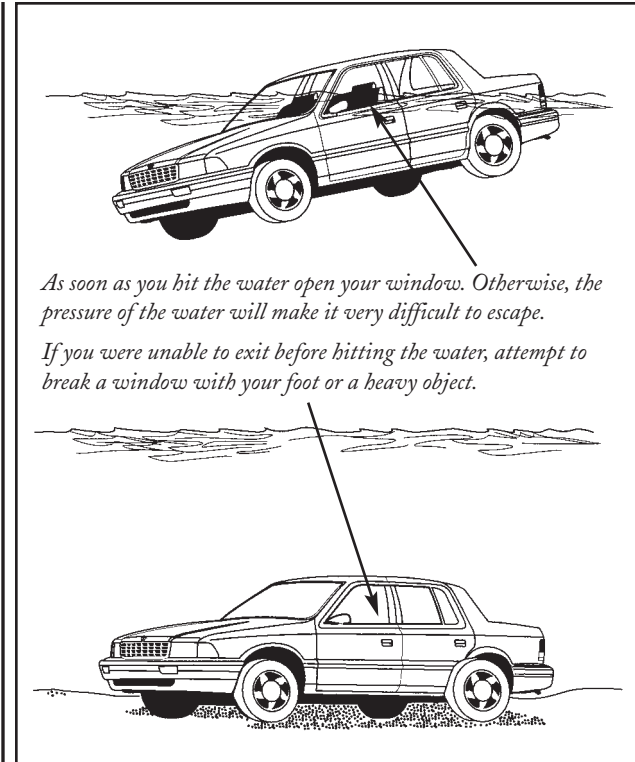

As soon as you hit the water open your window. Otherwise, the pressure of the water will make it very difficult to escape.

If you were unable to exit before hitting the water, attempt to break a window with your foot or a heavy object.

through the trunk and cab, and an air bubble is unlikely to remain once the car hits bottom. Get out as early as possible.

4 If you are unable to open the window or break it, you have one final option.

Remain calm and do not panic. Wait until the car begins filling with water. When the water reaches your

head, take a deep breath and hold it. Now the pressure should be equalized inside and outside, and you should be able to open the door and swim to the surface.

HOW TO AVOID BREAKING THROUGH THE ICE

- Cars and light trucks need at least eight inches of clear, solid ice on which to drive safely.
- Driving early or late in the season is not advisable.
- Leaving your car in one place for a long period of time can weaken the ice beneath it, and cars should not be parked—or driven—close together.
- Cross any cracks at right angles, and drive slowly.
- New ice is generally thicker than old ice.
- Direct freezing of lake or stream water is stronger than refreezing, freezing of melting snow, or freezing of water bubbling up through cracks.
- If there is a layer of snow on the ice, beware: a layer of snow insulates the ice, slowing the freezing process, and the snow's weight can decrease the bearing capacity of the ice.
- Ice near the shore is weaker.
- River ice is generally weaker than lake ice.
- River mouths are dangerous, because the ice near them is weaker.
- Carry several large nails in your pocket, and a length of rope. The nails will help you pull yourself out of the ice, and the rope can be thrown to someone on more solid ice, or can be used to help someone else.

**WORST-CASE
SCENARIO.**

HOW TO ESCAPE FROM KILLER BEES

- 1** If bees begin flying around and/or stinging you, do not freeze.

Run away; swatting at the bees only makes them angrier.

- 2** Get indoors as fast as you can.

- 3** If no shelter is available, run through bushes or high weeds.

This will help give you cover.

- 4** If a bee stings you, it will leave its stinger in your skin.

Remove the stinger by raking your fingernail across it in a sideways motion. Do not pinch or pull the stinger out—this may squeeze more venom from the stinger into your body. Do not let stingers remain in the skin, because venom can continue to pump into the body for up to ten minutes.

- 5** Do not jump into a swimming pool or other body of water—the bees are likely to be waiting for you when you surface.

If bees begin flying around and/or stinging you, DO NOT freeze; DO NOT swat them. Run away. If no shelter is available, run through bushes or high weeds.



If a bee stings you, remove the stinger by raking your fingernail across it in a sideways motion. Do not pinch the area.

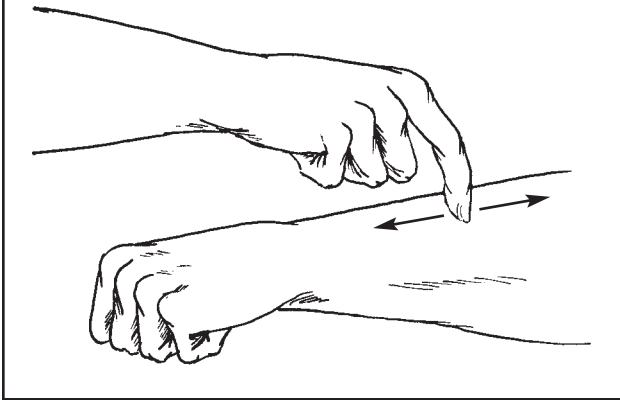

RISK OF ATTACK

The Africanized honeybee is a cousin of the run-of-the-mill domesticated honeybee that has lived in the United States for centuries. The “killer bee” moniker was created after some magazine reports about several deaths that resulted from Africanized bee stings some years back. Africanized honeybees are considered “wild;” they are easily angered by animals and people, and likely to become aggressive.

Bees “swarm” most often in the spring and fall. This is when the entire colony moves to establish a new hive. They may move in large masses—called swarms—until they find a suitable spot. Once the colony is built and the bees begin raising their young, they will protect their hive by stinging.

While any colony of bees will defend its hive, Africanized bees do so with gusto. These bees can kill, and they present a danger even to those who are not allergic to bee stings. In several isolated instances, people and animals have been stung to death. Regular honeybees will chase you about fifty yards. Africanized honeybees may pursue you three times that distance.

Most often, death from stings occurs when people are not able to get away from the bees quickly. Animal losses have occurred for the same reasons—pets and livestock were tied up or penned when they encountered the bees and could not escape.

TO MINIMIZE RISK

- Avoid colonies by filling in holes or cracks in exterior walls, filling in tree cavities, and putting screens on the tops of rainspouts and over water meter boxes in the ground.
- Do not bother bee colonies: if you see that bees are building—or have already built—a colony around your home, do not disturb them. Call a pest control center to find out who removes bees.

HOW TO ESCAPE FROM QUICKSAND

- 1** When walking in quicksand country, carry a stout pole—it will help you get out should you need to.
- 2** As soon as you start to sink, lay the pole on the surface of the quicksand.
- 3** Flop onto your back on top of the pole.
After a minute or two, equilibrium in the quicksand will be achieved, and you will no longer sink.
- 4** Work the pole to a new position: under your hips and at right angles to your spine.
The pole will keep your hips from sinking, as you (slowly) pull out first one leg and then the other.
- 5** Take the shortest route to firmer ground, moving slowly.

HOW TO AVOID SINKING

Quicksand is just ordinary sand mixed with upwelling water, which makes it behave like a liquid. However, quicksand—unlike water—does not easily let go. If you try to pull a limb out of quicksand, you have to work against the vacuum left behind. Here are a few tips:

- The viscosity of quicksand increases with shearing—move slowly so the viscosity is as low as possible.
- Floating on quicksand is relatively easy and is the best way to avoid its clutches. You are more buoyant in quicksand than you are in water. Humans are less dense than freshwater, and saltwater is slightly more dense. Floating is easier in saltwater than freshwater and much easier in quicksand. Spread your arms and legs far apart and try to float on your back.

When in an area with quicksand, bring a stout pole and use it to put your back into a floating position.



Place the pole at a right angle from your spine to keep your hips afloat.

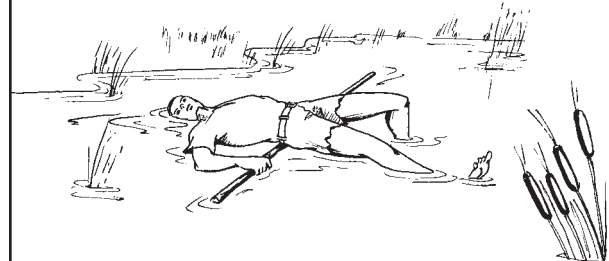

HOW TO FEND OFF A SHARK

1 Hit back.

If a shark is coming toward you or attacks you, use anything you have in your possession—a camera, probe, harpoon gun, your fist—to hit the shark's eyes or gills, which are the areas most sensitive to pain.

2 Make quick, sharp, repeated jabs in these areas.

Sharks are predators and will usually only follow through on an attack if they have the advantage, so making the shark unsure of its advantage in any way possible will increase your chances of survival. Contrary to popular opinion, the shark's nose is not the area to attack, unless you cannot reach the eyes or gills. Hitting the shark simply tells it that you are not defenseless.

HOW TO AVOID AN ATTACK

- Always stay in groups—sharks are more likely to attack an individual.
- Do not wander too far from shore. This isolates you and creates the additional danger of being too far from assistance.
- Avoid being in the water during darkness or twilight hours, when sharks are most active and have a competitive sensory advantage.

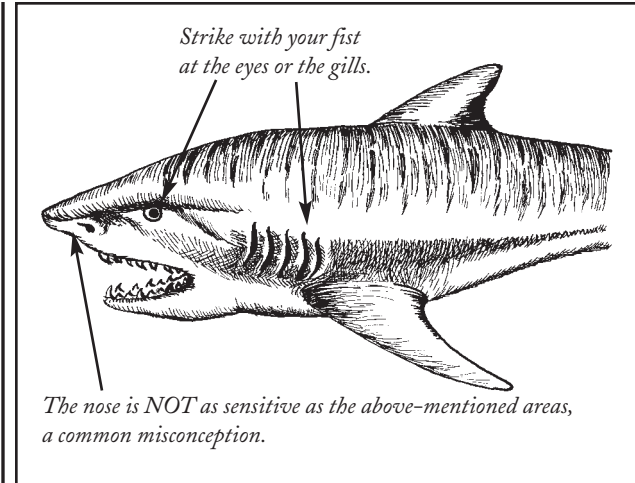

- Do not enter the water if you are bleeding from an open wound or if you are menstruating—a shark is drawn to blood and its olfactory ability is acute.
- Try not to wear shiny jewelry, because the reflected light resembles the sheen of fish scales.
- Avoid waters with known effluents or sewage and those being used by sport or commercial fishermen, especially if there are signs of bait fish or feeding activity. Diving seabirds are good indicators of such activity.
- Use extra caution when waters are murky and avoid showing any uneven tan lines or wearing brightly colored clothing—sharks see contrast particularly well.
- If a shark shows itself to you, it may be curious rather than predatory and will probably swim on

and leave you alone. If you are under the surface and lucky enough to see an attacking shark, then you do have a good chance of defending yourself if the shark is not too large.

- Scuba divers should avoid lying on the surface, where they may look like a piece of prey to a shark, and from where they cannot see a shark approaching.
- A shark attack is a potential danger for anyone who frequents marine waters, but it should be kept in perspective. Bees, wasps, and snakes are responsible for far more fatalities each year, and in the United States the annual risk of death from lightning is thirty times greater than from a shark attack.

THREE KINDS OF SHARK ATTACKS

“**HIT AND RUN**” **ATTACKS** are by far the most common. These typically occur in the surf zone, where swimmers and surfers are the targets. The victim seldom sees its attacker, and the shark does not return after inflicting a single bite or slash wound.

“**BUMP AND BITE**” **ATTACKS** are characterized by the shark initially circling and often bumping the victim prior to the actual attack. These types of attacks usually involve divers or swimmers in deeper waters, but also occur in nearshore shallows in some areas of the world.

“**SNEAK**” **ATTACKS** differ: the strike can occur without warning. With both “bump and bite” and “sneak” attacks, repeat attacks are common and multiple and sustained bites are the norm. Injuries incurred during this type of attack are usually quite severe, frequently resulting in death.

Be Aware

Most shark attacks occur in nearshore waters, typically inshore of a sandbar or between sandbars where sharks feed and can become trapped at low tide. Areas with steep drop-offs are also likely attack sites. Sharks congregate in these areas, because their natural prey congregates there. Almost any large shark, roughly six feet or longer in total length, is a potential threat to humans. But three species in particular have repeatedly attacked man: the white shark (*Carcharodon carcharias*), the tiger shark (*Galeocerdo cuvieri*), and the bull shark (*Carcharhinus leucas*). All are cosmopolitan in distribution, reach large sizes, and consume large prey such as marine mammals, sea turtles, and fish as normal elements of their diets.

HOW TO GET TO THE SURFACE IF YOUR SCUBA TANK RUNS OUT OF AIR

- 1 Do not panic.**
- 2 Signal to your fellow divers that you are having a problem—point to your tank or regulator.**
- 3 If someone comes to your aid, share their regulator, passing it back and forth while swimming slowly to the surface.**

Take two breaths, then pass it back to the other diver. Ascend together, exhaling as you go. Then take another two breaths, alternating, until you reach the surface. Nearly all divers carry an extra regulator connected to their tank.
- 4 If no one can help you, keep your regulator in your mouth; air may expand in the tank as you ascend, giving you additional breaths.**
- 5 Look straight up so that your airway is as straight as possible.**
- 6 Swim to the surface at a slow to moderate rate.**

Exhale continuously as you swim up. It is very important that you exhale the entire way up, but the rate at

Keep your regulator in your mouth.

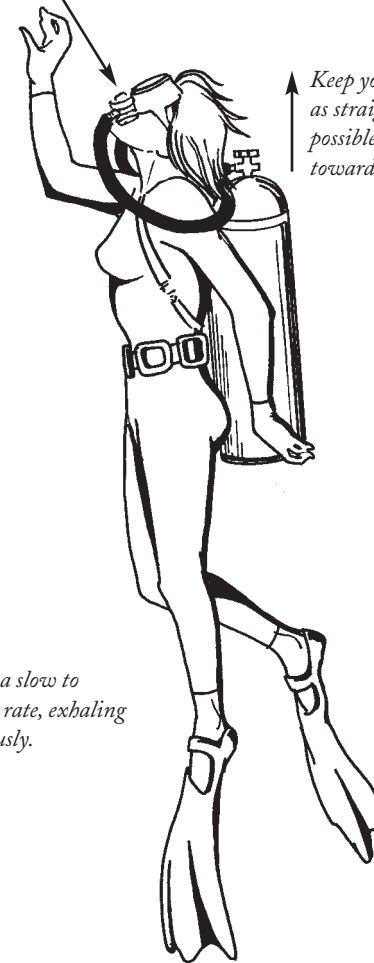

Keep your airway as straight as possible by looking toward the surface.

Swim at a slow to moderate rate, exhaling continuously.

which you exhale is also important. Exhale slowly—do not exhaust all your air in the first few seconds of your ascent. As long as you are even slightly exhaling, your passageway will be open and air can vent from your lungs.

WARNING: If you do not exhale continuously, you risk an embolism.

Be Aware

- Never dive alone.
- Watch your pressure and depth gauges closely.
- Make sure your fellow divers are within easy signaling/swimming distance.
- Share a regulator in an emergency. It is much safer to use your partner's regulator than to try to make a quick swim to the surface. This is especially true the deeper you are, where you need to surface gradually.
- Always use an alternate air source instead of swimming up unless you are fewer than thirty feet below the surface.

**WORST-CASE
SCENARIO®**

HOW TO HOT-WIRE A CAR

Hot-wiring a car without the owner's permission is illegal, except in repossessions. Hot-wiring can be dangerous; there is a risk of electrical shock. Hot-wiring will not work on all cars, particularly cars with security devices. Some "kill switches" can prevent hot-wiring.

1 Open the hood.

2 Locate the coil wire (it is red).

To find it, follow the plug wires, which lead to the coil wire. The plug and coil wires are located at the rear of the engine on most V-8s. On six-cylinder engines, the wires are on the left side near the center of the engine, and on four-cylinder engines, they are located on the right side near the center of the engine.

3 Run a wire from the positive (+) side of the battery to the positive side of the coil, or the red wire that goes to the coil.

This step gives power to the dash, and the car will not run unless it is performed first.

4 Locate the starter solenoid.

On most GM cars, it is on the starter. On Fords, it is located on the left-side (passenger-side) fender well.

Run a wire from the positive (+) side of the battery to the red coil wire.

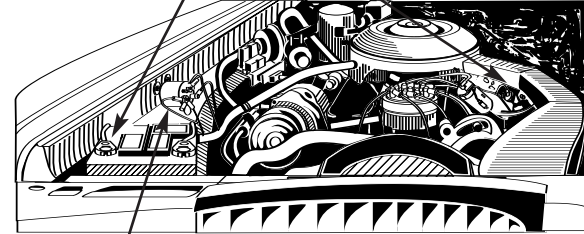

solenoid

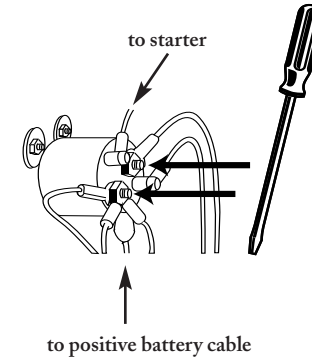

Cross the terminals with a screwdriver or pliers (Ford).

An easy way to find it is to follow the positive battery cable. You will see a small wire and the positive battery cable. Cross the two with a screwdriver or pliers. This cranks the engine.

Unlocking the Steering Wheel

*Place screwdriver
at top center of
steering column.*

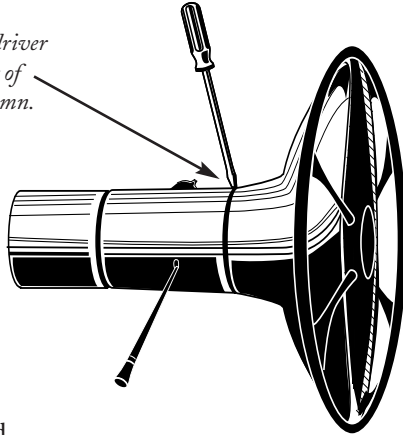

GM solenoid

- 5** If the car has a standard transmission, make sure it is in neutral and the parking brake is on. If it has an automatic transmission, make sure it is in park.

- 6** Unlock the steering wheel using a flat blade screwdriver. Take the screwdriver and place it at the top center of the steering column. Push the screwdriver between the steering wheel and the column. Push the locking pin away from the wheel. Be very firm when pushing the pin; it will not break.

**WORST-CASE
SCENARIO.**

HOW TO IDENTIFY A BOMB

Letter and package bombs can be very dangerous and destructive. However, unlike a bomb that goes off suddenly and with no warning, they can be identified. Observe the following procedures and warning signs.

HOW TO DETECT A LETTER BOMB

- 1** If a carrier delivers an unexpected bulky letter or parcel, inspect it for lumps, bulges, or protrusions, without applying pressure.
Check for unevenly balanced parcels.
- 2** Handwritten addresses or labels from companies are unusual.
Check to see if the company exists and if they sent a package or letter.
- 3** Be suspicious of packages wrapped in string—modern packaging materials have eliminated the need for twine or string.
- 4** Watch out for excess postage on small packages or letters—this indicates that the object was not weighed by the post office.
It is no longer legal to mail stamped parcels weighing more than sixteen ounces at mailboxes in the United States—they must be taken to a post office.

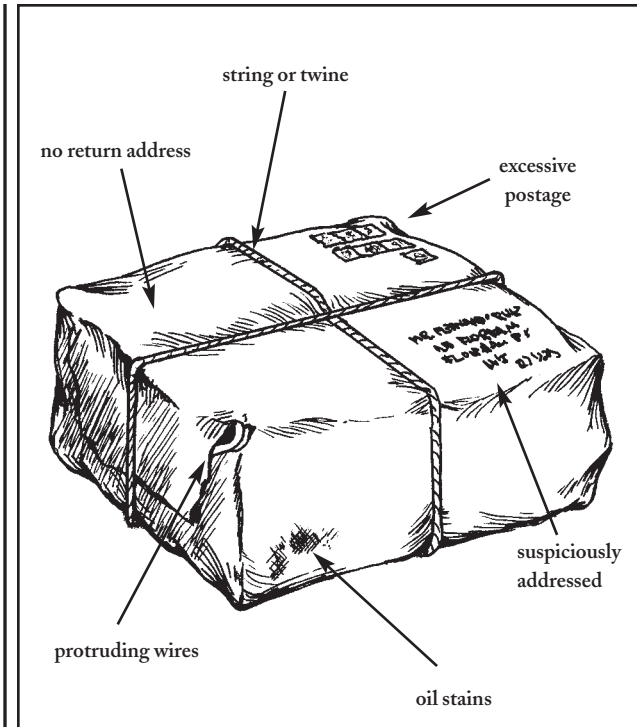

- 5** Watch out for leaks, stains (especially oily stains), protruding wires, or excessive tape.
- 6** Watch out for articles with no return address or a nonsensical return address.

HOW TO SEARCH FOR A BOMB

Government agencies use well-defined search procedures for bombs and explosive devices. After a bomb threat, the following can be used as a guide for searching a room, using a two-person search team.

1 Divide the area and select a search height.

The first searching sweep should cover all items resting on the floor up to the height of furniture; subsequent sweeps should move up from there.

2 Start back-to-back and work around the room, in opposite directions, moving toward each other.

3 Search around the walls and proceed inward in concentric circles toward the center of the room.

4 If you find a suspicious parcel or device, do not touch it—call the bomb squad.

DETECTION DEVICES

There are several types of devices and methods that can be used to identify bombs, including metal and vapor detectors, as well as X-ray machines. Several devices are portable and inexpensive enough for an individual to obtain.

Particulate Explosives Detector

- Detects modern plastic explosive constituents as well as TNT and nitroglycerin.
- Detects RDX (used in C4, PE4, SX2, Semtex, Demex, and Detasheet); PETN (used in certain military explosives and Semtex); TNT (trinitrotoluene), and NG (nitroglycerin).
- Uses IMS (ion mobility spectroscopy) to detect micron-size particles used in explosives. A sample size of one nanogram is sufficient for detection.
- To use, swipe the suspect material with a sample wipe or a cotton glove. Analysis time is approximately three seconds. A visual display contains a red warning light and an LCD, giving a graphic display with a relative numerical scale of the target materials identified. An audible alarm can be triggered based on a user-defined threshold.
- Requires AC or battery.
- Approximately 15 x 12 x 5 inches.

Portable X-Ray System

- Uses a Polaroid radiographic film cassette and processor to create detailed radiographs of parcels and packages.
- Requires AC or a rechargeable battery.
- To use, simply point the lens at the suspect item and use the processor to view the image on the film.

Spray Bomb Detector

This portable aerosol spray is used in conjunction with laminated test paper to detect explosives—both plastic and traditional TNT—on parcels and on hands and fingerprints. The test kit includes test paper and two spray cans, E and X.

First, rub the white paper over the desired surface (briefcase, suitcase, etc.) and then spray with the E canister. If TNT is detected, the paper turns violet. If no reaction occurs, spray the paper with the X canister. The immediate appearance of pink indicates plastic explosives.

Expray can also be sprayed directly on paper and parcels. The procedure and results are identical.

Bomb Range Detector

This detector of radio-controlled explosives is mounted in a car.

The unit automatically scans and transmits on every radio frequency in a one-kilometer radius. When a radio-controlled explosive is in the area, the device jams it to render it harmless.

Be Aware

All bomb experts stress that avoidance is the key concept when dealing with explosives. Your best chance of survival lies with the bomb squad, not with one of these devices.

**WORST-CASE
SCENARIO.**

HOW TO JUMP FROM A BRIDGE OR CLIFF INTO A RIVER

When attempting a high fall (over twenty feet) into water in an emergency situation, you will not know much about your surroundings, specifically the depth of the water. This makes jumping particularly dangerous.

If jumping from a bridge into a river or other body of water with boat traffic, try to land in the channel—the deepwater area where boats go under the bridge. This area is generally in the center, away from the shoreline.

Stay away from any area with pylons that are supporting the bridge. Debris can collect in these areas and you can hit it when you enter the water.

Swim to shore immediately after surfacing.

How to JUMP

- 1** Jump feet first.
- 2** Keep your body completely vertical.
- 3** Squeeze your feet together.



Jump feet first in a vertical position; squeeze your feet together; clench your backside and protect your crotch.

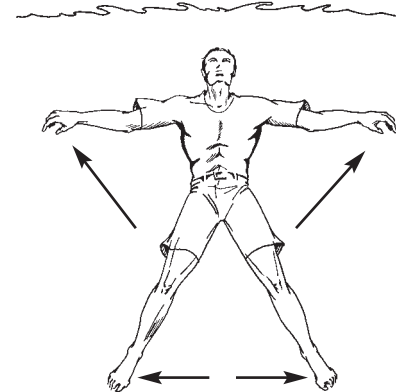

After you enter the water, spread your arms and legs wide and move them back and forth, which will slow your plunge. Attempt to slow your descent.

- 4** Enter the water feet first, and clench your buttocks together.

If you do not, water may rush in and cause severe internal damage.

- 5** Protect your crotch area by covering it with your hands.

- 6** Immediately after you hit the water, spread your arms and legs wide and move them back and forth to generate resistance, which will slow your plunge to the bottom.

Always assume the water is not deep enough to keep you from hitting bottom.

Be Aware

- Hitting the water as described above could save your life, although it may break your legs.
- If your body is not straight, you can break your back upon entry. Keep yourself vertical until you hit the water.
- Do not even think about going in headfirst unless you are absolutely sure that the water is at least twenty feet deep. If your legs hit the bottom, they will break. If your head hits, your skull will break.

**WORST-CASE
SCENARIO.**

**WORST-CASE
SCENARIO.**

HOW TO JUMP FROM A BUILDING INTO A DUMPSTER

How to JUMP

- 1 Jump straight down.**
If you leap off and away from the building at an angle, your trajectory will make you miss the Dumpster. Resist your natural tendency to push off.
- 2 Tuck your head and bring your legs around.**
To do this during the fall, execute a three-quarter revolution—basically, a not-quite-full somersault. This is the only method that will allow a proper landing, with your back facing down.
- 3 Aim for the center of the Dumpster or large box of debris.**
- 4 Land flat on your back so that when your body folds, your feet and hands meet.**
When your body hits any surface from a significant height, the body folds into a V. This means landing on your stomach can result in a broken back.



1.

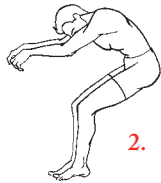

2.

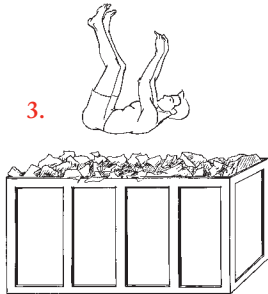

3.

1. Jump straight down.
2. Tuck your head and bring your legs around, executing a three-quarter somersault.
3. Aim for the center of the Dumpster and land flat on your back.

**WORST-CASE
SCENARIO.**

Be Aware

- If the building has fire escapes or other protrusions, your leap will have to be far enough out so you miss them on your way down. The landing target needs to be far enough from the building for you to hit it.
- The Dumpster may be filled with bricks or other unfriendly materials. It is entirely possible to survive a high fall (five stories or more) into a Dumpster, provided it is filled with the right type of trash (cardboard boxes are best) and you land correctly.

HOW TO JUMP FROM A MOVING CAR

Hurling yourself from a moving car should be a last resort, for example if your brakes are defective and your car is about to head off a cliff or into a train.

1 Apply the emergency brake.

This may not stop the car, but it might slow it down enough to make jumping safer.

2 Open the car door.

3 Make sure you jump at an angle that will take you out of the path of the car.

Since your body will be moving at the same velocity as the car, you're going to continue to move in the direction the car is moving. If the car is going straight, try to jump at an angle that will take you away from it.

4 Tuck in your head and your arms and legs.

5 Aim for a soft landing site: grass, brush, wood chips, anything but pavement—or a tree.

Stuntpeople wear pads and land in sandpits. You won't have this luxury, but anything that gives a bit when the body hits it will minimize injury.

6 Roll when you hit the ground.

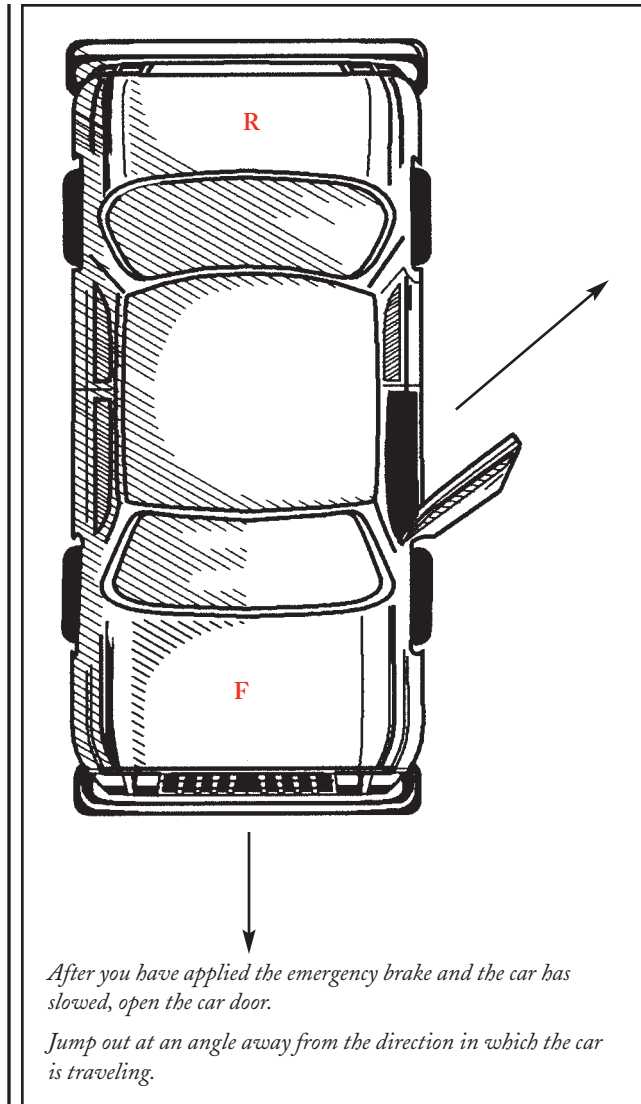

HOW TO LAND A PLANE

These instructions cover small passenger planes and jets (not commercial airliners).

1 If the plane has only one set of controls, push, pull, carry, or drag the pilot out of the pilot's seat.

2 Take your place at the controls.

3 Put on the radio headset (if there is one).

Use the radio to call for help—there will be a control button on the yoke (the plane's steering wheel) or a CB-like microphone on the instrument panel. Depress the button to talk, release it to listen. Say "Mayday! Mayday!" and give your situation, destination, and plane call numbers, which should be printed on the top of the instrument panel.

4 If you get no response, try again on the emergency channel—tune the radio to 121.5.

All radios are different, but tuning is standard. The person on the other end should be able to talk you through the proper landing procedures. Follow their instructions carefully. If you cannot reach someone to talk you through the landing process, you will have to do it alone.

5 Get your bearings and identify the instruments.

Look around you. Is the plane level? Unless you have just taken off or are about to land, it should be flying relatively straight.

YOKE. This is the steering wheel and should be in front of you. It turns the plane and controls its pitch. Pull back on the column to bring the nose up, push forward to point it down. Turn left to turn the plane left, turn right to turn it right. The yoke is very sensitive—move it only an inch or two in either direction to turn the plane in flight. While cruising, the nose of the plane should be about three inches below the horizon.

ALTIMETER. This is the most important instrument, at least initially. It is a red dial in the middle of the instrument panel that indicates altitude: the small hand indicates feet above sea level in thousand-foot increments, the large hand in hundreds.

HEADING. This is a compass and will be the only instrument with a small image of a plane in the center. The nose will point in the direction the plane is headed.

AIRSPPEED. This dial is on the top of the instrument panel and will be on the left. It is usually calibrated in knots, though it may also have miles per hour. A small plane travels at about 120 knots while cruising. Anything under 70 knots in the air is dangerously close to stall speed. (A knot is $1\frac{1}{4}$ miles per hour.)

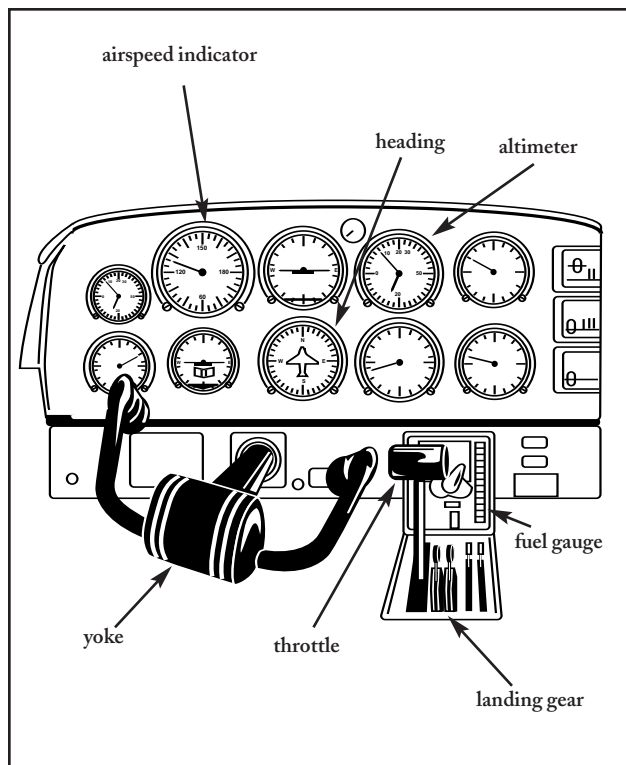

THROTTLE. This controls airspeed (power) and also the nose attitude, or its relation to the horizon. It is a lever between the seats and is always black. Pull it toward you to slow the plane and cause it to descend, push it away to speed up the plane and cause it to ascend. The engine will get more or less quiet depending on the direction the throttle is moved.

FUEL. The fuel gauges will be on the lower portion of the instrument panel. If the pilot has followed FAA regulations, the plane should have enough fuel for the amount of flying time to your intended destination plus at least an additional half hour in reserve. Some planes have a reserve fuel tank in addition to the primary one, but do not worry about changing tanks.

FLAPS. Due to their complexity, wing flaps can make the plane harder to control. Use the throttle to control airspeed, not the flaps.

6 **Begin the descent.**

Pull back on the throttle to slow down. Reduce power by about one-quarter of cruising speed. As the plane slows, the nose will drop. For descent, the nose should be about four inches below the horizon.

7 **Deploy the landing gear.**

Determine if the plane has fixed or retractable landing gear. Fixed landing gear is always down so you need do nothing. If it is retractable, there will be another lever between the seats near the throttle, with a handle that is shaped like a tire. For a water landing, leave the landing gear up (retracted).

8 **Look for a suitable landing site.**

If you cannot find an airport, find a flat field on which to land. A mile-long field is ideal, but finding a field of this length will be difficult unless you are in the Midwest. The plane can land on a much shorter

strip of earth, so do not bother to look for the “perfect” landing site—there is no such thing. Bumpy terrain will also do if your options are limited.

9 **Line up the landing strip so that when the altimeter reads one thousand feet the field is off the right-wing tip.**

In an ideal situation, you should take a single pass over the field to look for obstructions; with plenty of fuel, you may want to do so. Fly over the field, make a big rectangle, and approach a second time.

10 **When approaching the landing strip, reduce power by pulling back on the throttle.**

Do not let the nose drop more than six inches below the horizon.

11 **The plane should be one hundred feet off the ground when you are just above the landing strip, and the rear wheels should touch first.**

The plane will stall at fifty-five to sixty-five miles per hour, and you want the plane to be at just about stall speed when the wheels touch the ground.

12 **Pull all the way back on the throttle, and make sure the nose of the plane does not dip too steeply.**

Gently pull back on the yoke as the plane slowly touches the ground.

13 **Using the pedals on the floor, steer and brake the plane as needed.**

The yoke has very little effect on the ground. The upper pedals are the brakes, and the lower pedals control the direction of the nose wheel. Concentrate first on the lower pedals. Press the right pedal to move the plane right, press the left pedal to move it left. Upon landing, be aware of your speed. A modest reduction in speed will increase your chances of survival exponentially. By reducing your groundspeed from 120 to 70 miles per hour, you increase your chance of survival threefold.

Be Aware

- A well-executed emergency landing in bad terrain can be less hazardous than an uncontrolled landing on an established field.
- If the plane is headed toward trees, steer it between them so the wings absorb the impact if you hit.
- When the plane comes to a stop, get out as soon as possible and get away—and take the pilot with you.

HOW TO LEAP FROM A MOTORCYCLE TO A CAR

If you are planning to enter the car through one of its windows, remember that in many newer cars, only the front windows roll all the way down. You should attempt to be on the front passenger side.

- 1** Wear a high-quality helmet and a leather jacket plus leather pants and boots.
- 2** Make sure both vehicles are moving at the same speed.
The slower the speed, the safer the move. Anything faster than sixty miles per hour is extremely dangerous.
- 3** Wait for a long straight section of road.
- 4** Get the vehicles as close as possible to each other.
You will be on the passenger side of the car, so you will be very close to the edge of the roadway. Be careful not to swerve.
- 5** Stand crouched with both of your feet on either the running board or the seat.

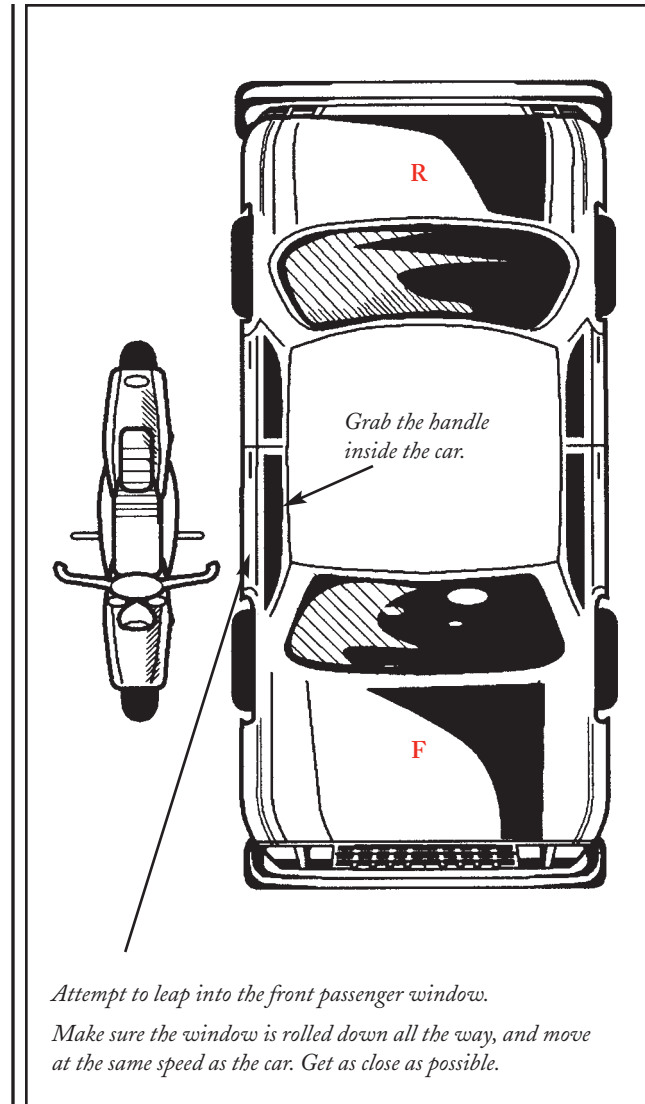

6 Hold the throttle until the last instant.

Remember, as soon as you release the throttle the bike speed will decrease.

7 If the car has a handle inside (above the door) grab it with your free hand.

If not, simply time the leap so your torso lands in the car. If someone can grab you and pull you in, all the better.

8 Have the driver swerve away from the bike as soon as you are inside.

Once you have released the handlebars, the bike will go out of control and crash. It may also slip under the rear passenger-side wheel of the car.

9 If you miss the window, tuck and roll away from the vehicles (see page 82 for jumping from a moving car).

Be Aware

The move is much easier if two people are on the motorcycle so that the non-jumper can continue driving.

In the movies and in stunt shows, these transfers are usually performed at slow speeds, and in fact often employ the use of a metal step installed on one side of the bike or car, which allows the rider to step off while keeping the bike balanced. You are not likely to have this option.

**WORST-CASE
SCENARIO.**

HOW TO MAKE FIRE WITHOUT MATCHES

WHAT YOU WILL NEED

- Knife
- Kindling. Several pieces, varying in size from small to large.
- Wood to keep the fire going. Select deadwood from the tree, not off the ground. Good wood should indent with pressure from a fingernail, but not break easily.
- Bow. A curved stick about two feet long.
- String. A shoelace, parachute cord, or leather thong. Primitive cordage can be made from yucca, milkweed, or another tough, stringy plant.
- Socket. A horn, bone, piece of hard wood, rock, or seashell that fits in the palm of the hand and will be placed over a stick.
- Lube. You can use earwax, skin oil, a ball of green grass, lip balm, or anything else oily.
- Spindle. A dry, straight $\frac{3}{4}$ - to 1-inch-diameter stick approximately 12 to 18 inches long. Round one end and carve the other end to a point.
- Fire board. Select and shape a second piece of wood into a board approximately $\frac{3}{4}$ to 1 inch thick, 2 to 3 inches wide, and 10 to 12 inches long. Carve a shallow dish in the center of the flat side approximately

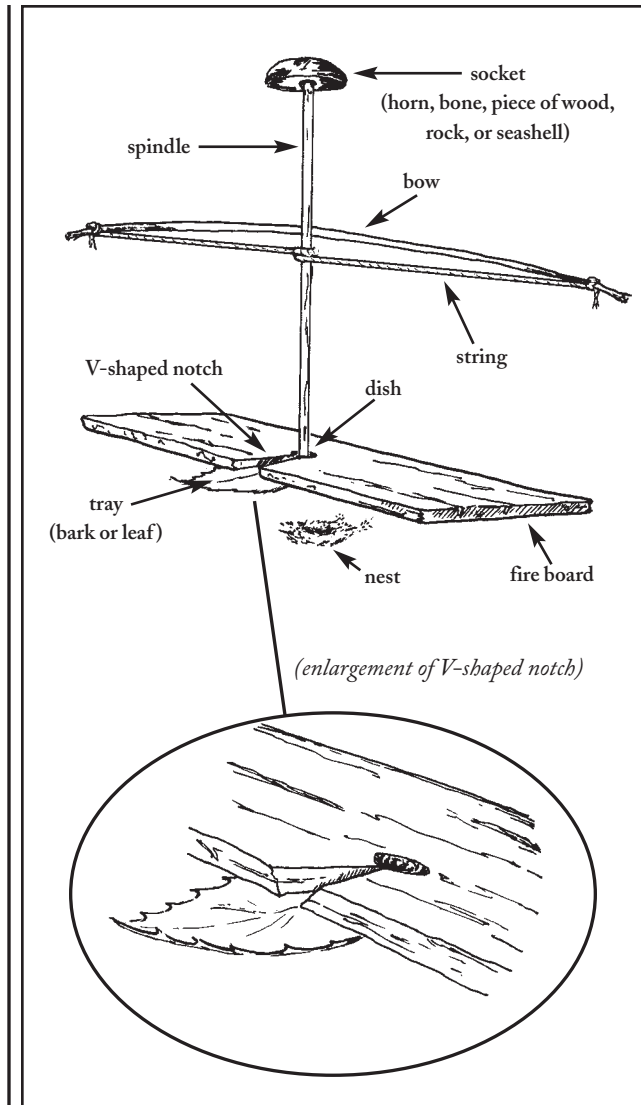

½ inch from the edge. Into the edge of this dish, cut a V-shaped notch.

- Tray. A piece of bark or leaf inserted under the V-shaped notch to catch the ember. The tray should not be made of deadwood.
- Nest. Dry bark, grass, leaves, cattail fuzz, or some other combustible material, formed into a bird nest shape.

HOW TO START THE FIRE

- 1** Tie the string tightly to the bow, one end to each end of the stick.
- 2** Kneel on your right knee, with the ball of your left foot on the fire board, holding it firmly to the ground.
- 3** Take the bow in your hands.
- 4** Loop the string in the center of the bow.
- 5** Insert the spindle in the loop of the bowstring so that the spindle is on the outside of the bow, pointed end up.
The bowstring should now be tight—if not, loop the string around the spindle a few more times.
- 6** Take the hand socket in your left hand, notch side down. Lubricate the notch.

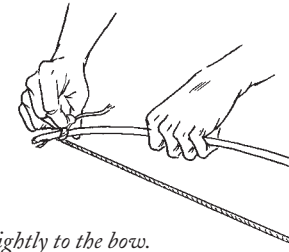

Tie a string tightly to the bow.

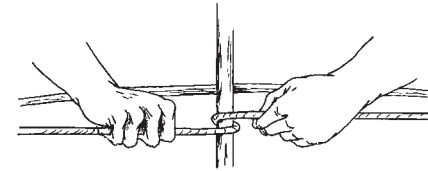

Loop the string in the center and insert the spindle.

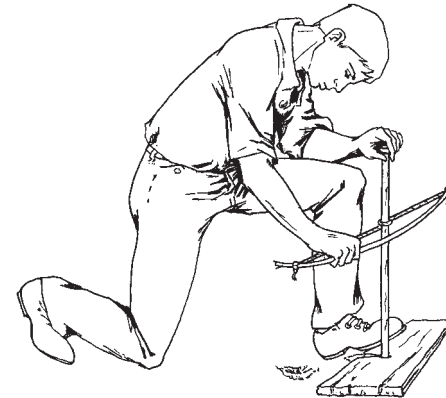

Press down lightly on the socket. Draw bow back and forth, rotating spindle. Add pressure to the socket and speed your bowing motion until fire ember is produced.

- 7** Place the rounded end of the spindle into the dish of the fire board and the pointed end of the spindle into the hand socket.
- 8** Pressing down lightly on the socket, draw the bow back and forth, rotating the spindle slowly.
- 9** Add pressure to the socket and speed to your bowing until you begin to produce smoke and ash.
When there is a lot of smoke, you have created a fire ember.
- 10** Immediately stop your bowing motion and tap the spindle on the fire board to knock the ember into the tray.
- 11** Remove the tray and transfer the ember into your “nest.”
- 12** Hold the nest tightly and blow steadily onto the ember. Eventually, the nest will catch fire.
- 13** Add kindling onto the nest. When the kindling catches, gradually add larger pieces of fuel.

Be Aware

You should not be dependent on any primitive fire method to maintain life in a wilderness survival emergency. Making fire in this manner can be quite difficult under actual harsh conditions (rain, snow, cold).

You should practice this method at home before you attempt it in the wilderness to familiarize yourself with the quirks of the process.

**WORST-CASE
SCENARIO.**

**WORST-CASE
SCENARIO.**

HOW TO MANEUVER ON TOP OF A MOVING TRAIN AND GET INSIDE

- 1 Do not try to stand up straight (you probably will not be able to anyway).**
Stay bent slightly forward, leaning into the wind. If the train is moving faster than thirty miles per hour, it will be difficult to maintain your balance and resist the wind, so crawling on all fours may be the best method until you can get down.
- 2 If the train is approaching a turn, lie flat; do not try to keep your footing.**
The car may have guide rails along the edge to direct water. If it does, grab them and hold on.
- 3 If the train is approaching a tunnel entrance, lie flat, and quickly.**
There is actually quite a bit of clearance between the top of the train and the top of the tunnel—about three feet—but not nearly enough room to stand. Do not assume that you can walk or crawl to the end of the car to get down and inside before you reach the tunnel—you probably won't.

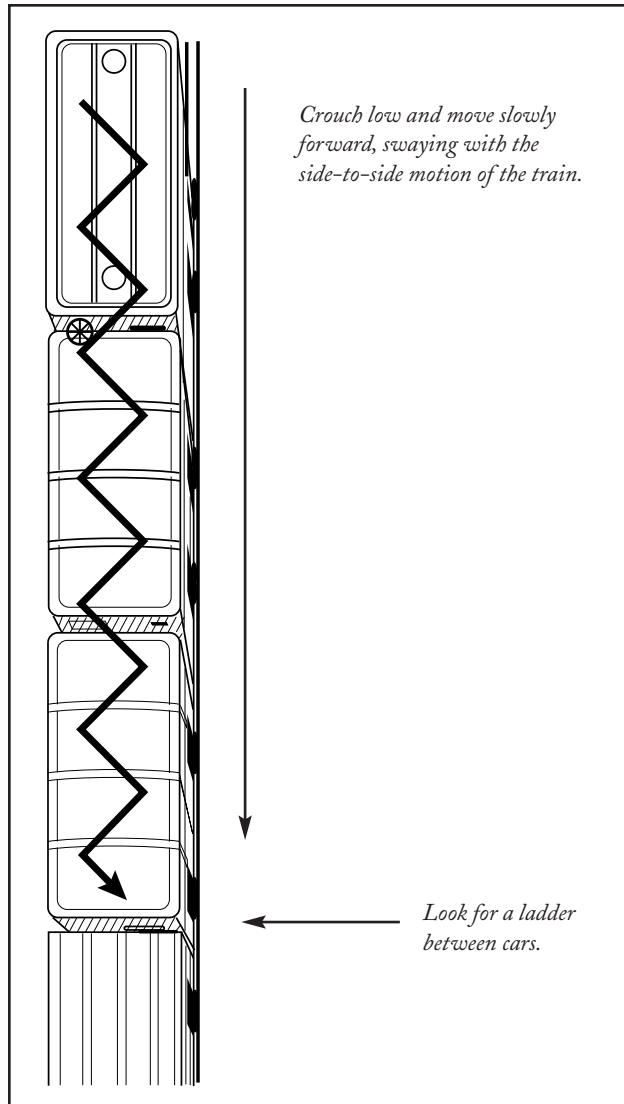

- 4** Move your body with the rhythm of the train—from side to side and forward.

Do not proceed in a straight line. Spread your feet apart about thirty-six inches and wobble from side to side as you move forward.

- 5** Find the ladder at the end of the car (between two cars) and climb down.

It is very unlikely that there will be a ladder on the side of the car—they usually appear only in the movies, to make the stunts more exciting.

Be Aware

The sizes and shapes of the cars on a freight train may vary widely. This can either make it easier or significantly more difficult to cross from one car to another. A twelve-foot-high boxcar may be next to a flatbed or a rounded chem car. If on this type of train, your best bet is to get down as quickly as possible, rather than to try a dangerous leap from car to car.

**WORST-CASE
SCENARIO.**

HOW TO PERFORM A FAST 180-DEGREE TURN WITH YOUR CAR

FROM REVERSE

- 1** Put the car in reverse.
- 2** Select a spot straight ahead. Keep your eyes on it, and begin backing up.
- 3** Jam on the gas.
- 4** Cut the wheel sharply ninety degrees around (a quarter turn) as you simultaneously drop the transmission into drive.

Make sure you have enough speed to use the momentum of the car to swing it around, but remember that going too fast (greater than forty-five miles per hour) can be dangerous and may flip the car (and strip your gears). Turning the wheel left will swing the rear of the car left; turning it right will swing the car right.

- 5** When the car has completed the turn, step on the gas and head off.

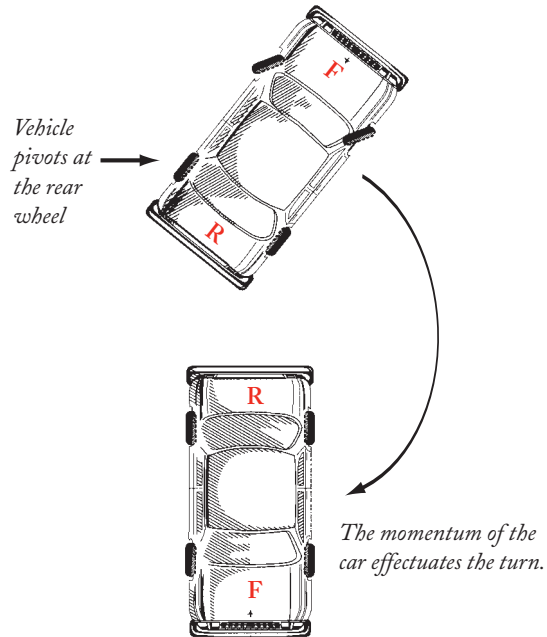
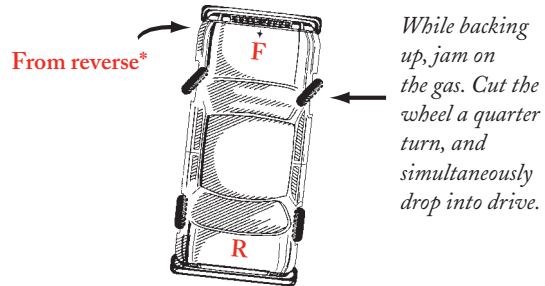

**At speeds no greater than 45 mph*

FROM DRIVE

- 1** While in drive, or a forward gear, accelerate to a moderate rate of speed (anything faster than forty-five miles per hour risks flipping the car).
- 2** Slip the car into neutral to prevent the front wheels from spinning.
- 3** Take your foot off the gas and turn the wheel ninety degrees (a quarter turn) while pulling hard on the emergency brake.
- 4** As the rear swings around, return the wheel to its original position and put the car back into drive.
- 5** Step on the gas to start moving in the direction from which you came.

Be Aware

- The 180-degree turn while moving forward is more difficult for the following reasons:
- It is easier to swing the front of the car around, because it is heavier and it will move faster with momentum.
- It is harder to maintain control of the rear of the car—it is lighter and will slip more easily than the front. Spinning out of control, or flipping the car, are potential dangers.
- Road conditions can play a significant role in the success—and safety—of this maneuver. Any surface without sufficient traction (dirt, mud, ice, gravel) will make quick turns harder and collisions more likely.

HOW TO PERFORM A TRACHEOTOMY

This procedure, technically called a cricothyroidotomy, should be undertaken only when a person with a throat obstruction is not able to breathe at all—no gasping sounds, no coughing—and only after you have attempted to perform the Heimlich maneuver three times without dislodging the obstruction. If possible, someone should call for paramedics while you proceed.

WHAT YOU WILL NEED

- A first aid kit, if available
- A razor blade or very sharp knife
- A straw (two would be better) or a ballpoint pen with the inside (ink-filled tube) removed. If neither a straw nor a pen is available, use stiff paper or cardboard rolled into a tube. Good first aid kits may contain “trache” tubes.

There will not be time for sterilization of your tools, so do not bother; infection is the least of your worries at this point.

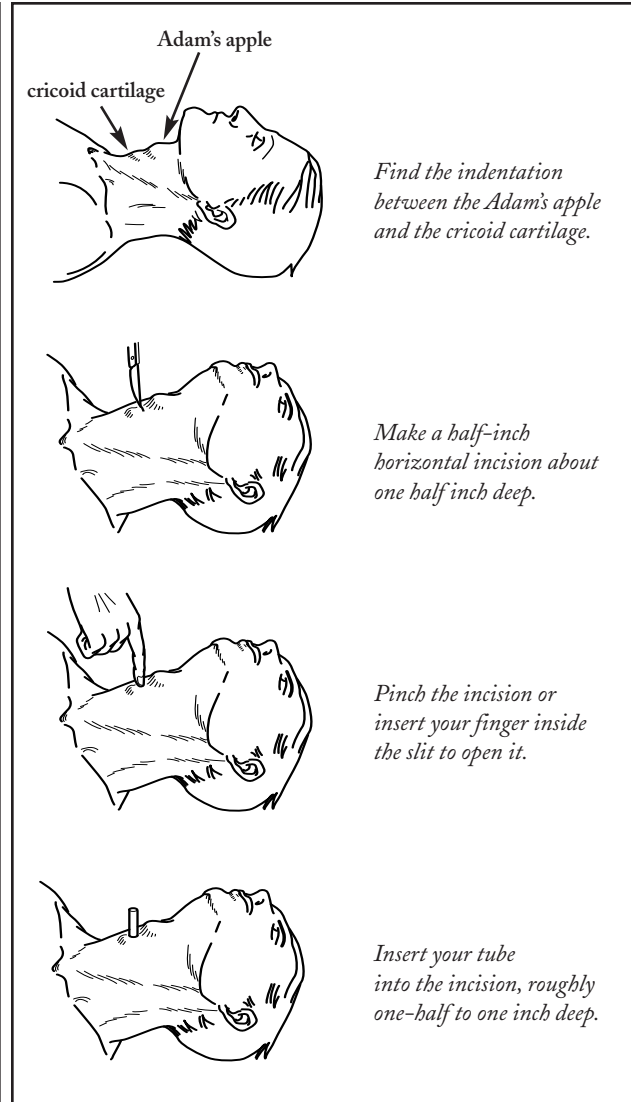

HOW TO PROCEED

- 1 Find the person's Adam's apple (thyroid cartilage).**
- 2 Move your finger about one inch down the neck until you feel another bulge.**

This is the cricoid cartilage. The indentation between the two is the cricothyroid membrane, where the incision will be made.
- 3 Take the razor blade or knife and make a half-inch horizontal incision.**

The cut should be about half an inch deep. There should not be too much blood.
- 4 Pinch the incision open or place your finger inside the slit to open it.**
- 5 Insert your tube in the incision, roughly one-half to one inch deep.**
- 6 Breathe into the tube with two quick breaths.**

Pause five seconds, then give one breath every five seconds.
- 7 You will see the chest rise and the person should regain consciousness if you have performed the procedure correctly.**

The person should be able to breathe on their own, albeit with some difficulty, until help arrives.

**WORST-CASE
SCENARIO.**

HOW TO RAM A CAR

Ramming a car to move it out of your way is not easy or safe, but there are some methods that work better than others and some that will minimize the damage to your vehicle. Keep in mind that the best way to hit a car blocking your path is to clip the very rear of it, about one foot from the rear bumper. The rear is the lightest part of a car, and it will move relatively easily. Hitting it in the rear can also disable the car—with the rear wheel crushed, you have time to get away without being pursued.

1 **Disable your air bag, if you can.**

It will deploy on impact and will obstruct your view after it deploys.

2 **Wear a seat belt.**

3 **Accelerate to at least twenty-five miles per hour.**

Do not go too fast—keeping the car at a slow speed will allow you to maintain control without slowing down. Then, just before impact, increase your speed to greater than thirty miles per hour to deliver a disabling crunch to the rear wheel of the obstacle car.

4 **Ram the front passenger side of your car into the obstacle car at its rear wheel, at a ninety-degree angle (the cars should be perpendicular).**

5 **If you are unable to hit a car in the rear, go for the front corner.**

Avoid hitting the car squarely in the side; this will not move it out of your way.

6 **The car should spin out of your way—hit the gas, and keep moving.**

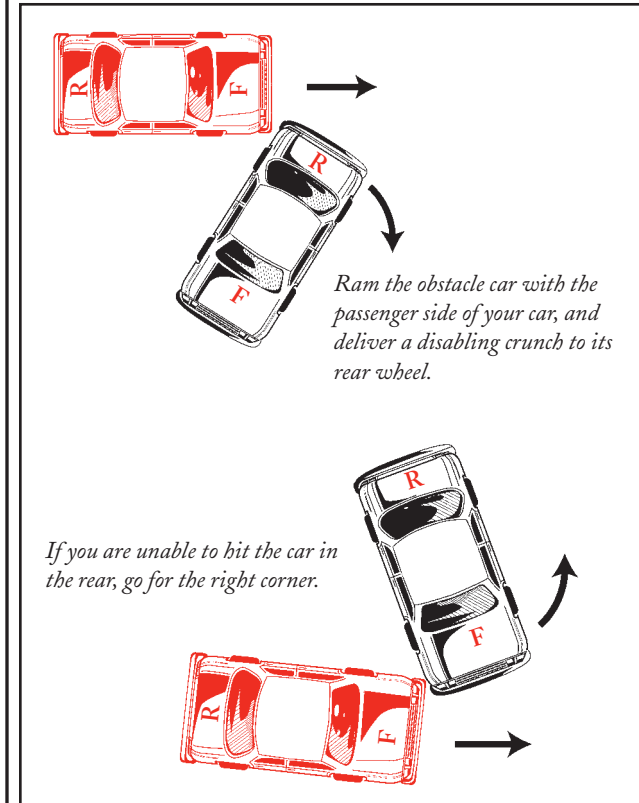

HOW TO SURVIVE A POISONOUS SNAKE ATTACK

Because poisonous snakes can be difficult to identify—and because some nonpoisonous snakes have markings very similar to venomous ones—the best way to avoid getting bitten is to leave all snakes alone. Assume that a snake is venomous unless you know for certain that it is not.

HOW TO TREAT A BITE

1 Wash the bite with soap and water as soon as you can.

2 Immobilize the bitten area and keep it lower than the heart.

This will slow the flow of the venom.

3 Get medical help as soon as possible.

A doctor should treat all snakebites unless you are willing to bet your life that the offending snake is nonpoisonous. Of about eight thousand venomous bites a year in the U.S., nine to fifteen victims are killed. A bite from any type of poisonous snake should always be considered a medical emergency. Even bites from nonpoisonous snakes should be treated professionally, as severe allergic reactions can occur. Some

Mojave rattlesnakes carry a neurotoxic venom that can affect the brain or spinal cord, causing paralysis.

4 Immediately wrap a bandage tightly two to four inches above the bite to help slow the venom if you are unable to reach medical care within thirty minutes.

The bandage should not cut off blood flow from a vein or artery. Make the bandage loose enough for a finger to slip underneath.

5 If you have a first aid kit equipped with a suction device, follow the instructions for helping to draw venom out of the wound without making an incision. Generally, you will need to place the rubber suction cup over the wound and attempt to draw the venom out from the bite marks.

WHAT NOT TO DO

- Do not place any ice or cooling element on the bite; this will make removing the venom with suction more difficult.
- Do not tie a bandage or a tourniquet too tightly. If used incorrectly, a tourniquet can cut blood flow completely and damage the limb.
- Do not make any incision on or around the wound in an attempt to remove the venom—there is danger of infection.
- Do not attempt to suck out the venom. You do not want it in your mouth, where it might enter your bloodstream.

Snakes coil before they strike.



Snakes can strike at a distance approximately half their length; half their body does not leave the ground.



HOW TO ESCAPE FROM A PYTHON

Unlike poisonous snakes, pythons and boas kill their prey not through the injection of venom but by constriction; hence these snakes are known as constrictors. A constrictor coils its body around its prey, squeezing it until the pressure is great enough to kill.

Since pythons and boas can grow to be nearly twenty feet long, they are fully capable of killing a grown person, and small children are even more vulnerable. The good news is that most pythons will strike and then try to get away, rather than consume a full-grown human.

1 **Remain still.**

This will minimize constriction strength, but a python usually continues constricting well after the prey is dead and not moving.

2 **Try to control the python's head and try to unwrap the coils, starting from whichever end is available.**

HOW TO AVOID AN ATTACK

- Do not try to get a closer look, prod the snake to make it move, or try to kill it.
- If you come across a snake, back away slowly and give it a wide berth: snakes can easily strike half their body length in an instant, and some species are six feet or longer.
- When hiking in an area with poisonous snakes, always wear thick leather boots and long pants.
- Keep to marked trails.
- Snakes are cold-blooded and need the sun to help regulate their body temperature. They are often found lying on warm rocks or in other sunny places.

WORST-CASE SCENARIO.

HOW TO SURVIVE ADRIFT AT SEA

- 1 Stay aboard your boat as long as possible before you get into a life raft.**

In a maritime emergency, the rule of thumb is that you should step up into your raft, meaning you should be up to your waist in water before you get into the raft. Your best chance of survival is on a boat—even a disabled one—not on a life raft. But if the boat is sinking, know how to use a life raft. Any craft that sails in open water (a boat larger than fourteen feet) should have at least one life raft. Smaller boats may only have life jackets, so these vessels should stay within easy swimming distance of land.

- 2 Get in the life raft, and take whatever supplies you can carry.**

Most importantly, if you have water in jugs, take it with you. Do not drink seawater. A person can last for several days without food at sea, but without clean water to drink, death is a virtual certainty within several days. If worse comes to worst, throw the jugs of water overboard so that you can get them later—they will float.

Many canned foods, particularly vegetables, are packed in water, so take those with you if you can. Do not ration water; drink it as needed, but don't drink more than is necessary—a half-gallon a day should be sufficient if you limit your activity.

Objects you can use to signal for help



watch

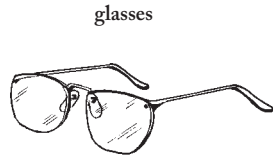

glasses

aluminum can

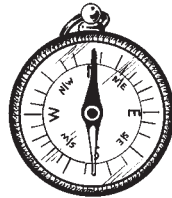
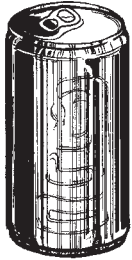

compass

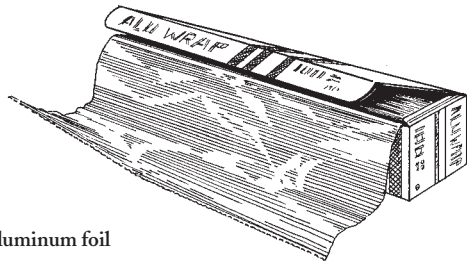

aluminum foil

3 If you are in a cold water/weather environment, get warm.

You are more likely to die of exposure or hypothermia than of anything else.

Put on dry clothes and stay out of the water. Prolonged exposure to saltwater can damage your skin and cause lesions, which are prone to infection.

Stay covered. Modern life rafts have canopies, which protect passengers from sun, wind, and rain. If the canopy is missing or damaged, wear a hat, long sleeves, and pants to protect yourself from the sun.

4 Find food, if you can.

Life rafts include fishing hooks in their survival kits. If your raft is floating for several weeks, seaweed will form on its underside and fish will naturally congregate in the shade under you. You can catch them with the hook and eat the flesh raw. If no hook is available, you can fashion one using wire or even shards of aluminum from an empty can.

5 Try to get to land, if you know where it is.

Most rafts include small paddles, but life rafts are not very maneuverable, especially in any wind above three knots. Do not exhaust yourself—you will not be able to move any significant distance without great effort.

6 If you see a plane or boat nearby, try to signal them.

Use a VHF radio or a handheld flare kit to get their attention. A small mirror can also be used for signaling.

HOW TO PREPARE

Never go out on a boat unprepared. Most boats should have at least one type of emergency signaling device, which is called an Emergency Position Radio Beacon, or EPIRB. These devices send out global marine distress signals and come in two forms: 406 MHz and 125 MHz. Both will send your boat identification and position, but the 406 goes to other ships, passing airplanes, and satellites, while the 125 only goes to ships and planes. People without one of these devices can drift for months before they are found.

Always carry a “go bag” that contains:

- Warm, dry clothes and blankets
- A hat
- Food (canned goods, backpacking foods, dried fruit)
- A handheld VHF radio
- A small, handheld GPS (Global Positioning Satellite) tracking unit
- Drinking water in portable jugs
- A compass
- A flashlight with extra batteries
- Handheld flares
- A handheld watermaker

**WORST-CASE
SCENARIO.**

HOW TO SURVIVE AN AVALANCHE

1 Struggle to stay on top of the snow by using a freestyle swimming motion.

2 If you are buried, your best chance of survival is if someone saw you get covered.

The snow in an avalanche is like a wet snowball: it is not light and powdery, and once you are buried, it is very difficult to dig your way out.

3 If you are only partially buried, you can dig your way out with your hands or by kicking at the snow.

If you still have a ski pole, poke through the snow in several directions until you see or feel open air, then dig in that direction.

4 If you are completely buried, chances are you will be too injured to help yourself.

However, if you are able, dig a small hole around you and spit in it. The saliva should head downhill, giving you an idea of which direction is up. Dig up, and do it quickly.

Be Aware

- Never go hiking or skiing alone in avalanche territory.
- Carry an avalanche probe—a sturdy, sectional aluminum pole that fits together to create a probe

Struggle to stay on top of the snow by using a freestyle swimming motion.



six to eight feet in length. Some ski poles are threaded and can be screwed together to form avalanche probes.

- Know where and when avalanches are likely to occur.
- Avalanches occur in areas with new snow; on the leeward side of mountains (the side facing away from the wind); and in the afternoons of sunny days, when the morning sun may have loosened

the snowpack. They occur most often on mountainsides with angles of thirty to forty-five degrees—these are often the most popular slopes for skiing.

- Avalanches can be triggered by numerous factors, including recent snowfall, wind, and sunlight. As new snow accumulates with successive storms, the layers may be of different consistencies and not bond to one another, making the snow highly unstable.
- Loud noises do not cause avalanches except if they cause significant vibrations in the ground or snow.
- The activity with the highest avalanche risk is now snowmobiling. Snowmobiles—sometimes called mountain sleds—are powerful and light, and can get high into mountainous terrain, where avalanches occur.
- Carry a beacon. The beacon broadcasts your position by setting up a magnetic field that can be picked up by the other beacons in your group. If skiing on a dangerous slope, go down one at a time, not as a group, in case a slide occurs.

HOW TO RESCUE OTHERS

If you have witnessed others being buried by an avalanche, contact the ski patrol as soon as possible. Then search first by trees and benches—the places where people are most commonly buried. All searchers should have small, collapsible shovels to help them dig quickly if they find someone.

**WORST-CASE
SCENARIO.**

HOW TO SURVIVE AN EARTHQUAKE

1 If you are indoors, stay there!

Get under a desk or table and hang on to it, or move into a doorway; the next best place is in a hallway or against an inside wall. Stay clear of windows, fireplaces, and heavy furniture or appliances. Get out of the kitchen, which is a dangerous place. Do not run downstairs or rush outside while the building is shaking or while there is danger of falling and hurting yourself or being hit by falling glass or debris.

2 If you are outside, get into the open, away from buildings, power lines, chimneys, and anything else that might fall on you.

3 If you are driving, stop, but carefully.

Move your car as far out of traffic as possible. Do not stop on or under a bridge or overpass or under trees, light posts, power lines, or signs. Stay inside your car until the shaking stops. When you resume driving watch for breaks in the pavement, fallen rocks, and bumps in the road at bridge approaches.

4 If you are in a mountainous area, watch out for falling rocks, landslides, trees, and other debris that could be loosened by quakes.

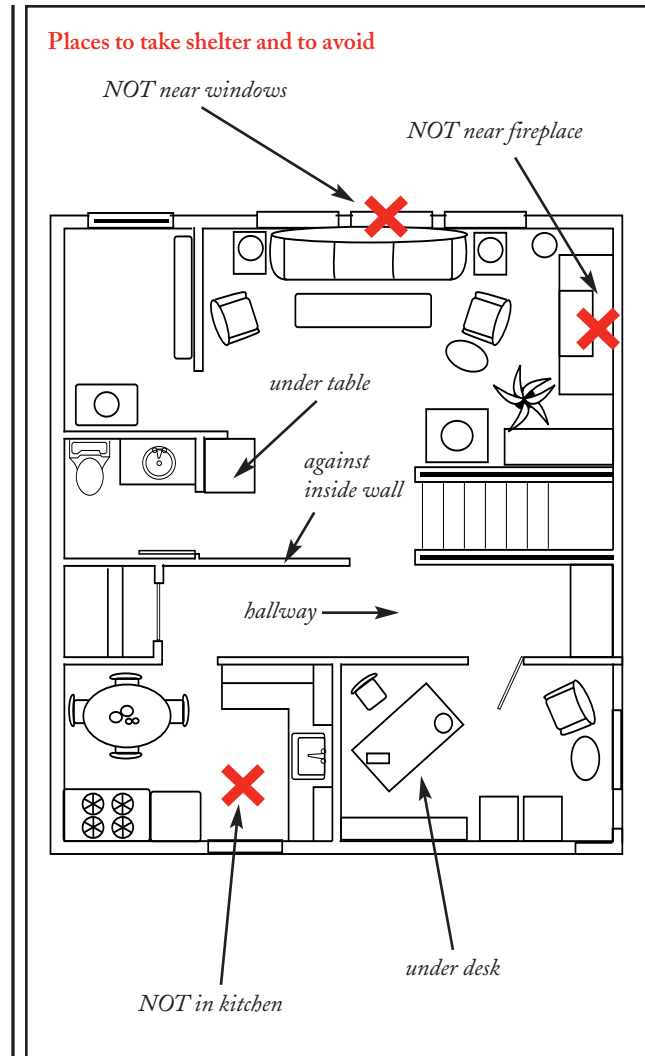

5 **After the quake stops, check for injuries and apply the necessary first aid or seek help.**

Do not attempt to move seriously injured persons unless they are in further danger of injury. Cover them with blankets and seek medical help for serious injuries.

6 **If you can, put on a pair of sturdy thick-soled shoes (in case you step on broken glass, debris, etc.).**

7 **Check for hazards.**

- Put out fires in your home or neighborhood immediately.
- Gas leaks: shut off main gas valve only if you suspect a leak because of broken pipes or odor. Do not use matches, lighters, camp stoves or barbecues, electrical equipment, or appliances until you are sure there are no gas leaks. They may create a spark that could ignite leaking gas and cause an explosion and fire. Do not turn on the gas again if you turned it off—let the gas company do it.
- Damaged electrical wiring: shut off power at the control box if there is any danger to house wiring.
- Downed or damaged utility lines: do not touch downed power lines or any objects in contact with them.
- Spills: clean up any spilled medicines, drugs, or other harmful materials such as bleach, lye, or gas.

- Downed or damaged chimneys: approach with caution and do not use a damaged chimney (it could start a fire or let poisonous gases into your house).
- Fallen items: beware of items tumbling off shelves when you open closet and cupboard doors.

8 **Check food and water supplies.**

Do not eat or drink anything from open containers near shattered glass. If the power is off, plan meals to use up frozen foods or foods that will spoil quickly. Food in the freezer should be good for at least a couple of days. If the water is off you can drink from water heaters, melted ice cubes, or canned vegetables. Avoid drinking water from swimming pools and spas.

9 **Be prepared for aftershocks.**

Another quake, larger or smaller, may follow.

Be Aware

- Use your telephone only for a medical or fire emergency—you could tie up the lines needed for emergency response. If the phone doesn't work, send someone for help.
- Do not expect firefighters, police, or paramedics to help you immediately. They may not be available.

HOW TO PREPARE

Being prepared for an earthquake is the best way to survive one. Make sure each member of the household knows what to do no matter where they are when a quake occurs:

- Establish a meeting place where you can reunite afterward.
- Find out about earthquake plans developed by your children's school or day care.
- Transportation may be disrupted, so keep emergency supplies—food, liquids, and comfortable shoes, for example—at work.
- Know where your gas, electric, and water main shutoffs are and how to turn them off if there is a leak or electrical short. Make sure older members of the family can shut off utilities.
- Locate your nearest fire and police stations and emergency medical facility.
- Talk to your neighbors—you can help one another during and after an earthquake.
- Take Red Cross first aid and CPR training courses.

**WORST-CASE
SCENARIO.**

WORST-CASE SCENARIO.

HOW TO SURVIVE IF YOU ARE IN THE LINE OF GUNFIRE

IF YOU ARE THE PRIMARY TARGET

- 1 Get as far away as possible.**
An untrained shooter isn't likely to be accurate at any distance greater than sixty feet.
- 2 Run fast, but do not move in a straight line—weave back and forth to make it more difficult for the shooter to draw a bead on you.**
The average shooter will not have the training necessary to hit a moving target at any real distance.

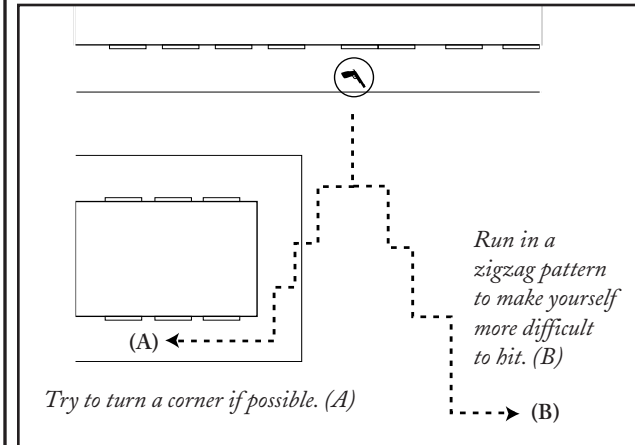

3 Do not bother to count shots.

You will have no idea if the shooter has more ammunition. Counting is only for the movies.

4 Turn a corner as quickly as you can, particularly if your pursuer has a rifle or assault weapon.

Rifles have much greater accuracy and range, and the person may be more likely to either aim or spray bullets in your direction.

IF YOU ARE NOT THE PRIMARY TARGET

1 Get down, and stay down.

If the intended target is near you or if the shooter is firing at random, get as low as possible. Do not crouch down; get flat on your stomach and stay there.

2 If you are outside and can get to a car, run to it and lie behind a tire on the opposite side of the car from the shooter.

If no cars are present, lie in the gutter next to the curb. A car will stop or deflect a small-caliber bullet fired toward you. However, higher caliber bullets—such as those from an assault rifle or bullets that are designed to pierce armor—can easily penetrate a car and hit someone on the opposite side.

3 If you are inside a building and the shooter is inside, get to another room and lie flat.

If you cannot get to another room, move behind any heavy, thick objects (a solid desk, filing cabinets, tables, a couch) for protection.

4 If you are face-to-face with the shooter, do anything you can to make yourself less of a target.

Turn sideways, and stay low—stray bullets are likely to be at least a few feet above the ground. If the shooter is outside, stay inside and stay away from doors and windows.

5 Stay down until the shooting stops or until authorities arrive and give the all clear.

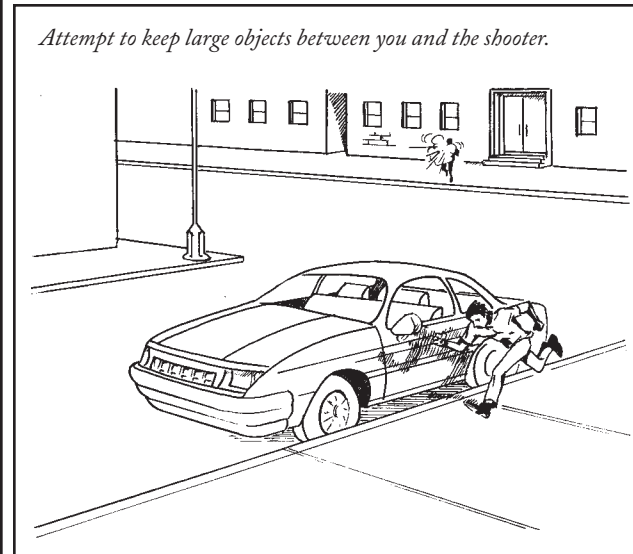

WORST-CASE SCENARIO.

HOW TO SURVIVE IF YOUR PARACHUTE FAILS TO OPEN

- 1** As soon as you realize that your chute is bad, signal to a jumping companion whose chute has not yet opened that you are having a malfunction.
Wave your arms and point to your chute.
- 2** When your companion (and new best friend) gets to you, hook arms.
- 3** Once you are hooked together, the two of you will still be falling at terminal velocity, or about 130 miles per hour.
When your friend opens his chute, there will be no way either of you will be able hold on to one another normally, because the G-forces will triple or quadruple your body weight. To prepare for this problem, hook your arms into his chest strap, or through the two sides of the front of his harness, all the way up to your elbows, and grab hold of your own strap.
- 4** Open the chute.
The chute opening shock will be severe, probably enough to dislocate or break your arms.

Hook arms with your companion. Then hook your arms into his chest strap, up to the elbows, and grab hold of your own.

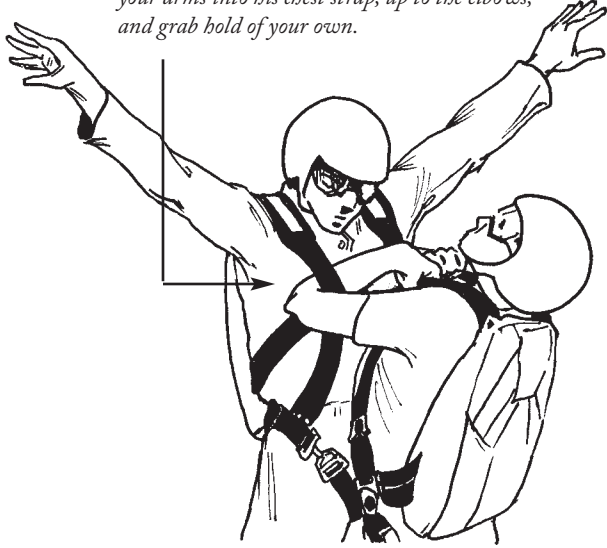

6 **If there is a body of water nearby, head for that.**

Of course, once you hit the water, you will have to tread with just your legs and hope that your partner is able to pull you out before your chute takes in water.

HOW TO PREPARE

Check your chute before you jump. The good news is that today's parachutes are built to open, so even if you make big mistakes packing them, they tend to sort themselves out. The reserve chute, however, must be packed by a certified rigger and must be perfect as it is your last resort. Make sure that:

- The parachute is folded in straight lines—that there are no twists.
- The slider is positioned correctly to keep the parachute from opening too fast.

5 **Steer the canopy.**

Your friend must now hold on to you with one arm while steering his canopy (the part of the chute that controls direction and speed).

If your friend's canopy is slow and big, you may hit the grass or dirt slowly enough to break only a leg, and your chances of survival are high.

If his canopy is a fast one, however, your friend will have to steer to avoid hitting the ground too fast. You must also avoid power lines and other obstructions at all costs.

WORST-CASE SCENARIO.

HOW TO SURVIVE WHEN LOST IN THE DESERT

- 1 Do not panic, especially if people know where you are and when you are scheduled to return.**
If you have a vehicle, stay with it—do not wander!
- 2 If you are on foot, try to backtrack by retracing your steps.**
Always move downstream or down country. Travel along ridges instead of in washes or valleys, where it is harder for you to see and for rescuers to see you.
- 3 If you have completely lost your bearings, try to get to a high vista and look around.**
If you are not absolutely sure you can follow your tracks or prints, stay put.
- 4 Build smoky fires during daylight hours (tires work well) but keep a bright fire burning at night.**
If fuel is limited, keep a small kindling-fire burning and have fuel ready to burn if you spot a person or vehicle.
- 5 If a car or plane is passing, or if you see other people off in the distance, try to signal them with one of the following methods:**

In a clearing, you can use newspaper or aluminum foil weighed down with rocks to make a large triangle; this is the international distress symbol.

- A large I indicates to rescuers that someone is injured.
- An X means you are unable to proceed.
- An F indicates you need food and water.
- Three shots from a gun is another recognized distress signal.

6 To avoid heat prostration, rest frequently.

Deserts in the United States can reach temperatures upwards of 120 degrees during the day, and shade can be scarce. In the summer, sit at least twelve inches above the ground on a stool or a branch (ground temperatures can be thirty degrees hotter than the surrounding air temperature).

When walking during daylight hours:

- Walk slowly to conserve energy and rest at least ten minutes every hour.
- Drink water; don't ration it.
- Avoid talking and smoking.
- Breathe through your nose, not your mouth.
- Avoid alcohol, which dehydrates.
- Avoid eating if there is not a sufficient amount of water readily available; digestion consumes water.
- Stay in the shade and wear clothing, including a shirt, hat, and sunglasses. Clothing helps ration sweat by slowing evaporation and prolonging cooling.

- Travel in the evening, at night, or early in the day.
- In cold weather, wear layers of clothing, and make sure you and your clothes are dry.
- Watch for signs of hypothermia, which include intense shivering, muscle tensing, fatigue, poor coordination, stumbling, and blueness of the lips and fingernails. If you see these signs, get dry clothing on immediately and light a fire if possible. If not, huddle close to companions for warmth.

7 Try to find water. The best places to look are:

- The base of rock cliffs.
- In the gravel wash from mountain valleys, especially after a recent rain.
- The outside edge of a sharp bend in a dry streambed. Look for wet sand, then dig down three to six feet to find seeping water.
- Near green vegetation. Tree clusters and other shrubbery, such as cottonwood, sycamore, or willow trees, may indicate the presence of water.
- Animal paths and flocks of birds. Following them may lead you to water.

8 Find cactus fruit and flowers.

Split open the base of cactus stalks and chew on the pith, but don't swallow it. Carry chunks of pith to alleviate thirst while walking. Other desert plants are inedible and will make you sick.

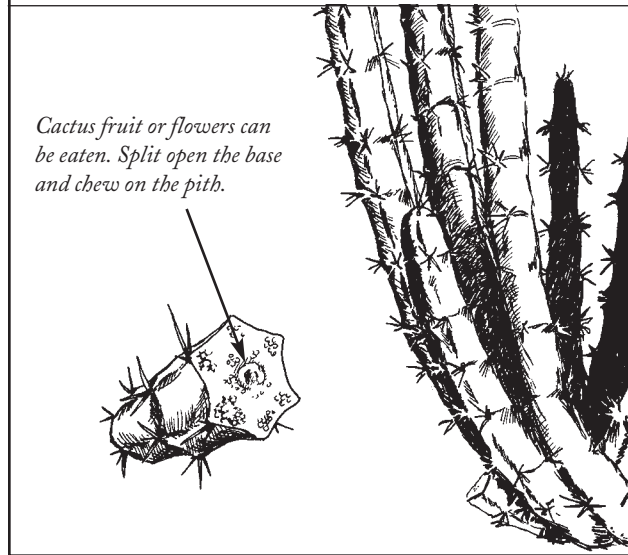
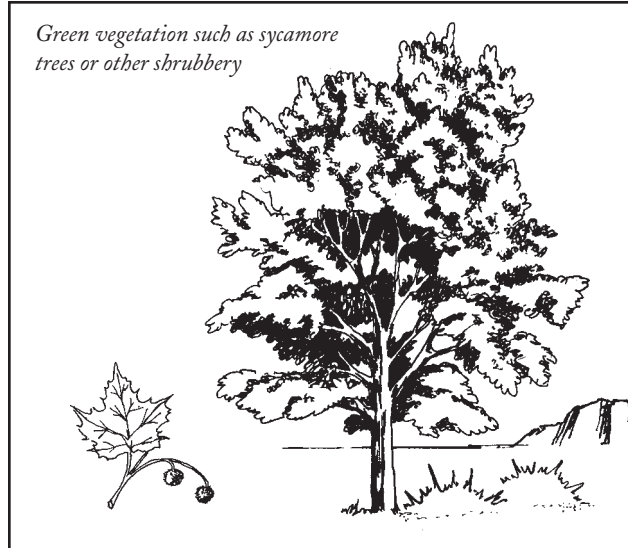
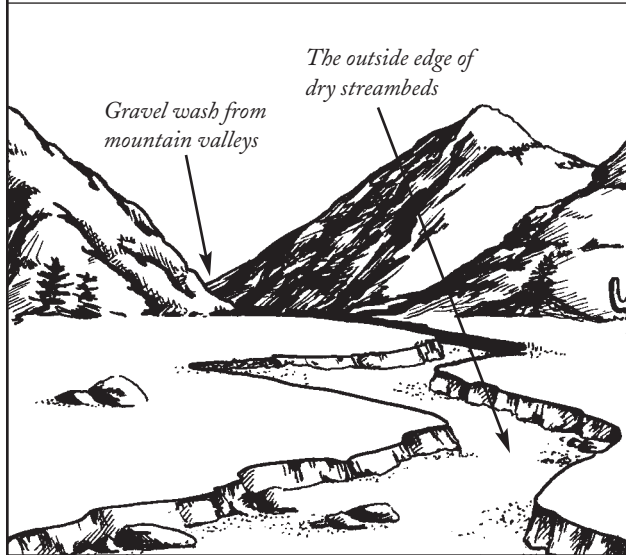
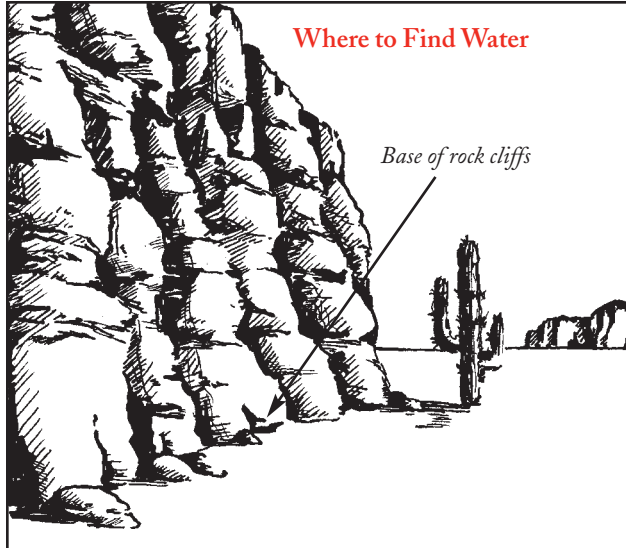

HOW TO PREPARE

When planning a trip to a desert area that is sparsely populated, always inform someone of your destination, the duration of the trip, and its intended route. Leaving without alerting anyone and getting lost means no one will be looking for you.

If traveling by car, make sure your vehicle is in good condition, and make sure you have:

- A sound battery
- Good hoses (squeeze them: they should be firm, not soft and mushy)
- A spare tire with the proper inflation
- Spare fan belts
- Tools
- Reserve gasoline and oil
- Water (five gallons for a vehicle)

HOW TO DRIVE SAFELY

Keep an eye on the sky. Flash floods can occur in a wash any time thunderheads are in sight, even though it may not be raining where you are. If you get caught in a dust storm while driving, get off the road immediately. Turn off your driving lights and turn on your emergency flashers. Back into the wind to reduce windshield pitting by sand particles. Before driving through washes and sandy areas, test the footing. One minute on foot may save hours of hard work and prevent a punctured oil pan.

If your vehicle breaks down, stay near it; your emergency supplies are there. Raise the hood and trunk lid to denote “help needed.” A vehicle can be seen for miles, but a person is very difficult to find.

- Leave a disabled vehicle only if you are positive of the route to help.
- If stalled or lost, set signal fires. Set smoky fires in the daytime, bright ones for the night. Three fires in a triangle denotes “help needed.”
- If you find a road, stay on it.

WHAT TO BRING WHEN TRAVELING BY FOOT

- Water (one gallon per person per day is adequate; two or more gallons is smarter and safer)
- A map that shows the nearest populated areas
- Waterproof matches
- A cigarette lighter or flint and steel
- A survival guide
- Strong sunscreen, a hat, warm clothes, and blankets
- A pocket knife
- A metal signaling mirror
- Iodine tablets
- A small pencil and writing materials
- A whistle (three blasts denotes “help needed”)
- A canteen cup
- Aluminum foil
- A compass
- A first aid kit

HOW TO AVOID GETTING LOST

- When hiking, periodically look back in the direction from where you have come. Taking a mental picture of what it will look like when you return helps in case you become lost.
- Stay on established trails if possible and mark the trail route with blazes on trees and brush, or by making *ducques* (pronounced “ducks”), which are piles of three rocks stacked on top of one another.

**WORST-CASE
SCENARIO.**

HOW TO SURVIVE WHEN LOST IN THE MOUNTAINS

The number one cause of death when lost in the mountains is hypothermia—humans are basically tropical animals. Staying calm in the face of darkness, loneliness, and the unknown will greatly increase your chances of survival. Eighty percent of mountain survival is your reaction to fear, 10 percent is your survival gear, and the other 10 percent is knowing how to use it. Always tell someone else where you are going and when you will return.

1 Do not panic.

If you told someone where you were going, search and rescue teams will be looking for you. (In general, teams will search only during daylight hours for adults, but will search around the clock for children who are alone.)

2 Find shelter, and stay warm and dry.

Exerting yourself unnecessarily—like dragging heavy logs to build a shelter—will make you sweat and make you cold. Use the shelter around you before trying to construct one. If you are in a snow-covered area, you may be able to dig a cave in deep snow for shelter and protection from the wind. A snow trench may be a better idea—it requires less exertion. Simply use

In snow-covered country, build a snow cave or a snow trench for shelter and warmth. Use dead leaves and branches for insulation.

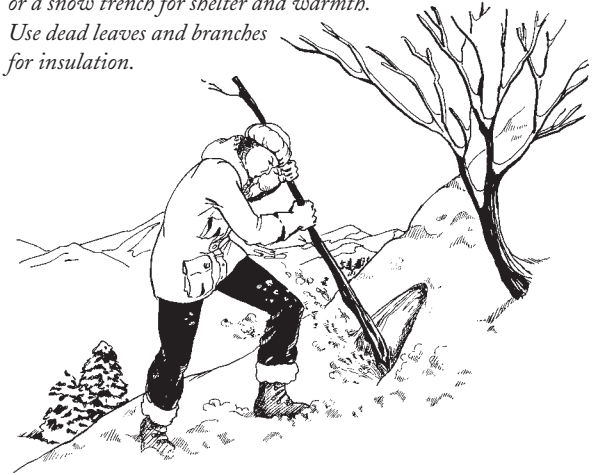

something to dig a trench, get in it, and cover it with branches or leaves. You should attempt to make your shelter in the middle of the mountain if possible. Stay out of the valleys—cold air falls, and the valley floor can be the coldest spot on the mountain.

3 Signal rescuers for help.

The best time to signal rescuers is during the day, with a signaling device or three fires in a triangle. Signal for help from the highest point possible—it will be easier for rescuers to see you, and any sound you make will travel farther. Build three smoky fires and put your blanket—gold side facing out, if it is a space blanket—on the ground.

4 Do not wander far.

It will make finding you more difficult, as search teams will be trying to retrace your path and may miss you if you have gone off in a different direction. Searchers often wind up finding a vehicle with no one in it because the driver has wandered off.

5 If you get frostbite, do not rewarm the affected area until you're out of danger.

You can walk on frostbitten feet, but once you warm the area and can feel the pain, you will not want to walk anywhere. Try to protect the frostbitten area and keep it dry until you are rescued.

HOW TO PREPARE

You must dress properly before entering a wilderness area. Layer your clothing in the following manner:

FIRST (INNER) LAYER: long underwear, preferably polypropylene. This provides only slight insulation—its purpose is to draw moisture off your skin.

SECOND (MIDDLE) LAYER: something to trap and create warm “dead air” space, such as a down parka.

THIRD (OUTER) LAYER: a Gore-Tex or other brand of breathable jacket that allows moisture out but not in. Dry insulation is key to your survival. Once you are wet, it is very difficult to get dry.

Make sure you have the following items in your survival kit, and that you know how to use them (reading the instructions for the first time in the dark wilderness is not recommended):

A HEAT SOURCE. Bring several boxes of waterproof matches, as well as a lighter. Trioxane—a small, light, chemical heat source that the Army uses—is recommended. Trioxane packs can be picked up in outdoor and military surplus stores. Dryer lint is also highly flammable and very lightweight.

SHELTER. Carry a small space blanket, which has a foil-like coating that insulates you. Get one that is silver on one side (for warmth) and orange-gold on the other, which can be used for signaling. The silver side is not a good color to signal with. It can be mistaken for ice or mineral rock. The orange-gold color does not occur in nature and will not be mistaken for anything else.

A SIGNALING DEVICE. A small mirror works well, as do flares or a whistle, which carries much farther than a voice.

FOOD. Pack carbohydrates: bagels, trail mix, granola bars, and so on. Proteins need heat to break down and require more water for digestion.

**WORST-CASE
SCENARIO.**

HOW TO TAKE A PUNCH

A BLOW TO THE BODY

- 1 Tighten your stomach muscles.**
A body blow to the gut (solar plexus) can damage organs and kill. This sort of punch is one of the best and easiest ways to knock someone out. (Harry Houdini died from an unexpected blow to the abdomen.)
- 2 Do not suck in your stomach if you expect that a punch is imminent.**

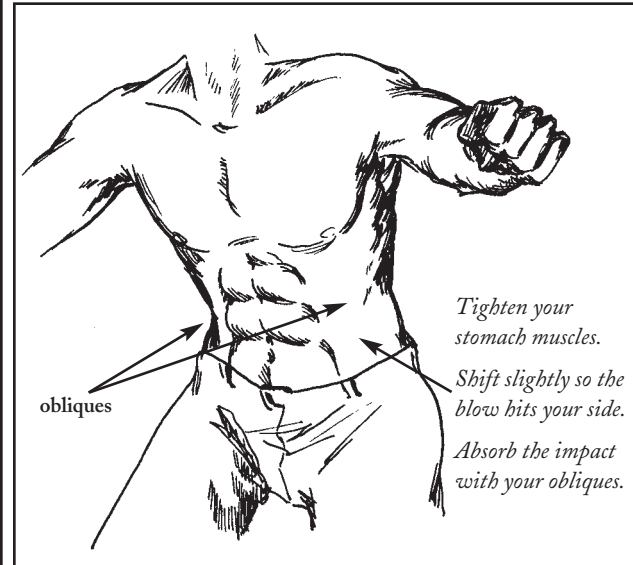

- 3** If possible, shift slightly so that the blow hits your side, but do not flinch or move away from the punch.

Try to absorb the blow with your obliques: this is the set of muscles on your side that wraps around your ribs. While a blow to this area may crack a rib, it is less likely to do damage to internal organs.

A BLOW TO THE HEAD

- 1** Move toward the blow, not away from it. Getting punched while moving backward will result in the head taking the punch at full force. A punch to the face can cause head whipping, where the brain moves suddenly inside the skull, and may result in severe injury or death.
- 2** Tighten your neck muscles and clench your jaw to avoid scraping of the upper and lower palettes.

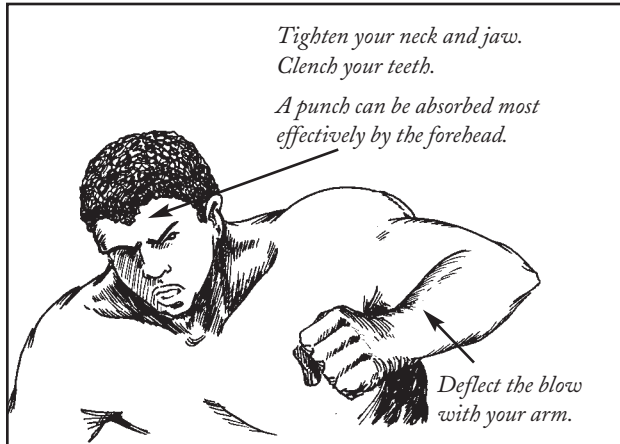

A STRAIGHT PUNCH

- 1** The straight punch—one that comes straight at your face—should be countered by moving toward the blow. This will take force from the blow.
- 2** A punch can be absorbed most effectively and with the least injury by the forehead. Avoid taking the punch in the nose, which is extremely painful.
- 3** Attempt to deflect the blow with an arm. Moving into the punch may result in your attacker missing the mark wide to either side.
- 4** (optional) Hit back with an uppercut or roundhouse.

A ROUNDHOUSE PUNCH

- 1** Clench your jaw. A punch to the ear causes great pain and can break your jaw.
- 2** Move in close to your attacker. Try to make the punch land harmlessly behind your head.
- 3** (optional) Hit back with an uppercut.

AN UPPERCUT

- 1 Clench your neck and jaw.**
An uppercut can cause much damage, whipping your head back, easily breaking your jaw or your nose.
- 2 Use your arm to absorb some of the impact or deflect the blow to the side—anything to minimize the impact of a straight punch to the jaw.**
- 3 Do not step into this punch.**
If possible, move your head to the side.
- 4 (optional) Hit back with a straight punch to the face or with an uppercut of your own.**

**WORST-CASE
SCENARIO.**

**WORST-CASE
SCENARIO.**

HOW TO TREAT A BULLET OR KNIFE WOUND

- 1 Do not immediately pull out any impaled objects.**
Bullets, arrows, knives, sticks, and the like cause penetrating injuries. When these objects lodge in the vital areas of the body (the trunk or near nerves or arteries) removing them may cause more severe bleeding that cannot be controlled. The object may be pressed against an artery or other vital internal structure and may actually be helping to reduce the bleeding.
- 2 Control the bleeding by using a combination of direct pressure, limb elevation, pressure points, and tourniquets (in that order).**
DIRECT PRESSURE. You can control most bleeding by placing direct pressure on the wound. Attempt to apply pressure directly to bleeding surfaces. The scalp, for instance, bleeds profusely. Using your fingertips to press the edges of a scalp wound against the underlying bone is more effective than using the palm of your hand to apply pressure over a wider area. Use the tips of your fingers to control bleeding arterioles (small squirting vessels).

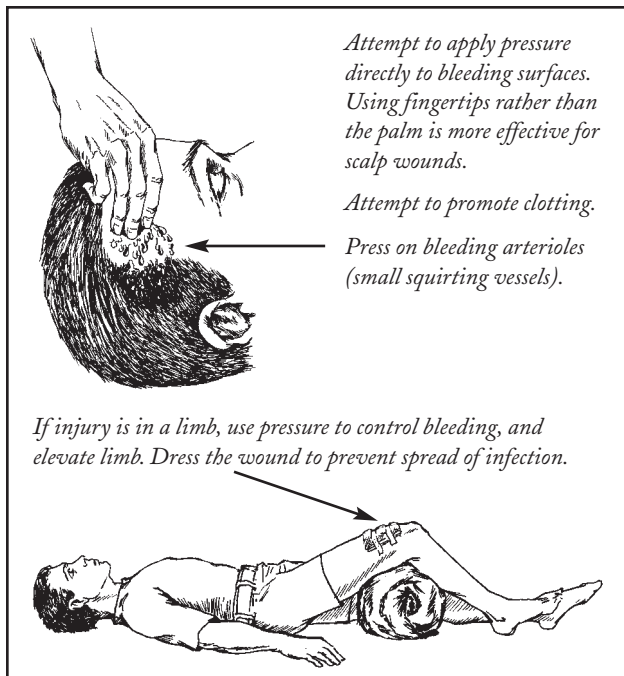

LIMB ELEVATION. When a wound is in an extremity, elevation of the extremity above the heart, in addition to direct pressure, may reduce the bleeding further. Never make people who are in shock sit up simply to elevate a bleeding wound.

PRESSURE POINTS. To reduce blood flow you usually have to compress an artery (where you can feel the pulse) near the wound against an underlying bone. Just pressing into the soft belly of a muscle does not reduce blood flow by this mechanism.

TOURNIQUETS. A tourniquet is a wide band of cloth or a belt that is placed around an extremity and tightened (usually using a windlass) until the blood flow is cut off. The blood supply must be compressed against a long bone (the upper arm or upper leg) since vessels between the double bones in the lower arm and lower leg will continue to bleed despite a tourniquet. The amount of pressure necessary typically causes additional vascular and nerve trauma that is permanent. A tourniquet should only be used as a last resort—to save a life at the expense of sacrificing a limb.

3 Immobilize the injured area.

Using splints and dressings to immobilize an injured area helps protect from further injury and maintain clots that have begun to form. Even if an injury to a bone or joint is not suspected, immobilization will promote clotting and help healing begin.

4 Dress the wound, and strive to prevent infection.

Use sterile (or at least clean) dressings as much as possible. Penetrating injuries may allow anaerobic (air-hating) bacteria to get deep into the tissue. This is why penetrating wounds are typically irrigated with sterile or antibiotic solutions in surgery. While this is rarely practical outside of the hospital, it is important to remember that smaller penetrating wounds (nail holes in the foot and the like) should be encouraged to bleed for a short period to help “wash out” foreign material. Soaking an extremity in hydrogen peroxide may help kill anaerobic bacteria as well. Do not apply

ointments or goo to penetrating wounds as these may actually promote infection.

Emergency Tip

Some data indicate that pure granular sugar poured into a penetrating wound can decrease bleeding, promote clotting, and discourage bacteria. You are not likely to see it used in your local emergency department, but it might be worth consideration if your circumstances are dire.

5 Get medical attention as soon as possible.

Be Aware

It should be noted that tourniquets are rarely helpful—it is uncommon to have life-threatening bleeding in an extremity that cannot be controlled by the methods described above. The areas that cause fatal bleeding (like the femoral arteries or intra-abdominal bleeding) do not lend themselves to the use of a tourniquet. Even most complete amputations do not bleed all that much, and are controlled by direct pressure. Arteries that are severed only part of the way through tend to bleed more profusely than those that are completely severed.

**WORST-CASE
SCENARIO.**

HOW TO TREAT A LEG FRACTURE

Most leg injuries are only sprains, but the treatment for both sprains and fractures is the same.

- 1 If skin is broken, do not touch or put anything on the wound.**
You must avoid infection. If the wound is bleeding severely, try to stop the flow of blood by applying steady pressure to the affected area with sterile bandages or clean clothes.
- 2 Do not move the injured leg—you need to splint the wound to stabilize the injured area.**
- 3 Find two stiff objects of the same length—wood, plastic, or folded cardboard—for the splints.**
- 4 Put the splints above and below the injured area—under the leg (or on the side if moving the leg is too painful).**
- 5 Tie the splints with string, rope, or belts—whatever is available.**
Alternatively, use clothing torn into strips. Make sure the splint extends beyond the injured area.
- 6 Do not tie the splints too tightly; this may cut off circulation.**



Do not move the injured leg.

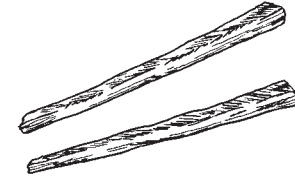

Find two stiff objects of the same length—wood, plastic, or folded cardboard.



Place the splints above and below the injured area.



Tie the splints with string, rope, or belts—whatever is available.



Do not tie the splints too tightly—you should be able to slip one finger under the rope, belt, or fabric.

You should be able to slip a finger under the rope or fabric. If the splinted area becomes pale or white, loosen the ties.

7 **Have the injured person lie flat on their back.**

This helps blood continue to circulate and may prevent shock.

SYMPTOMS OF A FRACTURE, SPRAIN, OR DISLOCATION

- Difficult or limited movement
- Swelling
- Bruising of the affected area
- Severe pain
- Numbness
- Severe bleeding
- A visible break of bone through the skin

WHAT TO AVOID

- Do not push at, probe, or attempt to clean an injury; this can cause infection.
- Do not move the injured person unless absolutely necessary. Treat the fracture and then go get help.
- If the person must be moved, be sure the injury is completely immobilized first.
- Do not elevate a leg injury.
- Do not attempt to move or reset a broken bone; this will cause severe pain and may complicate the injury.

**WORST-CASE
SCENARIO.**

WORST-CASE SCENARIO.

HOW TO TREAT FROSTBITE

Frostbite is a condition caused by the freezing of water molecules in skin cells and occurs in very cold temperatures. It is characterized by white, waxy skin that feels numb and hard. More severe cases result in a bluish black skin color, and the most severe cases result in gangrene, which may lead to amputation. Affected areas are generally fingertips and toes, and the nose, ears, and cheeks. Frostbite should be treated by a doctor. However, in an emergency, take the following steps.

- 1** Remove wet clothing and dress the area with warm, dry clothing.
- 2** Immerse frozen areas in warm water (100–105° F) or apply warm compresses for ten to thirty minutes.
- 3** If warm water is not available, wrap gently in warm blankets.
- 4** Avoid direct heat, including electric or gas fires, heating pads, and hot water bottles.
- 5** Never thaw the area if it is at risk of refreezing; this can cause severe tissue damage.

6 Do not rub frostbitten skin or rub snow on it.

7 Take a pain reliever such as aspirin or ibuprofen during rewarming to lessen the pain.

Rewarming will be accompanied by a severe burning sensation. There may be skin blistering and soft tissue swelling and the skin may turn red, blue, or purple in color. When skin is pink and no longer numb, the area is thawed.

8 Apply sterile dressings to the affected areas.

Place the dressing between fingers or toes if they have been affected. Try not to disturb any blisters, wrap rewarmed areas to prevent refreezing, and have the patient keep thawed areas as still as possible.

9 Get medical treatment as soon as possible.

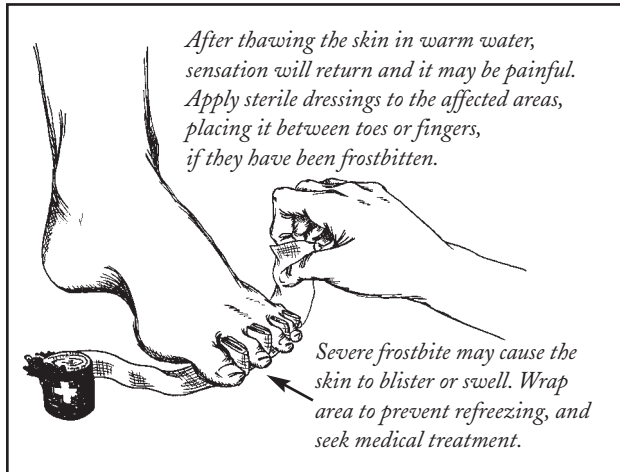

HOW TO TREAT FROSTNIP

Frostnip is the early warning sign of frostbite. Frostnip is characterized by numbness and a pale coloring of the affected areas. It can be safely treated at home.

1 Remove wet clothing.

2 Immerse or soak affected areas in warm water (100–105° F).

3 Do not allow patient to control water temperature—numb areas cannot feel heat and can be burned.

4 Continue treatment until skin is pink and sensation returns.

HOW TO AVOID FROSTBITE AND FROSTNIP

- Keep extremities warm and covered in cold weather.
- Use layered clothing and a face mask.
- Wear mittens instead of gloves, and keep the ears covered.
- Take regular breaks from the cold whenever possible to warm extremities.

WORST-CASE SCENARIO.

HOW TO USE A DEFIBRILLATOR TO RESTORE A HEARTBEAT

Defibrillation is the delivery of a powerful electrical shock to the heart. (The defibrillator is the device used in movies and TV shows: two handheld pads are placed on the victim's chest while an actor yells "Clear!") In the past, defibrillators were very heavy, expensive, needed regular maintenance, and were mostly found only in hospitals. Now there are more portable units available. A defibrillator should be used only for a Sudden Cardiac Arrest (SCA), an electrical problem that cannot be helped by CPR.

HOW TO USE A DEFIBRILLATOR

- 1 Turn on the defibrillator by pressing the green button.** Most machines will provide both visual and voice prompts.
- 2 First, remove the person's shirt and jewelry, then apply the pads to the chest as shown in the diagram displayed on the machine's LED panel.** One pad should be placed on the upper right side of the chest, one on the lower left.

*Apply one pad to the upper right of the patient's chest,
the other pad to the lower left.*

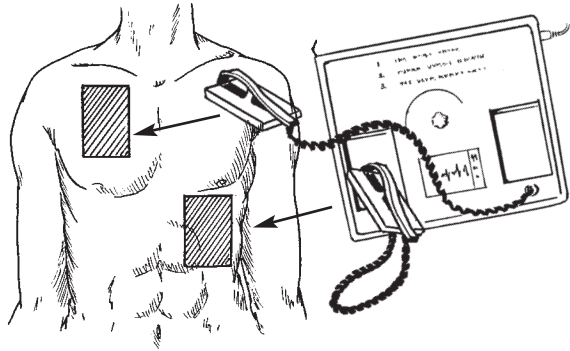

5 Check the patient's airway, breathing, and pulse.

If there is a pulse but the patient is not breathing, begin mouth-to-mouth resuscitation. If there is no pulse, repeat the defibrillation process.

Be Aware

A defibrillator should be used for a person experiencing sudden cardiac arrest (SCA), a condition where the heart's electrical signals become confused and the heart ceases to function. A person experiencing SCA will stop breathing, the pulse will slow or stop, and consciousness will be lost.

3 Plug the pads into the connector.

The defibrillator will analyze the patient and determine if he needs a shock. Do not touch the patient at this time.

4 If the machine determines that a shock is needed, it will direct you—both audibly and with visual prompts—to press the orange button to deliver a shock.

Do not touch the patient after pressing the button. The machine will automatically check to see whether or not the patient needs a second shock and if so will direct you to press the orange button again.

HOW TO WIN A SWORD FIGHT

Always keep your sword in the “ready” position—held in front of you, with both hands, and perpendicular to the ground. With this method, you can move the sword side to side and up and down easily, blocking and landing blows in all directions by moving your arms. Hold the tip of the sword at a bit of an angle, with the tip pointed slightly toward your opponent. Picture a doorway—you should be able to move your sword in any direction and quickly hit any edge of the doorframe.

HOW TO DEFLECT AND COUNTER A BLOW

1 Step up and into the blow, with your arms held against your body.

React quickly and against your instincts, which will tell you to move back and away. By moving closer, you can cut off a blow’s power. Avoid extending your arms, which would make your own counterblow less powerful.

2 Push or “punch” at the blow instead of simply trying to absorb it with your own sword.

If a blow is aimed at your head, move your sword completely parallel to the ground and above your head. Block with the center of your sword, not the end. Always move out toward your opponent, even if you are defending and not attacking.

How to Deflect a Blow

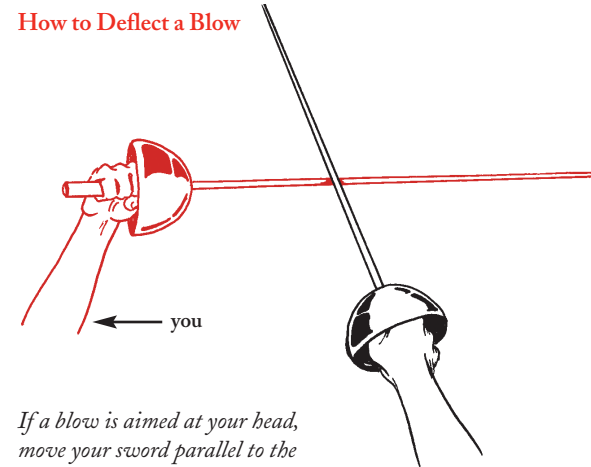

If a blow is aimed at your head, move your sword parallel to the ground and above you.

How to Attack

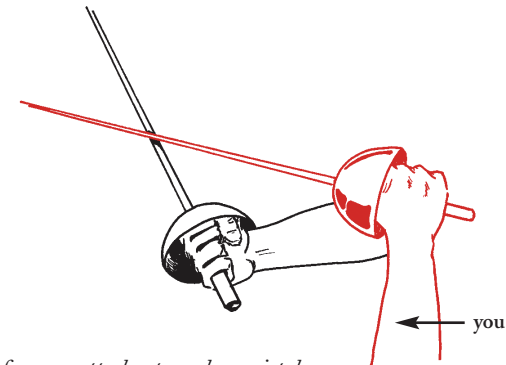

Wait for your attacker to make a mistake. Deflecting a blow to the side will throw your opponent off balance.

HOW TO ATTACK

- 1 Move the sword in steady, quick blows up and down and to the left and right.**

Assuming you must disable your attacker, do not try to stab with your sword. A stabbing motion will put you off balance and will leave your sword far out in front of you, making you vulnerable to a counterblow.
- 2 Do not raise the sword up behind your head to try a huge blow—you will end up with a sword in your gut.**
- 3 Hold your position, punch out to defend, and strike quickly.**
- 4 Wait for your attacker to make a mistake.**

Stepping into a blow or deflecting it to the side will put him/her off balance. Once your opponent is off balance, you can take advantage of their moment of weakness by landing a disabling blow, remembering not to jab with your sword but to strike up and down or from side to side.

**WORST-CASE
SCENARIO.**

HOW TO WIN A SWORD FIGHT

Always keep your sword in the “ready” position—held in front of you, with both hands, and perpendicular to the ground. With this method, you can move the sword side to side and up and down easily, blocking and landing blows in all directions by moving your arms. Hold the tip of the sword at a bit of an angle, with the tip pointed slightly toward your opponent. Picture a doorway—you should be able to move your sword in any direction and quickly hit any edge of the doorframe.

HOW TO DEFLECT AND COUNTER A BLOW

1 Step up and into the blow, with your arms held against your body.

React quickly and against your instincts, which will tell you to move back and away. By moving closer, you can cut off a blow’s power. Avoid extending your arms, which would make your own counterblow less powerful.

2 Push or “punch” at the blow instead of simply trying to absorb it with your own sword.

If a blow is aimed at your head, move your sword completely parallel to the ground and above your head. Block with the center of your sword, not the end. Always move out toward your opponent, even if you are defending and not attacking.

How to Deflect a Blow

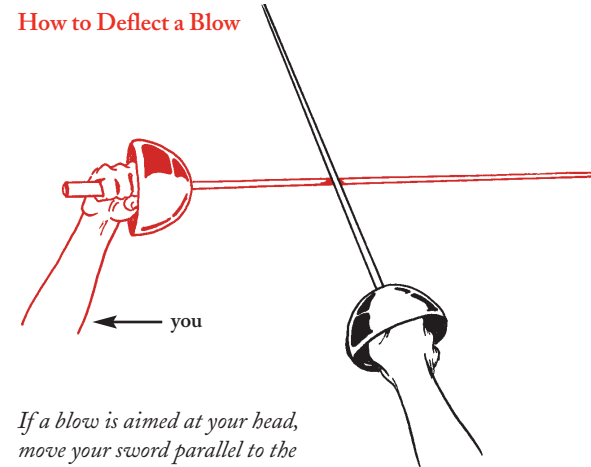

If a blow is aimed at your head, move your sword parallel to the ground and above you.

How to Attack

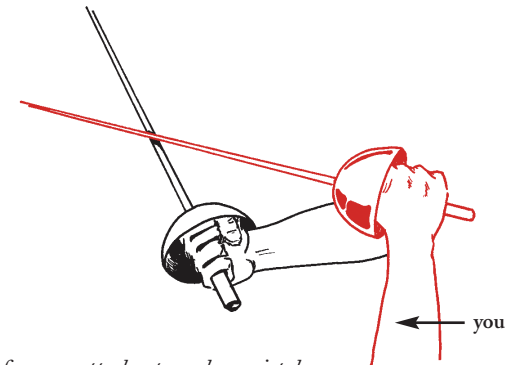

Wait for your attacker to make a mistake. Deflecting a blow to the side will throw your opponent off balance.

HOW TO WIN A SWORD FIGHT

Always keep your sword in the “ready” position—held in front of you, with both hands, and perpendicular to the ground. With this method, you can move the sword side to side and up and down easily, blocking and landing blows in all directions by moving your arms. Hold the tip of the sword at a bit of an angle, with the tip pointed slightly toward your opponent. Picture a doorway—you should be able to move your sword in any direction and quickly hit any edge of the doorframe.

HOW TO DEFLECT AND COUNTER A BLOW

1 Step up and into the blow, with your arms held against your body.

React quickly and against your instincts, which will tell you to move back and away. By moving closer, you can cut off a blow’s power. Avoid extending your arms, which would make your own counterblow less powerful.

2 Push or “punch” at the blow instead of simply trying to absorb it with your own sword.

If a blow is aimed at your head, move your sword completely parallel to the ground and above your head. Block with the center of your sword, not the end. Always move out toward your opponent, even if you are defending and not attacking.

How to Deflect a Blow

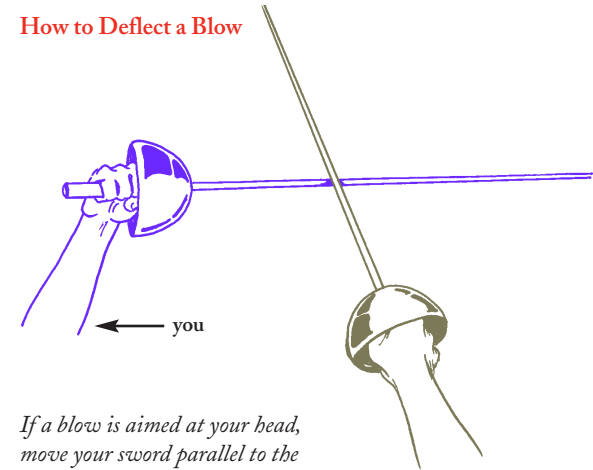

If a blow is aimed at your head, move your sword parallel to the ground and above you.

How to Attack

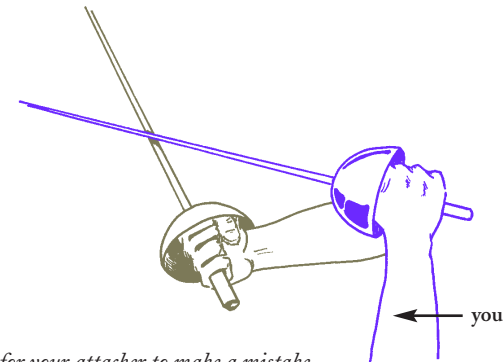

Wait for your attacker to make a mistake. Deflecting a blow to the side will throw your opponent off balance.

HOW TO ATTACK

- 1 Move the sword in steady, quick blows up and down and to the left and right.**

Assuming you must disable your attacker, do not try to stab with your sword. A stabbing motion will put you off balance and will leave your sword far out in front of you, making you vulnerable to a counterblow.
- 2 Do not raise the sword up behind your head to try a huge blow—you will end up with a sword in your gut.**
- 3 Hold your position, punch out to defend, and strike quickly.**
- 4 Wait for your attacker to make a mistake.**

Stepping into a blow or deflecting it to the side will put him/her off balance. Once your opponent is off balance, you can take advantage of their moment of weakness by landing a disabling blow, remembering not to jab with your sword but to strike up and down or from side to side.

**WORST-CASE
SCENARIO.**

WORST-CASE SCENARIO.

HOW TO WRESTLE FREE FROM AN ALLIGATOR

- 1** **If you are on land, try to get on the alligator's back and put downward pressure on its neck.**
This will force its head and jaws down.
- 2** **Cover the alligator's eyes.**
This will usually make it more sedate.
- 3** **If you are attacked, go for the eyes and nose.**
Use any weapon you have, or your fist.
- 4** **If its jaws are closed on something you want to remove (for example, a limb), tap or punch it on the snout.**
Alligators often open their mouths when tapped lightly. They may drop whatever it is they have taken hold of, and back off.
- 5** **If the alligator gets you in its jaws, you must prevent it from shaking you or from rolling over—these instinctual actions cause severe tissue damage.**
Try to keep the mouth clamped shut so the alligator does not begin shaking.
- 6** **Seek medical attention immediately, even for a small cut or bruise, to treat infection.**
Alligators have a huge number of pathogens in their mouths.

To get an alligator to release something it has in its mouth, tap it on the snout.

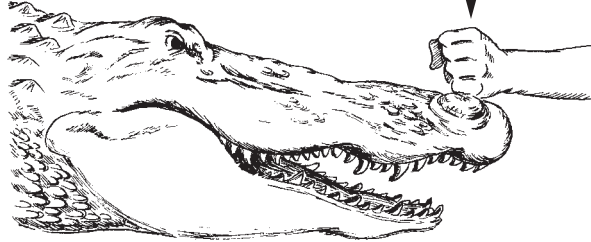

HOW TO AVOID AN ATTACK

While deaths in the United States from alligator attacks are rare, there are thousands of attacks and hundreds of fatalities from Nile crocodiles in Africa and Indopacific crocodiles in Asia and Australia. A few tips to keep in mind:

- Do not swim or wade in areas alligators are known to inhabit (in Florida, this can be anywhere).
- Do not swim or wade alone, and always check out the area before venturing in.
- Never feed alligators.
- Do not dangle arms and legs from boats, and avoid throwing unused bait or fish from a boat or dock.

- Do not harass, try to touch, or capture any alligator.
- Leave babies and eggs alone. Any adult alligator will respond to a distress call from any youngster. Mother alligators guarding nests and babies will defend them.
- In most cases the attacking alligators had been fed by humans prior to the attack. This is an important link—feeding alligators seems to cause them to lose their fear of humans and become more aggressive.

**WORST-CASE
SCENARIO.**

THE EXPERTS

FOREWORD

Source: “Mountain” Mel Deweese, a Survival Evasion Resistance Escape Instructor, has trained military personnel and civilians to survive in all kinds of environments. He runs the Colorado Survival Skills Tipi Camp.

CHAPTER I: GREAT ESCAPES AND ENTRANCES

How to Escape from Quicksand

Source: Karl S. Kruszelnicki, Julius Sumner Miller Fellow at the School of Physics of the University of Sydney, Australia, the author of several books on physics and natural phenomena, including *Flying Lasers*, *Robofish*, and *Cities of Slime* and other brain-bending science moments.

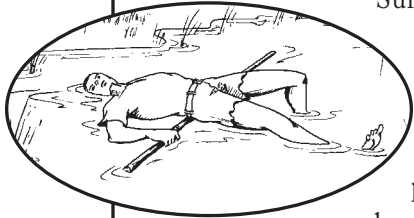

How to Break Down a Door

Source: David M. Lowell, a certified Master Locksmith and Education/Proficiency Registration Program Manager of the Associated Locksmiths of America, an industry trade group.

How to Break into a Car

Source: Bill Hargrove, a licensed locksmith in Pennsylvania with 10 years of experience opening locks.

How to Hot-wire a Car

Sources: Sam Toler, a certified auto mechanic, demolition derby driver, and member of the Internet Demolition Derby Association; *Cartalk*, a weekly radio program on car repair broadcast on National Public Radio.

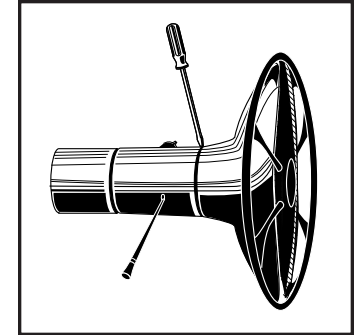

How to Perform a Fast 180-Degree Turn with Your Car

Sources: Vinny Minchillo, Internet Demolition Derby Association; Tom and Peggy Simons.

How to Ram a Car

Sources: Sam Toler (see above); Tom and Peggy Simons.

How to Escape from a Sinking Car

Sources: The U.S. Army's Cold Regions Research and Engineering Lab, located in New Hampshire; "Danger! Thin Ice," a publication of the Minnesota Department of Natural Resources; Tim Smalley, a boating and safety specialist at the Minnesota DNR.

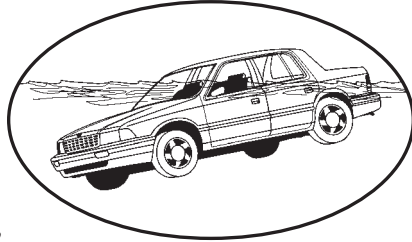

How to Deal with a Downed Power Line

Source: Larry Holt, a senior consultant at Elcon Elevator Controls and Consulting in Prospect, Connecticut.

CHAPTER 2: THE BEST DEFENSE

How to Survive a Poisonous Snake Attack

Sources: John Henkel, a writer for the U.S. Food and Drug Administration and a contributor to *FDA Consumer* magazine; Al Zulich, director of the Harford Reptile Breeding Center in Bel Air, Maryland; Mike Wilbanks, webmaster of the website Constrictors.com.

How to Fend Off a Shark

Sources: George H. Burgess, director of the International Shark Attack File at the Florida Museum of Natural History at the University of Florida; Craig Ferreira, board member, Cape Town's South African White Shark Research Institute, a nonprofit organization dedicated to research of the white shark and the preservation of its environment.

How to Escape from a Bear

Sources: "Safety Guide to Bears in the Wild," a publication of the Wildlife Branch of Canada's Ministry of Environment, Lands, and Parks; Dr. Lynn Rogers, a wildlife research biologist at Minnesota's Wildlife Research Institute and a director of the North American Bear Center in Ely, Minnesota.

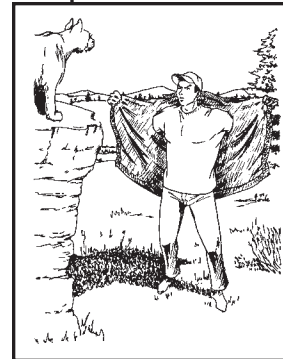

How to Escape from a Mountain Lion

Sources: The National Parks Service; the Texas Park and Wildlife Association; Chris Kallio, backpacking guide for About.com; Mary Taylor Gray, a writer for *Colorado's Wildlife Company*, a publication of the Colorado Division of Wildlife.

How to Wrestle Free from an Alligator

Sources: Lynn Kirkland, curator of the St. Augustine Alligator Farm; Tim Williams of Orlando's Gatorland, who has worked with alligators for nearly 30 years and now lectures and trains other alligator wrestlers.

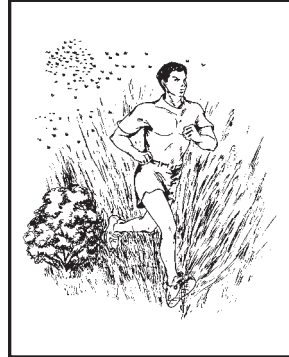

How to Escape from Killer Bees

Source: The Texas Agricultural Extension Service.

How to Deal with a Charging Bull

Source: Coleman Cooney, director of the Bullfight School.

How to Win a Sword Fight

Source: Dale Gibson, stuntman, teaches sword fighting skills to Hollywood actors and stunt people. He plays the knight in the Marine Corps commercials, and performed sword fighting stunts in *The Mask of Zorro*.

How to Take a Punch

Source: Cappy Kotz, a USA Boxing certified coach and instructor, and author of *Boxing For Everyone*.

CHAPTER 3: LEAPS OF FAITH

How to Jump from a Bridge or Cliff into a River

Source: Chris Caso, stuntman, member of the UCLA gymnastics team and the U.S. gymnastics team, has produced and performed high-fall stunts for numerous movies, including *Batman and Robin*, *Batman Forever*, *The Lost World*, and *The Crow: City of Angels*.

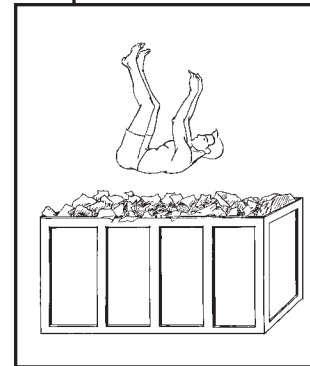

How to Jump from a Building into a Dumpster

Source: Chris Caso (see above).

How to Maneuver on Top of a Moving Train and Get Inside

Source: Kim Kahana, stuntman, stunt director, and filmmaker. He has

appeared in more than 300 films, including *Lethal Weapon 3*, *Passenger 57*, and *Smokey & the Bandit*.

How to Jump from a Moving Car

Sources: Dale Gibson (see above); Chris Caso, (see above).

How to Leap from a Motorcycle to a Car

Source: Jim Winburn, the director and stunt coordinator for two amusement park shows: “Batman” and the “Butch & Sundance Western Show.”

CHAPTER 4: EMERGENCIES

How to Perform a Tracheotomy

Source: Dr. Jeff Heit, M.D., director of internal medicine at a Philadelphia area hospital.

How to Use a Defibrillator to Restore a Heartbeat

Sources: Dr. Jeff Heit, M.D. (see above); Tom Costello, district manager of Hewlett-Packard; Heartstream; the American Heart Association.

How to Identify a Bomb

Source: Brady Geril, vice president of Product Management for the Counter Spy Shops, the retail division of CCS International Ltd. of London. He is an expert in both survival products and tactics, and served as a supervising officer and undercover agent in the New York Police Department’s narcotics division for 10 years.

How to Deliver a Baby in a Taxicab

Source: Dr. Jim Nishimine, M.D., obstetrician and gynecologist at Alta Bates Hospital in Berkeley, California. He has been delivering babies for 30 years.

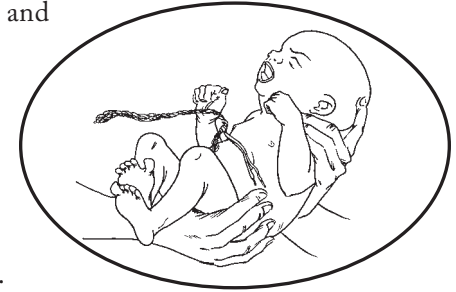

How to Treat Frostbite

Source: John Lindner, director of the Wilderness Survival School for the Denver division of the Colorado Mountain Club, runs the Snow Operations Training Center, an organization that teaches mountain survival skills to power companies and search and rescue teams.

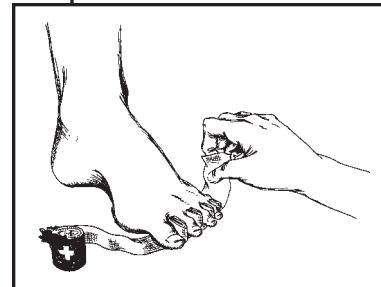

How to Treat a Leg Fracture

Source: Dr. Randall Simms, M.D.

How to Treat a Bullet or Knife Wound

Source: Charles D. Bortle, BA, RRT, NREMT-P, Paramedic and GMS Educator.

CHAPTER 5:

ADVENTURE SURVIVAL

How to Land a Plane

Sources: Arthur Marx, a pilot for more than 20 years, owns Flywright Aviation, a flight training and corporate flying service on Martha's Vineyard; Mick Wilson, author of *How to Crash an Airplane (and Survive!)* has a gold seal flight instructor certificate for both single- and multi-engine aircraft.

How to Survive an Earthquake

Sources: The U.S. Geological Survey; The National Earthquake Information Center.

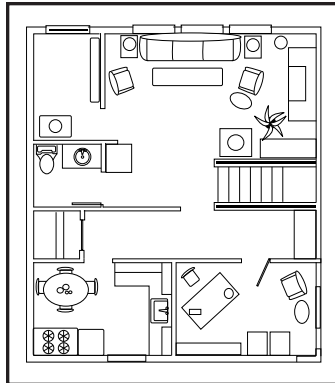

How to Survive Adrift at Sea

Source: Greta Schanen, managing editor of *Sailing Magazine*, has extensive experience both racing and pleasure cruising in deep water.

How to Survive When Lost in the Desert

Sources: The Arizona State Association of 4 Wheel Drive Clubs; *The Desert Survival Guide*, a publication of the City of Phoenix, Arizona.

How to Survive If Your Parachute Fails to Open

Source: Joe Jennings, skydiving cinematographer and skydiving coordination specialist. He has designed, coordinated, and filmed skydiving stunts for numerous television commercials, including Mountain Dew, Pepsi, MTV Sports, Coca Cola, and ESPN.

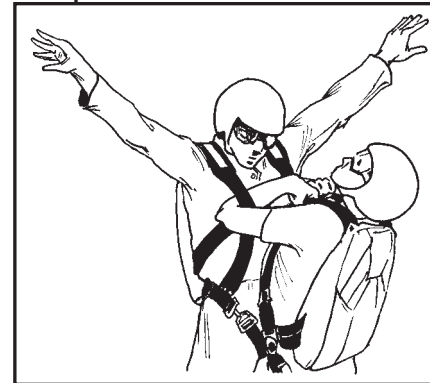



How to Survive an Avalanche

Source: Jim Frankenfield, director of the Cyberspace Snow and Avalanche Center, a nonprofit organization dedicated to avalanche safety education and information based in Corvallis, Oregon. Frankenfield has a degree in snow and avalanche

physics and has led avalanche safety training for 10 years in Colorado, Montana, Oregon, and Utah.

How to Survive If You Are in the Line of Gunfire

Source: Brady Geril (see above).

How to Survive When Lost in the Mountains

Source: John Lindner, Colorado Mountain Club, director of the Wilderness Survival School (see above).

How to Make Fire Without Matches

Source: Mel Deweese (see Foreword, page 9).



How to Avoid Being Struck by Lightning

Sources: John Lindner (see above); The Lightning Safety Group of the American Meteorological Society; the National Weather Service Forecast Office in Denver, Colorado.

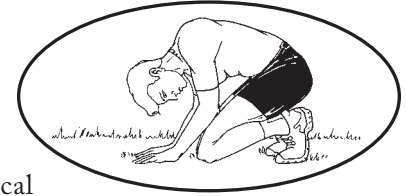

How to Get to the Surface If Your Scuba Tank Runs Out of Air

Source: Graham Dickson, Professional Association of Diving Instructors (PADI) Master scuba instructor.

The
WORST-CASE SCENARIO
Survival Handbook:
TRAVEL

By Joshua Piven and David Borgenicht
Illustrations by Brenda Brown



CHRONICLE BOOKS
SAN FRANCISCO

Copyright © 2001 by Quirk Productions, Inc.

All rights reserved. No part of this book may be reproduced in any form without written permission from the publisher.

Worst-Case Scenario™ and The Worst-Case Scenario Survival Handbook™ are trademarks of Quirk Productions, Inc.

The authors wish to thank all of the experts, whose invaluable knowledge and experience have made this book possible, and may have even saved a life or two. Special thanks and good karma to all those who worked on the book: Mindy Brown, Erin Slonaker, Jason Rekulak, Susan Van Horn, Frances J. Soo Ping Chow, Jason Mitchell, Steve Mockus, and of course, Jay Schaefer.

Library of Congress Cataloging-in-Publication Data available.

ISBN: 0-8118-3131-0

Printed in the United States of America

Typeset in Adobe Caslon, Bundesbahn Pi, and Zapf Dingbats

Designed by Frances J. Soo Ping Chow



A **QUIRK** Book

www.quirkpackaging.com

Visit www.worstcasescenarios.com

Distributed in Canada by Raincoast Books

9050 Shaughnessy Street

Vancouver, British Columbia V6P 6E5

Chronicle Books LLC

85 Second Street

San Francisco, California 94105

www.chroniclebooks.com

© 1999-2007 by Quirk Productions, Inc. All rights reserved.

WARNING

When a life is imperiled or a dire situation is at hand, safe alternatives may not exist. To deal with the worst-case scenarios presented in this book, we highly recommend—instist, actually—that the best course of action is to consult a professionally trained expert. **DO NOT ATTEMPT TO UNDERTAKE ANY OF THE ACTIVITIES DESCRIBED IN THIS BOOK YOURSELF.** But because highly trained professionals may not always be available when the safety of individuals is at risk, we have asked experts on various subjects to describe the techniques they might employ in those emergency situations. **THE PUBLISHER, AUTHORS, AND EXPERTS DISCLAIM ANY LIABILITY** from any injury that may result from the use, proper or improper, of the information contained in this book. All the information in this book comes directly from experts in the situation at hand, but we do not guarantee that the information contained herein is complete, safe, or accurate, nor should it be considered a substitute for your good judgment and common sense. And finally, nothing in this book should be construed or interpreted to infringe on the rights of other persons or to violate criminal statutes: we urge you to obey all laws and respect all rights, including property rights, of others. Nonetheless, enjoy your trip.

—The Authors

Dr. Peter Henderson, director of Pisces Conservation Ltd. in Lymington, England, has worked on piranha and other South American fish for more than 20 years (www.irc-house.demon.co.uk).

How to Treat a Severed Limb

Source: Dr. James Li, practitioner in the Division of Emergency Medicine at Harvard Medical School in Cambridge, Massachusetts, is an instructor for the American College of Surgeon's course for physicians, Advanced Trauma Life Support. He is the author of articles on emergency practice in remote settings.

How to Remove a Leech

Source: Mark E. Siddall is assistant curator for the Division of Invertebrate Zoology at the American Museum of Natural History in New York City.

APPENDIX

Foreign Emergency Phrases

Sources: French: Jennifer Wolf, MA, doctoral candidate in Comparative Literature, University of Pennsylvania; German: Lisa Marie Anderson, MA, doctoral candidate in Germanic Languages and Literatures, University of Pennsylvania; Japanese: William M. Hammell, MA, Japanese Literature, Yale University; Spanish: Paul Carranza, MA, doctoral candidate in Comparative Literature, University of Pennsylvania.

Gestures to Avoid

Source: Roger E. Axtell, author of *Gestures: Do's and Taboos of Body Language Around the World* and seven other books in his *Do's and Taboos* series. He is also a popular speaker on the after-dinner circuit.

ABOUT THE AUTHORS

Joshua Piven, a computer journalist and freelance writer by day, is a continent hopper by night. He has been chased by knife-wielding motorcycle bandits, stuck in subway tunnels, robbed and mugged, and is consistently served pasta when they run out of the chicken. He is the co-author of *The Worst-Case Scenario Survival Handbook*, and lives in Philadelphia with his wife.

David Borgenicht, a writer, editor, businessman and world traveler, has canoed in alligator breeding ponds, ridden elephants in India, stowed away on Amtrak, and almost always gets the exit row in which the seats don't recline. He is the co-author of *The Worst-Case Scenario Survival Handbook*, and author of *The Jewish Mother Goose* (Running Press, 2000) and *The Little Book of Stupid Questions* (Hysteria, 1999). He, too, lives in Philadelphia with his wife, who is still his best-case scenario.

Brenda Brown is a freelance illustrator and cartoonist whose work has appeared in many books and major publications, including *The Worst-Case Scenario Survival Handbook*, *Reader's Digest*, *The Saturday Evening Post*, *The National Enquirer*, and *Federal Lawyer and National Review*. Her digital graphics have been incorporated into software programs developed by Adobe Systems, Deneba Software, Corel Corp, and many websites.

Check out www.worstcasescenarios.com for updates, new scenarios, and more! Because you just never know. . . .

Acclaim for the authors' first book, the best-selling
THE WORST-CASE SCENARIO SURVIVAL HANDBOOK

“Nearly 180 pages of immediate-action drills for when everything goes to hell in a handbasket (*SOF* editors all keep a copy on their desk at all times). . . . Odds are good you’ll meet more than one of the situations during your life, and the time spent studying this volume may turn out to be some of the best time you ever invest.”

—*Soldier of Fortune*

“ . . . an armchair guide for the anxious.”

—*USA Today*

“The book to have when the killer bees arrive. . . .”

—*The New Yorker*

“This really is a nifty book.”

—*Forbes*

“ . . . an improbable how-to manual . . . but that doesn’t mean we can’t worry . . .”

—*Time*

“What you need to play by Murphy’s Laws.”

—*People*

“ . . . you need this.”

—*Boston Globe*

“ . . . compulsively readable . . .”

—*Chicago Tribune*

“Parachute won’t work? Open this instead.”

—*Washington Post*

. . . and featured in the (London) *Times*, the *Sydney Morning Herald*, the *Toronto Sun*, and on best-seller lists around the world.

FOREWORD

By David Concannon, Explorers Club

During a lifetime of travel and adventure, I have learned some things the hard way—by living through many dangerous and unpleasant experiences. These experiences have taught me several very valuable lessons.

Lesson #1: The unexpected usually happens.

It was July 1989. I was standing at 15,000 feet on the side of Mt. Kilimanjaro in Tanzania, wondering if I would live.

I could still hear the voices of my friends before I left: “Kili is a cake walk. You don’t need any technical climbing experience to summit. You might get a little altitude sickness, maybe a touch of edema. Don’t worry, you will survive.”

My thoughts were interrupted by the voice of a climbing partner, a physician, as he finished examining me. “Your lung has collapsed,” he said. “You also have pulmonary and cerebral edema, and retinal hemorrhages in both eyes.” Well, I thought, at least that explained the difficulty I had breathing, my new speech impediment, and the pain I felt in my eyes whenever I removed my sunglasses.

I could handle the inability to speak and the mental confusion. What really bothered me was the knowledge that I had collapsed a lung (for the second

time in my life), and that my one good lung was filled with fluid. “If you get pneumonia, you will be dead by morning,” the doctor said. “You better start walking.”

And walk I did, for 24 miles.

Two days later, I flew in an unpressurized airplane to Kenya, followed by a flight to Germany and a horrible ride in the smoking section of a Pan Am flight to New York. After five days, I walked into a hospital in Philadelphia, where I was examined in stunned silence by a neurologist and specialist in pulmonary medicine. According to the textbooks, I shouldn’t have made it. But I did. I had survived.

From that point on, I knew I could survive any worst-case scenario in my travels if I just kept my wits about me and forged ahead. Miraculously, I have always emerged from my adventures without permanent injuries, and have even been able to exit under my own power.

Lesson #2: Accept the things that are beyond your control.

Although I have not always been able to predict specifically what problems, major or minor, are going to arise, I have learned that once something does occur, I need to accept it as unavoidable. Having my pants pockets razored in Buenos Aires, being diverted through Kosovo because of “terrorist activity” in Croatia, and losing my luggage on domestic flights through Atlanta are the inevitable consequences of travel rather than extraordinary occurrences or self-inflicted mistakes.

When I was living in Kenya, I chartered airplanes to travel on weekends because flying was considered safer than driving. One time the plane I wanted to charter was booked; that weekend the plane crashed. The Kenyans reacted nonchalantly. “Hakuna ma tata,” they said. “No problem. Things happen.” Sometimes things happen for a reason, I thought. Sometimes they don’t. But the following weekend, I took the train.

For some people, putting themselves in extreme situations and then facing the dire consequences is part of the thrill of travel. But for all types of travel, you must resign yourself to the fact that your luggage will be lost, your hotel reservations will be canceled, and the last flight out will leave without you.

The key is to then decide what you are going to do about it.

Lesson #3: Always have a contingency plan.

With a little advance preparation, you can survive the unexpected.

I once suffered from severe hypothermia thanks to an old cotton sleeping bag I carried on a backpacking trip through the White Mountains of New Hampshire. The weather forecast in the lowlands called for sunny skies and mild temperatures. Up in the mountains, however, it rained for five days straight. Everything I had was soaked, and I was never able to get warm. I eventually became delirious—and nearly unconscious.

After spending two days in another person’s dry sleeping bag with two half-naked companions to restore my body temperature, I vowed I would never be caught unprepared again. I have not.

Now I research everything before I travel. I study alternative travel arrangements, accommodations, climate, travel advisories, appropriate equipment for my destination, and anything else that may be relevant. I have avoided being stranded in airports due to missed connections by knowing about later flights on competing airlines. I once traveled on eleven trains and buses to make it from Switzerland to the Hague, Netherlands, before my hostel locked its doors at midnight. (My first Swiss train was ten minutes late, and I missed every one of my original connections through Germany and the Netherlands. I still made it.) But you must be prepared. After all, a rainy day in Paris can be just as miserable as a gale in the North Atlantic if you are caught without the proper gear.

Lesson #4: No matter how bad you think things are now, they can always get worse.

I recently participated in a month-long expedition to the R.M.S. *Titanic*. The expedition provided a daily dose of Murphy’s Law (“Anything that can go wrong, will”). Each day brought new and exciting challenges, sometimes several at once. Equipment failed, the weather was horrendous (we survived three gales and a hurricane), and the team was stricken with food poisoning. And all this was on top of the incredibly high level of risk we had expected to encounter.

Diving in the submersibles meant routinely facing death by implosion, drowning, fire, freezing, or asphyxiation. And to heighten the tension and discomfort, the expedition was being covered by the world's media. Nevertheless, we survived and succeeded by dealing with each challenge head-on, fixing it, and moving on to the next. We never let problems accumulate, or else we would have been overwhelmed. On our expedition or on your trip, the emphasis should not be on how bad everything is but on how to make it better, one step at a time.

Once you've learned all these lessons, you still need to know what, technically, to do. That's where this guide comes in.

People don't take trips—trips take people.
—John Steinbeck

The timorous may stay at home.
—Justice Benjamin Cardozo

INTRODUCTION

The statistics are against you: more than 50 percent of all travelers run into problems. While we hope that the worst that you'll ever encounter is a seat-back that won't recline or a dripping sink in your hotel room, there is a lot more that could go wrong.

Hijackings. Leeches. Runaway trains. Tarantulas. Tsunamis. Severed limbs. Muggings. Plane crashes. Brake failure. UFO abduction. Maybe a hotel fire while you're sleeping on the 33rd floor.

Our advice is simple: always be ready for the worst.

We don't believe that the response to the possibility of bad luck or danger is to stay home. (For one thing, as we examined in our first book, *The Worst-Case Scenario Survival Handbook*, sometimes adventure gets thrust upon you even when you are staying in and around the house.) Go out and see the world. Climb mountains, cross rivers, ride camels, sample the local cuisine, set a course for adventure—just know what to do when your travels take a turn toward disaster.

To provide you with as much help and protection as possible, we've taken an expansive view of what constitutes travel: A sandstorm might be an exotic, foreign experience if you live in New Jersey but not if you live in Saudi Arabia; if you live in Tahiti, knowing what to do if you fall onto subway tracks is a remote possibility, but if you live in Paris, New York, Tokyo, or other cities, it may well be a daily concern. A local excursion for one person might be completely foreign to another.

So for the purposes of this book, travel begins the minute you go out your front door, whether you are going across town or across the equator. These are the worst-case scenarios you could encounter, and these are the skills that could save your life.

But even though we mean well and want you to feel reassured, we are not experts in safety or survival. We are just ordinary tourists—civilians, amateurs, two regular guys (albeit regular guys with a healthy dose of paranoia and a lot of curiosity). So to deal with the threatening situations, we have again consulted experts in their fields: the U.S. Army and State Department, security specialists, pilots, railroad engineers, movie stuntpeople, counter-terrorist consultants, expedition guides, exotic creature zoologists, and demolition derby drivers, among others. (Biographies of the experts are included at the back of the book.) With their input and advice, we have constructed these illustrated, step-by-step instructions on what you need to do in dozens of dire situations.

To make this handbook useful even on less eventful days, we also asked our legions of experts to provide us with their personal, insider approach to traveling in comfort. We've compiled an appendix with select strategies for packing, flying, lodging, and traveling in general, using their collective advice and our own experience. Rounding out the appendix is a list of extreme emergency phrases (in five languages) and a selection of physical gestures to avoid, since their meaning varies widely from country to country.

If, just once, whether tomorrow or in ten years,

you are called upon to apply the information you've learned from this handbook, you could save a life—your life, or the life of someone you're with. This book could be your passport to survival. And the pages can be used as emergency toilet paper if you're really in a jam.

At the very least, it will provide good information and entertainment for the armchair survivalist.

Bon voyage.

**WORST-CASE
SCENARIO.**

FOREIGN EMERGENCY PHRASES

In a foreign land, when a worst-case scenario occurs, it is extremely helpful to know the native language. While we cannot provide you with a complete phrasebook, we have translated several helpful English phrases into **Spanish, French, German, and Japanese** (transliterated). Even though the local language may be different from all of these, odds are that you will get your point across if you know these key phrases.

Help!

¡Socorro! (Spanish)

Au secours! (French)

Hilfe! (German)

Tasukete! (Japanese)

Stop, thief!

¡Alto, ladrón!

Arrêtez-vous, voleur!

Halt, Dieb!

Mate, dorobô!

Run!

¡Corre!

Courez!

Lauf!

Nigero!

Is there a doctor/pilot/lawyer in the building?

¿Hay un médico/piloto/abogado en este edificio?

Y a-t-il un médecin/un pilote/un avocat dans le bâtiment?

Gibt es einen Arzt/Pilot/Anwalt im Haus?

*Kono biru no naka ni isha/
pairotto/bengoshi wa imasuka?*

Hello—I have been seriously wounded.

Hola—tengo una lesión grave.

*Bonjour—je suis sérieusement
blessé(e).*

*Guten Tag—ich bin schwer
verletzt worden.*

*Konnichiwa—watashi wa ôkega wo
shite imasu.*

I am bleeding profusely.

Estoy sangrando mucho.

Je saigne abondamment.

Ich blute stark.

*Watashi wa obitadashiku chi ga
dete imasu.*

May I use your belt as a tourniquet?

*¿Podría yo usar su cinturón para un
torniquete?*

*Je peux utiliser votre ceinture comme
tourniquet?*

*Darf ich Ihren Gürtel als Aderpresse
benutzen?*

*Anata no beruto wo karite
shiketsutai ni shitemo iidesuka?*

May I borrow a towel to wipe up the blood?

*¿Me presta una toalla para limpiar
la sangre?*

*Je peux emprunter une serviette pour
éponger le sang?*

*Darf ich ein Tuch borgen,
um das Blut abzuwischen?*

*Taoru wo karite chi wo fuite
mo iidesuka?*

Would you please take me to a clean hospital?

*¿Me podría llevar a un hospital
bueno?*

*Pourriez-vous m'emmener à un
hôpital propre, s'il vous plaît?*

*Würden Sie mich bitte in ein sauberes
Krankenhaus bringen?*

*Kirei na byôin ni tsurete itte
kudasai masuka?*

Is this safe to eat?

¿Se puede comer?

On peut manger ceci sans danger?

*Sind Sie sicher, dass man das
essen kann?*

Kore wo tabetemo daijôbu desuka?

Why is the water brown/green/black?

*¿Por qué es turbia/verde/negra
el agua?*

*Pourquoi l'eau est-elle
brune/verte/noire?*

*Warum ist das Wasser
braun/grün/schwarz?*

*Kono mizu wa dôshite
chairoin desuka/midori iro
nandesuka/kuroin desuka?*

What kind of meat is this?

¿Qué tipo de carne es ésta?

Quel type de viande est-ce que c'est?

Was für Fleisch ist das?

Kore wa nanno niku desuka?

I am sorry—I did not mean to offend you.

*Lo siento—no quise ofenderlo/
ofenderla.*

*Je suis désolé(e)—je ne cherchais pas à
vous offenser.*

*Es tut mir leid—ich wollte Sie nicht
beleidigen.*

*Gomennasai—anata no kibun wo
gaisuru tsumori wa
arimasen deshita.*

Please do not injure me.

Por favor, no me lastime.

Ne me blessez pas, s'il vous plaît.

Verletzen Sie mich bitte nicht.

*Watashi wo itai me ni
awasenaide kudasai.*

Do not make me angry.

No me enoje.

Ne me fachez pas.

Ärgern Sie mich nicht.

Okoraseruna yo.

I do not wish to hurt you.

No le quiero hacer daño.

Je n'ai pas l'intention de vous blesser.

Ich will Ihnen nicht weh tun.

*Anata wo itai me ni awasetaku
arimasen.*

Is it bleeding much?

¿Está sangrando mucho?

Ça saigne beaucoup?

Blutet es stark?

Chi wa takusan dete imasuka?

Please forgive me, and accept this money/camera/watch as a gift.

Disculpe, por favor, y acepte este dinero/esta cámara/este reloj como regalo.

Pardonnez-moi, et veuillez accepter cet argent/cet appareil-photo/cette montre comme cadeau.

Bitte verzeihen Sie mir, und akzeptieren Sie dieses Geld/diese Kamera/diese Uhr als Geschenk.

Kono okane/kamera/tokei wo owabi no shirushi toshite uketotte watashi wo yurushite kudasai.

Where is the nearest embassy/airport/hospital/police station?

¿Dónde está la embajada/aeropuerto/hospital/estación de policía más cercano a?

Où se trouve l'ambassade/l'aéroport/l'hôpital/la gendarmerie le/la plus proche?

Wo ist die nächste Botschaft/der nächste Flughafen/das nächste Krankenhaus/das nächste Polizeiamt?

Ichiban chikai taishikan/kikô/byôin/kôban wa dokodesuka?

Yes, I have my papers.

Sí, tengo mis documentos.

Oui, j'ai mes papiers.

Ja, ich habe meine Papiere.

Hai, shorui wo motteimasu.

Where are your papers?

¿Dónde están tus documentos?

Où sont vos papiers?

Wo sind Ihre Papiere?

Anata no shorui wa dokodesuka?

I'm not going to tell you.

No se lo voy a decir.

Je ne vous dirai pas.

Ich sage es Ihnen nicht.

Anata niwa oshiemasen.

Do you know a place where I can hide?

¿Sabe usted dónde puedo esconderme?

Vous connaissez un endroit où je peux me cacher?

Wissen Sie, wo ich mich verstecken kann?

Dokoka watashi ga kakure rareru tokoro wo shitte imasuka?

How fast can this car go?

¿A cuánta velocidad puede ir este coche?

À quelle vitesse cette voiture peut-elle rouler?

Wie schnell kann dieses Auto fahren?

Kono kuruma wa doregurai hayaku hashiremasuka?

How quickly can you leave?

¿Se puede ir lo más pronto posible?

En combien de temps pouvez-vous partir au plus vite?

Wie schnell können Sie mich von hier wegbringen?

Doregurai hayaku deraremasuka?

How far is it to the border?

¿A qué distancia está la frontera?

C'est quelle distance à la frontière?

Wie weit ist es bis zur Grenze?

Kokkyô made doregurai desuka?

You will never make me talk.

Usted nunca me hará hablar.

Vous ne me ferez jamais parler.

Sie werden mich nie zum Sprechen bringen.

Zettai watashi wo shaberaseru koto wa dekinai.

WORST-CASE SCENARIO®

GENERAL TRAVEL STRATEGIES

- ★ **EMERGENCY INFO**—On a business card, write down emergency contact information and place it in your wallet. Include the names of your doctors, as well as anyone who should be contacted in the event of an emergency. Give your emergency contact a copy of your itinerary, and the name of where you'll be staying.
- ★ **BATHROOM EMERGENCIES**—If you need a bathroom in a hurry, head for the nearest large hotel. Most hotels have bathrooms on or near the lobby that are usually clean and well-kept. Large, expensive hotels are also good for other services—telephones, faxes, e-mail—and will gladly point you in the right direction.
- ★ **FRESHENING UP**—Department stores are great places to freshen up or reapply makeup. Just head for the sample counters and you'll find an array of lipstick, makeup, and perfume at your disposal.
- ★ **TAXIS**—When getting out of a taxi, make sure you leave the door open while you are getting your bags out of the trunk; that way the taxi can't drive off before you get your bags out.
- ★ **HIDING PLACES**—Bras with removable pads are great for hiding money, as are tampon tubes. Not many are willing to invade such private places to find it.

GESTURES TO AVOID

THE UPSIDE-DOWN GLASS ON BAR

In the United States and other countries, turning your glass upside-down might indicate that you do not want anything to drink. In some pubs in Australia, however, finishing your drink, turning the glass upside-down, and placing it squarely on the bar may signal that you believe you can win a fight with anyone present.

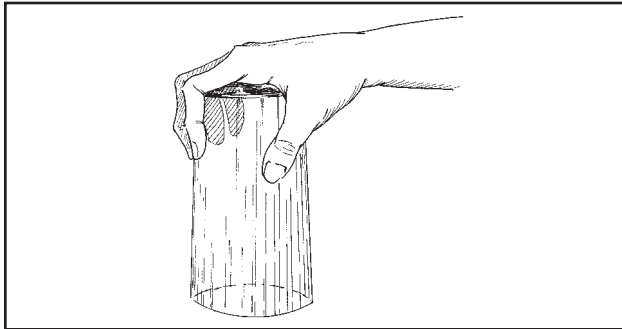

EYE CONTACT

In Pakistan, staring is common. Do not be offended if someone stares at you.

In Zimbabwe, do not maintain continued direct eye contact. It is considered rude, particularly in rural areas.



In New York City, do not make eye contact with anyone on a subway, train, or bus. Read a book or newspaper, or maintain an unfocused, nonresponsive visage to avoid incident.

THE FIG GESTURE

The fig gesture is formed by making the hand into a fist and protruding the thumb upward between the forefinger and middle finger. In most Latin American countries it is considered phallic and very rude. In Brazil, the fig gesture means “good luck.” In parts of the United States, it means “I’ve got your nose,” part of a children’s game in which one person pretends to have captured the other person’s nose.

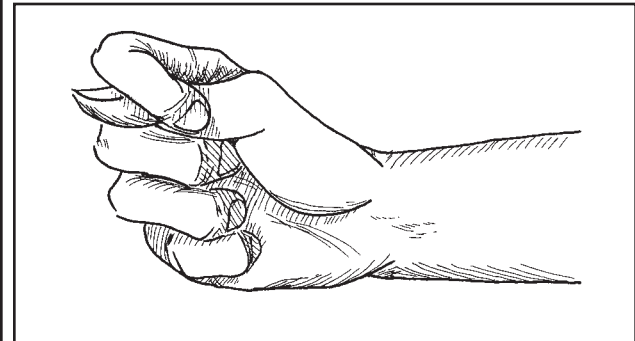

THE “OK” SIGN

Touching the thumb and index finger to suggest a circle, with the other fingers on the hand fanned out, indicates that everything is okay in the United States.

In Brazil, Germany, and Russia, however, it indicates a very private orifice and is an insult.

In Japan, the sign indicates that you want change. Use this gesture if you want a cashier in a store to give your change in coins.

In France, it is an insult. It denotes the number zero or the concept of something being worthless. When placed over the nose, it means “drunk.”

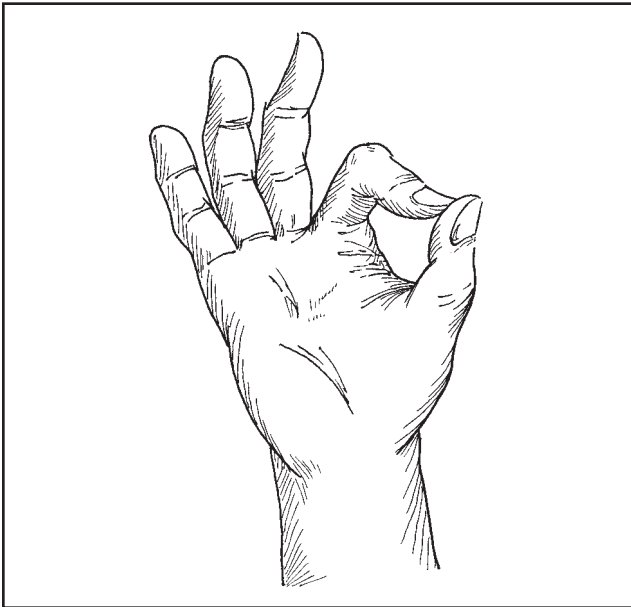

**WORST-CASE
SCENARIO.**

HOW TO BUILD A SHELTER IN THE SNOW

BUILDING A SNOW TRENCH

- 1** Map out a trench so that the opening is at a right angle to the prevailing wind.

You need to find a space large enough so that the width and length are just a bit longer and taller than your body when lying down. You need only a minimal depth to maintain a cozy space for body heat conservation.

- 2** Dig the trench with a wider, flatter opening on one end for your head, using whatever tools you have or can create.

A cooking pan or long, flat piece of wood works well as an entrenching tool.

- 3** Cover the top of the trench with layers of branches, then a tarp, plastic sheeting, or whatever is available, then a thin layer of snow.

A “door” can be made using a backpack, blocks of snow, or whatever materials provide some ventilation and yet block the heat-robbing effects of the wind.

BUILDING A SNOW CAVE

- 1** Find a large snowdrift or snowbank on a slope. Plan your cave with the opening at a right angle to the prevailing wind.
- 2** Dig a narrow tunnel into the slope (toward the back of the slope) and slightly upward. Create a cavern big enough to lie in without touching the sides, roof, or ends.

Dig your snow cave into the drift, at a right angle to the prevailing wind.

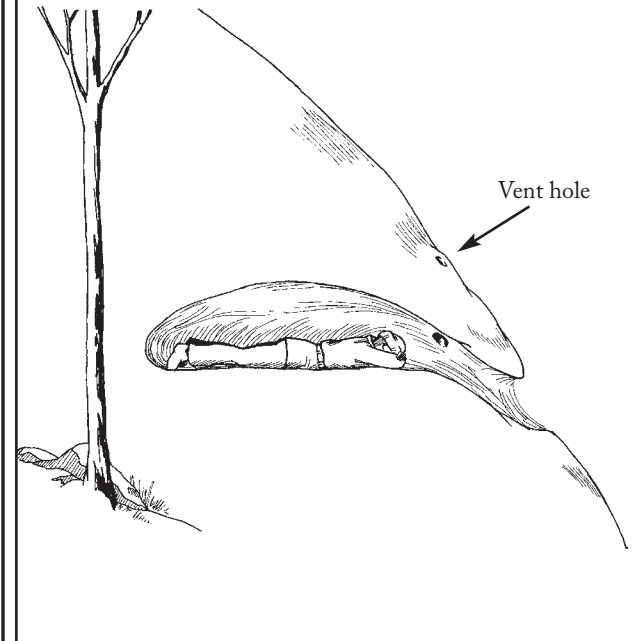

3 Make the ceiling slightly dome-shaped.

A flat ceiling has no strength and will in most cases collapse before you are finished digging. The roof should be at least 12 inches thick. If you can see blue-green light (from filtered sunlight) through the top, the roof is too thin.

4 Put a small vent hole in the roof.

The hole will provide fresh air and a vent for a candle, if you are going to use one. Do not add any heat source larger than a small candle. Excessive heat will cause the ceiling to soften, drip, and weaken.

BUILDING A QUIN-ZHEE

If snow depth is minimal and you have a lot of time and energy, build a Quin-Zhee. A Quin-Zhee is a snow shelter that was developed by the Athabaskan Indians, who lived mainly in Canada and Alaska.

1 Pile up a very large mound of packed snow.

The pile needs to be big enough for you to sit or lie down comfortably inside when it is hollowed out.

2 Wait an hour for the snow to consolidate.

3 Dig in and build a snow cave.

Be Aware

- A preferable alternative to building a snow shelter is a man-made structure or vehicle. If none is

available, search for anything that will help protect your body from heat loss. Caves, downed timber, or rock outcroppings can help protect you from the elements.

- If you cannot stay dry in the process of building a snow shelter, or you cannot get dry after you have built it, do not build it! Moving enough snow to create a shelter big enough for even just one person is hard work, and any contact of your skin or clothing with snow while digging will amplify your body's heat losses.
- When building a shelter, the oldest snow will be the easiest to work with, since it consolidates over time.
- Snow is an excellent insulating and sound-absorbing material. From within a snow shelter, you will be unlikely to hear a search party or aircraft. You may want to make a signal above ground that can be noticed by a search party (a tarp, the word "help" or "SOS" spelled out in wood).
- In any shelter, use whatever you can find to keep yourself off the ground or snow. If pine boughs or similar soft, natural materials can be found, layer them a foot or more high, since the weight of your body will compress them considerably.
- When you are inside, the warmth from your body and your exhaled warm air will keep your shelter somewhat comfortable.

HOW TO CATCH FISH WITHOUT A ROD

- 1 Determine the best location for your fishing.**
Fish usually congregate in shadow, near the edges of lakes, rivers, and streams.
- 2 Find a forked sapling approximately two feet long. (The forked ends should be approximately one foot long.)**
Cut it down or break it off.
- 3 Bend the two ends toward each other and tie them together.**
The tied ends will form the circular frame of a net.
- 4 Remove your shirt or T-shirt.**
- 5 Tie a knot in the shirt just below the arm and neck holes.**
- 6 Slip the sapling into the shirt, and pin or tie the shirt securely to all sides of the frame.**
- 7 Scoop up the fish.**

Alternative

Large fish can also be speared with a pole sharpened to a point at one end. This method works best at night, when fish come to the surface.

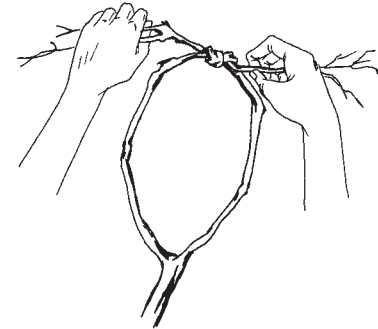

Find a forked branch. Tie the ends together.

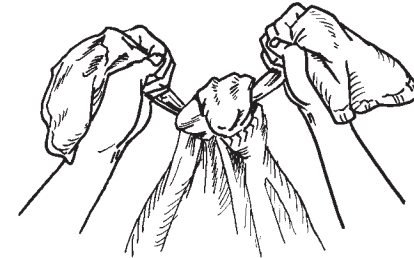

Tie a shirt into a knot.



Slip the branch into the shirt; secure the shirt to the frame.

WORST-CASE SCENARIO.

HOW TO CLIMB OUT OF A WELL

WITH A NARROW OPENING

Use the “chimney climbing” technique if the opening is narrow enough to keep your back against one wall and your feet against the opposite side, holding yourself off the ground.

- 1 Place your back against one wall and your hands and feet against the other wall.**
Your body will be in an “L” shape, with your back straight and your legs sticking out—the soles of your feet pressing against the opposite wall. If the well is not completely vertical but is tilted in one direction, place your back on the lower wall.
- 2 Use even, steady pressure from your thighs to maintain traction on the feet and friction on your back, and to hold yourself off the ground.**
- 3 Place the palms of your hands against the wall behind you, below your buttocks.**
- 4 Take your right foot off the opposite wall and place it under your backside.**
Bend your leg under you so that your left foot is on one wall and your right is on the other.



**To climb out of a well
with a narrow opening:**

*Place your back against one
wall and your hands and feet
against the other.*



*Using even pressure to
maintain traction, place your
hands below your rear.*



*Take one foot off the wall and
place it under your rear.*



*Push up with your hands.
Repeat step 1 through 4.*

5 While pressing your back away from the wall with your hands, push up with your hands and your feet. Move only about 6 to 10 inches.

6 Place your back on the wall again and move your right foot back onto the opposite wall, now a bit higher than your left foot.
Rest.

7 Repeat the procedure, beginning with your left foot. Alternate feet, slowly working your way to the lip of the well.

8 When you approach the lip of the well, reach up with your hand overhead and perform a “mantle move.”
Pull yourself halfway up from a chin-up hang position, then roll (shift) your weight onto your forearms as they clear the lip of the well. Shift your body weight to your hands, and press up. Use your feet against the wall to assist in pulling yourself up out of the well.

WITH A WIDE OPENING

Use the “spread eagle” or “stemming” technique for an opening that is too wide to use the chimney climbing technique but narrow enough that you can touch opposite walls with your hands.

1 Place your right hand and right foot on one wall and your left hand and left foot on the opposite wall.

Your hands should be lower than your shoulders, and your fingers should point down.

2 Keep the pressure on your feet by assuming a somewhat scissored leg stance, with your body facing slightly to your right.

3 Brace yourself by pushing out with your hands.

4 Move one foot quickly up a few inches, followed quickly by the other.

5 Continue until you reach the top, where you will have to grab something sturdy and swing up over the edge.

If nothing is available to grab onto, keep going until your upper body is out of the well, then flop over forward and use leverage to climb out.

HOW TO CONTROL A RUNAWAY CAMEL

- 1 Hang on to the reins—but do not pull them back hard in an attempt to stop the camel.**

A camel's head, unlike that of a wayward horse, cannot always be pulled to the side to slow it down. Camels are usually harnessed with a head halter or nose reins, and pulling on the nose reins can tear the camel's nose—or break the reins.

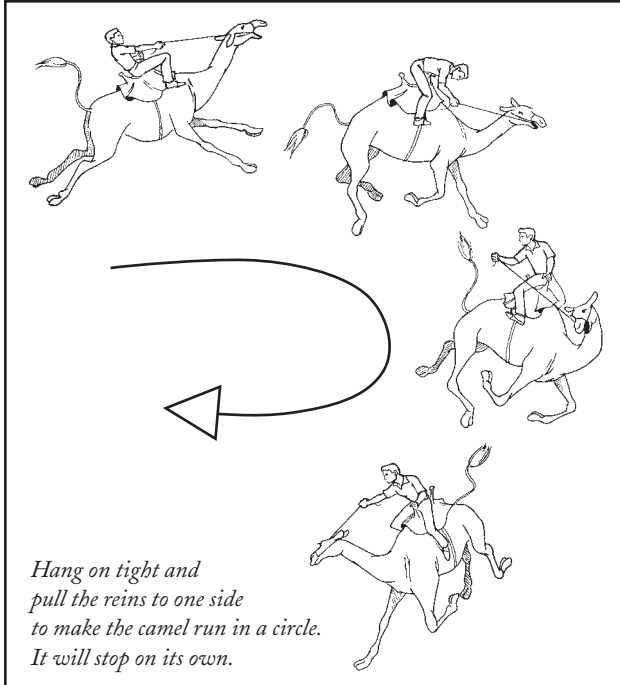

- 2 If the camel has sturdy reins and a head halter, pull the reins to one side to make the camel run in a circle.**

Do not fight the camel; pull the reins in the direction the camel attempts to turn its head. The camel may change direction several times during the incident—let it do so.

- 3 If the camel has nose reins, just hang on tight.**

Use the reins for balance, and grip with your legs. If there is a saddle, hold on to the horn.

- 4 Hold on until the camel stops.**

Whether the camel is running in circles or in a straight path, it will not run very far. The camel will sit down when it grows tired.

- 5 When the camel sits, jump off.**

Hold on to the reins to keep it from running off.

HOW TO CRASH-LAND A PLANE ON WATER

These instructions apply to small passenger propeller planes (not commercial airliners).

1 Take your place at the controls.

If the plane has dual controls, the pilot will be in the left seat. Sit on the right. If the plane has only one set of controls and the pilot is unconscious, remove the pilot from the pilot's seat. Securely fasten your seat belt.

2 Put on the radio headset (if there is one) and call for help.

There will be a control button on the yoke (the plane's steering wheel) or a CB-like microphone on the instrument panel. Depress the button to talk, release it to listen. Say "Mayday! Mayday!" and give your situation, destination, and plane call numbers (which should be printed on the top of the instrument panel). If you get no response, try again on the emergency channel, 121.5. The person on the other end should be able to talk you through proper landing procedures. If you cannot reach someone to talk you through the landing process, you will have to do it alone.

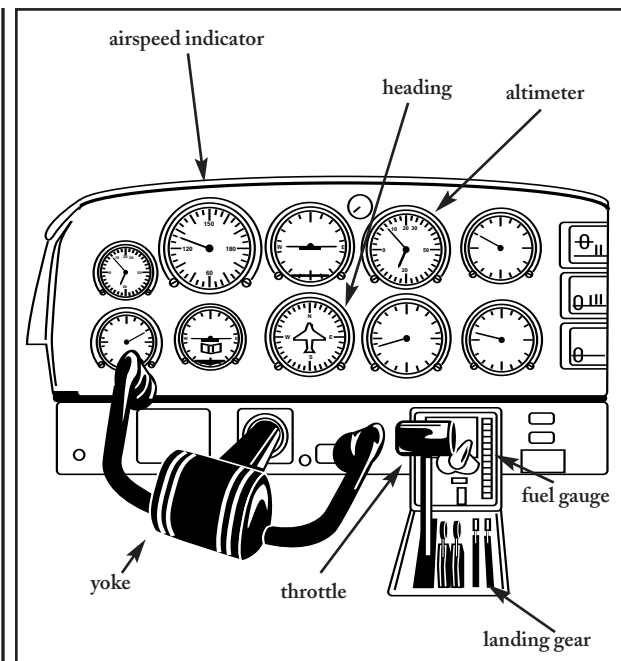

3 Get your bearings and identify the instruments.

YOKE. This is the steering wheel, and it should be in front of you. The yoke turns the plane and controls its pitch. Pull back on the column to bring the nose up, push forward to point it down. Turn it left to turn the plane left, turn it right to turn the plane right. The yoke is very sensitive—move it only an inch or two in either direction to turn the plane. While cruising, the nose of the plane should be about three inches below the horizon.

ALTIMETER. This is the most important instrument, at least initially. It is a black-faced dial in the middle of the panel with white hands and numerals, with zero at the top. The small hand indicates feet above sea level in thousand-foot increments, the large hand in hundreds.

HEADING. This is a compass. It will be the only instrument with a small image of a plane in the center. The nose of the image will point in the direction the plane is headed.

AIRSPEED. This dial is on the top of the instrument panel and will be on the left. It is usually calibrated in knots, though it may also have miles per hour. A small plane travels at about 120 knots while cruising. Anything under 70 knots in the air is dangerously close to stall speed. (A knot is $1\frac{1}{4}$ mph.)

TACHOMETER. This instrument (not visible in ill., but located near the throttle) displays the engine's power in revolutions per minute (rpm). In more sophisticated aircraft, a manifold pressure gauge may be present. This gauge supplies manifold pressure in inches of mercury, and shows you how much power an engine is producing. If present, it should be used in place of the tachometer. (One inch of mercury equals approximately 100 rpm; 10 inches corresponds to 1,000 rpm.)

THROTTLE. This lever controls airspeed (power) and also the nose attitude, its relation to the horizon. It sits between the seats and is always black. Pull it toward you to slow the plane and cause it to descend, push it away from you to speed up the plane and cause it to ascend.

FUEL. The fuel gauges will be on the lower portion of the instrument panel. If the pilot has followed FAA regulations, the plane should have enough fuel for the amount of flying time to your intended destination, plus at least an additional half hour of reserve. Some planes have a reserve fuel tank in addition to the primary one, but do not attempt to change tanks. Full tanks will provide $4\frac{1}{2}$ to 5 hours of flying time for a light aircraft. If the gauge indicates the tanks are half full, you will have half that time. However, be advised that fuel gauges on airplanes can be inexact and experienced pilots do not rely on them. Always assume you have a fuel emergency despite what the fuel gauge may indicate. You want to land the plane as soon as possible to avoid an uncontrolled landing.

MIXTURE CONTROL. This is a red knob or lever on the instrument panel, or between the pilot and co-pilot positions. The knob regulates fuel flow to the engine. Pull it out (toward you) to reduce fuel flow, push it in (away from you) to increase it.

AUTOPILOT. The autopilot panel will be on the lower third of the instrument panel and will generally be to the immediate left or right of the yoke. There will be an on/off switch and separate switches or buttons reading “alt,” “heading,” and “nav.”

FLAPS. The flaps are the moveable parts of the wings that are used to change the speed of the plane and adjust its altitude. Due to their complexity, wing flaps can make the plane hard to control. Use the throttle to control airspeed instead.

4 If the plane is flying straight and level, engage the autopilot.

Press the “alt” (altitude) and heading buttons until the displays read “hold.” This will maintain your present altitude and heading and give you an opportunity to continue to use the radio and assess your landing choices.

5 Once you have determined your landing strategy, turn the autopilot off and reduce power by moving the throttle toward you.

Slowly move the throttle enough to cause the nose to drop and the plane to descend slightly. You will need to be at approximately 2,000 feet to be able to clearly see the water below you.

6 When the altimeter reads 2,000 feet, level the nose with the horizon using the yoke.

Increase power slightly by moving the throttle away from you if pulling back on the yoke does not work.

7 Assess the water ahead of you.

It is imperative that you land in calm water and that you avoid landing the plane in the face of swells, where there is a significant risk of waves breaking over the aircraft. The plane should be heading into the wind (called a headwind), so you land on the backside of any waves.

8 Reduce power by moving the throttle toward you.

Do not use your flaps or your landing gear, which might catch on the water. Bring the plane to an altitude of 100 to 200 feet.

9 Continue to reduce power until the tachometer reads 1,500 to 1,700 rpm or 15 to 17 inches of mercury.

10 Move the nose of the plane up at least 5 to 10 degrees above the horizon by pulling the yoke toward you slightly.

You must exercise a nose-up landing to keep the propeller out of the water and prevent the plane from flipping end-over-end. The angle of the nose should be such that the horizon is almost completely obscured.

11 Just before touchdown, make sure the throttle is in its furthest position toward you.

The plane should be no more than 10 feet above the water at this point.

- 12** Pull the red fuel mixture control knob toward you to cut fuel to the engine when the plane is about five feet above the water.

Use the surface of the water, not the altimeter, to judge your altitude at this low level.

- 13** Keep the nose up by pulling back gently on the yoke. The plane should fall gently onto the water. Concentrate on making sure the rear of the plane hits the water first. If the plane has non-retractable landing gear, it will most likely flip over because the landing gear will catch on the water.

- 14** Open the door or window as soon as you hit the water, and quickly get out of the plane. It may be difficult to open the door or window once you begin to sink. If you are unable to open the cabin door, kick out the windshield.

- 15** If the plane has life vests or a raft, inflate them outside of the plane. The plane's emergency location transmitter (ELT) should continue broadcasting your location to rescue personnel.

**WORST-CASE
SCENARIO.**

WORST-CASE SCENARIO.

HOW TO CROSS A PIRANHA- INFESTED RIVER

- 1 Do not cross if you have an open wound.**
Piranhas are attracted to blood.
- 2 Avoid areas with netted fish, docks where fish are cleaned, and areas around bird rookeries.**
Piranhas may become habituated to feeding in these areas and may be more aggressive there.
- 3 Stay out of the water when piranhas are feeding.**
When large numbers of piranhas are attacking prey—a true feeding frenzy—they may snap and bite at anything around them. If you see them feeding, stay away, or well upriver.

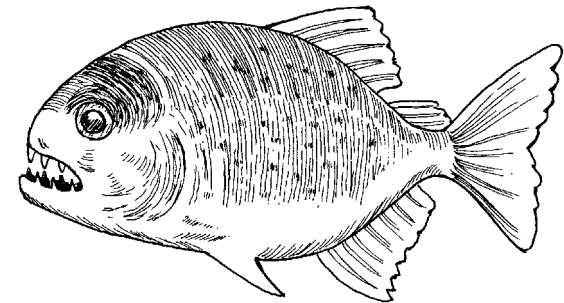

Piranhas are more active (and hungry) during the day, so cross an infested river at night.

4 **Cross the river at night.**

Virtually every species of piranha rests at night, and when awakened, will swim away rather than attack. Piranhas are most active at dawn, though some large adults may hunt in the evening.

5 **Swim or walk across quickly and quietly.**

Try not to create a large disturbance in the water that might awaken piranhas.

Be Aware

- Piranhas are freshwater, tropical fish. In the wild, they exist only in South America, in slow-moving rivers, backwaters, or floodplain lakes. Piranhas generally do not live in either mountain lakes or streams; the water is too cold and flows too fast.
- Piranhas generally do not attack humans or large animals—unless they are already dead or injured. During the dry season, however, when their food supply is scarce, piranhas can be more aggressive. When driving cattle across a river suspected of containing piranhas, farmers will sometimes sacrifice a sick or injured animal downstream before letting the herd enter the water.

**WORST-CASE
SCENARIO.**

HOW TO DEAL WITH A TARANTULA

Tarantulas are usually not hostile and do not have fatal bites. However, their bites can cause dangerous allergic reactions in some individuals and can be extremely painful, so take care when one crawls on or near you.

1 Find something you can use to brush the tarantula off of you or away from you.

A small stick, rolled newspaper or magazine, or glove works well. Most tarantulas are very skittish, and as soon as you poke them, they will leave in great haste. It is safer to remove the tarantula using an implement than using your bare hand.

2 If the tarantula is on you and cannot be brushed off, stand up carefully and bounce up and down gently.

The tarantula should fall off or skitter away.

HOW TO TREAT A BITE

1 Do not panic if you are bitten.

The vast majority of tarantulas give “dry” bites (which look like two pin pricks) first, and then a second bite to inject venom. Avoid *Pterinochilus* and *Heteroscodra*, two species of “baboon spiders” in Africa, and *Poecilothera*, “ornamental tarantulas” in southern Asia, which deliver potent bites.

Use a rolled-up magazine or newspaper or another item to brush the tarantula off.

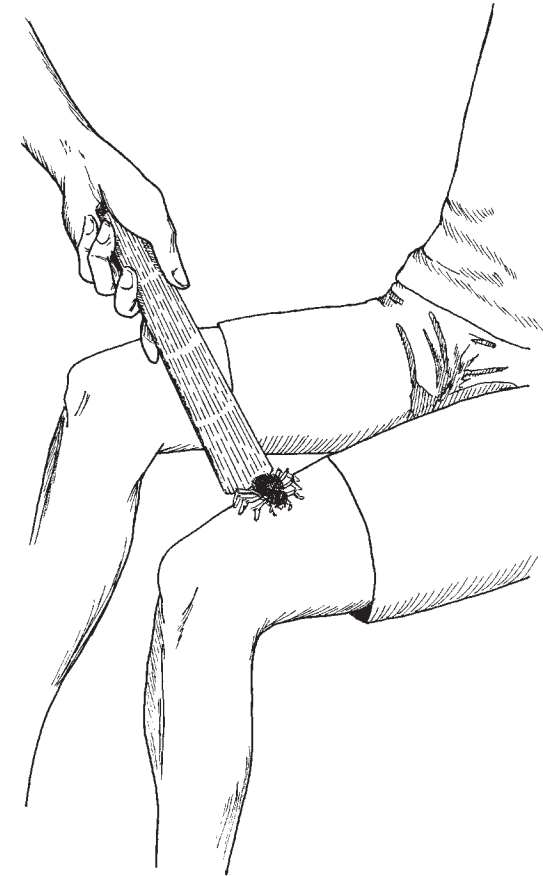

2 **Treat a dry bite like any other small puncture wound: use an antiseptic to clean it out, and bandage the site quickly.**

3 **Observe the area around the bite carefully.**

A few varieties of tarantula may inject venom that can cause swelling and redness in the area around the bite, as well as pain and tenderness lasting 2 to 6 hours. If these symptoms persist for longer than 12 hours, or if other, more serious symptoms develop, seek medical attention. Unless absolutely necessary, do not drive a vehicle.

4 **Treat excessive swelling with antihistamines.**

The allergic reaction can be eased with antihistamines, although they are usually slow acting. If symptoms such as extreme flushing in the face, blurred vision, dizziness, profuse swelling around the face or eyes, or restricted breathing occur, epinephrine may be necessary.

5 **Watch closely for complications.**

While the bite itself is probably not life-threatening, it can become infected, and this is the greatest danger if you are bitten. Seek immediate medical attention if you see signs of tetanus (muscle stiffness, spasm, fever, convulsions, difficulty swallowing, irregular heartbeat, trouble breathing), tularemia (fever, nausea, swollen lymph nodes, sore throat, vomiting, diarrhea), or septicemia (spiking fever and chills, rapid breathing, shock, disorientation, inability to urinate, swollen limbs, blue lips and fingernails).

Be Aware

- Tarantulas are basically just big spiders. Few will bite you unless you try to pick them up.
- Tarantulas are not carriers of any known disease that affects humans or other vertebrates. Tetanus, tularemia, and other diseases that may follow a tarantula bite are most likely the result of post-bite contamination due to unclean environmental conditions. (See step 5.)
- Tarantulas can be found in North America, west of the Mississippi River; in South America; and in warm climates throughout the world. Their habitats vary, and include deep deserts, grassy plains, scrub forests, and rainforests. Most live in burrows, though a few species prefer trees and areas around the base or under the roof of human dwellings.
- Tarantulas are mostly nocturnal and are difficult to notice unless you are searching for them. Most people encounter adult males, which wander during daylight hours looking for female mates.
- Never try to pick up a tarantula. Tarantulas have tough bristles on the tops of their abdomens which can irritate the skin. These come loose easily and float freely through the air. They are shaped like small harpoons with barbed tips and may penetrate the skin and cause a rash or hives.

HOW TO ESCAPE FROM A CAR HANGING OVER THE EDGE OF A CLIFF

- 1 Do not shift your weight or make any sudden movements.**
- 2 Determine how much time you have.**

If the car is like the majority of cars, it is front-wheel drive with the engine in front. This means the bulk of its weight is over the front axle. If the rear, rather than the front, is hanging over the edge of the cliff, you probably have more time to climb out. If the front of the car is over the edge, assess your situation. What is the angle of the car? Is it teetering? Does it sway when you shift your weight? If the car is shifting, you must act quickly.
- 3 If the front doors are still over land, use these doors to make your escape, regardless of which way your car is facing.**

Open the door gradually, move slowly, and get out.
- 4 If the front doors are over the edge, move to the rear of the car.**

Proceed slowly and deliberately; do not jump or lurch. If you have a steering wheel lock or a screwdriver, take it with you—you may need it to get out.

If the front doors are over the edge of the cliff, move slowly to the rear of the car and get out.

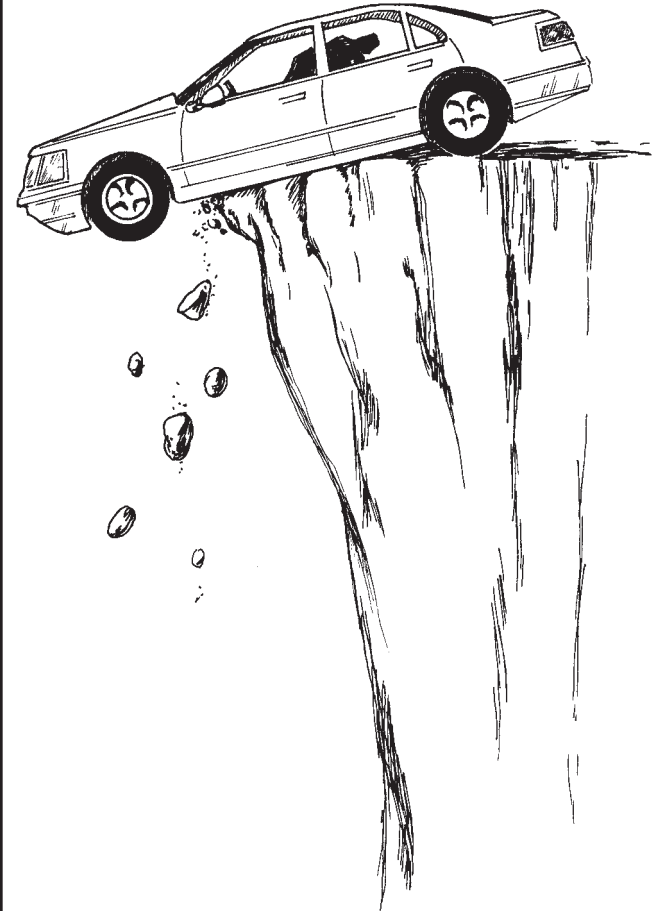

5 **Reassess your situation.**

Will opening the rear doors cause the car to slide? If not, open them slowly and get out quickly.

6 **If you think that opening the rear doors will cause the car to slide over the edge, you must break the window.**

Without shifting your weight or rocking the car, use the steering wheel lock or screwdriver to shatter the rear door window (this is safer than breaking the back window because it will require less movement as you climb out). Punch it in the center—the window is made of safety glass and will not injure you.

7 **Get out as quickly as possible.**

Be Aware

- In situations involving several people, everyone in the front (or everyone in the back) should execute each step simultaneously.
- If driver and passengers are in both front and rear seats, the people who are closest to the edge of the cliff should attempt to get out of the car first.

**WORST-CASE
SCENARIO.**

HOW TO ESCAPE FROM THE TRUNK OF A CAR

1 If you are in a trunk that has no wall separating the backseats and the trunk, try to get the seats down.

Although the release for most seats is inside the passenger compartment, you may be able to fold or force them down from the trunk side. (If not, continue to step 2.)

2 Check for a trunk cable underneath the carpet or upholstery.

Many new cars have a trunk release lever on the floor below the driver's seat. These cars should have a cable that runs from the release lever to the trunk. Look for the cable beneath carpeting or upholstery, or behind a panel of sheet metal. If you locate the cable, pull on it to release the trunk latch. (If not, continue to step 3.)

3 Look for a tool in the trunk.

Many cars have emergency kits inside the trunk, underneath or with the spare tire. These kits may contain a screwdriver, flashlight, or pry bar. Use a screwdriver or pry bar to pry the latch open. You can also pry the corner of the trunk lid up and wave and yell to signal passersby. (If there is no tool, continue to step 4.)

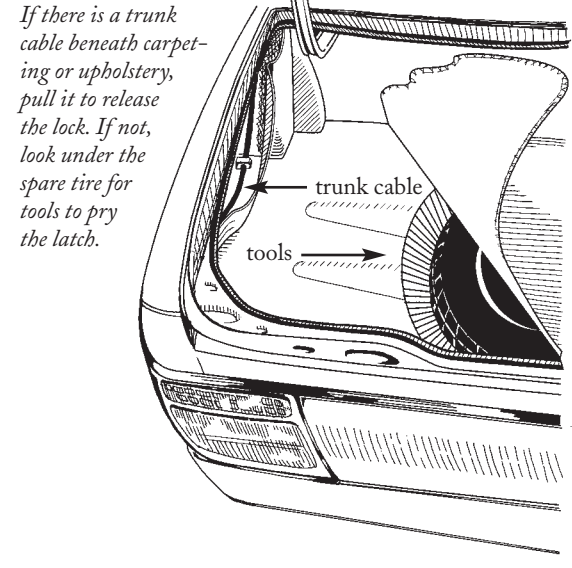

4 Dismantle the car's brake lights by yanking wires and pushing or kicking the lights out.

Then wave and yell to signal passersby or other cars. This method is also recommended if the car is moving and you need to signal cars behind you.

Be Aware

- No car trunk is airtight, so the danger of suffocation in a car trunk is low. Breathe regularly and do not panic—panic increases the danger of your hyperventilating and passing out. Keep in mind, however, that on a hot day the interior temperature of a car trunk can reach 140 degrees. Work quickly but calmly.

WORST-CASE SCENARIO.

HOW TO ESCAPE WHEN TIED UP

UPPER TORSO BONDS

- 1** When your captors start binding you, expand your body as much as possible.
 - Take a deep breath, puff out your chest, and pull your shoulders back.
 - Flex your arms against the bonds.
 - Push against the bonds as much as possible.
- 2** When your captors are away, suck in your chest and stomach.
- 3** Wiggle free with the extra room you have given yourself.

HAND AND WRIST BONDS

- 1** Push or flex against the bonds as your captors are tying you.
- 2** Keep your wrists apart, if possible.
- 3** Use a pointed object that protrudes (a spike or hook) to work the bonds loose.
You may also be able to work the knots free with your teeth by biting and pulling on the knots.

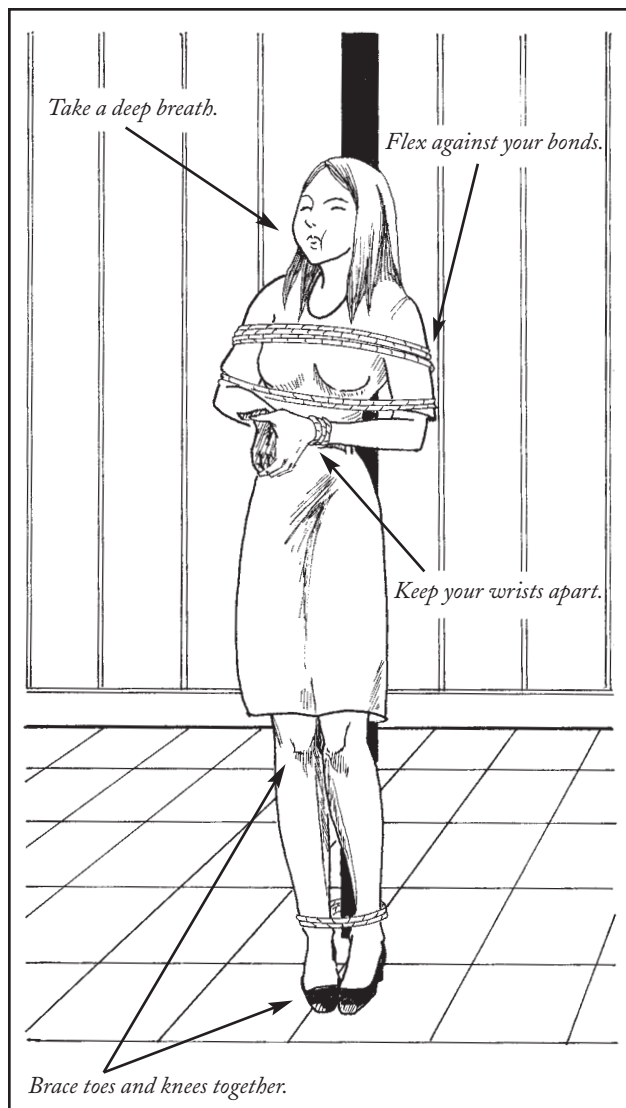

- 4** Free yourself by relaxing your hands and wrists and working until the slack can ride over your palms and fingertips.

LEG AND ANKLE BONDS

- 1** While being bound, flex your thighs, knees, calves, and ankles against the bonds.
- If being bound at the ankles, force them apart by bracing the toes of your shoes and knees together.
 - If being bound at the thighs or calves, force them apart by keeping the toes of your feet together and your legs turned slightly outward.
- 2** Relax your legs and work the bonds down. Use your hands to pull the bonds off your legs and ankles, even if your hands are bound.

REMOVING GAGS

- ★ Rub your face or head against a wall, a piece of furniture, or anything projecting to slip the gag down over your chin.

HOW TO FIND WATER ON A DESERTED ISLAND

1 Collect rainwater in whatever container is handy.

A bowl, plate, or helmet will work—so will a life raft and stretched clothing. In very dry environments, condensation forms on surfaces overnight. Use a tarp or other fabric—shaped as a bowl—to collect water.

2 Collect dew.

Tie rags or tufts of fine grass to your ankles and walk in grass or foliage at sunrise. The dew will gather on the material, which can then be wrung out into a container.

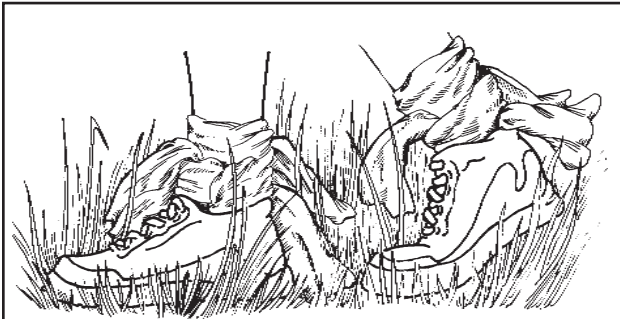

Tie rags to your ankles to collect dew.

3 Head for the mountains.

An island that appears barren on the coast may have a green, mountainous interior, which is an indication of freshwater streams and creeks. Find these by following trails of vegetation. Do not waste too much energy hiking or moving long distances unless you are relatively certain you will find water (meaning that the lush greenery is not far away).

4 Catch fish.

The area around a fish's eyes contains drinkable liquid, as do fish spines (except shark spines). Suck the eyes, and break the vertebra of the spine apart and suck the liquid from them. Fish flesh also contains drinkable water—but fish are high in protein, and protein digestion requires additional water, so you are better off squeezing raw fish in clothing or a tarp to extract water.

5 Look for bird droppings.

In arid climates, bird droppings around a crack in a rock may indicate a water source. (Birds often congregate around cracks where water collects.) Stuff a cloth into the crack, then wring it out into a container or your mouth.

6 Locate banana and plantain trees.

Cut down the tree, leaving a stump about one foot high. Scoop out the center of the stump, so the hollow is bowl shaped. The roots will continually refill the stump with water for about four days. The first

three fillings will be bitter, but subsequent fillings will be less so. Cover the stump to keep out insects.

Be Aware

- Seawater is generally not safe to drink; its high salt content can cause kidney failure. Moreover, two quarts of body fluid are required to rid the body of the waste in one quart of seawater. As a last resort, you can drink less than 32 ounces of seawater per day; while not healthy, it may keep you alive.
- Rainwater collected in a container is generally safe to drink, provided the container is clean and the water does not stand; any standing water is capable of breeding bacteria.

**WORST-CASE
SCENARIO.**

HOW TO FIND YOUR WAY WITHOUT A COMPASS

STICK AND SHADOW METHOD

Be aware that the closer you are to the equator, the less accurate this method is.

What You Need:

- An analog watch
- A six-inch stick

Northern Hemisphere

- 1** Place a small stick vertically in the ground so that it casts a shadow.

In the Northern Hemisphere, place your watch on the ground so that the hour hand is parallel to the shadow. In the Southern Hemisphere, place your watch so that 12:00 is parallel to the shadow.

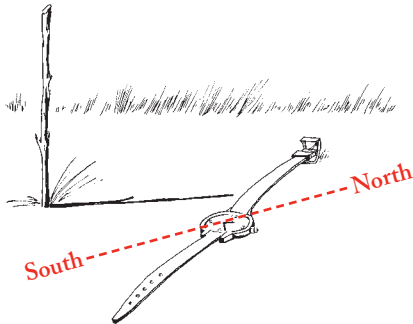

- 2** Place your watch on the ground so that the hour hand is parallel to the shadow of the stick.

- 3** Find the point on the watch midway between the hour hand and 12:00.

If the watch is on Daylight Savings Time—which is during most of the summer—use the midway point between the hour hand and 1:00.

- 4** Draw an imaginary line from that point through the center of the watch.

This imaginary line is a north-south line. The sun will be located toward the south.

Southern Hemisphere

- ★** Place your watch on the ground so that 12:00 is parallel to the shadow.

Then find the midway point between the hour hand and 12:00. Draw an imaginary line from the point through the center of the watch. This is the north-south line. The sun will be located toward the north.

STAR METHOD

Northern Hemisphere

- ★** Locate the North Star, Polaris.

The North Star is the last star in the handle of the Little Dipper. Walking toward it means you are walking north. You can use the Big Dipper to find the North Star. A straight imaginary line drawn between the two stars at the end of the Big Dipper's bowl will

point to the North Star. The distance to the North Star is about five times the distance between the two “pointer” stars.

Southern Hemisphere

★ Find the Southern Cross.

The Southern Cross is a group of four bright stars in the shape of a cross and tilted to one side. Imagine the long axis extends in a line five times its actual length. The point where this line ends is south. If you can view the horizon, draw an imaginary line straight down to the ground to create a southern landmark.

CLOUD METHOD

★ Look at the clouds to determine which direction they are moving.

Generally, weather moves west to east. While this may not always be true in mountain regions, it is a good rule of thumb and may help orient you.

MOSS METHOD

★ Locate moss.

Mosses grow in places with lots of shade and water: areas that are cool and moist. On tree trunks, the north sides tend to be more shady and moist than the south sides, and therefore, moss usually grows on the north sides of trees. However, this method is not infallible—in many forests, both sides of a tree can be shady and moist.

**WORST-CASE
SCENARIO.**

HOW TO FOIL A SCAM ARTIST

Con artists come in all shapes and sizes. In order to thwart them, you need to understand how they most commonly work. Here are a few of the most common scams, with instructions on how to avoid falling victim to them.

LUGGAGE GRAB

How the scam works

This airport scam involves two people. Scam Artist #1 gets in front of you on the line for the metal detector. You place your bags on the X-ray machine's conveyor belt. Scam Artist #2 abruptly cuts ahead of you in the line. Scam Artist #2 has lots of change and other metal objects in his pockets. You wait as he empties his pockets and goes through the metal detector several times until it stops beeping. Meanwhile, Scam Artist #1 grabs your bag as if it were his own and makes off with it. When you finally get through the metal detector, your bag is gone, and neither man is anywhere to be found.

How to foil the scam

- 1** Carry a bag that is distinctive and difficult to mistake for another.

- 2** Know what to expect.

Orderly lines may not be the norm in all countries. In some places, pushing and shoving are more accepted, which makes the scammers' job easier.

- 3** Never let valuables out of your sight.

Angle your body so you are able to see the far end of the X-ray machine.

- 4** Do not allow anyone to cut in front of you at the metal detector once you place your items on the conveyor belt.

- 5** Watch your luggage and be assertive with security and customs officials.

- 6** If you are traveling with one or more companions, do not go through the metal detector one after another.

Space yourselves several people apart, and give the majority of your valuables to the last person passing through. The first person through can watch the X-ray machine until the bag with your valuables appears.

PASSPORT AND CREDIT CARD COPY

How the scam works

When you present a traveler's check to a merchant, the merchant asks to see your passport to make sure the signatures match. She says the signatures do not match, and asks to photocopy your passport and a

credit card as proof of identification. She copies your information and uses it for unauthorized charges at a later date.

How to foil the scam

- 1 Always sign traveler's checks in front of the merchant.**

She cannot claim the signature is forged if she watched you sign the check.

- 2 Never allow your credit cards or passport to be photocopied.**

- 3 Pay cash, or leave the store immediately.**

CARDBOARD CHILDREN

How the scam works

Small bands of children (usually 6 to 10 of them) confront you for change. The children swarm you, beg loudly for money or candy, while at the same time pressing pieces of cardboard against your body. The shouting distracts you, while the cardboard desensitizes you to the small hands entering your pockets or bags. The scam takes just a few seconds at most. The children suddenly disperse in different directions, taking your valuables with them. Even if you were to realize you had been robbed, you would have no way of knowing which child to follow.

How to foil the scam

- 1 If you are alone and are approached by a group of begging children, get to a well-populated area.**

Walk into the nearest store or restaurant.

- 2 If there is no place to hide, hold your wallet tightly in your hand so that it cannot be snatched.**

Even better, distribute your money in multiple pockets beforehand.

- 3 Make as loud a scene as you can.**

Be Aware

- A money belt or waist pouch, while better than a wallet for securing valuables, can be breached by experienced thieves. If you wear a waist pouch, always make sure it faces forward and is not worn as a "fanny" pack.
- Keep your passport in a hotel safe and carry a photocopy. If you must travel with an original passport, secure it inside a pocket with a safety pin.

HOW TO FOIL A UFO ABDUCTION

- 1 Do not panic.**
The extraterrestrial biological entity (EBE) may sense your fear and act rashly.
- 2 Control your thoughts.**
Do not think of anything violent or upsetting—the EBE may have the ability to read your mind. Try to avoid mental images of abduction (boarding the saucer, anal probes); such images may encourage them to take you.
- 3 Resist verbally.**
Firmly tell the EBE to leave you alone.
- 4 Resist mentally.**
Picture yourself enveloped in a protective shield of white light, or in a safe place. Telepathic EBEs may get the message.
- 5 Resist physically.**
Physical resistance should be used only as a last resort. Go for the EBE's eyes (if they have any)—you will not know what its other, more sensitive areas are.

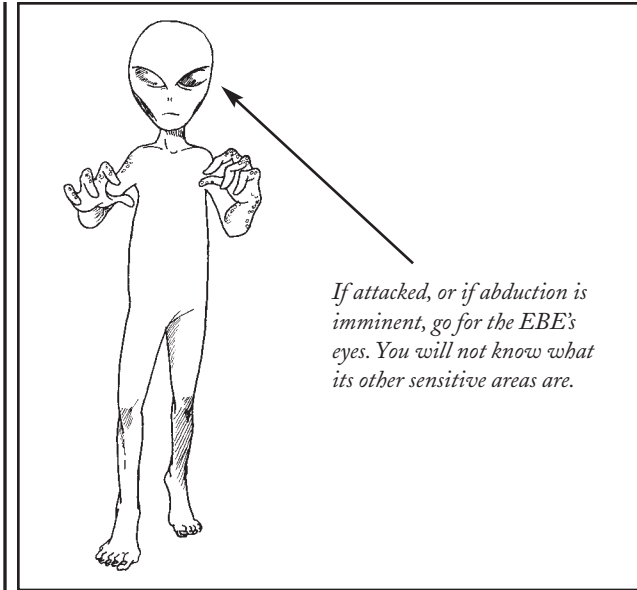

HOW TO REPORT A UFO SIGHTING

- 1 Stay calm.**
If you become upset or excited, you are likely to forget important details.
- 2 Accurately record the time at the start of the sighting, the time of any change of direction in the UFO's flight pattern, and the time at the end of the sighting.**
If possible, use a mechanical stopwatch, since close proximity to a UFO may prevent electronic instruments from functioning correctly.

3 Sketch a schematic of the UFO's path in the ground.

Mark your position in the ground at the start of the sighting, and draw a line in the direction of the object when first seen, for each direction change, and when last seen.

4 Try to identify any horizon landmarks with regard to the UFO's position.

5 If you have a video or still camera, record the sighting.

Neither video nor still images carry much weight on their own, so it is essential that the images include reference information such as a tree, a mountain, or a skyline.

6 Report the sighting as soon as possible.

Contact the UFO Reporting and Information Service (206-721-5035), the Mutual UFO Network (830-379-2166), or the National UFO Reporting Center (206-722-3000).

Be Aware

- Most sightings are in rural areas, away from bright lights, and near military installations. They occur most frequently during the summer months, around 9:00 P.M., with a secondary peak at around 3:00 A.M.

**WORST-CASE
SCENARIO.**

WORST-CASE SCENARIO.

HOW TO JUMP FROM A MOVING TRAIN

- 1 Move to the end of the last car.**

If this is not an option, you can jump from the space between cars, or from the door if you can get it open.
- 2 If you have time, wait for the train to slow as it rounds a bend in the tracks.**

If you jump and land correctly, you will probably survive even at high speeds (70 mph or more), but you increase your chances of survival if the train is moving slowly.
- 3 Stuff blankets, clothing, or seat cushions underneath your clothes.**

Wear a thick or rugged jacket if possible. Use a belt to secure some padding around your head, but make certain you can see clearly. Pad your knees, elbows, and hips.
- 4 Pick your landing spot before you jump.**

The ideal spot will be relatively soft and free of obstructions. Avoid trees, bushes, and, of course, rocks.
- 5 Get as low to the floor as possible, bending your knees so you can leap away from the train car.**

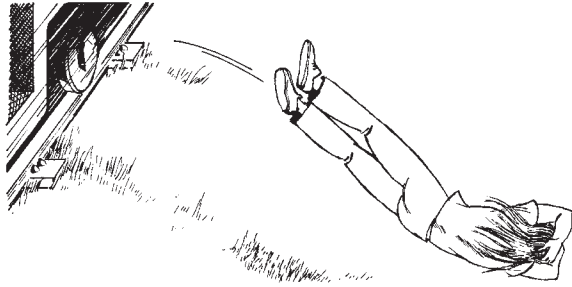

Pick your landing spot, and jump as far away from the train as you can. Protect your head.



Try to land so that all parts of your body hit the ground at the same time.

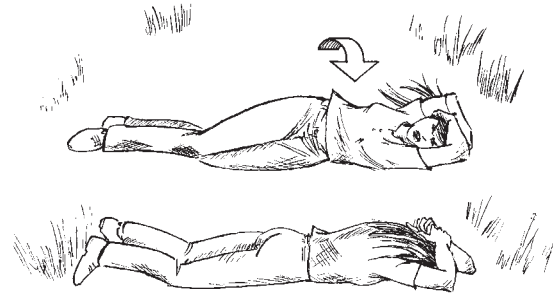

Roll like a log, keeping your head protected.

6 **Jump perpendicular to the train, leaping as far away from the train as you can.**

Even if you jump from the last car, leap at right angles to the direction of the train. This way, your momentum will not carry you toward the wheels and tracks.

7 **Cover and protect your head with your hands and arms, and roll like a log when you land.**

Do not try to land on your feet. Keep your body straight and try to land so that all parts of your body hit the ground at the same time—you will absorb the impact over a wider area. If you land on your feet, you will most likely break your ankles or legs. Do NOT roll head over heels as if doing a forward somersault.

HOW TO JUMP FROM ROOFTOP TO ROOFTOP

1 Look for any obstructions if you have time.

You may have to clear short walls, gutters, or other obstacles as well as the space between buildings.

2 Check your target building.

Make certain that you have enough space to land and roll. If the target building is lower than your building, assess how much lower it is. You risk broken ankles or legs if there is more than a one-story differential in the buildings. If there are two stories or more, you risk a broken back.

3 Check the distance between the buildings.

Most people cannot jump farther than 10 feet, even at a full run. If the buildings are farther apart than this distance, you risk catastrophic injury or death. You must clear the distance and land on the other roof, or be able to grab on to a ledge on the other side. If the target building is lower, your forward momentum will continue to carry you even as you fall, so you may be able to leap a greater distance—though probably not more than about 12 feet. You could successfully leap a span across an alley, but not a two-lane road.

Jump with your arms outstretched, ready to grab the ledge if you undershoot your mark.



4 Pick a spot for take off and a spot for landing.

5 Run at full speed toward the edge.

You must be running as fast as possible to attempt a leap of a distance of more than a few feet. You will need 40 to 60 feet of running room to develop enough speed to clear about 10 feet.

6 Leap.

Make sure your center of gravity is over the edge of your target building in case your whole body doesn't clear the span and you have to grab hold. Jump with your arms and hands extended and ready to grab the ledge.

7 Try to land on your feet, then immediately tuck your head and tumble sideways onto your shoulders, not forward onto your head.

Because you will not be moving fast, it is safe to roll head over heels, unlike jumping from a moving vehicle.

**WORST-CASE
SCENARIO.**

WORST-CASE SCENARIO.

HOW TO LOSE SOMEONE WHO IS FOLLOWING YOU

IF YOU ARE IN A CAR

- 1 Determine if you are actually being followed.**

If you suspect a tail, observe the car as you continue to drive. If the car remains behind you, make three to four turns in a row to see if it continues to follow you. Then signal a turn in one direction but turn quickly in the other direction. See if the other car turns as well.
- 2 Once you are certain you are being followed, get on a highway, or drive to a populous and active area.**

Do not drive home, to a deserted place, or down an alley. You are more likely to shake your tail in a crowd than in a deserted area.
- 3 Drive at the speed limit, or a bit slower.**

Soon, another car (not that of your pursuer) will attempt to pass you. Speed up slightly so the car pulls in behind you. Repeat, but don't go so slowly that an innocent car behind you is able to pass you.

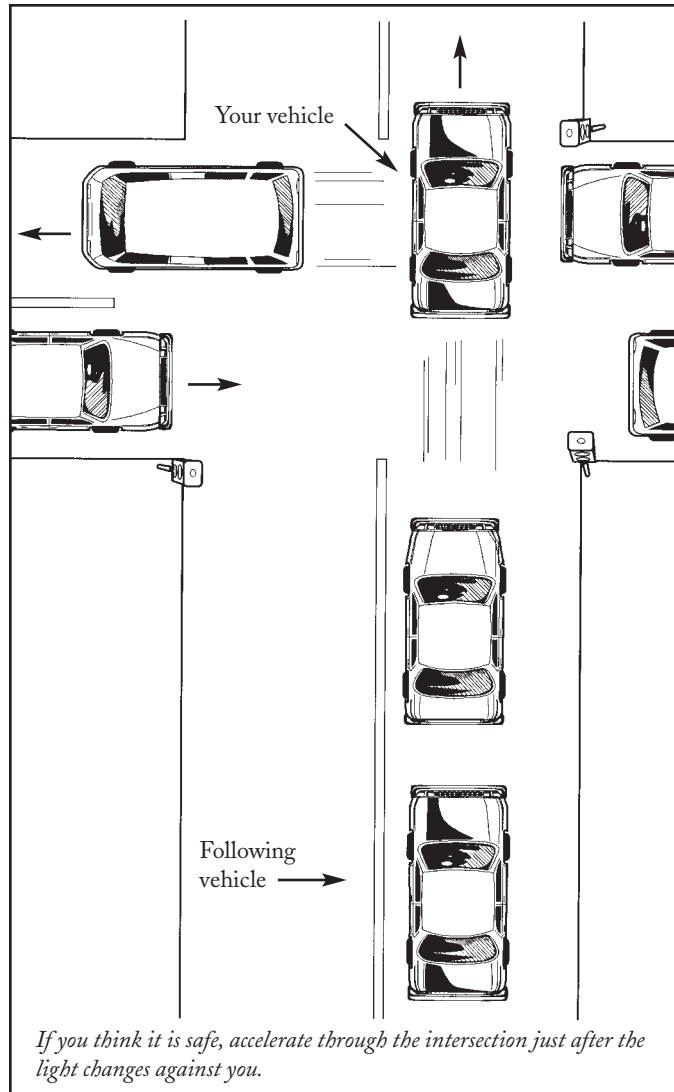

- 4** Slow down at a busy intersection with a traffic light, then accelerate through the intersection just after the light changes.

The car following you may get stuck at the red light. If you attract the attention of the police for running a red light, your pursuer will most likely leave the scene.

- 5** When you have several cars around you, speed up, get off the highway (if you are on one), and make several quick turns to further elude your pursuer. Your pursuer should be too far back to follow closely.

- 6** Once you are out of sight of your pursuer, pull into a parking lot, a garage, or a shopping center with lots of other cars.

- 7** If you still have not lost your tail at this point, drive to a police station and get help.

IF YOU ARE ON FOOT

- 1** Determine if you are being followed, and identify your tail.

Take a random path: Make unexpected changes in direction at intersections and retrace your steps, effectively making a U-turn. Do not, however, get yourself disoriented or lost. Note any identifying characteristics of your tail (dress, gait, height, and weight).

2 **Keep an eye on your pursuer, but do not look back at him/her.**

Use reflective surfaces such as shop windows to see behind you. If you have a makeup case with a mirror, use that.

3 **Stay in crowds.**

Do not head for home, to a deserted place, or down alleys.

4 **Once you are certain that you are being followed, use these methods to shake your tail:**

- Enter the front of a store, shop, or restaurant and go out through the back entrance—most restaurants have exits in the kitchen.
- Buy a ticket for a movie, enter after it has started, and leave through an emergency exit before your pursuer enters the theater.
- Use mass transit, and exit or enter the train or bus just before the doors close.

5 **If you have not shaken your tail, walk to a police station or call the police from a public place.**

Never head for home unless you are certain you are no longer being followed.

Be Aware

- If you are certain your tail is not dangerous, you may want to confront your pursuer in a public place with many people around. Say that you know you are being followed and ask your pursuer why. Use this method only if you feel the person is not dangerous.

**WORST-CASE
SCENARIO.**

HOW TO MAKE ANIMAL TRAPS

Holding Traps

Use a holding trap (or snare) to trap small ground animals. Holding traps capture animals but do not kill them.

- 1 Procure a two-foot-long wire and a small stick.**
Wire is essential—animals can bite through string and twine.
- 2 Wrap one end of the wire around the stick.**
Twist the stick while holding the wire on both sides of the stick with your thumb and forefinger. You will create a small loop around the stick while wrapping the wire around itself.
- 3 Remove the stick by breaking it near the wire.**
Slide the ends out. You will be left with a small loop at one end of the wire.
- 4 Take the other end of the wire and pass it through the loop.**
This will make a snare loop, which becomes a snare that will tighten as the animal struggles. The snare loop should be about five inches in diameter.

- 5 Twist and tie the end of the wire to a one-foot stake.**

- 6 Place the snare in an animal track or at the entrance to an animal burrow or hole.**

You can also use two snares, one behind the other, to increase your odds of catching something. The struggling animal caught in one snare will likely become caught in the other.

- 7 Anchor the stake in the ground.**

Position the stake in an area where the animal won't see it. Mark it so that you can find it later.

- 8 Check the trap only once or twice daily.**

Checking the trap too often may frighten away the animals. When an animal heading for its home becomes caught in the snare, it will struggle to get away, which will tighten the wire trap.

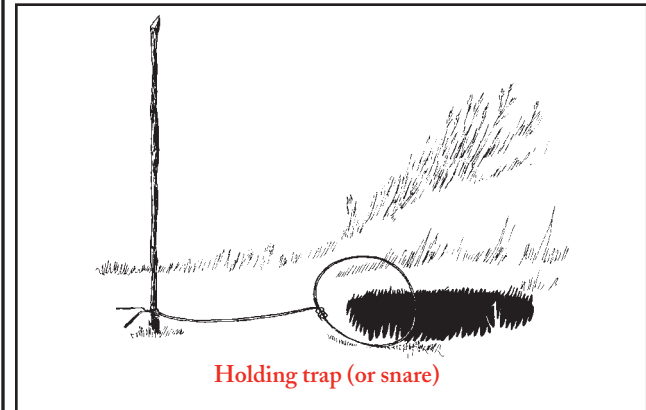

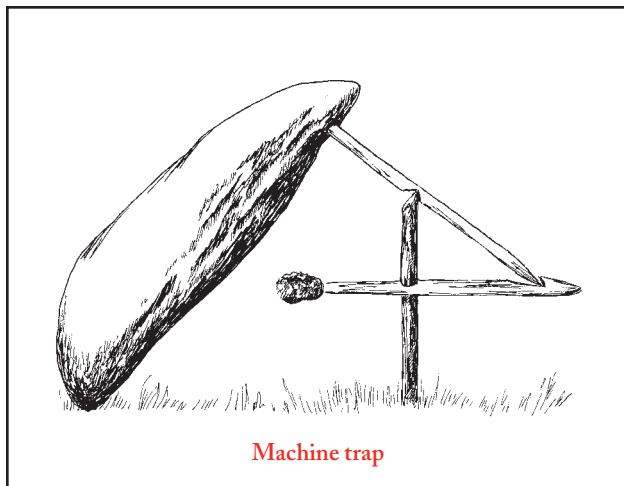

Machine trap

MACHINE TRAPS

Machine traps use gravity, activated by a trigger, to trap or kill animals. The easiest machine trap to build is a deadfall, where a trigger releases a rock or heavy piece of wood to trap or kill an animal.

- 1** Look for a well-worn animal path on which to place the trap.
- 2** Find three straight sticks or pieces of wood that are approximately the same length and diameter, and a large, heavy stone or log.

The length and thickness of the sticks you need will depend upon the weight of the stone or log you intend to prop up—use your judgment.

- 3** **Cut a squared notch in the middle of one stick.**
Cut the point of the stick to look like the tip of a flat-head screwdriver—thin and flat. This is your upright support bar.
- 4** **Cut a squared notch (to fit into the first squared notch like Lincoln Logs) in the middle of another stick.**
On this stick, cut a triangular notch a couple of inches from one end, and whittle the other end of the stick to a point. This is your bait bar.
- 5** **Cut a triangular notch into the middle of the last stick.**
This notch should fit on the top of your support stick. Cut one point of this stick to look like the tip of a flat-head screwdriver (to fit into the triangular notch of your bait bar), and cut the other end flat. This is your locking bar.
- 6** **Anchor your support stick in the ground, perpendicular to the ground.**
- 7** **Attach a piece of meat or food to the end of your bait bar, and insert the bait bar into the notch of your support stick, parallel to the ground.**
- 8** **Place your locking bar on top of your bait and support bar, forming a 45-degree angle with your bait bar.**
The screwdriver tip of your locking bar should fit into the notch at the end of your bait bar, and the tip of the support bar should fit into the triangular notch of your locking bar.

9 Lean the stone or log so that the top end rests on the top of your locking bar.

When an animal comes along the trail, it will take the bait, causing the locking bar to dislodge and trigger the deadfall, trapping or crushing your prey.

Be Aware

- To increase the odds of trapping an animal, always set multiple traps, preferably 8 to 10.
- Set the traps where animals live or in areas they frequent, near water and feeding areas. Watch animal patterns to see where they come and go regularly. Dung piles indicate nesting areas.
- Check traps once or twice daily. Dead animals will quickly rot or become food for other animals.
- Do not build the trap where you intend to place it. Build the trap components in camp, then bring them to the place you have chosen. This way, you will not frighten away animals by spending too much time in their habitats. Try to de-scent your traps using leaves or bark to remove your smell.
- Set traps in the narrow parts of animal trails, such as between rocks or in areas with thick brush on either side. Animals will generally only approach traps if there is no easy way around them. Like humans, animals tend to take the path of least resistance.
- Be careful around traps. Animal traps can injure you, and can trap bigger animals than you expect.
- Be alert when approaching any trapped animal. It may not be dead, and it may attack you.
- Do not leave traps or trap elements behind when you leave an area.

**WORST-CASE
SCENARIO®**

HOW TO NAVIGATE A MINEFIELD

- 1** Keep your eyes on your feet.
- 2** Freeze—do not move any farther.
- 3** Look for spikes, detonators, wires, bumps, or discoloration in the ground around you.
- 4** Avoid spikes, detonators, wires, bumps, or discoloration in the ground, and back up slowly in your own footsteps.
Do not turn around. Walk backward.
- 5** Stop when you are certain you are safe.

HOW TO IDENTIFY AND AVOID MINEFIELDS

The simplest way of avoiding mines is to avoid regions where you suspect they may be, such as post-war countries. If you are in such a region, follow these tips.

- Ask locals.
Explosive Ordnance Disposal (EOD) technicians, local women, and children are the best sources of information (in that order) for where danger zones are located.

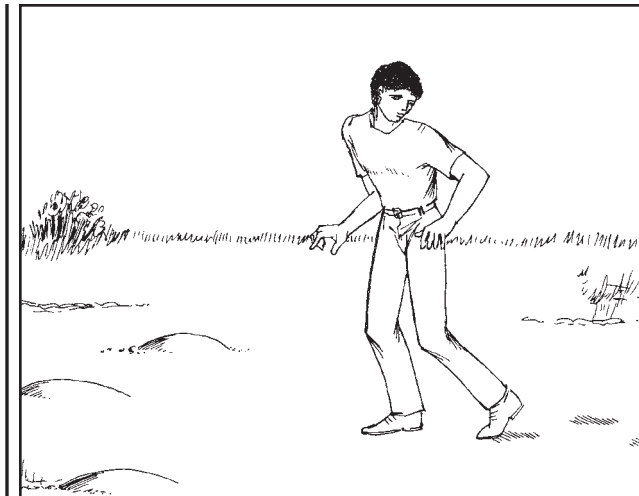

*As soon as you realize you are in danger, do not move farther.
Back up slowly in your own footsteps.*

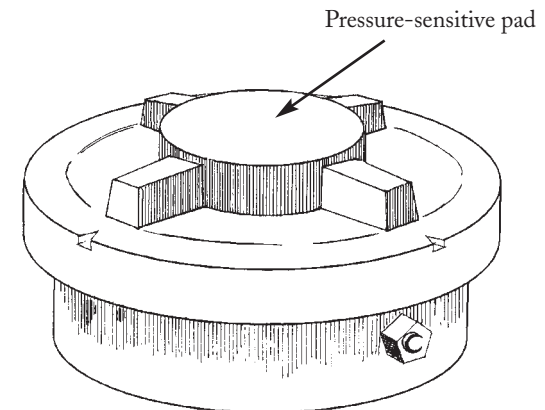

typical direct-pressure landmine

- Observe animals.
Field animals are considered de facto mine-sweepers. Fields with large quantities of mutilated animals, untouched by people, may indicate a minefield.
- Watch the movements of locals.
Locals who avoid perfectly good trails are probably avoiding a mined area. Observe which routes they will not travel on and avoid them. Never travel alone in a suspected mined area.
- Look for dirt that has been disturbed.
Transference of dirt or discoloration of fields may indicate hasty placement of mines.
- Look for wires across trails.
Trip wires strung across trails indicate mines or other explosives.
- Look for newly destroyed vehicles on or just off the road.
Evidence of recent mine detonations includes burning or smoking vehicles and craters. Never assume that because a mine has already detonated the path is clear.
- Avoid brush and overgrown fields and trails.
These will not be clearly marked with mine clearance signs, and are more difficult to navigate on your own.

Be Aware

- Many mines stay active indefinitely. Be sure to ask for guidance in an area known for mines.

- There are four basic mine types:

TRIP-WIRE MINES. Stepping across a wire attached to the detonator will cause the mine to explode.

DIRECT-PRESSURE MINES. Stepping down on a pressure-sensitive pad will activate the detonator.

TIMER MINES. A timer can be an electrical clock, an electronic digital clock, a dripping/mixing chemical, or a simple mechanical timer that will detonate the mine.

REMOTE MINES. A remote mine can be detonated via an electrical charge across a wire (a “clacker”), via a radio signal, or from a heat or sound sensor.

HOW TO PASS A BRIBE

1 If you are hassled by an official, be friendly, but aloof.

Do not show concern or act surly. Remain calm and good-natured. Try to determine if there is an actual problem or if the official is seeking some additional, unofficial compensation.

2 Never blatantly offer a bribe.

If you have misinterpreted the official's intentions, you may get yourself in additional trouble by overtly offering a bribe.

3 If you are accused of an infraction, ask to pay a fine on the spot.

Say that you would rather not deal with the mail or go to another location, citing your fear that the payment will get lost. Mention that you want to make sure the money gets to the proper person.

4 Try to speak to and deal with only one official.

Speak to the person who acts as though he/she is in charge. If you offer money to a junior officer while a superior is present, the superior may demand more.

5 Offer to make a "donation" to the official's organization.

Say that you would like to pay for gas, uniforms, car repairs, expenses, or other needs.

To resolve a customs dispute, offer the official a "sample" of the goods in question—for example, a bottle of liquor.

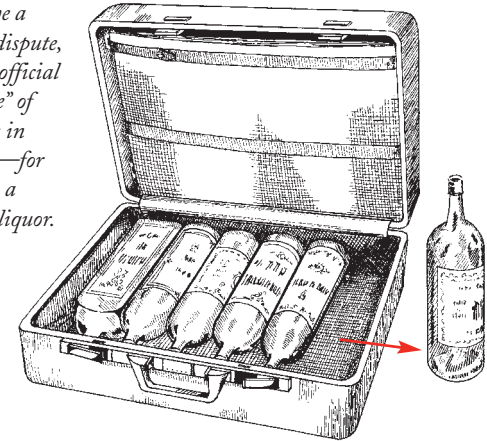

6 If you do not have cash, be prepared to offer goods instead.

Watches, cameras, and other electronics are often accepted as bribes. You might consider offering goods instead of cash even if you have the money, particularly if the "problem" concerns these goods. If, for example, a customs official tells you that you are transporting too many bottles of liquor, you might speed your trip and lighten your load by offering some of the items in dispute to the official.

Be Aware

- Carry only a small amount of money in your wallet and hide the rest. This will prevent an unscrupulous official from seeing your entire wad.

WORST-CASE SCENARIO®

HOW TO PURIFY WATER

There are four ways to obtain safe drinking water in the wilderness: filtration, chemical treatment, boiling, and distillation.

FILTRATION

Filter water from all sources in the wild—mountain stream, spring, river, lake, or pond.

1 Find or make your filter.

Coffee filters, paper towels, ordinary typing paper, or even your clothing can serve as filters (the more tightly woven, the better). You can also make an effective filter by filling a sock with alternating layers of crushed charcoal, small crushed rocks, and sand.

2 Pour the water through a filter.

Do this several times to clean out impurities.

Be Aware

- Filtration will only remove some of the water's impurities. It will not kill bacteria or other microorganisms. The best procedure is to filter water first, then treat it with chemicals or boil it.

CHEMICAL TREATMENT

- 1 Add two drops of household bleach for each quart of water.**
Use three drops if the water is extremely cold or cloudy.

Or

Use one iodine tablet or five drops of drugstore iodine (2 percent) per quart of water.
- 2 Mix the water and bleach or iodine, and let it sit for at least one hour.**
The chemicals will kill microorganisms; the longer the water sits, the purer it will be. Leaving the water overnight is the safest course of action.

DISTILLATION

A solar still uses the heat of the sun to evaporate water trapped in the ground and funnels it into a container for drinking. To build a solar still:

- 1 Dig a hole about a foot deep, and wide enough to hold your container.**
- 2 Place a clean container at the center of the hole.**
- 3 Cover the hole with a piece of plastic.**
A tarp or a section of a garbage bag works well as a cover.

- 4 Place sticks or stones around the edges of the plastic so that it is flush with the ground and air cannot escape.**
- 5 Poke a 1/4-inch to 1/2-inch hole in the center of the tarp and place a small stone next to the hole, so the tarp looks like a funnel.**
Make sure the hole is above, but not touching, the top of the container.
- 6 Wait.**
The heat from the sun will cause water in the ground to evaporate, condense on the plastic, and drip into the container. While your solar still will not produce much liquid (less than one cup), the water is safe to drink immediately. The process can take anywhere from several hours to a full day to produce water, depending on the water in the ground and the strength of the sun.

BOILING

- ★ Boil water for at least one minute, plus one minute of boiling time for each 1,000 feet above sea level.**
If fuel is abundant, boil water for 10 minutes before drinking it. The longer the water boils, the more microorganisms that are killed. Beyond 10 minutes, however, no further purification occurs. Be sure to let the water cool before drinking it.

HOW TO RAM A BARRICADE

1 Identify the barricade's weakest point.

The side of the barricade or gate that opens, or the place where a lock holds it closed, is usually its most vulnerable spot. Some barricades and gates have no locks at all: These are opened and closed by the force of an electric motor or magnet, which can be overpowered rather than rammed (see below).

2 Aim for the weak spot.

If possible, use the rear of the car to ram the weak spot—hitting with the front may damage the engine and cause the car to stall.

3 Accelerate to a speed of 30 to 45 mph.

Too rapid an approach will cause unnecessary damage to the car. Keep your foot on the gas all the way through. Consider how much room you will need to turn or stop once you clear the barricade.

4 Duck just before impact if you are heading toward an extremely tall barricade or fence.

Pieces of the barricade may come through your window or the windshield may shatter.

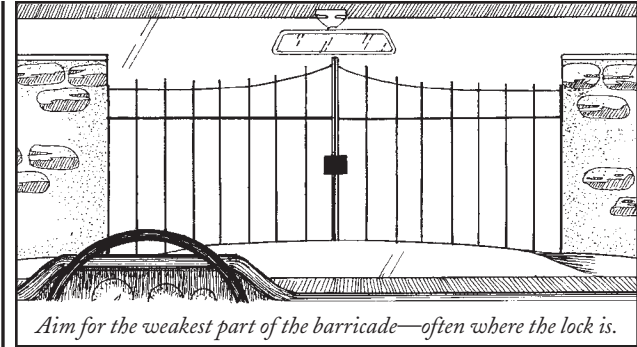

5 Avoid poles or anchors that are sunk into the ground.

These may bend and not break, and then drag against and damage the underside of the car, preventing you from driving.

6 Repeat as necessary to break through.

ELECTRONIC GATES

Electrically powered gates that swing open and closed (like those found in gated communities and apartment complexes) are best pushed open rather than rammed. Pushing or forcing the gate open with your car will result in minimal damage and will almost always open the gate. If you are traveling in the direction the gate opens, simply ease your bumper up to the gate and push. Your car will easily overpower the small electric motor that operates the gate.

HOW TO REMOVE A LEECH

- 1 Do not attempt to remove a leech by pulling up on its middle section or by using salt, heat, or insect repellent.**

Dislodging by squeezing, salting, burning, or otherwise annoying the leech while it is feeding will cause it to regurgitate, most likely spreading the bacteria from its digestive system into your open wound, causing infection.

- 2 Identify the anterior (oral) sucker.**

Look for the small end of the leech. A common mistake is to go immediately to the large sucker.

- 3 Place a fingernail on your skin (not on the leech itself), directly adjacent to the oral sucker.**

- 4 Gently but firmly slide your finger toward where the leech is feeding and push the sucker away sideways.**

When the seal made by the oral sucker is broken, the leech will stop feeding. After the oral sucker has been dislodged, the leech's head will seek to reattach, and it may quickly attach to the finger that displaced the head. Even if the oral sucker attaches again, the leech does not begin to feed immediately.

Identify the oral sucker—the small end.

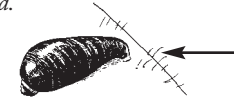

Place your fingernail next to the oral sucker.

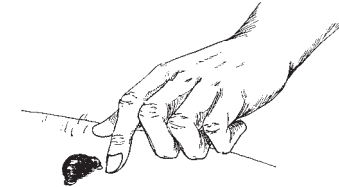

Push the leech sideways to break the seal.

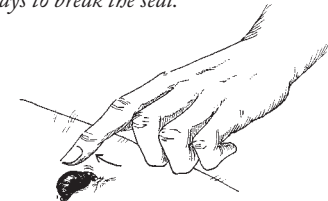

Push or pick at the hind sucker, while continuing to flick at the small end.



- 5 Displace the posterior (hind) sucker.**

While continuing to flick occasionally at the small end, push at or pick under the large end (hind sucker) with a fingernail to cause it to lose its suction.

6 **Dispose of the leech.**

At this point, the leech may have securely attached itself to the finger you used to remove it. Flick it off—it should detach easily. Once the leech is detached, you can put salt or insect repellent directly on it to keep it from attaching to anything else.

7 **Treat the wound.**

After the leech's anticoagulants lose their effect, the wound should heal quickly. Keep the area clean, and cover it with a small bandage if necessary. Avoid scratching the wound. If itching becomes severe, take an antihistamine.

IF A LEECH INVADES AN AIR PASSAGE

Hirudiniasis is a potentially serious condition in which one or more leeches invade a body orifice. In particular, *Dinobdella ferox* (literally, “the terrifying ferocious leech” or “nasal leech”) has a predilection for airways, where it may cause a blockage or asphyxiation, especially if leeches invade the passage in large numbers. If there is a leech invading your airway and you can breathe, do not attempt to remove it—seek medical attention immediately. If you cannot breathe, take the following steps:

1 **Gargle with diluted 80-proof alcohol.**

Most distilled liquors—vodka, gin, bourbon, scotch—have the requisite alcohol content. Use a mixture of 50 percent alcohol, 50 percent water. Be careful not to aspirate (inhaling the leech and the alcohol).

2 **Spit out the leech.**

Alternative

If gargling does not work and the leech is visible, remove it by grasping firmly at the hind sucker and yanking.

Be Aware

- There is virtually no risk of substantial blood loss from leech bites. The wound will continue to bleed for some time after a leech has finished feeding, but this level of blood loss is not dangerous.
- Leeches are generally not known to transmit blood parasites to humans.
- Leeches are more likely to be encountered in still water than in rivers or streams. They are more often found near the edges of clean, clear water than in or near swamps.
- Leeches need a solid surface to hold onto even when they are not feeding. Avoid leeches by staying in the open: Swim in deep, open water, avoid boat docks, and do not wade through areas with submerged branches or rocks. In jungles, remain on trails and be aware of leeches on overhanging branches and vines.
- Both aquatic and terrestrial leeches have incredible senses of perception. They are attracted by vibrations and by body heat, and they have 10 pairs of eyes to detect movement. Keep moving, and check yourself and your traveling companions regularly.

WORST-CASE SCENARIO.

HOW TO STOP A CAR WITH NO BRAKES

- 1** Begin pumping the brake pedal and keep pumping it.

You may be able to build up enough pressure in the braking system to slow down a bit, or even stop completely. If you have anti-lock brakes, you do not normally pump them—but if your brakes have failed, this may work.

- 2** Do not panic—relax and steer the car smoothly.

Cars will often safely corner at speeds much higher than you realize or are used to driving. The rear of the car may slip; steer evenly, being careful not to overcorrect.

- 3** Shift the car into the lowest gear possible and let the engine and transmission slow you down.

- 4** Pull the emergency brake—but not too hard.

Pulling too hard on the emergency brake will cause the rear wheels to lock, and the car to spin around. Use even, constant pressure. In most cars, the emergency brake (also known as the hand brake or parking brake) is cable operated and serves as a fail-safe brake that should still work even when the rest of the braking system has failed. The car should slow down and, in combination with the lower gear, will eventually stop.

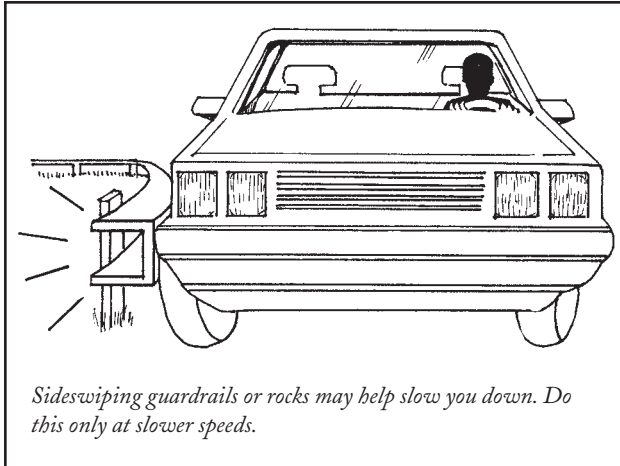

5 **If you are running out of room, try a “bootlegger’s turn.”**

Yank the emergency brake hard while turning the wheel a quarter turn in either direction—whichever is safer. This will make the car spin 180 degrees. If you were heading downhill, this spin will head you back uphill, allowing you to slow down.

6 **If you have room, swerve the car back and forth across the road.**

Making hard turns at each side of the road will decrease your speed even more.

7 **If you come up behind another car, use it to help you stop.**

Blow your horn, flash your lights, and try to get the driver’s attention. If you hit the car, be sure to hit its square, bumper to bumper, so you do not knock the other car off the road. This is an extremely dangerous maneuver: It works best if the vehicle in front of you is larger than yours—a bus or truck is ideal—and if both vehicles are traveling at similar speeds. You do not want to crash into a much slower-moving or stopped vehicle, however.

8 **Look for something to help stop you.**

A flat or uphill road that intersects with the road you are on, a field, or a fence will slow you further but not stop you suddenly. Scraping the side of your car against a guardrail is another option. Avoid trees and wooden telephone poles: They do not yield as readily.

9 **Do not attempt to sideswipe oncoming cars.**

10 **If none of the above steps has enabled you to stop and you are about to go over a cliff, try to hit something that will slow you down before you go over.**

This strategy will also leave a clue to others that someone has gone over the edge. But since very few cliffs are sheer drops, you may fall just several feet and then stop.

HOW TO STOP A RUNAWAY HORSE

1 Hold on tight to the saddle with your hands and thighs.

Most injuries occur when the rider is thrown, falls, or jumps off the horse and hits the ground or some immovable object, such as a tree or fence post.

2 Grip the saddle horn or the front of the saddle with one hand and the reins with the other.

If you have lost hold of the reins, hold on to the saddle horn or the horse's mane and wait for the horse to slow or stop.

3 Sit up in the saddle as much as you can.

Fight the instinct to lean forward (it will be especially strong if you are in a wooded area with many trees and branches), since this is not the standard position for a rider when the horse is asked to stop (*whoa!*), and the horse can feel the difference. Keep a deep seat, with your feet pushed a little forward in the stirrups.

4 Alternately tug and release the reins with a medium pressure.

Never jerk or pull too hard on the reins of a horse running at full speed—you could pull the horse off-balance, and it may stumble or fall. There is a very high risk of serious injury or death if the horse falls while running at full speed (25 to 30 mph).

5 When the horse slows down to a slow lope or a trot, pull one rein to the side with steady pressure so that the horse's head moves to the side, toward your foot in the stirrup.

This maneuver will cause the horse to walk in a circle. The horse will become bored, sense that you are in control again, and slow to a near stop.

6 When the horse is at a walk, pull back with slow, steady pressure on both reins until the horse stops.

7 Dismount the horse immediately, before it has a chance to bolt again.

Hold the reins as you get down to keep the horse from moving.

Be Aware

- Long reins dangling in front of a horse may cause it to trip. Inexperienced riders should tie the ends of the reins together so that they cannot fall past the horse's neck and pose added danger.
- Horses bolt when they are frightened or extremely irritated. The key response is to remain in control of the situation without causing the horse greater anxiety. Talk to it reassuringly and rub its neck with one hand. Yelling, screaming, and kicking the horse will only make it more agitated.

HOW TO STOP A RUNAWAY PASSENGER TRAIN

1 Locate the emergency brake.

There is an emergency brake valve just inside each end of every passenger car. These valves are generally red and should be clearly marked.

2 Pull the handle.

This opens a valve that vents brake pipe air pressure to the atmosphere, applying the brakes for an emergency stop. There is a possibility of derailment, depending upon track curvature and grade, train weight, and the number of coaches.

IF THE BRAKE DOES NOT WORK

1 Call for help.

Locate a crew member's radio. Depress the "talk" button between the earpiece and the microphone. Do not change the channel, even if you do not hear an answer. Transmit an emergency distress call: Give any information that may help the listener understand the location of the train (for example, train number and destination). The Train Dispatcher should hear you and may clear traffic without responding. If you cannot find anyone on the radio, you will have to attempt to stop the train yourself.

2 Make your way to the front of the train.

Pull all emergency brake valves as you proceed, or instruct other passengers to apply handbrakes. These brakes are different from the red valves described earlier, and are located on each end of the passenger coach, inside the vestibule. They are applied by turning a wheel or pumping a lever. Tighten these valves as much as possible, and leave them applied.

3 Enter the locomotive.

The locomotive is usually right after the baggage car, just in front of the passenger coaches. Exercise extreme caution when stepping over and across the car couplers that connect the locomotive and baggage car.

There may be several locomotives on the train—not just one. Repeat the following steps in each locomotive. However, there is a chance that the trailing locomotive cab will be reversed, and that you will not be able to proceed any farther forward. If this is the case, retreat to the last car of the train and follow the instructions on page 26: "If the Train is Not Slowing or a Crash is Imminent."

4 Open all emergency valves located in the engine room on or near the dash (at the left side of the cab).

The emergency valves will be clearly marked. Place the handles in the farthest position forward.

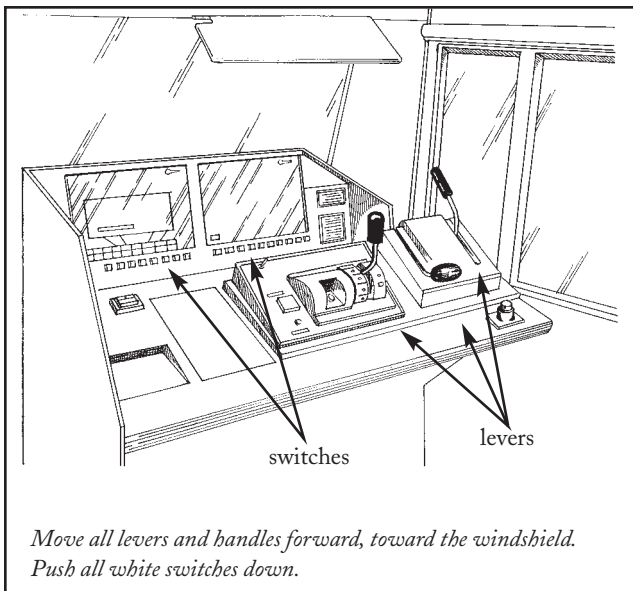

- 5** **Move all levers and handles forward, toward the windshield.**
Be certain to move the brake valves forward (they will have the word “brake” at the base of the handles). Quickly push or move down all white sliding switches on and around the control stand to shut off electricity to the engine(s).
- 6** **If the train is still not slowing down, enter the engine room, which will be behind you to your right.**
A very loud engine room will indicate that the locomotive is “under load,” or still operating.

- 7** **Move rapidly through the engine room, along the engine block.**
The engine block stands about four or five feet tall and looks like a large automobile engine.
- 8** **Shut down the engine by pulling the layshaft lever.**
This is a two-foot-long handle at shoulder height near the end of the engine block. It may be difficult to find, as it is not painted a different color from the engine itself. Push the handle all the way in, and the engine will run too fast and shut down. This lever is mechanical and will shut down the engine without fail.
- 9** **Return to the cab and sound the whistle to warn others of your approach—it may take several miles to stop the train completely.**
The whistle is either a handle the size of your hand that points upward, or a button located on the control panel marked “horn.”

IF THE TRAIN IS NOT SLOWING OR A CRASH IS IMMINENT

- 1 Proceed as calmly and quietly as possible to the rear of the train.**

This is the safest place to be in the event of a crash. Instruct the other passengers to move to the back of the train with you.
- 2 Prepare for a crash.**

Sleeping cars are usually placed on the tail end of the train and have mattresses and pillows that can be used for protection. Sit or lay against a wall that is toward the leading end of the train, so you will not fly forward in the event of a crash. The farther you are from the locomotive the better.

**WORST-CASE
SCENARIO.**

HOW TO SURVIVE A FALL ONTO SUBWAY TRACKS

- 1 Do not attempt to climb back onto the platform unless you are certain that you have enough time to do so.**
If a train is approaching, you will need to act quickly.

- 2 Avoid areas of the ground near the track and the wall that are marked with a strip of tape or with red and white painted stripes.**
Such markings indicate that the train passes extremely close to these areas, and you will not have enough clearance. In areas with these markings, there should be alcoves every several yards. These alcoves are safe to stand in if you can fit within them.

- 3 If the tracks are near a wall, check to see if there is enough space to stand between the train and the wall.**
Clearance of 1½ to 2 feet should be enough. Remove any articles of clothing or bags that could catch on the train. Stand straight, still, and tall facing the train, which will pass just inches in front of you.

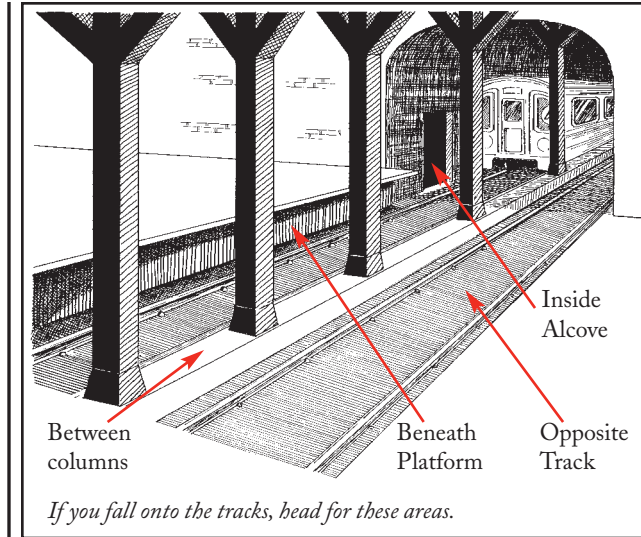

- 4 If the tracks are located between the platform and another set of tracks, you may be able to move to the other track instead.**
Be mindful of trains approaching on the other side. Cross the third rail (which carries the electric current) by stepping completely over it—do not step on the wooden guard, since it may not hold you.
- 5 If a line of columns separates the tracks from other tracks, stand between the columns.**
Remove any articles of clothing or bags that could catch on the train, and stand straight, still, and tall.

6 Check to see if there is enough space for you to crawl under the lip of the concrete platform and avoid the train.

Use this only as a last resort—this strategy is not recommended since all platforms are different.

Alternatives

If none of these options is feasible, you have two other choices.

- Run past the leading end of the platform, beyond where the front car will stop.

Since trains running on the track closest to the platform are likely to stop at a station (as opposed to express trains, which usually run on center tracks), you can clear the train by running well past the leading end of the platform and thus the front car. (Note: This method will not work for express trains that only stop at some stations, so you are taking your chances.)

- If there is a depression in the concrete between the rails, lie down into it—there will be enough room for a train to pass over you. (Use this method only in desperation—the train may be dragging something, or there may not be enough clearance.)

**WORST-CASE
SCENARIO.**

HOW TO SURVIVE A HIGH-RISE HOTEL FIRE

Always treat a hotel fire alarm seriously, and exit following hotel procedure. If the fire is nearby, use the following procedure.

1 **Feel your hotel room doorknob with the back of your hand.**

If the doorknob is hot to the touch, go to step 2 and then skip to step 5. If it is not hot, follow the steps in order.

2 **Partially fill the bathtub with cold water.**

Soak towels, washcloths, bedsheets, and blankets in the water. If the water is off, use water from the toilet tank. Put a wet washcloth over your mouth and nose and a wet sheet or towel over your head.

3 **Open the door.**

4 **If the hallway is smoke-filled, get as low as possible—one to two feet above the floor.**

Make your way to an emergency exit. Never use the elevator.

5 **If the door or doorknob is hot, do not open the door.**

Wedge wet towels in the crack under the door to keep smoke out.

6 **Try calling the front desk or rooms on other floors to check on conditions in other areas.**

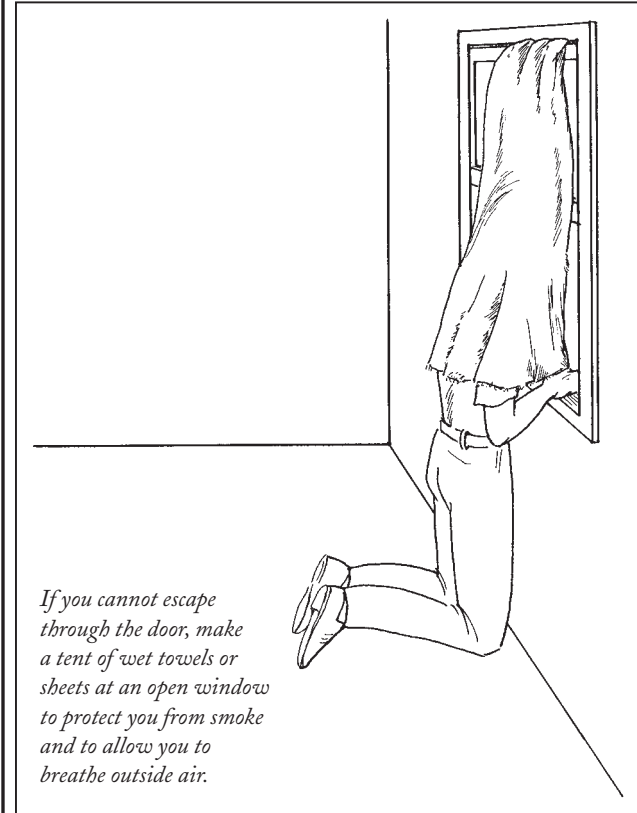

If you cannot escape through the door, make a tent of wet towels or sheets at an open window to protect you from smoke and to allow you to breathe outside air.

7 Turn off fans and air conditioners that could draw smoke into the room, and open the window slightly.

If the fire is on a floor below you, smoke may enter the room through the window, so keep the opening narrow. If the fire is not below you, open the window a third or halfway.

8 Make a tent of wet towels and sheets at the window.

Do not build the tent if smoke is billowing into the room. Hold or attach one side of the towel or sheet to the window and allow the other side to fall behind you, so you are protected from smoke and are breathing outside air. The towels should help to cool the air and make it easier to breathe.

9 Signal rescue personnel with a white towel or a flashlight.

Wait for rescue.

10 If the air in the room is getting worse, breathing becomes difficult, and no rescue is forthcoming, try to kick through the wall into the adjacent room.

Closets are the best locations to try to break through. Sit on the floor of the closet, and knock on the wall until you hear a hollow sound. (Wall studs are normally spaced 16 inches apart.) Use both feet to kick through both surfaces of drywall. You may survive by using this as a breathing hole, or you may need to continue breaching the wall until you can escape into the next room.

11 If you cannot breach the wall, go to a window and look at the outside of the building.

If the rooms have balconies that are close together, consider climbing to another balcony on the same floor. If there are no neighboring balconies, you can tie bedsheets together and climb to a balcony directly beneath yours. Use square knots (the first step in tying your shoes, done twice) and lower yourself one floor only. Consider this option only as a last resort, and only do it if you are attempting to escape an immediate danger or to reach rescue personnel.

Be Aware

- Ladders on fire trucks usually reach only to the seventh floor of a high-rise building. Consider booking a room below this level.
- Poolside or courtyard rooms are likely to be inaccessible to ladder trucks, even if they are below the seventh floor. Consider staying in a streetside room.
- Upon check-in, make sure the hotel has smoke detectors and fire sprinklers.
- Count the doors between your room and the nearest fire exit. This will help you get out safely if smoke reduces visibility.
- Keep your room key where it can be found in the dark.
- Never jump from a height of more than two floors or you risk death.

WORST-CASE SCENARIO®

HOW TO SURVIVE A HOSTAGE SITUATION

Terrorists need to exercise power and control, and they do this by turning their victims into objects, which are easier to mistreat. Follow these tips to avoid mistreatment or worse.

1 Stay calm.

Help others around you to do the same—remember that the hostage takers are extremely nervous and scared. Do not do anything to make them more so. Do not speak to them unless they speak to you.

2 If shots are fired, keep your head down and drop to the floor.

If you can, get behind something, but do not move far—your captors may think that you are attempting to make an escape or an attack.

3 Do not make any sudden or suspicious movements.

Do not attempt to hide your wallet, passport, ticket, or belongings.

4 Comply with all demands.

Hesitation on your part may get you killed instantly, or may mark you for later retribution or execution. Remain alert and do not try to escape or be a hero. If you are told to put your hands over your head, to keep your head down, or to get into another body position,

do it. It may be uncomfortable, but do not change your position on your own. Talk yourself into relaxing into the position—you may need to stay that way for some time. Prepare yourself both mentally and emotionally for a long ordeal.

5 **Never look at a terrorist directly or raise your head until you are directed to speak to him or her.**

Always raise your hand and address the hostage takers respectfully. When answering questions, be respectful but not submissive. Speak in a regulated tone of voice.

6 **Never challenge a hostage taker.**

They often look for potential execution victims, and if you act contrary in any way, they may select you.

7 **Carefully observe the characteristics and behavior of the terrorists.**

Give them nicknames in your mind so that you can identify them. Be prepared to describe them by remembering attire, accents, facial characteristics, or height—any aspect that might later help authorities.

8 **If you are the victim of a skyjacking, know where the plane's closest emergency exits are located.**

Count the rows between you and the exit. In the event of an emergency rescue, smoke may obscure visibility, and you must know the fastest path out of the aircraft. Do not attempt escape unless it is clear that a massacre is imminent.

9 **If a rescue team enters, get down and stay still.**

Shots may be fired, and any sudden movements may draw terrorist or friendly fire.

10 **Upon resolution, be prepared to identify yourself and terrorists to the rescuers.**

Some terrorists may try to exit with you, posing as hostages.

Be Aware

- To avoid making yourself attractive to terrorists, try not to take out your passport in public places.
- Be especially alert at airports, train stations, bus stations, in lobbies of expensive hotels, and in stores that cater to affluent tourists. While civil strife and guerrilla activity usually focus on nationals—thus tourists are relatively safe—terrorists often choose targets that will get them the most attention.

WORST-CASE SCENARIO.

HOW TO SURVIVE A MUGGING

- 1 Do not argue or fight with a mugger unless your life is clearly in danger.**

If all a mugger wants is your purse, wallet, or other belongings, surrender them. Your possessions are not worth your life.

- 2 If you are certain that your attacker means to do you or a loved one harm, attack vital areas of your assailant's body.**

Aim to disable him or her with the first blow by:

- Thrusting your fingers into and above your attacker's eyes.
- Driving your knee in an upward direction into his groin (if mugger is male).
- Grabbing and crushing the attacker's testicles as if crushing a handful of grapes (if mugger is male).
- Striking the front of his or her throat, using the area between your thumb and first finger, or the side of your hand, held straight and strong.
- Slamming the tip of your elbow into the side of the mugger's ribs.
- Stomping down on the mugger's instep.

- 3 Use an object as a weapon.**

Many common objects can be effective weapons if they are aimed at vulnerable body parts. Pick up and use what is easily available:

- A stick can jab at an attacker's eyes or groin.
- Keys held between your fingers can slash or punch.
- A car antenna can jab or slash your attacker's face and eyes.

**WORST-CASE
SCENARIO.**

HOW TO SURVIVE A RIOT

1 Remain indoors if you learn about any nearby rioting or civil unrest.

Avoid the windows. Listen for reports on radio or television. If you hear gunfire, try to find out where the shooting is located. Use the telephone if it is still functioning, or ask an official or your hotel manager for information.

2 If you believe the crisis is unresolvable or seriously threatens your life, plan to leave the country quickly.

3 Determine the best route to the airport or embassy, and leave the building through any safe exit.

Make sure that the airport is operating before you travel there. If you cannot make it to your own country's embassy, plan to head for the embassy of an allied nation.

4 Wear clothing in muted tones.

Put on a long-sleeve shirt, jacket, jeans, a hat, socks, and lightweight boots. (Although you may be in a tropical or warm part of the world, it gets quite cold on planes, and you may have to sleep in an airport or connect to a flight landing in a colder region.)

5 Exit away from gunfire or mobs.

Select a way out that is not easily observed. Exits include windows, vents, or even the roof.

6 Leave as a group.

Especially if you have to dash across an open area, such as the front of a building, a wide street, or a plaza, you are safer with company. Snipers or enemies will have multiple objects to focus on, not just one, and will not be as likely to make a move.

7 Do not run.

Unless your life is in imminent danger, walk. Walking is harder for the eye to detect: The human eye can quickly sight someone running. Running can also generate excitement—people may chase you.

8 If you must travel by car, be prepared for evasive maneuvers.

Drive on back streets, not main roads, and be prepared to abandon the car if the situation becomes critical. Watch out for checkpoints, roundabouts, major intersections, and military/police barracks. Do not stop for anything—remember the car can be a useful 2,000-pound weapon that even a mob cannot stop. If you cannot drive forward, drive in reverse.

A reliable driver who knows the area will be able to navigate much better than you. If no driver or taxi is available, hire a local to drive your car for you. (You may need to promise to give your car in exchange.) Abandon the car outside the embassy or airport.

If a Molotov cocktail (flammable liquid in a glass container with a lighted wick) hits your car, speed up—it may burn out as you gain speed.

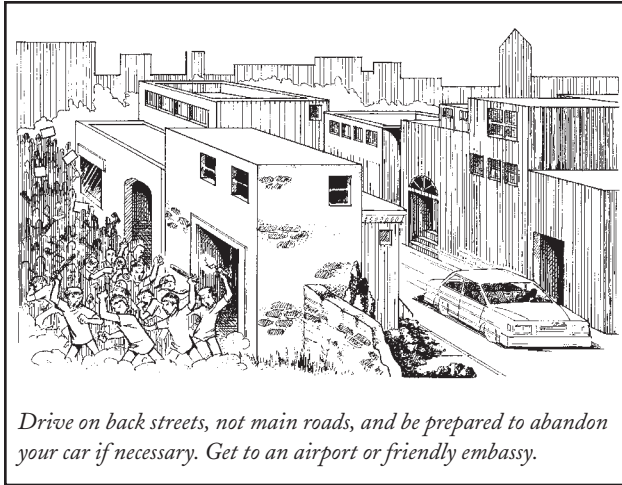

Drive on back streets, not main roads, and be prepared to abandon your car if necessary. Get to an airport or friendly embassy.

9 **If you encounter unavoidable roadblocks, be prepared to bargain your way to safety.**

You might need to give up everything you are carrying in order to get away. Offer cash first, equipment (watches, cameras, jewelry) second.

10 **Get to an embassy or to the airport as soon as possible.**

Be Aware

- If you are in a volatile region where there is a likelihood of civil disorder, be prepared for a rapid evacuation. Each person and family member should have an escape pack set aside near the front door. A good, small backpack is preferable to any type of luggage. It should contain the following:

FLASHLIGHT. Pack a mini-flashlight with extra batteries. Affix a red or blue lens if you have one; red or blue light is difficult for observers (snipers, mobs) to see at night.

SMALL COMPASS AND A DETAILED MAP OF THE CITY. Be sure to mark the embassy and helicopter landing zones on the map.

KNIFE. Include a small pocketknife for cutting.

FIRE-STARTING TOOL. Carry storm-safe matches or a lighter in a waterproof bag. Pack small baggies of dryer lint, which is light and highly flammable.

BLACK GARBAGE BAGS. Use these for emergency shelter and camouflage.

WATER AND FOOD. Carry at least two quarts of water per person. Bring only high-energy or instant foods. Do not eat unless you have water.

- Conceal on your person, in a multi-pocket neck pouch, the following items:

MONEY. Take \$25 in single U.S. dollars and all of your local currency and divide it among your pouch and pockets. This will serve as bribe money for checkpoints. Dole it out in heaps until it appears you have no more. Do not offer your papers. Carry more money in your neck pouch,

but keep the bulk of your cash in your socks, crotch, or ankle pouch.

PASSPORT. Place a full photocopy of your passport in the main section of the pouch for easy access. Keep your original passport in a separate section. Show the copy to locals who demand it. Never give up the original.

OFFICIAL DOCUMENTS. Visas, phone numbers, proof of citizenship, birth certificates, and so on should be kept with your original passport.

SOFT EARPLUGS. Helicopters are very noisy, and earplugs are useful when you want to sleep in a battle zone.

**WORST-CASE
SCENARIO.**

HOW TO SURVIVE A RIPTIDE

Riptides, or rip currents, are long, narrow bands of water that quickly pull any objects in them away from shore and out to sea. They are dangerous but are relatively easy to escape.

1 Do not struggle against the current.

Most riptide deaths are caused by drowning, not the tides themselves. People often exhaust themselves struggling against the current, and cannot make it back to shore.

2 Do not swim in toward shore.

You will be fighting the current, and you will lose.

3 Swim parallel to shore, across the current.

Generally, a riptide is less than 100 feet wide, so swimming beyond it should not be too difficult.

4 If you cannot swim out of the riptide, float on your back and allow the riptide to take you away from shore until you are beyond the pull of the riptide.

Rip currents generally subside 50 to 100 yards from shore.

5 Once the riptide subsides, swim sideways and back to shore.

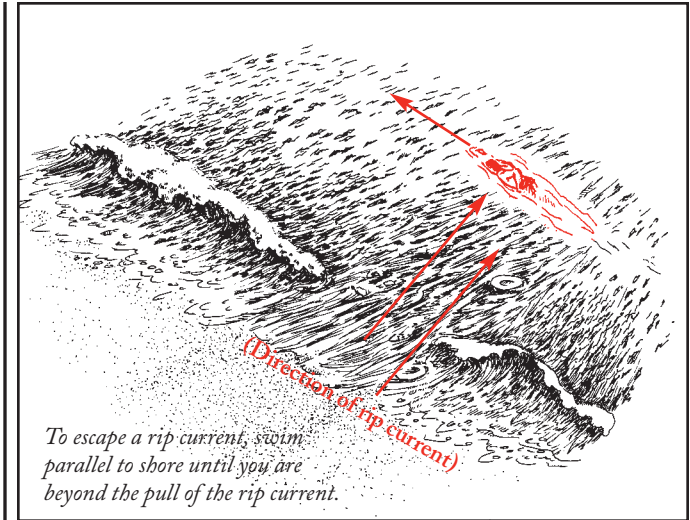

Be Aware

- Riptides occur more frequently in strong winds.
- Streaks of muddy or sandy water and floating debris moving out to sea through the surf zone are signs that riptides are present, as are areas of reduced wave heights in the surf zone and depressions in the beach running perpendicular to shore.

HOW TO SURVIVE A SANDSTORM

- 1** Wet a bandanna or other cloth and place it over your nose and mouth.
- 2** Use a small amount of petroleum jelly to coat your nostrils on the inside.
The lubricant will help to minimize the drying of mucous membranes.

Wear a wet cloth or bandanna over your nose and mouth to avoid inhaling sand particles.

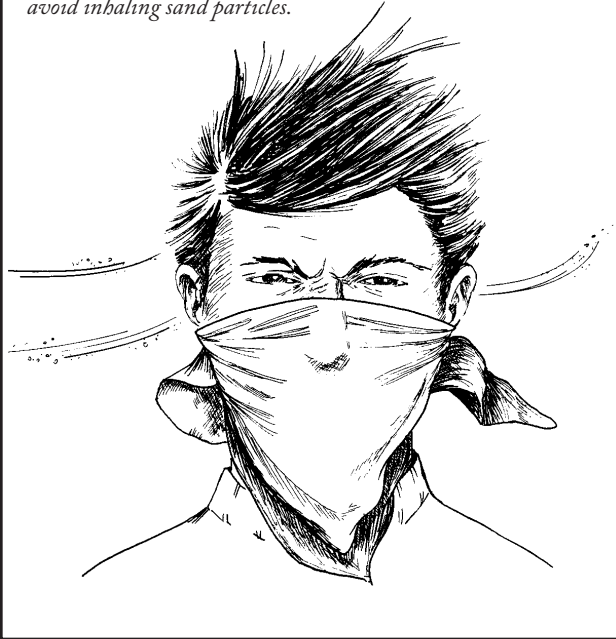

- 3** All members of a group should stay together.
Link arms or use a rope to avoid becoming separated during the storm and to keep track of group members who might become injured or incapacitated.
- 4** If driving in a car, pull off the road as far as possible on the shoulder.
Turn off your lights, set the emergency brake, and make sure your taillights are not illuminated. Vehicles approaching from the rear have been known to inadvertently leave the road and collide with the parked car. Keeping your taillights out will help to avert this danger.
- 5** Try to move to higher ground.
Sand grains travel across the surface of the earth mostly by saltation, or bouncing from place to place. Because grains of sand will not bounce high on grass, dirt, or sand, moving to solid high ground is advisable, even if it's just a few feet higher. However, sandstorms can be accompanied by severe thunderstorms, and there may be a risk of lightning. If you hear thunder or see lightning during a sandstorm, do not move to high ground.

Be Aware

- Whenever you are in an area with sandstorm potential (basically, anywhere that there is a lot of sand and wind), wear long pants, socks, and shoes. Because of the way sand moves, your feet and lower legs are more likely to be “burned” by the abrasion of sand than the upper part of your body.

HOW TO SURVIVE A TRIP OVER A WATERFALL

- 1 Take a deep breath just before going over the edge.**
You probably will not have much control while you are in the air, and the water may be deep.
- 2 Go over the falls feet first.**
The biggest danger in going over a falls is hitting your head on something underwater and being knocked unconscious. Even feet first there is a risk of broken limbs. Squeeze your feet together and remain vertical.
- 3 Jump out and away from the edge of the falls just before you go over.**
You want to avoid hitting rocks directly at the bottom of the falls.
- 4 Put your arms around your head to protect it.**
- 5 Start swimming immediately upon hitting the water, even before you surface.**
Swimming will slow your descent.
- 6 Swim downstream, away from the falls.**
It is essential that you avoid being trapped behind the waterfall or on the rocks underneath.

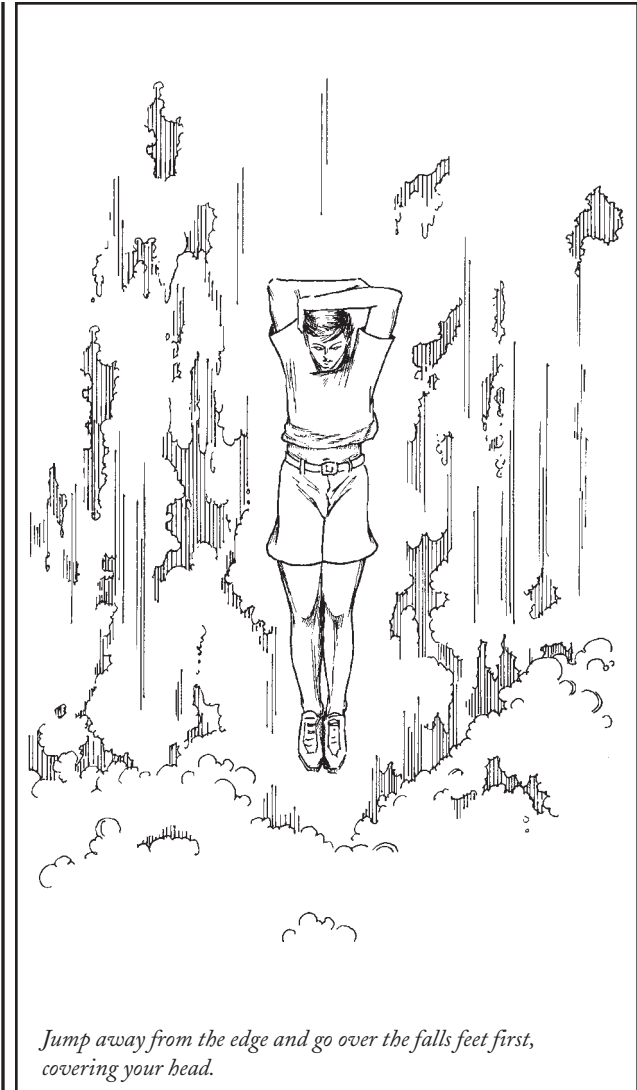

Jump away from the edge and go over the falls feet first, covering your head.

HOW TO SURVIVE A TSUNAMI

A tsunami (from the Japanese word meaning “harbor wave”) is a series of traveling ocean waves of extremely long length generated by geological disturbances such as earthquakes, underwater volcanic eruptions, and landslides. They can form hundreds or even thousands of miles away. The waves have been known to range from 50 to 100 feet in height. (Tsunamis are often mistakenly referred to as tidal waves, but they are not the same thing. Tsunamis are not related to the gravitational forces which cause tides and, therefore, tidal waves.)

1 If you are near the ocean, be aware of the warning signs of an approaching tsunami:

- Rise or fall in sea level
- Shaking ground
- Loud, sustained roar

2 If you are on a boat in a small harbor and you have sufficient warning of an approaching tsunami, move it quickly.

Your first choice should be to dock and reach high ground. Your second choice is to take your boat far into open water, away from shore where it might be thrown into the dock or the land. Tsunamis cause damage when they move from deeper to more shallow waters; the waves back up against one another at the shallow shelf. Often tsunamis are not even felt in deep water.

3 If you are on land, seek higher ground immediately. Tsunamis can move faster than a person can run. Get away from the coastline as quickly as possible.

4 If you are in a high-rise hotel or apartment building on the coastline and you do not have enough time to get to higher ground away from the shore, move to a high floor of the building.

The upper floors of a high-rise building can provide safe refuge.

Be Aware

- The first tsunami wave may not be the largest in the series of waves.
- Tsunamis can travel up rivers and streams that lead to the ocean.
- Flooding from a tsunami can extend inland 1,000 feet or more, covering large expanses of land with water and debris.

HOW TO SURVIVE A VOLCANIC ERUPTION

1 Watch out for falling rocks, trees, and debris.

If you are caught amid falling debris, roll into a ball to protect your head. If you are trapped near a stream, watch out for mudflows. (Mudflows are mudslides caused by a large volume of melted snow or ice combined with rocks, dirt, and other debris.) Move up slope, especially if you hear the roar of a mudflow.

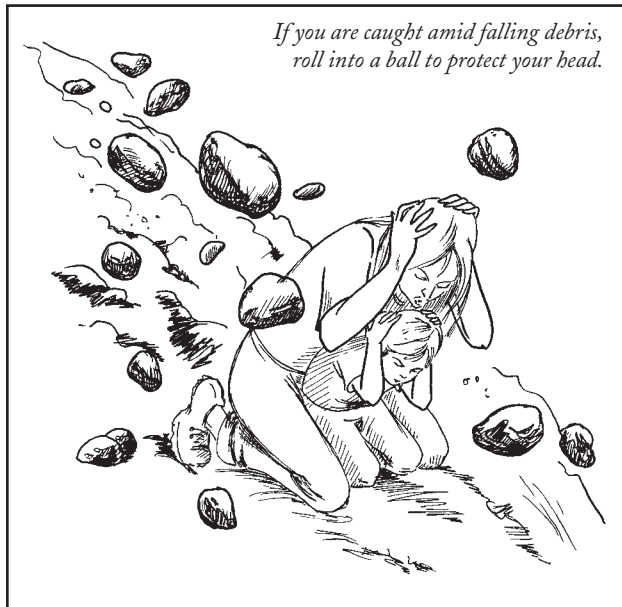

2 If you are in the path of lava, try to get out of its path in any way possible.

You will not be able to outrun the lava, so do not try to race it downhill. If you are near a depression or valley that might divert the flow from you, try to get to the safe side.

3 Move indoors as soon as possible.

If you are already inside, stay there and move to a higher floor, if possible. Close all doors and windows, and move any cars or machinery indoors, if there is time.

4 Do not sit or lie on the floor or ground.

It is possible to be overcome by volcanic fumes. The most dangerous gas is carbon dioxide: It does not have a strong odor, and it is denser than air, so it collects near the ground.

5 Evacuate the area, but only if authorities tell you to do so.

Your best chance of survival is to use a car to drive to a safer area, but even a car may not be fast enough to outpace a lava flow. Some flows travel at 100 to 200 miles per hour. Since volcanic ash can quickly clog the radiator and engine of your car, avoid driving except to evacuate.

Be Aware

Volcanoes can cause all kinds of secondary damage, including mudslides, earthquakes, tidal waves, and dangerous acid rain. If you will be spending time in a volcanic region, have the following emergency supplies at hand:

- Flashlight with extra batteries
- First-aid kit
- Emergency food and water
- Non-electric can opener
- Essential medicines
- Dust masks
- Sturdy shoes
- Goggles
- Portable oxygen tank

**WORST-CASE
SCENARIO.**

WORST-CASE SCENARIO

HOW TO SURVIVE AN AIRPLANE CRASH

TO DECREASE THE ODDS OF A CRASH

- 1 Take a nonstop flight, if possible.**

Most accidents happen in the takeoff and landing phases of flight; the fewer stops you make, the less chance of an accident.
- 2 Watch the skies.**

Many accidents involve severe weather. As takeoff time approaches, check the weather along the route, particularly in places where you will land. Consider delaying your flight if the weather could be severe.
- 3 Wear long-sleeved shirts and long pants made of natural fibers.**

Radiant heat and flash burns can be avoided if you put a barrier between you and the heat. Avoid easy-care polyester or nylon: most synthetic materials that aren't specifically treated to be fire resistant will melt at relatively low temperatures (300 to 400 degrees Fahrenheit). Synthetic fabrics will usually shrink before they melt, and if they are in contact with skin when this happens, they will make the burn—and its treatment—much more serious. Wear closed-toe, hard-soled shoes; you might have to walk through twisted, torn metal or flames. In many cases, people survive the crash, but are killed or injured by post-impact fire and its by-products, like smoke and toxic gases.

4 Select a seat on the aisle, somewhere in the rear half of the cabin.

The odds of surviving a crash are higher in the middle-to-rear section compared to the middle-to-front section of the cabin. An aisle seat offers the easiest escape route access, unless you are sitting right next to an emergency exit: If you can get a window seat right next to the emergency exit, this is a better choice.

5 Listen to the safety briefing and locate your nearest exits.

Most airplane accident survivors had listened to the briefing and knew how to get out of the plane. Pick an exit to use in an emergency, and an alternate in case the first one is not available.

6 Count the seats between you and the exits in case smoke fills the plane and you cannot see them.

Make sure you understand how the exit doors work and how to operate them.

7 Practice opening your seat belt a few times.

Many people mistakenly try to push the center of the buckle rather than pull up on it.

TO PREPARE FOR A CRASH

1 Make sure that your seat belt is tightly fastened and that your chair back is fully upright.

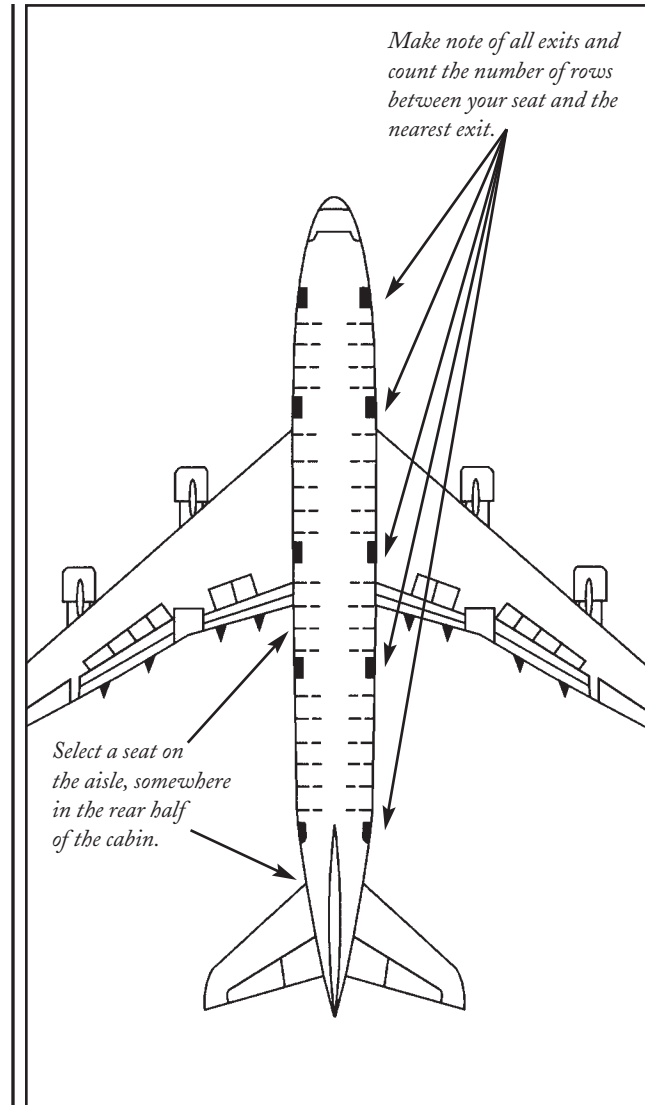

2 Bend forward with one arm across your knees.

3 Place your pillow in your lap and hold your head against the pillow with your free arm.

4 Push your legs forward and brace for impact by placing your feet or knees against the chair in front of you.

If you are over water, loosen your shirt (and tie) so that your movement is not restricted when you attempt to swim. Be ready for two jolts: when the plane first hits water and when the nose hits water again.

5 Stay calm and be ready to help yourself.

The vast majority of crash survivors were able to get out either under their own power or with the help of someone already on the plane. Fire and rescue personnel are unlikely to enter the airplane to pull you out.

6 Do not take anything with you.

If you have something you absolutely cannot part with, you should keep it in your pocket and not in your carry-on baggage.

7 Stay low if the plane is on fire.

Follow the exit procedures described in the safety briefing. Illuminated floor lights should indicate the exits: the lights are red where exit rows exist.

**WORST-CASE
SCENARIO.**

**WORST-CASE
SCENARIO.**

HOW TO SURVIVE IN A PLUMMETING ELEVATOR

1 Flatten your body against the car floor.

While there is disagreement among the experts, most recommend this method. This should distribute the force of impact, rather than concentrate it on one area of your body. (Standing may be difficult anyway.) Lie in the center of the car.

Lie flat on the floor in the center of the elevator, covering your head for protection.

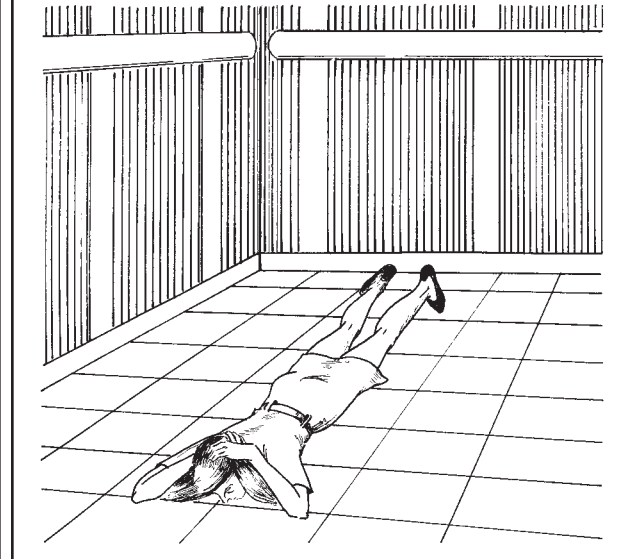

2 Cover your face and head to protect them from ceiling parts that may break loose.

Be Aware

- Hydraulic elevators are more likely than cable elevators to fall. These elevators are pushed from the bottom by a giant piston, similar to car jacks at service stations. Because the jack is subject to ground corrosion, it can rot, which could eventually cause the car to fall. The height of hydraulic elevators is limited to about 70 feet, so a free fall would probably result in injury—but not death.
- Elevators have numerous safety features. There have been very few recorded incidents involving death from plummeting elevators. In general, it is highly unlikely for a cable (also called traction) elevator to fall all the way to the bottom of the shaft. Moreover, the compressed air column in the elevator hoistway and the car buffers at the bottom of the hoistway may keep the forces of the impact survivable.
- Jumping just before the elevator hits the bottom is not a viable alternative. The chances that you will time your jump exactly right are infinitesimally small. Besides, the elevator will not remain completely intact when it hits—it will likely collapse around you and crush you if you are in the middle of your jump, or even if you are still standing.

**WORST-CASE
SCENARIO.**

HOW TO SURVIVE IN FRIGID WATER

1 Do not attempt to swim unless it is for a very short distance.

A strong swimmer has a 50-50 chance of surviving a 50-yard swim in 50-degree Fahrenheit water. Swim only if you can reach land, a boat, or a floating object with a few strokes. (Swimming moves cold water over skin, causing rapid cooling. Cold water saps body heat 25 times faster than air of the same temperature, and water any colder than 70 degrees Fahrenheit can cause hypothermia.)

2 If you are alone and wearing a flotation device, assume the heat escape lessening posture (HELP).

Cross your ankles, draw your knees to your chest, and cross your arms over your chest. Your hands should be kept high on your chest or neck to keep them warm. Do not remove clothing. Clothes will not weigh you down but will hold warm water against your skin like a diver's wetsuit. This position can reduce heat loss by 50 percent.

3 If two or more people are in the water and all are wearing flotation devices, assume the "huddle" position.

Two to four people should "hug," with chest touching chest. Smaller individuals can be sandwiched between larger members. This position allows body heat to be

shared. Also, rescuers can spot groups more easily than individuals.

4 Keep movement to a minimum.

Increasing the heart rate speeds body cooling. Try to breathe normally.

5 Once you are rescued, look for signs of hypothermia.

Slurred speech and a lack of shivering are signs of severe body temperature loss. Immediately rewarm your body.

IF YOU ARE NOT WEARING A FLOTATION DEVICE

1 Grab anything that floats.

A piece of driftwood, a floating cooler, and a plastic bag full of air all work well as flotation devices.

2 If nothing buoyant is available, float on your back, tread water very slowly, or assume the HELP position (see step 2 above).

3 If you are unable to float or tread water, button the top button of a coat or shirt and splash air and water under the bottom edge of your clothing to trap air.

Trapping air under clothing may help you stay afloat, but can also be dangerous since it increases movement and hence cooling.

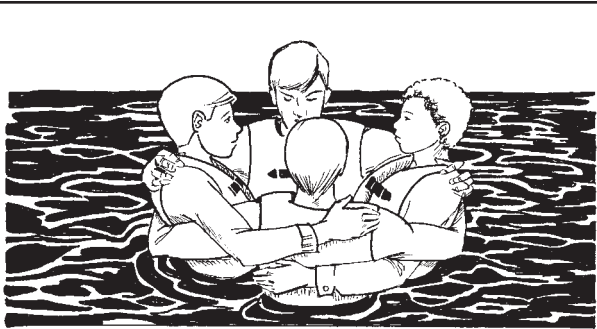

If two or more people are in the water together, assume the huddle position, hugging chest to chest.

TO TREAT HYPOTHERMIA AND TO REWARM

- 1** Rewarm slowly in a tub of lukewarm water (105° to 110°F), with extremities hanging out of the tub.
In hypothermia cases, cold blood pools in the extremities. If you rewarm them with the rest of the body, as blood vessels dilate, cold blood rushes back toward the heart and can trigger ventricular fibrillation and a heart attack.
- 2** Do not massage extremities.
- 3** If warm water is not available, seek a nearby shelter.
Build a fire inside—a small fire can be made in a snow cave without causing significant melting.

- 4** Give the victim sugar water, sweets, tea, glucose tablets, or other high-energy, warming foods to restore energy.

Be Aware

- Rewarming through body contact can be dangerous to a single person attempting to warm another—too much body heat may be lost in trying to rewarm the victim, resulting in two people with hypothermia. Use two people if available. Zip two sleeping bags together and put one person on either side of the victim. Keep everyone talking to help spot or prevent loss of consciousness.

HOW TO SURVIVE WHEN LOST IN THE JUNGLE

HOW TO FIND CIVILIZATION

- 1 Find a river.**
Generally, animal trails will lead you to water. Water is the key to jungle navigation and usually the quickest way to travel.
- 2 Fashion a makeshift raft using the method on page 93.**
- 3 Let the current carry you downstream.**
- 4 Travel on the rivers only during the daylight hours.**
Alligators and crocodiles are generally night hunters, so avoid traveling on water at night.
- 5 Watch closely for signs of villages or settlements.**
Many jungle settlements and villages are located along the shores of rivers.

HOW TO FIND FOOD AND WATER

- ★ **If you do not have the means to purify water (see page 129 for details), cut sections from large water vines, or cut banana trees (see page 127 for details) and capture the water welling out of the stalks.**

To make a raft:

You will need two tarps or ponchos, green brush, two large saplings, and ropes or vines.

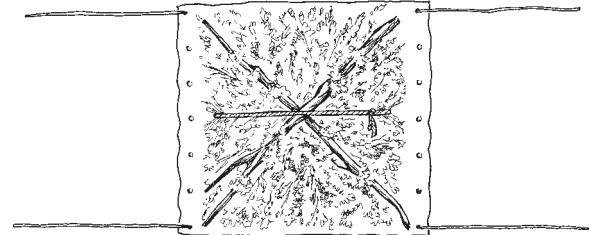

Tie the rope to the corners of one tarp. Pile fresh green brush 18 inches high all around. Place two saplings across the brush in an X.

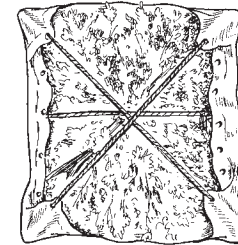

Pile another 18 inches of brush atop the X. Compress the brush. Pull the sides of the tarp tightly around the pile, and tie diagonally.

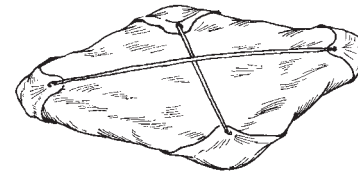

Place another tarp on the ground. Put the bundle open-side down in the center of the tarp on the ground. Tie tightly as shown. Use the raft rope-side up.

Only drink water from streams and rivers as a last resort, when dehydration and death are a near certainty. Diarrhea will most likely result, so increase your water intake and keep moving.



If you cannot peel it or cook it, do not eat it.

Avoid brightly colored plants or plants with a milky sap (many of these are poisonous).

Insects, grubs, and raw fish (except those with bristles or spines rather than scales) are safe to eat. Look for grubs and insects beneath rotting logs and vegetation. Pinch the heads off and eat them raw. Peel fruits carefully before eating; the peels may harbor diarrhea-causing bacteria.

HOW TO TRAVEL OVER LAND

- Mark your trail by breaking and turning over fresh vegetation. This will reveal the bright undersides of leaves and will leave a clear trail should you need to backtrack.
- Look for shelter during bad weather. Large hollow tree buttresses can often be used. Line the ground with palm fronds, and stand several more palm fronds over the opening. Note: Do not build this shelter under a tall tree during a thunderstorm because of lightning danger.
- Be prepared for the dangers of the jungle. Most jungle creatures (such as big cats and snakes) want to avoid you as much as you do them. The real danger comes from the smallest creatures: scorpions,

ants, flies, mosquitoes, and the bacteria in water and on fruit. The best defense against bites and stings is to watch where you put your hands and feet. Ants rule the jungle, so do not camp for the night in their line of travel or near nests. Never touch any brightly colored amphibians. Many, like the poison dart frog, have a powerful toxin in their skin, and any contact can make you very ill.

Be Aware

- Before traveling to a remote area, take the time to look at any available maps. Pay attention to topography and any roads or waterways nearby. If you get lost, you will need to know what general direction of travel will intersect a road or waterway and thus, eventually, civilization.
- The jungle canopy can totally occlude the sun, so a compass may be your only means of determining direction. The same heavy canopy will make it impossible for would-be rescuers to find you, or even to locate a downed aircraft. Unlike being lost in a wilderness situation, staying put in the jungle means virtually certain death.
- To make a natural insect repellent, you can use a termite nest. These nests are abundant on the ground and in trees. They resemble irregular-shaped dirt mounds the size of 55-gallon barrels. Break up the mounds (they look like dirt but are actually digested wood) and rub the material on your skin.

HOW TO SURVIVE WHEN YOU FALL THROUGH ICE

- 1 Breathe steadily.**
The shock of hitting the cold water will be great, but remain calm.
- 2 Turn in the direction from which you came.**
You most likely came from the area with the strongest ice.
- 3 Use your elbows to lift yourself up onto the edge of the hole.**
Do not get out yet. Hold yourself in that position. Let as much water as possible drain from your clothing.



Reach out onto solid ice, digging keys or another item into the ice to help your grip. Kick your feet as you pull yourself out.

- 4 Reach out onto the solid ice as far as possible.**
If you have car keys, a comb or brush, or anything that might help you dig into the surface of the ice, use it to help pull yourself out.
- 5 Kick your feet as though you were swimming, and pull yourself up as you continue kicking.**
- 6 Once on the ice surface, do not stand up.**
Stay flat and roll away from the hole. This distributes your weight more evenly and decreases your chances of breaking through the ice again.

WORST-CASE SCENARIO.

HOW TO TAIL A THIEF

- 1 Before attempting to follow someone who you believe has stolen from you, try to alter your appearance.**
Remove your jacket, if you were wearing one; remove your shirt, if you are wearing a T-shirt underneath; put on or remove a hat or sunglasses. You do not want the thief to recognize you.
- 2 Never stare directly at the person you are following.** You can observe the person without being obvious. Never make eye contact.
- 3 Note the thief's identifying characteristics (dress, gait, height, and weight).**
You will be able to keep track of the thief in a crowd (or after losing sight of him or her) if you are looking for particular details.
- 4 Stay well behind the person you are following.**
Never tail a person by walking right behind him or her. Follow from a distance of at least 40 feet, or from across the street.
- 5 If the thief goes into a store, do not follow.**
Remain outside, looking in the store window, or wait a few doors down for the thief to come out. If the thief does not emerge quickly, check for a back exit.

6 Once you have determined that the thief has arrived at his or her destination, call the authorities.

Confronting thieves alone is risky. Use a phone or ask a storeowner to call the police. Describe your target and his or her location.

Be Aware

- Wallet thieves and pickpockets often follow a similar pattern: They pass the wallet to another person immediately following the theft in order to throw you off the trail, and that person passes it to another. If you can, follow the initial thief: The thief may no longer be carrying your wallet, but might lead you to those who are.

**WORST-CASE
SCENARIO.**

HOW TO TREAT A SCORPION STING

1 Remain calm.

Scorpion venom induces anxiety in victims, so try especially hard to avoid panic. Most species of scorpion have venom of low to moderate toxicity and do not pose a serious health threat to adult humans, other than severe pain.

2 Apply heat or cold packs to the sting site for pain relief.

The most severe pain usually occurs at the site of the sting. Also use an analgesic (painkiller) if available.

3 If an allergic reaction occurs, take an antihistamine.

Scorpion venom contains histamines, which may cause allergic reactions (asthma, rashes) in sensitive persons.

Scorpion venom induces anxiety in victims.

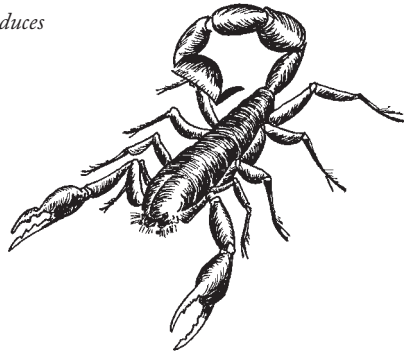

4 Watch for an irregular heartbeat, tingling in extremities, an inability to move limbs or fingers, or trouble breathing.

Most scorpion stings cause only instantaneous pain at the site of the sting; stings feel similar to those of a wasp. The pain of a scorpion sting may radiate over the body several minutes after the initial sting. Pain tends to be felt in joints, especially in the armpits and groin. Systemic symptoms may also occur—possibly numbness in the face, mouth, or throat; muscle twitches; sweating; nausea; vomiting; fever; and restlessness. These symptoms are normal and not life-threatening, and usually subside in one to three hours. The site of the sting may remain sore and/or sensitive to touch, heat, or cold for one to three days.

5 Seek emergency medical care if you exhibit the above symptoms.

Small children who are stung should seek emergency medical care immediately. Adults, however, have much more time—the odds of dying or even becoming seriously ill as a result of a scorpion sting are extremely slim. You will have at least 12 hours to get to a hospital—probably more.

6 Do not apply tourniquets, as the toxins are small and move extremely rapidly away from the site of the sting.

A tourniquet will not help the wound, and could cause more harm if applied incorrectly.

7 Do not attempt to cut the wound and suck out the poison.

This can cause infection or transfer the venom into the bloodstream of the person attempting to remove the poison.

Be Aware

- Scorpions are active at night, when they hunt and search for mates. During the day, scorpions hide in burrows or in any available crack or crevice, depending upon the species. Scorpions are notorious for seeking shelter in objects such as shoes, clothing, bedding, and bath towels. Your presence may surprise the scorpion and it could sting if disturbed. If you are in an area that has scorpions, shake out these items before using them, and check bedding before sleeping.
- Many species of scorpions will readily enter homes and other buildings, which increases the likelihood of an encounter. Scorpions will sting if surprised or threatened, but generally will not sting if unprovoked.
- Scorpions cannot usually deliver enough venom to kill a healthy adult. While venom toxicity varies among species, some scorpions contain very powerful neurotoxins, which, ounce for ounce, are more toxic to humans than the venom of cobras. However, scorpions inject relatively small amounts of venom (compared to snakes), so the overall dose of toxins per sting is survivable.

**WORST-CASE
SCENARIO.**

WORST-CASE SCENARIO.

HOW TO TREAT A SEVERED LIMB

- 1** **Locate any individual bleeding arteries on the stump.**
The arteries will bleed in pulsating spurts.
- 2** **Pinch off the large arteries that are bleeding the most.**
The brachial artery in the arm and femoral artery in the leg carry blood into the limb, and are the major vessels you should find. Someone (the victim or another person) should continue pinching while you proceed to the next step.
- 3** **Apply a tourniquet.**
Choose a strip of material at least an inch wide and tie it around the stump as close to the end as possible so that the tourniquet will not fall off when it is tightened. Tie the tourniquet moderately tight but do not immediately cinch it as tight as possible or you may crush and destroy viable tissue. Tighten the tourniquet just enough to stop most of the remaining bleeding. Keep pinching the arteries.
- 4** **Tie off the ends of any blood vessels being pinched.**
Use fishing line, dental floss, or heavy thread (in that order of preference) along with a sewing needle if available to carefully tie off the arteries. Pass the line completely around the blood vessel being pinched, as

far up as possible. Tighten the first knot down hard, then place several securing knots on top of the first one. You may want to tie the vessel down in two places, in case one of the stitches comes apart later.

5 Clean the stump thoroughly.

Preventing infection is very important:

- Pick out foreign material lodged in the wound.
- Cut off crushed tissue remnants still attached to the stump. Use a sharp knife or scissors.
- Wash the wound, vigorously irrigating it with a stream of water.

6 Optional: Cauterize remaining bleeding sites.

Using an iron or piece of heated metal, identify the vessels that are still oozing blood. This is simpler during irrigation, when debris and clotted blood are washed away. Dab at each vessel lightly with cloth or gauze to allow yourself to see exactly where its end appears in the wound, then apply cauterization at that point. Do not worry about completely eliminating bleeding. If rapid bleeding is well controlled, oozing will be controllable once the dressings are applied.

7 Loosen the tourniquet.

As the pressure from the tourniquet decreases, you will be able to check your ties and ensure more ties (or cauterization) are not needed. If bleeding is just a moderate ooze, you have been successful and the tourniquet can be removed. To preserve tissue at the stump, do not leave a tourniquet applied for more than 90 minutes.

8 Dress the stump.

Coat the end of the stump with any type of available antibiotic ointment (examples include bacitracin, polymyxin, and mupirocin). Then tightly cover the end of the stump with clean cloth or gauze. Elastic strapping works well to hold the dressing onto the stump end. The tighter the dressing, the less the chance of sustained bleeding.

9 Elevate the stump end as high as possible to allow gravity to assist in slowing further bleeding.

10 Put an ice pack over the dressing.

11 Be prepared to apply and tighten a tourniquet again, should heavy bleeding resume.

12 Treat pain and shock from blood loss.

Use any available pain medication to treat pain from the injury. To treat shock, give the victim animal meat or a liquid containing salt (such as chicken soup). These will help to restore plasma and hemoglobin.

HOW TO PRESERVE THE SEVERED LIMB

1 Gently wash the severed limb with water.

2 Wrap the limb in a moist, clean cloth.

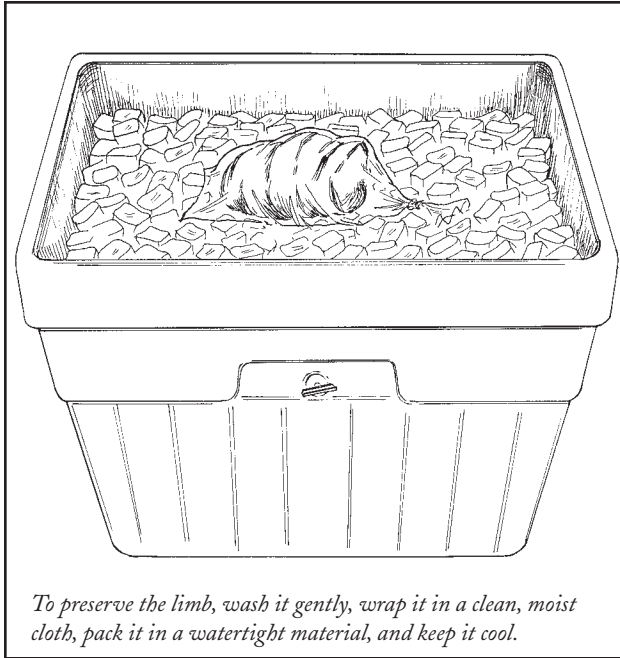

To preserve the limb, wash it gently, wrap it in a clean, moist cloth, pack it in a watertight material, and keep it cool.

- 3** **Wrap the limb again in watertight material (such as a plastic bag).**
- 4** **Keep the limb cold.**
Do not freeze the limb. Freezing will destroy tissue. Use a cooler full of ice or a refrigerator.
- 5** **Get to a hospital immediately.**
A limb saved in this manner can remain viable for reattachment for up to six hours.

Be Aware

- Traumatic amputation of a limb is not necessarily a fatal injury. In order of severity, the immediate problems that you must deal with are rapid severe arterial bleeding; slower bleeding from cut veins; pain; and infection. Only severe bleeding carries an immediate, life-threatening risk, with the possibility of death in minutes.
- Submerging a severed limb in water may cause damage that could hinder its reattachment. You can, however, place it in a watertight container and then submerge that in a river or lake to keep the limb cool.

STRATEGIES FOR FLYING

- ★ **BEST SEATS**—For the best seat in the coach cabin, try for a seat in the emergency exit or bulkhead rows. These are assigned on a first-come, first-serve basis at the airport, so get there early. The exit row seats are also obviously some of the safest in the cabin—your nearest exit is no more than a few feet away.
- ★ **UPGRADES**—Getting upgraded is often as simple as asking at the airport or even on the plane. Although some frequent-flier programs require that you purchase a full-fare ticket in order to use miles for an upgrade, you may be able to obtain a “stand-by upgrade” at the time of your flight if you request it. Just make sure you have your frequent-flier number with you, and that you ask the ticket agent if you can go “stand-by for a first class or business class upgrade.” You may be able to get an upgrade by ingratiating yourself with the flight attendants. Some travelers take gifts (cookies, doughnuts) to give the flight attendants upon departure. In other cases, upgrades have been given to passengers who yield their seats to others who might want to sit together. Be nice—not pushy.
- ★ **CANCELLATIONS**—If your flight is canceled (or if a delay will cause you to miss a later connection and require you to rebook), you are better off calling the

airline or your travel agent for immediate rebooking. This way, you won’t have to fret in line with the rest of the passengers. As an alternative, go back to the ticket counter at the front of the airport for rebooking if the line at the gate is too long.

Another alternative is to ask that your ticket be endorsed over to another airline that has a more acceptable flight to your destination. Rather than waiting several hours or overnight for the next available flight, seek out a competing airline’s schedule, determine if seats are available, and then contact the airline or your travel agent to insist that your ticket be endorsed over to the other airline. Be sure that they route your luggage correctly.

- ★ **JET LAG**—To beat jet lag, drink a lot of water before, during, and after the flight. Exercise, eat, and sleep well immediately before the trip. Avoid cigarettes and alcohol. Eat lightly in the air. Purchase a small self-inflating pillow to make your sleep more comfortable.

STRATEGIES FOR HOTELS

- ★ **ROOM UPGRADES**—If your reserved room is not available upon arrival, request an upgraded room or another hotel. Also, do not hesitate to complain about broken toilets, dripping showers, or late room service—your stay will be more comfortable when the problem is fixed, and you may get a reduced rate.
- ★ **FINDING YOUR WAY BACK**—If you do not speak the local language, carry a matchbook, card, or brochure with the name and address of your hotel. You can show it to taxi drivers or when asking for directions.
- ★ **SECURITY**—Never use the “Please Make Up My Room” doorhanger in a hotel—it advertises to others that you are not in. Housecleaning will check in and clean your room anyway.
- ★ **DRYING WET CLOTHES**—Hang wet clothes overnight in the bathroom on a coat hanger and leave the light on. They should be dry by morning.
- ★ **CLIMATE CONTROL**—In newer hotels with windows that cannot be opened, the ventilation system may dehydrate you. To avoid waking up with a dry mouth and thirsty feeling, soak a towel in water and drape it over a chair in the room. Place the bottom of the towel in a wastepaper basket. The wet towel will add moisture to the air.

STRATEGIES FOR TRAVEL IN DANGEROUS REGIONS

- ★ **CHECK BEFOREHAND**—The U.S. State Department posts warnings on their website (http://www.travel.state.gov/travel_warnings.html) about recent activities (warfare, terrorism, civil unrest) in all parts of the world.
- ★ **I.D. PICTURES**—If you are traveling with friends, spouses, or children, make sure you all have color pictures of each other in case something happens. Carry a photocopy of your passport identification page and a copy of your credit card numbers in a safe hiding place.
- ★ **DRESS**—Dress conservatively, and do not wear or carry obvious signs of wealth (designer branded clothing, gold watches, expensive jewelry, cameras, CD players, etc.).
- ★ **PHOTOS**—Ask permission before taking pictures; do not try to sneak photos. Do not take photographs of military installations, government buildings, women, the infirm, or the elderly.

STRATEGIES FOR PACKING

- ★ **LUGGAGE MARKINGS**—Give each piece of your luggage a unique look—tie a bandanna to a handle or purchase a colored luggage tag. Bags often look alike, and even though you may be able to tell one bag from another, not everyone else is as smart as you are. It will also be easier for you to keep track of your bag from a distance. In lieu of locks, purchase plastic ties to loop through your zippers. These are by no means infallible, but may thwart a thief who is looking for a bag that is easy to open.
- ★ **CHECKED VS. CARRY-ON**—Pack items you must have with you in transit or upon arrival in your carry-on. Medicine, toiletries, and a change of clothing (or at least underwear) are essentials. Carry with you any items that would be difficult to replace if your luggage is lost or late. Do not risk losing anything valuable in your checked luggage—most airline baggage is insured for only \$1,000. If you are traveling with someone you know well, pack half your clothes in their bag and carry half of theirs in your bag. That way, if one bag gets lost, you both have at least half your possessions.
- ★ **AVOID WRINKLES**—Use plastic dry-cleaning bags between fine garments to keep them from wrinkling. Pack smaller items in zip-lock bags to keep them wrinkle-free.

- ★ **CREATE SPACE**—If you run out of space, zip your suitcase and drop it a few times on the floor. This will compress items a bit and free up space.
- ★ **AVOID EQUIPMENT-SPECIFIC BAGS**—If you are taking valuable electronic equipment with you (such as cameras, video recorders, or laptops), consider packing them in a diaper or baby bag instead of the fancy, easily identifiable cases designed for them. A diaper bag is less likely to be stolen and has a lot of extra pockets for storage.
- ★ **FALSE WALLET**—Prepare a “mugger’s wallet” that contains a small amount of money along with a photo ID (not your driver’s license or passport) and additional, but replaceable, cards, for bulk. Use this wallet for your daily small expenses, but be prepared to surrender it in an emergency. Carry the wallet in your front pocket, and place a rubber band around it. You will feel any attempt to remove it. Turn it sideways rather than up and down—you will notice more easily if someone tries to remove it.

STRATEGIES FOR HOTELS

- ★ **ROOM UPGRADES**—If your reserved room is not available upon arrival, request an upgraded room or another hotel. Also, do not hesitate to complain about broken toilets, dripping showers, or late room service—your stay will be more comfortable when the problem is fixed, and you may get a reduced rate.
- ★ **FINDING YOUR WAY BACK**—If you do not speak the local language, carry a matchbook, card, or brochure with the name and address of your hotel. You can show it to taxi drivers or when asking for directions.
- ★ **SECURITY**—Never use the “Please Make Up My Room” doorhanger in a hotel—it advertises to others that you are not in. Housecleaning will check in and clean your room anyway.
- ★ **DRYING WET CLOTHES**—Hang wet clothes overnight in the bathroom on a coat hanger and leave the light on. They should be dry by morning.
- ★ **CLIMATE CONTROL**—In newer hotels with windows that cannot be opened, the ventilation system may dehydrate you. To avoid waking up with a dry mouth and thirsty feeling, soak a towel in water and drape it over a chair in the room. Place the bottom of the towel in a wastepaper basket. The wet towel will add moisture to the air.

STRATEGIES FOR TRAVEL IN DANGEROUS REGIONS

- ★ **CHECK BEFOREHAND**—The U.S. State Department posts warnings on their website (http://www.travel.state.gov/travel_warnings.html) about recent activities (warfare, terrorism, civil unrest) in all parts of the world.
- ★ **I.D. PICTURES**—If you are traveling with friends, spouses, or children, make sure you all have color pictures of each other in case something happens. Carry a photocopy of your passport identification page and a copy of your credit card numbers in a safe hiding place.
- ★ **DRESS**—Dress conservatively, and do not wear or carry obvious signs of wealth (designer branded clothing, gold watches, expensive jewelry, cameras, CD players, etc.).
- ★ **PHOTOS**—Ask permission before taking pictures; do not try to sneak photos. Do not take photographs of military installations, government buildings, women, the infirm, or the elderly.

WORST-CASE SCENARIO®

ABOUT THE EXPERTS

FOREWORD

Source: David Concannon, a fellow of The Explorers Club and chairman of its legal Committee, has traveled extensively on four continents, usually with great success. He recently made three deep submersibles dives to the R.M.S. *Titanic*, at a depth of 12,500 feet, including the first dive of the century on July 29, 2000.

CHAPTER I: GETTING THERE

How to Control a Runaway Camel

Source: Philip Gee, safari operator, runs Explore the Outback, a safari group that leads nature tours of Australia on camelback (www.austcamel.com.au/explore.htm).

How to Stop a Runaway Passenger Train

Source: Tom Armstrong has more than 25 years of railway experience. He has been a locomotive engineer since 1977, and served as accident prevention coordinator for the Canadian Pacific Railway. He lives in Saskatoon.

How to Stop a Car with No Brakes

Source: Vinny Minchillo, demolition derby driver, has written for a variety of automobile magazines, including *AutoWeek*, *SportsCar*, and *Turbo*. When not smashing cars, he is the creative director of an advertising agency in Dallas.

How to Stop a Runaway Horse

Sources: John and Kristy Milchick, horse trainers, own and manage Hideaway Stables, a horse farm in Kentucky, where they breed, train, and sell foundation American Quarter Horses. They also publish articles on horse care and training on their website, www.hideawayhorses.com.

How to Crash-Land a Plane on Water

Sources: Arthur Marx, a flight instructor, has been a pilot for 20 years and owns Flywright Aviation, a flight training and corporate flying service on Martha's Vineyard. He is ATP certified and has single- and multi-engine and instrument instruction ratings; Tom Claytor, bush pilot, is currently attempting a solo flight around the world to seven continents (read about it at www.claytor.com). He is a fellow of The Explorers Club, a subject of the National Geographic Special *Flight Over Africa*, and a recipient of the 1993 Rolex Award for Enterprise.

How to Survive an Airplane Crash

Source: William D. Waldo, professor of Aeronautical Science at Embry-Riddle Aeronautical University and associate director of the Center for Aerospace Safety Education at ERAU-Prescott, Arizona, has completed more than 75 field investigations and over 200 accident analyses. He manages the Robertson Aviation Safety Center and has been flying actively in general aviation for more than 20 years.

CHAPTER 2: PEOPLE SKILLS

How to Survive a Riot

Source: The Chief Consultant of Real World Rescue (who must remain anonymous) has more than 20 years of special operations and counter-terrorism experience. Real World Rescue is a small, high-risk travel security company based in San Diego that trains elite U.S. Government Special Operations personnel and Federal law enforcement agents on international terrorism and Third World survival. The company is on the Web at www.realworldrescue.com.

How to Survive a Hostage Situation

Source: The Chief Consultant of Real World Rescue.

How to Pass a Bribe

Source: Jack Viorel, teacher, has lived and worked throughout Central and South America. He currently lives in Northern California.

How to Foil a Scam Artist

Source: Steve Gillick, executive director of the Canadian Institute of Travel Counselors-Ontario, is the author of *Defining Travel Common Sense* and *Son of Scam*, two travel booklets available from www.citontario.com.

How to Foil a UFO Abduction

Source: The Society for the Preservation of Alien Contact Evidence and Geographic Exploration (SPACEAGE), a grassroots organization dedicated to preserving the nation's extraterrestrial points of interest. The society is the author of *UFO USA: A Traveler's Guide to UFO Sightings, Abduction Sites, Crop Circles, and Other Unexplained Phenomena*.

How to Survive a Mugging

Source: George Arrington, self-defense instructor, has taught classes in self-defense for more than 25 years. He holds a 4th-degree Black Belt and formal teaching license in Danzan-Ryu Jujutsu and has also studied Karate, Aikido, T'ai-chi Ch'uan, Pa Kua, and Hsing-I.

How to Tail a Thief

Sources: Robert Cabral, self-defense instructor, is the founder of The International Academy of Martial Arts in West Los Angeles. He has served as a police defensive tactics trainer and worked for 10 years as a bodyguard in Hollywood. He holds Senior Masters credentials in karate under The Okinawan Karate Federation; Brad Binder,

Ph.D., is vice president of W.R. Associates, Inc., a security firm based in Wisconsin. He has served as a private investigator and protective escort and provides security consultations for individuals and corporations.

How to Lose Someone Who Is Following You

Sources: Robert Cabral; Brad Binder.

CHAPTER 3: GETTING AROUND

How to Jump from Rooftop to Rooftop

Source: Christopher Caso, stuntman, has produced and performed high-fall stunts for numerous movies, including *Batman and Robin*, *The Lost World*, and *The Crow: City of Angels*.

How to Jump from a Moving Train

Source: Christopher Caso.

How to Escape from a Car Hanging over the Edge of a Cliff

Source: Christopher Caso.

How to Escape When Tied Up

Sources: Tom Flanagan (“The Amazing Flanagan”), magician and escape artist; *The Book of Survival* by Anthony Greenburg.

How to Ram a Barricade

Source: Vinny Minchillo.

How to Escape from the Trunk of a Car

Source: Janette E. Fennell, founder of Trunk Releases Urgently Needed Coalition (TRUNC), a nonprofit whose mission is to make sure children and adults trapped in trunks can safely escape. Interior trunk-release regulations based on her work go into effect in 2001.

How to Survive a Fall onto Subway Tracks

Source: Joseph Brennan, author of *The Guide to Abandoned Subway Stations (Disused or Unused Underground Railway Stations of the New York Area)*, at www.columbia.edu/~brennan. He works in the Academic Technologies Group of Academic Information Systems at Columbia University.

How to Survive in a Plummeting Elevator

Sources: Jay Preston, CSP, PE, is a general safety engineering consultant and a forensic safety engineering specialist. He is a former president of the Los Angeles chapter of the American Society of Safety Engineers; Larry Holt is senior consultant at Elcon Elevator Controls and Consulting in Prospect, Connecticut.

CHAPTER 4: OUT AND ABOUT

How to Survive When Lost in the Jungle

Source: Jeff Randall and Mike Perrin, survival experts, run Randall’s Adventure and Training (www.jungletraining.com), a service which guides extreme expeditions and facilitates training in the jungles of Central America and the Amazon. They have both completed the Peruvian military’s jungle survival school for downed pilots in the Amazon.

How to Find Your Way without a Compass

Sources: Jeff Randall and Mike Perrin; *The U.S. Army Survival Manual*.

How to Climb out of a Well

Source: Andrew P. Jenkins, Ph.D., WEMT, professor of Community Health and Physical Education at Central Washington University, is trained in exercise physiology, wilderness emergency medicine, and mountain rescue; John Wehbring, mountaineering instructor and a member of the San Diego Mountain Rescue Team, is a former chairman of

the Mountain Rescue Association (California region). He has taught the Sierra Club's Basic Mountaineering course; Jon Lloyd, an adventure consultant with VLM Adventure Consultants in the United Kingdom, provides adventure sport activities for individuals, youth groups, independent and state schools, company groups and special needs groups (www.vlmadventureconsultants.co.uk).

How to Navigate a Minefield

Source: The Chief Consultant of Real World Rescue.

How to Survive a Riptide

Sources: The National Weather Service in Miami, FL; Dr. Robert Budman, M.D. ("The Surf Doctor"), an American Board of Family Practice certified physician and *Surfer* magazine's medical advisor; the California Surf Life-Saving Association.

How to Survive When You Fall through Ice

Source: Tim Smalley, Boating and Water Safety Education Coordinator for the Minnesota Department of Natural Resources.

How to Survive in Frigid Water

Source: Tim Smalley.

How to Survive a Trip over a Waterfall

Sources: Jon Turk, author of *Cold Oceans: Adventures in Kayak, Rowboat, and Dogsled*, www.coldoceans.com. He has traveled the Northwest Passage by sea kayak and conquered Baffin Island and the Canadian Arctic by dogsled. He made the successful trip around Cape Horn in a sea kayak a day after his 51st birthday; Christopher Macarak, kayak instructor, owns Paddle TraX Kayak Shop in Crested Butte, Colorado.

How to Survive a Volcanic Eruption

Sources: Scott Rowland, Ph.D., volcanologist and the editor and publisher of the *Hawaii Center for Volcanology Newsletter*; the U.S. Geological Society.

CHAPTER 5: FOOD AND SHELTER

How to Survive a High-Rise Hotel Fire

Source: David L. Ziegler, president of Ziegler & Associates, a security consulting firm concentrating on fire and arson investigation (www.ziegler-inv.com). Formerly an agent with the Federal Bureau of Alcohol, Tobacco & Firearms specializing in fire, arson, and explosion cases, he is a certified fire investigator and a member of the International Association of Arson Investigators (IAAI); John Linstrom, executive director of the Fire & Emergency Television Network, which provides training, information, and education for 240,000 emergency personnel via satellite, videotape, and the Internet. He has degrees in Fire Protection Administration and Fire Science, and is certified as a Master Firefighter, Master Inspector, Fire Instructor, Fire Investigator, Fire Officer, and Emergency Medical Technician.

How to Find Water on a Deserted Island

Sources: Jean-Philippe Soule, leader of the Central American Sea Kayak Expedition and former member of the elite French Mountain Commando Unit; Benjamin Pressley, founder of Windsong Primitives, staff editor at *Backwoodsman* magazine, the Southeastern U.S. field editor for *Wilderness Way* magazine, and webmaster of www.perigree.net/~benjamin/index.htm; *The U.S. Army Survival Manual*.

How to Purify Water

Source: Andrew P. Jenkins.

How to Build a Shelter in the Snow

Source: John Lindner, director of the Wilderness Survival School for the Colorado Mountain Club, is also director of training for the Snow Operations Training Center, an organization that teaches mountain survival skills to utility companies, search and rescue teams, and government agencies.

How to Survive a Tsunami

Source: Eddie Bernard, Ph.D., is director of the Pacific Marine Environmental Laboratory, leader of the U.S. team in the 1993 Sea of Japan tsunami damage survey, and director of the Pacific Tsunami Warning Center; the National Tsunami Hazard Mitigation Program; the NOAA Tsunami Research Program; the International Tsunami Information Center.

How to Survive a Sandstorm

Source: Thomas E. Gill, adjunct professor in the Department of Geosciences, and a research associate at the Wind Engineering Research Center of Texas Tech University, and Jeffrey A. Lee, associate professor in the Department of Economics and Geography at Texas Tech. Gill and Lee are members of the Texas Wind Erosion Research PersonS (TWERPS), an informal research group of scientists and engineers from the U.S. Department of Agriculture and Texas Tech who study blowing sand and dust storms; the Office of Meteorology, National Weather Service; the U.S. Army Medical Research & Material Command.

How to Catch Fish without a Rod

Source: Jean-Philippe Soule.

How to Make Animal Traps

Source: Ron Hood, survival expert, received his early wilderness training while a member of the U.S. Army and taught wilderness survival classes for 20 years. Currently, he and his wife, Karen, produce wilderness survival training videos.

CHAPTER 6: SURVIVING ILLNESS AND INJURY

How to Deal with a Tarantula

Source: Stanley A. Schultz, president of the American Tarantula Society, is the author of the *Tarantula Keeper's Guide, 2nd edition*. He and his wife/co-author Marguerite live in Calgary and currently own approximately 350 tarantulas.

How to Treat a Scorpion Sting

Source: Scott Stockwell, a major in the United States Army, works as a combat medical entomologist, consulting on scorpion envenomation. By his own reckoning, he has probably been stung by more species of scorpion and other venomous arthropods than any other living person. He holds a Ph.D. in entomology from the University of California, Berkeley, and works in Fort Sam Houston, Texas.

How to Cross a Piranha-Infested River

Source: Paul Cripps, director of Amazonas Explorer, an organization specializing in adventure travel in Peru and Bolivia. He has guided trips through the Amazon for 13 years; Dr. David Schleser, researcher and eco-travel guide, has researched piranhas and led eco-tours to the Brazilian and Peruvian Amazon. He is the author of *Piranhas: Everything About Selection, Care, Nutrition, Diseases, Breeding, and Behavior (More Complete Pet Owner's Manuals)*; Barry Tedder, marine biologist and jungle survival expert, raises piranhas and has studied them in the southern Amazon. He serves in the New Zealand Royal Navy;

Dr. Peter Henderson, director of Pisces Conservation Ltd. in Lymington, England, has worked on piranha and other South American fish for more than 20 years (www.irc-house.demon.co.uk).

How to Treat a Severed Limb

Source: Dr. James Li, practitioner in the Division of Emergency Medicine at Harvard Medical School in Cambridge, Massachusetts, is an instructor for the American College of Surgeon's course for physicians, Advanced Trauma Life Support. He is the author of articles on emergency practice in remote settings.

How to Remove a Leech

Source: Mark E. Siddall is assistant curator for the Division of Invertebrate Zoology at the American Museum of Natural History in New York City.

APPENDIX

Foreign Emergency Phrases

Sources: French: Jennifer Wolf, MA, doctoral candidate in Comparative Literature, University of Pennsylvania; German: Lisa Marie Anderson, MA, doctoral candidate in Germanic Languages and Literatures, University of Pennsylvania; Japanese: William M. Hammell, MA, Japanese Literature, Yale University; Spanish: Paul Carranza, MA, doctoral candidate in Comparative Literature, University of Pennsylvania.

Gestures to Avoid

Source: Roger E. Axtell, author of *Gestures: Do's and Taboos of Body Language Around the World* and seven other books in his *Do's and Taboos* series. He is also a popular speaker on the after-dinner circuit.

ABOUT THE AUTHORS

Joshua Piven, a computer journalist and freelance writer by day, is a continent hopper by night. He has been chased by knife-wielding motorcycle bandits, stuck in subway tunnels, robbed and mugged, and is consistently served pasta when they run out of the chicken. He is the co-author of *The Worst-Case Scenario Survival Handbook*, and lives in Philadelphia with his wife.

David Borgenicht, a writer, editor, businessman and world traveler, has canoed in alligator breeding ponds, ridden elephants in India, stowed away on Amtrak, and almost always gets the exit row in which the seats don't recline. He is the co-author of *The Worst-Case Scenario Survival Handbook*, and author of *The Jewish Mother Goose* (Running Press, 2000) and *The Little Book of Stupid Questions* (Hysteria, 1999). He, too, lives in Philadelphia with his wife, who is still his best-case scenario.

Brenda Brown is a freelance illustrator and cartoonist whose work has appeared in many books and major publications, including *The Worst-Case Scenario Survival Handbook*, *Reader's Digest*, *The Saturday Evening Post*, *The National Enquirer*, and *Federal Lawyer and National Review*. Her digital graphics have been incorporated into software programs developed by Adobe Systems, Deneba Software, Corel Corp, and many websites.

Check out www.worstcasescenarios.com for updates, new scenarios, and more! Because you just never know. . . .

The
WORST-CASE SCENARIO
Survival Handbook:
EXTREME EDITION

By Joshua Piven and David Borgenicht
Illustrations by Brenda Brown



CHRONICLE BOOKS
SAN FRANCISCO

Copyright © 2005 by Quirk Productions, Inc.

All rights reserved. No part of this book may be reproduced in any form without written permission from the publisher.

Worst-Case Scenario® and The Worst-Case Scenario Survival Handbook™ are trademarks of Quirk Productions, Inc.

Library of Congress Cataloging-in-Publication Data available.

ISBN: 0-8118-4538-9

Manufactured in Canada

Designed by Frances J. Soo Ping Chow

Illustrations by Brenda Brown

Typeset in Adobe Caslon, Bundesbahn Pi, and Zapf Dingbats



A **QUIRK** Book

Visit www.worstcasescenarios.com

Distributed in Canada by Raincoast Books

9050 Shaughnessy Street

Vancouver, British Columbia V6P 6E5

10 9 8 7 6 5 4 3 2 1

Chronicle Books LLC

85 Second Street

San Francisco, California 94105

www.chroniclebooks.com

WARNING

When a life is imperiled or a dire situation is at hand, safe alternatives may not exist. To deal with the extreme worst-case scenarios presented in this book, we highly recommend—insist, actually—that the best course of action is to consult a professionally trained expert. But because highly trained professionals may not always be available when the safety or sanity of individuals is at risk, we have asked experts on various subjects to describe the techniques they might employ in these emergency situations. **THE PUBLISHER, AUTHORS, AND EXPERTS DISCLAIM ANY LIABILITY** from any injury that may result from the use, proper or improper, of the information contained in this book. All the information in this book comes from experts in the situation at hand, but we do not guarantee that the information contained herein is complete, safe, or accurate, nor should it be considered a substitute for your good judgment and common sense. And finally, nothing in this book should be construed or interpreted to infringe on the rights of other persons or to violate criminal statutes; we urge you to obey all laws and respect all rights, including property rights, of others.

—The Authors

ABOUT THE AUTHORS

JOSHUA PIVEN has wrestled with a giant octopus, escaped from a car perched on the edge of a drawbridge, and survived a spinout at 200 mph. Well, not really, but he could, if he had to. He is the co-author, with David Borgenicht, of the *Worst-Case Scenario Survival Handbook* series.

DAVID BORGENICHT is a writer and armchair adventurer who has survived encounters with mountain lions, alligators, barracudas, and Al Roker. He is the co-author, with Joshua Piven, of the *Worst-Case Scenario Survival Handbook* series and the publisher of Quirk Books.

BRENDA BROWN is an illustrator and cartoonist whose work has appeared in many books and publications, including the *Worst-Case Scenario Survival Handbook* series, *Esquire*, *Reader's Digest*, *USA Weekend*, *21st Century Science & Technology*, the *Saturday Evening Post*, and the *National Enquirer*. Her website is <http://webtoon.com>.

Visit www.worstcasescenarios.com for updates, new scenarios, and more! Because you just never know. . . .

ACKNOWLEDGMENTS

Josh Piven is extremely grateful to all the gnarly experts for their radical contributions, as well as to his way cool editors Melissa, Jay, and Steve. As always, he thanks his co-author David “Dude” Borgenicht. All you guys rock!

David is grateful for the help of many people involved in the making of this book. Specifically: Jay Schaefer, Steve Mockus, and Melissa Wagner for their wily editing and creative guidance, Frances J. Soo Ping Chow for her design and hair, Brenda Brown for her uniquely wonderful illustrations, and everyone else at Quirk and Chronicle Books for their creativity, loyalty, and friendship. When I think of the countless lives we’ll likely save as a result of this book, it warms the cockles of my cold, cold heart and makes me glad to have known you all.

ABOUT THE AUTHORS

JOSHUA PIVEN has wrestled with a giant octopus, escaped from a car perched on the edge of a drawbridge, and survived a spinout at 200 mph. Well, not really, but he could, if he had to. He is the co-author, with David Borgenicht, of the *Worst-Case Scenario Survival Handbook* series.

DAVID BORGENICHT is a writer and armchair adventurer who has survived encounters with mountain lions, alligators, barracudas, and Al Roker. He is the co-author, with Joshua Piven, of the *Worst-Case Scenario Survival Handbook* series and the publisher of Quirk Books.

BRENDA BROWN is an illustrator and cartoonist whose work has appeared in many books and publications, including the *Worst-Case Scenario Survival Handbook* series, *Esquire*, *Reader's Digest*, *USA Weekend*, *21st Century Science & Technology*, the *Saturday Evening Post*, and the *National Enquirer*. Her website is <http://webtoon.com>.

Visit www.worstcasescenarios.com for updates, new scenarios, and more! Because you just never know. . . .

ACKNOWLEDGMENTS

Josh Piven is extremely grateful to all the gnarly experts for their radical contributions, as well as to his way cool editors Melissa, Jay, and Steve. As always, he thanks his co-author David “Dude” Borgenicht. All you guys rock!

David is grateful for the help of many people involved in the making of this book. Specifically: Jay Schaefer, Steve Mockus, and Melissa Wagner for their wily editing and creative guidance, Frances J. Soo Ping Chow for her design and hair, Brenda Brown for her uniquely wonderful illustrations, and everyone else at Quirk and Chronicle Books for their creativity, loyalty, and friendship. When I think of the countless lives we’ll likely save as a result of this book, it warms the cockles of my cold, cold heart and makes me glad to have known you all.

INTRODUCTION

We are dismayed and sorry to report that despite our best efforts, the world hasn't really gotten any safer.

We tried, with the publication of the first *Worst-Case Scenario Survival Handbook* in 1999, to give readers the expertise and the confidence to survive life's sudden turns for the worse. Our approach was simple:

1. Be prepared.
2. Don't panic.
3. Have a plan.

That first book provided plans for dealing with quicksand, killer bees, leaps from rooftops, and many other misadventures.

We followed up with *The Worst-Case Scenario Survival Handbook: Travel*, which proved enormously helpful for anyone leaving their house, and then diversified, providing survival techniques for entirely different kinds of dangers: *Dating & Sex*, *Golf*, *Holidays*, *Work*, *Parenting*, *College*, and *Weddings*.

With this handbook we return to our roots—good old-fashioned, action-packed survival for those inclined to extreme activities that go bad.

Within, you'll find all-new advice about surviving dozens of scenarios, from an elephant stampede to a runaway hot air balloon, from skiing off a 100-foot drop to landing a helicopter if the engine fails. You'll learn how to survive if you're stranded on an iceberg,

if you fall down a street grating, and if you find yourself choking or having a heart attack. All the advice is backed by our network of experts, and all comes with clear, step-by-step, illustrated instructions.

Because, after all this time, after the TV show and the calendars and journals and cards and games, we still want you to be prepared. And, trust us, you're not as prepared as you could be.

Because you just never know. . . .

—The Authors

FIVE CRITICAL KNOTS

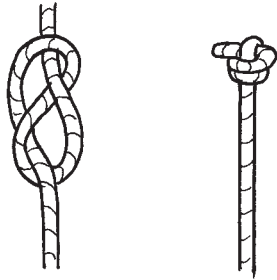
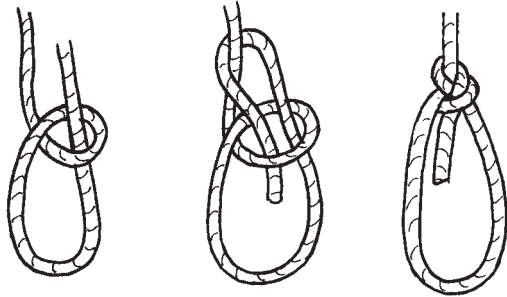

FIGURE 8

Used to keep the end of a rope from running out, as through a pulley on a boat.



BOWLINE

Used to make a small, nonslipping loop to secure around an object.

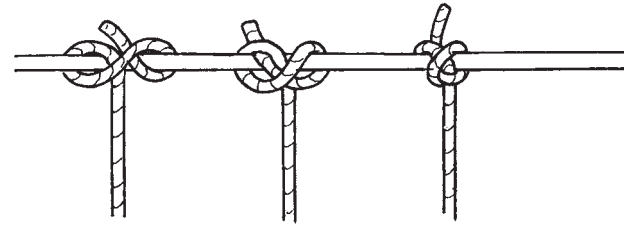

CONSTRUCTOR

Used for securing a load. May be difficult to untie when pulled tight.

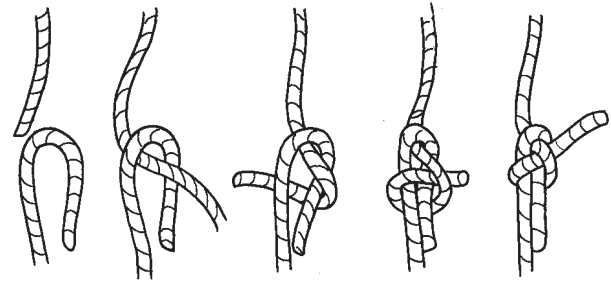

SHEET BEND

Typically used to join two ropes together.

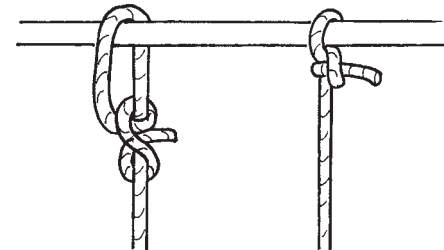

TWO HALF HITCHES

Used in mooring a boat.

**WORST-CASE
SCENARIO.**

HOW TO AVOID A VAMPIRE ATTACK

1 **Garlic, garlic, garlic.**

Wear a necklace of strung garlic, which vampires despise. A hearty meal of pasta with garlic sauce and garlic bread will also help to ward them off. A garlic garland on a doorway will prevent a vampire from entering, even if he's been invited.

2 **Stay outside during daylight hours.**

While sunlight will not kill vampires, it will severely burn them. Most vampires sleep during daylight hours and avoid direct sunlight whenever possible, preferring to hunt for victims in the dark of night.

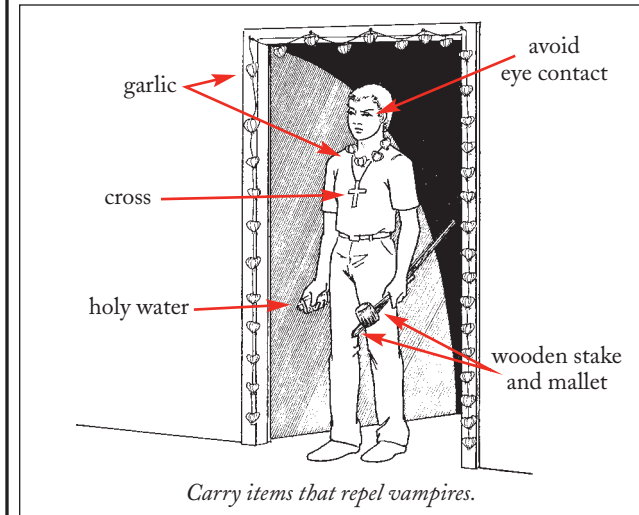

3 **Wear a cross.**

Vampires dislike crosses, but a cross will not kill a vampire. Press the cross into the vampire's flesh to cause burning and scarring and drive the vampire away. For some vampires, the wearer must believe in the power of the cross for it to be an effective weapon.

4 **Do not make direct eye contact.**

To avoid the vampire's charms, do not look him directly in the eye.

5 **Carry a vial of holy water.**

Holy water thrown on a vampire causes severe burning and scarring. It may also be used as a detection device: The water will glow or bubble in the presence of the undead.

6 **Carry a wooden stake.**

For most vampires, a wooden stake driven through the heart causes death. The stake must be 2 to 2¹/₂ feet long, with one end sharpened to a point and the other flat. Using a mallet, drive the stake in quickly with a single blow—a second blow may revive the vampire. The stake must pierce the heart and should be made of wood from an ash tree or a cross.

Be Aware

A vampire will bite any part of the body with ample blood flow. Major arteries are located in the throat, underarms, inner thighs, and at the back of ankles.

**WORST-CASE
SCENARIO®**

HOW TO BAIL OUT OF A STREET LUGE

1 Stay with your board.

Hold on to your board (even if it is broken), and use it to absorb some of the force of the impact. Do not reach out to grab passing objects or drag your legs to try to slow the luge, or you will risk serious injury. Keep your feet on the pegs and your hands on the handles with your back straight throughout the crash. Your helmet, full leathers, and pads will reduce road rash and also help to limit injury.

2 If you are separated from your luge, slide on your back, with your feet pointing downhill.

Do not roll. Rolling will result in more damage to your knees and elbows.

3 Slow your speed with your hands.

Move your arms to a 45 degree angle to your body. Place your gloved hands, palms down, on the road surface. Use the friction created by your gloves to slow your slide and control its direction. Adding pressure with your right hand will alter your slide path to the right, while pressure on your left hand will move you left. Expect to slide at least 200 feet (or triple that, if the road is wet) or until you hit an obstruction.

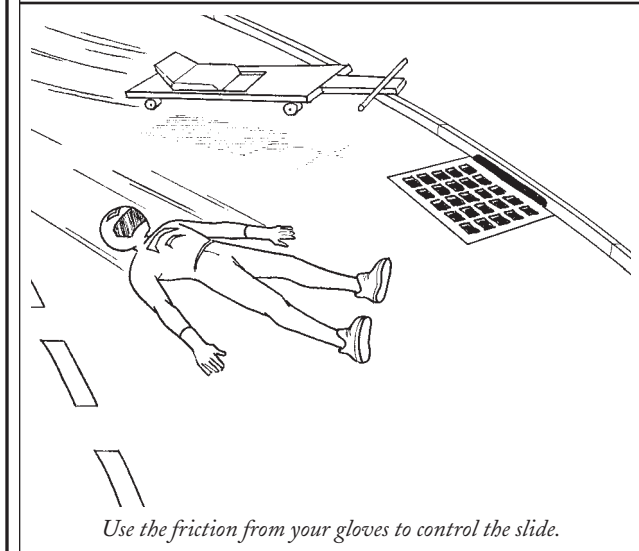
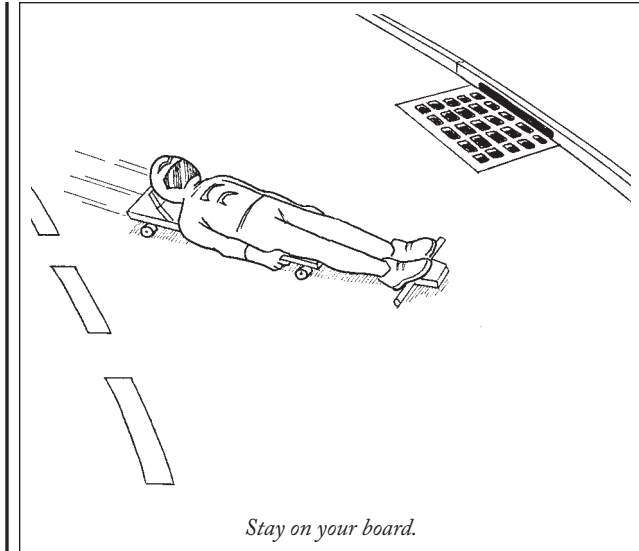

4 Absorb the impact of the crash.

If an impact is unavoidable, bend your knees slightly to absorb the force of the crash feet first. Keep your toes pointed up, and hit the object with the balls of your feet, not your heels.

Be Aware

- A wheel coming off at speed is the most common street luge equipment failure.
- A truck that is too loose may not be noticeable until you are at speed, when severe wobbling will throw you from the board.
- Race luges do not have brakes.
- Spine, elbow, and knee pads are recommended to reduce serious injury.

**WORST-CASE
SCENARIO®**

**WORST-CASE
SCENARIO.**

HOW TO CLEAN AND COOK A SQUIRREL

1 Place the squirrel on the ground, belly up.

2 Pull the end of the squirrel's tail up slightly toward you.

3 Cut.

Using a very sharp knife, make a small incision across the base of the tail, where it meets the body. Do not cut the tail completely off: The cut should be deep enough to sever the tail but should leave the skin on top of the squirrel intact.

4 Split the hide.

Make an incision through the hide down the inside of one hind leg so it connects to the cut at the tail. Repeat for the other hind leg. You should have one continuous incision from the tip of one hind leg to the tail, then back up the other hind leg.

5 Place your foot on the squirrel's tail.

6 Pull.

Pull up sharply on the squirrel's hind legs. The skin should peel off from the bottom of the squirrel to the head. Squirrels have tough skin that is difficult to remove, so it will take some time.

7 Remove the head and feet.

Cut the squirrel's head off at the neck, then cut off the feet.

8 Field dress.

Slice the belly from stem to stern and remove all entrails. Discard. Rinse off excess blood with clean water.

9 Cook.

A smaller, younger squirrel will be tender and may be roasted, while an older squirrel will have tough meat that is better stewed, if a pot is available.

- **To Roast.** For a youngster, sharpen a green stick (sapling) and impale the squirrel from stem to stern. Lay the sapling horizontally between two upright, forked branches positioned on either side of a fire. Slowly cook the squirrel, rotating the sapling periodically for even cooking. The meat is done when it is slightly pink inside the thickest part of the thigh. Cut with your knife to check.
- **To Stew.** Cut an older squirrel into serving pieces: legs, back, and rib sections. Place the sections in a pot of boiling water. Add fuel to the fire to return the pot to a boil, then remove fuel as necessary to maintain a simmer. The squirrel is done when the meat falls off the bone easily. Remove from the heat and remove bones before eating.

**WORST-CASE
SCENARIO®**

HOW TO CROSS BETWEEN BUILDINGS ON A WIRE

A relatively level wire can be crossed by performing a modified Tyrolean traverse, a mountaineering technique used in crossing crevasses.

1 Test the wire.

The wire should be at least one inch thick and fully secured on both sides, preferably bolted or clamped (with steel) to stationary objects. Place your foot on the wire and apply hard downward pressure. The wire should flex slightly. If the wire remains taut, your weight will put too much stress on the side anchors.

2 Check the wire's angle.

The wire should be basically level, parallel to the ground. If slightly angled, the departure side should be a bit higher than the arrival side, so you are traveling “downhill” rather than “uphill” for at least the first half of the trip. (Because of the flex of the wire, you will be climbing “uphill” once you reach the midpoint of your journey.)

3 Protect your hands.

If you do not have gloves, tear out your pants pockets and use them as mittens, put your socks on your hands, or hold two squares of thick cardboard. Gloves

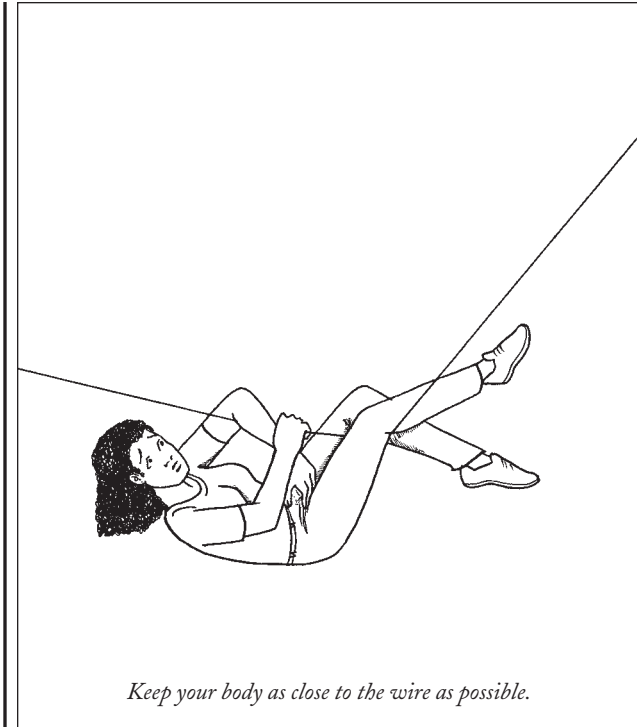

will protect your hands, absorb sweat, reduce friction and “rope burn,” and allow your hands to slide more easily along the wire.

4 Hold the wire.

Stand on the edge of the building, facing the wire. Grab the wire with your hands, approximately two feet beyond the edge of the building. (Crouch down if the wire is at your feet.)

5 **Position your legs.**

Holding the rope tightly, bend at the waist and swing one leg up and over the wire. This leg should be on top of the wire, with the wire running under your knee. Swing your other leg up and cross your legs at your calves. The leg sitting on the wire should be “locked down” by your other leg.

6 **Position your arms.**

Holding on to the wire with your dominant hand, let go with your other hand and place your free arm up and over the wire. Bend this arm so the wire runs under your elbow, similar to the position of your leg. Your other arm should be gripping the wire a few inches beyond your bent elbow.

7 **Check your position.**

You should be hanging upside down, stomach toward the wire, head facing your direction of travel. Your body should be slightly bent at the elbows, knees, and waist.

8 **Begin moving.**

Slightly extend the arm that is gripping the wire. Pull your lower body after you, keeping one leg locked over the other. Your face should be as close to the wire as possible, with your hand not too far beyond your head. You will have moved about a foot.

9 **Continue to face the wire, keeping your body as close to it as possible.**

Do not look down.

10 **Repeat.**

Continue to travel in this fashion, resting between moves as necessary. Once you reach the midpoint of the wire, you will be traveling “uphill,” and progress will be slower and more exhausting.

Be Aware

- Do not attempt to cross an electrical wire. Follow the path of the wire visually. If it appears to run from a pole into a building, the wire may be electrified and should not be crossed.
- A wire with too much flex will be extremely difficult to climb up once you reach its midpoint.

WORST-CASE SCENARIO.

HOW TO DEAL WITH A QUADRUPLE BLOWOUT

1 Hold steering wheel firmly.

Though the car will become increasingly difficult to control, concentrate on keeping the car moving in a straight line. Grasp the steering wheel tightly—it will be shaking violently.

2 Put your hazard lights on.

Your hazards will signal drivers behind you that you are in distress.

3 Apply the brakes.

Put light but steady pressure on the brake pedal to reduce speed. Though the tires are blown, you should still have some tread remaining on each wheel for a few minutes. The “contact patches” (the section of each tire in contact with the road surface) will be greatly reduced, however, and will continue to shrink as pieces of the tire spin off the wheel. The smaller the contact patch, the less friction available to the brakes, less stopping power, and more possibility of spinning out of control. The car will be shaking, along with the steering wheel, and the vehicle will become progressively harder to control.

4 **Steer toward a safe stopping point.**

Scan the road ahead. Look for a relatively open, flat area on the shoulder. If you are in the center or inside lane, signal and move to the outer lane, but make a gradual lane change with no sudden inputs to the steering wheel. If you cannot see or cannot immediately reach a stopping point, see “How to Continue Driving on Four Blown Tires,” below.

5 **Let the car roll to a stop.**

Once you reach a safe area out of the flow of traffic, take your foot off the brake and allow the car to coast to a stop.

HOW TO CONTINUE DRIVING ON FOUR BLOWN TIRES

1 **Go straight.**

If you are on a bridge or stretch of road where you cannot stop safely, keep the car moving in a straight line for as long as possible. Driving on four blown tires, and, eventually, four rims, will be similar to driving on ice: You will have very little stopping power, and the car will tend to spin as you enter turns.

2 **Accelerate smoothly.**

Less friction with the road surface increases the likelihood of spinning wheels, which will make fast acceleration impossible. Apply the throttle (gas pedal) smoothly and sparingly and only to maintain control while moving in a straight line or through a very



3 **Stay on a paved surface.**

Avoid driving the car off the roadway at all costs. With no rubber remaining, the metal wheels will readily bite into soft ground and cause the car to flip.

4 Listen for the last pieces of rubber to fly off the wheels.

The car will shake increasingly violently as the tires disintegrate, and you will hear very loud flapping sounds from the corners. The tread will not stay centered on the wheel, and the contact patch will shift wildly, making the car difficult to control. After a mile or two, the last pieces of rubber will come off, and the flapping sound will disappear. Provided the shredded tires have not gotten caught in the wheel wells, driving on the metal rims should provide less shaking and more control. Your contact area with the road, however, will be extremely small (the width of two pencils for each wheel) and traction will be severely limited. The rims will spark as you drive on them.

5 Pull over as soon as possible.

Eventually, the rims will flatten or crack and the bottom of the car will begin dragging on the road until the friction stops your progress. Steel wheels will last longer and go further than aluminum or magnesium wheels, which are lighter, more brittle, and have a tendency to bend and break under stress.

Be Aware

Run-flat tires have reinforced sidewalls that will support the weight of the car and allow driving with a puncture. However, tires that are severely punctured by treadles or road spikes will begin to shred, and the sidewalls will eventually separate from the tread and come off.

**WORST-CASE
SCENARIO®**

WORST-CASE SCENARIO.

HOW TO DEAL WITH A SUSPICIOUS WHITE POWDER

- ★ **Hold your breath.**
As soon as you see suspicious white powder, stop inhaling. Anthrax spores are generally only fatal when inhaled in large numbers.
- ★ **Do not crouch to the floor.**
Unless aerosolized as a bioweapon, anthrax spores fall to the ground and stay there when released. Stand on a table or chair when handling the envelope or other container of the spores to reduce the chance of inhalation—when the spores fall to the floor, you'll be farther from them.
- ★ **Stay upwind of the letter or parcel.**
Anthrax spores travel on wind gusts. Hold the envelope or other container away from you and downwind of any air vents or room fans. If outside, leave the envelope in place and get inside. Close all windows and doors.
- ★ **Cover your nose and mouth.**
For the best protection, wear a gas mask capable of filtering particles 1 to 5 microns in size. If no gas mask is available, use a surgical mask or a bandanna to cover your nose and mouth.

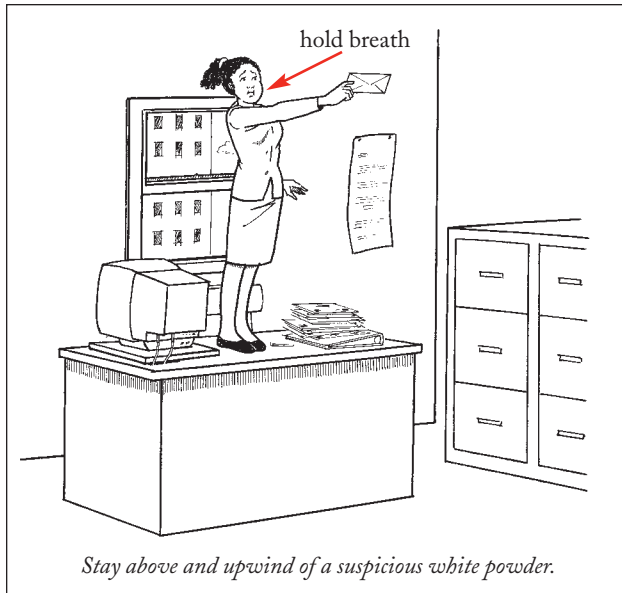

★ **Do not wash clothes or disinfect surfaces.**
Detergents may increase the virulence of anthrax spores.

★ **Call the authorities to report the incident.**

Be Aware

- Anthrax cannot be transmitted from person to person, so it is safe to warn people around you of the danger.
- Anthrax spores may cause localized infection if they enter the body through the skin, especially through a cut. Wear rubber gloves when handling a suspect letter or parcel.

**WORST-CASE
SCENARIO®**

WORST-CASE SCENARIO.

HOW TO DRIVE THROUGH A CHEMICAL SPILL

- 1 Extinguish any cigarettes.**

Many hazardous chemicals are highly combustible. If you are smoking, put the cigarette out completely in your ashtray. Make sure all embers are fully extinguished. Do not throw a lit cigarette out the window.
- 2 Turn off the air circulation systems.**

Make sure the heat, air-conditioning, and all blower fans are off and vents are closed. These systems will bring contaminated outside air into the car.
- 3 Shut the windows.**

Make sure all windows (and the sunroof, if you have one) are fully closed.
- 4 Cover your mouth.**

Tie a handkerchief, cloth napkin, or bandanna around your head so the fabric covers your nose and mouth. Do not wet the fabric beforehand: Some gases and vapors are attracted to water and may combine with it to form dangerous and/or unstable compounds.

5 Monitor your speed.

In most cases, you should drive through chemical hazards at a moderate speed. However, when driving through a dry chemical spill, move extremely slowly (less than 15 mph) to avoid kicking up plumes of toxic dust.

6 Drive uphill and upwind of the spill site.

Once through the spill, continue driving away from it. Many dangerous gases are heavier than air and will tend to settle in low-lying areas. Get to a higher elevation immediately.

7 Abandon your car.

When you are uphill and upwind of the spill, at least half a mile away, and in an unpopulated and low-traffic area, leave your car, which is now contaminated. Use caution when getting out, and do not touch any external surface.

8 Run.

Proceed uphill and upwind of your car as quickly as possible. Do not crawl.

9 Inform authorities that your vehicle and possibly your person are contaminated.

Be Aware

- It is always safer to turn around and drive away from a spill rather than through it. Do not drive through a spill unless you are instructed to do so, or have no other choice.
- HEPA and other microfilters used in the air circulation systems of some cars are not effective protection from toxic substances.

HOW TO ESCAPE A WILD TAXI RIDE

- ★ **Claim you have no money.**
Tell the cabbie you forgot your wallet. The ride should end immediately.
- ★ **Light a cigarette.**
Tell the cabbie that his driving is making you nervous and light a cigarette (or a cigar, for better results). Smoking in cabs is usually illegal and your driver may stop the car.
- ★ **Threaten to vomit.**
Inform the cabbie that his driving is making you sick. There are few things cabbies like less than a passenger who vomits in the backseat. The driver may ask you to exit the cab.
- ★ **Use your cell phone.**
Make a loud show of pretending to call police (or the local taxi commission) and reporting the driver's name and license/medallion number. The driver will want to get rid of you as soon as possible.
- ★ **Run.**
If the cab stops at a light, open the door and take off.



- ★ **Jump.**
If the driver will not stop, wait until the cab approaches a turn or slows for a light. As the driver brakes, open the door on the side of the cab facing the sidewalk. Do not bail out into traffic. Tuck your chin to your chest, cover your head with your hands, and jump out of the car. Roll away from the taxi in a somersault position, protecting your head with your arms. If you have a bag or leather briefcase, hold it on top of your head for added protection. Make sure your path takes you away from the rear wheels. The cab's forward momentum will cause you to roll for several yards before coming to a stop.

WORST-CASE SCENARIO.

HOW TO ESCAPE FROM A CHARGING RHINO

- ★ **Climb a tree.**
See “How to Survive an Elephant Stampede,” on page 16.
- ★ **Run for scrub.**
A rhino probably will not follow you into thick scrub brush. Get as far in as possible. Adrenaline will prevent you from noticing the painful thorns until you try to get out.
- ★ **Stand your ground and shout.**
If no tree or scrub is available to allow your escape, stand and face the animal (rhinos have poor eyesight but are attracted to movement). As the rhino approaches, scream and shout as loud as you can. A charging rhino may veer away from a noisy target.
- ★ **Run in the opposite direction.**
A rhino will continue running in the same direction when it is charging and is not likely to turn around and come back for another attack. Once you have evaded the charge and the rhino has veered off, run in the opposite direction.



Be Aware

- A surprised or startled rhino's first instinct is to charge a threat, whether real or imagined.
- A mother rhino will aggressively defend a calf by charging any and all threats.
- Rhinos can climb steep slopes and will also charge into water or mud.
- A rhino will charge and attack a vehicle and may chase one for more than a mile. A large male (5,000 pounds or more) can easily knock over a car.
- African black rhinos are generally considered the most dangerous and likely to charge, though white and Indian rhinos will also charge. Javan and Sumatran rhinos are smaller, shier, forest-dwelling, and considered less dangerous to humans.
- A white rhino's anterior (front) horn can be as long as 62 inches.

**WORST-CASE
SCENARIO®**

WORST-CASE SCENARIO.

HOW TO ESCAPE FROM A GIANT OCTOPUS

1 Pull away quickly.

In many cases, a human can escape from the grasp of a small- to medium-sized octopus by just swimming away. Propel yourself forward to create a pulling pressure on the octopus's arms. If you cannot get away, or if you feel yourself being pulled back, continue to the next step.

2 Do not go limp.

Octopi are naturally curious and, if strong enough, will check to see if you are a food item before letting you go. Do not act passively, or you may be bitten or quickly enveloped by the octopus's web, a flexible sheath used to trap prey. Once you are caught in a "web-over," escape will be extremely difficult. However, octopi tire easily, so continue to put pressure on the arms by attempting to swim away. The octopus may decide to let you go rather than bring you in for a closer look.

3 Prevent the octopus's arms from wrapping around your arms.

Initially, the octopus will secure itself to a rock or coral formation and reach out to grab you with just one or two arms. Once it has a firm grip on you, it

will move you toward its mouth (called a “beak”) by transferring you to the next sucker up the arm. Do not allow the first two octopus arms to pin your own arms to your sides, or you will have little chance of fighting it off.

4 Peel the suckers from your body.

Using your hands, start at the tip of each octopus arm and remove each successive sucker from your body, like peeling up a bath mat. Once you have loosened one of the octopus’s arms, give it a spear, raft, surfboard, or other object to latch on to. Work quickly, before the suckers reattach to your body or the octopus’s other arms have a chance to grab you.

5 Detach the octopus from its anchor.

Using the sucker removal method described in step 4, separate the octopus from its anchor. Octopi prefer to be anchored to a fixed object, and may swim away once dislodged.

6 Turn somersaults in the water.

If you have detached the octopus from its mooring but are still being held, turn your body in circles in the water to irritate it into releasing you.

7 Swim toward the surface.

Octopi dislike air intensely and will release you once they break the surface. Continue to peel the octopus’s suckers from your body as you swim.

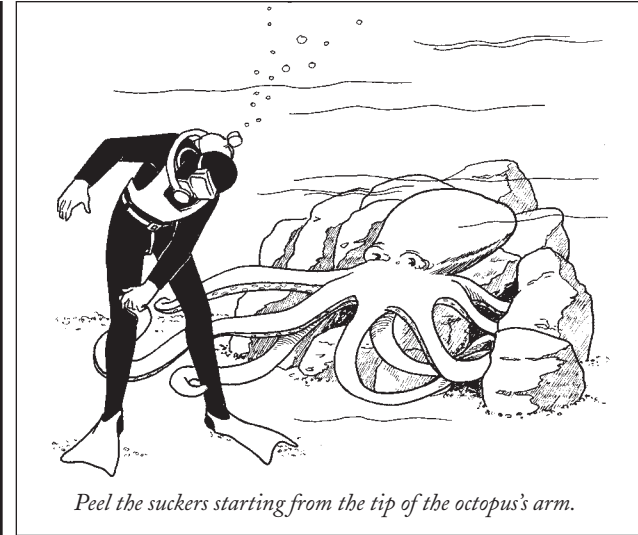

Be Aware

- A giant Pacific octopus may be well over 100 pounds, with an arm span of 23 feet.
- Giant octopi are extremely strong, but do not constrict prey to kill: They tear victims with their sharp beaks.
- Giant Pacific octopi are not poisonous, though bites may become infected.
- Octopi typically eat crabs and clams, though they may eat fish and birds, and may bite at anything.
- Without training or free-diving experience, a swimmer will typically be able to hold his or her breath for only about a minute before losing consciousness.

HOW TO ESCAPE FROM AN ANGRY GORILLA

1 Evaluate the gorilla's behavior.

A stressed or angry gorilla is likely to vocalize loudly and pound, jump, or slap the ground before attacking. A gorilla that is just tugging at clothes or grabbing at you may simply be curious.

2 Do not react.

Do not scream, hit, or otherwise antagonize the gorilla. Even if the gorilla grabs you, it may be playful behavior. Scaring or aggravating the gorilla may provoke an angry response.

3 Be submissive.

Do not look directly at the gorilla. Remain quiet. Do not shout or open arms wide to try to appear larger. The gorilla may interpret these acts as hostile.

4 Watch for a bluff charge.

A gorilla may make a “bluff charge” before an attack to scare potential threats. It may scream or “bark,” stomp its hands on the ground, and tear at vegetation as it advances toward you. A bluff charge is fast and intimidating and resembles an actual attack.

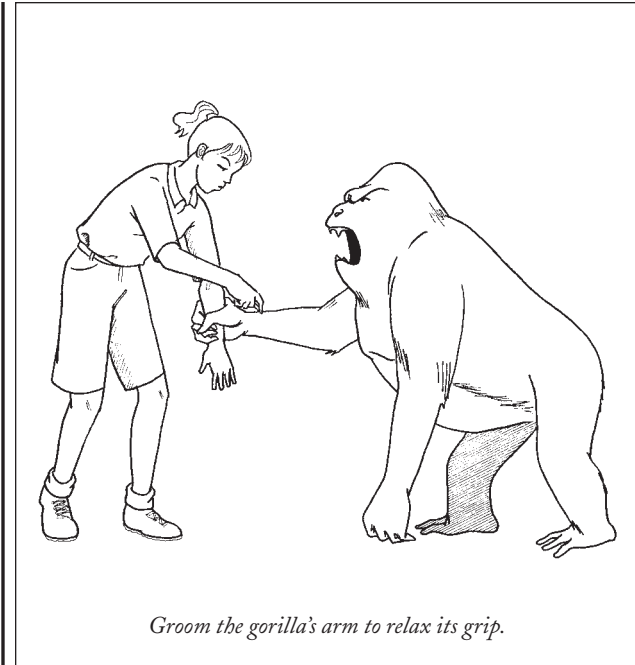

Groom the gorilla's arm to relax its grip.

5 Crouch down and make yourself as small a target as possible.

If the gorilla feels threatened during a bluffing display, it may decide to follow through with an attack.

6 Stay quiet and submissive.

An attack may include severe biting and pounding or tearing with the gorilla's hands. Even if it appears that the gorilla means to harm you, do not actively resist or fight back: It will interpret this behavior as threatening and may attack more severely.

7 Groom.

If the gorilla has gotten hold of you, begin to “groom” its arm while loudly smacking your lips. Primates are fastidious groomers, and grooming the gorilla in this fashion may distract the gorilla in a nonthreatening way. As the gorilla’s grip relaxes, slowly move your grooming hand to the gorilla’s hand, showing keen interest in any bits of leaf or dirt on the gorilla.

8 Remain quiet and passive until the gorilla loses interest or until help arrives.

Be Aware

If the gorilla has you in its grip, do not attempt to pry the gorilla’s fingers apart to remove his hand. A full-grown silverback gorilla is much stronger than any adult human. The gorilla’s grip will be like a vise that is impossible to open.

**WORST-CASE
SCENARIO®**

WORST-CASE SCENARIO.

HOW TO ESCAPE FROM FIRE ANTS

1 **Brush the ants off.**

Fire ants inject venom from a stinger connected to a poison gland. A single ant will pinch the skin with its jaws and sting numerous times, injecting more venom with each sting. As the venom enters the skin, you will experience the intense, burning sensation that gives fire ants their name. Using your hand or a cloth, make a fast, sharp, brushing motion until their jaws dislodge from the skin and they fall off. Jumping up and down, shaking the affected area, and placing the ants under running water will not prevent the ants from attacking and may cause further injury.

2 **Run from the area.**

As you remove the ants, flee the area of the attack. When a mound or nest is disturbed, or foraging fire ants are encountered, they immediately climb up any vertical surface and sting. Hundreds of ants may attack within seconds, especially in mild to high temperatures, when ants stay closer to the surface. The ants will continue to attack even after you have left the nest area, however. Continue brushing them as you run.

3 **Remove your clothing.**

Fire ants will stay in the creases of clothing and may sting later. Once you have reached safety and removed

all visible ants, take off your shoes, socks, pants, and any other articles of clothing where the ants were visible. Inspect your clothes carefully, especially the pockets and seams, before putting them back on. If possible, launder the items before wearing them again.

4 **Treat the affected area.**

After several minutes, the site of each bite will redden and swell into a bump. A topical antihistamine may relieve some itching at bite sites. Several hours to several days later, the bumps will become white, fluid-filled pustules, which will last for several days or, in some cases, weeks. Immediately upon the appearance of pustules, treat the affected areas with a solution of half bleach, half water to lessen pain and reduce itching. Use an over-the-counter pain medication to reduce discomfort. Pustules will form regardless of topical treatment. If pustules break, treat with a topical antibacterial ointment to prevent infection. Pustules may leave scars.

5 **Monitor symptoms.**

Even a healthy adult may have a severe reaction to hundreds of stings, and people with certain allergies may develop serious complications. Watch for severe chest pain, nausea, severe sweating, loss of breath, severe swelling of limbs, and slurred speech. Seek immediate medical attention if any of these symptoms are present. In highly allergic people, anaphylaxis may occur from fire ant stings. Administer epinephrine immediately.

**WORST-CASE
SCENARIO®**

HOW TO FALL DOWN A FLIGHT OF STAIRS

- 1 Lower your center of gravity.**
When you sense yourself falling, crouch low to the floor.
- 2 Do not attempt to break your fall.**
Avoid using your hands to try to break your initial fall. The weight of your body, in conjunction with the gravitational forces of the fall, may break your wrists.
- 3 Move to the inside wall.**
As you fall, keep your body close to the wall of the stairway, if there is one. You are more likely to catch an arm or a leg in the banister (or fall through or over it) than to injure yourself on the wall.
- 4 Tuck.**
Move your arms, legs, hands, and knees in close to your body. Tuck your chin to your chest. With your elbows tucked in, place your hands on the sides of your head.
- 5 Roll in a zigzag pattern.**
Concentrate on rolling on your major muscle groups: lats (back), deltoids (shoulders), quads (thighs), and gluteus maximus (rear end). Avoid rolling head

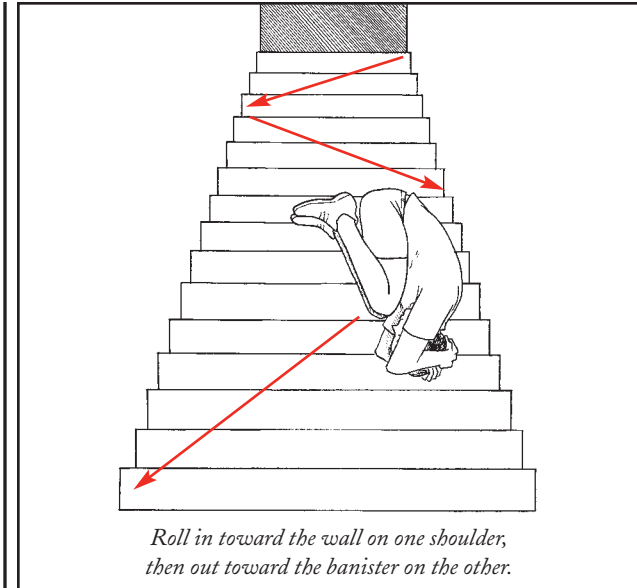

- 6 Check for injury.**
Do not get up immediately. Slowly move each limb in turn to make sure nothing is broken. If you are in extreme pain, yell for help.

WORST-CASE SCENARIO.

HOW TO FREE YOUR LEG FROM A BEAR TRAP

1 Move your foot and wiggle your toes.

Bear traps are designed to catch and hold the leg of a bear, not cut it off. Your leg may be badly bruised, but it should not be severely injured or amputated. Attempt to move your foot and toes to determine if you still have circulation and to check for tendon and muscle damage. In general, the steel “jaws” of the trap are not sharp. Each side of the jaw should have “teeth” that are designed to allow circulation. If you cannot feel your foot or do not have range of movement, you will have to work quickly.

2 Sit with the trap in front of you.

Sit on the ground and move the trapped leg so it is in front of you, bent slightly. The trap may be anchored to the ground with a short chain, or the chain may be attached to a loose hook. (When the caught animal runs away, the hook leaves a trail that is easy to track.)

3 Familiarize yourself with the trap.

The trap will have one piece of bent steel (a “spring”) to the left and another piece to the right of the jaws. The center of the trap will have a flat steel plate called a “pan.” Your leg will be between the jaws, your foot on the pan.

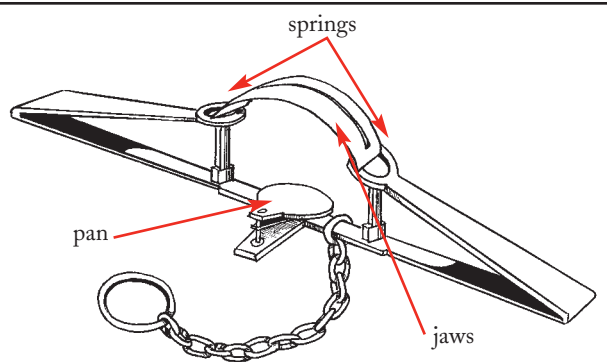

Familiarize yourself with the trap.

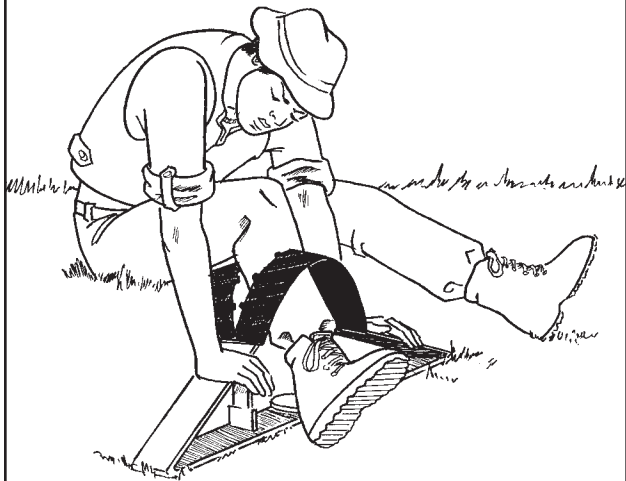

Press to compress the springs and relieve pressure on the jaws.

4 Place one hand on the top of each spring.

5 Close the springs.

With as much force as possible, press down hard on the springs to compress them. As the springs compress, they will lower and relieve pressure on the jaws.

6 Once the jaws are loose, slip your foot out of the trap.

7 Release the springs.

Take pressure off the springs slowly to avoid snapping the jaws closed suddenly.

8 Check your leg for damage.

Look for broken skin and tissue damage. Seek medical attention if you are injured. Be sure to request a tetanus booster if metal has pierced the skin.

WORST-CASE SCENARIO.

HOW TO LAND A HANG GLIDER IN A WIND SHEAR

A wind gradient or “shear” is the boundary between two air masses moving at different velocities. The shear will stall the glider or produce extreme turbulence, making it difficult to control. Regain control by increasing speed, which will increase airflow across the sail (the flexible skin of the glider, also called the “wing”).

- 1 Pull in on the control bar so the nose of the glider tilts toward the ground.**
- 2 Shift your weight forward.**
This will increase your velocity as you glide toward the ground.
- 3 Monitor your altitude.**
Your variometer (a small computer strapped to the control bar) indicates your altitude in feet. You will probably be at a few thousand feet, descending quickly.
- 4 Monitor your airspeed.**
Check the variometer for your speed. Your “VNE” (velocity never to exceed) on a hang glider is about 50 mph. If you are accelerating rapidly and approaching the glider’s limits, pull back on the control bar slightly to bring the nose up and gain a bit more lift.

5 Unzip your harness.

As you approach an altitude of 500 feet, unzip your harness so you are no longer in the prone position. Your legs will be hanging down at a slight angle.

6 Position your hands on the down tubes.

As the glider approaches an altitude of 40 feet, move your hands from the horizontal section of the control bar to the down tubes, which are connected to either side of the bar.

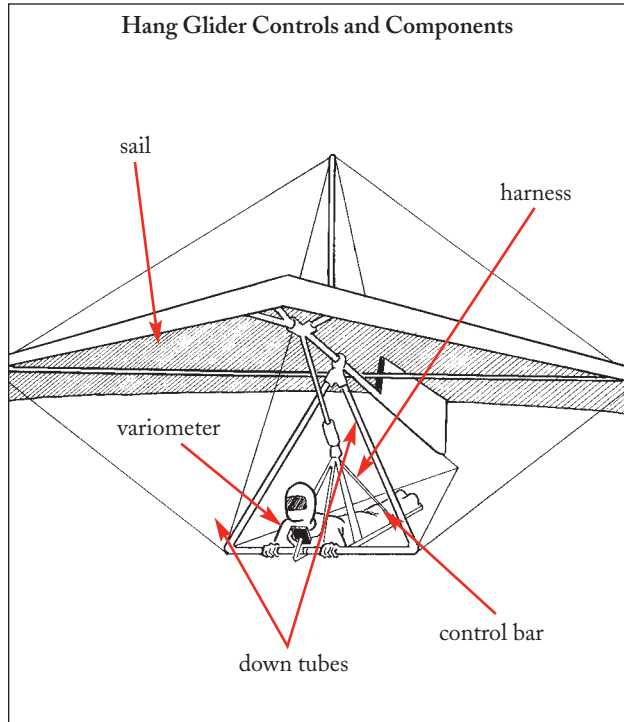

7 Flare the sail.

Push the control bar forward with a smooth, fast motion. The hang glider's nose will pitch up. As the sail angle changes, the air between it and the ground will become compressed and act as an air brake to slow you down.

8 Land in a standing position.

The glider will have slowed sufficiently to make a stand-up landing possible. As your feet touch the ground, begin a slow run to maintain control and keep the sail from pitching forward suddenly. If the glider frame has wheels, use them to absorb some of the force of the impact.

9 Come to a stop.

The glider should settle gently to the ground.

Be Aware

- Many hang glider pilots wear a parachute on their chest to use if they are caught in dangerous turbulence or in a severe updraft that sends the glider above 10,000 feet.
- Carry a lightweight package of dental floss for use in an emergency, tree-based landing. When stuck in the tree, hold one end of the floss and toss the dispenser to rescuers. Instruct them to tie their end of the floss to a rope. Use the floss to pull the rope up, tie off, and climb down.

WORST-CASE SCENARIO.

HOW TO LAND A HELICOPTER IF THE ENGINE FAILS

When a helicopter's engine stalls, it cannot be restarted in mid-flight. The helicopter's low flying altitude (usually 500 to 1,000 feet) means you will have just seconds to react before it crashes to earth. A controlled emergency landing after engine failure, called autorotation, uses the weight of the helicopter and its downward trajectory to move air across the blades. The air causes the main rotor to rotate enough to give you some lift and slow your descent to a controlled rate. At an elevation of 500 feet, you will hit the ground in about 20 seconds. You will not have time to use the radio to call for help. Perform the following steps carefully but immediately.

- 1** **Locate the critical flight controls.**
 - **COLLECTIVE.** This is a lever to the pilot's left that controls the helicopter's altitude. Moving the collective slightly changes the pitch angle of the blades, which in turn changes the helicopter's angle of attack, allowing it to climb or descend.
 - **PEDALS.** The two pedals (left and right) control the pitch of the tail rotor, which prevents the helicopter body from spinning in the opposite direction from the main rotor. The pedals are used to move the helicopter left and right during flight.

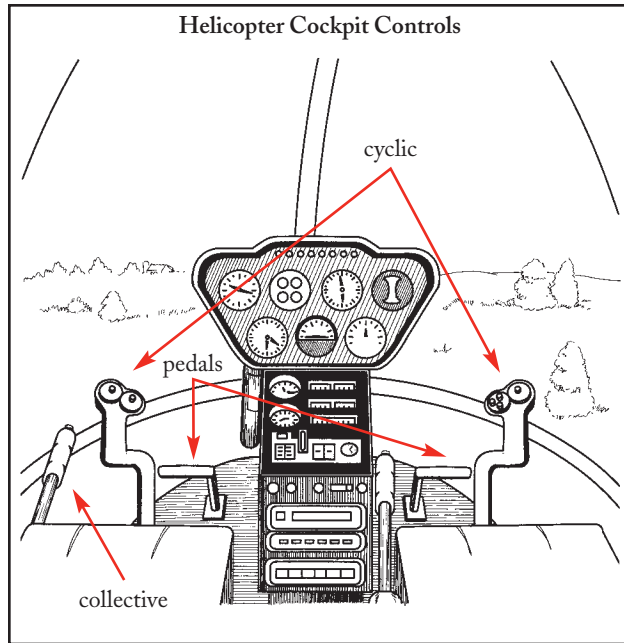

- **CYCLIC.** This stick, directly in front of the pilot, controls the tilt of the rotor disk, which allows the helicopter to move forward or backward.

2 Lower the collective.

Move the collective lever all the way down to its lowest position. This will cause the helicopter to descend (if it isn't already), but it will allow the air moving over the blades to turn the rotor. You will have only about one second to fully lower the collective after engine cutout before the helicopter becomes completely uncontrollable.

3 Place your feet on the pedals.

The left pedal will move the helicopter to the left, the right will move it right. Though you will have minimal forward motion, you should be able to use the pedals to move the helicopter in either direction to position it for a safer landing. The pedals are extremely sensitive, so do not put too much pressure on them.

4 Glide.

While an airplane will glide forward about 20 feet for every 1 foot it descends (a glide ratio of 20:1), a helicopter's glide ratio is just 4:1, so you will not be able to move forward very far before hitting the ground. Look for a smooth surface and keep a slow forward speed. Ideally, you should set the helicopter down in an empty parking lot or other paved, open space free of people, cars, power lines, and other obstructions. Avoid landing in a field: The landing skids may catch on rocks, stumps, or mud, causing the helicopter to slide or flip over. Do not attempt a water landing. Make sure you are strapped in to the seat.

5 Pull the collective all the way up.

At about 50 feet above the ground, keep the helicopter level and pull the collective all the way up to cushion the ground contact as much as possible.

6 Prepare for impact.

When properly executed, an autorotation will bring the helicopter to the ground at about 20 mph, slow enough for the impact to be easily survivable. However, the blades on the main rotor will bend downward from the impact, and may slice through the tail boom and/or hit the ground and snap off. Get on the floor of the cabin as soon as you feel impact, then run from the cabin, which may explode, as soon as there is no danger of being hit by the rotor blades.

Be Aware

Performing an autorotation above and then landing in tall trees (which offer a relatively flexible and cushioned landing surface) may protect occupants, but will probably destroy the helicopter.

**WORST-CASE
SCENARIO®**

WORST-CASE SCENARIO.

HOW TO LAND A RUNAWAY HOT AIR BALLOON

1 Use a radio to contact your chase crew.

A chase vehicle will be following your progress from the ground, usually ready to meet the balloon when it lands. Using the pilot's two-way radio, press the talk button and explain your situation to the crew. Release the button to listen. Tell a crew member to call emergency services to meet the balloon when it touches down.

2 Establish whether the balloon is ascending or descending.

Look to the horizon, 90 degrees to the right or left of the direction the balloon is traveling. If the horizon is moving higher, you are descending; if it is moving lower, you are ascending.

3 Determine the balloon's farthest point of travel.

Face in the same direction the balloon is traveling. Look for a point on the ground ahead of you that does not appear to be rising or descending. This point is the farthest the balloon will travel at its present rate of descent. If no serious hazards (power lines, buildings, people) are between you and the farthest point of travel, skip to step 5. If there are hazards ahead, continue to step 4.

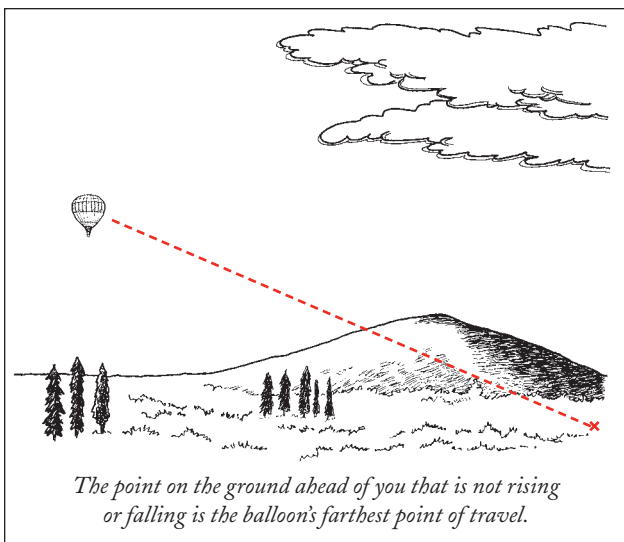

4 Change your flight path.

To clear a populated area or avoid a collision, increase the balloon's altitude by adding more heat to the balloon. Locate the blast valve, a lever-type valve protruding from under the propane burner. Open the valve by rotating the handle to the vertical position, hold it open for 5 to 10 seconds, then release it. (The valve is spring-loaded to the off position. The faster you are descending, the longer you will need to leave the valve open to slow your descent.) Leave the valve closed for 10 seconds. Continue to operate the valve in this sequence until you see the balloon ascend. Do a horizon check (step 2) and check the farthest point of travel (step 3) to determine your altitude and ability to clear obstructions.

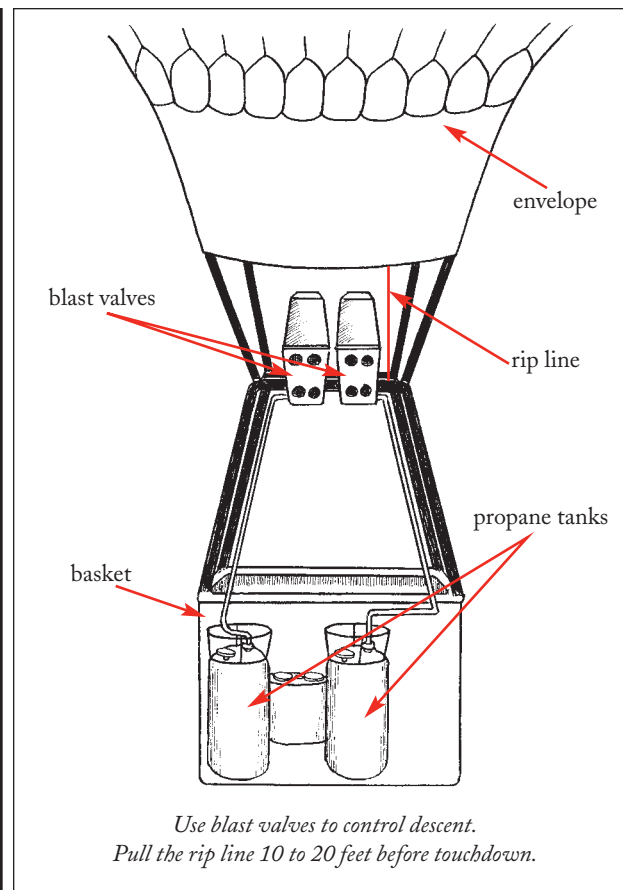

5 Once all obstacles are cleared and a suitable landing site is in view within your direction of travel, begin your descent.

If you do not open the blast valve, the balloon will slowly begin to descend. Hot air balloons are designed

so that terminal velocity (the speed at which the basket and balloon will hit the ground if the blast valve is fully closed) is only about 20 mph. At this speed, landing will be similar to landing under a parachute: a sharp bump, but survivable. Use the blast valve to slow your descent, if necessary, but be careful not to add so much hot air that you begin to ascend.

6 Pull the rip line.

The rip line is a red rope or strap hanging down into the basket from the envelope (the open balloon). It opens the vent at the top of the envelope, which allows hot air to escape quickly just before and right after landing. Ten to 20 feet before touchdown, pull hard on the rip line. There will be at least 20 feet of slack, perhaps more if the line is attached to pulleys to make pulling easier. Continue to pull the line until there is no more slack. Hold the line until the balloon has landed and deflated.

7 Brace for impact.

Bend your knees and grab the uprights or handles in the basket to avoid being thrown out upon contact with the ground. Avoid grabbing fuel lines or placing any part of your body outside the basket. Do not try to remain standing during impact: Collapse yourself into the bottom of the basket when you hit the ground.

8 Remain in the basket until the balloon has come to a complete stop.

The basket may bounce and skip several times before coming to a stop on the ground. The balloon should deflate and collapse in the downwind direction. If you have landed in trees, the basket should be upright, but you may need to wait for rescue.

Be Aware

- Failing to pull the rip line will result in a dangerous bouncing landing and increase the risk of the balloon hitting the ground and then floating away again.
- Though the envelope, wicker basket, and propane tanks will float, landing on water adds complications and should be considered only as a last resort.
- Hot air balloons have no mechanical steering mechanism—you can only force a balloon to climb (by opening the valve, adding propane to the envelope) or descend (by doing nothing). Steering is accomplished by harnessing wind currents at different altitudes.

HOW TO LEAVE A TRAIL FOR RESCUERS IF YOU ARE LOST IN THE WILDERNESS

1 Walk through “track traps.”

Mud pools, wet sandy areas, snow, and other soft terrain can hold footprints for long periods (days or weeks, between storms). Step in these areas, write “HELP,” and draw arrows to signal your direction of travel to potential rescuers. If you reverse course, step in the tracks again on your way out. Your footprints will indicate that the search should not continue past the track trap.

2 Build campfires.

Smoke from campfires can be seen for miles, and fires show up well at night. Warm fire rings also indicate to rescuers that you were recently in a particular area. Do not leave fires burning, but make sure coals or dirt are still warm when you leave. (Warm coals can reignite, so leave warm fire rings only in wet areas or under conditions of low fire danger.)

3 Follow roads and rivers.

Rescuers will use natural boundaries to limit their search area. Do not cross roads or rivers. Rather, follow them to more populated areas. Do not climb steep slopes unless you must: Your searchers will follow, delaying your rescue.



Step in soft terrain to signal rescuers.

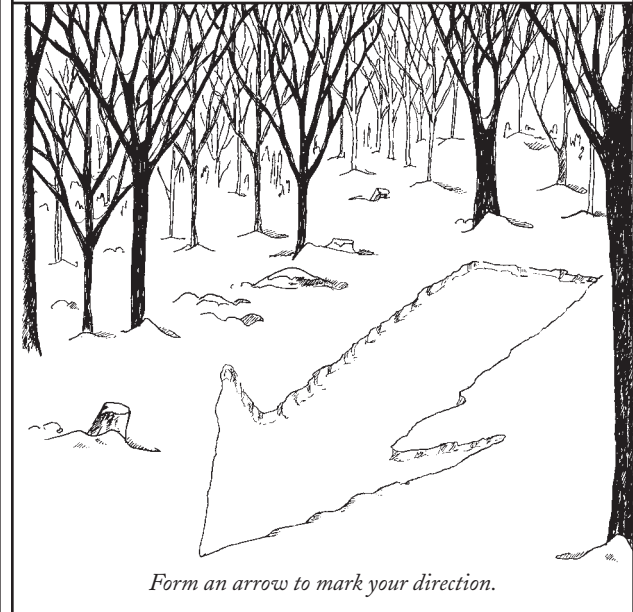

Form an arrow to mark your direction.

4 **Leave markers.**

If you abandon marked trails, signal your direction of travel by turning over fresh vegetation or leaving small piles of rocks.

5 **Listen carefully.**

In addition to shouting your name, searchers may use a “call word,” an unusual word yelled back and forth to distinguish members of the search party from the victim when not in the line of sight. Listen for odd words (“Hoboken,” “spaghetti,” “Internet”) that sound out of place in the wilderness.

6 **Yell loudly and make noises in groups of three.**

Three calls is the international distress signal. Use a whistle, if available, to signal your position.

7 **Sleep lightly.**

A rescue party may continue during the night, so use a flashlight or head lamp. Look for flashlights and listen for searchers between naps.

8 **Leave personal items behind.**

If you are lost in warm weather and have excess clothing or supplies, leave small items along your path as a signal to rescuers. Traveling light will also make hiking easier.

9 **Use a mirror to signal to air searchers.**

A mirror or other reflective device will help rescuers in planes or helicopters locate your position. Special “survival” mirrors with a hole in the center are especially effective in focusing sunlight.



WORST-CASE SCENARIO.

HOW TO OUTWIT A PACK OF WOLVES

1 Slowly move to solid terrain.

In winter, wolves tend to chase their prey into deep snow or onto frozen lakes, surfaces where the hooves of the victim sink or slide. The wolves' large, padded feet give them a tremendous range-of-movement advantage in these areas. If you see wolves around you, slowly walk toward solid ground. Do not crouch down, and do not run. Even during warmer months, wolves will readily chase prey over solid ground and are capable of bursts of high speed, as fast as 35 mph over short distances. You cannot outrun a wolf.

2 Observe the wolves' posture.

A wolf can attack from any position, but a tail straight up in the air and ears pricked up are a signal of dominance and often indicate that the wolf is preparing to attack.

3 Charge one member of the pack.

Wolves are generally timid around humans and have a strong flight response. Running toward one wolf while yelling may scare it and the other members of the pack away from you.

4 **Throw sticks and rocks.**

If the wolves continue with an attack, throw sticks and rocks at those closest to you. Wolves tend to attack the lower portions of their victims' bodies in an attempt to hobble and then bring them to the ground. Kick or hit the wolves as they approach your legs until you scare them off.

Be Aware

- Captive wolves are more likely to attack a human than wolves in the wild. Attacks are often a dominance display. Captive wolves may attack and then eat a person.
- Solitary wolves are generally considered more of an attack threat to humans than pack wolves, though a pack of wolves can inflict more damage more quickly.
- Wild wolves habituated to the presence of humans are more likely to attack, since they have lost their fear of people.
- Wolves may hunt at any hour of the day or night.
- The bite pressure of an adult wolf is about 1,500 pounds per square inch. By contrast, the bite pressure of a German shepherd is about 500 pounds per square inch.
- A wolf pack may have 30 members.

**WORST-CASE
SCENARIO®**

HOW TO SAVE YOURSELF FROM CHOKING

1 Try to talk.

If you can talk or are able to vocalize in any way, or if you make a sound when coughing, your airway is not completely blocked and you are not in imminent danger of death. Keep coughing to dislodge the stuck material. If you cannot make any sounds, you will need to perform the one-person Heimlich maneuver.



2 Quickly locate a blunt object at waist level.

If you are indoors, find a chair, table, counter, or other piece of furniture; if you are outside, look for a tall tree stump, fence, ledge, or large rock.

3 Face the object.

4 Bend over the object.

Lean so that the object touches your body six inches above your navel.

5 Fall.

Let yourself drop forward hard and fast onto the object. This movement should force the air up your windpipe and eject the item that is blocking your airway.

HOW TO SAVE YOURSELF IF YOU ARE HAVING A HEART ATTACK

1 Chew aspirin.

As soon as you suspect a heart attack, thoroughly chew and swallow one 325-mg aspirin tablet, or four 81-mg baby aspirins. For best effect, do not swallow the aspirin whole. Heart attacks occur when the blood vessels supplying oxygen to the heart muscle become clogged. Aspirin will not stop the heart attack or remove the blockage, but it will prevent blood clotting cells (platelets) from adding to the blockage.

2 Alert others.

If possible, tell people around you that you are having a heart attack. Instruct them to call emergency services.

3 Decrease the heart's oxygen consumption.

Stop all activity. The faster your heart pumps, the more oxygen it uses up. Think calming thoughts about bringing your heart rate down to one beat per second. If you have a watch with a second hand, focus on the second hand. For each second think or say quietly "heart-beat." Repeat.

4 Increase oxygen delivery to the heart.

Lie down on the ground. Elevate your legs to keep as much blood pooled around your heart as possible; this will decrease the work your heart must do to pump blood. Open the windows to increase the room's oxygen level. If you have access to an oxygen tank, place the nasal cannula under your nose, turn the knob to 4 liters (or until you feel air coming through the nasal prongs), and take deep, slow breaths through your nose and out your mouth.

5 Perform cough-CPR.

Breathe, then cough every three seconds. Take a breath in through your nose, think "heart-beat, heart-beat, heart-beat," then cough. Repeat. Coughing will deter fainting and help you stay conscious until conventional CPR can be administered.

Be Aware

Do not consume food or water. You may need a hospital procedure to "unclog" your arteries, and food or liquids in your system complicate treatment.

WORST-CASE SCENARIO.

HOW TO SKI OFF A 100-FOOT DROP

1 Look for danger below.

Just before you ski off the edge of the cliff, look down and out over the slope. If your projected path takes you toward rocks, trees, or another cliff, change your takeoff angle by jumping to the left or right so you will head toward safer, wide-open terrain.

2 Jump up and off the ledge.

Just as you are leaving the ground, hop up and slightly forward to help you clear any rocks or other obstructions that may be hidden just below the ledge and that could knock you off balance.

3 Pull your legs and skis up and tuck them under your rear end.

This compressed “ball” position will help you maintain balance while airborne and help you to land safely.

4 Thrust both arms out in front of you, elbows slightly bent.

Avoid the “cat out the window” position, where your arms and hands are splayed out above your head. That position will put you off balance when you land.

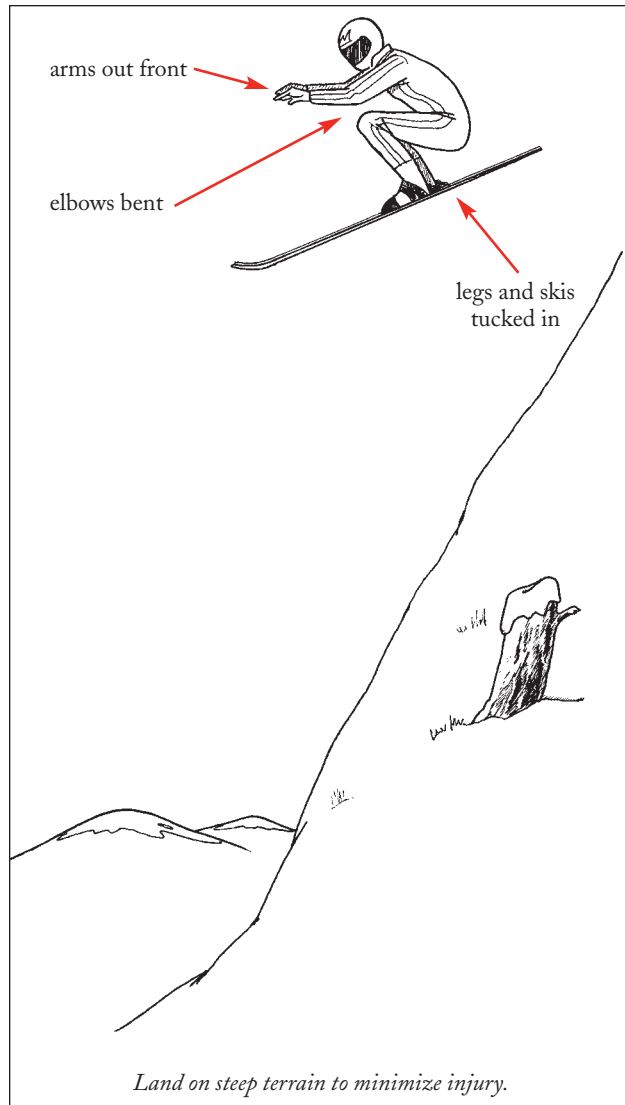

5 Look out, not down.

Looking down at the ground will lead to a “door hinge” landing, where you bend forward at the waist and plant your face in the slope. Look out over the mountain.

6 Focus on a suitable landing site.

Land on very steep terrain. Avoid a low-angled slope or, worse, a flat section of the mountain. As long as the snow is powder and at least one foot deep, you should be able to land without serious injury.

7 Bend your knees as you land.

As you approach the side of the mountain, keep your knees bent to absorb the force of the impact with the ground. Avoid leaning back, which will cause a “tail first” landing and probable back injury. If you cannot ski away from a landing, land on your hip. Do not lean too far forward or you will fall on your face.

8 Extend your feet, bend your knees, and turn across (or “into”) the mountain to slow down.

Because of your extreme speed while airborne, you must minimize acceleration by turning as soon as you land, or you risk hurtling down the mountain out of control. Modern skis should stay on top of deep powder instead of sinking, giving you a reasonable amount of control.

- 9** Continue making turns to keep control and reduce speed as you ski away.

Be Aware

- If you feel yourself falling backward while airborne, move your hands further in front of you and make fast circular motions, forward and back. This balancing maneuver is called “rolling down the windows.”
- In any jump greater than 15 feet, avoid landing in the same spot a previous jumper landed; the snow will already be compacted and will not provide sufficient cushioning.

**WORST-CASE
SCENARIO®**

HOW TO STEER YOUR BIKE DOWN A ROCK FACE

A wrong turn can send your mountain bike down a sheer rock face.

1 Choose a line to follow.

The instant you feel the bike pitching forward down-slope, look ahead of you and choose the line that you will follow down the rock face. The line should be as free of large boulders, drop-offs, and deep ruts as possible. Follow this line.

2 Adjust your seating position.

Move slightly “out-of-saddle,” above the seat with your knees bent, similar to a jockey on a horse running down the stretch. Keep your weight shifted toward the back of the saddle, or behind it, to counteract the pull of gravity.

3 Move the pedals to the three and nine o’clock positions.

Keep your feet on the pedals, with the pedals positioned across from one another. Do not put your feet straight up (twelve o’clock) and down (six o’clock), where the risk of making contact with rocks or the ground is greater. It is also more difficult to maintain a level position with the pedals straight up and down.

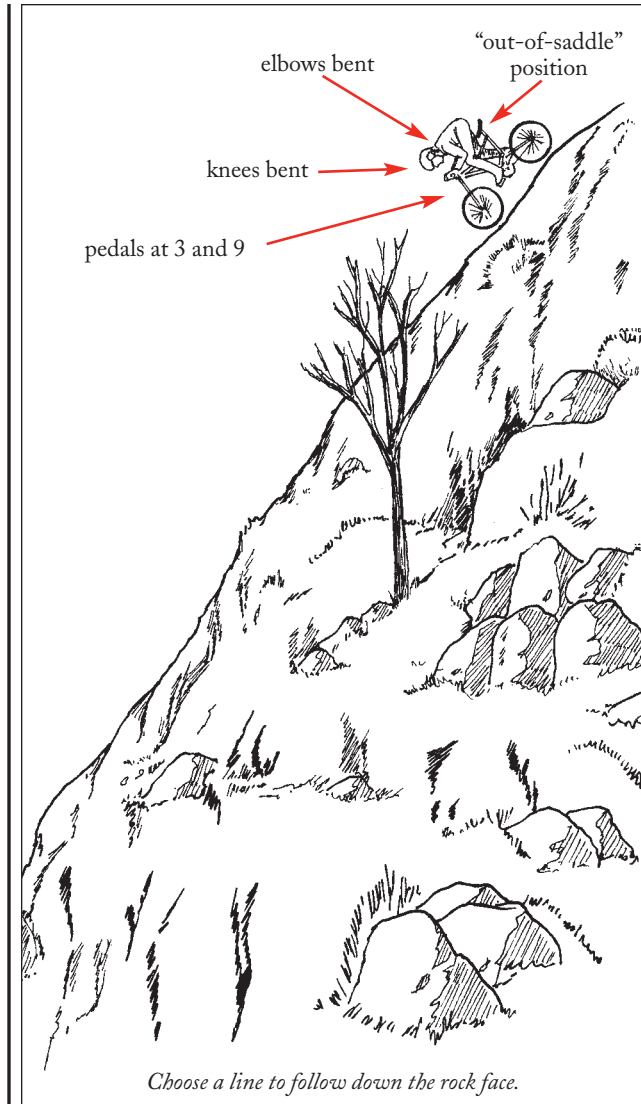

Choose a line to follow down the rock face.

4 Heavily apply the rear brake.

On most bikes, squeezing the brake lever by your right hand will apply the rear brake. Do so as you ride downslope to maintain control of the bike. If you do not brake sufficiently, you risk “bombing,” or speeding out of control down the rock face. Apply the brakes enough to maintain a speed that enables you to see oncoming obstacles in your path.

5 Feather the front brake.

Using your left hand (on most bikes), gently apply the front brake as you climb obstacles, and release it to maintain momentum as you overcome them. This gentle apply-and-release action is called “feathering.” Avoid applying the front brake suddenly and with full force or the bike will stop short and you will pitch over the handlebars.

6 Keep the bike in the middle-to-low gear range.

Low gears are easier to pedal; high gears are harder. The gear should be low enough that you can pedal easily over an obstacle, but not so low that you don’t have any traction. It should not be so high that surmounting an obstacle becomes difficult or impossible.

7 Shift your weight.

As you approach large rocks and boulders, shift your body back to take the weight off the front wheel. This shift will allow the front wheel to more easily ride up and over the obstruction.

8 Keep your knees and elbows bent.

Bend your knees and elbows to absorb shocks and to make fast, fluid position changes easier.

9 Bail if you lose control.

If you feel yourself gaining sudden momentum and you begin to lose control, do not attempt to stay with the bike: You do not want to crash while riding at high speed. Let the bike drop out from beneath you, guiding it so it lands on the non-derailleur side to minimize damage that might make the bike unrideable. Tuck your elbows and knees in as you roll to safety.

HOW TO STITCH A GAPING WOUND

You will need 3 clean, dry hand towels or other cloths, clean water, tweezers, small pliers, scissors, a high-proof liquor (preferably vodka or gin), diphenhydramine (a liquid antihistamine), a sewing needle, unused fishing line or dental floss, and tissues.

1 Stop the bleeding.

Hold one of the hand towels over the wound for 15 minutes, using firm pressure. Do not use a tourniquet because you will cut off the blood supply and may force an amputation. Raise the affected limb above the level of the heart to slow bleeding. Do not attempt to stitch the wound until bleeding is under control.

2 Clean the wound.

Soak the injured body part in warm water. Gently scrub the wound, taking care not to dislodge any obvious blood clots. Irrigate by running cool water over the wound for 5 minutes.

3 Inspect the wound carefully for foreign material.

Use tweezers to remove any foreign objects, then irrigate again. (Remember the phrase: “The solution to pollution is dilution.”)

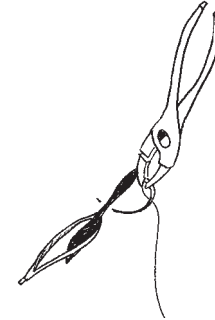

Grip the needle with the pliers so that the needle's point curves upward.

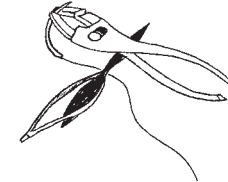

Enter the skin $\frac{1}{4}$ inch from the wound's edge. Pull the needle through the skin using the pliers.

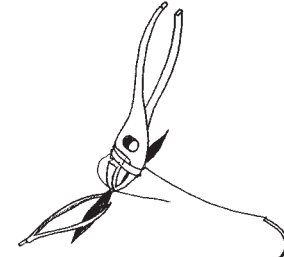

Wrap two loops of thread from the “needle” side of the thread around the nose of your pliers. Grab the 2-inch tail of the thread with your pliers and gently pull it through the looped thread to create the knot.

4 Sterilize your equipment.

Wash the needle, tweezers, pliers, and scissors in hot, soapy water. Rinse once with warm water, then again with alcohol. Lay the tools to dry on one of the towels.

5 Wash your hands.

Lather for at least 5 minutes.

6 Prepare the victim.

Instruct the victim to lie down on a table or the floor, preferably on his back. Do not allow the victim to sit or stand. Rinse the wound again with warm water and pat it dry. Splash lightly with alcohol and wait 3 minutes. Pour several capfuls of the diphenhydramine directly into the wound to provide some anesthesia.

7 Prepare a clean work space.

Cut a hole in the center of the third towel. Place this “smock” over the wound, making sure the complete wound is visible through the hole.

8 Prepare the needle and thread.

Using the pliers, bend the needle into a “C” shape. Measure out ten times the length of the wound in fishing line or dental floss. Cut. Run the “thread” through the eye of the needle so the needle rests one-quarter of the way down the thread. Rewash your hands.

9 Make the first stitch.

You should “throw” the first stitch at the midpoint of the wound. First, grip the needle with the pliers, clamping over the needle’s hole. Next, hold the pliers so that the needle’s point curves upward. Turn your wrist and aim the point directly down at the skin. Use your other hand to hold up the wound edge with the tweezers. Finally, enter the skin $\frac{1}{4}$ inch from the wound’s edge, come through the wound, enter the other side of the wound’s edge, and come out $\frac{1}{4}$ inch from the other edge of the wound.

10 Knot each stitch.

Pull the needle through the skin using the pliers, then pull the thread with your hand until 2 inches are left on the side where the needle entered the skin. Loosely wrap two loops of thread from the “needle side” of the thread around the nose of your pliers. Grab the 2-inch tail with your pliers, then apply gentle upward pressure to bring both edges of the wound together. Pull your pliers back through the looped floss to create the knot, pulling gently in opposite directions so the knot lies flat on the skin.

11 Lock the knot.

Quickly arc your pliers-hand toward the needle side of the thread and pull both ends of the thread down onto the skin. Doing so “locks” the knot and moves the knot onto the skin rather than over the wound.

12 **Secure the knot.**

Repeat the looping and knotting five times, alternating the direction of the looping; this will avoid “granny” knots that will not hold. If you notice that your hands are alternating back and forth in a rhythmic pattern as you tie each knot, you are tying correctly. Double-check that the knot is pulled to the side so that it lays over the skin, not on the wound itself.

13 **Cut the thread.**

Cut both ends of thread. Leave a $\frac{1}{4}$ -inch tail of thread so the stitching can be removed later.

14 **Continue stitching.**

Choose the midpoint between the first stitch and one end of the wound and repeat steps 10 through 14. Continue to bisect the wound between stitches, throwing additional stitches and tying knots until the wound is closed.

**WORST-CASE
SCENARIO®**

HOW TO SURVIVE A BUNGEE JUMPING DISASTER

The bungee cord is under maximum stress at the very bottom of your jump, before you rebound; it is at this point that a break is most likely. If you are over water and the cord breaks or comes loose, you will be falling head first and have about two seconds to prepare for impact.

- 1 Straighten your legs and body.**
Put your feet and legs together, and point your toes.
- 2 Tuck your chin into your chest as far as it will go.**
Avoid the urge to look at the water rushing up to meet you: It will result in black eyes, whiplash, or severe spinal trauma.
- 3 Point your arms below your head in a diving position.**
Ball your fists.
- 4 Enter the water fists first.**
Your hands will break the surface tension of the water, putting less stress on your head. If the bungee cord was attached and broke at your rebound point, it will have slowed you almost to a stop, making for a relatively safe entry. If the cord was not attached or came loose during your fall, the impact will be more severe.

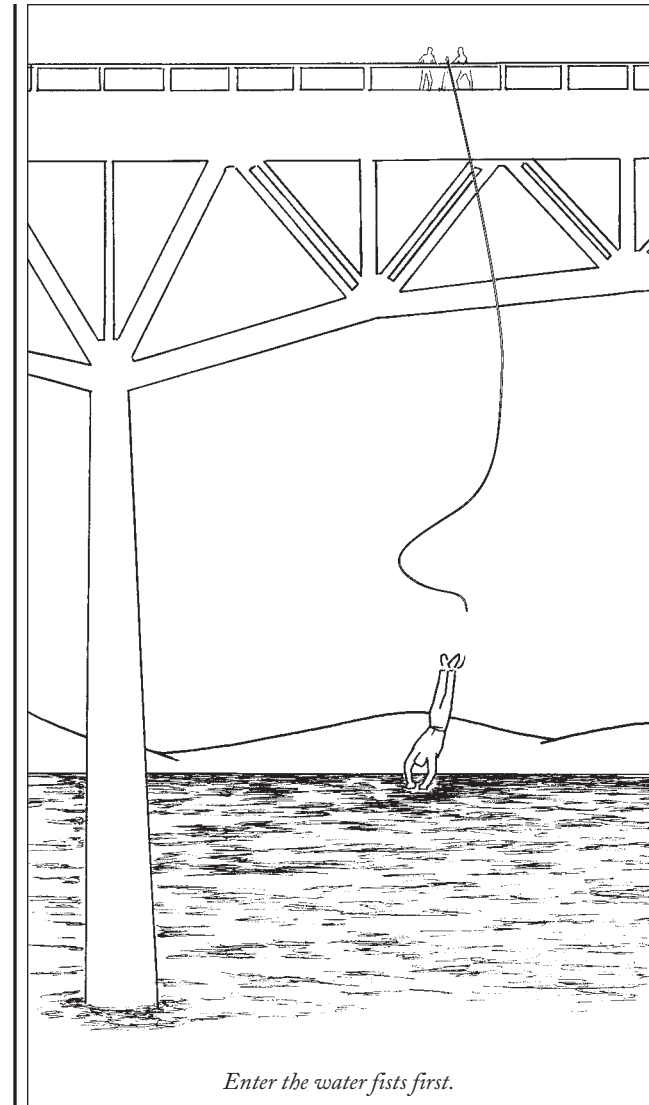

Enter the water fists first.

5 Spread your arms and legs.

After entering the water, spread your arms and legs to slow your momentum and reduce the possibility of hitting the bottom.

6 Swim to the surface.

Signal to the crew above that you are okay.

Be Aware

- Do not attempt to retie or hold the cord. You will not have time to tie a knot sufficient to support your weight, and the cord will fly out of your hands no matter how tightly you grasp it.
- Improper cord connection is a major source of bungee accidents. Before jumping, double-check that you are connected to the cord (generally with a carabiner) and the cord is connected to the bungee platform.
- Bungee cords are weight-specific, and you should always jump on a cord designed for your weight. Always overestimate, not underestimate, your weight.

**WORST-CASE
SCENARIO®**

HOW TO SURVIVE A FALL DOWN A STREET GRATING

- 1 Bend your knees.**

The moment you feel the grating beneath you begin to give way, bend your knees. Your legs will act as shock absorbers, flexing on impact.
- 2 Hold your arms close to your body.**

Do not fling your arms out and attempt to grab anything on your way down. Your hands or wrists may catch on something and break as you descend.
- 3 Prepare for impact.**

Unless the grating is over a sewer line or subway tunnel, you will probably only fall about 10 feet. Most gratings on the sidewalk are used to allow sunlight to enter one floor below grade.
- 4 Land.**

Land in a crouch on the balls of your feet, not flat-footed, on your heels, nor on your rear end. Bend your knees further, absorbing impact with your quads (thigh muscles). Do not use your hands to break your fall.

- 5 Roll onto your shoulder.**

After impact, avoid pitching forward by immediately rolling onto your shoulder, provided there is room to do so.
- 6 Look for a ladder.**

Some gratings have ladders, especially those over subways, sewers, or utility tunnels. Find one and climb out.

HOW TO SURVIVE A FLASH FLOOD

IN A CAR

- ★ **Watch cars in front of you.**
If you see drivers stalling, or notice water reaching halfway up car wheels, do not proceed.
- ★ **Estimate the water depth.**
Water may be deeper than it appears. A car will stall (and float) in six inches of water. If you are unsure if a road is safe to drive through, get out of your car and check the water level using a stick.
- ★ **Exit the vehicle immediately if the car stalls or begins to float.**
If the door will not open, crawl out the window (you may need to break a power window if the car's electronics become saturated).
- ★ **Walk or run to safety.**
Get to higher ground as fast as possible.
- ★ **Float.**
If you are knocked off your feet by the rushing water, cover your head with your arms and attempt to float on your back, feet first, until you can grab a stationary object and climb to safety.

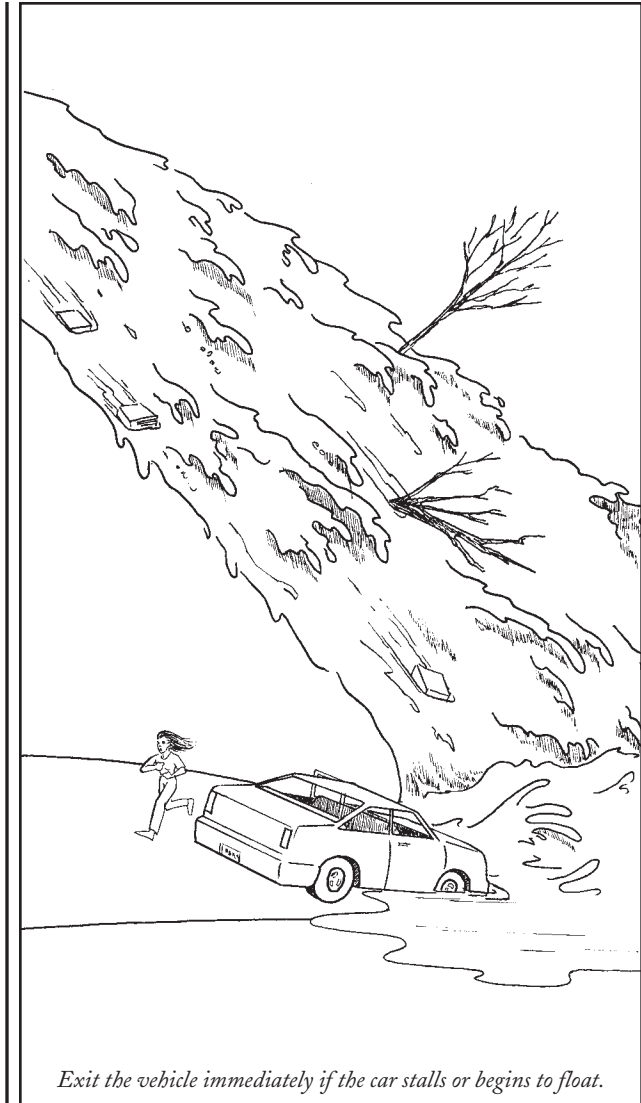

Exit the vehicle immediately if the car stalls or begins to float.

AT HOME

★ Call for help.

When you see floodwaters heading toward your house, seek help. Because of the risk of electric shock, avoid using a wired telephone if there is water in the house. Use a cellular phone.

★ Observe the water level.

If the water outside is less than six inches deep, and you are able to walk without falling down, move to higher ground. If walking is impossible, go back inside.

★ Move to the highest floor.

If the house is three or more stories, move to a high floor. If the house is two stories or less, get on the roof.

★ Signal rescuers.

Use a whistle, wave a white T-shirt or another piece of clothing, or shout to make your presence known. Continue to call for help until you are rescued or the waters recede.

Be Aware

- If time permits, quickly gather these supplies and place them in a plastic bag: flashlight with spare batteries; battery-operated radio; first-aid kit; rope; whistle; gallon of water; bread, granola bars, or other nonperishable, high-carbohydrate

foodstuffs; essential medications. Take them with you when you leave your house.

- Do not eat or drink any foods that have been touched by floodwaters. The packaging may harbor dangerous germs or chemicals.
- When reentering a flooded building, wear boots and waders, and watch for snakes.
- Pump out flooded basements gradually (approximately one-third of the water per day) to avoid sudden structural damage.
- Have the property checked by a qualified structural engineer before moving back in.

ON FOOT

★ Find a flotation device.

Put on a life jacket, inflate a pool toy, or grab a foam (not down or cotton) sofa cushion. Wood floats, but a large piece of furniture may be unwieldy and difficult to carry.

★ Run.

Get to high ground or a high floor of a multistory building immediately. Avoid low-lying areas such as spillways, areas near storm drains, and creeks and riverbanks. Before crossing flooded open areas and streets, watch for floating objects (trees, cars, appliances) that might knock you down.

★ **Check shallow water.**

If the water is less than six inches deep and not moving quickly, you should be able to walk quickly or run. The water level may rise quickly, however, and fast-moving water can knock you down. Prepare to move fast.

★ **Move to the roof.**

If you are trapped by rising, fast-moving water and cannot get to higher ground, get on the roof of a two- or three-story house. Avoid the first and second floors, as these may become inundated quickly.

Be Aware

Do not attempt to swim across floodwaters. Deep, quickly moving floodwaters will almost certainly overpower you and sweep you away. You will be unable to see large objects, such as trees, that may be carried by the water, and you may be struck by them.

**WORST-CASE
SCENARIO®**

HOW TO SURVIVE A FLU PANDEMIC

★ **Wear a surgical mask in public.**

Influenza is a virus that enters the body through contact with mucous membranes, so you must protect your nose and mouth. If you cannot get a mask, keep a bandanna tied securely over your nose and mouth. Do not touch or rub your eyes, nose, or mouth.

★ **Restrict and ration towel usage.**

Each member of the household should have an assigned towel, washcloth, dishcloth, and pillow. (All household members should sleep in separate bedrooms, if possible.) Label towels with masking tape to avoid mix-ups. Wash all towels with bleach.

★ **Sneeze and cough into your elbow.**

Sneezing and coughing into your elbow will prevent germs from reaching your hands and being spread through contact. Recommend that others follow suit.

★ **Keep your hands clean.**

When washing hands in a public restroom, first pull the lever on the towel dispenser to lower a towel, then wash your hands. Rip off the dispensed towel, then use it to pull the dispenser lever again and to turn off the water faucet. Discard the first towel. Tear off the second towel and use it to dry your hands and open the bathroom door, then discard.

To Survive a Flu Pandemic

DO



Cough into elbow.

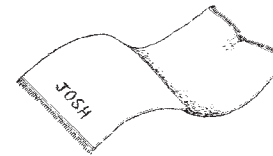

Use only your own towel.

AVOID

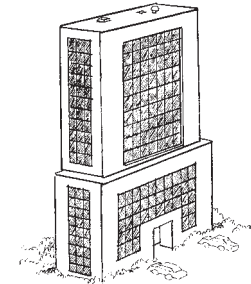

Recirculated air.



Places where children gather.

★ **Sanitize before touching areas with high germ potential.**

Disinfect light switches, doorknobs, keyboards and mice, telephone receivers, refrigerator door handles, sink faucets, and the flush handle on the toilet. Do not use public telephones.

Disinfect Everyday Objects

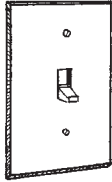

light switches

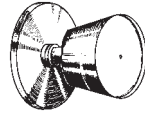

doorknobs

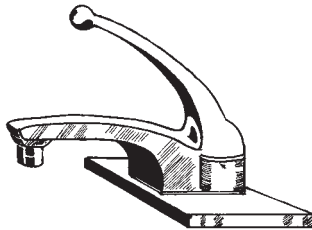

faucets

★ Empty the trash often.

Do not let used tissues pile up in wastebaskets; they may carry the flu. Wear rubber gloves when emptying trash. Wash the gloves frequently, or throw them out after each use and get a new pair.

★ Avoid areas with recirculated air systems.

Do not get on an airplane. Avoid entering buildings that use recirculation systems designed to reduce fuel consumption. (In the United States, many such structures were erected during the 1970s energy crisis.)



Do not enter areas where people congregate.

Hospitals, prisons, day-care centers, college dorms, movie theaters, checkout lines, and other places where large numbers of people cohabitate or group closely together should be avoided during the pandemic.

Be Aware

- Get a flu shot as soon as they become available.
- Wash hands frequently and immediately upon returning home from being outdoors.
- Not all masks are equally effective. For best protection, use an N95 “respirator” mask that completely covers the nose, mouth, and chin.

HOW TO SURVIVE A MOTORCYCLE SPINOUT

1 **Remain on the bike.**

Try to regain control until the last possible moment. Even if you feel the bike begin to slide, the tires may regain traction in an instant, allowing you to recover and ride away. If the spinout is unavoidable, execute a low-side crash, wherein the bike slides out and away from you as you slide in the same direction, but behind the bike.

2 **Apply both brakes.**

As you feel the wheels lose traction, squeeze the brake lever with your right hand to apply the front brake, and press down on the pedal with your right foot to apply the rear brake. With both brakes locked, the bike will keep sliding out, eliminating the possibility of the wheels regaining traction and throwing you over the high side.

3 **Slide.**

Stay on your back as you slide, with your helmet slightly raised so you can see any approaching obstructions. Keep arms and legs slightly spread to distribute your body weight evenly and to reduce the possibility of a head-over-heels tumble.

4 **Once you have come to a stop, stay still.**

Do not try to stand up until your slide has stopped completely. You will pitch forward if you try to get up before your slide has completely stopped.

5 **Get up slowly.**

Check for injuries. If you were wearing full leathers, pads, gloves, and a helmet, you should be relatively uninjured.

6 **Check the bike.**

There is little chance of an explosion after a spinout, so it is safe to approach your motorcycle and look for damage.

Be Aware

- A high-side crash, in which the bike begins to slide in one direction, suddenly regains traction, and throws you across it in the opposite direction, is much more dangerous than a low-side crash and slide.
- Very few motorcycles have antilock brakes, so applying full braking is an effective way to lock the wheels and continue a low-side spinout.
- Motorcycles are highly sensitive to steering and brake application, and are not very forgiving. To avoid spinouts, always apply fast, smooth, gentle pressure and avoid jerky movements.

WORST-CASE SCENARIO.

HOW TO SURVIVE A MUD SLIDE

- 1 Run perpendicular to the slide.**

You cannot outrace a mud slide. Run across the terrain and seek high ground.
- 2 Avoid riverbeds.**

Mud and debris flows generally travel in the channels made by rivers, creeks, and streams (though the slide may be wider than the channel), so move away from these areas as quickly as possible.
- 3 Seek shelter.**

If you do not have time to escape the slide, get inside a building—preferably one made of concrete, stone, or brick—that has a foundation. Avoid mobile homes, cabins on concrete pilings, and other structures that are not built into the ground, as they cannot withstand the force of the debris flow and will likely be severely damaged or carried away.
- 4 Move to an upper floor.**

Mud and debris may penetrate windows and walls of lower floors. Get to a second or third story for added protection.

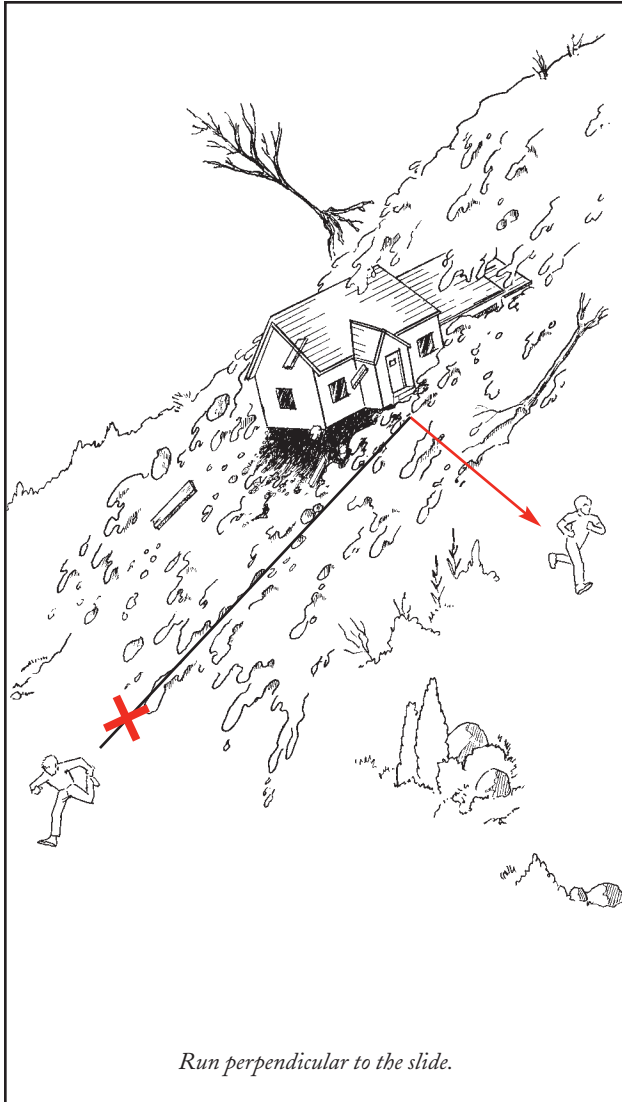

5 **Take cover.**

Get under a desk, large table, or other heavy piece of furniture to protect you from falling objects should the slide rock the structure or knock it from its foundation.

HOW TO DETECT AN IMMINENT MUD SLIDE

1 **Monitor creeks and streams.**

Fast-rising water levels in mountain waterways indicate there have been large amounts of rainfall that can cause mud slides or debris flows. If you notice that streams and creeks are overflowing their banks or have become brown and muddy, expect a slide. Deforested areas and those recently burned are prone to mud slides. Note any barren or blackened land at a higher elevation than your position.

2 **Listen.**

Mud slides begin with rainwater but quickly pick up dirt, rocks, trees, and other objects, giving the debris flow an unmistakable rumbling sound as it quickly moves downhill. A loud, sustained rumble indicates that a mud slide is approaching.

HOW TO SURVIVE A RACE CAR SPINOUT

On the racetrack, a high-speed (180 mph or more) spinout is a rear-wheel skid or slide, also called “oversteer.” To counteract oversteer and regain control of the car, take the following steps.

1 Turn into the spinout.

Determine which way the rear of the car is sliding, then turn the steering wheel in the same direction. For example, if the back of the car is sliding to the right, turn the steering wheel to the right. Do not jerk the wheel. Apply smooth, controlled inputs or you risk losing control. (The steering systems on race cars vary, but typical stock cars have power-assisted steering.)

2 Apply steady throttle.

Oversteer occurs when the rear wheels lose traction. Because most race cars are rear-wheel driven, stepping on the gas and accelerating transfers the car’s weight to the rear wheels, aiding traction. (These same forces “push” you back into the driver’s seat when you accelerate quickly during everyday driving; this is called “weight transfer.”)

3 Do not brake.

Applying the brakes transfers weight to the front wheels, which will only increase your spin.

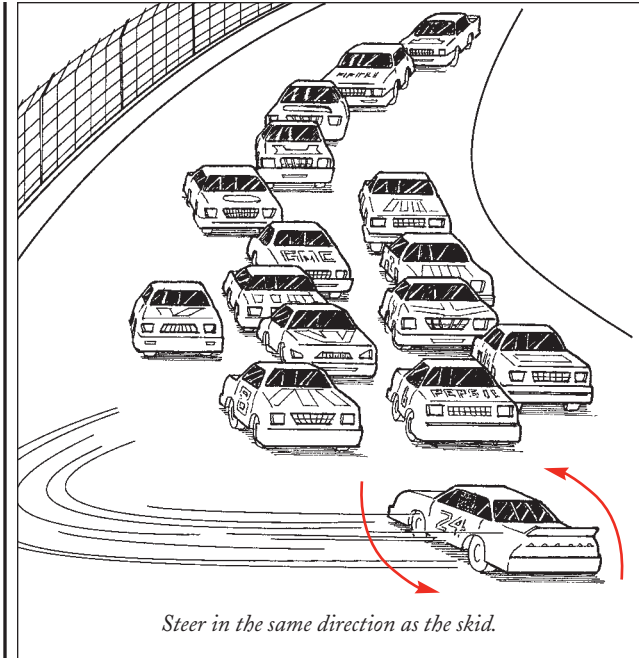

4 Focus on the track ahead of you.

During the skid (and after you regain control), make sure the car is heading in the proper direction. Observe the cars around you and concentrate on where you want the car headed, not where it is going.

5 Unwind the wheel.

As you feel the rear of the car begin to come in line, slowly bring the steering wheel back to center. Avoid attempting to “counteract” the spin by turning the wheel too far in the opposite direction. If you cannot regain control, continue to the next step.

6 Brake.

Once the car is out of control and a crash is imminent, apply the brakes to slow your rotational momentum.

7 Prepare for impact.

A stock car has a full race cage, a racing harness (a five-point seat belt), and a collapsible steering column, and you will be wearing a head and neck restraint. If you sense that impact with the wall or another vehicle is imminent, relax your body and let the car's safety devices protect you. Loosen your grip on the wheel or let go of it, keep your knees slightly bent, and do not tense your neck muscles.

8 Get out.

Your fire-protection suit and gloves are designed to protect you from heat and flames for several minutes. However, in the event of fire, get out of the car (climb through the window opening) as soon as it is safe to do so, or when help arrives.

Be Aware

- Do not downshift during a spinout—it is likely to lock the rear wheels. Downshift only when the car is moving in a straight line.
- Stock cars do not have air bags.
- All stock cars have braided, stainless-steel fuel lines to reduce the possibility of a fuel spill after a crash.

- The fuel tank in a stock car contains a rubber “bladder” filled with foam to absorb crash impact forces and reduce the chance of explosion.
- Standard racing tires (or “racing slicks”) have no treads. The fewer the grooves, the more rubber the tire has against the road to increase traction. After multiple laps (the number varies with the tire compound and track conditions) tires get too hot, their rubber compounds break down, and they need to be replaced.
- During a race, the car's cockpit temperature may reach 130 degrees Fahrenheit or more, and the steel roll cage may be even hotter.

HOW TO SURVIVE A ROLLOVER IN A CAR

1 Use your legs to brace your lower body.

You will have just fractions of a second to prepare for impact. Remove your feet from the pedals, placing the soles of your feet flat against the sheet metal behind the pedals. Using your leg muscles, press hard against the metal surface, as if you are on a leg press. Extend your legs as far as possible, pressing your body back into the seat.

2 Push your upper body against the seat.

Using both hands, grab the wheel at the three and nine o'clock positions and grip tightly. Push out with your arms, pressing your torso as far into the seat back as possible. Keep your elbows tucked in to your body.

3 Secure your head and neck.

Press the back of your head and neck into the headrest as far as they will go.

4 Tense all of your muscles.

Exert as much force as possible to move your entire body back into the seat, which is your best protection during the rollover.

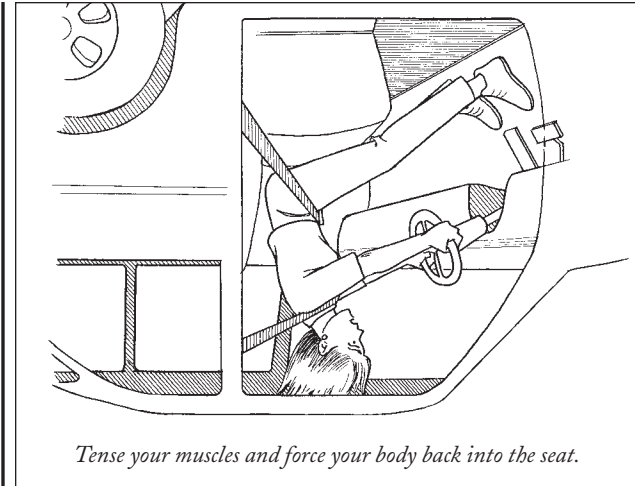

Tense your muscles and force your body back into the seat.

5 If the car lands upright and the engine is still running, steer the car away from obstructions or oncoming traffic.

Because they have a lower center of gravity than trucks and SUVs, cars tend to roll over completely and land on their wheels.

6 If the car lands on its roof, turn off the ignition.

Most modern cars (those manufactured after 1985) have a cutoff switch that kicks in automatically to stop fuel flow to the engine when the vehicle senses a rollover. If the engine is still running, turn it off.

7 Carefully remove your seat belt.

You will be hanging upside down, with your safety belt holding you in your seat. Brace your hands and feet against the roof before unlatching the belt.

In a single-vehicle rollover with no collision, your primary (steering wheel) air bag may not have deployed. Any side curtain air bags and head protection systems will have deployed, however, so watch for hot gas escaping from these devices.

8 **Escape from the car.**

The vehicle's steel safety cage and roll bars may have preserved the integrity of the car, keeping the doors in working condition. If you cannot open the door, crawl through the window. If the window has not been broken during the rollover and is intact, try to roll it down. If you are unable to do so, use a metal object such as a steering wheel lock to break the glass.

9 **Run.**

Move away from the car as quickly as possible in case there is a fuel leak, which could cause an explosion.

Be Aware

- SUVs and trucks have less-stringent safety standards than cars and tend to have a higher center of gravity, making them more prone to a rollover.
- The roofs of early-model SUVs and trucks may be deformed in a rollover.
- When occupants are wearing seat belts during a rollover, most injuries are to the head (from hitting the roof supports) and arms (from being flung out the windows by rollover forces). When occupants are not wearing seat belts, they will most likely be thrown from the vehicle.

**WORST-CASE
SCENARIO®**

WORST-CASE SCENARIO.

HOW TO SURVIVE A TWO-WAVE HOLD-DOWN

A two-wave hold-down occurs when a surfer falls off a surfboard while riding a large wave and is held under water for two successive waves.

1 **Bail your board.**

If you are in the impact zone (the area where the lip of the wave meets the trough), dive off your board.

2 **Avoid the “washing machine.”**

The washing machine, the white water that occurs as the wave crashes, is turbulent, full of air, and difficult to pierce and swim in. Attempting to surface through it will extend your hold-down.

3 **Do not struggle.**

Fighting a very big (or “rogue”) wave will quickly exhaust you and increases your risk of drowning. Remember to “think before you sink.”

4 **Dive.**

Swim as deep as you can. Big-wave leashes (the rope that connects you to your floating board) may be 20 feet long, allowing you to go very deep.

5 **Allow the first wave to pass over you.**

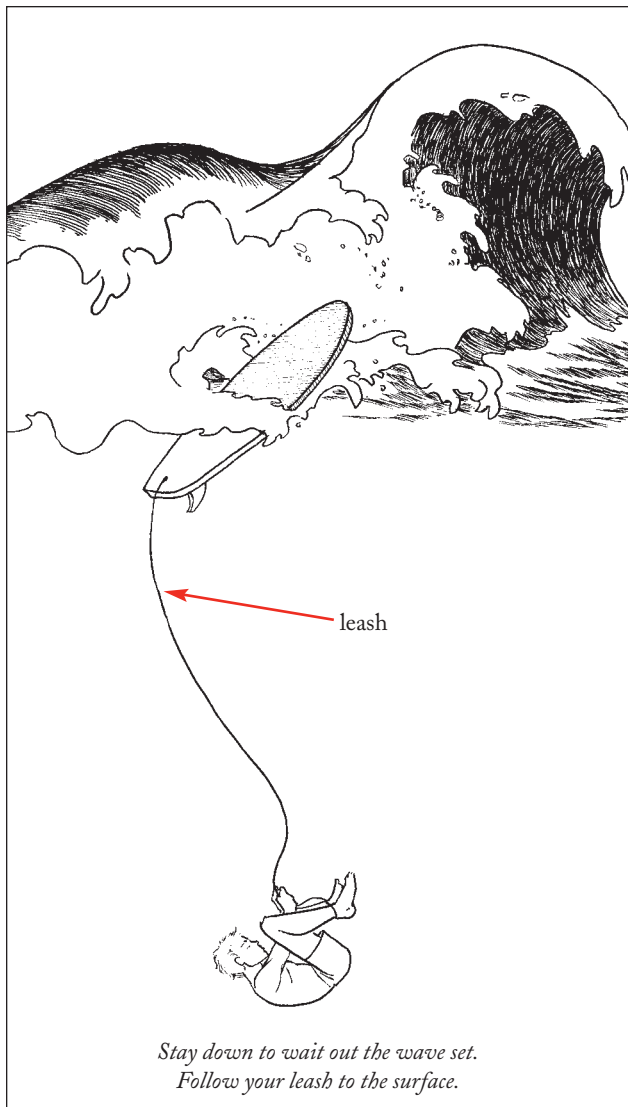

6 **Locate the board's leash.**

If you are disoriented and unable to determine which way is up, grab your ankle and “follow your leash.” Since the leash is attached to your floating surfboard, it will lead you to the surface.

7 **Swim toward the surface.**

As you approach the surface, place your hands above your head. Your surfboard may be “tombstoning,” with its tail submerged and its nose pointing to the sky. Positioning your arms above your head will protect you from hitting your surfboard, a Jet Ski, or another wiped-out surfer as you come up for air.

8 **Wait out the set of waves by diving underneath them.**

Waves typically come in sets of three to five, depending on the day and surf conditions. Count the waves as they break so you’ll know when the water will calm. Swim as deep as you can and curl your body into a defensive ball as the waves pass overhead. Come up for a quick breath between each wave, if possible, as you wait for the set to subside.

9 **Paddle to calmer water.**

When the set has passed, swim to the surface. Climb on your surfboard and paddle as fast as you can farther out to sea, beyond the impact zone, or into the “channel,” the blue water that is sometimes to the left or right of the white water.

Be Aware

- Never position your surfboard between your body and a big wave: It will smash into you.
- Never put your back to the waves unless you are paddling to catch a wave and ride it.
- A big wave may hold you down for more than 30 seconds.

**WORST-CASE
SCENARIO®**

HOW TO SURVIVE AN ELEPHANT STAMPEDE

★ Take available cover.

Elephants stampede when they are startled by a loud noise or to escape a perceived threat. If the elephants are running away from a threat but toward you, do not try to outrun them. Elephants can run at a speed in excess of 25 mph. Even while charging, they can make sharp turns and are able to climb steep slopes. Seek a sturdy structure close by and take cover.

★ Climb a tree.

The elephants are likely to avoid trees when running. Grab a branch at its base and use your legs to power yourself up the tree, keeping three of your limbs in contact with the tree at all times as you climb. If you cannot climb the tree, stand behind it. Elephants will avoid large obstacles when running.

★ Lie down.

Unless the elephant is intent on trampling you, because you are hunting or the elephant thinks you are hunting, elephants typically avoid stepping on a prone human being, even while charging.

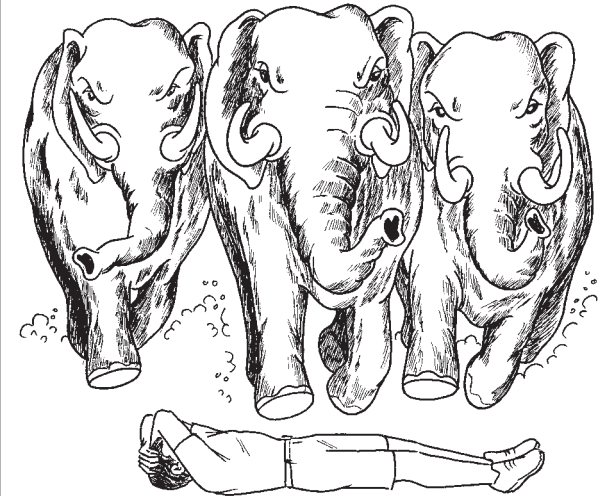

If you cannot find cover, lie down. Elephants typically avoid stepping on a prone human being, even while charging.

★ Protect your face.

Do not get up immediately. After the threat has passed, an elephant may show great interest in the apparently dead bodies of humans and may attempt to “bury” you under tree branches, leaves, and dirt. If you sense an elephant moving above you, lie still and cover your face with your hands. The rough skin on the elephant’s trunk may cause severe abrasions if it rubs against you.

Be Aware

- An angry elephant will tuck its ears back and curl its trunk up, away from danger.
- If the elephants are angry at you, they may attempt to spear you with their tusks and then fling your body.
- If the last human the elephant met was a hunter/poacher, it will be more likely to treat you as a threat and attempt an attack.

**WORST-CASE
SCENARIO®**

HOW TO SURVIVE IF YOU ARE BURIED ALIVE

1 Conserve your air supply.

If you are buried in a typical coffin, you will have enough air to survive for an hour or two at most. Take deep breaths, then hold for as long as possible before exhaling. Do not breathe and then swallow, which will lead to hyperventilation. Do not light a match or lighter. Combustion will quickly use your available oxygen. It is safe to use a flashlight if you have one. Do not yell. Yelling will lead to panic, which will increase your heart rate and lead to fast breathing that will rapidly consume your air supply.

2 Press up on the coffin lid with your hands.

An inexpensive “pine box” (chipboard coffin) or a recycled paperboard coffin will have some give to it, so it will be relatively easy to break through. If you feel flex in the coffin lid, continue to step 3. A metal-clad or hardwood coffin will be impossible to pierce. In this case, your only hope is to signal for rescue. Use a metal object (ring, belt buckle, coin, flask, pen) to signal that you are alive. Tap SOS, the international distress signal, on the coffin lid: three quick taps, followed by three slower taps, followed by three quick taps. Continue to repeat the distress call until someone hears you.

3 Remove your shirt.

Cross your arms over your chest, then uncross your arms so that your elbows are bent and your hands are at your shoulders. Pull your shirt up and off your head from the shoulders, do a partial sit-up (as much as you can in the space available), then pull your shirt over your head and off.

4 Tie the bottom of the shirt in a knot.

The shirt should have only one large opening, at the neck, as does a bag.

5 Place your head through the neck hole.

The knot should be on the top of your head. The shirt will prevent you from suffocating on loose earth.

6 Break through the coffin.

Using your feet, begin kicking the coffin lid. A cheap coffin may have already split from the weight of the earth above, making your job easier. Break apart the lid with your hands and feet and let the loose dirt rush in.

7 Use your hands to push the dirt toward your feet.

There should be some space at the bottom end of the coffin, below your feet. As the dirt rushes in, work quickly but calmly to fill the space at your feet. When this space fills up, push dirt to your sides. Breathe slowly and regularly.

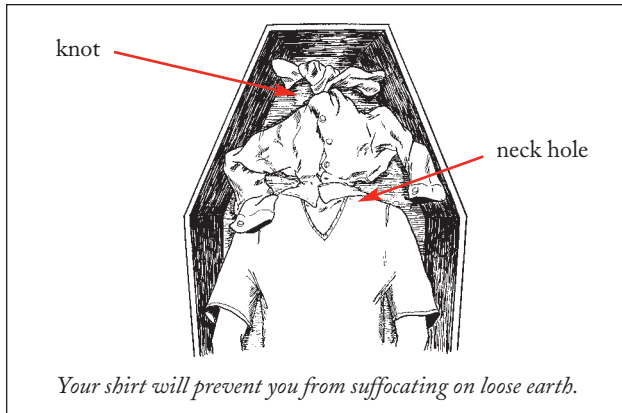

8 **Sit up.**

As you move to a seated position, the loose earth above will move to fill the space you just occupied. As the dirt falls, continue to push it into the coffin until you can stand up.

9 **Stand.**

Once you are standing, you should be able to push the dirt above you up and out of the grave. When you have cleared all the dirt above you, climb out.

Be Aware

- A recently interred coffin will be covered with loose earth that is relatively easy to dig through.
- Escaping from a coffin interred during a rain storm will be difficult. The compacted weight of the wet earth will make digging almost impossible.
- The higher the clay content of the soil, the more difficult your escape will be.

**WORST-CASE
SCENARIO.**

HOW TO SURVIVE IF YOU ARE STRANDED ON AN ICEBERG

1 Construct a shelter.

For protection from the harsh climate, you must build a snow shelter immediately. Your iceberg should have plentiful amounts of snow, so construct either a snow cave (make a huge pile of snow, hollow it out, and crawl inside) or a snow trench (dig a deep channel in the snow, cover the top by stacking snow blocks or improvising a tarp out of materials on hand, and crawl in). A snow trench requires less energy and time to construct, but will limit your range of movement and should be used only if you expect quick rescue.

2 Melt snow and ice to make water.

Place snow in a container and melt over a flame to create drinkable water. If snow is not available, scrape shavings from the topmost layer of ice. Though sea ice contains salt, over time the salt leeches from the ice due to surface melt, and the water from the top ice should be safe for drinking.

3 Cross icebergs to get closer to land.

Wind and ocean currents will keep icebergs in motion, often causing them to crash into one another. Step onto a new iceberg if it will bring you closer to a land mass. Use caution when crossing; the edges may

4 Catch fish and seabirds.

Fashion a fishing rod with anything available (harpoon, spear, ski pole, or walking stick) and use it for fishing. Seabirds congregate on icebergs, and may be killed with ice balls.

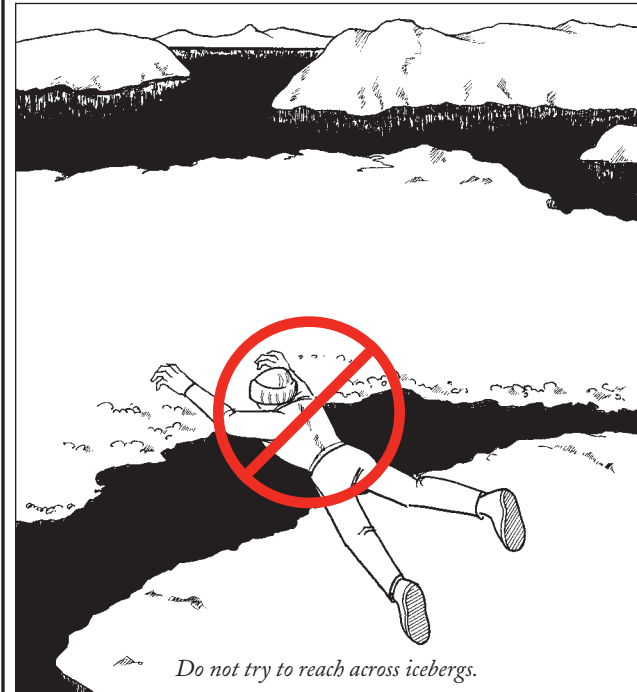

5 Look for seals.

Seals eat fish, and you may be able to scare one away from a fresh catch. As a last resort, if you're not likely to be rescued for a while and can't cross to another iceberg, and only if your life is at risk, consider killing a seal. Seals can serve both as food and as a source of fuel. Unless there is surface melt, without a fuel source you will be unable to melt snow and ice for drinking water and you will quickly die of dehydration. (Avoid sucking on ice: It will lead to hypothermia.) Seals will occasionally jump on drifting icebergs to escape predators and may pop up through breath holes in the ice. While out of the water, seals are generally inactive and docile. Approach adults stealthily from the rear and kill using a club, harpoon, or homemade spear to the skull.

6 Make fuel from seal blubber.

Cut blubber (fat) from the seal carcass and place in the best bowl you can fashion. Using an implement, pound the blubber until it liquifies. Roll a small piece of material into a wick, place it in the blubber, and light.

7 Roast or boil seal meat for food.

8 Burn moist seal skins to create smoky signal fires during the day.

However, your best chance of polar rescue is from land. Just because a ship can see you on an iceberg does not mean it can rescue you.

Be Aware

- Small penguins are also a good food source. Penguins have most of their strength in their flippers, however, so avoid being bashed by a flipper when hunting by approaching from the rear and pinning wings to the sides. Avoid attacking from the front or you risk being badly "beaked."
- In Antarctica, which is a frozen landmass surrounded by ice, icebergs tend to drift in a clockwise pattern around the South Pole, pushed by the circumpolar current. An iceberg may eventually pass a populated weather station or move into a shipping channel. (Weather and research stations may be located hundreds of miles apart in polar regions.) In the Arctic, which is a frozen sea, the currents also move clockwise, east to west, around the polar ice cap. However, the transpolar drift, a current that carries water and ice eastward from Siberia, may bring an iceberg down the east coast of Greenland into more populated areas. The trip from the edge of the Arctic to Greenland may take several months.

WORST-CASE SCENARIO.

HOW TO SURVIVE IF YOUR CAR CAREENS DOWN A MOUNTAINSIDE

- 1 Apply firm and steady braking pressure.**

Do not slam on the brakes as you leave the roadway and begin traveling down the slope. If you lock up your brakes, the wheels lose traction and may cause the vehicle to skid sideways, increasing the risk of a rollover.
- 2 Maintain a firm grip on the steering wheel.**

The car is likely to bounce wildly and severely jostle you in your seat. Place your hands at the ten and two o'clock positions. Keep your thumbs outside the steering wheel: If the car hits an object, the force may yank the steering wheel around, injuring your thumbs or arms.
- 3 Point the car downhill.**

Keep the car facing and traveling straight downhill, continuing to apply steady braking pressure. A vehicle is much more likely to roll over if it is sideways across a hill. Though you may be able to survive a rollover, you will have no control and will not be able to stop the car.

4 **Steer.**

Keep the front wheels turned in the direction the car is sliding/moving in order to increase traction and make braking and steering more effective.

5 **Downshift.**

Once you regain control of the car and it is facing downhill, use engine braking to slow the car's momentum. If the car has a manual transmission, keep your foot off the gas and downshift to first gear. For an automatic, keep your foot off the gas and shift the car from drive to first gear or the lowest gear available. Continue to apply just enough braking pressure to control your speed, but not enough to lock up your wheels.

6 **Turn the wheel in the same direction the car is sliding to regain control.**

On a steep downslope, the weight of the car will transfer to the front axle as you brake, possibly causing the tail to spin out and around toward the front. To regain traction, turn the wheel in the direction the vehicle is sliding, then apply the gas lightly.

7 **Use steady braking pressure to stop the car.**

Once the car has stopped moving, apply the emergency brake and get out. If you cannot stop the car using the brakes, go to step 8.

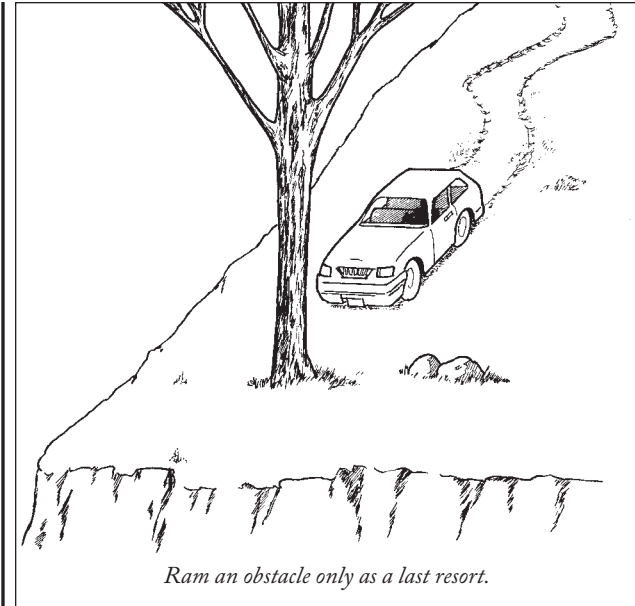

8 **Attempt to “high-center” the car.**

If you are not able to stop the car in time to avoid an approaching cliff, look for a large rock or fallen tree. Drive over the object centered between your front wheels to try to force the car to “bottom out” and get stuck before the rear wheels roll over the obstacle. This maneuver will typically work only with an obstacle that is about one foot high. If you cannot high-center the car, continue to the next step.

9 **Ram an obstacle.**

Slow the car to 20 mph or less to increase your chance of survival. Ram the car head on into a tree or large

boulder to stop your progress. Do not turn the car across the slope and ram the object sideways; you risk a rollover. You (and all passengers) must be wearing a seat belt and the car must have an air bag for you and your front-seat passenger. Ram the obstacle only as a last resort.

Be Aware

A vehicle's antilock braking system is usually not effective off-road: ABSs monitor wheel speed, and will apply the brakes only enough to equalize the rotation of the wheels, not to stop them from spinning when there is no traction. You will need to pump the brakes and to be aware that the braking system might apply pressure unequally to the wheels.

HOW TO GET THE CAR BACK TO THE ROAD

1 Assess damage to vehicle.

Once you have stopped the car, get out and inspect the vehicle. Check for brake fluid (red liquid pooling under the car) or damaged steering components (broken rods hanging down from the insides of the front wheels). Do not drive the car if it has a broken axle or damaged steering components, or if it is leaking brake fluid.

2 Walk your intended route before driving it.

Look for ditches, obstacles, and cliffs that may prevent you from getting back to the roadway.

3 Drive slowly.

Use light acceleration and braking and smooth steering. Keep your speed to 5 mph or less, terrain permitting. Follow the off-roading maxim: "As slow as you can, as fast as you must."

4 Monitor the path in front of you.

Look downslope to determine where you are headed and when you will need to stop the car. On a mountainside, the car will require 10 to 20 times its normal dry-pavement stopping distance.

5 Look for a switchback.

Most steep mountain roads contain numerous switchbacks, or sharp turns that take you across the slope but at a slightly higher or lower elevation (depending on your direction of travel). If you see a lower section of the road cutting across the mountainside ahead of you, attempt to steer the car back onto the asphalt at the next opportunity. Watch for steep drop-offs that are common in mountain road cuts, however.

Be Aware

- Most passenger cars will roll side over side on any slope greater than 30 degrees.
- When your air bag deploys, fuel to the engine will likely be cut off, making further controlled driving impossible.

WORST-CASE SCENARIO.

HOW TO SURVIVE IF YOUR FOOD IS BEING POISONED

- 1 Induce vomiting.**

Regurgitating the agent before it can be absorbed into the bloodstream will help to reduce its effects. If you cannot force yourself to vomit, take 1 tablespoon of syrup of ipecac, followed by a glass of water, soda, or juice. (Do not drink milk.) Vomiting should occur within a few minutes. If it does not, follow with a second tablespoon of the ipecac.
- 2 Take activated charcoal.**

Drink a single, premixed container of activated charcoal slurry, or mix the powder with the proper amount of liquid (follow the instructions on the package) to absorb the poison. Do not take activated charcoal within 30 minutes of taking ipecac, or while vomiting is still occurring. Activated charcoal is most effective when administered in an emergency room.
- 3 Test food and drink promptly.**

Take your meal to a lab and have it tested. Once the toxins are identified, an antidote, if available, and treatment can be administered. However, some exotic poisons such as dioxin, mercury, and other heavy metals may be difficult or impossible to detect, especially in low concentrations.

4 Seek medical attention promptly.

Call the local poison control center as soon as possible. Some remedies can be prescribed over the phone, without an examination. With an examination and blood, urine, and other tests, health-care professionals can determine the effects of the poison on your body.

Be Aware

- Poisons may be sedatives (or mixed with sedatives) to induce loss of consciousness. If you pass out but wake up later, do not assume the poison has worked its way out of your system.
- A percolating drink—or one that appears to be foaming or releasing quantities of odd-smelling gas—should be avoided. The chemical agent phosgene, for example, is an odorous poisonous gas at room temperature but may be a liquid when cooled.
- Depending on the agent, poison may be absorbed into the bloodstream in seconds or minutes.

In sufficient concentrations, several common poison agents are relatively easy to detect in food or drink, based on their odor. These include:

ARSINE

Type: blood agent

Odor: garlic

Timing of Symptoms: minutes or hours

Symptoms: may include headache, dizziness, difficulty breathing, abdominal pain, nausea, vomiting, and bloody urine

CHLORINE

Type: choking agent

Odor: bleach

Timing of Symptoms: seconds to minutes

Symptoms: may include headache, nausea, weakness, and loss of consciousness (when ingested in high doses)

CYANIDE

Type: choking agent

Odor: bitter almonds

Timing of Symptoms: seconds to minutes

Symptoms: may include headache, nausea, weakness, anxiety, and loss of consciousness

HYDROGEN CHLORIDE

Type: blood agent

Odor: acrid, metallic

Timing of Symptoms: seconds to minutes

Symptoms: may include eye and skin irritation, fluid in the lungs, and blue skin (in high doses)

PHOSGENE

Type: choking agent

Odor: decaying fruit

Timing of Symptoms: 1 to 24 hours

Symptoms: may include burning eyes, sore throat, cough, and chest tightness

HOW TO SURVIVE NUCLEAR FALLOUT

- 1 Put distance between yourself and the blast site.**

Radioactivity diminishes significantly with physical protection, time, and distance from the epicenter of the explosion. For a five-megaton weapon detonated at 2,000 feet (an average weapon yield and detonation altitude), move at least 20 miles away for safety. Travel in a crosswind direction (not with or against the wind) as quickly as possible. Drive a car with the windows rolled up. If no car is available, ride a bike or run.
- 2 Find shelter.**

Any material will at least partially block radioactive particles. However, equal thickness, dense materials like lead, concrete, and steel are more effective than porous materials like wood, tile, drywall, and insulation. If you cannot get into a designated fallout shelter, move to the basement of a building made of stone or concrete, preferably with few windows. The deeper the basement, the more protection you'll have from radioactive particles.
- 3 Gather water.**

The existing water in a basement water tank should be safe to drink, as is water in pipes. However, if dams and water treatment plants become contaminated, new water entering the system may be dangerous. Stored bottled water is safe, provided the water does

not come into contact with the outside of the bottle, which may be covered with radioactive particles.

- 4 Gather food.**

Packaged foods and those that can be peeled or shelled—and that are already in the house—are safe to eat, provided the packages, peels, or shells are rinsed thoroughly with clean water to eliminate radioactive alpha and beta particles. Canned goods are also safe, provided the cans are washed with clean water and food does not come into contact with the can's exterior. Avoid foods from opened packages, even if the packages have been resealed with tape or clips.
- 5 Wash your hands before eating and drinking.**

Using soap and clean water, wash your hands (and under your fingernails) thoroughly before handling food. Radioactive particles traveling on dust can be transferred to food easily. Once ingested, these may settle in bone marrow and internal organs, causing long-term illness.
- 6 Stay in your shelter.**

Without a radiation rate meter, you will not know when it is safe to leave your shelter. If you have access to a battery-powered radio, listen for news and monitor emergency announcements regarding the safety of your location. Cellular and wired telephones may not work, and even satellite phones may suffer from severe interference. If available, use a CB or short-

wave radio to communicate with others until telephone service is restored.

Be Aware

A radiation suit will prevent you from tracking radioactive particles into the shelter (as long as you remove the suit upon entering), but will not offer protection from fallout.

WHAT TO DO IF YOU THINK YOU HAVE BEEN EXPOSED TO FALLOUT

1 Remove contaminated clothing.

Radioactive dirt and dust will cling to clothing, causing radiation burns, sickness, and contamination of other people and objects. Remove contaminated clothing before entering a clean area.

2 Take a shower.

Showering in clean, fresh water is the best way to remove harmful radioactive particles from your skin. Use soap and warm water and clean under fingernails and toenails. If you do not have a sufficient amount of uncontaminated water for a shower, fill a bucket with as much water as possible and take a sponge bath, making sure the contaminated water goes down the drain.

3 Take potassium iodide (KI) or potassium iodate (KIO₃) pills.

Potassium iodide or iodate helps prevent radiation absorption by the thyroid gland. While it is most effective when taken 48 hours prior to exposure, potassium iodide provides some benefit if taken within 16 hours of exposure to radioactive fallout. If no pills are available, mix 2 ounces of granulated potassium iodide (available at chemical supply stores) with clean water and shake or stir vigorously, adding more potassium iodide until the solution is fully saturated. (You will see unmixed granules at the bottom of the glass or bottle.) Take 4 drops of the solution per day for at least 10 days. For infants, paint iodine onto the soles of the feet.

4 Monitor your symptoms.

Mild exposure to radiation may result in skin burns, weakness, loss of appetite, vomiting, and diarrhea, while higher doses lead to fainting, bleeding from the nose and gums, hair loss, anemia, hemorrhage, brain damage, and sometimes death within 48 hours. In general, breathing or swallowing radioactive particles or exposure to gamma rays result in more severe illness than surface exposure to radioactive particles, which are relatively easy to remove from the skin.

5 Get help.

Though there is no known treatment for radiation sickness, seek medical attention as soon as it is safe and possible to do so. A bone marrow transplant might alleviate some damage from exposure.

Be Aware

- Iodized salt is not an effective protection against radiation damage to the thyroid: You will get salt poisoning before absorbing enough iodine to have a beneficial effect.
- Victims of exposure to high levels of radiation may appear to improve several days after exposure as the body superficially heals. But deep biological damage remains, and the victim may rapidly deteriorate after the initial improvement.

**WORST-CASE
SCENARIO®**

HOW TO SURVIVE WHEN STUCK ON A MOUNTAIN LEDGE IN A BLIZZARD

★ **Check the mountain above you.**

If the rock face above your ledge is vertical or nearly vertical, snow will probably not build up sufficiently to create a serious danger of a slide or avalanche. If the angle of incline allows snow to build up, however, prepare for sliding snow that has accumulated above. Stay as far back from the edge as possible.

★ **Make a guardrail.**

Using snow and any available loose rocks, make a large, horizontal mound at the edge of the ledge. This “guardrail” may prevent you from accidentally rolling off if you fall asleep.

★ **Build shelter.**

Use a tent, tarp, or bivouac sack to make a windbreak and to prevent snow from accumulating on your ledge and burying you. Secure the material to the rock face using anchors and rope, or with rocks and snow on the edges. If space permits, build a snow cave by making a large pile of snow and hollowing it out. Position the entrance so it faces the mountain, not the open air, if there is room to do so.

★ **Anchor yourself to the ledge.**

Use anchors and rope to secure yourself to the rock face. Run the rope through the anchor and tie it tightly around your waist. If anchors are not available, make a loop with the rope and place it over a rock outcropping or a large boulder. The loop should be positioned so that if you fall, it slips further down the outcropping or boulder, rather than off it. Tie a knot in the rope just beyond the loop, then tie the remaining portion of the rope tightly around your waist.

★ **Stay warm.**

Put on all available clothing, especially a hat, mittens or gloves, dry socks, and shoes. To reduce heat loss, use any extra clothing as padding and insulation. Place it under you so it acts as a barrier between your body and the snow or rock you are lying on.

★ **Eat and drink.**

If you do not have water to drink, use a small camping stove to melt snow into drinkable water and to cook any available food. When using the stove in a snow cave, poke a hole in the roof to allow carbon monoxide to escape.

★ **Massage and exercise.**

To keep blood circulating and prevent frostbite, massage your hands, fingers, toes, nose, and ears. Muscle activity generates heat, so periodically do push-ups, sit-ups, or just tense and relax muscles to maintain adequate circulation and stay warm.

Facial Expressions to Avoid Frostbite

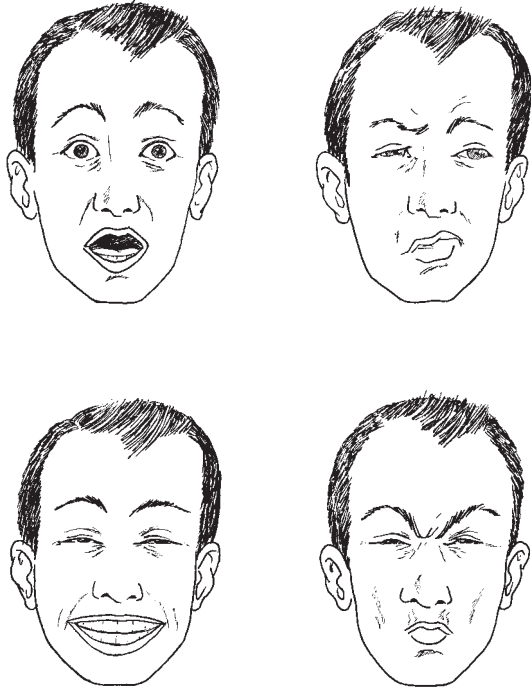

Flex your facial muscles to increase blood flow.



Wait.

Do not attempt to leave your ledge until the snow has stopped and winds have calmed sufficiently. Most blizzards last a day or two at most, with three days possible but unlikely.

**WORST-CASE
SCENARIO.**

HOW TO SURVIVE WHEN STUCK ON AN OPENING DRAWBRIDGE

1 Draw attention to yourself.

Two-leaf bascule drawbridges—those with two movable sections of roadway that swing from horizontal to vertical—will have a bridge “tender” (operator) in the control house who should be able to stop the opening. Flash your headlights and honk your horn repeatedly to attract his attention so he will lower the drawbridge. If the bridge tender cannot see you (his view may be blocked by one of the open spans) or is not paying attention, you will have to proceed on your own.

2 Back up.

Drawbridges take several minutes to open fully. If the opening span is still relatively horizontal, back up off the bridge (or at least as far back as you can).

3 Get out.

Place your car in gear (or in park if it has an automatic transmission) and apply the emergency brake. Get out of the car and move away: Even with the brake on, the vehicle will begin sliding backward by the time the roadway opens about 30 degrees.

4 Hold on.

The bridge should have some type of railing and/or a grated road surface that offers hand- and footholds. If a railing is present, grab one of the vertical (fast becoming horizontal) railing supports. Wrap both your arms around the section and grasp your belt, if you're wearing one. If the road surface is grated, face it, place your hands in the grate, and hold on. Drawbridges typically take several minutes to open completely, giving you time to brace yourself.

5 Wait.

Depending on the height of the vessel moving under the bridge, the span may not move to a completely vertical position. Even in its fully open condition, however, the span will not move beyond 90 degrees, so you will not be hanging upside down. Wait until the ship passes and the bridge span lowers, then walk off the bridge. Your car will have slid down the open span and crashed into the joint where it meets the horizontal section of the roadway.

6 If you begin to lose your grip or cannot find a handhold, jump.

Though any high fall into water should be considered only as a last resort, you stand a better chance of avoiding major injury when landing in water than landing on the road surface. Because the bridge is over a shipping channel, the water below you should be deep enough for you to avoid hitting the bottom. Look down to make sure the ship is not directly

below the bridge, then jump as soon as you can, before the opening span adds elevation to your leap and before the ship is so close that you cannot get out of its way. Keep your legs and feet together, point your toes, and place your arms straight above your head.

7 After breaking the surface, open your arms and legs wide to slow your descent.

8 Head for shore.
Immediately swim up and away from the path of the approaching ship as fast as you can.

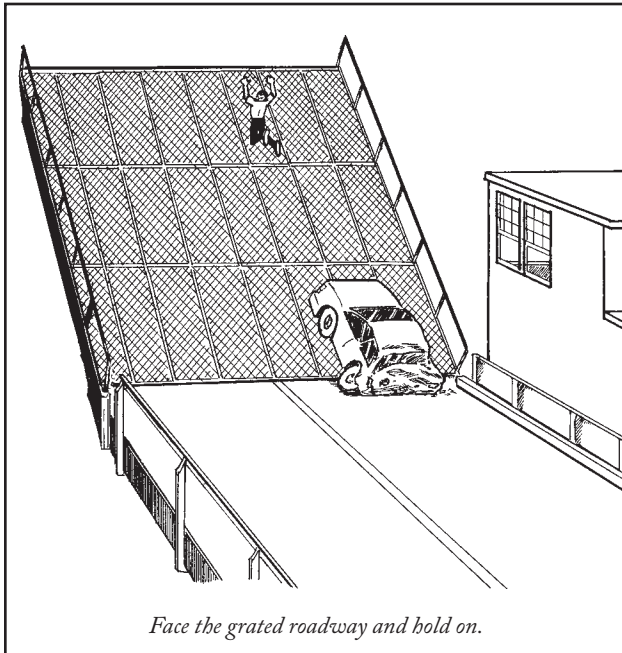

**WORST-CASE
SCENARIO.**

HOW TO SURVIVE WHEN TRAPPED IN A SEWER

1 Find a light source.

Sewers are usually pitch-black over long stretches and navigation will be impossible without some type of light. Use a flashlight, penlight, LED from a cell phone or car key, matches, or a lighter to see. Although sewer gases are generally not combustible in the concentrations found in mains, use an open flame light source as a last resort. If you have no light source, look upward for daylight reaching the sewer main through storm drain inlets, gratings in the street, or the small holes in (or around the rims of) manhole covers. Head to the light source: Generally it will lead to a way out or a place where you can communicate with the surface.

2 Stand straight and tall.

Bacteria breaking down organic material create hydrogen sulfide (H_2S), which is responsible for the “rotten egg” odor in sewers. While the foul smell is distasteful, in small concentrations the gas is not deadly (though high concentrations can be fatal). In addition, hydrogen sulfide is slightly heavier than air and will tend to be in higher concentrations lower in the sewer pipe. Keep your head as high as possible, near the top (or “crown”) of the pipe. Covering your

nose and mouth with a handkerchief may provide minimal relief.

3 Wait until late at night to move.

Large, combined sewer systems—those that aggregate household wastewater and storm water—generally have their highest flows after breakfast and after dinner, when toilets are flushed and dishes are washed, and during or just after rainstorms. Flows will be lowest, and navigation and movement easiest, in the middle of the night. Wait until 2 or 3 A.M. to begin your escape, unless it is raining and the system is filling with storm runoff. Expect a sewage depth of 12 to 18 inches in the middle of the night, and up to 36 inches during busier periods. The deeper the flow, the greater the forces acting on you will be, making it harder for you to maintain balance.

4 Check the direction of the flow.

Sewers move wastewater downhill, using gravity. Smaller diameter pipes enter the system upstream and connect to larger and larger mains as you move downstream in the system. Locate a larger main (72 or 92 inches in diameter) and establish the directional flow of the sewage.

5 Move upstream.

Though it seems counterintuitive, move upstream toward smaller pipes. Larger mains downstream will contain older sewage, which has been broken down by bacteria over a longer period of time. These

downstream pipes will have much higher levels of hydrogen sulfide, which may be deadly. Instead, move upstream to areas with fresher sewage and lower concentrations of gas.

6 Watch your step.

The floor and walls of the sewer will be coated with slime and will be extremely slippery. There may also be a channel in the center of the pipe to accelerate the flow of sanitary sewage. Walking in this channel will be difficult, so keep to the sides of the main.

7 Observe the behavior of rats and cockroaches.

Though both rats and cockroaches can swim, they prefer dry land and are likely to be on ledges above the sewage flow, on walls (for roaches), and in your path. As you walk, check the concentration of rats and especially roaches: Both serve as your early warning system of danger in the sewer. The presence of rats in large numbers can be a good sign. Rats indicate that the air is safe to breathe, even near the bottom of the sewer main. If you notice a sharp increase in the number of rats and roaches, or see them heading past you upstream, dangerous conditions exist downstream—a broken pipe or a full siphon may be causing sewage to back up toward your position. If they begin scurrying past you, be ready to move upstream quickly, away from the problem.



Rats will indicate that the air is safe to breathe.

8 Locate a lateral storm sewer.

Look for a relatively dry main entering the combined main; this is a storm sewer “lateral” and should be easier to walk in, with lower levels of gas and odor. The lateral pipe may be smaller in diameter (48 inches, perhaps less), so be prepared to kneel or crawl. Look up for an overhead storm sewer grate or inlet. Push it up and to the side, then slide it over and climb out or yell for help. If you cannot find a lateral main, or cannot access the inlet, continue to step 9.

9 **Locate a manhole cover.**

Listen for traffic and street noise above you. If you see light entering the sewer main from above and hear the pounding of cars, you will likely be under a manhole cover. Look for iron rungs built into the wall leading up 10 to 20 feet to the manhole cover. Use caution when climbing: Another byproduct of sewage decomposition is sulfuric acid, which over time may have disintegrated the cast-iron rungs leading to the manhole.

10 **Open the manhole cover.**

The cover may weigh 150 pounds or more. Wait until the traffic noise subsides, push the manhole cover up slightly at one edge, then slide it over. Watch for traffic as you climb out. If you cannot locate or lift a manhole cover, continue to step 11.

11 **Bang on pipes.**

In the main or lateral sewer, look for smaller diameter (12 inches or less) metal pipes emptying into larger mains. These “household” sewer connections enter the sewer from homes and buildings. Bang on one to signal someone on the surface and/or in the connected building. Metal pipe carries sound very efficiently.

12 **Plug a pipe.**

If you cannot escape and banging does not bring rescuers, use your shirt, a piece of wood, or another object to block a household pipe where it enters the

sewer. The sewage will begin backing up into the building, and eventually someone will access the sewer to investigate the blockage.

Be Aware

- Water and sewer department personnel are more likely to be working on smaller pipes further up the system than larger (72- or 92-inch) mains near the downstream end. Your best chance of finding people is in the smaller pipes.
- In high concentrations, hydrogen sulfide deadens your olfactory senses. If you smell hydrogen sulfide (rotten egg smell) and then suddenly stop smelling it—particularly if you are moving downstream—the concentration of the gas may have increased dramatically. Speed up your efforts to escape.
- Do not drink any liquids found in the sewer, even if the sewer carries only rainwater runoff. If sewage inadvertently enters your body through an orifice, or via cuts or skin abrasions (no matter how minor), seek medical treatment as soon as you escape.

HOW TO TAKE A BULLET

- 1 Face the shooter.**
You do not want to take the bullet in your back or the base of your skull.
- 2 Get low.**
In addition to making yourself a smaller target, by keeping a low profile you will be better able to protect your head, neck, and midline—all areas where a bullet wound is most likely to cause fatal injury or permanent disability.
- 3 Sit.**
Sit with your rear end on the ground. Bend your knees and keep your legs in front of you, protecting your midline with your shins and thighs.
- 4 Move your elbows into the center of your body.**
Place both forearms in front of you, covering your face.
- 5 Place your hands over your head.**
Hold your fingers together, with your palms toward you. Keep your hands an inch or two in front of you to absorb the impact of the bullet.
- 6 Wait for the impact.**
You may notice little more than a “punch” sensation, or you may feel nothing at all.

- 7 Determine the site of the injury.**
Bullet wounds in the hands and feet, lower legs, and forearms are rarely fatal, provided blood loss is controlled.
- 8 Control the bleeding.**
Place firm, direct pressure on the wound to slow blood loss. If the bullet entered an appendage and pressure does not stop the bleeding, use a belt or narrow strip of cloth as a tourniquet. Place the tourniquet on the affected limb, several inches above the injury site. It should be tight enough to stop heavy blood flow. A tourniquet may cause permanent damage to the affected limb, and should be used only as a last resort. Never leave a tourniquet in place for more than a few minutes.
- 9 Get help.**
Seek medical attention as soon as possible.

Be Aware

- If you are crouching next to a wall, stay a foot or more away from the surface. Bullets will skid along the wall after impact.
- Gunshot wounds to the neck are almost always fatal.
- Most interior walls and doors (including car doors) will not stop a bullet larger than .22 or .25 caliber.

LAST-DITCH LIQUIDS YOU CAN DRINK

AFTER DISTILLING

- Urine (long-term ingestion can cause problems)
- Blood (human blood may contain hepatitis or HIV, so animal blood is somewhat safer)
- Seawater

AFTER DISINFECTING

- Freshwater creeks/streams
- Toilet tank water (not toilet bowl water), as long as the tank does not have any type of disinfectant, and provided the rubber seal between the tank and bowl is intact and does not leak
- Water from an unknown source

NEVER DRINK

- Ink
- The water in a vinyl water bed
- Swimming pool water (but OK for bathing)
- Water in a hot tub (but OK for bathing)

LAST-DITCH FOODS YOU CAN EAT

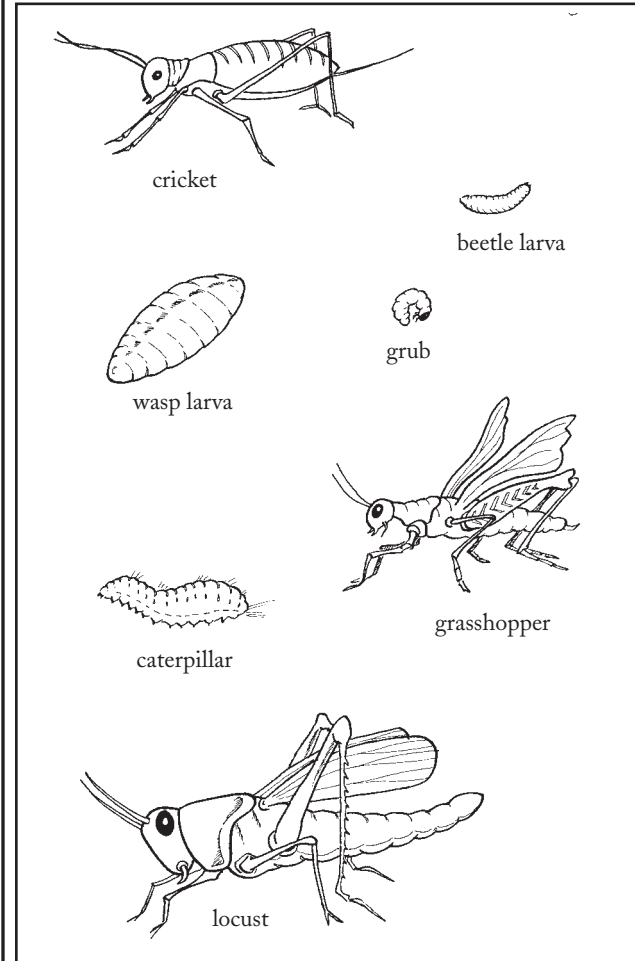

LAST-DITCH LIQUIDS YOU CAN DRINK

AFTER DISTILLING

- Urine (long-term ingestion can cause problems)
- Blood (human blood may contain hepatitis or HIV, so animal blood is somewhat safer)
- Seawater

AFTER DISINFECTING

- Freshwater creeks/streams
- Toilet tank water (not toilet bowl water), as long as the tank does not have any type of disinfectant, and provided the rubber seal between the tank and bowl is intact and does not leak
- Water from an unknown source

NEVER DRINK

- Ink
- The water in a vinyl water bed
- Swimming pool water (but OK for bathing)
- Water in a hot tub (but OK for bathing)

LAST-DITCH FOODS YOU CAN EAT

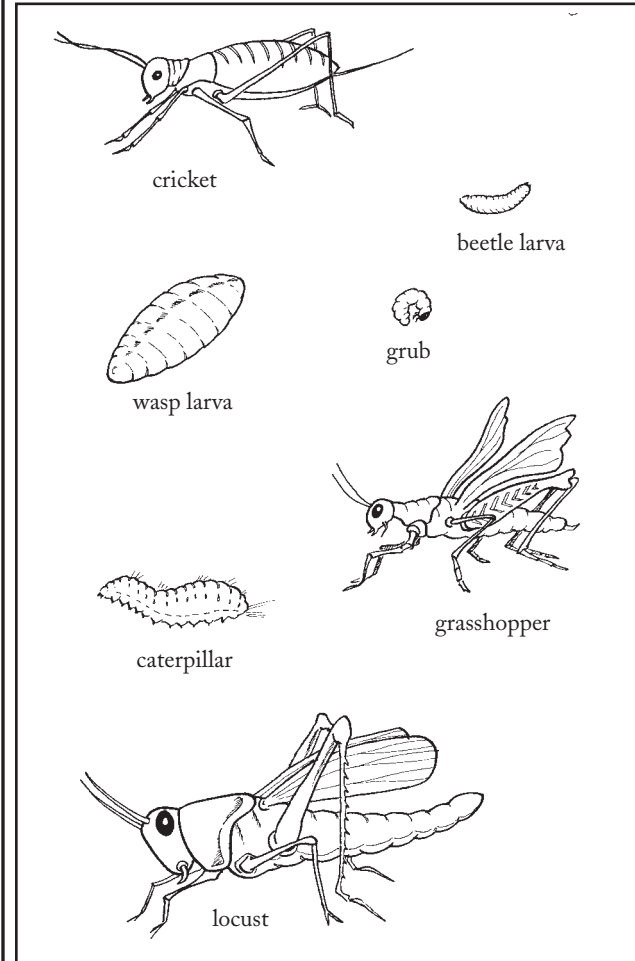

LAST-DITCH LIQUIDS YOU CAN DRINK

AFTER DISTILLING

- Urine (long-term ingestion can cause problems)
- Blood (human blood may contain hepatitis or HIV, so animal blood is somewhat safer)
- Seawater

AFTER DISINFECTING

- Freshwater creeks/streams
- Toilet tank water (not toilet bowl water), as long as the tank does not have any type of disinfectant, and provided the rubber seal between the tank and bowl is intact and does not leak
- Water from an unknown source

NEVER DRINK

- Ink
- The water in a vinyl water bed
- Swimming pool water (but OK for bathing)
- Water in a hot tub (but OK for bathing)

LAST-DITCH FOODS YOU CAN EAT

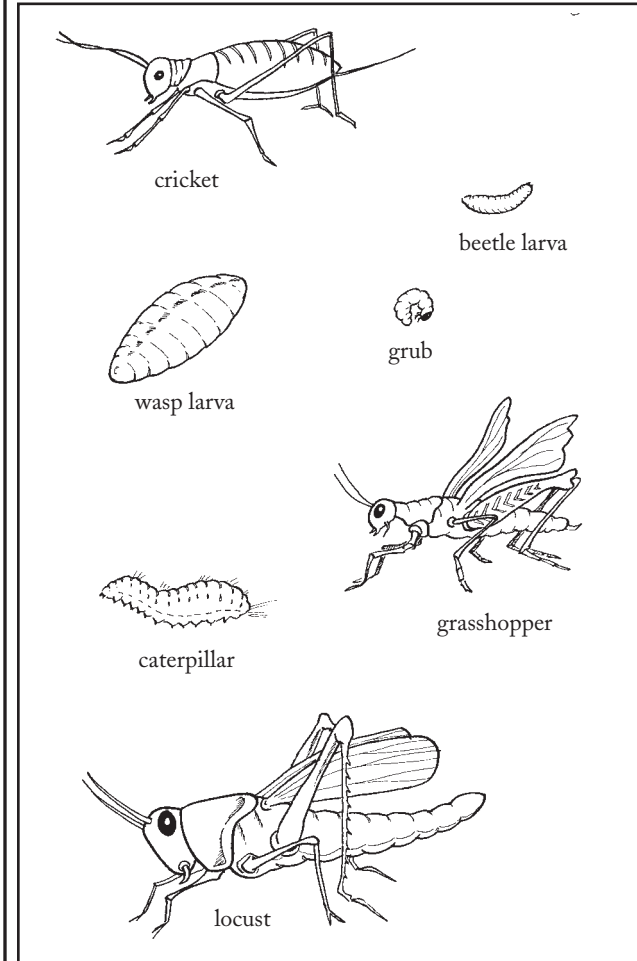

THE EXPERTS

Nena Barlow runs Sedona Jeep School (www.sedonajeeptool.com), a four-wheel drive instruction and guide service in Sedona, Arizona. She has been driving off-road since 1976.

Charles L. Barr is the author of *Welcome to Texas: Avoiding the Sting of Fire Ants*, a publication of the extension service of Texas A&M University.

Bruce Beach (www.webpal.org) trained as a radiological scientific officer in the 1960s and has built dozens of nuclear survival shelters. He is the coordinator of Ark Two, the world's largest privately owned survival complex.

Carrie Brewer is an actor, stuntwoman, fight choreographer, and stage combat instructor in New York City. She is founder and co-artistic director of the Lady Cavalier Theatre Company (www.ladycavaliers.com).

Brennen Brunner is a cold climate survival expert and supervisor of field safety for the U.S. Antarctic Program. He works with the U.S. Air Force's Barren Land Survival Training Program in Greenland and serves as a mountain guide in Alaska and Washington for Alpine Ascents International.

Peggy Callahan is the founder and executive director of the Wildlife Science Center (www.wildlifesciencecenter.org), a nonprofit training, research, and education center in Forest Lake, Minnesota. She has studied captive gray wolves and participated in wolf radio-collaring programs for 20 years.

Around-the-world cyclist Dennis Coello (www.denniscoello.com) has been bike touring since 1965 and mountain biking since testing fat-tire models in the Utah deserts in 1983. He is the author of 13 books and more than 100 articles on various aspects of bicycling.

Cathy Dean, chair of the UK Rhino Group, is director of Save the Rhino International (www.savetherhino.org), a charity committed to ensuring the survival of the rhinoceros species in the wild.

Pat Denevan owns and runs Mission Soaring Center (www.hang-gliding.com), which provides professional hang gliding training in Milpitas, California.

Bastiaan "Bart" Drees, an internationally recognized expert on fire ants, is a professor and extension entomologist at Texas A&M University and the author of *Medical Problems and Treatment for the Red Imported Fire Ant*, among other publications.

Charlie Duchek is chief pilot for Midwest Helicopter (www.flymidwest.com), a helicopter training, rental, and aerial photography company based in Chesterfield, Missouri. He is a certified flight instructor for both airplanes and helicopters.

Dan Egan, one of the world's premier adventure skiers, has appeared in 12 Warren Miller films and has been nominated for 3 Emmy Awards for his own extreme skiing movies. He is the co-founder of Skiclincs (www.skiclincs.com), which coaches extreme skiers and runs ski clinics throughout the world.

Christopher Elliott (www.elliott.org) is *National Geographic Traveler* magazine's ombudsman and a writer for *US News & World Report*, the *New York Times*, and MSNBC. A frequent contributor to National Public Radio, he has written about wild taxi rides and how to survive them.

Floods and Flash Floods, FEMA Fact Sheet, www.fema.gov/hazards/floods/floodf.shtm.

Steve Fettke (www.fettke.com/bungee) teaches and trains bungee jumpers in California and does bungee stunts for film and television. He organized the U.S. Bungee Jumping Championships in 1995 and has competed in the X Games.

Patrick J. Flynn runs En-Fuse Inc. (www.en-fuse.com), an environmental health and training consulting firm. He is a certified environmental trainer with a decade of experience instructing companies on the safe transport, storage, and emergency response to hazardous materials.

Michael Gianetti, an FAA-licensed commercial hot air balloon pilot and pilot instructor, is a certified hot air balloon inspector, repairman, and dealer for new and used balloon systems. He owns Lifecycle Balloons (www.lifecycleballoons.com) in Boulder, Colorado.

Guidance: Potassium Iodide as a Thyroid Blocking Agent in Radiation Emergencies, U.S. Department of Health and Human Services, Food and Drug Administration, Center for Drug Evaluation and Research, November 2001 Procedural.

Dean Gunnarson (www.alwaysescaping.com) is one of the world's foremost escape artists. The first recipient of the Houdini Award, he has escaped from coffins, shark cages, hungry alligators, and a straitjacket while free-falling from an airplane.

Bill Hughes, a hot air balloon pilot and instructor, has been flying balloons and helicopters for 34 years. A former navy pilot, he also served as director of training for American Eagle Airlines. His balloon business (www.blueskyballoons.com) is based in Beacon, New York.

Alexander Jason (www.alexanderjason.com) is a certified crime scene analyst, an expert in the analysis of shooting incidents, and the creator of several videos on the effects of bullets on the human body.

Cory Kufahl owns and runs D-Aces (www.d-aces.com), an extreme stunt motorcycle group and film production company. He has been stunt riding street bikes for 8 years and has performed extreme stunts across the United States and around the world. His latest DVD is *No Mercy*.

Melisa W. Lai, MD, is emergency medicine attending physician at Mt. Auburn Hospital in Cambridge, Massachusetts, and a fellow in medical toxicology at the Massachusetts/Rhode Island Poison Control Center.

Darren Law (www.darrenlaw.com) is a professional race car driver who served as chief driving instructor at the Bondurant School of High Performance Driving, where he taught precision driving, skid control, and accident avoidance for many years. He drives a Daytona prototype race car in the Rolex Grand Am series.

Tom Mason (www.lugeyourmind.com), the "Bad Boy of Street Luge," is a professional street luge pilot. A stuntman and actor, he has appeared in numerous films and television commercials and is a past winner of the World Extreme Games.

Loui McCurley, a technical specialist for Alpine Rescue in Colorado, works for a rescue equipment manufacturer, consulting on equipment testing, standards, and the performance of rope rescue and access equipment for firefighters, mountain rescuers, and window cleaners.

Vinny Minchillo, an auto enthusiast, demolition derby driver, and lawn-mower racer for 20 years, has survived numerous rollovers and crashes. He has written for *AutoWeek*, *Sports Car*, and *Turbo* magazines. When not crashing cars, he is an advertising executive in Texas.

Nick Moriarty is founder and director of Ropes Course Developments (www.rcd.co.uk), one of the world's leading ropes course construction and training companies. Ropes Course Developments has constructed more than 400 facilities in 15 countries and trained more than 3,500 ropes course instructors.

Rick Murphy, gorilla keeper, photographer, and research assistant, has studied captive gorilla gestures, vocalizations, and personality differences for more than two decades. He is currently involved in gorilla conservation activities in Rwanda and the Democratic Republic of Congo.

Meryl Nass, MD (www.anthraxvaccine.org), is a practicing internist with expertise in anthrax and biological terrorism. In 1992, she identified the first modern use of biowarfare, and she has criticized the use of current anthrax and smallpox vaccines due to safety concerns. Many of her recommendations for prevention and mitigation of bioterrorism were adopted by the Centers for Disease Control.

Ian Redmond is a naturalist and conservationist who has worked with gorillas and elephants in the wild for decades. He is chief consultant for UNEP/UNESCO's Great Apes Survival Project and currently works with the Born Free Foundation's Elefriends Campaign (www.bornfree.org.uk/elefriends/).

Francis Rizzo is an attorney who has surfed in Long Beach Island, Costa Rica, and Hawaii. He lives outside Philadelphia.

David Scheel is assistant professor of marine biology at Alaska Pacific University and is the principal investigator on the university's Giant Octopus Research Team (www.marine.alaskapacific.edu/octopus/). He has studied the ecology of the Giant Pacific Octopus for 10 years.

Jon Schladweiler (www.sewerhistory.org) is deputy director for the Pima County Wastewater Management Department in Tucson, Arizona. He has three decades of experience in the planning, design, construction, and management of sanitary sewerage facilities. A sewer historian, he runs an exhibit of historical artifacts, photos, and documents depicting the evolution of sewers from prehistory to the present.

Marc Siegel, MD (www.doctorsiegel.com), is an internist and associate professor of medicine at NYU Medical School and the author of *False Alarm: Profiting from the Fear Epidemic*. He is a frequent contributor to the *Nation*, *New York Times*, and *Los Angeles Times*.

Keith Sutton writes a bimonthly adventure column for ESPNOudors.com. A resident of Alexander, Arkansas, he is the author of *Hunting Arkansas: A Sportsman's Guide to the Natural State* and *Catfishing: Beyond the Basics*.

Vampress (www.vampress.net), an aspiring horror personality, creates and maintains a Web resource dedicated to vampire culture in literature and movies. She stalks her victims in the Toronto area, and only bites if asked nicely.

Jack Viorel has lived and surfed on the Northern California coast for 20 years. He has surfed big waves in Australia, Costa Rica, the Dominican Republic, Fiji, Indonesia, Mexico, Nicaragua, and the North Shore.

Ken Zafren, MD, FACEP, is an emergency physician and medical director of the Alaska Mountain Rescue Group. He is on the faculty at Stanford University and has spent more time than he cares to admit on mountain ledges and searching for lost people.

The
WORST-CASE SCENARIO
Survival Handbook:
DATING & SEX

By Joshua Piven, David Borgenicht, and Jennifer Worick
Illustrations by Brenda Brown



CHRONICLE BOOKS
SAN FRANCISCO

Copyright © 2001 by Quirk Productions, Inc.

All rights reserved. No part of this book may be reproduced in any form without written permission from the publisher.

Worst-Case Scenario™ and The Worst-Case Scenario Survival Handbook™ are trademarks of Quirk Productions, Inc.

Library of Congress Cataloging-in-Publication Data available.

ISBN: 0-8118-3241-4

Printed in the United States

Typeset in Adobe Caslon, Bundesbahn Pi, and Zapf Dingbats

Designed by Frances J. Soo Ping Chow

Illustrations by Brenda Brown



A **QUIRK** Book

www.quirkproductions.com

Visit www.worstcasescenarios.com

Distributed in Canada by Raincoast Books

9050 Shaughnessy Street

Vancouver, BC V6P 6E5

10 9 8 7 6 5 4 3 2 1

Chronicle Books LLC

85 Second Street

San Francisco, California 94105

www.chroniclebooks.com

© 1999-2007 by Quirk Productions, Inc. All rights reserved.

WARNING

When a dire situation is at hand, safe and sane alternatives may not exist. To deal with the worst-case dating and sex scenarios presented in this book, we highly recommend—insist, actually—that you carefully evaluate the situation before you act; that you act responsibly, safely, and within the boundaries of the law; and that you attempt to consult a professionally trained expert, therapist, or physician before placing yourself in harm's way. However, because highly trained professionals may not always be available when the physical or emotional well-being and safety of individuals is at risk, we have asked experts on various subjects to describe the techniques they might employ in these emergency dating situations. **THE PUBLISHER, AUTHORS, AND EXPERTS DISCLAIM ANY LIABILITY** from any harm or injury—physical or emotional—that may result from the use, proper or improper, of the information contained in this book. We do not claim that the information contained herein is going to be complete, safe, or accurate for the specific situation you may find yourself in. Moreover, it should by no means be considered a substitute for your good judgement and common sense. And finally, nothing in this book should be construed or interpreted to infringe on the rights of other persons nor to encourage you to violate criminal statutes: all activities described should be conducted by consenting adults and in accord with all state and federal laws. Breaking a heart is one thing—breaking the law is another.

—The Authors

ABOUT THE AUTHORS

JOSHUA PIVEN is the co-author (with David Borgenicht) of the best-selling *The Worst-Case Scenario Survival Handbook* series. He has been stood up, put down, lied to, and cheated on, but fortunately not by his wife. He lives in Philadelphia.

DAVID BORGENICHT is a writer, editor, and part-time lover whose turn-ons are candlelight dinners, stargazing, and women who aren't afraid of sharks. Turn-offs: sewage treatment plants, proboscis monkeys, and sucking chest wounds. He is the co-author, with Joshua Piven, of the best-selling *Worst-Case Scenario Survival Handbook* series, and lives in Philadelphia with his wife—a woman who is not only three times a lady, but who saved him from a life of dating hell.

JENNIFER WORICK is an editor and the author of *My Dysfunctional Life* and *My Fabulous Life* (Chronicle Books), as well as *Nancy Drew's Guide to Life*. She has dated a variety of motley men, including a fellow who was briefly trapped in a cult compound in upstate New York and a boyfriend who went weak in the knees whenever he heard Tears for Fears. She has also extricated herself without incident from a hotel room with the entire Wisconsin rugby team. She lives in Philadelphia and—at press time—is single.

BRENDA BROWN is a freelance illustrator and cartoonist whose work has appeared in many books and major publications, including *The Worst-Case Scenario Survival Handbook* series, *Reader's Digest*, the *Saturday Evening Post*, the *National Enquirer*, *Federal Lawyer*, and *National Review*. Her digital graphics have been incorporated into software programs developed by Adobe Systems, Deneba Software, Corel Corp, and many websites.

Check out www.worstcasescenarios.com for updates, new scenarios, and more! Because you just never know . . .

ACKNOWLEDGMENTS

The authors would like to extend their thanks and the promise of lifelong good karma to all of the experts who contributed their knowledge and experience to this project. Without you we are nothing—or at least a lot less knowledgeable.

Josh Piven thanks his wife, Christine, and his parents for their support.

David Borgenicht thanks Jay Schaefer, Steve Mockus, Jason Rekulak, Frances Soo Ping Chow, Brenda Brown, and the entire staff at Chronicle Books and Quirk Productions. He'd also like to apologize to everyone who dated him before his wife.

Jennifer Worick thanks Margy Dooley, Irv Furman, Robin Gorman Newman, Peter Gwin, Richard Marx, Jason Rekulak, Karen Salmonsohn, Kerry Tessaro, and Nan Troiano.

**ACCLAIM FOR THE AUTHORS'
INTERNATIONAL BEST-SELLERS**

The Worst-Case Scenario Survival Handbook

“Nearly 180 pages of immediate-action drills for when everything goes to hell in a handbasket (*SOF* editors all keep a copy on their desk at all times). . . .”

—*Soldier of Fortune*

“. . . an armchair guide for the anxious.”

—*USA Today*

“The book to have when the killer bees arrive . . .”

—*The New Yorker*

“Parachute won’t work? Open this instead.”

—*The Washington Post*

The Worst-Case Scenario Survival Handbook: Travel

“. . . riveting.”

—*People*

“. . . a lifesaver.”

—*Forbes*

“. . . better hope you’ve packed a copy . . .”

—*Chicago Sun-Times*

Watch for these new titles, available spring 2002:

The Worst-Case Scenario Dating & Sex Address Book

The Worst-Case Scenario Survival Handbook: Golf

ABOUT THE AUTHORS

JOSHUA PIVEN is the co-author (with David Borgenicht) of the best-selling *The Worst-Case Scenario Survival Handbook* series. He has been stood up, put down, lied to, and cheated on, but fortunately not by his wife. He lives in Philadelphia.

DAVID BORGENICHT is a writer, editor, and part-time lover whose turn-ons are candlelight dinners, stargazing, and women who aren't afraid of sharks. Turn-offs: sewage treatment plants, proboscis monkeys, and sucking chest wounds. He is the co-author, with Joshua Piven, of the best-selling *Worst-Case Scenario Survival Handbook* series, and lives in Philadelphia with his wife—a woman who is not only three times a lady, but who saved him from a life of dating hell.

JENNIFER WORICK is an editor and the author of *My Dysfunctional Life* and *My Fabulous Life* (Chronicle Books), as well as *Nancy Drew's Guide to Life*. She has dated a variety of motley men, including a fellow who was briefly trapped in a cult compound in upstate New York and a boyfriend who went weak in the knees whenever he heard Tears for Fears. She has also extricated herself without incident from a hotel room with the entire Wisconsin rugby team. She lives in Philadelphia and—at press time—is single.

BRENDA BROWN is a freelance illustrator and cartoonist whose work has appeared in many books and major publications, including *The Worst-Case Scenario Survival Handbook* series, *Reader's Digest*, the *Saturday Evening Post*, the *National Enquirer*, *Federal Lawyer*, and *National Review*. Her digital graphics have been incorporated into software programs developed by Adobe Systems, Deneba Software, Corel Corp, and many websites.

Check out www.worstcasescenarios.com for updates, new scenarios, and more! Because you just never know . . .

ACKNOWLEDGMENTS

The authors would like to extend their thanks and the promise of lifelong good karma to all of the experts who contributed their knowledge and experience to this project. Without you we are nothing—or at least a lot less knowledgeable.

Josh Piven thanks his wife, Christine, and his parents for their support.

David Borgenicht thanks Jay Schaefer, Steve Mockus, Jason Rekulak, Frances Soo Ping Chow, Brenda Brown, and the entire staff at Chronicle Books and Quirk Productions. He'd also like to apologize to everyone who dated him before his wife.

Jennifer Worick thanks Margy Dooley, Irv Furman, Robin Gorman Newman, Peter Gwin, Richard Marx, Jason Rekulak, Karen Salmonsohn, Kerry Tessaro, and Nan Troiano.

**ACCLAIM FOR THE AUTHORS'
INTERNATIONAL BEST-SELLERS**

The Worst-Case Scenario Survival Handbook

“Nearly 180 pages of immediate-action drills for when everything goes to hell in a handbasket (*SOF* editors all keep a copy on their desk at all times). . . .”

—*Soldier of Fortune*

“. . . an armchair guide for the anxious.”

—*USA Today*

“The book to have when the killer bees arrive . . .”

—*The New Yorker*

“Parachute won’t work? Open this instead.”

—*The Washington Post*

The Worst-Case Scenario Survival Handbook: Travel

“. . . riveting.”

—*People*

“. . . a lifesaver.”

—*Forbes*

“. . . better hope you’ve packed a copy . . .”

—*Chicago Sun-Times*

Watch for these new titles, available spring 2002:

The Worst-Case Scenario Dating & Sex Address Book

The Worst-Case Scenario Survival Handbook: Golf

5 Relationship Survival...133

How to Survive If You Run into Your Ex...134

How to Survive Meeting the Parents...136

How to Survive If You Forget a Birthday...139

How to Deal with a Cheating Lover...140

How to Have an Affair and Not Get Caught...142

If You Are Caught...145

How to Stop a Wedding...147

How to End a Relationship...150

Appendix...153

The “It’s Not You, It’s Me” Letter...154

Useful Excuses...155

Pickup Lines to Avoid...157

Guide to Body Language...160

The Experts...163

About the Authors...174

Acknowledgments...175

INTRODUCTION

In nature, the process of finding a mate is a fairly simple one. Animals signal their readiness by fanning their plumage, or changing the color of their buttocks, or growling in a certain way. Potential suitors present themselves, then vie for the right to mate. In nature, there are no singles bars, personal ads, safe lunches, or blind dates.

Among humans, however, finding a suitable mate is a lot more complex, and more dangerous. From the first attraction across a crowded room to the perils of meeting, dating, undressing, sleeping with, and loving or leaving that special someone, you are completely at risk: your body, your heart, your mind, and your spirit, not to mention your bank account. Literature and lyrics say it all: Love hurts. Love is blind. Love stinks. Love is a battlefield.

Think of this book as your guide to fighting, surviving, and ultimately winning that battle.

We’ve learned a few things about survival in writing *The Worst-Case Scenario Survival Handbook* and *The Worst-Case Scenario Survival Handbook: Travel*. We’ve learned how to fend off an alligator, how to survive a jump from a bridge, how to escape from quicksand, and how to survive many other life-threatening situations.

That was the easy part.

It was easy to give readers instructions for surviving the elements or wild animal attacks. It’s simple enough to predict what a shark is going to do, or to

teach people how to jump from a moving car, or to give readers information about what to do during an earthquake. Sharks are always going to behave like sharks, moving cars are always going to function according to the principles of physics, and earthquakes affect the ground and buildings in a very predictable way.

But human nature is much less predictable than Mother Nature.

In dating and sex, perhaps more than in any other aspect of life, you've got to be able to cope when things don't work out as planned. If you are careless or you panic, if you say or do the wrong thing or do the right thing at the wrong time, the consequences could be emotionally catastrophic and life-threatening, or life-producing. This book can keep you safe.

There are plenty of books out there that provide guidance on how to find Mr. or Ms. Right. This is the only book that tells you how to escape from Mr. or Ms. Wrong. Identify an axe murderer, slip away from a bad date, survive when your credit card is declined, fake an orgasm, recognize breast implants and toupees, remove difficult articles of clothing—*The Worst-Case Scenario Survival Handbook: Dating & Sex* can save your evening and your love life.

Once again, we've assembled a team of experts to give real advice and tips about what to do when good dates (and relationships) go bad. We've consulted with sex therapists, etiquette instructors, CIA and FBI agents, lawyers, bartenders, psychologists, emergency medical instructors, nutritionists, college

professors, barbers, fashion consultants, dermatologists, and dozens of other professionals who have generously lent us their knowledge and experience in order to give you the information you'll need to survive the treacherous dating and sex scenarios that follow.

You'll find out how to survive dozens of physically and emotionally threatening situations in bars, restaurants, bedrooms, and airplane lavatories. And in the handy appendix, you'll find excuses you might need, a guide to pickup lines to avoid, and a body language interpretation chart for encouragement—or for extra protection.

We've added a new, female member to our team of authors, to make sure we cover all the bases. Generally, we've assigned a "he" or "she" to each of the scenarios for the sake of simplicity, but you'll know if the scenario applies to you. And even if it doesn't, you might find out how to help a friend or lover in distress.

So go out, have fun, and carry this book at all times—because you just never know.

—Joshua Piven, David Borgenicht, and Jennifer Worick

HOW TO CARRY A DATE WHO IS PASSED OUT

- 1 Plan to carry your date only for a short distance.**
Your destination should be a nearby couch, taxi, or bed. Do not attempt to carry him a long way.
- 2 Prepare to lift.**
Bend your knees and place your stronger arm under your date's back and the other under his knees. Your arms should go all the way under and across his body.
- 3 Begin to lift your date.**
Use the strength of your legs and knees, holding them close to your body and keeping your back straight. Do not lift with your back.
- 4 Stand up quickly.**
In one continuous motion, rotate your date's body so that your stronger arm guides him over your opposite shoulder. The motion should be like tossing a sack of potatoes. His upper body should be hanging over your back, his lower body hanging over your front. Steady him with your other hand.
- 5 Walk to your destination.**

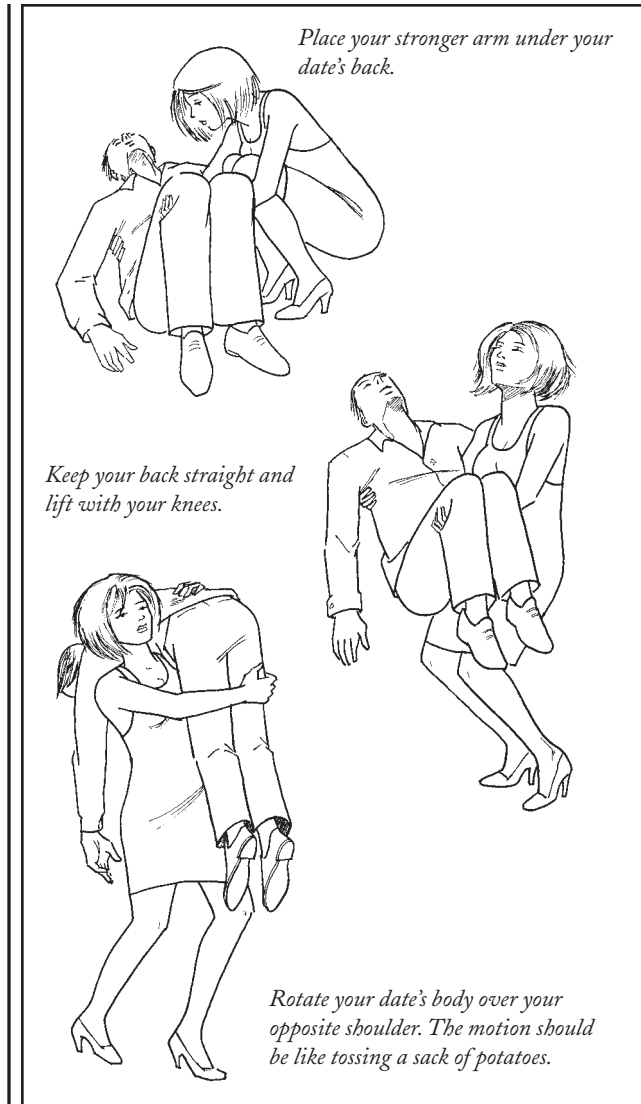

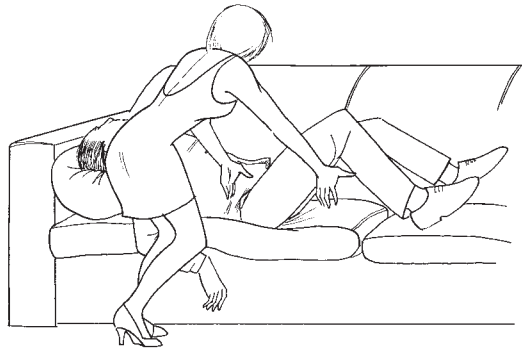

Guide your date off your shoulder and onto a bed or couch.

6 **Lower your date.**

Bending your knees and keeping your back straight, guide your date off your shoulder and onto a bed or couch or into a chair.

**WORST-CASE
SCENARIO®**

HOW TO CREATE PRIVACY IF YOUR DOOR DOES NOT LOCK

BLOCKADE A DOOR THAT OPENS INWARD

- 1 Find a straight-backed wooden or metal chair.**
- 2 Shut the door.**
- 3 Place the chair about a foot from the door.**
How far away you place it will depend upon how tall the chair's back is, so adjust the distance accordingly.
- 4 Tilt the chair backward so that the top of the chair is wedged underneath the doorknob.**
The seat should be facing upward. If necessary, pull the bottom of the chair out a bit so that the top of the chair will fit under the knob.
- 5 Push down on the front of the seat or the bottom of the front legs.**
When the chair is securely wedged, kick it in further to make the blockade tight.
- 6 Place a large item of furniture (a trunk or dresser) directly against the chair.**
The chair buttressed by other furniture will make it extremely difficult to open the door from outside.

Tilt the chair backward so that the top of the chair is wedged underneath the doorknob.

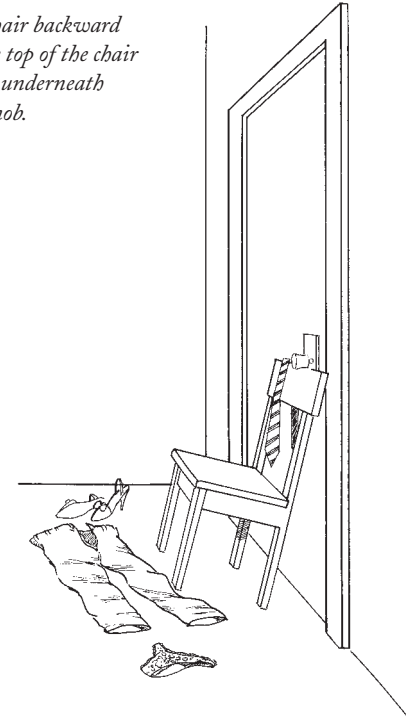

BLOCKADE A DOOR THAT OPENS OUTWARD

Using a rope, fishing line, phone cord, or electrical cord, tie the doorknob to the leg of a heavy dresser or other immovable object. Loop the rope around the knob several times so that it will not slip off, and be sure the line to the fixture remains taut. Anyone trying to enter the room will be unable to pull the door open.

ENTRY ALARM

1 **Collect stackable items that will make a noise if toppled.**

Empty cans—between 6 and 10—work best. Jars or bottles will also work in an emergency, but the glass might break.

2 **Select a door.**

Alarm a door other than the one to the room you are in, so that you will have advance warning if someone is coming. For example, alarm the front door if you are in the bedroom.

3 **Shut the door**

4 **Stack the items against the door.**

5 **Retreat to your room.**

If someone opens the alarmed door, the items will topple and you will have time to prepare for their approach.

Alternate Method

Tie several cans, cowbells, or Christmas ornaments to the doorknob. When your intruder opens the door, the objects will knock against each other, warning you of an interruption.



HOW TO DEAL WITH A BAD KISSER

TOO AGGRESSIVE

- 1 Slow him down.**
Ask your date to kiss more gently. Say, “Can I show you the way I really like to kiss?” and slowly lean forward to offer a demonstration.
- 2 Kiss your date.**
- 3 Draw away from the kiss.**
Briefly drawing away from the kiss is another way of saying slow down.
- 4 Gently hold his face.**
Your hands can provide a caress, and also prevent him from zooming back in for more.
- 5 Tilt his head.**
While your hands are in place, tilt his head to the angle of greatest comfort. Tilt your head accordingly.
- 6 Surround his mouth with gentler kisses.**
Reinforce the message by sighing and saying, “I love it like this.”
- 7 Repeat as necessary.**

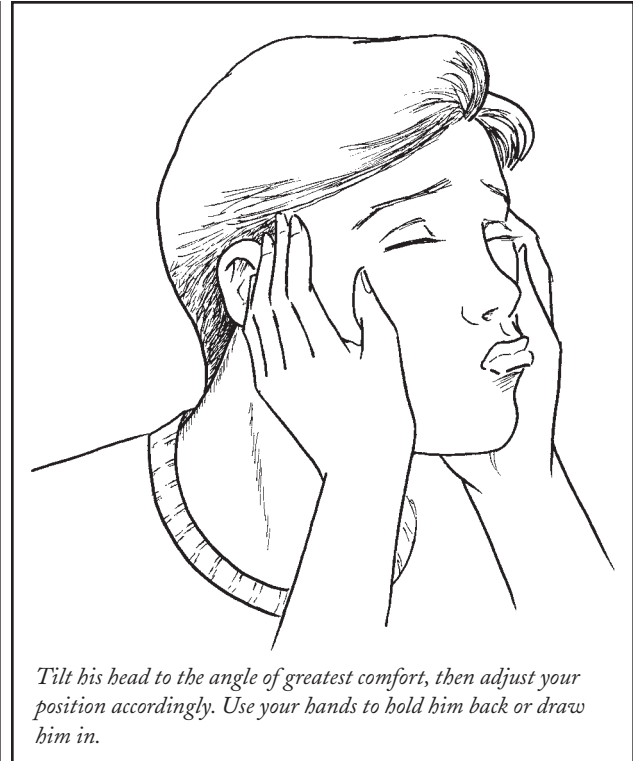

Be Aware

Very aggressive tongue kissing may be just right when you are very aroused, but not so great when you are just beginning. Be careful not to scare him away from things you might enjoy later.

Too Passive

- 1 Look your date in the eye.**
A warm, smiling gaze signals affection and also lets him know something is about to happen.
- 2 Hold his face.**
- 3 Kiss him passionately.**
The kiss should be as deep and passionate as you want his to be. Remember to tilt your date's head before kissing him.
- 4 Break away from the kiss.**
Murmur, "Mmm, kiss me back harder." You are taking charge of the situation.
- 5 Pause and redirect.**
If you are still not getting the desired result—if his tongue is not responding—shift to lip-focused rather than deep-mouth kissing.

Be Aware

You may be dealing with someone who thinks your kissing style is too aggressive. He may be passively resisting your technique instead of trying to slow you down by using the more direct response to "too aggressive" kissing (see above).

Too Wet

- 1 Keep your kisses focused on the lips.**
Do not venture inside the mouth.
- 2 Use your thumbs to wipe away excess wetness.**
Gently outline his lips with a thumb or other finger. This will serve as a sensual caress and will also remove excess moisture.

How to Deliver the Perfect Kiss

- 1 Cradle your date's face with your hands.**
Look into his eyes.
- 2 Tilt his head.**
- 3 Tilt your head.**
- 4 Bring your mouth toward his mouth.**
Gradually move closer.
- 5 Gently touch your lips to his.**
Focus initially on the lips, giving soft, quick kisses. Slowly part your lips, letting your tongue softly dart out to touch his lips. This is an excellent way to gauge your partner's receptiveness to furthering the kiss. If lips part, proceed to the next level.

6 Explore delicately with your tongue.

Open your mouth wider and push your tongue into his mouth. Probe the various parts of his mouth. Run your tongue over the teeth. Imagine your tongue fencing with your partner's tongue, lunging, darting, and parrying.

7 Take frequent breaks.

Keeping your tongue inside each other's mouths for an extended period of time will produce a very sloppy, wet kiss. Move your head away from his every so often. This will also allow you to catch your breath.

8 Know when to stop.

End the kiss before your jaw begins to ache, or before you are both worn out. It may be time to move on to other activities, or it may be fine to stop and leave him wanting more.

Be Aware

If either or both of you wear glasses, remove them prior to a prolonged kissing session. Wearing glasses for a medium-intensity, brief kiss is acceptable, but glasses may hinder greater intimacy (and they may get fogged up or even scratched). Set them someplace safe, where you will not be likely to roll onto them later.

**WORST-CASE
SCENARIO®**

HOW TO DEAL WITH A CHEATING LOVER

1 Ask her outright.

If you suspect your lover is cheating on you, do not worry about embarrassment or gathering too much evidence. The fact that you are unsure of her fidelity is enough to raise the issue. If she expresses surprise by the question or hesitates, present your reasons for asking in as calm a way as possible.

2 Do not act impulsively and end the relationship.

If you ascertain that she is cheating on you, all is not lost. Talk or cry together, and then spend some time apart. If this is the first time, seek counseling with your partner. Discuss why it happened and what it means to both of you. This could lead the two of you to be more honest, and perhaps more trusting and intimate.

3 Discuss the seriousness of the affair.

Talk about whether the indiscretion was a one-time incident with someone of little consequence, or whether your partner is in an ongoing relationship. Talk about the difference and think hard about what the circumstances mean to both of you. Professional counseling can help clarify your feelings and priorities. It can also help you to rebuild a trusting relationship, if this is still desired.

4 Decide what you want first—then ask your partner to decide what she wants.

The best possibility is if you both want the same thing, either an end to your relationship or an end to the affair.

5 Act according to your wishes, not your partner's.

If you want to work it out but your partner does not, work on the relationship until you are certain you have tried your best to salvage things. If this is a recurring problem with your partner and you have talked about it at length before, it probably means that she wants out, or that you can expect her to continue having affairs. To end the relationship, go to page 150.

HOW TO DEAL WITH A DATE WHO MOVES TOO FAST

- 1 Watch for the signs of “relationship acceleration.”**
If your date starts talking about moving in or having kids or marrying, and you are not yet ready to proceed that quickly, you may have a problem.
- 2 Tell your date to slow down.**
Send a clear, unambiguous message. Sometimes joking about it will convey your feelings, but if a light touch does not work, express it more directly: tell him that you think he is getting too serious too soon, and that you think you both should spend time with other friends.
- 3 Do not agree to more than one date a week.**
By no means should you plan a weekend vacation together.
- 4 Talk about past relationships.**
Find out what goals he had in recent relationships. Someone who moves at a lightning pace may be on the rebound, wanting only to replace a past relationship. Be sure you are not being used merely as a vehicle for accomplishing a goal that you were not involved in setting, like having kids or buying a house.

- 5 Postpone any conversation about the future of your relationship.**

If you want to continue dating this person but do not want to get serious yet, suggest discussing the situation at a specific date in the future, after you have spent some more time together.

- 6 Beware of flattery.**

When someone wants to move too fast, he may just be lonely or incapable of being single. You may feel flattered by his seriousness, but often his intensity does not have much to do with you. He may only want to be with someone, anyone.

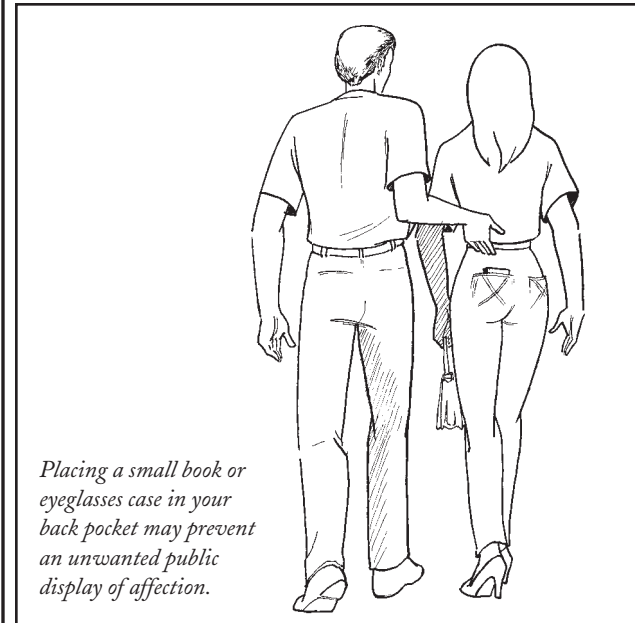

HOW TO STOP UNWANTED PDAs

Overeager dates may use a Public Display of Affection (PDA) to accelerate a relationship, unaware that these PDAs may make you, your friends, or even casual bystanders feel uncomfortable. The best solution is to voice discomfort—but because that can be awkward, use the following techniques to block an unwanted PDA:

- **Handholding:** If your date tries to hold your hand, allow him to do so for a few minutes, release the hand to adjust your hair, and then lower the hand to your side. **Alternative:** You could fake a sneeze, then lower both hands to your sides.
- **Kissing:** As your date advances, step back and explain you're catching a cold. Sound concerned for your date's health and well-being. **Alternative:** Sneeze or cough in his face.
- **Walking with One Hand Slipped in the Rear Pocket of Your Pants:** Pull your date's hand out of your pocket, perhaps with a coy line like, "Wait until we get home." **Alternative:** Place an object—a checkbook, a wallet, a folded scarf, a glasses case, or a rolled newspaper—in the pocket.

**WORST-CASE
SCENARIO®**

WORST-CASE SCENARIO.

HOW TO DEAL WITH A DRUNKEN DATE

1 Avoid confrontation.

You realize your date is drunk, but he might not believe it. Keep the conversation light and happy, but don't let him have any more to drink. Suggest a change of plans, like a walk outside.

2 Keep your date on his feet.

Support him as needed. Put your arm around his waist, putting his arm over your shoulder. If that doesn't work, try holding him up by the belt. If you cannot hold your date upright, keep him seated and call a taxi.

3 Lead your date out into the air.

Bars are often smoky and short of oxygen, and oxygen is a major factor in reducing drunkenness. Calmly walk your date outside to get some fresh air into his lungs. This may help him become more awake and aware. If he objects, say you need to go outside to make a phone call.

4 Encourage your date to vomit.

If your date is so drunk that he cannot walk, or if he is speaking unintelligibly, he should expel alcohol from his system. Vomiting purges the stomach and prevents more alcohol from entering the bloodstream. Make sure your date rehydrates after purging. If your

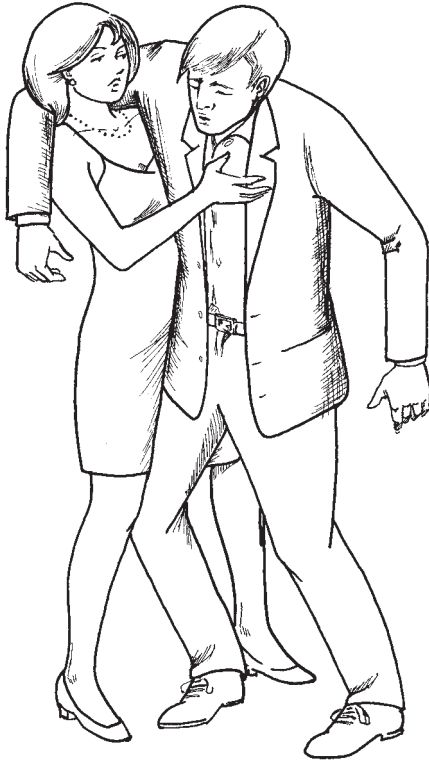

Suggest a walk outside, to get some fresh air.

date falls to the floor and passes out, roll him onto his side to prevent him from choking on his vomit.

5 Watch for alcohol poisoning.

Signs of alcohol poisoning include tremors, unresponsiveness, unconsciousness, and lack of breathing.

If you suspect alcohol poisoning, position your date on his side, stay with him, and have someone call 911 for assistance.

6 Help your date to sober up.

See the next section, “How to Sober Up Fast.”

Be Aware

- Common “cures” for drunkenness such as coffee or a cold shower are generally not effective; they will simply produce a more awake or wet drunk.
- Your body burns off approximately one drink an hour. It makes little difference if your drink is a 1-ounce shot of whiskey, a 5-ounce glass of wine, or a 12-ounce mug of beer—all contain similar amounts of alcohol. If you consume more than one drink per hour, you run the risk of becoming intoxicated. To minimize dehydration, drink a glass of water between rounds.
- If your drunk date goes to the restroom, stand outside and keep talking to him to be sure he remains conscious and responsive.

HOW TO DEAL WITH BAD BREATH

1 Chew gum or mints.

Excuse yourself from the table and head for the host's desk, where there may be a dish of mints. A waiter or busboy may also be able to give you a piece of gum. Go to the restroom and chew the gum for two minutes, then spit it out. This will get your saliva flowing and keep bad breath at bay for an hour or more. Chewing for more than a few minutes is not necessary. Sugar-free gum is best.

2 Chew parsley, mint, or a cinnamon stick.

On the way to the bathroom, pull your waiter aside and ask for one of these common garnishes. Parsley and fresh mint leaves are natural breath fresheners. A cinnamon stick, if chewed, will also clean your breath; do not use ground or powdered cinnamon. Most bartenders will have a stick on hand.

3 Order a salad or some fresh carrots.

If you cannot leave the table, order coarse foods that can help clean the tongue, a major source of bad breath.

Be Aware

Food odors are generally not as bad as you think, but when possible, avoid onions and garlic during your date.

To freshen breath, chew on any of the following items:



aniseed



mint sprig



cloves



egg shells

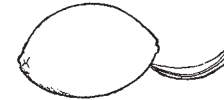

lemon

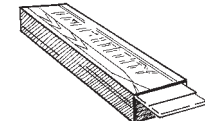

gum



cinnamon stick

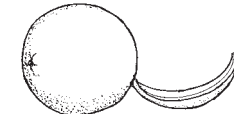

orange



parsley



salad

HOW TO PREVENT BAD BREATH

- 1 Floss.**

Before going to bed, floss your teeth. Use unscented floss and smell it after each pass through. Areas that smell the worst need the most attention. Flossing may also help you live longer, as gum disease can shorten your life.
- 2 Sweep the tongue.**

Gently sweep the mucus off the very back of your tongue with a commercially available tongue cleaner. Avoid cleaners made from sharp metal and do not scrape the tongue.
- 3 Brush with mouthwash.**

Use an effective mouthwash. Shake if necessary, then pour some into the cap. Dip your toothbrush into it and brush your teeth properly for a few minutes. Do not use mouthwash and toothpaste at the same time as they can cancel out each other's active ingredients. Rinse and gargle with the rest of the mouthwash in the cap.

**WORST-CASE
SCENARIO®**

WORST-CASE SCENARIO.

HOW TO DEAL WITH BODY ODOR

1 Apply cologne or perfume.

If you are on the way to a date and discover a problem with body odor, find a drugstore or department store. Apply the scent liberally.

2 Change your shirt or remove the offending article of clothing.

A simple change of clothing can often eliminate the odor, especially from an undershirt. Purchase a new shirt if you have to.

3 In mid-date, use one of the following techniques in the bathroom:

- Wet a stack of paper towels with hot water and a bit of soap. Take a second stack of towels and wet them without adding soap. Wash under your arms and wherever necessary with the soapy towels, then rinse with the remaining towels.
- Obtain chamomile tea bags from your server if you are in a restaurant. Soak them in hot water, then wipe down the offending areas with the bags. If possible, leave them in place for several minutes.
- Obtain a handful of fresh rosemary from the kitchen, wet it slightly, and rub it over the offending areas.
- Apply bathroom soap (powdered works best) to the offending areas to mask the scent.

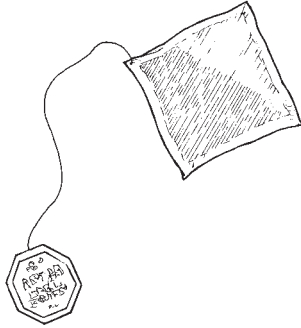

Soak chamomile teabags in hot water. Wipe the offending areas with the tea bags. If possible, leave the bags in place for several minutes.

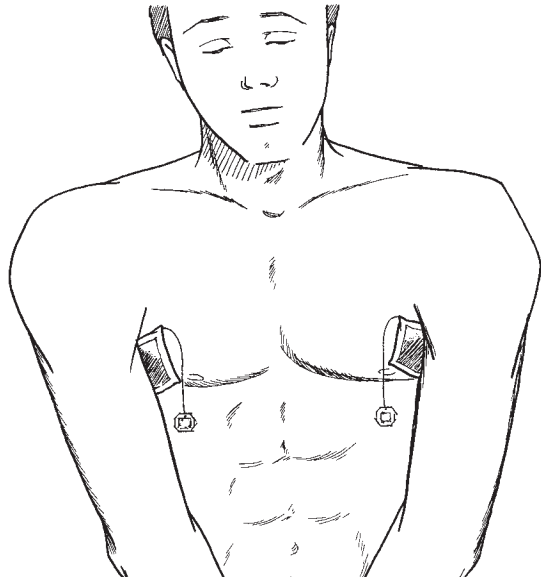

Be Aware

- To avoid B.O., try bathing using an antibacterial soap. Prolonged use can cause dryness, however.
- Avoid spicy or garlicky foods—these can cause body odor to worsen.
- Unusual body odor—not the typical “sweaty” smell—may indicate a more serious condition.
- Watch for the warning smells of B.O.:
 - Beer smell may indicate a yeast infection.
 - Nail polish smell may indicate diabetes.
 - Ammonia smell may indicate liver disease.

WORST-CASE SCENARIO.

HOW TO DETERMINE IF YOUR DATE IS A CON ARTIST

1

Watch for the following:

- Has your date missed a string of dates with you?
- Does she change dates at the last minute?
- Does she frequently receive unexplained phone calls?
- Does she refuse to give out information about her past?
- Is she known only by a first or last name?
- Is she loath to contact family members?
- Does she lack connections to the community, friends, or co-workers?
- Does she frequently express concerns about her finances?
- Has she ever asked you for a short-term loan or investment?
- Does she often change her stories and claims?

If the answer to three or more of these questions is yes, you may be dating a con artist (or a pathological liar).

2

Watch your date's eyes during conversation.

Most people look to their right when recalling the truth, the past, and events that actually happened. People look to the left when “creating” or spinning out new versions of past events. Ask her a question about her past and see where her eyes move.



Most people look to their right when recalling the truth and events that actually happened. People look to their left when “creating” or spinning out new versions of past events.



3 Obtain her social security number and investigate her records.

With a social security number or driver’s license number and birthdate, you can check out a person’s records—criminal, financial, voting, and more. A good place to start is a “people finder” website on the Internet. Or you can hire a private detective.

4 Trust your intuition.

If you have doubts, there is probably a reason.

5 Protect yourself.

Take an inventory of your credit cards, bank accounts, and other financial assets. If you have broken off the relationship and she is desperate, she may try to dupe or rob you. Request new credit cards; change your e-mail, voicemail, burglar alarm, and banking passwords; select a new PIN for each of your accounts. Change your locks, if necessary.

HOW TO DETERMINE IF YOUR DATE IS AN AXE MURDERER

1 Watch for the following:

- A Caucasian male in his twenties or thirties
- Obsession with fire or matches
- Cruelty to animals
- History of bed-wetting
- Sexually abused as a child
- Middle-class background combined with loner behavior
- Difficulty maintaining relationships

An individual who exhibits more than three of these traits may be dangerous.

2 Trust your intuition.

Your instinct is a powerful weapon. If something feels wrong, it probably is.

3 Check him out officially.

Obtain his social security number and investigate him. Call the Federal Prison Locator Service (202-307-3126) to determine if he was ever incarcerated. Many online companies can aid in financial reports or tracking down previous addresses. You may also want to enlist the services of a private detective.

4 If you discover grounds for suspicion, break off the relationship immediately.

Be clear and definite about your decision. Return all of his belongings and gifts. Do not make promises to keep in touch. Be straightforward and kind, and talk only about yourself and why the relationship no longer works for you. Do not blame him. Try not to make him angry.

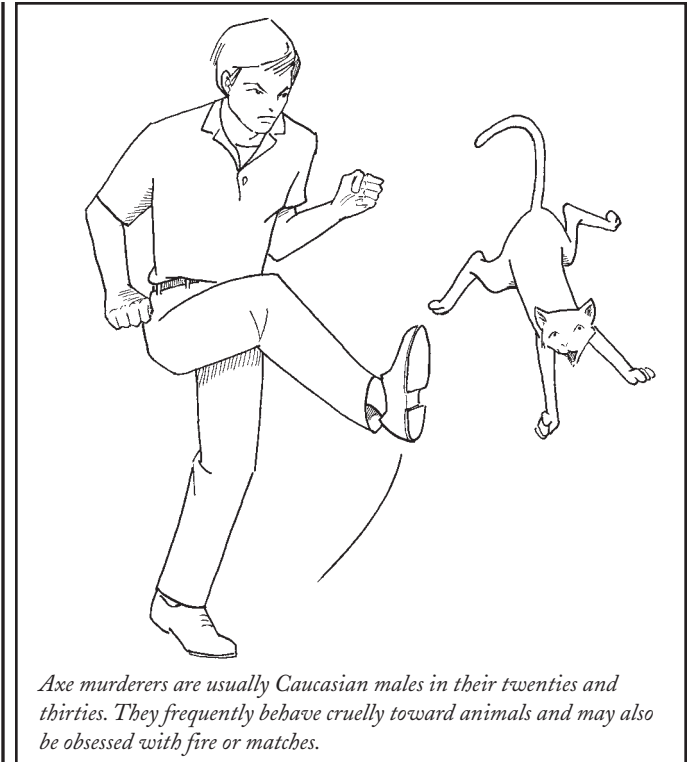

Axe murderers are usually Caucasian males in their twenties and thirties. They frequently behave cruelly toward animals and may also be obsessed with fire or matches.

5 Take steps to maintain your safety.

- Carry a cell phone.
- Install a home security system.
- Change your phone numbers.
- Stay near populated, well-lit areas.
- Apprise a friend or relative of your concerns.
- Document any strange or unusual happenings.
- Take a personal safety/self-defense class.

**WORST-CASE
SCENARIO®**

WORST-CASE SCENARIO.

HOW TO DETERMINE IF YOUR DATE IS MARRIED

- 1 Examine the left ring finger.**

After a period of about one year, a wedding band leaves a circle of lighter skin around the base of the ring finger. Your date may also touch the base of that finger inadvertently, as if something is missing.
- 2 Ask for a home phone number.**

Most people in committed relationships spend at least one or two hours a week on the phone; if your date will not give you his home phone number, then he is worried someone else will answer when you call.
- 3 Insist on holding hands when walking in public.**

If your date is interested and attracted to you, then he will not object to such a small and commonplace display of affection—unless he fears that someone will spot you together.
- 4 Search your date's car.**

The automobile registration may be in the spouse's name, or in both names. It is usually kept in the glove compartment, behind the sun visor or, for non-smokers, in the ashtray. Look for signs of a spouse (clothing, makeup) or other indicators (pacifiers, pieces of crackers, toys) of a family your date has not mentioned.

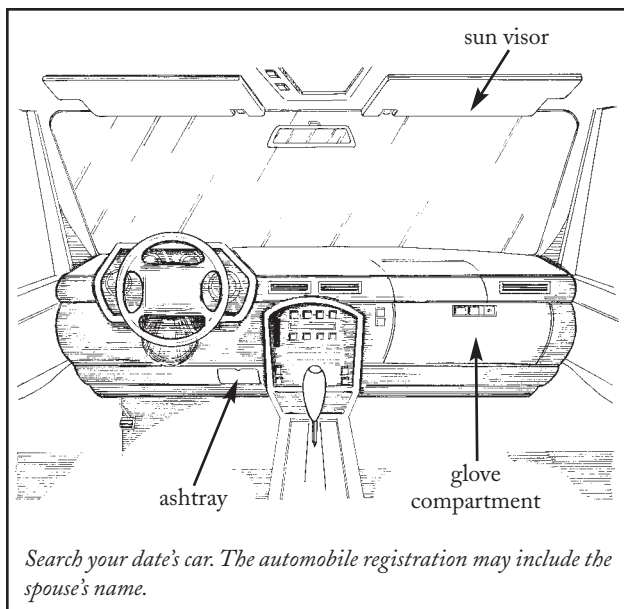

5 Ask to meet some of his friends.

After two or three dates, this is not an unusual request. If your date claims that his friends remain close to his ex-wife, or that it's too soon to bring you into their social circle, you have good reason to believe that you are not the only woman in his life.

6 Invite him to spend the night.

If you have engaged in sexual activity on several occasions but he always refuses to stay the night, then he very likely has someone waiting for him.

7 Make plans to spend a weekend together.

If you never see him on Saturdays and Sundays, be suspicious. Your date may say that he spends weekends with his parents and/or with his children. But if he cares so much for you, and if his family is as great as he says they are, they will understand if you come along or if he shares time on the weekends with you.

8 Ask to meet his children.

He might have legitimate reasons for not introducing you to his children early in the relationship—for example, he may not want to present you as a possible mommy replacement until the relationship becomes more serious. However, it may also mean he is still married to their mommy.

Be Aware

Be suspicious of a lover who never writes you letters or sends e-mails, and signs greeting cards with only a nickname, an initial, or a term of endearment. This person may be making a conscious effort to avoid any paper trails to the relationship. For this same reason, also be wary of a date who always pays cash (see “How to Have an Affair and Not Get Caught,” page 142).

HOW TO DETERMINE THE GENDER OF YOUR DATE

1 Look at her (or his) hand.

Compare the length of your date's fourth and second fingers. Most men have ring fingers that are conspicuously longer than their index fingers, whereas most women have ring fingers that are close to the same length. Testosterone levels likely account for the greater length.

Also take notice of the amount of hair on your date's knuckles, hands, and forearms. Most men will have visible, dark hair (or signs of recently removed hair) on their hands and wrists, and sometimes knuckles.

2 Be suspicious of baggy clothing.

Your date may be trying to conceal a telltale bulge.

3 Look for an Adam's apple.

Most men have a bump in the middle of their throat. Most women do not.

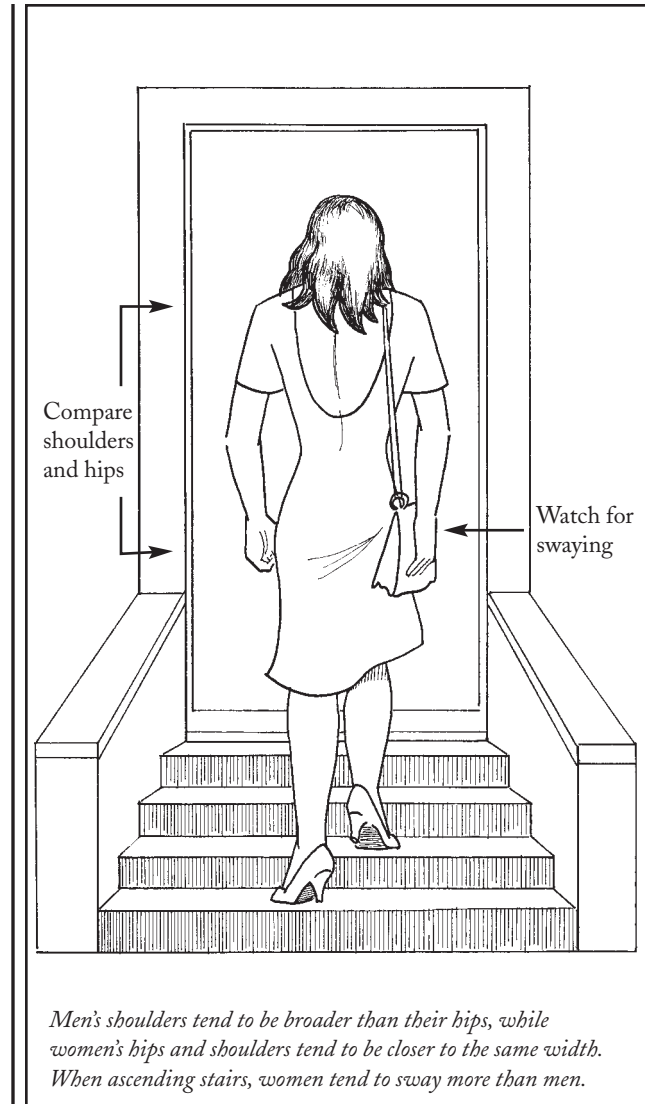

4 **Observe shoulders and hips.**

Men's shoulders tend to be broader than their hips, while women's hips and shoulders tend to be closer to the same width. Do not be fooled by shoulder pads.

5 **Follow your date up a flight of stairs.**

Take note of how she (or he) moves while ascending. Men tend to walk in a more "straight ahead" motion with minimal "wobbling" back and forth. Women tend to sway a bit from side to side, due to the position of their pelvises. Women also tend to lean forward slightly.

Be Aware

- Look for at least three of these characteristics before you draw conclusions about your date's gender, then make your plans accordingly.
- Voice is not always a good indicator of gender—a low voice may simply be the result of hard living.

**WORST-CASE
SCENARIO®**

HOW TO END A RELATIONSHIP

1 Get out immediately.

The moment you realize you are in—or starting to get into—a relationship that is not working for you, just say “no.”

2 Decide on a mode of communication.

Voicemail, e-mail, or a card may be considered cowardly. However, these options have their advantages, particularly for a short-term relationship. If you are ending a long-term relationship, consider drafting a letter as a way to begin a conversation. Hand it to your partner to read while you are there.

3 Be kind.

Mention the things you like about your partner and express gratitude for the good times you have had together. This may seem contrived, but do it anyway.

4 State your position simply.

Be decisive, leaving no room for doubt or negotiation. It is not necessary for the other person to agree with you or to understand your reasons, but try to explain. One of the consequences of terminating a relationship is that you no longer have to get the other person to understand or agree.

5 Keep the focus on yourself.

Talk only about yourself, not the other person: Don't make it their fault. Say something simple and true, such as, “I prefer not to continue dating, but I want you to know how much I have enjoyed your sense of humor,” or, “This relationship just is not working for me.” If necessary, repeat these phrases.

6 Do not belabor the point.

You do not need to go over all the advantages and disadvantages of the relationship. Do not offer critical feedback or long explanations. If your real reason for breaking up might be painful for the other person to hear, do not mention it.

7 Do not try to take away the pain.

You are doing what is right for you and the other person has a right to a response. It is no longer your job to make the person feel better. Be firm but not cruel.

8 Never say, “I will call you.”

When tossed out insincerely, this phrase is unimaginative and unkind. Instead, try saying something more honest and more final: “Maybe we will see each other again sometime. If not, have a nice life.”

WORST-CASE SCENARIO.

HOW TO ESCAPE FROM A BAD DATE

FAKE AN EMERGENCY

- 1 Excuse yourself from the table.**

Tell your date that you are going to the restroom to “wash up.” Take your cell phone with you. If you do not have one, locate a restaurant phone that’s out of your date’s line of vision. Bring a restaurant matchbook or a business card that includes the restaurant’s phone number.
- 2 Call a friend or relative for help.**

Tell them to call you (either on your cell phone or on the restaurant’s phone) and pretend there has been an emergency. Believable emergencies are:

 - Personal Crisis: “My friend just broke up with her husband—she’s having a breakdown. I have to go.”
 - Business Crisis: “My boss just called—she’s in Seattle for a major presentation, and has lost all her files. I have to e-mail them to her immediately.”
 - Health Crisis: “My sister just called—our grandmother is alone and ill.”
- 3 Leave quickly before your date can protest.**

Apologize, but refuse any attempt your date makes to accompany you. If you leave swiftly and without hesitation, your date won’t have time to understand what’s happening or to object.

SLIP AWAY UNNOTICED

1 Identify your escape route.

Observe your surroundings. Take note of the exits, especially the back doors. Look for the best way out and an alternative.

2 Plan to alter your appearance.

Think about your most distinctive features and figure out how to hide or disguise them. The person you are trying to leave is going to see a figure moving past and away at a distance and will be focusing on the first impression. If you are not familiar to him and are uninteresting, you will not get a second look.

3 Excuse yourself from the table.

Move to the restroom or any private area with a mirror to begin your transformation. Your date will probably wait only two or three minutes before expecting you to return, so act quickly, before he begins looking for you.

4 Add or remove clothing.

Layering garments will change your body shape and even suggest a different gender. A long coat will obscure your body type. Hats are especially useful because they conceal your hair and facial features. Eyeglasses, whether added or removed, work wonders. A shopping bag is a handy prop and can be used to hold your belongings.



Add—or remove—eyeglasses. Roll or unroll your sleeves; tuck in or untuck your blouse. Modify your hairstyle.



5 **Change your walk and posture.**

If you usually walk quickly, move slowly. If you stand up straight, hunch over. To alter your gait, slip a pebble in one shoe or bind one of your knees with a piece of string or cloth.

6 **Use or remove cosmetics.**

Lipstick can change the shape of your mouth, heighten the color in your cheeks and nose, and even give you tired eyes if dabbed and blended on your eyelids. An eyebrow pencil can be used to add age lines, change the shape of your eyes and brows, or create facial hair.

7 **Change your hairstyle or color.**

A rubberband, hairspray, water, or any gooey substance can be useful for changing a hairstyle, darkening your hair, or altering a hairline. Borrow flour from the kitchen to lighten or gray your hair color.

8 **Adopt a cover role.**

A waiter in the restaurant may have an apron and be carrying a tray. If you can manage to procure these items, add or subtract a pair of eyeglasses and alter your hairline or hairstyle, you can become invisible as you are moving out of the restaurant, into the kitchen, and out the rear door. Or you can take on the role of a maintenance worker; carry a convenient potted plant out the front door and no one will think twice.

9 **Make your move.**

Do not look at your date.

SLIP OUT THE WINDOW

If you do not think you will be able to change your appearance enough to slip past your date, you may have to find another way to depart. Back doors are the simplest; they are often located near the restrooms or are marked as fire exits. Do not open an emergency exit door if it is alarmed unless absolutely necessary; an alarm will only draw attention. If there are no accessible alternate doors, you will need to find a window.

1 **Locate a usable window.**

Avoid windows with chicken wire or large plate glass. Bathroom windows often work best. If you are not on the ground floor, be sure there is a fire escape.

2 **Attempt to open the window.**

Do not immediately break the window, no matter how dire your need to get out.

3 **Prepare to break the window if you cannot open it.**

Make sure no one is around. If you can, lock the bathroom door.

4 **Find an implement to break the window.**

Try to avoid using your elbow, fist, or foot. Suitable implements are:

- Wastebasket
- Toilet plunger
- Handbag or briefcase
- Paper towel dispenser

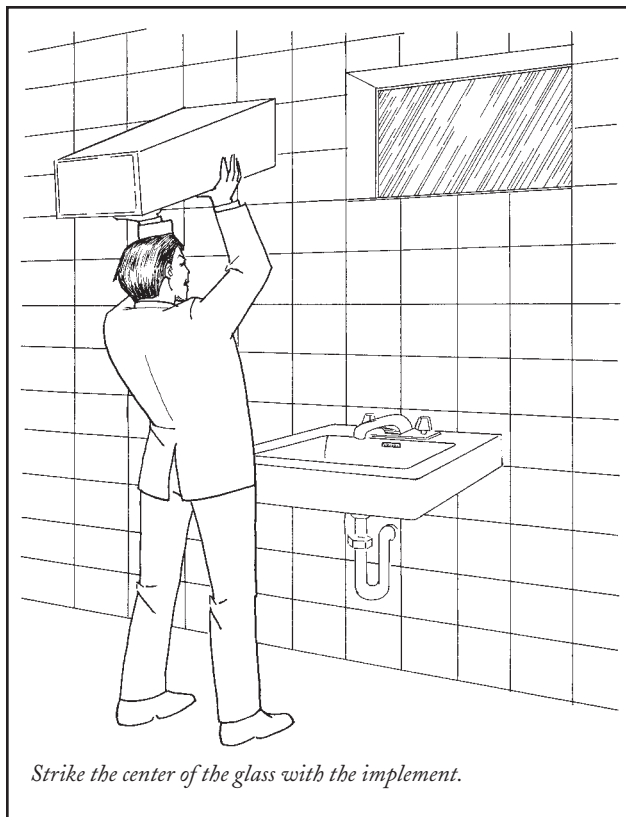

Strike the center of the glass with the implement.

- 5 Strike the center of the glass with the implement.**
If the hand holding the implement will come within a foot of the window as you break it, wrap it with a jacket or sweater before attempting to break the glass. If no implement is available, use your heavily wrapped hand; be sure you wrap your arm as well, beyond the elbow.

- 6 Punch out any remaining shards of glass.**
Cover your fist with a jacket or sweater before removing the glass.
- 7 Make your escape.**
Do not worry about any minor nicks and cuts. Run.

GET YOUR DATE TO LEAVE

- 1 Say something offensive.**
If you know your date is of a particular religion or ethnicity, make inappropriate comments.
- 2 Behave inappropriately.**
Do things that you think he will find unattractive or distasteful: chew with your mouth open, eat with your fingers, argue with the waiter, close your eyes and pretend to sleep, light matches and drop them on your plate, ignore everything he says, and/or call someone else on your cell phone.
- 3 Send your date on a “fool’s errand.”**
- Tell him you want to go to a specific nightclub, but explain that it gets very crowded and that if you are not in line by a certain time (say, fifteen minutes from then), you won’t get in. Tell your date that you have arranged to have your friend stop by the restaurant with guest passes, but that if your date does not go ahead to the nightclub to get in line, you’ll never make it inside. If your date wants your cell phone number, give the number

willingly but make sure you change one digit.
Promise you will see your date within half an hour.
Never show.

- Fake an allergy attack, and insist that he leave in search of the appropriate over-the-counter allergy medicine. Explain that you must have been allergic to something in the drink/appetizer/food/toxicab, and that if you do not obtain your medicine you will break out in hives. When your date dutifully leaves, slip away.

Be Aware

Blind dates are the riskiest form of dating—it is best to check out a potential suitor extensively before the date.

- Have a friend agree to check out your potential suitor and call you before you enter the bar/restaurant. Send your friend in with a cell phone. Situate yourself at a bar nearby, and await her call. Have her contact you when she has identified the mark.
- If you discover unsavory facts about someone you're supposed to meet, call immediately to cancel the date. Blame work and say that you have to stay late at the office, or say that you're experiencing car trouble. A more permanent solution is to say that an old flame has reentered your life; this will prevent your blind date from calling you again and asking for a rain check.

**WORST-CASE
SCENARIO®**

HOW TO FAKE AN ORGASM

1 Begin your vocal and physical ascent.

During sexual activity, start to make noise and move rhythmically.

2 Moan and cry out, building in volume and intensity.

You may say your partner's name over and over. Many people, in the thralls of ecstasy, will blurt out sentences or requests that are utterly incomprehensible: try this occasionally.

3 Move faster rhythmically and then increasingly "out of control."

As you approach "climax," increase the tempo of your movements, particularly of the hips. Add jerky movements. If you have not moved or vocalized much before you start to fake the orgasm, it will seem all the more fake, so you might need to fake enjoyment all the way through. (Note: If you do not usually move your hips during sex, try it. You may find it affects your arousal enough that you will need less faking.)

4 Contract your muscles.

For many people, this is an involuntary side effect of an orgasm; the classic examples are toe-curling or fingers clutching the sheets. You might also arch your back, scrunch your facial muscles, or open your mouth wide.

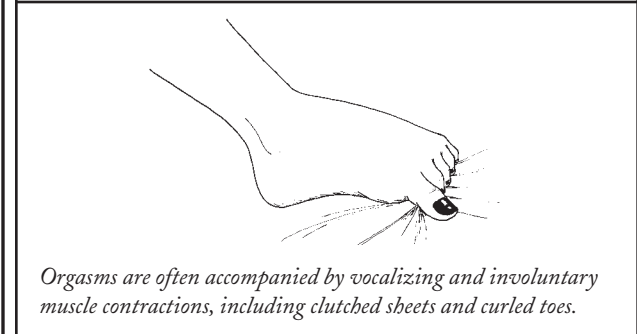
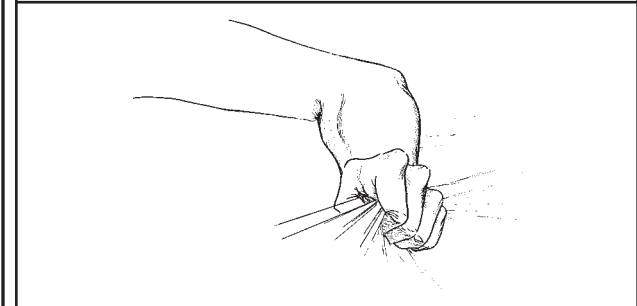
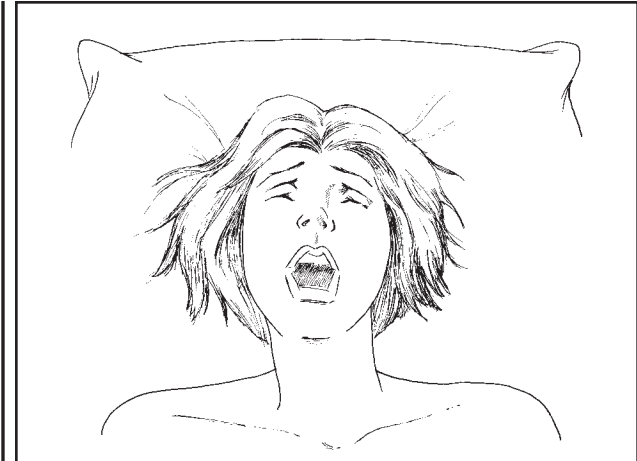

Orgasms are often accompanied by vocalizing and involuntary muscle contractions, including clutched sheets and curled toes.

5 Ratchet up the moaning and writhing in volume and intensity.

6 Culminate in a loud moan or cry.

7 Slow down immediately, tensing your body.

8 Relax, as if exhausted or spent.

Smile with enjoyment.

HOW TO DETECT A REAL ORGASM

Real orgasms are not always as theatrical and loud as fake ones. Some people are silent comers and do not exhibit many visible signs. Real orgasms tend to have some or all of the following elements:

- changes in breathing
- increased vocalizations
- intensified movements
- involuntary muscle contractions
- a pink or reddish flush on the face and chest
- sweat on the shoulders
- and pelvic muscle contractions.

Be Aware

- Be sure that you want to fake the orgasm. You will be sending your partner a message that you are enjoying the sex more than you really are. If your partner is an ongoing lover or spouse, think hard before giving him or her the impression that he or she is doing everything right when that is not the case. If you are enjoying a one-night encounter, consider why it should make a difference to you if your partner thinks you have had an orgasm or not.
- Men can fake orgasms too, particularly if a condom is being used.
- Do not accuse your partner of faking an orgasm if they are not demonstrative, spasmodic, and loud. Conversely, do not accuse your partner of faking if they display all the characteristics of a faked orgasm.

WORST-CASE SCENARIO.

HOW TO FEND OFF A PICKUP ARTIST

- 1 Recognize the traits of a pickup artist.**

Is your suitor overly charming and quick with cash? Does he appear to have an immediate connection with you? Is he scanning the room while talking to you? Is he calling you familiar or condescending names such as “honey,” “sweetie,” or “babe”?
- 2 Do not accept drinks.**

Letting a pickup artist buy you drinks will encourage him and make him feel he is entitled to your attentions.
- 3 Keep personal information to yourself.**

Do not give him your name, and do not tell him where you live, who you are waiting for, or any other detail or insight into your personal life or plans.
- 4 Make it clear that you are not interested.**

Be direct and forceful. If he persists, you may have to become rude or leave. If you make it obvious that nothing is going to happen that evening, he’ll move on to other prospects.
- 5 Turn away and ignore him.**

Talk to a friend or the person sitting on the other side of you. The pickup artist likes the chase most of all—put a stop to the chase and he will look elsewhere.



The Elbow Knock: Turn back to glance at the pickup artist and sweep your elbow toward the glass.



The Time Check: Turn your wrist to look at your watch, and spill your drink on the pickup artist.

6 Cause an “accident.”

- **The Elbow Knock:** Use this technique if you are seated at a bar or table. Notice where glasses and plates are located on your table. Turn around to talk to a friend, or simply look away, and position your elbow. As you turn back, sweep your elbow into any glasses or plates on the table, knocking them into his lap or onto his shirt.
- **The Hair Flip:** While standing facing your suitor, bring your hand up to adjust your hair. Do this quickly so that he tips his glass toward his body and his drink spills all over him.
- **The Time Check:** While standing next to your would-be suitor, hold your drink in the hand of your watch arm. Say, “Is it *time* yet?” Then turn your wrist to look at your watch, thereby spilling the drink on the pickup artist.

7 Apologize insincerely.

HOW TO FEND OFF AN OBSESSIVE EX

1 **Make your rejection final and firm.**

Do not give your ex a chance to manipulate or negotiate. Refuse all offers for dates, favors, and “friendly meetings.” Express your wish to be left alone. Make sure your body language sends the same message. Do not touch during the rejection, but look your ex firmly in the eyes.

2 **Do not discuss the past.**

Never mention the good times you had together. Instead, speak enthusiastically about how happy you are now, and make it clear that you have moved on with your life.

3 **Immediately sever all ties.**

Return all of your ex’s belongings (including any gifts to you) in one shipment. Do not prolong the process. If your ex continues to call, get a new, unlisted phone number. Do not call or send cards, letters, or e-mails; these will result in a mixed message and may give your ex hope of reconciliation.

4 **If your ex will not leave you alone, sound a warning.**

At the first sign that your ex is not listening to you, announce that if the unwanted behavior persists, you will take action. Threaten to contact the authorities, and be prepared to do so. Do not give in to any threats that may come your way. Be ready to secure

a restraining order or civil protection order if it becomes necessary for your peace of mind.

5 **Inform your family, friends, and co-workers about the situation.**

Having larger, stronger friends around may serve as a deterrent.

6 **Keep a paper trail.**

You may need evidence later. Save any relevant letters, notes, e-mails, and voicemails—anything that can prove unwanted attention. Maintain a log or diary of your ex’s actions and report any unlawful behavior to the police immediately. Report phone calls from your ex to both the phone company and the police. Write down your caller ID log, if you have one.

7 **Inform the authorities.**

Do not let fear of retribution stop you from taking action. If your ex persists in contacting you, becomes easily enraged by your rejections, is overly interested in your private life, or shows up in unexpected locations, he or she has become a stalker. Take legal action immediately and obtain a restraining order.

8 **Move.**

Make sure that your new address is unlisted. Contact the department of motor vehicles and the voter registration bureau to have them block your address. Forward your mail to a P.O. box, and do not accept any packages unless you are certain who sent them.

9

Take steps to preserve your safety.

Get a cell phone and carry it with you at all times. Consider getting a guard dog and taking self-defense classes.

Be Aware

If your ex shows up where you work, notify co-workers of the situation and vary the times you come and go from work. If possible, have someone accompany you as you approach the building.

**WORST-CASE
SCENARIO®**

WORST-CASE SCENARIO.

HOW TO FEND OFF COMPETITORS FOR YOUR DATE

- 1 Evaluate the situation.**

Are you on a first date that is not going well? Is your date paying more attention to the interloper than to you? Do you want to continue dating this person?
- 2 Determine the seriousness of the offense.**

Is it a passing rude drunk, a persistent boor, or someone seriously interested in leaving with your date? How big is the interloper? These factors will determine your response.
- 3 Stand your ground.**

Put your arms around your date, whisper in her ear, and kiss and caress her. Show the suitor that your date is enamored with you, and you with her.
- 4 Place yourself in the “pickup screen” position.**

Wedge yourself between the suitor and your date, with your back to the suitor. Try to block the suitor’s path of vision. An “accidental” bump or push with your shoulders or buttocks may be appropriate.

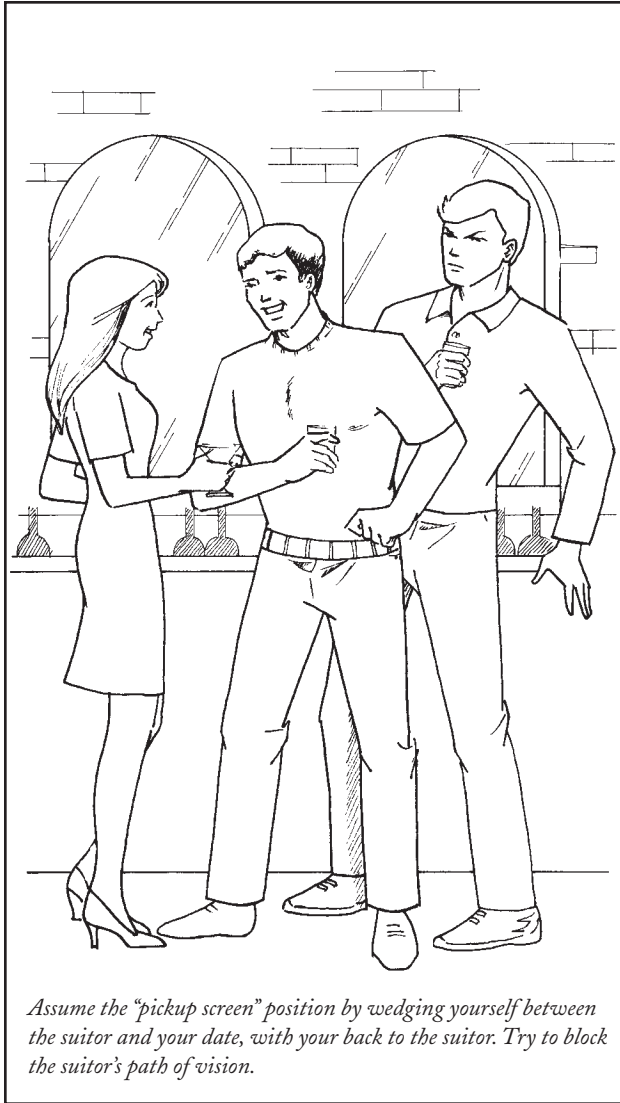

Assume the "pickup screen" position by wedging yourself between the suitor and your date, with your back to the suitor. Try to block the suitor's path of vision.

- 5** **Ask the interloper to stop.**
Politely but firmly explain that you are trying to have a conversation with your date and that you would both prefer to be left alone. If the suitor persists, use humor or sarcasm to diffuse the situation. Tell him you can offer him a few phone numbers, or tell him that tonight she's taken, but you will let him know when she's available.
- 6** **If the suitor is with friends, enlist their help to rein him in.**
- 7** **Ask your date tell the suitor to back off.**
Your date should tell him that she's flattered but not interested.
- 8** **Try to leave.**
If given the choice, choose flight over fight. Suggest to your date that you both move to a table or go to a new establishment. A fight generally doesn't make the evening go any better.

HOW TO TREAT A BLACK EYE

- 1** **Make a cold compress.**
Put crushed ice in a plastic bag and wrap the bag in a thin piece of cloth. Alternatively, use a bag of frozen vegetables or a cold, raw steak.

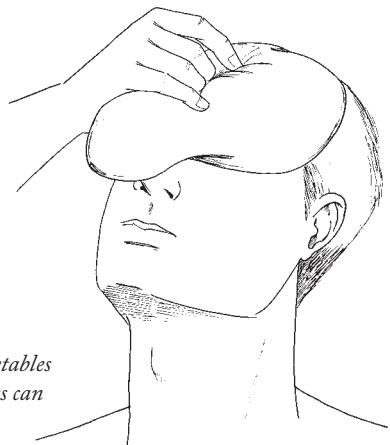

A bag of frozen vegetables applied as a compress can reduce swelling.

2 Sit down, tilt your head back, and cover your eye with the compress.

Use minimal pressure. This position allows gravity to aid in swelling reduction. If the compress is too cold to hold over your eye, use a thicker cloth. Keep the compress over your eye for an hour.

3 Take a painkiller.

For pain, take acetaminophen or ibuprofen.

HOW TO TREAT A BROKEN NOSE

1 Stop the bleeding.

Tilt your head back slightly. Pinch the bridge of your nose (the region just below the hard cartilage) closed, not just the nostrils. Hold a tissue underneath your nostrils to catch the blood.

2 Apply a cold pack or ice immediately.

Keep your head tilted back. Continue to apply ice as needed to keep the swelling down.

3 Do not reset a broken nose yourself.

The only reason for you to attempt to relocate the position of the nose is if you are having trouble breathing through your mouth. If you aren't getting any air, you can attempt to adjust the position of your nose so that you can breathe through it, but this will be quite painful.

4 Seek medical attention.



If your nose is broken, pinch the bridge of your nose (the region just below the hard cartilage) closed, not the nostrils. Hold a tissue underneath your nostrils to catch the blood.

Be Aware

The following symptoms indicate a more serious injury and the immediate need for professional care:

- Bleeding from the nose does not stop within 10 minutes
- Bleeding from both nostrils
- Trouble breathing through your nose
- Eye pain, trouble seeing, or blood on the surface of the eye
- Clear, watery fluid leaking out of the nose after the injury
- Swelling, bruising, or tenderness extending over the cheek area or below the eye

**WORST-CASE
SCENARIO®**

HOW TO GET AN EMERGENCY RESERVATION

BRIBE

- 1 Determine how much to offer the maitre d' as a bribe.**

The right amount will depend on the exclusivity and reputation of the establishment. Offer a minimum of \$10. You usually get only one chance to try the bribe.
- 2 Fold the bill into your right palm.**

Hold it between your thumb and forefinger.
- 3 Pass the bribe.**

Shake his hand as you tell him how you are sure that he understands how important this night is to you. Be prepared, however, for the occasional maitre d' who takes your money and does not honor your request.

SOB STORY

- 1 Talk calmly to the maitre d'.**

Controlled pleading can prove effective if you bend the right ear at the right time. A friendly, familiar demeanor is most likely to get the first available table. A whiny or arrogant voice will not help at all. If the maitre d' looks harried, wait until he or she has a moment to focus on you.

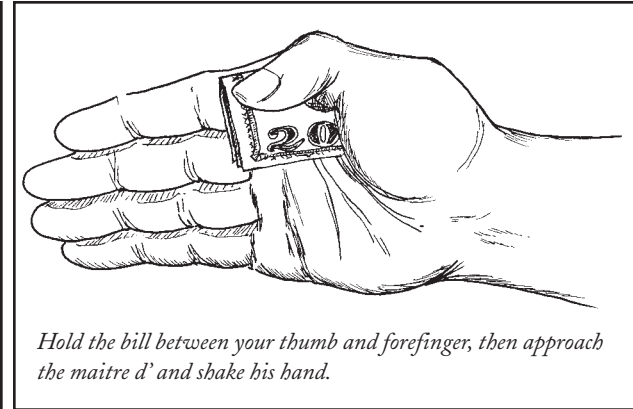

Hold the bill between your thumb and forefinger, then approach the maitre d' and shake his hand.

- 2 Explain your situation.**

Be sure to stress the importance of the evening and the special need for a table, embellishing the facts as necessary: an anniversary dinner, a plan to propose marriage (but be prepared to produce a ring), a recovery from a long illness, an overdue reunion.
- 3 Speak with emotion.**

Catch your voice, have difficulty breathing, shed a tear. You become harder to ignore. Also, the maitre d' will not want you upsetting the other waiting guests and creating a scene.
- 4 Appeal to the host's understanding nature.**

Create the impression that you would be especially embarrassed in front of your date, since you told her you had a reservation.

5 **Look to fellow diners for sympathy.**

If you cannot sway the host or maitre d', approach other diners and bribe or persuade them into giving up their table. Use the special event strategy (step 2, above). However, be careful to avoid offending the patrons or embarrassing your date. It is best to try this when your date leaves your side for a moment.

6 **Pull rank.**

Your final option is to play the “do you know who I am?” card. Unfortunately, you actually have to be somebody for this one to work.

Be Aware

- Do not try the “lost reservation” ploy; no one believes it anyway. Claiming that the restaurant is at fault for misplacing your reservation provokes confrontation rather than conciliation, and rarely results in a table.
- You can try the “celebrity name drop,” but it could backfire. Asking for a table in the name of a celebrity will sometimes get you seated even though the celebrity is “late” in arriving, but the host may also ask you to wait until your group is all present before seating you—and you will be precluded from using other tactics.

**WORST-CASE
SCENARIO®**

HOW TO HAVE AN AFFAIR AND NOT GET CAUGHT

1 Assemble an array of convincing alibis and witnesses to explain your frequent disappearances.

Telling your partner “I have to work late” will only get you so far. Enlist the help of a friend or colleague, and have them “invite” you to a reception or sports event, or call with an “emergency.” Create a false trail of evidence by having them leave messages on your answering machine that your partner will hear.

2 Do not make multiple, obvious changes to your lifestyle.

Do not alter the way you dress or the foods you eat all at once. This will tip off your partner that something has changed.

3 Do not discuss topics you previously knew nothing about.

If your lover has encouraged you to become interested in sports or cooking or opera or other topics you never cared about, do not suddenly start talking about them with your partner, who may wonder—or ask—how you knew that.



Always pay cash. Avoid credit cards.



Use cell phones. Never use the hotel phone.

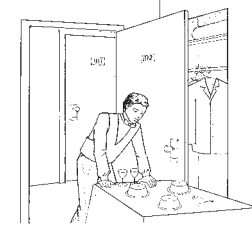

Use room service. Avoid popular restaurants.



Always drive separately. Never drive together.

- 4 Do not change all your sexual habits at once.**
An affair might make you more sexually adventurous, but do not try too many new things at once with your partner.
- 5 Never leave for work wearing one outfit and return wearing another.**
Keep a change of clothing in your car or at your office and wear that outfit with your lover. Afterward, change back into the clothing you wore when you left home. This will help avoid evidence of your indiscretion (e.g., lipstick, cologne or perfume, or inappropriate wrinkles). Make sure that you do the laundry that contains your “affair” clothing.
- 6 Take a shower to remove the scent of the affair.**
Bathing is especially necessary if you have been in a smoky bar, if your lover wears strong aftershave or perfume, or if you have a dog waiting at home.
- 7 Never call your partner from a hotel or motel phone, or from a restaurant.**
Use your cell phone only—caller ID may reveal your whereabouts.
- 8 Pay bills in cash only.**
Never use a credit card to charge meals, hotels, or day trips. Your partner will probably notice the increase in spending or find the charge slip. Make sure you have enough cash before you head off to your rendezvous; cash machine usage is traceable as well.

- 9 Drive in a separate car from your lover.**
Should there be an accident or a police incident, there will not be any official record of another passenger in the car with you. There will also be no unintentional physical traces—adjusted seat, forgotten scarf—of the passenger.
- 10 Do not go to fancy or popular restaurants with your lover.**
Out-of-the-way places are best; you are less likely to be spotted by friends of your partner. Places just out of town are even better. Room service in a hotel is very private.

IF YOU ARE CAUGHT

- 1 Do not deny your guilt.**
Admit your indiscretion immediately. Dissembling only makes matters worse.
- 2 Decide immediately whether or not you want to continue the affair.**
You will have to be clear about your choice. Ask yourself if you would rather continue with the lover or with your partner. Be honest with yourself and act accordingly.
- 3 If you want out of your relationship, cut the cord immediately and be ruthless.**
Do not try to be nice or understanding—it will only make things more difficult for your soon-to-be-ex-partner. Be a jerk—it will make it easier for them to

move on. Explain that you have simply fallen for someone else, that you can't help it, and that you realize that your relationship must end.

4 **If you want to continue your relationship, be prepared to work hard.**

Regaining trust will be a long haul. Proceed to steps 5 through 7.

5 **Be completely honest with your partner.**

Answer all questions and admit your wrongdoing fully. Constantly reiterate how much you care for your partner. Your steadfastness and honesty is your only hope. Gifts can be an essential part of making up, but mostly you will have to put in a lot of time and energy to make amends.

6 **Do not give up on the relationship.**

Prepare yourself for many difficult conversations and arguments. You will have to explain your true intentions time and time again, and it may be a struggle even to begin a conversation at times. Do not take the easy way out. If kicked out of the house, do not leave easily; make it clear that you are willing to struggle through whatever you are faced with to make the relationship work.

7 **Avoid all contact with your former lover and potential lovers.**

Never look at or discuss someone of the opposite sex unless specifically asked to do so by your partner—and even then, be cautious.

**WORST-CASE
SCENARIO.**

WORST-CASE SCENARIO.

HOW TO HAVE SEX IN A SMALL SPACE

AIRPLANE LAVATORY

- 1 Pick a rendezvous time.**

Select a time when you are least likely to have to wait in line and when you will not be disturbed. The best times are just before the plane reaches cruising altitude or during the in-flight entertainment.
- 2 As the plane is ascending, listen for a beep from the in-flight messaging system.**

The first beep comes without a subsequent announcement and indicates to the flight attendants that cruising altitude has almost been reached and that it is safe to begin their preparations. The FASTEN YOUR SEATBELT sign will still be illuminated, but the flight attendants will get up. As soon as the flight attendants clear the aisle, head for the lavatory. Try to select one that is not visible from the galleys. Have your date wait at least a minute, then meet you in the lavatory. You should hear the beverage carts roll by. After a few minutes, the flight attendants will begin to serve drinks, blocking the aisle from passenger access. Alternatively, or in addition, proceed to step 3.
- 3 Meet during the movie.**

Plan your rendezvous for the beginning of the film, preferably when the film is at least fifteen minutes

underway. Most passengers and flight attendants stay out of the aisles and galley areas during the entertainment portion of the flight, so you will have more privacy. You should proceed to the lavatory first, to be followed a minute later by your date.

4 Put down the toilet seat lid and clean it.

Wipe the seat with sani-wipes if they are available, or use a wet paper towel with soap. Place paper towels or a sanitary toilet seat cover on top for extra protection.

5 Be quiet and be quick.

You will not have a lot of time before people are lining up to get into the restroom.

6 Be ready for turbulence.

The safest positions involve one partner sitting on the closed toilet seat. Then, in the event of bumpy air, neither partner will be too close to the ceiling, risking a concussion.

7 If you do encounter turbulence, hold on.

Brace yourself against the sink and do not try to stand up or move. Stay where you are and ride it out.

8 Exit the lavatory together, feigning illness.

It is illegal to have sex in an airplane bathroom—so deny it in the unlikely event that you are asked. Tell the flight attendant or other passengers that one of you was ill and the other was offering assistance.

ELEVATOR

1 Find a building with an older elevator.

Many older elevators have an emergency STOP button that will allow you to halt the elevator. On other units, flipping the switch from RUN to STOP will cause an alarm bell to sound. You will still have plenty of time, at least ten or fifteen minutes, possibly as long as an hour, before firefighters or other emergency personnel are able to access the elevator cabin.

2 Alternatively, look for a freight elevator with padding on the walls.

Freight elevators will be less likely to have an alarm that sounds when the STOP switch is thrown. The padding may also muffle sound and provide comfort.

3 Look for a camera.

Virtually all new elevators have security cameras, as do some older ones, including freight elevators. If a camera is present, cover the camera lens—it will probably be in a rear corner—with a piece of tape or with several postage stamps. The security system may include audio as well, however.

4 Stop the elevator between floors.

Elevator doors house a mechanical clutch that opens the corridor (outer) doors. If the elevator is not level with a floor, the corridor doors cannot open, and someone from the outside will not easily be able to open the inner doors.

- 5** Release the STOP button or flip the switch to RUN when you are ready to leave.

Exit the elevator normally. If emergency personnel are present, tell them there was a malfunction but that you are okay.

Be Aware

If the elevator is stopped level with a floor, an elevator technician will be able to open both the outer (corridor) doors and the inner (elevator) doors from the outside.

DRESSING ROOM

- 1** Look for a dressing room that has a door and walls that extend to the floor.

If all the dressing rooms have a gap between the floor and the walls, look for one with a secure door, rather than a curtain. If you are in a store that has several dressing rooms, look for the least-trafficked or least-monitored areas. Some dressing rooms have very hard-to-detect security systems—including two-way mirrors—so you cannot guarantee that you will not be seen.

- 2** Carry clothes as if you are going to try them on.

Trail after a demanding customer who is requiring the attentions of the sales associate on duty. When the employee is occupied, make your move and duck into the dressing room.

- 3** Have your partner follow behind a few minutes later.

- 4** Be quiet.

The walls to dressing rooms are thin.

- 5** Be quick.

Speed is important, especially if your legs are visible beneath the walls.

- 6** Depart from the dressing room one person at a time.

Check your appearance in the mirror, and leave the store's clothes in the dressing room. If you are in the women's section of a department store, the woman should leave first and make sure the coast is clear. If you are in the men's department, the man should leave first.

Be Aware

For speed and efficiency in airplanes, elevators, and dressing rooms, be sure to wear loose, baggy clothing. Do not wear underwear.

WORST-CASE SCENARIO.

HOW TO REMOVE DIFFICULT CLOTHING

BACK-CLASPING BRA (WITH ONE HAND)

- 1 Move your date forward.**

If your date is lying on her back or leaning against a sofa, you will not have the necessary space to attempt this maneuver. Use a gentle embrace to guide her into a position so that you have access to her back.
- 2 Visualize the clasp.**

Most bras have a hook-and-eye closure. The hooks are generally on her right side; the eyes will be on her left side.
- 3 Reach your right hand around to the clasp.**

Bend your index finger over the bra clasp and place it between the fabric and her skin.
- 4 Brace your thumb against the eyes of the clasp.**
- 5 Holding your index finger down, push the hook-side of the bra with your thumb.**

It may take a few attempts before you get good at this, so do not be discouraged—try again.
- 6 Slide the now-open bra off her arms.**

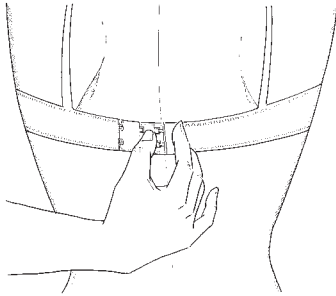

Brace your thumb against the eyes of the clasp.

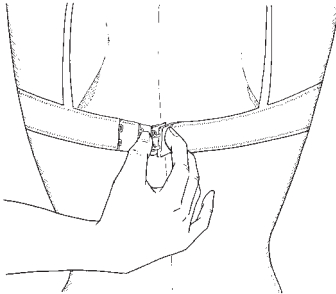

Holding your index finger down, push the hookside of the bra with your thumb.

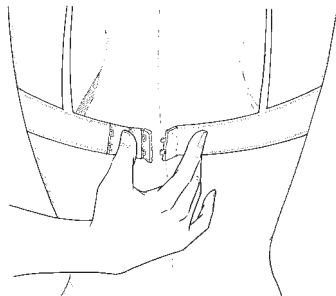

Slide the now-open bra off her arms.

Be Aware

The bigger the breasts, the bigger the challenge, since the closure on her bra is bearing more weight and is likely to be more taut.

FRONT-CLASPING BRA

- 1 Determine the type of clasp.**

There are two different varieties: a pin-in-slot clasp, which has a pin inserted vertically in a slot, and a clicker clasp. Clicker clasps, when closed, often look like a circle or an oval.
- 2 For a pin-in-slot clasp, pull the pin upward.**

This will free the two cups, and you can proceed to step 4.
- 3 For a clicker clasp, push both ends away from you.**

Place your thumbs at the center of the clasp and, using a motion similar to snapping a small wafer in half, apply pressure until it unclicks. Then lift up and separate the two halves of the closure. Depending on the clasp, you will need to raise either the left side or the right side first; try it one way, then the other.
- 4 Slide the now-open bra off her arms.**

Be Aware

To maximize intimacy, maintain eye contact throughout the entire process. Do not look away unless you need to take a quick glance at the closure.

TIGHT BOOTS

1 Sprinkle powder down the shaft of each boot.

Talcum powder or baking powder will reduce the sweat and humidity inside the boots, making them easier to remove.

2 Position your date on the edge of a bed or couch.

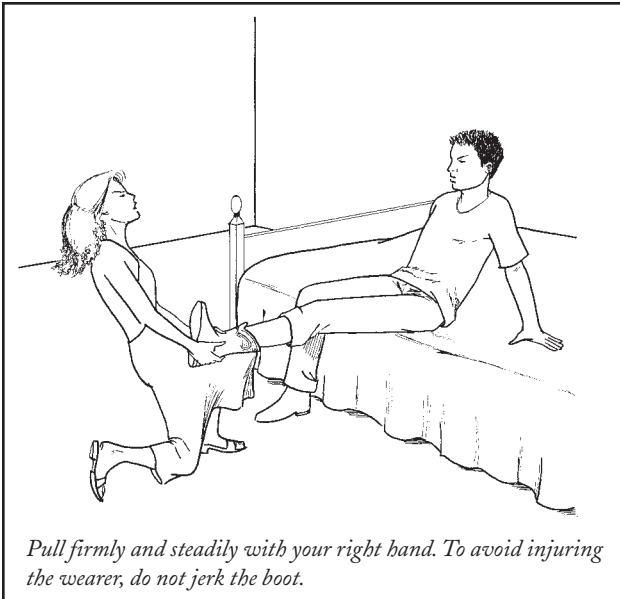

Pull firmly and steadily with your right hand. To avoid injuring the wearer, do not jerk the boot.

3 Position yourself opposite your date.

Sit in a chair braced against a wall, or rest one knee on the floor with the other foot flat on the floor.

4 Cup the heel of the boot in your right hand.

Place your left hand on the area of the boot that covers the front of the leg/shin. Instruct your date to relax the foot in the boot.

5 Pull firmly and steadily with your right hand.

You should feel some give in the heel. When you cannot move the boot anymore, gently rock the boot back and forth. Your date should point the foot only slightly. To avoid injuring the wearer, do not jerk the boot.

6 Slide the boot off slowly.

Caress the newly released foot.

WORST-CASE SCENARIO.

HOW TO SAVE YOUR DATE FROM CHOKING

- 1** **Speak firmly.**
Keep your voice low and your sentences short. All communications should be in the imperative. Explain that you are going to perform the Heimlich maneuver.
- 2** **Tell your date to stand up and stay put.**
- 3** **Hug your date from behind.**
Put your arms around your date and make one hand into a fist.
- 4** **Place your fist in your date's solar plexus.**
The solar plexus is the first soft spot in the center of the body, between the navel and the ribs.
- 5** **Place your other hand, palm open, over your fist.**
- 6** **Tell your date to bend forward slightly.**
If your date does not respond, push on the upper back and repeat, "Lean forward."
- 7** **Pull your fist in and up.**
Use force and a quick motion. This will push out the residual lung gas under pressure, clearing any obstructions from the trachea.

8 Repeat steps 3 through 7 several times if choking persists.

9 After several unsuccessful attempts, instruct your date to bend over the back of a chair.

The top of the chair should be at the level of your date's hips.

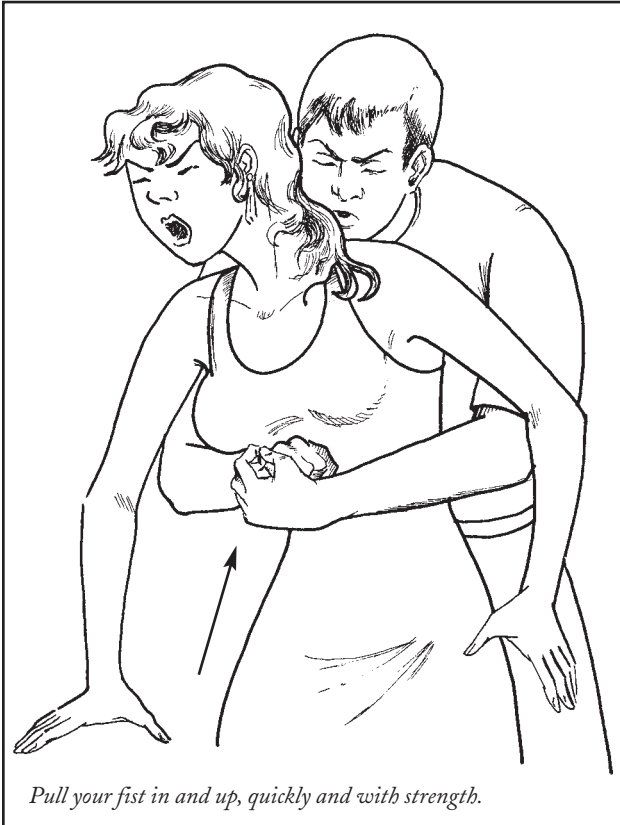

Pull your fist in and up, quickly and with strength.



Strike your date between the shoulder blades with the heel of your open hand.

10 Strike your date between the shoulder blades with the heel of your open hand.

The blow generates gaseous pressure in a blocked airway and, with a head-down position, sometimes works when the Heimlich does not.

Be Aware

- If the choking is noiseless—or if your date raises her hands to her throat—then the air passage may be completely blocked and you must proceed quickly.
- If your date is coughing or gagging, you simply need to be polite, smile sympathetically, and offer water when the choking is over. Water does nothing for choking, but it gives the choker some time to regain dignity.
- In most cases, the first thrust of the Heimlich maneuver will dislodge the choked item from the trachea. Once the choking is over, your date will need some time to recover: a sip of brandy, a quiet moment. Do not rush your date to the emergency room; in most cases, there is no need to go to the hospital after the blockage has been removed.

**WORST-CASE
SCENARIO®**

HOW TO SOBER UP FAST

1 Avoid pills.

Do not take ibuprofen, acetaminophen, or aspirin just before, during, or after drinking. Acetaminophen may cause liver damage in conjunction with alcohol. Ibuprofen can cause severe stomach irritation. Aspirin thins the blood, which may exacerbate a hangover.

2 Drink lots of fluids.

Dehydration from alcohol can be treated with water, sweet juices, or sports drinks. Orange juice and tomato juice contain potassium, which will help overcome the shaky feeling of a major hangover.

3 Take vitamins.

A good multivitamin or vitamin B complex combats vitamin depletion.

4 Eat.

Starchy foods—bread, crackers, rice, or pasta—break down into sugar, which speeds absorption of alcohol into your system. A spoonful of honey (which is high in fructose) helps to quickly burn off any remaining alcohol in the stomach. Listen to your body's cravings: if eggs sound good, eat them. If something spicy sounds better, eat that. There are no right or wrong things to eat; just take your food slowly and in small amounts.

5 Rest or sleep for as long as possible.

6 Repeat steps 2 through 5 if you wake up with a hangover.

HOW TO PREVENT A HANGOVER

- Eat before you begin to drink and snack while drinking.
- If you do not eat, coat your stomach with a full glass of milk.
- Pace yourself and drink water between drinks.
- Drink clear liquors. Some spirits are higher in congeners (impurities) than others; red wine, brandies (including cognac), and whiskies usually have more than other types of alcohol. Generally, the clearer your spirit, the fewer impurities and the less severe the hangover.
- Champagne and mixed drinks made with carbonated sodas allow for faster alcohol absorption; they should be sipped slowly.
- Know your limits. In most states, a Blood Alcohol Content (B.A.C.) of .10 means you are legally drunk—and some states now use the stricter .08 B.A.C. For most average-size adults, this can mean as few as two drinks in an hour.
- Do not mix your liquors. Each spirit has different toxins that must be processed by your liver. It is best not to overload it.
- Before going to bed, have a snack of a banana or cheese and crackers.
- Keep water beside your bed and drink it if you awaken during the night.

HOW TO SPOT A FAKE

BREAST IMPLANTS

- 1 Remember: if they look too good to be true, they probably are.**

If a woman is over thirty and her breasts defy gravity without a bra or she has a strikingly full and firm upper cleavage and bosom, chances are her breasts are not fully natural. You should also be suspicious of breasts that sit very high on a woman's chest; this is another good sign of implants.

- 2 Assess breast size as compared to frame size.**

Most, though not all, petite women have naturally small breasts.

- 3 Be suspicious of baseball-shaped breasts or strangely arranged breasts.**

In cases of a poor augmentation, the outline of the implant may be noticeable, or the breast may have a very firm, round, baseball-like appearance. Poorly placed implants can often be seen through tight tops. While a good augmentation procedure can be difficult to detect by visual inspection alone, a bad one is quite noticeable.

- 4 Check cleavage for rippling of the skin.**

Implants may ripple in the cleavage or on top of the breasts; look for a wave pattern across the surface.



Natural breasts, even very large breasts, although soft, will never have a rippled appearance.

- 5 If appropriate, brush up against or hug someone with suspected breast implants.**

If her breasts feel firmer than normal, implants may be in use.

- 6 Check under and around the breast for scarring.**

In an intimate situation, the opportunity may arise for a closer visual and tactile inspection. Look for scarring under the breasts, around the nipple, and in the armpit area.

TOUPEES

1 Look for uneven hair texture.

Since toupees do not cover the entire scalp like a wig does, there will always be a place where the real hair meets the purchased hairpiece. Generally, men who wear toupees have thinning hair, so look for a patch of thick hair surrounded by areas with thinner coverage.

2 Beware of an abnormally thick patch of hair on the top of the scalp.

Toupees are very thick in order to effectively cover the nylon or fabric cap that is attached to the scalp.

3 Watch for inconsistent coloring.

Toupees generally do not perfectly match the color of the hair surrounding them. A very dark area of hair surrounded by thinner, lighter hair may indicate a toupee.

4 Note any shifting of hair on the scalp.

Toupees are usually attached to the scalp with wig tape or special adhesive, which can come loose, especially during high winds or excessive perspiration. A patch of hair that has moved or is out of place is a sure sign of a toupee.

5 Test your theory.

Reach for your date's head, saying, "You've got something in your hair." If he reacts quickly to stop you from touching his hair, you may have found a toupee.

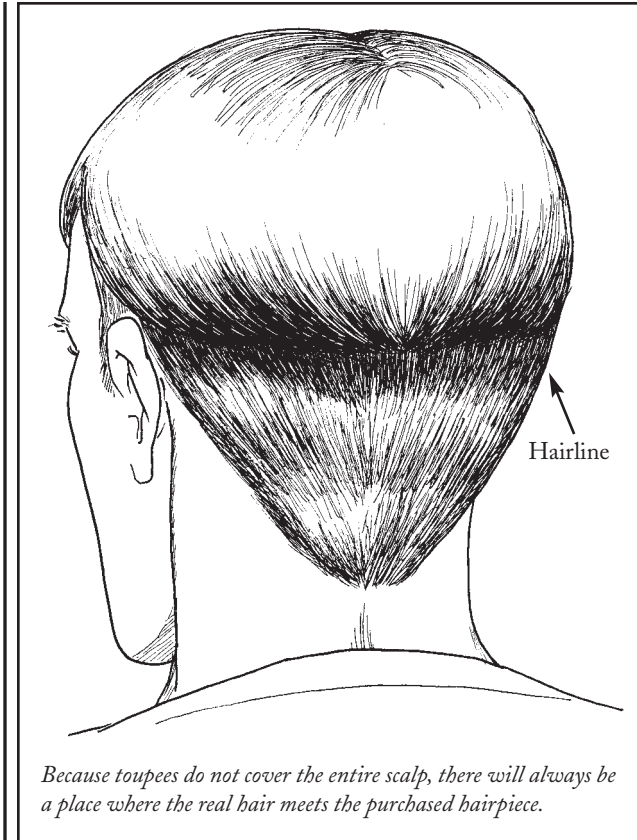

Be Aware

Many men with thinning hair choose hair plugs, which are hair follicles that have been surgically implanted in the scalp. Lots of small bumps that resemble knots at the base of the hair shafts are a good indicator of hair plugs.

WORST-CASE SCENARIO.

HOW TO STOP A WEDDING

If the object of your affection is about to marry someone else, you need to act quickly to present your case or forever hold your peace.

1 Make your feelings known before the service.

If you cannot appeal directly to the bride (or groom), ask to speak to the officiant. The officiant should be trained in how to handle such situations (go to step 4).

2 If you cannot stop the ceremony beforehand, wait until the ceremony.

When you hear the officiant ask, “Does anyone know a reason why these two people should not wed?” stand up, say “I do,” and approach the wedding party. (If you do not wish to speak out, proceed to step 5.)

3 Ask the officiant if you can present your concerns in private.

4 Present your objections.

The bride and groom will most likely join you and the officiant for a consultation. If all agree with you (very unlikely), the wedding will be halted. If the service is to continue, respect the decision and leave immediately. Expect to be escorted from the premises.

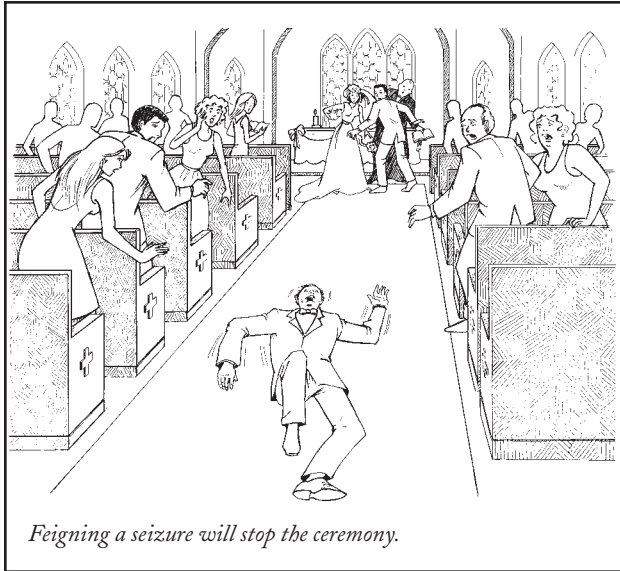

5 **If you do not have the courage to speak up during the ceremony, feign illness.**

Fainting is a common occurrence at weddings, and faking it may not stop the ceremony. Instead, feign a seizure. Be sure to act before the vows are spoken. During the commotion while you are being carried out, insist on speaking with the officiant and then confess your feelings.

6 **Pull the fire alarm.**

If you cannot fake illness, pull the fire alarm. This will disrupt the ceremony, but will only delay the service until the alarm can be turned off. Use this time to speak with the officiant.

7 **If the ceremony has been completed, prevent the signing of the wedding license.**

This is your last chance to prevent the marriage. Exchanging vows may make the marriage legitimate in the eyes of most people, but not necessarily in the eyes of the law. All states require a certificate of marriage signed by the officiant, bride, and groom. Traditionally, this document is not signed until after the service. Immediately after the ceremony, speak to the officiant and try to prevent the signing.

8 **If the license has been signed, try to prevent the marriage from being consummated.**

In some states and in some religions, the marriage is not final until physical consummation. Find out where the bride and groom are planning to spend the first night and profess your love one last time. If that fails, your only hope is divorce.

HOW TO SURVIVE A FASHION EMERGENCY

SHIRT CAUGHT IN ZIPPER

- 1** Slide your hand inside the front of the pants above the zipper area.
- 2** Lower your hand until you reach the shirttail.
- 3** Pull the stuck fabric taut and upward.
- 4** Guide the zipper down with your free hand.
Apply steady force to the zipper: pull but don't yank too hard. Be careful not to pinch your fingers. Also, be sure to keep the garment away from the body, so the teeth of the zipper don't bite your skin. This is especially important if you're not wearing underwear.

SPLASHED BY A TAXI

- If you are splashed with water, head for the nearest restroom and use the hot-air hand dryer. Stand very close to the dryer and rock from side to side, using your hands to billow and fluff whichever garment is wet.
- If you are splattered with mud, add a dash of salt to a glass of club soda from the closest bar and dab

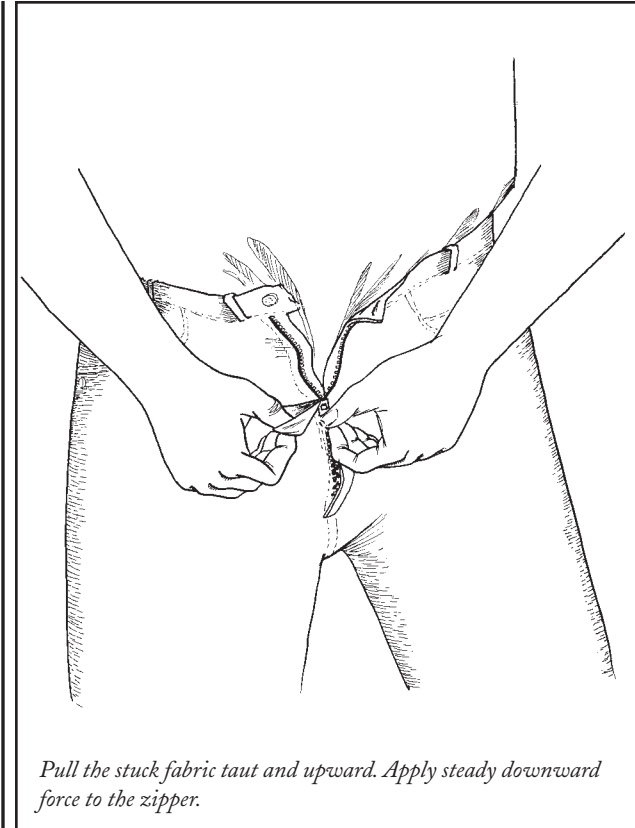

it onto the dirty spots. The soda will work on the mud; the salt will lift out any oil from the street that was mixed in with the mud.

- If you are wearing a skirt, turn it around so that the splash is less visible. Untuck a shirt or blouse to cover a splashed skirt or pants.

WINE STAIN

- For white wine, wet a cloth napkin with cold water and dab the stain. Avoid hot water, which will set the stain.
- For red wine, soak a cloth napkin with white wine and apply to the stain area. Then dab the stain with cool water.
- Rub toothpaste—the white, pasty kind only—onto the stain to make it easier to clean later.
- If you spilled the wine on your date, apologize, offer to pay the dry cleaning bill, and immediately pour or order another glass of wine.

LIPSTICK STAIN

- Apply a generous amount of petroleum jelly to the spot. Baby wipes or wet towelettes will also remove most of the stain. Dry clean as soon as possible.
- Use a scarf to camouflage the area, unless it is on your date's pants.

RIPPED STOCKING

- Use clear nail polish or a spritz of hairspray to keep the run from spreading.
- If the rip is at the toe, stretch the toe out further and tuck the excess fabric under your foot so that the rip cannot be seen.

- If the rip is down the front, twist your pantyhose to your inner thigh so that the tear is less visible. Be careful as you twist to avoid ripping it further. Or put the hose on backwards, as long as they are not seamed or embellished.
- As a last resort, remove the stockings and go bare-legged.

**WORST-CASE
SCENARIO.**

HOW TO SURVIVE IF YOU ARE STOPPED BY THE POLICE

1 Pull over immediately.

Put your hazard lights on, take off your sunglasses, turn off the radio, and turn off the engine. Roll down your window. Keep your hands in plain sight, preferably on the steering wheel. Make sure your date's hands are also in view.

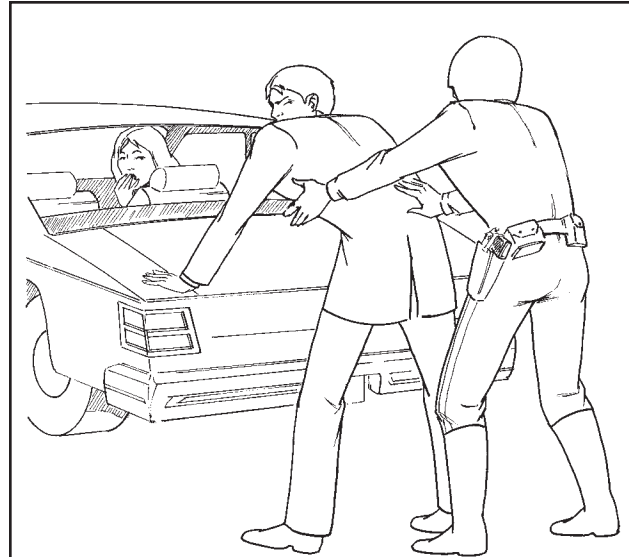

Address the officer as "Officer." Respect for authority will get you out of the situation much more quickly and easily.

2 Address the officer as “Officer.”

Displaying proper respect will get you out of the situation much more quickly and easily.

3 Always tell the truth about your record.

The police officer already knows (or will soon know) the answers to the questions asked. Do not claim that you have a clean driving record if this is not the case.

4 Do not argue with or challenge the officer.

Not only will you look foolish and/or arrogant in front of your date, your comments may be recorded on the officer’s copy of the ticket so they can be used to refresh the officer’s memory in court. Do not give the officer a reason to take a personal interest in you or your case, which would only encourage the officer to show up in court if you decide to fight the ticket. (Many defendants succeed in court because the officer is not present to testify.)

5 Do not falsely claim your innocence.

The officer has seen you do it, and denying the infraction or making lame excuses will only serve to irritate the officer.

6 Use the presence of your date to help you.

Try saying, “Officer, I’m sorry. I’m on a date and I guess I was pretty distracted. I’m a bit nervous and probably was paying more attention to her than to my driving. I’ll be more careful.” This may appeal to the officer’s sense of romance, helping you get off completely.

IF YOU ARE ARRESTED

1 Contact a bail bondsman.

A bondsman will need to know the name of the jail you are in, the charges against you, the amount of your bail, and your booking number. The bondsman will charge you a fee of about 10 percent of your total bail amount and then make a guarantee to the court on your behalf that you will show up for your court date. (If bail is set at \$50,000, for example, you will be required to pay the bondsman a nonrefundable fee of approximately \$5,000.)

2 Be prepared to put up collateral.

When a bondsman writes a bail bond for you, he is on the hook for the entire amount of your bail should you not show up in court. He will demand a guarantee that you can pay him the full amount if you should jump bail. Ninety percent of the time, large bail bonds are secured with real property. Evaluate your assets in light of the amount of bail.

WORST-CASE SCENARIO.

HOW TO SURVIVE IF YOU FORGET A BIRTHDAY

- 1 Apologize. Apologize. Apologize.**
Your apology might have to take several forms—flowers, verbal protestations, love letters, a special dinner. Be creative.
- 2 Accept responsibility for your error.**
Recognize sincerely that you blew it. Excuses will only make things worse.
- 3 Acknowledge your partner's feelings.**
Accept your partner's anger as valid and do not question or challenge any reaction. Say, "I can only begin to imagine how you must feel."
- 4 Plan a special event to fix the mistake.**
A weekend getaway, a night at a fancy hotel, or an extremely thoughtful gift will be necessary. However, do not show up two days late with a windfall of gifts, expecting that all will be forgiven. All the presents in the world cannot eliminate the need for talking the matter through.

WORST-CASE SCENARIO.

HOW TO SURVIVE IF YOU HAVE EXCESSIVE GAS

- 1 Limit your lactose intake during the date.**

Many people suffer from an inability to digest milk sugar, or lactose. Colon bacteria ferment the milk sugar, forming a gas that creates a bloated feeling. Keep your intake to less than half a cup at a sitting, and avoid dairy products before your date.
- 2 Eat a small meal.**

Eating a huge dinner on a date is a sure-fire way to precipitate gas.
- 3 Avoid gas-forming foods.**

Bacteria ferment the indigestible carbohydrates in beans, broccoli, cabbage, and other vegetables and fruits into gases.
- 4 Drink peppermint tea.**

Replace an after-dinner drink with a cup or two of peppermint tea. This herb may give you some relief from the gas discomfort that follows a meal.
- 5 Emit the gas in private.**

As a last resort, head to the bathroom. If you feel bloated but are unable to pass gas easily, you can facilitate the emission of gas as follows:

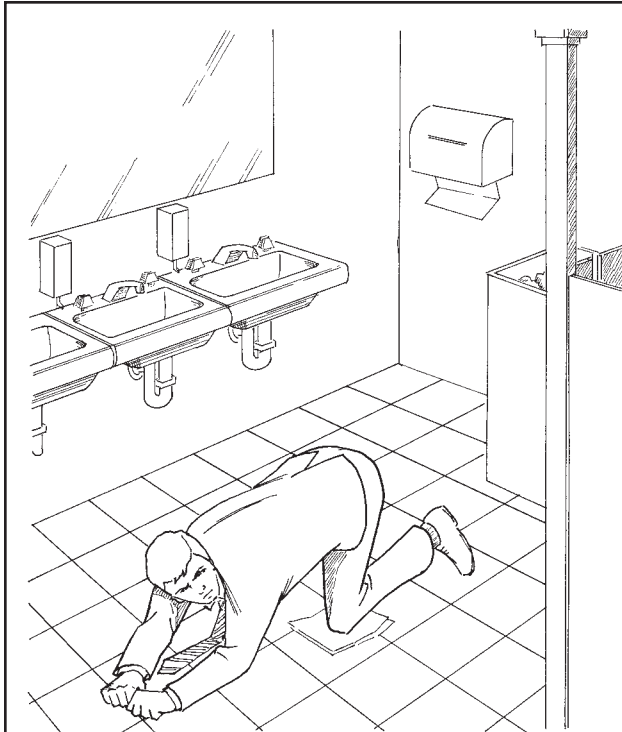

Kneel on the floor, bend forward, and stretch your arms out in front of you. Keep your buttocks high in the air, forming a triangle with your upper body and the floor.

Place paper towels on the floor. Kneel on the towels, bend forward to the floor, and stretch your arms out in front of you. Keep your buttocks high in the air, forming a triangle with your upper body and the floor. This position will force out the unwanted gas and relieve the pressure.

Be Aware

- On average, humans produce $\frac{3}{4}$ of a liter of gas daily, which is released 11 to 14 times a day.
- Men typically produce more gas than women because they consume more food.

GASSY FOODS TO AVOID

No two digestive systems are alike. Experiment with foods to determine which ones affect you most. In the meantime, exercise caution around the following high-risk items:

- Beans (particularly baked beans)
- Borscht
- Broccoli
- Brussels sprouts
- Cabbage
- Carbonated beverages
- Cauliflower
- Chili
- Cucumbers
- Fatty foods
- Fresh fruit
- Grains and fiber, especially pumpernickel bread
- Gum
- Onions
- Oysters
- Salads (green)

HOW TO SURVIVE IF YOU RUN INTO YOUR EX

Running into your ex at a party can be problematic for many reasons: lingering affection, pain over being dumped, unresolved emotions, passionate memories, or poor selection of your current date.

1 Do not avert your gaze.

Look him in the eye and smile. Shying away from eye contact only diminishes your power. Keep someone's gaze and you keep control.

2 Be nice.

3 Do not sit.

Do not let yourself get stuck in a corner or on a couch with your ex. Remain standing and be ready to move.

4 Take charge of the conversation.

Start by mentioning something that you noticed earlier in the day. This keeps the dialogue fresh and superficial and in your control, and helps you to avoid complimenting or talking about the ex. Be upbeat—enthusiasm is a handy tool. Breezing by someone indicates you are not fazed or upset.

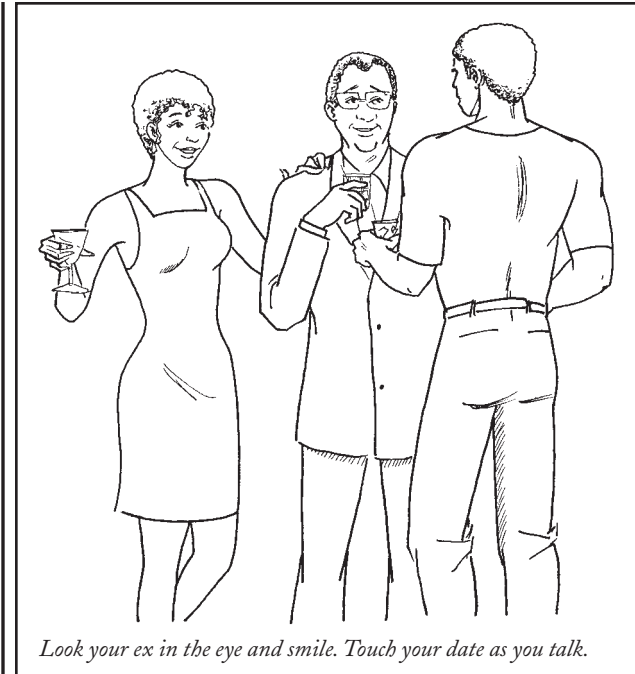

5 Introduce your date and send clear signals that this is who you are with now.

Touch your date as you converse with your ex, making it clear that you have moved on.

6 Keep your conversation short and sweet.

Tell your ex that you are “meeting friends,” but that it was nice to see him. Or, tug your date's arm and say, “Oh look, there's Sally. I want you to meet her.”

7 Move on.

WORST-CASE SCENARIO.

HOW TO SURVIVE IF YOU WAKE UP NEXT TO SOMEONE WHOSE NAME YOU DON'T REMEMBER

AT THEIR PLACE

- 1 Do not panic.**
Evidence of your partner's name exists somewhere nearby. Your task will be to find it before she awakens, or before she starts any sort of meaningful conversation.
- 2 Get up and go to the bathroom.**
The bathroom is a normal place to visit first thing in the morning, and it is also a place where you might discover her name.
- 3 Look through the medicine cabinet for prescription medicines with her name on the label.**
- 4 Sort through magazines, looking for subscription labels with her name and address.**
- 5 Go through a wastebasket to find discarded junk mail addressed to her.**

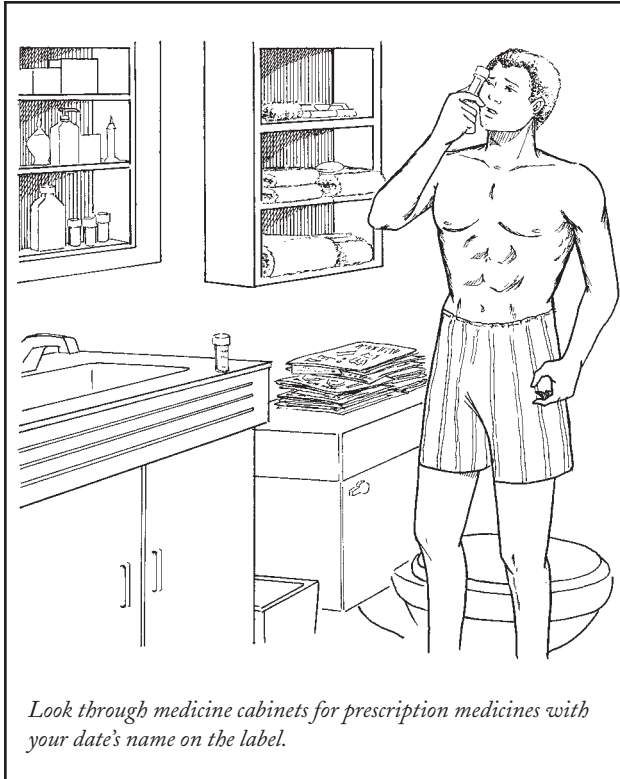

Look through medicine cabinets for prescription medicines with your date's name on the label.

6 **Return to the bedroom.**

If she is awake, ask her to make coffee for you. Use the time alone to search the bedroom for evidence. Look for: wallet, checkbook, ID or name bracelet, photo album, scrapbook, business cards (a stack of cards, not just one), or luggage labels. If she is sleeping, look for these and other items throughout the house.

Be Aware

Try to find at least two items with the same name to be certain that you have identified her, unless the name on one item rings a bell.

AT YOUR PLACE

1 **Use terms of endearment when addressing her.**

Do not guess at her name. Acceptable terms of endearment are:

- Honey/Sweetie/Cutie
- Darling/Baby/Sugar
- Beautiful/Handsome/Gorgeous

2 **Unless you are certain you have ample time, do not go through her belongings.**

If your partner is showering, you can count on having at least a few minutes of privacy to search through her belongings. Otherwise, do not risk it—it would be far more embarrassing to be caught searching through her possessions than to admit you cannot remember her name. (She may be in the same predicament.)

3 **Ask leading questions while making small talk.**

Fishing for information is risky and can backfire by calling attention to what you are trying to do. However, if you feel you can pull it off, try to trick her into revealing her name:

- While getting dressed, pull out your own ID and ask her if she thinks that your hair is better now or in the picture. Laugh about how silly you used

to look. Ask her if she likes the picture on her license. (She may think that you are checking her age.)

- Ask her if she ever had a nickname. She might say, “No, just [*Name*].”
- Ask her how she got her name.

4 **As she is leaving, give her your business card and ask for hers.**

If she does not have a business card, ask her to write her vital information on yours. Tell her you may want to send her a little surprise. Do not forget to send something later in the week and make sure that you spell her name correctly.

**WORST-CASE
SCENARIO®**

HOW TO SURVIVE IF YOUR CREDIT CARD IS DECLINED

TALK WITH THE MANAGER

- 1 Be subtle.**

After the waiter informs you that your card has been declined, excuse yourself from the table and head for the reception desk. Explain the situation to the manager and show whatever identification you have. Ask him or her what you might do. Call the credit card company and inquire about your card. Speak firmly and sternly to the company. Ask the credit card company to extend your credit temporarily and immediately by the amount that you need.
- 2 Offer collateral.**

Offer to leave something of value until you can return with the payment. Do not use your date as collateral. Offer a watch or a driver's license.
- 3 Provide references.**

If you are known at any other restaurants, ask the manager to check with them, and say the management there will vouch for you. Promise to return immediately with payment.

- 4 Seek funds.**

Order another drink for your date (at the table or the bar) and confess the situation. Dash home for money or to a friend's house for a loan. Alternatively—unless it is the first date—you can ask your date to pay.

DINE AND DASH

- 1 Accept the consequences.**

You will never be able to be seen in this restaurant again if you skip out. Your date may be offended and embarrassed. And if this restaurant is in an area that you frequent, you may be identified and caught later.
- 2 Tell your date the plan.**

You do not want to catch your date off guard. Do not abandon your date, since she will likely be very upset and may help the authorities track you down. Plan to leave together.
- 3 Plan your route of escape.**

The best route is through the front door. However, restaurant staff may give chase. Assume that you will be followed. Visualize where you are going once you exit the restaurant. Head toward crowded or darkened areas.
- 4 Wait until the staff is busy.**

Have your belongings within reach for a hasty retreat. Do not appear anxious or ready to bolt.

5 Pretend to pay the bill with cash.

Place whatever bills you have in the bill holder with the check. The illusion of a cash payment will buy you valuable minutes of escape time; your waiter isn't likely to count the money until he reaches the nearest available cash register.

6 Walk confidently out the door.

Proceed slowly and with authority.

7 As soon as you are outside, run.

8 If you are being followed, do not go directly to your car.

It is very easy for your pursuer to jot down your license number. Wait at least twenty minutes before returning to your vehicle.

Be Aware

Stiffing the restaurant is illegal and may land you in jail, where the food is not very good. Arrange to pay the restaurant, directly or through a third party, as soon as you can. Include a message encouraging them to be more understanding of customers with credit card problems in the future.

WASH DISHES

1 Offer to wash dishes.

Tell the manager that you are willing to work to cover the cost of your meal. Explain that you have experience with the technology involved.

2 Prepare to get wet.

Take off your jacket, your watch, and any jewelry. (Men should also remove tie and long-sleeve shirt, if wearing an undershirt). Take off your glasses (unless you have a major problem seeing without them). It is hot and wet in the kitchen. Ask for an apron, if available.

3 Prerinse the dirty dishware.

Remove the dirty dishes from the bus tub. Load the dishes into a square peg rack (a 20-by-20-inch plastic tray with holes in the bottom), place the peg rack over a slop sink, and rinse with a hose.

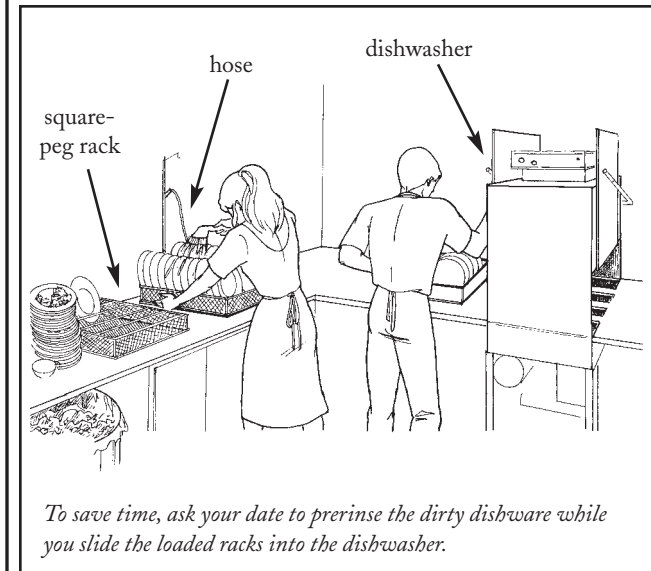

4 Lift the door to the dishwasher and slide in the rack.

5 Close the dishwasher door and begin the wash cycle. Most machines begin automatically when locked, but you may need to press the start button. When the cycle is done, raise the door on the opposite side of the machine and remove the peg rack. Some systems utilize a conveyor belt that has claws to grab onto and pull the peg rack through the wash cycle.

6 Place the peg rack with the clean dishes in a drying rack.

The drying rack may be a wheeled racking system that holds many peg racks. Or it could be a slanted rack mounted on the wall. When the rack is placed on the angled wall unit, the excess water drips onto the stainless steel shelving. The dishes are now ready for use.

**WORST-CASE
SCENARIO®**

HOW TO SURVIVE MEETING THE PARENTS

1 Pay attention to your surroundings.

If you are prone to spilling things or tripping over rugs, move slowly and carefully. Present an image of confidence and poise.

2 Greet them with a firm, but brief, handshake.

A weak handshake is a turnoff, but so is squeezing too hard. Shake hands so that the entire hand is clasped. Let go of the hand after a few pumps. Maintain eye contact.

3 Do not kiss or hug the parents unless they make the first move.

If they offer air kisses, fine, but never kiss a potential in-law on the mouth. If they opt to hug you, do not retreat from it.

4 Call them “Mr.” and “Mrs.” unless they ask you to address them by their first names.

This shows respect. Do not shorten or change their names or call them “Mom” or “Dad.”

5 Give them personal space.

Allow at least three feet of airspace during conversation.

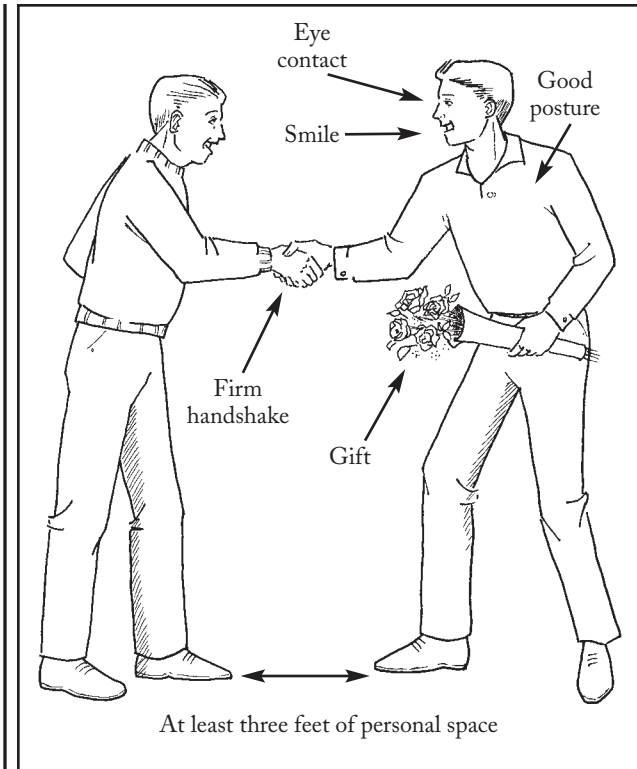

6 Show poise.

Be positive, good natured, and relaxed. Smile, but not continuously: if you look happy all of the time, something's not right. Remember that good posture projects confidence and successfulness. Walk, stand, and sit up straight. Speak loud enough to be heard.

7 **Be sincere and be yourself.**

Do not pretend to be someone you are not. People can spot a fake a mile away. Do not try too hard to make an impression. At the same time, do not act too familiar—no winking, shoulder punching, or joking. Follow their lead.

8 **Send a note or card the next day.**

Mention how nice it was to finally meet them and that you look forward to seeing them again. If you stayed at their house for a while, thank them for an enjoyable visit.

Be Aware

Practicing the following social graces can help make a favorable impression:

- Ring the doorbell once only. Do not lean on the bell or pound the door.
- Turn off your cell phone and pager.
- If invited to dinner, bring wine, flowers, or dessert, even if they say not to.
- Wait to be invited inside, and wait to be seated. Do not sit down before they do.
- Pet the dog or cat.
- Compliment them on only one or two things: the view, the couch, a painting, the flowers—don't overdo it.
- Do not spend too much time in the bathroom (and do not go too often).

**WORST-CASE
SCENARIO®**

HOW TO SURVIVE SNORING

1 Keep your date on her side or stomach.

Sleeping on the back tends to lead to snoring. If your date falls asleep on her back, change her position using one of the following techniques:

- **The Pillow Lift:** Grab the nearest corner of the pillow (the corner she is facing, if she is on her side) and lift it up until she begins to rustle and turn over. This may cause her to wake up momentarily and stop snoring.
- **The Bed Flop:** Actively flip yourself over (from one side to the other, or from your stomach to your back) with an unusually aggressive flop. Make it forceful enough to shake the bed. Often this will disturb her just enough to cause her to turn over as well.

2 Wake up your date.

If the more subtle approaches do not work, become more aggressive. A strategically placed elbow nudge or kick may awaken your date. Repeat until effective.

3 Use earplugs.

Be prepared for the worst—have earplugs handy. If you do not have earplugs, try using a small amount of wadded-up cotton from a cotton ball, or even toilet paper. Your final alternative is to sleep in separate rooms. It may not be romantic, but it is an effective temporary solution.

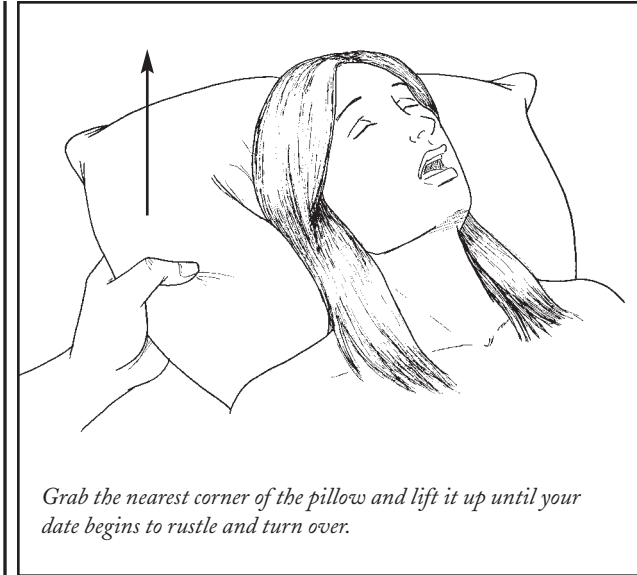

Grab the nearest corner of the pillow and lift it up until your date begins to rustle and turn over.

Be Aware

- Drinking alcohol promotes snoring, so prevent your date from drinking too much. Alcohol depresses the activity of nerves in the nasal air passages, enervating the airway muscles that would keep the air passages open at night and prevent snoring.
- Drinking coffee reduces snoring. Caffeine may stimulate the airway nerves, keeping them open. Caffeine may also make a person sleep more lightly, which can reduce snoring.

HOW TO FIND A PARTNER WHO IS LESS LIKELY TO SNORE

- Avoid the obese, as they have a higher incidence of snoring.
- Avoid individuals with short, fat necks, as these people also have a higher incidence of snoring.
- Avoid individuals who are constantly sniffing and snorting; this may indicate a chronic sinus condition that can cause snoring.
- Avoid heavy drinkers; high alcohol intake leads to a higher incidence of snoring.
- Avoid someone who consistently falls asleep in social situations. Tiredness may be a sign that this person is experiencing reduced quality of sleep due to a sleep disorder that may include snoring.

**WORST-CASE
SCENARIO®**

HOW TO TREAT A PIMPLE

- 1 Apply a warm compress.**
Soak a hand towel in hot water, then hold it against the pimple for a minute or more.
- 2 Apply a topical medication.**
Use any over-the-counter benzoyl peroxide product.

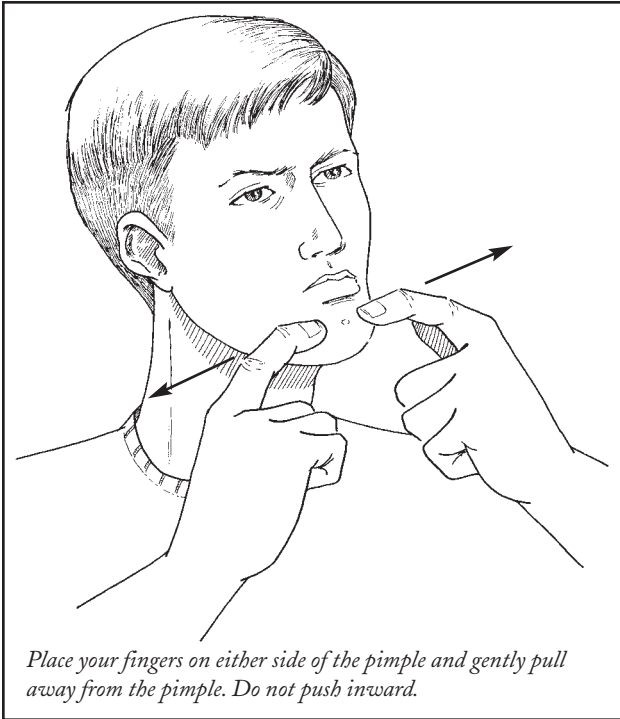

Place your fingers on either side of the pimple and gently pull away from the pimple. Do not push inward.

- 3 Do not touch.**
Leave the pimple alone for as long as possible.
- 4 Reassess the situation.**
Immediately before your date, determine if the pimple has come to a head. If so, proceed to step 5.
- 5 Pop the pimple.**
Place your fingers on either side of the pimple and gently pull away from the pimple. Do not push inward. The pimple will expel its contents if it is ready to, but no harm will be done if it is not.
- 6 Apply a cover-up.**
Dab the now-empty pimple gently with a tissue to remove any remaining liquid. Apply any cosmetic with a green tint, which will conceal a pimple or the red mark left from a popped pimple (red and green are complementary colors and will negate each other).

HOW TO TREAT A SHAVING WOUND

MINOR CUT

1 Rinse the cut with clean, cold water.

2 Apply alum salts or talcum powder.

Alum, a mineral sometimes sold as styptic powder or a styptic pencil, stops blood flow. Hold the alum in place for 10 to 20 seconds, depending on the severity of the wound. While effective, this technique can be painful, since it is literally applying “salt to the wound.” The quickly dried cut may also form a noticeable scab. Alternatively, apply a liberal coating of talcum powder to the cut. Although slightly messier than alum, talcum is considerably less painful and will conceal the nicks and cuts.

If alum or talcum powder is not available, proceed to step 3.

3 Apply toilet paper.

Tear off a tiny piece of toilet paper or tissue and press it onto the cut for at least 15 seconds, until it adheres by itself.

4 Wait a few minutes.

5 Remove the toilet paper.

Moisten the paper before carefully pulling it from the cut. If it is not moistened, the paper may reopen the cut when you peel it off.

MAJOR LACERATION

Most serious shaving wounds occur to the neck, underneath the nose, or underneath an earlobe. The steps below focus on a neck laceration, but can apply to a major wound anywhere.

1 Apply firm pressure directly over the wound.

Place your fingertips at the point where the bleeding seems to be most severe.

2 If the bleeding stops, continue the pressure for an additional 10 minutes.

Remain still until the bleeding subsides. Then go to an emergency room.

3 If the bleeding does not stop, do not panic.

You probably have slowed the flow enough to have time for the next steps.

4 Pinch and hold the bleeding area.

Use your dominant thumb and index finger to pinch the skin where the blood flow is coming from. This will most likely close the vessel even if you cannot see it and will stop the serious bleeding.



Apply firm pressure directly over the wound. Place your fingertips at the point where the bleeding seems to be most severe.

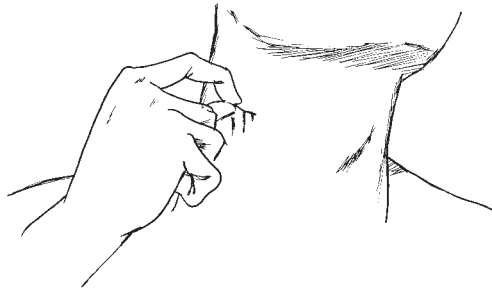

Pushing above or below the site will help seal the area where blood vessels enter the wound.

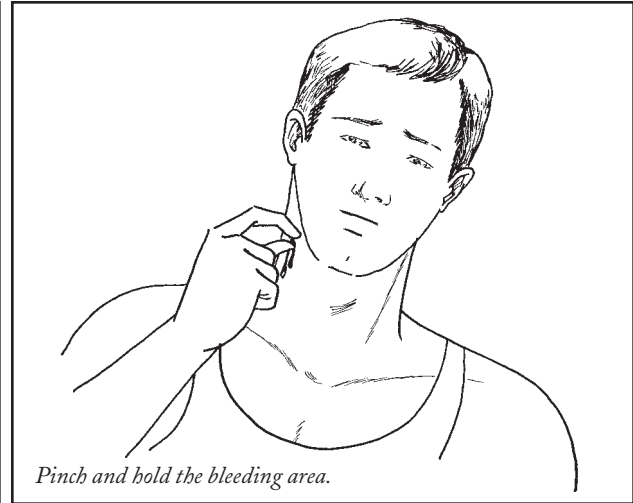

Pinch and hold the bleeding area.

5 **Locate the bleeding vessel.**

If the bleeding continues despite the steps above, use a piece of cloth or tissue to help you find the exact location of the cut vessel. Carefully ease off the finger pressure while wiping blood away from the wound with the cloth. This should make it easier to see the end of the cut vessel, or to pinpoint its location even if it is deep under the skin. When you see it, try pinching it again.

6 **Apply pressure directly above and below the bleeding site.**

If bleeding is still profuse, maintain finger pressure over the wound while pushing immediately above and below the bleeding site. This will seal the areas where blood vessels enter the wound.

7 Get to an emergency room.

If you are being driven to the emergency room, recline with your head raised slightly. Keep firm pressure on the wound even if the bleeding seems to slow.

Be Aware

- If the blood flows in a steady stream, you have hit a vein and can block the blood flow by pressing above the wound. If the blood is spurting, you have lacerated an artery and can block the blood flow by pressing (hard) below the wound. (See step 6.)
- There are four jugular veins. The external jugulars, paired on the right and left sides of the neck, are vulnerable because they lie right under the surface of the skin. The internal jugulars, also paired, lie close to the center of the neck front, but are about an inch under the skin in a protective sheath. If you accidentally cut your neck razor-shaving and notice a great deal of bleeding, you've probably cut the external jugular.

**WORST-CASE
SCENARIO®**

GUIDE TO BODY LANGUAGE

GOOD SIGNS

Leans in = receptiveness

Legs slightly apart = attraction

Makes good eye contact = sincerity

Matches your breathing = a meeting of the minds

Moves when you do = a good match

Holds palms open = receptiveness, an invitation



Parts lips = desire

Smiles with crow's feet = genuine amusement, attraction

Touches face, cheek = interest, attraction

Touches you = desire, attraction

Twirls hair = attraction, flirtation

Unbuttons jacket or shirt = comfort, interest



BAD SIGNS

Clenches jaw = impatience, anger

Crosses legs or arms = defensiveness

Holds finger to chin or lips = evaluation, criticism

Looks around = disinterest, boredom

Looks away = insincerity

Nods too much = disinterest, short attention span

Rubs neck or head = impatience, frustration

Rubs nose or eyes = dismissal, readiness to move on

Shifts weight = uncertainty, nervousness

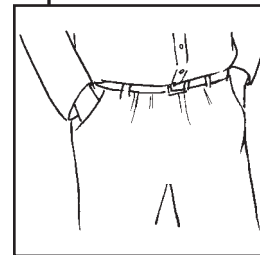
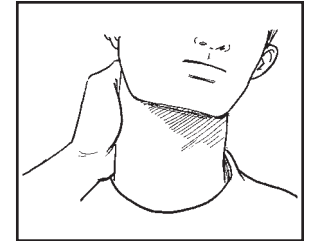

Shoves hands in pockets = feelings of inadequacy or insecurity, disinterest

Slouches = boredom, disinterest

Smiles without crow's feet = an attempt to look happy

**WORST-CASE
SCENARIO.**

PICKUP LINES TO AVOID

The human body is 90 percent water, and I'm real thirsty.

Can I buy you a drink or do you just want the money?

With a mane like that you must be a Leo.

Do you have a mirror in your pants? Because I can see myself in them.

Are your legs tired? Because you have been running through my dreams all night.

Is your father a thief? He has stolen the stars from the skies and put them in your eyes.

Are you okay? It must have been a long fall from heaven.

I really like that outfit. It would look great crumpled at the end of my bed.

What do you like to eat for breakfast? Oh good, I have that.

I know they say milk does a body good—but damn, how much have you been drinking?

So, are you legal?

I have cable TV.

If I told you have a lovely body, would you hold it against me?

Did the sun just come out or did you smile at me?

Is it hot in here, or is it just you?

Do you believe in love at first sight or do I have to walk by you again?

Hey, I lost my phone number . . . can I have yours?

If you were a burger at McDonald's, I'd call you McBeautiful.

Hi, my name's _____. But you can call me . . . tonight.

No wonder the sky's gray today—all the blue is in your eyes.

What's your name? Or shall I just call you mine?

If I could rearrange the alphabet, I'd put U and I together.

Look at you with all those curves and me with no brakes!

I may not be Fred Flintstone/Wilma Flintstone, but I can sure make your bed rock!

Do you have any raisins? No? How about a date?

Do you have a Band-Aid? 'Cause I skinned my knee when I fell for you.

Can I have a picture of you so I can show Santa what I want for Christmas?

My bed is broken. Can I sleep in yours?

I'm not feeling myself tonight. Can I feel you?

My name is _____. Remember that; you'll be screaming it later.

Is that a ladder in your stockings or the stairway to heaven?

I may not be the best looking guy/girl in here, but I'm the only one talking to you.

(Lick finger and wipe on his/her shirt.) Let's get you out of these wet clothes.

THE “IT’S NOT YOU, IT’S ME” LETTER

Dear _____,

I won't be able to make it this Saturday, or any Saturday, in fact. The truth is, I just can't be in a committed relationship right now. It's not you, it's me. I'm just not able to appreciate all that you have to give.

I feel like we've been spinning our wheels these last few years / months / weeks / days. I can't believe how wonderful you've been to me and how much you've put up with. You deserve better. I can't put you through this anymore and I can't give you what you need / want / deserve right now. I need more space, and I need time to figure out who the real [your name here] is.

It may take some time, but I hope we can still be friends.

Sincerely,

[your name here]

*For short-term relationships, this letter may be sent via fax or e-mail.
To download the latest version, visit www.worstcasescenarios.com.*

**WORST-CASE
SCENARIO®**

**WORST-CASE
SCENARIO.**

USEFUL EXCUSES

This never happened to me before.

I had a really tough day at work.

Not tonight, I have a meeting.

I have to get up early.

I'm too drunk.

I'm not drunk enough.

My turtle died.

I'm gay.

I'm straight.

I can't decide.

It's an old football injury.

I forgot my wallet.

I have to wash my hair.

My Aunt Flo is visiting.

I am leaving the country.

I need to take my medication.

I couldn't find a place to park.

I couldn't get a cab.

I left it in the cab.

I have to catch a plane.

I buy it for the articles.

They're supposed to test them at the factory.

Nobody's perfect.

I warned you about me.

We don't know each other well enough.
We know each other too well for that.
I didn't think you were coming back today.
He/she needed a friend.
It meant nothing to me.
Someone told me it was an art film.
We might learn some new things from it.
I have a bad back.
I have bad knees.
I asked you first.
I have to walk my dog.
That's not what I meant.
I don't remember saying that.
I'm terrible with names.
I can't bend over that far.
I didn't think you would notice.
My pager is broken.
My cell phone needs recharging.
My computer has a virus.
Your voicemail was full.
Your server must have been down.
I thought you meant next Friday.
It won't stain.
They're family.
I thought you understood without my having
to say it.
Next time will be better.

**WORST-CASE
SCENARIO®**

THE EXPERTS

CHAPTER 1: DEFENSIVE DATING

How to Determine If Your Date Is an Axe Murderer

Source: Julie Harmon, Ph.D., is executive director of IMPACT Safety Programs, a Columbus, Ohio-based nonprofit, anti-violence organization with affiliates across the United States (1-800-345-KICK). With a background in psychology, she has worked for 25 years in various areas of anti-violence programming.

How to Determine If Your Date is Married

Source: Pat Gaudette is an Internet publisher specializing in various aspects of relationships, including divorce and midlife crisis.

How to Determine the Gender of Your Potential Date

Sources: Glenn Fitzpatrick, Ph.D., is an anthropologist based in Phoenix, Arizona, who has undertaken a study of physical differences between genders. • Linda Hunter is a private investigator and security specialist in Santa Barbara, California.

How to Determine If Your Date Is a Con Artist

Source: Julie Harmon, Ph.D.

How to Fend Off an Obsessive Ex

Source: Julie Harmon, Ph.D.

How to Fend Off a Pickup Artist

Source: Nancy Slotnick is the owner of Drip Café,

a New York City café with a dating service, and www.DripCafe.com, a national network of dating cafés.

How to Deal with a Date Who Moves Too Fast

Sources: Margaret Shapiro, MSW, is assistant director of the Pennsylvania Council for Relationships. She is a licensed clinical social worker in Massachusetts and Pennsylvania, and has been a practicing psychotherapist for 25 years. • Sarah Raskin is outreach and volunteer coordinator for Helpmate, a domestic violence service agency in western North Carolina. She provides educational sessions to professionals, civic groups, religious organizations, schools, government agencies, and other community groups.

How to Escape from a Bad Date

Source: Antonio J. Mendez is a retired CIA intelligence officer and the author of *The Master of Disguise: My Secret Life in the CIA*. For 25 years he worked undercover and has held various positions within the CIA, including Chief of Disguise and Chief of the Graphics and Authentication Division.

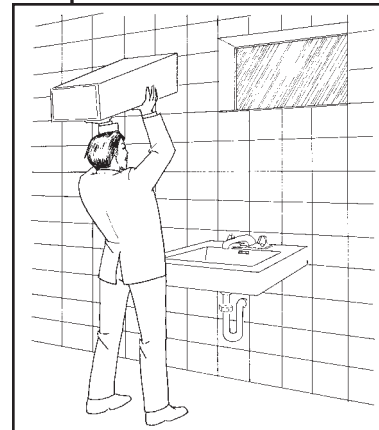

CHAPTER 2: FIRST IMPRESSIONS

How to Spot a Fake

Sources: Nicole Cummings is the founder of the world's largest online breast augmentation resource, Breast Augmentation and Breast Implants Information

by Nicole, at www.implantinfo.com. Her site has been featured in the *New York Times* and in the *Journal of the American Society of Plastic Surgeons*. She is the producer of an educational video, *Before and After Breast Augmentation*, which won a Telly Award. • Carliz S. Teague is CEO of 1stclasswigs.com, a website that provides wigs and hair accessories for men and women.

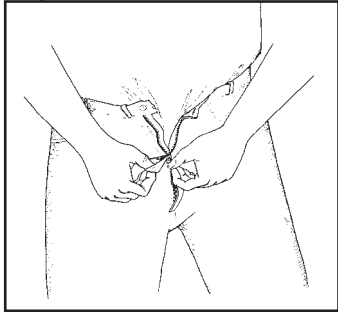

How to Survive a

Fashion Emergency

Source: Karen Bressler is a New York City-based freelance writer, editorial director of fashionwindow.com, fashion columnist for *Ocean Drive* magazine, and co-author of *A Century of Lingerie*.

How to Treat a Pimple

Source: Dermatologist Jerome Aronberg is a fellow of the American Board of Dermatology and a past president of the Missouri State Dermatological Society. Currently, he is an assistant clinical professor of dermatology at Washington University in St. Louis. He is the author of *Caring for Your Skin with Over-the-Counter Drugs* and has contributed to *Shape* and *Glamour* magazines. Dr. Aronberg has a private practice in Clayton, Missouri.

How to Treat a Shaving Wound

Sources: Robert and Charlotte Johnston own the Barber Shop Trading Co., a men's store in the United Kingdom, www.barbershop.co.uk. • Dr. James Li practices and teaches in the Division of Emergency Medicine at Harvard Medical School in Cambridge,

Massachusetts. He is an instructor for the American College of Surgeons' course for physicians, Advanced Trauma Life Support.

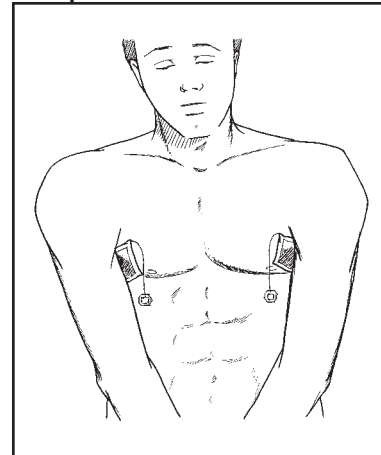

How to Deal with Body Odor

Sources: Maryann Bart is a homeopathic nurse and nutritionist who lives in Canton, Ohio. • Ginseng is a homeopathic drugstore based in Philadelphia, Pennsylvania.

How to Deal with Bad Breath

Sources: Mel Rosenberg, Ph.D., is a professor of microbiology at the Goldschleger School of Dental Medicine at Tel-Aviv University, where he heads the Laboratory for Oral Microbiology. He also holds positions with the University of Toronto Faculty of Dentistry and the University of Pennsylvania School of Dental Medicine. Dr. Rosenberg focuses on the diagnosis and treatment of oral malodor, and he has published more than ninety scientific articles, chapters, editorials, books, reviews, and patents in this area. • Richard Hafter, D.D.S., has practiced family dentistry in Hammonton, New Jersey, for 35 years. • Mehdi Kalani, M.D., is a surgeon, also in Hammonton, New Jersey.

CHAPTER 3: RESTAURANT AND BAR SURVIVAL SKILLS

How to Get an Emergency Reservation

Source: Phyllis Richman was the restaurant critic for the *Washington Post* for 23 years. She has written three mysteries featuring restaurant critic Chas Wheatley: *The Butter Did It*, *Murder on the Gravy Train*, and *Who's Afraid of Virginia Ham?*

How to Save Your Date from Chocking

Source: Dr. James Li.

How to Survive If You Have Excessive Gas

Source: Liz Applegate, Ph.D., is a faculty member of the Nutrition Department at the University of California, Davis, and a recognized expert on nutrition and performance. She has written more than 300 articles for national magazines and is nutrition editor and columnist for *Runner's World* magazine. Dr. Applegate is the author of several books, most recently *Eat Smart, Play Hard*.



How to Survive If Your Credit Card Is Declined

Sources: Phyllis Richman (above), who does not recommend “dining and dashing” under any circumstances. • Jamie Hoffman is the general manager of Singer Equipment Company, a Pennsylvania-based restaurant supply company. He has been in the business for 18 years.

How to Fend Off Competitors for Your Date

Sources: Sherry Amatenstein is the author of *The Q & A Dating Book* and *Love Lessons from Bad Breakups*. She is the dating columnist for iVillage.com, conducts dating seminars around the country, and has appeared on numerous talk shows as a relationships expert. • Shawn Croft is Love & Dating correspondent for the largest online-only men's magazine, AskMen.com. He has a background in business, sociology, psychology, women's studies, and anthropology. He has also been a waiter and a bartender. • Dr. James Li.

How to Deal with a Drunken Date

Source: Kathy Hamlin has been a bartender at Mr. G's Lounge in Deltona, Florida, for 10 years. She is the Cocktails Guide at About.com and is the author of numerous articles on cocktails and cocktail history.

How to Sober Up Fast

Source: Kathy Hamlin.

How to Carry a Date Who is Passed Out

Source: Vince Christopher is a physical therapist and amateur weight lifter who lives in New York City.

How to Survive if You Are Stopped by the Police

Sources: Attorneys Barry D. Kowitt and Kevin M. Unger are partners in the law firm of Unger & Kowitt, and have offices in Plantation and Miami, Florida. They have handled more than twenty thousand traffic tickets

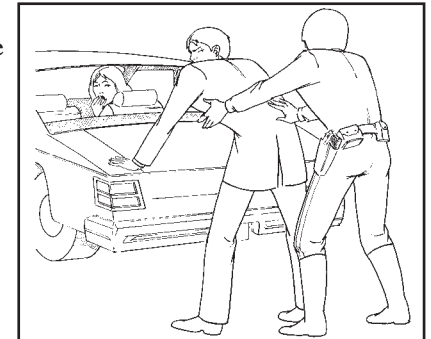

for clients. • Attorney Mel Leiding has been in private practice in California for 18 years and is the author of *How to Fight Your Traffic Ticket & Win!* He is a member of the experts' panel for the National Motorists Association, an advocacy group for motorists' rights. • Josh Herman owns Josh Herman Bail Bonds in Beverly Hills, California, and writes bail throughout the country. He has handled thousands of felony DUI cases and has written bail for numerous high-profile clients. The company is online at jhbail.com.

CHAPTER 4: BEDROOM SURVIVAL SKILLS

How to Deal with a Bad Kisser

Source: Carol Queen, Ed.D., is the staff sexologist at Good Vibrations in San Francisco. She is an author and sex educator who has written and edited several books, including *Exhibitionism for the Shy* and *Real Live Nude Girl: Chronicles of Sex-Positive Culture*.

How to Remove Difficult Clothing

Sources: Carol Queen, Ed.D. • Gilly Aroshas is the owner of Gilly Jeans Western Fashions in Philadelphia, Pennsylvania. He has been in business for 16 years and has been wearing cowboy boots for 35 years.

How to Fake an Orgasm

Source: Carol Queen, Ed.D.

How to Create Privacy If Your Door Does Not Lock

Source: Linda Hunter.

How to Have Sex in a Small Space

Sources: The Masked ScaVENger is a general safety engineering consultant and a member of the American Society of Safety Engineers. He uses this pseudonym to protect his identity. • Carol Queen, Ed.D.

How to Survive Snoring

Source: Jason H. Mateika holds a Ph.D. in physiology and is an assistant professor at Teachers College, Columbia University. He has been involved in sleep research since 1990 and is currently the director of the Sleep and Respiratory Physiology Laboratory at Teachers College.

How to Survive If You Wake Up Next to Someone Whose Name You Don't Remember

Source: Linda Hunter.

CHAPTER 5: RELATIONSHIP SURVIVAL

How to Survive If You Run into Your Ex

Source: Mary Mitchell is the author of six books on manners, and president of the Mitchell Organization, a Philadelphia-based corporate training company. She writes a syndicated newspaper column, "Ms. Demeanor," as well as columns for the Work channel of iVillage.com, under the moniker "Confidence Coach."

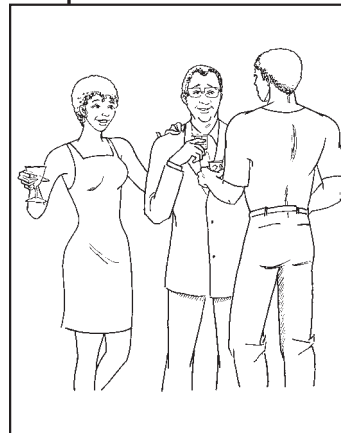

How to Survive Meeting the Parents

Source: Robin Thompson founded the Robin Thompson Charm School in 1983 and lectures on business etiquette and image at colleges, universities, and businesses throughout the country. She is the author of *Be the Best You Can Be* and runs etiquette-network.com.

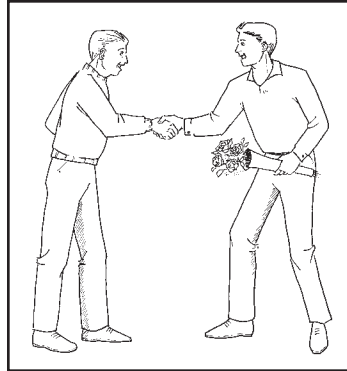

How to Survive If You Forget a Birthday

Source: Mary Mitchell.

How to Deal with a Cheating Lover

Source: Margaret Shapiro, MSW.



How to Have an Affair and Not Get Caught

Sources: Mark Burns, Ph.D., is a licensed psychotherapist based in Seattle, Washington, who specializes in couples therapy; *How to Have an Affair and Not Get Caught*, by Paul and Linda Lewis; *How to Have an Affair and*

Never Get Caught, by Jay D. Louise. • Debbie Layton-Tholl, Ph.D, is a clinical psychologist in Boca Raton, Florida, who specializes in extramarital affairs. She is a frequent speaker and lecturer on affairs and divorce.

How to Stop a Wedding

Source: Robin Thompson.

How to End a Relationship

Sources: Susan Page conducts relationship workshops and is the author of *If I'm So Wonderful, Why Am I Still Single?*; *Happily Married: The Eight Essential Traits of Couples Who Thrive*; *How One of You Can Bring the Two of You Together*; and *If We're So in Love, Why Aren't We Happy?* • Sherry Amatenstein.

The
WORST-CASE SCENARIO
Survival Handbook:
COLLEGE

By Joshua Piven, David Borgenicht, and Jennifer Worick
Illustrations by Brenda Brown



CHRONICLE BOOKS
SAN FRANCISCO

Copyright © 2004 by Quirk Productions, Inc.

All rights reserved. No part of this book may be reproduced in any form without written permission from the publisher.

Worst-Case Scenario™ and The Worst-Case Scenario Survival Handbook™ are trademarks of Quirk Productions, Inc.

Library of Congress Cataloging-in-Publication Data available.

ISBN: 0-8118-4230-4

Manufactured in the United States of America

Typeset in Adobe Caslon, Bundesbahn Pi, and Zapf Dingbats

Designed by Frances J. Soo Ping Chow

Illustrations by Brenda Brown



A **QUIRK** Book

www.quirkpackaging.com

Visit www.worstcasescenarios.com

Distributed in Canada by Raincoast Books

9050 Shaughnessy Street

Vancouver, British Columbia V6P 6E5

10 9 8 7 6 5 4 3 2 1

Chronicle Books LLC

85 Second Street

San Francisco, California 94105

www.chroniclebooks.com

© 1999-2007 by Quirk Productions, Inc. All rights reserved.

WARNING

When a life is imperiled or a dire situation is at hand, safe alternatives may not exist. To deal with the worst-case scenarios presented in this book, we highly recommend—insist, actually—that the best course of action is to consult a professionally trained expert, most likely not an academician. But because highly trained professionals may not always be available when the safety or sanity of individuals is at risk, we have asked experts on various subjects to describe the techniques they might employ in these emergency situations. **THE PUBLISHER, AUTHORS, AND EXPERTS DISCLAIM ANY LIABILITY** from any injury that may result from the use, proper or improper, of the information contained in this book. We do not guarantee that the information contained herein is complete, safe, or accurate, nor should it be considered a substitute for your good judgment, your common sense, or everything your parents ever taught you. And finally, nothing in this book should be construed or interpreted to infringe on the rights of other persons or to violate criminal statutes; we urge you to obey all laws and respect all rights, including property rights, of others, even members of other fraternities and sororities, the faculty and administration, and visiting teams and their mascots.

—The Authors

ABOUT THE AUTHORS

JOSHUA PIVEN graduated from a large Ivy League university in just four-and-a-half years. He owes everything to his English professors, who choose to remain anonymous. He is the co-author, with David Borgenicht, of the *Worst-Case Scenario Survival Handbook* series.

DAVID BORGENICHT has survived dozens of collegiate nightmares, including the one where you wake up naked in the middle of an art history exam for which you haven't studied. He is the co-author, with Josh Piven, of the *Worst-Case Scenario Survival Handbook* series.

JENNIFER WORICK graduated from a kick-ass Big 10 school. After surviving pints of peach schnapps and countless walks of shame, she moved on to an illustrious writing career. Among her many books, she is the co-author of the *Worst-Case Scenario Survival Handbook: Dating & Sex*.

BRENDA BROWN is an illustrator and cartoonist whose work has been published in many books and major publications, including *The Worst-Case Scenario Survival Handbook* series, *Esquire*, *Reader's Digest*, *USA Weekend*, *21st Century Science & Technology*, *The Saturday Evening Post*, *The National Enquirer*, and many other magazines. Her website is <http://webtoon.com>.

Visit www.worstcasescenarios.com for updates, new scenarios, and more! Because you just never know. . . .

ACKNOWLEDGMENTS

Josh Piven thanks all of the experts, for their college knowledge; his parents, for footing the bill for his education; and the cast of the film *Animal House*, for their inspirational approach to higher learning.

David Borgenicht would like to thank his alma mater and his alma pater; his editors, Jay Schaefer, Steve Mockus, and Melissa Wagner; the entire team at Chronicle Books and Quirk Books; Frances J. Soo Ping Chow; and all the experts who contributed their, er, expertise. He'd also like to apologize for the time he started that food fight, killed the ROTC captain's horse, slept with the mayor's daughter, and ruined the big parade at the end of the movie.

Jennifer Worick would like to thank the following people: editor Melissa Wagner; co-authors Dave Borgenicht and Josh Piven, whom she sorely wishes had gone to college with her so they could have helped her research and cram for exams; all of the talented experts; and Sacha Adorno, Brenda Brown, Mindy Brown, Kerry Colburn, Josh Freely, Liesa Goins, Laurel Rivers, Alison Rooney, Jay Schaefer, Frances J. Soo Ping Chow, Ann Wilson, and all of her family and friends. She also thanks her college roommates—Maria, Donna, Janet, Amy, and Nadine—who helped her through four years with minimal damage to her liver or her sanity.

ABOUT THE AUTHORS

JOSHUA PIVEN graduated from a large Ivy League university in just four-and-a-half years. He owes everything to his English professors, who choose to remain anonymous. He is the co-author, with David Borgenicht, of the *Worst-Case Scenario Survival Handbook* series.

DAVID BORGENICHT has survived dozens of collegiate nightmares, including the one where you wake up naked in the middle of an art history exam for which you haven't studied. He is the co-author, with Josh Piven, of the *Worst-Case Scenario Survival Handbook* series.

JENNIFER WORICK graduated from a kick-ass Big 10 school. After surviving pints of peach schnapps and countless walks of shame, she moved on to an illustrious writing career. Among her many books, she is the co-author of the *Worst-Case Scenario Survival Handbook: Dating & Sex*.

BRENDA BROWN is an illustrator and cartoonist whose work has been published in many books and major publications, including *The Worst-Case Scenario Survival Handbook* series, *Esquire*, *Reader's Digest*, *USA Weekend*, *21st Century Science & Technology*, *The Saturday Evening Post*, *The National Enquirer*, and many other magazines. Her website is <http://webtoon.com>.

Visit www.worstcasescenarios.com for updates, new scenarios, and more! Because you just never know. . . .

ACKNOWLEDGMENTS

Josh Piven thanks all of the experts, for their college knowledge; his parents, for footing the bill for his education; and the cast of the film *Animal House*, for their inspirational approach to higher learning.

David Borgenicht would like to thank his alma mater and his alma pater; his editors, Jay Schaefer, Steve Mockus, and Melissa Wagner; the entire team at Chronicle Books and Quirk Books; Frances J. Soo Ping Chow; and all the experts who contributed their, er, expertise. He'd also like to apologize for the time he started that food fight, killed the ROTC captain's horse, slept with the mayor's daughter, and ruined the big parade at the end of the movie.

Jennifer Worick would like to thank the following people: editor Melissa Wagner; co-authors Dave Borgenicht and Josh Piven, whom she sorely wishes had gone to college with her so they could have helped her research and cram for exams; all of the talented experts; and Sacha Adorno, Brenda Brown, Mindy Brown, Kerry Colburn, Josh Freely, Liesa Goins, Laurel Rivers, Alison Rooney, Jay Schaefer, Frances J. Soo Ping Chow, Ann Wilson, and all of her family and friends. She also thanks her college roommates—Maria, Donna, Janet, Amy, and Nadine—who helped her through four years with minimal damage to her liver or her sanity.

INTRODUCTION

Dozens of images come to mind when you think about college life. Professors. Fraternities. Tweed jackets with suede elbow patches. Parties. Football games. Backpacks loaded with books. Parties. Intense seminars. Sororities. Huge, hushed classrooms filled with students taking tests. Parties. All-night cram sessions. Wool sweaters/surfboards (depending on region). Beverages. A blinking cursor on a blank computer screen. The homecoming parade.

To be sure, heading off to college for the first time is one of life's great milestones. You're finally leaving the nest, heading out on your own to choose your own path. You're ready to learn what it takes to succeed, to explore your inner self, and to figure out what you really want to be. The world is your oyster— if only you can figure out how to shuck it.

Thankfully, first-time college students have a variety of resources at their disposal to help them prepare. Guidance counselors, alumni, faculty advisors, resident advisors, and campus tour guides do their best to give students a sense of what's in store. And when it comes to the basics, they do just fine. They are perfectly capable of preparing you for the more common challenges you'll face at school—how to pick a major, how to add or drop classes, how to improve your study habits, and how to find your way around campus. Your mom can teach you how to do your laundry and heat up canned soup, and your high school teachers should be able to give you the basic study skills you'll need.

But what about when college life takes a sudden turn for the worse?

Who do you go to when you discover you have a nightmare roommate, or when you're served a tray of completely unrecognizable and probably dangerous institutional food? How do you deal with a thoroughly gross dorm bathroom, or open a bottle without an opener? What's the best way to ask your parents for money, and how do you survive the walk of shame? What do you do if you've never attended a class and now you have a test?

That's where we come in.

With expert advice from experienced bartenders, truckers, lifeguards, safety instructors, bail bondsmen, poison control workers, and, of course, professors, admissions officers, and psychologists, among many other experts, *The Worst-Case Scenario Survival Handbook: College* is your guide. It is required reading for every student.

We've organized the book into four sections— Getting Settled, Room and Board, Extracurricular Survival Skills, and Class Survival—and have included an appendix with extra special aids: Because we know that *sounding* smart can be even more important than *being* smart, we've provided an easy-to-use pronunciation guide to philosophers, artists, and writers with weird names. The appendix also includes a useful letter/speech to tell your parents that you've been expelled. And should all else fail, there's a more-or-less realistic-looking diploma (you fill in your name) that you can enlarge on a photocopy machine, frame, and hang.

Whether you're attending a small college or a large university, living in a dorm or off-campus, or are a freshman or a senior, you still must survive your college experience. This book tells you how.

—The Authors

CHAPTER I

GETTING SETTLED

FOOD EQUIVALENCY CHART

Food item

Calorie equivalent in mugs of beer*

Apple pie, 1 slice.....	🍷🍷🍷
Bagel with cream cheese.....	🍷🍷
Beef jerky, 1 stick.....	🍷
Breadsticks with marinara sauce, 6.....	🍷🍷🍷
Brownie, frosted.....	🍷
Burrito, bean and cheese.....	🍷🍷🍷
Cheeseburger.....	🍷🍷🍷
Chicken breast, fried.....	🍷🍷🍷
Chicken fingers, 6.....	🍷🍷🍷
Chili, 1 cup.....	🍷🍷
Chocolate chip cookies, 10.....	🍷🍷🍷🍷
Coffee with 2 tbsp. cream.....	🍷
Cola, 12-oz can.....	🍷
Dip, French onion, ¼ cup.....	🍷
Double bacon cheeseburger.....	🍷🍷🍷
Doughnut, glazed.....	🍷
Eggs Benedict.....	🍷🍷🍷🍷🍷
Falafel in pita with yogurt dressing.....	🍷🍷🍷
French fries, medium size.....	🍷🍷🍷
Fried-egg bagel sandwich, bacon and cheese.....	🍷🍷🍷
Fried rice, vegetarian.....	🍷🍷
Frozen yogurt, chocolate, ½ cup.....	🍷
Hot fudge sundae, small.....	🍷🍷
Hot wings, 8.....	🍷🍷🍷
Hummus and pita bread.....	🍷🍷
Latte, low-fat.....	🍷
Macaroni and cheese, 1 cup.....	🍷🍷
Milkshake, chocolate, 10 oz.....	🍷🍷🍷
Muffin, blueberry, large.....	🍷🍷
Nachos, 8.....	🍷🍷
Pad Thai with chicken and shrimp.....	🍷🍷
Pho.....	🍷🍷
Pizza, pepperoni slice.....	🍷🍷
Popcorn, microwave popped, ½ bag.....	🍷

Potato, baked, plain.....	🍷
Potato chips, 6-oz bag.....	🍷🍷🍷🍷
Ramen noodles, 1 package.....	🍷🍷
Salad dressing, balsamic vinaigrette, ¼ cup.....	🍷
Salad dressing, ranch, ¼ cup.....	🍷🍷
Sandwich, corned beef on rye.....	🍷🍷
Sandwich, peanut butter and jelly.....	🍷🍷
Sesame chicken.....	🍷🍷
Spaghetti with meatballs.....	🍷🍷
Sugary breakfast cereal, 1 bowl, no milk.....	🍷
Taco, beef.....	🍷
Cocktails	
Beer, light, mug.....	🍷
Bloody Mary.....	🍷
Cosmopolitan.....	🍷
Daiquiri.....	🍷
Fuzzy navel.....	🍷🍷
Gin and Tonic.....	🍷
Grain alcohol, shot.....	🍷
Kamikaze.....	🍷
Long Island iced tea.....	🍷🍷
Malt liquor, 40 oz.....	🍷🍷🍷
Margarita.....	🍷
Martini.....	🍷
Mudslide.....	🍷🍷
Piña colada.....	🍷
Rum, shot.....	🍷
Rum and Coke.....	🍷
Screwdriver.....	🍷
Seabreeze.....	🍷
Sex on the beach.....	🍷
Tequila, shot.....	🍷
Vodka, shot.....	🍷
Whiskey, shot.....	🍷
Whiskey sour.....	🍷
Wine, glass.....	🍷
Wine cooler.....	🍷

* One mug of beer is equivalent to 150 calories.

WORST-CASE SCENARIO.

HOW TO ASK YOUR PARENTS FOR MONEY

- ★ **Focus on one parent.**
Ask the parent you think is most likely to dole out funds. Harken back to childhood by using the parent's favorite term of endearment, such as "Mommy" or "Pop."
- ★ **Make the request in person.**
Request money during a trip home. "Reluctantly" bring up the subject and look extremely embarrassed to be asking for a handout.
- ★ **Write a letter if you are unable to ask in person.**
Sending a plea for funds through the mail rather than telephoning or sending an e-mail will add a personal, serious, and traditional touch. Follow up with a phone call after the letter arrives. If you must make your request via e-mail, write your message in the form of a letter; start with a traditional greeting such as "Dear Mommy" and use proper punctuation and upper- and lowercase letters. Do not use abbreviations or emoticons. Be aware that it is easier for a parent to turn down a request by a reply e-mail than it is when responding by letter.



Tell a sob story.

Tell your parent that you have been trying to stand on your own two feet, but that college is much, much harder than you thought it would be, and that you are having to spend many hours a day in the library. Convey your concerns that getting a job will seriously impact your study time: Say that you could work a late-night job, but you're not sure how safe it is to be out alone in that neighborhood. This works especially well if you are taking a full course load. Detail your professors' difficult demands and your massive assignments.



Highlight your accomplishments.

Demonstrate what a solid investment you are. Point to your stellar grades, mention how you are juggling multiple commitments, list your extracurricular activities, and note any praise you've received from a professor. If you have not achieved any of these accomplishments, mention that you could achieve them if you had more time to devote to your studies and activities, and that money would facilitate getting that time.



Be specific about how much you need.

Request an exact amount and give the reason why you need the money. If you are direct, your parents will see your need as real and will be more likely to believe that you have explored other means of getting money. Your appeal is less compelling if you use a vague number or ask them to send what they can spare.



Ask for more than you need.

You will probably receive less than your requested amount, so overestimate the amount you need.



Emphasize the intangible things the money will enable you to do.

Funds might be needed to service your computer immediately, to take an off-campus course, or to cover membership fees for an organization that will look great on your résumé. If you tell them the money will go to buy furniture or a new printer, expect to show the items to them when they visit.



Send a thank-you note.

Express gratitude for and relief at the amount you receive. Your parents will be pleased with your good manners and will be more likely to send money again.

HOW TO AVOID A DISASTER MATTRESS

★ Arrive at school early.

Get to your dorm and your room when nobody else is around.

★ Test the mattress.

- **SMELL TEST:** Is this an odor you can live with?
- **COIN TEST:** Bounce a quarter on the mattress. If it has any bounce at all, you have found an exceptional mattress.
- **JUMP TEST:** Leap from floor to bed repeatedly on different areas of the mattress. Will it support your weight, or has the mattress collapsed?
- **SUPINE TEST:** Lie down on the mattress. Does it have a smooth surface, or is it lumpy or sunken?
- **DOUBLE SUPINE TEST:** Lie down with a friend and ask him to roll over, bounce, and sit up. How does your half of the bed respond?
- **FLIP TEST:** Repeat all tests on the other side of the mattress.

★ Find a better mattress.

If the mattresses in your room don't pass the test, check mattresses in other, empty dorm rooms and the dorm storage area. Take the best one, replacing it with yours.

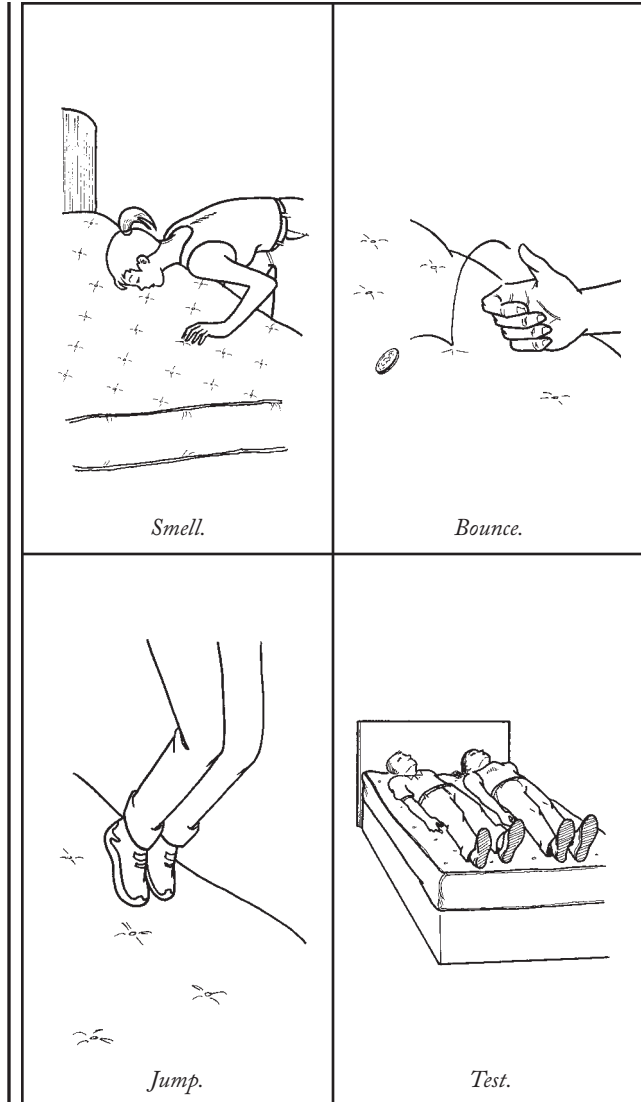



Stake your claim.

Make up the bed you have selected before your roommate arrives. Stack books, clothes, and other personal items on the bed to further mark your territory.

Be Aware

- Every few months, flip your mattress over or move it around so that the head becomes the foot of the bed. This will prevent any permanent indentations or lumps from forming in the mattress.
- Check with the custodial staff before installing your own water bed.

**WORST-CASE
SCENARIO®**

WORST-CASE SCENARIO.

HOW TO AVOID DOING LAUNDRY

- ★ **Air out your dirty clothes.**
Hang dirty clothes in your room. Spritz key areas with a spray deodorizer. Turn on an oscillating fan or use a blow-dryer to dry and refresh the garments.
- ★ **Wear dark colors.**
Dark-colored clothing will usually hide stains better than lights or whites. However, wearing dark colors in hot weather may increase perspiration and its resultant odors. Camouflage and heavily patterned clothing is also effective in hiding stains.
- ★ **Borrow clothes.**
Befriend people your size and ask for loans.
- ★ **Wear clothes inside out.**
When clothing becomes stained, turn it inside out and put it back on; make sure labels are in the back, or remove them using scissors. This strategy works best with T-shirts, socks, and underwear.
- ★ **Enlist the help of your roommate.**
Trade an item or skill you have for your roommate's wash-and-fold skills. Offer a party invitation you received, a hot prospect's phone number, or a short paper in exchange for an appropriate amount of laundry.

★ **Wear less clothing.**

The fewer clothes you wear, the fewer you'll need to wash. Skip unnecessary items like underwear and socks. Wear a long coat or sweater over bare skin.

★ **Send clothes home.**

Unless you have family members nearby, expect at least a week of turnaround time. You can save money by sending the clothes book-rate, but this method may take 10 days to 2 weeks.

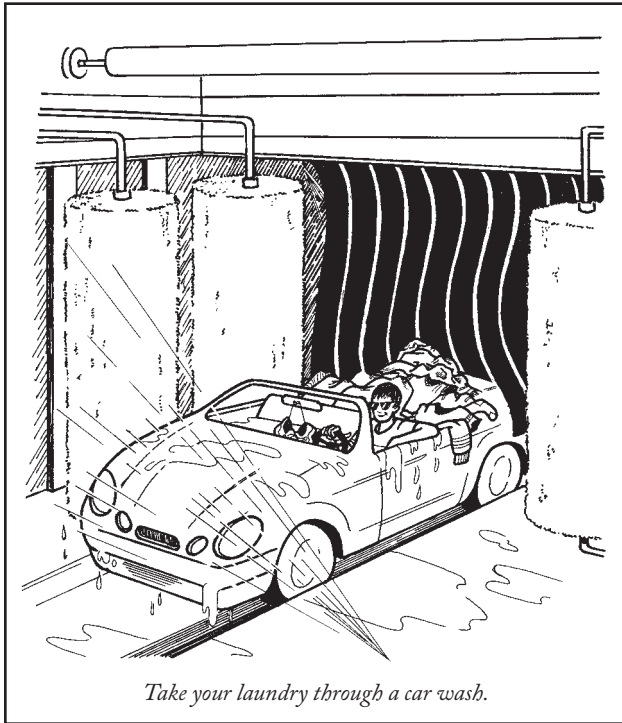

Take your laundry through a car wash.

★ **Hang clothes outside on a clothesline.**

Put clothes outside on windy, rainy, or snowy days and let the weather do the work for you. Do not hang clothes outside on a very hot, sunny day. The heat of the sun can set the smell or stain and make the garment difficult to clean later on.

★ **Shower with your clothes on.**

Use a liquid soap, which will penetrate layers of clothing more effectively than bar soap. Rinse thoroughly. Alternatively, wear clothing in swimming pools and outdoor fountains, though chlorine may leave a residual odor.

★ **Drive through a car wash with the windows open.**

Pile clothes on the passenger seats of an open convertible or car with the windows open. Close your eyes and hold your breath.

HOW TO AVOID GOING TO THE WRONG COLLEGE

1 Visit the college during the school year on a day with a regular class schedule.

Visiting during holidays, homecoming, or other times when students are away or not in their normal routine will not give you an accurate picture of everyday life at the school.

2 Observe the students.

- Are the students walking energetically to class while talking animatedly, or are the few students in sight wandering aimlessly?
- Are the students bright-eyed, with glowing complexions, or are they red-eyed, with a pasty pallor?
- Are the students carrying armfuls of books and notebooks, or are they carrying surfboards and coolers?
- Are the students eagerly seeking out professors after class and in the cafeteria, or are the students ducking into doorways and under tables to avoid professors?
- Are students in class paying attention and taking notes, or are they wearing headphones, reading the newspaper, or dozing?

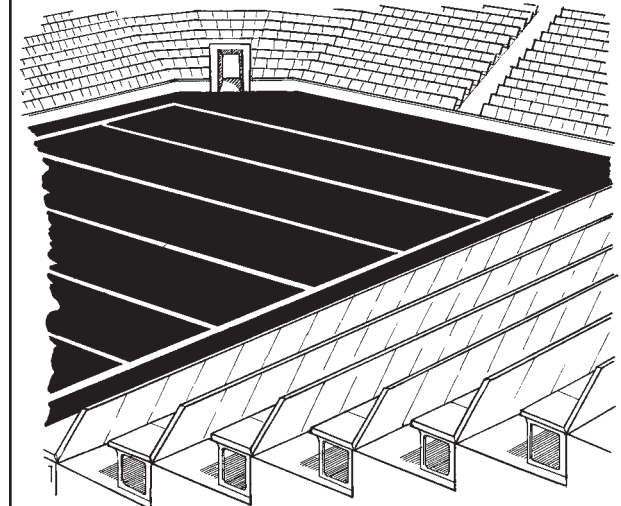
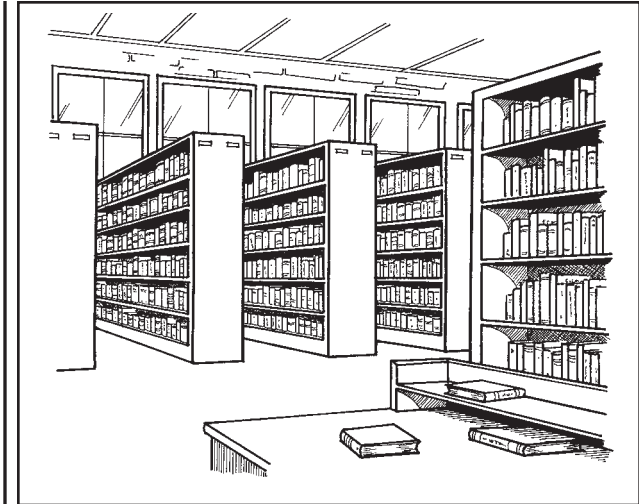

Compare the number of books in the library to the number of seats in the stadium.

3 Evaluate the facilities and surroundings.

- Compare the number of books in the library to the number of seats in the stadium.
- Compare the number of flyers promoting free lectures to the number of flyers promoting spring break getaways.
- Compare the number of nearby art galleries to the number of nearby hair salons.
- Compare the number of nearby bookstores to the number of nearby bars.
- Compare the number of students wearing T-shirts with the school logo to the number of students not wearing any shirt.
- Compare the number of ads in the school newspaper offering “Students Available to Tutor” to the number of ads offering “Research Papers Written—Any Topic.”
- Compare the number of times you hear chamber music to the number of times you hear sirens from emergency vehicles.

4 Select your school accordingly.

HOW TO IDENTIFY A PARTY SCHOOL

★ Assess the school’s location.

Party schools are often those farthest from urban centers: Such a location necessitates that all social activities occur on campus or in campus-adjacent locations, and therefore there are parties daily due to the lack of other entertainment opportunities. Cities

with a warm climate and good beaches are also home to party schools, as many students opt for surfing, sunbathing, and pitchers of margaritas over class.

★ Count the number of bars, liquor stores, fraternities, and sororities on or near campus.

The more plentiful the watering holes and Greek organizations, the more likely the students are to party.

★ Look for schools with successful sports teams.

Schools with particularly winning sports programs are likely to offer many months of pre- and post-game victory parties. Avoid schools with losing records or sparsely attended games, and those with teams that usually lose the homecoming alumni game.

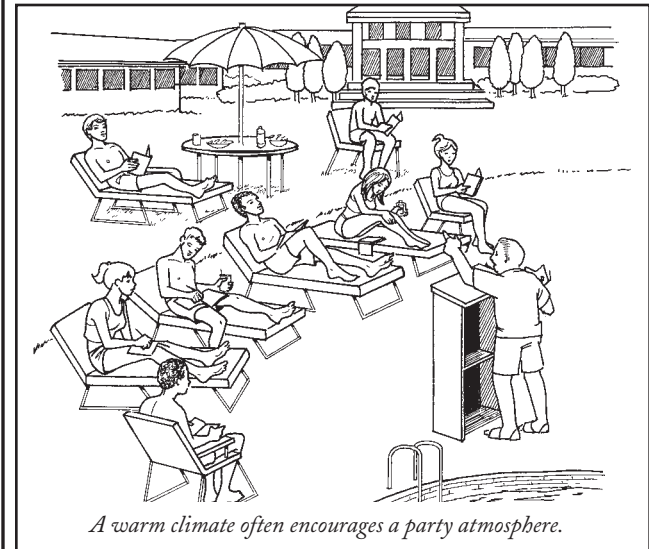

A warm climate often encourages a party atmosphere.

★ **Interview the school's administrators and alumni.**
Talk to the school's local boosters (ask the admissions office for names) about their memories of social activities at the school. If more than three of them recount stories of drinking at 6 A.M. or have no memory of college at all, the school is most likely a party school.

★ **Visit the school on a Thursday.**
A good party school will have multiple parties raging on this night. Walk the campus and listen carefully for whoops, yells, and loud music. Look for students staggering, talking loudly, or vomiting in the bushes, all of which are signs of raucous social activity. Enter a fraternity or sorority party. Gatherings without alcohol and centered around a knitting circle or a discussion of nineteenth-century English poetry indicate a college that does not measure up.

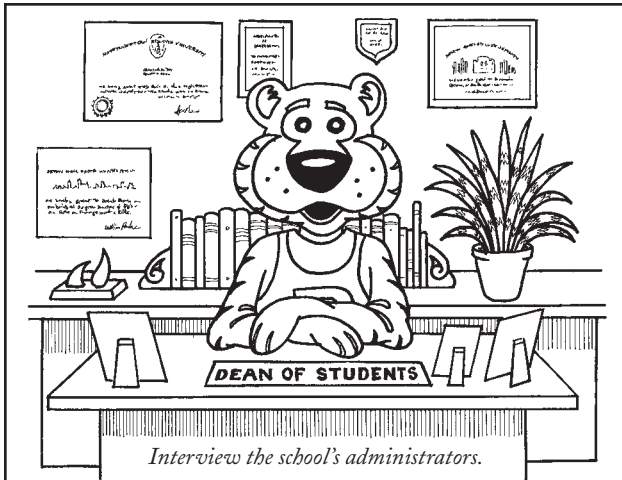

**WORST-CASE
SCENARIO.**

HOW TO AVOID GOING TO THE WRONG COLLEGE

1 Visit the college during the school year on a day with a regular class schedule.

Visiting during holidays, homecoming, or other times when students are away or not in their normal routine will not give you an accurate picture of everyday life at the school.

2 Observe the students.

- Are the students walking energetically to class while talking animatedly, or are the few students in sight wandering aimlessly?
- Are the students bright-eyed, with glowing complexions, or are they red-eyed, with a pasty pallor?
- Are the students carrying armfuls of books and notebooks, or are they carrying surfboards and coolers?
- Are the students eagerly seeking out professors after class and in the cafeteria, or are the students ducking into doorways and under tables to avoid professors?
- Are students in class paying attention and taking notes, or are they wearing headphones, reading the newspaper, or dozing?

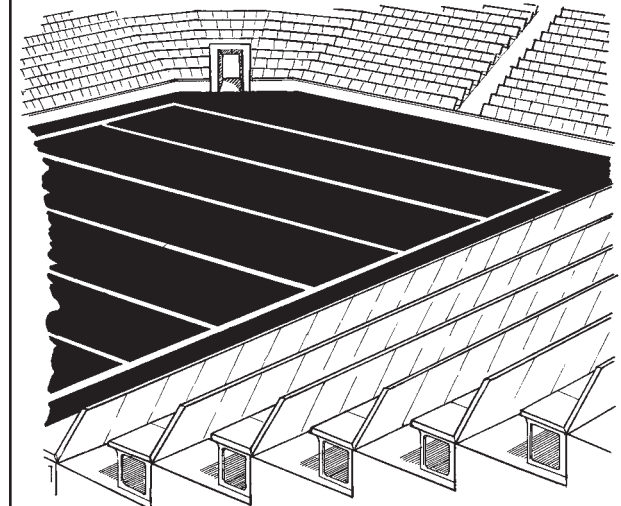

Compare the number of books in the library to the number of seats in the stadium.

3 Evaluate the facilities and surroundings.

- Compare the number of books in the library to the number of seats in the stadium.
- Compare the number of flyers promoting free lectures to the number of flyers promoting spring break getaways.
- Compare the number of nearby art galleries to the number of nearby hair salons.
- Compare the number of nearby bookstores to the number of nearby bars.
- Compare the number of students wearing T-shirts with the school logo to the number of students not wearing any shirt.
- Compare the number of ads in the school newspaper offering “Students Available to Tutor” to the number of ads offering “Research Papers Written—Any Topic.”
- Compare the number of times you hear chamber music to the number of times you hear sirens from emergency vehicles.

4 Select your school accordingly.

HOW TO IDENTIFY A PARTY SCHOOL

★ Assess the school’s location.

Party schools are often those farthest from urban centers: Such a location necessitates that all social activities occur on campus or in campus-adjacent locations, and therefore there are parties daily due to the lack of other entertainment opportunities. Cities

with a warm climate and good beaches are also home to party schools, as many students opt for surfing, sunbathing, and pitchers of margaritas over class.

★ Count the number of bars, liquor stores, fraternities, and sororities on or near campus.

The more plentiful the watering holes and Greek organizations, the more likely the students are to party.

★ Look for schools with successful sports teams.

Schools with particularly winning sports programs are likely to offer many months of pre- and post-game victory parties. Avoid schools with losing records or sparsely attended games, and those with teams that usually lose the homecoming alumni game.

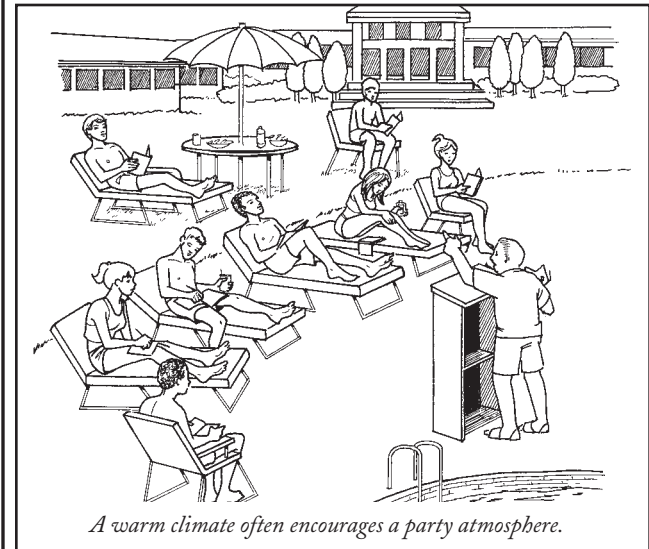

A warm climate often encourages a party atmosphere.

★ **Interview the school's administrators and alumni.**
Talk to the school's local boosters (ask the admissions office for names) about their memories of social activities at the school. If more than three of them recount stories of drinking at 6 A.M. or have no memory of college at all, the school is most likely a party school.

★ **Visit the school on a Thursday.**
A good party school will have multiple parties raging on this night. Walk the campus and listen carefully for whoops, yells, and loud music. Look for students staggering, talking loudly, or vomiting in the bushes, all of which are signs of raucous social activity. Enter a fraternity or sorority party. Gatherings without alcohol and centered around a knitting circle or a discussion of nineteenth-century English poetry indicate a college that does not measure up.

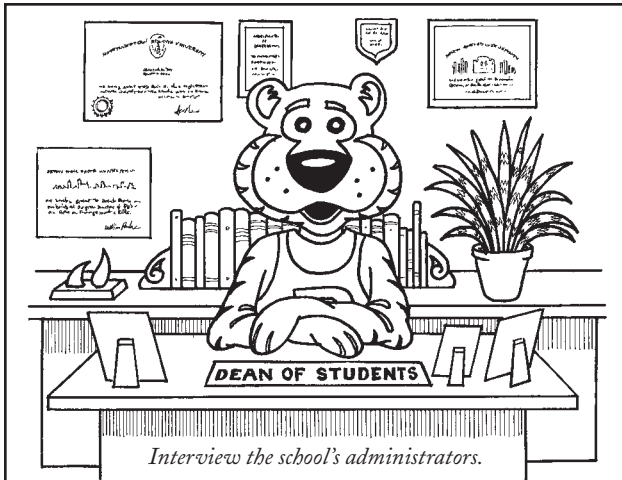

**WORST-CASE
SCENARIO.**

HOW TO AVOID THE FRESHMAN FIFTEEN

- ★ **Avoid foods you can eat with your hands.**
Pizza, French fries, hamburgers, onion rings, bagels with cream cheese, hot wings, jalapeño poppers, dip
OKAY: Raw vegetables, fruit
- ★ **Avoid foods you can get from a vendor at a sporting event.**
Beer, peanuts, ice cream bars, nachos, popcorn, hot dogs, garlic fries
OKAY: Bottles of water, Popsicles
- ★ **Avoid foods you can get from a vending machine.**
Potato chips, soda, candy bars, cheese and crackers, cookies, muffins, hot chocolate
OKAY: Sugarless gum, diet soda, water, mini pretzels, black coffee
- ★ **Avoid foods that melt quickly.**
Ice cream, sorbet, gelato, ice cream bars, frozen custard, chocolate bars
OKAY: Fat-free frozen yogurt, Popsicles, fruit and juice bars, ice cubes
- ★ **Avoid foods that you can eat with chopsticks.**
Chinese stir-fry in heavy sauce, pad Thai, fried rice, chicken teriyaki, dim sum
OKAY: Sushi, steamed vegetables, brown rice, *be bim bop, pho*

- ★ **Avoid foods that come in a crinkly bag.**
Potato chips, cookies, tortilla chips, crackers, cheese puffs, nuts, snack cakes
OKAY: Ready-to-eat salads (no dressing), cereal, rice, precut vegetables
- ★ **Avoid foods that are orange.**
Candied yams, pumpkin pie, cheddar cheese
OKAY: Bell peppers, acorn squash, oranges, sweet potatoes (baked)
- ★ **Avoid foods with phosphates.**
Bacon, hot dogs
OKAY: None

Be Aware

Trying to keep track of the number of calories in the foods you eat is difficult, impractical, and annoying. Think of the calorie content of food in terms of its equivalent in mugs of beer and adjust your intake accordingly (see chart on next page).

FOOD EQUIVALENCY CHART

Food item	Calorie equivalent in mugs of beer*
Apple pie, 1 slice.....	3
Bagel with cream cheese.....	2
Beef jerky, 1 stick.....	1
Breadsticks with marinara sauce, 6.....	2
Brownie, frosted.....	1
Burrito, bean and cheese.....	2
Cheeseburger.....	2
Chicken breast, fried.....	2
Chicken fingers, 6.....	2
Chili, 1 cup.....	2
Chocolate chip cookies, 10.....	2
Coffee with 2 tbsp. cream.....	1
Cola, 12-oz can.....	1
Dip, French onion, ¼ cup.....	1
Double bacon cheeseburger.....	2
Doughnut, glazed.....	1
Eggs Benedict.....	3
Falafel in pita with yogurt dressing.....	2
French fries, medium size.....	2
Fried-egg bagel sandwich, bacon and cheese.....	2
Fried rice, vegetarian.....	2
Frozen yogurt, chocolate, ½ cup.....	1
Hot fudge sundae, small.....	2
Hot wings, 8.....	2
Hummus and pita bread.....	2
Latte, low-fat.....	1
Macaroni and cheese, 1 cup.....	2
Milkshake, chocolate, 10 oz.....	2
Muffin, blueberry, large.....	2
Nachos, 8.....	2
Pad Thai with chicken and shrimp.....	2
Pho.....	2
Pizza, pepperoni slice.....	2
Popcorn, microwave popped, ½ bag.....	1

Potato, baked, plain.....	1
Potato chips, 6-oz bag.....	2
Ramen noodles, 1 package.....	2
Salad dressing, balsamic vinaigrette, ¼ cup.....	1
Salad dressing, ranch, ¼ cup.....	2
Sandwich, corned beef on rye.....	2
Sandwich, peanut butter and jelly.....	2
Sesame chicken.....	2
Spaghetti with meatballs.....	2
Sugary breakfast cereal, 1 bowl, no milk.....	1
Taco, beef.....	2
Cocktails	
Beer, light, mug.....	1
Bloody Mary.....	1
Cosmopolitan.....	1
Daiquiri.....	1
Fuzzy navel.....	2
Gin and Tonic.....	1
Grain alcohol, shot.....	2
Kamikaze.....	1
Long Island iced tea.....	2
Malt liquor, 40 oz.....	2
Margarita.....	1
Martini.....	1
Mudslide.....	2
Piña colada.....	2
Rum, shot.....	1
Rum and Coke.....	1
Screwdriver.....	1
Seabreeze.....	1
Sex on the beach.....	2
Tequila, shot.....	1
Vodka, shot.....	1
Whiskey, shot.....	1
Whiskey sour.....	1
Wine, glass.....	1
Wine cooler.....	1

* One mug of beer is equivalent to 150 calories.

HOW TO CHILL BEVERAGES WITHOUT A REFRIGERATOR

INDOORS

- ★ **Make your own cooler.**
Fill a washing machine, bathtub, or sink with ice for an instant cooler. Drain the water when it warms and add more ice. For faster cooling, twirl the bottles in the ice. Guard these locations if they are in shared or public areas.
- ★ **Use a toilet tank.**
The water in the tank is usually cool. Place sealed bottles and cans in the tank. Thoroughly wash and rinse the bottle before drinking.
- ★ **Use a soda machine.**
Stick a bottle of wine up the ramp of a soda machine. Guard it well.
- ★ **Use an aerosol “keyboard duster.”**
Turn the can upside down and spray it around the bottle from about six inches away. The cold air under pressure will come out more quickly, slightly chilling the beverage.

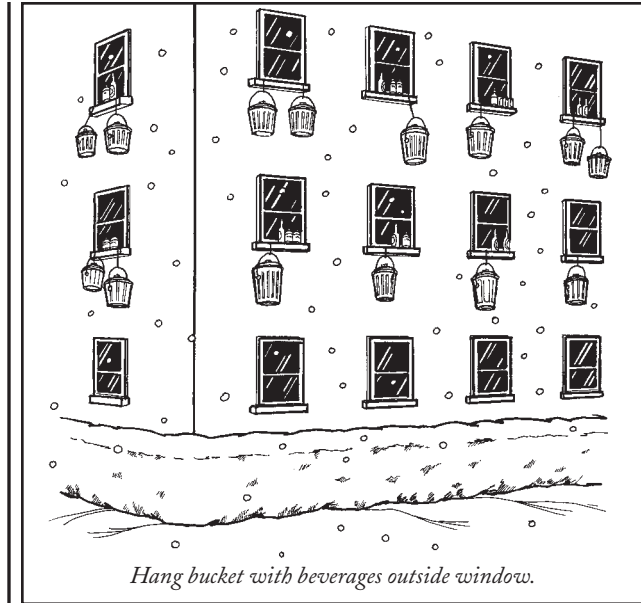

OUTDOORS

- ★ **Use the weather.**
If the weather is cold, rainy, or snowy, place the beverages on your windowsill or hang a bucket or shelf from your window to store beverages outside. Do not leave drinks outside for more than an hour on very cold days, or you run the risk of freezing them. Do not hang drinks outside the window if you live on the first floor unless you are able to guard them constantly.
 - **BUCKET METHOD:** Tie a square knot to fasten one end of a rope to the handle of a bucket; secure the other end of the rope to your desk or another

sturdy, immovable object. Dangle the bucket outside the window. Make sure the bucket is not overloaded, or the bucket or bottles may fall and seriously injure a passerby below. Do not fill the bucket with water; the cold air will cool the bottles enough.

- **SHELF METHOD:** Use a plank and knot a rope around each end. Lower the shelf out your window so that it is level and within arm's reach. Tie securely to sturdy objects inside the room. Place your bottles carefully on the shelf and hang it out the window. Note: Do not use this method on especially windy days.



Stow bottles and cans in a fountain.

Chilling your beverages in public places can result in theft or unwanted attention from authorities, so store your beverages in a less-trafficked location.



Ask an ice cream vendor to chill your bottle.

Ask a friendly looking vendor with an ice-cream or food cart to store your beverage in his cooler or refrigerator. Make sure you know his route if he moves around campus so you can retrieve it when it is needed. Do not entrust beverages to a vendor in a motorized vehicle.

**WORST-CASE
SCENARIO.**

HOW TO DATE THREE PEOPLE AT ONCE

- ★ **Assign them the same nickname.**
Call them all “honey” or “sweetie” or “pumpkin” so that you do not accidentally use the wrong name with the wrong person. It also helps if you discuss the same topics and pick the same song as “our song.”
- ★ **Keep to a schedule.**
See them only on their assigned day—Mary every Thursday, Emily every Friday, and Jenny every Saturday. They will see you as highly disciplined and will not expect to monopolize your time.
- ★ **Select three different favorite bars, activities, or restaurants.**
A special place for each reduces your chances of running into another date. Look for dimly lit, off-campus locations.
- ★ **Be vague.**
Provide few details to each date about your whereabouts during nondate evenings. Offer ambiguous responses like “I wish I had time to see you more often, too.”
- ★ **Keep your answering machine volume turned down.**
If you are home with one of your dates and another calls, you will not be found out.

- ★ **Advise your roommate to say as little as possible.**
Explain your situation and ask for cooperation. Tell your roommate to say only “Nice to see you” when he sees one of your dates. He should avoid “Nice to meet you” or “Nice to see you again” since he may be easily confused about who he is talking to.
- ★ **Do not place photographs around your room.**
The fewer things and people to explain, the better. Also remove stuffed animals, flowers, cards, mix CDs, or anything that might look like a romantic gift.
- ★ **Tell everyone that you have a large family.**
Prepare for the time that you will be spotted with another date. If asked later who you were with, you can say she was your cousin.
- ★ **Refer to several part-time jobs.**
Say that you are sorry to be so unavailable because you are always working. Mention that you are saving all the money you are earning for tuition and other living expenditures so that you don’t build expectations about gifts or expensive dates.
- ★ **Do not boast.**
Aside from your roommate, keep any mention of the simultaneous relationships to yourself. The more people you tell about your multiple assignments, the more likely it is that you will be discovered.

WORST-CASE SCENARIO.

HOW TO DEAL WITH A NIGHTMARE ROOMMATE

- ★ **Cover foul odors.**
Burn incense or spray air freshener to mask your roommate's scent. To better circulate the incense, place it in front of an open window or oscillating fan.
- ★ **Secure your possessions in locked storage containers.**
To discourage theft or misuse of your belongings, lock as much as possible in safes, military-issue foot lockers, trunks, and other lockable storage containers. Long, flat containers can be placed under your bed for further protection.
- ★ **Divide the room in half.**
Draw a line down the center of the room to designate your own private space. Remember that you'll have to share the door.
- ★ **Wear noise reduction headphones.**
Don the headphones anytime your roommate is in the room with you.
- ★ **Leave a bar of soap on his pillow.**
- ★ **Put neglected dirty dishes in your roommate's bed.**

★ **Gather long-unwashed clothes into a pile.**

If the pile of dirty clothes isn't remedied after a week, transfer the pile to trash bags and seal tightly to eliminate odors. If the bags remain after several weeks, put them in the trash.

★ **Misalign the satellite dish.**

Disrupt the constant blare of sporting events by redirecting your roommate's satellite dish.

★ **Buy your roommate concert tickets.**

If your roommate never leaves the room, buy him a ticket to an all-day concert, a movie, or a sporting event. Do not ask your roommate if he wants to go; just purchase the ticket—the farther away the event, the better.

Be Aware

If you notice any of the following in your room, you may have a nightmare roommate:

- Giant speakers
- Lack of toiletries
- Machete
- More than 15 stuffed animals

**WORST-CASE
SCENARIO®**

WORST-CASE SCENARIO.

HOW TO DEAL WITH A PROMISCUOUS ROOMMATE

- ★ **Prearrange a “keep out” signal.**
Agree that a towel wrapped around the door handle, a hotel-style “Do Not Disturb” sign, or an index card in the doorjamb indicates the room is occupied and being used, and you should stay out for an agreed-upon period of time. Forty-five minutes should be the maximum.
- ★ **Dismantle bunk beds and move your bed far away from his.**
You will be less likely to be awakened if your bed frame is not attached to his.
- ★ **Pretend that nothing is happening.**
Start a conversation with your roommate as though nothing is going on. Ask questions about how his day has been, what he’s planning on doing tomorrow, or what he had for dinner. Talk to his hook-up. “I don’t believe that we’ve ever met before. What is your name? What’s your major?”
- ★ **Play your stereo.**
Blast loud, raucous music from your stereo to break your roommate’s concentration. Avoid sultry songs that will only provide encouragement.

★ **Watch television.**
Wear headphones plugged into your television to block out noise and distract yourself.

★ **Foil future hook-ups.**
Be your roommate's shadow at parties. When it appears that a hook-up may be in the offing, quickly intercede when your roommate is distracted. Mention how great it is that the two have gotten together "in light of his recent condition," then be evasive. Comments such as "I hope you have a better time than the others" and "I expect I'll be seeing more of you since I rarely leave the room" will also discourage the hook-up. If all else fails, tell your roommate that you forgot your keys and ask him to walk you home. If he won't leave with you, ask for his keys. When he returns home, you can choose whether or not to unlock the door.

★ **Obtain a date of your own.**

HOW TO SILENCE SQUEAKY BEDSPRINGS

★ **Lubricate.**
When your roommate's bed is not in use, oil the bedsprings and any joints of the bed frame that are visible.

★ **Tighten the nuts and bolts.**
Use a wrench to strengthen the bed's framework.

★ **Wrap the bed's joints.**
Wrap cotton strips or thick socks around the bed's joints to muffle a squeaking sound. Use duct tape to secure the wrapping in place.

★ **Remove the mattress from the frame.**
Encourage your roommate to sleep with the mattress directly on the floor or set it on a thick piece of plywood resting on cinder blocks.

★ **Wear earplugs.**
The bed might still squeak, but you won't notice.

★ **Make your own bed squeak.**

HOW TO DEAL WITH AN UNEXPECTED VISIT FROM YOUR PARENTS

1 Stall for time.

Enlist the help of your roommate or another nearby friend. Ask her to greet your parents and to delay them outside, telling them that you just stepped out of the shower and you need a moment to dry off and dress. This should buy you at least five minutes to get the room ready.

2 Hide all inappropriate items.

Search for objects or people that may cause your parents distress or cause them to reconsider their financial contribution to your college tuition. Hiding these items is your first priority; cleaning can come later, if you have time. Locate and conceal the following:

- beer cans, empty or full
- liquor bottles
- cigarettes (including butts, cellophane wrapping, cigars, ashtrays, lighters, and matches)
- certain magazines, videos, posters, and calendars
- stolen street signs
- firecrackers
- partially clothed members of the opposite sex
- women's undergarments (if male)
- men's undergarments (if female)

- completed exams that belong to anyone but you
- newly acquired expensive electronic equipment
- travel brochures
- parking tickets
- all forms of birth control

3 Air out the room.

Open the window, no matter what the outside temperature. Douse a sock with cologne, perfume, a styling product, or another heavily scented liquid that will mask the odor of any smoke, mold, or musty laundry in the room. Swing the sock in a circular motion above your head while walking around the room.

4 Check the time.

Your parents will grow suspicious if you keep them waiting for too long. Determine whether you have time to continue to clean up your room.

5 Stow your clothes.

Gather all of your dirty clothes into the middle of the floor. Shove as many articles as possible into your hamper or laundry bag. Stand on top of the hamper to force the clothes down so that you can add more on top. When you run out of room, put the rest of your clothes under the bed, stack them on the floor of the closet, or use them as makeshift furniture: Sit on the pile to create an indentation. Cover the pile with a sheet, tucking the sides of the sheet under the pile. The laundry now looks like a beanbag chair.

*Gather clothes
into a pile.*



*Create an
indentation.*

Cover the pile.



6 **Make your bed.**

Remove the comforter from the bed. Throw flat items like magazines, books, and papers onto your mattress, taking care not to pile them. Fluff the comforter to increase thickness, then tuck it under the mattress to secure. Arrange pillows on top.

7 **Check the time.**

If you've kept your parents waiting for more than five minutes, skip to step 9. Blame any remaining mess on your roommate. If you have time, continue to step 8.

8 **Sweep away clutter.**

Shoes, toiletries, food, mail, dirty plates, pizza boxes, hangers, dead plants, empty soda cans or bottles, and any other unsightly clutter can be jammed under your bed or into the closet on the floor or a high shelf. Carefully close the door. Do not open the closet while your parents are in the room.

9 **Primp.**

Put on deodorant or apply an odor-concealing perfume or aftershave. Put on clean clothes or, if unavailable, turn dirty attire inside out. Wet and comb your hair to give yourself a just-showered look.

10 **Greet your parents.**

Enthusiastically embrace your parents. Tell them that it is a wonderful surprise to see them. Make it clear that you have a lot of studying to do before the day is over so that you can keep the visit short. Allow your

parents to make a quick survey of your room, then suggest going out for a tour of campus and some coffee. Gently but forcefully lead them away as quickly as possible.

Be Aware

Use caution when opening the closet door after a rush-cleaning job. Tuck your chin to your chest, curl one arm over your head for protection, and expect an avalanche.

**WORST-CASE
SCENARIO®**

HOW TO DEAL WITH THE AFTERMATH OF A WILD PARTY

HOLE IN THE WALL

1 Hide it.

If the hole is above waist height, hang a poster or other wall decoration over the hole. If the hole is below waist height, move a sofa or easy chair from another location and place it in front of the hole. Sweep or vacuum the floor where the furniture was previously located, or its absence will be obvious.

2 Make faux-Spackle.

Slowly mix flour and water together until they form a thick paste, or use white toothpaste for a quick fix.

3 Fill the hole.

Using a butter knife or your fingers, fill the hole with the mixture. For very large holes, first fill the cavity with crumpled newspaper. Make sure the paste completely covers the hole and extends onto the wall around it. Spread paste evenly and remove clumps.

4 Allow to dry.

Wait at least 30 minutes, or until the paste hardens.

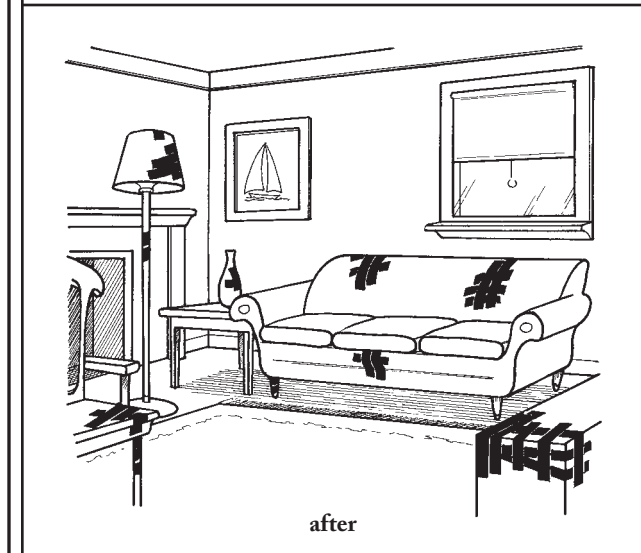
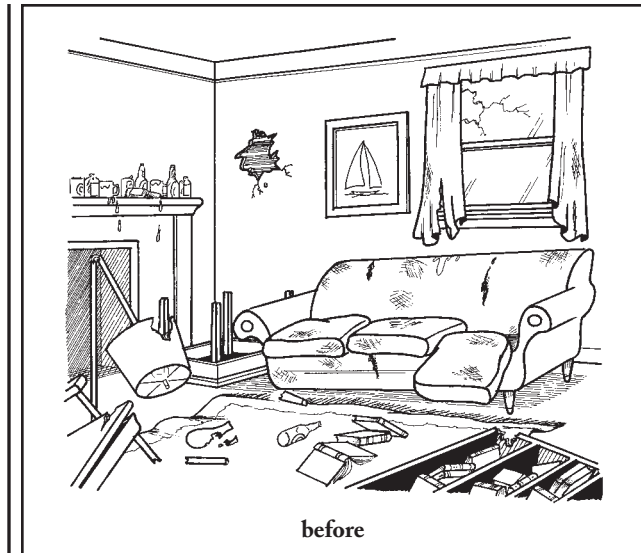

5 Sand.

Using fine-grain sandpaper, sand the wall until it is smooth. Paint if necessary.

6 Camouflage the fix.

If the wall color was not white originally, use a suitable Magic Marker or nail polish to conceal your repair.

Be Aware

Repairing large broken sections (bigger than fist-size) may require extensive sawing of the cracked drywall and patching with drywall and/or chicken wire, which is a difficult, time-consuming process. For holes of this size, cover the affected area with a piece of furniture until professional repairs can be made or you move out.

BROKEN WINDOW

1 Secure the remaining glass.

Stripe duct tape diagonally across pane to help prevent further breakage.

2 Patch the hole.

Use cardboard to cover the hole, securing it with more duct tape.

3 Pull down the shade or close the curtains.

Be Aware

- If you are expecting to have a particularly raucous party, striping windows with tape beforehand can minimize damage.
- Other things that can be fixed with duct tape include torn upholstery, plates and mugs (but do not put in dishwasher), pole lamps, putters, vases, end tables, and small goldfish bowls.

RED WINE SPILL

1 Blot rug or carpet immediately.

Use an absorbent cloth (like an old T-shirt) to soak up as much of the stain as possible. Do not rub the stain, as you will push the wine further into the carpet.

2 Saturate.

Pour large amounts of club soda or cold water on the stain and surrounding area. White wine is also an effective stain remover, but pouring good wine on the carpet is wasteful.

3 Repeat.

Reiterate steps 1 and 2 several times until the stain disappears. If the stain remains but is no longer being transferred to the cloth, stop blotting and saturating.

4 Make a stain removal paste.

If stain persists, make a paste of 3 tablespoons of borax or baking soda and 1 tablespoon of water.

5 Rub the paste onto the stain.

Use an old toothbrush or a spoon. Allow the paste to dry.

6 Vacuum.

7 Repeat steps 4 through 6 until the stain is no longer visible.

If the stain still remains, treat with a commercial carpet spotter.

WAX ON CARPET

1 Allow to dry.

Do not attempt to remove the wax while it is still hot.

2 Place an ice cube on the wax.

Hold the ice in place for 30 seconds or until the wax hardens completely.

3 Break and scrape.

Gently break apart the wax with your fingers until you have a pile of loose shavings. Scrape as much wax as possible off the carpet with a spoon or dull knife.

4 Vacuum.

5 Iron.

If wax still remains, place a clean cloth or paper bag over the wax. Slowly move a warm iron across the cloth or bag. The wax will melt and adhere to the

warm surface of the cloth/bag. Rotate the cloth/bag as the wax is absorbed so you are always ironing on a clean section.

6 Vacuum.

If wax remains, use a commercial carpet cleaner to remove remnants.

SPILL ON KEYBOARD

1 Unplug the keyboard.

Do not turn on the computer.

2 Place the keyboard upside down on an absorbent cloth.

3 Leave overnight.

4 Dry.

Using a can of compressed air or a blow-dryer, thoroughly dry keyboard, making sure no wet or damp areas remain.

5 Test.

Plug the keyboard into an older computer or one without critical files, if available. Turn on the computer. If the keyboard is recognized and the computer works properly, it is safe to plug the keyboard into your main system.

Be Aware

- Powering up a computer with a wet keyboard can result in an electrical short circuit, which damages the entire system.
- For laptop computers, keep the system off and follow steps 2 through 5. If you are not sure the keyboard is completely dry, send the unit out for repair before turning it on.
- Highly acidic drinks like coffee and tea or sugary beverages like hot chocolate and soda may cause electrical parts to corrode if the spill is not properly cleaned.

**WORST-CASE
SCENARIO®**

WORST-CASE SCENARIO.

HOW TO DEAL WITH “THE SPINS”

- 1 Focus your gaze on a stationary object in the room.**
Keep your eyes open. Avoid looking at ceiling fans. Stare at the object for one minute.
- 2 Close your eyes.**
- 3 Picture the object you were looking at.**
Imagine that the object is imprinted on the inside of your eyelids.
- 4 Open your eyes.**
If the spinning returns, stare at your object for one minute.
- 5 Close your eyes.**
Repeat steps 3 and 4.
- 6 Repeat steps 3, 4, and 5 until the spinning stops or you pass out.**

Be Aware

- The spins usually occur when your eyes are closed. Watch television, go out for some air, or eat a meal—anything to stay awake and keep your eyes open until you sober up.

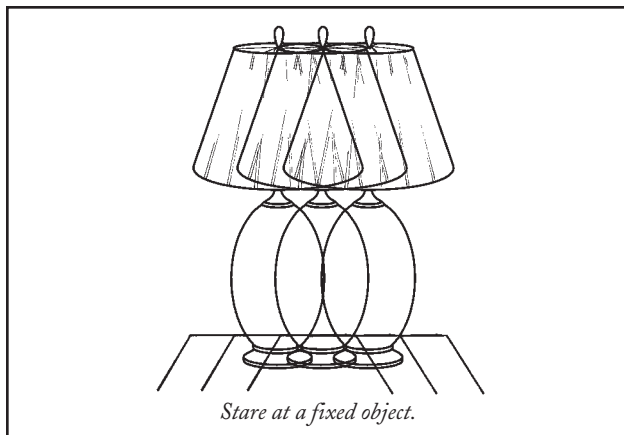

- Eating reduces drinking-related sickness by reducing the speed at which alcohol in the stomach is absorbed into the bloodstream. Eat before drinking: Once you have the spins, it is too late.
- Alcohol is a diuretic and dehydrates. After drinking, replace lost fluid, vitamins, and electrolytes by consuming sports drinks. Avoid drinking excessive amounts of plain water, which will dilute the sodium concentration in the body.

HOW TO VOMIT CORRECTLY

- 1 Be prepared.**
Vomiting may be preceded by sweating, nausea, gagging, increased saliva, or the sensation of swelling under the tongue.

- 2 Move quickly.**
Get to a quiet bathroom or a private area with an appropriate receptacle, such as a toilet, trash can, or metal bowl. If outdoors, look for an area secluded by trees or bushes. Avoid public spaces.
- 3 Remove necktie or necklace.**
- 4 Open collar.**
Unbutton your shirt at least two buttons and pull the sides apart. If you are wearing a pullover, remove it completely, if time permits. Tie back long hair.
- 5 Relax.**
Do not resist.
- 6 Target a destination.**
Vomit into the receptacle. If vomiting into a toilet, grip the sides for support.
- 7 Wait.**
The first bout of vomiting may not be the last. Wait several minutes to make sure you remain in control.
- 8 Clean up.**
Wash your hands and face, rinse out your mouth, and brush your teeth.
- 9 Return to the party.**

WORST-CASE SCENARIO.

HOW TO DECORATE YOUR ROOM WHEN YOU'RE BROKE

MILK CRATE CHAIR

You will need a square, stackable milk crate; a cloth placemat or your favorite fabric in a similar size; an old magazine; 6 large car-wash sponges; heavy upholstery thread; an upholstery sewing needle; and scissors.

1 Turn the crate upside down.

2 Create the base of the cushion.

Place the magazine on top of the bottom of the crate. Use the scissors to trim the magazine pages so that the magazine rests about $\frac{3}{4}$ inch from the inside edge of the crate.

3 Arrange 4 sponges on top of the magazine.

Lay the sponges next to one another to form the cushion. You may have to use the scissors to trim them to fit squarely to the top of the crate.

4 Lay the remaining sponges on top of the existing row.

Create a second layer of cushion by centering 2 sponges on top of the first layer.

5 Anchor the placemat to the crate.

Position the placemat on top of the sponges. Using the needle and thread, secure both shorter sides of the placemat to the crate by hooking a single loop stitch through the edge and around a crate grid square.

6 Push down on the placemat.

Compress the sponges until the longer sides of the fabric reach the edges of the crate.

7 Sew the placemat to the crate.

Secure the placemat with a continuous loop stitch around the perimeter of the crate.

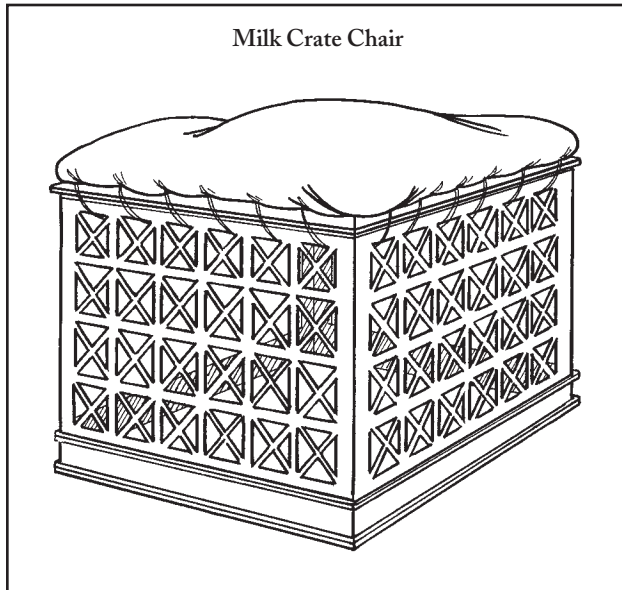

8 Sit.

You can also use the crate as an ottoman or low stool, or stack it on top of another crate for a desk-height chair.

Be Aware

If you're using your own fabric rather than a placemat, lay a strip of masking tape $\frac{1}{4}$ inch from the edges around the perimeter of the fabric to prevent fraying before securing the fabric to the crate.

T-SHIRT CURTAINS

To accommodate a window of approximately 4 feet x 4 feet, you will need 13 of your favorite old T-shirts; 1 spool of thread in any color; 1 to 2 spools of iron-on hem tape; 1 spool of picture-hanging wire; 2 medium-weight eyehole screws; 1 manila folder (or similarly stiff paper); a medium-tipped marking pen; a sharp pair of scissors; and a sewing machine.

1 Make a stencil.

Cut the manila folder into a rectangle (9 inches x 12 inches) or a square (10 inches x 10 inches) to make a stencil.

2 Cut the T-shirts into pieces.

Lay a T-shirt on a flat surface for cutting. Put the stencil on the center of the shirt body. Trace the outline of the stencil with the marker on the T-shirt. Lift the stencil off the shirt. With the scissors, cut through

T-Shirt Curtains

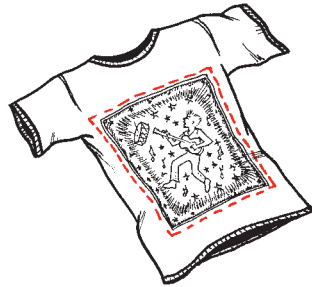

Cut.

Sew.

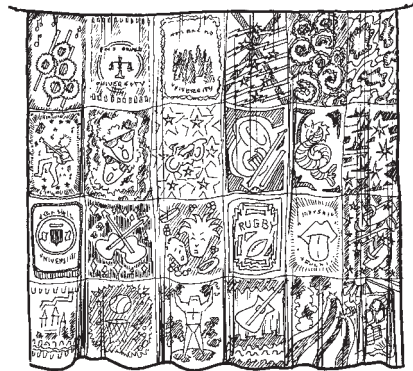

Hang.

both layers of the T-shirt, following the drawn cut-line. Perform this step on all the shirts.

3 Arrange the pieces to make a curtain.

On the floor or your bed, arrange the pieces next to one another in a pattern you like. Use as many pieces as you need to create a covering a little bit longer and wider than your window.

4 Disassemble the curtain.

Collect your horizontal rows into piles and set them down next to your sewing machine.

5 Sew the pieces together.

Place the front faces of two pieces together and sew, using a medium straight stitch $\frac{1}{4}$ inch from the edge of the mated pieces.

6 Connect the rows.

Sew front face to front face. Make sure any design on the T-shirt pieces is right-side up.

7 Finish the edges.

Once you have sewn the window covering to the desired size, cut the hem tape to size for the perimeter of the covering. Iron on the hem tape along the sides so the tape wraps around the edge, covering the front and back of the edge.

8 Prepare the curtain for hanging.

Facing the front of your window piece, fold back 2 inches of the top edge to form the place to string the picture-hanging wire through. Secure the folded portion by sewing $\frac{1}{4}$ inch along the edge. Cut the wire 1 foot longer than the width of your window opening. Thread the wire through the pipeline you created.

9 Hang the curtain.

With your hand, screw in the eyehole screws at either edge of your window. Hang the window covering by wrapping 6 inches of excess wire through the eyehole hooks.

Be Aware

If you do not have a sewing machine, hem tape, or a needle and thread, use a stapler or duct tape to secure the T-shirt pieces together.

ALTERNATE METHOD:

If you would rather keep your T-shirts intact, run a curtain rod straight through the armholes of as many T-shirts as it takes to cover the width of the window. Repeat this procedure, adding more rows until the window is covered. Smelly, worn T-shirts can be put on the rods to be aired out, thus saving you from having to wash them.

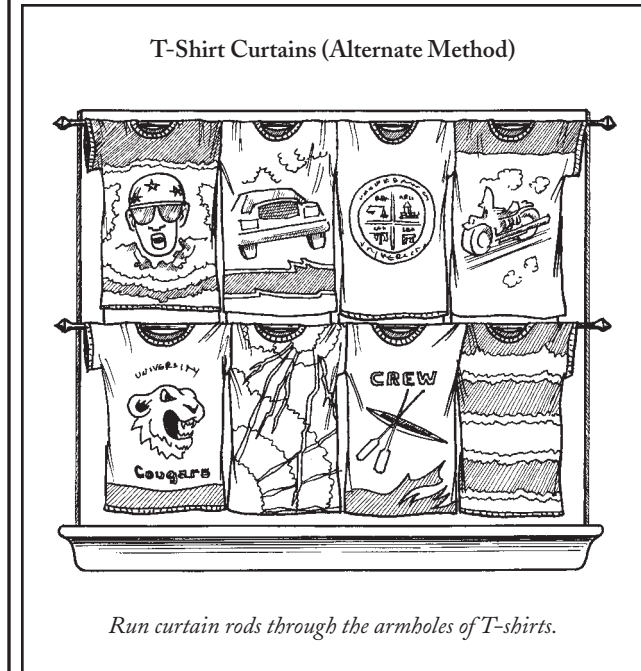

PICTURE FRAME

You will need an empty, transparent jewel case from a CD; a photo; and scissors.

1 Detach the cover of the jewel case at its hinge.

2 Reattach the cover, wrong-side out.

This will form a wide V shape that can stand up on a flat surface.

3 Insert your photo on top of the outer half of the case.

Use the scissors to trim the photo to fit. Add colored paper behind the photo for a more sophisticated look.

4 Display.



WORST-CASE SCENARIO.

HOW TO EAT WHEN YOU'RE BROKE

HOW TO EAT FOR NOTHING

- ★ **Look for free samples.**
Membership food clubs and grocery stores offer free food samples in their aisles. One or two sweeps through the store might supply you with a well-balanced meal, including a beverage. Weekends are the prime time for grocery store samples due to the high volume of shoppers. Travel the aisles with a partially filled cart for greater acceptance. Ice cream parlors usually allow you to sample a flavor or two.
- ★ **Share your friends' bounty.**
Monitor the campus mailroom for friends who receive care packages and ask them to share. Ask acquaintances on the college meal plan to bring you fruit and containers full of cereal. Follow pizza delivery people and ask the recipients for a slice after they've all taken their first piece. Promise to pay them back later.
- ★ **Offer to deliver food (without a tip).**
Many pizza restaurants offer a free pizza after every five (or some other number of) pizzas ordered. Collect the required number of orders from friends or dorm-mates, go to the pizza place, and pick up the pizzas—plus the free pizza. Be sure to collect payment for the pizzas in advance.

- ★ **Make friends at restaurants and bars.**
Making friends with cooks, waitstaff, or bartenders can result in free food, albeit leftovers at the end of a shift. Alternatively, offer to clear trays at a drive-in or restaurant. Consume leftover burgers, fries, and milkshakes between the table/car and kitchen.
- ★ **Participate in on-campus extracurricular activities.**
Join one or several university clubs that feature snacks at meetings and gatherings. Dorms offer special study nights during midterms and finals and frequently open their cafeterias for a study area. Snacks will be plentiful.
- ★ **Attend happy hour.**
Many bars and restaurants near campus serve complimentary hors d'oeuvres between 5 and 7 P.M.
- ★ **Sample the condiment bar.**
Some fast-food outlets have condiment bars with vegetables, sauces, salsa, and pickles. Help yourself to a few samples, but do not eat on the premises. Bring along a plastic bag to stow your snacks.
- ★ **Crash parties.**
Loiter at a local hotel and follow well-dressed people to trade shows, weddings, and bar mitzvahs. Visit the buffet table. Use caution when speaking to guests.

- ★ **Stake out hotel hallways.**
Snack on uneaten or partially eaten rolls, sandwiches, and garnishes from leftover room service trays. Make sure the meal has already been served and eaten, or you will risk a confrontation with a hungry hotel guest.
- ★ **Dumpster dive.**
The Dumpsters behind supermarkets and restaurants are almost always filled with untouched, uneaten food that was thrown away simply because it passed its expiration date. Take bread, canned goods, and other wrapped items. Do not break into a locked Dumpster.

HOW TO EAT FOR UNDER A DOLLAR

- ★ **Eat fast food.**
Most fast-food restaurants have items on the menu that cost less than a dollar. Bulk up your sandwich with loads of condiments for extra calories; you will stay full longer.
- ★ **Look for specials and sales.**
Restaurants, convenience stores, and grocery stores all run sales and specials. Look for two-for-one deals on soda, candy, cookies, noodles, and soup, and for markdowns on perishables like meat, fruit, bread, and vegetables.
- ★ **Buy generic.**
Generic or store labels are always cheaper than name-brand items.



Eat beans.

Beans are a very cheap source of protein and fiber, and contain other essential nutrients.



Eat pasta.



Eat a baked potato.

A single potato usually costs less than a dollar and can be baked or heated in a microwave: Poke several fork holes in the potato to allow steam to escape and reduce the chance of explosion.



Eat canned goods.

Canned food is nearly always cheaper than its fresh alternative.



Go for quantity, not quality.

Buy foods that last for several meals so the average cost per meal is low. A loaf of bread will go a lot further than one piece of fruit. A jar of peanut butter might cost several dollars but will provide many meals for under a dollar when you pair it with two slices of bread and jelly packets from the cafeteria or a diner. Boxes of pasta, a package of bagels, generic cereal, a carton of eggs, oatmeal, a package of hot dogs, and cans of soup are cheap to begin with, and you will get more than one meal out of them.

**WORST-CASE
SCENARIO.**

HOW TO GET A FREE DRINK WHEN YOU'RE BROKE

- ★ **Appeal to your friends' soft side.**
Tell your friends that you are having your annual "drink-free" night. When they look confused, express mild discomfort and then sheepishly admit you are broke. Your reluctance to take advantage of the situation may result in your friends plying you with free drinks.
- ★ **Goad strangers into making you drink.**
Sidle up next to someone, preferably from a boisterous state like Texas. Order water. When he ridicules you, tell him you have never had a drink before. Allow him to goad you into drinking for as long as he is willing to buy. This strategy will also work on someone who is alone and is not particularly attractive.
- ★ **Tell a sob story.**
Create a plausible tale of woe. Sit next to a woman with a sympathetic face. Say that you had to put your dog to sleep that day. Reveal that you caught your girlfriend in bed with your roommate. Pepper your story with as many details as possible. Cover your face with your hands. Apologize for being so upset and thank her for being such a good listener. Gratefully accept a drink.

- ★ **Plan an accident.**
Ask for a glass of water with a twist of lime. Pick a mark—choose someone with sweeping arm movements—and accidentally bump him with your elbow and spill your drink on yourself. When he offers to get you a new drink, ask for a gin and tonic. You can also set your glass of water near someone's elbow. When she knocks it over, allow her to replace it.
- ★ **Scavenge leftover drinks.**
Drink the half-empty beers or mixed drinks left behind by bargoers. Carry a small spray bottle of disinfectant or soapy water. Spray a napkin and wipe the glass with it. Beware of smokers who leave behind drinks—they often drop butts in their drinks or bottles.
- ★ **Gamble.**
Make bets that you know you will win, or perform a surefire bar trick for drinks. Select a mark, preferably someone who has been drinking heavily. You will need a small brandy snifter, an empty glass, and a stemless maraschino cherry.
 - Place the snifter upside down over the cherry.
 - Wager a free drink that you can get the cherry into the empty glass without touching the cherry or empty glass. The cherry can touch only the snifter, which must remain upside down. Squashing the cherry onto the rim is prohibited.
 - When he bets, show him the power of centrifugal force. Hold the base of the snifter and rotate it quickly on the bar top. When the cherry starts

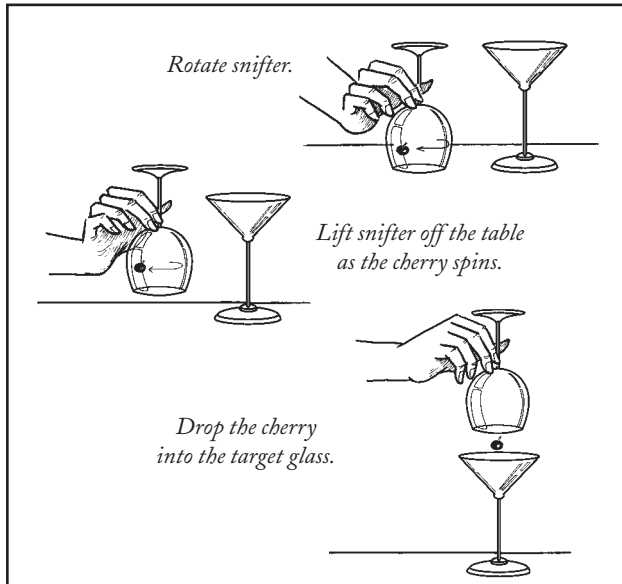

spinning inside the glass, lift the snifter off the table. Keep rotating the snifter and hold it over the glass. When you slow your rotation, the cherry will drop into the glass. Collect your free drink.

Be Aware

- Frequent the same bar. Bartenders and waitstaff will get to know you and may occasionally send free drinks your way or let you drink on credit.
- Skip dinner. The drinks you do get will have more effect on an empty stomach.
- Frequent happy hours that have two-for-one specials. Other patrons may be willing to give you their “free” drink.

**WORST-CASE
SCENARIO.**

**WORST-CASE
SCENARIO.**

HOW TO GET INTO A CLASS THAT IS FULL

- ★ **Befriend someone in the registrar's office.**
An inside contact can place you at the top of a waitlist, determine the likelihood of getting into a particular class, give you information about the professor, or even slip you statistics on the dropout rate of the class.
- ★ **Ask the professor in person.**
Make the extra effort to plead your case directly. Seek out the professor during her office hours before the first class.
- ★ **Present a compelling reason.**
Earnestly convey a specific reason as to why you are so keen on taking this particular class. Mention that you've already done a lot of work in the area of study, refer to an obscure article, or say that you've published articles on the subject. Convince the professor that your experience and enthusiasm will make the class better for all the students.

- ★ **Flatter the professor's curriculum vitae.**
Bring up a few details about the professor's alma mater, publications, academic expertise, and reputation. Demonstrate that you are an admirer who wants to study at the feet of the master.
- ★ **Attend the first class.**
See if someone drops it or if there are unexpected openings. Stay for the whole class, and participate. Make your presence known. Have all necessary paperwork on hand in case the professor agrees to admit you to the class.
- ★ **Be persistent.**
Go to the professor's office. Leave her numerous voicemail messages. Visit her office again. Keep yourself in her field of vision—she may give in and admit you just so that you will leave her alone.
- ★ **Cry.**
Crying may help you gain sympathy.
- ★ **Convince a student to drop the class.**
Explain why the class is so important to you. Offer goods and services, or perhaps some money for her trouble. Avoid direct threats.

**WORST-CASE
SCENARIO®**

WORST-CASE SCENARIO.

HOW TO HIDE THINGS IN YOUR DORM ROOM

SMALL ITEM



Use an old textbook.

Stash cash between pages. For other items, make a secret compartment.

- Open the book to page 50 or beyond.
- Use a razor blade or a sharp knife to cut a square hole in the center of the book. Use a metal ruler to guide you, and keep repeating your cut lines to go deeper and deeper.
- Remove the square cut-out pages.
- Put the item in the compartment.
- Reshelve the book.



Use a potted plant.

- Seal the item in a plastic bag.
- Dig a hole several inches deep in the soil.
- Bury the bag.



Construct a beer can safe.

- Using a nail or pen, poke a small hole in one side of a beer can, near the bottom. Drink or discard the contents.
- Use scissors or tin snips to cut away the side of the can with the hole, leaving the top and bottom intact.

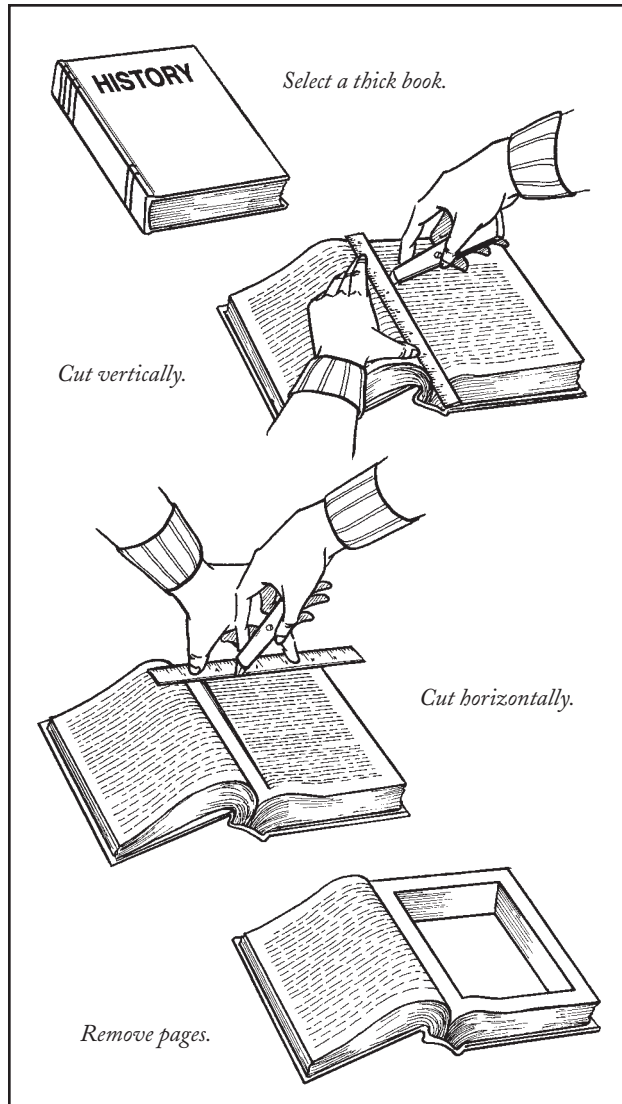

- Stash valuables in the can and place it on a wall covered with other, similar cans. Make sure the hole in the can faces the wall.



Use electrical outlets.

This location is suitable for very small and dry items only.

- Use a screwdriver to unscrew the switch plate that surrounds a light switch or electrical outlet.
- Insert the item in the wall cavity.
- Replace the plate.



Use shampoo bottles.

- Seal the item in a waterproof bag.
- Hide the bag in a bottle of shampoo.
- Keep your bathroom items separate from your roommate's to avoid detection.



Use baseboards.

- Pry a small section of baseboard away from the wall, using a hammer and chisel or flat screwdriver.
- Use the hammer to pound a hole in the drywall just above the floor, in an area that will be concealed by the baseboard.
- Stash the item in the hole.
- Replace the baseboard by wedging it in place.

LARGE ITEM



Camouflage.

Pile dirty or damp clothing on the item to be hidden. Make sure the pile looks and smells sufficiently unappealing to prevent scrutiny.



Use a feather pillow.

Depending on the size and weight of the item, you may be able to stash it in a feather pillow. Unzip the pillow and bury the item in the middle. Make sure all hard edges are well covered with several inches of feathers. Re-zip and cover with a dirty pillowcase to deter inspection.



Use your roommate.

If you suspect you will be the subject of a search (particularly a search by a thieving roommate), hide valuables among your roommate's possessions. Make sure the hidden item is well concealed in the back of a closet, under her bed, or in another location she is unlikely to visit regularly. Check periodically to be certain the hidden item has not been detected.

**WORST-CASE
SCENARIO®**

HOW TO IDENTIFY UNSAFE CAFETERIA FOOD

MEAT AND POULTRY



Check the color.

When fully cooked, beef turns brown or gray; chicken is white or brown without a trace of pink or red (depending on whether it is light or dark meat); and pork is also white, with no tinge of pink or red. If you cannot identify what kind of meat you are being served, do not eat it. No meat or poultry should ever be yellow, blue, or green.



Check the temperature.

Hot foods should be piping hot; cold foods should be chilled. If the temperature is in doubt, ask a food service operator for a cooking thermometer and stick it into the center of the item. Hot meats should be at least 145°F, cold foods no warmer than 40°F.



Poke with a fork.

If the juices run red, the meat is undercooked.



Look at the gravy.

Sauces and gravies may have a thick “skin” or float in a puddle of congealed oil. These items are a breeding ground for bacteria.

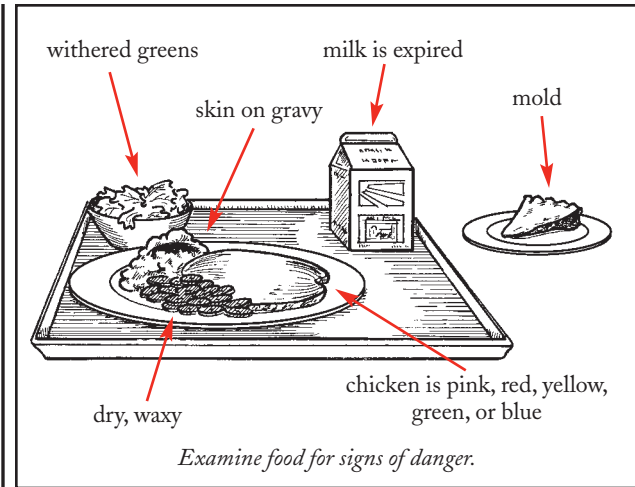

SALAD BAR



Look for a sneeze guard.

Salad bars and other self-serve areas should have plastic guards to protect food from germs. Avoid foods in areas without these protective devices.



Watch for slow food turnover.

Food left out too long will have a dry, waxy, or withered appearance. Food should not be left out from breakfast to lunch and lunch to dinner. If you suspect slow turnover, mark a piece of food with a carefully placed garnish; parsley works well. Return to the dining hall later in the day to see if your marked item is still present. If it is, complain to the chef or management.

★ **Avoid foods that need to be eaten soon after being cooked.**

Scrambled eggs should not sit in a steam tray for more than two hours; hardboiled eggs keep at room temperature for two hours or for up to one week if refrigerated.

PACKAGED FOODS

★ **Check the expiration date.**

If it is past the date shown on the package, do not eat it. This applies to yogurt, milk, sushi, and any prepared or packaged foods.

★ **Check the package for damage.**

If the seal is broken or the package looks damaged, do not eat the contents. Gently squeeze the bag of chips or pretzels to see if the bag holds air and remains firm. For vacuum-sealed jars, make sure the top has not popped up, which would indicate that the jar has been opened and the contents may be unsafe to eat. Do not eat food from dented cans—the sharp point of the dent may allow air and germs into the can.

Be Aware

- Watch for overripe fruits and vegetables. Extensive brown or black spots are not good.
- Check bread and pies for mold. Green means STOP.

**WORST-CASE
SCENARIO®**

**WORST-CASE
SCENARIO.**

HOW TO OPEN A BOTTLE WITHOUT AN OPENER

ANOTHER BOTTLE

- 1** Hold the bottle you wish to open upright in your nondominant hand.
Grip the neck of the target bottle, placing your index finger over the back edge of the cap.
- 2** Hold the second bottle horizontally around the label.
Grip this bottle, the opener, as though shaking hands with the bottle.

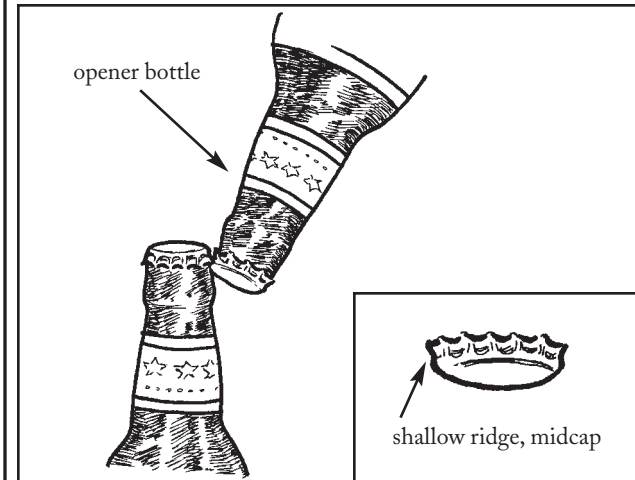

- 3** Fit the shallow ridge found at midcap of the opener bottle under the bottom edge of the cap of the bottle you wish to open.

By using this ridge, and not the bottom of the cap, you will not risk opening the second bottle in step 4.

- 4** Using the opener bottle as a lever, press down and pry the cap off the target beer bottle.

- 5** Enjoy.

ALTERNATE METHOD:

Hold both bottles end to end perpendicular to the ground, with the crimped edges of the caps together, locking them in place. Pull. Be careful, however, as either or both bottle caps could come off.

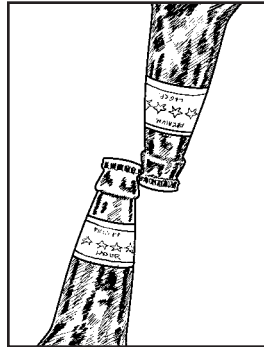

LIGHTER

- 1** Grip the bottle in your nondominant hand.

Make a fist around the top of the bottle so that your thumb overlaps your index finger and the web between your thumb and index finger sits in the groove under the cap.

- 2** Fit the bottom of the lighter under the teeth of the cap.

Position the lighter so that it rests on the middle knuckle of your index finger.

- 3** Press the top of the lighter down and toward the bottle.

Use the index finger on your dominant hand to provide resistance.

- 4** Pry off the cap.

If necessary, turn the bottle and repeat.

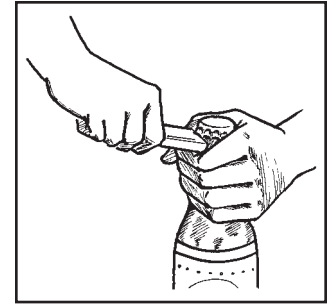

TABLE EDGE

- 1** Put the teeth of the bottle cap against the edge of a table.

The cap should be on top of the table edge; the bottle should be below the table. Do not attempt on a soft wood or antique table.

- 2** Use your fist to hit the bottle.

The bottle will take a downward trajectory, and the cap will pop off.

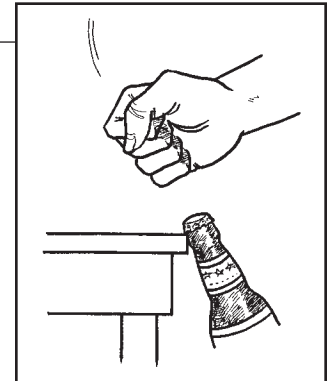

SCREWDRIVER, SPOON, FORK, OR KNIFE

1 Place the implement under the bottle cap, as high as it will go.

2 Pry off the cap.

Slowly go around the cap and lift up each crimped area with the tool, similar to opening a can of paint.

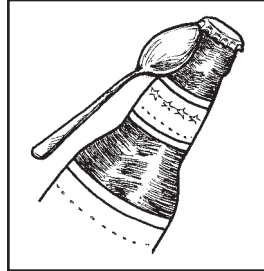

3 When the cap starts to move, fit the tool higher up under the cap and remove it.

BELT BUCKLE

1 Unfasten your belt buckle.

If your pants are in danger of falling down, sit.

2 Pull the “tooth” of the buckle to one side.

3 Fit the cap into the buckle so that one edge is wedged against the buckle.

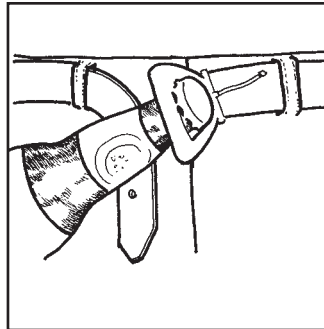

4 Pry off.

Pull the bottle slowly. A quick tug may result in a spill.

5 Refasten your belt.

DEADBOLT LOCK

1 Fit your bottle into the lock.

Place the head of the bottle into the recession in a doorframe into which a deadbolt slips, so that the cap fits against the notch in the lock's frame.

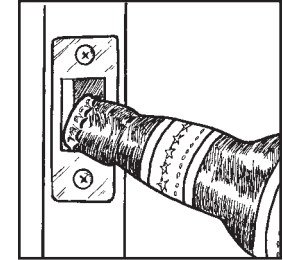

2 Pull up slowly.

The bottle cap should pop right off.

FIRE HYDRANT

1 Look for an arrow on top of the hydrant labeled “open.”

2 At the end of the arrow, locate the recess between the screw and the nut.

3 Insert the cap into the recess.

4 Press down slowly on the bottle until the cap comes off.

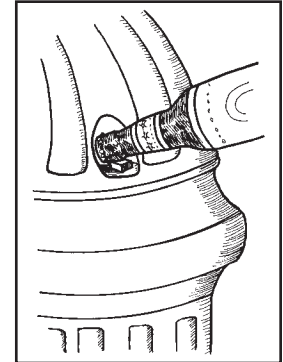

IN-LINE SKATE

- 1 Place the cap between the shoe and the blade.**

Hold onto the bottle with your dominant hand. If you are wearing the skate, use the hand opposite the skate to open the bottle.

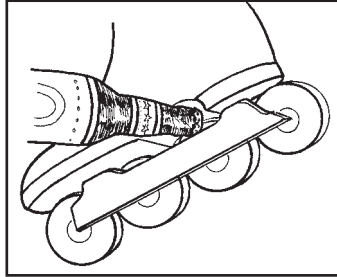

- 2 Pull up slowly on the bottle and pry off.**

Quickly right the bottle to avoid spilling.

METAL POOL BRIDGE

- 1 Hold the stick of the bridge in one hand and a beer bottle in the other.**

Do not attempt to open over the pool table.

- 2 Position the cap inside the opening of the bridge.**

Fit the cap snugly against the edge.

- 3 Press down on the bottle.**

Slowly increase the pressure until the cap loosens. Right the bottle immediately to prevent spillage.

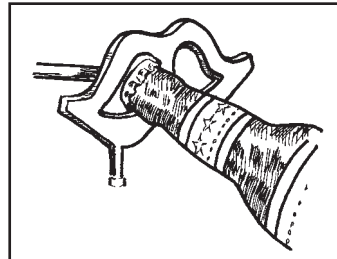

VENDING MACHINE

- 1 Locate a newspaper, snack, or soda vending machine.**

An older soda machine might actually have a bottle opener.

- 2 Place the cap in the coin return.**

Wedge the cap against the top of the opening.

- 3 Press down slowly until the cap is removed.**

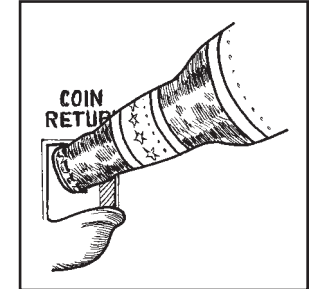

Be Aware

Never drink from a bottle with broken or chipped glass.

WORST-CASE SCENARIO.

HOW TO PAD A RÉSUMÉ



Be descriptive and creative.

Employ uncommon action verbs to describe your qualifications and experience. Instead of *worked*, say *coordinated*, *organized*, or *interfaced*. Consult your thesaurus to avoid repetition.



Exaggerate job experiences.

Describe your previous jobs in the most sophisticated language you can. No job is unimportant. If you worked the drive-through lane at a fast-food restaurant, state that you “interacted with a diverse client base in a fast-paced environment.” See the Job Description Euphemism Chart, page 158.



Quantify your experience.

If you were a peer counselor or guided new students through orientation, be specific about how many people you assisted. If you have handled money in a work or extracurricular situation, include a specific monetary amount or number of transactions. List your campus activities, no matter how trivial they may seem. Mention leadership positions within your fraternity, groups you have organized, volunteer work, or participation in protests. The more full the page looks, the better.

JOB DESCRIPTION EUPHEMISM CHART

What you did:	What you list:
Worked the deep fryer	Acted as sous-chef in popular lunch venue
Bagged groceries	Coordinated order fulfillment
Answered phones	Interfaced with clients
Mowed lawns	Landscaped for private clients
Made beds	Arranged accommodations for a hotel
Dug ditches	Industrial waste facilitator
Waited tables	Managed client relations
Babysat	Child development consultant
Folded clothes in department store	Sales associate in the garment industry
Gas station/convenience store clerk	Auto mechanic's assistant
Lifeguard	Health and safety supervisor
Washed dishes	Restaurant critic
Lifted boxes in a warehouse	Inventory manager
Centerfold	Centerfold



Keep your résumé to one page.

A single page looks solid and full and makes you look more focused and experienced. Reduce the type size, change the font, or decrease the margins at the top, bottom, and sides to make it fit.



Provide information strategically.

If your grade point average is below a 3.0, do not include it. If you have a strong GPA in your concentration, list only that. List study groups you have led or special projects in which you have participated. If you include hobbies and interests, be as specific as possible.



Work your contacts.

If you or your parents know someone in the company, or if you were referred to the job by an alumnus or another contact, mention it in the first line of your cover letter.



Impress with your presentation.

Buy heavy cream linen or white laid paper and envelopes to create the impression that you are stylish and sophisticated. If you are including a writing sample, put it in a binder. Type the mailing label or envelope. Make sure the paper stock of your envelope matches that of your résumé. If you are e-mailing a résumé, be specific about the job you are applying for in the subject line. Do something to grab their attention, such as “Marketing Assistant position—YOUR SEARCH IS OVER!” Include the résumé as

an attachment to your e-mail and also cut and paste it into the body of your message to make it as easy as possible for your potential employer to read it.

Be Aware

- Check your spelling. Slowly read your résumé backward to ensure that each word is correct. Pay extra attention to your phone number and contact information.
- Make sure you have a professional-sounding outgoing phone message and that you check your e-mail account regularly. If you live in a group situation, list your cell phone number instead of your home telephone to avoid a roommate answering the phone inappropriately or failing to deliver a message.

**WORST-CASE
SCENARIO®**

HOW TO PULL AN ALL-NIGHTER

- ★ **Eat a light dinner.**
Do not skip a meal, but do not eat to the point of drowsiness or sluggishness. Select foods with protein, like chicken breast, and complex carbohydrates, such as whole-wheat bread, brown rice, or beans, to provide you with energy and stamina for a long night. Later, when you feel your energy ebb, eat an energy bar.
- ★ **Consume peppermint.**
Peppermint is a stimulant; even a whiff of it will make you more alert and awake. Eat peppermint candy, chew peppermint gum, or drink peppermint-flavored herbal tea. Rub peppermint oil on your temples or wrists.
- ★ **Turn on the radio or television.**
A bit of white noise in the background will engage your senses. Select a classical or jazz station on the radio. If you turn on the television, turn to an infomercial or shopping channel. Keep the volume low. Do not select a rerun of your favorite situation comedy or anything you might otherwise be interested in.
- ★ **Turn on a strong overhead light.**
A bright light will help you see what you are reading as well as prevent you from falling into a deep sleep.

Close the curtains and put clocks out of sight; your body will become confused as to what time of night it is.

- ★ **Turn down the thermostat.**
The cold temperature will help keep you awake. Make sure the temperature does not dip below 50°F, at which you are susceptible to hypothermia, especially if you have wet hair or skin. A high temperature slows your pulse and makes you drowsy.
- ★ **Do not lie down.**
Pinch yourself or wear tight shoes and constricting underwear. Physical discomfort will keep you distracted and awake.
- ★ **Consume caffeine.**
Drink caffeinated beverages or eat a few caffeinated mints, but proceed with caution: Too much caffeine can leave you distracted and wired. Three hundred milligrams is considered a safe daily amount of caffeine for adults, which translates into a six-pack of soda or three to four cups of brewed coffee.
- ★ **Breathe deeply.**
Go to an open window or step outside for a few minutes. Stand up straight, close your eyes, and inhale deeply through your nose. Hold the breath for as long as you can. Exhale slowly through your nose or mouth. Repeat several times. Deep breathing will clear your mind and give you a shot of energy.

★ **Stretch.**

Stretch your limbs by taking a walk or doing a few yoga poses. This will work out any tension you are holding in your muscles.

- Lift your arms over your head and reach for the sky, alternating arms.
- Lean over to each side and then lean forward from the waist, bringing your arms out in front of you and down to the ground.
- Let your arms dangle; swing them from side to side.

★ **Do a headstand.**

Increase your circulation by standing on your head.

- Find an area of clear floor space next to a wall.
- Kneel on the floor, facing the wall.
- Place your head on the floor a few inches from the wall.
- Place your forearms on the floor on either side of your head.
- Raise your body and legs slowly up the wall. Keep your body weight on your arms, not your head. Lean against the wall as needed.

★ **Raise your heart rate.**

If you find yourself nodding off, do a few calisthenics to raise your heart rate. Do 25 jumping jacks, or skip rope or jog in place for 5 minutes.

★ **Get a study partner.**

Even if he is not cramming for the same exam, you and your partner can quiz each other and talk as



you start to get drowsy. Do not stay up with someone you know will distract you with either idle chatter or sexual tension.

Be Aware

Even if you don't plan on going to sleep, set your alarm clock. To make sure that you are awake when you need to be, set every alarm you can find—watches, computers, cell phones, and hand-held electronic devices often have built-in alarms. Arrange for a friend or your roommate to back up the alarms with a wake-up call.

HOW TO PUT OUT A MICROWAVE FIRE

1 Turn off the microwave.

Press the STOP button. Do not open the door, or you will risk adding oxygen to the fire. Check for flames or smoke by looking through the glass window in the oven's door.

2 Unplug the microwave from the wall.

Do not yank on the cord. Wiggle the plug free at the wall.

3 Open the windows.

Smoke will escape the microwave through the vent. Open the windows to clear the smoke, and turn on a fan facing out of your room to blow the smoke through. Close the door to your room to keep the smoke from moving into the hallway and panicking your neighbors. If too much smoke collects in your room, you may set off the fire alarm.

4 Wait 30 seconds.

Microwaves are designed to contain a small fire without spreading heat or flames. Wait for the fire to burn itself out or use all available oxygen. If the fire does not go out on its own in half a minute, the seals on the microwave door may be old and allowing in oxygen to feed the flames. Call the fire department.

5 Use a fire extinguisher to douse the flames.

If a fire extinguisher rated type ABC is available, aim the nozzle at the base of the fire, and apply the P.A.S.S. technique to snuff out the flames: Pull the safety pin from the top of the extinguisher. Aim the nozzle at the base of the flames. Squeeze the handle of the extinguisher. Sweep the hose from side to side until the flames are out.

6 Check for flames.

If the fire has gone out, feel the glass door with the back of your hand. If it is hot to the touch, do not open it.

7 Wait another 30 seconds.

When the glass has cooled, open the microwave door. Step away from the microwave in case the newly introduced oxygen creates a flare-up.

8 Remove the burned item.

The container is likely to be hot. Use oven mitts or pot holders. Keep your face away from the container to reduce the possibility of steam burns.

9 Discard the food and container.

The container may have melted into the cooked item. Do not try to salvage the burned snack or its container. If it is still hot to the touch, place the burned item under running water before discarding.

Be Aware

Do not use the microwave again until it has been checked for damage.

HOW TO SLEEP IN THE LIBRARY

★ Find the right location.

Look for a spot that is not heavily trafficked. Well-heated, dimly lit rooms with small cubicles or carrels near deserted stacks are ideal locations.

★ Sleep on the desk.

Spread a long coat or blanket, yoga mat, or crumpled-up newspaper on the desk to cushion the surface. Ball up a sweater or sweatshirt to use as a pillow. Assume the fetal position and tuck yourself into the space.



Use clothing as a pillow and assume fetal position.

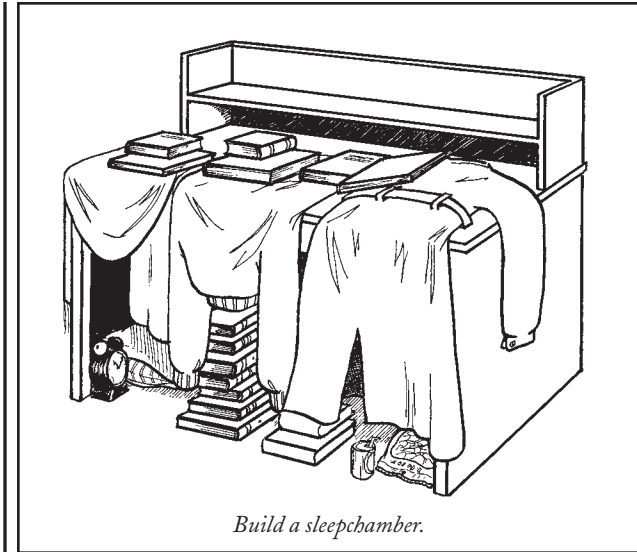

Build a sleepchamber.

★ Build a sleepchamber under a carrel.

Drape coats, sweatshirts, and sweaters over the desk to block the view and the light. Crawl under the desk, taking water, snacks, a small pillow, and other provisions. Create a wall around you by piling up books. Set an alarm clock if you have a class or meeting later in the day.

★ Create a bed out of chairs.

Put two chairs together. Lay fabric or paper between your skin and the chairs' vinyl or wooden seats; the seat of a chair is a breeding ground for microbes.

Be Aware

- Protect your belongings. Conceal your wallet on your person. Leave your laptop at home.
- To avoid getting stiff, regularly stretch your legs and arms when you awaken. Roll onto your back and raise your arms and legs toward the ceiling. Flex and point your feet several times. Repeatedly bend your knees and straighten your legs. Shake out your arms. Shift position by rolling on your back to your other side, keeping legs bent.

HOW TO HOOK UP IN THE LIBRARY

1 Scout out a suitable makeout location.

Look for dim lighting and empty aisles in the stacks on a higher floor. Avoid areas near doors, entrances, main aisles, and passenger elevators. Library carrels, stairwells, and freight elevators in out-of-the-way locations are also good options. The oversized book collection features large tables and big, bulky volumes that allow for privacy. Determine less-traveled areas by reviewing the Dewey Decimal System. Sections that begin with the call numbers below are most likely to be quiet:

- 090 Manuscripts and book rarities
- 110 Metaphysics
- 170 Ethics (moral philosophy)
- 210 Natural religion
- 480 Hellenic; Classic Greek
- 510 Mathematics
- 670 Manufactures

- 707 Antiques and collectibles
- 930 General history of the ancient world

Sections with the following call numbers offer more risky locations but may provide some inspiration and atmosphere for the hook-up:

- 440 Romance languages, French
- 577 Pure science: General nature of life
- 618 Gynecology and other medical specialties
- 757 Painting: Human figures and their parts
- 770 Photography and photographs
- 811 Poetry

2 Time your rendezvous.

Select a time when your designated location will be deserted.

3 Meet at a predetermined location.

Pass a note to your hook-up target with a time and location. Indicate a specific Dewey Decimal section for the rendezvous.

Be Aware

Be respectful of the books. Do not damage or misuse them.

HOW TO SOUND INTELLIGENT: USEFUL NAMES

PHILOSOPHERS

Aristotle	AIR-is-tot-el
Confucius	Con-FYOO-shes (like “confusion”)
Descartes.....	Day-CART
Erasmus	Ir-ASS-muss
Kant.....	KAHNT
Kierkegaard	KEER-ki-guard
Machiavelli.....	Mock-ee-ah-VEL-lee
Nietzsche	NEE-cha
Plato	PLAY-toe
Sartre	SAR-tra
Schopenhauer.....	SHOW-pen-how-er
Socrates.....	SOCK-ra-tease
Sun Tzu.....	SOON ZOO

ARTISTS

Botticelli	Bot-i-CHEL-lee
Brueghel.....	BROY-gull
Cézanne	Say-ZON
Chagall	Sha-GALL
Dalí.....	DA-lee
Da Vinci	Da VIN-chee

Degas	Day-GA
Delacroix.....	Del-a-QUA
Duchamp	Doo-SHAN
Gauguin	Go-GAN
Gentileschi.....	Gen-tile-LESS-ski
Hokusai.....	HOE-koo-sigh
Klee	CLAY
Magritte.....	Ma-GREET
Manet	Ma-NAY
Matisse.....	Ma-TEESE
Miró.....	Mee-ROW
Monet	Moan-NAY
Munch	MOONK
Raphael.....	RA-fay-el
Renoir	REN-war
Rodin	ROW-dan
Seurat.....	Se-RA
Toulouse-Lautrec	Too-LOOSE Lo-TRECK
Van Dyck	Van DIKE
Van Gogh.....	Van GO

NOVELISTS, POETS, AND PLAYWRIGHTS

Aristophanes	Air-is-TOF-an-ees
Baudelaire	Bode-a-LARE
Brontë	BRON-tay
Camus	Cam-OO
Capote	Ca-PO-tee
Cervantes	Sir-VON-tease
Cocteau.....	Cock-TOE
Dante	DON-tay

DostoyevskyDost-ta-YEF-ski
DumasDoo-MA
FlaubertFlow-BEAR
García Márquez.....Gar-SEE-ah MAR-kez
GoetheGER-ta
KafkaCOUGH-ka
KunderaCoon-DUH-ra
Maugham.....MOM
MolièreMole-YARE
Nabokov.....Na-BOK-ov
Poe.....PO
Pynchon.....PIN-chin
Rabelais.....RAB-a-lay
Rushdie.....RUSH-dee
Shakespeare.....SHAKE-spear
Solzhenitsyn.....Soul-jen-EAT-zen
YeatsYATES

**WORST-CASE
SCENARIO®**

HOW TO SURVIVE A BORING CLASS

- ★ **Pull your hair or pinch yourself.**
Making yourself physically uncomfortable will make you less likely to fall asleep.
- ★ **Wear as few items of clothing as possible.**
The cold will keep you awake.
- ★ **Hide more interesting reading material.**
Prop open your textbook and conceal a novel or magazine inside it. Hold a highlighter in your hand and pretend to be taking notes as you read.
- ★ **Suggest holding class outside.**
If the weather is nice, ask the professor to teach out on the college green. This strategy rarely works for large survey classes or the sciences.
- ★ **Send text messages on your cell phone.**
Engage in a running text message exchange with other students in the class about how bad the professor is. Make sure that your keypad is set to mute so that you do not distract other students around you or draw your professor's attention to yourself.
- ★ **Make paper airplanes.**
Make as many models as you can. Pretend they are having fierce battles.

Paper Airplane

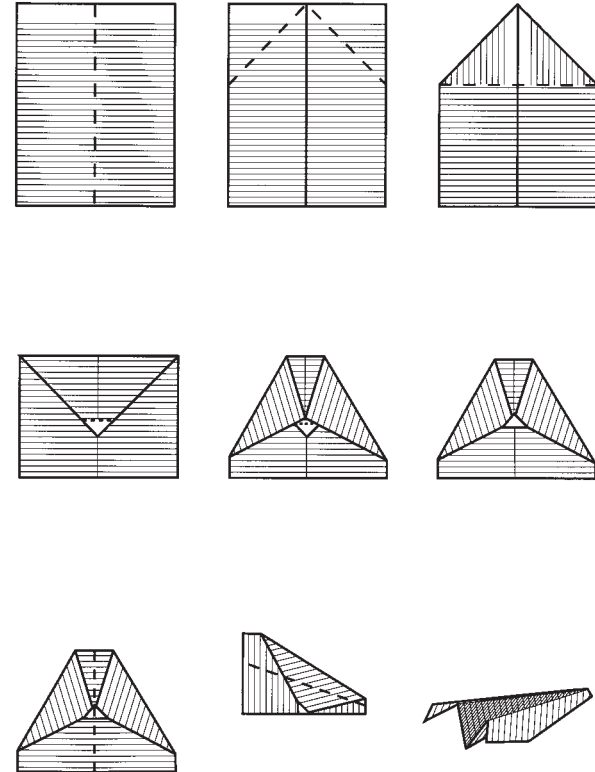

★ **Keep a list of words with dirty meanings.**

Write down words with alternate sexual meanings (*melons, stock, position, score*) as they are spoken by your professor. In the right frame of mind, almost any word will work.

★ **Take notes with your nondominant hand.**

Concentrate on staying in the lines.

★ **Take notes in a foreign language.**

Practice your language skills by translating your professor's lecture. Bring along your translation dictionary to increase your vocabulary.

★ **Keep a superlative log.**

Identify the most interesting people in the class on a daily basis. Observe how people change over time. Categories could include:

- Most attractive
- Tallest
- Blondest
- Ugliest
- Dirtiest
- Dumbest

★ **Pretend you are a secret agent.**

You are on a dangerous mission and must make it through the class alive. Spy on people to see what they are writing. Use a small hand mirror and a penlight to send Morse code to a confederate across the room.

HOW TO SLEEP IN CLASS

1 **Wear a hat.**

Sharply bend the brim of a baseball cap and pull the visor low over your face to hide your eyes in the shadow. Do not wear a wool ski hat, beanie, or yarmulke, as none of these casts a shadow.

2 **Sit in the rear of the class.**

Choose a seat in the back of the classroom or at least far enough from your professor that he will not notice your heavy breathing.

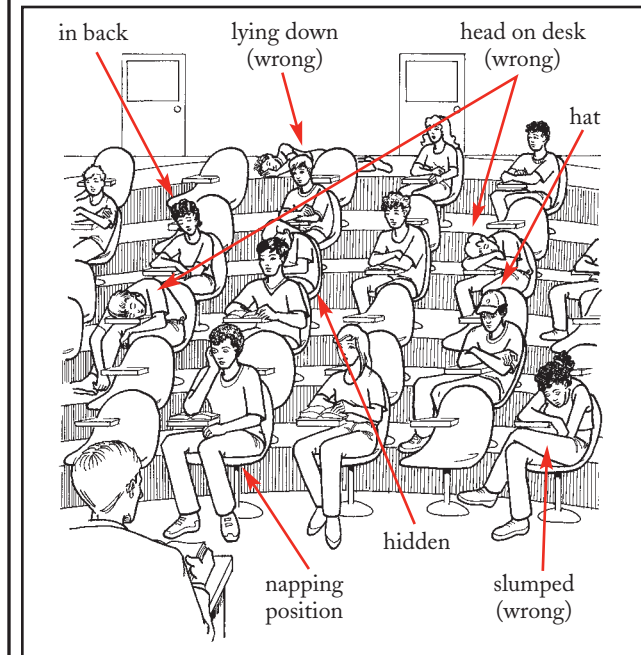

3 **Sit behind a tall person.**

Position yourself behind a member of the basketball or volleyball team to interrupt your professor's line of vision. Sitting behind an obese person can also block your professor's sight line.

4 **Sit on the opposite side of the class from known class participants.**

5 **Pad the desktop in front of you.**

Fold a scarf, sweater, or sweatshirt on your desk. Bend one arm and place your elbow on the folded item.

6 **Assume the napping position.**

- Place your thumb under your chin, supporting your jaw.
- Rest your four fingers on the side of your face.
- Balance your head on your hand, keeping it upright.
- Place your notebook open and in front of you; hold a pen in your other hand, to look as if you are ready to take notes.

Be Aware

- Avoid wearing dark sunglasses in class. While they may serve to shade your eyes, they also attract attention.
- Do not let your head slump down to your chest.
- Do not rest your head on your desk.
- Do not lie down.



WORST-CASE SCENARIO.

HOW TO SURVIVE A NIGHT IN JAIL

1 Request a single.

If you notice an empty cell, ask to be housed there. Do not offer special reasons for wanting a private cell—those factors may work against you if you are later placed in a group cell.

2 Do not show fear.

Fear means weakness in jail. If you cannot stop shaking, pretend you are psychologically unsound: Wave your arms around, babble nonsense, and yell at no one in particular.

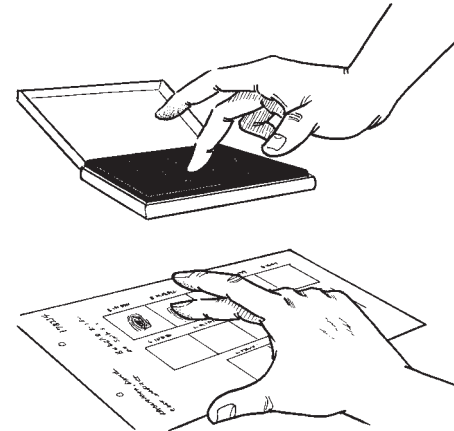

Relax hand and roll finger to make a clean print.

3 Stay within sight of the guard.

The cell may be monitored in person by a guard or via closed-circuit television. Make sure you remain visible.

4 Do not sleep.

Lying down on a bench or cot gives other inmates the opportunity to claim that you are lying on “their” bunk. Sit on the floor with your back to the wall, preferably in a corner of the cell. Do not remove any clothing to use as a blanket or pillow, or you will risk losing the item to other inmates.

5 Keep to yourself.

Do not start a conversation with anyone, but do not be rude. Answer any questions you are asked, and keep your responses short. Do not talk about the reason for your arrest, as there may be police informants in the cell. Do not make eye contact with other inmates, but do not avert your eyes.

6 Do not accept favors.

Other inmates may offer to help you in various ways, then claim that you “owe” them. Resist the temptation to ask for or accept help.

7 Do not tell anyone you are a college student.

The population of the cell may make various assumptions about the privileges, wealth, health, preferences, defenselessness, connections, and value of students.

8 Do not try to escape.

**WORST-CASE
SCENARIO®**

WORST-CASE SCENARIO.

HOW TO SURVIVE A STADIUM RIOT

1 Scan the crowd.

Quickly determine the focus of the rioting: mascot, goalpost, star player, referee, fans, band members, coaches, or cheerleaders. Physically distance yourself as quickly as possible.

2 Hide any obvious school affiliation.

If the mob appears to be attacking your school's fans, remove any clothing items with school colors, letters, or emblems. Stuff these items into a nondescript bookbag or plastic bag. Wrap your arms around your bag and use it to shield your torso as you begin your escape. If you do not have an appropriate carryall, leave your school gear behind.

3 Create a protective helmet.

Stuff crumpled-up newspaper or cardboard inside your hat for cushioning. If you do not have a hat, place an empty popcorn tub or other container over your head.

4 Move away from the mascots.

Regardless of whether they are the focus of the riot, both teams' mascots are especially vulnerable to attack. Stay well clear of either mascot.



Move quickly away from the mascots.

5 **Observe movement patterns.**

Most rioters move en masse in a single direction toward a particular object. Determine which way the mob is headed.

6 **Watch for projectiles.**

Bend your knees and keep your head low to avoid flying cans, bottles, pennants, water balloons, rocks, pipes, benches, people, or other objects.

7 **Move sideways through the crowd to the nearest exit.**

Avoid moving forward (toward the center of the riot) or backward (against the surging mob).

Be Aware

If you're the cause of the riot due to your actions as a fan, player, or mascot, ditch your uniform or suit and run.

WORST-CASE SCENARIO.

HOW TO SURVIVE CLASS WHEN HUNGOVER

- ★ **Stay up.**
Rather than sleep off your drinking binge, stay awake through the night: You will be wired with exhaustion by the time you get to class. Stay out for the night, winding up at a greasy spoon.
- ★ **Medicate.**
In the morning, take a combination vitamin B and C pill or an antihistamine with a stimulant. Dab hemorrhoid cream under your eyes to reduce puffiness. Drink lots of water. Carry a bottle of water with you.
- ★ **Eat breakfast.**
- ★ **Enjoy the hair of the dog.**
Drink a beer or knock back a shot before you go to class. You'll retain your buzz and delay your hangover until the class is over. Take care not to act the fool.
- ★ **Drink an energy drink.**
For added pep, consume a sports drink.
- ★ **Wear a hat.**
A hat with a brim will shield your eyes from harsh lighting and can serve as a cover should you fall asleep.



Show up on time.

Walking in late will only draw attention to you and your condition. If you do arrive late, wait until the professor's attention is distracted by a question from a student or his back is turned. Be as quiet as possible.



Sit in the back of the room.

Avoid being jarred by loud, unpleasant noises, like your professor's voice.



Do not rest your head.

Do not put your head on your hand or the desk; these positions are very conducive to sleep. Sit up straight in your seat.



Remain silent.

Do not raise your hand or try to answer questions.

Be Aware

- To prevent a hangover, eat a combination of a banana, a sports drink, and a multivitamin after drinking/before going to class.
- An alternative way to prevent a hangover is to eat fatty foods, which coat your stomach, before drinking alcoholic beverages.
- The best way to prevent a hangover is not to drink.

**WORST-CASE
SCENARIO®**

HOW TO SURVIVE IN A SMALL ROOM

- ★ **Hang mirrors.**
Affix a large mirror to one wall, flush with a corner. Mirrors create the illusion of space: The bigger the mirror, the longer the appearance of the wall and the better the illusion. Place another mirror opposite a window to reflect light.
- ★ **Repaint the room.**
Go light, not white. Light colors give the appearance of spaciousness, but most dorm rooms are painted bright white, which is very antiseptic. Paint the walls a warm shade of off-white (cream or vanilla). If you are prohibited from painting in your dorm, tack up cream-colored sheets to cover drab walls.
- ★ **Use torchiers rather than overhead fluorescent lighting.**
Torchiers, or standing floor lamps, project light toward the ceiling. The light diffuses and bounces back into the room, giving the feeling of spaciousness. Halogen torchiers are economical but can also increase the risk of fire due to the intense heat of the bulb.
- ★ **Furnish sparsely.**
The fewer the belongings, the larger the room appears to be. Decorate with furniture that serves dual purposes, such as a coffee table/storage unit.

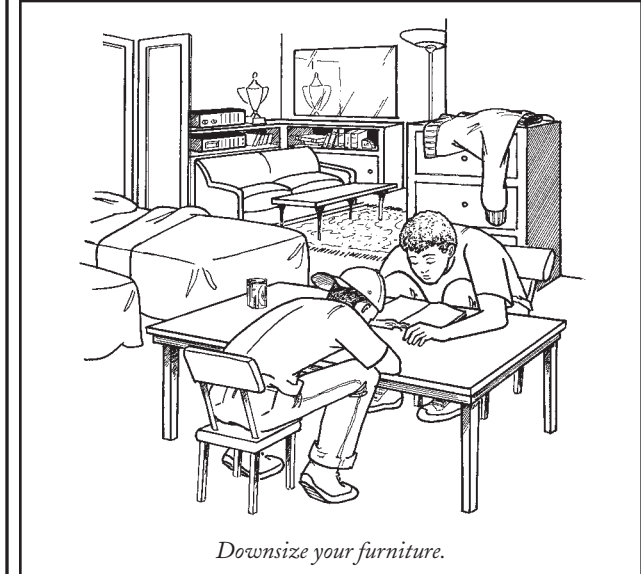
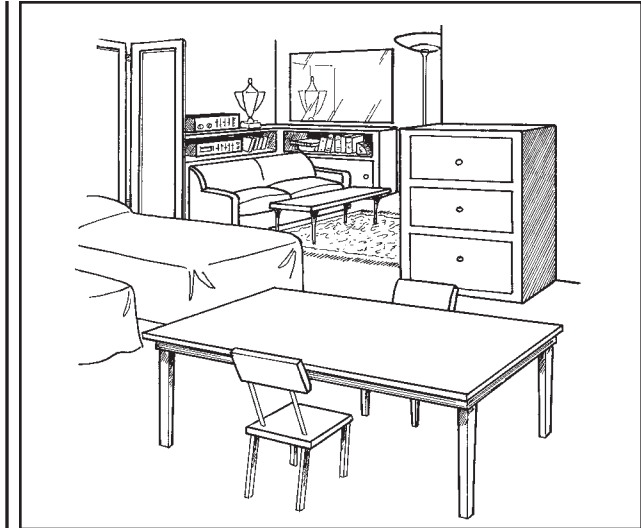

Downsize your furniture.

★ **Add small rugs and lamps.**

Use desk lamps and small area rugs to fashion several distinct pools of light and space. When the eye sees multiple separate spaces, the brain is fooled into thinking a room is bigger than it is.

★ **Divide the room.**

Use a folding screen or fabric to divide a room or create privacy. Use double-sided tape or thumbtacks to attach a flowing, semi-opaque fabric to the ceiling to partition a room while still allowing light to filter through.

★ **Elevate your bed.**

Add valuable storage space by raising your bed off the floor. Use cinder blocks to gain 6 inches of storage room, or build a loft and put your mattress on top of it. Place your desk under the loft to create a cozy workspace.

★ **Downsize your furniture.**

Buy children's or other small furniture. This will make the room appear larger. However, you might not be able to sit down.

★ **Kick out your roommate.**

**WORST-CASE
SCENARIO®**

WORST-CASE SCENARIO.

HOW TO SURVIVE INITIATION NIGHT

SWALLOWING SOMETHING GROSS

- 1 Control your breathing.**
Take deep breaths and exhale slowly. Ignore others who are attempting to eat the item, especially if they are gagging or vomiting. Remember, it will go down in a second.
- 2 Center yourself.**
Visualize yourself lying on a beach, sipping a cool drink, or strolling by a breezy lake.
- 3 Numb your tongue.**
Apply ice or an over-the-counter oral numbing agent to your tongue. You will temporarily lose feeling but not your sense of taste.
- 4 Breathe through your mouth.**
You can reduce any bad taste by breathing through your mouth, not your nose.
- 5 Move the object to the back of your tongue.**
Taste buds on the front and sides of the tongue are most sensitive. Quickly push the object as far back on your tongue as you can.

- 6** **Swallow.**
Use one quick gulp. Do not chew.

GETTING PADDLED

- 1** **Wear several pairs of underwear.**
Underwear will reduce pain if you are required to lower your pants. Consider wearing flannel boxers. Avoid thongs.
- 2** **Wear thick pants.**
Put on bulky trousers, not shorts. Avoid corduroy, which may leave paddle lines.
- 3** **Do not bend all the way forward.**
Bending fully forward will tightly stretch your gluteus maximus, creating a less-forgiving surface and reducing your body's natural padding. Try to remain upright, or bend only slightly.
- 4** **Exhale.**
Inhale deeply, then exhale as the paddle connects.

ENDURING PSYCHOLOGICAL TORTURE

- 1** **Do not show weakness.**
Your tormentors will look for weak individuals, focus on them, and exploit their fears. Resist the urge to burst into tears, beg for mercy, flee, or bond with your tormentors.

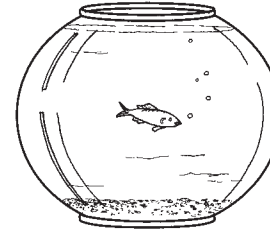

*Be prepared
to swallow anything.*



*Wear several pairs
of underwear.*



Visualize yourself in a pleasant environment.

2 **Live in the moment.**

Do not worry about what comes next. Do not dwell on what just passed. Deal with each horror on its own terms, as it happens.

3 **Keep your mind occupied.**

You may be isolated from the group, kept awake for several days, or seemingly singled out for special treatment. In such situations, keep your brain active by recalling the lyrics of all the songs you know, remembering pleasurable experiences, or focusing on the goal of joining the group.

**WORST-CASE
SCENARIO®**

HOW TO SURVIVE SPORTS EMERGENCIES

MAN OVERBOARD

- 1 Stop rowing.**
As soon as a team member falls off the scull, cease rowing.
- 2 Coordinate strokes.**
Position the boat to within an oar's length of the victim.
- 3 Perform an extension rescue.**
The person closest to the teammate in the water should extend an oar to the victim, making sure not to hit him with it. If the victim is injured or otherwise unable to grab the oar, the rescue must take place in the water; skip to step 7.
- 4 Pull the victim close to the boat.**
- 5 Hold the victim against the side of the boat.**
Do not attempt to bring him on board (or let him climb in), or you will risk capsizing the craft.
- 6 Row the boat to shore.**



- 7 Enter the water.**
Dive from the boat (or swim from shore) to the downed rower.
- 8 Approach the victim from the rear.**
- 9 Perform a double armpit tow.**
Facing the victim from behind, place your dominant arm under one of the victim's arms. Extend your arm across the victim's chest and grab him under the opposite armpit.

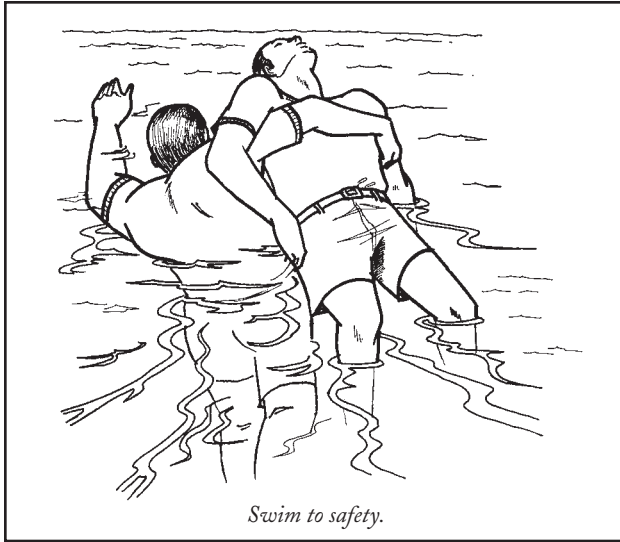

10 **Tow the victim to safety.**

Using a breast-stroke or side-stroke kick, swim the victim back to the boat, to a trailing boat, or to shore.

Be Aware

If the victim is unconscious, call for emergency assistance.

HIT IN THE EYE WITH A HOCKEY PUCK

1 **Place the victim on her back.**

Lying with the eye facing up reduces the chance of leakage of the liquid inside the eyeball.

2 **Elevate the head slightly.**

Place a folded jacket or towel underneath the victim's head, elevating it slightly above the level of the heart to reduce pressure inside the skull and the eyeball.

3 **Apply a cold compress.**

Place ice in a plastic bag. Do not apply the compress directly to the skin: Use a layer of clothing or plastic to prevent tissue from freezing. Hold the compress gently on the tissue surrounding the eye. Avoid pushing or putting pressure on the eye.

4 **Offer pain medication.**

If the victim is conscious, administer 600 milligrams of ibuprofen. If ibuprofen is not available, use acetaminophen. Avoid administering aspirin: It may cause excess bleeding, which can be harmful during an eye operation.

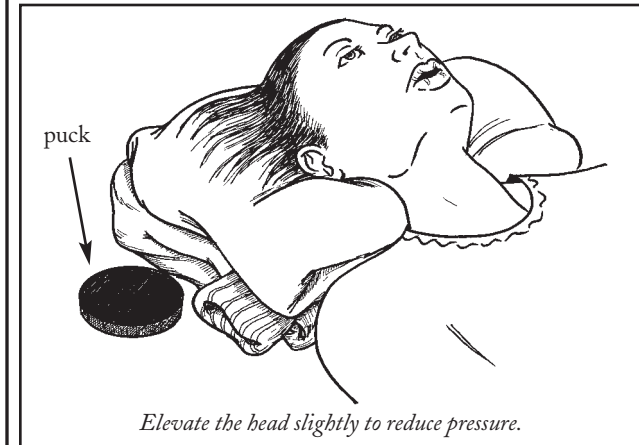

5 Get help.

Tell the emergency operator that you require an emergency room with a qualified ophthalmologist and ear-nose-throat (ENT) surgeon on call.

Be Aware

- A hockey puck to the head may fracture the socket containing the eye and/or rupture the eyeball itself. Both conditions require immediate medical attention.
- Always ask the victim about allergies to medicine before administering any drugs, even ibuprofen.

DART INJURY

1 If the dart is embedded in the head, neck, chest, or back, leave it in place.

Rinse a small, clean towel in cold water, wring it out, and wrap the towel around the base of the dart to stabilize it and prevent further penetrating or shearing injury. Take the person to the hospital, or call for an ambulance.

2 Remove the dart.

If the dart is embedded in an arm or leg, remove it from the victim using a fast, pulling motion. Put the dart in a safe location where it will not cause further injury. (If the dart bounced or has already fallen off the victim, ask where he was hit.)

3 Place the victim in a sitting position.

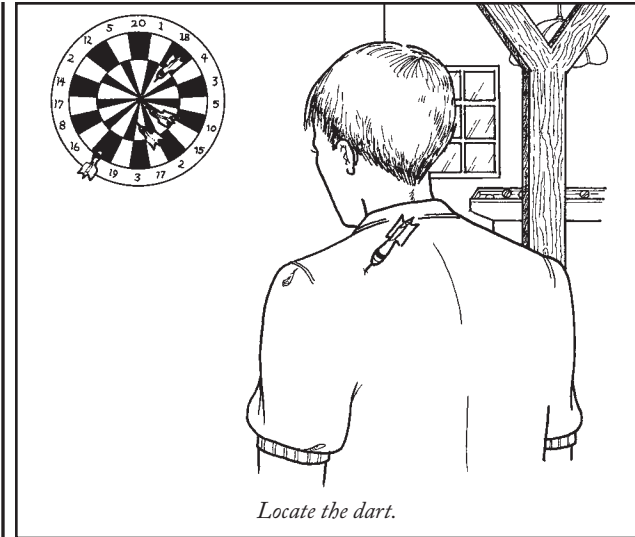

4 Examine the wound.

If blood is spurting from the wound, apply a clean cloth to the injury site. If there is bleeding but no spurting, skip to step 8.

5 Apply pressure.

Elevate the affected area above the level of the heart. Hold the cloth firmly in place for 5 minutes.

6 Remove the cloth and check the wound.

If blood continues to spurt, apply a new, clean cloth, elevate, and apply pressure for 15 additional minutes. Change the cloth as needed. For persistent oozing, apply pressure for 30 minutes.

7 **Examine the wound.**

Once the wound has stopped spurting, check the injury site, wiping away any seeping blood.

8 **Rinse.**

When the bleeding has stopped or slowed, gently rinse the wound under cool tap water.

9 **Bandage.**

Cover with a large, sterile dressing.

10 **Clean the dart.**

Rinse the dart under hot tap water, then wipe thoroughly with rubbing (isopropyl) alcohol.

11 **Remove the victim from the field of play.**

Be Aware

A tetanus booster may be required if the victim has not had one in the previous 10 years.

**WORST-CASE
SCENARIO®**

**WORST-CASE
SCENARIO.**

HOW TO SURVIVE THE DORM BATHROOM

TOILET

- ★ **Clean the seat.**
Wipe the toilet seat with baby wipes, or spray the seat with disinfectant.
- ★ **Use a seat cover.**
Bring a child-size life preserver to place on the toilet seat (be sure the straps hang outside of the bowl). Alternatively, completely cover the seat with paper seat covers or at least four layers of toilet paper.

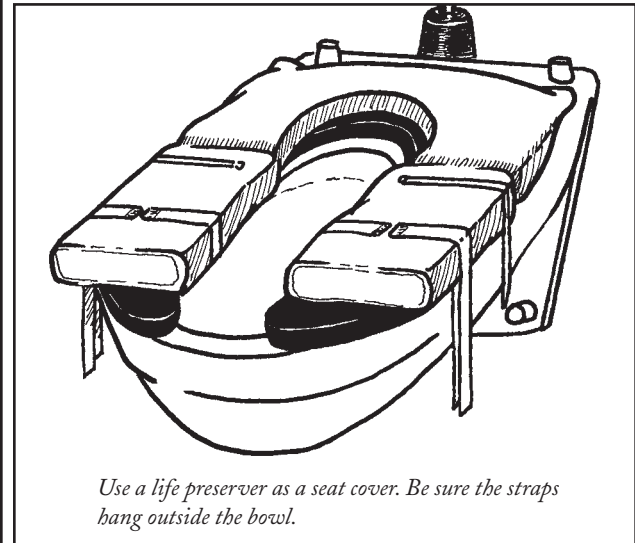

Use a life preserver as a seat cover. Be sure the straps hang outside the bowl.

★ **Squat.**

Tie your belt or necktie around the cubicle latch, hold on to the other end, and squat over the toilet seat, never touching the surface.

★ **Find alternative facilities.**

Scope out other bathrooms on campus for cleanliness and privacy. The admissions office generally has a nice public restroom for prospective students and their parents. The library is probably clean and quiet immediately after opening. Avoid athletic facilities.

Be Aware

If toilet paper is nowhere to be found, use napkins, paper towels, coffee filters, day-old newspapers (the ink will be dry), pages from a telephone book, old blue books, foreign currency (after checking the exchange rate), literary magazines on uncoated paper, glossy magazines, or pages from a textbook.

SHOWER

★ **Shower at off hours.**

Shower in the middle of the night or at midday to avoid a wait and ensure hot water. Shower at the gym during—not after—a team practice or at off hours.

★ **Protect your feet.**

Never touch the floor with your bare feet. Wear flip-flops, clogs, or other elevated or enclosed footwear. Shoes with rubber soles will prevent slipping.



★ **Keep toiletries together.**

Carry your toiletries in a mesh basket or bucket with a hole in the bottom to drain excess water. Hang the bucket from the showerhead rather than putting it on the floor or leaving it beside the sink.

★ **Use liquid soap.**

Bar soap can slip out of your hand and fall on the floor or into another shower stall.

★ **Shave and brush your teeth in the shower.**

You are much more able to control your shower environment than the sink environment, and you are better able to retain some privacy. Alternatively, forgo shaving and grow a beard (if male) or wear long pants (if female).



Date someone who lives off campus.

Shower there whenever possible.

Be Aware

- Dormitory showers are prime areas for pilfering. Leave valuables in your room. Put your keys on a key chain that you can wear around your wrist while showering. Lock your cell phone, pager, jewelry, money, laptop computer, and all other expensive items in your room.
- Dorm bathrooms are often crowded and unpleasant. To avoid the bathroom, use your room to:
 - Shave, preferably with an electric razor
 - Clean your hair with a dry shampoo
 - Brush your teeth with a bottle of water
 - Clean your face with cold cream and a tissue
 - Apply makeup
 - Add hair product and blow-dry hair
 - Mask body odor with talcum powder, underarm deodorant, or deodorant body spray

**WORST-CASE
SCENARIO®**

HOW TO SURVIVE THE WALK OF SHAME

1 **Locate all your belongings before vacating the premises.**

2 **Replace missing clothing.**

If you are lacking pants, put your legs through the sleeves of your shirt and tape or staple the neck. If you are missing a shirt, use your socks as a bikini top, held in place with shoelaces from your running shoes: One lace goes through the top of each sock and is knotted at each end; that lace will go around your neck. The other lace goes through the heel of each sock, is knotted at each end, and becomes the strap that goes behind your back. Adjust for proper fit.

3 **Dumb down your evening garments.**

Remove any showy clothing or jewelry and wash your face to remove any trace of heavy makeup. Wear a hat, sunglasses, and drab clothing, if you have the option.

4 **Avoid crowds.**

Leave for home very early in the morning, when there will be fewer people on the street. If you wake up late, do not cross campus during peak class times.

5 **Walk briskly.**

Match the gait of other passersby—but do not run. The faster you walk, the less likely you'll be noticed. Walking fast also cuts down on the amount of time and thus the number of people to whom you will be exposed.

Be Aware

- Arrange in advance a signal (bird call) to get your roommate's attention when you arrive after hours with no keys.
- Prepare and practice excuses and explanations for parents, boyfriend, and others you may encounter.

HOW TO AVOID A NIGHTMARE HOOK-UP

1 **Do not get drunk.**

When you need to refill your glass, do it yourself. Do not let a stranger get a drink for you. Drink a glass of water between alcoholic drinks.

2 **Clearly convey your desire for a straightforward hook-up.**

Verbalize your desire to hook up with him for that night. State that you are not interested in pursuing a relationship of any sort. If he agrees to this, he may be interested in only a one-night stand as well, and may be just what you're looking for.

3 Clear the potential hook-up with a trusted friend.

Always go to a party or bar with a reasonably conscientious friend who does not have a penchant for drink or proven bad taste in men. Leave your keys with her. Introduce her to your potential hook-up and ask if she thinks you are about to make a mistake.

4 Retrieve your keys from your friend.

5 Go to your place.

Your place is usually the preferred destination, since you will be more in charge and comfortable.

6 Give yourself a last-minute excuse to get out.

Say that your roommates may be home and they would create a problem, so you will have to say good-night right now.

7 Assess his place.

If you do wind up at his apartment or dorm room, look for signs of misrepresentation or personality disorder. Flip through recent photos to get an idea of his social activities. Lock yourself in the bathroom and check out the contents of his medicine cabinet. Check the bedroom for concealed cameras. If his roommates are home, note whether your hook-up is winking at them or if he politely introduces you by name. Chat with them to make sure you are comfortable in the situation.

8 End the encounter.

If you become uncomfortable or suspicious, leave quickly if you are at his place. If you are at home, say that you forgot that your boyfriend is coming over or that you've got a major headache/infection/test in the morning and need to get a few hours of sleep. If he seems reluctant to leave, give your roommate a sign to rescue you. Do not make any promises, however vague, to see him again.

Be Aware

- Going to your place for a hook-up can be problematic because he will know where you live and he may observe more about you than you would like. Also, you can't get up and leave when you want to end the hook-up.
- If you anticipate that you may be bringing a hook-up home, leave a note taped to your door. "Honey, I went to bed early. Please be quiet when you come in.—Mike." You can then explain later to your hook-up, if you want an excuse to end the evening, that your boyfriend has unexpectedly come over. If you want to continue with the hook-up, you can say that Mike is dating your roommate.

HOW TO SURVIVE WHEN YOU'RE CALLED ON AND DON'T KNOW THE ANSWER

- ★ **Stall for time.**
Repeat the question aloud. Very slowly, say, “So [deep breath], essentially [deep breath], what you are [clear throat] asking me is . . .” This will buy you a few extra seconds to create a suitable response.
- ★ **Redirect.**
If you’ve done the reading but simply don’t know a particular answer, steer the subject to a more familiar topic. Say, “That’s an interesting question that leads me to the essential part of last night’s reading . . .”
- ★ **Discuss another subject.**
Answer confidently. Act like you are convinced that you know the right answer. Make eye contact with the professor as you expound on the topic of your choice.
- ★ **Quote the book.**
Flip open the book and begin to scan the pages. Say, “I really couldn’t say this any better than the author—I remember a quote in here somewhere; give me a moment to find it. . . .” After a silent moment or two,

the professor will move on to another student. Have a passage ready to read in case the professor returns to you for your answer.

- ★ **Feign choking.**
Begin coughing vigorously and point to your mouth. Wheeze for greater effect. After a few seconds of a coughing fit, say you need to leave to get a drink of water. Come back only when you are sure the topic has changed.
- ★ **Be honest.**
Since some professors appreciate honesty, consider admitting that you do not know the answer, but be prepared for an embarrassing public rebuke.

Be Aware

- If you are not prepared for class, do not wear a big floppy hat, dress in bright colors, or do anything to draw the professor’s eye. Do not make eye contact with the professor. If possible, sit behind a tall student to help conceal your presence.
- Read the introduction and conclusion of an assignment to gain enough basic information to bluff your way through an unexpected question.

HOW TO TAKE A TEST WHEN YOU HAVE NOT STUDIED

ESSAY

- ★ **Find a pocket of related knowledge.**
Pull in details from a subject you know well. If you are passionate about abstract expressionism, bring in details of the art movement to answer a question in a twentieth-century history exam.
- ★ **Use a few key words.**
Employ short, less common words, such as *wan*, *fey*, *nay*, and *cur*. Add a few French bons mots. If you cannot spell the words, write sloppily. You will impress your professor with your linguistic erudition, which is better than not impressing him at all.
- ★ **Write something.**
Do not leave a question unanswered. You may not receive full credit for the answer, but displaying some knowledge about something will prevent you from taking a zero.
- ★ **Scribble an outline.**
On the inside cover of your blue book, illegibly write what appears to be an outline of an answer to show that you thoughtfully planned your answer.

- ★ **Do not complete the last sentence.**
No matter when you finish the essay exam, do not write the last sentence. Instead, write “TIME” across the bottom of your exam. This indicates that you would have written much more if you had more time.

MULTIPLE CHOICE

- ★ **Eliminate the wrong answers immediately.**
When there are four choices, two answers are usually completely wrong. Cross them out. If you can discount any other answer, cross it out. “None of the above” and “all of the above” are often the correct answer. Do not discount these right away if you are unsure of the answer.
- ★ **Trust your instincts.**
Do not talk yourself out of your gut reaction. If you think a particular choice is the right answer, there is a reason. You may vaguely recall a lecture, something you read in passing, or even relevant information from an episode of your favorite television show.
- ★ **Look for a pattern on your answer sheet.**
Watch for some order, be it ABCDABCDABCD or BADDABBADDAB. Be wary if your answers are AAAAAAAAAAAAAA.
- ★ **Do not labor over one question.**
All questions are worth the same amount on multiple-choice exams, so do not get overly involved in any one

question. Move on and return to unanswered questions as you have time.

★ **Answer every question.**

Very seldom are wrong answers weighted more heavily against you than an unanswered question. Depending on the number of choices, you have a 20 to 25 percent chance of answering a question correctly. Guess every time.

Be Aware

- Take a class pass/fail if it is not in your concentration, if you have an overloaded schedule, or if you are concerned about your grade point average.
- There are usually more “true” answers than “false” answers on a true/false exam because false answers are harder to write.
- Determine what part of the test counts for the most points. Spend a proportionate amount of your time on this section.
- When possible, reuse facts and information from the multiple-choice portion of an exam in an essay question.

**HOW TO POSTPONE AN EXAM OR
GET AN EXTENSION FOR A PAPER**

★ **Blame another class/professor.**

Explain that you had another exam right before the one you want to reschedule, and that since the professor was nice enough to let you run over the allotted

time to finish, now you don't have enough time to take this exam.

★ **Blame stress.**

Explain to the professor that you care so much about the test/paper that you're paralyzed and unable to concentrate. Bring in problems from other areas of your life, and talk about how everything is coming down on you all at once. Say that you are afraid the stress is becoming too much to handle.

★ **Blame your alarm clock.**

Say you were studying all night and slept through your alarm. Offer to meet the professor in person to demonstrate your understanding of the material. Schedule the meeting for several days hence.

★ **Blame your computer.**

Leave your professor a voicemail in the middle of the night and explain in a panicked voice that your computer crashed and you've lost the file. Say that you are starting over from scratch on a friend's computer and that you will deliver the paper as soon as possible. Make sure that you call the professor's office number rather than her home phone number—you are unlikely to gain the empathy you're looking for if you wake your professor in the middle of the night.

★ **Send an unreadable file.**

Contact your professor five minutes before the paper is due. Say you are having trouble printing. Ask for a

Extension Strategies



Blame your alarm.

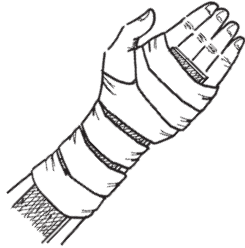

Blame an accident.

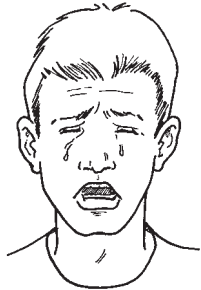

Cry.

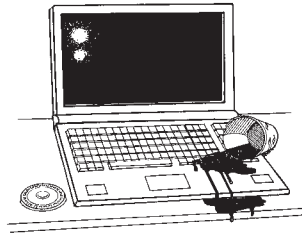

Blame your computer.

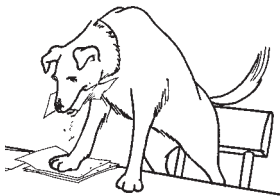

Blame your pet.

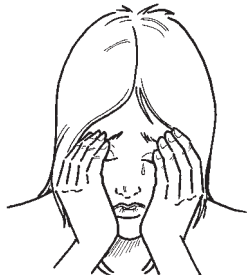

Cry.

short extension. Be prepared for your professor to suggest that you e-mail her the paper or put it on a disk and take it to her office to print. If this occurs, send the wrong file or send a system file that cannot be opened. In the text of the e-mail, promise to drop off a hard copy as soon as you are able to print the file, and be sure to take a hard copy as soon as you are finished writing it.



Collapse.

Attend the exam as expected, but after sitting with the test for about five minutes, interrupt the class with a disruptive sickness. Vomiting, fainting, or a seizure are popular choices. The professor will have little choice but to allow you to reschedule the exam. Offer your apologies and say that you would continue with the test if you could.



Cry.

**WORST-CASE
SCENARIO.**

HOW TO TAKE ON A NEW IDENTITY

College matriculation is the start of a new academic career and, if you so choose, the beginning of your new persona.

JOCK

ATTIRE

Wear:

- Baseball cap with school logo
- Sweatpants
- Shorts (if temperature above 50°F)
- Fleece (if temperature under 50°F)
- T-shirt with arms cut off
- Elastic ankle or wrist brace
- Expensive new running shoes or expensive, worn cross-training shoes

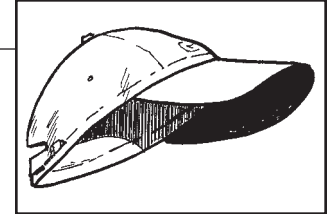

Do Not Wear:

- Tweed or plaid
- Nail polish
- Lace or bows
- Leather pants
- Stilettos

PARAPHERNALIA TO CARRY

- Gym membership card
- Topical pain reliever

- Weight-lifting gloves or belt
- Sports drink, energy bars
- Keys on shoelace around neck
- Large duffel bag with team name

WHERE TO HANG OUT

- Field house
- Greek parties
- Gym
- Jock dorm
- Sports bar

WHERE TO SIT IN CLASS

In the back, if you show up

BUZZWORDS TO USE

- Lats
- Quads
- Carbo-loading
- Strength training
- Stats
- Reps
- Scouts

CRITICAL KNOWLEDGE

- Mold the brim of your baseball cap into a half circle before wearing it. Wash new hats with bleach and rub a few spots with sandpaper for added authenticity.
- Sprinkle creatine powder on your cereal at breakfast.

HIPPIE

ATTIRE

Wear:

- Homemade clothes
- Bell bottoms
- Sandals
- Wool socks
- Hemp jewelry
- Tie-dyed T-shirts
- Flowers in hair

Do Not Wear:

- Necktie
- Spandex
- Three-piece suit
- Shoes

PARAPHERNALIA TO CARRY

- Bootleg cassettes
- Rolling papers
- Frisbee
- Hackey-sack
- Dog

WHERE TO HANG OUT

- Park or nature preserve
- Food co-op
- Jam band concert
- Vegetarian café
- Protest



WHERE TO SIT IN CLASS

Indian-style on the desk or floor

BUZZWORDS TO USE

- 420
- Resin, carb
- Set list
- Spun-out
- Bummer

CRITICAL KNOWLEDGE

- How to roll your own cigarettes.
- The location of nearest campground to every major stadium and concert venue in North America.
- Jerry Garcia's birthday.

INTELLECTUAL



ATTIRE

Wear:

- Glasses
- Rumpled tweed jacket with elbow patches
- Khaki pants or wrinkled long skirt
- Mussed hair
- Bow tie
- Sweater vest

Do Not Wear:

- Sunglasses
- Low-rider jeans

- Thong underwear
- Hair products
- Sweat bands

PARAPHERNALIA TO CARRY

- Pipe
- Umbrella
- Cane or walking stick
- Hefty tome
- Battered leather briefcase

WHERE TO HANG OUT

- Library
- Dorm lounge
- On-campus snack bar
- Professors' offices

WHERE TO SIT IN CLASS

In front row

BUZZWORDS TO USE

- Dissertation
- Orals
- Academic armamentarium
- MCATs, LSATs, GREs
- Phi Beta Kappa, magna cum laude, summa cum laude

CRITICAL KNOWLEDGE

- See "How to Sound Intelligent," page 162.

FOREIGN STUDENT

ATTIRE

Wear:

- Shirt with obscure logo
- Foreign flag patch on your backpack
- Cologne or perfume
- High-style shoes not sold in this country
- Leather clutch purse (men), large leather shoulder bag (women)

Do Not Wear:

- White socks
- Baseball cap
- American flag pin
- Deodorant

PARAPHERNALIA TO CARRY

- Translation dictionary
- Map of foreign country
- Electrical adapter
- Adult contemporary CDs
- Airmail envelopes

WHERE TO HANG OUT

- The international dorm
- Library
- With other foreign students
- At foreign films

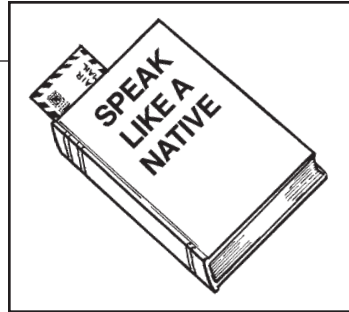

WHERE TO SIT IN CLASS

In the middle, trying (unsuccessfully) to blend in

BUZZWORDS TO USE

- Student visa
- “In your country . . .”
- “How do you say . . . ?”

CRITICAL KNOWLEDGE

- Names of the leaders, major landmarks, and holidays in the country you’re pretending to be from.
- Key curse words and phrases in “your language.”

**WORST-CASE
SCENARIO.**

HOW TO TELL YOUR PARENTS YOU'VE BEEN EXPELLED

Mom and Dad—I've got something big I need to tell you. Your baby boy/girl is coming home! And not just for a visit this time—for good.

I've decided that college just isn't working out for me. And believe me, I've discussed this with the dean, my advisors, and several professors, so I'm very sure about it. In a while I'll probably be ready to try school again, at another college, one that is a better fit for my strengths and abilities. This just wasn't the right time and place.

Due to a whole tangle of academic rules and regulations—which were part of the problem, actually—you'll be getting a letter from the dean. Officially, of course, he has to come up with some important-sounding explanations and a lot of exaggerated descriptions of what I've done and not done, and reasons for not refunding the tuition.

But that's not important. What is important is that I miss you guys, and I think that it's best if I leave school now. After all, isn't college really about figuring out who you are and want to be?

I love you both very much. Please send a plane ticket and money to the local youth hostel, where I'm now staying. I look forward to seeing you soon.

Love,
Your son/daughter

HOW TO WRITE A LAST-MINUTE PAPER

- ★ **Reduce, reuse, and recycle.**
Reduce your study time, reuse old texts, and recycle old ideas. Select a topic or thesis that you have written on before in a different class. You already know the material, and you can lift particularly strong points or written passages.
- ★ **Write an outline.**
Figure out your main thesis and write down all the points you will use to support your main idea. Refer to this while you are writing your paper; it will help you stay on theme and maximize your time.
- ★ **Know your professor.**
Make your essay fit a professor's personality or agenda. Do not write on a topic in which she is a specialist. She will see the flaws or shortcomings in your argument immediately.
- ★ **Focus on what you know.**
Write on an issue about which you are passionate. You will write more quickly and easily and in a persuasive and compelling manner.
- ★ **Manipulate the formatting.**
Increase the leading (the space between each line of text), point size (the size of the type), and margins.

Select a font that is large to begin with. These visual tools will make your essay look longer. Do not go overboard: Using 18-point type is an immediate giveaway that you are fudging the length of the paper.

Be Aware

Take interrelated courses or a general and a specific course on the same subject. If you have taken a Shakespeare class, take an Elizabethan history course. This will cut down on studying multiple material.

HOW TO CRAM FOR A TEST

- ★ **Pull in outside material.**
Read condensed or simplified versions of the course material. Dig up old textbooks or material from previous classes. Take advantage of study guides, whether published online or photocopied from previous classes. If you are in an English class, watch the movie adaptation of a required book or play. Check the description of a work on literary websites.
- ★ **Skim reading material.**
Read the first and last sentence of paragraphs. Read the book jacket, introduction, conclusion, table of contents, and glossary.
- ★ **Seek out other students.**
Ask someone from class if you can photocopy his notes. Also ask what he considers the main points to

study. If he's been paying attention in class, he will have a good idea of what will be on the exam.

★ **Review exams from previous courses taught by your professor.**

Check your campus and dorm libraries; they often keep old exam files on hand.

★ **Find a quiet place to study.**

Seek out a well-lit empty classroom, coffee shop, or quiet area of the library. Avoid studying in your dorm room or apartment; there are too many distractions. If you can find a friend to study with, bring him along. You can quiz each other periodically and keep each other's spirits up. Bring caffeinated drinks, snacks, gum, and anything else you might need to stay alert. You do not want to be distracted by hunger.

★ **Maintain your normal routine.**

If you normally eat breakfast, eat something before the exam. Practice “state-dependent” learning—if you drink coffee while studying, drink coffee during or right before your exam. If you chew gum while memorizing slides, chew gum during a test.

★ **Be prepared.**

Wear comfortable clothes in layers in the event that the lecture hall or classroom is too hot or cold. You do not want your external surroundings to distract you. If you work better in complete silence, bring earplugs. Bring extra pens, pencils, and blue books.

★ **Use every minute before your test.**

Review your notes or texts up to the moment your exam begins. Information you most recently reviewed will be uppermost in your mind during the exam; this is called the “recency effect.” You are likely to recall specific details that you can effectively incorporate in an essay.

★ **Do not discuss the subject as you enter the examination room.**

Last-minute discussions about content or people's panicked questions can be confusing and misleading. You've done all you can—stay focused.

WORST-CASE SCENARIO SURVIVAL DIPLOMA

- 1 Place diploma on photocopier.**
Lay the diploma (page 167) on the glass of the photocopier. For best results, remove the diploma from the book by cutting along the dotted line.
- 2 Enlarge.**
Copy at 175 percent onto 8¹/₂-x-11-inch or larger paper.
- 3 Write your name and the date on the photocopy.**
Use a calligraphy pen to write your first, middle, and last names on the first blank line of the diploma. Write the date on the second blank line.
- 4 Frame.**
Select an 8¹/₂-x-11-inch frame with glass. Center the diploma (trimming the sheet of paper to fit) in the frame.
- 5 Hang high on a wall.**
Choose a height and location that discourages close inspection.
- 6 Be proud.**
We congratulate you.



THE EXPERTS

The Association of Home Appliance Manufacturers (www.aham.org).

Nicole Beland is the author of *The Cocktail Jungle* and is a former senior editor at *Cosmopolitan* and *Mademoiselle* magazines. She writes regularly for *Men's Health* and other national publications on topics ranging from sex and relationships to food and wine. She lives in Brooklyn, New York.

Shoshana Berger is editor-in-chief of *ReadyMade*, a magazine she co-founded in 2001. She has been a writer and editor for publications ranging from the *New York Times* to *Spin*.

David Blend is a freelance writer who began his career as a bar columnist for the now defunct *Met* magazine in Dallas. He has written for *Men's Journal* and *Details*, wrote the *Pocket Idiot's Guide to Tailgating*, and maintains a drinking etiquette column called "Drinking With . . ." at danm.us/blog.

Amy Calhoun, former associate director of admissions at the University of Pennsylvania, has worked with the school's University Scholars Program and in alumni giving. She currently heads the school's digital media design group.

Dominic Cappello (www.tentalks.com) designs safety, health, and communications programs for parents and educators and is the author of *Ten Talks about Violence* and the co-author of *Ten Talks about Sex and Character* and *Ten Talks About Drugs and Choices*. He is currently developing an animated television series.

"Mountain" Mel Deweese is a retired U.S. Navy Survival Evasion Resistance Escape instructor who has taught more than 100,000 students and has more than 30 years of survival training experience. He is the owner of Nature Knowledge in Grand Junction, Colorado (www.youwillsurvive.com).

Gerry Dworkin is an aquatics safety and water rescue consultant at Lifesaving Resources Inc. (www.lifesaving.com), which seeks to prevent and/or reduce the number of drownings and aquatic injuries throughout the United States through the education and training of lifeguard, aquatic safety, and recreation personnel.

Shawn Engbrecht is one of the world's top protection officers. When he is not on operational assignment, he is one of the instructors at the Center for Advanced Security Studies, specializing in the training and placement of bodyguards.

Ben Freely has been in the bar and restaurant business in Philadelphia and London for 12 years.

Rick Frishman is president of Planned Television Arts and executive vice president at Ruder*Finn. A book publicist and public speaker, he is the co-author of *Guerrilla Marketing for Writers* and *Guerrilla Publicity*.

Anthony Giglio is a New York-based wine/food/spirits writer and sommelier. He writes the "Liquids" column for *Boston Magazine* and the "Nightlife" column for *Wine & Spirits*, and is a restaurant critic for the *New York Sun*. He has also written for *Esquire*, *Details*, and *Food & Wine*.

Grace Hawthorne is publisher and CEO of *ReadyMade*, a magazine she co-founded in 2001. She has also worked as an entertainment media consultant for Trimark Pictures and Giant Robot.

Allison Hemming is the author of *Work It! How to Get Ahead, Save Your Ass and Land a Job in Any Economy*. She is an established career authority and the creator of the Pink Slip Party, a networking event that benefits the recently downsized. Hemming is also the president and “Top Gun” of The Hired Guns (www.thehiredguns.com), an interim workforce agency based in Manhattan.

Josh Herman owns Josh Herman Bail Bonds in Los Angeles (www.jhbail.com).

Dave Hill, a U.K.-based food industry consultant, advises manufacturers and caterers on safe food production. He has written numerous guides to good hygiene practice and is a fellow of the Institute of Food Science and Technology (www.ifst.org).

Chuck Hughes, author of *What It Really Takes to Get into the Ivy League* (www.roadtocollege.com), was senior admissions officer and a dorm proctor at Harvard University.

Tony Kearney is the coordinator for Undergraduate Staff Development, Office of Staff Development & Judicial Programs, Russell Hall, University of Georgia in Athens. He has lived in residence halls for 12 years as an undergraduate, a graduate student, and a professional at the University of North Carolina, the University of South Carolina, and the University of Georgia.

Ann Keith Kennedy graduated from the University of Kansas in 1990 and has been an English teacher in Japan, window display designer, architect, and librarian.

Melisa W. Lai, M.D., a former admissions officer at Brown University, is emergency medicine attending physician at Mt. Auburn Hospital in Cambridge, Massachusetts, and a fellow in clinical toxicology at the Massachusetts/Rhode Island Poison Control Center.

Bryan Lindert is a test-prep instructor for high school and college students and a social worker in south Florida. He had a perfect score on the verbal portion of his SAT.

Virginia Mattingly is a middle school teacher and the co-author of *Field Guide to Stains*.

Melissa McDaniels, M.A., has advised college students and adults for 10 years on issues related to career development, work-based conflict resolution, and job search strategies. She has worked at Boston College, Boston University, and Northeastern University, in addition to working with private clients. She is currently a doctoral student in higher, adult, and lifelong education at Michigan State University.

Tom McManus, former regional director of admissions at the University of Pennsylvania, is director of college counseling at the Tatnall School in Wilmington, Delaware.

Charlotte R. Miller is a peer mediation specialist at the Center for Professional Development & Instructional Support, part of the Harris County Department of Education in Houston, Texas. She trains teachers,

counselors, and principals in the development of mediation programs.

Susan Newman, Ph.D. (www.susanneymanphd.com), is a social psychologist and the author of numerous books on social and familial relationships. She teaches at Rutgers University.

Marv Pinkey is the owner of Ten Stone, a Philadelphia bar. He has been a bartender for 15 years.

Don Rabon (www.donrabon.net), manager of the Investigations Center for the North Carolina Justice Academy, has trained investigators in interviewing and interrogation techniques in 47 states. He has also trained members of the U.S. military, the Secret Service, the CIA, and NATO forces.

Jason R. Rich (www.jasonrich.com), president of Teen Talk Communications, is the author of numerous books, including *The Everything College Survival Book*. He lives in Massachusetts.

Pete Riley was a trucker on the overnight shift for 2 years, both cross-country and on the East Coast.

Chris Robinson works at A1 Commercial & Residential Janitorial Maintenance, a cleaning services company based in Philadelphia.

Mann A. Shoffner is a former president of the Sigma chapter of Zeta Psi at the University of Pennsylvania.

The Sociology Department of the University of California at Berkeley.

Brett Stern, author of *99 Ways to Open a Beer Bottle without a Bottle Opener*, invents surgical instruments and implantable medical devices.

G. Keith Still, Ph.D., runs Crowd Dynamics Ltd. (www.crowddynamics.com), an international crowd safety and pedestrian planning and design firm based in the U.K.

Sarah Susanka, AIA, is an architect and the author of the *Not So Big House* series (www.ntsobighouse.com).

Daina Taimina, Ph.D., is a math professor at Cornell University who has heard every excuse in the book.

Katherine Tallmadge, M.A., R.D., is spokesperson for the American Dietetic Association and the author of *Diet Simple: 154 Mental Tricks, Substitutions, Habits & Inspirations* (www.dietsimple.info).

Brett Thomas is a bartender at Ten Stone, a bar located in Philadelphia.

Jared Von Arx, Ph.D., is a child/adolescent clinical psychologist. He lives in Philadelphia.

The
WORST-CASE SCENARIO
Survival Handbook:
WORK

By Joshua Piven and David Borgenicht
Illustrations by Brenda Brown



CHRONICLE BOOKS
SAN FRANCISCO

Copyright © 2003 by Quirk Productions, Inc.

All rights reserved. No part of this book may be reproduced in any form without written permission from the publisher.

Worst-Case Scenario™ and The Worst-Case Scenario Survival Handbook™ are trademarks of Quirk Productions, Inc.

Library of Congress Cataloging-in-Publication Data available.

ISBN: 0-8118-3575-8

Manufactured in the United States of America

Typeset in Adobe Caslon, Bundesbahn Pi, and Zapf Dingbats

Designed by Frances J. Soo Ping Chow

Illustrations by Brenda Brown



A **QUIRK** Book

www.quirkproductions.com

Visit www.worstcasescenarios.com

Distributed in Canada by Raincoast Books

9050 Shaughnessy Street

Vancouver, British Columbia V6P 6E5

10 9 8 7 6 5 4 3 2 1

Chronicle Books LLC

85 Second Street

San Francisco, California 94105

www.chroniclebooks.com

© 1999-2007 by Quirk Productions, Inc. All rights reserved.

WARNING

When a life is imperiled or a dire situation is at hand, safe alternatives may not exist. To deal with the worst-case work scenarios presented in this book, we highly recommend—insist, actually—that the best course of action is to consult a professionally trained expert. But because highly trained professionals may not always be available when the safety or sanity of individuals is at risk, we have asked experts on various subjects to describe the techniques they might employ in these emergency situations. **THE PUBLISHER, AUTHORS, AND EXPERTS DISCLAIM ANY LIABILITY** from any injury that may result from the use, proper or improper, of the information contained in this book. All the information in this book comes directly from experts in the situation at hand, but we do not guarantee that the information contained herein is complete, safe, or accurate, nor should it be considered a substitute for your good judgment, common sense, or regard for job security. And finally, nothing in this book should be construed or interpreted to infringe on the rights of other persons or to violate criminal statutes; we urge you to obey all laws and respect all rights, including property rights and employment rights, of others.

—The Authors

ABOUT THE AUTHORS

JOSHUA PIVEN, a writer and former cubicle dweller, enjoys working in his pajamas until noon and celebrating “take yourself to lunch day.” He is the co-author, with David Borgenicht, of *The Worst-Case Scenario Survival Handbook* series and lives in Philadelphia with his wife, Christine.

DAVID BORGENICHT is a writer, editor, husband, and working father who has been a shoe salesman, door-to-door canvasser, dishwasher, and pool boy in his working life. He is the co-author, with Joshua Piven, of all of the books in *The Worst-Case Scenario Survival Handbook* series, and of *The Action Hero's Handbook* (Quirk Books) with his brother, Joe. He lives in Philadelphia with his family (by night) and his employees (by day).

BRENDA BROWN is a freelance illustrator and cartoonist whose work has been published in many books and major publications, including *The Worst-Case Scenario Survival Handbook* series, *Esquire*, *Reader's Digest*, *USA Weekend*, *21st Century Science & Technology*, *The Saturday Evening Post*, *The National Enquirer*, and many other magazines. Her work has also appeared in specialized education series, websites, and promotional ad campaigns. Brenda's website: <http://webtoon.com>.

Check out www.worstcasescenarios.com for updates, new scenarios, and more! Because you just never know . . .

ACKNOWLEDGMENTS

David Borgenicht would like to thank everyone who made this book possible: Jay Schaefer and Steve Mockus (you can be my nightmare bosses anytime), and everyone else at Chronicle Books; Melissa Wagner (for her stellar editing and saintly patience), and everyone else at Quirk Books; the experts who lent their knowledge and experience to the scenarios within; and of course, all the workers of the world—unite!

Josh Piven thanks all the experts who contributed their diverse range of career expertise. Without your help, writing this book would have been more work than fun.

ABOUT THE AUTHORS

JOSHUA PIVEN, a writer and former cubicle dweller, enjoys working in his pajamas until noon and celebrating “take yourself to lunch day.” He is the co-author, with David Borgenicht, of *The Worst-Case Scenario Survival Handbook* series and lives in Philadelphia with his wife, Christine.

DAVID BORGENICHT is a writer, editor, husband, and working father who has been a shoe salesman, door-to-door canvasser, dishwasher, and pool boy in his working life. He is the co-author, with Joshua Piven, of all of the books in *The Worst-Case Scenario Survival Handbook* series, and of *The Action Hero's Handbook* (Quirk Books) with his brother, Joe. He lives in Philadelphia with his family (by night) and his employees (by day).

BRENDA BROWN is a freelance illustrator and cartoonist whose work has been published in many books and major publications, including *The Worst-Case Scenario Survival Handbook* series, *Esquire*, *Reader's Digest*, *USA Weekend*, *21st Century Science & Technology*, *The Saturday Evening Post*, *The National Enquirer*, and many other magazines. Her work has also appeared in specialized education series, websites, and promotional ad campaigns. Brenda's website: <http://webtoon.com>.

Check out www.worstcasescenarios.com for updates, new scenarios, and more! Because you just never know . . .

ACKNOWLEDGMENTS

David Borgenicht would like to thank everyone who made this book possible: Jay Schaefer and Steve Mockus (you can be my nightmare bosses anytime), and everyone else at Chronicle Books; Melissa Wagner (for her stellar editing and saintly patience), and everyone else at Quirk Books; the experts who lent their knowledge and experience to the scenarios within; and of course, all the workers of the world—unite!

Josh Piven thanks all the experts who contributed their diverse range of career expertise. Without your help, writing this book would have been more work than fun.

INTRODUCTION

Most people spend more than one-third of their adult waking lives on the job.

And during any given work week, usually Monday to Friday, you will spend half your awake time working—more than that, if you include commuting time (and a little less than that if you sleep on the job).

If you work in an office, this means you will most likely spend more time sitting in your desk chair than you will spend shopping, driving your car, playing with your dog, running errands, going to the movies, working out at the gym, playing golf, reading to your children, and eating *combined*. If your workplace is not an office, you'll spend just as much time there *and* you'll probably be surrounded by heavy machinery, dangerous chemicals, unpredictable environments, or incompetent co-workers. And everyone faces the risks imposed by a nightmare boss.

You spend so much time in the work environment, the odds are staggering that something is going to go wrong while you're there. Very wrong. Using an ergonomic chair or bending your knees when you lift something heavy is not going to be enough to keep you safe.

You need this book.

Work, to start with, isn't the greatest thing—that's why they call it *work*. But there's no sense in making it even worse by being unprepared and succumbing to physical, mental, social, and occupational

disasters. To keep you safe and productive in all the phases of your work life, we've created this indispensable handbook. After all, that's *our* job.

We've discovered that most people at work focus too much attention on too few problems and complaints: There are many more things that can get you than you realize.

From a job interview gone bad to a satisfying way to quit, from a deep-fryer burn to ways to sneak out of a meeting, from a necktie caught in a copy machine to expunging the nasty e-mail you sent, and from being locked in a walk-in freezer to retrieving a candy bar stuck in the lunchroom vending machine, this book will give you the tools necessary to survive and keep working. Sometimes you will be covering your own mistakes—restoring a shredded document, fixing a bad haircut, undenting the company car—other times you will be dealing with crises thrust upon you—a stockroom avalanche or the company picnic. In other instances, you will be turning your liabilities into advancement by disguising your tattoos, surviving an office romance, enhancing your stature, and starting a rumor. All the information in this book is geared toward helping you survive your workaday life, whether you're working behind the counter, behind the wheel, or behind a desk.

As with our other *Worst-Case Scenario Survival Handbooks*, we've consulted dozens of highly trained professionals to come up with clear, step-by-step instructions for emerging intact from the situation at hand. These experts—brain surgeons, human

resources specialists, forklift operators, professional slackers, plumbers, photocopier technicians, lion tamers, escape artists, private investigators, and many others—all have one goal in mind: getting you through the on-the-job worst-case scenario so you can work another day.

—The Authors

CHAPTER I

THE INTERVIEW

JARGON BINGO

Photocopy the Jargon Bingo cards on this spread, cut along the dotted lines, and take the cards with you to your next meeting. Keep one for yourself, and give the others to colleagues. Check off each word or phrase as it is used during the meeting. If you complete a row (across, up and down, or diagonally), you've won! Signal your fellow players by flipping your pen in the air and touching your index finger to your nose.

brand management	optimize	buzz	guerilla	no-brainer
takeaway	zero-sum	outside the box	slippery slope	team player
killer app	do the heavy lifting	★	ballpark	step up to the plate
up the flagpole	fast track	outsource	tipping point	viral
metrics	big picture	put to bed	downmarket	paradigm shift

blue sky	dog and pony show	game plan	merch	deliverable
upmarket	synergize	quality-driven	check with accounting	empower
facilitate	brainstorm	★	backburner	marketing hook
value-driven	fast track	impulse priced	profit-driven	win-win
user friendly	proactive	counter-intuitive	revisit	incentivize

re-prioritize	quality-driven	crash	big picture	brainstorm
team player	test case	perceived value	zero-sum	empower
ballpark	facilitate	★	repurpose	brand management
market-driven	backburner	optimize	check with legal	no-brainer
slippery slope	outside the box	fast track	takeaway	upmarket

WORST-CASE SCENARIO®

HOW TO AVOID DOWNSIZING

MAKE YOURSELF SEEM INDISPENSABLE

- ★ **Perform thankless tasks.**
Offer to do the billing, track vacation or comp time, sort the mail, answer the phones at lunchtime, replace the toner, or clean out the refrigerator. Master the jobs no one else wants.
- ★ **Offer to organize office social events.**
Do more than your share of planning office birthday parties and making sure everyone signs the card. Organize office parties, picnics, and holiday gatherings. Maintain a password-protected database of contacts and suppliers.
- ★ **Get your name out.**
Write an occasional article for the company newsletter or speak at a company event.
- ★ **Become the key master.**
Cultivate a collection of keys and codes for as many doors and drawers as possible. Store them in a locked place.
- ★ **Be the one at meetings who says, "OK, let's get started."**



Be the office handyperson.

Bring your tool kit to work and fix little problems around the office.



Propose ways to save the company money.

Suggest that employees use second-day postage rather than express; turn off lights in unused offices; re-use sticky notes; recycle memos, reports, and other documents internally by using the back side for scrap paper and drafts; insert “saving the resources of our company and our country” into every conversation; and remind your boss that “a dollar not spent goes right to the bottom line.”



Start wearing glasses.

You will look more intelligent.

**WORST-CASE
SCENARIO.**

HOW TO CLEAN UP A SPILL IN AISLE SEVEN

- 1 Stay with the spill.**
Monitor the area from the moment you discover it.
- 2 Examine the spilled item.**
A spill will be “dry,” “wet,” or “wet with glass.” Determine which type you are facing.
- 3 Announce the spill.**
Shout, “Wet spill with glass, aisle seven.” Ask the employee who responds to remain with the spill while you get cleaning materials.
- 4 Prepare the cleaning supplies.**
Bring a broom, dustpan, and rolling garbage can with bag if the spill is dry. If the spill is wet or wet with glass, also get two caution signs, rubber gloves, paper towels, a rag mop, and a filled bucket with ringer. Add an all-purpose cleaning agent to the water.
- 5 Prepare the spill area.**
Place a caution sign on either side of a wet spill. Keep your bucket clear of the spilled material to avoid leaving tracks when you move it.



Use short, back and forth strokes. Rinse frequently.

6 Remove the glass pieces and sweep.

Wearing the rubber gloves, pick up all noticeable glass shards and place them in the garbage bag. (Use paper towels if no gloves are available.) Sweep as much of the spilled item into the dustpan as possible and dump in the garbage can.

7 Mop.

Thoroughly soak the mop head. Mop using short, back-and-forth strokes until no spillage remains. Avoid wide strokes, which will spread the spilled item. Dunk the mop head in the water frequently and wring thoroughly.

8 Check the floor.

Some items (spaghetti sauce, for example) may stain floor surfaces. If you cannot remove the stain by mopping, leave a message for the night cleaning staff to clean and buff the area.

9 Leave the signs in place.

10 Wait 20 minutes, then check the spill area.

Remove the signs when the floor is dry.

Be Aware

Sticky items like soda, juice, and syrup or slippery items like oil, salad dressing, and concentrated detergent may require extra-thorough mopping.

**WORST-CASE
SCENARIO.**

HOW TO COVER YOUR MISTAKES

EXPUNGE A NASTY E-MAIL

- ★ **Recall it.**
Some e-mail programs allow you to “recall” a message you sent, giving you the option of deleting or replacing it. This feature only works if the recipient is also using the same brand of software and if the recipient is on your local area network. In the Sent Items folder, open the e-mail and click “Recall This Message” on the Tools menu (or Actions menu, depending on which software you have). Follow the instructions.
- ★ **Retract it.**
Several free software programs or add-ins allow you to “retract” (delete) an e-mail before it is read. Instead of sending the actual message, these programs send the recipient a link to a website that stores your sent e-mail, enabling you to send a “delete” command before the recipient opens the message. If you tend to get angry and impulsive, consider buying such a program.
- ★ **Delete the message from the recipient’s computer.**
As soon as you realize your mistake, call the recipient and send him on a fool’s errand, or have the recipient paged to another area. Go to his desk. Kneel so you are not easily visible. Open his e-mail program and

delete the message. Check the “trash” mailbox to make sure it was fully deleted and not just moved. Delete it permanently.

- ★ **Claim poor spelling or blame the automatic spell checker.**
Insist to the recipient that your message isn’t what you meant to say. Explain that the bad language was a typo, or that it was a typo that the automatic spell checker changed into another, unintended word.
 - ★ **Claim that someone else sent the e-mail from your machine.**
 - ★ **Blame computers generally.**
Explain that a moment’s frustration was blown way out of proportion because computers make it so easy to vent and send. Claim that before computer technology and e-mail, this never would have happened.
- ### Be Aware
- It is best to queue outgoing e-mail in your outbox rather than send it immediately. This gives you the opportunity to pause and reflect on your wording, and then change or delete the message before it is sent.
 - One e-mail program offers a “Mood Watch” function that monitors your typing and alerts you if a message is approaching “flame” status.

SALVAGE A COFFEE-STAINED DOCUMENT

If you are working with a signed contract or a document you cannot replace, you will have to restore the existing pages.

1 Blot the stain immediately.

Use a clean rag or paper towel to remove as much of the coffee as possible before it dries. Blot, do not wipe. The longer the stain sets, the more difficult the removal.

2 Examine the stain.

If the stain caused the ink to run, you are probably dealing with an unsalvageable document. Follow the directions in step 3 to be sure.

3 Determine the printing method.

Wet the end of an ear swab and quickly run it across a non-stained word. If the ink transfers to the cotton, the document was printed on an ink-jet printer and salvage is not possible. Use as is.

4 Make a vinegar solution.

For a small stain (1 to 2 inches in diameter), mix 1 tablespoon white vinegar with 1 tablespoon cold water. (Double or triple the amounts based on stain size.) Pour the mixture into a plate or shallow dish.

5 Place the stained document on the edge of the dish.

Using a metal spoon, weight the stained portion so it rests in the solution. It is not necessary to immerse the entire sheet.

6 Soak for 5 minutes.

If the stain is still present, let the document soak for five additional minutes.

7 Remove from the solution and blot.

Blot the wet area using a clean, dry paper towel. Do not rub.

8 Dry.

For best results, clip the paper to a string with a clothespin or paper clip to expose both sides to the

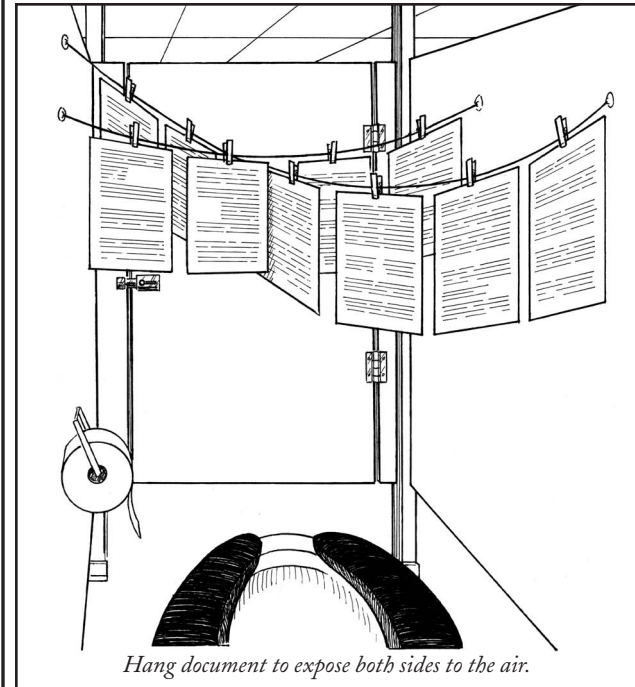

air. Drying time is about 30 minutes. If time is of the essence or the document is very wrinkled, use a warm iron to carefully smooth the stained area and to speed the drying process.

Be Aware

- Do not rub the stained area when the stain is fresh or damp from the vinegar, as you may rip the document.
- Depending on the severity and freshness of the stain, blotting repeatedly with a vinegar-soaked paper towel instead of soaking may be effective for removal. When the stain has faded, blot with a clean, dry paper towel and dry as above.
- If the signature page at the end of a contract is the stained page, do not try to remove the stain. Blot dry and leave alone. The signatories may have used a fountain pen or a type of ink that is water soluble.

SPILL ON A PATRON

- 1 Apologize immediately.**

Even if the spill was clearly the fault of the diner, apologize. The apology must sound sincere.
- 2 Get club soda and clean napkins.**

The carbonation in club soda helps bring the stain to the surface, making for easier cleanup. Use on any stain except red wine or a red wine-based dish like Chateaubriand. If the stain is red wine, go to step 5.

- 3 Analyze the location of the stain.**

Helping in stain removal may not be appropriate, depending on where the stain is located and the sensitivities of the patron. Offer the club soda and napkins to another guest at the table and suggest that the guest assist the diner with stain removal in the restroom. If the stain is on a jacket, offer to take the jacket and work on the stain. (Most stains occur over the right shoulder, since drinks are served and cleared from this side.)

- 4 Replace the spilled beverage or food item.**

- 5 Offer to pay for dry cleaning.**

For a red-wine stain, you or the manager should offer to have the clothing cleaned at the restaurant's expense. You might also offer a complimentary dessert or bottle of wine on the diner's next visit.

FIX A BAD HAIRCUT

IF THE CUT IS UNEVEN

- 1 Offer to make good.**

Explain to the customer that you can fix the haircut. Avoid offering a refund. If the client insists, offer several free hair-care products instead.

2 **Keep cutting.**

Unless you plan to offer the customer extensions or a hair weave, going shorter is the only way to even out the hair. Make sure you tell the client what you are doing. Say, “I’m taking a little more off the top here, just to even it out.” Stop every few minutes and hold up a hand mirror to display the new length.

3 **Maintain a sense of humor.**

Say, “Didn’t I tell you I specialize in asymmetrical haircuts?” If the client is still angry, try compliments: “You know, your hair looks great at this length. We should have cut it shorter a long time ago.” Avoid getting defensive.

4 **Use camouflage.**

Hide the uneven cut by slicking back all the hair with a heavy, wet-look gel. The glare of the gel under lights or sunlight may make the short side difficult to see.

5 **Use the ears.**

An uneven section of hair can often be hidden behind one ear. Apply gel to slick the hair back and behind the ear, and a good dusting of hairspray to hold it in place.

6 **Accessorize.**

Place a large hair clip on the shorter side to obscure your mistake. If the accessory will not cover the short section, put it on the longer side to attract the eye and draw attention away from the shorter side.

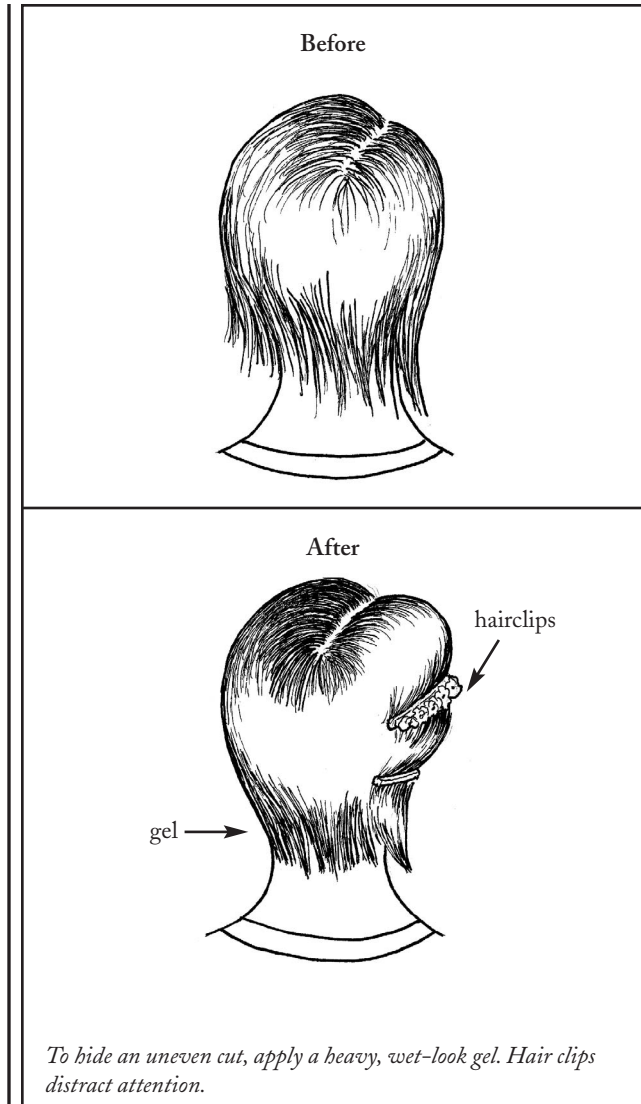

To hide an uneven cut, apply a heavy, wet-look gel. Hair clips distract attention.

IF IT'S A BAD DYE JOB



Re-dye.

Using the ten-level system to classify hair color (1 is black, 3 is darkest brown, 5 is medium brown, 7 is dark blond, and 10 is very light blond, with all other colors falling somewhere in between), make sure the new dye color is no more than two levels above the natural hair color. If the natural color cannot be discerned, use the existing color as your baseline.



Go brighter, not lighter.

Dye dark hair a bright color such as auburn, mahogany, or caramel. Any hair color above level 5 should never be given blond highlights.



Apply a color glaze.

If the highlights are too light (too much bleach), use a conditioning color glaze to tone down the highlights, then re-highlight with a hair color. Avoid using more bleach at all costs.



Go dark.

Light-colored hair—or any hair—easily can be made darker. Do not change the color by more than two levels (see step 1). If the hair has a damaged, orange hue, use a color with an ash tint to cut the orange.

Be Aware

Many home coloring treatments are bad for the hair shaft and can damage follicles and cause hair to fall out. If you run out of professional hair color, make a

healthy substitute. For dark color, mix already brewed, damp coffee grounds with regular shampoo until the mix is the color you are seeking. Wash the hair normally and rinse well for a quick-and-dirty (but safe) dye job. To lighten hair, mix hair gel with standard iodine.

HOW TO DEAL WITH A NIGHTMARE BOSS

THE CONTROL FREAK

The Control Freak will attempt to micromanage your every task and responsibility.

- ★ **Bombard him with information.**
Copy him on every e-mail even remotely involving him or his area of responsibility. Leave towering stacks of reports and copies of all correspondence on his desk. Include him in the most mundane meetings and discussions. You may be able to short-circuit his control mechanism with the sheer volume of data.
- ★ **Solicit his opinion, but control the options.**
If you must leave a decision up to your boss, offer the solution you favor and two or three lame options—ridiculous or unworkable possibilities that will direct him to choose your course of action. Using phrases such as “You’ve probably already thought of this” and “I tried to put myself in your shoes when I worked on this” will help you gain favor.
- ★ **Remain calm and pleasant.**
When your boss interferes with your work or second-guesses your decision, do not become defensive or combative. Say, “How ridiculous—I should have thought of that. Thank goodness I included you!” and

then lead your boss back to your position, while encouraging him to think you’re following his guidance.

- ★ **Continue to do your job.**
Bide your time. Your boss may ultimately believe that he’s shown you the way and he can now go on to help others.

THE BUDDY

The Buddy will generally attempt to blur the lines between employee and supervisor, soliciting personal information and seeking inclusion as though you are the best of friends. Include the Buddy in small ways, but keep your distance.

- ★ **Invent a hobby.**
Avoid sharing intimate details of your real life by inventing a hobby, which you can discuss with her in minute detail. Your fictional toothpick sculptures or love of steam locomotives will become of great interest to the Buddy and can serve as the basis of your “friendship.” Movies, restaurants, and sports are also safe, impersonal topics to raise.
- ★ **Offer social invitations you know she can’t accept.**
Invite her to lunch on a day you are certain she has another appointment. Ask her out for a drink with “the gang” after work on the night she always goes to her yoga class, or when she will be away on business.

Be aware that she may proffer invitations in return, which easily can be evaded by inventing a nightly class of your own.

★ **Avoid hugs.**

If she attempts to throw a friendly arm around you, fake a sneeze. Blame allergies rather than perfume, which she can change. Your “allergies” can then also become a topic of friendly conversation.

THE WORKAHOLIC

The Workaholic has lost all sense of perspective, and has sacrificed his life to his job. He will expect the same of you.

★ **Present evidence of the real world.**

Replace all calendars he sees with ones depicting tropical retreats, ski slopes, or other vacation locales. Litter the office with travel brochures, and purchase office subscriptions to food, travel, and entertainment magazines. E-mail him regularly with weather updates of distant cities.

★ **Discuss family at every opportunity.**

Show him pictures of your family. Show him pictures of his own family. If even your most distant relative has bought a car, won a part in a school play, or suffered a toothache, offer these stories in careful detail—perhaps they will trigger recognition that he, too, has a wife, sister, uncle, or son.

★ **If he has ever discussed a personal interest, become obsessed with it.**

Pounce on any non-work-related subject in the hope of rekindling his own passion. Discuss popular subjects and pastimes to spark some vestigial interest. Try baseball, politics, food, music, and celebrity gossip. Avoid even juicy office gossip, since that will lead him back to work-related issues.

THE TELLER OF BAD JOKES

His jokes are always bad.

★ **Be prepared.**

Steel yourself for the punchline. If you are unable to determine if the punchline has been delivered, watch your boss for response cues such as a long pause or an expectant grin.

★ **Determine the nature of the required reaction.**

A secure boss will be satisfied with a friendly groan and head shaking, while an insecure boss will require a more elaborate show of amusement and appreciation. Respond accordingly.

★ **Fake amusement.**

THE SHOULDER SHAKE—Smile, cover your mouth with one hand, and shake your shoulders up and down. This is especially good for puns.

THE AMUSED CHUCKLE—Smile, look directly at your boss, and say, “Heh, heh, heh.” This is a versatile, all-purpose laugh response.

THE GENUINE GUFFAW—Smile broadly, then let out a single, loud “Ha!” Slap your thigh in amusement. If seated, slap your knee.



Change the subject immediately.

Do not give him the chance to “tell you another one.”

Be Aware

Be on guard for other styles of bad boss behavior, and be prepared to take quick action:

• **THE SUPREME DELEGATOR**

Always willing to accept all of the credit but none of the blame, the Supreme Delegator is really setting up others to take the fall. Although she tries to cloak her behavior in an air of confidence, the Supreme Delegator has very low self-esteem and fears that she will fail.

From the moment a project is handed off to you, through all the key decisions, to the final action, make sure you advise your boss—in writing—of all key decisions and plans. Keep copies. Do not be afraid to proceed as you think best, but be prepared for your boss to disavow all knowledge of the details should there be a problem.

• **THE YES/NO MANAGER**

This boss is ever-increasingly bored with meaningful information, intelligent discussion, and any complexity. He wants every decision reduced to an overly simplified YES or NO.

Present an executive summary, with several alternatives for action. Attach the full report with

well-reasoned, well-documented arguments for each point. If asked for your recommendation, give it orally.

• **THE PASSIVE-AGGRESSIVE BOSS**

The Passive-Aggressive Boss puts things off, then complains at the last minute that he has not had enough time. The boss can then blame those above or below him for doing a bad job.

Be firm with deadlines and set them in writing. Involve others in the process when possible. These co-workers can then serve as witnesses to any misbehavior on your boss’s part.

• **THE INDECISION MAKER**

This boss ascended to power by a fluke—he can’t actually make a decision himself. He needs input from three or four different sources in order to feel comfortable in his own shoes.

Present any question to your boss as if you’ve taken an informal survey. Include information from any key employees he’d want to hear from.

• **THE ALL-BUSINESS-IS-PERSONAL MANAGER**

The All-Business-Is-Personal Manager has a seriously dysfunctional life outside of work, and thus cannot ever really separate business life from personal life. He will take everything personally. He has nothing but work to cling to, so make your work time with him enjoyable. One bad day can ruin a whole relationship.

HOW TO DEAL WITH A NIGHTMARE CO-WORKER

THE TALKER

The Talker just won't shut up.

- ★ **Look busy.**
Free time means chat time to the Talker. Leave paperwork handy on your desk, and spreadsheets or other documents open on your computer at all times. When the Talker approaches, stare at the task intently and pretend not to notice his arrival.
- ★ **Evade and deflect.**
Say, "I'd love to hear more, but I've got to finish this by [fifteen minutes from now]." Or, rise from your desk and say, "Oh my gosh, I've got to go to that meeting." As you walk away, suggest that another co-worker has expressed interest in whatever is on the Talker's mind and aim him in that direction.
- ★ **"Yes" the conversation to death.**
Talkers are often of the life-is-a-struggle type, for whom everything is a hardship, and they must convince you of this. As the Talker's tale unfolds, keep agreeing with the Talker, but be sure you do not ask a question or volunteer information. After five flat

agreements ("Yes . . . yes, I see.") the Talker should count this as adequate confirmation and wander off.

- ★ **Avoid showing emotion.**
Do not be cheerful around the Talker, as this may make her dejected and even more talkative. Do not be sad around the Talker, since this may encourage him to top your tale of woe with his own.

THE KISS-UP

The Kiss-Up craves approval mostly from the boss, but will also seek approval from you.

- ★ **Congratulate her on her dedication and achievements, no matter how dubious:**
"You've sure got a way with a spreadsheet," "It's not everyone who'd work five straight weekends," or "You make the *best* coffee."
- ★ **Get her to do some of your own work as well.**
Suggest that this is a good way to further bring her talents to the boss's attention.
- ★ **Avoid her during restructuring.**
During times of management turmoil or when the chain of command is uncertain, the Kiss-Up may become disoriented or hostile. Give her a wide berth.

THE TMI (TOO MUCH INFORMATION)

TMIs have no boundaries and no shame. Every unsettling piece of personal information is worth sharing with you.

- ★ **Avoid TMIs on Mondays.**
The weekend will provide him with an abundance of ammunition for inappropriate personal tales. By Tuesday or Wednesday, he may have expended the most harrowing of these stories on fellow workers.
- ★ **Do not get on an elevator with a TMI.**
If you see a TMI waiting for an elevator, take the stairs. If you are already inside the elevator, feign some activity—a forgotten wallet, pocketbook, or keys—that will provide an excuse for your quickly exiting to retrieve the item.
- ★ **Maintain a buffer of at least two co-workers between the TMI and yourself at any company party or off-site function.**
If the first co-worker bolts, you will still have time for evasive maneuvers as the TMI engages the second.
- ★ **Say, “Thanks for sharing.”**
Upon the completion of a long and sordid tale—his tapeworm, his night on the town, or his dream about the boss—say “Thanks for sharing.” Without further comment or response from you, the TMI will move on to seek a more appreciative audience.

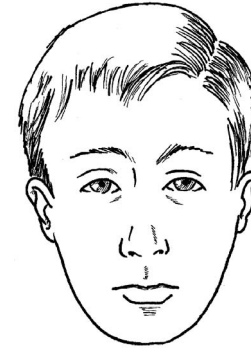

neutral

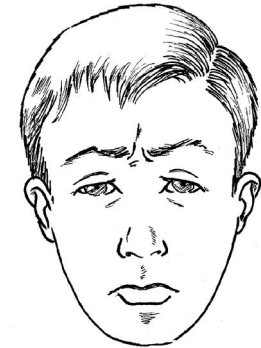

concern



interest

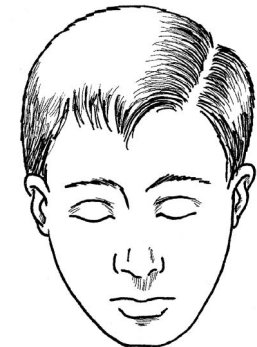

asleep

Practice these useful expressions to mask your true feelings.

THE GOSSIP

While sharing many of the characteristics of the TMI, the Gossip specializes in spreading too much information about other people.



Beware the signs.

A sure sign of a hopeless (but amateur) gossip is someone who proceeds a statement with, “I shouldn’t be telling you this but . . .” or, “I promised I wouldn’t tell anyone but . . .” Apply the techniques for avoiding a TMI, above, to save yourself from a gossip who wants to tell you everything.



Bait and switch.

Offer outrageous stories about yourself in order to stun and distract him from prying into your true private life. With a serious expression, tell the Gossip that you were locked in the monkey cage at the zoo all weekend and had the time of your life; or that you accidentally sent a very revealing personal photo via e-mail to all the executives in the company. The juicier the story, the better. When he asks, “Is that true?” say, “I’m sorry, I can’t talk about it anymore.”

**WORST-CASE
SCENARIO.**

WORST-CASE SCENARIO

HOW TO DEAL WITH A NIGHTMARE CUSTOMER

IRATE RETAIL CUSTOMER

- 1 Watch for warning signs.**

A customer will usually display several “build up” physical cues before becoming irate. Look for clenching of the hands, locking of the knees, crossing of the arms, rolling of the eyes, and leaning in toward you to reduce the amount of personal space between you.
- 2 Listen, listen, listen.**

The customer will raise his voice and become demanding, and may begin assessing blame, claiming victimhood, threatening to report you, and insisting on satisfaction. Let him rant—interrupting or defending your actions during the rant will only exacerbate the problem.
- 3 Do not mimic the posture or volume of the irate patron.**

Avoid leaning in, but do not lean away, either: Moving away indicates that you are becoming defensive. Maintain a placid, neutral position.



Remain calm.

- 4 Stay loose.**
Keep your weight evenly distributed on both feet. Breathe deeply and exhale slowly.
- 5 Speak softly.**
Wait until the customer is finished speaking, then speak calmly. Never state that the customer is angry or upset. Instead, say, “I recognize that you are raising your voice. What is it you need me to do? What is it you need the store to do?” Anger results from unmet needs, so try your best to solve the problem.

- 6 Send a clear message and offer a clear resolution.**
Say, “My commitment is to a quick, successful resolution of this problem.” Offer an exchange, a return, or a new item according to your company’s policies. If you are unable to provide a satisfactory solution, ask a manager for help.

- 7 Apologize.**
Before you find a manager, say, “I am sorry we were unable to help you today. I do hope that you will come back to shop at our store again.”

ABUSIVE RESTAURANT PATRON

- 1 Listen.**
Allow the customer to explain what is wrong. If he begins yelling or using foul language, do not respond in kind.
- 2 Do not argue.**
If the customer complains that the food is a funny color, that the bread is stale, or that the coffee tastes of detergent, do not respond by saying, “It looks/ tastes okay to me!” Never taste a customer’s food.
- 3 Observe the customer.**
If the customer stands up angrily, moves in close, or begins gesticulating wildly, move away and quietly ask him to lower his voice. If he refuses, or if he starts poking or grabbing the food, ask him to leave.

4 **Observe the room.**

Quickly check the room to see if other diners are being disturbed. If you notice turned heads or whispering, contact the manager immediately to deal with the other customers, or to back you up with yours.

5 **Placate.**

Keep your tone even and your volume low. If a dish is unsatisfactory, offer to take it back and provide him with another selection. If the customer's dinner arrived late or cold, offer to remove it from the bill.

6 **Check back.**

Once the problem is resolved, check back with the customer to make certain everything is acceptable. Do not check more than once. Consider offering a dessert or after-dinner drink "on the house."

Be Aware

- Watch for a setup. A customer may eat and complain in hopes of getting a complimentary meal. If a customer returns to the restaurant to dine and complains again, alert the manager and consider asking the patron to leave and not return.
- Avoid physical confrontation with patrons, particularly if the tables in the restaurant are close together.

**WORST-CASE
SCENARIO.**

HOW TO DISGUISE A TATTOO

1 Wear long sleeves.

Long-sleeve shirts can cover arm and shoulder tattoos. The garment should be a dark, medium-weight fabric, not sheer or ultrathin; light-weight white shirts and blouses will not effectively cover upper-body tattoos in bright light.

2 Wear a scarf and hat.

A tasteful scarf (for women) or ascot (for men) can be used to hide neck tattoos. A wide-brimmed hat is effective for concealing forehead tattoos.

3 Wear boots.

Cover ankle tattoos with ankle boots, but they should be worn to an interview only if accompanied by a pantsuit or a long skirt. Do not wear cowboy boots or high-top lace-up shoes to a job interview.

4 Wear pants or dark stockings.

For leg tattoos, wear pants, or use cosmetics (see step 5) and wear black or off-black medium sheer hosiery; ultra-sheer hosiery will not hide a tattoo. (Colored tattoos may be noticeable even through opaque stockings without the preliminary application of makeup.)

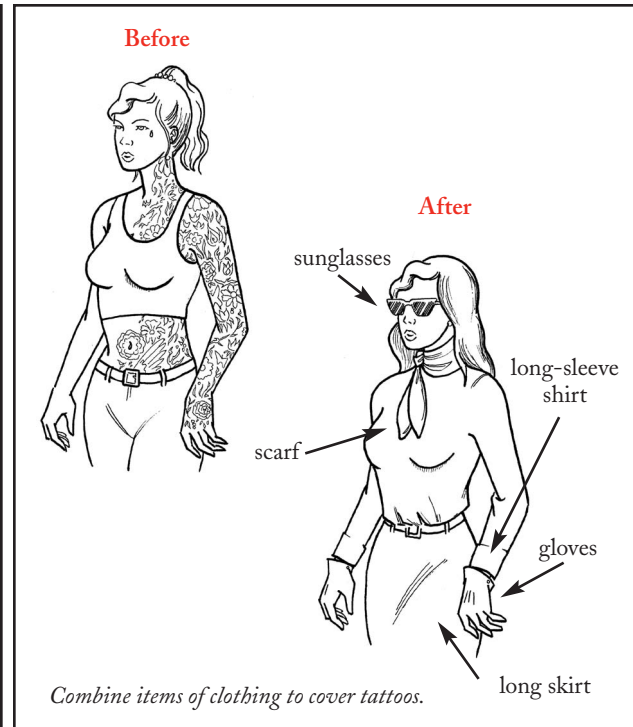

5 Apply a layer of eye shadow over the tattoo.

Use matte shadow without sparkle. Depending on the tattoo's colors and complexity, you may need to apply multiple colors of eye shadow:

- Dark tattoo colors (black, blue, purple): Use yellow eye shadow to cover.
- Red: Use light green eye shadow to cover.
- Yellow: Use light to medium pink eye shadow to cover.

If no eye shadow is available, use colored makeup. Apply green foundation to red shades in a tattoo, pink to yellow shades, and yellow concealer (usually used to cover dark circles under the eyes) for black, blue, or purple in the tattoo.

6 **Apply full-coverage makeup.**

Use a layer of thick, full-coverage foundation that matches your skin tone. Cover with a dusting of translucent powder to set the coverage. Allow the makeup to dry.

HOW TO DISGUISE A PIERCING

1 **Fill holes evenly with wax filler.**

Wax filler is available at most department stores. Use slightly softened beeswax if no filler is available.

2 **Touch up the area with a full-coverage makeup.**

Use a base that matches your skin tone.

3 **Dust with translucent powder.**

Use a fluffy cosmetic brush.

4 **Remove excess powder or makeup.**

Use an ear swab.

5 **Wear glasses with thick frames.**

The glasses can be either corrective or clear. The frames will obscure an eyebrow piercing and distract from a nose or lip piercing.

6 **Shade a lip piercing with a lip pencil.**

Choose a lip pencil that matches your natural lip color or wear a colored lipstick. Matte-finish lip pencils with long-lasting color stay are most effective; avoid soft lip pencils. Avoid wearing lipgloss or ultra-shiny lipsticks—the extra shine will draw more attention to your lips.

Be Aware

- Multiple ear piercings can be concealed with hair; use hairspray to keep the hair in place.
- In a pinch, wear bandages to conceal tattoos, but never on the face.

HOW TO FAKE A TATTOO OR PIERCING

★ **Wear or draw temporary tattoos.**

Draw with an indelible marker or apply a temporary tattoo to your forearm, neck, hands, or shoulders several hours before the interview and allow it to dry completely. Pick a tattoo that matches the job.

- Yin/yang—health store clerks, coffeeshop workers
- Mermaids—dockworkers, fishermen
- Blood, thorns—bike messengers
- “Mother”—bouncers, mechanics

★ **Wear clip-on earrings or magnetic nose rings.**

An ear cuff may also be used in the nose to simulate a nose piercing.

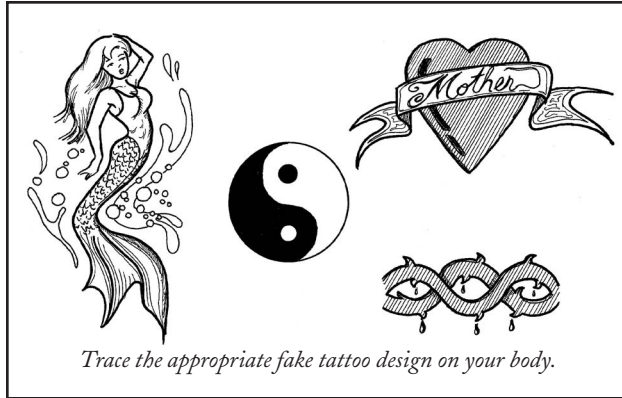

★ **Do not play with the fake rings or stare at the “tattoos.”**

Treat the piercings or tattoos as if they have always been a part of your body.

★ **Do not perspire.**

Even though most temporary tattoos claim to be long-lasting and sweat resistant, perspiration can cause the tattoo to stain clothing or furniture, and fake piercings can become slippery and slide off.

Be Aware

Do not expose tattoos and jewelry completely. Place your fake tattoos just above a pants line, or below a sleeve. Hide piercings behind strands of hair, allowing you to naturally brush it back at some point to reveal the “piercing.” A little exposure can be more natural and convincing than a fully visible tattoo.

**WORST-CASE
SCENARIO.**

HOW TO ENHANCE YOUR STATURE

PRETEND YOU HAVE AN ASSISTANT

- ★ **Alter your outgoing voicemail message.**
Ask a spouse or friend, preferably with an intriguing foreign accent, to record your outgoing message. It should be a version of the following: “You have reached the office of [*your name here*]. S/he is not available to take your call. Please leave a message and s/he will return your call as soon as possible.”
- ★ **Receive calls on your mobile phone.**
While you are with someone you want to impress, either in an office conference room or at a restaurant, have a friend call you at a pre-arranged time. Answer the phone and say to the person with whom you are meeting, “Sorry, but I have to take this call. No one but my assistant has this number and I told him to call me only in emergencies.”
- ★ **Use a pager.**
Subscribe to a paging service that alerts you with a beep for headlines or sports scores. Pretend the pages are from your assistant. In an exasperated voice, say, “It’s my new assistant. He can’t seem to do anything without my approval!”

- ★ **Tip the host at a restaurant.**
Tell the host to come to your table during the meal and say that you have an urgent phone call from your assistant.

ATTEND MEETINGS TO WHICH YOU ARE NOT INVITED

- ★ **Ask the receptionist for a conference room reservation schedule.**
Determine which meetings are worth crashing.
- ★ **Choose meetings carefully.**
Do not attend any meeting at which your direct supervisor is present. If your supervisor is out of the office, definitely attend the meeting and people will think you have been designated as a replacement. If your supervisor is in town, go to other departments’ meetings.
- ★ **Invent a reason for attending.**
Approach the person running the meeting in advance and explain that you are attending for “professional development.” The chairperson will most likely assume that there is some new Human Resources department program. Others attending the meeting will assume you are supposed to be there.
- ★ **Bring snacks.**
People will never question your attendance if you bring food.

MOVE INTO AN UNOCCUPIED OFFICE

- 1** **Take note of offices that have been vacant for a significant length of time.**
- 2** **Slowly take possession of an office.**
Begin by working on a project in the office. If questioned, explain that you “needed a little peace and quiet in order to get [*project name*] done.”
- 3** **Occupy the office regularly.**
For two weeks, spend at least an hour a day in the space, working on your project.
- 4** **Expand your hours of occupancy.**
After two weeks, begin leaving personal items and other files in the office.
- 5** **Log onto the computer in the new office with your password.**
- 6** **Forward your phone calls.**
Program your phone to send your calls to the extension in the new office.
- 7** **Complain to the IT department.**
Tell the Information Technologies department that your old extension still hasn’t been transferred to your new phone.

8 **Move your nameplate.**

Place your nameplate on the new desk or in the slot outside the door, depending on company practice.

9 **Close the door when working.**

Look annoyed when anyone knocks or tries to come in. After approximately eight weeks of squatting, the office will be perceived as yours.

ALTER YOUR BUSINESS CARDS

★ **Count the number of characters in your title.**

The new title you select needs to occupy roughly the same space on the card so that it doesn’t float or appear obviously doctored. For example, “Editorial Assistant” can become “Editorial Director,” but not simply “Editor” or “Senior Editor.” Suggested replacements:

- “Marketing Manager” with “Marketing Director”
- “Assistant to the President” with “Assistant Vice-President”
- “Executive Secretary” with “Chief Exec. Officer.”
- “Customer Service Rep.” with “Customer Service Mgr.”

★ **Use correction fluid, tape, a razor blade, and modified printer labels to add or subtract words and letters from your business card.**

USE PROPS

- ★ **Carry a briefcase.**
Invest in a good-quality leather briefcase or attaché case and carry it at all times. When someone asks you for something, say, “Oh, I have it here in my briefcase.” Consider a locking model for added stature.
- ★ **Carry a fountain pen.**
Fountain pens denote wealth and good breeding. Do not carry the pen in a pocket protector.

LOOK BUSIER THAN YOU ARE

- ★ **Purchase a headset and attach it to your phone.**
It doesn't matter whether it's actually connected or not—tape it to the bottom of the phone if it won't hook in. Wear it constantly, and talk loudly whenever someone passes by.
- ★ **Keep large piles of paper on your desk at all times.**
Re-arrange the stacks occasionally.
- ★ **Type furiously from time to time.**
Position your monitor so the screen is not visible to anyone passing by or entering your space. Periodically, look intently at the monitor and type as fast as you can. Type nonsense, if you must—but do it at a speed of at least 70 words per minute.

- ★ **Show up early and stay late.**
You can maintain the same eight-hour day—just run your errands in the middle of the day. Few people will think twice about your absence from your desk in the middle of the day, but everyone will notice how early you get there and how late you leave. Long midday absences, if noticed, will be interpreted as business lunches, a sign of importance.

- ★ **Muss your hair and look stressed whenever you pass your supervisor's office.**

START A HELPFUL RUMOR

- ★ **Receive messages from headhunters.**
Have a friend, posing as a headhunter, make repeated calls to the receptionist. The friend should say, “I'm with [*official sounding name*] Headhunting Agency—may I speak with [*your name*]?” Word will likely get back to your supervisor.
- ★ **Plant a reference check with the Human Resources department.**
When the office is sure to be closed—late at night, on a weekend, or when you are certain everyone in the Human Resources department has left for the day—have a friend leave a voice-mail message saying he or she is checking references on [*your name*] and will call back later. The caller should not leave a return phone number nor a company name, but can leave their own name. The caller should sound casual but busy, as if

he or she is checking a list of names with a variety of employers.

★ **Take the receptionist or your direct supervisor's assistant into your "confidence."**

Explain that you are "entertaining" a position at another company, but that you "really want to stay." Ask for advice, knowing that word will get back to the boss.

★ **Talk with people in other departments about forthcoming changes in your department.**

Say you are not at liberty to reveal the whole story, but major changes will be coming. Ask if they know anything about future plans for your supervisor's parking place/office.

★ **Conduct rumor-inducing conversations in public areas.**

Spend time conversing at the water cooler, the lunchroom, bathroom, lobby, stairwells, elevators, and hallways. A loud whisper is most effective in getting people's attention. What you are talking about is not important: The fact that you are engaging in so many hushed conversations is the important factor.

**WORST-CASE
SCENARIO.**

WORST-CASE SCENARIO.

HOW TO ESCAPE A STOCKROOM AVALANCHE

- 1 Position your head on your chest.**
Immediately move your head down, touching your chin to your chest, as soon as you hear shelves creaking or detect objects falling.
- 2 Protect your head.**
Bring your arms up over your head. Clasp your hands together behind your head and bring your elbows together in front of you. Keep your chin down and your arms over your head at all times.
- 3 Run toward the door.**
If you see a relatively clear path of escape, proceed to the door as quickly as possible.
- 4 Find a safe spot.**
If you cannot escape the room, move to the center of the floor, away from shelves, or take cover near shelves holding softer items.
- 5 Drop and curl.**
Lie down and assume the fetal position, with your arms covering your head. Allow lighter, lower objects to cover you and give you protection from heavier objects falling from higher shelves.



Run.

HOW TO EXTRICATE YOURSELF FROM AN AVALANCHE

- 1 Move slowly.**
Crawl on your hands and knees, maintaining a low profile. Expect a secondary slide. Avoid sudden movements that may cause precariously perched items to fall.
- 2 Check for injuries.**
Feel your arms, legs, torso, and hands. Wiggle your toes, flex your fingers, and bend your arms and legs slightly. Make sure nothing is broken before you get up.
- 3 Move debris.**
Push fallen items to the side. Be careful not to jar shelves or you risk another slide.
- 4 Stand up.**
Step over and around items and make your way to the door.
- 5 Exit the stockroom.**
Do not slam the door. Warn others of the danger.

HOW TO FIX A DENTED COMPANY VEHICLE

Dents can be fixed by either pushing out the dent from behind or pulling on it from the front. The latter is more difficult, but may be your only hope if you cannot access the back of the dented panel.

1 Check the location of the dent.

Dents on quarter panels, trunks, hoods, and fenders are relatively easy to fix. If the dent is in the door or on the roof, or if the dent is very sharp or deep, see “Make a Glue Puller,” page 148.

2 Access the rear of the panel.

If the dent is on the hood or trunk, open the hood or trunk to access the back of the panel. If the dent is on a fender, remove the plastic liner panel (which may require removing plastic screws) to gain access to the sheet metal. If the dent is on a quarter panel, pull back the carpet or trunk liner until you see the metal plate.

3 Push out the dent with your hand.

Press firmly but gently. For better results, use a golf ball, baseball, or other hard, round object to push out the dent. Small dents will require greater pressure. Do not push too hard or you will create a dent in the other direction; sheet metal on cars is very thin.

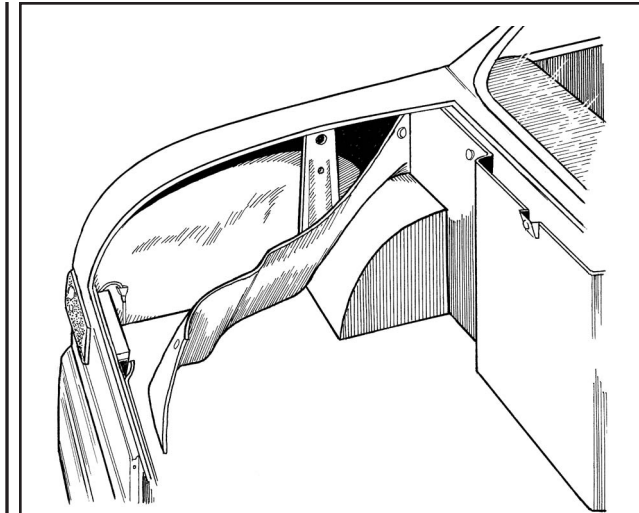

Pull back the trunk liner to reveal metal plate.

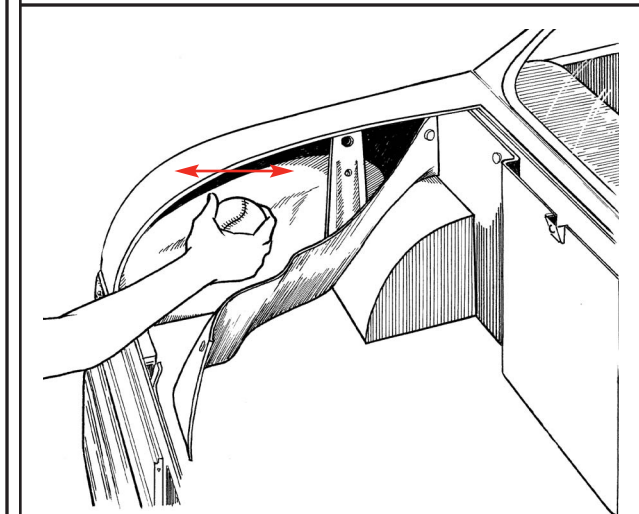

Use a baseball to roll out the dent. Press firmly but gently.

MAKE A GLUE PULLER

You will need: hot-glue gun, wood-glue sticks (amber, not white), denatured alcohol, and a dowel rod (2 inches by 18 to 24 inches long).

1 Insert a glue stick into the glue gun.

2 Plug in the glue gun.

Allow the gun to heat for 5 to 10 minutes.

3 Clean the dent.

Use a clean cloth to rub alcohol on the dent to strip any wax from the area and ensure a good bond.

4 Coat the dowel rod with glue.

Cover a 1-inch section at the tip of the dowel rod with the melted glue.

5 Press the dowel into the dent.

Immediately place the glue-covered end of the dowel rod into the center of the dented area. Hold it very still against the steel for 1 to 2 minutes or until the glue is dry. Do not wiggle the dowel rod or you will break the bond.

6 Yank the dowel rod.

Use a single swift, hard motion to pull the dent out. The dowel should also pull free of the car.

7 Repeat, if necessary.

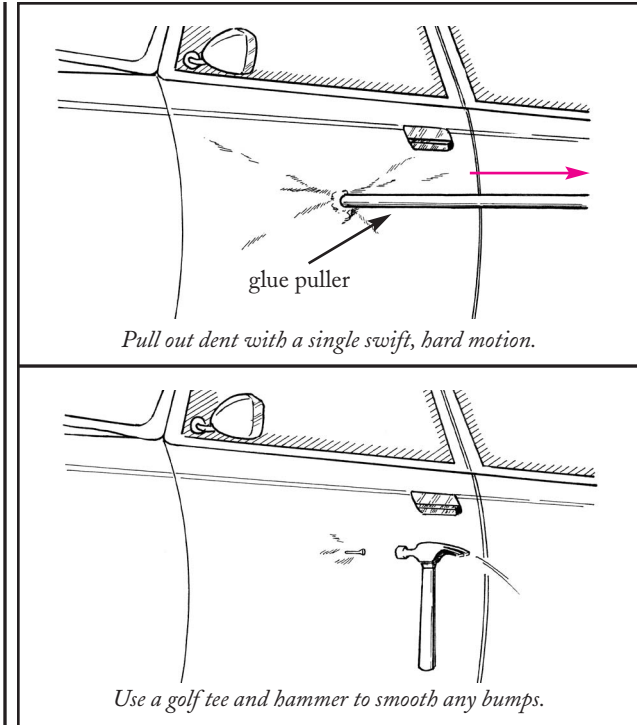

8 Smooth out any bumps.

If you pulled too hard and there is now a bump, flatten the high spot by placing the tip of a golf tee over the bulge. Tap a hammer against the wide end of the tee until the bump is flush. This method should not remove the paint.

9 Remove excess glue.

Pour alcohol on a clean cloth and rub the panel to remove any glue that remains.

WORST-CASE SCENARIO®

HOW TO GET A JOB YOU'RE NOT QUALIFIED FOR

FANCY RESTAURANT

Restaurant interviews focus on your service experience, knowledge of standard service customs and procedures, and familiarity with a wide range of food items. You also are judged on your overall appearance and general demeanor.

ATTIRE

Wear:

- Tuxedo
- or
- White blouse with black skirt (below the knee)

Do Not Wear:

- Ripped jeans
- Facial hair (except a groomed mustache)
- Dark-colored nail polish
- Lots of jewelry (limit is a watch, a wedding band and/or engagement ring, and a pair of stud earrings)

PARAPHERNALIA TO BRING

- Table crumber
- Worm (waiter's corkscrew)
- Matches or a lighter

BUZZWORDS TO USE

- Cover (one person's dinner—derives from a single dinner plate with metal cover)
- Gooseneck (gravy boat)
- Eighty-sixed (the item is gone/finished)
- Bring-back (an unsatisfactory dish returned to the kitchen)
- Weeded (when you are attempting to serve too many tables at once)
- One fancy French wine appellation, perfectly pronounced

CRITICAL KNOWLEDGE

- American banquet trays should be carried in the left hand, leaving the right hand free to pick up service items and open doors. (Doors in restaurants in the United States swing out and have hinges on the right.) Your left hand should be flat, palm up, thumb toward your body, under the center of the bus tray, with the tray resting on your shoulder.
- You should be able to carry 10 covers at once.
- Stack the covers on the banquet tray as follows: One stack of two plates at each oblong end of the tray, one stack of three plates directly over your left shoulder, and one stack of three plates just beyond it.
- Hold cocktail trays at waist level, for beverages.
- Never put empty dishes and glassware together on the same banquet tray.

INSIDER TIPS

- Serve food from the left, drinks from the right. In the United States, all food items should be served from the left, using the left hand, left foot in toward the table. Drinks should be poured and items cleared from the right, using the right hand, right foot in. (French restaurants and exclusive hotels may use “modern French service,” with all items served and cleared from the right.)
- Do not look at drinks as you carry them on a tray—it is easier to maintain a steady hand if you are not watching the liquids shift.
- Offer job references from out-of-town restaurants. Say, “I worked for years at Chez Louis in Chicago.” If pressed for the name of a person, add, “Unfortunately, the restaurant never reopened after the fire and I don't know how to reach the owner/manager anymore.”

CEO

Applying for a CEO job is a lengthy process and will require multiple interviews. Be prepared for several face-to-face meetings with the human resources department, senior management, and board members.

ATTIRE

Wear:

- Navy or beige suit, white shirt, and a solid or wide-striped tie
- or

- Navy or beige jacket and skirt or a pantsuit or dress (for less conservative companies)
- Expensive-looking watch
- Shined shoes

Do Not Wear:

- Bow tie or clip-on necktie
- Loud-print blouse
- Open-toed shoes
- Pastels

Do Not:

- Remove your jacket during the interview
- Have dirty fingernails

PARAPHERNALIA TO BRING

- Leather portfolio
- Ultra-expensive fountain pen
- Cigar clipper
- Putter (collapsible)
- Credit cards and large bills—no coins or bills smaller than \$20

BUZZWORDS TO USE

- Gross margin (the difference between sales revenue and the cost of the goods sold)
- Book value (the value of all the assets)
- EBITDA (earnings before interest, taxes, depreciation, and amortization)
- Buy-in
- Buy-out

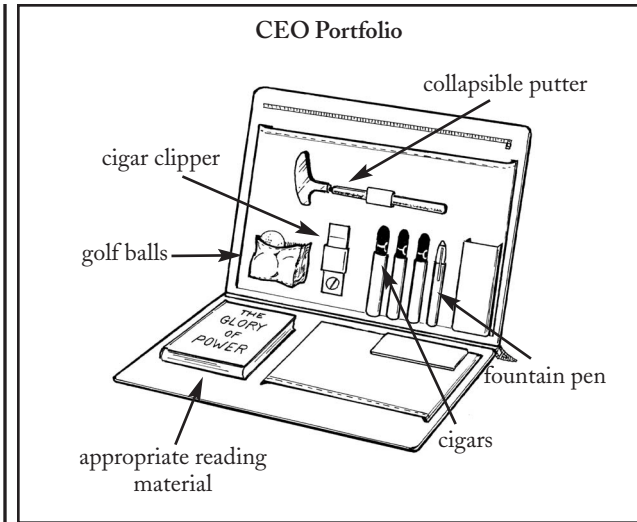

- Re-conceptualize
- Re-energize
- Right-size

CRITICAL KNOWLEDGE

- Ask about the company's challenges over the next 6 to 12 months, its business plan or model, and whether it is in "growth" mode.
- Focus your questions on the business as a whole, the marketplace, or the global economy rather than on the details of the job.
- To prepare, read books on good grammar and writing style rather than business books. People are always more impressed with someone who communicates clearly, effectively, and correctly.

Use spell-checking software whenever you draft a cover letter or resume.

INSIDER TIP

- Be sure to ask about the number of stock options available to you, as well as their “strike price” (the price at which you can exercise them).
- When asked about your hiring strategy, say, “To hire people smarter than I am.” Presidents like hearing this—it makes them trust you.
- Always negotiate for a higher salary and better benefits than offered—presidents will be more comfortable placing the business in the hands of a bulldog.

FORKLIFT OPERATOR

Driving a forklift requires specialized skills and lots of practice, so mention that you have operated a “fork” or “stacker” at many previous job sites.

ATTIRE

Wear:

- Clean T-shirt
- Work boots
- Baseball cap

Do Not Wear:

- Loafers or flip-flops
- Necktie
- Collared shirts other than flannel
- Short pants

PARAPHERNALIA TO BRING

- Lunch box/cooler
- Work gloves
- Cigarettes or chew
- Multi-purpose tool on belt

BUZZWORDS TO USE

- Towmotor, high-low, stacker, truck (slang forklift names)
- Forks, carriage, mast/upright, load backrest (important parts of the forklift)
- Cage/DOG (for Driver’s Overhead Guard)/ROPS (pronounced “ropes,” Roll-Over Protection Structure)

CRITICAL KNOWLEDGE

- The primary fork controls on a forklift are the lift-lower, the tilt forward-back, and the side shifter.
- A fork has a transmission selector (forward, reverse, neutral), steering wheel, parking brake, and accelerator and brake pedals. Most units are now automatic, and these may also have a separate inching pedal to the left of the brake pedal that slips the transmission and moves the forklift very slowly. The inching pedal may also be built into the brake pedal itself: Depress it slowly for inching, fully for braking.

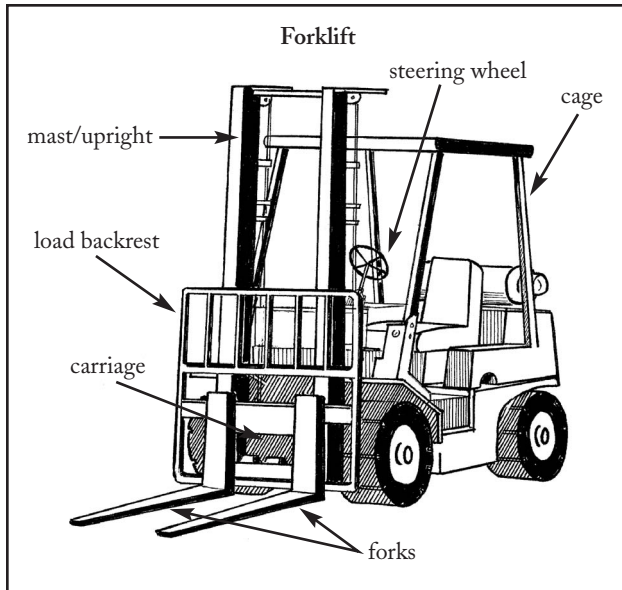

INSIDER TIP

- Mention that you have handled concrete blocks and paper rolls. Add that you have used 2,000- to 10,000-pound units (these refer to the forklift's lifting capacity, not the weight of the unit itself), as well as units equipped with paper-roll clamps. You might also say that you've handled "your fair share" of four-wheel sit-downs, walk-behinds, and pallet trucks.
- Ask about the number of trailers and the number of pallets you will be expected to handle per day (fewer is better).
- Since most people who operate forklifts are not licensed to do so, don't worry that you do not have a license to show.

BRAIN SURGEON

Brain surgeons train for as long as eight years after medical school, so you should be, or appear to be, at least 34.

ATTIRE

Wear:

- Suit and tie
- or
- Blouse and skirt

DO NOT WEAR:

- White lab coat or scrubs
- Stethoscope around your neck

PARAPHERNALIA TO BRING

- Surgical loupe. Loupes are worn like glasses or over glasses and provide strong magnification during surgery. They are custom-fitted and all brain surgeons have them. Borrow a pair, or carry an empty loupe case. The case should be wooden with a surgeon's name engraved on a metal template. Keep the name on the template obscured. If you cannot borrow an actual loupe or case, substitute a wood case about 10 inches long by 5 inches wide. Do not wear surgical loupes on a chain around your neck, as you would reading glasses or sunglasses.
- Do not carry other surgical instruments.
- Do not carry medical charts.

Surgical Loupe

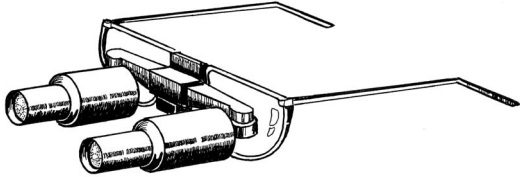

Human Brain

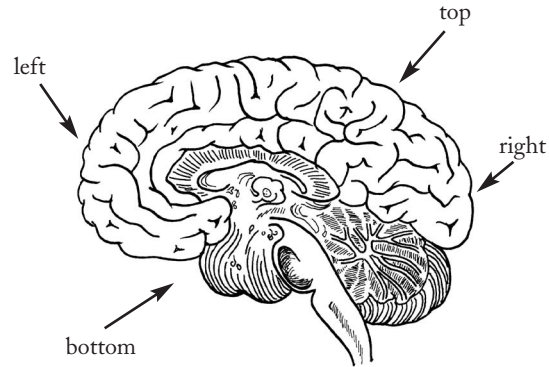

BUZZWORDS TO USE

- Surgical drill (for drilling into bone)
- Deep brain stimulation (abbreviated DBS, targets particular areas of the brain with electrical pulses)
- Spinal instrumentation (implantation of permanent therapeutic devices in the spine)

CRITICAL KNOWLEDGE

- Ask about the hospital's type of operating microscope and its image-guidance system. Also ask about the strength of the magnet in the hospital's MRI (magnetic resonance imager).
- All brain surgery begins with either drilling or sawing through the cranium.

INSIDER TIP

- Interviewers will want to know about papers you have published in well-known medical journals. Mention that you are awaiting publication in *Neurosurgery* (frequently called the "red journal"), the *Journal of Neurosurgery* (known as the "white journal"), and are expecting a book contract.

SHOE SALESPERSON

Shoe sales has become a much less service-oriented business in recent years, so involved and caring salespeople are hard to find. Make sure you appear to be friendly with a ready smile and that you are well dressed.

ATTIRE

Wear:

- Conservative suit and tie
or
- Tasteful blouse and skirt
- Socks
- Clean, shined shoes, without scuffs

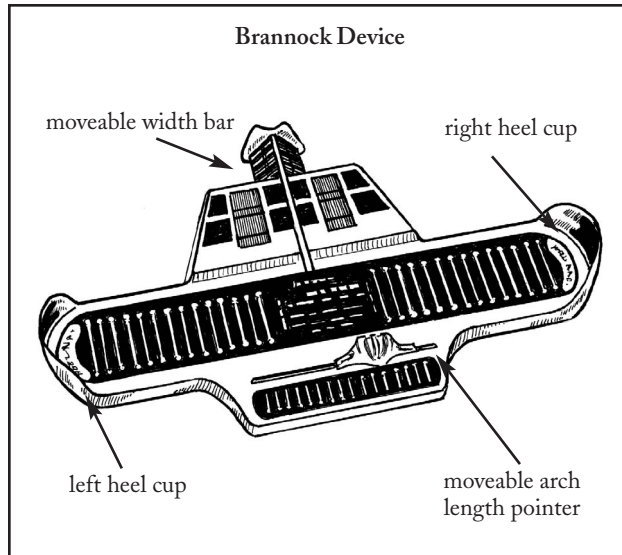

Do Not Wear:

- Sneakers
- Flip-flops
- Heavy cologne or perfume

BUZZWORDS TO USE

- Brannock Device (the metal foot measurer)
- Slippage (either toe or heel)
- Trees (short for “shoe trees”)

CRITICAL KNOWLEDGE

- A good fit should leave $\frac{1}{4}$ -inch of room between the big toe and the tip of the shoe. There should be no slippage.

- Shoes with four or five eyelets will take a 36-inch lace, while athletic shoes will generally take a 40- to 45-inch lace.

INSIDER TIP

- If the patron needs a half-size larger but it is not available, substitute a “wide” style of the lower full size (i.e., a 7 wide for a 7 $\frac{1}{2}$).
- Shoes that will be worn on a daily basis should be fitted at the end of the day, when the feet have expanded.
- “Toe length” refers to the total length of the foot.

HOW TO IDENTIFY A NIGHTMARE WORKPLACE

1 Interview at the beginning or end of the day.

Arrive early for your morning interview and observe the workers as they arrive. Slouching, pouting, and dejected expressions indicate low morale. Note whether workers acknowledge the receptionist with a smile and a greeting or are oblivious to the receptionist. With an interview at the end of the day, observe if large numbers of workers leave promptly at quitting time, which may indicate a bored, clock-watching staff. Large numbers of people working late, however, may indicate that employees are overworked and deadlines are unrealistic.

2 Examine the bathrooms.

Are the bathrooms clean? Is there enough toilet paper? Are paper towels strewn about the floor? Lack of attention to these small details may indicate a lack of respect for the workplace and lack of attention to larger details.

3 Monitor the air quality.

Does the work area have natural light and outside air? Is the environment quiet? Is the air too hot or too cold? Are there any rancid or chemical smells? Is smoke billowing from any vents or machinery? Are

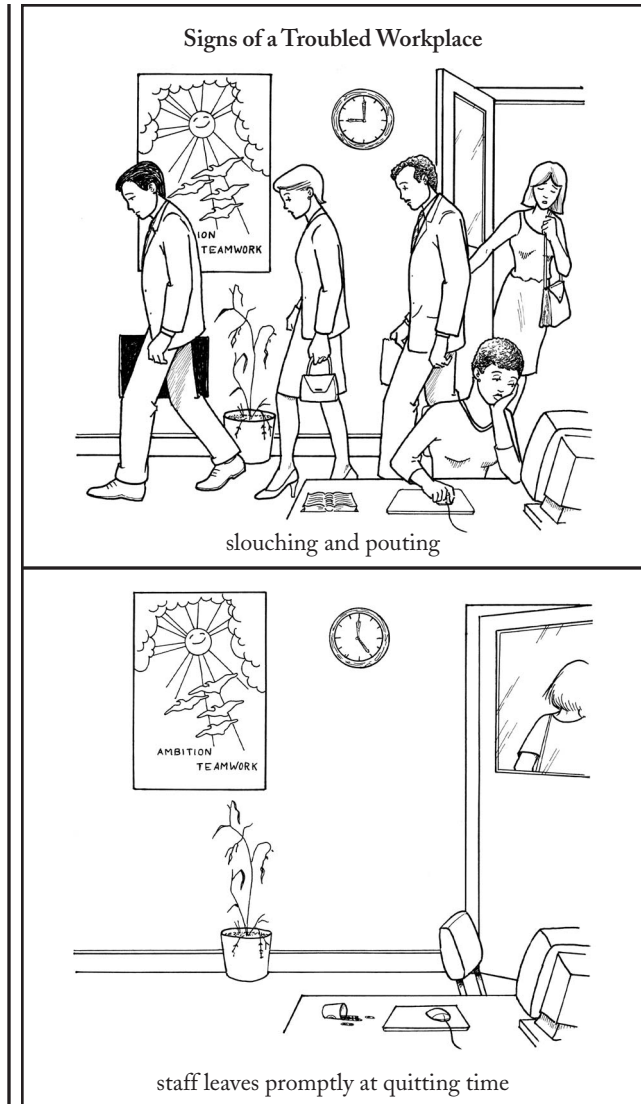

workers sniffing or sneezing frequently? All of these are indicators of poor air quality or a “sick” workplace.

4 Look for signs of a troubled workplace.

- Lack of personal photos on desks—only motivational images of rowers and bears catching salmon
- Droopy eyelids obscuring the whites of the workers’ eyes
- Multiple sandwiches (partially eaten) and cans of soda at workstations
- Employees sleeping, doodling, or fist-fighting at meetings
- Employees with their foreheads on their desks, fists pounding the desktops
- Outdated or no-longer-manufactured candy in the vending machine
- Brown water in the cooler
- Flickering or humming fluorescent lights
- Music playing through speakers in the ceiling
- “Warning: Hazardous Waste” signs
- Groups of workers whispering
- Individual workers whispering to themselves
- Groups of workers silently praying
- Office layout based on slave ship rather than feng shui
- Carpet stains that could be coffee, could be blood

If you observe three or more of the above danger signs, you may have discovered a nightmare workplace.

5 Evaluate.

Is this the job for you?

**WORST-CASE
SCENARIO.**

WORST-CASE SCENARIO.

HOW TO MAKE AN IMPROMPTU TOAST

1 Keep it simple.

A toast made in front of colleagues should be brief and safe.

2 Follow the “Past, Present, Future” (PPF) rule.

Acknowledge past successes, present situations, and future objectives. For example: “We’ve been through a difficult year together, but in the end, we made it a successful one. I can think of no better team to be moving forward with—I love working with all of you. Here’s to a bright and successful future together.”

3 Avoid problems.

Stay away from losses, morale problems, indictments, former employees, or other natural or human-made disasters. If the last year has been truly horrible, refer to it in a neutral, ambiguous way: “It’s been quite a year . . .” or, “As this extraordinary year comes to an end . . .” If the problems are continuing and you don’t want to lie, say something emphatic but meaningless: “What a group of people to work with!” or, “I’ve never worked with a group like this!” or, “The talents and abilities of all of you continue to amaze me!” The future is the easiest portion of the toast, since you can hope and wish without regard to reality. Nonetheless, moderation is best: “The coming year promises to be astonishing!” or, “The sky’s the limit in the year ahead.”



Be brief. No one is really listening.

4 Focus on the people.

Your toast should be about people in general—about spirit, creativity, and bonding—rather than about specific financial results, projects undertaken, or company goals. All of the partygoers are hoping you don't mention them by name, and they really want to get back to eating and drinking.

5 Use humor judiciously.

A little levity may be appreciated, but jokes can slow down your toast and breed restlessness. Depending upon your condition, you may be in no position to gauge what is funny. Attempts at humor could backfire and insult people, open wounds, or just be incomprehensible. If a remark or a joke bombs, keep going. Pausing will only call attention to it and add to the audience's discomfort.

6 Smile, nod, and look proud as you are speaking.

Keep your glass raised and lift it even higher as you conclude the toast. Remember, no one is really listening, anyway.

HOW TO REMOVE A TIE CAUGHT IN THE DOCUMENT FEEDER

1 Determine how quickly you will need to act.

If your breathing is constricted, do not hesitate—cut the tie off quickly (see step 5). You may be able to reduce some of the constriction by getting as close to the feeder as possible.

2 If your breathing is not restricted, try pulling the tie.

Use firm but steady pressure. Do not yank: If the document feeder uses gear-driven rollers, you may strip the gears or tear the tie. If the feeder is particularly powerful, you may be unable to pull the tie out.

3 Turn off the copier.

If you can reach the power switch, turn it off. Alternatively, yank or kick out the power cord.

4 Search the area for a cutting implement.

Copier areas often house scissors, utility knives, paper cutters, and other devices you might use to cut the tie free. Open the copier supply door and look in there. Feel around on nearby tables and inside nearby cabinets for useful items.

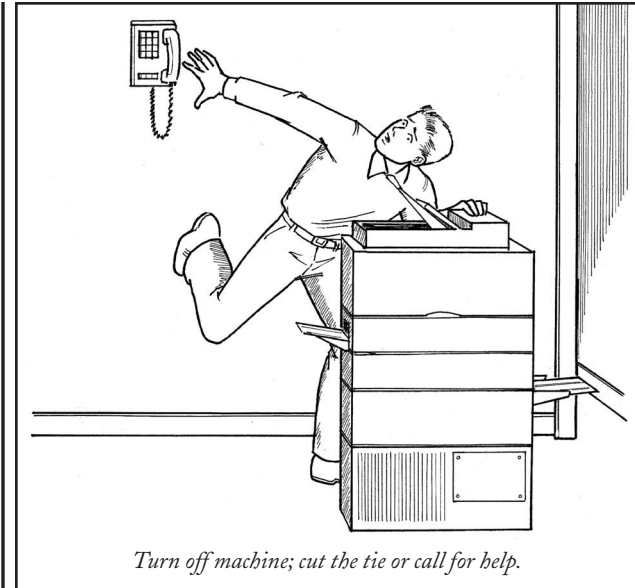

5 Make a single fast cut across the tie at its shortest visible point.

Pull the tie taut with your neck or free hand, and slice through it quickly.

6 Call for help if you cannot fix the situation yourself.

Cry out for help. If a phone is within reach, call the receptionist or a co-worker.

7 If help does not arrive and no cutting implement is available, try to detach the feeder unit.

Often, the feeder unit simply snaps onto the top of the copier. You may be able to lift it off its hinges.

HOW TO RESTORE A SHREDDED DOCUMENT

1 Determine the identifying characteristics of the document.

Use paper color and weight, distinctive type fonts, illustrations, and logos to establish which is the document you are trying to restore. Find an unshredded document or letter from the same sender as a model.

2 Sort the shreds.

Using the identifying characteristics of the stationery, and comparing the angle of the edges of each shred, begin to organize the shred strips. Separate and discard shreds from other documents until all remaining shreds are from the target document.

3 Begin paste-up.

Place the first shred vertically on your paste-up board (a whiteboard works well) using clear, removable tape. Using the same orientation, place a second shred alongside the first. Compare it against one side, then the other. If it is a match, tape it down next to the original shred. If it is not, lightly tape it down an inch away, parallel to the first strip.

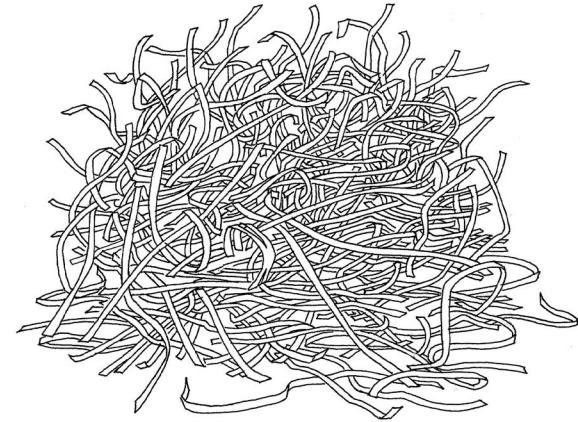

Sort shreds by distinctive color, type, and design. Discard shreds not from target document.

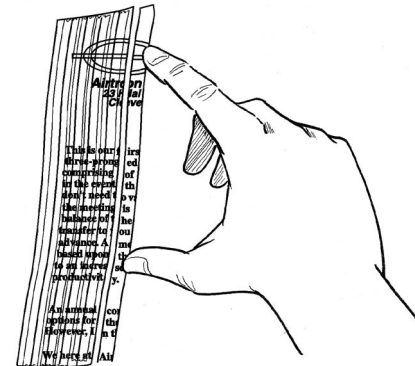

Tape each shred in place to re-assemble document.

4 Repeat.

Continue comparing strips. Keep the “raw” (uncompared) strips separate from the “rejected” (compared but non-matching) strips. If you run out of room, use a second paste-up board. Join matching strips as soon as the match is discovered.

5 Copy the reconstituted document.

When the document is re-assembled, sandwich taped strips between two sheets of clear overhead projector film or clear contact paper and photocopy.

Be Aware

- A three-page document will have 100 to 200 shred strips, and reassembly will take 1 to 2 hours, depending on skill level.
- Cross shredders, which shred documents in both directions, make salvage virtually impossible.

**WORST-CASE
SCENARIO®**

WORST-CASE SCENARIO®

HOW TO RETRIEVE A CANDY BAR STUCK IN THE LUNCHROOM VENDING MACHINE

1 Wait several seconds.

Newer vending machines may be equipped with special technology that senses when an item has not dropped; the machine may return your money or give you another selection.

2 Purchase the item again.

Depending on how severely the snack is stuck and how much money you have, you may be able to jar it loose and get a second one by selecting the same item again.

3 Choose an item from the row above.

If your snack is stuck at an angle toward the glass at the end of the row, an item dropping from above may knock it free.

4 Jostle the machine.

Vending machines are extremely heavy and can cause major injury if they tip over. Carefully bang on the side of the machine. Do not hit glass areas.

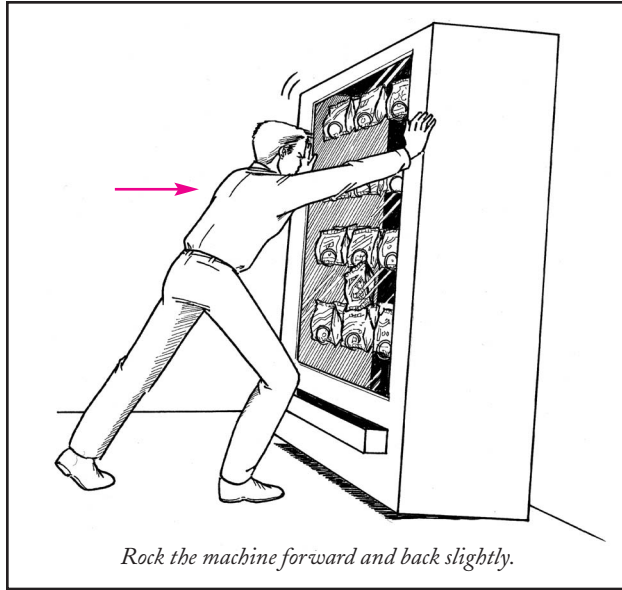

5 **Rock the machine.**

Tip the machine backward very slightly (not side-to-side) and let it drop back in place to jar the item loose. Do not press on the glass.

6 **Push in the vending door and remove the candy.**

Once the item—or items—have dropped, reach in and slowly extricate it.

Be Aware

Anti-theft devices make it virtually impossible to reach in and up past the vending door. Do not risk getting your arm stuck in the machine.

**WORST-CASE
SCENARIO.**

HOW TO SNEAK OUT OF A MEETING

SNEAK OUT IN PLAIN SIGHT

- 1 Establish your presence.**
Lay the groundwork for your departure by first making a brief speech, giving a short presentation, or otherwise making your presence known. In this way people will remember that you were there.
- 2 Call attention to yourself.**
Make a show of going out and then coming back into the meeting several times. Say, "Boy, this coffee really goes right through me!" and then go to the restroom twice. Make sure people notice when you return.
- 3 Make your escape.**
The third time you leave, don't return.

SNEAK OUT USING A DISTRACTION

- 1 Express interest in attending the meeting.**
Before the meeting, say to your boss or a colleague, "I can't wait to see what Phil has to say" or, "Which conference room is the meeting in?" Make it clear that you really want this meeting and, thus, would be the last one to miss it.

- 2 Sit away from the focus of attention.**
Sit on the opposite end of the room from the person running the meeting or from the screen where the presentation will be displayed.
- 3 Sneak out.**
When the lights dim and the presentation begins, quietly get up from your seat. If there are empty chairs around the table, just walk away from your chair. If all the seats are taken, move your chair away from the table against a wall so the vacant chair will not be noticed. Leave the room and don't come back. Have a plausible cover story ready, such as an unexpected visit from a client/customer or a personal emergency regarding your spouse/child/pet.

CRAWL UNDER THE TABLE

- 1 Assess the size and shape of the table.**
The ideal conference table to escape is rectangular and seats at least 12 people, preferably more, with some of the seats left empty. People cluster at the center or at one end of the table if it is not full, usually leaving one or both ends available for an exit route. Do not attempt to sneak away under a round table since you may be surrounded by legs.
- 2 Slide under the table.**
When no one is looking, slide quietly down your chair to the floor. Push your chair against the wall or leave it in its place, depending on how full the table is (see step 3 above). Do not call attention to yourself.



Do not attempt to escape under a round table.



Crawl along the center of the table, avoiding your co-workers' feet.

3

Crawl.

Proceed on your hands and knees under the center of the table. Avoid bumping shins, feet, or loose shoes. If you are discovered, say you are looking for your pen.

4

Monitor conversation.

The end of the table will probably be closest to the door. Wait until someone at a long side of the table is speaking: People will look in that direction.

5

Continue on all fours.

Crawl out from under the table and to the door. Reach up and open the door quietly. Check for people outside.

6

Exit the room.

When the coast is clear, crawl into the hallway.

7

Stand up and walk away.

Be Aware

- If you plan to escape by crawling, wear loose-fitting clothes.
- Most people have limited peripheral vision; when looking straight ahead, they cannot see an object at an angle of more than 45 degrees behind and to the side. Use this as a guide when determining if your escape will be noticed.
- If other escape plans will not work, spill a cup of lukewarm coffee on your pants. This strategy wins sympathy and also offers a perfect excuse for

leaving the meeting. If someone later asks why you never returned, say you got a slight burn. They probably will not seek to verify.

HOW TO STAY AWAKE DURING A MEETING

- ★ **Use correct meeting posture.**
Keep your head up, shoulders back, and spine straight. Keep your legs bent at a 90-degree angle, not fully extended. Feet should be flat on the floor.
- ★ **Be on guard for mind-numbing repetition.**
Repetitive noise patterns and repetitive images can cause a trance-like state that deadens the senses. If phrases like “need better communication” and “building a team” are repeated, or if tables, graphs, and pie charts are projected endlessly, exit the room for a few minutes.
- ★ **Wear sunglasses.**
The harsh glare of fluorescent lights can cause eye strain and lead to fatigue. Wear dark glasses.
- ★ **Exercise.**
Exercise combats fatigue and keeps the mind alert. Take frequent walks around the room or do calisthenics. If possible, jog in place.
- ★ **Stay hydrated.**
Drink water or sports drinks that provide energy and contain potassium, salt, and carbohydrates. Coffee

contains caffeine, a stimulant that also acts as a diuretic, which will cause dehydration, so drink at least one glass of water for every cup of coffee you consume. This will also promote trips to the bathroom, and consequently, movement and stimulation. Do not drink alcohol: It depresses the nervous system and leads to fatigue.

- ★ **Use interrogation techniques.**
Pinch yourself, sit in an uncomfortable position, poke your leg with a pen or paper clip, or stare wide-eyed at a bright light—the pain will heighten your awareness.

Be Aware

Warning signs of meeting fatigue include inattentiveness, back tension, shallow breathing, frequent blinking, heavy eyelids, and snoring.

HOW TO SPOT A SHOPLIFTER

1 Watch for attentive behavior.

Most shoppers are absorbed in the browsing process and oblivious to their surroundings. Shoplifters will look around and be highly attuned to the proximity of others.

2 Observe movements.

Shoplifters often have a rigid posture and a strained expression. They avoid making eye contact and make quick, jerky movements as they conceal pilfered items.

3 Look for bulges.

Shoplifters may keep a folded bag under their shirt or jacket, or may be carrying a near-empty bag from the same store. Once shoplifters begin acquiring merchandise, they may put on several layers of clothing and fill the bags they are carrying.

4 Watch from above.

If the store has multiple, open floors, observe from a higher vantage point. Alternatively, stand behind a rack of clothing and peer between garments. Do not attempt to look under or above the walls of dressing rooms unless such surveillance is acceptable store policy.

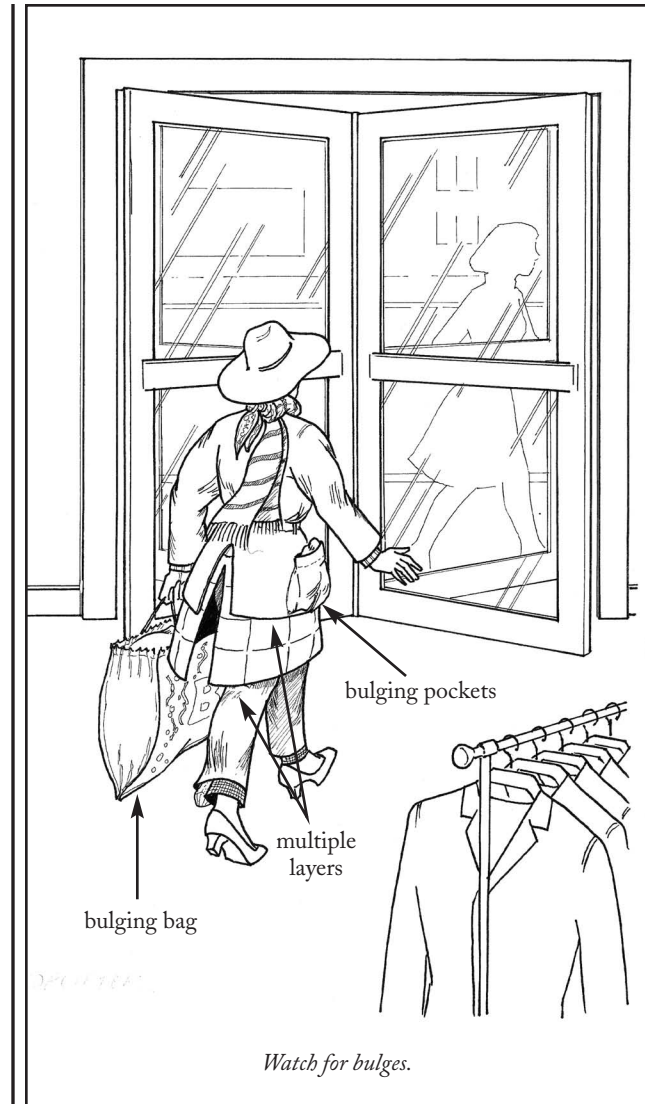

HOW TO THWART A SHOPLIFTER

1 Keep items well organized.

Thieves thrive on disorganization and will take advantage of unshelved stock. Fold clothes well and make sure each pile has the same style and an identical number of items. A quick glance will tell you if something is missing.

2 Employ defensive merchandising.

Do not shelve the newest, trendiest, or most expensive items right by the door where a thief can grab something and run.

3 Make your presence known.

Shoplifters do not want to stand out and be noticed. Regularly walk the floor, make eye contact, and offer to help customers.

4 Monitor changing rooms.

Track the number of items a shopper brings into (and takes out of) the changing room by keeping all rooms empty of merchandise and clean of tags, pins, and labels. Check the room after the shopper exits and make sure all items are accounted for.

**WORST-CASE
SCENARIO.**

WORST-CASE SCENARIO®

HOW TO SURVIVE A NIGHTMARE BUSINESS TRIP

FLYING IN COACH

1 Be prepared.

Take supplies with you to make the flight more pleasant:

- Good food. Coach-class meals have never been stellar, and you're guaranteed a good meal if you bring something good onboard. Plus, you can eat whenever you wish.
- Neck pillow. The inflatable pillow makes sleeping and even sitting much more comfortable.
- Water. Avoid becoming dehydrated by the plane's air conditioning system.
- Lip balm. Avoid uncomfortable and unsightly chapped lips.

2 Get a seat with extra legroom.

The bulkheads and exit rows usually offer the most room to stretch out. A middle seat in an exit row may be more comfortable than an aisle seat in a non-exit row. Make sure, however, that the seatbacks recline—certain exit rows have non-reclining chairs.

3 Request a seat at the rear of the plane, in a row with open seats.

The rear is not only the safest area in the event of a crash, but it will allow you to board immediately after the first-class passengers, giving you the first available access to the overhead storage bins as well as pillows and blankets. Open seats will allow you to stretch out. Choose a window seat. If you sit on the aisle, you risk being disturbed every time someone in your row wants to get up or every time a person passes on the way to the lavatory. With a window seat, you'll be in control of the shade and have a wall to lean against.

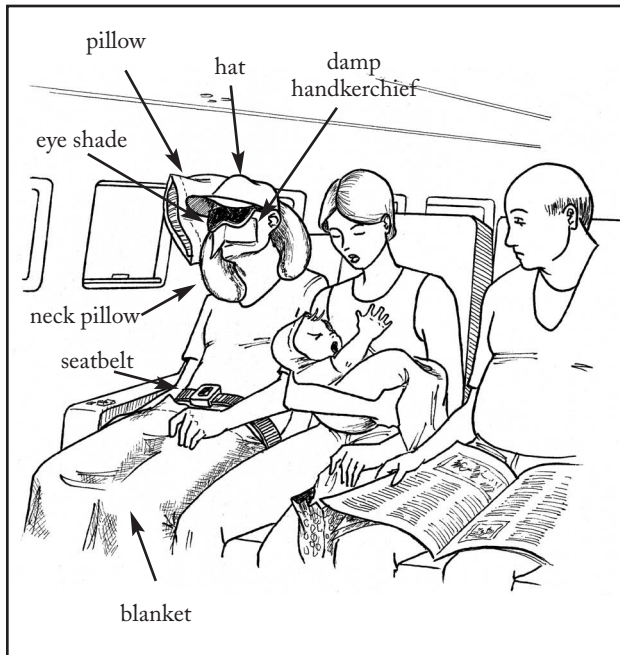

4 Place your carry-on bag in the overhead compartment.

Keep the space under the seat in front of you clear, so you can stretch. If there is no room in the overhead compartment for your bag, place it under another open seat on your row. If you must stash it beneath the seat in front of you, plan to use it as a footrest by pulling it out slightly.

5 Make yourself comfortable.

Remove your shoes, as feet tend to expand slightly during flight. Recline your seat to a comfortable position. Lift the between-seat armrest to give yourself a little extra room if you have an empty seat next to you. Place an inflatable neck pillow around your neck, or use an airline pillow. Lean against the wall of the plane.

6 When the seatbelt sign is turned off, move about the cabin.

Walk and stretch in the galley area to keep your legs from stiffening and to prevent blood clots from forming.

7 When sleeping, insert cotton in your ears and place a moist handkerchief over your nose.

Low-level engine noise can disrupt sleep patterns. For better rest, filter out noise using sterile cotton instead of ear plugs, so the inner ear can adjust to cabin pressure changes. If sterile cotton is not available, use noise-canceling headphones connected to a tape or

CD player. A damp handkerchief over your nose will prevent your nasal passages from drying out. Block out as much of the light as possible. Close the window shade. Don an eye mask, or use an article of clothing (sweater, jacket, hat) as a blindfold.

8 Use deep-breathing techniques to relax.

Breathe in deeply through your nose, then out through your mouth. Focus only on the breaths you are taking—say to yourself, “Sleeeeeeeep. Sleeeeeeeep. Sleeeeeeeep,” as you inhale and exhale. Do not think about work, about your big meeting tomorrow, about how much you would rather be at home—think only about sleep.

Be Aware

Keep your seatbelt visible at all times. If your seatbelt is not in plain sight, you risk being awakened by the flight crew for a belt check.

LOST LUGGAGE

1 File a report at the airport.

As soon as you realize your bags are missing, go immediately to the lost-luggage counter and file a report. Get a copy of the report, and write down the name of the person who helps you and the report number.

2 Obtain the direct phone number for the baggage counter.

Airport personnel may give you a toll-free number to call to check on the status of your bags. Take the number, but ask for the number of the lost-baggage counter at the airport itself.

3 Request compensation.

Some airlines will issue a check on the spot to cover the immediate cost of your buying clothing or essentials. Or the airline may give you a toiletries bag to cover your grooming needs until your bag is retained.

4 Call the airport baggage counter regularly.

Do not assume the airline will call you.

5 Be prepared for a two-day delay.

Do not assume that your bag will be put on the next departing flight to your destination: Airlines place recovered luggage only on their own planes, not on those of other carriers. If the next flight is not until late the following evening, you may not see your bag for two days.

6 Purchase necessary items before you leave the airport.

If you arrive at your destination on a holiday or late at night, you may not be able to shop for essentials in town.

Be Aware

- If luggage is lost rather than just delayed, an airline's liability in the United States is limited to \$1,250 per passenger, no matter how many bags have been lost. On international flights, the liability limit is about \$9 per pound of checked baggage. Reimbursement may take months.
- To make your bag easier to spot, place a colored ribbon on the handle or a distinctive strap around the bag before checking it.
- Watch the bags as they come down the conveyer belt to the carousel, even if you do not have immediate access to it. You will be able to see if anyone else takes your bag.
- Write your name and the phone number of the place you will be staying for the first two days of your trip on two business cards. Place one inside your luggage and one in a card holder on the outside of your bag. (Never place your home address and phone in a visible identification tag. You do not want to advertise that you are away from home.)
- Dress for the worst—wear clothing on the plane that you can live in (and with) for two days. Anticipate that you might be giving your presentation or attending the meeting in what you are wearing on the plane.
- Carry essential medical and hygiene items, as well as any irreplaceable presentation materials, in your carry-on luggage.

CHEAP HOTEL

- 1 Request a room with a quiet location.**
Avoid rooms near elevators, vending machines, the ice maker, the parking lot, or a noisy bar. Ask for a room at the end of the hall so there is less foot traffic outside the door.
- 2 Check the mechanicals and plumbing.**
Before unpacking, check air conditioning, heat, television, lights, and water pressure. If any are not working properly or are otherwise unacceptable, request a new room.
- 3 Remove the bedspread.**
Cheap hotels do not regularly clean bedspreads. Use towels for warmth. Call the front desk to request extra towels if there aren't enough in the room.
- 4 Clip the curtains closed.**
If the curtains do not fully close, secure the two sides together using whatever you have on hand—paper or binder clips, tape, or pins and needles from a sewing kit.
- 5 Check the mattress firmness.**
If the bed is too soft, place the mattress on the floor.
- 6 Check the clock.**
Make sure the alarm is not set to go off in the middle of the night. Avoid the wake-up service—it is

notoriously unreliable in cheap hotels. Set the alarm clock, or carry a travel clock with an alarm.

7 **Avoid the morning shower rush.**

Cheap hotels may run out of hot water anytime between 7 and 9 A.M. Shower earlier or later.

Be Aware

- Travel with lightbulbs bright enough to use for reading.
- Travel with two small rubber doorstops. For security, wedge one firmly under the door to your room and the other under the door that adjoins the next room.
- Travel with snacks, including protein bars and instant hot cereal. Cheap hotels may have no restaurant, no in-room coffee, and no vending machines. Even if there is a restaurant, the food might be terrible.

DULL TOWN

★ Ask the locals for recommendations.

Ask the hotel clerk (or better yet, a porter) for a restaurant where you can “sample the local flavor.” Most towns have at least one dish, restaurant, or tourist attraction that residents consider special.

★ Adopt an alias.

Pretend to be someone else when you go out. Be a secret service agent, an astronaut, a mime—whatever

your fantasy is. Pretend you have an accent. Cross-dressing is not recommended for all towns, however.

★ Do the opposite of everything you normally do.

If you usually go to bed early, stay out late. If you usually drink beer, drink coffee. Talk to the people you would normally ignore or avoid.

★ Play cards.

If none of the above works, obtain a deck of cards. Solitaire is a great time killer. Build a house of cards, or try to toss as many as you can across the room and into the wastebasket.

HOW TO SURVIVE A WORKPLACE ROMANCE

- ★ **Do not tell colleagues.**
Do not discuss any aspect of your relationship with anyone at work, even close friends. Avoid telltale references, such as, “When we were at the movies last night . . .” Do not play guessing games with co-workers, such as, “I’m going out with someone from the office but you’ll never guess who.”
- ★ **Resist physical contact at the office.**
Avoid all physical contact, including kissing, hand-holding, hugging, casual touching, and back rubs, even if you think you are alone. Maintain at least a foot of personal space between you and the person you are dating.
- ★ **Send gifts to the home.**
Do not have flowers, candy, clothing, or other personal items sent to the office, even with an unsigned card: People will begin asking questions.
- ★ **Do not use company e-mail to send personal notes.**
Many employers monitor e-mail messages, and even deleted messages are stored. It is also too easy to send an e-mail to the wrong person or to “everyone.”

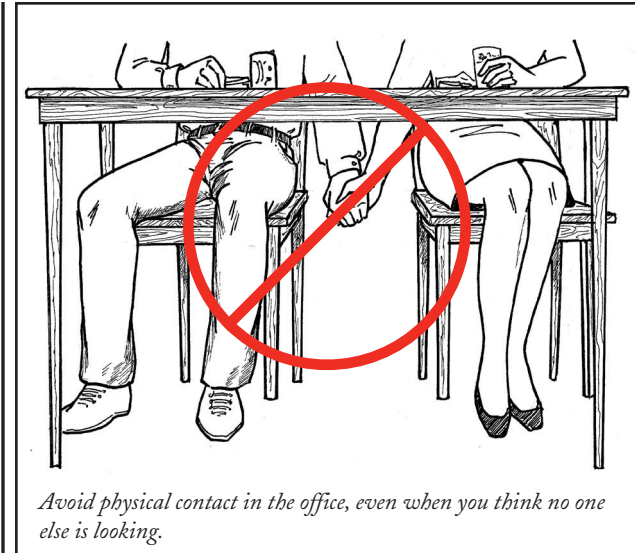

- ★ **Avoid long or excessive lunch dates.**
While it is acceptable for colleagues to eat together, extended or repeated outings may attract notice. Maintain the lunch routine you practiced before you started dating your co-worker.
- ★ **Avoid arriving and departing together.**
Unless you are in a car pool with others, stagger your arrival and departure times.
- ★ **Use discretion.**
At company picnics or parties, or at off-site meetings, do not drink excessively, dance intimately, or openly display affection with your office significant other.

Be Aware

- Most office romances begin in the spring.
- Dating more than one person from the same company at the same time is not a good idea.

THE BREAK-UP

★ Do not break up at work.

Emotions can be difficult to hide, and people can act irrationally when they are upset. The workplace, especially in a cubicle but even in a private office, is a poor choice of location for a confrontation. Avoid breaking up over lunchhour, as well.

★ Break up over a long weekend.

Choose a time when your partner will have several days to heal before having to see you at the office. Try to be sensitive to his or her feelings, however: Do not break up just before the other person leaves on an extended vacation.

★ Be prepared for the worst.

A bad break-up may require you to transfer or even resign, particularly if you are dating someone above you in the office hierarchy. Ending a relationship with someone who reports to you could lead to a charge of sexual discrimination.

★ Do not immediately begin dating someone else at work.

Your new relationship may be hurtful to your ex, if you are spotted. You may also gain a reputation for being opportunistic or desperate.

★ Do not discuss personal feelings or emotions with your ex while at work.

If you want to check on how your former lover is doing, call at home.

Be Aware

No matter what you call it—fishing off the company pier, mentoring the intern, kissing company cousins, refilling the toner, mergers and acquisitions—office romances are dangerous.

WORST-CASE SCENARIO.

HOW TO SURVIVE IF TRAPPED IN ...

If kicking or banging on the door to the **bathroom, supply closet, walk-in-freezer, or lion cage** does not summon help immediately, save your energy for other means of egress.

A BATHROOM

BREAK THROUGH THE WALL

- 1 **Tap on the wall until you hear a hollow sound.**

Wall studs are 16 inches apart. The hollow sound indicates the space between the studs.

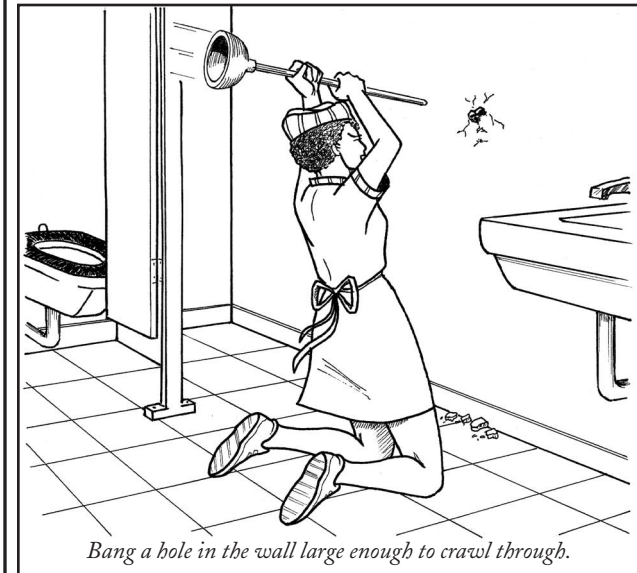

2 Bang a hole in the wall.

Use a wooden plunger handle or other strong bathroom implement to poke at the wall. Avoid tiled areas. Continue jabbing and breaking the wall until you have opened a wide hole.

3 Crawl through.

Squeeze your body between the studs.

CLIMB OUT THROUGH THE CEILING

1 Push out the ceiling tiles.

Stand on the sink or other sturdy fixture. Push several drop-tile squares up and over to the side.

2 Look for pipes or other handholds.

3 Select a horizontal pipe that leads out of the bathroom.

4 Pull yourself up and onto the pipe.

Grab a pipe at least 6 inches in diameter. Pull up as you would for a chin-up, then swing your legs onto the pipe. Do not put your weight on the ceiling tiles or you risk falling through.

5 Crawl.

Shimmy along the pipe until you are no longer above the bathroom.

6 Kick out a ceiling tile and drop down into the hallway.

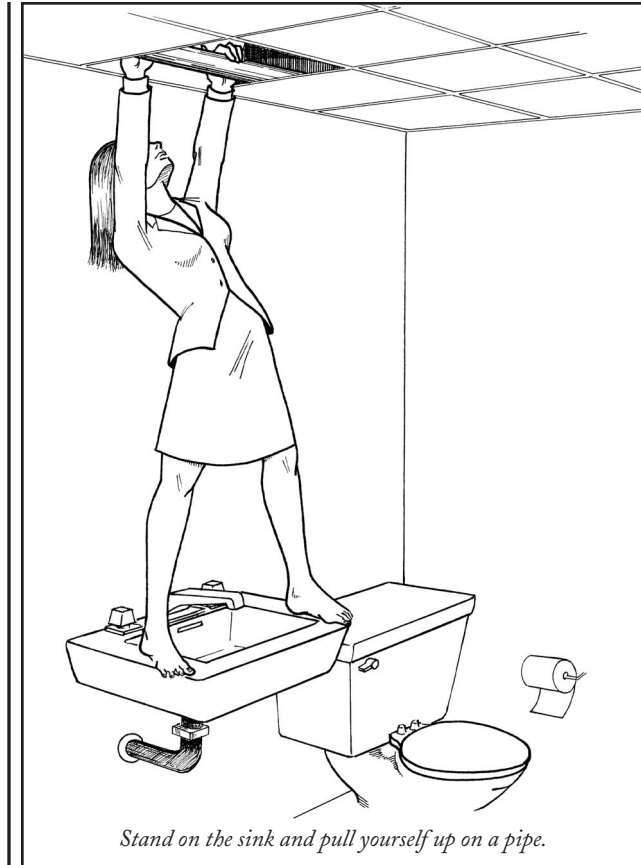

Be Aware

With ready access to water from the sink, you should be able to survive for days, if not weeks, in the bathroom, even without food.

A SUPPLY CLOSET

1 Find a screwdriver.

If no screwdriver is available, look for a letter opener, bottle opener, tape dispenser, cocktail shaker, three-hole punch, or other metal implement with a flat end. A metal pen or strong plastic pen can also work.

2 Examine the door hinges.

Most doors open in and have the hinges on the inside. Locate the lower hinge.

3 Place the tip of the screwdriver under the top edge of the hinge pin.



4 Push or bang on the top of the handle of the screwdriver.

Pound with a hammer, shoe heel, table or chair leg, or other hard, unbreakable object.

5 Remove the pin from the hinge.

6 Remove the upper hinge.

Repeat steps 3 through 5.

7 Lift the door away from the door frame.

Pull on the hinge side first. You may be able to pull the door completely away from the frame.

8 Exit.

A WALK-IN FREEZER

1 Stay calm.

Panic wastes energy, which is warmth. The room's insulation and motor noise will likely prevent anyone from hearing your cries for help. Find a metal implement (keys or coins will work) and tap several times on the door to get someone's attention.

2 Check the door and lock area.

By law, all walk-in freezers and refrigerators must have an emergency release switch on the interior. Look on the door for a fluorescent knob that turns, or a lever that moves up and down.

3 **Locate a power switch.**

Most units have a temperature control module on the inside, but it is likely to be well protected and may require tools to access. Some models may have an accessible on/off switch. If you can access the switch, turn off the cooling element.

4 **Locate boxes.**

Tear cardboard boxes apart and spread the cardboard on the floor. The freezer's floor will be concrete or metal, and coming in contact with it will reduce your body temperature quickly.

5 **Look for insulating materials.**

Many food items are packed in paper, plastic, foam peanuts, or straw. Lie down on the cardboard and cover yourself with insulating items to preserve body heat. Take care to cover your head completely: In cold conditions, an enormous amount of heat is lost through the head.

6 **Breathe slowly and stay put.**

Take slow breaths and do not move around in the freezer or overexert yourself.

7 **Stay hydrated.**

Suck on ice cubes or on frost from food parcels. Do not use body heat to melt frozen items or you risk hypothermia.

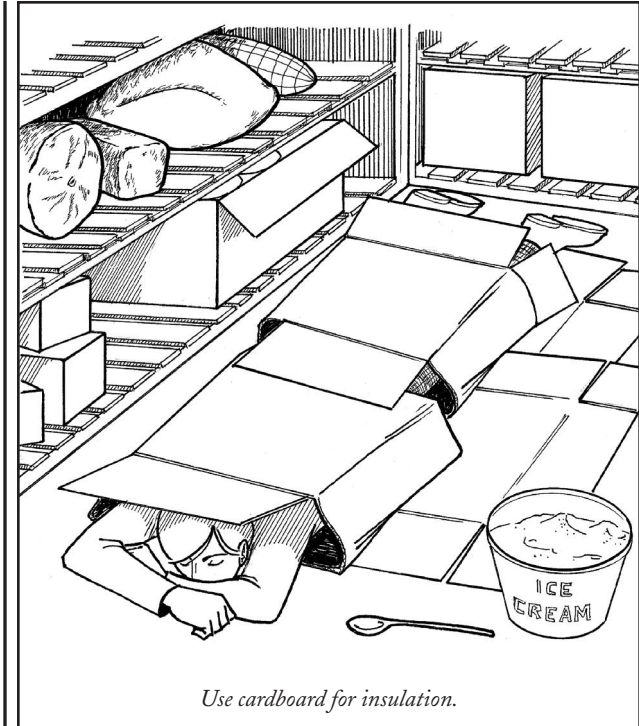

8 **Eat only if ice is available.**

Digestion requires water, so do not eat unless there is a sufficient supply of ice for you to melt. Eat ice cream or other foods intended to be eaten frozen. Avoid meats; these are likely to be frozen solid anyway.

9 **Tap on the door every 15 minutes until help arrives.**

Be Aware

- Do not attempt to disable the refrigeration mechanism. This may cause the unit to malfunction and leak noxious chemicals.
- Remain close to the ground. Although in most environments heat rises, the freezer will have a uniform temperature throughout, and the refrigeration mechanism is likely to be closer to the ceiling than at floor level.
- It is often customary to don a fur or other warm coat before entering a commercial freezer for any length of time. If you are wearing a coat, use it, but avoid over-exertion as you move around: Sweating causes the body to cool rapidly. If you feel yourself begin to sweat, open the coat slightly.
- Do not build a fire in an enclosed space.

A LION CAGE

IF THE LION IS NOT IMMEDIATELY VISIBLE

1 Quickly survey the cage.

Check to see if the lion is present. Most zoos have a large outdoor area for the lions to roam, and the lion may have wandered outside. The cage will be connected to this area through a small passage with a door that allows the cage to be sealed and cleaned while the lion is outside.

2 Shut the door.

If a door is present and the lion is not, shut the door. If the lion is present, do not shut the door.

3 Yell for help.

IF THE LION IS VISIBLE

1 Do not run.

Even if the cage is large, or you feel you can safely make it to the passageway and through the door to the outdoor area, do not turn and run. This will only get the lion's attention, and there may be more lions outside.

2 Stay still and calm.

Do not provoke the lion by moving around, running, or charging.

3 Check for cubs.

A lioness guarding cubs will defend them fiercely, and may be more inclined to attack. If you see cubs, freeze.

4 Check for food.

Lions are extremely protective of food, and even a lion with a full belly will protect his "kill." If the lion appears to be feeding or you notice fresh meat, do not approach the lion or its food.

5 Observe the lion's eyes and tail.

A lion in a zoo will be desensitized to the presence of humans and may not attack immediately. Lions have different temperaments, however, and can range from

passive to highly aggressive. Even a passive lion is likely to eventually attack a stranger in its cage. If the lion meets your gaze and its tail begins to twitch, the lion is getting ready to attack.

6 Listen for a growl.

A low staccato growl, combined with eye contact and a lashing tail, usually indicates that an attack is likely.

7 Find a defensive tool.

Moving very slowly, pick up anything within reach: a water bowl, bench, or anything else that may be used to fend off a charge.

8 Back away slowly.

Moving carefully, back toward the door of the cage. Using a quiet but firm voice, tell someone to open the cage or, if impossible, to get the lion keeper immediately.

9 Watch for mock charges.

A lion may make several “mock” charges before actually attacking. It will run forward suddenly, then stop. It may back away before charging again. Mock-charging is an indication that a real attack is imminent. Stand your ground and be ready.

10 Yell.

Yell as loud as you can. Lions are sensitive to loud noises and yelling may discourage one from further charges.

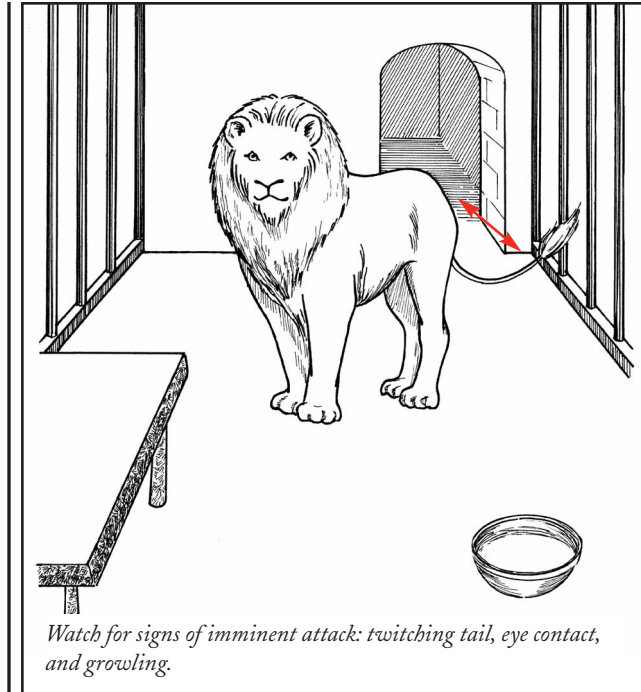

Fend off attack.

If the lion attacks, use a bench, bowl, or any other object to push its paws and head away from you.

Yell for help.

Keep screaming as loudly as possible.

HOW TO SURVIVE IF YOU ARE CAUGHT SLACKING

SURFING THE WEB



Blame your search engine.

Explain that your search engine mistakenly has provided you with an address to an inappropriate site. Alternatively, claim you made a typing error in the Web address.



Blame your browser.

Say that someone has set a new “home page” on your Internet browser. Sounding annoyed, loudly ask, “Who keeps setting my browser to open on this sports page? I’m trying to get those new numbers for my report!” You can also claim that you’re having trouble loading certain work-related websites and so you are visiting more popular sites to see if the computer is working properly.



Blame the website.

Claim that the window with inappropriate material opened unexpectedly while you were viewing something else. Lament that such “pop-ups” are very common and should be regulated.



Blame an e-mail correspondent.

Claim that someone sent you the hyperlink, and you clicked it without knowing what it was.

Be Aware

- When surfing the Web, always keep the corporate intranet site up in a separate browser window. Be ready to click over quickly.
- Position your monitor at an angle that prevents anyone standing at the entrance to your office or cube from viewing the screen.

ASLEEP AT YOUR DESK



Blame work.

Say, “I’m so exhausted; I was here until midnight last night!” Do not attempt this if your boss works late and you do not.



Blame medication.

Claim that your new allergy medicine has been making you drowsy. Say, “Those antihistamines just knock me out!”



Blame lunch.

Say, “Wow, I guess I should not have eaten that turkey sandwich. Triptophan really makes me sleepy!”

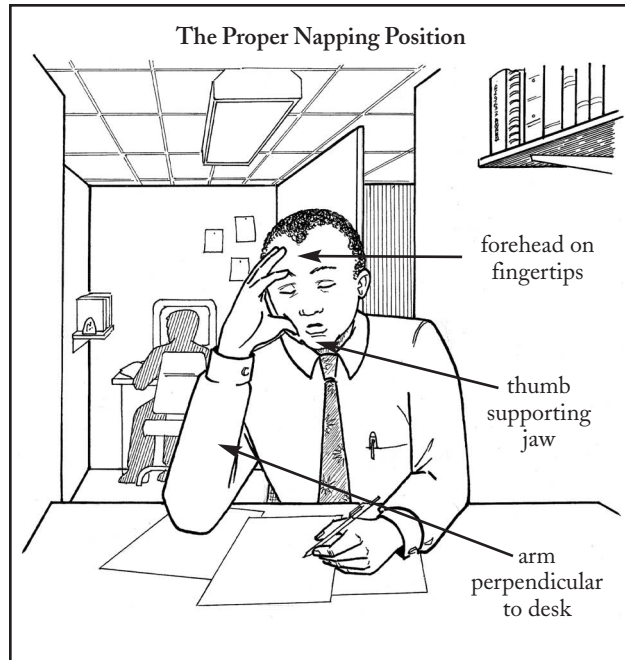

Be Aware

When taking a nap, always rest your elbow on your desk and keep your arm perpendicular to the desktop. Your forehead should rest on your four fingers—your thumb, spread apart from the fingers, should support your jaw. This position will keep your head up and aimed at your desk. Face in a direction so that it is not immediately visible to someone approaching your desk that your eyes are closed. Keep an important group of documents in your perceived line of sight so as to appear to be reading intently.

**WORST-CASE
SCENARIO.**

HOW TO SURVIVE IN A TINY WORKSPACE

CUBICLE

1 Select a good location.

Opt for a cube away from main hallways, bathrooms, supply rooms, and other high-traffic areas, if you have the choice. Avoid cubes within the boss's line of sight.

2 Use comfort devices.

Requisition a more comfortable chair, or select one from an empty cubicle or office (some styles of chairs may be assigned to employees above a certain level, so be careful about what you borrow). Alternatively, obtain a doctor's note stating that you require a comfortable chair for medical reasons—your employer will be obligated to provide you with one. A back pillow and footrest will also make cube life more comfortable and relaxed. Do not attempt to fit in recliners, love seats, or hammocks.

3 Install convenience items.

A wireless telephone headset will give you increased freedom of movement. Noise-canceling stereo headphones (with an extra-long cord) will eliminate outside distractions. A small fan is effective in filtering out annoying noises such as typing and phone conversations. (The fan will also make it more difficult for co-workers to eavesdrop on your conver-

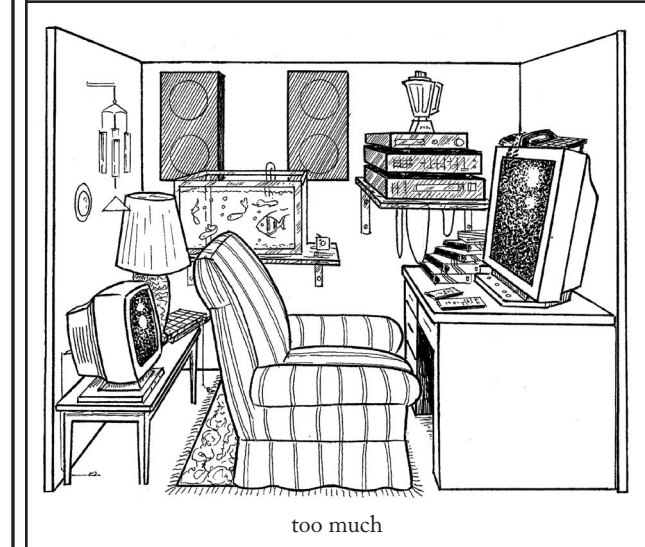
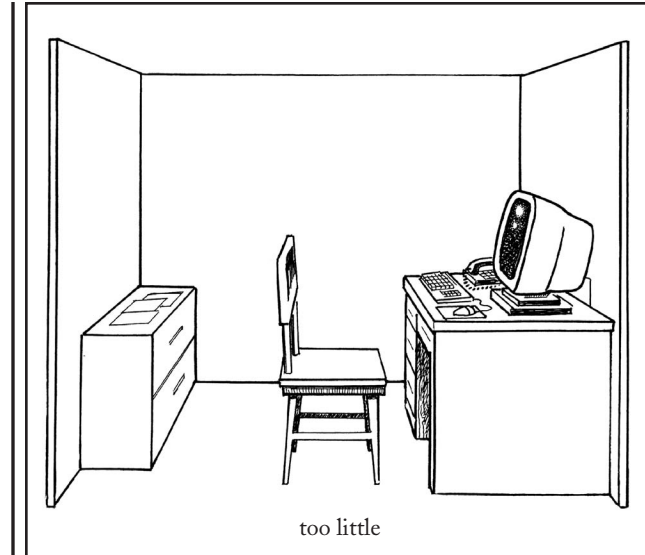

sations.) Small refrigerators, hair dryers, televisions, VCRs, and blenders should not be easily visible.

4 Personalize your space.

Decorate your cubicle with your family photographs and drawings, as well as other pictures and cartoons you like, giving your cube a homey touch. Avoid hanging too many items or you risk a cubicle that looks like a dorm room or refrigerator door.

5 Build upward.

There is usually no limit to the amount of vertical space you can occupy. Stack in/out trays high atop elevated surfaces for additional room. Staplers, tape dispensers, card files, and other items that traditionally occupy valuable space on top of a desk can be suspended from the ceiling to create a more spacious environment below.

6 Use mirrors.

Hang a large mirror on the cubicle wall to create the illusion of spaciousness.

Be Aware

- Health and safety codes dictate that cubes may not have roofs. Do not attempt to construct a fully-enclosed cubicle for privacy.
- Adding a small, stick-on, wide-angle mirror to the edge of your monitor allows you to see if someone is peering into your cubicle from behind.

- Notify your supervisor that you would like to sit in a “double-wide” cubicle if one becomes available. Standard cubes are 8 by 8 feet and 4 to 6 feet high—double-wides offer twice the floor space of standard units, plus an L- or U-shaped desk. The double-wide cubicle does carry some risk: If office space gets tight, you may find yourself with a cube-mate, a particularly undesirable situation.

HOW TO SURVIVE LIGHT DEPRIVATION DISORDER (LDD)

Working indoors during all of the daylight hours throws off your biological clock. If you work in a building without windows, or if you have a cubicle in the middle of the floor, you are susceptible to LDD.



Increase your exposure to sunlight.

Eat outside at lunchtime. Take your coffee breaks outside. Arrange for meetings outside of the office. Go on regular “market research” field trips. Work in conference rooms with windows.



Use artificial light.

Fill your cubicle with additional desk lamps and warm lights (not fluorescents). Install lightboxes that are designed specifically for treating LDD.



Place any lights in front of you.

Arrange lamps or lightboxes so that the light hits the back of your eye. Your goal is to increase the number of photons hitting your retina.

Be Aware

- Symptoms of LDD include insomnia or regular napping, carbohydrate cravings, depression, frustration at normal workday tasks, family problems, loss of libido, emotional disconnect, lethargy, joint pains, stomach problems, lowered resistance to infection, behavioral problems, attitude problems, and alcohol abuse. The disorder is often difficult to detect.
- Even if your workplace has a lot of windows, you are at risk. A corner office with a window is still highly unlikely to get the 2,500 Lux (the level of light the sun emits during daytime hours) your body needs. A well-lit office usually proffers only a few hundred Lux.
- If you work the night shift, avoid light during the day when you are trying to sleep. Blackout curtains and dawn simulation alarm clocks can help you achieve proper conditions.

TRUCK CAB

- 1 Use a quality seat.**
Choose a model (either when ordering the truck or after-market) with heat, massage, and multiple adjustment options. If these are not available, use a portable massager to maintain circulation and a heating blanket for comfort.
- 2 Install a sunroof.**
Natural light from above will make the cab seem more open.

- 3 Listen to satellite radio and books on CD.**
Satellite radio technology offers hundreds of stations, mostly commercial free, that will remain tuned in as you drive. Books will keep you alert and reduce fatigue.
- 4 Use a hands-free cellular phone with a speaker.**
Choose a service with good national coverage and avoid using an ear piece, which can be uncomfortable on long trips.
- 5 Use a CB or ham radio.**
Radios will keep you in contact with other drivers, alert you to traffic tie-ups or accidents, inform you of the location of police, or offer an outlet for conversation.
- 6 Install a power inverter with two 110-volt receptacles.**
These outlets will allow you to easily add items like portable computers, personal digital assistants, and coffee pots. Electronics may also be used for locating freight, sending e-mail, and getting directions.
- 7 Keep photos nearby.**
Pictures will give the cab a more personal feel. If you have children, consider putting some of their drawings on the dashboard.
- 8 Bring a pet.**
Dogs tend to be more amenable to long hauls than cats or fish.

Be Aware

For overnight hauls you can purchase a sleeper cab, which can be personalized to include all the necessities of home, including a toilet, a kitchenette, a television, VCR, DVD player, and cabinets for plenty of storage.

TOLLBOOTH

1 Adjust the seat.

The assigned seat may be hard and uncomfortable. Bring a cushion or a small, folding stadium chair with back support to place on the seat. A massager or vibrating seat pad will also combat discomfort.

2 Adjust interior elements.

Place the chair in an acceptable spot. If the booth has an adjustable table lamp, move it so the light is not in your eyes. Most tollbooths have a computer monitor or an adjustable touch screen on a swivel arm. Position the screen so you can view it comfortably.

3 Install comfort items.

Space heaters provide warmth during cold winter months; fans cool during the hot summer months. A small radio or television will keep your brain active, reducing fatigue. Most highway authorities do not allow “boom boxes.”

4 Bring books or games.

Books and crossword puzzles keep your mind occupied in the booth during light traffic periods.

5 Play car-spotting games to help pass the time.

Pick two specific types of cars, and guess which one will pass your booth first. Count the number of cars of a certain color that you see in one day—then try to break your record.

6 Use the intercom.

The booth should have an intercom for communicating with other booths. Chat every now and then, but be aware that supervisors always monitor the channel.

7 Take breaks.

Take advantage of all your rest breaks—at least two 15-minute breaks plus a half hour for lunch. A brisk walk or calisthenics will increase blood flow and make you more alert on the job. Reading—but not watching television—can also be an invigorating break.

8 Drink fluids.

Staying hydrated will keep you sharp and reduce lethargy. Avoid coffee, which dehydrates.

Be Aware

Toll plazas at lightly traveled exits are generally preferable to busy interchanges. Try to arrange for work assignments at less-populated areas and avoid the first or last entrance/exit of turnpikes. Time seems to pass more quickly the busier you are, however.

HOW TO SURVIVE THE INTERVIEW

IF YOU ARE LATE

1 Call ahead.

If you are stuck in traffic or otherwise running late, call as soon as you know you will be substantially late. Ask to reschedule, either later in the day or on another day.

2 Clean yourself up.

Use a bathroom before meeting your interviewer if you are sweaty and disheveled when you arrive. Wash your face with cold water and blot it dry with paper towels. Gargle. Check your teeth for pieces of food.

3 Apologize.

Tell the interviewer you are sorry for your tardiness, but do not overdo the apology. Do not fabricate an explanation that can easily be verified. The following are acceptable excuses, if true.

- The traffic was terrible.
- There was an accident on the bridge.
- My car caught on fire.
- I was stuck in the elevator.
- I had to take my mother/daughter/pet to the emergency room.

DO NOT SAY:

- My alarm clock is broken.
- I lost track of the time.
- I couldn't find my belt.
- I was out so late last night . . .

IF YOU ARE ASKED A DIFFICULT OR LEADING QUESTION

★ Always respond with a positive.

If the interviewer says, “I see you don’t have experience,” counter with, “That’s true, but I’ve always wanted to learn and I’m a quick study!”

★ Use personal experiences to demonstrate strengths in areas that are professionally weak.

If the interviewer asks about project management experience and you don’t have any, talk about planning your wedding or organizing a large family function (hiring vendors, designing a database, and creating seating charts based on the interests of guests).

★ Answer confidently.

It isn’t always what you say, but how you say it. Often, questions are designed to assess your professional attitude and maturity level more than your knowledge base. Be sincere in your responses, and act professionally—even if you don’t have a good answer. Be straightforward, even when your answer is “I don’t know.”

★ **Memorize the following good answers to these standard hard-to-address questions:**

Q: Where do you see yourself in five years?

A: At a good job in this industry, at a good company, learning and contributing to the company's growth.

Q: Why should I hire you?

A: I've got the right experience, I understand your needs, and I'm a good team player—both in the office and on the softball field.

Q: Why did you quit your last job?

A: I simply wasn't able to contribute to the company's future in the way I wanted. I'm looking for more opportunities for myself, and for a company that can fully utilize my abilities.

★ **Prepare a last-resort response.**

If you are asked the one question you dreaded, take a page from the politicians' playbook: Acknowledge the question, then move on. Say, "I'm very glad you asked that, and I'd like to give it some thought. But I'd really like to discuss . . ."

Be Aware

- Always remember the three C's: Cool, Calm, and Confident. An interview is as much about you wanting the job as it is about the job wanting you.
- Always remember the three A's: Ask a lot of questions, Appear clean-cut and well-dressed, and Act to impress.
- Avoid scheduling interviews just after lunch, when most people get sleepy and irritable.

HOW TO KNOW IF YOU ARE TANKING

1 Watch the interviewer's eyes.

An interviewer that is simply going through the motions will not make eye contact. Check for a glazed or glassy stare and heavy or droopy eyelids.

2 Listen carefully.

A bored or disinterested interviewer may quietly hum a tune, whistle softly, or shuffle papers repeatedly.

3 Observe the interviewer's actions.

An interviewer who is constantly checking the time, eating a sandwich, or takes lots of phone calls probably won't offer you the job.

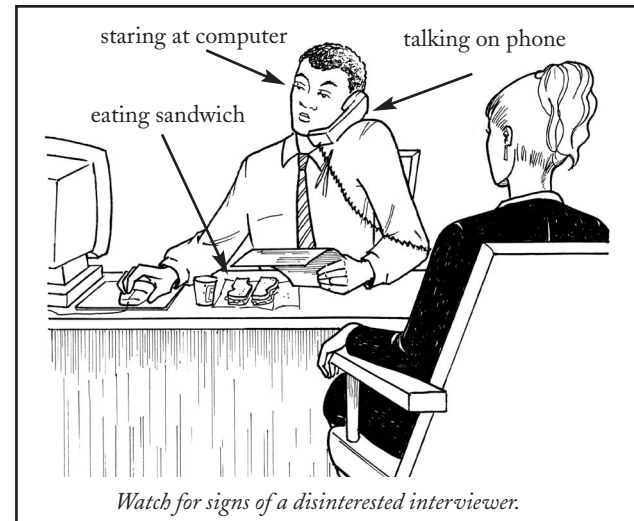

Watch for signs of a disinterested interviewer.

4 Pay attention to the amount of time your interviewer speaks versus the amount of time you speak.

If your interviewer speaks more than you do, you may not be coming across very strongly. (On the other hand, some less-experienced interviewers love to hear themselves talk, and may come away with the impression that the interview was very interesting.)

5 Attempt to rescue the situation.

Your goal at this point should simply be to make it through this interview to the next phase of interviewing, where you can hopefully make a stronger impression. Pick one or more of the following statements designed to get you back in front of the interviewer for a second shot:

- “I’m so certain I’m the right person for this job, I’d be willing to bet my first month’s paycheck I’ll be your top candidate after round two.”
- “The insider knowledge I gained at [*insert name of major competitor here*] definitely gives me an edge over any other prospective hire. I look forward to talking again soon.”
- “The work I did for the CIA/FBI/NSA makes me the perfect choice for this position. I’d love to tell you more about it at a second interview, provided that you have the necessary clearance.”

Be Aware

No matter how well the rest of the interview seems to go, you may not be offered the job if any of the following mishaps occur:

- You ask if a photo on your interviewer’s desk is his daughter, and it turns out to be his wife.
- You ask to go to the bathroom three times or more, or one trip lasts more than 15 minutes.
- You don’t take off your headset during the interview.
- You receive and respond to more than two cell phone calls.
- You make a cell phone call.
- You answer, “A beer would be nice,” when your interviewer asks if you’d like something to drink.

WORST-CASE SCENARIO.

HOW TO SURVIVE THE OFFICE PICNIC

- 1 Do not enter the picnic alone.**

If you arrive early, wait until you see a group enter, then tag along with the crowd. This reduces the possibility of being forced into conversation with the one or two people already there.
- 2 Lay the groundwork for an early departure.**

Upon arrival, tell your boss a convincing story that would necessitate leaving early. Mention that the sitter has another obligation, that your dog is sick at home alone (whether you have a dog or not), that you have the beginnings of the flu, or another appropriate excuse. Apologize and act sorry that you will not be able to stay longer. Should you decide to escape quickly, your early exit will not seem abrupt.
- 3 Control your alcohol intake.**

You risk embarrassment (or worse) if you get drunk in front of your colleagues. Have no more than one drink at the beginning of the picnic to help you relax, then limit your consumption to one drink per hour. Make sure you eat, too.



Food is a safe topic for company picnic conversation.

4 **Talk about the food.**

If you find yourself stuck with people you don't know (or don't like), discuss the food. It is a common topic for picnic conversation and may lead to discussion of restaurants, travel, and other easy subjects. Other safe topics include the weather, the latest celebrity divorce, television programs, sports, movies, and books. Avoid talking about the physical attractiveness of other employees, the incompetence of managers, the annoying habits of your co-workers, or diseases of any kind.

5 **Avoid discussing work.**

It's best to avoid all topics relating to the company itself, including projects, policies, culture, and co-workers. Alcohol can loosen tongues, and you may not know everyone within earshot, nor their allegiances. Assume that everything you say will be repeated, out of context, to the person you don't want to hear it.

6 **Do not be the first to leave.**

Unless you prepared upon your arrival for an early departure (see step 2), do not be the first person to leave. Wait for two or three other people to go, and depart shortly thereafter. If you observe your boss checking the time as people are leaving, delay your exit for another 15 to 20 minutes.

IF YOU BECOME INTOXICATED

1 **Do not talk to your boss.**

Excuse yourself from any conversations with bosses, managers, or co-workers who might later recount any of your inappropriate comments or behavior.

2 **If you become trapped in a conversation with your boss, become a "Yes man."**

Smile, nod, and find a way out.

3 **Spill something.**

As a last resort, knock your drink over on the table, or spill it on yourself. Then excuse yourself to go wash up. The person or persons you were talking to will move on to another conversation.

4 **Withdraw.**

Find an out-of-the-way tree or park bench. Ask for help from a colleague if you cannot make it on your own, but get out of harm's way before you damage your reputation.

5 **Do not return.**

Take a walk and drink plenty of water. If you cannot sober up, have a colleague tell your boss that you had to leave "because something suddenly came up."

**WORST-CASE
SCENARIO.**

WORST-CASE SCENARIO.

HOW TO THWART A LUNCH THIEF

1 Prepare a special lunch bag.

Staple your lunch bag shut. This will send the thief who has been stealing your lunch a not-so-subtle message that you know what he is up to. Write your name on the bag in large block letters to prevent the thief from claiming a bag mix-up.

2 Track the items stolen.

A clever thief will not risk being caught red-handed with your entire lunch bag; he will simply remove his favorite items. Assess the thief's appetite and level of sophistication by observing for several days what items are taken and when. If the labeled and stapled bag does not deter him, you are dealing with a dedicated thief.

3 Set a trap.

Once you have determined the thief's method and preferences, alter your lunch accordingly. If the thief likes sandwiches, hide a layer of well-chopped jalapeño peppers between the other ingredients (cover with a thin layer of mayonnaise, if necessary). If the thief prefers cookies, cupcakes, or other sweets, sprinkle a layer of cayenne pepper on the underside of these items. These traps will teach the thief a lesson and may flush the thief out into the open (wait by the water cooler later) if you are unable to catch him in the act.



Wait until the thief has removed the item from your lunch bag.

4 **Monitor the refrigerator.**

Find a surveillance spot with a clear view of the office kitchen or stroll past once every few minutes. Mid- to late-morning is the prime time for lunch theft. Each time someone goes to the refrigerator, listen for the sound of your bag being ripped open. If there is no ripping sound, check the staples after each person leaves. Resume hiding until you hear a ripping sound or you see someone with his back to you, peeking into the refrigerator for a longer than usual time.

5 **Wait for the crinkle.**

Listen attentively until you hear the thief open your bag and remove an item; if you move too soon you risk the defense of simple bag confusion.

6 **Pounce.**

As the thief turns away from the fridge with your lunch item, jump out from your hiding spot. Say, "I believe that's my lunch you have in your hand!" If the thief denies that the item is from your lunch bag, show him the now-unsealed bag and explain that it was sealed before he opened the refrigerator door. If he still professes innocence, tell him to prove it by taking a large bite of the (doctored) item.

HOW TO TREAT WORKPLACE INJURIES

STAPLED FINGER

- 1 Determine where the staple entered the finger.**
If the staple is embedded in the fleshy pad of the finger, proceed to step 2. If the staple entered through the nail or the side of the finger, see Be Aware, page 120.
- 2 Obtain strong tweezers or needle-nose pliers.**
If neither tool is available, use a flat-head screwdriver.
- 3 Place one side of the tip of the tool between the staple and the skin.**
If using a screwdriver, place the tip under the staple.
- 4 Lift or pry the staple out.**
With a fast, steady motion, close the tweezers or pliers and pull upward. The staple should be pulled straight out in the direction that it entered the finger. The staple will be in its original shape: The ends will be straight and should not cause further injury upon removal.
- 5 Wash the wound with soap and warm water.**
- 6 Apply isopropyl alcohol or hydrogen peroxide.**
Use a sterile cotton ball or a clean cloth to wipe on the disinfectant.

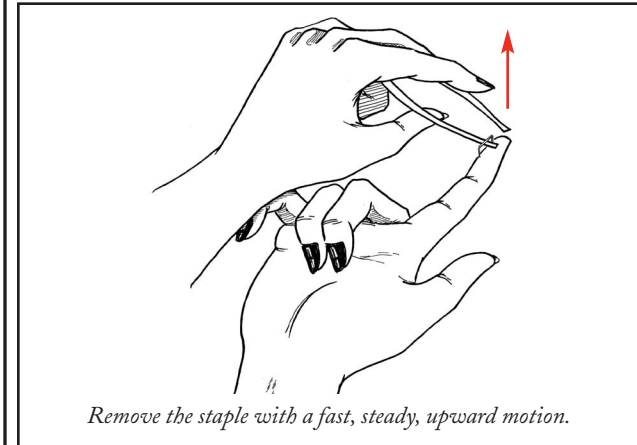

- 7 Apply pressure to the wound to stop residual bleeding.**
- 8 Dress the wound with a bandage.**
- 9 Examine the staple.**
If the staple is not intact, a piece may still be in the wound and can cause pain, swelling, and infection. Seek medical help if any part of the staple remains in the finger.
- 10 Monitor the wound.**
With or without a piece of the staple in it, a deep puncture wound may cause an infection. If the finger swells or remains painfully sore for more than 24 hours, see a healthcare professional.

Be Aware

- A staple that enters the finger through the nail can cause a small bone fracture or a bone infection (osteomyelitis). If the staple has punctured the nail, seek medical attention to rule out either of these conditions.
- A staple that enters the side of the finger can damage nerves, tendons, or blood vessels. If the staple is in the side of the finger, is especially deep, or causes numbness, it is best to seek professional help before removal.
- Tetanus bacteria, *Clostridium tetani*, can enter the body through a cut or puncture even if the penetrating object is not dirty or rusty. If you experience painful muscle spasms, lockjaw, difficulty swallowing, or difficulty breathing, seek medical attention immediately. To be safe, get a tetanus booster if you have not had one within five years.

DEEP-FRYER BURN

1 Take your hand out of the hot oil.

If the burn was caused by splattering oil, stand back from the deep fryer. Avoid touching the burned area.

2 Watch for flames.

Grease is highly combustible. Any oil above 400° to 600°F (200° to 300°C) may burst into flames and set fire to clothing. Smother any flames with wet oven mitts or wet towels to extinguish.

3 Plunge the burned area into cold running water.

Immerse the burn immediately and keep the hand or other body part under water until you are ready to apply the dressing.

4 Apply a dressing.

When the area is cool, cover it with a dry clean sheet or towel. Use a clean apron if nothing else is available.

5 Call emergency services.

While any burn the size of a dime or larger on the hands, feet, or face should be checked by a healthcare professional, a burn larger than a few inches across requires an immediate visit to the emergency room. Burn victims should always be transported by ambulance: Tell the emergency phone operator and emergency room attendant that you have a burn injury. If there is a burn center within 30 minutes, bypass other hospitals and seek specialized care.

Be Aware

- Because of the risk of damage to nerves and blood vessels, any circumferential burn (around an arm, leg, finger, or the entire body) should be treated at an emergency room immediately.
- Infection is not an immediate concern: Hot grease sterilizes the area temporarily.
- Do not put oils or other petroleum-based products on the burn.

FINGER CUT ON DELI SLICER

1 Turn off the slicer.

Use the power switch or yank out the cord. Yell for help if necessary.

2 Control the bleeding.

Locate a large, clean, absorbent cloth (a shirt or an apron is effective). Wrap the cloth around the injured finger and apply steady pressure with your other hand to stop the bleeding. Sit down and elevate the injured hand above the level of your heart. The fingers have a large number of blood vessels, so the blood loss may appear significant, but it probably is not.

3 Determine if part of the finger is missing.

Check (or ask a co-worker to check) the slicer for any missing piece of the finger. If part of the finger has been cut off, perform the following steps, then see “If Part of the Finger Has Been Amputated,” page 124.

4 Maintain pressure.

Apply pressure on the finger for 5 minutes, then check the wound. If blood continues to spurt from the laceration, continue to apply pressure for 15 additional minutes. As the cloth becomes saturated, remove and replace it with a new one.

5 Clean the wound.

When the bleeding has slowed or stopped, examine the wound while gently rinsing it in a stream of cool tap water, taking care not to dislodge any visible blood clots.

6 Determine severity.

If the wound is through a finger joint or the nail bed, if part of the finger is attached to the hand by only skin, or if bone is visible, go to an emergency room; have a co-worker drive you. Bring additional towels and continue to apply pressure.

7 Cover and close the wound.

If the wound is less than half an inch in length, if you can move your finger normally, and if you can feel your fingertip, try to bring the skin edges of the wound together with pressure. Continue washing the wound under running tap water. Pat dry and re-apply direct pressure with a clean cloth to absorb any blood. Use an adhesive bandage to cover the wound and maintain the contact of the edges of the skin.

8 Get a tetanus shot.

If you have not had a tetanus booster in the last five years, get one as soon as possible.

IF PART OF THE FINGER HAS BEEN AMPUTATED

1 Do not submerge the severed part.

The severed piece should not be placed in water, milk, or any other liquid.

2 Do not attempt to clean the severed part.

Cleaning the amputated piece may alter the character of the skin and other tissue that may be re-attached.

3 Prepare for transport.

Get a clean cloth or paper towel and soak it in cold running water. Wring to remove excess water and gently wrap the severed part in the towel.

4 Chill.

Place the bundled piece in a small bowl filled with ice. Cover the bundle with more ice. Do not let the part come into direct contact with ice.

5 Call emergency services.

Driving yourself, or having someone drive you, is not advisable if you or the driver are prone to fainting. Call an ambulance and bring the bowl containing the amputated part with you.

**WORST-CASE
SCENARIO.**

WORST-CASE SCENARIO.

HOW TO UNCLOG THE OFFICE TOILET WITHOUT A PLUNGER

- 1 Wait several minutes.**
Often clogs will resolve themselves with time.
- 2 Prepare more water.**
Hold a full pitcher of water three feet above the rim of the bowl.
- 3 Pour and flush.**
Pour the water into the bowl as you flush the toilet. The added water and pressure increases the force of the flush.
- 4 Check the bowl.**
If it is still clogged, continue.
- 5 Get a wire coat hanger.**
Untwist the hanger until it is relatively straight.
- 6 Tie a small hand towel to the hanger.**
Create a loop at one end of the hanger to give you a better grip. Tie the hand towel in a knot at the other end. The knot should be approximately the same size as the opening at the bottom of the bowl. Make another small loop in the hanger just below the towel to prevent it from sliding off.

7 **Push the hanger through the clog.**
Continue pushing as far as you can.

8 **Plunge.**
Move the hanger up and down and in small circles to clear the clog.

9 **Withdraw the hanger.**

10 **Flush.**
If the clog does not clear, wait 10 minutes, then repeat steps 7 through 10. If the water level in the bowl remains high and close to the rim, do not try to flush the toilet.

IF PUSHING THE HANDLE DOES NOT FLUSH THE TOILET

1 **Remove the toilet tank lid.**
If the toilet does not have a tank—often the case with high-pressure toilets in office buildings—do not try to fix a non-flushing toilet. Just leave and call maintenance.

2 **Check the back of the handle.**
The handle should be connected inside the tank to one end of the “lift chain,” or to a thin rod (float arm) connected to the chain. At its other end, the lift chain should be connected to the toilet flapper. One of the connections is most likely broken.

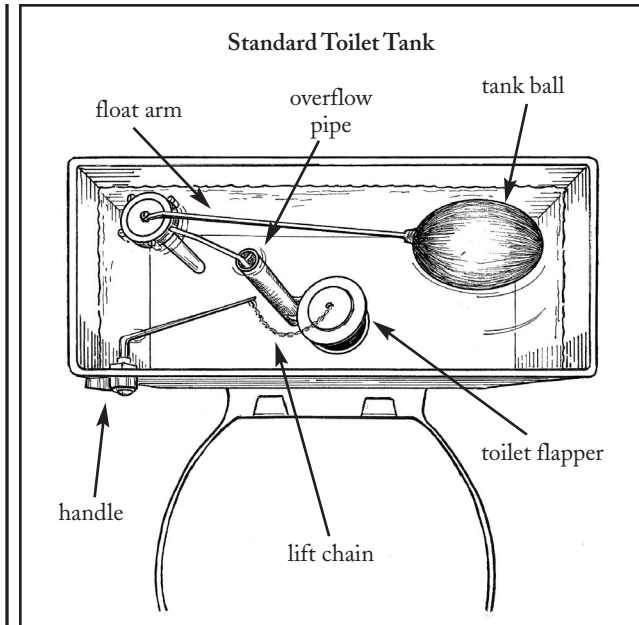

3 **Turn off the water.**
Turn the water off at the valve just below the tank. Put on a pair of thick rubber gloves.

4 **Pull up the lift chain.**
Tank water may be contaminated with waste if the trap seal is broken. Using your gloved hand or a hanger, pull up the chain. The toilet will flush. If the water supply is still on, the tank will begin filling quickly, so you will need to work fast.

5 Re-connect the flapper and chain.

Attach the chain to the handle using a paperclip, safety pin, or twist tie.

6 Turn the water back on.

7 Wash your hands thoroughly.

Use antibacterial soap or hydrogen peroxide.

Be Aware

Occasionally the toilet will not flush because the flapper has become dislodged and is not seating properly, causing the water to keep running into the bowl and the tank to remain empty. Jiggle the handle slightly to reseal the flapper properly.

**WORST-CASE
SCENARIO.**

THE “I QUIT” LETTER

Dear [*your boss's name*],

During the **years / months / days** that I have worked here, I've come to better understand my own needs and the needs of the company. Regrettably, I've reached the conclusion that these needs are no longer in synch.

Without any blame or bad feelings / For personal reasons I'd rather not discuss / On advice from my psychiatrist and lawyer, I've decided to tender my resignation. This is not a decision I've made lightly nor in haste. I want you to know that my departure has nothing to do with the fact that **I am over-worked and under-paid / you promoted that idiot instead of me / the company is severely dysfunctional and evil.**

It's just that I want to **spend more time in a job I feel I can grow in / work with people I respect while doing something worthwhile / get out before everyone gets indicted.**

I sincerely want to thank you for **giving me the opportunity to work with you / providing a job that allowed me to discover what I didn't want to do / nothing.**

I wish you the best of luck in the future, and hope we'll have a chance to cross paths again in **the future / the very, very distant future / court.**

Sincerely,
[*your name*]

**WORST-CASE
SCENARIO.**

WORST-CASE SCENARIO®

THE EXPERTS

CHAPTER I: THE INTERVIEW

How to Identify a Nightmare Workplace

Source: Eileen Levitt is president of the HR Team (www.thehrteam.com), a company that specializes in employee communications, training, recruitment and retention strategies, and executive/employee coaching.

How to Get a Job You're Not Qualified For

Sources: Ian B. Maksik, "America's Service Guru" (www.usawaiter.com), conducts seminars and training courses in the hospitality industry around the world. • Peter Post is the great-grandson of Emily Post and an expert in business and personal etiquette. He is the co-author of *Etiquette Advantage in Business* and director of the Emily Post Institute (www.emilypost.com) in Burlington, Vermont. • Carole Martin (www.interviewcoach.com) is the interview coach at Monster.com. She holds a master's degree in Career Development and coaches MBA students on interviewing techniques at the Haas School of Business at the University of California at Berkeley. • R. J. Meagher, M.D., is a neurosurgeon in private practice at JRCT Neurosurgical Associates in Reading, Pennsylvania. • Seth Haplea, M.D., is a neurologist with a private practice in West Grove, Pennsylvania. • Leslie Hafter is an area manager with T. Williams Consulting, a management consulting firm that specializes in human capital solutions. • Franklin Lever, principal of Franklin Consulting Fork Lift Specialists (www.frankcon.qpg.com), has 36 years of experience providing solutions to forklift problems, including driver training and expert witness services in

forklift-related litigation. • LaVonda Henderson is a former shoe sales associate at Payless ShoeSource, Inc.

How to Survive the Interview

Sources: Carole Martin. • Leslie Hafter.

How to Disguise a Tattoo

Source: Sherry Maysonave is the author of *Casual Power: How to Power Up Your Nonverbal Communication and Dress Down for Success* and the founder and president of Empowerment Enterprises (www.casualpower.com), a consulting firm specializing in communication and image.

CHAPTER 2: PEOPLE SKILLS

How to Deal with a Nightmare Boss

Sources: Jan Yager, Ph.D. (www.janyager.com) is a sociologist, consultant, speaker, and author of *Business Protocol: How to Survive & Succeed in Business*. • *The Diagnostic and Statistical Manual of Mental Disorders*, Fourth Edition. • Leslie Hafter. • Johnathan Lazear lectures on the topic of workaholism and is the author of *Meditations for Men Who Do Too Much* and *The Man Who Mistook His Job for a Life*.

How to Deal with a Nightmare Co-Worker

Source: Jan Yager. • *The Diagnostic and Statistical Manual of Mental Disorders*, Fourth Edition.

How to Deal with a Nightmare Customer

Sources: Dianne Lancaster is the founder of the Anger Management Institute (www.manageanger.com) in Boulder, Colorado, and the author of *When Anger Is in Control*. She consults on stress management and anger in schools, the workplace, and the home. • Ian B. Maksik.

How to Survive the Office Picnic

Source: Phyllis Cambria is a celebrations expert and co-author with Patty Sachs of *The Complete Idiot's Guide to Throwing a Great Party*. She has organized hundreds of events for groups of 2 to 10,000. Cambria and Sachs own PartyPlansPlus.com, an online event planning, marketing, and party products company.

How to Make an Impromptu Toast

Source: Alfred Herzing is president of Toastmasters International (www.toastmasters.org), a nonprofit organization dedicated to helping its members improve their communication and leadership skills.

How to Survive a Workplace Romance

Source: Barbara Pachter (www.pachter.com) is a business communications and protocol specialist and the author of several books, including *When the Little Things Count . . . And They Always Count*.

CHAPTER 3: ON-THE-JOB SURVIVAL

How to Survive in a Tiny Workspace

Sources: Christopher R. Ryan is the creator of the Cubicle Survival Kit, a set of essential items for improving the cubicle experience, and CubeGuy.com, which offers survival strategies for cube dwellers. • Steve Hayes is the CEO and managing director of Outside In, an 11-year-old company specializing in the sale of lights to treat various body-clock problems. • Fred Lapp, a trucker for 17 years, currently hauls machinery and other freight east of the Mississippi. • John Ammons hauls lumber and other freight for Penske Trucking in eastern Ohio. • Max Heine is editorial director for *Overdrive*, *Truckers News*, and eTrucker.com. • Ed DeLozier, executive director of

the E-470 Public Highway Authority in Aurora, Colorado, served as a toll collector on the New Jersey Turnpike for 9 years. • Angus Kress Gillespie, Ph.D., a professor of American Studies at Rutgers University, is the co-author of *Looking for America on the New Jersey Turnpike*, a history of the roadway and its workers. • W. R. (Ross) Jennings III is the president of Cushing Manufacturing, a fabricator of toll booths and other commercial metal structures, in Richmond, Virginia.

How to Sneak Out of a Meeting

Sources: Peter Earnest, a former CIA field operative, spent 20 years in the agency's Clandestine Service in Europe and the Middle East. He currently serves as executive director of the International Spy Museum (www.spymuseum.org) in Washington, D.C. • The National Safety Council.

How to Cover Your Mistakes

Sources: Chris Pirillo is co-author of *Poor Richard's E-mail Publishing* and manages Lockergnome.com, a series of electronic publications. • Virginia Mattingly is a middle school teacher and co-author of *The Field Guide to Stains*. • Ian B. Maksik. • Steven Tamaccio owns Estetica Salons in Philadelphia and Wayne, Pennsylvania. He has been a hairdresser for 25 years and has his own line of hair-care products.

How to Survive If You Are Caught Slacking

Source: David Wiskus is a writer, musician, and founder of SlackersGuild.com, an online community for slackers of all stripes.

How to Survive a Nightmare Business Trip

Sources: Marybeth Bond (www.womentraveltips.com) is a travel expert/spokesperson, motivational speaker,

television and radio commentator, and author of five books, including *A Woman's World* and *Gutsy Women*. • Drew Dimond is the president of the International Society of Hospitality Consultants and a 30-year veteran of the hotel and hospitality industries. He is also president of Dimond Hospitality Consulting Group (www.dimondconsultinggroup.com). • Bob Rosner is the author of *The Boss's Survival Guide* and *Working Wounded*, and the founder of RetentionEvangelist.com. He has 2 million frequent flyer miles and most people feel he needs to get a life. • Diana Fairechild (www.flyana.com) is an expert witness and speaker and the author of *Noni* as well as *Jet Smart* and *Jet Smarter*, which help airline passengers cope with the physical, emotional, and spiritual stresses of flying. She spent 21 years as a flight attendant, logging more than 10 million air miles.

How to Enhance Your Stature

Source: Bob Rosner.

How to Avoid Downsizing

Source: Bob Rosner.

CHAPTER 4: WORKPLACE EMERGENCIES

How to Treat Workplace Injuries

Sources: Seth Haplea. • Ken Zafren, M.D., F.A.C.E.P, is an emergency physician who lives in Anchorage, Alaska. He serves as medical director of Emergency Medical Services for the state of Alaska and is on the faculty at Stanford University Medical Center. • Melisa W. Lai, M.D., is a clinical chief resident in Emergency Medicine at the Harvard Affiliated Emergency Medicine Residency Program at Massachusetts General Hospital-Brigham & Women's Hospital-Mt. Auburn.

How to Retrieve a Candy Bar Stuck in the Lunchroom Vending Machine

Source: D & S Vending Inc. (www.dsvendinginc.com) sells and services vending machines in Cleveland, Ohio.

How to Thwart a Lunch Thief

Source: Bob Rosner.

How to Spot a Shoplifter

Source: Chris E. McGoey (www.crimedoctor.com) has been in security management for 30 years. He is a consultant and frequent lecturer on security and loss prevention.

How to Survive If Trapped in . . .

Sources: Michael Griffin (www.escapeguy.com) has escaped from prison cells, steel coffins, and from 25 pounds of chains and locks at the bottom of the Pacific Ocean. • Bill Stumpf, sales manager at Bally Refrigerated Boxes (www.ballyrefboxes.com) in Morehead City, North Carolina, has worked in commercial refrigeration for 30 years. • Ken Zafren. • Michael Hackenberger runs the Bowmanville Zoological Park (www.bowmanvillezoo.com), Canada's oldest private zoo. He has bred and trained lions for 20 years, and his cats have appeared in such films as *George of the Jungle* and *The Ghost and the Darkness*. • Gareth Patterson, author and environmentalist (www.garethpatterson.com), has dedicated most of his adult life to the preservation of the African lion and its wilderness home.

How to Remove a Tie Caught in the Document Feeder

Source: Larry Raisch has worked with photocopiers for 30 years as a manufacturer, technician, technical manager, and service representative.

How to Fix a Dented Company Vehicle

Source: Brian Jump is president of the Superior Auto Institute (www.nodents.com) and has 22 Paintless Dent Repair schools worldwide.

How to Restore a Shredded Document

Source: C.J. Bronstrup (www.InvestigatorWebs.com), retired owner of Atlas Investigations, specialized in information gathering and skip tracing. He currently provides marketing services and websites for private investigators.

How to Unclog the Office Toilet Without a Plunger

Sources: Mike Carlin is a master plumber and principal of MC Associates (www.mcassociates.com), a plumbing and HVAC contractor in Massachusetts. • John Turmel, a master plumber, is the owner of Turmel Plumbing, with locations in Corpus Christi, Austin, and Fort Worth, Texas.

How to Escape a Stockroom Avalanche

Sources: James Li, M.D., practices and teaches in the Division of Emergency Medicine at Harvard Medical School in Cambridge, Massachusetts. He is an instructor for the American College of Surgeons' course for physicians, Advanced Trauma Life Support. • John Simonetti is an astronomer and Associate Professor of Physics at Virginia Tech in Blacksburg, Virginia.

How to Clean Up a Spill in Aisle Seven

Source: Christian Quickle is a front-end manager at the Columbus Boulevard Super Fresh Superstore in Philadelphia, Pennsylvania.

The
WORST-CASE SCENARIO
Survival Handbook:
WEDDINGS

By Joshua Piven, David Borgenicht, and Sarah Jordan
Illustrations by Brenda Brown



CHRONICLE BOOKS
SAN FRANCISCO

Copyright © 2004 by Quirk Productions, Inc.

All rights reserved. No part of this book may be reproduced in any form without written permission from the publisher.

Worst-Case Scenario® and The Worst-Case Scenario Survival Handbook™ are trademarks of Quirk Productions, Inc.

Library of Congress Cataloging-in-Publication Data available.

ISBN: 0-8118-4537-0

Manufactured in the United States of America

Typeset in Adobe Caslon, Bundesbahn Pi, and Zapf Dingbats

Designed by Frances J. Soo Ping Chow

Illustrations by Brenda Brown



A **QUIRK** Book

www.quirkpackaging.com

Visit www.worstcasescenarios.com

Distributed in Canada by Raincoast Books

9050 Shaughnessy Street

Vancouver, British Columbia V6P 6E5

10 9 8 7 6 5 4 3 2 1

Chronicle Books LLC

85 Second Street

San Francisco, California 94105

www.chroniclebooks.com

WARNING

When a life is imperiled or a dire situation is at hand, safe alternatives may not exist. To deal with the wedding worst-case scenarios presented in this book, we highly recommend—instist, actually—that the best course of action is to consult a professionally trained expert. But because highly trained professionals may not always be available when the safety or sanity of individuals is at risk, we have asked experts on various subjects to describe the techniques they might employ in these emergency situations. **THE PUBLISHER, AUTHORS, AND EXPERTS DISCLAIM ANY LIABILITY** from any injury that may result from the use, proper or improper, of the information contained in this book. We do not guarantee that the information contained herein is complete, safe, or accurate, nor should it be considered a substitute for your good judgment, your common sense, or the advice of your mother and/or wedding planner. And finally, nothing in this book should be construed or interpreted to infringe on the rights of other persons or to violate criminal statutes; we urge you to obey all laws and respect all rights, including property rights, of others, even your new in-laws.

—The Authors

ABOUT THE AUTHORS

Joshua Piven's wedding featured a flower girl temper tantrum, bad catering, and the happy couple's impressive performance of "The Hustle." He is the co-author, with David Borgenicht, of the *Worst-Case Scenario Survival Handbook* series. Still happily married, he and his family live in Philadelphia.

David Borgenicht is a writer and book publisher whose own wedding took place more than nine years ago. At the wedding, he survived nightmare rabbis, marathon toasting, excessive drunkenness, and a cousin who ate the chocolate flowers off the cake before it was served. It was a wonderful occasion.

Sarah Jordan is a National Magazine Award–nominated writer whose wedding featured a band so committed to entertaining that they refused to stop playing so guests could leave the dance floor for dessert. Co-author of *The Worst-Case Scenario Survival Handbook: Parenting*, she lives in Philadelphia with her family.

Brenda Brown is an illustrator and cartoonist whose work has been published in many books and major publications, including *The Worst-Case Scenario Survival Handbook* series, *Esquire*, *Reader's Digest*, *USA Weekend*, *21st Century Science & Technology*, *The Saturday Evening Post*, *The National Enquirer*, and many other magazines. Her Website is <http://webtoon.com>.

Visit www.worstcasescenarios.com for updates, new scenarios, and more! Because you just never know . . .

ACKNOWLEDGMENTS

Joshua Piven thanks everyone involved for the wonderful memories: co-authors, editors, experts, caterers, florists, pastry chefs, bartenders, and, of course, the band. Expect a thank-you note in six to nine months.

David Borgenicht would like to thank everyone who contributed to making this magical night—er, book—happen: his co-authors, Josh and Sarah; his editors, Jay Schaefer, Steve Mockus, and Melissa "Wedding Planner" Wagner; perennial *Worst-Case* designer Frances J. Soo Ping Chow; and all of the experts whose knowledge makes the world a safer, saner place.

Sarah Jordan thanks all the experts who shared their wisdom and insights into how to prevent a wedding disaster; she also thanks her family, Jessica Capizzi, and Cadence Berns.

ABOUT THE AUTHORS

Joshua Piven's wedding featured a flower girl temper tantrum, bad catering, and the happy couple's impressive performance of "The Hustle." He is the co-author, with David Borgenicht, of the *Worst-Case Scenario Survival Handbook* series. Still happily married, he and his family live in Philadelphia.

David Borgenicht is a writer and book publisher whose own wedding took place more than nine years ago. At the wedding, he survived nightmare rabbis, marathon toasting, excessive drunkenness, and a cousin who ate the chocolate flowers off the cake before it was served. It was a wonderful occasion.

Sarah Jordan is a National Magazine Award–nominated writer whose wedding featured a band so committed to entertaining that they refused to stop playing so guests could leave the dance floor for dessert. Co-author of *The Worst-Case Scenario Survival Handbook: Parenting*, she lives in Philadelphia with her family.

Brenda Brown is an illustrator and cartoonist whose work has been published in many books and major publications, including *The Worst-Case Scenario Survival Handbook* series, *Esquire*, *Reader's Digest*, *USA Weekend*, *21st Century Science & Technology*, *The Saturday Evening Post*, *The National Enquirer*, and many other magazines. Her Website is <http://webtoon.com>.

Visit www.worstcasescenarios.com for updates, new scenarios, and more! Because you just never know . . .

ACKNOWLEDGMENTS

Joshua Piven thanks everyone involved for the wonderful memories: co-authors, editors, experts, caterers, florists, pastry chefs, bartenders, and, of course, the band. Expect a thank-you note in six to nine months.

David Borgenicht would like to thank everyone who contributed to making this magical night—er, book—happen: his co-authors, Josh and Sarah; his editors, Jay Schaefer, Steve Mockus, and Melissa "Wedding Planner" Wagner; perennial *Worst-Case* designer Frances J. Soo Ping Chow; and all of the experts whose knowledge makes the world a safer, saner place.

Sarah Jordan thanks all the experts who shared their wisdom and insights into how to prevent a wedding disaster; she also thanks her family, Jessica Capizzi, and Cadence Berns.

INTRODUCTION

Your wedding day is going to be the best, most wonderful day of your life, if you believe what you've been told by your family, friends, romantic novels, soap operas, movie musicals, and countless magazines that sell fashion and lifestyle.

And it is entirely possible that it's true—there is indeed something magical and transforming about standing in front of the people you love and know best and declaring your endless devotion and commitment to your soul mate.

On the other hand, why should everything go right? Just because you want it to? There's more than a passing chance that the wedding reception is costing way more than you budgeted. That the band won't show up. Your wedding gown or tuxedo will be too tight, or something will spill on it. Your in-laws will hate you. A friend of the groom's will offer a truly offensive toast. A fight will break out between the guests. Or simply that the stress of the event will be too much for you to handle.

For some reason, and it's been true since the first exchange of vows in front of an audience, people become quintessentially themselves at weddings. Whatever tendencies and quirks they regularly have become wildly exaggerated, even more so if they are in the wedding party. Think of the shortcomings and annoying habits of everyone on your guest list—including yourself and your spouse—and expect to see those traits in spades. Is someone rude? Is someone

else a hypochondriac? Have a relative who is self-centered? Invite anyone who is mean spirited? Know anyone who likes to drink too much?

Now you're beginning—but just beginning—to grasp why we felt it necessary to prepare you for the full range of worst-case wedding scenarios.

By comparison with what comes next, deciding to get married is the easiest step: all you have to do is say yes. One person asks one question, the other person gives a one-word answer: done. But then, almost immediately, other questions pour out—beginning with when and where—and you and your betrothed are caught up in a vortex of decisions, uncertainty, complications, and the realization that lots of things could go wrong.

Whether your wedding is a formal affair, inventive and exotic, or laid-back and casual, you can't escape one fundamental fact: Every bride and groom experience significant tension during the planning phase of the wedding. It's simple. If you didn't care about these people, about whether they'd attend and what kind of time they'd have, you wouldn't be having a wedding reception in the first place. And so okay, you've decided to have a reception, but who pays for it, and whom do you invite? That leads to endless discussions about picking the menu, the band, the bridesmaid dresses, and the flowers—and remember that stress causes insomnia, pimples, rashes, strains on relationships, and an increased likelihood of accidents.

Weddings seem to be designed for accidents anyway. Who decided that veils, trains, and high heels go

together, especially when they are to be worn by someone who is excited, moving around a lot, and possibly drinking champagne?

If you haven't already paid the caterer, you may still be able to elope: Grab a few things, run out the door, and get hitched in front of a court officer and witnesses you've never met before and will never see again. You would be reducing some of the risks covered by this book, but not all of them. You still are not safe. You cannot stop reading.

As with our previous *Worst-Case Scenario Survival Handbooks*, we've consulted dozens of highly trained professionals in the hope that we can preempt a nuptial nightmare. We spoke with florists, public speaking consultants, chefs, emergency medical physicians, wedding planners, dentists, nutritionists, sexologists, and dozens of other highly trained professionals who have provided step-by-step answers to the most likely nightmare scenarios within.

This handbook takes you chronologically through the wedding process, from planning to the honeymoon, from surviving a bachelor or bachelorette party to treating wedding day-related injuries, from finding a groom who has gone missing to making emergency rings. We've even included an appendix with a handy Gift Evaluator/Thank-You Note Generator.

So forget about something borrowed, something blue. When you walk down the aisle, carry this book. Here's to the happy bride and groom.

—The Authors

CHAPTER I

PRENUPTIAL SURVIVAL SKILLS

GIFT EVALUATOR/ THANK-YOU NOTE GENERATOR

Use the following equation and score chart to assess the ACTUAL VALUE (AV) of any wedding gift; then select the appropriate thank-you note.

$$V/GI \times (TQ + AQ) = AV$$

V = Estimated retail value
(in dollars)

GI = Estimated gross annual income of giver
(in thousands of dollars)

TQ = Tastefulness quotient (from tacky to attractive
to classy, on a scale of 1–10)

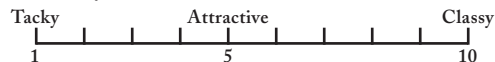

AQ = Appropriateness quotient (from dumb to useful
to cool, on a scale of 1–10)

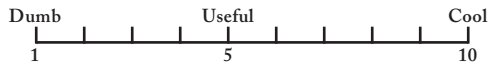

AV = ACTUAL VALUE

Example:

You are given a blender with a retail value around \$100 by a college friend with a gross annual income of around \$40,000. It is quite tasteful in design (you'd rate it a 9 in TQ as blenders go) and will be quite useful (a 9 as well, since you don't have a blender).

Thus, this gift receives a score of:
 $100/40 \times (9 + 9) = 45$, a high score.

If you received the same gift from a wealthy family friend, however, with a gross annual income around \$140,000, the gift would receive a score of:

$100/140 \times (9 + 9) = 12.86$, a low score.

You are given a doormat with a retail value around \$35 by a neighbor with a gross annual income of around \$100,000. It's hideously ugly (a TQ rating of 2), and you already have a doormat (AQ rating of 3, as there would be some pleasure in wiping your feet on it).

$35/100 \times (2 + 3) = 1.75$, a score below the scale.

Score Chart

Below 10 A very bad gift—no note
10–20 A bad gift—use Note A
21–40 A good gift—use Note B
41+ A great gift—use Note C

Note A

Dear _____,

Thank you so much for the *[name of gift here]*. We can't believe you thought of it for us! We will put it in a special place. Know that whenever we look at it, we'll think of you.

Sincerely,

[your names here]

Note B

Dear _____,

Thank you so much for the *[name of gift here]*. We genuinely appreciate your thoughtfulness in seeking out such a practical and appropriate gift. Just know that whenever we use it, we'll think of you.

Sincerely,

[your names here]

Note C

Dear _____,

Thank you so much for the *[name of gift here]*. We can't believe your generosity and creativity. It's a fabulous gift. You must come over and enjoy it with us soon. We think of you always.

Sincerely,

[your names here]

WEDDING SURVIVAL CHECKLISTS

Make sure you have these items.

Walking-Down-the-Aisle Survival Checklist

- Bride
- Veil
- Wedding dress
- Shoes (hers)
- Maid of honor
- Bridesmaids
- Someone to give the bride away
- Groom
- Tuxedo/suit
- Shoes (his)
- Best man
- Rings
- Petroleum jelly (in case ring won't fit)
- Chewing gum (use wrappers to make emergency rings)
- Groomsmen
- Officiant
- Emergency vows (in case officiant forgets)
- Small paper bag (to alleviate hyperventilation)
- Flask with alcohol (for courage)
- Tranquilizers
- Smelling salts

Reception Survival Checklist

- Food
- Liquor
- Place to put presents
- Formal gloves (to block reception line germs)
- Butter (to soothe chapped lips from kissing)
- Photographer

- Garter
- Scarf (to use as emergency garter)
- Tables
- Chairs
- Napkins
- Cake
- Band
- Small car with loud sound system (to replace missing band)
- Petroleum jelly (apply to insteps for gliding dance moves)
- Duct tape and shot glasses (to replace shoe heel)
- Electrical tape (to make tuxedo stripe on pants)
- Insect repellent (for outdoor weddings)
- Tranquilizers
- Smelling salts

Honeymoon Survival Checklist

- Airline tickets
- Toothbrushes
- Toothpaste
- Straw hats (for hot climates)
- Hats with earflaps (for cold climates)
- Insect repellent (for tropical climates)
- Flashlight
- Sunscreen
- Aloe (to treat sunburn)
- Aspirin (for headaches)
- Ice pack (for headaches, sunburns, and sprains)
- Tea bags (to soothe swollen eyes and tongue)
- Petroleum jelly
- Bottled water (for sunburn, upset stomach)
- Antacids (for upset stomach)
- Club soda (for upset stomach)
- Crackers (for upset stomach)
- Sexy lingerie
- Smelling salts
- Tranquilizers

WORST-CASE SCENARIO.

HOW TO AVOID A FIGHT FOR THE BOUQUET

- ★ **Rig the toss.**
Tell your favorite to step away from the pack. When you give her a prearranged signal, toss bouquet to her.
- ★ **Split your bouquet into several individual bouquets.**
Divide the bouquet into as many mini-bouquets as necessary to satisfy all the serious contenders. If there are more than four who really want the bouquet, or you're not sure how many there are, disassemble the bouquet entirely and shower the crowd.
- ★ **Throw wild.**
Throw the bouquet way past everyone. Throw it in the opposite direction from the crowd. Or pump fake to your left, sending the majority of women in that direction, then toss the bouquet far to your right. Once the bouquet hits the floor, the spell is broken: You need to catch the bouquet on the fly in order to be married within the year.

Be Aware

- Good spacing among the women can prevent scuffles caused by tight clustering.
- Brides should throw a secondary bouquet that is smaller and lighter and that will get better "air."

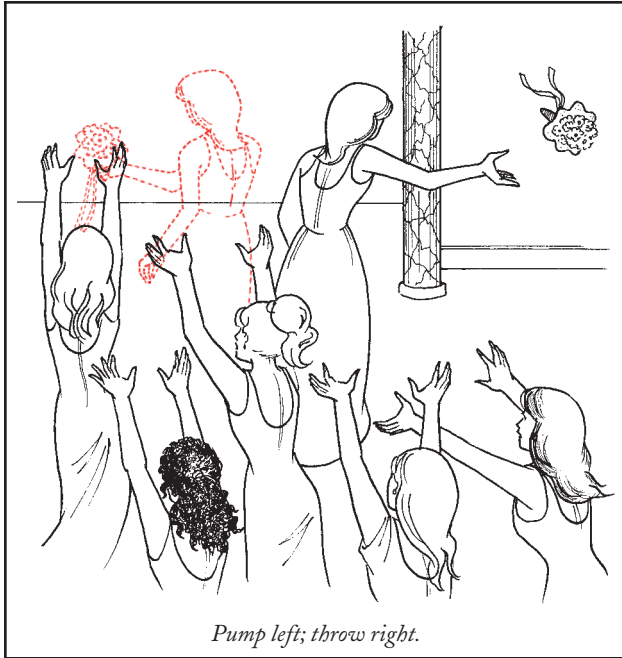

Pump left; throw right.

- The proper distance from the pack of single women is six large paces.
- You may find that no women want to catch the bouquet, for a variety of reasons. If no one steps forward, give the bouquet to the couple who has been married the longest. Alternatively, organize young girls and boys onto the dance floor and toss the bouquet to one of them.

**WORST-CASE
SCENARIO.**

HOW TO AVOID AN ALLERGIC REACTION TO FLOWERS

- 1 Be alert to the smell of flowers.**
Highly fragrant flowers (including roses and lilies) are likely to have open buds, more pollen, and a higher level of allergy danger.
- 2 Send an usher or bridesmaid to examine the buds.**
Floral buds that are completely open—especially flowers that are dying—release more pollen, which causes allergic reactions. If buds are wide open, do not approach the flower.
- 3 Ask the attendant to check the interior of the bud.**
Pollen is supplied by the stamen, the male reproductive organ in a flower. The stamen usually consists of a long filament topped by an anther, which holds the pollen. If the stamen is highly visible, the flower is more likely to cause an allergic reaction.
- 4 Instruct the attendant to clip the anthers.**
Using a sharp pair of scissors, carefully cut all the anthers and remove.

Highly Allergenic

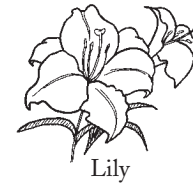

Lily



Lilac



Gardenia



Calla Lily



Peony

Less Allergenic



Tulip



Snapdragon



Baby's Breath



Bougainvillea



Cactus

5 **Avoid sap.**

Floral sap can cause severe allergic reactions. The clear sap from lily stems causes “lily rash,” a persistent itch that may come and go for years. Do not touch sap or place your hands in water that has been in contact with lilies. Avoid the milky white sap, called latex, from poinsettias, cacti, and other *Euphorbias*: It is highly allergenic and can cause blindness if rubbed in the eyes.

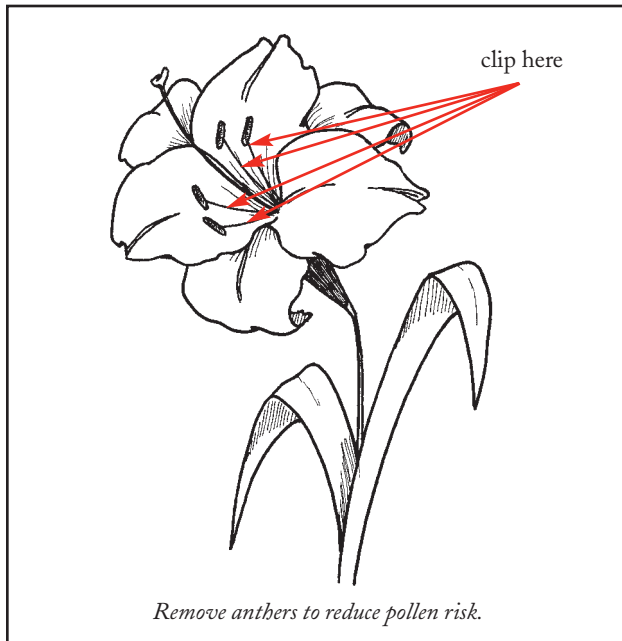

**WORST-CASE
SCENARIO.**

HOW TO BREAK UP AN ARGUMENT

- ★ **Speak to the offending guests softly and slowly.**
Quietly tell them that their behavior is inappropriate for a wedding, and that they must control themselves. Do not raise your voice.
- ★ **Reseat the guests.**
If the argumentative guests are at the same table, ask one to sit at another table.
- ★ **Propose a toast.**
As voices are being raised, begin tapping your glass with a spoon to signal a toast. Other guests will follow suit and the noise should drown out the shouting. The argument will be put on hold during the toast, and hopefully forgotten afterward—especially if the toast is long and boring.
- ★ **Stage a dance-off.**
Clear the floor of other guests and have the band play 20 seconds for each fighting guest. Use an informal survey of applause from other guests to determine the victor.
- ★ **Restrain the fighting guests.**
If guests are coming to blows, enlist the help of burly members of the wedding party or guests. Approach the offending guests from behind and wrap each

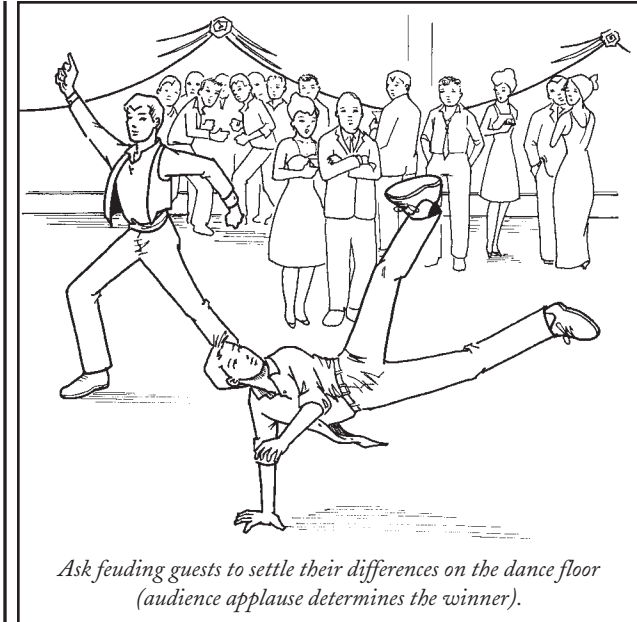

of them in a bear hug, with arms held firmly by their sides.

- ★ **Propose a contest to resolve the dispute.**
Seat combatants at a table that has been cleared. Let them pick between arm wrestling or thumb wrestling. Two out of three wins determines the victor.
- ★ **Set up an outdoor competition.**
Ask the fighting guests to step outside. Explain that you are authorizing a race that will establish who wins the argument. Lay out a very long course.

HOW TO CONCEAL WEDDING DAY BLEMISHES

DARK CIRCLES UNDER EYES

- 1 Make two cold compresses.**
Place a handful of ice in a plastic bag. Wrap the bag in a cloth napkin or other fabric. Repeat for the other eye.
- 2 Sit up straight.**
Keep your head elevated above your heart—do not lie down before applying the compresses.
- 3 Apply compresses.**
Hold the compresses on the eyes for 10 minutes.
- 4 Check under the eyes.**
If the bags remain, continue to step 5.
- 5 Steep two tea bags in warm (not boiling) water for 2 minutes.**
Black tea is most effective, but any variety of non-herbal tea will suffice. Tannic acid, which reduces swelling, is not present in herbal teas.
- 6 Place the tea bags in ice water to cool.**

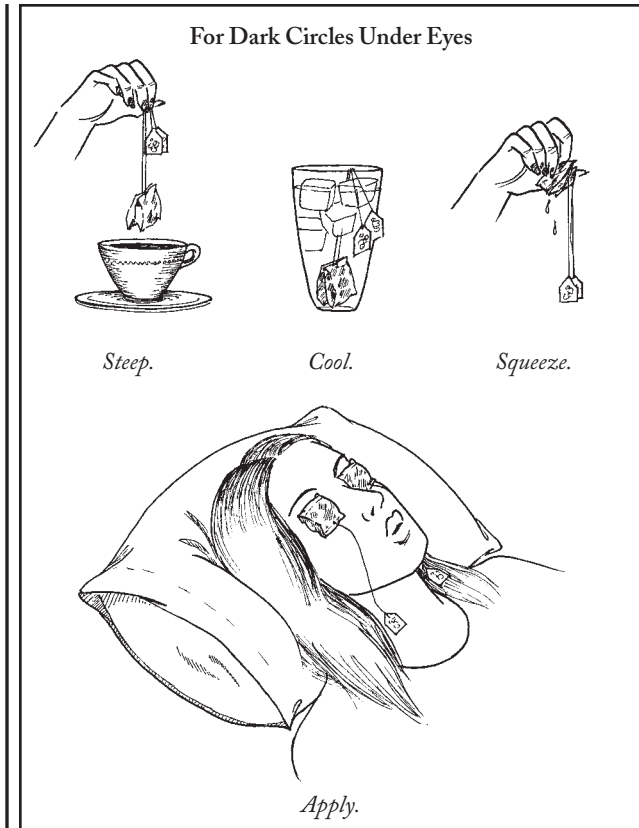

- 7 Apply tea bags to eyes.**
Squeeze out the excess liquid, then place and hold one tea bag over each closed eye for 5 to 10 minutes.
- 8 Check under the eyes.**
The bags should be noticeably smaller or have disappeared altogether. Clean off any liquid and apply a

layer of under-eye concealer one shade lighter than your foundation if the lids are recessed, and one shade darker than your foundation if they are puffy.

Be Aware

Hemorrhoid ointment may be used to reduce swelling and tighten skin under the eyes. Apply carefully to the affected area and allow to remain for 5 to 10 minutes. Wash your face thoroughly, keeping your eyes closed. Note that hemorrhoid ointment may contain fish oils, which leave a displeasing odor.

PIMPLE

- 1 Apply a warm compress.**
Soak a hand towel, handkerchief, or cloth napkin in hot water, then hold it against the pimple for at least 1 minute.
- 2 Assess.**
Check the pimple. If it has a small white area at the center, it has come to a head: It may be popped to relieve pressure and lessen swelling. If there is no visible head, go to step 4.
- 3 Pop the pimple.**
Place your fingers on either side and gently pull away from the pimple. Do not push inward. The pimple will expel its contents if it is ready, but no harm will be done if it is not.

- 4 Apply cover-up makeup.**
Dab the pimple gently with a tissue to remove any remaining liquid. Apply a cosmetic with a slight green tint to conceal the pimple or the red mark. Red and green are complementary colors and will negate each other, making the pimple less visible.

RASH

- 1 Apply ice.**
If the rash is itchy, place ice in a plastic bag, wrap it in a napkin, and place the bag on the rash. Wait 10 to 15 minutes. The compress will cool any hot patches of skin, numb the area, and reduce any visible swelling.
- 2 If redness and itchiness persist, apply 5 to 10 drops of redness-relieving eye drops to the affected area.**
Spread evenly on the rash with a napkin. The redness should temporarily fade or disappear.
- 3 Cover.**
If any redness remains, apply a small amount of light green, matte eye shadow to the rash. The green will offset the red and make the rash less visible.
- 4 Conceal.**
Depending on the area where the rash is located, it can be strategically covered with short or long dress gloves, a scarf or ascot, hosiery, two strands of pearls, or decorative jewelry glued to the skin.

WORST-CASE SCENARIO.

HOW TO DEAL WITH AN INTOXICATED BRIDESMAID

- 1 Remove her shoes.**

Do not expect the intoxicated bridesmaid to walk down the aisle wearing high heels.
- 2 Have all the bridesmaids line up in pairs.**

Couple the intoxicated bridesmaid with another member of the wedding party who is strong enough to support her weight.
- 3 Help her down the aisle.**

Position the intoxicated bridesmaid to the right of her partner. The partner should put her right arm around the bridesmaid's waist, with her left hand firmly grasping the intoxicated bridesmaid's left forearm so she can provide support and guide her down the aisle. The intoxicated bridesmaid should carry both of their bouquets in her left hand to hide the support.
- 4 Ask the musicians to play the processional music at a slower tempo.**

The slower pace will help the intoxicated bridesmaid to keep her balance as she walks in time to the music.



5 Position the intoxicated bridesmaid close to the door.

Once she's made it up to the altar, make sure that she is positioned at the end of the line close to the door for an easy escape. Bridesmaids on either side may need to support her once they're at the front, or she may need to be seated in the first row of seats, just in case.

**WORST-CASE
SCENARIO.**

HOW TO DEAL WITH AN OVERBEARING MOTHER-IN-LAW

- ★ **Say yes, mean no.**
Agree with everything your future mother-in-law says when you are together, but do what you wish when she is gone. Just nod at her sweetly and pat her on the shoulder when she says or does something inappropriate. If she later asks about decisions, say you and your future spouse discussed it further and you hope she understands.
- ★ **Hire/designate a fake professional.**
Get a friend or an actor to impersonate a wedding planner, and have your mother-in-law share her ideas with him. When her ideas aren't executed, blame the fake planner.
- ★ **Blame your bladder.**
Leave the room when her difficult nature flares. Apologize, appear mildly embarrassed, and say you need to use the bathroom. Drink plenty of water and other fluids when in her presence so your exits appear justified.
- ★ **Send her on useless missions.**
Instruct her to meet with vendors you have no intention of using. Match her up with notoriously difficult

florists, bandleaders, caterers, and other wedding suppliers.

Be Aware

Mothers-in-law have a tendency to pull something at the last minute, just when you thought you had safely made it to the day of the wedding. Be on guard for her claims of illness—dizziness, nausea, diarrhea—that shift the focus of attention to her. Be especially prepared for the most common stunt, inappropriate wedding attire that:

- shows too much cleavage
- is more appropriate for a funeral
- steals the show (bright red)
- flaunts her own wedding dress (especially if she is recently divorced)

To avoid the surprise dress, ask well before the wedding to see what she will be wearing.

WORST-CASE SCENARIO.

HOW TO DEAL WITH LOST RINGS

- ★ **Use cigar bands.**
The best man or groomsmen may have cigars in their pockets. Slip the paper band off the cigar and give one to the bride and one to the groom to use in place of wedding bands. Large cigars with wide ring gauges have bands that are most likely to fit.
- ★ **Borrow from guests.**
Send the best man to collect rings from guests. Ask him to bring back an assortment of sizes so that one is sure to fit. The style of the ring does not matter.
- ★ **Use a ponytail holder.**
Twist the elastic in figure-8s until it is small enough to fit on a finger.
- ★ **Bend paperclips.**
Straighten and then bend the paperclips into a ring. Watch for sharp ends.
- ★ **Braid rubber bands.**
Braid three rubber bands, then tie loose ends together to form a ring.

HOW TO MAKE AN EMERGENCY RING

You will need the foil wrapper from a stick of chewing gum and a piece of tape. For a man's ring, use an entire wrapper; for a woman's ring, use a wrapper that has been cut in half lengthwise.

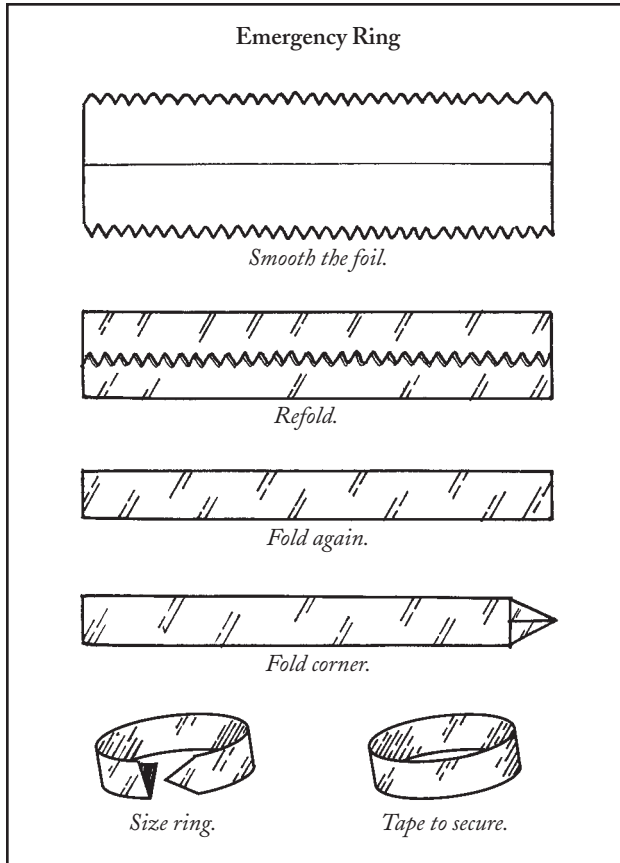

- 1 Remove the gum from the foil wrapper.**
Discard or chew the gum.
- 2 Smooth the foil on a flat surface.**
Flatten all wrinkles and folds.
- 3 Refold the wrapper lengthwise.**
Follow the existing crease lines and fold each of the longer sides up to meet in the middle, leaving the short ends unfolded.
- 4 Fold the wrapper in half lengthwise.**
The seams will be hidden in the middle.
- 5 Fold one end into a point.**
- 6 Insert the point into the fold.**
- 7 Fit the strip around your finger in the shape of a ring.**
Size the ring to a comfortable fit.
- 8 Secure the ring with a small piece of tape.**

Be Aware

If a gum wrapper is not available, or if you prefer a different color ring, you can use paper money. Select foreign currencies for a more dramatic palate. Other options (cut to fit) include candy bar wrappers, aluminum foil, writing paper, or bank checks.

HOW TO DEAL WITH OUTDOOR WEDDING DISASTERS



Extreme heat

- Have the caterer serve all refrigerated items immediately. Do not be concerned about mixing up traditional courses such as dessert, dinner, and appetizers. Serve ice cream and fish first and save bread, crackers, and other nonperishables for last.
- Soak napkins in ice water and wear as headbands, neck wraps, or hats.
- Remove nonessential clothing.



Extreme cold

- Tell guests to huddle together to use body heat to stay warm. Cram additional guests into each row of seats or table. Place children on laps of adults for additional heat source.
- Pass out candles in glass globes. Guests can hold the globe as a hand warmer, passing it along after a few moments.



Rain with no tent

- Make a paper hat. Take a wedding program and orient it in front of you as you would to read it. Turn it 90 degrees so that the bound part is on top and the open part is on the bottom. Take the top

Extreme Heat



Extreme Cold



Paper Hat

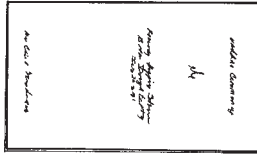

Obtain program.

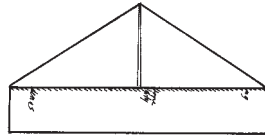

Fold corners.

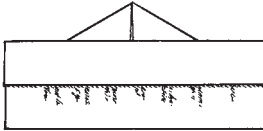

Fold. Flip. Repeat.

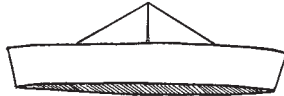

Open.

two corners of the program and fold them into the middle. Now take the bottom flap and fold up once or twice. Turn “hat” over and turn up the other page once or twice. You now have a “Napoleon” style paper hat. Perch it delicately on your head to keep the water off your face.

- Have the groomsmen pick up the aisle runner and hold it over the heads of the bride, groom, and officiant as a canopy.
- Instruct guests to take off their jackets and hold them over their heads as makeshift umbrellas.



Swarm of insects

- Grind up garlic, mix with water, and spray flying insects to repel them. Kill mosquitoes by spraying them with catnip oil. To stop invasions of ants, grind citrus peels and mix with water, then dump on hill.
- Instruct guests or members of the wedding party wearing yellow to change the color of their clothes. Likewise, guests wearing citrus-infused perfumes and colognes should wash them off. Bumblebees are attracted to the color yellow and the odor of citrus.
- Build a yellow-jacket trap. Find a two-liter bottle and cut off the top several inches. Invert the top and place it into the bottle. Staple the pieces together for added security. Find a sweet-smelling liquid (orange soda, vanilla soda, root beer, lemonade) and pour five ounces into the bottle as a lure. The yellow jackets will fly in but won't be able to escape.
- Place sweet-smelling strips of fabric softener on tables to repel insects.

Be Aware

If you are not completely comfortable with the possibility of storms, infestations, floods, and other extreme weather, plan an indoor wedding.

HOW TO DEAL WITH WEDDING NIGHT JITTERS

- 1 Eat.**

You've probably been so busy and excited that you didn't have a chance to eat at the reception. Have some food now.
- 2 Postpone physical contact.**

Unwind from the stress and excitement of the wedding before heading to the bedroom. Do something you both enjoy: Get an ice cream, take a stroll in a park, or just sit in a quiet place and talk about the day.
- 3 Eat mood-enhancing food.**

Chocolate is an excellent mood enhancer: It contains the stimulants caffeine, theobromine, and phenylethylamine, as well as anandamide, a chemical—also produced naturally by the brain—that may enhance feelings of well-being.
- 4 Get the room ready.**

Dim the lights, adjust the temperature, light scented candles, and put on soft music. Keep juices, bottled water, and fresh fruit on hand to rehydrate, rejuvenate, and reinvigorate.

- 5 Get yourselves set.**

The bride and groom should be relaxed, comfortable, and confident. Offer a foot rub. Use lavender soap and scent to promote relaxation. Put on a cozy nightgown or robe over sexy lingerie or underwear.

- 6 Do something you've never done before.**

HOW TO REVIVE YOUR NEW SPOUSE

- ★ **Brew coffee.**

Pass a mug of coffee repeatedly under your spouse's nose.
- ★ **Begin undressing your spouse.**

Remove his socks to cool his body, then follow with his shirt, pants, and underwear. Most people will wake up if they sense they are being undressed.
- ★ **Rub ice cubes over your spouse's body.**

Start with the forehead, wrists, and soles of the feet. Keep going.
- ★ **Apply pressure to the nail bed.**

Take the tip of one of your spouse's fingers and hold it between your thumb and index finger. Very gently, apply steady pressure to the nail bed. Do not squeeze too hard. This method, used by emergency personnel to determine unconsciousness/unresponsiveness in victims, causes sharp pain. It should revive your partner quickly.

Reviving Your New Spouse

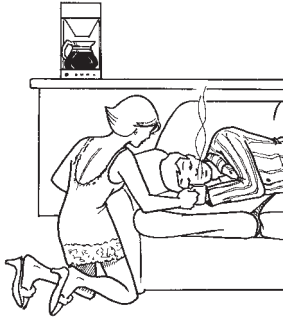

Use coffee.

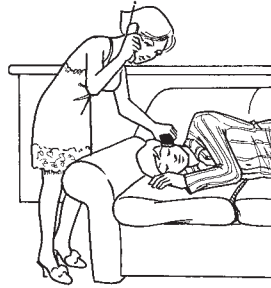

Use his phone.

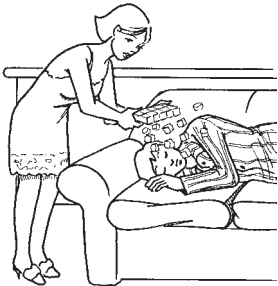

Use ice.

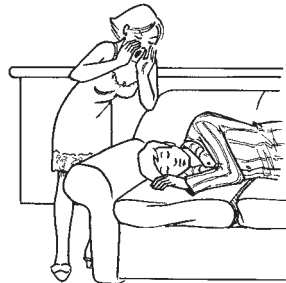

Use lung power.



Tickle.



Call on the telephone.

If you are in a hotel, call the front desk and ask them to ring your room. Or call your spouse's mobile phone from your mobile. Most people will respond to the sound of a ringing phone.



Pretend there is an emergency.

Yell "Fire!" "Earthquake!" "Muggers!" and "Watch out!" repeatedly to get your spouse's adrenaline flowing. Once your spouse is awake, you can explain that you weren't ready for your special night together to end.

**WORST-CASE
SCENARIO.**

HOW TO DEAL WITH WEDDING-RELATED INJURIES

CAN'T FIT RING ON FINGER

- ★ **Try the other hand.**
The ring finger on the opposite hand may naturally be slightly smaller in diameter.
- ★ **Try a different finger.**
No one will notice if, for a little while, the ring is on the pinky.
- ★ **Elevate hand.**
Hands and feet swell in warm, humid weather. Hold your arm above your head for several minutes. Blood will flow from the hand and reduce the swelling so the ring will fit.
- ★ **Grease finger.**
Coat the ring finger with lip gloss, petroleum jelly, butter, margarine, or water.
- ★ **Cool finger.**
Submerge your ring finger in a glass of ice water for 15 minutes. The cold will constrict blood vessels and shrink the diameter of the finger slightly.



Elevate hand or soak ring finger in ice water to reduce swelling.

FOOT CUT ON GLASS

- 1 Remove the shoe.**
Unlace or unbuckle the shoe completely and remove it gently. If the victim is in severe pain, use scissors or a very sharp knife to cut the laces and save time.
- 2 Remove large shards of glass.**
Wrap a napkin around the protruding piece. Using a single swift motion, pull the shard directly out of the foot.
- 3 Determine the source of bleeding.**
Check for any remaining shards and remove them.

4 Stop the bleeding.
Using towels, napkins, or tablecloths, apply direct pressure to the wound for 5 minutes. If the wound is spurting, sustain pressure for 15 minutes.

5 Clean the foot.
Soak the foot in a bowl filled with warm water, then use a damp napkin or clean sponge to gently rub off any remaining blood.

6 Inspect the wound.
Using your fingers, gently spread the sides of the wound apart. Look closely for any remaining glass shards. Remove with sterile tweezers (hold the tweezers under hot running water for 30 seconds, then in a candle flame for 30 seconds). The wound should stop bleeding profusely when all the glass has been removed.

7 Treat and bandage.
Apply a thin layer of antibiotic ointment to the wound. Cover with a sterile adhesive bandage or gauze and medical tape.

Be Aware

- Wounds through the sole of the shoe may become infected by the microbe *Pseudomonas*.
- Wounds $\frac{1}{2}$ inch in length or longer should be sutured at a hospital.
- If the victim has not had a tetanus booster in the last five years, one should be given at a hospital within 48 hours of the injury.

- Seeping from the injury site may indicate that glass remains in the wound.
- When wrapping a glass in a napkin for the Jewish wedding ritual, be sure to lay the glass on its side before stomping on it.

FALL FROM CHAIR DURING CHAIR DANCE

1 **Seat the victim.**

If the victim is conscious, move her to a chair and have her sit down. If she is unconscious on the floor, leave her in place. Most people who are knocked out after a fall regain consciousness within a few minutes.

2 **Test cognition.**

Ask the victim her name. Have her point to a few family members or friends in attendance and state their names. Ask her what type of event she is attending and the city in which it is being held. Ask her to state the date, including the day of the week and year. Correct answers indicate that she has not suffered a concussion. If she answers incorrectly, check again in 10 minutes.

3 **Check responsiveness.**

Ask the victim to follow your finger with her eyes as you move it from side to side and up and down. Ask her to move her arms and legs in coordinated motions. Help the victim stand, then ask her to walk forward, then backward, then forward again. Accomplishing these tasks indicates there is no neurological damage.

4 **Watch for vomiting or loss of consciousness.**

Pay particular attention to the victim for the next hour.

5 **Prevent alcohol consumption.**

Ask the victim if she has had anything alcoholic to drink or has taken tranquilizers or other medication, all of which may mimic the symptoms of injury. Do not let the victim drink.

CHAPPED LIPS FROM KISSING

★ **Apply lip balm.**

Spread a thin layer of petroleum jelly, vitamin E, or skin cream (used sparingly) to lips. Wait several minutes for the treatment to be absorbed.

★ **Apply olive oil.**

Using your fingers, work a small amount of olive oil into your lips. Wait several minutes for the lips to become less slippery.

★ **Apply butter.**

Work butter into your lips using your fingers. To prevent infection, avoid using butter if your lips are cracked and bleeding.



Kiss.



Apply.



Kiss.

HIT IN THE EYE WITH BOUQUET

1 Check the eye for swelling.

If the eyelid is swollen shut and covering the eyeball, reduce the swelling before continuing with treatment. Place a handful of ice in a cloth napkin and twist it closed. Wrap it in a second napkin and place it on the injured eye for 15 minutes, removing it occasionally to check swelling.

2 Examine the cornea.

Under a bright overhead light or pointing a flashlight at the injured eye, instruct the victim to look in all directions and blink repeatedly. Carefully examine the sclera (the white of the eye) and the cornea (the layer covering the pupil and iris) for any foreign material: petal shards, pieces of stem, or leaves.

3 Assemble irrigation equipment.

Obtain a clean, unused liquor spout from the bartender. Place the pourer on a bottle of flat spring water or a bottle filled with cool tap water.

4 Irrigate the cornea.

With the victim seated and her head tilted so she is looking up at the ceiling, gently push her eyelids back and away from the cornea using your thumb and forefinger. From a low height, delicately pour a steady stream of cool water on the eyeball. Occasionally wipe the area around the eye socket with a clean napkin.

5 Check the eye.
After a full bottle has been poured, dry the area and check the eyeball for remaining foreign material. If any material is still present, repeat irrigation with a second bottle of water.

6 Check for corneal abrasion.
Instruct the victim to look in all directions and blink repeatedly for several seconds. If she reports blurred vision, discomfort, or notes a sensation of something in her eye, a corneal abrasion may be present. Seek medical attention immediately.

SPRAINED ANKLE

1 Prepare a cold compress.
Place ice in a plastic bag. Wrap the bag in a piece of clothing, or place it in a second plastic bag.

2 Elevate the ankle.
Seat the victim and raise the injured ankle at least 18 inches from the ground; a chair works well. Keep the ankle in this position.

3 Hold the compress on the ankle.
The cold will constrict blood vessels and reduce swelling.

4 Leave the compress in place for 30 minutes.
If the sprain is particularly bad and swelling is rapid and severe, leave the compress on for 15 additional minutes.

5 Test the ankle.
Have the victim put weight on the injured ankle. If standing or walking is still too painful, continue to step 6.

6 Construct a pressure bandage.
Cut or tear a tablecloth, shirt, or another piece of material into two 3-foot-long, 4-inch-wide strips.

7 Wrap the ankle.
Place one end of the bandage in the middle of the foot. Using a figure-8 pattern, bring the cloth up and over the ankle and back around the foot. The bandage should be snug and the ankle immobile. Use rubber bands, a garter, or two bow ties to secure the bandage to the leg.

8 Administer pain medication.
Ibuprofen will reduce swelling and relieve pain. If ibuprofen is not available, offer acetaminophen or aspirin.

9 Limit dancing.

WORST-CASE SCENARIO.

HOW TO FIND THE GROOM

- 1 Be patient.**

The groom will probably be back in a minute.
- 2 Locate the best man.**

The best man should know the groom's whereabouts at all times. If he does not, enlist his help in the search. If both the groom and the best man are missing, seek help from the ushers or the groom's parents and siblings.
- 3 Establish communication procedures.**

Equip all members of the search party with mobile phones. Exchange numbers and set up a phone tree. Alternatively, set up a conference call and stay on the line.
- 4 Split up.**

You will cover more ground more quickly with multiple people searching independently.
- 5 Check the bathroom.**

The groom may be adjusting his attire, mopping his brow, or dealing with a nervous stomach.
- 6 Check the front and rear entrances of the building.**

The groom may be getting some air to calm his nerves.

Where Is the Groom?

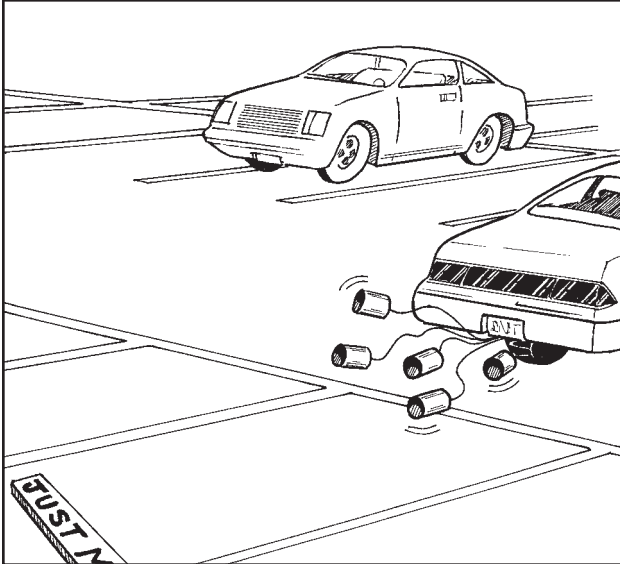
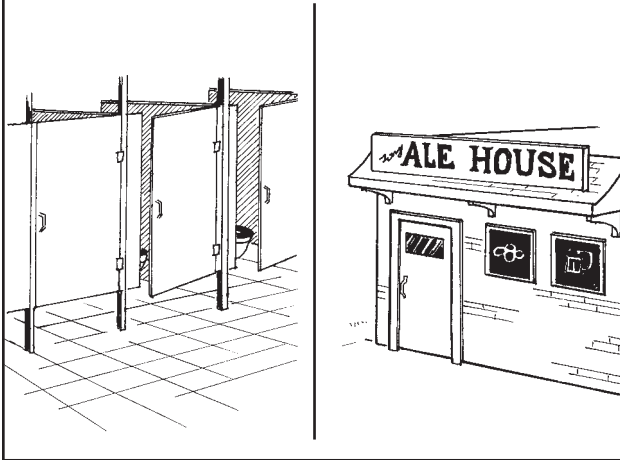

7 Check the water cooler.

Look for vending machines and a water fountain. The groom may be having a glass of water to cool off.

8 Check the parking lot.

See if the car the groom arrived in is still there.

9 Check nearby bars.

Check the bus depot, train station, and airport.

Be Aware

- Do not approach guests and ask if they have seen the groom. This will be awkward, at best.
- After the groom has been missing for two hours, announce to guests that there has been a change in scheduling.

HOW TO STALL THE CEREMONY

1 Keep music playing.

2 Announce a short delay.

The best man or maid of honor should deliver the message: "Sorry, we are running a little late. We will let you know when we are ready to begin."

3 Serve food and alcohol.

If the ceremony and reception are happening in the same place, instruct the caterer to pass cold hors d'oeuvres and glasses of champagne.

4 **Stay out of sight.**

The bride should not mingle with the guests while the hunt for the groom continues. With neither the bride nor the groom present, guests will not become as suspicious.

5 **Show photo albums/videos of the happy couple.**

6 **Ask if anyone else wants to get married.**

A spontaneous wedding is a memorable opening act, and doesn't increase the costs.

**WORST-CASE
SCENARIO.**

**WORST-CASE
SCENARIO.**

HOW TO FIX THE BRIDE'S WEDDING ATTIRE

STAINED DRESS



For tea, coffee, or dirt stains

- Apply a dot of clear liquid soap and water to a cloth and dab gently on the back of the stain. Do not use excessive water. Do not rub the stain, as you will take the finish off the fibers of the dress.
- Dab the cloth with club soda.
- If the stain remains, dab with a solution of vinegar and water.



For a red wine stain

- Wet a cloth with white wine and blot behind the stain. Do not rub the stain, as you will take the finish off the fibers of the dress.
- When the stain has faded, dab with water to rinse.



For grease or makeup stains

- Gently rub a bit of chalk on the stain to absorb the mark. After a few moments, whisk away the chalk dust.
- If you do not have chalk, try baking soda, baby powder, or talcum powder, but they are less absorbent. Sprinkle powder on and then lightly shake off dress.



For a lipstick stain

- Dab some petroleum jelly on the mark to dissolve the stain.
- If the stain remains, conceal with baby powder, chalk, or baking powder. Blot the stain to remove as much of it as possible. Pat baby powder on the area gently. Also, try rolling a de-linting brush over the stain to lift it off. This works best for stains that are not embedded into the fibers.

Be Aware

- Before treating a stain, read the label on your dress. The fabric will dictate how or if you should clean it. Silk is the most fragile fabric and toughest to clean. Polyester is the easiest.
- White correction fluid or toothpaste may work to cover up a stain, but because they both possess alcohol, they can pull the color out of your dress, leaving a permanent mark even after professional dry cleaning.
- Avoid using hot water, which will set the stain; always use cool or cold water when cleaning.
- After cleaning a stain, dry the area thoroughly. Water marks are a hazard for dresses, particularly silk ones. Use a hair dryer on the coolest setting to dry the area while stretching the fabric with your fingers to prevent wrinkling.

DRESS WET FROM RAIN

- 1 Do not put the dress in a clothes dryer.**
Dryer heat is too intense and can cause the dress to shrink, wrinkle, and lose beading.
- 2 Air dry.**
Air drying is best when there is just a sprinkling of water on the dress and there is no time left before the ceremony. If you have been caught in a downpour, remove the dress and air dry it, then follow up with some hand steaming to remove the resulting wrinkles. If you do not have a hand steamer, hang the dress in the bathroom while running hot water in the shower, creating a makeshift sauna. Another option is to activate the steam component from a clothes iron and wave it near the dress.
- 3 Use a hair dryer to dry the dress.**
Set the dryer on low and hold it at least 6 inches from the wet fabric. Keep the fabric taut to prevent wrinkling. Use a circular motion with the hair dryer to avoid burning the fabric. Do not try to speed the process by holding the dryer close to the dress; you will only damage the fabric.
- 4 Use the hot-air dryer in the bathroom.**
Do not let the dress drag on the bathroom floor.

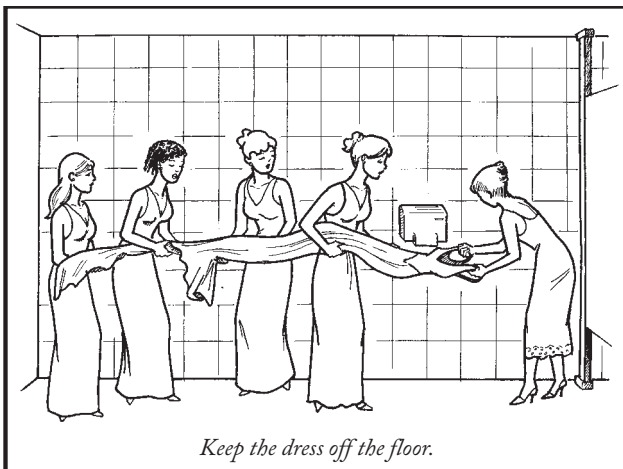

5 Finish with an iron.

Test the iron first on the inside of the dress. Place a pressing cloth on the dress before applying the iron and keep the setting on low.

BROKEN STRAND OF PEARLS

1 Find all the pearls.

2 Put the pearls on a towel or cloth.

Arrange the pearls so that the biggest pearls are in the middle, flanked by pearls of diminishing size.

3 Find a needle and string.

Use dental floss, fishing wire, or nylon thread to restring the pearls. Waxed floss is stiff so it will eliminate the need for a needle. Stiffen the end of fishing wire or a thread with glue if you are without a needle.

4 Make a triple knot on one end of the string.

Add a dab of glue on top of the knot for extra security. Leave extra length on the string beyond the knot for tying.

5 Add a pearl.

6 Make a loose overhand knot.

Place a pin, needle, or tweezers in the open knot and slide the knot next to the pearl. Then pull the knot loop snug as you remove the pin, needle, or tweezers.

7 Add the next pearl.

Keep your knot-tying tension consistent. If time is running out, tie a knot after every five pearls.

8 Repeat steps 5 through 7 until all the pearls are on the string.

Make a triple knot after the final pearl. Add a dab of glue to the knot.

9 Tie the necklace on the bride's neck using a secure square knot.

Dab with glue for added strength. Trim off the excess string.

Be Aware

If the bride's strand of pearls breaks and not enough of the pearls can be located, scan the guests' necks for the best piece of replacement jewelry. Once the most appropriate jewelry has been spotted, ask the

guest to help the bride by lending her the jewels for the big event—or at least for the photographs. Most guests will be flattered to help save the day. Be sure to return the jewelry.

BROKEN HEEL

★ Remove both shoes and go barefoot.

Depending on the length of your dress and the formality of your wedding, going barefoot may be an acceptable option. If you are wearing a floor-length gown, you may need to use straight pins to temporarily hem the dress an inch or two at the bottom to keep it from dragging on the floor and tripping you as you walk.

★ Borrow shoes from others.

Ask a member of the wedding party or a guest with the same size foot if you can wear her shoes for the ceremony. Do not be choosy about style or color.

★ Make an emergency heel.

Find a sturdy object or objects the same height as the broken heel. A shot glass, a stack of sticky notes (so long as it's not raining), or a votive candleholder are acceptable choices. Alternatively, use duct tape to make a cylinder out of several short pencils or metal lipstick tubes. Wrap duct tape around your shoe and the substitute heel to secure it in place.



Be Aware

- A replacement heel is fine for a short period of light activity, but do not dance, run, carry heavy objects, walk more than 10 yards, or stand for long periods of time with your weight on the emergency heel.
- Once the dancing begins at the reception, your guests will be relieved to see that you have removed your shoes. They will feel much more comfortable about taking off their own uncomfortable and restricting shoes and having fun.

EMERGENCY UP-DO HAIRSTYLE

- 1** **Brush your hair back from your forehead.**
Comb it long enough to make the hair on top of your head smooth.
- 2** **Gather your hair at the nape, slightly to the left, as if you were going to put in a low ponytail.**
- 3** **Twist the hair twice, in a clockwise direction, to anchor it in place.**
You can also use bobby pins to hold the hair in place.
- 4** **Brush the remaining hair down toward the direction of the nape of your neck.**
- 5** **Twist it clockwise while lifting the ends.**
You are creating a roll effect on the back of your head.

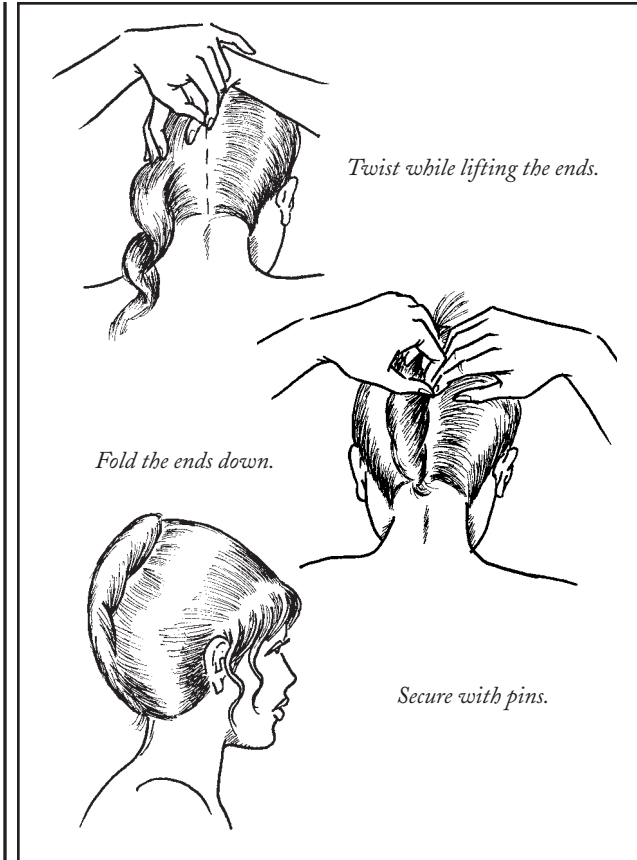

- 6** **Continue to twist until the roll feels tight and secure.**
Your loose ends should be at the top of the roll.
- 7** **With your right hand, fold the ends down toward the nape of your neck, under the twist.**

8 **Pin the roll in place.**

Use your left hand to hold the twist in place while your right hand works the bobby pins. Slide one long pin in the top of the roll, facing down. Place another long pin in the bottom, going up the middle. Insert a final large pin at an angle through the side of the roll. Finish with enough small bobby pins to secure the twist and smooth any ruffled areas.

9 **Pull out a few tendrils.**

Loosen a few strands of hair around your face for a more romantic look. Curl the strands with a curling iron if one is available.

Spray the twist in place with hairspray.

**WORST-CASE
SCENARIO.**

**WORST-CASE
SCENARIO.**

HOW TO FIX THE GROOM'S WEDDING ATTIRE

Tux Too Small



Swap tuxedos.

If your tuxedo matches the style of those worn by the groomsmen or waiter, exchange yours for one that fits: It is better for a groomsman or waiter to look poorly dressed than the groom.



Expand the waistband.

Make a chain of two or three safety pins, depending on how much additional room is required. Secure the sides of the waistband together using pins. Your cummerbund will hide the fix. Do not remove the cummerbund during the wedding.

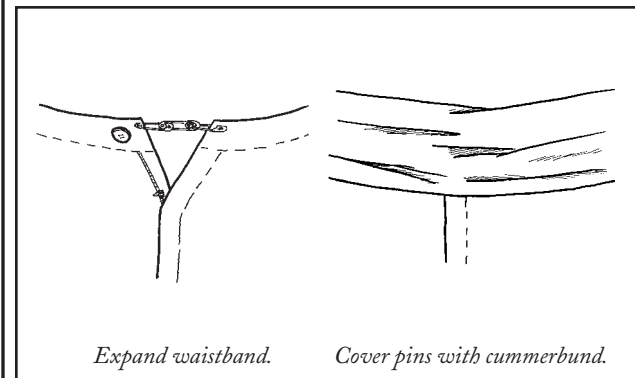

★ **Replace the pants.**
Locate a pair of black pants that fit. Cut a piece of black electrical tape the same length as the pant leg, waist to hem. Cut the tape in half lengthwise. Affix one half on the side seam of the right leg of the pants. Repeat for your left leg.

★ **Keep the jacket unbuttoned.**
Buttoning the jacket will make the improper fit more apparent.

★ **Distract with your cufflinks.**
If the jacket sleeves are too short, make sure your cufflinks are of a high quality. Keep your arms slightly bent at all times to reduce the obviousness of the length disparity.

★ **Expand the shirt collar.**
Loop a rubber band through the buttonhole of the shirt collar. Secure the ends to the collar button. Conceal with a necktie. Do not remove the tie during the wedding.

SPLIT SEAM

1 **Remove the jacket, shirt, or pants.**

2 **Turn the garment inside out.**

3 **Pull the seam together.**
There will be a narrow section of fabric behind the

seam. Pull the split sections together. Line up the sides carefully.

4 **Pin.**
Using safety pins, connect the two sides. Pin the material as close to the seam as possible, but not so close that the pins will be visible from the outside.

5 **Check the repair.**
Turn the garment right-side out. If the seam holds and the pins are not visible, the repair was successful. If the pins are visible, remove and start over.

Be Aware

If no safety pins are available, use staples. Take care when removing them to prevent rips in the fabric. If neither pins nor staples are available, use electrical or duct tape. Fast-drying glue is also effective for repairing torn garments, but may damage or stain the fabric.

LOST BOW TIE

★ **Make an emergency replacement from a cloth napkin.**

- Place a well-starched white dinner napkin flat on a table in front of you. Using a pencil, carefully draw a circle about 1 inch in diameter.
- To the left of the circle, draw a triangle with sides about 2 inches long. One point of the triangle should extend slightly into the circle.

- Repeat, drawing a second triangle to the right of the circle, with one point extending into the circle. Your drawing should look like a bow tie when viewed from the front.

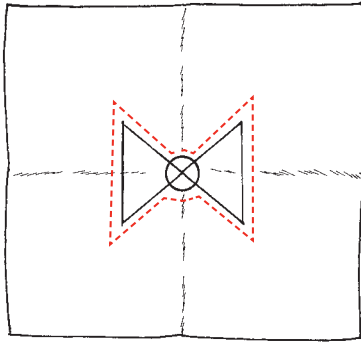

Draw tie pattern on cloth napkin. Cut and remove.

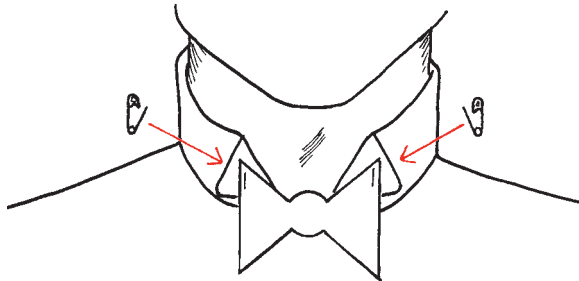

Attach tie, unmarked side out, to collar.

- Use scissors to cut the bow tie from the napkin. Turn the bow tie over so the pencil marks are on the back.
- Secure the cutout to your collar using loops of tape or safety pins. Do not wear with a black cummerbund: Make an emergency napkin cummerbund (see page 68) to match.



Wear a medallion.

Open your shirt at the collar and open three additional buttons. For a more fashionable look, borrow a spread collar shirt (one without a wing collar, which is made for a bow tie). Borrow and wear a large medallion, gold cross, Star of David, giant locket, or flashy pendant. To make a medallion:

- Open a wedding gift wrapped in gold-colored wrapping paper.
- Wrap the gold paper around a drink coaster or a similar-sized piece of cardboard. Cut the paper to fit, then tape or glue to cover.
- Affix your medallion to a black dress shoelace or piece of string with tape.
- Hang around your neck.



Make a bolo tie.

- Thread a black shoelace (leather or nylon) under and around your shirt collar to simulate a bolo lanyard.
- Run the two loose ends through the backing of a pin, pendant, or horizontal tie clasp.
- Slide the clasp up so it sits just below the second shirt button. Keep your collar button open.

EMERGENCY CUFF LINKS

- 1 Remove your shirt.**
- 2 Thread a narrow ($\frac{1}{8}$ - to -inch-wide) ribbon through the cuff holes.**

Leave the cuff open about half an inch. Do not tie the ends.
- 3 Tie knots.**

On the outside of one cuff, tie a small knot on the ribbon as close to the hole as possible. Tie a second knot on top of the first.
- 4 Check the knot diameter.**

Test the knot by pulling gently on the other end of the ribbon. If the knot pulls through easily, tie another knot on top of the first two.
- 5 Trim the ends.**

When the knot is too big to fit through the hole easily, snip the excess ribbon just past the knot. Repeat on the other side of the cuff, then on the other sleeve. The knots may be pushed through the cuff holes after the shirt is on. They will hold the cuffs closed and look similar to braided silk cuff knots.

Be Aware

- Keep the jacket sleeve pulled down as far as possible to hide an unsightly fix.

Emergency Cuff Links

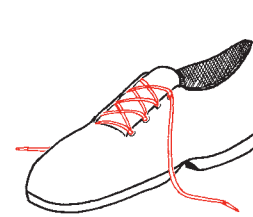

shoelace



cherry stem

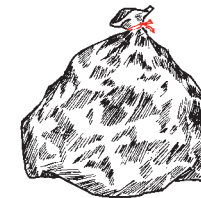

twist tie

- Items that can be used as emergency cuff links:
 - paper clips
 - twist ties
 - rubber bands
 - the metal rings from two key chains
 - large earrings
 - Maraschino cherry stems tied in knots
 - shoelaces (cut short)

EMERGENCY CUMMERBUND

You will need a white cloth napkin for a white-tie wedding or a black or dark blue napkin for a black-tie event, plus a couple additional napkins to secure the cummerbund. The napkins should be starched and slightly stiff.

- 1 Place the napkin flat on a table in front of you, with one corner pointing toward you.**
- 2 Fold the corner closest to you and the opposite corner into the center of the napkin.**
- 3 Fold the bottom half of the napkin up toward the top edge.**
The bottom edge should be about one inch above the top edge when the fold is complete.
- 4 Fold both upper edges down toward the bottom edge.**
The lower of the two pleats should be one inch above the bottom edge. The napkin should now have three

pleats and be the approximate shape of a cummerbund.

5 Secure.

Tightly roll another napkin on the diagonal so it is long and thin. Tie or pin the second (or two more) napkin(s) to one end of the cummerbund, run it around your back, then tie or pin it to the other end. The pleats of the cummerbund should face up. Your jacket will obscure the sides of the napkin, even when unbuttoned.

PREVENT PERSPIRATION STAINS FROM SHOWING

- ★ **Wear an undershirt.**
A thin cotton T-shirt will absorb sweat before it reaches your exterior layer of clothing.
- ★ **Wear perspiration shields.**
Tape several layers of tissue paper, paper towels, or cocktail napkins to the underarm area of your shirt to absorb excess wetness. Do not use colored tissue or napkins because the ink from the dye may stain your shirt when wet.
- ★ **Wear chamois.**
Cut a piece of chamois cloth, the ultra-absorbent cloth often employed for drying and polishing cars, into two 4-inch squares. Tape the squares to the underarm area of your shirt to remain extra dry.



Wear a pantiliner.

Apply a self-sticking pantiliner or other feminine product to the underarm area of the shirt. Make sure you remove the product in private before joining your new spouse after the wedding.

Be Aware

If you discover that the sweat has come through and is visible on your shirt, use a blow-dryer or hot-air hand dryer to dry the wet areas. It is not necessary to remove the shirt first.

**WORST-CASE
SCENARIO.**

WORST-CASE SCENARIO.

HOW TO KEEP THE BRIDE AND GROOM FROM SEEING EACH OTHER BEFORE THE WEDDING

If the bride and groom are already living together, special measures are required to avoid seeing each other before the ceremony on the day of the wedding.

- ★ **Stay out all night partying.**
Since the wedding day—and the start of the prohibition on seeing each other—begins at midnight, one or both should stay out partying all night (at different clubs). The next day, the bride and groom should go right to where they will be married.
- ★ **Stay with the best man and maid of honor.**
Spend the night sleeping at the home of the main support players in the wedding, as long as they don't live together.
- ★ **Establish a schedule.**
Agree on a timetable that prevents the bride and groom from being in the same room at the same time. For example, the groom will use the bathroom at 10:30 A.M. and the bride at 11:00 A.M.



Wear sleep masks.

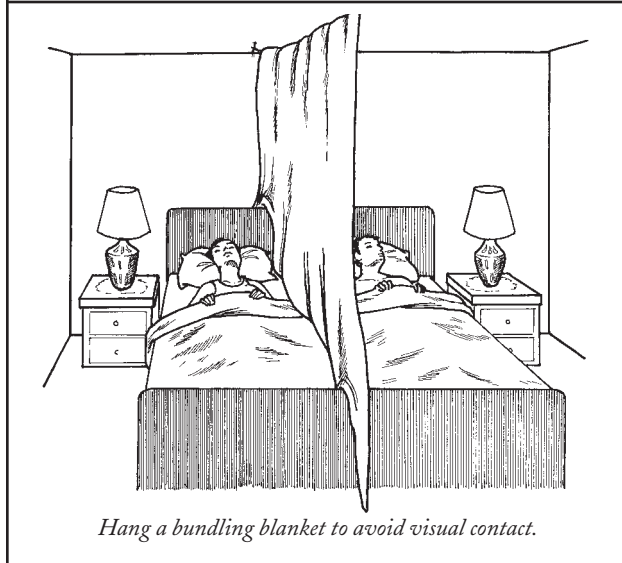

Hang a bundling blanket to avoid visual contact.

- ★ **Stay in different rooms in a hotel.**
- ★ **Stay home and use escorts.**
You should each have a friend stay overnight to guide you and your soon-to-be spouse through the house, checking that the coast is clear before you venture into shared spaces.
- ★ **Maintain mobile phone contact.**
Stay home and in constant communication so your paths do not cross.
- ★ **Wear bells.**
The noise from the bells will warn the other person of your presence.
- ★ **Wear blindfolds.**
- ★ **Hang a divider between you in bed.**
Create a bundling blanket or board by hanging a blanket from a line strung over the bed. Alternatively, attach the blanket to the ceiling, as long as it reaches the bed and provides visual protection.

**WORST-CASE
SCENARIO.**

HOW TO MAINTAIN COMPOSURE DURING THE CEREMONY

CRYING JAG

- ★ **Take deep, measured breaths.**
Inhale through your nose and exhale through your mouth. Deep breathing will calm you and prevent hyperventilation brought on by crying.
- ★ **Stare at inanimate objects.**
Focus on floral arrangements, your clothing, or the floor.
- ★ **Recall trivial details.**
Try to remember the color of your childhood blanket, or the make and model of all the cars you have owned. Attempt to say the alphabet or the months of the year backward.
- ★ **Stand up straight.**
Crying will cause you to bend forward and make your head and shoulders shake. Concentrate on good posture: Keep your back straight and your head held high to combat the physical effects of your emotions.

Be Aware

Crying at weddings tends to be contagious and mutually reinforcing. Do not look at others who are crying or you may lose control.

LAUGHING FIT



Bite your tongue.

Bite down on your tongue hard enough to cause pain but not so hard that you cause bleeding or other injury.



Prick your finger.

Using the pin from your boutonniere or a thorn from a rose in your bouquet, quickly stick the pad of your thumb to cause pain. Put pressure on the pricked area for several minutes to avoid bloodstained clothing.



Pinch yourself.

The skin on the back of the upper arm is very sensitive. Squeeze a small section of skin between the thumb and index finger of your opposite hand. Release quickly to avoid a bruise.



Think about how much the wedding costs.

HICCUPS



1 Inhale through your mouth.



2 Hold your breath.

How to Avoid a Laughing Fit

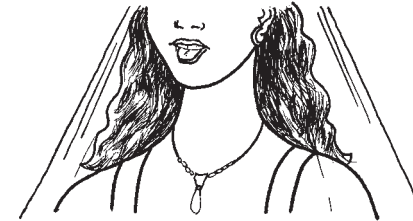

Bite your tongue.



Prick your finger.



Pinch yourself.

- 3** Slowly count to ten.
- 4** Swallow three times slowly.
- 5** Exhale.
- 6** Repeat.

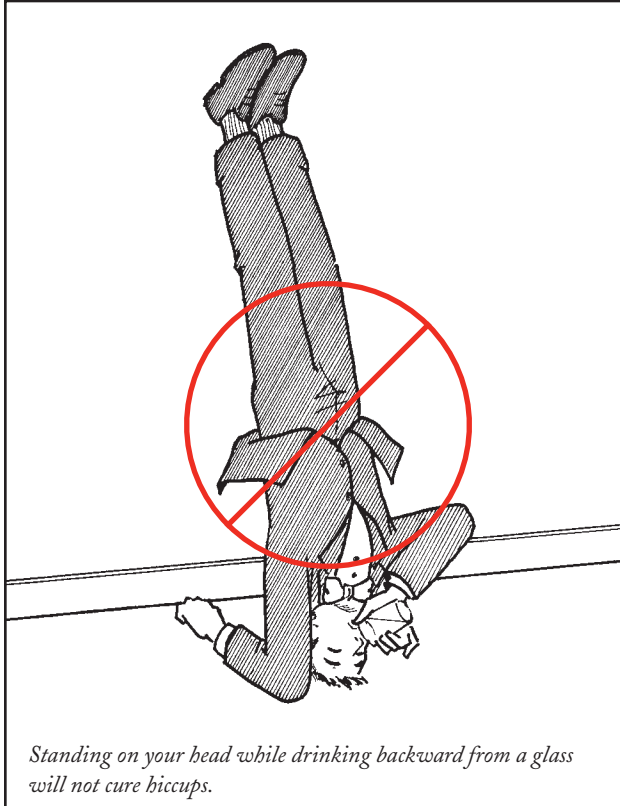

Be Aware

Swallow a flat (nonheaping) teaspoon or one paper packet of sugar in one quick gulp. Do not use a sugar substitute. Do not use salt.

FLATULENCE

- ★ **Alter your stance.**
Flatulence is more audible with the legs and buttocks close together. Shift your position so your feet are approximately 3 feet apart.
- ★ **Sit down.**
- ★ **Shift the blame.**
Look disapprovingly at a nearby guest or member of the bridal party. Do not look accusingly at your betrothed.

Be Aware

- Avoid introducing excess gas into your system. Do not smoke, chew gum, or drink carbonated beverages, and avoid beans, broccoli, cabbage, cauliflower, onions, and dairy products (if lactose intolerant) just before the ceremony.
- Chew activated charcoal tablets before the wedding. The charcoal will absorb odor caused by intestinal bacteria. Do not chew briquettes.

WORST-CASE SCENARIO.

HOW TO MAKE AN EMERGENCY GARTER

- ★ **Use a scarf or bandanna.**
- ★ **Use a large cloth hair tie.**
- ★ **Use a headband.**
- ★ **Use a baby's head wrap.**
- ★ **Cut off the top of a turtleneck**
Pull it on over your leg.
- ★ **Use a large rubber band.**
Tape tissue paper to it to make it more attractive.
- ★ **Use tape.**
Attach adornments to it with more tape.
- ★ **Make a chain of twist ties.**
Wrap around your leg and fasten the ends.
- ★ **Use a silk stocking.**
Cut off the foot and roll the stocking into the shape of a garter. Make a pretty bow with excess fabric.

WORST-CASE SCENARIO.

HOW TO MAKE YOUR BETROTHED'S PARENTS LIKE YOU



Be direct.

Have a conversation about your feelings. Start with, "I've noticed a change in our relationship, and I was wondering if I have done something to offend." Talk about the issue from your point of view. Use phrases such as "I feel this" as opposed to "you did this" so they will not feel attacked. Listen carefully and remain open to criticism.



Be nice.

Remain pleasant and respectful, and you will eventually wear them down. Be patient, as this might take some time.



Arrange for testimonials.

Ask friends, relatives, and neighbors to vouch for your value as a human being when your future in-laws come to visit. Leave information packets on their pillows that include letters of recommendation from coaches, employers, teachers, and religious and community leaders. Include a pie chart that expresses the amount of time you devote each day to your future spouse.



Volunteer your services.

Help with household tasks such as changing the kitty litter, caulking the tub, or walking the dog at the crack of dawn. Take them to the airport at rush hour, teach your betrothed's younger siblings how to drive, install their new computer system, re-point the brick exterior of their home, prepare their tax returns, refinish the floors throughout their house, and detail their car.



Find a common bond.

If your in-laws dislike you because they do not know you, invite them out together or separately on outings they enjoy. If your mother-in-law likes tea, ask her to tea. If she prefers the theater, take her to a play. Take your father-in-law golfing, or if he's a man of few words, to the movies or a nightclub. Pick up the tab.



Plant a diary where your in-laws will be sure to find it.

Fill the diary with virtuous thoughts and aspirations. Declare your love for your betrothed repeatedly. Add entries about how much you like your future in-laws and how much you hope they'll like you, too.



Pretend you are friends with celebrities.

Find out who their heroes are (politicians, authors, activists, sports figures, movie stars, etc.) and autograph and frame a glossy photo of a celebrity to yourself. Mention to your future in-laws you might be able to pull a few strings if they'd like to meet the famous person.



Pay for the wedding.

If you or your family are already paying for the wedding, offer to pay off their mortgage or car payments.



Let them move in.

Give them the big bathroom.



Promise to provide them with a grandchild within a negotiated period of time.

HOW TO RAISE MONEY FOR THE WEDDING

- ★ **Ask family members to pay for specific expenses.**
Have numbers ready to justify costs. If you sense resistance, threaten to elope or to have the reception at a seedy nightclub. For grandparents, offer upgrades at the reception in exchange for funding, such as seating at a table far from the band, their food served first, or wider, cushioned seats.
- ★ **Register for wedding ceremony and reception components.**
Instead of a bridal registry for china, crystal, and silver, register for floral arrangements, the band, limousine service, liquor for the reception, and each course of the meal.
- ★ **Hold a raffle.**
Offer the guests a chance to buy tickets to win the wedding dress, a ride in the limo, or a chance to join the honeymoon.
- ★ **Wash guests' cars.**
Hire a student at a low hourly rate to sell expensive car washes to the guests as they attend the ceremony and reception.

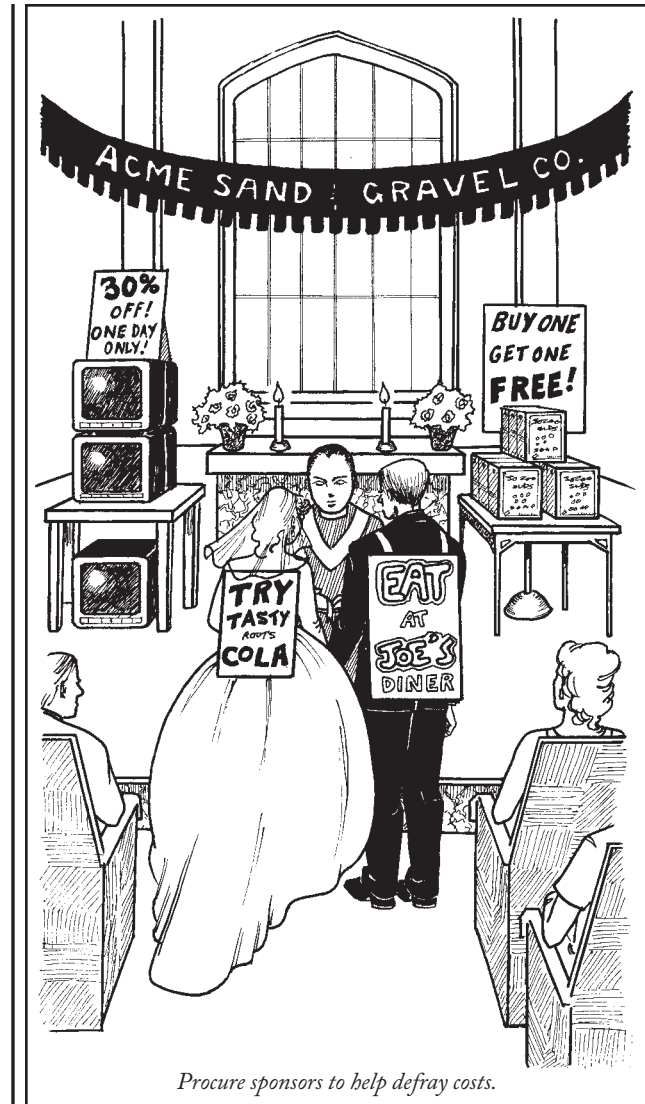

★ **Sell your belongings on Internet auction sites.**

Check to see which items you've registered for have been bought, or estimate which items you are sure to receive, and sell them online. The buyer will send payment, and, after the wedding, you send the sold item.

★ **Procure sponsors.**

Strike a deal with a local company. Agree to place its logo on the invitation, wedding dress, tuxedo, or cake. Have the band leader announce each song with, "This song has been brought to you by the good people at *[name of company]*." Hang company banners around the altar and behind the bandstand. Allow the company to set up a kiosk at the ceremony and reception site to dispense information, key chains, and other swag.

★ **Sell incentive packages to investors.**

Offer a percentage of wedding gifts, naming rights to kids, occasional dinners at your home, an invitation to the wedding (with preferred seating), the first dance with the bride/groom, and, for enough money, the opportunity to give away the bride.

**WORST-CASE
SCENARIO.**

WORST-CASE SCENARIO.

HOW TO REPAIR A DROPPED CAKE

MINOR SHIFTING OR SMASHED FROSTING

- 1 Smooth out rough edges with confectioners' sugar or chopped coconut.**
- 2 Reconstruct with icing or whipped cream.**

Damaged portions of a white cake may be built up and out using small amounts of buttercream or whipped cream. Apply with a spoon or butter knife. For a cake with chocolate frosting, mix slightly melted chocolate with confectioners' sugar to form a paste, then spread over the damaged area and cover as above.
- 3 Hide damage to the side of the cake with paper doilies.**

Cut several long strips from a paper doily: The strips should match the height of the damaged layer. If necessary, use clear tape on the side that will be touching the cake to connect multiple sections. Wrap the doily around the layer and secure with small dabs of frosting. Remove the doily before serving.
- 4 Use fruit or nonpoisonous flowers to hide repairs.**

Roses, pansies, and daisies are all nontoxic and attractive. Avoid lilies of the valley, calla lilies, and wisteria, all of which are poisonous. Place two or three large

strawberries over damaged areas, with several others around the cake to visually balance the repair.

MAJOR DAMAGE

- 1 Set aside any undamaged layers from the dropped cake.**
- 2 Replace damaged layers.**

Depending on the shape of the cake, locate rectangular or round boxes that approximately match the size of the damaged layers. Hat boxes work well for round cakes.
- 3 Place real cake layers on box layers.**
- 4 Poke wooden skewers or thin dowel rods through all the layers.**

Cover holes with frosting. The rods will prevent the layers from sliding, especially in warm weather.
- 5 Cover exposed sections of boxes with frosting as you would an actual cake.**

Add flowers or other flourishes to match the existing cake.
- 6 Prepare to move the cake directly after cutting.**

Once the first cut has been made, the cake should be taken immediately into the kitchen and the real layers sliced sparingly.

Major Cake Repairs

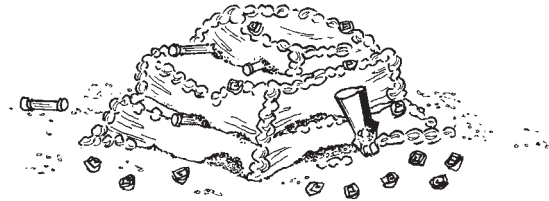

Assess damage.

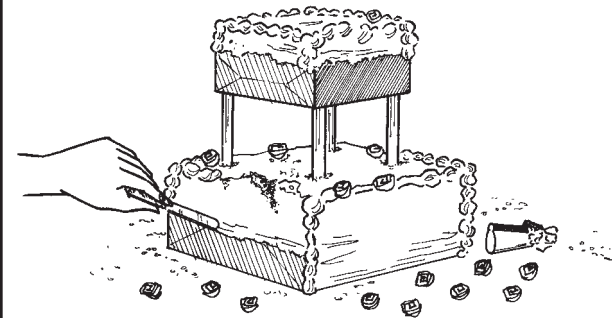

Re-frost.

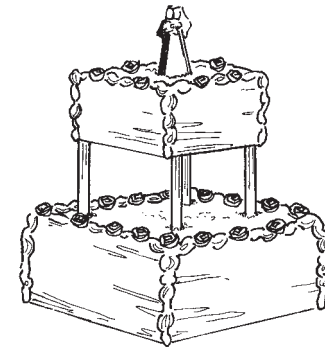

Place bride and groom.

Be Aware

- If the top layer of a tiered cake is damaged beyond repair, completely remove it and all support pillars, then repair remaining sections, making the next-to-the-top layer the top.
- If time permits, the caterer or pastry chef could bake or purchase a last-minute sheet cake. Serve that instead.

**WORST-CASE
SCENARIO.**

HOW TO REPURPOSE UNWANTED GIFTS

If an undesirable gift is monogrammed, handmade with nowhere to be returned, of an unknown origin, used before a better version arrived, from a relative who will ask about the gift when visiting your home, from a store that will no longer accept it as a return, or from a store that is no longer in business, you will need to find a way to put it to use in your home.

★ Candlesticks

- Place under your bed to keep sagging mattress firm.
- Use as lipstick holders on a crowded vanity.
- Use as paper clip holders on a desk.
- Use as tall saltcellars on the dining room table.

★ Bowl

- Use as a litter box. Make sure it is stable.
- Use as a sock bin.
- Use as a potty chair.

★ Blender

- Use as a flower vase.
- Use as a paper shredder.

★ Flower vase

- Use as a pen/pencil holder near a phone.
- Use as a beer mug or water glass.

★ Crockpot

- Use as a wax warmer for depilatory waxing.
- Use as an ice bucket (unplugged).
- Use as a planter for tropical plants (plugged in).

★ Gardener's wheelbarrow

- Use as a shopping cart.
- Use as a laundry basket.
- Use as a stroller for a baby.

★ Ironing board

- Use as a toboggan.
- Use as a table.

Be Aware

Even if you do not like the gift, you must still send a thank-you note. Thank the giver for the gesture and thoughtfulness. See the Gift Evaluator/Thank-You Note Generator on page 162.

HOW TO REVIVE A GUEST WHO HAS FAINTED

1 Make room around the victim.

Cool, fresh air will help to revive the guest. Do not crowd around the victim or obstruct her breathing or airway. Do not move her to another location.

2 Elevate the victim's legs.

Prop the guest's legs up on the seat of a chair or several hymn books to encourage blood flow to the head.

3 Assess the victim's breathing.

Get on your hands and knees. Observe the victim's chest: Make sure it is rising and falling rhythmically. Place your hand 2 inches above victim's nose and feel for breath. If the victim is not breathing, instruct someone nearby to call for help, then continue.

4 Check the victim's wrist for a pulse.

With your right hand, clasp the back of the victim's wrist so that your index and middle fingers lie gently over base of the palm, closer to the thumb than the pinky. Do not use your thumb to measure a pulse: The thumb can register your own pulse and mask the victim's. If you detect a pulse, skip to step 6.

5 Check for a neck pulse.

Kneel behind the victim's head so that you are looking down at her face. Using the index and middle fingers of your right hand, gently place your fingers under the victim's chin to the right of her Adam's apple. Using a watch with a second hand, count the victim's heartbeat for 15 seconds. Multiply the number of beats by 4 to determine the number of heartbeats per minute. If the victim's pulse is greater than 120 or less than 50, call for help and begin CPR. If the pulse is normal, continue to step 6.

6 Wait.

Most people faint from excessive heat, a sudden surprise, overwhelming emotion, or fatigue and will come to on their own without treatment.

7 Mop the victim's brow with a cold, wet napkin.

8 Reposition the victim once she regains consciousness.

When she revives, help her to a chair and direct her to keep her head between her knees. Administer non-alcoholic drinks in small sips.

Be Aware

Smelling salts, a combination of ammonia and strong perfume, can sometimes be effective in reviving a person who has passed out. However, they should be used only as a last resort. Their noxious odor may cause adverse side effects or toxicological reactions in some people.

WORST-CASE SCENARIO.

HOW TO STOP A BAD TOAST

- ★ **Employ humor.**
Call on the same techniques hecklers use at comedy clubs: loud, insincere laughter; throwing food; and snarky commentary (“Are you going to finish this toast by their first anniversary?”). Acting drunk may also help.
- ★ **Cue the band.**
Ask the wedding planner or an esteemed family member to tell the band leader to interrupt with rousing music to drown out the toast.
- ★ **Wait for a pause, then execute the “slow clap.”**
Start a loud, slow clap—approximately one clap per second. After about 15 seconds, others will join in, until the entire room is clapping for the toast maker. Continue clapping until he leaves the stage.
- ★ **Talk over the toast.**
Grab another microphone from the band or deejay and say, “Thanks so much for those warm wishes. Let’s move on and _____ [*fill in blank with ‘raise a toast,’ ‘cut the cake,’ ‘dance,’ ‘hear from Grandpa’*].”

★ **Ask the maid of honor to give the toast maker a big kiss.**

A passionate kiss in front of everyone will bring cheers and silence the speaker.

★ **Interrupt the toast maker with a bear hug.**

Cover the toast maker with an emotional hug while taking the microphone out of his hands and say, “Thank you so much for your kind words.”

★ **Create a distraction.**

Tilt your chair and fall over backward, begin a fire at your table with candles and napkins, or drop and smash the centerpiece—any action that will derail the speaker.

Be Aware

- Schedule toasts to take place before or at the beginning of dinner. Do not wait until the cake cutting when many guests have had the opportunity to consume alcohol during cocktail hour, dinner, and dancing.
- Set a limit of three or four toasts—never have an open microphone. If other friends wish to make toasts, schedule them to take place at the rehearsal dinner.

**WORST-CASE
SCENARIO.**

HOW TO SURVIVE A HONEYMOON DISASTER

EXTREME SUNBURN

1 Expose damaged skin to air.

Remove all clothing around the burn area: Clothing will irritate the burn site and may cause increased pain.

2 Drink water.

Drink at least 32 ounces of water to help promote sweating, which cools the skin.

3 Apply a cold compress.

Put ice in a plastic bag, wrap in a cotton T-shirt or other fabric, and apply to the burn area. If the burn area is very large, soak a bed sheet in ice water and apply it instead of a compress. Let the skin cool under the compress for 15 minutes to help reduce pain.

4 Apply a soothing gel or ointment to the burn area.

Carefully rub a cooling aloe lotion into the burned area. This is especially soothing if the aloe has been chilled in a refrigerator or a bucket of ice. Do not apply suntan lotion, baby oil, petroleum jelly, or any other foreign substance to the burn.

5 Take pain medication.

Ibuprofen will help reduce pain at the burn site.

6 Lie still.

Lie in a position that best exposes your sunburn to the air without coming into contact with the bed, your clothing, or another person. Do not bend sunburned joints.

7 Continue with your honeymoon.

Take advantage of loose-fitting island fashions as your sunburn heals.

Be Aware

Depending on the severity of the sunburn, a new layer of skin will replace the burned area in two days to two weeks.

MIGRAINE HEADACHE

1 Dim the lights.

Bright lights may exacerbate a migraine or prolong symptoms. Keep the shades drawn and the room lights off or very low.

2 Reduce noise levels.

Turn off the radio and television. The room should be silent, or with soothing “white” noise such as that created by a small fan.

Disaster Honeymoon

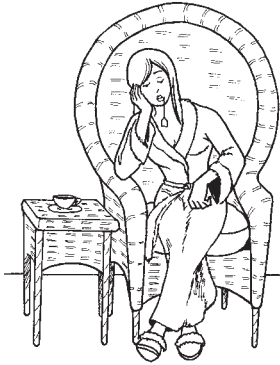

Tongue injury.



Migraine headache.



Extreme sunburn.

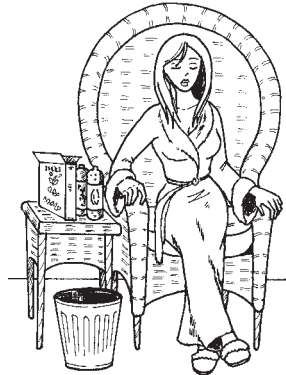

Food poisoning.

3 Limit movement.

Running, walking, and even climbing stairs may increase the intensity of a migraine.

4 Eat vitamin-rich foods.

Magnesium and vitamin B2 (riboflavin) may combat migraine symptoms. Spinach, Swiss chard, and many nuts are high in magnesium, while mackerel, shad, and other oily fish are rich in riboflavin.

Be Aware

A migraine may last as little as one hour or as long as three days.

ACUTE TONGUE INJURY

1 Prepare a tea bag.

Soak a tea bag in warm water for 2 minutes. Let it stand 1 minute at room temperature, then wrap it in gauze or a clean cloth napkin.

2 Apply tea bag to tongue.

Place the moist tea bag on the injury site and press steadily. The tannic acid in the tea is a natural coagulant and should stop the bleeding. The tongue has a large number of blood vessels near the surface and will bleed profusely until the blood coagulates.

3 Rinse.

Swish and spit using an anesthetic mouthwash, if available.

4 **Apply a numbing agent.**

Apply ice to the wound to numb and reduce pain.

5 **Avoid acidic and salty foods and liquids.**

Acidic substances, such as citrus fruits and vinegar, and those high in salt, such as nuts and potato chips, may aggravate the injury.

6 **Keep the tongue still.**

The tongue will heal more quickly if it is inactive.

7 **Protect the tongue.**

Wear an athletic mouth guard to protect the tongue until the injury heals.

FOOD POISONING

1 **Stay hydrated.**

Drink several gallons of water a day.

2 **Replenish mineral salts.**

Nibble on dry salted crackers or plain rice to replace salt lost through diarrhea.

3 **Do not induce vomiting.**

Vomiting will not remove the bacterial culprit, but will cause dehydration.

Be Aware

- Do not drink the water when traveling to the tropics or when you are unsure of its cleanliness. Avoid ice cubes in drinks, brushing your teeth with tap water, opening your mouth in the shower, or swallowing—or even rinsing your mouth with—water in swimming pools or the ocean.
- Only eat fruit that you can peel yourself. Avoid all vegetables and fruits that could have been washed in contaminated water, or fruits (like melons) that might have been soaked in water to increase their size and weight.
- If you don't know what it is, don't eat it.

HOW TO SURVIVE IF SOMEONE OBJECTS

- 1 Laugh it off.**
Smile, laugh, and keep things moving.
- 2 Make a joke.**
If the protester persists, loudly exclaim, “Mom, it’s going to be all right,” or “I thought we were serving the liquor after the ceremony!”
- 3 Turn the crowd against the protester.**
Say “This is the most important day of our lives, and we ask that you honor it with us.”
- 4 Direct the best man to handle it.**
If the guest continues to object, the best man should approach her, tell her quietly that she is disrupting the ceremony, and escort her out or to a side room, giving her the attention she craves.
- 5 Consider the objection in private.**
If the protester might have a legitimate objection (the groom is currently married to her), the best man should tell the bride, groom, and officiant, who should all discuss the matter before the ceremony continues.

Be Aware

The consent of guests is not required for the marriage ceremony to be completed.

**WORST-CASE
SCENARIO.**

HOW TO SURVIVE IF THE BAND DOESN'T SHOW UP

★ Round up street musicians.

If the reception is taking place in a city, you can also send a member of the wedding party into the subway to find musicians.

★ Call a local music school.

Send a member of the wedding party to ask for musicians who can arrive quickly. Tip them generously.

★ Play the radio.

Position a member of the wedding party at the controls of a boom box. Instruct your guests to use their mobile phones to call the radio station to make requests and dedications to the happy couple. Be prepared to change stations when necessary to avoid commercials and sad ballads.

★ Buy a CD player.

Send a member of the wedding party to purchase a CD player from a nearby electronics store. Ask guests to bring CDs from their cars.

★ Solicit musical volunteers from the crowd.

Hold a talent show, with the wedding party acting as judges.

★ Form a jug band.

Ask guests to blow across the tops of jugs of wine or whiskey. Others can bounce sets of spoons on their leg or torso. Pots and pans from the kitchen can be beaten with spoons or other cutlery. Others can play hambone, slapping thighs, chest, and face as a rhythmic accompaniment.

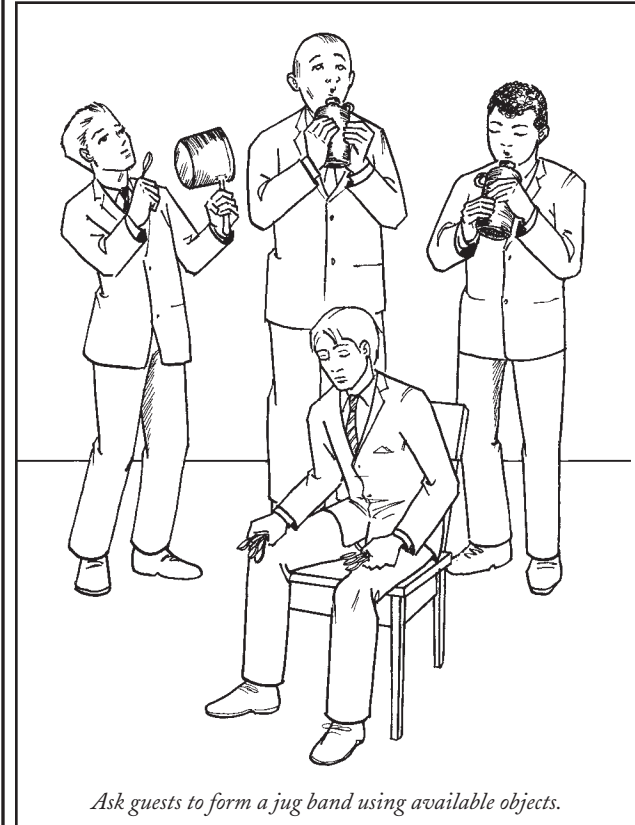

Ask guests to form a jug band using available objects.

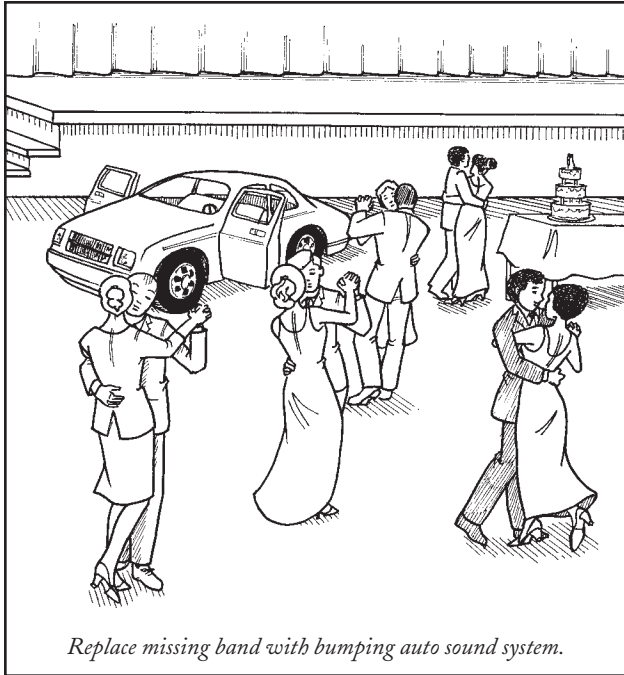

**WORST-CASE
SCENARIO.**

- ★ **Drive a small car into the reception room.**
Select a car with a premier sound system, open the car doors, and blast CDs.
- ★ **Borrow band members from other wedding receptions and events.**
Search the facility for band members on break or who have finished performing and put together a new band for your wedding.

HOW TO SURVIVE IF THE BRIDE'S GOWN IS LOST

★ **Make a dress from a tablecloth.**

- Remove a white tablecloth from table and cut a hole in the middle.
- Drop it over your head.
- Cut two more holes for your arms.
- Cut around the entire hem of the tablecloth to produce a sash. Tie this around your waist.

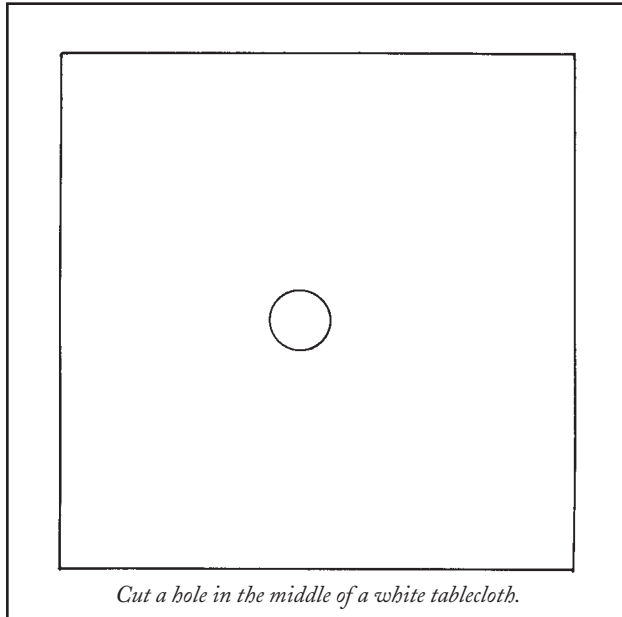

★ **Make a matching sheet bandeau-top and floor-length skirt.**

- Cut a sheet, tablecloth, or curtain into two pieces, with one piece about a third of the cloth and the other the remaining two thirds.
- Tie the smaller piece around your chest and tie it in the back. Adjust the width of your top by folding the fabric to suit before tying and securing. Another option is to bring the fabric from back to

front and make a knot at your sternum. Then twist the remaining fabric to reduce its bulk, bring the ends up and around your neck, and tie a second knot at the nape.

- For your skirt, take the remaining, larger cloth and tie it around your waist, knotting it at the front or side. A side knot will look more demure and bridal. Cut off excess length and quickly baste the bottom seam by bringing a threaded needle up through the fabric, then down and up again, at $\frac{1}{4}$ -inch intervals.

★ **Make a sheet ball gown.**

- Take an entire sheet and tightly wrap it once around your torso so that the top edge is level with your arm pits. Use safety pins to pin it vertically from the top to mid-thigh to secure it close to your body.
- Wrap the remaining fabric around you again as many times as there is fabric. Pin again vertically where the fabric ends so that the bottom of the sheet rests just above the toes.
- Use scissors to cut a vertical slit from the floor to the back of your knee so you can walk. Baste each edge of the cut fabric so the seams don't fray.
- Pin flowers or decorative appliqué elements taken from hats and handbags onto the dress to hide the safety pins. If anyone asks about your dress, tell them you got it at an exclusive bridal trunk show from a hot new couture designer.

Sheet Bandeau-top and Skirt

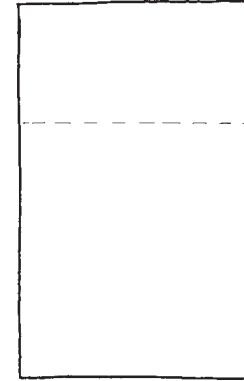

Cut.

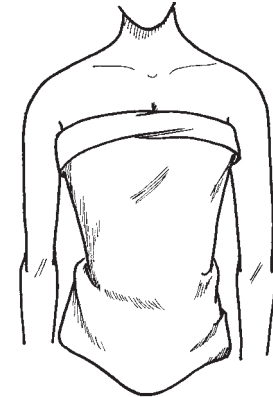

Finished top, front.

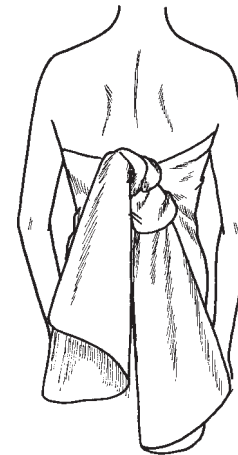

Finished top, back.



Finished gown, full view.



Make a tissue paper dress.

- Scavenge through wedding presents for white wrapping tissue paper.
- Tape or tuck tissue paper to your underwear or slip to create a floaty, layered look. Use the tissue from several packages for maximum demureness.
- To give the dress appealing detail, use scissors to make one inch vertical cuts to the tissue paper for fringe.



For a more casual or beach wedding, make a kicky, terry-cloth towel dress.

- Wrap a white towel around your torso.
- Cut off any overlap and sew the towel together from top to bottom.
- Safety pin white shoelaces from sneakers or casual shoes to the towel to fashion spaghetti-style straps for your dress.



Take a bridesmaid's dress.

Select the bridesmaid who is closest to you in size. Take her dress and soak it in bleach to make it white. Inform her gently that she is out of the wedding.

**WORST-CASE
SCENARIO.**

HOW TO SURVIVE IF THE FLOWERS DON'T ARRIVE



Use fruit.

Stack seasonal fruits in glass vases: cherries and navel oranges for spring weddings, strawberries and blueberries for summer, apples for autumn, or holly and pinecones for winter.



Borrow flowers.

Good hotels will have beautiful, ornate floral arrangements in the lobby area, in public spaces and sitting areas, and in the bar/restaurant. Dressed in your wedding attire, approach the manager to explain your situation. Tip generously.



Borrow from another wedding in the hotel or reception hall.

Ask someone in the other wedding party if you can use flowers from that wedding. Do not be choosy—don't decline some arrangements because the colors are wrong or you don't like them—and don't approach the bride and groom, since they probably will be busy.



Knock on neighbors' doors.

Explain your situation to people in nearby houses. Ask to borrow flowers from their gardens and construct bouquets and small arrangements.

Tissue Paper Flower

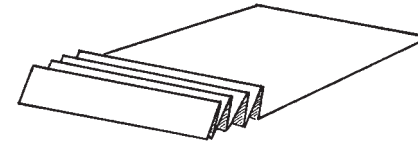

Fan fold sheets.

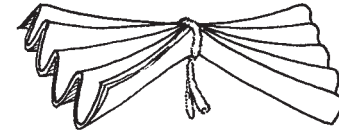

Tie at center.

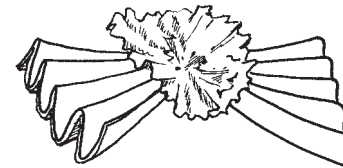

Pull each sheet toward center.



Fluff.



Make flowers from tissue paper.

- Stack three sheets of 6-x-12-inch tissue paper. Each piece should be a different color. If you don't have tissue paper on hand, open a few gifts—most will include tissue paper in the box.
- Make a 1-inch-wide fold up from the bottom (shorter) edge of the pile, then continue fan folding the sheets to the top edge.

- Fold a pipe cleaner or twist tie in half. Place the tissue paper inside the fold of the twist tie, then twist the ends together just under the sheets. The pipe cleaner or twist tie will act as the stem of the flower (you may need two twist ties to achieve the proper length).
- Fan the tissue pieces out, then carefully pull up each crease, starting with the top layer and continuing with the next two to form the petals of the flower. Fluff the paper to add volume.
- Repeat.



Borrow from a nearby cemetery.

Scout out graves with very large headstones, monuments, or other elaborate markers, which are likely to have more impressive arrangements. Find a fresh arrangement at a location with no one around. Before taking the flowers, take careful note of the grave's location so that you can return them after the wedding.

Be Aware

- If the flowers are severely drooping or nearly dead, re-cut the stems and place them in cool water. Make a 45-degree cut at least an inch from the bottom of the stems and remove all leaves and thorns below the water level. Add half a teaspoon of sugar to the vase to keep the flowers fresh; use lemon-lime or other clear soda if sugar is not available. Do not use cola. Then use a well-shaken bottle of sparkling water to spray the petals and

leaves with water. Avoid club soda, which contains sodium.

- Virtually all flowers dislike drafts, whether hot or cold. Keep arrangements away from doors, open windows, air conditioning and heating vents, and radiators.

HOW TO MAKE AN EMERGENCY BOUQUET

You will need 5 long pencils or pens, invisible tape, 5 colorful neckties, scissors, and curling ribbon from several large wedding presents.

1 Prepare a pencil or pen.

Wrap a piece of tape around the eraser-side of each pencil, with the sticky-side of the tape facing out. Secure the tape in place with another piece of tape so it will stay at the top of the pencil.

2 Roll a necktie into a rosette.

Affix the skinny end of the tie to the sticky tape at the end of the pencil. Tightly roll the tie over on itself, around the pencil, forming a tie rosette. As you continue to roll toward the thicker end of the tie, be sure to keep the top edge straight so the spirals create a rosette.

3 Secure the end with tape.

When you've run out of fabric, secure the end of the tie in place with a piece of tape.

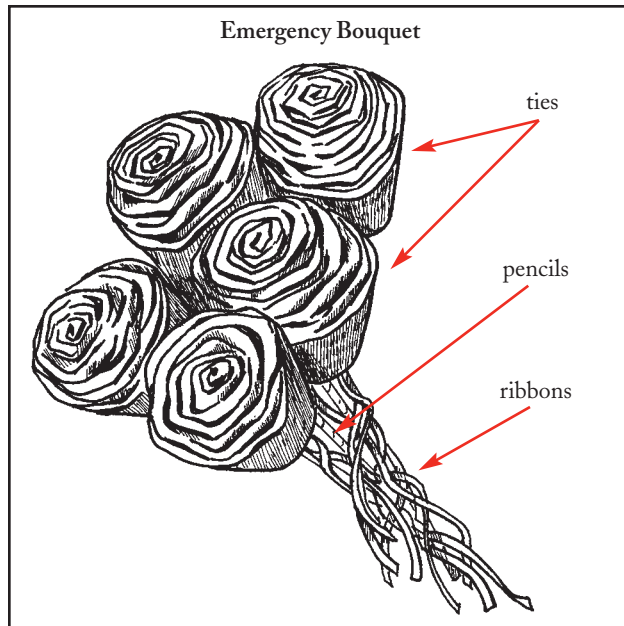

4 Repeat steps 1 through 3 with the remaining pencils and ties.

5 Tie the “flowers” together with ribbon.

Construct a bouquet by fashioning all of the tie rosettes into a makeshift bouquet. Wrap the pencils with several long strands of curling ribbon and tie a knot to hold them together. Allow some of the curly ribbon to hang low for a pretty effect.

Be Aware

For a more demure bouquet, cut the ties in half for smaller rosettes.

**WORST-CASE
SCENARIO.**

WORST-CASE SCENARIO.

HOW TO SURVIVE IF THE OFFICIANT DOESN'T SHOW UP

- ★ **Call for a substitute.**
Inquire at other rectories and churches for an available officiant.
- ★ **Inquire among guests if there is a judge or person “of the cloth” in the house.**
- ★ **Ordain a friend.**
Select someone who has a flair for drama and is comfortable with public speaking. Visit the Universal Life Church Website (www.ulc.org) or the Spiritual Humanist Website (www.spiritualhumanism.org). Instantly ordain your friend as a minister.
- ★ **Use an impostor.**
Select a wedding guest or passerby who looks the part of your officiant. Have him or her perform the ceremony. After the reception, complete a civil ceremony to make your union official.

Be Aware

Sea captains only have the authority to perform marriages on board a ship at sea.

HOW TO SURVIVE IF YOU FORGET YOUR ANNIVERSARY

- ★ **Order an emergency bouquet.**
Many florists can assemble arrangements with little notice. If you have just minutes to prepare, scour your neighborhood flowerbeds for daisies. Wrap them in colorful ribbon and present them as your initial gift.
- ★ **Buy chocolates.**
Most supermarkets and drugstores carry chocolate assortments. Choose a tasteful boxed set rather than several loose candy bars tied with ribbon.
- ★ **Create a voucher card.**
Prepare a card or piece of paper that shows the wonderful gift you're giving but can't give now because it isn't ready yet. Draw a picture of the gift on the card or paper.
- ★ **Apologize, apologize, apologize.**
If you're caught with nothing, making excuses will not help your case. Your level of contrition should be so extreme that your spouse begins to feel bad because you feel so terrible.

- ★ **Give an intangible present.**
Give her a homemade certificate for a weekend spa getaway. It could be for her only, or for a romantic weekend for both of you—a “second honeymoon” (but don't push your luck). A week free of household chores, a weekend of breakfasts in bed, or getting her car detailed are other possibilities.

HOW TO SLEEP ON THE COUCH

- 1 Remove the back cushions.**
If the couch has loose back cushions, take them off to add more width to the sleeping surface.
- 2 Remove the arm cushions.**
Side cushions take up precious head and leg room, and will just end up on the floor in the middle of the night anyway.
- 3 Fluff and flip.**
If the sofa design permits, remove the seat cushions, fluff them, then flip them so the side that was down is now the top. This will provide a more even sleeping surface.
- 4 Cover the seat cushions with a sheet.**
The sheet will protect your face from odors trapped in the cushions and will protect the seating area from saliva.

First Anniversary



Tenth Anniversary

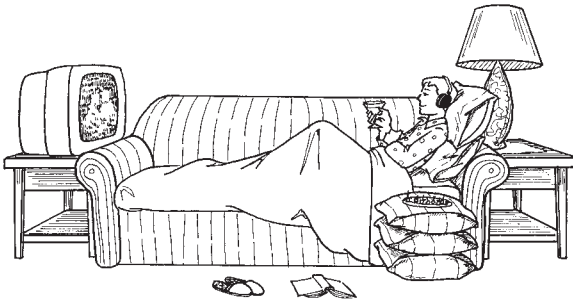

5 Use your usual pillow.

You will sleep better with your head resting on a familiar pillow. Get yours from the bedroom, if the bedroom is still accessible to you.

6 Depending on the temperature of the room and your comfort level, get a sheet, blanket, comforter, or large towel to put on top of you.

7 Relax.

Do not to go to bed angry.

Be Aware

If you are an active sleeper, lay the sofa cushions next to the sofa to break your fall should you roll off during the night.

HOW TO SURVIVE THE BACHELOR PARTY

HOW TO PICK A LOCK (WHEN HANDCUFFED TO A BOWLING BALL)

A classic bachelor party prank uses a bowling ball and handcuffs to translate literally the expression “the old ball and chain.”

1 Locate a pick.

A handcuff lock can be picked relatively easily with a piece of metal bent into the shape of a key. Whatever you use, the material must be resilient because the springs on a handcuff lock are strong. Use any of the following items:

- Mini screwdriver
- Large paper clip
- Any tough wire (e.g., chicken or piano)
- Small fork
- Hairpin

2 Bend a few millimeters of one end of your pick 90 degrees.

3 Insert the pick into the lock.

Fit the bend into the lock at the point where the nipple of the key fits. You will feel the bend move into place.

4 Turn the pick to open the lock.

Turn the pick left and then right. If the pick won't move, put the latch end of the handcuff vertically on a hard surface and press down. This may relieve a bit of pressure off the lock and make it easier to turn. Be careful, though: Pushing too hard may lock the cuff another tooth and restrict your hand movement.

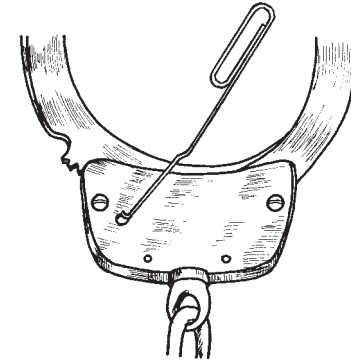

Insert the tip of the pick into the lock.

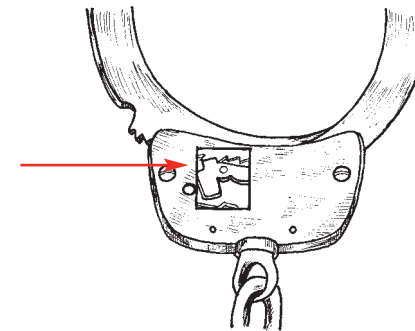

Turn the pick left and right to move the latch and unlock the cuffs.

HOW TO SMOKE A CIGAR

1 Clip the head.

The head, or smoking end, of the cigar is covered by a small area of leaf called the cap. Using a sharp cigar cutter, quickly make a guillotine cut, removing a small section ($\frac{1}{4}$ inch or less) of the cap. Do not cut below the end of the cap, or the wrapper may come apart. If no cigar cutter is available, punch a hole in the cap using the tip of a pen or pencil.

2 Hold the cigar in your nondominant hand.

3 Ignite a torch lighter or a long wooden match.

Do not put the cigar to your lips.

4 Toast the end.

Carefully move the flame to the foot (end) while rotating the cigar slowly. This will ensure an even burn. The foot should ignite thoroughly and evenly.

5 When the foot is lit, bring the cigar to your lips.

6 Draw smoke into your mouth.

Suck the smoke through the cigar slowly and evenly while still holding the flame an inch or two from the foot.

7 Puff gently until the foot is completely lit.

Do not inhale the smoke into your lungs.

8 Exhale.

Savor the flavor of the cigar in your mouth for a few seconds before expelling the smoke.

9 Repeat steps 7 and 8.

Take one or two draws from the cigar per minute, but do not rush. Rotate the cigar slowly in your fingers or allow it to sit in an ashtray between draws. Keep the foot elevated to maintain an even burn. Avoid squeezing the cigar.

Flick the ash.

Allow half an inch to an inch of ash to accumulate on the foot. Tap the cigar gently with a finger to make the ash fall. Many cigar smokers will try to get the ash as long as possible before flicking it. However, you should flick the ash if you feel it is about to fall and burn a hole in clothing or furniture.

Extinguish the cigar.

Many smokers will discard a cigar when half to three-quarters has been smoked. A quality cigar may be smoked as long as its flavor is still pleasing and the smoke is cool enough to be comfortable in your mouth.

Be Aware

- A *natural*—a cigar with a light brown wrapper—is mild and is more appropriate for beginners. (A *maduro*, or a cigar with a dark brown wrapper, will be rich and full flavored, but may be too harsh for a novice smoker.)

- The wrapper should not be dry, flaking, or crack when handled.
- Gently squeeze the cigar. It should be firm and give lightly to the touch, then regain its shape. A moist cigar has been overhumidified and will not draw well.
- While it may be socially frowned upon, a cigar may be extinguished and relit. Scoop or blow all carbon from the foot of the cigar before relighting, or cut the cigar just above the burned section.

**WORST-CASE
SCENARIO.**

WORST-CASE SCENARIO.

HOW TO SURVIVE THE BRIDAL SHOWER

HOW TO MAKE A TOILET PAPER DRESS

Most bridal showers include group games. A game that the bride and her guests are often asked to play involves breaking into groups and dressing several models in toilet paper to see who can create the best bridal gown.

- 1 Construct the bodice.**
 - Unwrap a roll of toilet paper around the model's midsection, beginning at her waist and wrapping around her torso, in overlapping layers, until she is wrapped to just underneath her underarms.
 - Without detaching the paper, make a small sleeve by wrapping from underneath one of her arms to over and around the opposite shoulder. Repeat over the other shoulder to give the dress a slightly off-the-shoulder neckline.
- 2 Make the skirt.**
 - Tape the free end of a fresh roll to the waist on the dress's bodice, unrolling a strip long enough to reach the floor (or your desired length—a short dress can also be nice, especially if your model is wearing a mini skirt or shorts).
 - Tape the next piece to the waist of the dress, overlapping to about the middle of the first strip. Unroll to meet the length of the first strip.

- Repeat in this way until you've taped strips the whole way around the model's waist.
- A staggered effect, with strips of different lengths, can earn extra points for creativity.

3 Make a belt.

Unroll several layers of toilet paper directly around the model's waist, to cover the area where the skirt is taped to the bodice of the dress.

4 Make the veil.

- Unwrap about four feet of toilet paper.
- Fold it in half, so that it's two feet long, and then in half again.
- Now fold it lengthwise several times, until you have a fairly sturdy, thick strip to use as a headband. Tape the sides of the headband to secure it.
- Tape several three- to five-foot-long strips of toilet paper to the headband. The length of the strips can be adjusted to suit your preference.
- Use bobby pins to secure the veil to the model's head.

HOW TO MAKE A BOW BOUQUET

As the bride unwraps her presents, a member of the wedding party is responsible for making a bow bouquet for the bride to carry at her wedding rehearsal. You will need a paper plate; a pencil, pen, or other long skinny object; tape; and bows and ribbons from gifts.

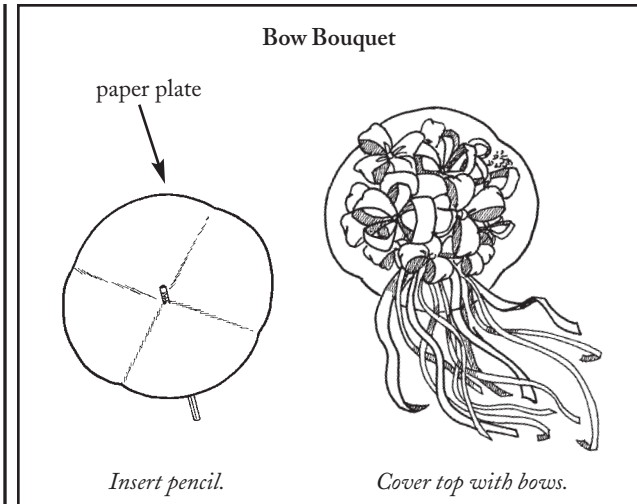

1 Make the base.

Fold a paper plate in quarters, then unfold. (The folds in the plate will provide the bow bouquet with volume.) Insert the pencil, pen, or other long skinny object into the center of the plate, push it through so that only about an inch shows through the top, and tape it in place at the top and bottom.

2 Build the bouquet.

As the bride unwraps her gifts, take each bow and ribbon and tape it on top of the plate. Place smaller bows in the center, and larger bows on the outside. Wrap long, curling ribbons around the pencil, allowing them to hang down from under the plate. If the bride has a lot of presents, layer the bows as necessary. Be sure to use all of the bows and ribbons.

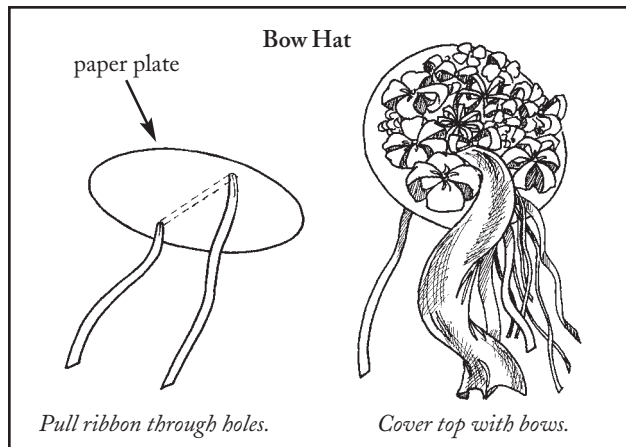

Alternate Method:

In some cases, the bows and ribbons from the bride's gifts are used to make a bow hat rather than a bouquet. To make a bow hat:

- Poke a hole about half an inch from the edge of a paper plate. Repeat on the opposite side.
- Thread a thick, wide ribbon through one of the holes, tying a knot at the end on top of the plate to keep it from slipping out. Repeat on the opposite side, leaving the bottom ends loose to tie the hat to the bride's head.
- Tape bows and ribbons to the top of the paper plate so that the largest bows are around the outside edge, the smallest in the center. Attach all long ribbons to hang down from the back of the hat.
- Tie the hat to the bride's head with the two wide ribbons at the sides. Laugh. Cry.

**WORST-CASE
SCENARIO.**

WORST-CASE SCENARIO.

HOW TO SURVIVE THE FIRST DANCE IF YOU HAVE TWO LEFT FEET

- 1 Warm up.**

Get comfortable moving together. Before the first dance, find a quiet space and move around the room in sync. Hold hands and move together in simple side to side and back and forth steps.
- 2 Dim the lights.**
- 3 Tell the band leader to keep it short.**

Inform the band of the name of your song and that you want it to end quickly. Two minutes are plenty.
- 4 Hold each other.**

Lean lightly into your partner from the center of your body. Keep your knees soft. The groom should place his hand on the bride's shoulder blade with his fingers parallel to the floor. The bride should place her hand on the groom's right shoulder. The couple's arms should maintain contact. Make sure your legs are offset so that each foot has its own "track" to move along. The groom's chin should line up with the bride's right shoulder.

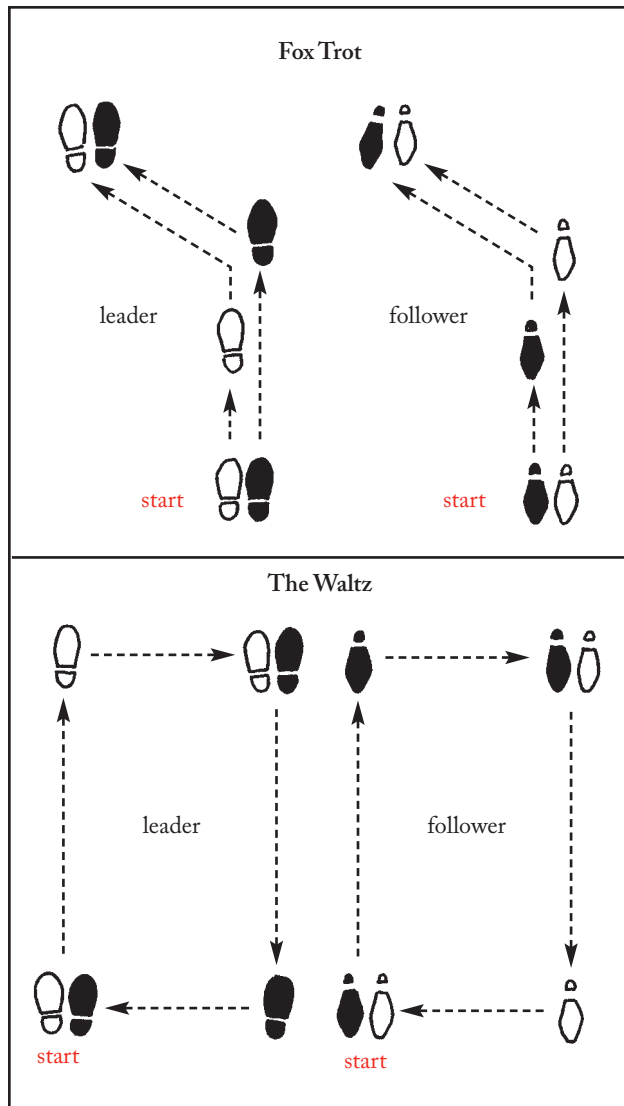

- 5 Do not rush.**
When the music starts, sway from side to side for a moment to feel the music. Then, on the beat, begin.
 - 6 Attempt a basic fox trot or waltz.**
See diagrams for each step on opposite page.
 - 7 Whisper and laugh.**
Appear to be conversing, enjoying yourselves, and joking. People will assume any missteps are the result of merriment rather than poor dancing ability.
 - 8 Distract the audience with a dip.**
A flashy dip will focus attention on what you can do instead of what you cannot. The groom should rotate the bride sideways rather than leaning over her in the dip, both to increase the drama and for increased safety. The bride should not give the groom her entire body weight to support, and he should not dip the bride so deeply that she cannot engage her abdominal muscles to support herself.
 - 9 Arrange for someone to cut in.**
Have the bride's father and the groom's mother cut in after 30 seconds, or fewer if you are severely challenged.
- Be Aware**
- Footwork is not that important, nor visible with a long wedding gown. You may improvise steps once you know the basics.

- Apply petroleum jelly to the surface of the instep of men's patent leather shoes so they will glide if they make contact.
- If you get rattled and lose the beat, recover by moving from side to side for a few moments until you both recover.
- Select a fast-tempo dance so you don't have to move together.
- Do not tango.

**WORST-CASE
SCENARIO.**

HOW TO SURVIVE THE RECEIVING LINE



Slow line

- Ask a member of the wedding party to leave the line and quietly tell a slowly moving person that someone in the other room very much wants to meet her now, then lead the slow-mover away.
- Instruct the band to relocate nearby and play very loudly so guests cannot be heard over the music and will not stop to talk.
- Insert a sweaty sous chef into the line.
- Instruct the caterers to serve food and beverages but not to get too close to the receiving line. If someone leaves the line, do not let them back in.



Chatty guest

- If a guest remains for too long, look over his shoulder, smile, and reach out your hand or cheek to greet the next guest in line, or say you will stop by the guest's table later to talk more.



Kiss on lips

- Position your face so that you are clearly offering your cheek for an air kiss.
- If a guest appears determined to make lip contact, recalculate the angle by using your ear as the target for his or her lips and turn your head sharply at the last second. Throw your arm around them to make the diversionary maneuver seem like a hug.

Dodging a Kiss



Calculate angle of approach.

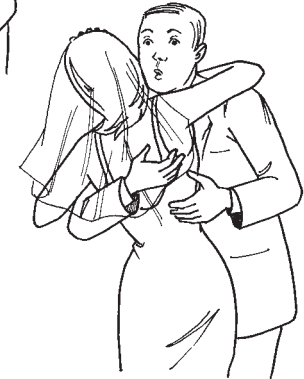

*Turn at last second.
Throw arm to hug.*

- If you know from past experience that a particular guest will lean in to kiss your lips, begin to move toward each other and then fake a cough or sneeze. When the guest momentarily pauses, rapidly move your cheek beside their cheek, completing the air kiss.
- Always keep your lips together, just in case a guest does surprise you with a direct hit.

★ Avoid a hand that's been sneezed on

- A bride should wear formal gloves in the receiving line to avoid germs from outstretched hands.
- Reach out and wrap one or both arms around the guest in a gracious hug.

★ Long bear hug

- Pat the hugger on the back. Continue increasing the force of the pats until you are released.
- Stomp on the hugger's foot. Once the hugger releases his clinch, apologize for losing your footing.
- Put your hands against the hugger's chest, stomach, or waist—whatever you can access—and push back. Do not go below the belt.
- Feign a fainting spell and transfer your total body weight onto the hugger for him to support. This will force him to recalculate his balance and give you the opportunity to step back.
- Cough in the hugger's ear.
- Give in and enjoy the moment.

★ Cheek pincher

- As the pincher approaches, drop your purse or pretend your watch fell off and quickly bend over to retrieve the object.
- Give a deep bow or curtsy, as is gender appropriate. This will result in the pincher missing his mark. Quickly turn to the next guest in line.

★ Ex-lover of spouse

- Use the “crusher” handshake. As your hand closes around your spouse's ex-lover's hand, add your other hand and exert maximum force. Smile. Grooms should not attempt if the ex is bigger and stronger.
- Pretend she is so unimportant that you do not even recognize her. Blandly say, “So nice of you to come,” and briskly move on to the next person.

★ Face tired from smiling

- Turn away from your guest and do some facial exercises to loosen cramping muscles and relieve tension. Grimace fiercely, then release the expression and open your mouth and eyes wide. Slide your jaw from side to side, curl your lips around your teeth to stretch the muscles around your mouth. Use your thumbs to press under your brow bones to release tension. Turn back around and resume smiling.

HOW TO TREAT A PANIC ATTACK

1 Realize that you're panicking.

Panic begets panic. Do not panic about panicking. Tell yourself that you are not dying or going crazy, but experiencing an anxiety attack. This awareness will prevent the attack from escalating.

2 Loosen your clothes.

Do not tear off your dress or jacket. Open a few buttons; lower a zipper.

3 Control your breathing.

Prevent hyperventilation by slowing your breathing. Breathe into a paper bag to restore a balance of oxygen and carbon dioxide in your lungs.

4 Distract yourself.

Focus on a physical object in the room. While breathing into the bag, close your eyes and try to recall the location and colors of all the objects in the room.

5 Act natural.

Open your eyes. Stop using the bag. Refasten zippers and buttons. Walk. Try to smile. Tell yourself it's over and everything is fine.

6 Resume your activities.



Be Aware

- An attack usually lasts between 15 and 30 minutes. Symptoms include pounding heart, sweating, dilated pupils, trembling, dry mouth, shortness of breath or sensation of being smothered, feelings of being choked, chest pain, nausea, dizziness, sense of being detached from oneself, and fear of losing control or going crazy.
- Knowing that you can conquer the attacks will sharply reduce their occurrence. Conversely, knowing that you are prey to attacks and cannot control them may sharply increase their occurrence.

HOW TO AVOID A NERVOUS BREAKDOWN BEFORE THE WEDDING

★ Ignore minor irritations.

Avoid driving at rush hour, upgrading your computer software, dealing with a governmental agency, thinking about your job, rooting for any sports team, undertaking a plumbing project, or listening to the local news.

★ Imagine yourself in a relaxing situation.

As you visualize, hold onto something tactile—a lucky rabbit's foot or your grandmother's favorite handkerchief. Hold it again later to restore your sense of calm. If you do not have a soothing object when the panic begins, conjure up safe and peaceful images.

★ Practice yoga.

Find a quiet room and close door. Dim the lights.

- Tree pose. Stand with your feet together. Draw your left foot up your right leg until it rests on your inner thigh. Put the palms of your hands together and raise them over your head. Balance and remain still. Lower your leg and repeat with the other side.
- Child's pose. Get on your hands and knees and sit back so that your bottom touches your heels and your chest is resting on your thighs. Keep your arms alongside your body with your fingers close to your ankles and your cheek on the floor. Rest.
- Corpse pose. Remain on the floor. Turn over on

Stress-Reducing Yoga Poses



tree pose



child's pose

your back. Rest your arms and legs flat on the floor. Close your eyes and relax every muscle. Do this for as long as it takes, but for at least 5 minutes. Do not fall asleep. Get up slowly when you feel calm, or when it is time to walk down the aisle.

★ Laugh.

Rent videos of musicals from the 1930s, 1940s, and 1950s, especially those with Gene Kelly and Fred Astaire.

★ **Go to sleep early the night before the wedding.**

Even if you cannot sleep, at least your body will be resting. Do not plan the bachelor or bachelorette party for the night before the ceremony.

★ **Eat and drink.**

Make sure you eat on the big day, even if you do not feel hungry. Avoid caffeine, alcohol, and gassy, bloating foods. Remain hydrated. If you are prone to fainting, drink some juice, sugary soda, or a shot of grappa (for courage) before walking down the aisle.

★ **Elope.**

Be Aware

If something goes wrong, keep in mind that it will make for a hilarious story at anniversary parties.

**WORST-CASE
SCENARIO.**

HOW TO TRIM THE GUEST LIST

1 Determine your budget.

Decide the maximum amount of guests you can afford to invite or who will fit at the wedding site.

2 Make lists.

The bride, groom, and respective parents each should make a list of people to invite.

3 Strike as many people as you can from your own list.

4 Remove unnecessary names from someone else's list.

Take turns striking one name at a time from the list of the person sitting to your right. If that person objects to the removal of the potential invitee, invoke the "two strikes" rule and find an ally to vote against the would-be guest. Remove contested names that have two votes against them. (There are variations on the rule that grant people paying for the entire wedding greater voting power: Their vote for removal counts as three votes, and the names on their list are untouchable.)

5 Compile a master list.

Combine the remaining names and organize them by category: wedding party, work contacts, relations, friends, parents' friends, college friends, others. Each person at the table should rank each person within a

category by importance, as determined by the answers to the following questions:

- How often have we seen this person in the last year?
- Did he really seem glad to see us?
- If I invite this person, will I be obligated to invite his spouse or friends?
- How much power does this person hold over me?
- How rich is he and will he use his wealth for good gifts?
- Will he seem impressive to my friends?
- Is he good looking? Will he improve my wedding photos or video?
- Can I handle the fallout if I do not invite him?

6 Agree in advance what the cut-off level will be.

Remove entire categories. Decide no kids, no work-related people, no relations beyond first cousins, no dates for singles, no redheads.

7 Remove people below a certain rank.

8 Create barriers to attendance.

Make it impossible for large numbers of people to attend.

- Hold the wedding in the middle of the week.
- Hold the wedding at a distant location (Antarctica, tiny Pacific island).
- Require formal attire or elaborate, expensive costumes.
- Hold the wedding at an inconvenient time (2 A.M.).

9 Recalculate the list.

Estimate how many people each barrier will knock out. If your list is still too large for your budget, continue to step 10.

Alternate knocking people off the list.

Only the bride and groom (advice from parents is acceptable) take turns removing individual names from the master list until they reach the desired number of guests. If this process becomes too heated, proceed to the next step.

Play Rock, Paper, Scissors.

The winner of each round can eliminate a name or add someone back onto the list.

Be Aware

- Send out the invitations six to eight weeks before the event. As you get negative responses, send out your “B list” invitations to people who didn’t make the cut. Stop sending invitations out a month before the wedding date; last-minute invitees will realize their status and be insulted.
- Manage expectations among potential guests. Let it be known that you plan on a small wedding so that no one is really expecting to be invited. If an invitation arrives, the invitee will be deeply flattered, but those who are not invited will not be hurt—at least that’s the theory.

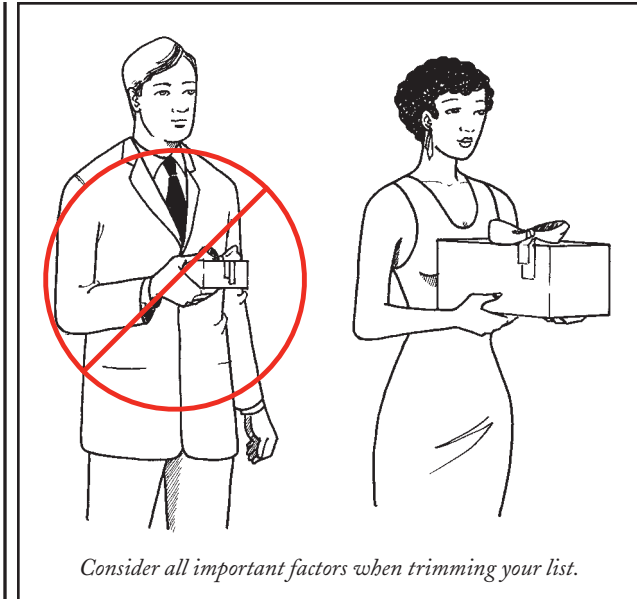

- You are expected to include spouses, fiancés, or long-term live-in companions of your guests. If a guest is only casually dating, you are not obligated to extend an invitation to his date.
- If you forget to invite someone, the next time you see them act annoyed with them for not sending back the RSVP card.

THE EXPERTS

Sherry Amatenstein is the dating columnist at iVillage and the author of *Love Lessons from Bad Breakups* (www.luvlessons.com). She lives in New York.

Kristi Amoroso owns Kristi Amoroso Special Events (www.kristiamoroso.com), a wedding planning, event design, and production management company serving Napa, Sonoma, San Francisco, and the Bay Area.

Liz Applegate, Ph.D., is a faculty member of the Nutrition Department at the University of California, Davis, and the author of several books, including *Eat Smart, Play Hard* and *Bounce Your Body Beautiful: 6 Weeks to a Sexier, Firmer Body*.

Sharon Ashe, along with her partner, Paul Overton, has been helping couples prepare for their first dance for almost a decade. Their North Carolina-based company, Now You're Dancing (www.nowyouredancing.com), was founded on the idea that dancing at your wedding can be fun and easy for everyone involved.

Karen Boehne is a second-generation dry cleaner with more than 37 years of experience in the field. She is a graduate of the International Fabricare Industry general dry-cleaning course and is currently the president of Minnesota Cleaners Association. Boehne cleans, restores, presses, and preserves wedding gowns at Wedding Gown Care Specialists (www.WeddingGownCareSpecialist.com) in New Hope, Minnesota.

Gloria Brame, Ph.D., M.P.H.H.S. (www.gloria-brame.com), is a clinical sexologist in private practice and a member of the American College of Sexologists. She lives and works in Athens, Georgia.

Jennifer Brisman is president of jennifer brisman weddings newyork, inc (www.theweddingplanner.com).

Byron Burge owns Advanced Air Solutions (www.advancedairsolutions.com), a company specializing in air filtration and purification systems, which supplies smoke and odor removal equipment to private homes, restaurants, cigar stores, smoking clubs, and other commercial establishments throughout the world.

Sharlene A. Caldwell is co-owner of White Glove Event Production, LLC (www.whitegloveep.com), based in Roanoke, Virginia. She and her business partner, Caroline Hammond, have varied experience, including work in the fields of advertising, fashion, and catering, which has equipped them with unique insight that has made their company one of the area's top firms.

Phyllis Cambria has been a wedding and event planner for more than 20 years. Her advice has appeared in *The Knot*, *Weddingpages*, and numerous other bridal publications. Together with her partner, Patty Sachs, she co-wrote *The Pocket Idiot's Guide to Choosing a Caterer* and *The Complete Idiot's Guide to Throwing a Great Party* and co-owns WeddingPlansPlus.com.

Sally Lorensen Conant, Ph.D., operates Orange Restoration Labs, the largest gown preservation service in New England. She is the administrative vice president of the Association of Wedding Gown Specialists (www.WeddingGownSpecialist.com/emergencygowncare.htm), a not-for-profit trade association of cleaners in the United States, Canada, and Australia who specialize in cleaning heirloom textiles of all types. Often featured in wedding books and magazines, Conant is recognized by the Association of Bridal Consultants as a "Master Wedding Vendor."

Tracey Ellenbogen, M.S.W., L.C.S.W., runs Calling All Brides, a stress management workshop for brides who are overwhelmed with the stress of wedding planning and preparing for marriage. She is a licensed psychotherapist in private practice in Bala Cynwyd, Pennsylvania.

Robbi Ernst III is a wedding planner, wedding consultant, and the founder of June Wedding Inc. (www.junewedding.com), an association for event-planning professionals. He is the author of *Great Wedding Tips from the Experts*.

Leslie Hafter, a mother of two, has been making gum wrapper rings, necklaces, and bracelets for 25 years. She lives in suburban Philadelphia.

Richard Hafter, D.D.S., is a dentist in private practice in Hammonton, New Jersey.

Caroline Hammond is co-owner of White Glove Event Production, LLC (www.whitegloveep.com), based in Roanoke, Virginia. She and her business partner, Sharlene A. Caldwell, have varied experience, including work in the fields of advertising, fashion, and catering, which has equipped them with unique insight that has made their company one of the area's top firms.

Seth Haplea, M.D., is a neurologist in private practice in Chadds Ford, Pennsylvania.

Tobias Haslam-Hopwood, Psy.D., is a licensed clinical psychologist and an assistant professor in the Menninger Department of Psychiatry at the Baylor College of Medicine in Houston, Texas.

Melisa W. Lai., M.D., is emergency medicine attending physician at Mt. Auburn Hospital in Cambridge, Massachusetts, and a fellow in clinical toxicology at the Massachusetts/Rhode Island Poison Control Center.

Sherry Maysonave is president of Empowerment Enterprises (www.casualpower.com), a firm specializing in image and communication, and the author of *Casual Power: How to Power Up Your Nonverbal Communication and Dress Down for Success*.

National Center for Health Statistics, part of the U.S. Centers for Disease Control and Prevention.

Tom Ogren (www.allergyfreegardening.com), a horticulturist who consults for the U.S. Department of Agriculture on the connections between landscape plants and allergies, is the author of several books, including *Safe Sex in the Garden*. He lives in California.

Paul Overton, along with his partner, Sharon Ashe, has been helping couples prepare for their first dance for almost a decade. Their North Carolina-based company, Now You're Dancing (www.nowyouredancing.com), was founded on the idea that dancing at your wedding can be fun and easy for everyone involved.

Melissa Paul is founder and creative director of Melissa Paul LTD (www.melissapaul.com). She is the Philadelphia local expert for theknot.com and contributing editor to *Wedding-pages* magazine and *The Knot Book of Wedding Flowers*. An active member in the Association of Bridal Consultants and the National Association of Catering Executives, she is also co-chair for the Association of Bridal Consultants Greater Philadelphia Branch.

Sarah Phillips, a former gourmet food broker, created the Healthy Oven line of baking mixes. She is the author of *Baking 9-1-1* and runs Baking911.com.

Peggy Post is the author of 10 books on etiquette, including *Emily Post's Etiquette* and *Emily Post's Wedding Etiquette*. Millions seek her advice through monthly columns in *Good Housekeeping* and *Parents* magazines, her wedding postings on WeddingChannel.com, columns in *InStyle Weddings*, and by visiting the Emily Post Institute Website (www.emily-post.com).

BethAnn Schacht, L.M.H.C. (www.thebridalcoach.com), is a life coach and licensed therapist in the Boston area. The unexpected stress of her own engagement led her to explore the emotional journey of getting married, and she now works with brides and couples to refocus the wedding planning around their relationship and personal values.

Brian Shapiro is the third-generation president of the Cigar Factory Outlet (www.discountcigars.com) in South Norwalk, Connecticut, which sells and distributes fine cigars worldwide. His family has been in the cigar business since 1932.

Jodi R. R. Smith has been working with organizations, corporations, educational institutions, and individuals since 1986 to increase their social savvy and confidence levels. In 1996, she founded Mannersmith (www.mannersmith.com), an etiquette-consulting firm that creates and delivers seminars to clients ranging from children to CEOs.

Sasha Souza established her company, Sasha Souza Events (www.sashasouza.com), in 1995, specializing in full-service wedding and event design and coordination. Sasha Souza Events has offices in the Beverly Hills and Napa Valley areas and is a distinguished member and accredited bridal consultant with the Association of Bridal Consultants (ABC) and a member of International Special Events Society (ISES).

Liz Stewart owns Liz Stewart Inspired Floral Design (www.lizflowers.com) in Jacksonville, Florida, and has been designing arrangements for weddings and other events for 16 years. She is also a member of the American Friends of Versailles, a select group of U.S. florists that does floral design at the Chateau de Versailles in France.

Elaine Tse launched her company, Tselaine Jewelry (www.tselaine.com), several years ago and creates distinct lines of handmade jewelry.

Mara J. Urshel is owner/president of Kleinfeld Bridal (www.kleinfeldbridal.com), located in Brooklyn, New York. With 30 years of experience in luxury merchandise, Urshel directs all merchandising, sales, marketing, and advertising at Kleinfeld Bridal. She is the co-author of *How to Buy Your Perfect Wedding Dress*.

The
WORST-CASE SCENARIO
Survival Handbook:
PARENTING

By Joshua Piven, David Borgenicht, and Sarah Jordan
Illustrations by Brenda Brown



CHRONICLE BOOKS
SAN FRANCISCO

Copyright © 2003 by Quirk Productions, Inc.

All rights reserved. No part of this book may be reproduced in any form without written permission from the publisher.

Worst-Case Scenario™ and The Worst-Case Scenario Survival Handbook™ are trademarks of Quirk Productions, Inc.

Library of Congress Cataloging-in-Publication Data available.

ISBN: 0-8118-4155-3

Manufactured in the United States of America

Typeset in Adobe Caslon, Bundesbahn Pi, and Zapf Dingbats

Designed by Frances J. Soo Ping Chow

Illustrations by Brenda Brown



A **QUIRK** Book

www.quirkpackaging.com

Visit www.worstcasescenarios.com

Distributed in Canada by Raincoast Books

9050 Shaughnessy Street

Vancouver, British Columbia V6P 6E5

10 9 8 7 6 5 4 3 2 1

Chronicle Books LLC

85 Second Street

San Francisco, California 94105

www.chroniclebooks.com

© 1999-2007 by Quirk Productions, Inc. All rights reserved.

WARNING

When a life is imperiled or a dire situation is at hand, safe alternatives may not exist. To deal with the parenting worst-case scenarios presented in this book, we highly recommend—in~~st~~ist, actually—that the best course of action is to consult a professionally trained expert. But because highly trained professionals may not always be available when the safety or sanity of individuals is at risk, we have asked experts on various subjects to describe the techniques they might employ in these emergency situations. **THE PUBLISHER, AUTHORS, AND EXPERTS DISCLAIM ANY LIABILITY** from any injury that may result from the use, proper or improper, of the information contained in this book. We do not guarantee that the information contained herein is complete, safe, or accurate, nor should it be considered a substitute for your good judgment, your common sense, or your mother's advice. And finally, nothing in this book should be construed or interpreted to infringe on the rights of other persons or to violate criminal statutes; we urge you to obey all laws and respect all rights, including property rights, of others, even children.

—The Authors

ABOUT THE AUTHORS

JOSHUA PIVEN stayed out past curfew, occasionally skipped class, and was once stuffed into a locker. He still has temper tantrums and avoids brussels sprouts, but is rarely robbed of his lunch money. He is the co-author, with David Borgenicht, of the *Worst-Case Scenario Survival Handbook* series.

DAVID BORGENICHT is the co-author of all the books in the *Worst-Case Scenario Survival Handbook* series, and the co-parent of a beautiful daughter, Sophie. He has survived sleep deprivation, diaper disasters, and airplane mishaps galore. He lives in Philadelphia.

SARAH JORDAN is a National Magazine Award nominee and writer living in Philadelphia with her husband, Jon, and son, Charles. She is a survivor of induced labor, mommy groups, nanny searches, and debates on issues such as tummy time and binky addiction.

BRENDA BROWN is a freelance illustrator and cartoonist whose work has been published in many books and major publications, including *The Worst-Case Scenario Survival Handbook* series, *Esquire*, *Reader's Digest*, *USA Weekend*, *21st Century Science & Technology*, *The Saturday Evening Post*, *The National Enquirer*, and many other magazines. Her work has also appeared in specialized education series, websites, and promotional ad campaigns. Brenda's website: <http://webtoon.com>.

Check out www.worstcasescenarios.com for updates, new scenarios, and more! Because you just never know . . .

ACKNOWLEDGMENTS

Josh Piven thanks the experts for their sage advice and great humor during the writing of the book. May their kids appreciate their wisdom as much!

David Borgenicht would like to thank his editors, Jay Schaefer, Melissa Wagner, and Steve Mockus, for their creative minds and critical eyes; Frances J. Soo Ping Chow for her graphic expertise and hair; and the entire staff at Quirk Books and Chronicle Books for just being there. Above all, he'd like to acknowledge the experts who contributed their knowledge to this work (your efforts will no doubt save the lives of beleaguered parents everywhere), his wife, Suzanne (he really couldn't have done this without HER), and his daughter, Sophie (who taught him everything he knows about parenting—the old-fashioned way).

Sarah Jordan thanks all the pediatricians and parenting experts; she also thanks her family and the team of babysitters—Barbara “Grandma” Jordan, Andrea Torzone, Jessica Capizzi, and Rebecca Kenton—who gave this mom the time to work. Finally, unending gratitude and love go to super-dad and husband, Jon, and adorable research assistant, son Charles.

ABOUT THE AUTHORS

JOSHUA PIVEN stayed out past curfew, occasionally skipped class, and was once stuffed into a locker. He still has temper tantrums and avoids brussels sprouts, but is rarely robbed of his lunch money. He is the co-author, with David Borgenicht, of the *Worst-Case Scenario Survival Handbook* series.

DAVID BORGENICHT is the co-author of all the books in the *Worst-Case Scenario Survival Handbook* series, and the co-parent of a beautiful daughter, Sophie. He has survived sleep deprivation, diaper disasters, and airplane mishaps galore. He lives in Philadelphia.

SARAH JORDAN is a National Magazine Award nominee and writer living in Philadelphia with her husband, Jon, and son, Charles. She is a survivor of induced labor, mommy groups, nanny searches, and debates on issues such as tummy time and binky addiction.

BRENDA BROWN is a freelance illustrator and cartoonist whose work has been published in many books and major publications, including *The Worst-Case Scenario Survival Handbook* series, *Esquire*, *Reader's Digest*, *USA Weekend*, *21st Century Science & Technology*, *The Saturday Evening Post*, *The National Enquirer*, and many other magazines. Her work has also appeared in specialized education series, websites, and promotional ad campaigns. Brenda's website: <http://webtoon.com>.

Check out www.worstcasescenarios.com for updates, new scenarios, and more! Because you just never know . . .

ACKNOWLEDGMENTS

Josh Piven thanks the experts for their sage advice and great humor during the writing of the book. May their kids appreciate their wisdom as much!

David Borgenicht would like to thank his editors, Jay Schaefer, Melissa Wagner, and Steve Mockus, for their creative minds and critical eyes; Frances J. Soo Ping Chow for her graphic expertise and hair; and the entire staff at Quirk Books and Chronicle Books for just being there. Above all, he'd like to acknowledge the experts who contributed their knowledge to this work (your efforts will no doubt save the lives of beleaguered parents everywhere), his wife, Suzanne (he really couldn't have done this without HER), and his daughter, Sophie (who taught him everything he knows about parenting—the old-fashioned way).

Sarah Jordan thanks all the pediatricians and parenting experts; she also thanks her family and the team of babysitters—Barbara “Grandma” Jordan, Andrea Torzone, Jessica Capizzi, and Rebecca Kenton—who gave this mom the time to work. Finally, unending gratitude and love go to super-dad and husband, Jon, and adorable research assistant, son Charles.

INTRODUCTION

Four out of five survival experts agree that the most perilous worst-case scenarios are not the ones that involve wild animals attacking, large machines malfunctioning, or Mother Nature getting angry. Sharks, runaway trains, and avalanches are not the real dangers—humans are.

And of all human beings, those posing the greatest risk are *children*.

This means that *parents* face the greatest dangers on earth. They face them not for the short duration it takes to escape from a car sinking in a river or to leap from building to building, but for years and years, sometimes as long as two decades. Just when parents think they might be getting a grip on dealing with the worst-case situations presented by an infant, the kid is a toddler, and then ten, and then a teen, each age requiring a whole new set of survival skills. This endurance contest; this emotional, physical, and financial marathon; this epic of survival, is parenthood.

For as long as there have been people on Earth, there have been parents and children, and still parenting hasn't really become any easier or less dangerous. Sure, some problems went away when families moved out of caves, but new problems arose when the teenager borrowed the car. As a result, classic child-rearing advice has been outstripped by developments in culture and technology, and also by the evolution of parent-resistant strains of children.

Hence the indisputable need for this survival handbook for you, the parent.

We have approached the subject of parenthood chronologically, beginning with the time your child is born and stopping with the time he or she leaves home (and providing you with ways to ensure your child doesn't move back in). The first section covers ages zero to three, with advice on how to deal with a screaming baby on an airplane, how to babyproof the house, and how to control a stroller in extreme conditions. The next section will help you navigate the years from three to twelve, with step-by-step instructions for removing a wad of paper from your child's nose, retrieving a child stuck in a tree, recapitulating a doll, and surviving a soccer Saturday. The final section addresses the teenage years, including how to survive your child's first date, first driving lesson, musical preferences, and provocative clothing.

The appendix is essential to understanding teenage slang and instant-messaging codes, and also offers a comprehensive list of parental clichés and a concise “the birds and the bees” speech.

As in our previous *Worst-Case Scenario Survival Handbooks*, we've assembled a team of experts to offer guidance. Attorneys, circus clowns, family therapists, chewing gum manufacturers, emergency room physicians, flight attendants, security consultants, and bike racers help us help you determine the course of action, no matter how dangerous or perplexing the situation.

To be sure, there's nothing more rewarding than parenting: To give your child love, to watch your child

develop, to teach skills that will help him or her have a healthy and happy childhood is amazingly fulfilling. To sneak into your child's room after your child has blissfully dropped off to sleep, to listen to the gentle breathing, to watch your child peacefully rest, is truly a joyous moment of parenthood.

This book is for all those other moments, when your child is not asleep.

—The Authors

CHAPTER I

ZERO TO THREE

WORST-CASE SCENARIO

HOW TO BABYPROOF THE HOUSE

- 1 Crawl around on your hands and knees to see the house from your child's point of view.**
Anticipate the things that will interest him.
- 2 Remove all sharp edges.**
Create corner bumpers out of foam or bubble wrap. Protect all hard edges within the child's reach, including coffee tables, end tables, bookcases, televisions, entertainment centers, hard chairs, dressers, bed stands, and desks.
- 3 Protect electrical outlets.**
Use spring-loaded release covers in electrical outlets; plastic slip-in outlet guards can be too easily removed. Alternatively, move electrical outlets higher on the wall, to just below the ceiling, or replace all electrical appliances with battery-operated appliances. Batteries are toxic, however.
- 4 Install window guards.**
Use window guards that prevent windows from opening more than 4 inches. Use the sliding button guard or the lock-and-key guard (which also keeps burglars out, but might prohibit a fast exit in an emergency). Protect low-to-the-ground windows with a hard plastic sheet or soft Mylar coating that prevents a child from shattering the glass. Do not use tilt-out windows

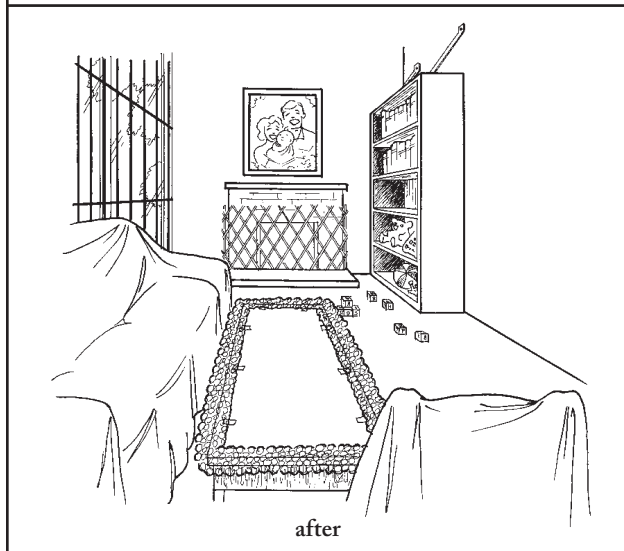
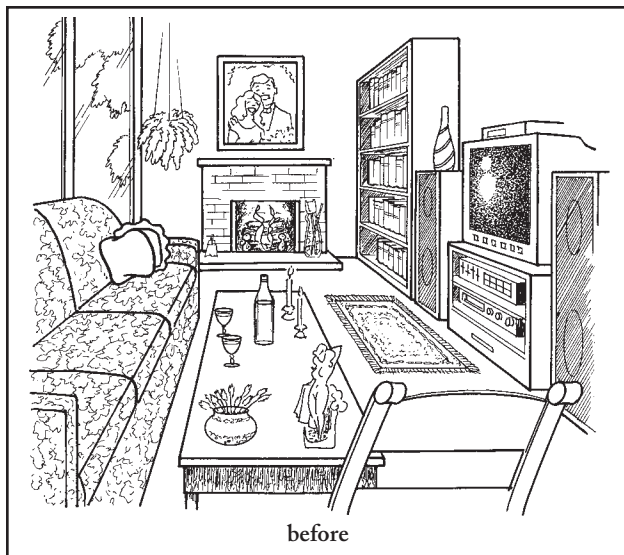

unless windows are kept closed and locked at all times. Alternatively, install bars not more than $2\frac{3}{8}$ inches apart on the outside of windows.

- 5 Install childproof doorknob spinners.**
Deter your child from entering unsafe rooms or closets by covering all doorknobs with childproof covers that will spin loosely when a child attempts to turn the knob.
- 6 Install drawer and cabinet guards.**
To prevent your child from reaching knives in a drawer or cleaning agents under the sink, secure drawers and cabinets with childproof latches.
- 7 Hang towels over the top of doors to prevent the child from slamming the door on his fingers.**
Alternatively, remove all doors.
- 8 Bolt heavy furniture to walls.**
Tall, heavy furniture can be tipped and pulled down by children, especially if they are climbing. Strap or secure bookcases, dressers, cabinets, and televisions. Tape lamps to tables or floors.
- 9 Avoid entanglements.**
Tie up (or down) or remove all curtains, blinds, and cords, especially electrical cords.
- 10 Remove poisonous plants.**
If you are not sure which plants are poisonous, throw them all away. Eliminate hazardous outdoor plants as well as houseplants.

11 **Install baby gates.**

Use gates that are 30 inches tall and have only vertical posts, with a bar top and bottom: Do not use diamond-shaped accordion gates that a child can climb. Place a gate at the top and bottom of a staircase. Keep gates closed at all times, even when the baby is asleep or not home.

12 **Block the fireplace.**

Put a nontoxic plant or fake logs in the grate. Install a gate around the outside of the hearth to prevent the child from approaching the fireplace or from sustaining an injury after hitting the edge of the fireplace. Put away all fireplace tools. Do not use the fireplace for actual fires until the child is older.

13 **Reduce the temperature of the hot water heater.**

Turn the water heater to 120°F or below to prevent scalding.

14 **Install a spout guard over the bathtub spigot.**

Mount foam on the metal faucet to prevent inadvertent head gouging or bumping while bathing.

15 **Install a stove guard.**

Attach a plastic shield in front of your stove's burners to prevent your child from reaching up and overturning pots and pans or burning fingers on hot or flaming surfaces. Affix knob protectors so your child cannot accidentally turn on the range.



16 **Put lid guards on all toilets.**

Do not let the baby watch a dog drink from the toilet bowl.

17 **Line floors with gym mats.**

Cover all flat surfaces with gym mats several inches thick to provide extra padding in case of a fall.

Be Aware

Keep purses and diaper bags, which are repositories for dangerous items and choking hazards, out of the reach of children. Put away guests' bags as well.

HOW TO BOND WITH YOUR TEENAGER

PERFORM AN OLLIE ON A SKATEBOARD

- 1 Position your feet on the board.**

Place your non-dominant foot toward the front of the deck (the wooden part of the board) over the trucks (front axle). Place the foot at a comfortable angle, not quite forward and not completely to the side. Angle your dominant foot across the board at the tail (rear end) of the board.
- 2 Bend your knees.**

Your knees should be slightly bent to help you keep your balance.
- 3 Propel the board slowly forward.**

Remove your back foot from the deck and use it to push on the ground and propel the board forward. Once it begins rolling, put your foot back in place at the rear of the board.
- 4 Slide your front foot back.**

Move your front foot back about six inches, toward the middle of the deck.

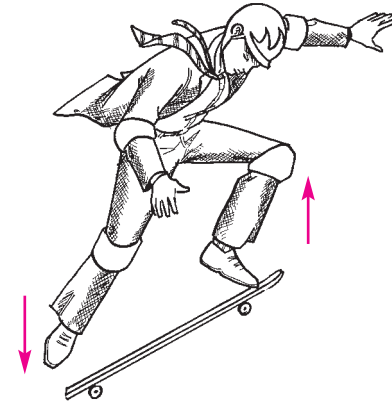

*Kick down hard on the tail of the deck.
The front of the board will rise off the ground.*



Land.

5 Kick the tail down.

Kick down hard on the tail section of the deck, while at the same time lifting your front foot up and springing up off your back foot. The front of the board will rise off the ground.

6 Move your front foot forward.

With the front of the board still in the air, move your front foot forward slightly while airborne. This will raise the tail section and get the skateboard completely off the ground. You may find it easier to simply rotate your front ankle, so the board is pivoting on the outside edge of your leading foot.

7 Stay centered over the deck.

While floating in midair, keep your feet centered over the board, since you will need to be properly positioned to land. Both you and the skateboard will be traveling forward at the same rate of speed, so this is a natural movement.

8 Let gravity take the board back.

The board will land with the wheels down, since the wheels and axles are heavier than the deck.

9 Land on the board.

Bend your knees to help absorb the impact of the landing.

DJ A PARTY

1 Spin the first record.

Select a song with a strong intro to establish the tone for the rest of the set. Place the first record on the left deck (or record player). Move the crossfader all the way to the left, so that channel will play the music. The left deck corresponds with channel one, the right deck corresponds with channel two.

2 Drop the needle.

Put the needle down on your record to play the song for the crowd.

3 Plug in the headphones.

The mixer has a cue input, or a 1/4-inch jack for headphones, that allows you to hear what's coming up next without broadcasting the music over the speakers.

4 Cue up a song.

Select the next track to blend with the song that is now playing through the speakers. Put the new track on the right deck, which will play on channel two, and make sure that the cue is set to play channel two. Hold one headphone to your ear, leaving your other ear free to hear the music playing to the house and to gauge the crowd reaction.

5 Line up eight counts.

Count from one to eight in time with the beats (or bass drum hits) of the song playing over the speaker.

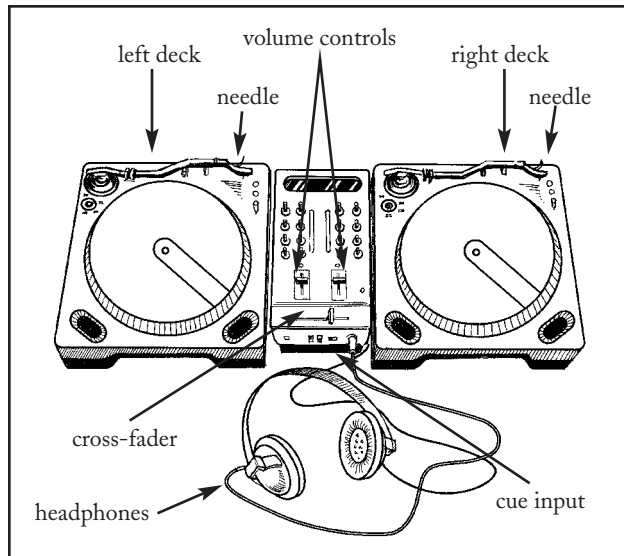

Play the cue song over your headphones, and line up the eight counts so the “1s” match. Use your finger to slow down or start the record on channel two to match the beats.

6 Cross fade into the new track.

The cross-fader is a rectangular slider control located at the bottom of the mixer. It slides horizontally rather than vertically, like the volume controls. Use the cross fader to blend the two channels.

7 Maintain song continuity.

Mixing the two songs at the right place is critical to keeping the crowd involved and dancing. Most dance

songs and DJ remixes have breaks, or areas of the song where the vocals and music purposely drop out and give you a chance to beat mix. Avoid mixing into or out of a track during a vocal segment.

8 Watch the crowd.

The crowd is the best gauge of how well you are DJing. If people are having fun—and, especially, if they are easily dancing through the transitions between songs—you are doing a good job. If, on the other hand, they are having trouble dancing to the beat, alter your song selections.

Be Aware

- Every mixer is different. Familiarize yourself with the equipment in the booth.
- Using a stopwatch or a watch or clock with a second hand, count the beats of the current song (or bass drum hits) for 15 seconds, then multiply by four to determine the number of beats per minute (BPM). Most sets begin with songs with a lower BPM, then gradually increase the BPM as the music increases in intensity. As a general rule, consider 88 to 110 BPM for a hip hop or rap music set, and 116 to 140 BPM for a house/techno set.
- Do not play the new song at a lower volume after the fade in. The volumes of the two songs should match, since a lower volume diminishes a song's energy.

HOW TO BREAK INTO YOUR CAR IF YOUR BABY IS LOCKED INSIDE

- 1 Maintain visual contact with your baby.**

Observe her medical condition. Trick your baby into thinking that you meant to create this situation. See “How to Keep Your Baby Calm” on the following page.
- 2 Try a key from a similar model of car.**

Ask passersby if they drive the same type of car. Ask if they will try to open your door with their key.
- 3 Use a coat hanger to break in.**

Bend a wire hanger into a long J. Square off the bottom of the J so that the square is about two inches wide. Slide the hanger into the door, between the window and the weather stripping. Feel for the end of the button rod and, when you have it, pull it up to open the lock.
- 4 Break the window.**

Don a pair of gloves, mittens, or socks to protect your hands from abrasion and injury. Select the window farthest from your child—a front window is ideal. Use a sharp object to punch through the middle of the window—try a rock, hammer, crowbar, piece of concrete from a broken curb, or even a low concrete parking-

spot marker. Hit the window with enough force to break the surface tension on the glass. Do not use your fist or a blunt object, neither of which will break the glass.

- 5 Call for help.**

Police officers and firefighters sometimes carry keys or lock-pick tools, or call a locksmith. A professional can often spring the lock in as little as three seconds with no damage to your car.

Be Aware

- In cold weather, do not warm up the car with the child inside. Many new cars automatically lock the doors once the ignition is turned on.
- Larger glass panels are less expensive to replace than fixed panels, such as small quarter panels.

HOW TO KEEP YOUR BABY CALM

- ★ **Pretend to be calm yourself.**

The baby will feed off of your fear if you reveal it.
- ★ **Play peek-a-boo.**

Begin with the standard hands-in-front-of-face style, then try hiding your face with a scarf or hat, and finally pop up from below various windows.
- ★ **Enlist the help of passersby.**

Select friendly-looking people and people with babies who can coo at your baby through the window. Keep your child entertained and happy.

- ★ **Hoist a small dog in front of a window.**
Turn the dog around to show its funny wagging tail.
- ★ **Hold up a magazine.**
Turn the pages in front of the window so baby can see bright images.
- ★ **Use makeup to color yourself like a clown.**
Smear lipstick on lips (go beyond true lip outline), cheeks, and tip of nose. Use eyeliner and eyeshadow to accentuate happy eyes and eyebrows.
- ★ **Do vigorous calisthenics.**
Babies think it's funny to see big people jump around.



**WORST-CASE
SCENARIO.**

HOW TO BRIBE YOUR CHILD

- 1 Make an offer you know your child can't refuse.**
Offer what your child desires most—money, new CDs, more video game time, candy.
- 2 Do not offer too much initially.**
If you are willing to give your child a quarter every time he remembers to flush the toilet, start lower—offer a dime first, and expect a couple rounds of negotiation. Children today are savvy negotiators.
- 3 Get performance first, then pay.**
Withhold payment until you have determined that your child has carried out the other side of the bargain. Children often conveniently forget their promises.

IF YOU WISH TO CONCEAL THE BRIBE

- 1 Make certain that you are alone when discussing terms.**
Even younger siblings who you think do not understand can turn you in.
- 2 Arrange a “dead drop” for making payments.**
Select a location in or around the home where you will deposit the bribe. Place the item(s) in a gym bag or another commonly seen container. Leave the bag at the predetermined spot (in the laundry basket, behind

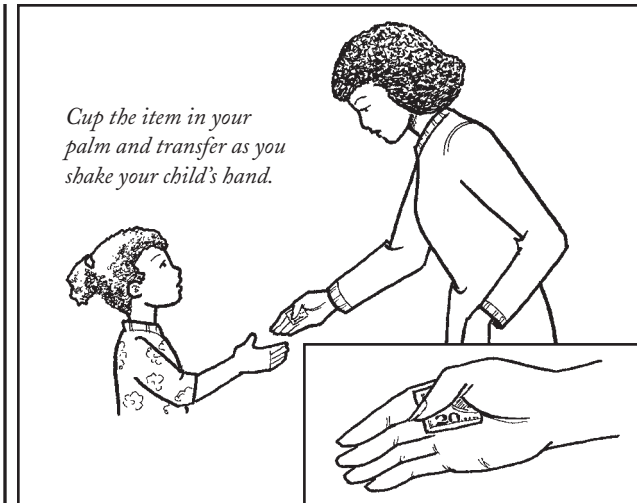

the coats in the closet, under your child's bed) and walk away quickly.

- 3 Master the “magician's palm” technique when paying with coins or bills.**
Hold the item in your palm, cupping it slightly. Congratulate your child on “a job well done” or on his maturity. Shake your child's hand, and give him the money.
- Be Aware**
- Bribes are highly effective but are almost always an indication of weak or lazy parenting. Choose what is most important at that moment.
 - Couples frequently disagree over whether to bribe children. Children almost always are in favor of it.

**WORST-CASE
SCENARIO.**

HOW TO CONSTRUCT AN EMERGENCY CRIB



Parents' bed.

Remove pillows and other loose items and put them on the floor around the base of the bed. Add additional pillows, sofa cushions, comforters, and spare blankets until the height of the surrounding pile reaches to within six inches, at least, of the top of the bed. The pillows will create a soft landing area if the baby wanders.

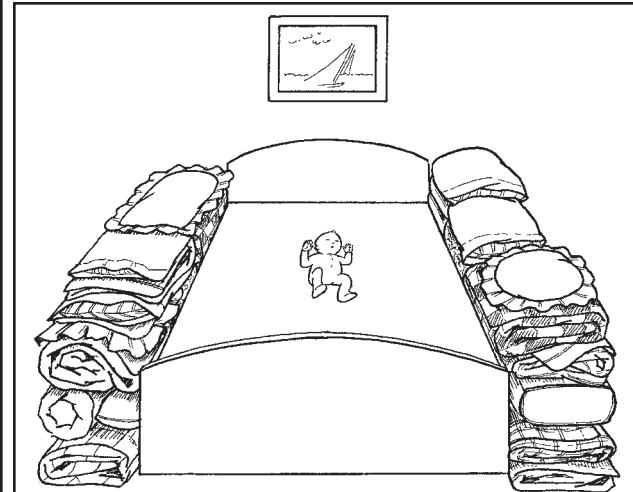

Pile extra blankets and cushions to within six inches of the top of your bed to create a soft landing area.

★ **Storage bin.**

Place an under-the-bed (half-height) plastic storage bin in the center of the room. Do not place under your own bed. Pad as necessary.

★ **Dresser drawer.**

Remove a drawer from a dresser and line with crib sheets and cotton blanket. Place on the floor.

★ **Laundry basket.**

Line a large basket with soft blankets or comforters.

★ **Wagon.**

Pad a child-sized wagon with blankets. Lock the wheels or wedge them with books to prevent rolling.

Be Aware

- In a regular or an improvised crib, pillows and other loose items may present a suffocation danger. Do not place small, sharp, heavy, electrical, or sporting objects in a crib. Also keep food, beverages, and pets out of the crib.
- Makeshift cribs must be monitored at all times.

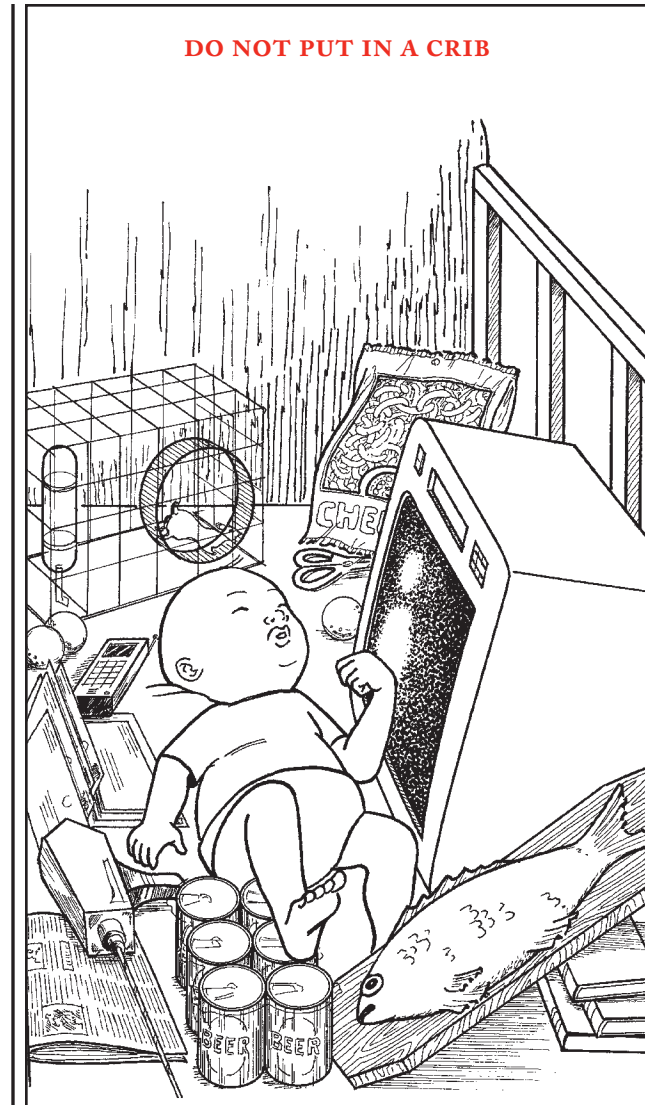

HOW TO CONTROL A STROLLER IN EXTREME CONDITIONS

SNOW AND ICE

- 1 Wear hiking boots.**
Put on boots or shoes with rubber soles and thick treads for good traction. Avoid high heels and shoes with smooth leather soles.
- 2 Add ballast.**
Place full formula bottles, bricks, or books over the stroller's wheels to provide added stability and traction.
- 3 Keep one foot firmly planted.**
Walk so that at least one foot has good traction continuously. If you begin to slide, slow down.
- 4 Hold the handles firmly.**
- 5 Avoid sharp turns and sudden movements.**
- 6 Steer into the slide.**
If the stroller begins to slide, bend your knees and steer into the slide. Avoid sudden corrective measures that may make the stroller harder to control or cause a spin-out.

- 7 Do not lean on the stroller.**
A stroller will not support the weight of an adult. Leaning on the stroller for balance may propel the wheels across the ice and cause you to lose your balance and control.
- 8 Abandon the stroller only in case of severe emergency.**
If you must abandon the stroller, use downed tree branches to mark the spot for recovery later. Remove the baby and other necessary items.

DOWN A STEEP HILL

- 1 Assess the slope.**
Do not roll children in strollers down a hill steeper than 30 degrees. If the hill looks very steep, or if you have trouble maintaining your footing, choose another path.
- 2 Check the safety belt.**
Buckle the stroller's safety belt snugly against the child, but not so tight that it causes pain.
- 3 Secure any loose items.**
Bottles, books, and toys stored in stroller pockets or in the basket underneath may come loose during the descent. Use spare diapers to wedge these items in place, or leave them behind.

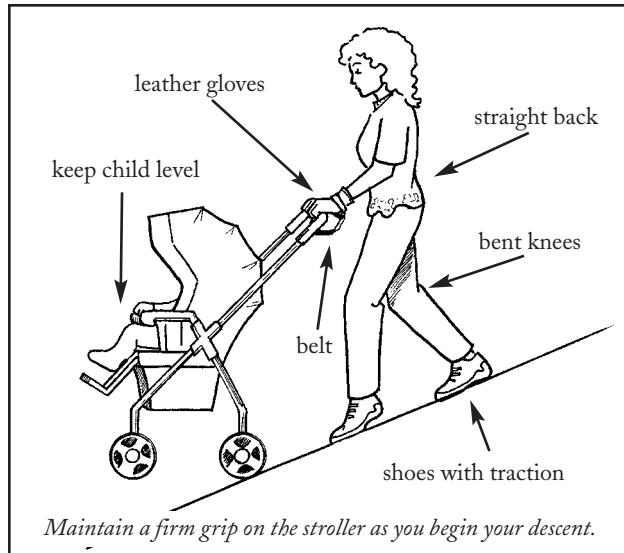

4 **Maintain your grip.**

Firmly hold both handles of the stroller at all times. If your hands are sweaty, dry them with a burping cloth before descent. Wear leather driving gloves to increase grip: Do not wear ski mittens, which are slippery.

5 **Lift up the front wheels.**

Angle the stroller so that the child stays level and does not pitch forward.

6 **Begin the descent.**

Move slowly, keeping your knees bent and your back straight. Avoid leaning forward or you risk toppling onto the stroller.

7 **Adjust the angle of the child and stroller.**

If the child is pitching forward, put additional downward pressure on the handles and angle the front wheels further toward the sky.

8 **Rest periodically.**

If you become tired, turn the stroller uphill so that the child faces toward the crest of the hill, and stand below it, facing the same direction. Apply the parking brake. Keep your legs straight while in this resting position.

Be Aware

For added safety, remove your belt and lash your wrist to one of the handles of the stroller or to the handle bar. Wrap the belt several times around your wrist and then around the handle, then fasten the buckle.

DO NOT USE A STROLLER . . .



as a shopping cart

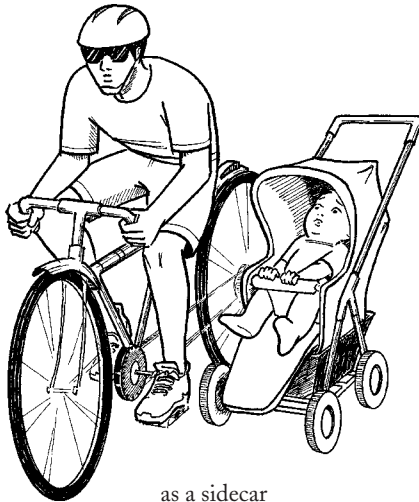

as a sidecar

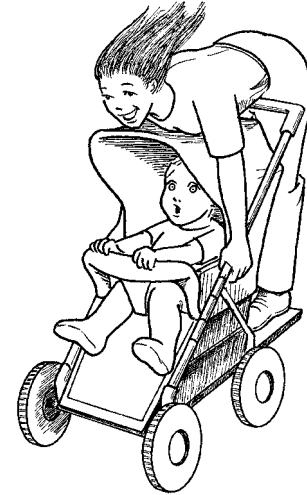

as a scooter/skateboard

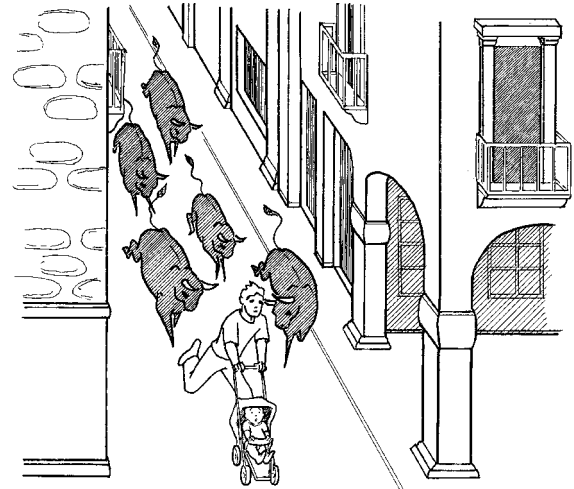

when running with the bulls in Pamplona

WORST-CASE SCENARIO®

HOW TO DEAL WITH A DEAD PET

1 Make sure the pet is really dead.

Cats often sleep without moving for hours, dogs can be lazy, reptiles are cold blooded and still, fish with parasites sometimes float upside down at the surface, and opossums are well known for feigning. Observe the pet's chest: If it rises and falls, even very slowly, the animal is still alive. Hold a mirror to the pet's nose. If no condensation appears, the animal is probably dead. Pick up the animal. If it does not move and its body is stiff and cold, it has passed away. Feel the neck for a pulse. If you cannot feel one, and all the other signs indicate death, the pet has died. Finally, check for involuntary blinking reflex: Lightly touch the pet's cornea. Any animal that is alive will blink reflexively.

2 Break the news to your child.

If the pet's death was sudden and unexpected, the child is likely to be distraught. Explain that death is a fact of life. Emphasize that the pet had a happy life, the child had taken good care of it, and that the pet is not suffering.

3 Prepare the body.

Close the animal's eyelids—you may need to hold them in place for several seconds so they will stay closed. Place the corpse in a matchbox, shoe box, or

wooden box and cover with a washcloth, towel, or sheet, depending on the size of the pet.

4 Hold a family funeral.

Pets are a part of the family, and children expect them to be buried when they die. Give everyone a chance to speak at the funeral ceremony. Burial should immediately follow the ceremony, though there may be laws restricting the burial of pets in a yard. Check with your local vet on burial options, or contact a pet cemetery.

5 Allow your child to grieve.

Do not replace the pet right away. Grieving is an important part of the recovery process, and children should be given time to adapt to the loss.

Be Aware

- A pet cemetery charges from \$100 to many thousands of dollars, depending on the coffin, type of service, and size and quality of the headstone/plaque.
- Many vets have cremation services available. If the local vet cannot help with disposal, the local public health department or any large veterinary hospital or university will have facilities.

**WORST-CASE
SCENARIO.**

HOW TO DEAL WITH A SCREAMING BABY ON AN AIRPLANE

1 Make highly visible efforts to quiet your child.

Passengers and flight attendants will not be as upset with you if they think that you are doing everything you can. Talk to your child, sing to him, and bounce him; offer him a bottle, pacifier, or food; rock him; walk him up and down the aisles; distract him with the air safety card, airsickness bags, or in-flight phone. Do everything you can think of to calm your baby, and do it loudly and noticeably.

2 Create confusion and distraction.

If your child has not quieted down, act crazy. Cross your eyes; make the “beebabeebeebabeebeeb” sound by moving your finger up and down between your lips; sing, preferably an aria, at full volume—do anything you can to distract your child from his tantrum. Then soothe him using more traditional methods.

3 Do not panic if your child will still not calm down.

Remember that this is only a moment in time, and that no matter how many nasty looks you are getting from fellow passengers, you are doing the best you can.



Tell yourself you will never see these people again.

4 Use drugs and alcohol.

Certain over-the-counter drugs can be administered in an emergency situation. Cold or allergy medicine for children, in particular, works well and usually causes drowsiness and a calming feeling. However, the medication may take half an hour or longer to take effect, and it frequently produces the opposite effect on children, speeding them up. The alcohol is for your consumption, in appropriate doses.

5 Use the lavatory.

If your child still will not calm down, retreat to the lavatory with him until he exhausts himself. Hold the baby in front of the mirror and say, “There’s another baby in the room!” or pretend that you are “walking downstairs” by moving back and forth in the lavatory, stooping lower with each step.

6 **Bribe fellow passengers for forgiveness.**
Offer free drinks, extra bags of snacks, earplugs, and reimbursement for dry-cleaning expenses.

7 **Remind yourself that you will never see these people again.**
Repeat.

Be Aware

- First-class and business-class passengers usually have less tolerance for screaming babies.
- Do not pretend you do not know the child. Laws regarding child abandonment and neglect are more troublesome than annoyed passengers.

IF YOU ARE OUT OF DIAPERS

1 **Ask the flight attendant for several cloth napkins.**
Cloth napkins make an excellent temporary diaper.

2 **Fold two cloth napkins into rectangles.**

3 **Place the two folded napkins (the liner) in the center of a third cloth napkin (the diaper).**

4 **Secure as you would a normal cloth diaper.**
Effective fasteners include safety pins, bobby pins, hair clips, or butterfly-style binder clips. Use for short periods only, since the starch in the napkins may irritate the baby's skin.

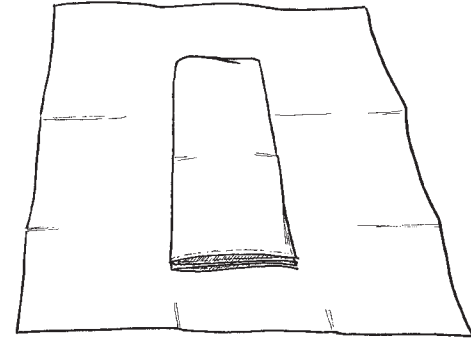

Place two folded napkins in the center of a third napkin.

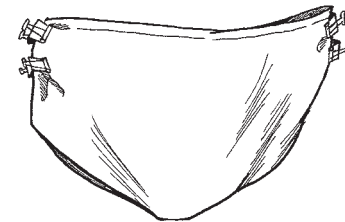

Butterfly-style binder clips are effective fasteners.

Be Aware

The following items should not be used in place of a diaper:

- Silk scarf
- Wool blanket
- Suede jacket
- Baseball cap
- Straw hat
- Flotation device

WORST-CASE SCENARIO.

HOW TO DEAL WITH A SMART ALECK

- 1 Ignore.**

Children with easy-going temperaments will try out smart-aleck behavior once or twice and drop it if it doesn't get a response.
- 2 Alert your child to the offensive behavior.**

If your child continues to display an impertinent attitude, point out specific information about his actions that are unacceptable. Raise a yellow flag, kept in your back pocket (the way a referee calls a foul), whenever your child says something obnoxious. Then give him a time-out.
- 3 Remove privileges.**

Reduce access to favorite activities, such as watching television or playing outside, in accordance with the severity and frequency of the insolence. Clearly state the reason for the consequence. Place favorite toys or video games in a "toy prison," from which they can be paroled for the child's good behavior.
- 4 Do not sass back.**

It will be tempting to respond in kind to offensive behavior; it is likely that you'd win a contest of wits, but you run the risk of encouraging your child to come up with better lines the next time.

5 Encourage your budding comedian.

Try to hone your child's wit into a marketable skill. Watch movies and listen to recordings featuring famous sarcastic comedians and work on his act. Beware that this could lead to the child becoming a "dirty talker," and, if the act succeeds, completely unmanageable.

Be Aware

Children learn to behave and speak by modeling what they observe at home. Do not use any language in front of the child that you would not want him repeating. Eliminate sarcasm, eye rolling, verbal mimicry, irony, and back talk from your own speech.

**WORST-CASE
SCENARIO.**

WORST-CASE SCENARIO.

HOW TO DEAL WITH PROVOCATIVE CLOTHING

- 1** **In a firm and calm voice, tell your teen to change into something more suitable.**
Do not yield to a tantrum. Remain neutral and impervious to eye rolling and heavy sighs.
- 2** **In a calm and firm voice, tell your teen to change into something more suitable.**
Do not yield to a tantrum. Remain neutral and impervious to eye rolling and heavy sighs.
- 3** **In a firm and calm voice, tell your teen to change into something more suitable.**
Do not yield a to tantrum. Remain neutral and impervious to eye rolling and heavy sighs.
- 4** **In a calm and firm voice, tell your teen to change into something more suitable.**
Do not yield to a tantrum. Remain neutral and impervious to eye rolling and heavy sighs.
- 5** **Employ reverse psychology.**
Wear the same outfit as your teen. The anarchy T-shirt, hoodie sweatshirt with silk-screened profanity, or teeny tiny skirt and ripped fishnet stockings will not look as cool when you are wearing them, too.

HOW TO DISCIPLINE AN IMAGINARY FRIEND

1 Outline responsibility.

Explain to your child and the imaginary friend that when they play together, they both need to be on good behavior and are both responsible for any broken vases, stolen cookies, or messes.



Explain to your child that both he and his imaginary friend are responsible for their bad behavior.

2 Assign consequences to the child and imaginary friend together.

Tell your child that he and his imaginary friend must wash dishes or take out the trash “together.”

3 Ask your child to suggest ways to make his friend behave.

Explain that you need his help in making his friend understand and behave.

4 Create activities to keep the imaginary friend out of trouble.

If the imaginary friend is a continuing source of mischief, enroll him in (imaginary) music lessons, (imaginary) summer camp, or (imaginary) boarding school to keep him occupied.

Be Aware

- Do not make up an imaginary friend for your child as a way to encourage his imagination.
- Respond respectfully to your child’s imagination and imaginary friend.
- If you are visiting someone, such as a boss, who may be uncomfortable with your child’s notion, tell your child that his friend will have to wait in the car, or that you hired a “babysitter” for the child’s friend to watch him at home.

WORST-CASE SCENARIO.

HOW TO FIX A WAGON WHEEL

1 Examine the wheel.

The wheel is generally held in place by two pins, one on either side of the hub, which is the center of the wheel. If the outer pin breaks, the wheel may fall off or become damaged. Most wagon wheel failures occur at the hub, which carries the weight of the wagon's load.

2 Locate the wheel's bushing.

The center of the hub has a thin plastic or metal bushing—a $\frac{1}{2}$ - to 1-inch section of tubing—that spins around the axle. Check for a missing or cracked bushing.

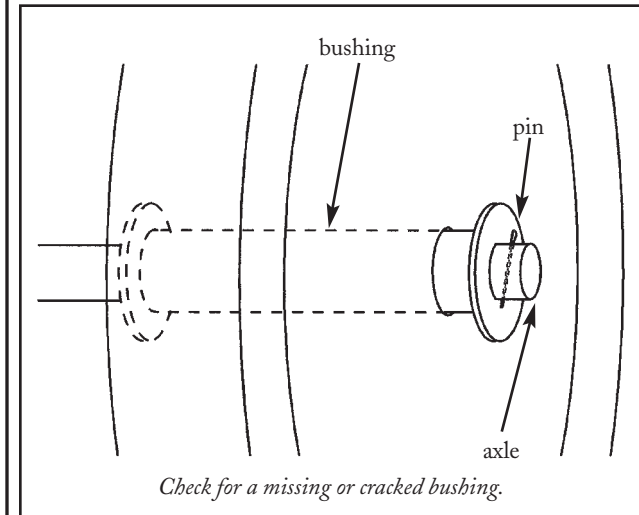

3 Remove the bushing.

If the bushing is still present, use pliers to remove it. If the bushing has broken into several pieces, remove all pieces.

4 Construct a new bushing.

Cut a small section of plastic tubing—a section of garden hose or plastic pipe—to fit inside the wheel hub. (If the bushing is metal, use a hacksaw to cut a small section of metal pipe.) The new bushing should fit snugly inside the hub, but should be a few millimeters in diameter bigger than the axle so the wheel can spin freely. Use pliers or a rubber mallet to fit the bushing into the hub, if necessary.

5 Replace the wheel.

6 Spin the wheel.

The wheel should spin around the axle with no wobbling: If the wheel wobbles, the bushing is not tight against the hub and should be reset.

7 Insert a bolt or pin through the axle.

Repair or replace the pins as necessary. If the pins are damaged and cannot be reused, insert small tacking nails through the pinholes. Bend the sharp end of the nail with a set of pliers to hold it in place. Be certain that the nails are secure and that there is no slippage.

HOW TO FIX A FLAT BIKE TIRE WITHOUT A PATCH

1 Release the brake.

Squeeze the brake, then pull out the brake cable from where it connects to the brake shoes next to the rim of the wheel.

2 Remove the wheel.

Open the quick-release lever or use a wrench to loosen the bolts from the wheel hub. Take the wheel off the bike.

3 Remove one side of the tire from the rim.

Insert the tip of a screwdriver, house key, or other metal instrument under the bead (the edge where the tire attaches to the rim) and press down on the tool. Repeat in several places until that side of the tire comes free.

4 Remove the tube.

Pull the tube out of the tire.

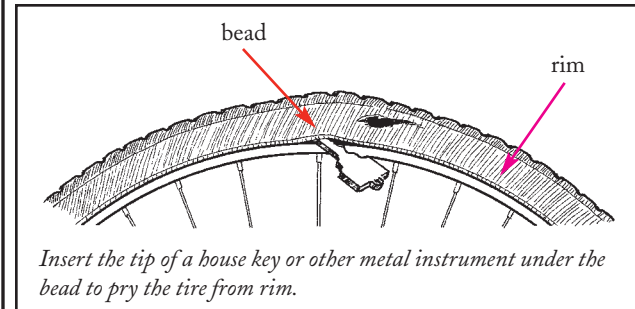

5 Construct an emergency patch.

Fold several small-denomination bills into squares or rectangles, depending on the size of the gash. Stack the folded bills and place the patch inside the tire. Cover the gash completely. If no cash is available, use a foil wrapper from an energy bar or candy bar.

6 Stuff the entire tire with leaves or grass.

Make sure your patch does not slip.

7 Replace the tire bead over the rim edge.

Use your hands to work the tire bead back over the rim edge. It may be necessary to use a key or screwdriver to fit the whole tire back on the rim. As you are working, you may need to add more grass or leaves to make the tire sturdy enough to ride. Once the tire is back on the rim, work both sides of the tire bead from side-to-side until it is fully secured.

8 Remount the wheel.

Replace the wheel by either snapping the quick-release lever back into position or by tightening the nuts that hold the wheel in place.

9 Ride home slowly.

Be Aware

A large gash in the tire's sidewall may result in the still-inflated tube sticking out of the tire. Serious injury may occur if the bike is ridden in this condition.

**WORST-CASE
SCENARIO.**

HOW TO GET YOUR BABY TO SLEEP

★ Swaddle the baby.

Fold down one corner of a receiving blanket and place the baby on top of the blanket with his head above the fold. Pull one side of the blanket securely across the baby's chest and tuck it underneath his body. Then pull up the bottom, folding the edge back, and finish by pulling the remaining side of the blanket across the baby's chest and underneath the body. The baby should fit snugly inside the blanket.

★ Sway.

Hold the swaddled baby close to your chest. Shift your weight from one foot to the other. This rhythmic stimulation will induce a sleepy state in the baby. Position the child so that his ear is over your heart. The beating will soothe him.

★ Generate soothing white noise near the baby.

Sound produced by a clothes dryer, dishwasher, blender, coffee grinder, hair dryer, vacuum cleaner, lawn mower, leaf blower, or air conditioner has a lulling potency that many babies cannot resist. Metronomes and ticking clocks can also soothe a baby to sleep by reminding a child of his mother's heart beat.

★ Put the baby on a washing machine or dryer.

Turn on the machine and set to normal cycle. The vibrations and noise are sleep-inducing. Do not leave the baby unattended.

★ Go for a drive.

The steady vibration of the car will have most infants asleep quickly. Open the window a crack and the air will keep you awake while the sound of the wind functions as soothing white noise for the baby. Do not get behind the wheel if you are exhausted and cannot operate heavy machinery.

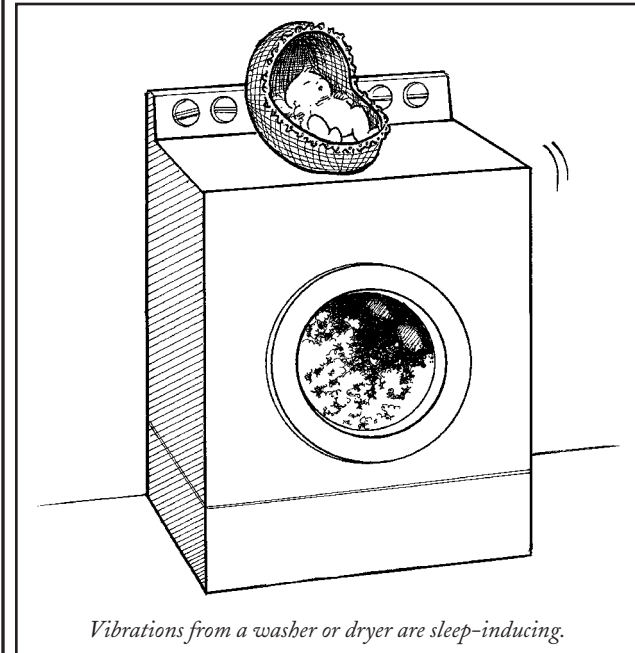

★ **Dance to music with a strong beat.**

Hold the child securely in your arms and bounce, twirl, and dip in a rhythmic fashion. Concentrate on moving the baby to the beat. The nonstop, steady jiggling will overload the brain's processing center. Avoid atonal, early-twentieth-century classical music, bebop, or any other music that could be jarring. Better choices include reggae, house, dance/trance, disco, minimalist, and pop.

★ **Climb up and down a staircase.**

Make sure your grip is tight around the baby. Go up and down at a rapid, steady pace.

★ **Use a pacifier.**

A pacifier (also known as a binky, paci, dummy, comforter, fooler, ninny, soother, soothie, or yum yum) can be an extraordinarily potent sleep inducer for some babies, but it can be habit-forming, and may cause problems if lost or stolen.

DO NOT USE AS A PACIFIER



bottle



cell phone

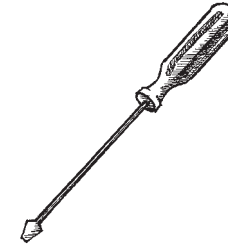

screwdriver

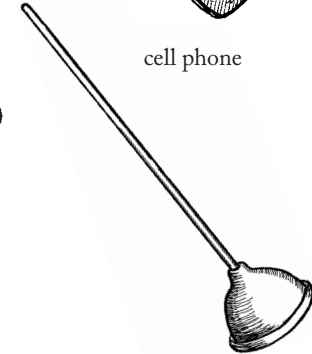

toilet plunger handle

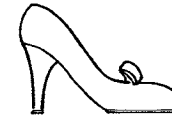

high-heel shoe



salt or pepper shaker



lightbulb

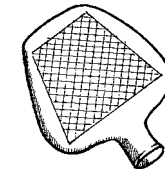

Ping-Pong paddle

WORST-CASE SCENARIO.

HOW TO GIVE YOUR BABY A BATH WITH- OUT A BATHTUB

You will need: soap, shampoo, bath toys, washcloth, cotton balls, hooded towel, and a post-bath diaper.

1 Select a location/container.

Acceptable locations include:

- Sink
- Roasting pan
- Large plastic container or bowl
- Litter box (empty and clean)
- Fish tank
- Ocean
- City fountain
- Koi pond

Do NOT use:

- Drive-through car wash (with open car windows)
- Toilet bowl
- Front-loading washing machines
- Outdoor power sprayer
- Dishwasher
- Hot tub

2 Line the bottom of the container with a towel.

Use towels to prevent the baby from slipping and to add cushioning for comfort.

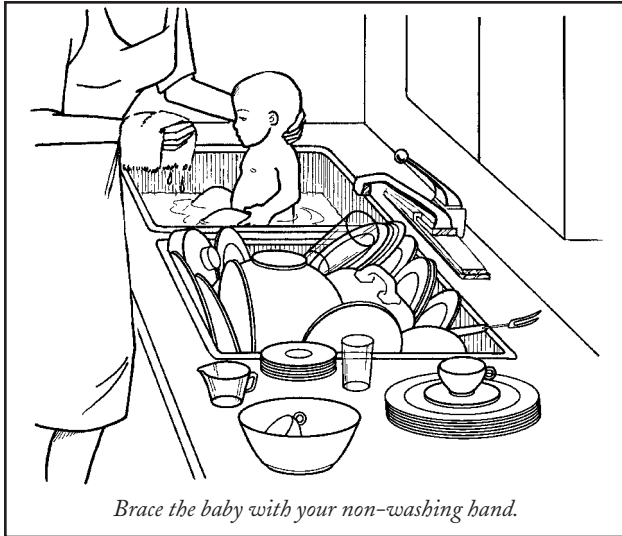

Brace the baby with your non-washing hand.

3 **Fill the receptacle with warm water.**

Check the temperature with your wrist or elbow before placing the baby in the water. Keep the room where the baby is bathing warm.

4 **Undress the baby.**

5 **Place the baby in the bathing receptacle.**

6 **Support the child while washing.**

Brace younger children with your non-washing hand. Introduce a makeshift bath toy such as plastic measuring spoons or a small ball. Do not offer the child measuring cups or other objects that can be used to bail out the tub.

7 **Rinse.**

Rinse the baby with a wet washcloth frequently dipped in clean water and squeezed over the baby. Alternatively, you can use water from a pitcher, but make sure it has not cooled past comfort levels. Do not attempt to rinse the baby by pouring water if the basin is full.

8 **Remove the baby and dry.**

Wrap the baby in a soft towel and pat dry immediately to keep her warm.

Be Aware

- Keep soap out of an infant's eyes while washing her hair by tilting her head back and placing a small washcloth on her forehead. Do not hold the washcloth in place or shield her eyes with your hand since you will need that hand to support the baby while the other hand washes and rinses. When the child is a little older, you can use a terry-cloth headband, bandanna, or tiny golf visor to shield the eyes from soap or shampoo.
- For spot cleaning, use a water gun, saline solution squirted from a bottle, or a spray bottle. A drinking fountain can also be used to rinse a slightly dirty baby when the target area can be positioned under the arc of water and when the water is not too cold.
- Do not wash the baby with wipes. What's good for the bottom can be too harsh for the rest of the body.

HOW TO MAKE AN EMERGENCY BOTTLE

- ★ **Use a medicine dropper or turkey baster.**
Dribble milk (or formula or other liquid) into the side of the baby's mouth. Allow time for swallowing before inserting the next dropperful.
- ★ **Use a straw.**
Suck fluid into a straw and sustain tension by placing your thumb on the top of the straw. Put the straw into the side of the baby's mouth and remove your thumb periodically from the straw, releasing the tension and allowing the liquid to dribble out at intervals.
- ★ **Use a gravy boat.**
Slowly pour small amounts of liquid into the baby's mouth with the spout directing intake. Small creamers from tea sets can also be used. Even better are creamers from children's tea sets.
- ★ **Use a water gun.**
Fill the barrel with milk. Gently pull the trigger and squirt milk into the side of the baby's mouth.
- ★ **Use a sports water bottle.**
Squeeze milk into the baby's mouth.

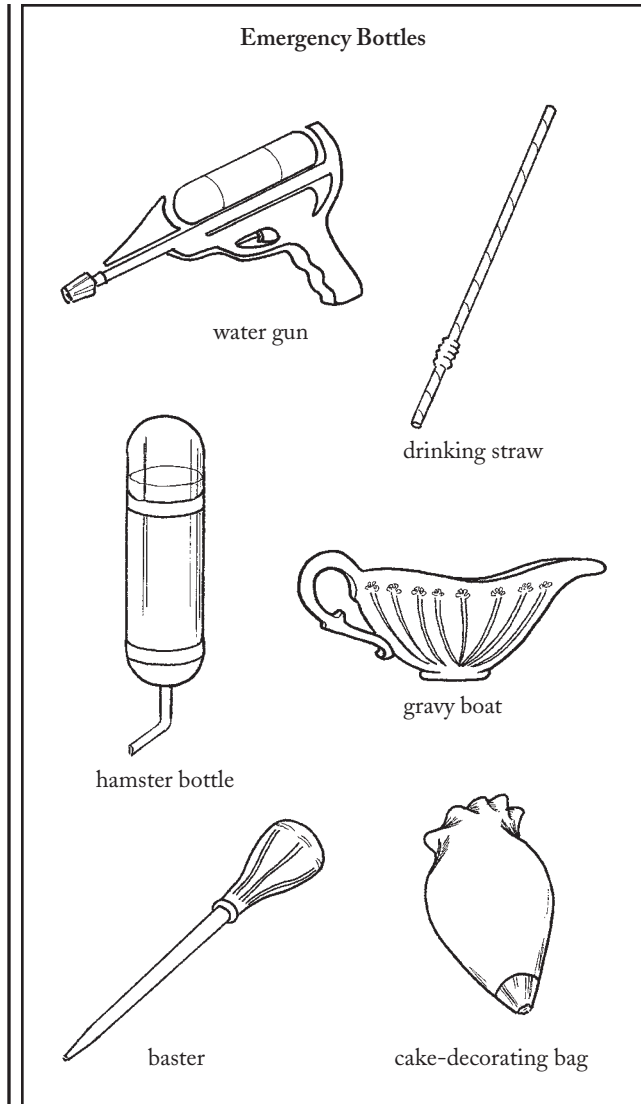

★ **Use a cake-decorating bag.**

Fill the bag three-quarters full with milk, keeping your finger over the hole of the decorating tip. Twist the end of the bag and hold it closed to contain the milk. Gingerly insert the tip into the baby's mouth at regular intervals and control the flow of the milk with your fingertip. Round, oval, and leaf decorating tips are preferred.

★ **Use a hamster bottle.**

Sterilize the bottle and tube. Fill the bottle with milk. The leakproof vacuum will prevent the milk from spilling. Do not secure the bottle onto a car seat or bassinet for self-feeding.

Be Aware

Do not use airplane mini-bottles or rubber gloves or balloons with a hole poked in the end as substitute bottles.

**WORST-CASE
SCENARIO.**

HOW TO MAKE EMERGENCY TOYS

- ★ **Turn objects into faces.**
Socks, spoons, pillows, plates—any object can become a fascinating toy when you give it eyes, a nose, and a mouth. Funny voices that appear to come from the object also add appeal.

- ★ **Add sound.**
Place coins, beans, rocks, keys, or other small objects inside a sippy cup or plastic storage container to create an instant rattle or musical instrument. Make certain the lid is tightly fastened to avoid potential choking hazards.

- ★ **Create pairs.**
Tie together two objects, like wooden spoons or shoes, with a short string. When the baby pulls one, the other follows, or when she knocks one off a table, the other falls, too. This cause-and-effect game sharpens a baby's motor skills and provides hours of fun.

AIRPLANE TELEPHONE

- 1** Remove the phone from the seat back in front of you.
- 2** Hand your child the phone.
- 3** Say, "See if you can call someone."

- 4** **Watch the button pushing and conversation.**
As long as you don't have a credit card in the phone, there's no activation and no charge.
- 5** **Discontinue the game if she becomes frustrated.**
Also discontinue if your neighbors become annoyed.

AIRPLANE AIRSICKNESS BAG PUPPET

- 1** **Remove the airsickness bag from the seat pocket in front of you.**
Verify that the bag is empty.
- 2** **Draw eyes on the bottom of the bag.**
- 3** **Lift the edge of the bottom slightly and add a tongue.**
This will be the mouth.
- 4** **Place your hand inside the bag.**
- 5** **Animate.**

RESTAURANT NAPKIN

- 1** **Obtain a paper napkin.**
Ask your server for an extra napkin, or borrow one from a nearby table.
- 2** **Open the napkin fully.**

Napkin into Bunny Rabbit

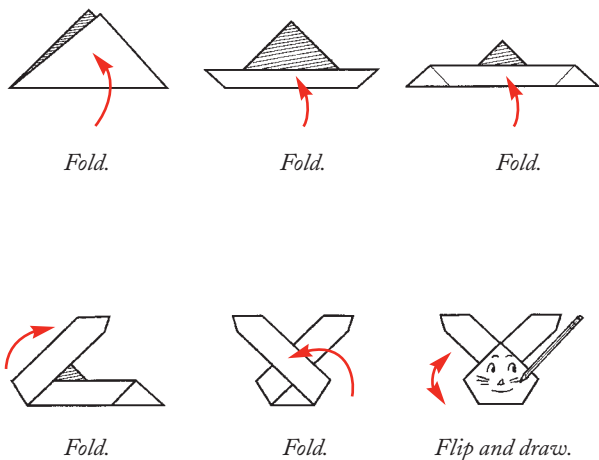

- 3** Fold it into a triangle.
- 4** Fold the longest side up approximately 1.5 inches.
- 5** Fold the same side the same amount again.
- 6** Fold one end of the bottom edge toward the center, on a diagonal, to form one of the ears.
- 7** Repeat with the other bottom edge.
- 8** Hold the napkin in place, and flip it over.

9 Draw a bunny rabbit face.

10 Play.

Tape the bunny's head to a spoon to make it into a stick puppet.

EVERYDAY ITEMS

Readily available items can be repurposed to entertain small children in an emergency.

- Tongue depressors—pickup sticks, dancing puppets.
- Rubber gloves—inflatable turkeys.
- Phonograph—merry-go-round for small dolls or animals.
- Funnel—megaphone, trumpet.
- Banana—telephone.
- Orange—soccer ball.
- Spice bottle—rattle.
- Tissue box—box of birds.
- CDs—ring toss.
- Wooden spoons and plastic containers—drums, twirling circus.

Be Aware

- Keep a toy everywhere—in the car, in the stroller (or tied to it), in the diaper bag, in the backpack—to avoid being caught without one.
- Purchase a backup of your child's favorite toy. The treasured toy will eventually get lost or broken.

WORST-CASE SCENARIO.

HOW TO MAKE YOUR CHILD EAT VEGETABLES

- ★ **Eat vegetables yourself.**
Be enthusiastic about vegetables. “Beans are awesome!” “Peas rule!” “Rutabagas rock!”
- ★ **Talk in euphemisms.**
Encourage your child by calling the vegetable a “growing food” or “brain food” or “run-fast food” or “beauty food.”
- ★ **Require one bite.**
Even if she does not like it, with the “one-bite rule” the child should eventually grow accustomed to the taste, though it may take years.
- ★ **Let the child select the vegetable.**
Take your child to the grocery store to pick out one vegetable. Invite her into the kitchen to help you prepare it for dinner. She will become emotionally invested in the vegetable and proud of it. She may not only eat the vegetable, she may urge others to do so.
- ★ **Sneak vegetables into other dishes.**
Camouflage vegetables in stews, lasagna, pot pies, pizza toppings, casseroles, or soups.

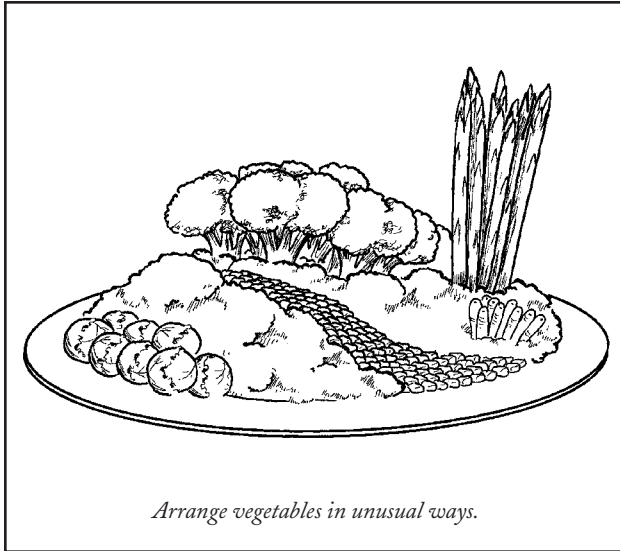

★ **Change presentation.**

Arrange vegetables in a happy face. Use unnaturally colored ketchup (pink, green, blue) to jazz up a pile of vegetables. Make trees with broccoli and asparagus, boats from endive, and a lake out of guacamole.

★ **Prepare the vegetable in different ways.**

If she rejected the steamed broccoli, next time serve it raw with a dip. If the asparagus in cream sauce was not popular, try it with butter and lemon. Use a blender or a juicer to transform the vegetable into a purée or a smoothie.

★ **Make vegetables the only option.**

Designate “vegetarian night” and serve nothing but vegetables. Your child will eat them if she is hungry and there is no other food available. When the meal is over, declare the kitchen closed and do not allow snacks or dessert.

★ **Do not make food into a battle of wills.**

Be matter-of-fact about whether your child does or does not eat her vegetables. Do not force a vegetable on your child or bribe her to eat. Do not say, “If you eat your brussels sprouts, you can have dessert.” This will interfere with her developing a genuine affection for the vegetable, and reinforce sweets as the truly desirable food.

WORST-CASE SCENARIO®

HOW TO MAKE YOUR CHILD GET DRESSED



Offer a controlled choice.

Give your child two items to choose between so she will feel as though she is asserting herself. Ask, “This shirt or this shirt?” followed by “These pants or these pants?” Do not offer too many alternatives, and agree with whatever choice is made.



Wrap your child’s clothes like a present.

Place your child’s outfit in a box. Wrap the box in gaudy paper festooned with ribbons. Place the “present” at the foot of the child’s bed so she gets up enthusiastically and finds her clothes all ready. The child may experience acute disappointment, however, when she discovers that she has not received a real present.



Play make-believe.

- Pretend your child is the local fire chief and must get dressed as quickly as possible to get to a fire.
- Pretend that your child has been selected to model clothes at a fashion show. Once dressed, she can parade back and forth on the “catwalk.” Take a few photographs.



Race.

Race to complete dressing before your child. Allow her to win. Since she now understands the concept of

speed-dressing, each day encourage her to race against her own times.



Distract.

Keep the child distracted by tickling, administering raspberries, or singing songs. Ask her to imitate animal sounds or recite the alphabet.



Warm the clothes.

In a dryer or on a radiator, warm the clothes you select and encourage your child to get dressed fast, while the clothes are still toasty warm.



Allow your child to wear pajamas to school.

Your child will quickly get the message that day clothes are preferable once she faces the stares of her peers.

Be Aware

- You're not done until the shoes are on, too. Make putting on shoes part of getting dressed or you will face a whole new struggle later.
- Offering a bribe—cash, extra television time, getting carried into the kitchen, dessert for breakfast—is inappropriate and sets a bad precedent. It can be extremely effective as a last resort, however (see “How to Bribe Your Child” on page 102).

**WORST-CASE
SCENARIO.**

HOW TO PREVENT BACKPACK OVERLOAD

- 1 Clean out the backpack.**
Remove extra pairs of running shoes, soda bottles, CDs (if more than five), and all electronic games.
- 2 Pack only the necessary books.**
All books do not need to go to and from school every day.
- 3 Buy a second set of books.**
Keep a set of textbooks, usually the heaviest books, at home, so the books don't need to be transported. Alternatively, photocopy the entire book at the beginning of the year and instruct your child to take home only those pages necessary for each day's assignment.
- 4 Hire a neighborhood sherpa.**
Pay a sibling, larger neighborhood child, or teamster to carry the load.
- 5 Affix saddlebags to your dog.**
Bike stores usually sell a variety of different-sized bags that can be slung across a dog's back. Use only large dogs and watch for overload.

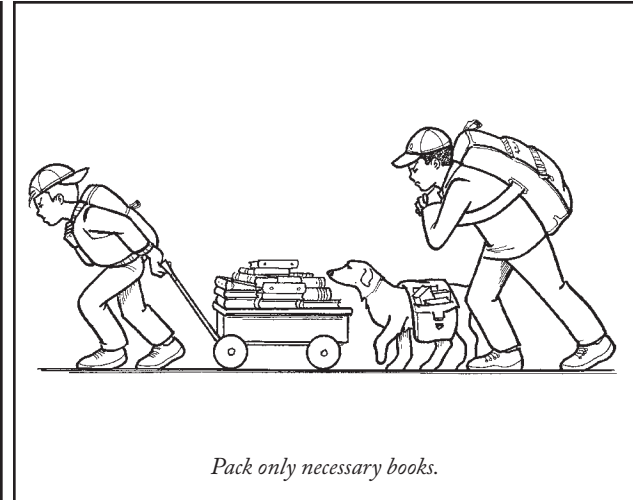

- 6 Ship the books overnight directly to school.**
As long as your child completes his homework by 8 P.M., you should be able to ship the books for next-day delivery at a courier's local drop box. Specify that the books should arrive for "early delivery" to ensure that they make it to school before your child's first class of the day.

Be Aware

- A backpack should never rest 4 inches or more below the waistline or be wider than the shoulders.
- Symptoms of backpack overload include pain or numbness in the arms, shoulders, and mid- to lower back; jaw pain; neck pain; and headache. If the child reports any of these symptoms, consult a healthcare professional.

HOW TO PROTECT YOURSELF FROM UNWANTED WETNESS

★ **Drape a burp cloth on each shoulder.**

Shoulders are the primary repository for baby's wetness. Cover each shoulder with a diaper or burping cloth (if unavailable, remove shoulder pads from your clothes, if you have them, and wear them on the outside). Do not pin the protective cloth to your shoulder, since the pin could scratch the baby.

★ **Secure your hair.**

Pull long hair back and away from the baby's grasping, food-smearied fingers. Wrap a ponytail into a bun on top of your head. Do not use pins, clips, or bands, which the baby can remove, to secure hair. Try a hairnet, bell cap, or ski mask for complete protection.

★ **Wear recreational spectacles.**

Use swimming goggles, laboratory goggles, or other protective eye gear to keep baby food, fluids, and fingers out of your eyes. Use strap-on eyewear, which is more difficult for the baby to remove than regular rest-on-ear glasses.

★ **Wear a smock.**

Use a large, old shirt, worn backwards.

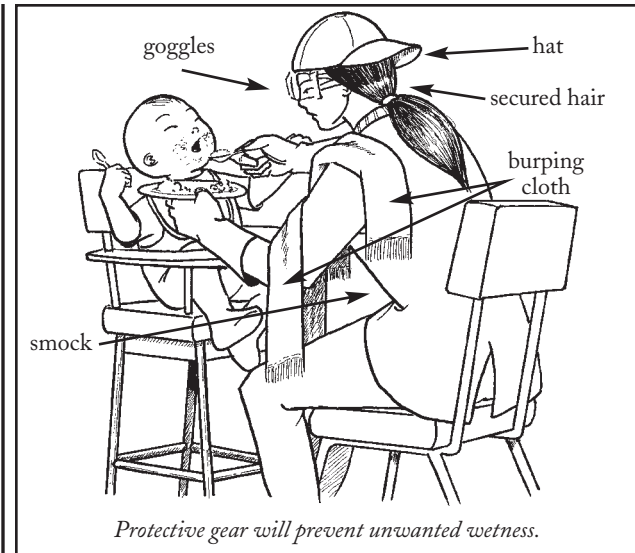

★ **Wear a bath towel.**

Cut a hole in the middle of the towel for your head. Roll back the edges of the incision and finish the edges to prevent unraveling.

★ **Wear an additional layer of clothing.**

Surgical scrubs or oversized pajamas provide comprehensive protection, are easy to put on and remove, and are easily washable.

★ **Wear nothing.**

Particularly when feeding a messy eater, wear as little clothing as possible. Take a quick communal bath afterwards.

★ **Keep a firm grip on your baby's ankles when changing a diaper.**

Maintain a tight but gentle clasp of both ankles. Allowing even one ankle to go free in mid-diaper change will provide the baby with the opportunity to slam his heel down to the surface of the changing area and into the contents of his soiled diaper.

★ **Make a barrier when changing your son's diaper.**

Place a diaper or burp cloth on his lower abdomen after you remove the old diaper. The protective cloth will guard against a potential fountain.

**WORST-CASE
SCENARIO.**

HOW TO RECAPITATE A DOLL

RAG DOLL

1 Restuff the head and torso.

If the neck area is mostly loose fabric and/or stuffing, use polyester fiberfill, available at craft stores, to replace lost stuffing. If fiberfill is unavailable, stuff nylon stockings into the head and neck areas.

2 Overlap the fabric of the head and neck slightly.

3 Sew the head to the neck.

Use standard-weight thread close to the color of the doll. Begin about $\frac{1}{8}$ inch from the initial stitch and sew three-quarters of the way around the doll's head.

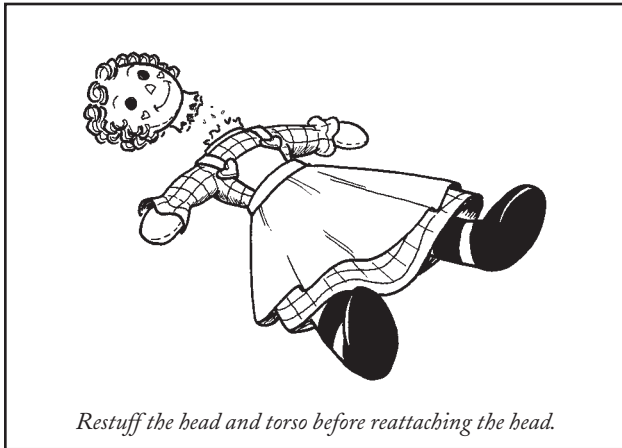

Restuff the head and torso before reattaching the head.

4 Check the position of the head.

If the doll's head lolls to either side, use additional stuffing to stiffen its position.

5 Complete the sewing.

Stitching once around the neck should be sufficient to hold the head in place. Cut the thread and tie it off.

6 Hide the stitches with an accessory.

If the stitch work is unsightly, tie a colorful ribbon or bandanna around the doll's neck to conceal the surgery.

PLASTIC DOLL

1 Determine if the doll has a cuff joint at the nub.

Most plastic dolls have a cuff joint at the area where the head meets the neck. The nub is the part of the doll, either the neck or the top of the shoulders, that has separated from the head.

2 Heat the head.

Heating the plastic will make it pliable enough to reinsert into the cuff joint. Use a lighter or hair dryer on its highest setting to heat only the area of the head that fits over the nub. Heat for 2 minutes. Alternatively, boil a pot of water, remove from the heat, and let stand 1 minute, then submerge the affected part of the head for 2 minutes. Do not heat hair, eyebrows, or eyelashes.

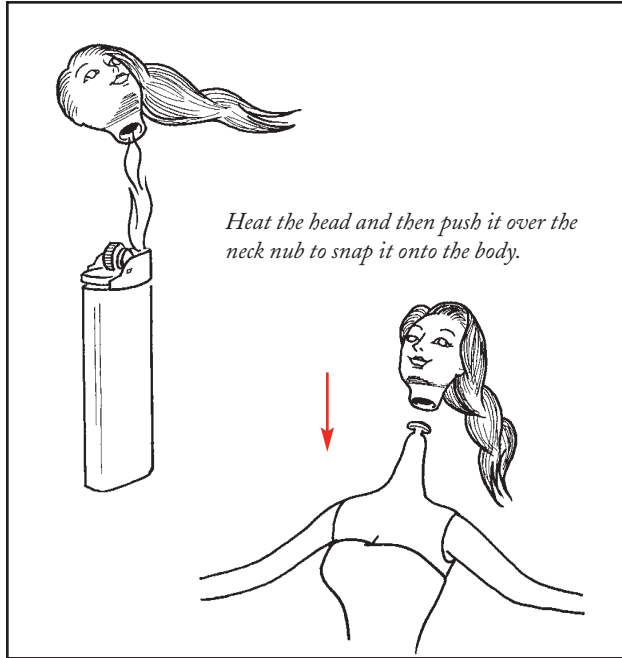

3 Push the head over the nub on the torso.

Work quickly, applying firm, steady pressure. Use a flathead screwdriver for added leverage, if necessary. The head should snap tightly onto the body.

4 Cool.

Allow the plastic to cool and reharden for several minutes before returning the doll to your child.

AN 18-INCH VINYL-HEADED DOLL

1 Find the neck string.

The doll head is held in place by a string that runs through the neck casing at the top of the doll's body. The string will be visible where it comes out of the casing on the back of the body (where the back of the neck would be).

2 Untie the neck string.

3 Reposition the head.

Place the head of the doll on the torso. You may need a second pair of hands to hold it steady while you prepare the string.

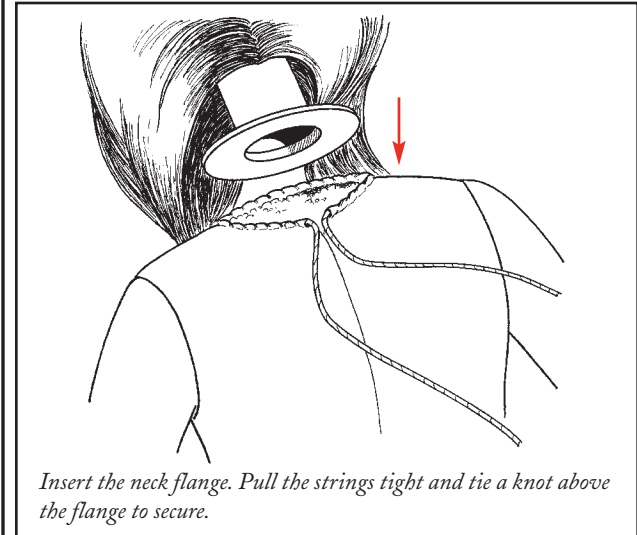

4 Pull the string to tighten.

Grasp the ends of the string and pull firmly until you feel it tighten around the neck flange and secure the head to the body.

5 Retie the string.

Tie the neck string in a square knot (see the diagram on page 49) to prevent it from coming loose. Tie a bow to shorten the ends of the string. Double-knot for added security.

**WORST-CASE
SCENARIO.**

WORST-CASE SCENARIO®

HOW TO REMOVE A HAND STUCK IN A JAR

- 1 Slather grease.**
Spread cooking oil, butter, margarine, mayonnaise, or other greasy substance on the part of the hand that is accessible.
- 2 Try to slide out the hand.**
Gently pull with steady, even pressure. Wedge the jar under your arm or have a third person hold the jar as you pull.
- 3 Submerge the hand and jar in ice water.**
The combination of the greased hand and the cold, which reduces swelling, may release the hand.
- 4 Try to slide out the hand.**
- 5 If the hand is still stuck, raise the hand.**
Elevate the hand (and jar) above the level of the child's heart for five minutes to reduce swelling.
- 6 Try to slide out the hand.**
- 7 Break the vacuum seal.**
Slide a straw, eating utensil, or plastic tubing in between the hand and the edge of the jar. Do not use a knife with a sharp blade.

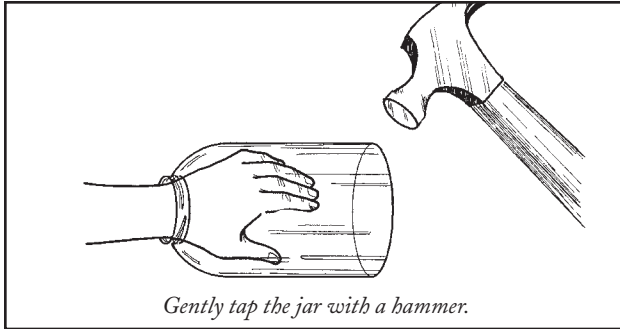

8 Try to slide out the hand.

9 Break the jar.

If all else fails, shatter the jar by tapping with a hammer. Tell the child to retract his hand to the opposite end.

10 Clear the debris.

Tell the child not to move his hand around until the task is finished and the hand is rinsed free of glass splinters.

HOW TO EXTRACT A FOOT STUCK IN SINKING MUD

1 Tell the child not to struggle and flail.

Calm the child and explain that she will not be swallowed up.

2 Instruct the child to let go of heavy objects.

Loaded backpacks, bags of gear, pockets filled with rocks, or other heavy items could drag her down farther.

3 Stabilize the surface around the hole and child.

Place planks, boards, or tree limbs on the ground so that you can approach the child. Use a walking stick, pole, or branch to test the ground's stability as you approach.

4 Grab the child and pull with steady upward momentum.

Approach the child from behind and grab the child's torso under the arms. Drag backwards. If her torso is not available for grabbing, pull the child by her hands, feet, or whatever is exposed.

HOW TO RETRIEVE A CHILD STUCK IN A TREE

1 Ask for directions.

Request that the child explain step by step how he got to where he is. This will focus his thoughts, calm him, and may provide a map as to how to climb back down.

2 Direct the descent.

From the ground, tell him where to put his hands and feet at each stage of the descent. Explain that if he was able to climb up, he should be able to climb back down.

3 Demonstrate how to climb down.

Select sturdy branches close to the ground and show him how to step on the part of the limb closest to the trunk.

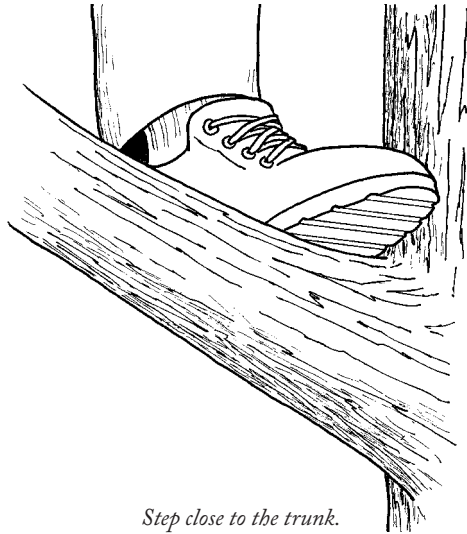

Step close to the trunk.



Call for help.

4 **Climb to his aid.**

Grab a branch at its base and use your legs, not your arms, to power yourself up the tree. Make sure that three of your limbs are in contact with the tree at all times. Once you have reached your child, hold his hand and say soothing things to calm him.

5 **Slowly talk your child down as you descend.**

Your arms should bear your weight on the way down. To increase your grip on the branches during your descent, turn your palms toward you when gripping the branches. Do not carry your child down the tree.

6 **Call for help.**

If you both get stuck, shout to attract a passerby who can get help. If you have a mobile phone, call the fire department.

Be Aware

Do not allow a child to jump from the tree or try to catch a jumping child. If a 50-pound child jumps just 10 feet into your outstretched arms, he exerts about 300 pounds of force, enough to injure both of you on impact.

WORST-CASE SCENARIO.

HOW TO REMOVE A WAD OF PAPER FROM YOUR CHILD'S NOSE

- 1 Pull gently on any protruding paper.**

Pinch the paper firmly between your index finger and thumb. Pull with a steady downward motion until the wad comes free, taking care not to rip it. If the wad does not budge, or if no paper protrudes, continue to the next step.
- 2 Sterilize a pair of tweezers.**

Rub them with hydrogen peroxide or isopropyl alcohol.
- 3 Tilt the child's head back to give you a clear view of the nostril and tissue wad.**

Use a flashlight or desk lamp for better visibility. Hold the child's head steady.
- 4 Insert the tweezers into the nose.**

Place the tip of the tweezers around as much of the paper wad as possible. Make certain the tweezers have a firm grasp on the paper wad or you risk tearing off small pieces and prolonging the job. Do not push the wad deeper into the nostril.
- 5 Pull steadily.**

Do not yank the wad. Have a clean tissue or handkerchief ready to absorb any leakage.

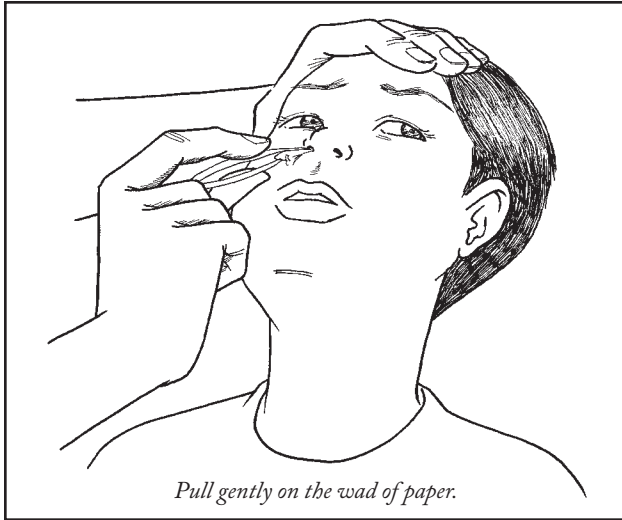

- 6** **Discard the wad.**
Wash hands thoroughly.

HOW TO REMOVE A PEA, MARBLE, OR OTHER SOLID OBJECT

- 1** **Place your mouth over the child's mouth.**
The position is the same as for mouth-to-mouth resuscitation.
- 2** **Press the unclogged nostril closed with your finger.**
- 3** **Blow.**
Blow a short but forceful puff into the child's mouth.
The stuck object should pop free.

**WORST-CASE
SCENARIO.**

HOW TO REMOVE CHEWING GUM FROM HAIR

USING ICE

1 Prepare an ice sack.

Place several cubes of ice in a plastic bag or thin cloth. Seal or hold it closed.

2 Apply ice pack to hair.

Move the affected hair away from the scalp and press the ice against the gum for 15 to 30 minutes or until the gum freezes solid. Use a rubber glove or a dry washcloth to hold the ice compress if your hand becomes chilled.

3 Crack the frozen gum into pieces.

With one hand, hold the stuck section of the hair between the gum clot and the scalp, and break the frozen gum into small pieces.

4 Remove the gum.

Gently pull the frozen gum pieces from the hair using your other hand. If the warmth of your hand begins to melt the gum, refreeze and repeat until all the gum has been removed from the hair.

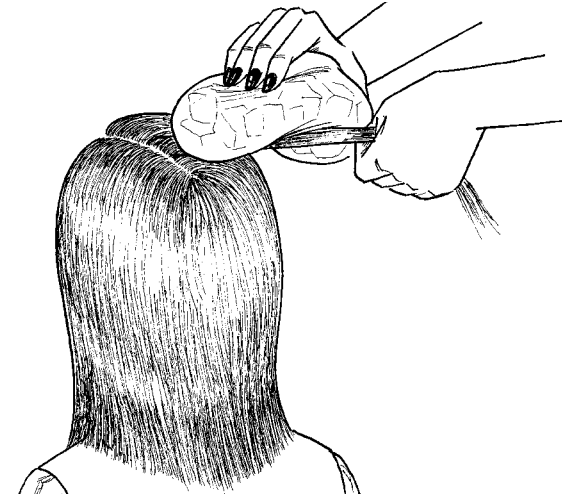

Hold ice against the gum until it freezes.



Remove the gum.

USING OILS

1 Rub a citrus-based solvent into the gum.

Cleaning products with oils from citrus fruit peels will reduce the stickiness of chewing gum and allow the hair to be pulled free. Apply a small amount of the solvent directly to the gum wad and rub until the hair can be separated without pain. Follow the solvent manufacturer's instructions and wear rubber gloves.

2 Loosen the gum with peanut butter.

If no solvent is available, the natural oils in peanut butter may loosen the gum. Work a teaspoon of peanut butter into the gum until the hair can be pulled free of the gum.

3 Apply mineral or cooking oil.

If the peanut butter is ineffective, work a very small amount of mineral or cooking oil into the gum to loosen it from the hair.

4 Wash and rinse.

Wash hair and hands with shampoo and soap to remove any lingering solvents, foods, or oils.

**WORST-CASE
SCENARIO.**

HOW TO REPAIR A BROKEN STROLLER

DAMAGED CANOPY



Patch.

- **UMBRELLA STROLLER**—Pull the damaged section taut. Sew a ripped or torn cloth canopy with needle and thread. Use duct or electrical tape to repair a plastic or vinyl canopy.
- **CARRIAGE STROLLER**—Canopies on larger, carriage-type strollers are generally sturdier, with plastic frames that rotate on hinges to cover the baby in various positions. Check the hinges (there should be one on each side of the stroller) where the canopy attaches to the stroller frame. If the canopy has come off its hinge, try to snap it back in place. If the hinge is damaged, secure the canopy to the stroller frame using string, yarn, a belt, or a purse strap.



Construct a makeshift canopy.

If the canopy cannot be repaired, place a shirt or other lightweight piece of material on the canopy frame and secure in place using string, tape, rubber bands, or hair clips. This will protect the baby from the elements temporarily.

Be Aware

In inclement weather, position an open umbrella in place of the canopy to keep the baby dry. Make sure the metal frame of the umbrella is far enough from the baby to be out of reach.

BROKEN STRAP



Pin the strap together.

A strap or safety belt that has torn in two can be reconnected using two small safety pins or one large diaper pin. Take the baby out of the stroller while you perform the repair.



Tie the ends with a square knot.

If there is enough slack, tie the two broken ends together with a square knot. Holding one end of the broken strap in each hand, pass the left over the right, and tuck under. Then pass the same end, now in the right hand, over the left, and tuck under. Pull the ends together tightly for added security.

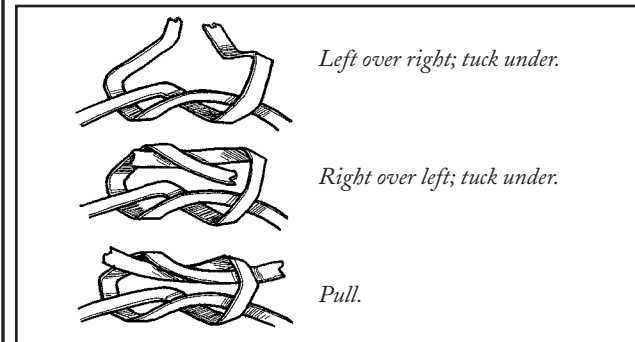



Substitute your own belt.

Use an adult's belt to hold the child in the stroller. Run the belt across the child's lap and around the back of the stroller. Buckle the belt behind the stroller.

FAULTY BRAKES



Disengage the brake.

- **PEDAL OR BAR BRAKE**—On standard strollers, the brakes are activated by pressing down on a pedal or bar above the rear wheels. A faulty brake will not stay in the raised position and will continue engaging, thereby stopping the wheels from turning. Use rubber bands, string, or twist-ties to attach the pedal or bar to the legs of the stroller: This will prevent it from falling and engaging the wheels. Make sure the connection is tight and there is no slippage.
- **HAND BRAKE**—Three-wheeled jogging strollers may have a hand brake, operated by squeezing a handle that pulls a cable, as on a bike. If the brake cable is broken, the brake will clamp the wheels and prevent them from turning. Pull the two ends of the wire together until the wire is taut. Twist the ends together for a temporary fix.

**WORST-CASE
SCENARIO®**

HOW TO RID A BEDROOM OF MONSTERS

- 1 Turn on the lights.**
Show your child that there are no monsters in the room.
- 2 Explain that you are making sure there will be no monsters in the future.**
- 3 Spray infested areas with water.**
Monsters are afraid of water. Fill a spray bottle with water and lightly mist problem areas, including under the bed, around the door, and in the closet.
- 4 Place sentries outside of closets and by windows.**
Monsters will avoid friendly-looking stuffed animals, dolls, clowns, and puppets. Assemble a battalion of these around all likely points of entry.
- 5 Use the color green.**
Many monsters are afraid of the color green. Use a green night light or encourage your child to wear pajamas with some green on them. A bandage, washable tattoo, nail polish, or a sticker with the color green are also effective.

Be Aware

If you encounter monsters, kill them with kindness. Hugs are particularly lethal, as are compliments.

**WORST-CASE
SCENARIO®**

WORST-CASE SCENARIO

HOW TO SAVE FOR COLLEGE

A four-year public college education (including room and board, excluding taxes and activity expenses) in the United States will cost approximately \$155,000 in 2020. A four-year private college education (including room and board) will cost approximately \$335,000. Here are some ways to pay for your newborn's education:

- ★ **Save money.**
Squirrel away \$23.60 a day for public school or \$51 a day for private school.
- ★ **Recycle.**
At 5 cents a can you will need to recycle 3,100,000 cans to pay for public school and 6,700,000 cans for private school.
- ★ **Sell lemonade.**
At 20 cents a cup your lemonade stand will need to sell 775,000 cups to pay for public school and 1,675,000 cups for private school.
- ★ **Hold a bake sale.**
At \$1.75 for a (cranberry-walnut) muffin, you will need to bake and sell 88,571 muffins to pay for public school and 191,429 muffins for private school. (Cost of ingredients not included.)



Pose as a model.

At \$8 an hour to pose nude for art students, you will need to sit for 19,375 hours (about two and a half years) to pay for public school and 41,875 hours (about four and a half years) for private school.



Babysit.

At \$10 an hour you will need to sit for 15,500 hours (about a year and a half) to pay for public school or 33,500 hours (nearly four years) to pay for private school.



Walk dogs.

At \$15 a walk (30 minutes) for one dog, you will need to walk 10,333 dogs to pay for public school and 22,333 dogs for private school.



Fish sit.

At \$9 a visit to maintain an aquarium you will need to see 17,222 tanks to pay for public school or 37,222 tanks to pay for private school.



Clean rain gutters.

If you are paid \$20 each time you clean a home's rain gutters, you will have to clean 7,750 homes to pay for public school and 16,750 homes for private school.



Mow lawns.

If the rate is approximately \$40 a lawn, you will have to mow 3,875 lawns to pay for public school and 8,375 lawns to pay for private school.

★ **Rake leaves.**

If you receive \$50 an acre, you will need to rake 3,100 acres for public school and 6,700 acres for private school.

★ **Groom pets.**

If you receive \$65 for an extra-large, long-hair dog (flea dip, clip, ears and teeth cleaned, nails clipped, anal glands checked), you will need to groom 2,385 dogs to pay for public school and 5,154 dogs for private school.

★ **Bartend.**

If you are working at a bar that generates \$200 per night in tips, you will have to work 775 nights to pay for public school and 1,675 nights to pay for private school.

★ **Sell hair.**

At \$5 an ounce for your hair, you will need to sell 1,938 pounds of hair to pay for public school and 4,188 pounds for private school.

★ **Sell your egg or sperm.**

At approximately \$20,000 an egg, you will need to harvest and sell eight eggs to pay for public school and 17 eggs to pay for private school. At \$50 a sperm sample, you will need 3,100 samples to pay for public school and 6,700 to pay for private school.

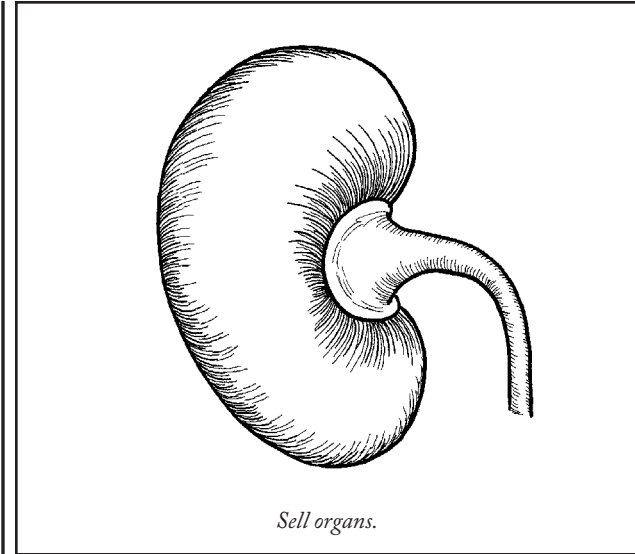

★ **Sell organs.**

At \$30,000 a kidney on the black market, you will need five members of your immediate family to donate one kidney to pay for public school and eleven members of your immediate family to donate a kidney for private school.

Be Aware

- All savings plans, above, assume that earnings are not taxed. Additional amounts will need to be earned to cover taxes.
- All savings plans assume that earnings are not invested; interest, dividends, or appreciation on investments will contribute to earnings.

HOW TO SOUNDPROOF YOUR TEENAGER'S ROOM

1 Move speakers away from walls.

Speakers placed directly against a wall will reverberate sound through the wall and into adjoining rooms. Also raise the speakers off the floor and place them on stands or small tables to reduce reverberations through the floor.

2 Lower the volume.

Turn down the volume 30 percent, then move the speakers closer to your teenager to provide him with the same volume of sound.

3 Disable bass-boosting features.

Bass-enhanced sound travels through most partitions more easily. Turn off the feature on the amplifier or equalizer.

4 Install carpeting.

A thick carpet with a rubber pad below it will absorb most sounds. Make sure it runs wall to wall. Do not hang carpeting or rugs on the walls. Soft, absorbent materials applied to walls change the acoustics of a room but rarely make it more soundproof.

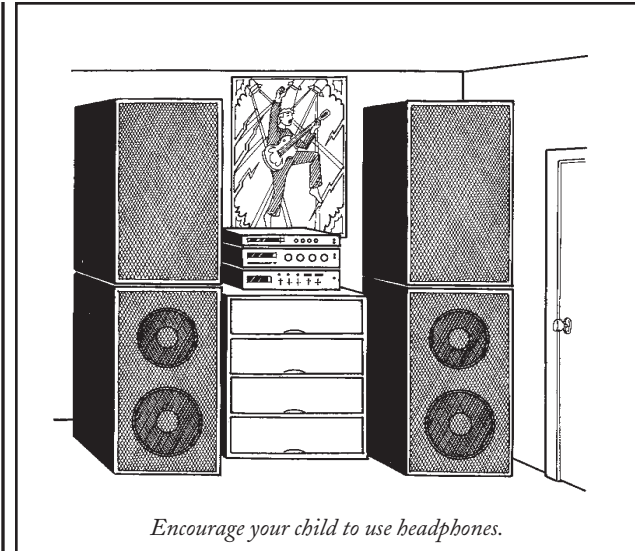

5 Install a solid wood door.

Solid wood doors offer better soundproofing than hollow-core or recessed-panel doors.

6 Install weather stripping.

Sound “leaks” from a room through the space around the door. Add sponge rubber weather stripping seals on the top, bottom, and sides of all doors.

Be Aware

Studio-quality headphones make an excellent present for your teenager. Explain that they enhance the quality of the sound and can really be blasted; hope that headphones replace the speakers.

HOW TO COPE WITH YOUR TEENAGER'S MUSICAL PREFERENCES

- ★ **Buy yourself earplugs.**
- ★ **Create loud white noise.**

Run the vacuum or turn on a wave machine set at the tsunami level to relax when your teen turns on his music.
- ★ **Learn to be “down” with your teen’s music.**

It will weird him out and probably make him switch his preferences. Eagerly ask if he has the latest [*insert his favorite music group*] disc. Proudly show off the poster, T-shirt, and other memorabilia you have collected of said group. Sing along whenever he plays the group’s CDs.
- ★ **Dig up embarrassing “early years” information on your teen’s favorite group.**

Find humiliating photographs of the band when it was starting out. You are bound to come across lame hair and clothing styles. Reveal damning facts on the band such as any classical training, experiences with all-boy or all-girl bands, and appearances on network television talent-search programs.
- ★ **Say you heard the creepy neighbor’s preteen listening to the same music last week.**

**WORST-CASE
SCENARIO.**

HOW TO SURVIVE A LONG CAR TRIP

- 1 Line the seats with a large bath towel or sheet.**
The cover will protect the back seat and expedite cleanup later.
- 2 Leave early.**
Start a long trip early—before dawn—to assure that kids will be sleepy and will nap for the first few hours of the ride. If they awaken at or near rush hour, pull over to avoid traffic and get a break from driving.



Bring only what you really need.

- 3 Bring along a few key items, but only what you really need.**
Essential items include snacks, games, open-ended creative toys, and passive entertainment devices (such as CD players and portable DVD players).
- 4 Make frequent stops.**
Do not expect small children to sit still for more than an hour or two at a time. Make frequent rest stops to switch drivers, stretch, throw a ball, run around, and use the bathroom. These stops also serve to fend off carsickness and keep the driver alert.

HOW TO PEE AT THE SIDE OF THE ROAD

- 1 Pull over.**
Find a spot with adequate coverage, usually in the form of bushes or thick trees, that is a safe distance from the road.
- 2 Exit the car away from the road.**
Leave the door open to further block visibility. Take tissues or napkins with you, if available.
- 3 Select a position behind a tree or bush.**
Position your child 180 degrees from view of oncoming traffic. In general, boys should pee facing downhill, while girls should pee facing uphill.

4 Assess the weather conditions.

Assess the direction of the wind, and position your child to pee with it.

5 Assemble a “human shield.”

If there is little or no coverage, line up other members of the family to form a “human shield.”

6 Keep quiet.

Do not speak to the family member who is attempting to go. It may be distracting and will only prolong the stop and the trip.



**WORST-CASE
SCENARIO.**

WORST-CASE SCENARIO

HOW TO SURVIVE A MEETING WITH THE PRINCIPAL

1 Dress appropriately.

Dress neatly and conservatively: a dark suit and solid or wide-striped tie for men, a dark suit or a dark skirt and neutral color blouse for women. Shoes should be clean, with laces tied. The principal is likely to make judgments about your parenting skills (and your child's behavior) based on your appearance.

2 Use proper salutations.

If you know you are in the right, call the principal "Principal" followed by her last name. Using the title will appear to show respect; you are not challenging her authority, you just happen to be in the right. If you are in the wrong, do not mention the title when addressing her. Call her "Miss" or "Ms.," which levels the playing field.

3 Observe the principal's reaction to meeting you.

If the principal comes around her desk and sits near you, this is a sign that the meeting is not likely to be confrontational. If the principal takes her place behind a desk, suggest moving the meeting to a more "comfortable" site, away from her home turf, such as a faculty break room, cafeteria, or a nearby coffee shop.

4 Mirror the principal's body language.

If the principal leans to the right and cocks her head to the right, lean left and cock your head to the left. Mirroring nonverbal behavior—also called matching and pacing—is an effective way to put another person at ease and make them more amenable to suggestion. Avoid crossing your arms, which connotes defensiveness.

5 Keep your story short and to the point.

The principal may try to interview you and your child separately, turning one against the other. Confer with your child before the meeting to get his side of the case. Make sure your claims and excuses are consistent and brief. The longer the justification or explanation, the more guilty you seem, and the more likely you are to contradict yourself or your child.

6 Take notes.

Make sure the principal notices you are keeping a written record of the conversation. This conveys that you are a serious and conscientious person. Do not tape-record the meeting, however, since the machine will create a barrier, defensiveness, and formality, at the same time that it implies you will lose and need the tape later.

7 Ask open-ended questions.

Questions that begin with words like “what,” “how,” “why,” “could,” and “would” encourage the principal to offer longer, more expository answers, which serve to give you more information about the situation. Avoid asking questions prefaced with words like “do,” “did,”

“is,” and “are,” which encourage shorter answers, and call for conclusions that might put you on the defensive.

8 When you get the answer you want, move on.

If the principal agrees with you on a point, don't rehash it or continue down the same path; switch to a new topic. Later, you can use any information gained to your advantage: “But didn't you say a few minutes ago that she's an excellent student?”

9 Concede meaningless points.

Do not admit to anything major, but make the principal think you are on her side by agreeing to tangential arguments. Say, “Yes, you are right, my son is bigger and stronger than most of the other children in his class.”

10 Create the impression you're all on the same side.

Do not make the meeting seem adversarial: You, your child, and the principal are trying to solve a common problem. If necessary, create understanding and a shared-problem bond with the principal and distance yourself from your child, or from children in general. (“Kids will be kids.”) If the principal has a rapport with you and trusts you to supervise your child, your child is more likely to get off easy.

Be Aware

Even if you feel your child has been wrongfully accused, fighting the principal may be a losing battle—and you don't want to make things worse. Besides, it's your child who will face the consequences, not you.

WORST-CASE SCENARIO.

HOW TO SURVIVE A SLUMBER PARTY

1 Begin the party at around 6 P.M.

Organize strenuous events such as tag, soccer, high-impact aerobics, calisthenics, or wind-sprint drills to exhaust the guests and encourage an early bedtime.

2 Serve carbohydrate-heavy foods.

Pizza, pasta, sandwiches, chili, and other heavy foods help induce sleep. Make certain these are on the menu, and encourage everyone to go back for seconds.

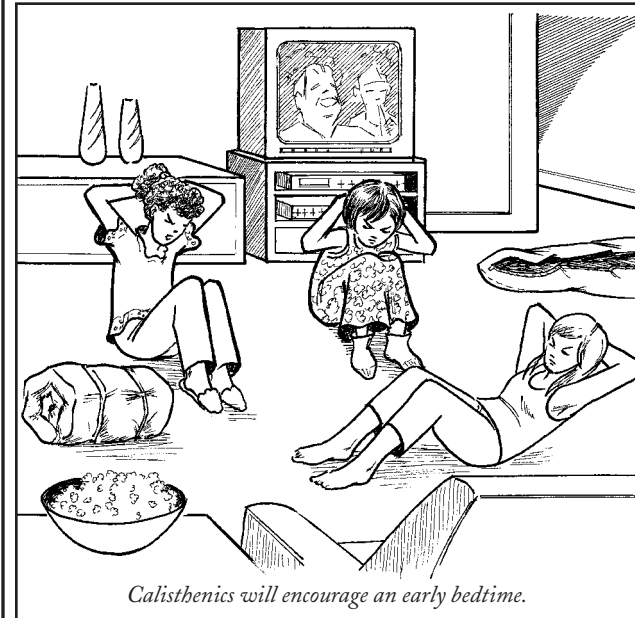

3 **Secure cabinets, rooms, and drawers you want to keep off limits.**

Use travel padlocks and cable ties to protect cabinets and drawers. To keep the children out of rooms that do not lock, place noisy pets inside the rooms, or stack cans behind the door to create an “intruder alert” system.

4 **Observe your guests unobtrusively.**

Use small bowls for snacks so they need to be refilled regularly, providing you with the opportunity to ensure that the children are behaving well. Listen with a tall glass pressed against a wall or door (holding the closed end to your ear) to eavesdrop. Check in every half an hour or so in order to “see if anyone needs or wants anything.”

5 **Introduce video games and movies to ratchet down the activity level.**

Lower energy levels with nonviolent video games as part of a cool-down phase. Show long, sweeping epic movies around 11 P.M. to get children into sleeping bags and a prone position.

Be Aware

When issuing invitations to the party, advise your guests to bring not only sleeping bags, pillows, and toothbrushes, but also their favorite board games, video games, game controllers, and stuffed animals.

**WORST-CASE
SCENARIO.**

WORST-CASE SCENARIO®

HOW TO SURVIVE A SOCCER SATURDAY

- ★ **Stay positive.**
Refrain from criticizing your child's gameplay or the skills of the other children. Shout only supportive comments, such as "Good header" or "Nice shot." Lead the other parents in group cheers.
- ★ **Focus on the game.**
Do not gossip with the other parents or talk on your cell phone.
- ★ **Do not criticize your child's coach.**
Don't worry about how much playing time your child gets or criticize the coach's strategy.
- ★ **Let the referee make the calls.**
Refrain from yelling "Offside" and "Hand ball!" Support the referee no matter what calls he makes.
- ★ **Bring healthful treats.**
Fruit or trail mix makes the best refreshment for tired players, siblings, and parents. Bring a cooler with sports drinks, including water.
- ★ **Bring folding chairs and extra clothing.**
"Camp" folding chairs are appropriate but chaise longues are not. In sunny weather, pack hats and sun block. In cold weather, bring blankets and extra jackets.

Be Aware

- Know the rules: A player is “offside” (not “off-sides”) when she is nearer to the other team’s goal line than two of the opposing players and when the ball touches or is played by one of her teammates. For determining an offside penalty, the ball counts as a “player” on the opposing team. The rule prevents players from hanging around the other team’s goal. The consequence for a player being caught offside is the loss of possession.
- To cut down on annoying chatter, bring lollipops, jawbreakers, or other candy that takes a long time to dissolve. Pass them out to fans of both the home and away team. The visiting team will be impressed by your team’s friendliness and may conduct themselves in a more civil manner. In any event, everyone’s mouth will be occupied.

HOW TO BREAK UP A FIGHT

1 Talk the parents down.

Do not yell; speak in a low, even tone and show understanding. Instruct the fighting parents to cease and desist. Call them by name, if you know their names. Remind the parents that they are setting a bad example for their children.

2 Prepare to intercede.

If the parents continue to fight, enlist the aid of another, preferably large, parent. Take off glasses, jewelry, or high heels. Disperse any audience that has

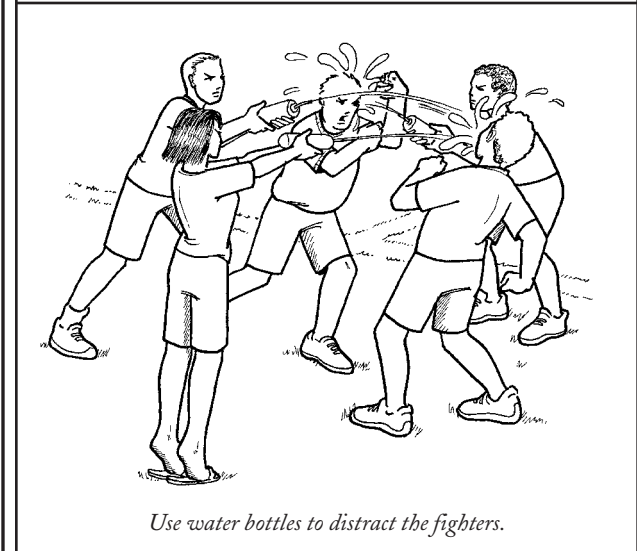
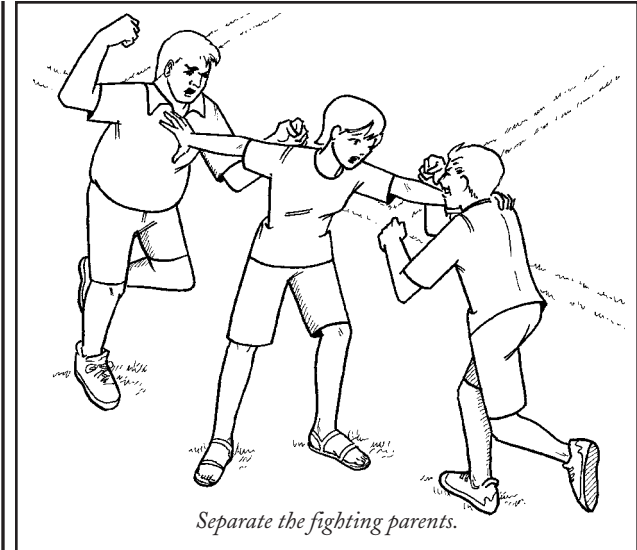

gathered. The fighters may feel a need to continue or save face if they are in front of a crowd.

3 Step between the fighting parents.

Position yourself in the middle of the fray. Extend your arms straight out to either side to push the parents as far from each other as possible. Continue to speak to the fighters in a calm but firm voice.

4 If you are with another person, pull the parents off of each other from behind.

From behind, clutch one of the sparring parents in a strong bear hug. Position your body with your chest pressing against his back. Reach your arms around him, over top of his arms, and grasp your hands together on his chest. Your partner should do the same with the other parent. Drag the opponents away from each other. Do not lift the parents off the ground: You will be susceptible to flailing legs and kicks to the shins, as well as to back strain.

5 Take fighters to separate areas.

Remove the parents to opposite sides of the field, or escort one of them to the parking lot, until you are assured that they have calmed down enough to finish watching the game in peace.

Be Aware

To break up a fight from a distance:

- Throw the contents of a large cooler on the fighting parents, or use squirt bottles to direct streams of water at their faces.
- Blow air horns near the fighters to frighten them.
- Throw slippery halftime snacks, like oranges, apples, or banana peels, under their feet to destabilize the fighting surface.
- Toss blankets or large towels over the heads of the fighters to disorient them.
- Pelt the fighters with soccer balls to distract them.

HOW TO TREAT A BLACK EYE

1 Make a cold compress.

Fill a clean sock with ice from the snack cooler. A cold can of soda or a juice box will also work.

2 Sit down.

Sit on a folding chair or on the ground.

3 Tilt your head back.

With your head tilted back, gravity will aid in reducing the swelling. Angle your head so that you can still watch the game with your good eye.

4 Cover the injured eye with the compress.

Use minimal pressure. If the compress is too cold, use a thicker cloth. Keep the compress over your eye for at least an hour or for the rest of the game.

HOW TO SURVIVE BABY-GEAR OVERLOAD

1 Wear cargo pants.

Fill the pockets with soft items:

- Burp cloth
- Bibs
- Change of clothes (for you and for baby)

2 Dress the baby in cargo pants.

Fill the pockets with small necessities:

- Baby's cap
- Small board book for entertainment
- Teething ring

3 Wear a photographer's or fisherman's vest.

Fill the pockets with necessities:

- Small camera and film
- Baby blanket
- Crib toy
- Baby manual
- Hand sanitizer
- Bowl and spoon
- Changing pad
- Shampoo
- Nail clippers
- Bath soap
- Fever-reducing medicine

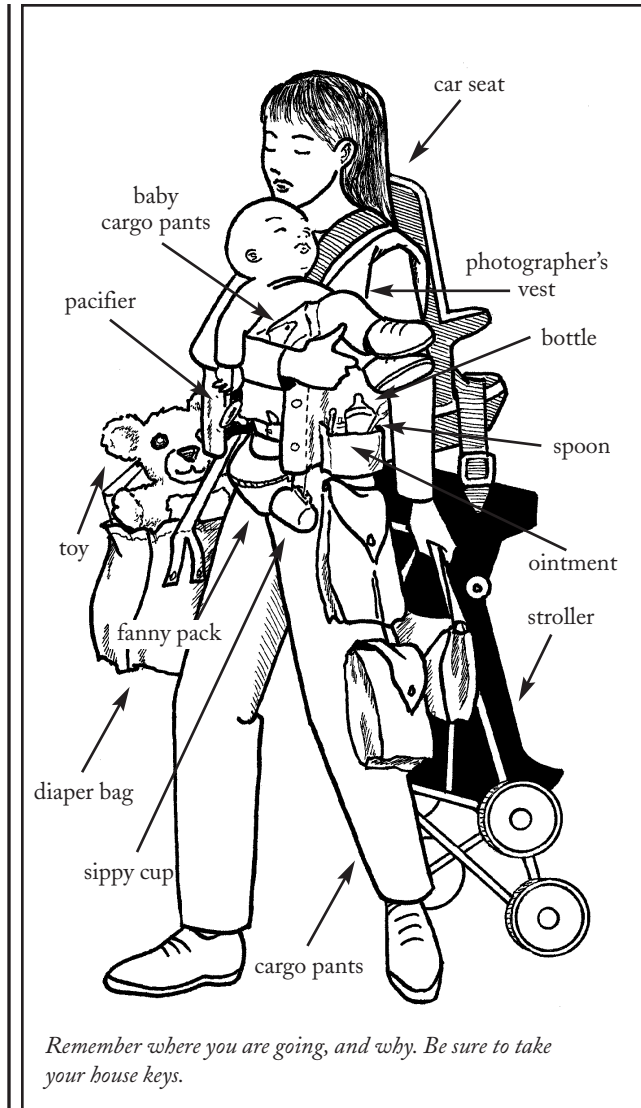

- Teething gel
- Anti-itch cream
- Saline drops
- Nasal bulb syringe
- Thermometer
- Tissues
- Meat tenderizer for bee stings
- Adhesive bandages
- Antibiotic ointment
- Toothbrush and paste
- Plastic bag for soiled diapers
- Plastic bag for wet/dirty clothes

4 **Wear a fanny pack.**

Fill with adult necessities:

- Keys
- Wallet
- Headache medicine
- Sunglasses
- Makeup
- Cell phone
- Shopping list
- Pen

5 **Circle your waist with a web belt.**

Attach a canteen (for you) and a bottle or sippy cup (for baby).

6 **Clip a pacifier to the baby.**

7 **Sling a messenger bag across your back.**

Fill with remaining necessities:

- Umbrella
- Toys
- Diapers
- Diaper wipes
- Cotton balls
- Sunscreen
- Diaper cream
- Juice
- Crackers
- Video camera

8 **Wear a baby carrier or sling.**

Place the baby in the carrier and go. Remember where you are going, and why, and be sure to take your house keys with you.

HOW TO SURVIVE BABY-GEAR OVERLOAD

1 Wear cargo pants.

Fill the pockets with soft items:

- Burp cloth
- Bibs
- Change of clothes (for you and for baby)

2 Dress the baby in cargo pants.

Fill the pockets with small necessities:

- Baby's cap
- Small board book for entertainment
- Teething ring

3 Wear a photographer's or fisherman's vest.

Fill the pockets with necessities:

- Small camera and film
- Baby blanket
- Crib toy
- Baby manual
- Hand sanitizer
- Bowl and spoon
- Changing pad
- Shampoo
- Nail clippers
- Bath soap
- Fever-reducing medicine

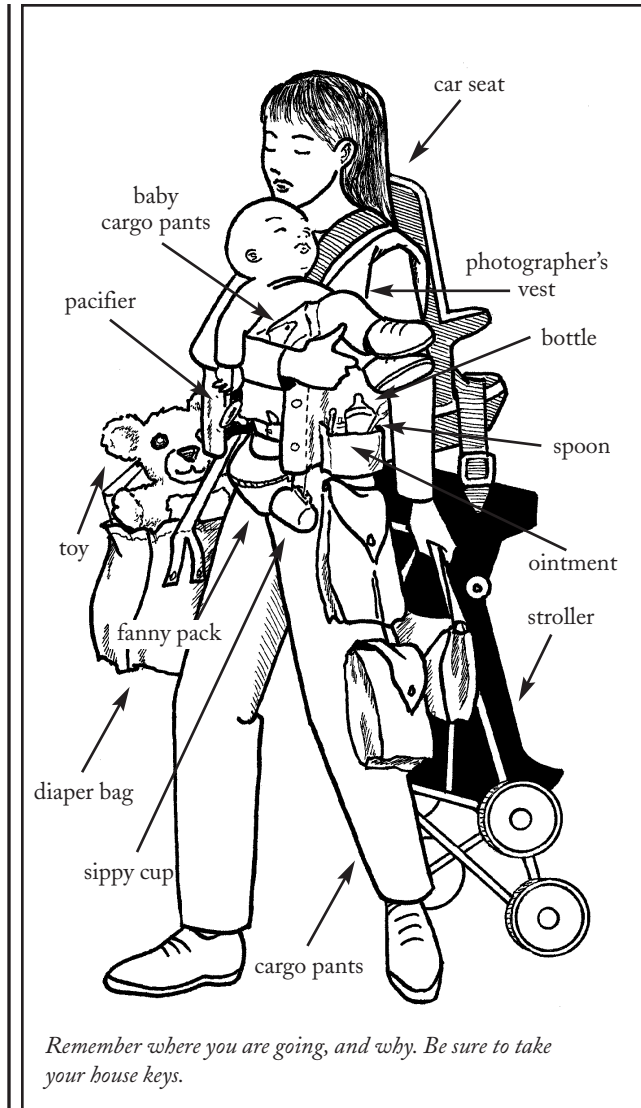

- Teething gel
- Anti-itch cream
- Saline drops
- Nasal bulb syringe
- Thermometer
- Tissues
- Meat tenderizer for bee stings
- Adhesive bandages
- Antibiotic ointment
- Toothbrush and paste
- Plastic bag for soiled diapers
- Plastic bag for wet/dirty clothes

4 **Wear a fanny pack.**

Fill with adult necessities:

- Keys
- Wallet
- Headache medicine
- Sunglasses
- Makeup
- Cell phone
- Shopping list
- Pen

5 **Circle your waist with a web belt.**

Attach a canteen (for you) and a bottle or sippy cup (for baby).

6 **Clip a pacifier to the baby.**

7 **Sling a messenger bag across your back.**

Fill with remaining necessities:

- Umbrella
- Toys
- Diapers
- Diaper wipes
- Cotton balls
- Sunscreen
- Diaper cream
- Juice
- Crackers
- Video camera

8 **Wear a baby carrier or sling.**

Place the baby in the carrier and go. Remember where you are going, and why, and be sure to take your house keys with you.

HOW TO SURVIVE EMPTY-NEST SYNDROME

1 Allow yourself time to grieve.

Sadness is a natural reaction to your child's departure. Permit yourself to cry now and again without shame.

2 Find a temporary replacement for your affection.

To ease the transition, get a pet, or take your child's photo to a copy center and get a life-sized replica.

3 Wean yourself.

- Rearrange furniture in your entire house, not just in your child's room. A new look can make you feel like you have entered a new stage of life.
- Remove the most recent photos of your child. Recent photos can be a reminder that he was recently in the house—replace them with older images.
- Establish a “Reminder Jar.” Similar to a “Swearing Jar” into which a parent places money for every swearing infraction, this jar reinforces behavior modification and punishes “remember when” infractions.

4 Convert your child's room into your own space.

Install a Murphy or sofa bed so that your child will have a place to stay when he comes home for visits, but alter the primary function of the room permanently. Set up a home theater, exercise room, or greenhouse.

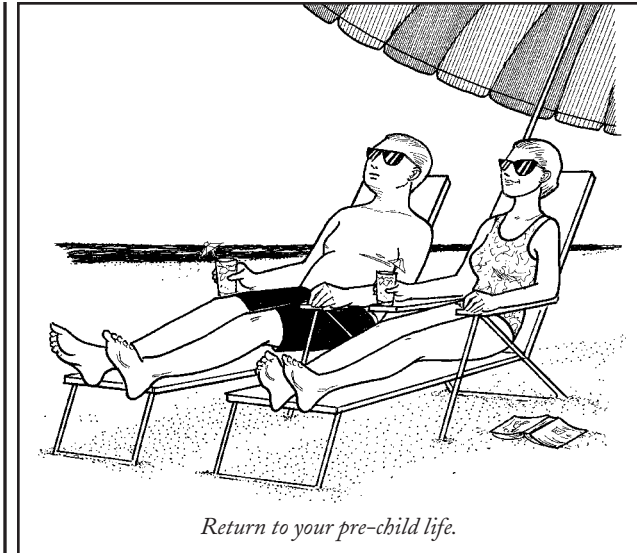

5 Return to your pre-child life.

- Read a book.
- Invite your friends over for dinner.
- Fire the maid.
- Enjoy the quiet and calm.
- Watch the television shows you want to watch.
- Find things just where you left them.
- Take a trip.

Be Aware

Keep a list of the things your child did that annoyed, frustrated, and angered you. When you start to recall these things with fondness and a smile, you will have successfully entered the next phase of your life.

HOW TO SURVIVE IF YOUR CHILD MOVES BACK IN

- ★ **Be sensitive to your child's needs—for a while.**
Sometimes a child returns home because of a negative life change. Be understanding, and realize that a child moving back home is a difficult situation for all involved. Do not let yourself be exploited, however.
- ★ **Charge rent.**
Match market rates—deep discounting will only encourage your child to stay where it's cheap and easy.
- ★ **Assign chores.**
More people means more work, so delegate laundry folding, mowing the lawn, cleaning the porches, washing dishes, raking leaves, and other tasks. Do not offer to pay an allowance. If other family members have also moved in—your son- or daughter-in-law or grandchildren—give them chores as well.
- ★ **Motivate change.**
Place the classified advertisements section of the newspaper by your child's door. Do not change the message on your answering machine. Do not provide him with meals, change his bed linens, or allow him to watch television in the family room.

- ★ **Do not alter your new lifestyle.**
Continue to host your book group, bridge club, and cocktail parties. Continue to use his old room for its new purpose—sewing, exercising, big screen television watching.

HOW TO PREVENT REENTRY

- ★ **Change the locks.**
Change the alarm code, too.
- ★ **Paint the house.**
He might not recognize an unfamiliar color.
- ★ **Hide the car.**
Park around the corner.
- ★ **Put a different name on the door/mailbox.**
- ★ **Get a large, unfriendly pet.**
Any size dog or cat can be effective if he is allergic.
- ★ **Move to a smaller place.**
- ★ **Disappear.**
Go on an extended vacation, rent an RV, or simply move out of town. Turn off your cell phone. Do not leave a forwarding address.

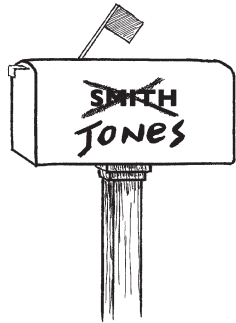

Put a different name on the mailbox.



Get a large unfriendly pet.

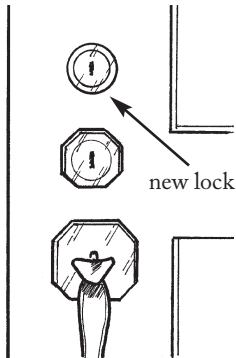

Change the locks.

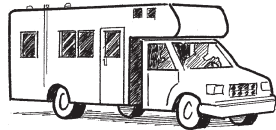

Disappear.

**WORST-CASE
SCENARIO.**

Be Aware

Parenting is forever.

WORST-CASE SCENARIO®

HOW TO SURVIVE PLAYING CATCH

1 Eat right.

Start the day with a high-protein, high-carbohydrate breakfast: Pancakes and sausage, bacon and eggs, or a bagel and an egg are all good choices. Drink plenty of fluids to aid in digestion, but avoid excess caffeine, which dehydrates. Wait 30 to 45 minutes for the meal to digest before playing ball.

2 Stretch.

Get the blood flowing with 15 to 20 minutes of intense stretching, fast jumping jacks, and vigorous running in place (get your knees up high). Make sure all major muscle groups—especially your arms, shoulders, thighs, and upper and lower back—are loose.

3 Tape ankles.

Wrap your ankles in first-aid tape to add support and reduce the chance of a twist or sprain.

4 Don head- and wristbands.

Keep sweat out of your eyes and off your hands.

5 Wear protective eyewear.

You may be forced to shag some flies or grab some pop-ups. Sunglasses will reduce glare and eyestrain and make the ball more visible. Wear a hat for added protection from the sun.

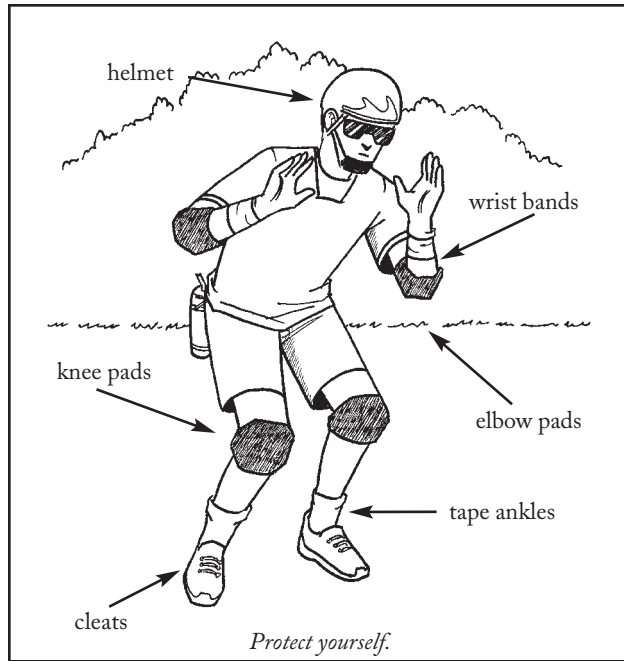

6 **Wear knee and elbow pads.**

Pads will protect your joints should you need to dive, slide, or roll, or should you trip.

7 **Wear cleats.**

Cleats provide added traction.

8 **Play ball.**

**WORST-CASE
SCENARIO.**

HOW TO SURVIVE TEENAGE ANGST

★ The Dark Poet

TELLTALE SIGNS: Black clothes, dark lipstick or nail polish, beret, cape of any color, carries book at all times, sullen, avoids direct sunlight.

WHAT HE/SHE WANTS: New family (suspects switched at birth), castle on a stormy heath, fangs, to write own zine.

WHAT TO SAY: “What a lovely moon tonight.”

WHAT TO GIVE: *The Collected Works of Edgar Allan Poe.*

★ The Spaz

TELLTALE SIGNS: Bumps into people and things, nervous tics, resembles overgrown puppy, tape on glasses, menace on the dance floor.

WHAT HE/SHE WANTS: Coordination, timing, to make the winning shot, cancellation of gym class.

WHAT TO SAY: “Don’t worry, it will heal fast.”

WHAT TO GIVE: Helmet, kneepads.

★ The Lovelorn

TELLTALE SIGNS: Flavored lip gloss, body glitter, furtive glances, seductive gait, nervous laughter, serial crushes.

WHAT HE/SHE WANTS: First kiss, boyfriend/girlfriend, to wear his/her Varsity jacket, someone to linger at locker with, recipient for reams of love poetry.

WHAT TO SAY: “I didn’t go to my prom either.”

WHAT TO GIVE: Puppy.

★ The Rebel

TELLTALE SIGNS: Black leather or red canvas jacket, white T-shirts with smokes rolled up in sleeve, belligerent, curt, squinty.

WHAT HE/SHE WANTS: To be freed from the shackles of oppression, parent to sweat over threats to move out, love and affection, boundaries, warm milk, cat to sleep on pillow.

WHAT TO SAY: “If nothing matters, why not enjoy?”

WHAT TO GIVE: Cool jeans.

★ The Loner

TELLTALE SIGNS: Stands near walls or in corners, travels solo by choice, slinks around house and school, headphones, heavy book bag, big sunglasses.

WHAT HE/SHE WANTS: Privacy, solitude, time for reading and thinking, an end to prying stares, flat screen TV, year off to meditate.

WHAT TO SAY: Nothing.

WHAT TO GIVE: Isolation tank.

★ The Egotist

TELLTALE SIGNS: Satisfied smirk, knows most everything, pained at having to listen to and make conversation at dinner table, coordinated separates, booming voice, eye rolling, heavy sighs, excellent grooming habits.

WHAT HE/SHE WANTS: Recognition, confirmation, validation, vindication, personal assistant.

WHAT TO SAY: “That’s nice, dear.”

WHAT TO GIVE: Monocle.

★ **The Worry Wart**

TELLTALE SIGNS: Wringing of hands, nail biting, furrowed brow, downcast glances, makes lots of lists.

WHAT HE/SHE WANTS: End to contingency planning, someone else to take charge, early acceptance into college of choice, fun.

WHAT TO SAY: “In the long run, it will all be okay.”

WHAT TO GIVE: Worry beads.

★ **The Looks Police**

TELLTALE SIGNS: Relentless self-scrutiny, armed with fashion magazines, water bottle and gym bag, avoids salad dressing.

WHAT HE/SHE WANTS: Clear dewy skin, to be “discovered,” to lose 20 pounds, to be leggy, boobs (if female), to lose boobs (if male), six-pack abs, good hair, admiring glances.

WHAT TO SAY: “You look great!”

WHAT TO GIVE: Magnifying mirror.

**WORST-CASE
SCENARIO.**

HOW TO SURVIVE THE PROM

IF A DATE CANCELS

If your teen's date cancels, put as many of the following plans into simultaneous action as possible to find a replacement date.

- ★ **Cruise local hotels and event venues.**
Phone to determine what other formal events are taking place that night, then visit the locales to find a suitable date. Weddings, bar and bat mitzvahs, and charity balls are good events to troll. Avoid 50th anniversary parties.
- ★ **Start a phone chain with family and friends.**
Cousins, family friends, and neighbors are the most likely candidates, as are foreign exchange students and visitors from out of town.
- ★ **Check formalwear stores.**
An employee in a formalwear store may already be dressed and ready to go.
- ★ **Order pizzas from several different pizza establishments.**
Select the most attractive delivery person. Tip well.



Hire an escort.

Find as reputable an entertainment service or modeling agency as possible. Do not tip well.

IF YOU HAVE TO DRIVE

1

Disguise yourself.

Wear a wig, chauffeur's cap, paste-on mustache, thick glasses, fake nose, or other identity-changing device. Protect your identity, not only for your teen's sake, but also for your own.

2

Alter the appearance of your car.

Make your car look more like a car service vehicle. Create a sign that reads "Professional Limo Service" and place it in the window. Place a small cooler with sodas and snacks in the back seat. Tape small signs on the back of the driver's and passenger's seats that say, "Do not talk to driver," and "Tipping permitted." If possible, borrow a friend's or family member's luxury sedan.

3

Speak in a cultivated, sophisticated accent.

Address your child and the date formally as "Sir" or "Miss."

4

Do not talk to your passengers.

Do not join the conversational flow. Even if there is awkward silence in the back seat, do not fill the gap with musings of your own prom and teenage exploits.

5 Resist the urge to act parentally.

Even if you see behavior you know to be inappropriate, restrain yourself from interjecting unless the law is being broken or lives are being threatened. You are the driver, not the parent. Discuss only pick-up times and wait times.

HOW TO AVOID A CORSAGE WOUND

Pin the corsage on your daughter's dress to save her date from embarrassment and her from injury. If it is your son going to the prom, instruct him on how to proceed.

1 Remove the corsage from its box.

2 Watch out for the long pin.

There will be at least one pin piercing the flower or stem.

3 Remove the pin(s) from the corsage.

4 Position the corsage so that the flowers point up.

5 Determine the best location for the corsage.

The ideal location for the corsage depends upon what the woman is wearing: Usually, it should be pinned on the dress near the collarbone, so that she can turn her head slightly to smell the flowers. Do not pin the corsage so high that her chin hits the flowers when she moves her head. If she is wearing a strapless dress, pin the corsage at her waist or on her evening bag.

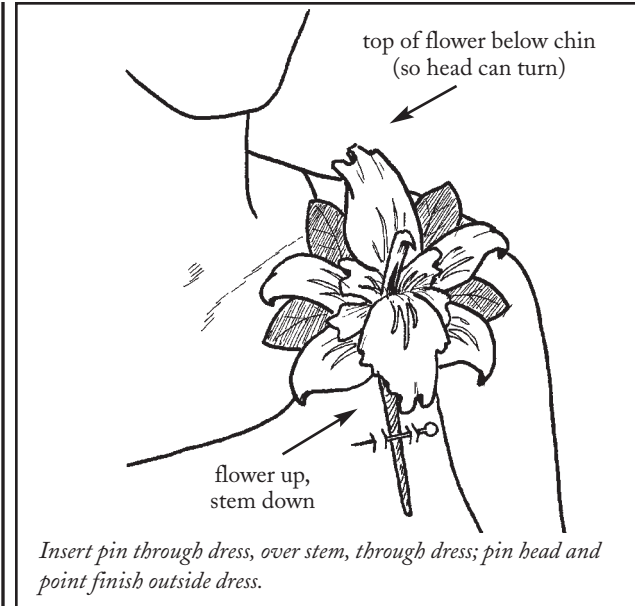

6 Pin the corsage to the fabric.

Gently pull the fabric away from her body, or slide your fingers, palm out, between the dress and her skin. Insert the pin horizontally (toward her skin), then back through fabric (away from her skin) and over the corsage stem to hold it in place. Complete the pinning by running the pin once more through the fabric (toward her skin) and back out again (away from her skin). You will have made four holes in her dress.

Be Aware

Remember to move the tip of the pin to the outside of her dress for its final resting place.

HOW TO SURVIVE WHEN YOUR CHILD BRINGS HOME A STRAY

Dog

1 **Involve your child in finding the dog's owner.**

Explain that the dog might be somebody else's pet. Ask her to make posters to put up around the neighborhood. Call the local humane society to determine if the pet has been reported missing. Have her speak to the local mail carrier and other dog owners in the area who might recognize the dog.

2 **Check the dog's tags.**

A dog kept as a pet should have a rabies tag, and may have a name tag. Contact animal control authorities, who can use the rabies ID number to locate the animal's vet and owner.

3 **Follow the dog.**

Take the dog back to the place where it was found and encourage the dog to lead you and your child to its home. Put the dog on a leash. Repeat, "Go home, boy!" or "Dinner time!" to motivate the dog. If you live in an area where several languages are spoken, repeat these phrases in each language.

4 **Take the dog to a veterinarian.**

The vet should give the dog a full behavioral and medical evaluation. The dog's mental and physical condition may determine whether it can be a suitable pet.

5 **Discuss dog ownership responsibilities.**

Explain to the child that caring for a dog is hard work. Detail pet care duties, and create a contract to make sure your child is fully vested in caring for and loving your new dog.

Be Aware

A dog with a runny nose, badly matted hair, and a dirty or unkempt appearance may have been on the streets for weeks or longer—approach such a dog with caution. Be wary of a dog that drinks lots of water and seems confused, withdrawn, or aggressive. Never approach any dog that appears to be foaming at the mouth.

EXCHANGE STUDENT

1 **Involve your child in finding the student's origins.**

Explain to your child that the student may already have a host family. "Found" signs should be created and posted around the local high school, college, or university.

2 **Check the student's papers.**

An exchange student should have a valid passport and student visa, and usually a letter of introduction to the school. School authorities should be able to reach the student's parents to verify his status.

3 Follow the student.

Take the student back to the place where he was found and encourage him to lead you and your child to his host family. Repeat, “Take me to your host family,” or “Show me where you live.” If the student smiles and nods but does not follow your instructions, repeat these phrases in several languages until the student responds appropriately.

4 Take the student to a health clinic.

The doctor should give the student a full medical and behavioral evaluation.

5 Discuss moving-in responsibilities, and prepare for a long stay.

While exchange students are generally friendly once they feel comfortable in their new surroundings, they can overstay their welcomes. Give the student his own bedroom, if available, and access to soft drinks, a television, and a telephone. (Be prepared for expensive long-distance telephone calls.)

Be Aware

Observe the student’s condition and behavior. A student with a runny nose, badly matted hair, and a dirty or unkempt appearance may have been on the streets for weeks or longer—approach such a student with caution. Be wary of a student who drinks constantly and seems confused, withdrawn, or aggressive. Never approach any student who appears to be foaming at the mouth.

**WORST-CASE
SCENARIO®**

**WORST-CASE
SCENARIO.**

HOW TO SURVIVE YOUR CHILD'S FIRST DATE

1 **Meditate.**

A few hours before the date, exercise, practice yoga or tai chi, or meditate. Take deep breaths in through your nose and out through your mouth. Listen to soothing music. If you take an anti-anxiety medication, make sure that you do not miss a dose that day. Alternatively, consume one cocktail 30 to 45 minutes before the date is scheduled to begin.

2 **Lay the ground rules.**

Inform your teen that you have a few simple requirements before she leaves on her date:

- Completion of a “dating plan” before departure, including the name of the date, age, and contact information, the intended venues and activities for the date, the names and contact information for other participants, and approximate time frame.
- Approval of attire, including amount of skin visible, number of tears in clothes, color and style of hair, makeup, and jewelry.
- Date must come inside to pick up her up. Honking or calling via cell phone when outside the house is not acceptable.
- Ask now any questions she has about the “Birds and the Bees” (see page 162).

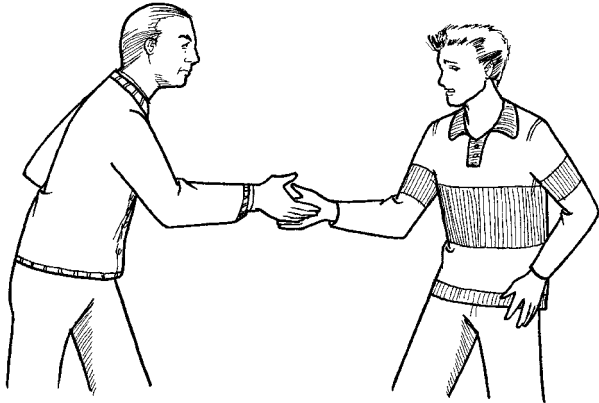

If the date does not meet your gaze and withdraws his hand quickly, you know you are in control.

- Curfews must be adhered to.
- Promise to call for any reason, including having a bad time, want a ride home, will be late—but can't be late.

3 Shake hands with the date.

Greet him with an unnecessarily long, firm handshake and good eye contact. If the date looks away and attempts to withdraw his hand quickly, this is a positive sign—you are making him uncomfortable; you are in control. If the date attempts to overpower your handshake and meets your gaze with a steely glare, he is challenging you and you should be worried.

4 Assess the date's attire.

Dressing too provocatively or too conservatively means the date is working too hard on his image.

5 Assess the date's age.

Excess facial or gray hair, crow's feet, and telltale phrases such as "when I was your age," "back in the day," and "they don't make them like they used to" are signs that your teen's date is no longer a teen himself.

6 Remind yourself that dating is a rite of passage, that you survived, and that your teen will, too.

GAMES TO PLAY WHILE WAITING UP

★ **Guess the arrival time.**

Each parent guesses the exact arrival time of the teen (hour and minute). As the chosen times pass with no arrival, each parent picks a new time. The parent with the time closest to the actual arrival wins.

★ **Pick the excuse.**

Each parent chooses three excuses the teen may use upon late arrival. The parent with the right excuse is the winner.

★ **Name the commercial.**

Turn on the television. The first person to correctly pick the name of the product being advertised—before it is mentioned—wins.

Be Aware

- Do not talk too long with the date. Five minutes of polite conversation is adequate when meeting the date. Do not show home movies or flip through photo albums. Do not take the date's picture or attempt to videotape the first date.
- Give your child a watch that is set ten minutes fast.
- Avoid direct interrogation. Do not say, "So, what are your intentions with my daughter?"
- Do not tag along on your child's first date. If you must see what goes on, follow from at least three or four cars back.

DIRECT QUESTION:	TACTFUL QUESTION:
How old are you?	Who did you vote for in the last election? The one before that?
Do you smoke?	Want a smoke?
Are you an alcoholic?	Want a drink?
Do you do drugs?	Are you holding?
What are your intentions?	Will I be seeing you again?

**WORST-CASE
SCENARIO.**

WORST-CASE SCENARIO®

HOW TO SURVIVE YOUR CHILD'S FIRST DRIVING LESSON

- 1 Dress casually.**
Do not wear a helmet or extra padding.
- 2 Check safety devices.**
Make sure seatbelts are securely fastened and mirrors are properly adjusted.
- 3 Breathe in deeply and exhale slowly.**
Continue to breathe.
- 4 Relax.**
Do not tense your muscles.
- 5 Keep your hands folded in front of you.**
- 6 Avoid sudden movements.**
Do not clench the dashboard, grab for the emergency brake handle, or make other movements that may surprise the teen and cause him to lose control. Do not smoke, eat, read, sing, play the radio, finger worry beads, or talk on the telephone.

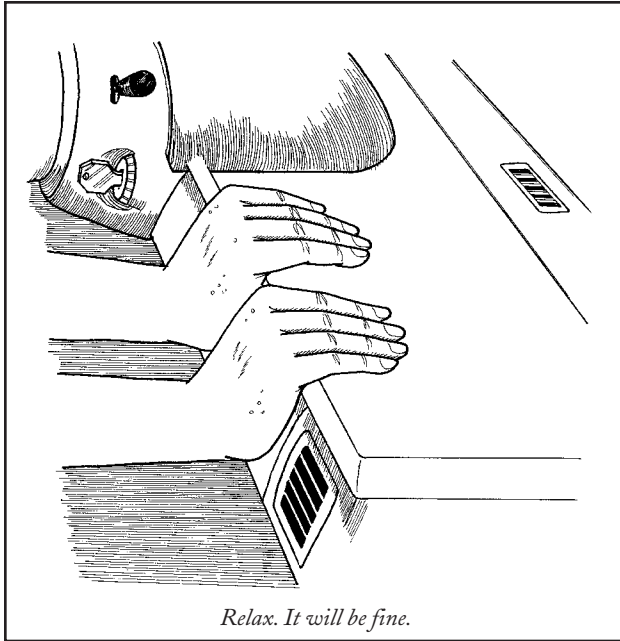

7 Compliment the driving.

Avoid the urge to comment negatively on your child's performance. Do not say things like "You're going to get us both killed!" Speak positively and in a calm voice.

8 Do not grab the steering wheel, gear shift, or hand brake.

Trust the driver.

9 Stay relaxed.

It will be fine.

HOW TO REATTACH A DAMAGED BUMPER

1 Assess the damage.

Examine the bumper and bumper cover. Many vehicles have a plastic or rubber bumper cover over a steel bumper. The lightweight cover, rather than the steel bumper, is likely to be the damaged portion.

2 Remove the bumper cover.

If the cover is completely separated from the bumper, reattachment is not advisable. Place bumper cover in the trunk or backseat and seek professional repair. If the cover is only partially separated from the car, proceed to step 3.

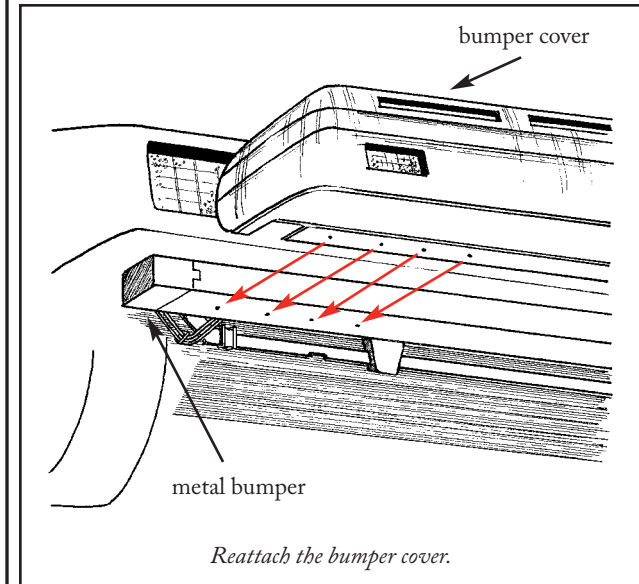

Reattach the bumper cover.

3 Check bumper cover bolts.

Bumper covers on passenger cars are attached in four to six places, generally with plastic screws or metal bolts through the bumper cover and into the plastic or metal bumper itself. Examine screw or bolt holes to determine if they have been ripped or are still usable.

4 Reattach bumper cover with wire.

If the holes are still intact, tie bumper back on the bumper frame with wire, string, rope, or yarn. Feed the wire through the holes where the bumper cover has come loose. Make several passes through the holes for security. Tie with square knots (see diagram on page 49).

5 Reattach bumper cover with duct tape.

If the mounting holes have been ripped or are inaccessible, apply duct tape completely around the bumper and cover. If necessary, tape the bumper cover to the hood of the car to prevent slippage.

Be Aware

- Plan the driving route so that you are able to return home via public transportation, if necessary.
- Car bumpers, as opposed to bumper covers, are very heavy, and damage to the bumper itself may be indicative of more serious damage to the radiator, shock absorbers, or the steel in the wheel wells. If you notice liquid leaking out from the engine area, call for a tow.

**WORST-CASE
SCENARIO.**

HOW TO TELL IF YOUR CHILD WAS SWITCHED AT BIRTH

1 Compare a photograph of yourself or your spouse as teenagers to a photograph of your child.

Look particularly at facial features—eyes, nose, mouth—and at body shape. If there are absolutely no similarities and your child was not adopted, you might be right: This strangely behaving person may not be your biological child. Proceed to step 2.

2 Compare personality traits.

Look for common tendencies and habits that are signs of a genetic connection. Allow for generation-specific differences such as musical taste and fashion sense.

3 Examine what happened immediately after your child's birth.

- Did you actually see the doctor place the ID band on your child's arm or leg in the hospital room?
 - Was your child out of your immediate view for more than a few seconds?
 - Did you notice any marked similarities between yourself and any other children in the nursery?
- If the answer to any of the above questions is “yes” or “I don't know,” look for further evidence of a long-ago error.

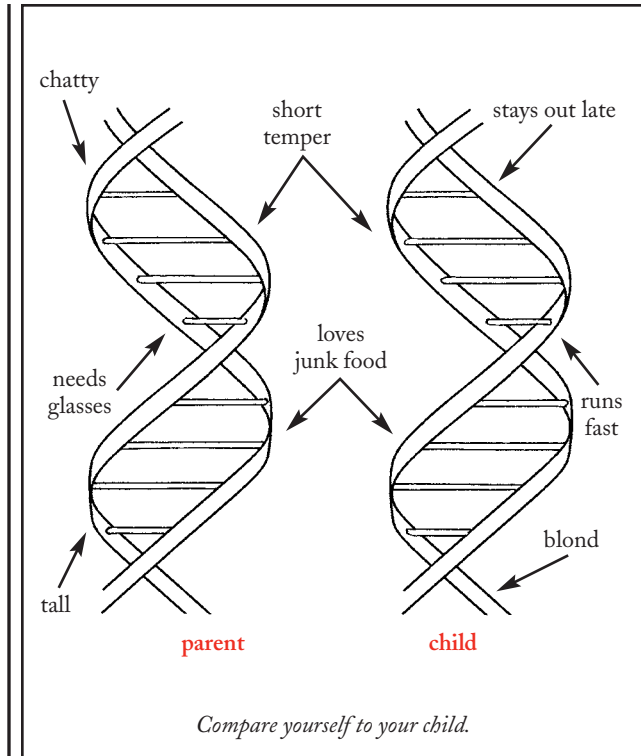

Be Aware

- Your child's difficult and dissimilar traits might be attributable to your spouse.
- DNA testing is expensive, and by now you're a family anyway.

WORST-CASE SCENARIO.

HOW TO TRACK YOUR TEENAGER'S MOVEMENTS

HOW TO DETERMINE IF YOUR CHILD IS DRIVING YOUR CAR

- 1** Purchase an inexpensive, analog watch.
- 2** Place the watch behind a rear tire of your car.
Place the watch before you go to bed at night or away on a trip. If your car is not parked so that it has to be backed up to be moved, place another watch in front of a front tire.
- 3** Check the watch.
In the morning or on your return, examine the watch. If your child has taken the car while you were away, it will have been crushed, stopping the machinery at the exact time and date.

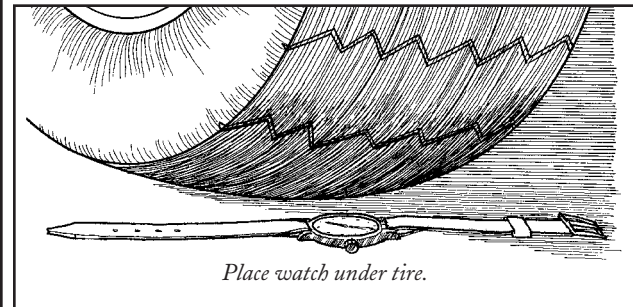

Place watch under tire.

HOW TO DETERMINE IF YOUR CHILD IS SNEAKING OUT AT NIGHT

- 1** After your child goes to his room for bed, remove a hair from your head.
- 2** Attach the hair to the door of your child's room.
Use saliva to place one end of the hair on the door-frame and the other on the door itself.
- 3** Wake up earlier than your child in the morning.
- 4** Check for the hair.
If your child has left the room during the night, the hair will have become detached or fallen off.

Be Aware

- If your teenager's room has a window to the garden, water the garden thoroughly each night and rake the dirt smooth. Look for footprints in the morning.
- If you do not have enough hair for the door-hair alarm, if your teen needs to open the door to go to the bathroom, or if a pet might dislodge the hair, grease the front door knob with butter. Check in the morning to see if the knob has been wiped clean so it could be turned and the door opened.

**WORST-CASE
SCENARIO.**

**WORST-CASE
SCENARIO.**

HOW TO UNTIE A SEVERELY KNOTTED SHOELACE

1 Gently pull one end of the lace.

Tangles that appear to be knots may actually be a series of intertwined loops and bows, which are held in place by friction rather than by a knot. Pull a free end of the lace using minimal force. If the tangle is not truly knotted, it will come apart immediately.

2 Loosen from the center.

If the lace is knotted, begin by loosening from the center of the tangle.

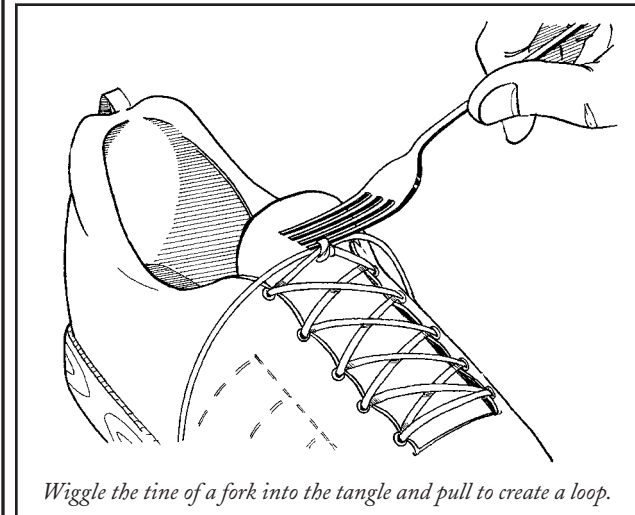

Wiggle the tine of a fork into the tangle and pull to create a loop.

3 Work slowly and patiently.

4 Do not yank.

Yanking on a loose end will not free the knot. It will make it worse. Be patient.

5 Insert a fork tine into the center of the knot.

Stubborn knots may be too tight for an adult's finger to manipulate. If the knot won't budge, wiggle the tine of a fork into the tangle and pull until a loop is created. Loosen one section, then repeat on the remaining sections of the knot.

HOW TO FIX A BROKEN SHOELACE

★ **Connect broken strands.**

Most laces have several inches of extra length. Tie the broken ends together using a square knot (see the diagram on page 49).

★ **Use the longer strand.**

If the lace broke near one end, discard the shorter section and relace using the longer strand. Wet and twist the ragged end to fit through eyelets.

★ **Make a replacement lace.**

Many children's jumpers or jackets have drawstrings. Pull the drawstring out—you may have to take out a knot at either end—and thread it through the shoe.

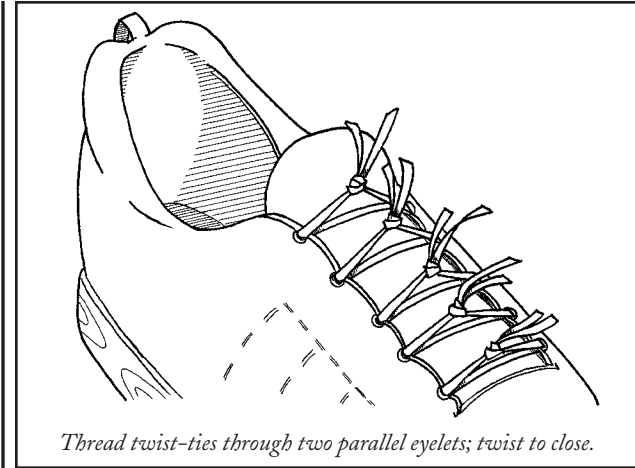

★ **Use twist-ties.**

Twist-ties are relatively strong and will hold the sides of a shoe together temporarily. Thread the tie through two parallel eyelets on either side of the tongue and twist to close. Repeat until the shoe is secure.

Be Aware

- Nylon laces have less friction than string or cloth laces. Consider replacing string with nylon to ease knot removal.
- Step-in shoes without laces or untied shoes eliminate the knot problem.

“BIRDS-AND-BEES” SPEECH

Son/Daughter, I think you're old enough now to understand some things about Nature and how we all got here. It's best that you hear about these things from me and not from the kids at school who might not understand everything. I'll explain things to you, and you can talk to me without feeling embarrassed.

You've noticed that there are differences between boys and girls, between moms and dads, and soon you will notice that your body is changing. These changes are normal, and have to do with hormones that your body produces. These hormones and changes are the way your body gets ready to become an adult and to be able to make a baby.

It takes both a man and a woman to make a baby, just the way it takes a male dog and a female dog to make puppies. The female has a litter, which means she gives birth to several tiny puppies at the same time. Other animals have babies by laying eggs, but it still takes a male chicken, called a rooster, and a female chicken, called a hen, to produce eggs that have chicks inside. Hens can produce eggs without a rooster, like the eggs we have for breakfast, but those eggs aren't fertilized, which means that they don't have a chick inside and they won't hatch. All birds lay eggs. Female bees and fish also lay eggs, but the way the male fertilizes the eggs is different.

I think that's enough for one day.

Any questions?

INSTANT-MESSAGING DECODER

TEXT MESSAGING ABBREVIATION	TRANSLATION
ASL (alternatively A/S/L)	Age, sex, location (posed as a question)
BF (alternatively B/F)	Boyfriend
BYOB	Bring your own bottle/booze
CIBM	Could it be magic?
4YEO	For your eyes only
GF (alternatively G/F)	Girlfriend
H4U	Hot for you
H&K	Hug and kiss
ILU (alternatively ILY)	I love you
IWALY	I will always love you
KOTC	Kiss on the cheek
LTR	Long-term relationship
MOSS	Member of same sex
MOOS	Member of opposite sex
POS	Parent over shoulder
PRL	Parents are listening
PRW	People are watching
QT	Cutie
SPST	Same place, same time
STR8	Straight
W&FME	Wait for me
YIWGP	Yes I will go private

ESSENTIAL PARENTAL CLICHÉS

When I was your age, we . . .
Because you're the child and I'm the parent.
Life isn't fair.
When you're the parent, you'll make the rules.
They call it bedtime for a reason.
Do I have to come up/in/over there?
You're bored? I'm Dad, nice to meet you.
Just a few more minutes/miles.
Don't make me tell you again.
That's twice. Three strikes and you're out.
You make a better door than a window.
Eat your vegetables.
So, I guess you don't like dessert anymore?
Because it's my house.
Because it's my car.
Because I'm the parent.
Just because.
There's no allowance without "allow."
I can't wait until you have kids.
Can you keep the noise down to a dull roar?
Are you trying to heat/cool the entire
neighborhood?
Money doesn't grow on trees.
I'll give you something to cry about.
Maybe.
You'll spoil your dinner.
Find something to do.

Do you have something you want to tell me about?
You won't be happy until someone loses an eye.
If [*fill in blank*] jumped off a bridge, would you?
I hope your kids are just like you.
When I was your age, we didn't have . . .
This is why we can't have nice things.
You're not going out looking like that.
No son/daughter of mine is . . .
This is going to hurt me more than it hurts you.
Do you want to catch pneumonia?
I do and do and do for you kids and this is the
thanks I get.
This is why I have gray hair.
You have nothing to do? I'll give you something
to do.
There are children starving in . . .
Because it's good for you.
Don't make me ask you again.
The food left on your plate could feed a small
village in . . .
Your face is going to stay like that.
Too bad, so sad.
Go to your room to cry.
Because I said so.
While you're under my roof, you follow my rules.
Children should be seen and not heard.
Don't make me pull this car over.
Go ask your mother/father.

GLOSSARY OF TEENAGE SLANG

WORD	MEANING
All up in my grill	Get in someone's face
Ape	Crazy
Ass	Anything displeasing
Bling-bling	Similar to flossin'; glamorous, to shine like a diamond
Bounce	Leave
Butta/money	Good
Chickenhead	Promiscuous girl
Dawg	Friend
Def	Definitely
Flossin'	Show off wealth or belongings
Fo sheazy	For sure
Gank/jack	Steal
Get your swerve on	Get drunk
Ghetto	Cheap, shoddy
Heezy	House
Hit it	Have sex
Hit me up	Call or page me
Holla	Greet or call

GLOSSARY OF TEENAGE SLANG

WORD	MEANING
Jacked	Messed up, stolen
Lights are on	Can't talk, parents are in the room
The Man/popo/5-0 (five-oh)	Police officer
M.I.L.F.	Attractive mom
Mos	Most
Off the hook	Fun, wild
Peeps	Friends
Pigeon	Ugly girl
Playa	Someone who is romantically involved with many people at the same time
Rents	Parents
Rocks	Big diamonds
Shot to the curb	Hung over/down and out
Skrilla/cheddar/cabbage/ dead presidents	Money
Spent	Tired
Spit game	Make a pass at someone
Stay up	See you later

THE EXPERTS

Colin C. Adams, Ph.D., is the Francis C. Oakley Third Century Professor of Mathematics at Williams College. He is the author of *The Knot Book: An Elementary Introduction to the Mathematical Theory of Knots*, used as the text in many knot theory courses, and the co-author of *How to Ace Calculus: The Streetwise Guide*.

American Academy of Pediatrics (www.aap.org).

Stevanne “Dr.Toy” Auerbach, Ph.D., is a child development specialist and the author of 15 books, including *FAO Schwarz Toys for a Lifetime: Enhancing Childhood Through Play* and *Dr. Toy’s Smart Play: How to Raise a Child with a High PQ*. Her website, www.drtoy.com, provides year-round guidance on toys and play.

David G. Berkebile, D.C. (www.dberk.com), treats posture-related problems in Johnstown, Pennsylvania, and works closely with Backpack Safety for Kids, an international organization. He is a frequent lecturer on posture, backpack safety, nutrition, and healthy lifestyles.

Amy L. Best is assistant professor of Sociology at San Jose State University. She is the author of *Prom Night: Youth, Schools, and Popular Culture*.

Marybeth Bond (www.womentraveltips.com) is a travel expert/spokesperson, motivational speaker, commentator, mother of two, and the author of five books, including *A Woman’s World*, *Gutsy Women*, and *Gutsy Mamas*.

Chad Boonswang is a Philadelphia attorney who has deposed and cross-examined hundreds of witnesses in civil and criminal cases.

Brent W. Bost, M.D., a fellow of the American College of Obstetricians and Gynecologists, has a private medical practice in Beaumont, Texas, and has delivered more than 7,000 babies. He is the author of *The Hurried Woman* (www.hurriedwoman.com).

Eileen Buckholtz and her son, Ryan, are the creators of www.TeenDriving.com, an award-winning website and community service project dedicated to promoting safe teen driving and saving lives.

Kathleen Burklow is a psychologist at the Cincinnati Children’s Hospital Medical Center. She is an assistant professor at Children’s Hospital Medical Center, Division of Psychology, University of Cincinnati.

Dominic Cappello designs safety, health, and communications programs for parents and educators, and is the author of *Ten Talks About Violence* and the co-author of *Ten Talks About Sex and Character* and *Ten Talks About Drugs and Choices* (www.tentalks.com). He is currently developing an animated television series.

Amy Chezem is the director of public relations for the National Association of Chewing Gum Manufacturers (www.nacgm.org).

Edward R. Christophersen, Ph.D., is a staff psychologist at Children’s Mercy Hospital in Kansas City, Missouri, and a professor of pediatrics at the University of Missouri at Kansas City School of Medicine. He is the author of *Parenting That Works*.

Karen S. Deerwester, Ed.S., is the founder and CEO of Family Time Inc. (www.familytimeinc.com), a parent-child coaching and consulting firm. Since 1984, she has trained early childhood teachers, developed and operated parent/child centers, and supported thousands of parents and teachers through parent/child classes, professional seminars, and one-to-one coaching.

Anita Dunham-Potter is a travel writer, former flight attendant, and mother of two. She writes magazine articles and publishes a newsletter on traveling with (and occasionally without) kids, available from her website, www.AnitaVacation.com.

Warren Eckstein (www.warreneckstein.com) has worked with animals for 30 years and is the author of 11 books, including *Memoirs of a Pet Therapist* and *How to Get Your Dog to Do What You Want*. His radio program, *The Pet Show with Warren Eckstein*, is syndicated in 90 markets, and he is the contributing pet editor on the *Today* show.

Kandy Ferriby owns The Doll Company (www.4theloveofdolls.com), a shop that specializes in the professional repair and restoration of antique and modern dolls. She lives in Texas.

Alan Fierstein, president of Acoustilog, Inc. (www.acoustilog.com), provides professional acoustic measurement, acoustic and noise consultation, and soundproofing design and troubleshooting services in New York City.

Chuck Fresh (www.chuckfresh.com) is a DJ and the author of *How to Be a DJ: Your Guide to Becoming a Radio, Nightclub or Private Party DJ*. He produces radio commercials and provides marketing consulting services for clubs and bars from his Florida home.

Mark Frey teaches computer science at Skyline High School in Oakland, California. He began keeping a record of teen slang in 1995 and maintains an online dictionary of Oakland teen slang at www.voxcommunications.com.

Jacqueline Haines is the director of the Gesell Institute of Human Development and co-author of *School Readiness* and *The Gesell Institute's Child from One to Six*.

Charles Henderson, Ph.D., is an Assistant Professor of Physics at Western Michigan University.

Joan Holub (www.joanolub.com) is the author/illustrator of more than 50 children's books, including *Eek-A-Boo! A Spooky Lift-the-Flap Book*, *Tatiana Comes to America*, and *The Garden That We Grew*.

Alice Sterling Honig, Ph.D., is professor emerita, Child Development Studies, Syracuse University. She is the author of numerous books on raising children, including *Behavior Guidance for Infants and Toddlers* and *Secure Relationships: Nurturing Infant-Toddler Attachment in Early Care Settings*.

Ron Huxley (www.parentingtoolbox.com), a licensed child and family therapist, anger management expert, and father of four, is the author of *Love & Limits: Achieving a Balance in Parenting*.

Harriet Joseph, Ed.D., is associate director of the University Scholars Program in the Center for Undergraduate Research and Fellowships at the University of Pennsylvania. She is a mother of two, and the former host of an exchange student.

Ken Kaiser, who has worked in the toy industry for 30 years, is president of KidCo, a Mundelein, Illinois-based company that specializes in the marketing, distribution, and manufacturing of upscale children's products.

Janis Keyser is a teacher, parent educator, program director, and speaker who specializes in early childhood and family development. She is the co-author of *Becoming the Parent You Want to Be: A Sourcebook of Strategies for the First Five Years* (www.becomingtheparent.com). She teaches at Cabrillo College in Aptos, California, and has been conducting workshops for parents and teachers for more than 30 years.

Melisa W. Lai, M.D., is a clinical chief resident in Emergency Medicine at the Harvard Affiliated Emergency Medicine Residency Program at Massachusetts General Hospital-Brigham & Women's Hospital-Mt.Auburn.

James Li, M.D., practices and teaches in the Division of Emergency Medicine at Harvard Medical School in Cambridge, Massachusetts. He is an instructor for the American College of Surgeons' course for physicians, Advanced Trauma Life Support.

Eric Lombardini, V.M.D., is a captain in the U.S. Army Veterinary Corps. He commands a veterinary medical detachment responsible for the care of military working dogs and other government-owned animals.

Jim Maas, Ph.D., a professor of psychology and sleep educator at Cornell University, coaches professional and Olympic athletes on effective sleep techniques. He is the author of the best-selling *Power Sleep*, as well as the children's book *Remmy and the Brain Train*. He maintains a website on sleep for children at www.remmyweb.com.

Richard Meischid is a Philadelphia consultant, volunteer soccer coach, and father of two athletic children involved in many sports leagues.

Steven Miller, M.D., is the director of Pediatric Emergency Medicine at New York Presbyterian Hospital.

Vinny Minchillo, a demolition derby driver for 20 years, has written for *AutoWeek*, *Sports Car*, and *Turbo* magazines. When not crashing cars, he is an advertising executive in Texas.

Dr. Jodi Mindell, Ph.D., is the associate director of the Center for Sleep Disorders at Children's Hospital of Philadelphia. She served as chair of the National Sleep Foundation's committee on newborn sleep (www.sleepfoundation.org) and is the author of *Sleeping Through the Night: How Infants, Toddlers, and Their Parents Can Get a Good Night's Sleep* and *Sleep, Your Baby, and You: Best Sleep Practices*.

Janet Mullington, Ph.D., an assistant professor of Neurology at Harvard Medical School, is director of the Human Sleep and Chronobiology Research Unit at the Beth Israel Deaconess Medical Center and the mother of twins.

Susan Newman, Ph.D. (www.susannewmanphd.com), is a social psychologist, parenting expert, and the author of numerous books, including *Nobody's Baby Now: Reinventing Your Adult Relationship with Your Mother and Father* and *Parenting an Only Child: The Joys and Challenges of Raising Your One and Only*.

Monica Pacheco-Zech (www.monicazech.com), public information officer and safety educator for the El Cajon Fire Department in El Cajon, California, spent 18 years as a television and radio traffic reporter. She lectures on driving, traffic safety, and injury prevention.

Don Rabon (www.donrabon.net), manager of the Investigations Center for the North Carolina Justice Academy, has trained investigators in interviewing and interrogation techniques in 47 states. He has also trained members of the U.S. military and Secret Service, the CIA, and NATO forces.

Bill Ranger is the fourth-generation owner of Macklem's Baby Carriages & Toys in Toronto (www.macklems.com), which specializes in the repair and restoration of strollers, baby carriages, and antique prams. He has been repairing carriages for 40 years.

Jeff Raz (www.jeffraz.com) has worked in circuses as a clown, acrobat, and juggler and in theater as an actor, director, and playwright. He is currently the director of the Clown Conservatory at the Circus Center, San Francisco (www.circuscenter.org).

Adelaide Robb, M.D., is a pediatrician in the psychiatry department at Children's National Medical Center in the District of Columbia.

Gail M. Saltz, M.D., is chairman of Public Information for the New York Psychoanalytic Institute and an assistant professor of psychiatry at New York Presbyterian Hospital, Weill-Cornell Medical Center. She has a private practice in New York City and is the mental health contributor for the *Today* show.

Ellyn Satter (www.ellynsatter.com) is a family therapist, dietitian, and author based in Madison, Wisconsin. She is the author of *Child of Mine: Feeding with Love and Good Sense*, *Secrets of Feeding a Healthy Family*, and *How to Get Your Kid to Eat . . . But Not Too Much*.

Lawrence B. Schiamberg is an associate dean and professor of Family and Child Ecology at Michigan State University in East Lansing. He is co-author of *The Encyclopedia of Human Ecology* and the author of numerous books and scholarly articles on human development, child and adolescent development, aging, and retirement.

Lisa Schulman (www.LisaShulman.com) is a parenting journalist who has contributed to iVillage, momsonline.com, *Parents* magazine, and kidshealth.org.

Hugh Shelton owns First Shot Photo and Carriage (www.firstshotphoto.com), a shop that specializes in the restoration and repair of antique wagons and wagon wheels. He lives in Gonzales, Texas.

Joan Elizabeth Shook, M.D., is chief of Emergency Medicine Service at Texas Children's Hospital in Houston, and serves as an associate professor of Pediatrics and chief of Pediatric Emergency Medicine at Baylor College of Medicine.

Myrna B. Shure, Ph.D., a developmental psychologist and Professor of Developmental Psychology at Drexel University, is the author of *Raising a Thinking Child* and *Raising a Thinking Preteen*. She creates curricula for schools and trains educators and parents in effective child development strategies.

John Simonetti is an astronomer and associate professor of physics at Virginia Tech in Blacksburg, Virginia.

Lorena Siqueiro, M.D., is a pediatrician at Miami Children's Hospital specializing in adolescent medicine.

Laurel Smith, a former teacher, runs www.Momsmivan.com, a resource for parents on travel games and road trip ideas. She has logged thousands of driving miles with her three children. She lives in Louisiana.

Paul Soven is a professor at the University of Pennsylvania who studies theoretical condensed-matter physics. He has served as associate chair of both undergraduate and graduate affairs in the physics department and has published numerous articles on the electronic structure of materials.

Gary Sowatzka, a doll doctor with 20 years of experience, has repaired thousands of dolls with restoration techniques that include bisque, papier-mâché, composition, felt, cloth, and hard plastics. He answers questions on dolls and doll repair from his website, www.sowatzka.com.

Maxine Sprague, B.Ed., is a parent, educator, and author of three books, including *Super Easy Bag Lunches*. She lives in Alberta, Canada, with her family.

Dr. Robert W. Steele is a noted author and practicing pediatrician at St. John's Children's Hospital in Springfield, Missouri. He has contributed to Parentsplace.com and *On the Safe Side: Your Complete Reference to Childproofing for Infants and Toddlers*, among other publications.

Bridget Swinney, M.S., R.D., is the author of *Eating Expectantly* and *Healthy Food for Healthy Kids* (www.healthyfoodzone.com). She is a nutrition expert in the field of prenatal and child nutrition and family eating issues.

Robin Thompson founded the Etiquette-Network (www.etiquette-network.com) in 1983 and lectures on etiquette and image for all ages at schools, universities, and businesses. She is the author of *Be the Best You Can Be: A Guide to Etiquette and Self-Improvement for Children and Teens*.

Judith Turow, M.D., is an assistant professor of Pediatrics at Thomas Jefferson University in Philadelphia and was named a "Top Doc" by *Philadelphia Magazine*.

David Ufberg, M.D., is an obstetrician and gynecologist at Pennsylvania Hospital, an assistant professor in the University of Pennsylvania Health System, and a father. He has delivered thousands of babies.

Penny Warner (www.pennywarner.com) is the author of *Slumber Parties* and numerous other party books for children.

James M. Watt, C.M.L., C.P.S., has been a locksmith since 1975. He co-founded the Montana Locksmiths Association and has served on the Associated Locksmiths of America (ALOA) Board of Directors and as Northwest Vice President.

Lennard Zinn (www.zinncycles.com), a bike racer, framebuilder, and technical writer, was a member of the U.S. Olympic Development (road) Cycling Team and is the author of *Zinn and the Art of Road Bike Maintenance*, *Zinn and the Art of Mountain Bike Maintenance*, *Mountain Bike Performance Handbook*, and *Mountain Bike Owner's Manual*.

The
WORST-CASE SCENARIO
Survival Handbook:
HOLIDAYS

By Joshua Piven and David Borgenicht
Illustrations by Brenda Brown



CHRONICLE BOOKS
SAN FRANCISCO

Copyright © 2002 by Quirk Productions, Inc.

All rights reserved. No part of this book may be reproduced in any form without written permission from the publisher.

Worst-Case Scenario™ and The Worst-Case Scenario Survival Handbook™ are trademarks of Quirk Productions, Inc.

Library of Congress Cataloging-in-Publication Data available.

ISBN: 0-8118-3599-5

Manufactured in the United States of America

Typeset in Adobe Caslon, Bundesbahn Pi, and Zapf Dingbats

Designed by Terry Peterson



A **QUIRK** Book

www.quirkproductions.com

Visit www.worstcasescenarios.com

Distributed in Canada by Raincoast Books

9050 Shaughnessy Street

Vancouver, BC V6P 6E5

10 9 8 7 6 5 4 3 2 1

Chronicle Books LLC

85 Second Street

San Francisco, California 94105

www.chroniclebooks.com

© 1999-2007 by Quirk Productions, Inc. All rights reserved.

WARNING

When a life is imperiled or a dire situation is at hand, safe alternatives may not exist—and elves are not always around to help out. To deal with the holiday worst-case scenarios presented in this book, we highly recommend—insist, actually—that the best course of action is to consult a professionally trained expert. But because highly trained professionals may not always be available when the safety or sanity of individuals is at risk, we have asked experts on various subjects to describe the techniques they might employ in these seasonal emergency situations. The publisher, authors, and experts disclaim any liability from any injury that may result from the use, proper or improper, of the information contained in this book. All the information in this book comes directly from experts, but we do not guarantee that the information contained herein is complete, safe, or accurate, nor should it be considered a substitute for your good judgment, your common sense, or your sense of peace on earth and goodwill toward men. And finally, nothing in this book should be construed or interpreted to infringe on the rights or presents of other persons or to violate criminal statutes; we urge you to obey all laws and respect all rights, including property rights, of others.

—The Authors

ABOUT THE AUTHORS

David Borgenicht is a writer, editor, husband, and father who has survived dozens of holiday worst-case scenarios, from being trapped in a blizzard to potato latke disasters, caroling nightmares, and mistletoe mishaps. He lives in Philadelphia with his family, and knows who's naughty and nice.

Joshua Piven is a writer, editor, and fixture on the holiday circuit. He is the coauthor of *The Worst-Case Scenario Survival Handbook* series. He lives in Philadelphia with his wife.

Brenda Brown is a freelance illustrator and cartoonist whose work has been published in many books and major publications, including *The Worst-Case Scenario Survival Handbook* series, *Esquire*, *Reader's Digest*, *USA Weekend*, *21st Century Science and Technology*, the *Saturday Evening Post*, the *National Enquirer*, and many other magazines. Her work has also appeared in specialized education series, websites, and promotional ad campaigns. Brenda's website: <http://webtoon.com>.

Check out www.worstcasescenarios.com for updates, new scenarios, and more! Because you just never know . . .

ACKNOWLEDGMENTS

David Borgenicht extends his thanks and holiday wishes of good cheer to the following: Jay Schaefer, Steve Mockus, and Erin Slonaker for their tireless editing efforts; Terry for his fabulous holiday design work; all of our experts for their knowledge and, well, expertise; and Santa Claus, Hanukkah Harry, the Grinch, and the Heat Miser (for just being there).

Joshua "The Heat Miser" Piven thanks Rebecca and Karen Hafter for making the holidays fun and entertaining. He also thanks Linus for teaching Charlie Brown the true meaning of Christmas.

ABOUT THE AUTHORS

David Borgenicht is a writer, editor, husband, and father who has survived dozens of holiday worst-case scenarios, from being trapped in a blizzard to potato latke disasters, caroling nightmares, and mistletoe mishaps. He lives in Philadelphia with his family, and knows who's naughty and nice.

Joshua Piven is a writer, editor, and fixture on the holiday circuit. He is the coauthor of *The Worst-Case Scenario Survival Handbook* series. He lives in Philadelphia with his wife.

Brenda Brown is a freelance illustrator and cartoonist whose work has been published in many books and major publications, including *The Worst-Case Scenario Survival Handbook* series, *Esquire*, *Reader's Digest*, *USA Weekend*, *21st Century Science and Technology*, the *Saturday Evening Post*, the *National Enquirer*, and many other magazines. Her work has also appeared in specialized education series, websites, and promotional ad campaigns. Brenda's website: <http://webtoon.com>.

Check out www.worstcasescenarios.com for updates, new scenarios, and more! Because you just never know . . .

ACKNOWLEDGMENTS

David Borgenicht extends his thanks and holiday wishes of good cheer to the following: Jay Schaefer, Steve Mockus, and Erin Slonaker for their tireless editing efforts; Terry for his fabulous holiday design work; all of our experts for their knowledge and, well, expertise; and Santa Claus, Hanukkah Harry, the Grinch, and the Heat Miser (for just being there).

Joshua "The Heat Miser" Piven thanks Rebecca and Karen Hafter for making the holidays fun and entertaining. He also thanks Linus for teaching Charlie Brown the true meaning of Christmas.

INTRODUCTION

The world thinks of the Holidays as a time of peace and joy—a time when all is harmonious, and we all join together eating, drinking, and generally being merry. We give gifts, we donate to charities, we spend time with our friends and loved ones—what could possibly go wrong?

Consider this: More suicides, car accidents, family arguments, and food and alcohol poisonings take place during the months of November and December than any other time of the year. Add travel mishaps, kitchen disasters, snow- and ice-related injuries, electrocutions, tree-trimming catastrophes, and gift-related traumas—there’s no such thing as a silent night when it comes to the holidays.

You may not be able to control Mother Nature, acts of God, mischievous elves, or bad cooks. But you can plan ahead to make sure that you’re ready to act when your holiday plans take an unscheduled dive.

We sincerely hope that the worst that awaits you this holiday season is merely a minor mishap—a slightly overcooked turkey, a precariously balanced Christmas tree, or an unwanted gift. But in case tidings somewhat less comforting and joyful come your way, we want you to be prepared.

And so, as we did with our other *Worst-Case Scenario Survival Handbooks*, we’ve consulted dozens of highly

trained professionals to come up with clear, step-by-step instructions for how to survive the perils of cooking and entertaining, friends and family, shopping, and assorted emergencies indoors and in the great outdoors. We spoke with chimney sweeps, physics professors, wilderness survival instructors, travel journalists, neurologists, craftmakers, professional carolers, gift consultants, motivational speakers, veterinarians, dentists, etiquette instructors, and dozens of others to obtain the responses to the worst worst-case scenarios we could imagine.

From how to extinguish a grease fire to how to fend off a charging reindeer, from how to deal with a runaway parade balloon to how to safely fall from a ladder, and from how to repurpose a fruitcake to how to make an emergency menorah, this handy guide should keep you safe and sound—at least between the end of November and New Year’s Day. In a useful appendix, we’ve also included a New Year’s Resolution-O-Matic and a sample “There is no Santa Claus” speech.

Being prepared is the best present you can give others—or yourself. (This book will fit in every stocking and under every tree.) With this guide in hand, you will be all set. So relax and enjoy the holidays. We hope that all your wishes come true and that your scenarios are best-case scenarios. But don’t count on it.

—The Authors

WORST-CASE SCENARIO.

HOW TO AVOID SHOOTING A CHAMPAGNE CORK

- 1 Hold the thumb of your non-dominant hand over the cage and cork.**

The cork may fly out of the bottle as soon as the wire mesh (known as the “cage”) is loosened. Keep pressure on the cork and point the bottle away from yourself and anyone nearby.
- 2 Turn the key of the wire cage.**

All cages on champagne and sparkling wine open after six clockwise half-turns. Remove the cage.
- 3 Place an opened cloth napkin over the cork and neck of the bottle.**

Hold the bottle in your non-dominant hand and the napkin over the cork in your other hand. Keep the bottle angled away from people.
- 4 Hold the cork tightly and slowly turn the bottle clockwise.**

Do not turn the cork or you risk breaking it.
- 5 As the cork begins to come out, apply downward pressure on it.**

The pressure will prevent the cork from shooting away from the bottle.



Turn the key of the wire cage six clockwise half-turns while keeping constant pressure on the cage and cork.



Cover the cork and neck of the bottle with a cloth napkin. Carefully turn the bottle clockwise until the cork pops.

6 Hold the cork at the mouth of the bottle for five seconds.

If champagne begins to bubble up and out, it will react with the end of the cork and flow back into the bottle.

7 Slowly pour the champagne.

Pour the champagne slowly until the froth (called “mousse”) reaches about $\frac{2}{3}$ up the glass, then pause. When the mousse has receded, continue filling until the glass is approximately $\frac{2}{3}$ full.

Be Aware

- The quieter the pop, the better the opening. A poor opening will cause champagne to spurt out of the bottle, resulting in lost champagne and carbonation.
- An uncontrolled opening may result in the cork leaving the champagne bottle with enough force to cause injury to someone nearby.
- Crystal flutes will improve the champagne experience: The slender shape makes the long streams of bubbles more visually appealing and concentrates the aroma. The finest leaded crystal (with a lead content of about 25 percent) has the smoothest surface and allows the champagne to maintain maximum carbonation.
- Never chill champagne flutes.
- Avoid champagne “saucers”: Their larger surface area releases more carbonation.
- The smaller the bubbles, the better the champagne.

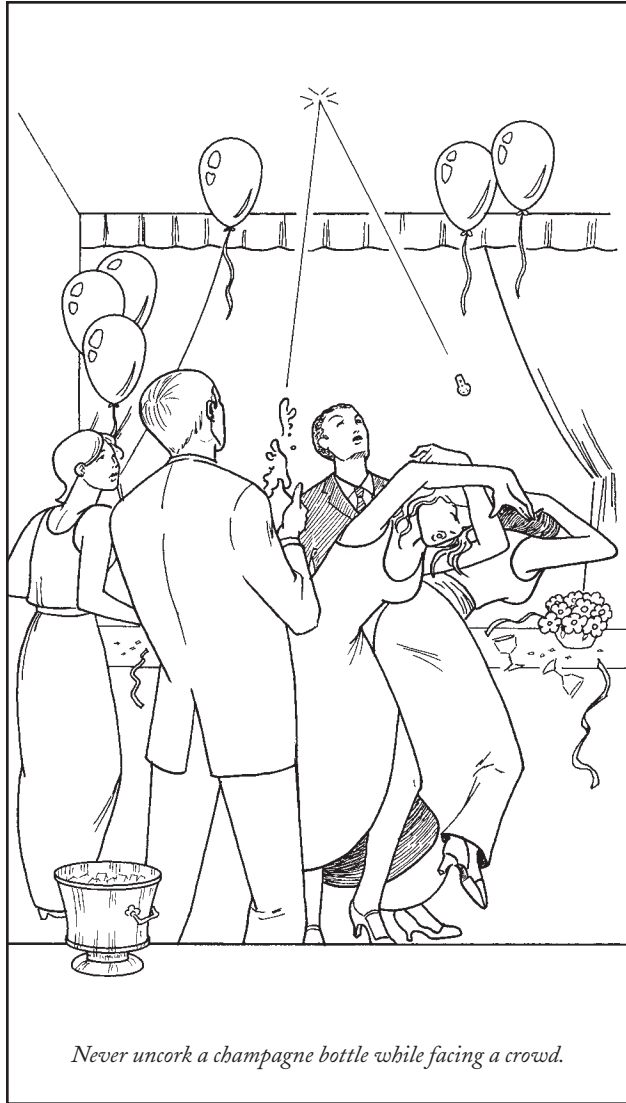

Never uncork a champagne bottle while facing a crowd.

**WORST-CASE
SCENARIO.**

WORST-CASE SCENARIO.

HOW TO DEAL WITH A BAD GIFT

- ★ **Do not lie.**
If you receive a gift you simply detest, do not complicate the situation by lying. Do not praise the gift and say that you've always wanted one: The giver may later wonder why you are not using the gift or why it is not displayed in your home—or you may get something similar next year. If you receive an awful sweater, say something neutral like, "I love sweaters." If the giver is still not convinced that you like the present, try it on; you may also be able to offer another partially true compliment: "What a perfect fit!" If you receive as a gift something you already own, you do not need to advise the giver. Say, "I love this [thing]. How did you know?"
- ★ **Thank the giver for the thought, not the gift.**
Say, "How thoughtful of you" or "Thanks for thinking of me" or "I can't tell you how much this means to me."
- ★ **Do not overpraise the gift or the giver.**
Keep your thanks simple and brief.
- ★ **Determine where the gift was purchased.**
If there was no gift receipt, check the packaging, label, and tags for a store name. If you cannot determine where it was purchased, ask the giver appreciatively: "Where did you ever find this?" Note the name in order to return the gift later.

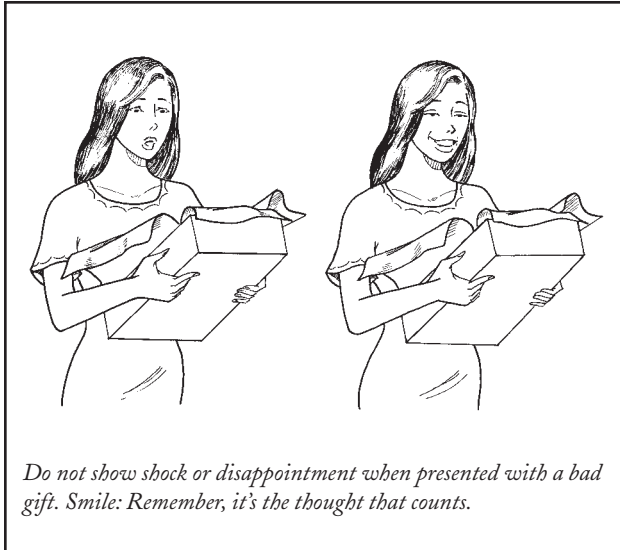

Regift it.

Unwrap the gift completely to make certain that it does not contain a hidden card, monogramming, or other giver- or recipient-specific identification. Rewrap it in fresh wrapping materials.

Be Aware

Regifting can be risky. You may later be embarrassed if you do not know where the gift you gave was purchased. Some regifts, particularly distinctive ones, may make the rounds (see “How to Repurpose a Fruitcake,” page 26) and end up being regifted to the original giver, a situation you may find hard to explain.

**WORST-CASE
SCENARIO.**

WORST-CASE
SCENARIO.

HOW TO DEAL WITH A CANCELED FLIGHT

1

Do not stand in line.

When a flight is canceled, for any reason, hundreds of people line up at the ticket counter for rebooking. Ignore them and find a telephone.

Do not stand in line at the ticket counter. Locate a telephone and call the airline to book a new flight.



2 Call the airline.

Ask the airline (or your travel agent) for a seat on the next flight going to your destination. You will get into the airline's computer system quickly, without having to stand in line. Your airline may be able to transfer your ticket to another flight on that airline, in which case you can proceed directly to the gate.

3 Book a new flight.

Carry a list of all airlines that fly to your destination. The airline on which you are ticketed may not be able to rebook you on a later flight, or might not be the airline with the next available flight. Call other airlines and book a seat on a convenient flight. Depending on the fare you originally purchased and its restrictions, it might be simpler and faster to purchase a new ticket on a different airline, over the phone, and not use your original ticket. If you purchase a new ticket, proceed directly to the new airline's gate.

4 Have your ticket endorsed.

If you have made a reservation on a different airline but have not purchased a new ticket, you will need to get your existing ticket endorsed over to the new carrier. You will have to stand in line at the counter of the airline that canceled the flight, but you, unlike others in line, will already have another flight arranged.

5 Save unused tickets.

Unused tickets, one-way or round-trip, are almost as good as cash: They can be credited toward another flight on the same airline or, in some cases, refunded.

Be Aware

- When flying within the United States, know Rule 240, which covers what an airline will do for you in the event of a flight delay or cancellation. Legally, airlines must compensate only ticketed passengers who arrive on time but are denied a seat. In the event of a lengthy flight delay or cancellation, airlines as a matter of good public relations generally will provide passengers a hotel, meal, free phone call, and other amenities (be sure to ask if they're not offered) or arrange flights on another airline. Check each airline's website for their delay/cancellation policies.
- If you know you will be traveling on a busy holiday weekend to a very busy airport, and especially if there is the possibility of severe weather, book a room in an airport hotel; you will be ready if your flight is canceled. Check the hotel's cancellation policy, so you are not charged for an unused room, and be sure to cancel the room if you don't need it.
- Do not use electronic tickets if there is a chance of bad weather, labor problems, or security delays. The computer systems of different airlines cannot communicate with one another, so e-tickets cannot be endorsed from one airline to another. A paper ticket must first be issued, extending the amount of time you will have to spend at the ticket counter.
- Carry on your bags whenever possible. If your luggage has been checked through to your final destination but you encounter delays, you may not be able to switch your luggage's flights and airlines as easily as your own.

HOW TO DEAL WITH A MEDDLING PARENT

1 Prepare yourself mentally.

Remember that the holidays are a time for celebration, and try to maintain a positive attitude no matter what your parents may say.

2 If your parents give unwanted or annoying advice, be polite and attempt to change the subject.

Thank them for their concern. Say, “I appreciate your advice, but I’d really rather talk about [insert new subject here].”

3 Avoid confrontation.

Never respond to a meddling parent with phrases that include “you always,” “you never,” or “leave it alone.” Suggest discussing the issue at another time. If you are a guest in someone else’s home, confrontation should be avoided at all costs.

4 Smother the conversation with kindness.

Always counter a negative remark with a positive one. If your parent says, “Your house really needs painting,” counter with, “This house is in such a great neighborhood. Isn’t that great for the kids!” If your parent says, “When are you going to get a real job?” counter with, “I’m making great progress on my novel!”

5 Do not discuss money in public.

How much things cost and financial success are attractive topics for a meddling parent. These are inappropriate subjects for group conversation, however. Do not get angry; deflect the inquiry. If a question about money is asked, say, “I can’t remember what we paid,” or “We’re just thankful for what we have.”

6 Avoid taking the bait.

If a meddling parent keeps mentioning how well other people are doing compared to you—how important a job, how many children, how big a house—or makes other implicitly critical comparisons, just say, “That’s wonderful.”

7 Ask for their advice about a less-irritating topic.

Meddling parents often simply want to be asked for their opinions. Seeking their thoughts on a less important subject or even on a made-up problem may placate them or distract them from sensitive issues (ask for their input on remodeling the kitchen, for example, even if you are not intending to do so).

8 If the meddling parent will not relent, excuse yourself from the conversation.

Casually excuse yourself (do not say, “I can’t listen to this anymore!”) and move to another room. For example, finish your drink and say, “I need to get a refill” (do not offer to get your parent one); or say, “Excuse me, I have to go to the bathroom,” or “I have to make a phone call,” or “I promised I would help in the kitchen.” Do not make any promises to come right back.

Be Aware

- It is best to preempt meddling parents by announcing lots of news before the holidays arrive. Phone or e-mail the week before with updates, keeping the news positive and upbeat.
- Remember that you do not have to answer every question. In advance of the holidays, practice non-responses or evasive responses, such as “Do you really think so?” or “That’s an interesting question. Let me think about it.” In front of a mirror, practice the blank stare.

**WORST-CASE
SCENARIO.**

HOW TO DETERMINE THE CONTENTS OF A WRAPPED GIFT

WITHOUT OPENING THE PRESENT

1 Observe the position of the gift.

If the box is on top of a stack of gifts or hidden on a high shelf, it is probably not fragile. If it seems to have been carefully stored, use caution when handling.

2 Note the gift's surroundings.

Draw a quick diagram or take a digital or instant-developing photo that shows the location of the gift relative to other presents or objects around it. You will need to return the gift to exactly the same location and position later.

3 Examine the wrapping paper.

The name of the store may be printed on the paper, or it may be sealed using a sticker from the store. Both will give clues to its contents.

4 Smell the box.

Chocolates, baked goods, bath products, and leather goods have distinctive aromas, as do many other items.

Much can be determined about a gift without unwrapping it.



Smell.

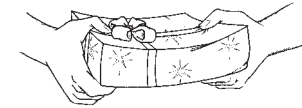

Squeeze.

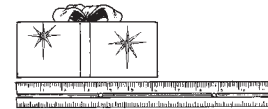

Measure.

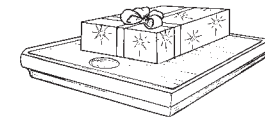

Weigh.

5 Squeeze the package.

Clothing boxes are generally light and will give slightly when squeezed. Electronics and other fragile items are usually packed in molded foam inserts that fit snugly inside thin outer boxes. Power tools are often packaged in rigid, thick cardboard boxes with large staples in the end flaps; you might be able to feel the staples through wrapping paper.

6 Measure the package.

Clothing boxes are generally longer than they are wide, and less than six inches high. Compact disc jewel cases are 5½ inches wide, 4¾ inches long, and less than ½ inch high. If the package has the first two dimensions but is higher (thicker), it is probably several discs or a double- or triple-disc set. DVD boxes are 5½ inches wide, about 7½ inches long, and ½ inch high. Books may be any form of rectangle but are relatively heavy for their size. Underwear and socks will often be wrapped but not boxed; the packages will be flexible, and the plastic may make a quiet, crinkling sound.

7 Shake the package gently.

If you hear slight rustling, the item is likely clothes covered in tissue paper. If the box is big, heavy, and clinks slightly, it may contain an appliance.

8 Weigh the package.

If you have a hunch about the item and the store it came from, go online and compare the weight of the box to the listed shipping weight of the suspected gift.

HOW TO REWRAP A GIFT

You will need the original wrapping paper, still taped but with the tape slit where it crosses edges; a roll of clear tape (or that which matches the tape on the gifts); glue; a ruler; and, in emergencies, a roll of wrapping paper that matches as closely as possible the pattern of the original wrapping paper.

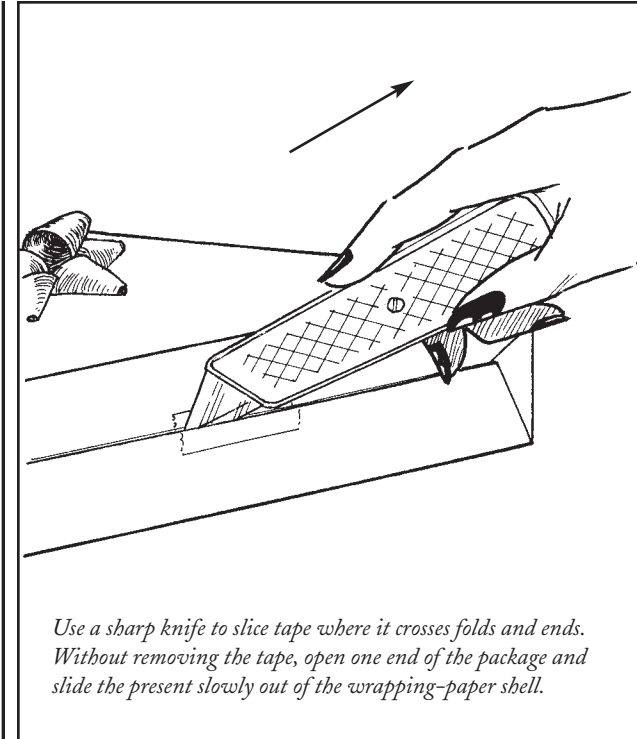

1 Do not remove the tape.

Leave tape on the wrapping paper. Pulling it off will cause the paper to tear.

2 Slide the box back into the paper.

Your rewrapping job will be easier if only the sides of the paper have been opened. If the paper is completely unfolded, place the box on the paper. Make sure the edges of the box align with the folds in the paper.

3 Follow the original wrapper's sequence.

Most wrappers will fold the paper around the gift first, then fold and seal the box at both ends. Follow the existing pattern of folds on the paper as you would in refolding a map. Use the ruler to re-crease the paper.

4 Glue or tape the paper.

If the opening was done properly, line up the old tape pieces and place glue under the flaps. This will give the tape a seamless appearance and avoid excess taping, which might be spotted. Hold the flaps of paper in place for several minutes until the glue sets. Wipe off any visible glue while it is still wet. If the opening was sloppy or the tape edges cannot be properly aligned, place a new, slightly larger piece over the old one.

5 Retie bows.

If the bows were hand-tied, retie them. If they were store-bought, make certain they are still stuck to the paper. If not, glue them on.

6 Reposition the gift.

Put the gift back in its original position. Refer to your diagram or photo (see "How to Determine the Contents of a Wrapped Gift," step 2, page 110).

7 Act surprised.

When you are given the present and open it legitimately, express delight. If the present you receive is not the one you opened and rewrapped, do not show surprise: The giver may have switched name tags (see "How to Thwart Gift Snoopers," page 107).

**WORST-CASE
SCENARIO.**

HOW TO DRIVE IN A BLIZZARD

- 1 Keep windows clear.**
Use the heater, wipers, and defroster to keep windows clear and free of condensation. Do not let the car get too warm, however—the heat may put you to sleep.
- 2 At night, use low-beam headlights.**
High-beams will reflect off the snow, making it more difficult to see.
- 3 Drive in high gear.**
Do not downshift. Use as high a gear as possible for maximum traction and to avoid skids on snowy and icy roads.
- 4 Drive slowly.**
Do not drive at maximum speed. Drive at a slow, constant speed.
- 5 Avoid sudden movements.**
Do not brake, change gears, or accelerate around turns. Slow down and move into a lower gear approaching the turn, then simply steer around the bend.
- 6 Watch for ice.**
Slow down before you reach icy or snowy patches of roadway. Skids are much more likely to occur on ice than on snow.

IF YOU SKID

- 1 Undo your last action.**
Take your foot off the brake, or ease off the accelerator, depending upon whether you attempted to slow down or to speed up.
- 2 Steer into the skid.**
To straighten the wheels, turn the steering wheel in the direction the car is moving. Do not jerk the wheel: steer smoothly to avoid further skidding. You may have to turn the wheel in one direction, then the other, to regain control and move straight.
- 3 Pump the brake pedal to slow down.**
If the brakes are anti-lock, simply depress the brake pedal, and your car will automatically pump the brakes.
- 4 Check for traffic.**
If you have come to a stop, or if you have spun out of your lane or slowed more than other traffic, you need to be especially careful not to block other vehicles.

IF YOU GET STUCK IN THE SNOW

- 1 Turn your wheels from side to side a few times to push snow out of the way.**
- 2 Place a traction aid under the drive wheels.**
Possible objects include a floor mat, bag of kitty litter, wood planks, cardboard, a blanket, or clothing.



While driver rocks the car back and forth, time your push to increase forward momentum.

3 Move passengers above the drive wheels.

Depending upon whether you have front-wheel or rear-wheel drive, move your passengers and heavy luggage to the front or rear of the passenger compartment. Increased weight over the drive wheels will help to gain traction.

4 Rock the car back and forth.

In a low gear, apply light pressure on the gas pedal to move as far forward as you can go without spinning, then release the pedal (or put in the clutch) so you roll back. Gradually, the car will move forward a few more inches with each back-and-forth rock and may gain enough momentum to roll out of its rut and gain traction.

5 Push the car.

If the car is still stuck, instruct passengers to push the car forward. Try rocking the car back and forth, with a well-timed push at the forward point.

IF YOU BECOME STRANDED

1 Stay with or in the car.

You can survive for several days in your car, especially if you have food and water and enough fuel to periodically run the engine and heater.

2 Clear the vents.

The vents for the heater are usually below the windshield wipers on the hood. The exhaust pipe is located under the rear bumper. A clear exhaust pipe allows you to run the engine without danger of carbon monoxide poisoning.

3 Open a window occasionally.

You will benefit from the fresh air, and will ensure that the windows do not become frozen shut.

4 If the car becomes completely buried, poke a breathing hole in the snow above the car.

Use an ice scraper or tire iron.

5 Light a candle inside the car.

If you do not smell any gas fumes, light a candle to provide extra warmth. The candle will also serve as a warning sign of carbon monoxide fumes; if the candle begins to flicker and die, ventilate the car quickly.

6 Put on extra clothing.

To conserve fuel, do not run the engine and heater at full blast. If you do not have enough extra clothing, use newspapers, seat covers, and maps. Huddle with passengers for warmth.

7 Watch for help.

If you have passengers, take turns sleeping so that someone is always alert for possible rescuers. Use a portable radio for news updates; to conserve fuel or your car battery, do not use the car radio.

8 Ration food and drink.

Open and use any useful holiday presents you may be carrying, whether clothing, equipment, food, or beverages. Avoid alcohol, which feels warming but actually lowers your body temperature.

Be Aware

Prepare for a drive in potentially snowy conditions by packing smart. Take extra clothing (including gloves and a water-resistant jacket), blankets and pillows, boots, food and drink, a battery-operated radio and flashlight, matches and candles, a mobile phone, and several wooden planks (or a bag of kitty litter) for traction. Also take a shovel, if possible.

**WORST-CASE
SCENARIO.**

HOW TO ESCAPE A RUNAWAY PARADE BALLOON

1 Watch for sudden changes in wind speed.

Parade balloons are only deployed if sustained winds are 23 mph or less, with gusts no more than 34 mph. If the winds exceed these levels during the parade, controlling the balloons becomes much more difficult. If you detect a significant change in wind speed or direction, look for other indications of danger.

2 Watch the anchor vehicles.

Large balloons (5,000 cubic feet and bigger) will be tethered to two anchor vehicles that look like oversized golf carts. These vehicles weigh two and a half tons each and act as failsafes, keeping a balloon from moving uncontrollably in case of emergency. In calm winds, the vehicles will be directly under the balloon and in the center of the street. If the anchor vehicles begin to move outward, toward the sidewalks, the wind is increasing substantially.

3 Watch the height of the balloon.

In calm winds, balloons will float at a maximum height of 50 feet. If the balloons are lower than this, winds may be dangerously high. In very strong winds, balloons may be almost at ground level.

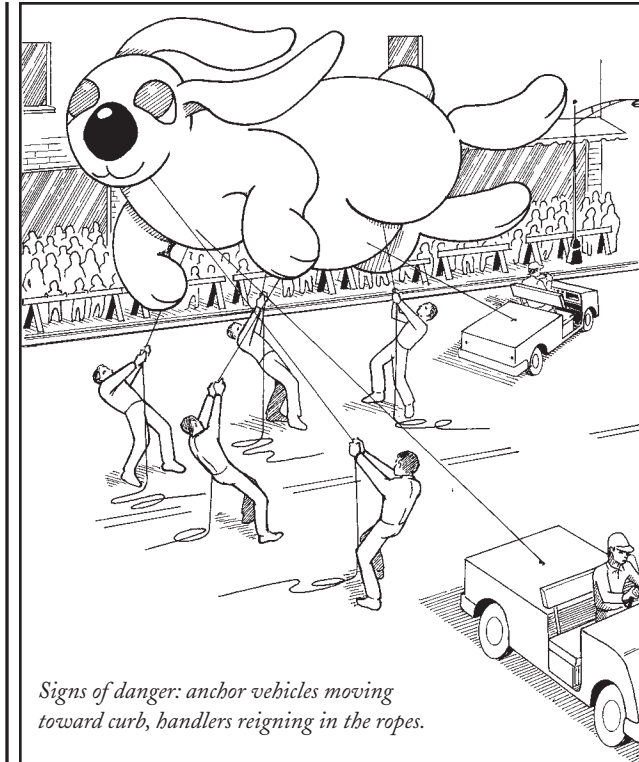

4 Observe balloon handlers.

Each balloon has at least one handler; the largest balloons may have 50. Each handler holds a rope, and each rope is marked in foot increments. As winds increase, handlers will pull in their ropes and move into the wind for better control of the balloon in a headwind. If you see handlers reining in lots of rope, they are dealing with a clear and present danger.

5 Do not try to rescue a balloon.

It is difficult for an observer to gauge the enormity of a parade balloon, the tension in the ropes, and the amount of energy required to control a balloon in high winds. Lending a helping hand may seem easy, but the situation may be more out of control than it looks. Stay clear of the street and the balloon operators. Balloons and their handlers need lots of space to maneuver. Never attempt to pull on any ropes, and do not poke or prod any balloon.

6 Avoid lampposts and traffic lights.

The most immediate risk is that a runaway balloon may knock over a traffic light or lamppost, which will strike those standing below. Often, traffic lights are either removed or repositioned before the parade; if any remain, stay away from them.

7 Do not panic.

A stampeding crowd is a greater threat than a renegade balloon. If you have detected the early signs of danger and have responded, you will be moving ahead of the crowd.

8 Evacuate the area.

Seek safety away from the parade route, if you have time. You may take immediate shelter in a building or subway station.

**WORST-CASE
SCENARIO.**

HOW TO EVADE A STAMPEDE OF SHOPPERS

★ Stay focused and visualize your goal.

Do not freeze in front of the pack; do not wait for the crowd of shoppers to get close before you make your move. Reacting early and decisively in crowds offers your best shot at survival.



Brace for an oncoming crowd by wrapping your arms tightly around your packages.

★ Avoid herd mentality.

Animals travel in herds because there is safety in numbers, and the safest place is at the center of the pack, insulated from predators. Avoid the temptation to join the herd—you cannot shop if you cannot see the merchandise.

★ Do not move toward the oncoming herd.

You risk being trampled if you try to thread your way through a stampede. If you are unable to get out of the way of a fast-moving crowd, bring your arms in tightly around any packages you are carrying, turn your body in the direction of the crowd, and let yourself be carried along as you work your way to the outside of the herd.

★ Maximize your movement options.

If you need to negotiate a crowd, stay on the edge. Use the space near the walls to gain a few extra yards of room. Most shoppers will leave at least several feet between themselves and surrounding walls. This will give you room to maneuver.

Be Aware

When heading into a shopping situation where crowds may be present, wear proper shoes. Open-toed shoes offer minimal protection for your feet, and high heels will restrict your mobility. Select shoes with flat heels. Rubber soles provide better traction.

HOW TO PENETRATE A CROWD TO GET THE LAST ITEM ON THE SHELF

- 1 Move slowly and decisively toward the front without appearing too aggressive.**
Shoving or cutting people off will provoke flying elbows and closed ranks.
- 2 Keep your eyes on the other shoppers, so you can anticipate their movements.**
- 3 Maintain a calm demeanor as you close in on the target item.**
Breathe evenly and slowly. Avoid signaling your urgency, which might alert the crowd to the desirability of the toy or other target. Avoid stepping on toes or panicking other shoppers, which may cause a stampede.
- 4 Smile.**
- 5 Grab the item.**
Tuck it under your arm as you would a football to prevent it from being knocked or torn loose.
- 6 Proceed to the nearest cash register.**
Continue to move with the crowd until you are able to slip down an aisle unnoticed.

**WORST-CASE
SCENARIO.**

HOW TO EXTINGUISH A BURNING TURKEY

1 Close the oven and broiler doors.

Turn the oven off.

2 Open nearby windows.

Smoke will pour out of the oven vent. Turn the vent-fan in the hood above the stove to its highest setting and open windows to help clear smoke. If possible, close the doors to the kitchen to contain the smoke. If you cannot close off the kitchen, open as many other windows in the building as possible to establish cross-ventilation.

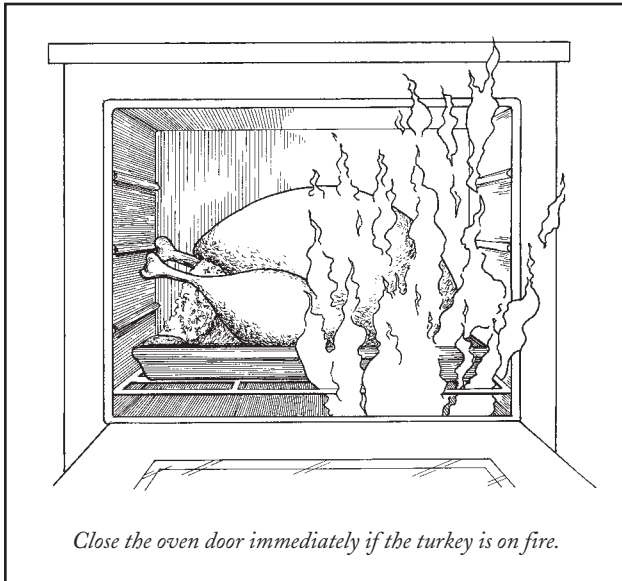

Close the oven door immediately if the turkey is on fire.

3 Wait five minutes.

Ovens are designed for high heat, so it should contain the fire without a problem. Keep the oven door closed to avoid adding oxygen to the fire.

4 Open the oven door slightly.

Keep your face well back from the oven when you open the door. After five minutes, the turkey fire should have burned itself out. If it is still burning, close the door immediately and wait several minutes before opening it again. If the fire continues to burn for more than 10 minutes, call the fire department.

5 Remove the burned bird.

Use caution: It will be extremely hot. Place the bird on a cutting board or platter. Wait at least 10 minutes before touching the turkey or attempting to rescue the meat. Often only the skin and fat will be burned. (See “How to Serve Burnt Turkey,” page 18.)

Be Aware

- Oven fires can usually be extinguished without help from the fire department. However, oven seals may fail in a high-heat fire, causing the fire to spread to surrounding areas. Have someone standing by the phone to call for help if needed.
- Do not attempt to pull a flaming turkey out of the oven: You risk grease burns on your arms and face.
- Do not attempt to smother a flaming turkey while it is in the oven. The high temperatures and flaming grease may ignite the material.

- Do not attempt to douse the fire by throwing flour, baking soda, gravy, or any other products on a flaming turkey. These may be combustible and may cause grease to spatter. Using a fire extinguisher will render the bird inedible.

HOW TO SERVE BURNT TURKEY

- 1 Remove the skin and charred sections.**
Discard these burned parts.
- 2 Slice the turkey.**
- 3 Pick out the scorched pieces.**
Usually the burned portion will be white (breast) meat, which has less fat. Discard it.
- 4 Check the dark meat.**
Some dark meat may also be severely overcooked. Pick out the moist sections and put them on a platter that has been warmed in the oven. Cover and set aside.
- 5 Moisten dry dark meat.**
Layer the salvaged but dry dark meat in a roasting pan. Soak it with several cups of chicken broth and melted butter. Cover it with a cloth and put it in a warm oven (make sure the oven is turned off). Let the meat rest for a few minutes. Drain and remove meat from pan and place on serving tray. Do not use a microwave to warm the meat or the meat will toughen.

- 6 Fatten the gravy.**
Add one stick of butter to a boiling pot of gravy, let the butter melt, and allow the gravy to cool to serving temperature. Pour the mixture over the turkey after it has been carved.
- 7 Make turkey hash.**
If all else fails, chop the meat, toss with potatoes and bacon, and offer your guests turkey hash. Tell them it's an old family tradition. Serve with large glasses of water.

HOW TO PREVENT A TURKEY FROM EXPLODING

- 1 Use a maximum of four beaten eggs in the stuffing.**
Eggs expand as they cook and can force stuffing to explode out of the turkey's abdomen.
- 2 Stuff the bird loosely.**
Leave several inches of space for the stuffing to expand as it roasts.
- 3 Keep a close watch on the bird as it cooks.**
Check the turkey every 20 minutes or so. If the stuffing begins to leak out of the abdominal cavity, remove several spoonfuls.

Be Aware

Cooking the stuffing separately avoids potential bacterial contamination of the stuffing from the turkey and will also avoid any possibility of explosion.

HOW TO KEEP A TURKEY MOIST DURING COOKING

★ Soak the bird overnight in brine.

To make brine, dissolve one pound of salt per gallon of water; it should be as salty as seawater. Put the mixture in a large bucket (use plastic to avoid any metallic taste). Cover and leave the bird outside to keep it cool. If the temperature is above 50° F or well below 32° F, keep it refrigerated instead.

★ Remove the legs of the turkey before cooking it.

Dark meat takes longer to cook than white meat, so cook the legs separately from the body. If you want to leave them on, cut the skin between the breast and the legs and spread them out, away from the abdomen, to expose more of the leg to heat.

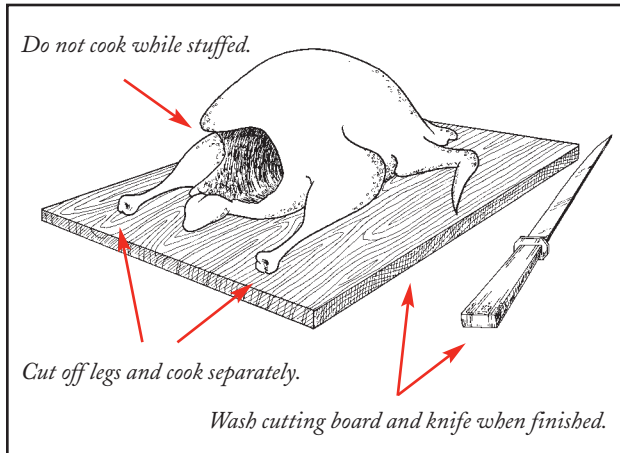

★ Cook the turkey breast-side down.

Cooking breast-side down will cause the juices to run down the sides and baste the breasts. Flip it over just before removing from the oven to crisp the skin.

HOW TO REMOVE A GRAVY STAIN

Try the following techniques until one succeeds in removing the stain.

1 Remove excess food as soon as possible.

Use a spoon or a blunt knife to scrape the stain. The longer a stain sets, the more difficult it is to remove.

2 Make a detergent solution.

Mix one teaspoon of clear, mild liquid dishwashing detergent with one cup of lukewarm water. Do not use detergent that contains bleach.

3 Apply the detergent solution to the stain.

Do not rub the stain. Work from the edge of the stain in, gently blotting.

4 Rinse the stain with cold water and blot dry.

If the stain comes out, go to step 14.

5 Make an ammonia solution.

If the detergent solution does not work, mix one tablespoon of household ammonia with ½ cup of warm water.

- 6** **Apply the ammonia solution to the stain.**
Blot the stain. Do not rub.
- 7** **Rinse with cold water and blot dry.**
If the stain now comes out, go to step 14.
- 8** **Make a vinegar solution.**
Mix $\frac{1}{3}$ cup white vinegar with $\frac{2}{3}$ cup cold water.
- 9** **Blot the stain with the vinegar solution.**
- 10** **Rinse with cold water and blot dry.**
If the stain has disappeared, go to step 14.
- 11** **Apply commercial enzyme detergent.**
Enzyme detergent is available in grocery, drug, and hardware stores. Blot the stain.
- 12** **Rinse the area with cold water.**
- 13** **Blot dry.**
Place a $\frac{1}{2}$ -inch-thick pad of white paper towels over the stained area and weigh it down with a flat, heavy object—a thick book works well. Change the absorbent pad until the transfer of the stain is no longer visible on the pad.
- 14** **Launder according to manufacturer's label.**

**WORST-CASE
SCENARIO.**

HOW TO EXTINGUISH A CHRISTMAS TREE FIRE

1 Assess the size and nature of the fire.

Quickly determine if the source of the fire is electrical, and observe how large an area of the tree is burning. A fire larger than the size of a small wastebasket cannot usually be contained, even with a home extinguisher. If the fire is that large, evacuate the building and call the fire department from a cellular phone or a neighbor's house.

2 If the fire is small and not electrical, douse it or smother it.

Extinguish the fire with a bucket of water or a multi-purpose (Class ABC) fire extinguisher, or smother it with a wet blanket.

3 If the fire is electrical, use a fire extinguisher.

Do not throw water on an electrical fire. Use a multi-purpose (Class ABC) home fire extinguisher.

4 When using a fire extinguisher, stand with your back toward an exit, six to eight feet from the fire, and Pull, Aim, Squeeze, Sweep (PASS).

Pull the release tab, aim at the base of the fire, squeeze the lever to release the pressurized chemicals, and sweep from side to side as you slowly move closer to the fire.

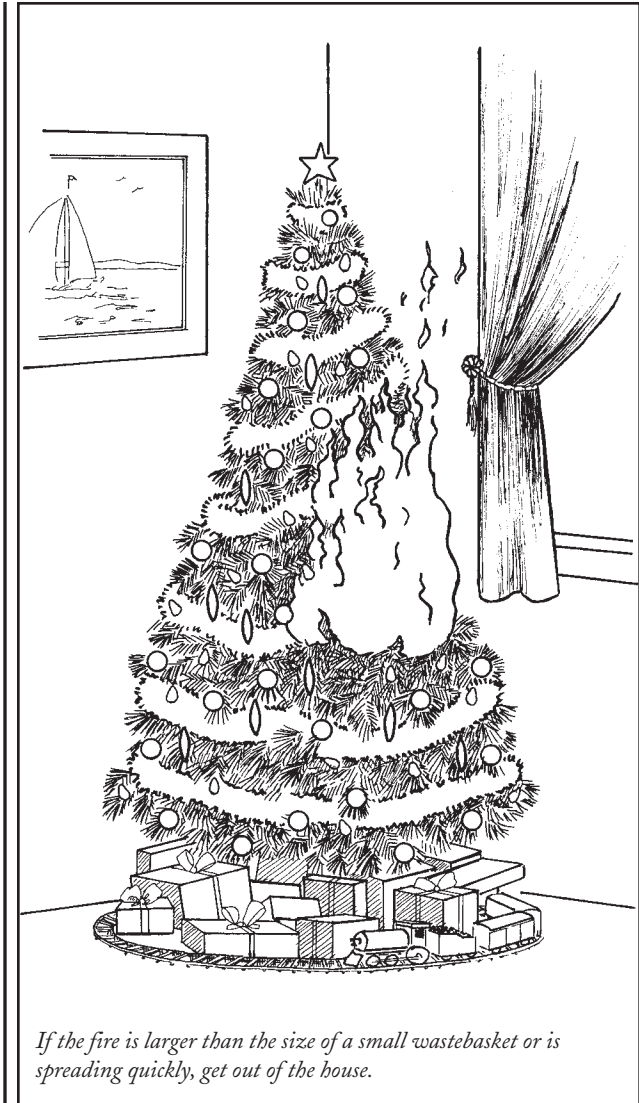

If the fire is larger than the size of a small wastebasket or is spreading quickly, get out of the house.

- 5** **If the fire is still spreading, exit the house.**
Evacuate the building quickly. Do not attempt to save ornaments, Christmas presents, or other valuables.

HOW TO PREVENT A CHRISTMAS TREE FIRE

- 1** **Select a fresh tree.**
A dry tree is a major fire hazard; to get the freshest tree, cut it yourself. If you purchase a precut tree, run your hand down a branch to make sure it is not dry and shedding needles. Test the tree by bending a needle: If it snaps, the tree is too dry.
- 2** **Leave the tree in a bucket of water overnight.**
Place the tree in the stand the next day. Water it daily.
- 3** **Place the tree at least three feet away from a fireplace, radiator, or other heat source.**
- 4** **Unplug tree lights when not in use.**
Do not leave the lights on during the day, when you go to bed, or when you leave the house.
- 5** **Do not place lit candles on or near a tree.**
If tradition requires candles, use specially weighted sconces that do not tip over. Do not add electric tree lights or other electric equipment to or around the tree (such as a train set), in the event that water must be thrown onto the tree. Do not leave the tree unattended.

**WORST-CASE
SCENARIO.**

WORST-CASE SCENARIO.

HOW TO FEND OFF A CHARGING REINDEER

- 1 Stand your ground.**

Most reindeer have been bred to be docile livestock; they are sometimes referred to as “tundra cows.” They will run around, rather than over, a standing person, even when charging in a herd.
- 2 Watch for reindeer in rut.**

Reindeer mate from late August to October, when they will be in rut, or heat, and much more dangerous. Each male, or bull, will keep a harem of females and will become unpredictable and aggressive with any person who approaches. While both male and female reindeer have antlers, male reindeer are noticeably larger, weighing 400 pounds or more. During rut, necks on males will be large and swollen.
- 3 Watch for front-leg kicking.**

When disturbed, reindeer will rear up on the hind legs and kick out with the front hooves. Females are generally not dangerous except when defending calves. Stay well back and to the side to avoid being kicked. During rut, reindeer bulls will try to gore rather than kick, if antagonized.

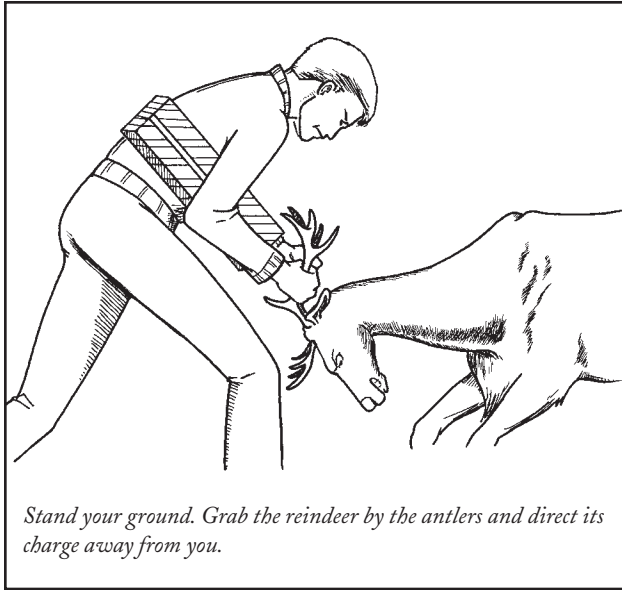

Stand your ground. Grab the reindeer by the antlers and direct its charge away from you.

- 4 Watch for antler display.**
Before goring, a male will often attempt to intimidate by showing, or “presenting,” its antlers, turning his head to the side. Be wary in approaching or cornering a bull reindeer during this display.
- 5 Back up slowly.**
Speak to the reindeer in a soft voice. Do not make any sudden movements.
- 6 Do not raise your arms over your head.**
The bull may take this as a challenge sign that you are also displaying antlers.

- 7 If the reindeer attempts to gore you, grab the antlers.**
Grasp one branch with each hand and attempt to steer the head away from you. If the reindeer tries to lunge forward, you may not be able to stop it, but guiding the antlers may allow you to redirect its charge.
- 8 Move to the side quickly as you release the antlers.**
The reindeer will now be beside you and may just move away. Do not run, or you will call attention to yourself. Carefully put distance between yourself and the reindeer.
- 9 Call for help.**
Using a voice and tone that does not further antagonize the reindeer, advise others in the area of your situation. They may be able to distract the reindeer, if it is still in pursuit.

Be Aware

- Caribou, which are much more aggressive and dangerous, are often mistaken for reindeer. Reindeer have shorter legs and are rounder.
- Male reindeer have huge antlers, with as many as 14 to 18 points per side.

HOW TO FEND OFF AN UNWANTED KISS

ON ARRIVAL

- 1** Carry a present, coat, hat, or child in front of you as you enter.
- 2** Extend your free arm in a wide arc and move into a hug position.
- 3** If the greeter leans in to plant a kiss, use the head-and-shoulders maneuver.

Move your head toward the kisser, then at the last moment, rotate your shoulders, throw your arm around, and bury your head in the kisser's neck.

UNDER THE MISTLETOE

- 1** Find the mistletoe.
As soon as you arrive, determine the location of the mistletoe. Check the lintel over doorways and hanging lights, which often obscure the mistletoe.
- 2** Establish alternate routes.
Avoiding the mistletoe is the best defense. Plan your comings and goings so that you do not pass under the mistletoe.

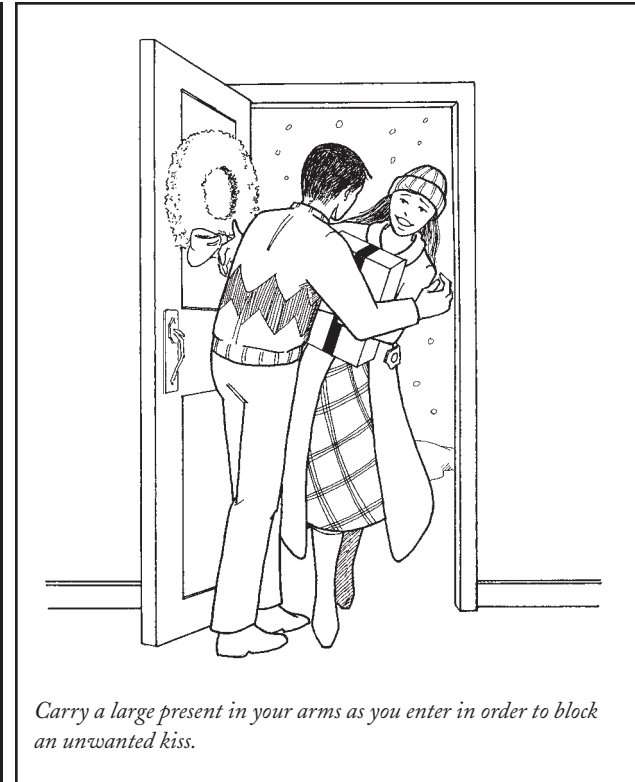

Carry a large present in your arms as you enter in order to block an unwanted kiss.

- 3** Employ evasive maneuvers.
If the mistletoe is hung in an inescapable location and someone is approaching, be prepared to use counter-measures:
 - Keep walking, as if you didn't realize you were under the mistletoe.
 - Carry a drink or plate of food at all times, and quickly take a sip or bite as the person approaches.

- Sneeze, cough, or scratch your nose just as the person moves in. When they hesitate, turn the attempted kiss into a friendly hug.
- Move rapidly and place a preemptive, glancing kiss on the person's forehead or cheek, thereby avoiding a more serious kiss.

4 **Make up a mistletoe-related fib.**

When fleeing from the would-be kisser seems too rude and other defensive tactics won't work, create a new mistletoe custom that would preclude the kiss:

- “This mistletoe has no berries! That's bad luck!”
- “That's not real mistletoe, it's plastic! How tacky—we can't kiss under that!”
- “Can you believe they put up mistletoe? Who believes in that anymore?”

Be Aware

- Portable mistletoe—a sprig attached to the end of a curved stick—is not valid mistletoe and does not invoke the kiss tradition. (You might also question why you are attending a party with someone who would attempt the “mistletoe-on-a-stick” trick.)
- Do not attempt to avoid a mistletoe kiss by claiming that you are not Christian. The custom of kissing under mistletoe is not specific to Christianity and is observed in many religions and countries.

**WORST-CASE
SCENARIO.**

HOW TO FIT INTO CLOTHING THAT IS TOO TIGHT

FOR MEN

1 **Wear newer shirts and pants.**

Garments (especially shirts) that have been laundered repeatedly are smaller than their original sizes. These items may also have loose buttons that might be ejected during a meal.

2 **Choose dark-colored garments.**

Lighter colors are less forgiving visually, while darker colors tend to obscure bulges.

3 **Move your collar button.**

Many men carry extra weight in the neck and jowls. Remove and reattach your collar button, moving it to the very edge of the collar tab. Wear a standard tie (not a bow tie) to hide the alteration.

4 **Wear suits.**

Suits are very effective for hiding pounds. They even out lines and offer structure to the body shape. Choose a dark-colored suit with a boxy shape rather than one cut narrow through the chest and waist. Shoulder padding is slimming, and is a must to balance the hips. (Broad shoulders help to create the

For Men

DO

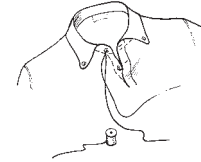

Move your collar button.



Wear dark-colored, boxy suits.

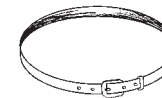

Use the proper belt notch.

DON'T



Wear fitted shirts.

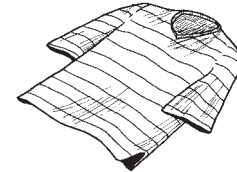

Wear horizontal stripes.

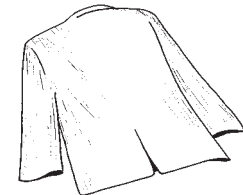

Wear single-vented suits.

ideal inverted triangle physique.) A suit jacket is also effective for hiding a large rear end: Choose a jacket with side vents/slits for extra room and comfort.

5 Move pants to below the belly.

Do not attempt to hike pants up and wear them high on the waist: This will result in an unsightly bulge, the pants may not close properly, and they will be too short in length. Wear them low on the hips, and use a jacket or loose-fitting shirt to conceal the gut.

6 Use the proper belt notch.

A belt should be worn in the third or fourth notch. Buy a longer belt rather than moving to a lower notch.

Be Aware

- Avoid fitted, knitted, polo-type tops, such as golf shirts. These garments accentuate what you want to hide.
- Avoid horizontal stripes, which widen your appearance.
- Avoid suits with a center vent in the back, which tends to ride on the rear end rather than fall over it.

FOR WOMEN

1 Choose classic-fit trousers and tunic shirts and blouses.

Even if a bit tight, these garments will fit better and look more appropriate than severely cut items. Blouses can be worn untucked, but only if they are cut straight across the bottom and not high on the sides. If you carry extra weight in your hips, avoid narrow-leg pants; instead opt for classic or wide leg styles.

2 Use safety pins on pants with side and rear closures.

Safety pins can be used to extend the waistband and may even be used in a chain of two or three. Wear a long jacket or over-blouse to hide the pins; take care in windy conditions.

3 Pick structured garments.

Jackets and cardigan sweaters that have a structured shape—even without you in them—hide pounds. Look for jackets that have shoulder pads, back seams that curve, and tapered sleeves. Unlike the boxy suits men should wear, women's suits should be tapered, giving the appearance of a slimmer waistline.

4 Layer tops and use tops as shirt-jackets.

Blouses that are too tight when buttoned can be worn partially unbuttoned over a round-neck or turtleneck knit top. Leave the over-blouse unbuttoned down to a button above the waist; tuck the top and blouse into your skirt/pants for a slimming layered look. Add a jacket, or wear the blouse completely unbuttoned as a shirt-jacket if it is cut straight across the bottom.

For Women

DO

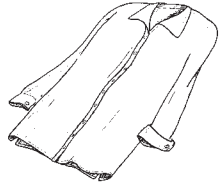

Wear tunic shirts and blouses.

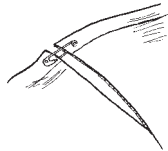

Use safety pins to close zippers.

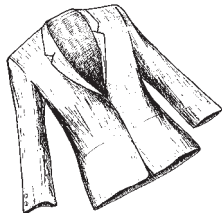

Wear structured garments.

DON'T



Wear spandex.

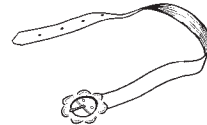

Wear flashy belts.



Wear bulky sweaters.

5

Choose monochromatic ensembles.

Wear dark suits, or pair a black skirt or pants with a black top or blouse. To maximize the slimming effect of dark, monochromatic ensembles, keep the darkest garment on the bottom. Place lighter shades of the same hue near your face.

6

Wear bright colors properly.

To wear bright colors and still look thin, pair them with dark neutrals. Wear black pants/skirt with a brightly colored blouse or knit top, topped off with a black jacket. Or choose a red jacket with a black top and black pants/skirt.

7

Draw attention to the face with striking accessories, stylish hair, and tastefully applied makeup.

Be Aware

- Avoid clingy knits and spandex. These materials keep no secrets and tend to draw the eye to bulges. Lycra creates some stretch in a garment and is far more forgiving than spandex.
- Before the holidays, purchase a few blouses and two pairs of dark pants that are one size too big. Wear them before the holidays and people will think you've lost weight. After the holidays, they will fit perfectly.
- Avoid drawing attention to the waist with flashy belts over large shirts.

HOW TO MAKE AN EMERGENCY ANGEL

If you do not have an angel or ornaments for your Christmas tree, you will have to make your own.

PAPER PLATE ANGEL

You will need a paper plate, crayons or coloring pencils, a coffee mug, a quarter, scissors, and glue or tape.

1 Draw the angel.

In the center of the paper plate, trace the circumference of the mug for the wings and trace the quarter on the top inside edge of the first circle for the head, as shown. Draw in the shoulders freehand.

2 Cut on the bold lines as illustrated.

Keep the body attached to the skirt. The upper portion will fall away.

3 Decorate the angel with crayons or colored pencils.

4 Overlap the edges of the skirt behind the angel's back and tape or glue into place.

If you have no tape or glue, cut two vertical slits: one at the top of the left side, the other at the bottom of the right. Interlock the two sides.

5 Set the angel atop the tree.

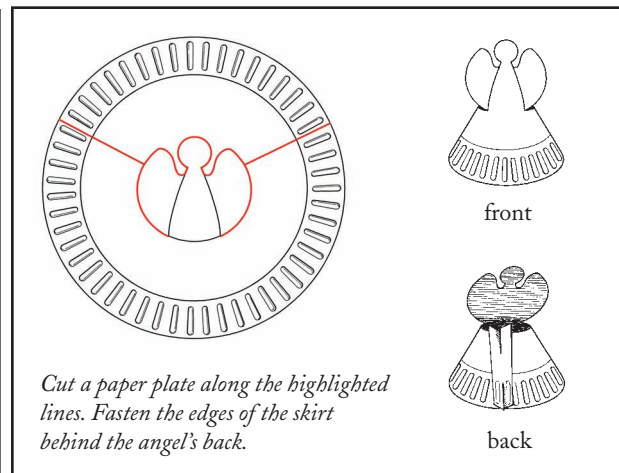

ALUMINUM FOIL ANGEL

You will need aluminum foil and a toilet paper tube.

1 Make the wings.

Cut a piece of foil approximately a foot and a half long. Fold it lengthwise like a fan, in alternating directions as illustrated. Hold the fan together in the center and spread out the foil in a wing-like manner.

2 Make the body.

Cut another piece of foil the same size and wrap it around the toilet paper tube, aligning one end of the foil with one edge of the tube; let the rest hang off. After rolling the tube in the foil, bunch the extra foil at one end to form the head. If the head seems too small, wrap another piece of tin foil around it to enlarge.

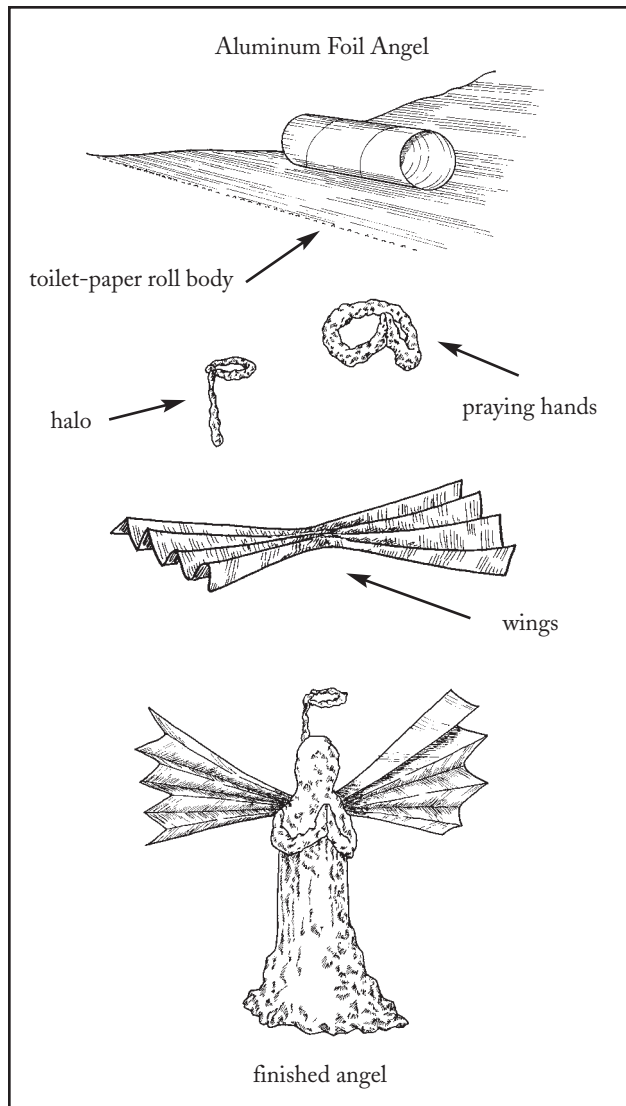

- 3 Make a skirt.**
Tear a strip of foil approximately five inches wide and wrap it around the tube to form a skirt. Bunch the skirt together in the back to hold it in place.
- 4 Make a halo.**
Tear a thin strip of foil. Make a ring at one end with the trailing piece coming straight down. Press the trailing piece into the crevices of the angel's head at the back.
- 5 Make praying hands.**
Tear another thin strip of foil approximately eight inches long. Wrap it around the angel's body, near the top of the tube. Press the ends together to form praying hands. Tear off any excess.
- 6 Attach the wings.**
Center the fan on the angel's upper back and press into the foil below the head to attach.
- 7 Set the angel atop the tree.**

ALTERNATIVE ORNAMENTS

Readily available items from home or a convenience store can be used as ornaments in an emergency.

- CDs—free-trial Internet providers' CDs or old music CDs create glittery reflective surfaces.
- Costume jewelry—earrings, brooches, and rings for ornaments, necklaces for tinsel.

- Clothing—scarves, lace undergarments, and anything for infants, especially hats, gloves, and shoes.
- Bread products—bagels or powdered-sugar donuts (around branches); white bread shaped into animals, balls, snowmen, or Santa; cookies; and fruitcakes (sliced).
- Lapel buttons—political or rock-and-roll pins, stuck or clipped to branches.

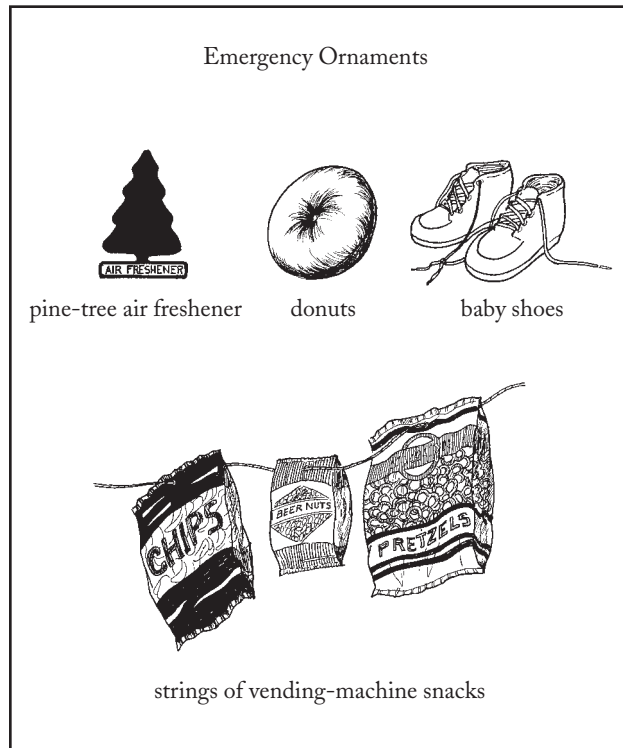

- Fruits and vegetables—jalapeño peppers, cherry tomatoes, zucchini, pearl onions, garlic cloves, and olives (with or without pimiento).
- Photographs—pictures of your family, photos of someone else's family or of celebrities torn out of magazines.
- Snack foods—vending-machine-sized bags of chips, cookies, and candy, strung together.
- Air fresheners—automobile fresheners, shaped like pine trees, in a variety of colors.
- Gumdrops or gelatin-based candies—hung individually, strung together, or licked and stuck together in festive shapes.

Be Aware

- Perishables such as lunch meats, cheeses, and giblets pose potential health risks, and therefore do not make good decorative items.
- Use tape, grocery store twist-ties, paper clips, or thread if you do not have hangers.

**WORST-CASE
SCENARIO.**

HOW TO MAKE AN EMERGENCY MENORAH

If Hanukkah arrives and you are without a menorah or candles, you will have to make your own. (See page 80 for making candles.)

BAKED MENORAH

You will need 2 cups flour, 1 cup salt, 1 cup water, 9 nuts or washers (at least $\frac{1}{2}$ inch in diameter), a large mixing bowl, and at least three hours.

- 1** Preheat the oven to 200° F.
- 2** Mix the flour and salt together in the large bowl.
- 3** Add water.
Slowly pour water into the mixture and stir until it becomes the consistency of dough. If it is too dry, add more water; if it is too wet, add more flour.
- 4** Roll the dough into a strip about 12 inches long, 1 to 2 inches wide, and 2 inches thick.

- 5** Cut a 1-inch piece off one end and press it into the center of the strip.

The center area will be raised slightly: It will hold the Shamos candle, which is used to light the other candles.

- 6** Add the nuts to the dough.

Press the nuts into the dough, four spaced evenly on each side of the Shamos holder. Place the ninth nut in the raised center portion. The nuts should be pushed in so that part of the nut sticks up above the top of the dough. The nuts are the candle holders.

- 7** Bake.

Place the menorah on a baking sheet, and place in the oven. Bake for about two hours. The menorah is ready when the dough becomes hard. (You can air dry the menorah instead of baking it; allow two to three days for hardening.)

- 8** Let cool.

The menorah should be completely cool before use.

Baked Menorah



*Press nuts into the dough before baking.
Let menorah cool completely before use.*

BOWL AND DIRT MENORAH

You will need a baking dish or bowl and sand, dirt, rice, or gravel.

- ★ Fill a 2-inch-deep (or deeper) bowl with sand, dirt, rice, gravel, or other nonflammable material.

Stick the appropriate number of candles in the dish each night (placing the Shamos on a slightly elevated mound) to create a makeshift menorah.

Be Aware

Do not make a menorah out of wood. Hanukkah candles must be allowed to burn down completely, and wood presents the risk of fire.

Bowl and Dirt Menorah

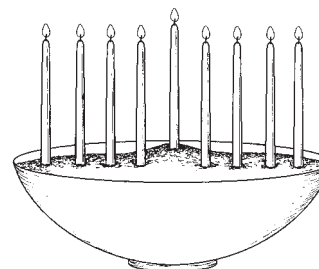

The Shamos candle should be set on a raised mound in the center of the bowl.

HOW TO MAKE MENORAH CANDLES FROM CRAYONS

You will need 4 cups distilled water; 8 tablespoons boric acid; 4 tablespoons salt; 26 feet of string, twine, or cotton yarn; cardboard; an empty metal coffee can; a saucepan larger than the coffee can; heavy-duty foil; 44 steel washers; and 137 crayons.

- 1 Prepare a mordanting solution for the wick.**
Mix the distilled water, boric acid (Borax), and salt in the large saucepan. This mordanting solution will minimize smoke and ash. Bring the solution to a boil.
- 2 Soak the string in the mordanting solution.**
Submerge the string, twine, or cotton yarn in the boiling solution, remove from the heat, and let steep for four to eight hours.
- 3 Remove the string and hang to dry overnight.**
Hang the string on the back of a folding chair, on a doorknob, or from a curtain rod. Ensure that loops of the string do not touch one another. Discard the mordanting solution and rinse the saucepan.

Crayons into Candles

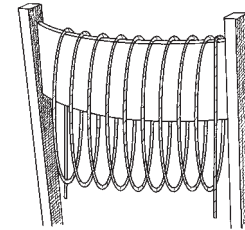

Dry.



Hang.

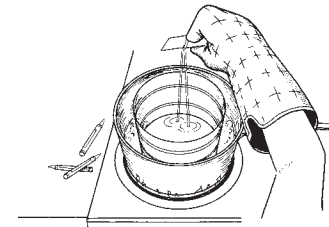

Dip.

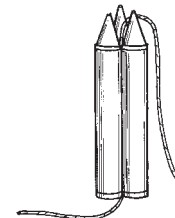

Bundle.

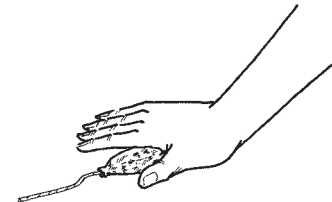

Roll.

- 4** **When the string is completely dry, cut 22 strands, each 14 inches long.**
Each strand will make a wick for two 6-inch candles at a time. Weight both ends of each length by tying on steel washers. These will keep the wick straight as the candle dries.
- 5** **Prepare the wicks for dipping.**
Drape each string piece over a 2-by-2-inch piece of cardboard folded in half, leaving equal lengths on either side. Cut slashes on opposite sides of the cardboard and lodge the wick into the slashes. Set aside.
- 6** **Place the coffee can in the saucepan on the stovetop.**
Fill the saucepan around the can with 3 to 4 inches of water. Bring the water to a boil, adding more water as necessary to keep the level constant.
- 7** **Melt five crayons in the coffee can.**
Remove all paper from the crayons before melting them. This wax will only be used to coat the wick, not to make the candles.
- 8** **Dip two wicks.**
Leave the wicks in the melted crayons until they are coated; 30 seconds is sufficient. Remove from the can and hang to dry.
- 9** **Once dry, cut the string.**
Remove the cardboard and washers and cut the string so that you have two prepared wicks, each about 7 inches long.

- 10** **Stack three additional crayons around each wick.**
Remove the paper from the crayons first. This arrangement will form your candle. Allow a few extra inches of wick to protrude at each end.
- 11** **Wrap the bundle tightly in several layers of heavy-duty aluminum foil.**
A few layers will be necessary to prevent leaking.
- 12** **Repeat steps 10 and 11 until all 44 candles are prepared.**
- 13** **Heat.**
Place the foil-wrapped bundles on a baking sheet and put in a preheated 200° F oven for 20 minutes to fuse them together.
- 14** **Shape.**
When the bundles are warm and pliable to the touch, roll until the candles are the proper diameter to fit your menorah.
- 15** **Remove the foil.**
- 16** **Set the candles.**
Place them in the refrigerator for 30 minutes to cool.

Be Aware

Crayon-based candles are very smoky, drippy, and tend not to burn evenly. Watch them carefully when lit.

HOW TO OPEN A BOTTLE OF WINE WITH A BROKEN CORK

- 1 Examine the cork.**

If the cork has broken due to improper corkscrew use, treat the broken cork as if it were whole. If the cork is pushed too far into the bottle, push it all the way in using any long thin implement and proceed to “With a Very Dry Cork,” step 5, below.
- 2 Reinsert the corkscrew.**

Six half turns of the corkscrew will usually be enough to allow you to remove a full cork, but you may need fewer for a partial cork. Turn the corkscrew slowly to prevent further cork breakage.
- 3 Pull the cork out.**

Pull up steadily on the corkscrew, being careful not to jerk the cork out of the bottle. If the cork remains in the bottle, go to “With a Very Dry Cork,” step 2, below.

WITH A VERY DRY CORK

- 1 Check for crumbling.**

If the cork is soft and powdery, it will not offer the corkscrew enough resistance. It may also be stuck to the sides of the bottle, making intact removal impossible.

- 2 Bore a hole through the center of the cork.**

Use the corkscrew as a drill.
- 3 Widen the hole.**

Wiggle the corkscrew from side to side to increase the diameter of the hole.
- 4 Try to pour.**

If the wine will not pour, continue to enlarge the diameter of the hole as above, or force the remainder of the cork into the bottle (see “How to Open a Bottle of Wine Without a Corkscrew,” page 32).
- 5 Make a filter.**

Place a piece of clean, unwaxed, unbleached cheesecloth over the mouth of a decanter and secure it tightly with a rubber band. If no cheesecloth is available, use a coffee filter (preferably unbleached). Do not use a T-shirt or any article of clothing you have washed in detergent—the detergent can affect the taste of the wine.
- 6 Strain the wine.**

Carefully pour the wine through the filter into the decanter. When the bottle is empty, remove the filter containing the pieces of cork from the mouth of the decanter and serve the wine.

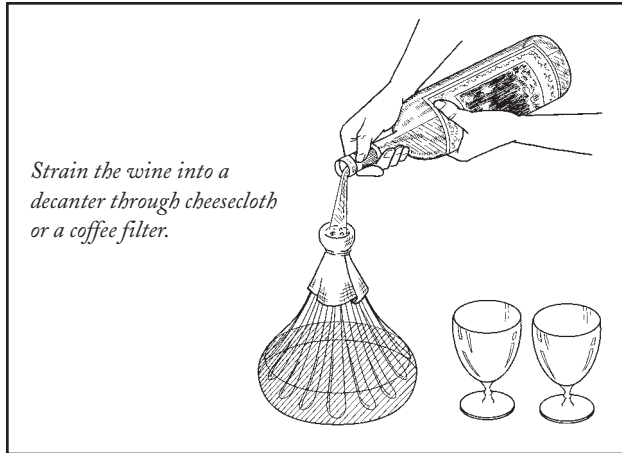

HOW TO OPEN A BOTTLE OF WINE WITHOUT A CORKSCREW

It is virtually impossible to remove a cork from a wine bottle without a device made for this purpose. However, the cork can be pushed into the bottle with a little effort.

- 1** Hold the bottle steady with one hand.
- 2** Use a blunt, unbreakable, skinny object, such as a screwdriver, the handle of a wooden mixing spoon, or a butter knife to push the cork in.
- 3** Apply steady pressure and be patient.
You may carefully tap the end of the blunt object with a hammer or meat tenderizer to force the cork into the bottle more quickly.

**WORST-CASE
SCENARIO.**

**WORST-CASE
SCENARIO.**

HOW TO OVERCOME HOLIDAY DEPRESSION

1

Avoid excess.

Overdoing certain things can promote depression. To prevent the onset of depression:

- Avoid increased stress.
- Avoid increased consumption of alcohol and sugar.
- Avoid poor eating habits and nutritional deficiencies.
- Avoid increased spending and financial burdens.
- Avoid overwhelming social commitments.

2

Eat mood-elevating foods.

L-tryptophane and L-tyrosine, two amino acids, are essential for the production of the mood elevator serotonin. Two natural sources of L-tryptophane are pumpkin seeds and turkey, while L-tyrosine can be found in dairy products, beans, meat, and fish. To support the nervous system and help resolve stress, take B-complex vitamins. Since low levels of magnesium can cause depression, eat green vegetables, since magnesium is part of the chlorophyll complex.

3

Exercise.

Take brisk walks or exercise vigorously. Strenuous exercise increases endorphin levels and elevates the mood. Activity also helps flush the lymphatic system and remove wastes that can adversely affect mood. Exercising outdoors in sunlight is also a mood enhancer.

4 Focus on the brevity of the holiday.
Even the longest day has only 24 hours.

5 Embrace the pain.
Instead of trying to avoid holiday activities (cooking, shopping, cleaning, traveling) or wallowing passively in your depression, actively embrace the very things you dread. This counter-intuitive approach will surprise others as well as yourself, and may shock your system into a better mood. It will also pass the time more quickly.

HOW TO DEAL WITH POST-HOLIDAY DEPRESSION

1 Remove all holiday decorations.
Holiday decorations, while attractive, can also serve to remind you of the celebration that is now a part of the past. Take them down and pack them away.

2 Return all unwanted gifts as soon as possible.
Unwanted gifts that remain in the house only serve as painful reminders of the holidays. Replace these items with new things that you genuinely want, and be happy with your new acquisitions.

3 Recognize the symptoms of post-holiday depression.
The symptoms include apathy toward work, social events, relationships, and goals; loss of energy, appetite, self-esteem; feelings of guilt, hopelessness, or free-floating anxiety; excessive or interrupted sleep; and frequent headaches. Accepting the fact that you

have post-holiday depression is the first step toward dealing with it.

4 Plan another event.
Look ahead to birthdays, trips, anniversaries, and other occasions you can celebrate soon.

5 Think about next year.
Remind yourself that your favorite holidays will be back again next year. Focus on how much fun you will have then.

6 Eat mood-elevating foods and exercise.
See “How to Overcome Holiday Depression,” steps 2 and 3, page 47.

Be Aware

- Holiday depression, stress, and anxiety often arise from letting things go until the last minute or from overspending. Plan and spend accordingly.
- Herbal mood elevators include St. John’s wort, skullcap and oats, kava kava and valerian root, milk thistle, and the Chinese herb Hsiao Yao Wan. Use as directed.
- An underactive thyroid gland can cause depression. If none of the above remedies are successful, have your thyroid checked.
- Many people suffer from seasonal affective disorder (SAD), which results from exposure to fewer hours of sunlight. It might be the season, not the holidays, that are at the root of your dissatisfaction.

HOW TO PREVENT A TREE FROM TOPPLING OVER

HOW TO MAKE AN UNTIPPABLE TREE STAND

- 1** Obtain 6-inch diameter PVC pipe and cut it to 15 inches long.
- 2** Stand the pipe in the center of an empty 5-gallon plastic bucket.

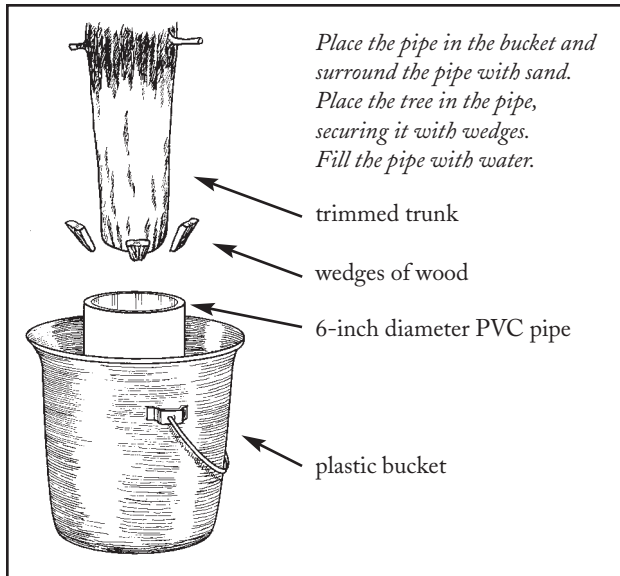

- 3** Fill the bucket, around the pipe, with sand.
- 4** Place the tree in the pipe.
The trunk should be free of branches on the bottom 15 inches. (See "If It Is Too Wide for the Stand," page 69, for trimming instructions.)
- 5** Secure the tree in the pipe with small wedges of wood.
Cut the wedges out of branches you removed earlier. Set them around the trunk at the opening of the pipe to hold it in place.
- 6** Fill the pipe with water.
Water may leak from the bottom of the pipe into the sand. Monitor the water level to ensure the tree stays moist. This stand will hold a 9-foot tree. Use a larger bucket and a longer pipe for a bigger tree.

HOW TO MAKE A CEILING GUY WIRE

- 1** Tie metal picture wire or heavyweight fishing line to the top of the tree.
Tie a short length of wire to the main trunk, just below the top of the tree.
- 2** Screw a hook into the ceiling directly above the tree.
- 3** Thread the wire through the ceiling hook and pull taut.
- 4** Knot the line securely.

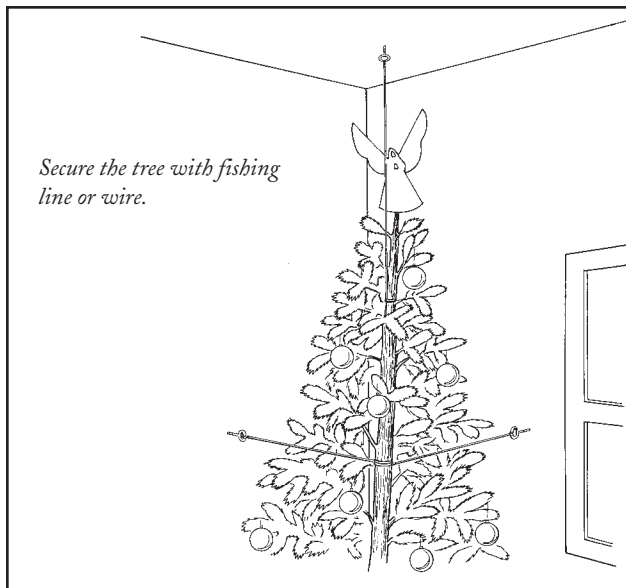

HOW TO MAKE WALL GUY WIRES

★ **Secure two wires to the trunk a third of the way down the tree.**

Tie the free end of each wire to a hook attached to the wall on either side of the tree. Alternatively, loop a single wire around the trunk and attach each end to the wall hooks.

Be Aware

Cut tree branches have many uses. Place them under the tree to cover the stand, or use them to make wreathes or window box decorations.

**WORST-CASE
SCENARIO.**

WORST-CASE SCENARIO.

HOW TO PUT OUT A GREASE FIRE

- 1 Do not douse with water.**
Oil and water do not mix: Water will cause the burning oil to spatter and spread the fire. Do not move the burning pan to the sink.
- 2 Turn off the stove.**
- 3 Put on an oven mitt.**
Large mitts are the safest option. If barbecue mitts—those that cover the forearm—are available, use for added protection.
- 4 Find a lid that fits the pan.**
A lid that is slightly larger than the pan will also work.

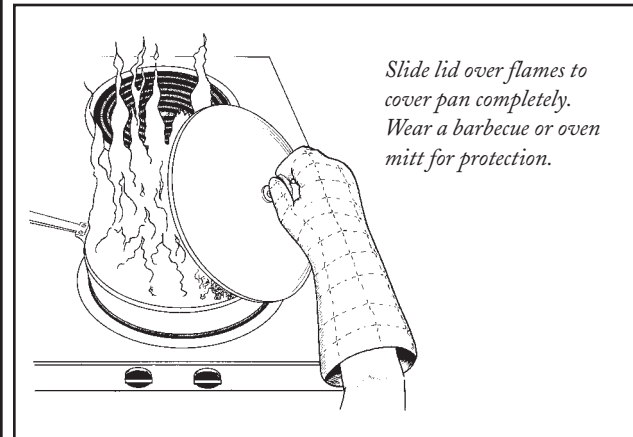

5 Hold the lid at an angle toward the fire.

Do not try to lower the lid directly onto the pan or you risk burning your arms. Keep your face and chest as far from the flames as possible.

6 Slide the lid onto the pan and hold it in place until the pan cools.

The pressure from the heat and flame can force a lid off the pan. Hold it securely in place.

7 Do not lift the lid.

Lifting the lid will add oxygen and feed the fire. Take the lid off only when the pan has become noticeably cooler.

8 If no lid is available, use baking soda.

Dump a large amount of baking soda on the grease fire to extinguish it quickly. Avoid using baking powder, which can cause the fire to flare.

Be Aware

- Do not use a dry chemical extinguisher to try to put out a grease fire. It is not effective, and the force of the compressed chemical agent can splatter burning material and spread flames.
- Never leave cooking oil to heat unattended: Flames may develop quickly.

HOW TO TREAT A GREASE BURN

1 Cool the burned area.

Immediately run cold water over the burned area for several minutes or until the injury site is cool.

2 Dry the burned area gently.

Blot the injury site using a clean, dry towel or sheet.

3 Check for blistering.

If the blisters are small, pop them with a sterilized pin and remove dead skin using scissors. (Wiping the tip of a pin in alcohol or heating it in the flame from a match will adequately sterilize the pin.) If there are no blisters and the burn is less than one inch across, apply burn cream and a sterile dressing.

4 Cover severe burns.

If the burn is larger than one inch across or is very blistered, cover it with a clean, dry sheet or towel and seek medical attention promptly.

Be Aware

- Infection is the main risk. Signs of infection include fever or local warmth, increased redness around the burned area, increased soreness, red streaks, swelling, or drainage of pus.
- Do not apply oily or greasy substances such as petroleum jelly or butter to the wound. These popular but misguided burn remedies are detrimental to the healing process.

HOW TO REPURPOSE A FRUITCAKE

- ★ **Turn the fruitcake into another dessert.**
Do not serve the fruitcake as is. Slice it very thin, tear the pieces apart, and use them in an English trifle, a dessert made with alternating layers of cake (née fruitcake), custard, whipped cream, and, sometimes, fresh fruit. Serve in a deep glass bowl (often called a trifle bowl).
- ★ **Use the fruitcake as a doorstop.**
Fruitcakes are very hardy and will last for years. Use the fruitcake to prop open a door.
- ★ **Use the fruitcake to prevent your car from rolling.**
When parked on a hill, wedge the fruitcake under the downhill side of a rear tire. In your garage, position the fruitcake on the floor as a tire stop to prevent the car from hitting the garage wall.
- ★ **Use the fruitcake as a dumbbell.**
A good-size fruitcake may weigh several pounds. Incorporate it into your exercise routine, holding it firmly for arm curls, or squeezing it between the feet for leg lifts.
- ★ **Use the fruitcake in a carnival game.**
Collect fruitcakes and stack them vertically in a pyramid. Using tennis balls, try to knock down the fruitcakes in five throws.

Fruitcakes are extremely hardy and can be used for a variety of purposes:

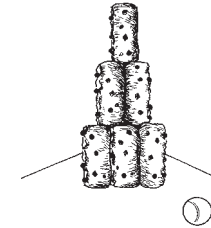

carnival game

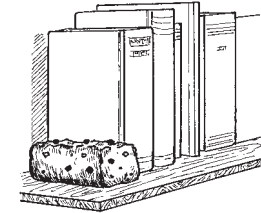

bookend



doorstop

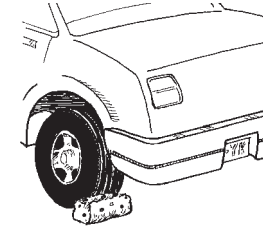

tire block



dumbbell

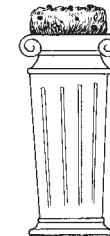

art

- ★ **Use as bookends.**
Set up two fruitcakes either horizontally or vertically, depending on the size of the books.
- ★ **Use as art.**
Bolt a fruitcake to a painted board, frame it and hang it on your wall, or simply place it on a pedestal. Position the fruitcake in a well-lit area.
- ★ **Use the fruitcake as compost.**
Fruitcakes are made of (mostly) organic material, and make good fertilizer. However, it may take several years for the fruitcake to decompose.

HOW TO SAFELY EAT A FRUITCAKE

- 1 Slice it thin.**
Cut the fruitcake into narrow slices—no more than $\frac{3}{8}$ inch—while the cake is cool. Place the slices on a serving platter, cover, and allow to come to room temperature.
- 2 Check the knife.**
After cutting, the blade should be somewhat sticky and slightly colored. If the knife does not have to be wiped with a damp cloth after each cut, the cake is too dry, and a healthy dollop of whipped cream will be necessary. If the knife is heavily streaked with cake ingredients after cutting, the fruitcake has not been baked long enough and may need to be repurposed.

- 3 Disguise the taste.**
Cover with lots of ice cream and whipped cream. Wash the fruitcake down with strong black coffee, Irish coffee, brandy, or a hot toddy.
- 4 Swallow without chewing.**
Cut the slice into small pieces. Swallow each piece whole, as you would a vitamin. If chewing is necessary, use your molars, not your front teeth or incisors, and try not to touch the food with your tongue, which has all your taste buds.

Be Aware

- Do not be fooled by a gift of a “Yule cake,” “Christmas ring,” or “dried fruit bread”—these are just other names for a fruitcake.
- If the fruitcake is very dark in color, it contains lots of molasses and corn syrup, making it exceedingly sticky, thick, and dense. The heavier the fruitcake, the more candied fruit and dark molasses it has. The darker or heavier the fruitcake, the more difficult it will be to swallow.
- A light-colored fruitcake is a good sign; the cake has plenty of batter and light corn syrup.
- Fruitcake should be stored in a cool place, such as a refrigerator or cellar. If kept cool and in a tin, the cake will last for at least a year, and you can give it as a present the following Christmas.

HOW TO RESCUE SOMEONE STUCK IN A CHIMNEY

- 1 Obtain a long, sturdy rope.**

Make sure the rope is longer than the length of the chimney. You will need approximately 10 feet of rope for each story (including the attic), plus 10 additional feet.
- 2 Tie a knot in the rope every two feet.**
- 3 Position yourself on the roof of the house.**

The opening of the chimney at the fireplace end is probably too narrow for you to pull the person out. You must perform your rescue from above.
- 4 Communicate with the person.**

Make sure that the person who is stuck is still conscious and able to help with the rescue. Tell him you are coming.
- 5 Lower the rope down the chimney.**

The rope should be tied securely around the chimney or another immovable object. Slowly feed the other end hand-over-hand down the chimney.
- 6 Tell the victim to grab the rope.**

Holding onto the knots provides both you and the victim a better grip.

- 7 Pull the victim up.**

Unless you are much larger than the victim (and very strong), you will not be able to pull the victim out unaided. The victim can help by using footholds to brace and climb. If the victim cannot climb out or otherwise help in the rescue, enlist others to help you pull the rope.

- 8 Call the fire department.**

If you cannot extricate the person from the chimney, call the fire department for assistance.

HOW TO CLIMB DOWN A CHIMNEY

- 1 Feel and smell for a lighted fire.**

Do not enter a chimney that is hot or smoking.
- 2 Assess the size and type of chimney.**

Some chimney flues may be as narrow as 12 by 12 inches, too small for an adult to enter. Chimneys 24 by 24 inches or larger are ideal. Big, old houses are more likely to have large chimneys and less likely to have an entry-impending damper at the bottom.
- 3 Remove the chimney cap.**

Many chimney openings are covered with a cap to prevent animals from entering the flue. The cap will have either four short legs tucked into the chimney and held in place by gravity, or four pressure screws attached to the inside surface of the flue.

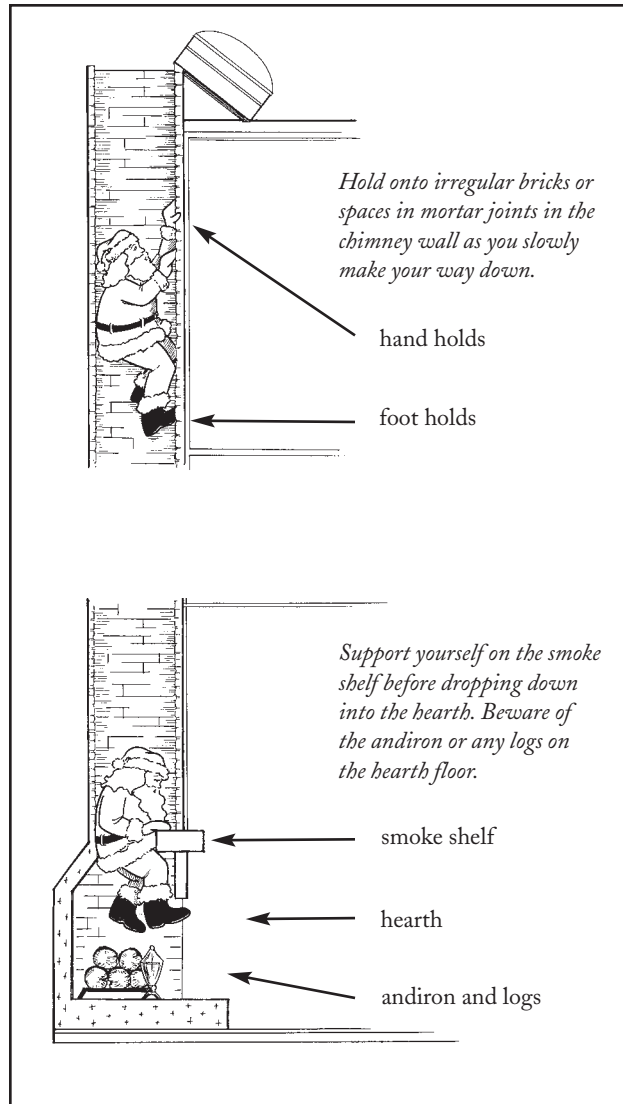

4 Examine the inner surface of the chimney.

Use a flashlight to peer into the flue. Homes built after 1935 may have a flue lined with clay tiles. Older homes have unlined brick flues. Brick flues have a more irregular surface, offering better hand and footholds. Some newer homes may have metal-lined flues. Avoid these, as they offer minimal traction.

5 Enter the chimney feet first.

Keep your hands above you and hold onto irregular bricks or spaces in the mortar joints. If the chimney is clay-lined, concentrate on the joints between the clay tiles for your handholds and footholds. These joints are two feet apart. The chimney is likely narrow enough that you can lean back against one wall while bracing your feet on the opposite wall.

6 Move slowly toward the bottom of the chimney.

You will quickly be covered with creosote (hardened soot) unless the chimney has recently been cleaned. Fresh creosote may be powdery and difficult to grip, or sticky (formed by burning moist wood), aiding your descent. Old creosote will be hard, shiny, and very slick. Keep your body straight to lessen the chance of getting stuck on sticky soot.

7 Look for the smoke chamber.

This brick-lined area is below the flue and has large amounts of soot and creosote. When you reach the smoke chamber, you will be just above the smoke shelf and close to the bottom of the chimney.

8 Use the smoke shelf to brace yourself.

The smoke shelf is a few feet above the hearth (the area where the fire is made, also called the “firebox”). This angled brick shelf is off to the bottom rear of the flue. It catches rain and funnels the wider area of smoke that comes from the hearth into the narrower passage of the flue. You may be able to rest your feet on it before continuing.

9 Open the damper.

Most fireplaces have a damper, a metal door that slides or swings closed to prevent drafts and to keep heat from escaping up the flue when no fire is present. Open the damper by pulling it toward you; use a heavy magnet if you cannot pull it open by hand. Some dampers use a screw-type mechanism that can be opened only from inside the house: If it or the damper is too small to pass through, or is screwed shut, you will have to climb back out the top of the chimney.

10 Lower yourself into the hearth.

If you can see the hearth, and can fit through the opening, carefully drop down into the fireplace and enter the house. Beware of an andiron or logs on the hearth floor.

**WORST-CASE
SCENARIO.**

HOW TO RESIZE A CHRISTMAS TREE

IF IT IS TOO TALL FOR THE ROOM

- 1 Do not force it inside.**
Keep the tree outdoors or in another room until you have made the necessary alterations.
- 2 Obtain pruning shears and a bow saw.**
Prepare to use long-handled, scissor-type shears for removing branches, and an open-throated bow saw with a 20- or 30-inch steel blade for cutting a large trunk.
- 3 Measure the height of the tree stand, the tree itself, and the height of the room.**
Figure out approximately how much shorter the tree needs to be.
- 4 Locate the whorl and internodal branches.**
Whorl branches are larger in diameter and grow out from the trunk in sets of four to six; they resemble the spokes of wheel. Sets of whorl branches are located every 12 to 15 inches along the trunk of a standard eight-foot-tall tree. Internodal branches are smaller in diameter and are randomly spaced on the tree between the whorl branches.



- 5 Mark the tree for cutting.**
Find the lowest level of whorl branches whose removal will sufficiently shorten the tree but will leave enough space for the trunk to neatly fit into the tree stand. Make a hash mark with the saw just above these whorl branches on the trunk.
- 6 Remove the branches below your hash mark to prepare the trunk for trimming.**
Use the shears for branches up to 1 inch in diameter, and use the bow saw for larger branches. Without branches, the trunk will be easier to cut.

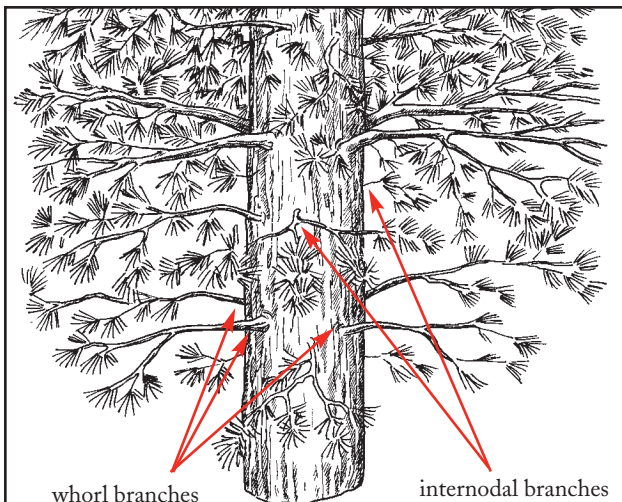

Cut the trunk just above the lowest set of whorl branches whose removal will sufficiently shorten the tree.

7 **Cut the trunk.**

Use the bow saw to cut the trunk at the hash mark.

8 **Place the tree in the stand to test the height.**

If it is still too tall, remove more of the trunk, always above the next set of whorl branches.

9 **Move the stand and the tree to the desired location.**

Secure the tree in the stand, ensuring that the tree is perfectly straight. Then gently rock the tree back and forth to check the stability of the stand. Turn the tree so that any gaps between branches face the wall. Fill the stand with water.

IF IT IS TOO WIDE FOR THE STAND

1 **Measure the diameter of the stand and the diameter of the tree.**

2 **Incrementally taper the trunk until it fits the stand.**
Use a bow saw to remove strips of bark and trunk, cutting parallel to the trunk. Remove equal amounts from all sides of the tree.

Be Aware

Do not attempt to use an electric carving knife to taper the trunk.

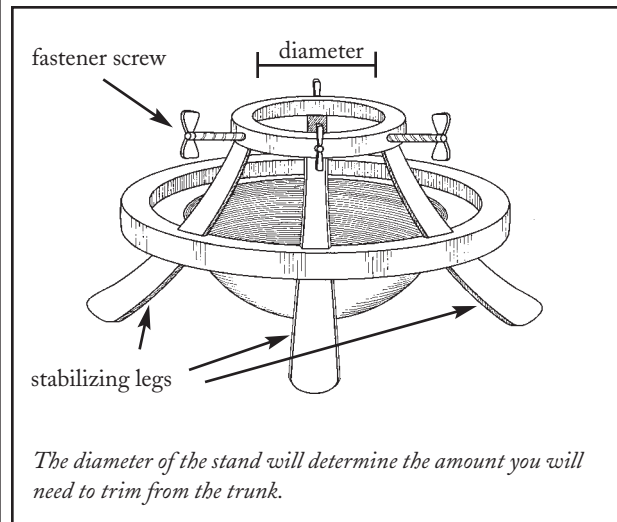

HOW TO SILENCE A GROUP OF CAROLERS

★ Turn out the lights.

As soon as you hear or see the carolers coming down the street, douse the lights. A dark house may deter them from stopping, since they will think no one is home. Turning out the lights belatedly—after they have arrived at your door—will send a strong message, but carolers are frequently very determined.

★ Turn up your music.

Without opening your door, play CDs at high volume. Speed metal and 1970s rock are likely to be in a different key than the carolers, who will be unable to stay in tune, become discouraged, and depart. If you are listening to Christmas music, shut it off immediately, or they may be encouraged to sing along.

★ Answer the door in a robe or towel.

Embarrassed, the carolers may simply leave. Nudity (even partial) may offend them and make them unable to sing. Call to another person inside the house (real or imaginary), “I’ll be right back.”

★ Answer the door holding a telephone.

Shout, “I can’t hear you! There are carolers singing!” into the mouthpiece until the carolers move on.

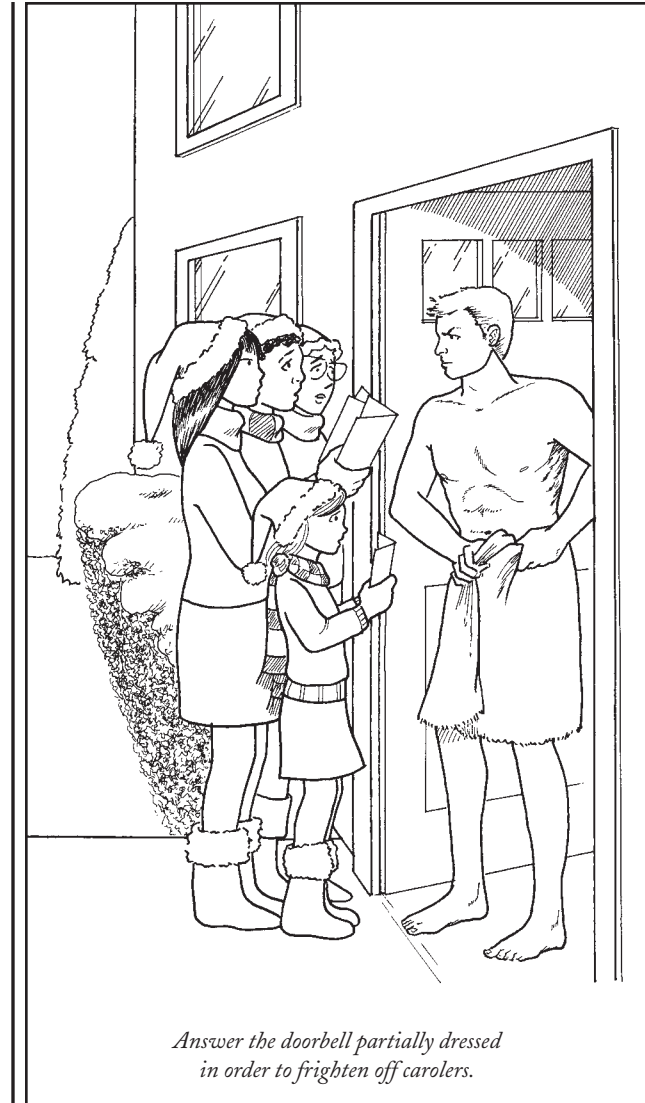

*Answer the doorbell partially dressed
in order to frighten off carolers.*

★ **Bribe them.**

Tell them you would like to make a small donation, and that you enjoy their singing—from a distance.

★ **Request songs they will not know.**

The song repertoire of the caroler is generally quite shallow. Good choices to stump the carolers include “Adam Lay Ybounden,” “Riu, Chiu,” and “The Zither Carol.”

★ **Send them to someone else.**

Smile and point to the house of a stranger or a neighbor you dislike, and say, “My friend over there really loves carols!” A house that is lavishly decorated for the season will prove irresistible to them.

HOW TO SING ALONG WHEN YOU DON'T KNOW THE WORDS

★ **Request “Deck the Halls.”**

Every verse ends with “Fa La La La La, La La La La,” which is easy to remember.

★ **Just join in.**

Carolers are irrepressible: If you are lost (or off-key), they will simply sing louder to drown you out.

★ **Listen for the chorus.**

Most carols have a repeating section, or chorus. Listen for it, and then sing only that part.

★ **Lip-synch.**

Move to the back of the group, then move your mouth soundlessly as they sing.

Be Aware

- Do not attempt to discourage carolers by stating that you are Jewish: You will get “Light the Menorah,” “The Dreidel Song,” “Sunrise, Sunset,” or another menu of ethnic songs.
- Do not tell carolers that you don’t celebrate Christmas: You are likely to hear “Frosty the Snowman,” “Sleigh Ride,” “Jingle Bell Rock,” or a litany of secular holiday songs.
- Do not attempt to avoid carolers by going to the bathroom; they will be waiting when you return.

WORST-CASE SCENARIO.

HOW TO STOP A RUNAWAY ONE-HORSE OPEN SLEIGH

- 1 Stay in the sleigh.**
Grip the seat or railing with one hand and the reins with the other. Most injuries occur when the rider is thrown, falls, or jumps off the sleigh, hitting the ground or a tree or rock. If you cannot reach the reins or they are loose and dragging on the ground, do not attempt to reach them. Hold onto the sleigh and wait for the horse or horses to tire.
- 2 Tug and release the reins with a medium pressure.**
Repeat until the horse begins to slow down.

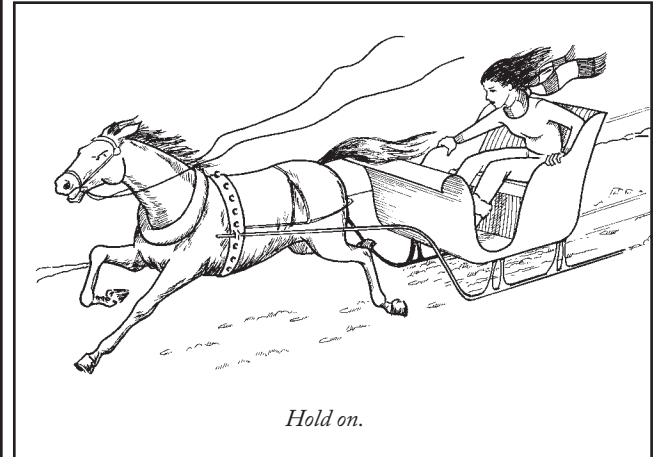

3 Do not jerk the reins of a horse that is running at full speed.

Never pull a running horse off balance, which might cause it to stumble or fall. Horses can run at a speed of 25 to 30 miles per hour while pulling a sleigh.

4 When the horse slows to a lope or a trot, pull one rein to the side.

With steady pressure, move the horse's head all the way around toward you. This will cause the horse to begin going in a circle. The horse will quickly tire of circling, begin to feel that you are in control again, and slow to a walk.

5 Pull back with slow, steady pressure on both reins until the horse stops.

Once the horse is at a walk, it is safe to bring it to a complete stop.

6 Dismount.

Be Aware

If a runaway sleigh is coming toward you, do not attempt to grab the horse or the reins. Even if you could grab a rein, that would more likely result in a broken rein than a stopped horse. Let the driver have space to gain control. Standing in front of a runaway horse and flapping your arms will not cause the horse to stop.

HOW TO JUMP FROM A RUNAWAY SLEIGH

Abandoning the sleigh should be a last resort. If the sleigh is headed for imminent peril, however, you will need to jump.

1 Move to the edge of the sleigh.

Remain seated until the last moment, holding on to the seat or railing.

2 Stuff your clothing with blankets or seat cushions to reduce the impact.

Give yourself as much protective padding as is readily available.

3 Open the sleigh door, if there is one.

4 Pick your landing spot.

If you can, wait until the horse rounds a bend, since it may slow down. The ideal landing spot will be well covered with soft snow and free of trees, rocks, and bushes.

5 Crouch low to the floor of the sleigh.

Bend your knees.

6 Jump perpendicular to the sleigh.

Leaping at a right angle away from the sleigh will make it much less likely for you to fall under the runners. Leap as far away as you can.

7 **Cover your head.**
Use your hands and arms to protect your head.

8 **Land flat.**
Do not attempt to land on your feet or do a somersault. Keep your body straight and try to land so that all parts of your body hit the ground at the same time. This will spread the impact over a wider area.

9 **Roll like a log.**

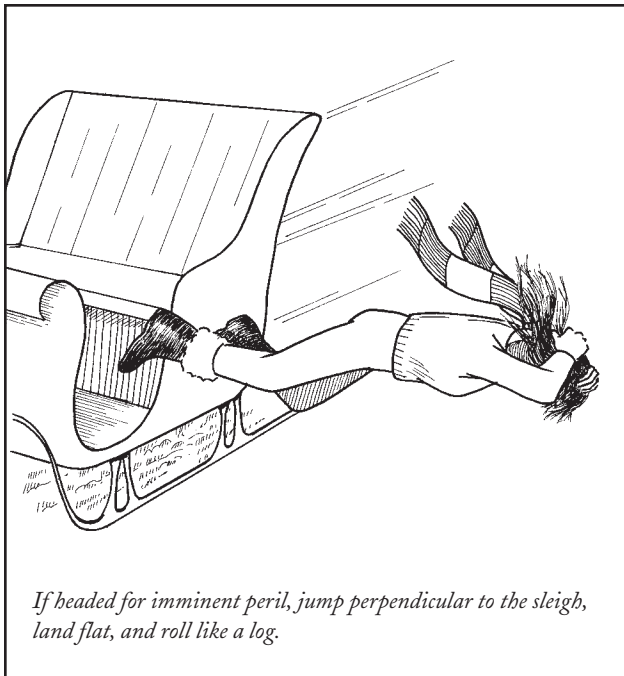

**WORST-CASE
SCENARIO.**

WORST-CASE SCENARIO.

HOW TO SURVIVE A FALL FROM A LADDER

- 1 Anticipate the fall.**
As soon as you feel the ladder or stepstool move or you begin to lose your balance, be ready to shift your position. You will have less than a second to react.
- 2 Do not grab at any fixtures or decorations.**
Lighting fixtures, decorations, hooks, and wires will not support your body weight—just prepare for impact.
- 3 Position your body.**
As you begin to fall, twist your body so your back is to the ground.

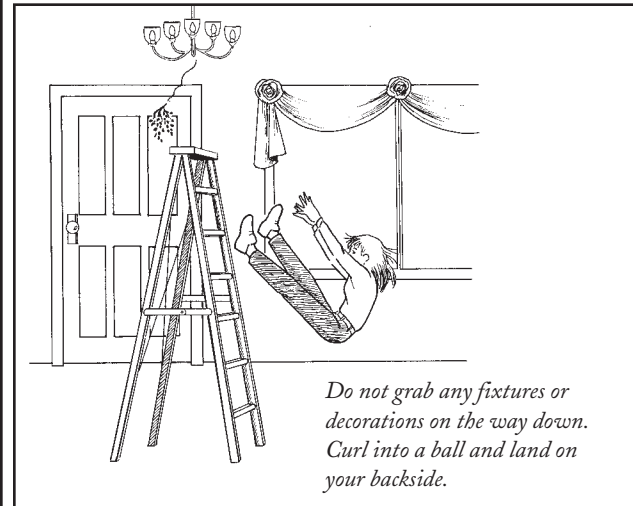

Do not grab any fixtures or decorations on the way down. Curl into a ball and land on your backside.

4 Curl into a ball.

Tucking in your arms and legs and curling into a ball will minimize the chance of breaking any limbs. The longer the fall, the more time you will have to prepare.

5 Attempt to land on your rear.

The safest part of the body to land on is the backside. This landing will minimize major damage, including broken heels and spinal cord injuries.

Be Aware

- A backside landing can cause a tailbone fracture or a vertebral compression fracture, but neither of these usually results in life-long disability.
- If you are on a taller ladder, do not try to land on your feet. While leg and ankle fractures are generally short-term injuries, heel (calcaneus) fractures have an extended recovery time and can cause long-term disability.
- If you are stranded on a roof with no way to get down and no one in sight, shout down the chimney. If there is a fire in the fireplace, however, do not inhale smoke between shouts.

**WORST-CASE
SCENARIO.**

WORST-CASE SCENARIO.

HOW TO SURVIVE A RUNAWAY SLED

- 1 Quickly survey the topography.**

If you are sledding in a wide-open field with few obstacles and no danger of a precipice, stay on the sled and ride it out. The sled will eventually stop once you reach level ground.
- 2 Slow the sled using emergency steering and braking.**

Steer the sled side to side to slow it down. Drag your feet (if feet first) or hands and feet (if head first) to slow the sled or to steer.
- 3 Redirect the sled.**

Turn the sled onto a course that traverses the hill, if possible. Gradually try to turn uphill to lose speed. An abrupt turn could send you flipping out of control.
- 4 Roll off the sled.**

Perform a single, sideways roll off the sled. If you were on your stomach, you will now be on your back sliding head-first down the hill. Roll one more time so that you are on your stomach. If you were riding the sled feet-first, you will be on your stomach sliding feet-first down the hill.
- 5 Protect, then roll.**

If tumbling out of control on a hill with obstacles, protect your head and face.

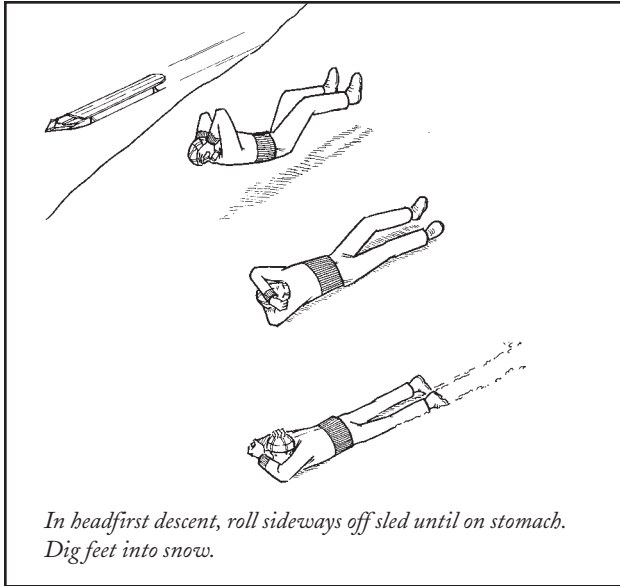

- 6** **Dig the toes of your shoes into the snow.**
Dragging (if head first) or digging (if feet first) with your toes to slow your descent only works on powdery snow. If you are on hard-packed snow, do not dig your feet while sliding or you risk flipping over.
- 7** **Use your hands.**
Dig your hands into the snow in “dog paddle” fashion. If you are sliding head first, this will cause your legs to swing around, and you will be descending more safely feet first. Avoid running into trees and do not grab stationary objects: An abrupt stop may dislocate a shoulder.

- 8** **Once stopped, push up from the side of the hill.**
Get up by moving your weight to your hands and feet. (Synthetic clothing slides on snow and tends to make the body function as a sled.)
- 9** **Climb or descend the hill slowly or wait for help.**
Do not remain in the middle of a hill being used by sledders unless you are unable to move. Retrieve your sled only if you can proceed safely.

Be Aware

If multiple riders have to abandon the sled, dive off the sled on opposite sides, at staggered intervals, so that you do not injure each other when you roll.

**WORST-CASE
SCENARIO.**

HOW TO SURVIVE CHRISTMAS TREE LIGHT DISASTERS

HOW TO UNTANGLE CHRISTMAS TREE LIGHTS

1 **Remain calm.**

Untangling tree lights can be a frustrating and prolonged process. Wear loose-fitting, comfortable clothing; turn on cheerful music; and sit in a comfortable chair. Trying to work quickly will only make you more frustrated and result in further tangles.

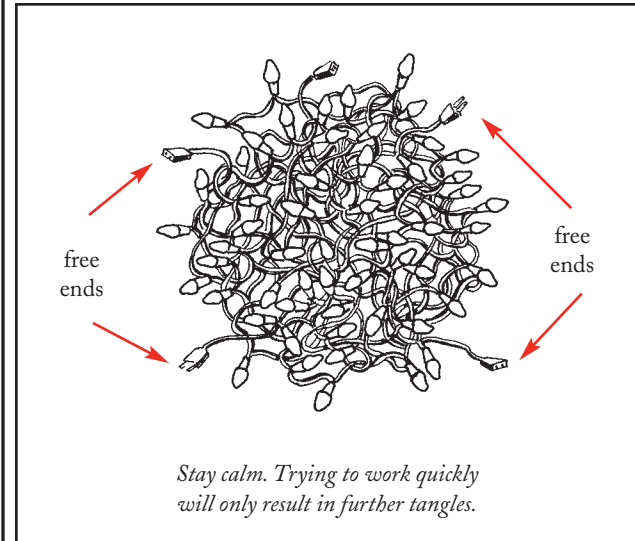

- 2 Unplug all connected strands.**
Light strands plugged into one another can create a very complex, knotted loop. Unplug all strands so that your tangle contains several separate sections.
- 3 Find a free end.**
Do not attempt to untangle the lights from the center of the knotted mass. If there is more than one free end, pick one.
- 4 Loosen all the knots.**
Splay your fingers open within the tangles of the knots to loosen them. When the knots are all loose, open a hole through the tangle to separate the free end from the mass.
- 5 Wind the free end methodically back through each knot.**
Do not yank on the free end; gently work it through the untangled knots. Always treat the strands gently to avoid breaking the bulbs.
- 6 Untie each successive knot carefully.**
Keep the free end rolled to make it easier to work with and to reduce the length of cord you need to pass through the knots.
- 7 Keep the free end under control.**
Never pull on the free end. Pulling will tighten the tangle and make the knots harder to untie. As you work, the knot-free section should continue to get longer. Even if the tangle seems to be getting more severe, if the knot-free section is lengthening, you will ultimately succeed.

- 8 Repeat as necessary.**
Once one strand of lights has been removed from the tangle, repeat the process with another free end until each strand is removed and the tangle eliminated. Keep yourself hydrated.

Be Aware

- The best way to prevent light strands from tangling is to coil them around a stiff piece of cardboard before putting them away.
- Severely knotted strands may take hours to untangle. If you do not wish to spend time in this manner, consider buying new lights. The cost of tree lights has dropped considerably in recent years.

HOW TO RESPOND TO PROLONGED TREE-LIGHT SHOCK

Faulty lights or extension cords may pose a risk of electrocution.

- 1 Do not touch a victim still connected to the power source.**
Shut off power at the breaker/fuse box as quickly as possible. You must eliminate the power source before handling the light string or touching the victim. Once the power is off, it is safe to touch the victim.

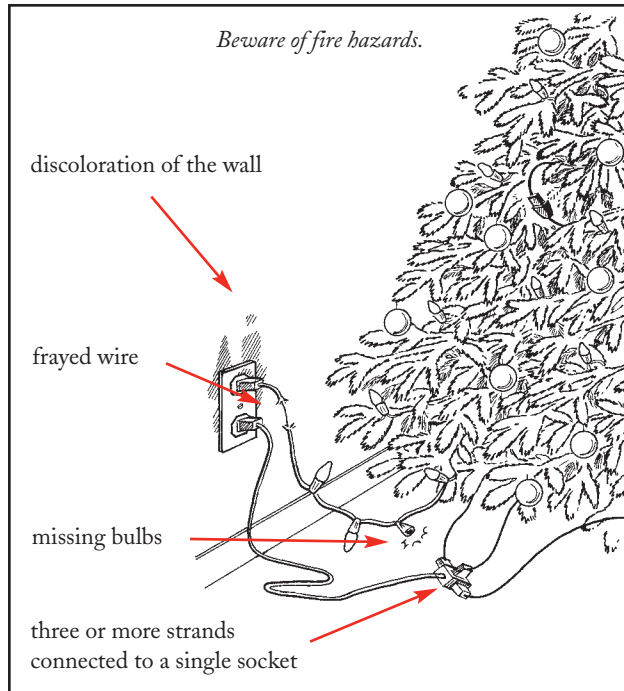

2 **If the fuse/breaker box cannot be found, kick out the cord.**

Use a rubber-soled shoe to kick the cord out of the wall outlet. Do not use a broom or another object to try to separate the victim from the power source; these items may have some conductivity.

3 **Instruct someone to call for emergency medical technicians.**

Administer CPR.

Be Aware

- Never connect more than three strands to a single socket. Count an extension cord as one strand.
- Check the condition of all light strands. Look for frayed wire, cuts, and cracking of the cords. Discard any lights in poor condition, or any strands with rusting sockets.
- Use light strands that have been approved by a certified testing lab.
- To reduce shock risk, always keep bulbs in all light sockets. Newer strands will light even with burned out or defective bulbs: Either replace the bad bulb before using the lights or leave the burnt bulb in place. Make sure connections between strands are tight.
- Check the outlet and wall area around it for discoloration, which may be a sign that the outlet is faulty.
- Light strands may be slightly warm to the touch; this is not unusual. However, if they are hot, unplug and replace them, or use another outlet.
- Never coil light strands when they are connected to power; this will generate heat and may cause a fire. Unplug lights during the day to reduce heat buildup.
- If using outdoor lights, wrap connections between strands with electrical tape, and make sure connections at the power source are protected from moisture.
- Plugging light strands into a surge protector does not offer protection from electric shock. These devices are designed to protect property from current spikes or surges, not to protect people from the current leakages that cause electric shock.

WORST-CASE SCENARIO.

HOW TO SURVIVE IF YOU HAVE NO ONE TO KISS ON NEW YEAR'S EVE

IF YOU ARE WITH OTHERS

- 1 Keep a glass in your hand.**
If others think you are being festive and uninhibited, you are much more likely to receive a kiss. Even if you are not drinking, always hold a partly full glass of champagne.
- 2 Hug people.**
As the clock strikes midnight, begin hugging everyone around you.
- 3 Select a desirable person.**
As you are hugging, look for an attractive person who you would enjoy kissing and who might kiss you. If a person is not randomly kissing others, he or she may be less likely to kiss you.
- 4 Begin your approach.**
Act casual, but keep your destination in view. Slowly move toward your chosen one, hugging everyone on the way.

5 Time your arrival.

Do not appear to be “lining up” to kiss this person. Time your arrival precisely as the person releases the previous reveler.

6 Yell first, then hug.

Yell “Happy New Year!” as you move in. Hug, embrace, then pull away slightly.

7 Kiss.

Keep your mouth closed, pucker slightly, and plant the kiss.

IF YOU ARE ALONE

★ Kiss a pet.

Dogs are generally agreeable and have relatively clean mouths. Cats are usually well groomed but are more passive and tend to get rather than give. Keep your mouth closed.

★ Kiss yourself.

Find a mirror, pucker up, lean close, and kiss. Keep the lips slightly parted. Do not attempt to use your tongue. Wipe the mirror clean after you have completed your kiss. You may also try kissing the back of your hand.

★ Kiss a celebrity.

Watch a favorite movie or show on television and kiss the screen when an appealing star has a close-up.



*If no humans are available to kiss at midnight, try kissing a pet.
Keep your mouth closed.*

Wipe the screen first to remove dust and static electricity, and wipe the screen after to remove any evidence.

★ Hug a pillow.

Full-body pillows are more satisfying.

★ Call a friend on the phone.

After you wish your friend a happy New Year, give the telephone mouthpiece loud, smacking kisses. (This works less well with cellular phones.)

WORST-CASE SCENARIO.

HOW TO THWART GIFT SNOOPERS

- ★ **Wrap gifts immediately.**
Snoopers will begin searching long before the holidays. Wrap gifts as soon as you bring them home to avoid early detection.
- ★ **Add items to the package.**
Include marbles, bells, silverware, small weights, or paper clips in the box before wrapping. These will throw off shakers.
- ★ **Switch the name tags.**
Put the wrong name tags on gifts to confuse and frustrate snoopers.

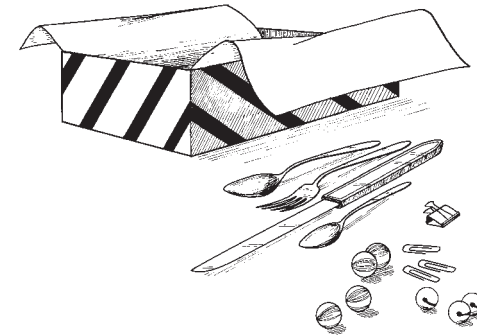

Adding objects such as bells, marbles, or silverware before wrapping will confuse snoopers.

★ **Move gifts frequently.**

Snoopers will check a hiding spot and then move on. Changing the location of gifts will lessen the chance they will be found.

★ **Use a box significantly larger than the gift.**

Good snoopers will be attuned to the sizes of specific gifts. Use larger-than-necessary boxes to throw them off the trail, and stiff cardboard to thwart squeezers.

★ **Use multiple boxes.**

Put the gift in a series of wrapped boxes, one inside the other, to frustrate the snooper and deter even the most persistent opener. Use glue instead of tape to secure wrapping paper, since glue is more likely to cause the paper to rip, deterring a rewrapper from proceeding further.

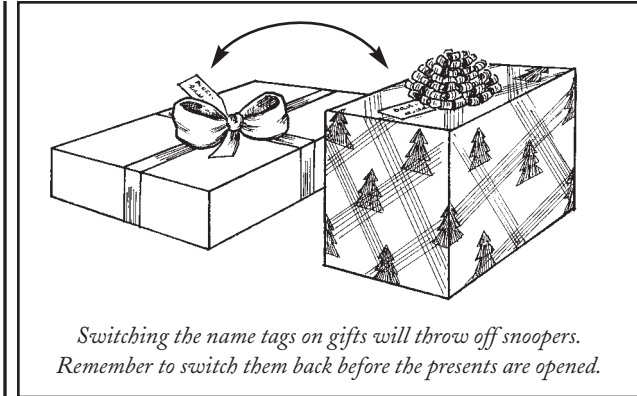
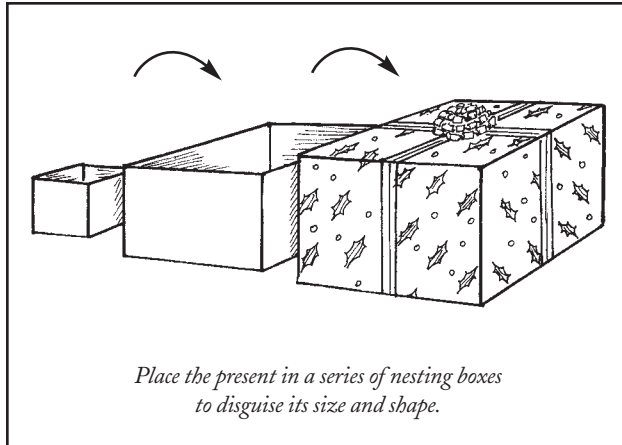

★ **Wrap a fake present.**

Box, wrap, and tag an old shoe, broken video cassette, or used tennis balls. A snooper who discovers and opens this “gift” will be flummoxed and suitably punished; he may be outraged at the pathetic present, but will be unable to say anything without giving himself away.

Be Aware

Keep track of your protective and evasive measures. If you’ve scrambled name tags, you will need to know who is really to receive each present. If you’ve added items to the box or used boxes within boxes, you will need to explain their presence to their recipients. If you added silverware, you may want to remove it before delivering the gift, lest you never see your silver again. If you’ve moved the presents too many times, you may forget where you placed them. Try to avoid having to rewrap all the presents at the last minute to undo your thwarting devices.

HOW TO TREAT A TONGUE STUCK TO A POLE

- 1 Do not panic.**
- 2 Do not pull the tongue from the pole.**
Pulling sharply will be very painful.
- 3 Move closer to the pole.**
Get as close as possible without letting more of the tongue's surface area touch the pole.



*If your tongue is stuck to a pole, do not panic or pull it.
Warm the pole with your hands until your tongue comes loose.*

- 4 Warm the pole with your hands.**
A tongue will stick when the surface of the pole is very cold. The top few layers of the tongue will freeze when the tongue touches the pole, causing bonding. Place your gloved hands on the area of the pole closest to the tongue. Hold them there for several minutes.
- 5 Take a test pull.**
As the pole warms, the frozen area around the tongue should begin to thaw. Gently pull the tongue away from the pole. You may leave a layer or two of skin on the pole, which will be painful, but the tongue will quickly heal.

Alternative Method

- ★ **Use warm water.**
Pour water from a water bottle over the tongue and the pole. Do not use water that is cold, or it may freeze and exacerbate the problem.

Be Aware

- Do not try to loosen your tongue with your own saliva: Although saliva is relatively warm, the small amount you will be able to generate is likely to freeze on your tongue.
- If another person is present, have him or her pour warm (not hot) water over your tongue. This may be difficult to articulate while your tongue is stuck—pantomiming a glass of water poured over your tongue should do the trick.

HOW TO TREAT A WRAPPING-PAPER CUT

1 **Keep the victim calm and immobile.**

A paper cut can cause intense pain at the injury site, but such cuts are usually superficial lacerations and rarely dangerous, except in the case of infection.

2 **Instruct the victim to lie down if he/she feels faint.**

After the initial rush of pain, the brain will become habituated to the discomfort and the pain will subside.

3 **If the injury is to the finger, keep the finger straight.**

Especially if the laceration crosses a knuckle, keep the finger straight to prevent pulling of the skin, which will increase pain. Hold the victim's other hand, if necessary.

4 **Inspect the wound.**

In the unlikely event that foreign material is lodged in the wound, remove the debris using sterilized tweezers.

5 **Clean the wound.**

Use warm water and soap to thoroughly wash out the wound.

6 **Disinfect the injured area.**

Treat the wound with isopropyl alcohol or hydrogen peroxide. This treatment may momentarily irritate the cut and cause slight pain.

7 **Apply pressure.**

Residual bleeding may occur if the cut is deep. Put pressure on the injury site, using a sterile bandage or clean cloth.

8 **Treat with an antibiotic ointment.**

Apply a topical antibiotic to impede bacterial growth.

9 **Dress the wound.**

Use a sterile bandage or adhesive strip. Until the wound heals, avoid contact with lemon juice and salt at the site of the wound: Both will cause intense pain.

10 **Take pain medication, if necessary.**

An especially deep paper cut may cause prolonged pain, which can be treated with an over-the-counter pain reliever such as aspirin, acetaminophen, or ibuprofen. Aspirin can thin the blood and may cause the wound to ooze for a longer period of time, however.

Be Aware

- In rare cases, a serious paper cut may be very deep and create a large flap of torn skin. Such an injury may require a butterfly bandage or stitches. If the wound does not stop bleeding even after applying continual pressure, or if an infection develops, seek medical attention.
- Open presents slowly.

HOW TO TREAT FOOD POISONING

1 Stay hydrated.

The symptoms of food poisoning vary depending on the type of microorganism or toxin ingested, but can generally cause severe stomach cramping, fever, vomiting, and diarrhea, leading to dehydration. Drink several gallons of water per day.

2 Replenish mineral salts.

Eat bland foods, in moderation, as soon as you are able. Diarrhea depletes the body of salts, and drinking water alone will not replace them; sports rehydration drinks are effective. Nibble on dry salted crackers or plain rice to replenish salts, too.

3 Do not induce vomiting.

Depending on the microorganism or toxin involved, food poisoning may cause vomiting, which does not clear the bacteria from the body, but will cause further dehydration.

4 Do not take anti-peristaltic medication.

Some anti-diarrhea medications work by slowing the movement of waste in the gut, causing the toxins to remain in the body for a longer period of time.

5 Avoid alcohol, spicy foods, and milk products.

These drinks and foods may aggravate the gut and cause additional gas and cramping. Never follow a suspect meal with a drink of alcohol to “kill” the germs; this is not effective.

6 Be prepared for several days of discomfort.

Food poisoning may induce a severe headache and sweating. Keep the body cool: Never try to sweat out the germs. The symptoms of food poisoning are usually short-lived. If the symptoms persist for more than a week, or if you detect bleeding, consult a health care professional.

HOLIDAY FOOD ALERT

★ Oysters should be fully cooked.

Raw oysters are particularly susceptible to invasions by microorganisms that can cause food poisoning: If the raw oyster tastes “off” in any way, do not swallow it.

★ Fully cook all meat.

Poultry should be fully cooked, with no traces of pink or red, to an internal temperature of 165° F. Beef and game should be cooked to at least 140° F.

★ Serve cooked foods immediately.

Cooked foods that are not served immediately must be kept at a holding temperature between 140° and 165° F. Do not leave food unrefrigerated longer than two hours or the chances of bacterial growth increase.

Foods That Pose a Special Risk of Food Poisoning



oysters

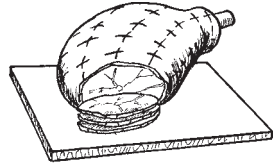

ham



turkey



shrimp cocktail



egg nog



damaged canned foods



Egg yolks should not be eaten raw or runny.

This will reduce the risk of salmonella poisoning. Egg nog usually contains raw egg yolks, so make sure the egg nog you drink has been pasteurized. Homemade mayonnaise is made with raw eggs, so avoid it.



Cooked shellfish should be kept on ice.

Fish and seafood, especially shellfish, are often harbor to many different kinds of microorganisms.



Avoid any dented cans.

If the seal on the can has been affected, the contents may be contaminated and you risk getting botulism.

Be Aware

- Food poisoning is caused by a range of microorganisms or their byproducts. Each bug has its own properties and set of symptoms: Some must be alive and present in large quantities to cause harm, while others, such as *E. coli* 0157, can inflict a lethal dose from just a few bacteria.
- Separate raw and cooked foods. Even foods that have been properly cooked can be contaminated if they come in contact with raw foods or implements (knives and cutting boards, for example) that have touched them.
- Drink bottled water when traveling to visit relatives if you are unsure of the safety of the tap water. Avoid ice cubes, as these are usually made with tap water. Check seals on bottles to make sure they are intact: If they are broken, the bottles may have been refilled with tap water.

WORST-CASE SCENARIO.

HOW TO TREAT MISTLETOE POISONING

Discovery of partially chewed mistletoe, or the symptoms of mistletoe poisoning, calls for different responses for pets and humans.

1 Determine if real berries have been ingested.

Ingesting large numbers of real berries can cause a rapid increase in blood pressure that can lead to cardiac arrest. For this reason, many mistletoe distributors often replace the natural berries with plastic ones, which are light-colored and waxy looking. Check the mistletoe to see if the remaining berries are real; if they are, go to step 3.

2 Look for missing or chewed leaves.

Mistletoe leaves contain less of the toxins (tyramine and beta-phenethylamine) found in berries, but present another danger: Leaves have a protein toxin (phoratoxin) that causes severe gastrointestinal pain, cramping, and diarrhea. Unlike berries, leaves on packaged mistletoe are generally not plastic. The most common mistletoe leaves in the United States (*Phoradendron tomentosum*) are $\frac{1}{2}$ to 2 inches long, smooth-edged, leathery, and green. These oblong leaves sprout in pairs from opposite sides of the stem. European mistletoe (*Viscum album*) has larger and thinner leaves that are less green.

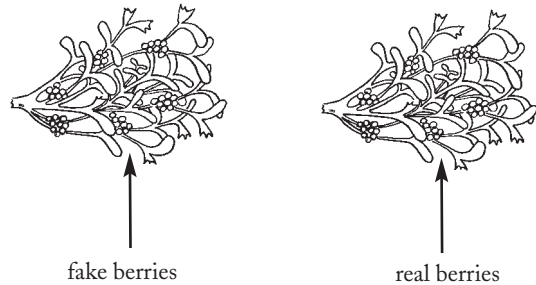

Real mistletoe berries—which are poisonous—are sometimes darker and less waxy looking than plastic berries.

3 Watch for the symptoms of mistletoe poisoning.

Recognizing mistletoe poisoning is complicated because the poisons in the plant can cause opposite (yet all potentially lethal) symptoms: While berry toxins may elevate blood pressure, protein toxins in the leaves can lower blood pressure and heart rate. Look for severe intestinal distress in the form of vomiting, gagging, and diarrhea. Ingesting amounts under three berries or two leaves is unlikely to produce significant clinical effects in pets or humans and probably will not require treatment.

4 Call a veterinarian or poison control center.

Follow the specialist's instructions for dealing with poisoning.

IN PETS

★ Induce vomiting.

Vomiting should be induced unless two or more hours have passed since mistletoe ingestion.

- Use 1 teaspoon of syrup of ipecac per 10 pounds of animal.
- If ipecac is unavailable, induce vomiting with 3-percent hydrogen peroxide. Administer 1 to 3 teaspoons every 10 minutes a total of three times.
- If neither ipecac nor hydrogen peroxide is available, use $\frac{1}{2}$ to 1 teaspoon of salt, placed directly on the back of the animal's tongue.

★ Coat the stomach.

If the pet ingested the mistletoe more than two hours ago, attempt to slow the plant's absorption by the body. Do not induce vomiting.

- Mix one tablet of activated charcoal per 2 teaspoons of water. Administer 1 teaspoon of the solution per 2 pounds of animal, followed by several cups of water. Do not use ipecac.
- After half an hour, administer 1 teaspoon of milk of magnesia per five pounds of animal. If unavailable, administer vegetable oil, egg whites, or milk to coat the gastrointestinal tract.

★ If the symptoms do not subside within four hours, take your pet to the veterinarian.

IN PEOPLE

1 Determine if the berries are real or not and ascertain what part of the plant has been consumed (see pages 73 and 74).

2 Call a poison control center immediately.
In the U.S., call 800-222-1222. Be prepared to tell the operator approximately how many leaves and (real) berries were ingested. The operator will instruct you on what to do. Do not administer pet rescue techniques to people.

Be Aware

- When administering help to your pet, be gentle—your pet is likely to be in distress. Be on guard for biting or wild behavior. Do not put your finger down your pet's throat to induce vomiting.
- When hanging mistletoe, consider placing it inside a piece of stocking (pantyhose) or a sealed sandwich bag to prevent any berries and leaves from falling to the floor, where they present a danger to pets and children.
- Poinsettias contain a latex sap that can irritate sensitive skin, and if ingested they may cause a burning sensation and intestinal disturbances, but they are not nearly as toxic as mistletoe.

**WORST-CASE
SCENARIO.**

HOW TO WIN A SNOWBALL FIGHT

1 Test the snow.

Stick a twig, chopstick, or a thin utensil in the snow and pull it out quickly to determine the packing consistency. It should go in and come out smoothly, not hitting icy or solid patches. Snowball snow should not be frozen, nor should it be too dry (“powder”) or too wet (“granular” or “corn”). The snow needs just enough moisture to hold together as you shape it.

2 Doctor the snow.

The best air temperature for snowball making is above 5° F and below 32° F. If the air temperature is below 5° F, warm the snow in your hands before attempting to make a snowball.

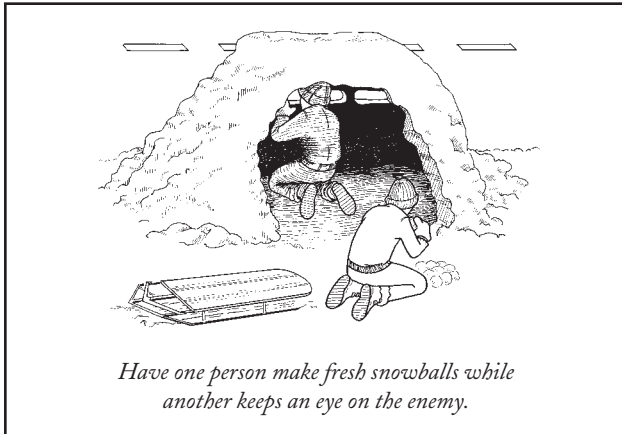

3 Establish a base camp.

Find a suitable location with good sight lines and plenty of fresh snow (see “How to Build a Snow Fort,” page 151). Consider keeping a wall at your back to thwart flanking maneuvers.

4 Begin preparations.

Make as many snowballs as you can in advance of the battle. A good snowball should be larger than a golf ball but smaller than a cantaloupe, and should hold its shape when others are stacked on top of it.

5 Build a snowball sled.

Secure a wooden produce crate or waxed cardboard box to a sled’s rope. Fill the box with snowballs. Use the snowball sled to transport ammunition or a fresh supply of snow.

6 Use shields.

Maintain a supply of garbage can lids with handles; use these for shields during battle.

7 Aim low and throw straight.

Snowball fight rules dictate that hitting in the face is forbidden. Aim for the chest or lower body. Ice balls or snowballs containing foreign material are also considered unfair.

8 Secure prisoners.

Snowball fight rules provide for the taking of prisoners: An enemy hit three times is considered captured.

Captives may not be forced to fight their comrades, but may be pressed into service as snowball makers.

HOW TO MAKE SNOWBALLS

- 1 Scoop up two handfuls of snow.**
- 2 Press your hands together around the snow to create a sphere.**
- 3 Squeeze and rotate the sphere.**
Add snow or take some away, squeeze, and rotate, until the ball is perfectly round. A smooth, perfectly rounded ball is more aerodynamic and will throw better. Make sure it is easy to pick up and throw.

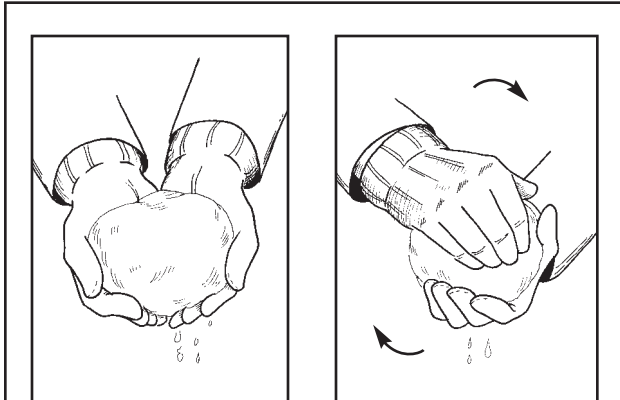

Scoop up two handfuls of snow, then squeeze and rotate until the ball is perfectly round.

4 Make more snowballs.

Good snowballs made from the right consistency snow will stack easily and not stick together. Keep a pile within arm's reach.

HOW TO BUILD A SNOW FORT

A Snow-Mound Fort

- 1 Find a pile of freshly plowed snow.**
Snow plows create huge mounds of snow, saving you the trouble of creating one. Look in parking lots or on street corners for such piles. The pile should be at least four feet tall and several feet wide at the base. You will build your fort into this mound. Do not pick a mound on an active street that is likely to be replowed.
- 2 Compress the snow.**
If you can find a big piece of plywood—about the size of a door—place it on top of the mound and use it to compress the snow until the mound is about four feet high. If you cannot locate plywood, lie down on the mound. Use good packing snow (see “How to Win a Snowball Fight,” step 1, page 148).
- 3 Dig into the back of the mound.**
Create a small entrance hole, strategically placed so the enemy cannot see or attack it easily.

4 **Hollow out the mound.**

Dig out the center of the mound, pushing the snow out of the entrance hole. Use this snow for making snowballs.

5 **Make peepholes.**

Punch through the wall opposite the entrance with your fist or the handle of a shovel every several feet to create observation holes. These will enable you to detect a surprise attack.

6 **Defend your fort.**

A fort that is overrun can be used by your enemies.

A Block Fort

1 **Find a wooden produce crate or waxed cardboard box.**

The box should be no larger than 1½ by 2 feet. Remove the flaps, if any, from the top. Utilize several boxes and people to expedite the process.

2 **Pack the box with snow.**

Pack tightly, with as little air as possible.

3 **Remove the snow block.**

Turn the box over. Gently pull the sides of the box and tap the sides of the box until the block slides out.

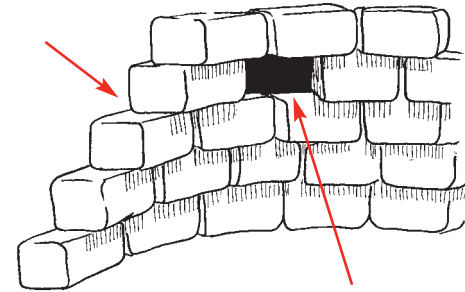

*Stagger snow blocks for increased stability.
Leave gaps for windows at eye level.*

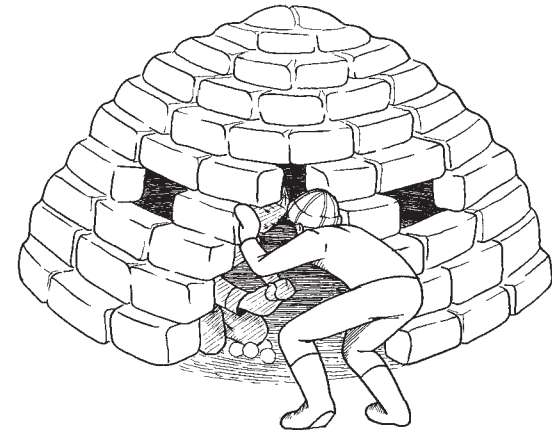

Keep a stash of snowballs inside the fort.

4 Amass snow blocks.

Repeat steps 2 and 3 until you have several dozen snow blocks.

5 Build an igloo-shaped structure.

Place the bottom level of blocks in a circle 6 to 8 feet in diameter. Leave an open spot for the door. Stack the next layer on top, offsetting the ends in the traditional bricklaying pattern, and moving each block in a few inches toward the center. On either side of the door opening, move the blocks toward each other by a few inches, to make a roughly triangular opening. Repeat until the blocks meet at the top and there is enough room for you to crawl in. (You may need to trim blocks before placing them at the very top of the fort.) Omit a few blocks at eye level for windows.

6 Fill in the cracks.

Use snow to fill in the spaces between the blocks.

7 Reinforce.

Sprinkle the fort with water from a watering can and let the fort set overnight. In the morning it will be a hardened bastion.

Be Aware

- You may not always have time to get inside your fort when attacked. A good snow fort should be high enough to protect you from incoming snowballs if you hide behind it, but it should also be low enough for you to see around and throw over.

- Keep a stash of snowballs inside the fort.
- In case of a long, sustained siege, keep drinks, food, and blankets in the fort. Set them in a corner, out of the way of the action.
- Divide your manpower so there are scouts and hurlers outside, and snowball makers inside.

WORST-CASE SCENARIO®

HOW TO WRAP A PRESENT WITHOUT WRAPPING PAPER

- ★ **Use newspaper.**
Newspapers (especially the colorful Sunday comics section) are a readily available substitute for wrapping paper. Avoid news sections that may have depressing headlines.
- ★ **Use tissue paper.**
Many stores provide tissue paper for packing the gift inside the box. Use that tissue to wrap the box.
- ★ **Use brown paper bags.**
Cut apart brown paper grocery bags; use them inside out if they are printed.
- ★ **Use shopping bags.**
Cut off the handles and bottoms and use the glossy shopping bags from the store. Some stores also put festive designs on their bags during the holiday season, giving your wrapping job a colorful touch.
- ★ **Use aluminum foil.**
Bright and shiny, foil is an excellent choice for giftwrap. Consider making small foil sculptures and putting them on top of the gift for added flair. Take care not to rip the foil, which tears easily. Alternatively, use waxed paper.

★ **Use shelf paper.**
If you do not have a roll of shelf paper, remove the paper that lines your drawers. Carefully peel it off (it should come up easily), wipe with a damp cloth, and cut to fit the present.

★ **Use colored plastic wrap.**
Plastic wrap intended for food storage comes in several colors, including red and green. Use it to wrap gifts, then shrink to fit using a hair dryer.

★ **Use fabric.**
Any fabric or cloth can be used as giftwrap. Gather the fabric around and tie with yarn for a homey touch. It is not necessary to hem the fabric. If using clothing or socks, be sure they are clean.

★ **Use sticky notes.**
Multicolored sticky notes can make an attractive pattern or layered effect.

★ **Use tissues.**
Facial tissues, if applied carefully, can be a colorful, soft giftwrap. Use toilet paper only as a last resort.

HOW TO WRAP A PRESENT WITHOUT TAPE

★ **Use ribbon, string, or yarn.**
Fold the paper as tightly as possible, then wrap ribbon or other string around the box to hold everything together.

★ **Use envelopes.**
Cut the sticky strips from the flaps of envelopes, moisten, and use as you would tape.

★ **Use stamps.**
Use one-cent stamps, if available.

★ **Make paste.**
Mix half a cup of water and 1 cup flour. Stir while heating the mixture over a low flame. Allow the batter to cool and use as you would glue.

★ **Use gum.**
Regular chewing gum works best; bubble gum is not as adhesive. Chew each piece for two minutes. Apply sparingly.

THE “THERE IS NO SANTA CLAUS” SPEECH

Son/Daughter,

Please sit down over here by me. There’s something I’ve been meaning to tell you for a long time, and I think you’re old enough now.

I know you believe with all your heart that there is a person called Santa Claus who brings you presents every year if you are good. But the truth is that there is no Santa Claus. “Santa Claus” is really all the parents in the world, who love their children very much and buy them presents to show how much they love them.

Your presents are not made by elves in a toy shop at the North Pole. There is no such thing as an elf; and the North Pole is actually one of the loneliest and most desolate places on Earth. The truth is that mom and dad buy all your presents at the mall, and we’re the ones who eat Santa’s cookies and drink Santa’s milk. Reindeer can’t fly, either.

But don’t cry. This doesn’t mean that the spirit of Santa Claus isn’t real. “Santa Claus” is inside all of us, whenever we give presents to those that we love or those who are less fortunate. When you grow up, you can be Santa, too. Or the Easter Bunny. Or the Tooth Fairy.

NEW YEAR’S RESOLUTION-O-MATIC

Choose one option from each of the concentric circles, beginning at the center, to create your New Year’s resolutions.

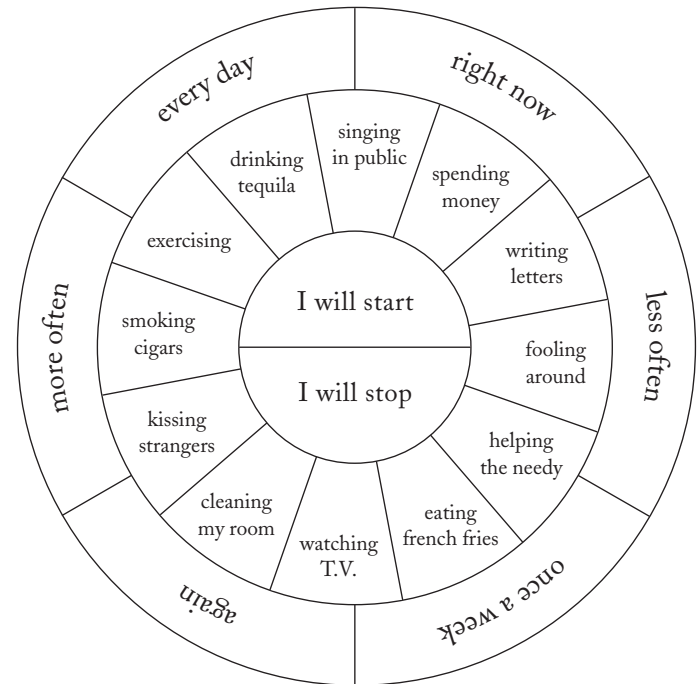

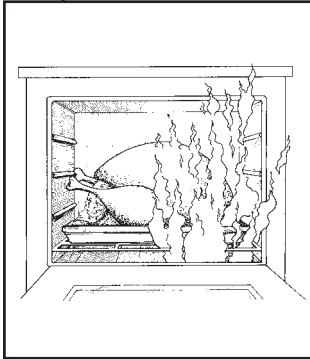

How to Extinguish a Burning Turkey

Source: *Recipe for Safer Cooking*, a publication of the Consumer Products Safety Commission.

How to Serve Burnt Turkey; How to Prevent a Turkey from Exploding; How to Keep a Turkey Moist During Cooking

Sources: David Burke is corporate chef for the Smith and Wollensky Restaurant Group, head chef at Park Avenue Café in New York City, and author of *Cooking with David Burke*. • Sherrie Rosenblatt is the director of public relations for the National Turkey Federation (www.eatturkey.com).

How to Remove a Gravy Stain

Sources: *Field Guide to Stains* by Virginia Friedman, Melissa Wagner, and Nancy Armstrong. • D. A. Burns & Sons is a Washington State-based carpet cleaning and textile craftsmanship company.

How to Put Out a Grease Fire

Sources: Meri-K Appy is vice president for public education at the nonprofit National Fire Protection Association (www.nfpa.org), which facilitates the development of national consensus safety codes and develops and implements public safety education and research

initiatives. She oversees all of the NFPA's public education and community outreach programs. • Chris Miles is a lieutenant in the Philadelphia Fire Department.

How to Treat a Grease Burn

Source: Ken Zafren, M.D., is the medical director of Emergency Medical Services for the State of Alaska and a fellow of the American College of Emergency Physicians. He specializes in remote region and high-altitude trauma.

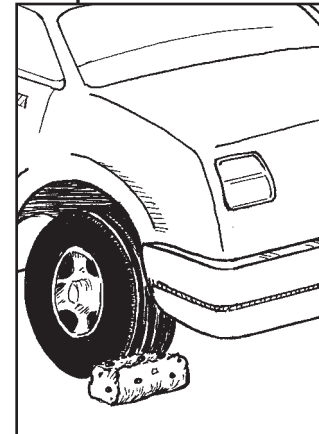

How to Repurpose a Fruitcake

Sources: Sarah Phillips is the author of *The Healthy Oven Baking Book* and the founder and president of Baking911.com. She is the creator of the Healthy Oven line of baking mixes and worked in food manufacturing for 10 years. • June Jacobs, a certified culinary professional, teaches cooking and wine classes. She leads food-and-wine focused tours of France through her

company, Festivals (www.festivals.com), and is the author of *Festivals Cooks at Home* and a director of the New York Association of Cooking Teachers. • Brother Barnabas Brownsey of the Cistercian Order of the Stritch Observance lives in Holy Cross Abbey and works in its Monastery Bakery in Berryville, Virginia (www.monasteryfruitcake.org).

How to Open a Bottle of Wine with a Broken Cork

Source: Daniel Dawson is the owner of Backroom Wines (www.backroomwines.com), a fine wine and wine tasting shop in Napa, California. He is a former sommelier at the French Laundry restaurant and a former wine merchant.

How to Avoid Shooting a Champagne Cork

Source: Daniel Dawson.

CHAPTER 2: FRIENDS AND FAMILY

How to Deal with a Meddling Parent

Source: Robin Thompson is the founder of the Etiquette Network (www.etiquette-network.com) and lectures on etiquette and image for all ages at schools, universities, and businesses. She is the author of *Be the Best You Can Be: A Guide to Etiquette and Self-Improvement for Children and Teens*.

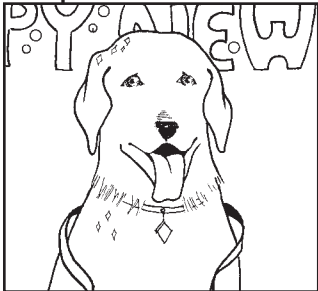

How to Survive If You Have No One to Kiss on New Year's Eve

Source: Sherry Amatenstein (www.luvlessons.com) is the author of *The Q and A Dating Book: Answers to the Thorniest, Sexiest, Most Intimate and Revealing Questions About Love, Sex, and Romantic Relationships* and

Love Lessons from Bad Breakups: Discover How to Make Relationships Last—by Learning from the Ones That Didn't, and is the dating columnist for ivillage.com.

How to Fend Off an Unwanted Kiss

Source: Sherry Amatenstein.

How to Overcome Holiday Depression

Source: Gerald H. Smith, D.D.S., is the author of the best-selling *Headaches Aren't Forever* and *Alternative Treatments for Conquering Chronic Pain*, and he maintains a clinical practice specializing in craniomandibular somatic disorders and pain therapy in Bucks County, Pennsylvania. He runs the International Center for Nutritional Research (www.icnr.com).

CHAPTER 3: HOLIDAY EMERGENCIES

How to Treat Food Poisoning

Source: Dave Hill is a UK-based food industry consultant who advises manufacturers and caterers on safe food production. He has written numerous guides to good hygiene practice and is a fellow of the Institute of Food Science and Technology (www.ifst.org).

How to Extinguish a Christmas Tree Fire

Sources: Meri-K Appy • Chris Miles.

How to Survive a Fall from a Ladder

Source: Ken Zafren.

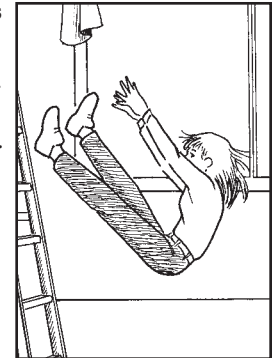

How to Survive Christmas Tree Light Disasters

Sources: Colin C. Adams, Ph.D., is the Francis C. Oakley Third Century Professor of Mathematics at Williams College. He is the author of *The Knot Book: An Elementary Introduction to the Mathematical Theory of Knots* and is the coauthor of *How to Ace Calculus: The Streetwise Guide*. • Michael Clendenin is executive director of Electrical Safety Foundation International (www.electrical-safety.org), a nonprofit dedicated to public awareness and education on electrical safety.

How to Resize a Christmas Tree

Source: Bill Asack owns and runs Asack and Son Tree Farm in Barton, Vermont (www.billasack.com).

How to Prevent a Tree from Toppling Over

Source: Bill Asack.

How to Treat Mistletoe Poisoning

Sources: Dan Brown, Ph.D., is an associate professor of Nutritional Toxicology at Cornell University and a staff scientist at the International Livestock Research Institute. • John P. Lamb, Pharm.D., CSPI, FCSHP, a toxicology management specialist and health educator for the Sacramento Division of the California Poison Control System (www.calpoison.org), is an assistant clinical professor of pharmacy at UCSF and an associate clinical professor of medicine at UCD. • Eric Lombardini, V.M.D., is a captain in the U.S. Army Veterinary Corps and the commander of a veterinary medical detachment responsible for care of military working dogs and other government-owned animals.

How to Make an Emergency Menorah

Source: Marsha Silver Heit is a Hebrew school teacher in Philadelphia.

How to Make Menorah Candles from Crayons

Sources: Michelle Espino is the author of *Candlemaking for Fun and Profit* and is the owner of Waxed Out Candles (www.waxedout.com), an artisan studio in Tallahassee, Florida. • Amy Segelin owns Luminous Creations (www.luminouscreations.com), a maker and distributor of beeswax candles in Los Angeles.

How to Fit into Clothing That Is Too Tight

Source: Sherry Maysonave, author of *Casual Power: How to Power Up Your Nonverbal Communication and Dress Down for Success*, is the president and founder of Empowerment Enterprises (www.casualpower.com), a consulting firm specializing in communication and image.

How to Silence a Group of Carolers

Source: Kevin St. Clair is the director of Dickens and Company (www.dickensandcompany.com), a professional caroling group based in Southern California, which books carolers nationwide.

CHAPTER 4: SHOPPING SURVIVAL

How to Evade a Stampede of Shoppers

Sources: G. Keith Still, Ph.D., is a mathematician and crowd dynamics expert who runs workshops on crowds and crowd safety (www.crowddynamics.com). He is the

creator of the Legion system, a crowd modeling method used to assist in planning the Sydney Olympics. • Stevanne “Dr. Toy” Auerbach, Ph.D., is a child development specialist and the author of *Smart Play: How to Raise a Child with a High P.Q.* Her website, www.drtoy.com, provides year-round guidance on toys and play.

How to Deal with a Bad Gift

Source: Peter Post, great-grandson of Emily Post, is an expert in business and personal etiquette. He is author of *Etiquette Advantage in Business* and director of the Emily Post Institute (www.emilypost.com) in Burlington, Vermont.

How to Thwart Gift Snoopers

Sources: Sherri and Larry Athay are the authors of *Present Perfect: Unforgettable Gifts for Every Occasion* and the founders of Present Perfect Gift Consultants and GiftElan.com.

How to Determine the Contents of a Wrapped Gift

Sources: Sherri and Larry Athay.

How to Rewrap a Gift

Source: Juanita Lewis (www.itsawrapgifts.com) has been a professional gift-basket designer and wrapping specialist for 18 years. She teaches classes and produces instructional videos on bowmaking, gift baskets, and gift wrapping, and has served as a judge for 3M’s annual “Most Gifted Wrapper” contest.

How to Wrap a Present Without Wrapping Paper

Source: Juanita Lewis.

How to Treat a Wrapping-Paper Cut

Source: Seth Haplea, M.D., is a member of the American Academy of Neurology and the American Association of Electrodiagnostic Medicine. He practices clinical neurophysiology in Phoenix, Arizona.

CHAPTER 5: SURVIVING THE GREAT OUTDOORS

How to Escape a Runaway Parade Balloon

Source: Henry Perahia is chief engineer for the New York City Department of Transportation and supervisor of the balloons for the Macy’s Thanksgiving Day Parade in Manhattan.

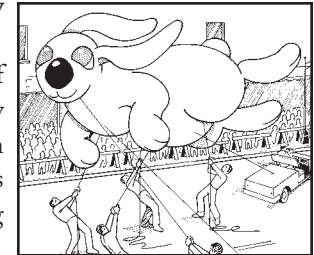

How to Deal with a Canceled Flight

Source: Rudy Maxa is the publisher of a monthly consumer travel newsletter (www.rudymaxa.com). He is also a commentator on public radio’s evening business show *Marketplace* and was the original host of public radio’s weekend show *The Savvy Traveler*.

How to Drive in a Blizzard

Source: *The SAS Survival Driver’s Handbook*, by John “Lofty” Wiseman.

How to Stop a Runaway One-Horse Open Sleigh

Sources: John and Kristy Milchick are horse trainers who own and manage Hideaway Stables (www.hideawayhorses.com), a horse farm in Kentucky, where they breed, train, and sell foundation American quarter horses. • Christopher Caso is a stuntman who has produced and performed high-fall stunts for numerous movies, including *Batman and Robin*, *The Lost World*, and *The Crow: City of Angels*.

How to Fend Off a Charging Reindeer

Source: Greg Finstad is program manager of the Reindeer Research Program of the University of Alaska, Fairbanks.



How to Rescue Someone Stuck in a Chimney

Sources: Karen Duke is one of only a few female certified chimney sweeps in the United States. She and her family operate Victorian Fireplace in Richmond, Virginia, which specializes in fireplaces for older homes. • Roger Hoelderlin runs Best Way

Maintenance (www.bestwaychimney.com), a licensed and certified chimney sweep and masonry company based in Levittown, New York. • Craig Issod is the Webmaster of *HearthNet* (www.hearth.com).

How to Survive a Runaway Sled

Source: John Markel is the operator of Midnight Sun Locations (www.alaskafilmlocations.com), a film and television stunt, location, and safety consulting firm based in Girdwood, Alaska. He is certified in High Angle Rescue and has 30 years of rock and ice climbing experience.

How to Win a Snowball Fight; How to Make Snowballs

Sources: David and Jeanie Stiles (www.stilesdesigns.com) are the authors of *Treehouses, Huts, and Forts* and *Treehouses You Can Actually Build*. • Kenneth G. Libbrecht is a professor of physics and physics executive officer at Cal Tech, where he studies ice physics and crystal growth of ice.

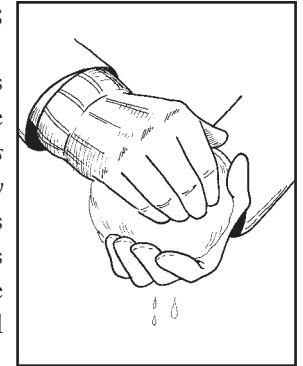

How to Build a Snow Fort

Sources: David and Jeanie Stiles. • John Lindner, Director of the Wilderness Survival School for the Colorado Mountain Club, is also director of training for the Snow Operations Training Center, an organization that teaches mountain survival skills to utility companies, search and rescue teams, and government agencies.

How to Treat a Tongue Stuck to a Pole

Source: Kenneth G. Libbrecht.

The
WORST-CASE SCENARIO
Survival Handbook:
GOLF

By Joshua Piven, David Borgenicht, and James Grace
Illustrations by Brenda Brown



CHRONICLE BOOKS
SAN FRANCISCO

Copyright © 2002 by Quirk Productions, Inc. All rights reserved. No part of this book may be reproduced in any form without written permission from the publisher.

Worst-Case Scenario™ and The Worst-Case Scenario Survival Handbook™ are trademarks of Quirk Productions, Inc.

Library of Congress Cataloging-in-Publication Data available.

ISBN 0-8118-3460-3

Manufactured in the United States of America

Typeset in Adobe Caslon, Bundesbahn Pi, and Zapf Dingbats

Designed by Terry Peterson

Illustrations by Brenda Brown



A **QUIRK** Book

www.quirkproductions.com

Visit www.worstcasescenarios.com

Distributed in Canada by Raincoast Books

9050 Shaughnessy Street

Vancouver, BC V6P 6E5

10 9 8 7 6 5 4 3 2 1

Chronicle Books LLC

85 Second Street

San Francisco, California 94105

www.chroniclebooks.com

© 1999-2007 by Quirk Productions, Inc. All rights reserved.

WARNING

When a dire situation is at hand, safe and sane alternatives may not exist. To deal with the worst-case golfing scenarios presented in this book, we highly recommend—insist, actually—that you carefully evaluate the situation before you act; that you act responsibly and within the boundaries of the law and course rules; and that you attempt to consult a professionally trained expert, golf pro, or physician before placing yourself in harm’s way. However, because highly trained professionals may not always be available when the physical or mental well-being and safety of individuals is at risk, we have asked experts on various subjects to describe the techniques they might employ in these emergency situations on and off the course. **THE PUBLISHER, THE AUTHORS, AND THE EXPERTS DISCLAIM ANY LIABILITY** from any harm or injury—physical or mental—that may result from the use, proper or improper, of the information contained in this book. We do not claim that the information contained herein is complete, safe, or accurate for your specific situations. Moreover, it should by no means be considered a substitute for your good judgment, skill, and common sense. And finally, nothing in this book should be construed or interpreted to infringe on the rights of other persons or entities, nor should it encourage you to violate criminal statutes or course rules: All activities described should be conducted in accordance with state and federal laws as well as the rules of the Royal and Ancient Golf Club of St. Andrews. Breaking a club is one thing—breaking the law is another.

—The Authors

How to Put Out a Cigar Brush Fire

Sources: The U.S. National Park Service. • www.firewise.org is a website devoted to fire-fighting techniques.



How to Cure a Golf Addiction

Source: Adapted from resource material provided by Narcotics Anonymous and Alcoholics Anonymous.

APPENDIX

Rules and Regulations

Sources: USGA Official Golf Rules. • *Rules of Golf* by Tom Watson. • *The Illustrated Golf Rules Dictionary* by Hadyn Rutter.

ACKNOWLEDGMENTS

The authors would like to extend their thanks and the promise of lifelong, good golf karma to all of the experts who contributed their knowledge and experience to this project. Without you we are nothing—or at least we’re a lot less knowledgeable.

Joshua Piven thanks all of the experts who contributed their time and golfing expertise, as well as the entire cast of the film *Caddyshack* for their inspiration, wisdom, and creative golf advice.

David “Fuzzy” Borgenicht thanks Jay Schaefer, Steve Mockus, Erin Slonaker, Terry Peterson, Brenda Brown, Joe Borgenicht, and the entire clubhouse at Chronicle Books and Quirk Productions. He would also like to thank his golf-nut grandmother, Helen Sandack, for not getting angry with him at age 10 when he “accidentally” hit her good golf balls into the road behind her house.

Jim Grace thanks his father, Bill Grace, for being an exceptional golfer, and an even better father. He also sends a huge “thank you” to the golf pros who took time out of their full summer days to answer his never-ending list of questions: Andrew Campbell, Jim Campbell, and Mark Heartfield. Finally, he would like to thank his wife, Lisa, and editor, Erin Slonaker, who now know more about golf than they ever wanted to.

ABOUT THE AUTHORS

Joshua Piven is the co-author of three previous *Worst-Case Scenario* books, including *The Worst-Case Scenario Survival Handbook*, which has been translated into more than 20 languages. He continues to work on his golf game, trying to bring his handicap down to double digits. He hopes to one day win all four majors in a single calendar year. He and his wife live in Philadelphia.

David Borgenicht is a writer, editor, and pre-duffer, as well as the co-author of *The Worst-Case Scenario Survival Handbook* series. He lives in Philadelphia with his wife, and has been known to act as her caddie—or he at least carries her bags and follows her around a lot.

James Grace is a lawyer, golf fanatic, and the author of *The Best Man's Handbook*, as well as the co-author of *The Art of Spooning*. Son of a lifelong golf lover, Jim held a golf club shortly after birth. He was an early master of miniature golf, and to this day he can perfectly time the windmill. He and his wife, Lisa, live in Boston, Massachusetts, with their two caddies-in-training, Avery and Cooper.

Brenda Brown is a freelance illustrator and cartoonist whose work has appeared in many books and major publications, including all the *The Worst-Case*

Scenario Survival Handbooks, *Reader's Digest*, the *Saturday Evening Post*, the *National Enquirer*, *Federal Lawyer*, and *National Review*. Her digital graphics have been incorporated into software programs developed by Adobe Systems, Deneba Software, Corel Corp, and many websites.

Check out www.worstcasescenarios.com for updates, new scenarios, and more! Because you just never know. . . .

FOREWORD

My entire life has revolved around golf, in one form or another. It started when I was five. I hit my first shot on the course with my father during his regular Saturday morning game, continued playing through the collegiate and amateur ranks, and ultimately played 10 years as a touring professional. Throughout all these years, I've encountered more than my fair share of disasters on the golf course. Like all good disasters, most of these were unexpected—but ultimately they taught me quite a bit about myself and the game.

SURVIVAL RULE #1: Watch where you're driving.

One year, my friends and I decided to enter a night tournament in Phoenix. We were all good players and thought that we would win most of the prizes easily. We were in our cart approaching the green on a par-3 late in the round—it was very dark—when the cart path suddenly split. Our partners went right, we went left. The next thing I knew, I was really wet. My partner and I burst out laughing. A hundred yards away, the members of the other cart were howling, too. Sure enough, we'd driven our carts into the greenside lake—and both carts were almost completely submerged. We didn't win that tournament, but we had by far the best stories to tell at the awards party. Still, we weren't invited back.

SURVIVAL RULE #2: An eye for an eye only makes the whole tour blind.

Physical confrontations are usually few and far between on the golf course. However, early in my career I played

in a Nike Tour event in Santa Rosa, California. I was paired with a friendly acquaintance for the first two rounds of the event. We had been paired together a disproportionate number of times that particular season, and I guess we were just growing a little tired of each other.

After he brought it home in 42 on the back nine to ruin a front nine 31, he signed his scorecard, approached me, and proceeded to antagonistically inform me that the lack of heart, talent, skill, and character he displayed on the back nine were all my fault. (In truth, some of it probably was, because I wasn't playing very inspired golf after a horrible front nine that left my clubs and my enthusiasm bruised and battered.)

Not wanting to get fined or suspended by decking him right then and there, I calmly listened to him and politely disagreed with everything he said. I tried chalking it up to end-of-the-year weariness, but it festered in my mind all night, and I knew that the next day would be agonizing, because we were still paired together. So I decided something had to be done.

On the driving range in the morning, I dropped my clubs, went over to him, and said, "If you have any intention of talking to me in that tone again, be prepared to settle it like a man." I spent the rest of the day trying to antagonize him into starting a physical confrontation.

In the end, we both played horribly, we both acted like children, and we both knew that our emotions cost us any chance of performing well in that tournament. To this day we're still friends, but I hope I never have to play golf with him again.

SURVIVAL RULE #3: When the weather gets rough, get going.

During the first round of the 1991 US Open, I was on the golf course putting out on the sixth green as a storm produced some vicious lightning. In those days, we were still allowed to complete the hole we were playing even if play was suspended due to threatening weather—and we decided to do so. Once finished, we were herded into a school bus, and we heard the sirens of an ambulance. We later learned that a spectator was killed by a bolt of lightning. Later that same year, another spectator was killed at the PGA Championship in Indianapolis. The danger of lightning was now thoroughly understood by everyone in golf.

Later in my career, I was among a group of three that actually terminated play for the entire field at a Nike Tour event in Shreveport, Louisiana. We felt in danger because of lightning, and decided to walk off the course. Our decision wasn't overly popular with the rules officials, but we weren't about to take any chances. You shouldn't either.

Golf has taught me many valuable lessons, and it has brought me many joys—but I still never know what's awaiting me on the next hole. Expect the unexpected. And the next time you find yourself in a situation that you never dreamed possible, remember, I warned you.

—**Jerry Foltz, Tournament Player and Journalist**

When I'm on a golf course and it starts to rain and lightning, I hold up my one iron, 'cause I know even God can't hit a one iron.

—Lee Trevino

They say that life is a lot like golf—don't believe them. Golf is a lot more complicated.

—Gardner Dickinson

INTRODUCTION

A triple bogey is the least of your problems!

Even if you think your game is under control and you are spending most of your time on the fairway and greens, you're at risk—the most dangerous sort of risk, because you think you are safe. But a round of golf can turn to nightmare in seconds: a bird suddenly attacks; a cart careens out of control; an alligator claims your ball. Even if you never have to disarm an angry golfer or extinguish a cigar brush fire—never need to stick your hand down a gopher hole, never hit a beehive, and never attempt to scale a fence to retrieve a wayward ball—you may face great peril on the links.

Many of these dangers are physical: every year, one out of two golfers is injured during play. To be sure, most of these injuries are not life-threatening—but the odds of walking off the last green unscathed are about as good as a coin flip. Even worse, think about this fact: you are more likely to get hit by lightning during the round than to hit an absolutely perfect drive off the first tee. (Lee Trevino, the celebrated touring professional, has been hit by lightning twice.) And every year, countless golfers are hit by golf balls traveling up to 130 miles per hour. With more than 100 million golfers around the world each hitting an average of 100 shots per round (97 for men, 114 for women, according to the National Golf Foundation), it's a wonder more of us haven't been hit.

Other perils are mental: you might worry about what club to use or which way the green breaks, but the really dangerous thing to worry about is worry itself. If you spend your time on and off the course worrying about your slice or your hook, becoming more and more aggravated over that bad shot and more and more obsessed with your game, you may hurt not only your playing, but your loved ones and livelihood as well—for these are the early signs of a golf addiction.

Even if you manage to avoid the physical and psychological dangers of the game, the rules of golf alone can ensnare you, costing you a match, a tournament, or even worse, a bet.

So we want you to be prepared for the worst golf has in store, no matter what the source.

As in our earlier *Worst-Case Scenario Survival Handbooks*, we have consulted a battalion of experts to help you survive the game, this time including golf pros, doctors, meteorologists, self-defense instructors, zoologists, and professional gamblers. The scenarios in this handbook are arranged into four chapters: playing out of difficult situations, dealing with equipment malfunctions, fending off dangerous creatures, and surviving a variety of other golf crises. We have also explained, throughout the book as well as in the appendix, how the official rules of golf apply to what you might encounter on the course, whether dangerous or just bizarre. The appendix also provides a handy glossary of golf slang, information on an assortment of fashion emergencies, and a guide to some of the more popular ways to wager on the golf course, should you feel lucky.

This book may not help you improve your swing, but it just might keep you physically and mentally healthy enough to come back and play another day. Because you just never know what you will encounter between the tee and the green.

So keep your head down, take a deep breath, and carry this book in your cart or bag. (Or keep it next to you on the couch when you watch golf on TV.)

Forewarned is forearmed.

—The Authors

CHAPTER I

BAD LIES

RULES AND REGULATIONS

The rules referred to throughout the book are the official rules of the United States Golf Association (USGA). The rules of other national golf associations, including the Royal and Ancient Golf Club of St. Andrews, are consistent with these rules, though the wording may vary.

Subsections of rules are indicated by a dash (Rule 1-4). Official decisions interpret rules, thus Decision 1-4/9 describes the ninth decision regarding the fourth section of Rule 1.

Stroke play rules refer to tournaments that count the total number of strokes per round, which is the more common type of competition. Match play rules apply to competition in which two players go head-to-head; the lowest score on each hole wins that hole. The player who wins the most holes is the winner.

TOO MANY CLUBS

You are allowed to take 14 clubs with you during a round of golf (Rule 4-4). You can take fewer clubs if you wish and add to that number during the round only if the total never exceeds 14. Any added clubs must be yours and not lent to you from anyone on the course. You can share clubs with a partner if the total number of clubs between the two of you is not more than 14 clubs.

If you realize that you have too many clubs in your bag before the start of the round, you can remove the extra clubs. Do not place the extra clubs in your golf cart. The clubs in the golf cart will be added to the number in your bag. If the round has started and you realize you have too many clubs, you must immediately declare the clubs out of play for the remainder of the round. If you do not immediately notify your playing partners that you have more than fourteen clubs, you will be disqualified. The penalty in stroke play for too many clubs is two strokes per hole, with a maximum penalty of four strokes.

BALL HITS BIRD OR BIRD CATCHES BALL

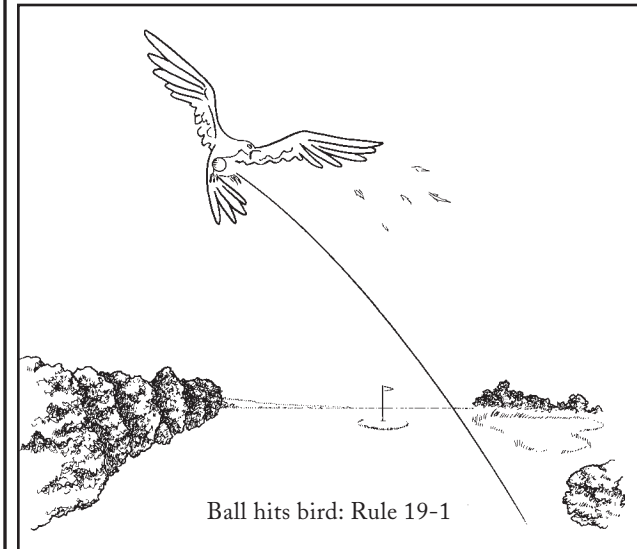

If you hit a flying bird, it is considered “a rub of the green,” also known as tough luck (Rule 19-1). You must play the ball where it lies. If the bird catches the ball in midair and carries it to the green, this is considered fair play, and you can play the ball where it lies.

BALL LANDS IN OR NEAR A BIRD’S NEST

If your ball lands in or near a bird’s nest, you may pick up the ball without penalty. You may not drop your ball any nearer to the hole. You must drop your ball as near as possible to the nest and in a way that would allow you to take your shot without damaging the nest. If the nest is in a hazard, you must drop your ball in the hazard (Decision 1-4/9).

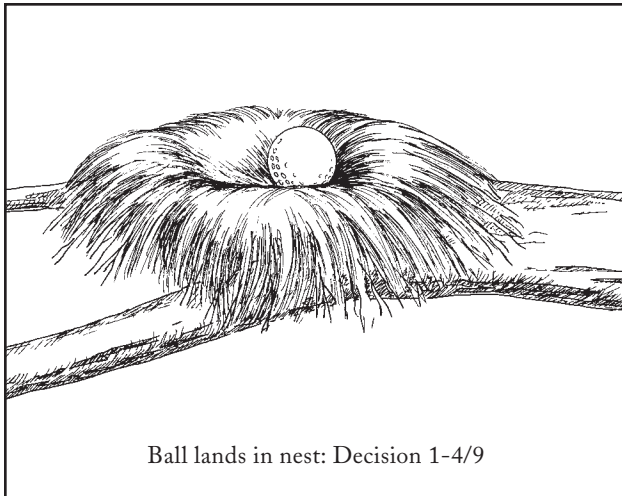

Ball lands in nest: Decision 1-4/9

USING THE WRONG CLUB

There is no such thing as using the wrong club during a round of golf. If you want to tee off with your putter, you can do so without penalty. In general, if the USGA has approved all the clubs in your bag and as long as there are fourteen or fewer clubs, you may use them as you think best.

USING AN ILLEGAL CLUB OR EQUIPMENT

All clubs in your bag must comply with the standards for golf clubs set by the USGA (Rule 4-1). If a golf club in your bag does not conform to the USGA standards, even if you do not use it, the penalty is disqualification of either the hole or the match.

Specifically, the rules state that you may also not use any artificial device or unusual equipment that might “assist” you in making a stroke or play (including distance gauges and measuring devices), or in gripping a club (other than plain gloves, powder, or a towel or handkerchief).

FALLEN HAT MOVES BALL

If during stroke play your hat falls off and moves your stationary ball, you are assessed a one-stroke penalty and you must replace the ball to its original location. You are assessed one more stroke if you do not replace it (Rule 18-2).

Hat moves ball:
Rule 18-2

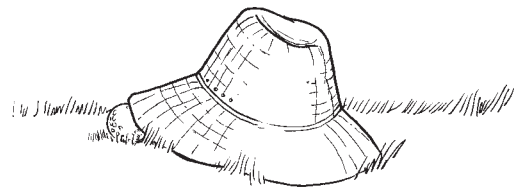

In stroke play, there is no penalty if someone else's hat unintentionally falls and moves your ball. You must replace the ball to its original position. You are assessed a two-stroke penalty if the ball is not replaced.

In match play there is a one-stroke penalty assessed against the player whose hat or whose caddie's hat moves an opponent's ball. It is a loss-of-hole penalty if the opponent does not replace the ball.

OPPONENT MOVES HIS BALL

If your opponent intentionally moves his stationary ball and that movement is not sanctioned by the rules, there is a one-stroke penalty in stroke play and a loss-of-hole penalty in match play (Rule 18-2). There are many situations when a golfer is allowed to move his ball. For example, a player can move the ball to identify it if he announces his intentions and the ball is not in a hazard, or if the ball is located in an area designated as "ground under repair."

BALL LANDS IN MANURE

If your ball lands in manure, you can either play it as it lies or declare it unplayable and take a free drop (Rule 23). If the ball is embedded in the manure, however, there is no free relief. Even though manure is a natural object, the manure is no longer a loose impediment if it is attached to the ball. You will incur a one-stroke penalty if you declare the ball unplayable in this situation.

If your ball lands near or behind a pile of manure, you can move the manure as long as the manure is not embedded in the ground. Rule 23 states that loose

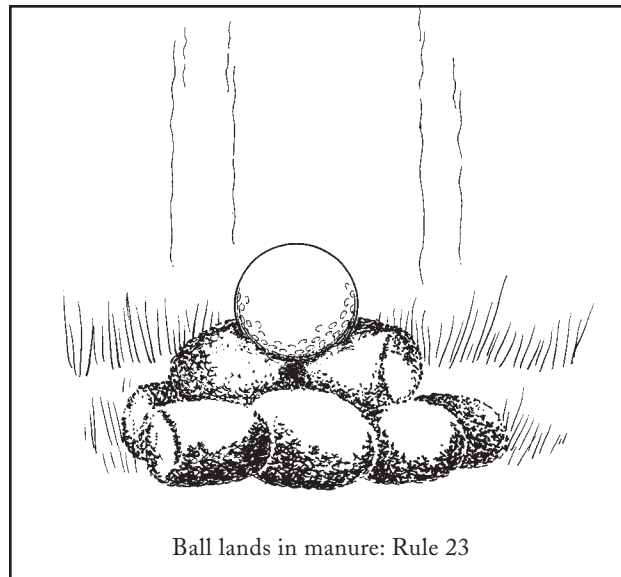

Ball lands in manure: Rule 23

impediments can be removed without penalty. Loose impediments are natural objects such as stones, leaves, twigs, branches, and dung (manure). This also includes worms and insects, and the casts or heaps made by them, provided they are not fixed or growing, are not solidly embedded, and do not adhere to the ball. Sand and loose soil are loose impediments on the putting green but not elsewhere.

USING PUTTER LIKE A POOL CUE

If you hit the golf ball with the top of a club grip as you would hit a pool ball with a pool cue, you will be in violation of Rule 14-1. You would be assessed a two-stroke penalty in stroke play and you would lose the hole in match play. The rule states that you must fairly strike the ball with the head of the club and not

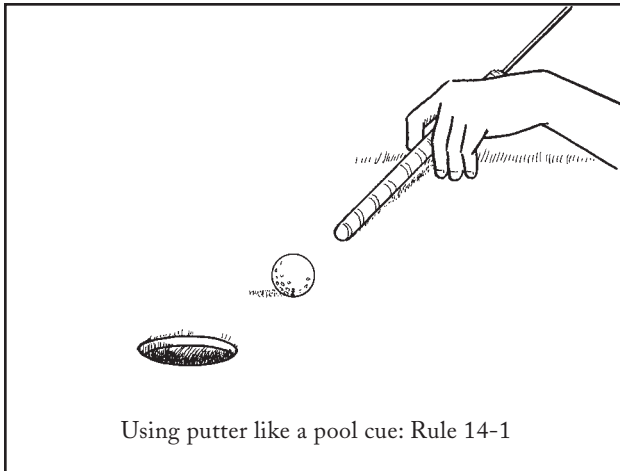

Using putter like a pool cue: Rule 14-1

push, scrape, or spoon the ball. A pool cue shot, even if you used the head of the club, would be considered a push under the rules (Decision 14-1/2).

ANIMAL STEALS YOUR BALL

If a dog, fox, or squirrel steals your ball as it sits on the fairway, you may replace the ball at the original spot without any penalty (Rule 18-1). However, a ball moved by wind or water must be played where it ends up. A snake that moves your ball is considered an outside agency, like a dog or squirrel, but a dead snake is a loose impediment and may be moved if it is blocking your path. Make sure the snake is actually dead. If you are not sure, you can take a free drop.

When a ball has been moved by an animal and it is not clear where its original position was, the player may replace his ball without penalty in an area that provides neither an advantage nor a disadvantage by agreement with opponents (Decision 18-1/5).

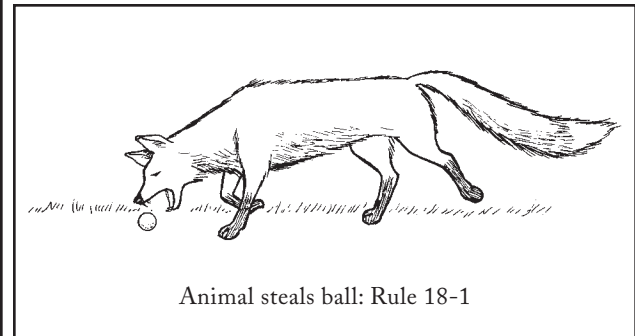

Animal steals ball: Rule 18-1

BALL LANDS ON THE WRONG GREEN

If you hit your ball onto the wrong putting green, you may not hit it off the green. There is no penalty for picking up your ball and dropping it off the green at the nearest point of relief (Rule 25-3). Drop the ball within one club-length of the nearest point of relief but no closer to your intended pin. The nearest point of relief would not include dropping it in a hazard or on the green. You may clean the ball when you lift it from the green.

BALL LEANING AGAINST FLAGSTICK

The top of the ball must be below the top of the cup to be considered holed. If the ball comes to rest against the flagstick (but is not holed), the stick may be moved or removed. If the ball falls in, it is considered holed (Rule 17-4). If the ball does not fall in, the player must mark the ball at the edge of the cup. If a player pulls out the stick and the ball is moved away from the hole, that individual must replace the ball without penalty at the edge of the cup. Not replacing the ball is a two-stroke penalty in stroke play and loss-of-hole penalty in match play.

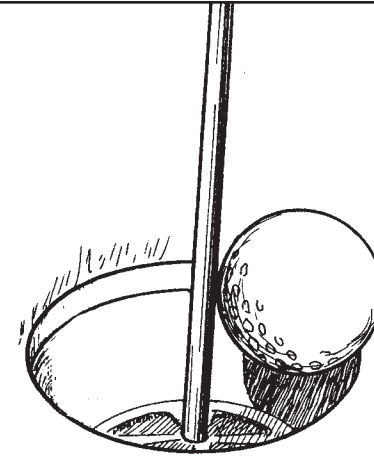

Ball leaning against flagstick: Rule 17-4

HOW TO AVOID DEHYDRATION

1 Get out of the sun.

Dehydration (actually, volume or fluid depletion) can be caused by excessive perspiration from strenuous activity in hot conditions. Rest frequently in a cool area out of the heat of the sun.

2 Drink water and eat salty foods.

Alternate drinking plain water and consuming salty crackers, pretzels, or water that contains sodium, potassium, and bicarbonate. Water alone will not replace lost electrolytes and should not be taken in excess if thirst is due to exertion or sweating.

3 Make an oral rehydration drink.

If salty snacks are not available to take with plain water, you can make an oral rehydration drink that is superior to any of the available sports drinks. In a quart of water, add one quarter-teaspoon of table salt, one quarter-teaspoon of baking soda, and two table-spoons of sugar. If baking soda is not available, use another quarter-teaspoon of salt instead. If available, add half a cup of citrus juice, coconut water, or a mashed ripe banana. (These contain recommended potassium.) Drink this until your thirst is quenched.

4 Eat sweet snacks high in carbohydrates.

Cookies and other sweet bread products will increase energy. Consume sweet drinks such as orange juice if no snacks are available.

5 Avoid alcohol.

Alcohol may worsen symptoms of volume depletion and should be avoided during excessive sweating.

Be Aware

- Some people will not realize they are fluid depleted until they are nearly unconscious. Drink balanced fluids regularly in hot weather and pay attention to thirst, headaches, dizziness, loss of appetite, darker urine, and fatigue, all signs of volume depletion.
- Severe volume depletion, which can include lethargy or loss of consciousness, may require treatment with specialized sodium-potassium-glucose drinks (oral rehydration therapy) or intravenous fluids.

WORST-CASE SCENARIO®

HOW TO AVOID GETTING HIT BY A BALL

- 1 Listen for the shout “Fore!”**
Whether the call comes in your direction or not, do not hesitate to react.
- 2 Do not look for the ball.**
Looking up may expose your face and head. Do not attempt to dodge an incoming ball.
- 3 Turn away from the source of the call.**
- 4 Drop your clubs or stop your cart.**
- 5 Cover your head with your hands and arms.**
Put your hands on the back of your head. Bend your arms around the top and sides of your head and tuck it into your chest.
- 6 Crouch, squat, or drop to the ground.**
Roll yourself into a tight ball. If you cannot get to the ground, fold your upper body into itself and bend over.

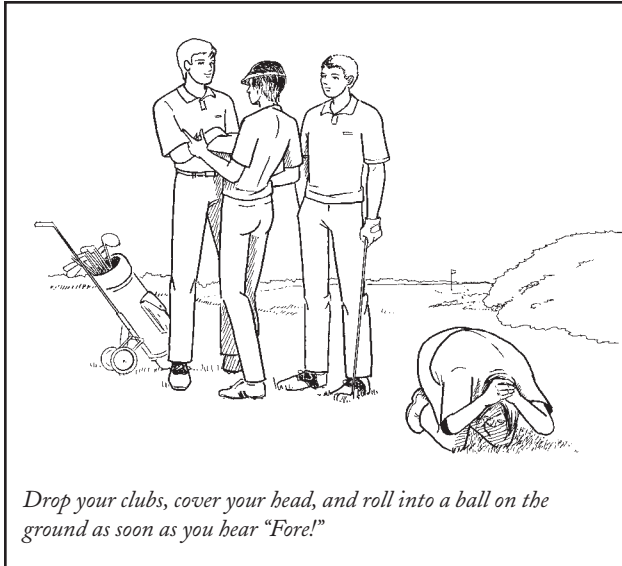

Be Aware

If you and your group are standing on or near the green and the group behind you is hitting up, do one of the following:

- Shield your eyes from the sun so you can easily watch their shots.
- Cover your head and crouch if you lose sight of the ball.
- Get behind your cart, golf bag, caddie, or another nearby object.

**WORST-CASE
SCENARIO®**

HOW TO AVOID LIGHTNING

- 1 Abandon your golf clubs.**
Metal and graphite clubs conduct electricity and should not be held or carried.
- 2 Seek shelter immediately.**
A sturdy building offers the best protection. Avoid sheds, isolated trees, and convertible cars. These will not protect you from lightning. Also avoid water and hilltops, as these can increase your chances of being struck by lightning.
- 3 If no building is nearby, get inside a hard-top automobile.**
Roll up all windows and do not make contact with any metal inside the car. Do not get in a golf cart; it does not offer lightning protection.
- 4 If you are stuck out on the course, find a low spot on the ground away from trees, fences, and poles.**
If you are in the woods, take shelter under short trees.
- 5 Make yourself the smallest target possible.**
If you feel your skin start to tingle or your hair stand up on end, squat on the balls of your feet, place your hands over your ears, and lower your head between your knees.

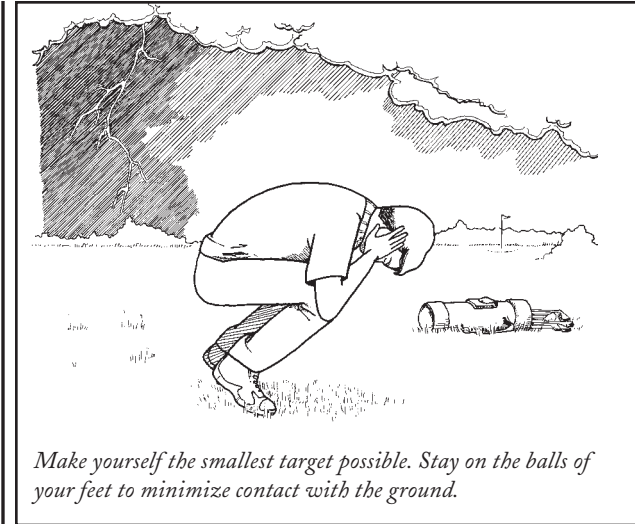

Make yourself the smallest target possible. Stay on the balls of your feet to minimize contact with the ground.

- 6 Do not lie down.**
Stay on the balls of your feet to minimize contact with the ground. Do not crouch with your hands on the ground.

Be Aware

- Stay away from rivers and creek beds during a thunderstorm; more people are killed each year from flash floods than from lightning or any other storm-related phenomenon. If you hear a loud, sustained roar, notice hail, or see the sky become greenish, run for shelter immediately. (See “How to Survive a Tornado” on the following page.)
- Do not use any electrical appliances for the duration of the storm. Use a wired telephone only in an emergency.

HOW TO CAROM THE BALL OFF A WALL

If your ball lands within a few feet of a wall, you may need to carom the ball off the wall. The ball's proximity to the wall may make it impossible for you to make a proper stroke.

1 Choose a club with enough loft to get the ball as high as possible off the wall.

Choose a club that has the loft of a seven iron or greater. A nine iron or pitching wedge is the most common choice. The higher on the wall that the ball hits, the farther it will travel.

2 Aim for the smoothest spot on the wall.

The direction of the shot will be greatly affected by the surface of the wall. The smoother the wall, the more predictable the shot will be.

3 If possible, play the ball in the middle of your stance.

This is the ideal stance for this shot. However, if you are only a few ball lengths from the wall, you will have no choice but to play the ball closer to your front foot. The closeness to the wall may have the greatest effect on the extent of your follow-through.

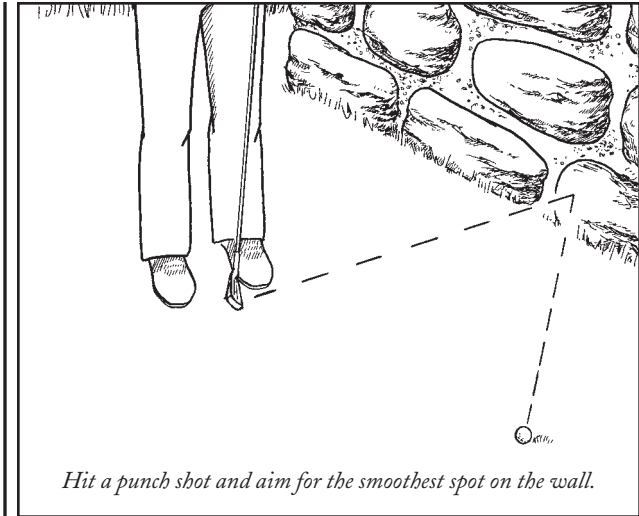

4 Map out the ricochet.

The ball will bounce off the wall at the same angle that it hits. Decide where you want the ball to land and imagine a line extending to that spot from the wall. Pick the spot on the wall for which the angle coming off the wall is equal to the angle toward the wall, and mark the spot in your mind. This is much like a bank shot in billiards.

5 Hit a “punch shot” to limit the follow-through.

Keep your hands in front of the ball and take the club away vertically by cocking your wrists. Hit down into the ball and then into the ground under the ball in order to create enough force to get the ball off the wall with as little follow-through as possible. Imagine you are swinging an ax.

The Rules

- ▶ You cannot push, scrape, or spoon the ball to gain better positioning or you will incur a two-stroke penalty. You must play the ball as it lies.
- ▶ If the ball comes off the wall and hits your body, equipment, or caddie, you will be assessed a two-stroke penalty. You will have to play the ball where it lies. Move your equipment and caddie away from the shot and keep your body out of the line of the shot as much as possible. If your body is in the line of the shot, it may be better to declare the ball unplayable and take a one-stroke penalty, but make certain that your lie for the next shot improves.
- ▶ Some walls on golf courses may be considered an “immovable obstruction” from which relief is available. Local rules would apply.

**WORST-CASE
SCENARIO®**

HOW TO CARRY AN INJURED GOLFER

IF ALONE

Use the “fireman’s carry” to bring the golfer to safety.

- 1 Face the injured person.**
- 2 Prop the victim upright in a sitting or partly standing position.**
Bend down so your shoulder is level with her waist.
- 3 Lean into her body.**
Have the injured golfer bend forward over your shoulder so her head and arms are behind you and her legs are in front of you.
- 4 Put your arms around her legs and stand up.**
The victim should be bent at the waist over your shoulder, head behind, with legs in front of you.
- 5 Walk the victim to the clubhouse.**
You should be able to walk a fair distance like this, as weight distribution is over your back and legs instead of your arms.



Lean into the injured golfer's body.

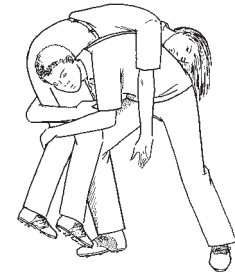

Put your arms around her legs and stand up.



Keep her weight over your back and legs as you walk her to the clubhouse.

IF ACCOMPANIED BY ANOTHER PERSON

Use the “deadlift carry” when you have the aid of another person.

- 1 Lay the injured golfer on his back.**
Alternatively, the injured golfer could be sitting upright on the ground.
- 2 Stand behind the injured golfer.**
Your carrying partner should be facing you on the other side of the victim, near his legs.
- 3 Kneel down.**
- 4 Slide your arms under the victim’s arms and wrap them around his chest.**
- 5 Instruct your partner to kneel between the victim’s legs.**
Your partner should place her arms under the victim’s knees, as if she were lifting the handles of a wheelbarrow to push it.
- 6 Stand up.**
You and your carrying partner should rise at the same time. You will have about two-thirds of the victim’s weight and your partner will have the rest.

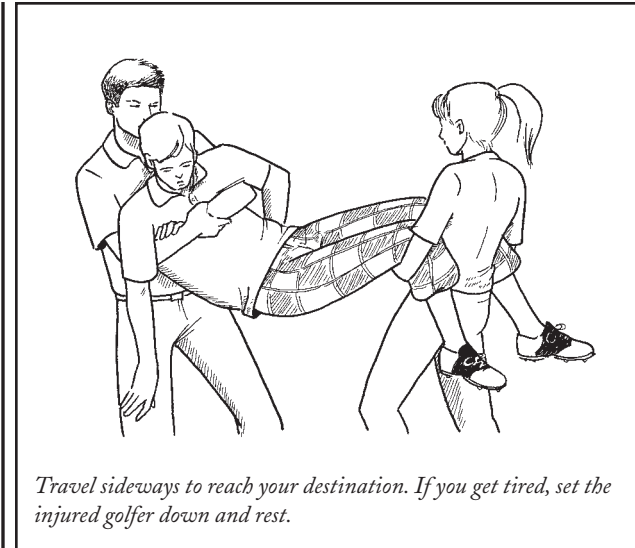

- 7 Walk to get help.**
This position is difficult to maintain for long distances. If you get tired, it is easier to sit the injured golfer down and pick him up again using this method than with the one-person fireman’s carry.

HOW TO CONTROL YOUR GOLF RAGE

- 1 Immediately set down anything you might be inclined to break or use as a weapon.**
Drop your clubs, bags, balls, spike-cleaning tools, golf shoes—anything you might use to injure another golfer.
- 2 Take ten deep breaths.**
Breathe by expanding your stomach and abdomen, not your chest. This will cause the oxygen to enter your bloodstream more quickly, calming you down.
- 3 Repeat the following words to yourself as you breathe: “It’s just a game. It’s just a game.”**
Putting the cause of your anger in perspective may help prevent you from causing harm.
- 4 If you feel you have been wronged, say so.**
Be polite but assertive—explain clearly to the person involved why you are angry. Limit the discussion to the specific cause of your anger—do not get into bigger issues such as, “You always act this way.”
- 5 Avoid making inflammatory statements.**
Making value-judgment and personal insults or implying illegal tactics will not be helpful.

- 6 Listen and tolerate.**
Inevitably, the object of your anger will have a few thoughts of his own. Let him talk—this will decrease the likelihood of a further argument, and increase the likelihood of a resolution. Try to see the situation through the other person’s eyes, even if this is difficult. The person you are speaking with will likely follow suit.
- 7 Forgive yourself or the other person for the infraction.**
- 8 Laugh it off.**
Try to defuse the situation with humor. Laughter, especially when it comes to golf, is often the best medicine.

Be Aware

However tempting it may be, taking your anger out on an inanimate object such as your clubs, your ball, or your golf cart may only lead to you hurting yourself or irreparably damaging the object. To release your anger, squeeze a golf ball or a plush toy you carry for this purpose.

HOW TO CURE A GOLF ADDICTION

1 Examine your behavior.

A golf addict is a person whose life is controlled by golf. You may think you have a problem with golf, but still not think that you are an addict. Ask yourself these questions. The total number of questions that you answer “yes” to is not as important as how you honestly feel about yourself as you answer these questions:

- Do you golf regularly? Do you feel empty inside if you cannot golf at your usual time?
- Do you ever golf alone, or watch golf alone?

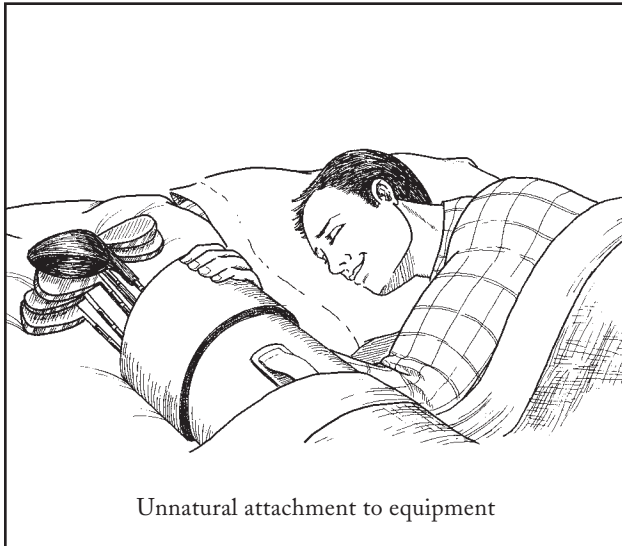

Unnatural attachment to equipment

- Have you ever substituted one club for another, thinking that one particular club was the problem?
- Have you ever cheated to obtain a better score?
- Have you ever lied to get into a golf course of which you were not a member?
- Has your job, family life, or school performance ever suffered from the effects of golf?
- Have you ever been arrested as a result of golf?
- Have you ever lied about the fact that you are playing, or about how much you play?
- Do you put the purchase of golf equipment ahead of your other financial responsibilities?

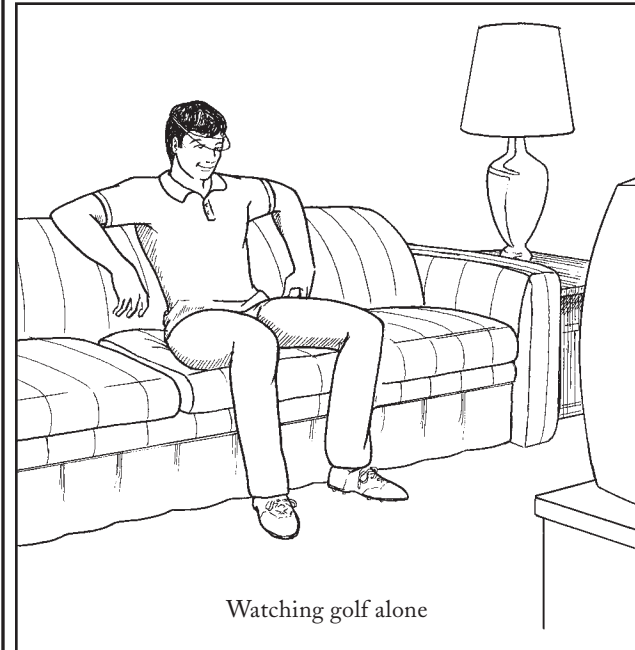

Watching golf alone

- Have you ever suffered a golf-related injury?
- Do you continue to golf despite the fact that you are never satisfied with your performance?
- Does golf interfere with your sleeping or eating?
- Does the thought of not being able to play golf terrify you?
- Do you feel it is impossible for you to live without golf?

2 Admit that you have a problem, and that you need help.

You are not responsible for your disease—but you are responsible for your recovery. You can no longer blame people, places, and courses for your addiction.

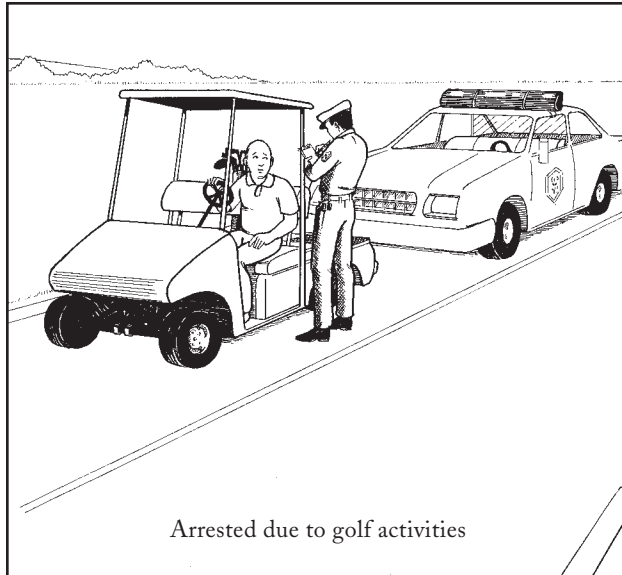

3 Admit to one other person that you have a problem.

This person will help you wean yourself off the game. This person should not be a regular in your foursome.

4 Reduce the amount of golf you play.

Going cold turkey may be difficult—first, reduce by half the number of times you play a week. Then cut that amount in half the following week, and so on. Replace golf with other activities to take your mind off the withdrawal you may experience. Make it a point to play other sports, go to the movies with your family, and watch alternate programming on Sunday afternoons.

5 **Make direct amends to everyone you have harmed physically or emotionally as a result of your addiction.**

This will help you to “own” your disease, and also allow others to help you when you need it.

6 **Watch yourself carefully—and be willing to forgive a relapse.**

Many addicts relapse at some point during recovery. If you fall back into your old ways, admit it to yourself first, then to others who can assist you in finding your way again.

7 **Do not be afraid to ask for help when you need it.**

Your golf pro may be able to direct you to others who have been through what you are dealing with. Form a support group. Therapists may also give you perspective. (Note: Sports therapy is physical therapy, not mental therapy.)

8 **Remember that no one is perfect.**

Seek the ability to change the things you can, and to accept the things you cannot change. Realize that you may never be able to play golf again without risk of a relapse. There is more to life than golf. But then again, relapses can always be cured.

**WORST-CASE
SCENARIO®**

WORST-CASE SCENARIO®

HOW TO DEAL WITH A SNAKE NEAR YOUR BALL

1 Observe the color pattern and markings of the snake—from at least six feet away.

All snakes should be considered dangerous. Although there is no universal way to determine whether a snake is venomous from its markings, there are some species that can be identified and should be avoided.

In the United States, watch for:

- Rattlesnakes, which are instantly recognizable by the rattle on the tail.
- Copperheads, which have a distinctive pattern of hourglass-shaped bands down the back.
- Water moccasins, which lack any single feature that allows them to be immediately identified except that they will open their mouths wide when disturbed, exposing the white interior (hence their nickname, “cotton mouth”).
- Coral snakes, which have repeating colored bands of black, yellow, and red—in that order.

Outside the United States, you may encounter:

- Cobras (Asia, Africa, and India), which flare a hood below their heads when disturbed. The hood may not be noticeable if the snake is calm. A cobra will rear up and “stand” when threatened, and

some types may spit venom up to several feet, aiming for the eyes. The venom can cause blindness.

- Kraits (Southeast Asia and India), which may be “common” (black with white bands) or “banded” (alternate black and yellow bands). Both have hexagonal scales along the ridge of the back, though these may be difficult to see from a distance.
- Tiger snakes (Australia, Tasmania, and surrounding islands), which vary in color, will raise their heads, flatten their necks, and hiss loudly when threatened.

2 If the snake appears to be one of these species, take a drop.

You should sacrifice your ball, but you do not need to sacrifice a stroke penalty: the rules allow a free drop to avoid dangerous animals.

3 If the snake is coiled, this is a sign that it is ready to strike—leave it alone and take a drop.

A coral snake can strike from what appears to be a relaxed posture, however.

4 Stand still.

If the snake does not feel threatened but is intimidated by the sight of you, it may leave the area on its own. Give it time to move away before attempting any ball retrieval measures. Do not try to scare the snake, however, or it is more likely to react defensively.

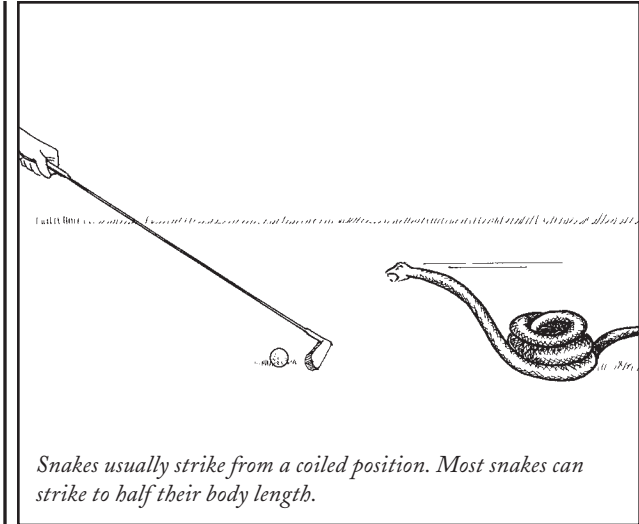

5 If the snake remains, is not coiled, and does not appear to be venomous, estimate its length before attempting to retrieve your ball.

If the snake is five feet long or shorter, use your club or a telescoping ball retriever to get your ball. A snake of this size should not be able to strike beyond the length of a golf club. Most snakes can strike half their body length. If the snake is longer than five feet, use a tree branch at least four feet long to retrieve your ball.

Be Aware

- Snakes can be encountered at any time of day in the spring or fall. During summer when temperatures rise, snakes are more active in the morning or late afternoon.

- Some nonvenomous snakes imitate the coral snake, but have a band pattern in the following color order: black, yellow, black, red.
- A golf glove will not provide sufficient protection to prevent a snake's fangs from entering your skin.
- Most deaths by snakebite are due to allergic reactions and lack of rapid medical treatment after a bite. Although a snakebite should be considered a medical emergency and treatment should be sought immediately, deaths from snakebites are extremely rare. There are thousands of bites each year in the United States but only a few dozen deaths.

**WORST-CASE
SCENARIO®**

HOW TO DEAL WITH AN ALLIGATOR NEAR YOUR BALL

1 Determine the size of the alligator.

Although even small alligators can cause injury, those less than four feet long are not as dangerous to humans. If the alligator is larger than six feet, be especially wary, as a bite can inflict major damage. Alligators larger than nine feet should be considered deadly.

2 Calculate the distance from the alligator to your ball.

The immediate danger zone is within 15 feet of an alligator.

3 Try to determine if the alligator sees your ball.

Alligators are attracted to objects that appear to be food. Golf balls look like alligator eggs, which alligators eat.

4 Do not stand between the alligator and water.

If disturbed, an alligator on land will seek refuge in water. Make sure the alligator is between you and any nearby water hazard.

5 Make a loud noise.

Alligators are sensitive to loud noises. Yelling or screaming may cause the animal to leave. If the alligator does not move, however, you will have gained its attention.

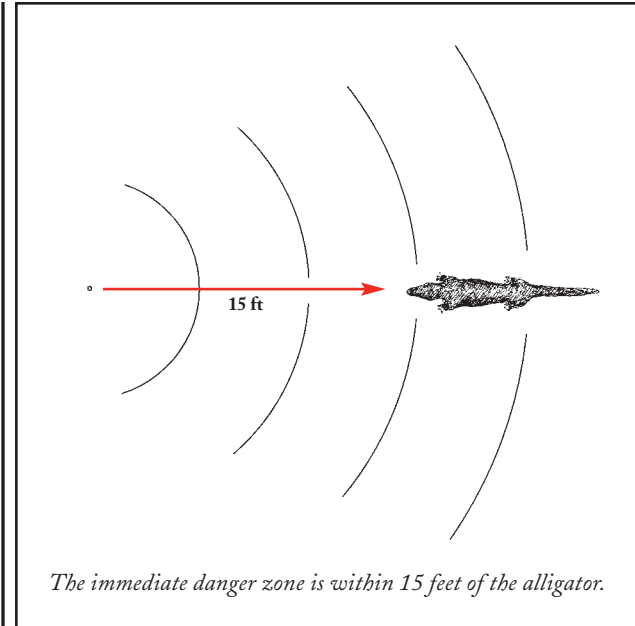

6 Use a ball retriever to recover the ball.

The alligator may lunge and bite at objects that invade its space. A telescoping ball retriever, best used when the alligator is not facing you or the ball, can quietly scoop up the ball. You can also use a flagstick, though you will have to use it to roll the ball out of the way.

7 Quickly move away from the alligator's territory.

After retrieving the ball, or if you encounter difficulties, run. While alligators can move fast, they generally will travel only short distances and probably cannot outrun an adult golfer.

Be Aware

- Alligators are common on golf courses throughout the Gulf Coast states in the United States, and can be found as far north as North Carolina. To be safe, assume that any body of water on a course in these states is home to an alligator.
- Never wade into a water hazard on a golf course known to be home to alligators. You are most likely to be attacked in or at the edge of water.
- Be especially wary during spring months, when alligators wander in search of mates, and during late summer, when eggs hatch. Mother alligators will respond aggressively to threats to their young, and any adult alligator may come to the aid of any youngster.
- An alligator more than nine feet long is likely to be male, and males tend to move around more and be more aggressive.
- Do not assume any alligator is safe to approach. While some animals may be habituated to the presence of humans, alligators are wild animals, and therefore unpredictable: they may attack without provocation.

**WORST-CASE
SCENARIO®**

WORST-CASE SCENARIO®

HOW TO DISARM AN IRATE GOLFER

- 1 Determine the level of danger.**

If a golfer is waving a club around angrily or drunkenly, or is exhibiting undue hostility, it may be necessary to act quickly to restore order and safety.
- 2 Try to talk him down.**

Speak calmly, keeping your tone even and your voice low. Do not make sudden gestures or movements. Remind him that it's only a game. Tell him to take a few deep breaths.
- 3 If he threatens to strike, quickly move into the center of the potential swing.**

As he draws the club back to swing at you, approach him at an angle that will bring you to the center of the club. Try to remain close to his body. You are much more likely to be injured by the outer end of the club.
- 4 Grab the club.**

At the top of his swing, or just as the club starts to descend, step close to him and, using one or both hands, clutch the club tightly near the grip. Pull down, staying close to him, until you can wrap your arm around the club. Hold the shaft with your armpit while keeping a firm grasp on the club's grip.

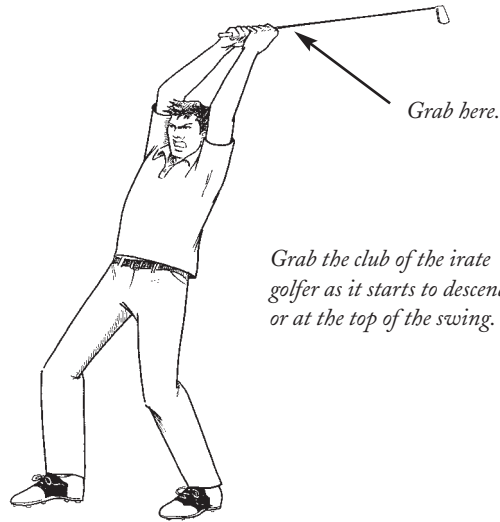

Grab the club of the irate golfer as it starts to descend or at the top of the swing.

Tuck the club under your armpit and wrench it away by rotating away from the irate golfer.

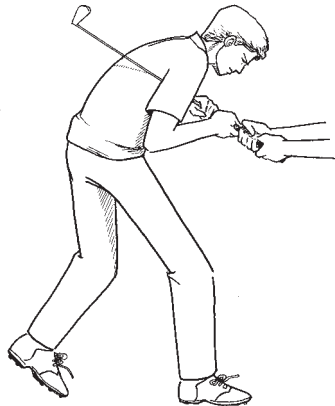

5

Wrench the club away.

Maintaining your hold, rotate your body around, away from the golfer's face. This maneuver should give you the leverage you need to wrench the club out of his grip. Pull with just enough force to free the club from his grasp.

6

Step back quickly, and be prepared for him to continue to be angry and to flail.

If necessary, use the club to keep him away from his bag, where he might obtain a second weapon.

7

If necessary, call for help.

Seek the assistance of your fellow golfers to help defuse the situation.

8

Continue to talk to him until he calms down.

Be Aware

It is always advisable to make all possible attempts to avoid physical confrontation. Your first choice should be to ignore and walk away from an irate golfer. Your next choice should be to use verbal skills to calm the golfer by speaking in low tones and showing understanding. Become physical only as a last resort, to avoid greater injury to yourself or others.

WORST-CASE SCENARIO®

HOW TO DRIVE WITH A PUTTER

- 1 Use a sturdy, flange-type putter.**

Most modern putters are not built to handle the force that driving a golf ball produces. Try to use a heavier putter, preferably one with a steel shaft inserted securely into (rather than over) a thick hosel.
- 2 Tee the ball up high.**

Since a putter does not have any loft, you will have to tee the ball up high, approximately 1½ to 2 inches off the ground.
- 3 Play the ball well forward in your stance.**

Tee the ball forward of your front shoulder.
- 4 Take several practice swings to get the feel of swinging a putter.**

Putters are very light and will fly around much faster than a driver, and with much less effort.
- 5 Make solid contact with the ball.**

Hit the ball on the upswing. Hitting cleanly is much more important than swinging hard when driving with a putter.

When driving with a putter, pick one that is less likely to break.

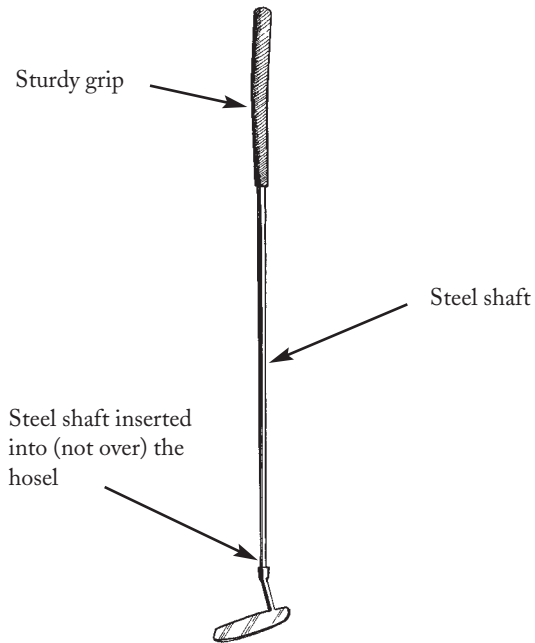

Be Aware

- Older, major-brand putters are less likely to break apart on impact. Used-club shops and club repair shops are the best places for finding a putter of this type, but you may find one in a sporting goods store.
- There is a danger that upon contact with the ball, the head of the putter will fly off the shaft. Make sure no one in your group is down course.

**WORST-CASE
SCENARIO®**

**WORST-CASE
SCENARIO.**

HOW TO GET A CART OUT OF A SAND TRAP

- 1 Check that the rear wheels are on the ground.**
All golf carts are rear-wheel drive and carts have very little chassis ground clearance; they can easily get stuck on uneven terrain. If the cart is partially in, partially out of a trap, or if the trap is on a slope, make sure the rear wheels are on the ground.

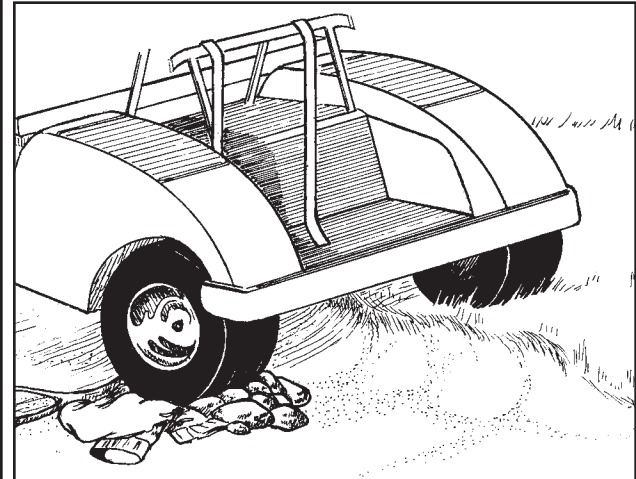

Create traction by piling sand, rocks, sticks, and clothing under the wheel in the trap.

2 Attempt to push the cart onto the ground to obtain more traction.

The average cart weighs about 800 pounds, but two or three players should be able to push it forward or back enough so that the rear wheels will grab.

3 If you cannot get it onto solid ground, create traction.

The tire treads on golf carts are very shallow and will not provide much traction. Try piling sand or small stones around the wheel to increase traction, or place jackets and other clothing under the rear wheels. An empty, collapsible golf bag may also work.

4 Flag down a passing cart and ask for a tow.

5 Tow the cart.

Secure a long, sturdy rope or chain to a tow hook on the chassis in the rear of the cart. If no hook is available, secure the rope or chain to the chassis using several good knots. Secure the other end of the rope to the rear of another cart, on the chassis. A single golf cart should be powerful enough to pull a disabled cart out of trouble. Use slow, steady acceleration to tow the cart until it has become dislodged and can be driven. If no other cart is available, three to five people may be necessary to push or pull the cart out.

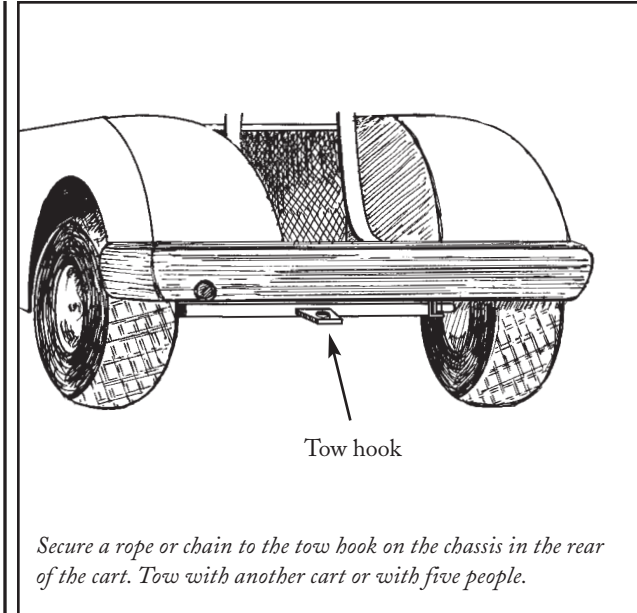

Be Aware

- Golf carts use an open differential drive train: the power will go to the rear wheel that has the most traction.
- If the cart is stuck in a bunker on a hill, use caution when towing or driving out. If the hill is steep, do not attempt to drive the cart in a direction that is parallel to the slope of the terrain; you risk losing traction and slipping or possibly overturning. Golf carts are not designed to be used on hills with more than a 25-percent grade (14-degree slope). Be especially careful on wet grass.

WORST-CASE SCENARIO®

HOW TO GET A CLUB OUT OF A TREE

- 1 Attempt to shake the tree.**

Depending on the size of the tree and the thickness of its trunk, you may be able to dislodge the club by gently shaking the tree. Take care to avoid being hit by the club when it falls.
- 2 Try to dislodge the club using a ball retriever, flagstick, or another club.**

Someone in your group may have a telescoping ball retriever, or, if you are near the green, grab the flagstick. Use the implement to reach the club or shake the branch where it is lodged.
- 3 Create a longer poker.**

Secure the flagstick to a golf club or to a telescoping ball retriever using athletic tape, shoelaces, or bandages. Tie the grip of the club to the base of the flagstick. Hold the head of the club and use the flag end of the stick to knock the club loose.
- 4 Climb the tree.**

Use this method only if you cannot dislodge the club with the above methods, the tree is easily climbable, and the club is not too high. Carry another club in your belt to help you reach the stuck club or the branch that it is resting on, or have another player

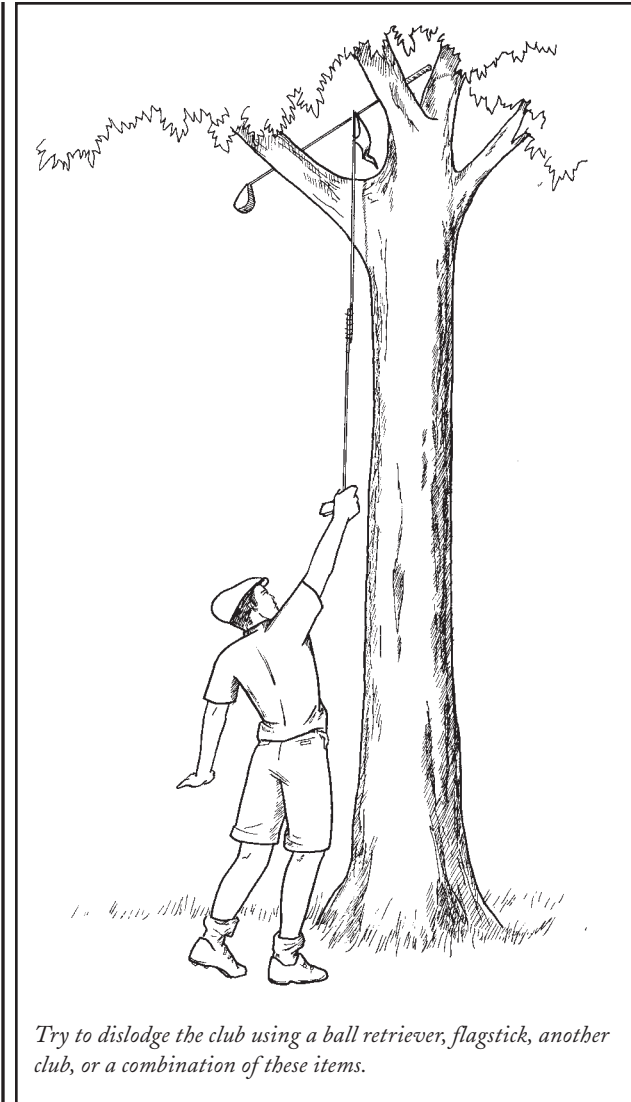

Try to dislodge the club using a ball retriever, flagstick, another club, or a combination of these items.

hand up a club when you are in position. See “How to Retrieve a Ball Stuck in a Tree” (page 24) for correct tree-climbing technique.

Be Aware

- Tossing other clubs into the tree in an attempt to dislodge the lost club may result in multiple stuck clubs or damage to the clubs.
- Do not throw sticks and stones at the errant club. They are not very effective and may hit you or members of your party on the way down.

WORST-CASE SCENARIO®

HOW TO KEEP SCORE WITHOUT A PENCIL



Use mental tabulation to keep track of the number of shots over or under par you are for the round.

Start at zero. If after the first hole you are two shots over par, you should remember your score as +2. After the second hole, if you are one shot under par, your score is +2-1, or 1. Shooting par does not change your total (+/- 0). At the end of the round, take the course's total par and add or subtract the final number (72 + 9, for example). This method will only assess your cumulative score for the round. It will not help you keep track of your score on each hole.



Use an alternate writing implement.

- **GOLF TEE**—Scratch your score onto the scorecard using the pointed end of a golf tee. Press hard to make the number visible. Rubbing dirt lightly over the scorecard and blowing away the excess may make the numbers more legible.
- **STICK OR KEY**—Use the pointed end of a piece of wood or a key to scratch out your score. If you are unable to read the scratch marks, dip the key or small pointed stick into mud or wet dirt, then mark your score onto the card. If you have a match and can char the end of the stick, this may also help. You may also be able to use the charred end of the match itself.

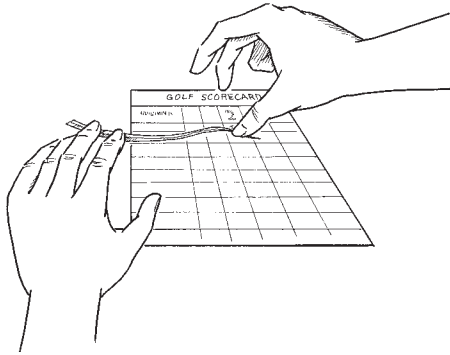

Mark the card by running your fingernail over a blade of grass.

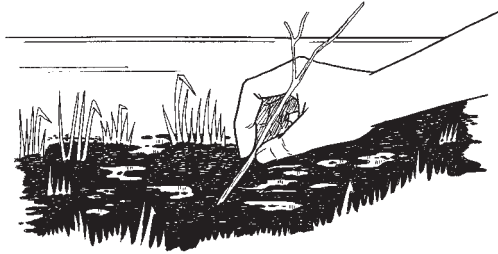

Use the end of a stick dipped in mud.

- **GRASS OR FRESH LEAF**—Find a wide blade of grass or a leaf, position it over the scorecard, and run a fingernail over it to leave a stain of a number or hash marks representing your score.
- **MAKEUP**—Lipstick, eyebrow pencil, or mascara may also work as a writing implement.

**WORST-CASE
SCENARIO®**

HOW TO PLAY OUT OF A WATER TRAP

1 Determine what is under your ball.

Ascertain what is beneath the water and whether you are hitting off sand or a rock bed before you take the shot. Unknowingly swinging into a hard surface can do significant damage to your hands or wrists and your club.

2 Calculate the ball's depth.

The more of the ball that is showing above the water line, the better. The reliability of executing this shot decreases considerably if the top of the ball is more than half an inch below the water line.

3 Take off your shoes and socks.

If you cannot stand on the bank, step into the water barefoot.

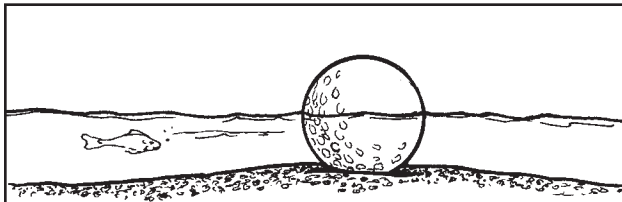

Try to determine what is underneath your ball before you swing. Unknowingly hitting a hard surface may damage your hands, wrists, or club.

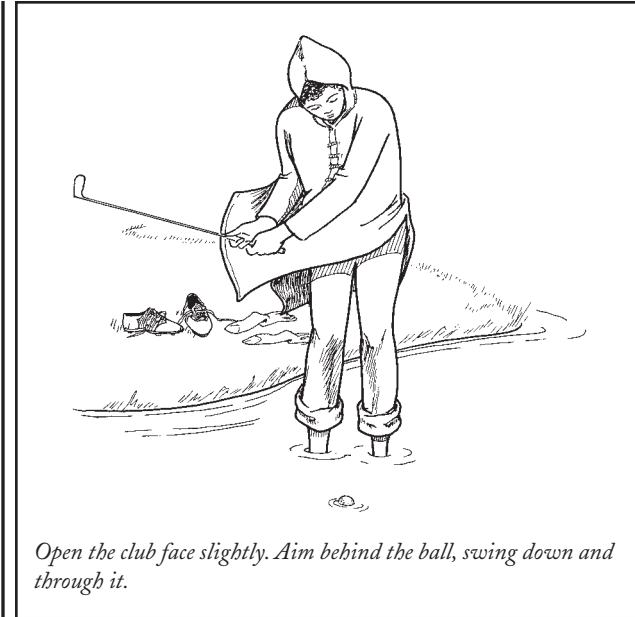

Open the club face slightly. Aim behind the ball, swing down and through it.

4 Wear a raincoat or other foul-weather gear.

There will be a large spray that may include mud.

5 Grip the club firmly.

Because the club will be moving through something with a high resistance—water—the club head will twist if you do not maintain a firm hold.

6 Open the club head slightly.

The club head will naturally close as the club moves through the water.

7 Aim behind the ball.

Play the shot as if the ball were buried in the sand. Hit the water approximately one ball length behind the ball. Do not be concerned about refraction of the light through the water; the ball is not deep enough for this to be a factor.

8 Swing down and through the ball.

Hit the ball hard. It will be the force of the water behind the ball that carries the ball out, not the impact with the club face itself.

Be Aware

- Going into or near the water may not be a good idea due to the possible presence of snakes, alligators, and other animals, particularly in natural water hazards. Courses along the ocean or deep lakes pose issues of general water safety. Check for posted signs throughout the course that warn of local hazards or dangerous animals.
- Check the back of the scorecard for local rules that might apply to hitting out of the water.

The Rule

 Your club cannot make contact with the water in the hazard prior to your shot. If contact is made, a two-stroke penalty will be assessed or in match play you will lose the hole.

**WORST-CASE
SCENARIO®**

WORST-CASE SCENARIO®

HOW TO PLAY OUT OF HIGH SAW GRASS



Saw grass is a large plant (between four and ten feet tall) with flat, stiff, narrow leaf blades that have small, sharp sawteeth along the midribs. Often, dense saw grass will be out-of-bounds or in a hazard, but under some circumstances you may be able to play a ball that is nestled in saw grass.

- 1 Determine if you are in a hazard.**
Look for hazard markers. The rules are stricter when hitting out of a hazard.
- 2 Prepare to enter the grass.**
Wear gloves on both of your hands to avoid getting cut. Be sure to wear long pants to protect your legs. Spray any exposed areas on your arms and legs with bug repellent to avoid contact with insects (e.g., ticks, chiggers, etc.).
- 3 Identify your ball.**
Use your index finger and thumb to pick up the ball. Mark the location of the ball, turn the ball over to see the markings, and then place it back in the exact same position. Do not clean your ball when identifying it. If you are in a hazard, you must first hit the ball and then identify it. If it is not in fact your ball, there is no penalty, but you must return to the grass to find your ball (and return the ball you hit to the spot you found it).

- 4 Use a wedge.**
The heavy bottom of a sand wedge or pitching wedge will help the club head slice through the grass. Its open face will increase loft, so that the ball will land softly. Never hit a wood out of high grass.
- 5 Take a practice swing.**
Find a spot away from the ball that has a similar rough and lie. Get a feel for how the club will react to plowing through the grass.
- 6 Set up the club level with the ball.**
Since the ball may be propped up several inches above the ground, be careful not to align the club underneath the ball. In order to make up the distance that the higher grass has created, choke up on the club.
- 7 Stand so that the ball is forward of the center of your stance.**
Play the ball between your front ankle and the center of your stance.
- 8 Open your stance and the club face slightly.**
Take your club back in a V-shaped swing rather than a U-shaped swing. Do this by cocking your wrists more quickly as you take the club away from the ball.

- 9 If you are a right-handed golfer, the ball will have a tendency to go to the left.**
To prevent this, grip the club firmly with your left hand and normally with your right hand. If you are left-handed, grip the club firmly with your right hand and normally with your left. Also, open the club face to decrease the likelihood of it closing as it fights its way through the grass prior to impact. Open the face to between 25 and 30 degrees.
- 10 Accelerate the club head through the ball.**
Use the weight of the club and the added wrist cock to increase the club head speed down through impact.
- 11 Shift the weight in your lower body as you hit.**
Adding a more pronounced weight shift will help you develop enough speed on your club head to pop the ball out of the grass.

The Rules

-  A two-stroke penalty will be assessed if you use your hands, club, or feet to improve the lie around the ball. Matting down the grass around the ball is prohibited.
-  When you sole your club at address, you may inadvertently create an indentation in the grass into which your ball may roll. This incurs a one-stroke penalty. If the ball is in a hazard, the rules do not permit you to ground your club at all.

HOW TO PREVENT A CLUB FROM FLYING OUT OF YOUR HANDS

- ★ **Dry the grip in the sun.**
If the grip is wet, or if there is a lot of moisture in the air, leave the club in the hot sun for as long as possible so the moisture will evaporate. Place the club on a hard surface like rock or concrete, which retains more heat than grass and will expedite the drying process.
- ★ **Wear gloves.**
Golf gloves provide added grip (and reduce chafing and blisters). If no golf gloves are available, thoroughly wet a pair of thin cotton gloves and wear them.
- ★ **Rub dry dirt, chalk (magnesium carbonate), talcum powder, cornstarch, dry crumbs, or a powdery stick antiperspirant on sweaty hands or the grip.**
These items will absorb excess moisture.
- ★ **Rub a slippery grip on sandpaper or concrete to scuff the grip.**

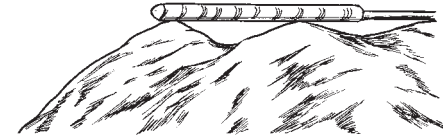

Place club on a hard surface.



Rub dirt on hands and grip.

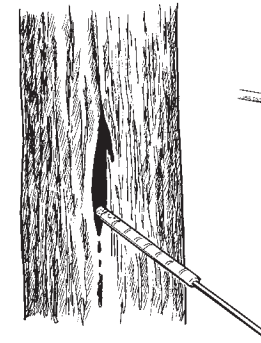

Smear tree sap on grip.

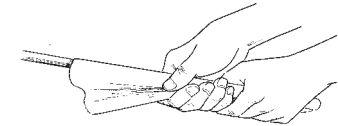

Wrap towel around grip.

★ **Smear tree sap on the grip to make it sticky.**

Sugar maples are good sources of sap in the spring and early summer, when it may run down the sides of the tree. You will be able to find sap from pines or other conifers (spruce, fir) any time of year, and can use it either dried or weeping. Sap can also be found on needles and cones. Note that sap is extremely sticky, and removing it from the skin and other objects will require the use of mineral spirits.

★ **Use a towel.**

Wrap a handkerchief or a thin towel around the grip of your club when hitting. This is perfectly legal, according to the rules.

**WORST-CASE
SCENARIO®**

**WORST-CASE
SCENARIO®**

HOW TO PUT OUT A CIGAR BRUSH FIRE

Brush fires can be started in many ways, but on golf courses, cigars pose a significant risk.

1 Stomp out the fire if it is small enough.
Flames that are larger than your shoe will not be safe to stomp out.

2 Immediately throw water or any other nonflammable liquid on the fire.
Use water from a thermos or cooler, a sports drink, or beer (which has a high water content). Do not use hard liquor, which may only increase the fire's strength.

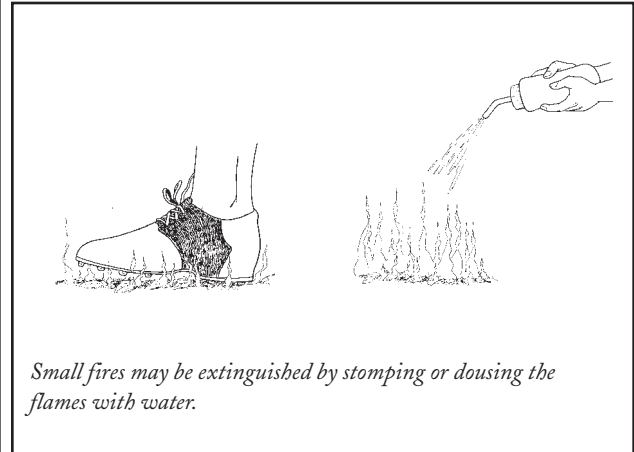

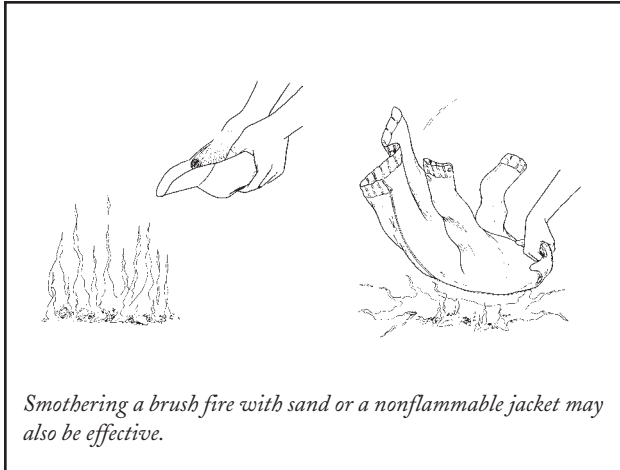

- 3** **Throw dirt or sand on any remaining flames.**
- 4** **Cover the fire and embers completely with a non-flammable blanket or jacket.**

Suffocate a fire that is just beginning—but be careful not to fan the flames or feed easily flammable material to the fire.
- 5** **Once the fire appears to be out, stomp on the embers to make certain they are no longer burning.**
- 6** **If the fire is still burning, use a cell phone to call the fire department directly—not the clubhouse.**

If you have been unable to douse the flames and you do not have a cell phone, head immediately to the clubhouse or an emergency phone to call for help.

HOW TO AVOID STARTING A FIRE

- 1** **Always carry a cup or bottle of water if you are smoking on the course.**

You can use this to quickly extinguish any embers or fires before they get out of control.
- 2** **Never puff on a cigar or cigarette while riding in a golf cart.**

The ember, carried by the breeze, may blow into leaves or dried grass, or onto flammable clothing.
- 3** **After lighting a cigar or cigarette, make certain that the match is cold, not just out.**

Hold it until it is cold, then break it so that you hold the charred portion before throwing it away.
- 4** **When you are finished smoking, grind out your cigar in the dirt or sand, or drown the cigar in water.**

Cover the butt with dirt. Never put out your cigar or cigarette by rubbing it against a stump, log, or other flammable object.

**WORST-CASE
SCENARIO.**

HOW TO PUTT WITH A DRIVER

1

Choke up on the grip.

A driver is longer than most putters. For comfort and control, place your hands lower than you do when you are using the club to drive.

2

Keep your feet relatively close together.

Stand taller than you normally do, playing the ball in a position opposite your forward foot.

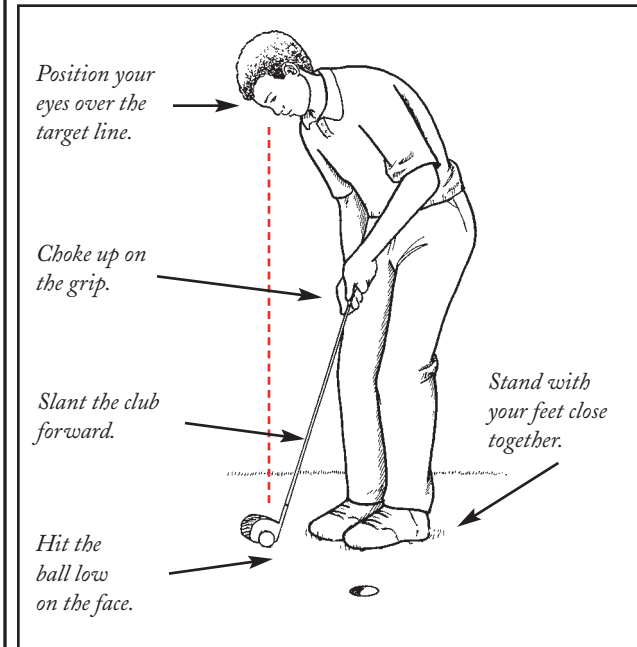

3 Move your hands in very close to your body and slant the club forward.

Tilting the shaft toward the target will decrease, or “close,” the loft of the club face. Turn or adjust the face of the club into a square position.

4 Position your eyes over the target line.

Lean your body forward from the hips so your eyes are directly above the target line. You should be able to see the alignment of the club’s face more easily from this position, increasing your chance of making quality contact and rolling the ball with the proper spin.

5 Do not hit the sweet spot.

Hitting the ball thin, or low on the face, will give you better control over the distance that you are trying to cover.

6 Hit smoothly.

Make an even-paced, smoothly accelerating, and rhythmic stroke, not a popping jerk or a jab. Focus on getting the distance right on longer putts rather than on getting the line exactly right.

**WORST-CASE
SCENARIO®**

**WORST-CASE
SCENARIO®**

HOW TO REMOVE A TICK

Because you will probably not feel a tick biting you, it's a good practice to check yourself for ticks thoroughly after every round of golf.

1 **Locate the tick.**

Look for a small bump on the skin, similar to the last remnants of a scab before it heals. Ticks vary in size from the head of a pin to a fingernail (when they are engorged) depending on the type and the stage of maturity. Ticks are usually brown or reddish. Check behind the knee, between fingers and toes, in the underarms, in the belly button, in and behind the ear, on the neck, in the hairline, and on the top of the head.

When engorged, ticks can be as large as your fingernail.

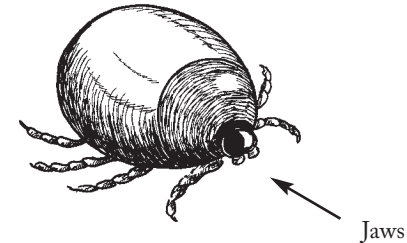

2 Act quickly to remove the tick.

Use a commercially available tick removal tool if one is available. Follow the instructions that come with the device. If no tick removal device is available, locate a pair of medium- or fine-tipped tweezers.

3 Place the tip of the tweezers around the area where the jaws of the tick enter the skin.

Using a slow, steady motion, pull the tick away from the skin. Do not jerk, crush, squeeze, or puncture the tick, because more pathogens from the tick may get into the wound. If part of the tick breaks off, try to remove it as you would a splinter. Your body will naturally eject the foreign material over time, so leave it alone if you cannot remove it easily.

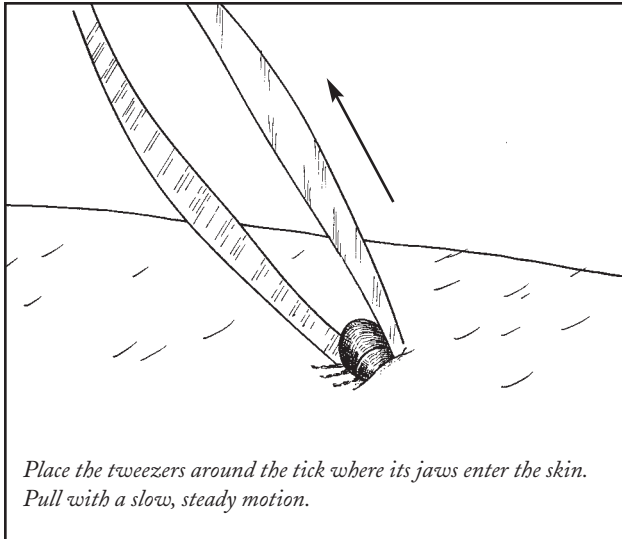

*Place the tweezers around the tick where its jaws enter the skin.
Pull with a slow, steady motion.*

4 If no tweezers are available, use the nails of your index finger and thumb.

Avoid touching the tick with your skin; use latex gloves, plastic baggies, or even paper towels to cover the skin of your fingers. If nothing to protect your skin is available, try using two credit cards as tweezers: squeeze the edges together to grab the tick and then pull firmly away from the skin. Failing this, it is better to remove the tick with bare forefinger and thumb than to leave it attached.

5 Immediately disinfect the area around the bite with soap and water, alcohol, or antibacterial ointment.

If you carry club-cleaning fluid in your bag, this may suffice until other disinfection means are available.

6 Place the tick, dead or alive, in a sealable container.

Include a lightly moistened paper towel. Take the tick to a local health department to be analyzed, to determine if it is carrying disease.

HOW TO RECOGNIZE LYME DISEASE

Watch for these symptoms:

- A round, “bull’s eye” rash on the skin, which may be very small or up to twelve inches across.
- Other rashes or skin bruising that can mimic common skin problems, including hives, eczema, sunburn, poison ivy, and flea bites. The rash may itch or feel hot, and it may disappear and return several weeks later. The rash will look like a bruise on people with dark skin color.

- Flu-like symptoms several days or weeks after a bite from an infected tick: aches and pains in the muscles and joints, low-grade fever, and fatigue.
- Other systemic symptoms, which can affect virtually any organ in the body, including jaw pain and difficulty chewing; frequent or painful urination and/or repeated urinary tract infections; respiratory infection, cough, asthma, and pneumonia; ear pain, hearing loss, ringing, sensitivity to noise; sore throat, swollen glands, cough, hoarseness, difficulty swallowing; headaches, facial paralysis, seizures, meningitis, stiff neck; burning, tingling, or prickling sensations; loss of reflexes, loss of coordination; stomach pain, diarrhea, nausea, vomiting, abdominal cramps, loss of appetite; and irregular heartbeat, palpitations, fainting, shortness of breath, and chest pain.

Be Aware

- Tucking your pants into your socks is a good preventive measure against ticks.
- Ticks do not drop from high vegetation or trees; they climb up your body, generally seeking the highest point on the body. However, if the tick meets resistance, it will stop and feed at that point.
- Ticks are most active in the spring and early summer, though they may be present at other times of the year.
- Ticks are found in virtually all climates and geographic regions, from the Antarctic to the Sahara. They will often be most abundant in areas with wildlife, whose blood provides their food supply.

- On the golf course, stay on the fairway and out of the rough to avoid ticks.
- Ticks can be difficult to remove, and improper removal can cause tick mouthparts to remain in the skin and/or pathogens from the tick's body to enter the bloodstream. In particular, small, immature ticks (called larvae or nymphs) can be very hard to remove in one piece.
- Lyme disease is treatable with antibiotics—and the sooner treatment begins, the better.

HOW TO RETRIEVE A BALL FROM A GOPHER HOLE

1 Determine whether your ball is in a gopher hole.

If you were able to see your ball land and you have checked that area carefully, look for a gopher hole. A gopher hole will be a well-groomed hole in the ground approximately two to three inches in diameter. There may be a cluster of gopher holes, especially if you are in the rough near the edge of the woods.

2 Attempt to make visual contact with the ball.

Do not put your hand down the hole. You do not know what is down there.

3 If you see the ball, use your longest club to hook the ball and drag it toward the top of the hole.

Use your two or three iron, a long club with a relatively small club head. A ball retriever, designed for water hazards, may also work.

4 Pick up the ball with your other hand as it comes close to the top of the hole.

5 Leave the area quickly.

The animal you have disturbed may be angered by your invasion. While most animals are more afraid of you than you are of them, caution is always the best policy.

Be Aware

- A ball in the depths of a gopher hole is nearly impossible to see. Be sure to keep your eye on the ball if there are gopher holes on the course. Use at least two points of reference to mark where your ball lands.
- The gopher's burrow system may be linear or highly branched. A single burrow system may be up to 200 yards long. Underground tunnels are two to three inches in diameter and usually are 6 to 12 inches below the ground, but they may be more than six feet deep. You may need to use a flashlight to see within the complex maze.
- Gophers have menacing upper and lower teeth that are always exposed. They also have strong forepaws with large claws. If you are bitten or clawed, seek medical attention immediately. Although gophers are normally shy, they will bite.

The Rules

Once you identify your ball, you must advise your fellow players that you will be lifting it. You can pick up your ball without a penalty and drop it at the nearest point of relief from where it lies. If you are not in a hazard, the nearest point of relief is one club length from the nearest location no closer to the hole that allows you to take your normal stance and swing. If you are in a hazard, you cannot remove the ball without taking a penalty stroke.



If the ball is lost in the gopher hole, you may replace it without penalty. This is an exception to the general rule that a lost ball will cost you a stroke. The main question your opponents will have is whether there is reasonable evidence that your ball disappeared into a gopher hole rather than that the ball was lost elsewhere.

**WORST-CASE
SCENARIO®**

HOW TO RETRIEVE A BALL LOST IN THE WASHER

There are two common types of ball washers. One has a vertical, central cylinder in which the ball is placed. This cylinder slides up and down on a rod surrounded by brushes and soapy water. The other common type of washer has a circular cylinder and a crank; the ball makes several rotations through brushes or a rubber squeegee and soapy water with one crank.

VERTICAL BALL WASHER

- 1 Use a stick or shoehorn to dislodge the ball.**
If the portion of the washer that slides up and down breaks off, the ball and cylinder may come to rest in the bottom of the bucket, out of reach of your fingers.
- 2 Attempt to scoop the ball out of the broken cylinder.**
- 3 Use a screwdriver to disassemble the washer.**
If you are unable to pry the ball out, take apart the washer. If a screwdriver is not available, use a metal cleat tightener.

Vertical ball washer, cross section

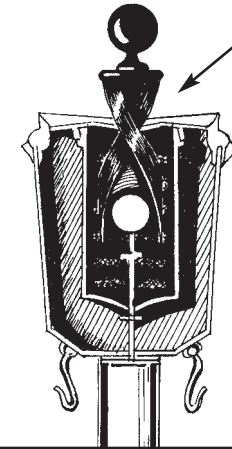

If plunger breaks off, use a stick or shoehorn to dislodge the ball.

- 4 If you are unable to take apart the washer, remove the washer from its mounting.**
The ball washer is usually attached to a post with a long screw or a cotter pin. Turn the washer upside-down.
- 5 Shake your ball out of the washer.**
- 6 Reassemble the washer.**

CIRCULAR BALL WASHER

- 1 Make a new crank.**
If the crank breaks off or the washer jams, use a wrench or pliers to fashion a new crank.

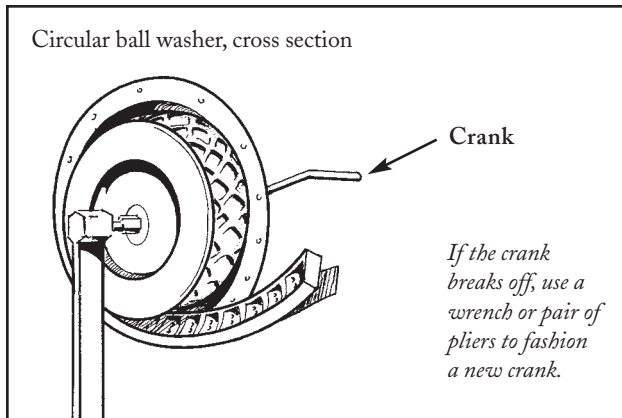

2 Take apart the washer.

If the improvised crank does not work, disassemble the washer (see steps 3 through 6, previous page).

Be Aware

- Greens keepers frown upon tampering with golf equipment. It may be better to simply use a new ball.
- Golf etiquette dictates that you should not delay play. If you think it will require more than a few minutes to disassemble the ball washer, retrieve your ball, and reassemble the washer, keep moving instead.

The Rule

No penalty is assessed for a ball lost in the washer.

**WORST-CASE
SCENARIO®**

HOW TO RETRIEVE A BALL STUCK IN A TREE

If your ball is lodged in a tree, you have the option to play it as it lies or declare it unplayable. No matter which decision you make, you will need to climb the tree to access the ball.

1 Attempt to identify the ball from the ground.

The rules require that a player identify his or her ball prior to hitting or moving it. You will save yourself a climb if you can determine from the ground that the ball is not yours.

2 Determine if the tree is dead or alive.

Do not climb dead trees—they are much more dangerous than living trees. A dead tree's limbs may break unexpectedly.

3 Survey the tree and surrounding area for hazards.

Do not climb a tree that is touching or is intertwined with power lines. Look into the tree to determine if there are any animal nests near your ball. Although most animals will flee when you get close, squirrels protecting their nests and raccoons living in the hollow of a tree may be dangerous.

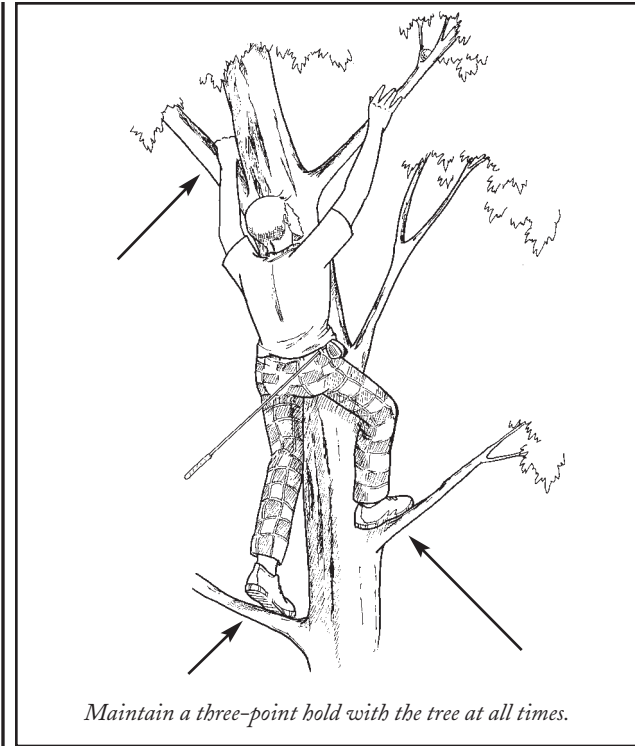

4 Grab a branch at its base or “crotch.”

The strongest and thickest part of the branch is the place it splits from the trunk. The farther you go out on the branch, the weaker it is. Be careful not to grab a dead branch.

5 Use your legs, not your arms, to power yourself up the tree.

Your arms should only guide your ascent.

6 **Maintain a three-point hold when you are in the tree.**

Make sure that three parts of your body are attached to or touching the tree at all times; for example, if both feet are on the trunk, have at least one hand on a branch above as you reach to go farther.

7 **If you need to rest, wrap your arms around the tree or a sturdy branch.**

Try to use your legs to support you, if possible, rather than your arms.

8 **Reach out to your ball.**

Either knock it to the ground or put it in your pocket.

9 **Begin your descent.**

Your arms should bear your weight on the way down. To increase your grip on the branches during your descent, turn your palms toward you when gripping the branches.

10 **Follow the same path to go down as you took when you went up.**

Be Aware

- Buds or leaves on a tree indicate that it is living. Although the tree as a whole may be alive, you still need to watch for dead branches. Dead branches may be discolored compared to the rest of the tree and they may be missing their bark.

- Do not climb a tree if you are alone. If you encounter problems, your partner might be able to assist you or find someone who can.
- Cover your eyes with glasses or sunglasses prior to climbing, if possible. Twigs and branches may poke you. Wear a hardhat or baseball cap to help protect your head.
- Do not climb a tree when it is raining or if the tree is wet. The tree will be slippery.

The Rules



If you shake the tree to get the ball down for the purpose of identifying it (before declaring it unplayable), you will incur a two-stroke penalty.



If, before declaring your ball unplayable, you swing at a branch lower than where your ball sits and you move the ball, you have incurred a one-stroke penalty for moving your ball. You must replace the ball. You are not charged a stroke for the swing at the branch. If you cannot replace the ball, you must now declare the ball unplayable and add a stroke to your score.

WORST-CASE SCENARIO®

HOW TO SCALE A FENCE TO RETRIEVE A BALL

- 1 Look for a gate.**

If you cannot reach over, under, or through a fence to retrieve your ball, you will need to get to the other side. A nearby unlocked gate is the easiest means. If the gate is locked, the lock mechanism may serve as a good foothold.
- 2 Look for the best part of the fence to scale.**

Assess the fence for hand- and footholds. Typically, fences will be either chain-link or slatted wood. Chain-link fences, the more common type, provide excellent hand- and footholds. If the fence is wood, look for a part of the fence with a support post (preferably on both sides).
- 3 Assess the dangers of your landing area.**

If the ground on the other side of the fence slopes off, make sure you can see what is at the bottom of the slope. Look also for rocks, soft sand, thorns, mud, water, or other hazards that may jeopardize your safety during and after your landing. Look for signs of animals. Snakes, alligators, or guard dogs may lurk on the other side. Whistle, or shake the fence before you attempt to climb; an animal may reveal itself.

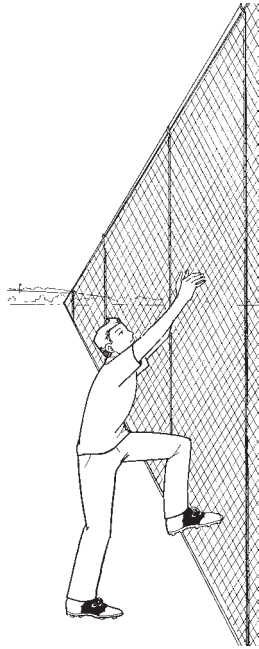

Grab as far up the fence as you can, and establish a foothold.

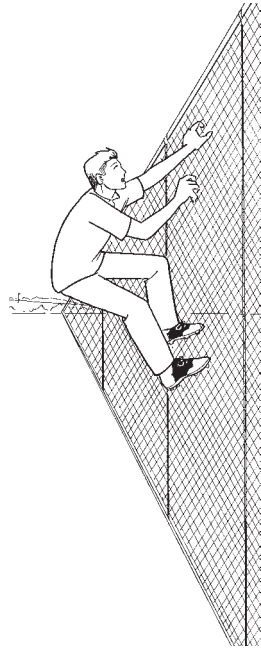

Use your legs and feet to push yourself up, and maintain balance with your arms.

4 Prepare to climb.

Stretch. Take a few deep breaths. Remove articles of clothing or jewelry that might get caught on the top of the fence.

5 Grab the fence as high as you can reach.

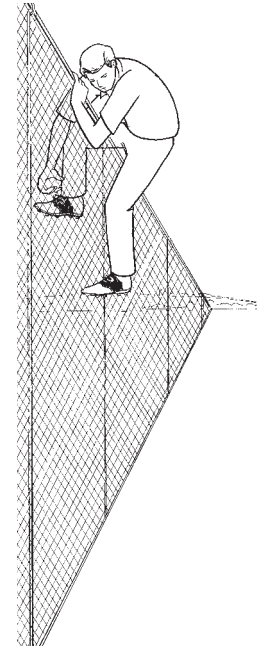

When you reach the top, swing your feet and legs over first. Find a foothold on the other side.

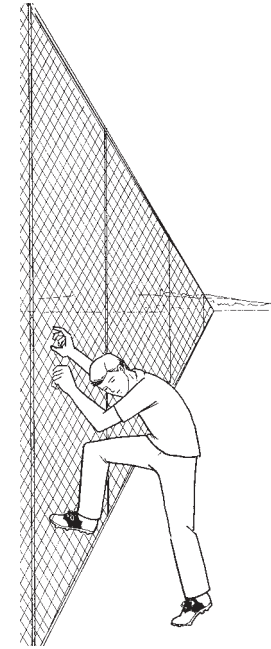

Climb down in the same manner you ascended.

6 Establish a foothold.

Try to get as much of your toe on the foothold (or inside it) without getting it wedged too tightly. Use the cleats in your golf shoes to clip onto the fence.

7 Use your legs and feet to push yourself up.

Maintain balance with your arms, and pull as needed. Your leg muscles are bigger and stronger than those in your arms. Your arms will tire more quickly, which may affect your ability to get back over the fence.

8 When you reach the top, determine the best method for your descent.

You may be able to climb down the fence in the same manner you ascended: place your feet over the fence first, finding a foothold that will support you as you lower yourself with your arms.

Or

Go over headfirst.

Place your stomach on top of the fence, dip your head down, and swing your legs over and down. If the top of the fence is sharp or jagged, do not use this method.

Or

Jump.

Golf shoes will not absorb the impact of a jump of any significant distance. Aim for a clear landing spot, deeply bend your knees on landing, and be prepared to roll. Roll to your strong side (i.e., if you are right-handed, roll to your right). Tuck your shoulder and continue to let yourself roll until you come to a stop naturally.

9 Retrieve your ball.

Place it in your pocket or toss it over the fence. Do not hold it in your hand as you climb back over.

10 Repeat the process to return to the course side of the fence.

Be Aware

- A ball retriever can help you reach a ball lying just on the other side of the fence. If you do not carry a specially designed ball retriever, be cautious about reaching through a fence with a club: you could wind up losing the club as well as the ball.
- Do not trespass. Although people living along a golf course may be used to people invading their land, trespassing is a crime, and a serious fence may be an indication that the owner will protect property rights.

The Rule



Hitting a ball out of bounds incurs a one-stroke penalty. The rule also states that you must hit your next shot from where you originally played the ball, not from where it landed. If you play your ball from its out of bounds position, you will be assessed a two-stroke penalty in stroke play and a loss-of-hole penalty in match play.

WORST-CASE SCENARIO®

HOW TO SPOT A RABID ANIMAL

- 1 Watch out for raccoons, skunks, and bats.**

All warm-blooded animals can carry rabies, but the disease is most common among these animals. Coyotes, foxes, and larger rodents, such as ground-hogs, can also carry rabies. It is rare among mice, squirrels, chipmunks, guinea pigs, hamsters, rabbits, rats, and other small rodents.
- 2 If the animal is foaming or appears to have a locked jaw, stay away.**

There are two type of rabies: “furious” rabies and “dumb” rabies. Animals with the former are hostile, may snap and bite, and have an increase in saliva, which makes their mouths appear to be foaming. Animals with the latter (also called paralytic rabies) are timid and shy, and may have paralysis of the lower jaw and muscles.
- 3 If you are bitten by any animal, immediately wash the bite out with soap and running warm water.**

The wound can also be treated with an antiseptic such as hydrogen peroxide or an antibiotic ointment. Dress the wound with a sterile cloth or bandage, and put pressure on the wound to stop bleeding. Get professional medical attention as soon as possible.

4 **Call animal control authorities to report the incident.**

Describe the animal and where you were when you received the bite so that they can try to catch the animal. Tests will determine if the animal has rabies. Without the animal to test, the medical treatment may mean painful injections, since health providers will have to assume the animal had rabies. Do not try to catch the animal yourself.

5 **Monitor your health.**

Early symptoms of rabies include mental depression, restlessness, and abnormal sensations such as itching around the site of the bite, headache, fever, tiredness, nausea, sore throat, or loss of appetite. Other early symptoms include muscle stiffness, dilation of pupils, increased production of saliva, and unusual sensitivity to sound, light, and changes of temperature. Symptoms usually develop within two to eight weeks after infection. The more severe the bite, the sooner the onset of symptoms.

Be Aware

Generally, you will know if a wild animal has bitten you. However, bat bites can be small and may not be felt. A bat that is active by day, that is found in a place where bats are not usually seen, or that is unable to fly is far more likely to be rabid.

**WORST-CASE
SCENARIO®**

HOW TO START A DEAD CART

- 1 Move the key switch to the “off” position.**
If you do not have the key, borrow one from another cart; most cart keys are interchangeable.
- 2 Locate the battery.**
The vast majority of golf-cart power failures are due to problems with the battery connections. The battery (or batteries) is generally located under the driver’s seat.
- 3 Cover your eyes.**
Put on glasses, sunglasses, or protective goggles before touching the battery.
- 4 Move the tow/maintenance switch to “off.”**
Most electric carts have a towing switch that provides power to the electric speed controller. Turning it off will help to prevent arcing (sparking) across the battery. The tow/maintenance switch should be located near the battery. Note that instead of “on” and “off,” the switch may be labeled “run” and “tow/maintenance,” respectively.
- 5 Check the terminals for corrosion.**
Look for corrosion where the wires meet the battery terminals. A poor connection at one of the battery terminals may cause the cart to stop running.

- 6 Secure the connection.**
A loose connection can cause the amperage to increase, which can damage the cart’s electrical system and prevent it from running. Use clamp-on pliers or vise grips to secure the wire-to-terminal connection. Wear your golfing glove(s) for safety.
- 7 Move the tow maintenance switch to “on” (or “run”).**
- 8 Move the key switch to the “on” position to start the cart.**
- 9 Put the cart in gear, depress the accelerator, and drive.**

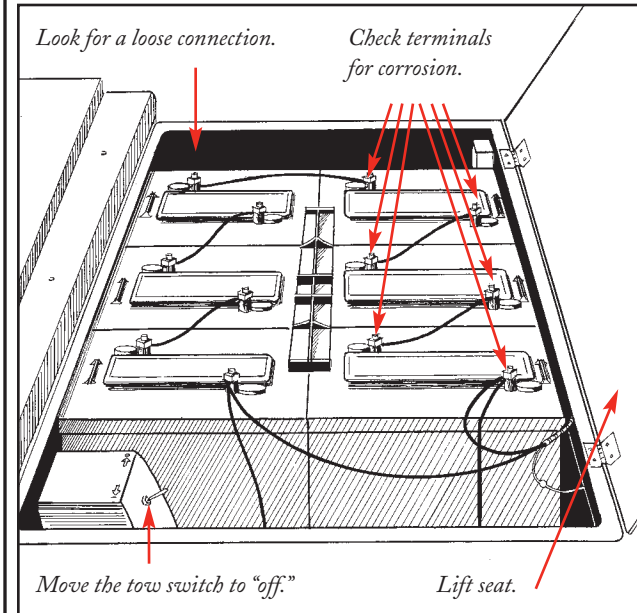

STARTING DEAD GAS CARTS

- Starter problems with gas carts are usually battery related. First check the battery connections. Repair as appropriate (see preceding pages).
- Check to see if you have run out of gas. Refill the tank if it is empty.
- Check the fuel lines and filter for a blockage or faulty connection. If the problem is not apparent, abandon the cart.

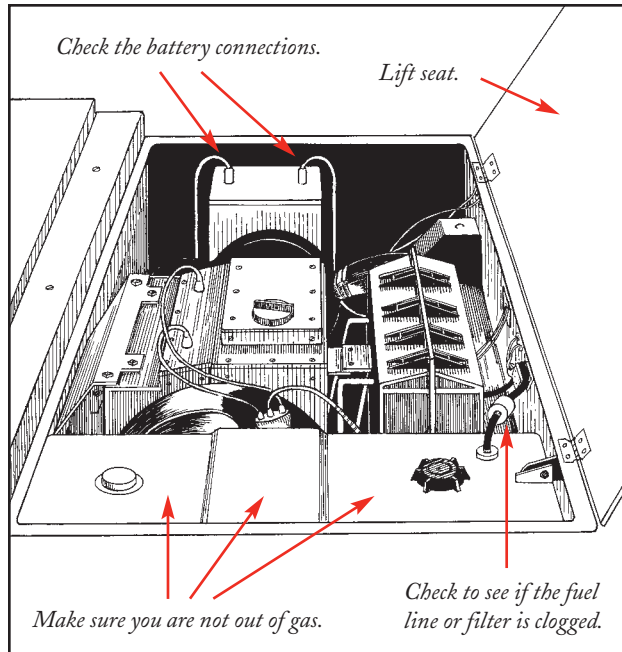

**WORST-CASE
SCENARIO.**

HOW TO STOP A RUNAWAY CART

IF YOU ARE IN THE CART

1 Attempt to shut off the cart.

If the cart is electric, turn the ignition key to the “off” position. If the cart is gas powered, do not turn the key to the “off” position—leave it in gear.

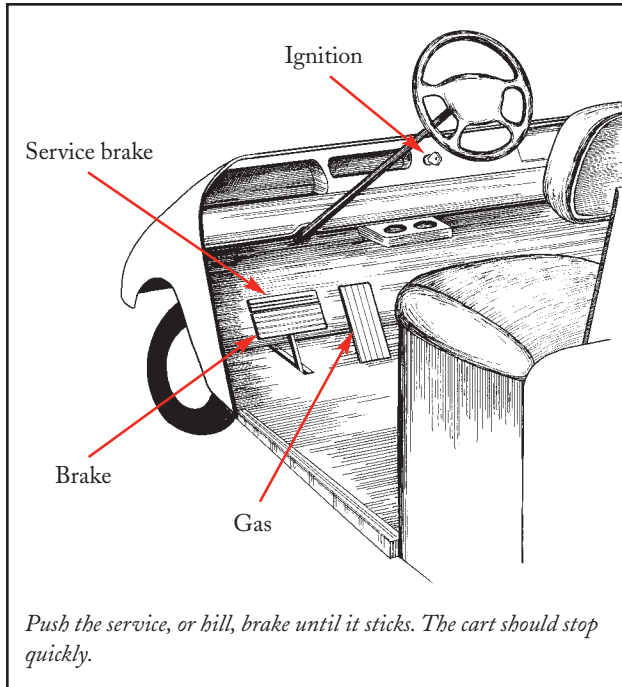

2 Try to engage the service brake.

The service, or hill, brake is located on the top half of the brake pedal. Push it forward until it sticks. If it engages, the cart should stop quickly.

3 If the service brake fails, wait for the automatic emergency system to stop the cart.

If you are still moving, there has been a brake failure. Most late-model electric carts also have “downhill braking,” an automatic emergency system that is designed to stop the cart in the event of downhill acceleration. This emergency brake should now engage. Gas carts do not use downhill braking: They have compression braking, which uses the engine to stop the cart experiencing uncontrolled acceleration. This emergency system should also activate automatically.

4 If the cart does not stop, attempt to ride it out.

You should be able to steer a golf cart even with the key turned off. Stay in the cart and steer onto a gentle incline, which will slow or stop it. Do not jerk the wheel or make any sharp turns. If the cart is accelerating downhill or into unsafe terrain and you cannot slow it down, prepare to exit.

5 Jump out of the cart.

Do not try to land on your feet. Leap out and away from the path of the cart, rolling on your side to lessen the impact until you are at a safe distance. Protect your head with your arms and aim for grass or other forgiving terrain.

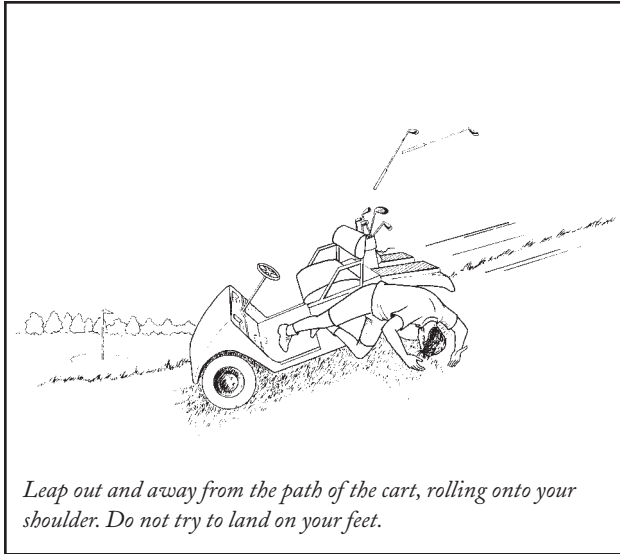

Leap out and away from the path of the cart, rolling onto your shoulder. Do not try to land on your feet.

IF YOU ARE NOT IN THE CART

1 Evaluate the situation.

If an empty cart is accelerating downhill and you are far behind, you may not be able to reach it. If the cart is headed uphill or into scrub brush rather than a water hazard, and there are no people in front of the cart, it may slow down on its own. If the cart is headed toward people, a green, or another area where it may cause damage, you may be able to intercept it.

2 Chase the cart and match its speed.

Unless the cart is traveling in a straight line downhill from your position, run at an angle that will allow you to catch up with it.

3 Grab the roof or a roof support.

If the cart is a model without a roof, grab the back of the seat. Do not reach for the wheel before you are in the cart, or you risk turning the cart into your path and running yourself over.

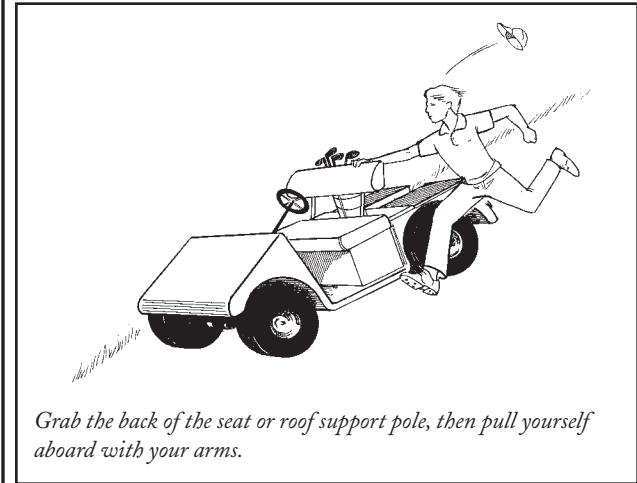

Grab the back of the seat or roof support pole, then pull yourself aboard with your arms.

4 Swing your body into the cart.

Do not dive into the cart head first. Pull yourself aboard using your arms. Swing your legs in.

5 Turn the steering wheel gently to obtain control.

Do not jerk it.

6 Steer the cart up a rise or into a sand trap.

The sand should slow it down and eventually stop it.

Be Aware

- The industry maximum speed for both electric and gas golf carts is about 14 miles per hour. (Special vehicles can reach speeds of 18 mph.) A runaway golf cart is usually traveling only with momentum, not with electric or gas power, and should not be traveling at more than a few miles per hour, unless it is going down a hill.
- Always set the hill brake when leaving the cart, whether or not you have stopped on a hill.

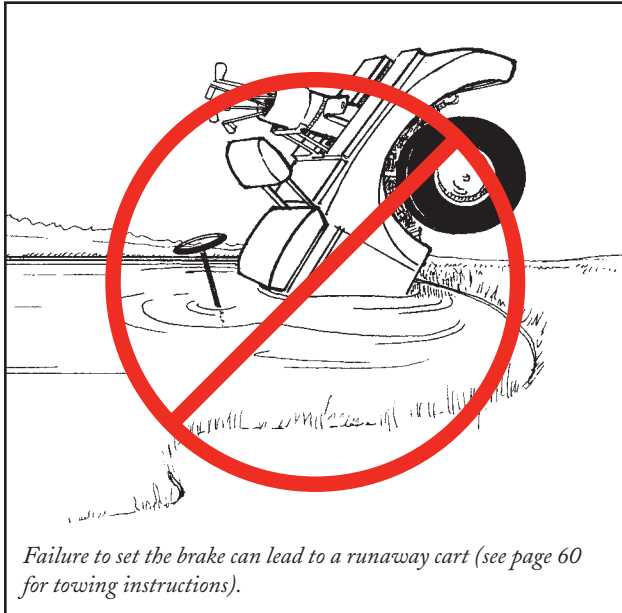

Failure to set the brake can lead to a runaway cart (see page 60 for towing instructions).

**WORST-CASE
SCENARIO.**

HOW TO STOP THINKING ABOUT A HORRIBLE SHOT

1 Express your displeasure.

It is important to express your anger or frustration with your bad shot so that you can let it go—just be sure to do so responsibly. Vent in a tactful way, in a manner that will not do damage to the golf course, your equipment, or another player.

2 Praise yourself for what you did right—and for the good shots you have had.

It is important to recognize your abilities. Pat yourself on the back. Do not get carried away, however; too much self-praise can lead to overconfidence.

3 Try to relax.

Breathe from the abdomen, in through the nose and out through the mouth.

4 Accept the fact that you will hit a few bad shots in any round.

If you know—but do not fixate on the fact—that you will hit a few bad shots during your round, your anticipation will replace your frustration. Create a checklist in your mind that includes potentially good and bad drives, approach shots, and putts. When you make one of your bad shots, simply check it off of your list and be glad it is gone.

5 Know that you cannot change the past, you can only alter the future.

There is no point in looking back to what was because there is nothing you can do about it.

6 Concentrate on your shots one at a time.

Each shot requires your focused attention based on the factors that are present at that moment.

7 Find your zone.

Learn to find that place where you feel empty just before you swing the club and let your shot happen.

8 Hit your next shot with confidence.

HOW TO SURVIVE A BIRD ATTACK

- 1 Watch for hovering and clacking.**
To intimidate predators, many species will hover and clack their beaks before attacking. If you observe this behavior, be ready for a bird attack.
- 2 Close your eyes and cover your ears.**
A bird will swoop down quickly, striking at the head or shoulders with its wings or beak.
- 3 Run for cover away from nesting and foraging areas.**
Run as fast as you can onto the green or fairway and away from the area, most likely in the rough, that the bird is protecting. Many species will attack if their nests or foraging areas are disturbed, even incidentally. If a bird attacks, it will continue to attack until you leave these areas. Continue to cover your ears while running.

Be Aware

- Wearing a hat can offer some protection to your head against attacks.
- Ducks and geese are notorious for going after people. They can approach noisily, heads high. When attacking, they will lower their heads, hiss and charge, and can tear exposed flesh with their sharp beaks.

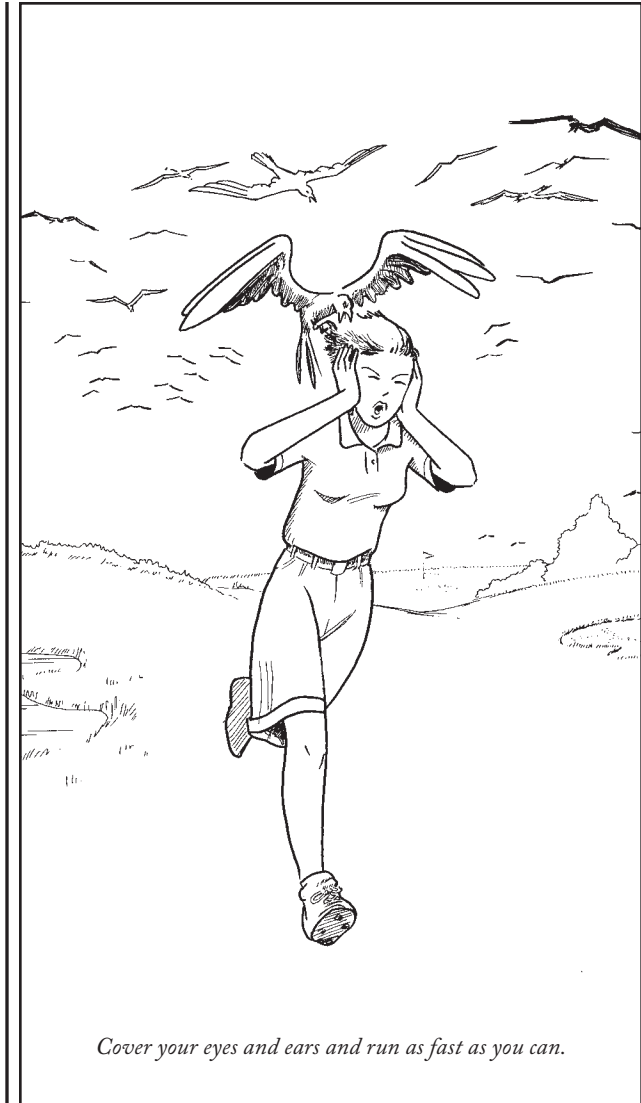

Cover your eyes and ears and run as fast as you can.

- Many species of bird common to golf courses will attack a human, particularly mockingbirds, blackbirds, and magpies.
- Do not carry food. Birds habituated to human contact, including seagulls and crows, will swoop down and bite at foods and the fingers that hold them, particularly if the person is gesticulating with the food.
- Birds and other wildlife found on golf courses are generally protected by law. Never use a golf club as a weapon against them.
- Do not assume it is safe to approach a nest just because no adult bird is in sight; eggs demand careful temperature regulation and adults are generally close by. Wild birds nest—and eggs hatch—during the spring, so be particularly careful when golfing at this time.
- While golfing in Australia, beware the cassowary. These flightless, ostrich-size birds may attack small humans when hungry.

**WORST-CASE
SCENARIO®**

HOW TO SURVIVE A TORNADO

1 Find shelter.

The worst place to be during a tornado is out in the open—as on a golf course. If you cannot get inside a sturdy building, find a ditch and lie flat, covering your head with your hands. A sand trap or bunker is a good spot. Do not attempt to outrun or use a golf cart to outrace a tornado.

2 If inside, go to the basement, storm cellar, or the lowest level of the building.

If you are in a building with no basement, go to a first-floor inner hallway or a small inner room without windows, such as a bathroom or closet. Avoid buildings—including clubhouses—that have eaves. High winds can get under the eaves and blow the roof off.

3 Stay low to the floor.

Very few “missiles” (wind-driven debris) penetrate walls below three feet above ground level.

4 Stay away from windows.

High winds and flying debris can shatter glass. Do not open windows.

5 Move to the center of the room.

Corners attract debris during high winds.

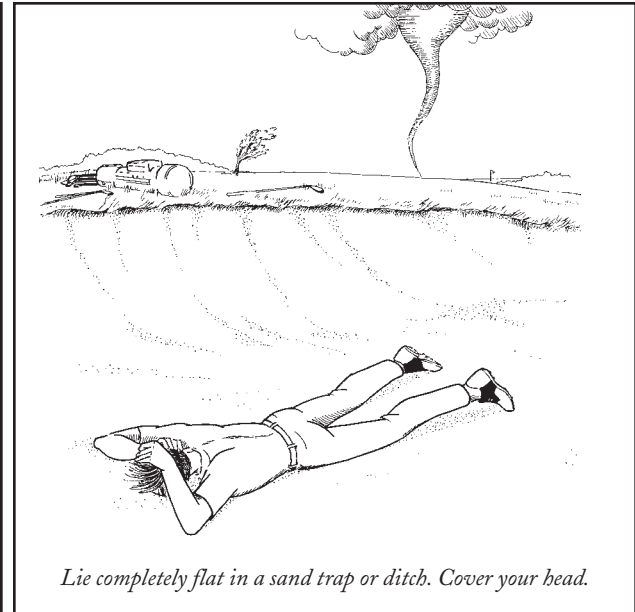

Lie completely flat in a sand trap or ditch. Cover your head.

6 Get under a piece of sturdy furniture.

Find a workbench or a heavy table or desk and hold on to it. If you are in a bathroom, lie down in a bathtub.

Be Aware

- Tornadoes are not always easy to spot. They can be nearly invisible, marked only by swirling debris at the base of the funnel. An approaching cloud of debris can mark the location of a tornado even if a funnel is not visible. Some tornadoes are composed of several mini-funnels.

- A dark, often greenish sky, large hail, or a loud roar can indicate that a tornado is imminent.
- Before a tornado hits, the wind may die down and the air may become still.
- Tornadoes generally occur near the trailing edge of a thunderstorm.
- Tornadoes can occur at any time of the year. In the southern United States, peak tornado season is March through May, while peak season in the northern United States is May through August.
- Tornadoes are most likely to occur between 3:00 and 9:00 P.M. but can occur at any hour.

**WORST-CASE
SCENARIO®**

WORST-CASE SCENARIO®

HOW TO SURVIVE BEING HIT IN THE GOOLIES

“Goolies” is a Scottish term, used at St. Andrews and elsewhere, that refers to the “privates,” or the groin area.

- 1 Lie down immediately.**
Do not walk around. Cover your private parts to shield the area from further injury (and embarrassment). Clutching yourself will probably be your natural reaction to being hit by a club head or ball.
- 2 Apply a cold pack to the injured area to reduce swelling.**
Use ice in a bag or cloth, or a cold can of soda or beer. This will help reduce the swelling and the pain.
- 3 Do not apply too much pressure.**
Extreme pressure may cause more pain.
- 4 If the pain is significant and does not subside within a few minutes, inspect the injury.**
Remove your pants to get a better look at the swelling and check for any irregularities.
- 5 If the pain lasts more than an hour, or if the area is significantly bruised, seek medical attention.**

WORST-CASE SCENARIO®

HOW TO SURVIVE IF YOU HIT A BEEHIVE

- 1 Get ready to act as soon as you realize that you have hit a hive.**

Striking a hive or nest with a ball or club will likely provoke a strong defensive response from the bees.
- 2 Do not swat.**

Never swat at honeybees or wasps. Swatting may incite them to sting when they otherwise had no intention of doing so.
- 3 Run from the nest.**

Bees and wasps can fly faster than you can run. However, the farther you get from the nest, the less likely they will be to follow you. When you are stung by a bee or wasp, you are marked with an alarm pheromone and other bees and wasps will continue the attack in response to the chemical. The intensity of the attack will continue to increase if you do not continue fleeing the hive area. Extremely defensive colonies may pursue you for half a mile.
- 4 Cover your face and head with your shirt or jacket.**

Bees and wasps usually focus their attack on the head and face. While running, pull your shirt or jacket up over your head, leaving only a small slit to see where you are going. A honeybee will lose its stinger and die once it stings, but a wasp can sting multiple times.

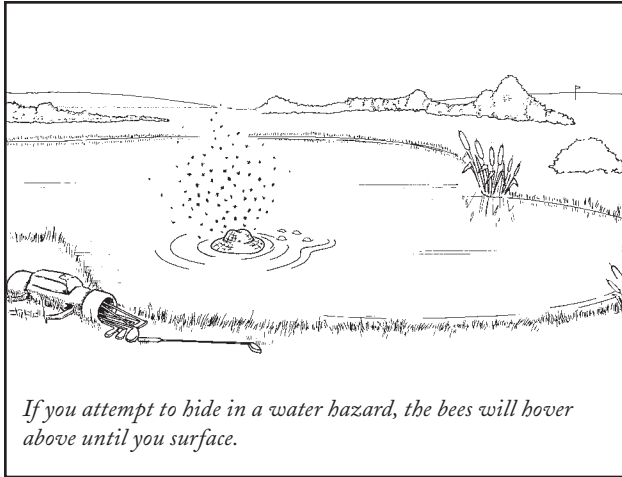

If you attempt to hide in a water hazard, the bees will hover above until you surface.

- 5** **Run for cover.**
Find the nearest enclosure: a car with the windows rolled up or a building are both good options.
- 6** **Do not jump into water.**
The bees will orient to your air bubbles on the surface and will remain there, stinging you each time you come up for air.

IF YOU ARE STUNG

- When you reach safety, quickly remove all the stingers by scraping them out with your fingernails, a credit card, or whatever is handy. Use a sideways motion; do not pinch the area. Seek medical attention if you have multiple stings.

HOW TO AVOID BEING STUNG

- Do not wear body fragrances such as scented creams, perfumes, and after-shave lotions. They may attract bees, and may incite an attack.
- Do not blow at or near a hive; bee and some wasp colonies react defensively to mammalian breath.
- Look for head-butting. Extremely defensive honey bee colonies will have a few bees patrolling the immediate vicinity of the nest. When approached they will begin to head-butt you in an effort to encourage you to leave. If this occurs, leave the area immediately.

Be Aware

- Honeybee colonies are commonly located in dark cavities in buildings, water valve boxes, and utility equipment, as well as in ground holes and cavities in trees. Usually the small entrance hole is all that is visible.
- Honeybee colonies are perennial, while wasp colonies develop in the spring and die in the fall. Both wasp and bee colonies reach their population zenith during the summer months.
- Vibrations from a golf cart may elicit a defensive reaction from the hive or nest.
- A swarm of honeybees may settle on a tree branch or on the overhang of a structure. These bees are looking for a new home, and such swarms are not usually defensive.

- Wasp colonies are usually much smaller than those of bees, and their paper nests are often exposed, leaving them more easily disturbed. Some wasp species build large enclosed nests that hang from tree branches.

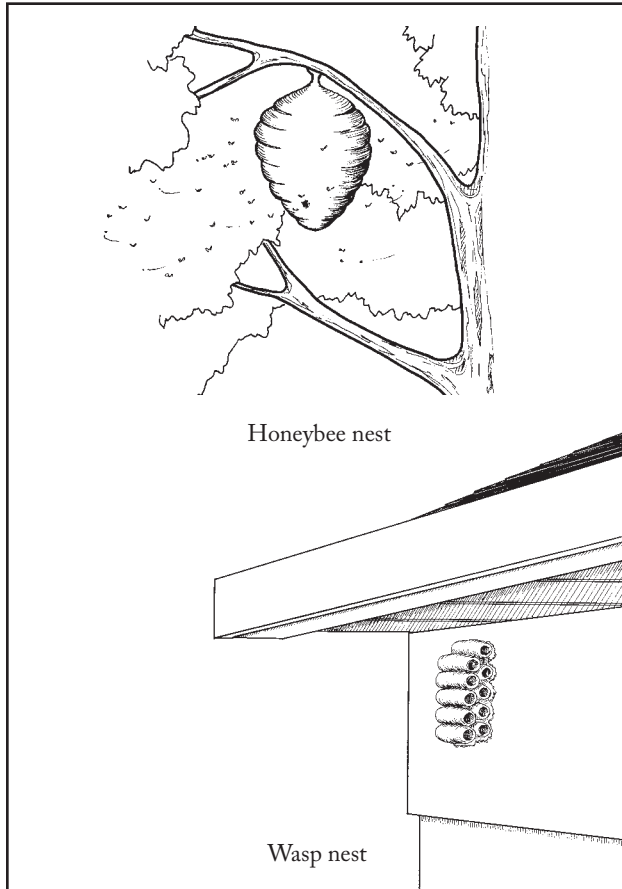

**WORST-CASE
SCENARIO.**

HOW TO SURVIVE IF YOU RUN OUT OF TEES

- ★ **Look for discarded or broken tees.**
Golf courses are often littered with broken tees. You may be able to find one with a long enough head, or one that you can easily repair with a bit of tape or gum.
- ★ **Build a pyramid of wet sand or dirt.**
Before the advent of plastic and wooden tees, golfers used sand to get the ball off the ground. If no sand is available, try using moist dirt from the rough to build your pyramid. Make certain the dirt does not contain pebbles or rocks that may alter your shot or fly down the course with your ball. Drive normally.
- ★ **Use smashed ground.**
Before your shot, swing the club face, leading edge down, into the ground. This will cause the turf to wedge up, creating a small mound on which you can place your ball.
- ★ **Use small sticks.**
Collect several sticks and build a pyramid. Gently place the ball on the pile.

The Rule

A player is not required to use a tee on the first shot, but has the option of doing so.



Repair a broken tee using gum or tape.



Build a pyramid out of sticks or dirt.

**WORST-CASE
SCENARIO®**

HOW TO TEE OFF IN FRONT OF A CROWD

1

Relax.

Try to see the first tee as any other shot in the round. Do not make significant changes in your tempo. Try not to rush any aspect of your pre-shot routine or swing. Ignore comments from the crowd waiting to play, or pressure from the starter to speed up.

2

Warm up.

Thoroughly stretch in whatever way increases blood flow to your body and feels good. Take as many practice swings as you need.

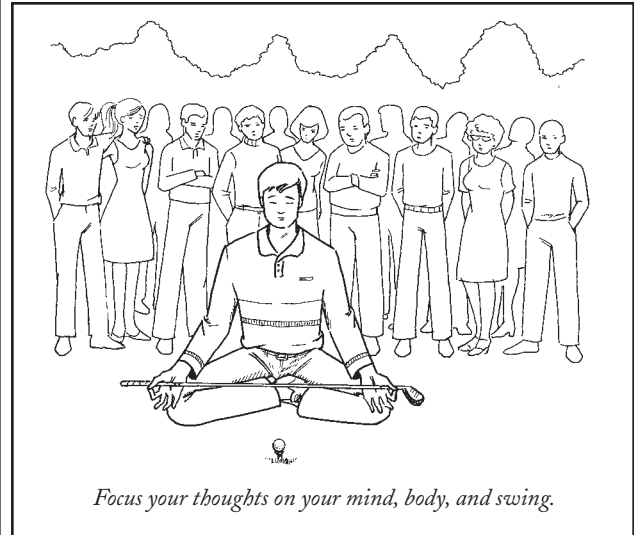

3 Release the tension in your body.
Identify where the tension is, consciously tighten that area of your body, and then consciously relax that area while noticing the difference. Take a deep breath—in through your nose and out through your mouth—before you hit.

4 Be mindful.
Tune in to your feelings prior to your first swing. Are you nervous? Anxious? Steeped in self-judgment? Be aware of these negative feelings and the consequences of them on your body. Recognize that these feelings often get in the way of your true golf swing and game. Replace those feelings with positive energy. Choose to feel competent and content. Remember a time when you played your best. Generate these thoughts until you are ready to hit the ball.

5 Be confident about your abilities and expectations.
If you hit the ball 200 yards 80 percent of the time, you will most likely hit the ball 200 yards this time. This does not mean that you should not strive for your personal best throughout the game. Recognize that the first tee is a starting point on which you are building a solid foundation for your day's golf game.

6 Select the club with which you feel most comfortable.
This may not be your driver. Use a long iron or three wood if your driver is not your best club off the tee.

7 Follow a routine for addressing the ball.
Keep to an established pattern of how you walk up to the tee, how many practice swings you take, how you set your stance, and at what moment you start your swing. This routine is especially important on the first tee.

8 Do not overanalyze your swing.
Your muscle memory will complete the swing for you if you cease to over-think it. Do not over-swing in an effort to hit the ball farther.

9 Focus.
Choose a single location on the fairway and aim at that spot.

Be Aware

- Spend time on the practice tee prior to hitting off the first tee. Go through six to eight clubs in your bag—start with wedges (they are easy to swing) and work your way up to woods. Visualize hitting off the first tee on your last 10 to 12 practice drives.
- Golf is the culmination of physical, emotional, and mental preparedness. It is a game that begins and ends in both the body and the mind of the golfer. The first tee is the initial setting where you need to understand and accept the interrelation of these three elements.

**WORST-CASE
SCENARIO®**

HOW TO THWART A CHEAT

Cheating at golf is so pervasive it seems to be part of the game: even people playing alone do it. There are mulligans off the tee, gimmies on the green, and lots of ways to get an unfair advantage in between. Here are a few of the most common scams and how to recognize and defeat them.

THE LOST BALL ROUTINE

While searching for a ball lost in the woods, the player drops another ball that he has been carrying and falsely announces to the group that he has found his original ball. He has saved himself a penalty stroke and has positioned the ball as he pleases. A variation on this play is to find a stray ball, claim it, hit it, and move on quickly.

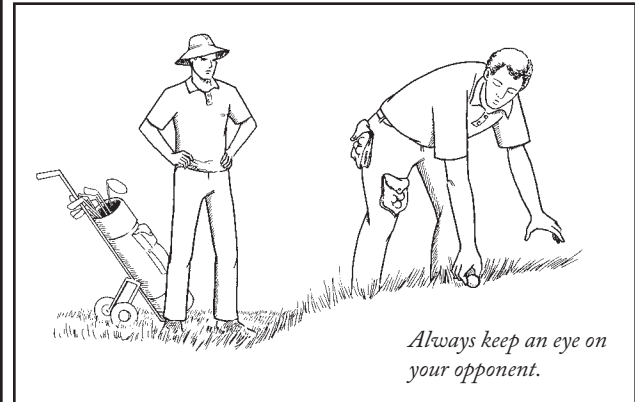

- 1** **Make a mental note of the markings on your opponent's ball at the start of the round.**

Notice color, scratches, brand, and number.

- 2** **Always help to look for a missing ball, and keep an eye on your opponent as well.**

Two people searching also speeds up play.

IMPROVING A LIE

The cheat gently taps her ball with a foot or the club, gaining a more favorable position.

- 1** **Stand near your opponent so that you can see the ball at all times.**

- 2** **Always watch your opponent, and, more important, let her know that she is being watched at all times.**

Subtle comments about her technique, her attire, or the nuances of her address will let her know she's being carefully observed. You do not have to stand by her side all day long, but put yourself in a position where you can see any errant moves. Being under constant surveillance makes most people less inclined to bend the rules.

- 3** **Note how much of the ball is visible as you approach it, and mark its position in relation to nearby objects, such as roads, trees, and traps.**

As the cheat goes to take the shot, the amount of the ball that is visible to you, even at a distance, should not change. Watch also for substantial changes in the ball's location; some players do not stop at simply tapping the ball to improve the lie.

REPORTING FEWER STROKES

On a hole on which everything went wrong, she drops a few strokes from the score before announcing or recording it. She realizes that most opponents will lose track at around eight or nine strokes, and may not question such a total for fear of embarrassing themselves or the player.

- 1** **Keep score carefully yourself.**

See "How to Keep Score without a Pencil" on page 69.

- 2** **Ask for a careful account of each stroke after every hole.**

Be supportive of your golfing companion. When she has a difficult hole, tell her to hang in there, that it happens to the best, and so on—but when the hole is complete, ask her to recap the hole in a friendly, sympathetic manner.

PLAYING DUMB

Though he has hit his ball out of bounds, into the water, or in any other situation where penalty strokes are applicable, he tries to take only one penalty stroke where two are warranted.

- 1** **At the completion of the hole, ask for a clear account of the score and applicable penalty strokes.**

- 2** **If there is any debate, be courteous, but firm.**
If the scoring remains unresolved, take it up with the club pro at the end of the round.

FAKE HANDICAP

Someone who has a five handicap introduces himself to a group of strangers and announces a higher handicap. After shooting a 78, he claims that it was the round of his life, and is somewhat sheepish about taking everyone's money.

- 1** **Take out your own USGA handicap card as you are having the discussion about handicaps.**
Tell the stranger that you have all agreed to show each other your cards before starting.

- 2** **At the end of nine holes, assess where this individual stands.**
If it is clear that things are not what they appear, demand an adjustment in his stated handicap. If he balks, play the back nine, but state that the competition or bet is off. If someone you just met dumps the front nine, scoring above his alleged handicap, be cautious about increasing ("pressing") a bet on the back nine. It could be a setup.

Be Aware

- Keeping an opponent honest requires you to be observant and to hold everyone accountable for his or her strokes as the round unfolds. This may seem

tedious at times, and may cause some odd interactions with your opponents. You must decide what is more important to you: interpersonal relations or winning.

- Cheating can occur even when there is no betting or competition between players. A player seeking to claim a new course record or his own personal best score can seek to shave strokes from the scorecard. You can decide how involved you want to be.

WORST-CASE SCENARIO®

HOW TO TREAT A BLISTER

- 1 Cover the blister with a bandage.**

If you do not have a bandage with you, you can fashion one with a tissue and a piece of adhesive tape or grip tape: fold the tissue until it is just big enough to cover the blister, then tape it. Small blisters (less than three-quarters of an inch) do not usually need any further care.
- 2 If the blister is large and swollen, prepare to pop it.**

Use alcohol (brandy or whiskey from a flask will do the trick) or the flame from a match or lighter to sterilize a needle. Hold the needle in the flame for at least ten seconds.
- 3 Pierce the blister with the needle.**

Hold the needle parallel to the surface of the skin. Puncture the blister near the edge to make draining easier.
- 4 Drain the fluid.**

Gently apply pressure to squeeze out the fluid. Dispose of the needle in a sturdy plastic or metal box so that it does not accidentally prick anyone else.

- 5** **Cover the sore immediately with a bandage.**
See step 1. If you have antibiotic cream, use it.

- 6** **Watch for signs of infection.**
These include redness, swelling, pain, discharge, and fever. If you have these symptoms, get to a health-care professional.

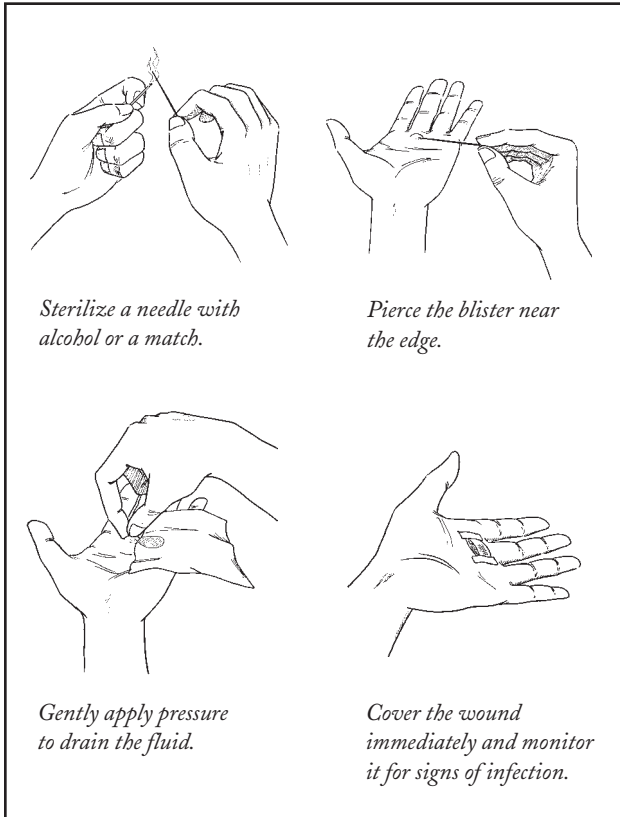

**WORST-CASE
SCENARIO®**

HOW TO TREAT A SPRAINED ANKLE

- 1 Sit or lie down immediately.**
Do not put any weight on the ankle.
- 2 Make a cold compress.**
Cold will constrict blood vessels and reduce swelling. Place ice in a plastic bag or wrap it in a shirt. Do not apply the compress directly to the skin; add a layer of clothing or plastic to prevent freezing of tissue. Applying cold cans may also reduce swelling.
- 3 Elevate the ankle.**
Sit down and raise the ankle at least 18 inches above the ground by putting a log, golf bag, or other object under the calf.

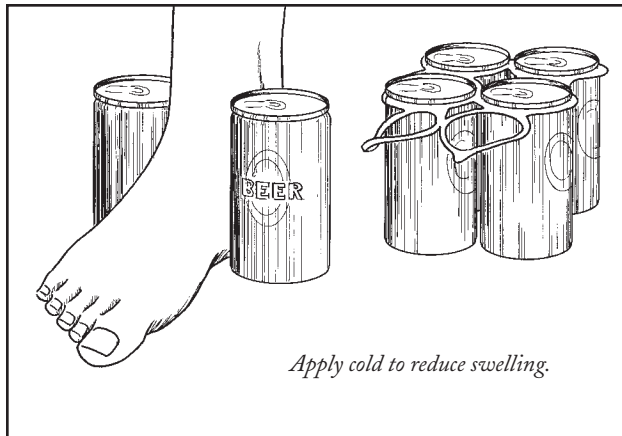

- 4 Apply the compress for 30 minutes, then remove.**
If the sprain is particularly bad and swelling is rapid and severe, leave the compress on for 15 additional minutes.
- 5 Make a pressure bandage.**
If no emergency bandage is available, cut or tear cloth into long, four-inch-wide strips. Two three-foot strips should be sufficient. If available, use an elastic wrap.
- 6 Wrap the ankle.**
Put one end of the bandage in the middle of the foot and use a figure-eight pattern to wrap up and over the ankle and back around the foot. Make sure the bandage is snug and the ankle immobile. Use tape, rubber bands, string, or shoelaces to secure the end of the bandage to the leg.

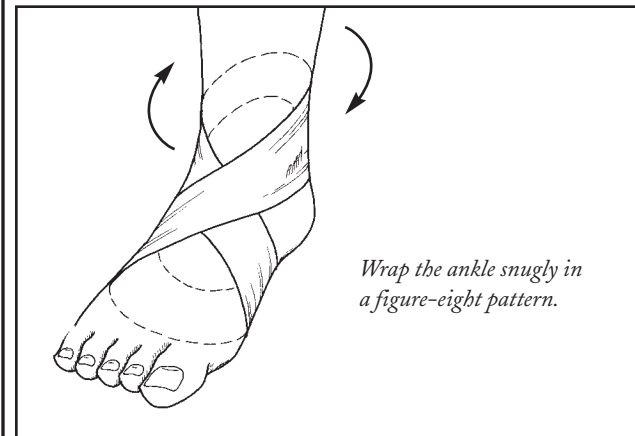

7 Reapply the cold compress for another 30 minutes.

8 Leave the course.

Use a golf cart to reach the clubhouse. If no cart is available, use an umbrella, ball retriever, sturdy tree branch, or sand wedge as a cane for support.

9 Take ibuprofen to reduce the swelling and relieve pain.

If ibuprofen is not available, take acetaminophen, which will relieve pain but not swelling. Avoid aspirin, which can thin the blood.

10 Seek medical attention immediately to ensure that the ankle hasn't been broken or fractured.

Be Aware

Sprains are generally a result of tissue damage to the front outside ligaments of the ankle. X-rays are usually not needed for sprained ankles but should be obtained if you are unable to bear weight for more than six steps; if you feel pain in the back of either of the bones that normally protrude from the sides of the ankle; or if you have pain anywhere along the line from your ankle to your smallest toe.

**WORST-CASE
SCENARIO®**

WORST-CASE SCENARIO®

HOW TO TREAT POISON IVY, POISON OAK, AND POISON SUMAC

- 1 Wash the exposed area of skin.**
Immediately wash the contaminated area with large amounts of running water.
- 2 Wash shoes, socks, pants, gloves, and clubs immediately.**
Urushiol oil, which causes the rash, can stay active on objects for up to a year. Dilute the oil by washing equipment with lots of water. Slop rubbing alcohol over exposed skin (except on the face) and rinse with water. (Carry a jar containing rubbing alcohol and a small cloth.) Rubbing alcohol neutralizes the oil.
- 3 Do not scratch the rash.**
A rash usually develops a few hours to a few days after exposure. It will start with an itch accompanied by a light rash that continually becomes more intense and eventually blisters. Excessive and continual scratching can lead to neural dermatitis (persistent itch) that can continue even after the reaction has stopped. The total reaction usually lasts two weeks or less. If the itch is intolerable, seek medical assistance.



Poison ivy



Poison oak



Poison sumac



4

To reduce itching, run hot water over the rash or blister area.

Gradually increase the temperature of the water (be careful not to burn yourself). Let the water run hot until you feel bursts of relief from the area, which may take five minutes or more. Hot water helps to release histamines from the skin. This method can relieve itching for eight hours or more. Warm or cold packs and calamine lotion can also reduce itching. Prescription cortisone cream is many times the strength of over-the-counter cortisone cream and can be used for severe itching.

Be Aware

- Poison ivy and oak thrive in disturbed ground, such as land molded and shaped for golf courses; be sure to ask if it is present on the course before beginning your round. Size and appearance of poison ivy and oak varies with habitat. Poison sumac is fairly rare and limited to deep swamps. Its leaflets can be from two to eight inches long, and the plants can be six inches high, or can vine to the top of a 20-foot-tall tree. All three plants contain urushiol.
- Poison ivy and poison oak grow in all areas of the United States except for southwestern deserts and mountain elevations above 4,000 feet.
- Even when leaves are not present, the stems, berries, and roots of the plants still contain the oil and should be avoided.
- To prevent exposure, wear shoes and socks and long pants, not shorts.

- Do not rub other plants or leaves on an affected area to treat or prevent a rash. There are no plant juices known to neutralize urushiol, and juices spread on the body in small quantities are likely to spread the oil and increase the rash.
- Even if you have not previously reacted to poison ivy, oak, or sumac, do not assume you are immune. After the first exposure, and especially after repeated exposures, 85 percent of people will have an allergic reaction.
- A golf ball that rolls through any of these poisonous plants, or that has come to rest among the leaves or vines of the plants, may be contaminated with urushiol oil. Carefully pick up your ball with a towel or while wearing your glove and wash the ball immediately. Wash the towel or glove before using it again.

**WORST-CASE
SCENARIO®**

WORST-CASE SCENARIO®

HOW TO TREAT SUNBURN

- 1 Get out of the sun immediately.**
- 2 Do not apply suntan lotion, oil, petroleum jelly, ointment, or butter to the burn.**

These will make the symptoms worse and prevent the skin from cooling in the air.
- 3 Apply a cool compress.**

Take off your shirt and soak it in cold water. Dunk it in a water hazard if no other source of water is available. Wear the shirt or hold it on the burned area. (Continue to apply the cool compress once you are at home, or take a cool bath.)
- 4 Drink water.**

Drinking 32 to 64 ounces of water will prevent dehydration and promote sweating.
- 5 Use a soothing gel or lotion on the skin to cool the burned area.**

Aloe works best. If aloe plants grow nearby, break off a leaf and squeeze the gel out directly.
- 6 Seek medical attention immediately if you experience serious symptoms.**

Side effects to watch for include faintness; dizziness; a fast pulse or fast breathing; pale, clammy, or cold skin; sensitivity to light; rash; fever; nausea; or chills.

Be Aware

- Avoid sun exposure between 10:00 A.M. and 2:00 P.M. standard time because the sun is at its hottest during these hours. Remember that the sun's rays are stronger at high altitude and close to the equator.
- Use a sunscreen with an SPF (sun protection factor) of at least 15, and apply it at least 30 minutes prior to exposure.
- If the burn is mild, a hot shower immediately after the burn can cause peeling and actually relieve itchiness more quickly.
- Prolonged exposure to sun and heat can also cause heat exhaustion and/or heatstroke. Heat exhaustion is usually a mild illness brought on by exposure to heat, but heatstroke, which develops beyond the point of heat exhaustion, can be fatal. Symptoms of both include fever and sweating, but an important difference is the presence of mental confusion. If the victim is confused, the illness is no longer heat exhaustion—it is heatstroke.

HOW TO TREAT HEATSTROKE

1 Immediately immerse the victim in cold water.

The core body parts (chest and abdomen) are the most important to cool. Body temperature must be reduced immediately. Heatstroke is usually fatal if not treated rapidly.

2 Remove the victim's clothing and spray the skin with cool misted water while fanning the skin.

Use this method, known as evaporative cooling, only if immersion is impossible. Do not use cold wraps with wet towels, alcohol, or ice cubes; these are not effective cooling measures.

3 Stop the cooling when the body temperature falls below 102° F.

Hypothermia may result if the victim becomes too chilled. In most cases, you will not have access to a thermometer, so continue cooling measures until safe temperatures are confirmed by a health-care professional.

4 Do not administer acetaminophen or aspirin.

Both of these drugs may worsen heatstroke: acetaminophen by damaging the liver, and aspirin by increasing core temperature.

5 Get the victim to a health professional as soon as possible.

HOW TO PREVENT HEATSTROKE

- Wear a light-colored cotton shirt.
- Wet your shirt in cool water to enhance cooling through evaporation.
- Spray misted water on your face, arms, and legs to promote cooling.
- Drink plenty of cold fluids.
- Take frequent shade breaks.

FASHION EMERGENCIES

SPLIT SEAM

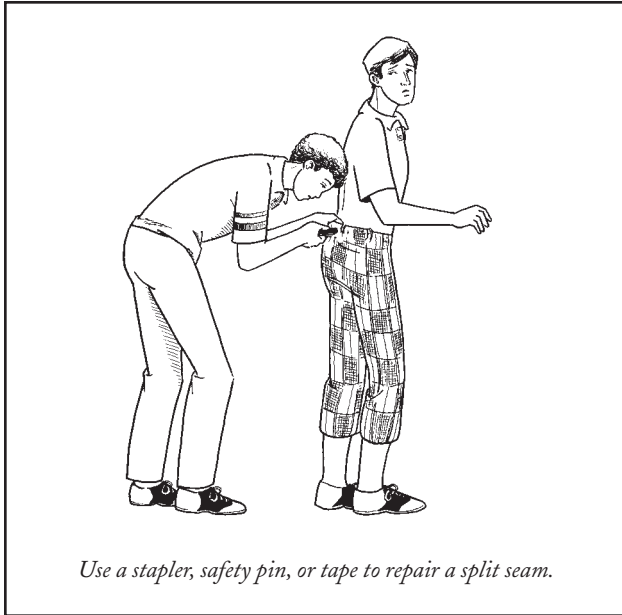

Use a stapler, safety pin, or tape to repair a split seam.



PIN

A safety pin is the fastest, most secure way to hold a seam together. However, many golfers sport lapel pins on their jackets, and these may work in a pinch. Two or three pins in the ripped area should suffice for a temporary solution.



STAPLE

Staples can be used to repair seams and will not damage most fabrics, provided they are removed carefully. Take care to avoid stretching the seam; the fabric may tear around the staples if it is pulled hard. If you are on the course and have any papers with staples already in them, carefully remove the staples and re-use them on the seam. Poke the ends through the fabric and bend them in. Alternatively, the pro shop, restaurant, or clubhouse will most likely have a stapler.



TAPE

Apply very sticky tape to the inside of the garment to hold a seam together. Adhesive tape from a first aid kit should work, though it might mark the garment. Electrical or duct tape will work best. Grip tape for clubs may also be used, but avoid the weaker masking tape and cellophane tape.

BROKEN SHOELACES



SQUARE KNOT

Tie the broken ends of the lace together using a square knot: stack two regular knots, wrapping the same strand over each time. Use the mnemonic “right over left, left over right.”



LONGER LACE

Remove the lace and retie it using only the longer end. You may have to skip a few eyelets to have enough length to tie a knot.

★ **OTHER LACES**

If you have carried your street shoes onto the course, they may provide a lace to use in place of the broken one.

★ **CADDIE'S LACES**

If you have a caddie, try borrowing the laces from one of his shoes.

★ **GOLF BAG**

Use a small strap or tie from your golf bag, if you have one.

SUNGLASSES THAT WON'T STAY ON

★ **STRING OR A RUBBER BAND**

Tie a piece of string or a long rubber band between the two ear pieces and stretch it across the back of the head. This will prevent sunglasses from slipping down a sweaty nose.

Alternatively, two rubber bands, one on each side, can be twisted around the earpieces to increase friction and reduce slippage.

★ **GRIP TAPE**

Cut two small pieces of grip tape, which is sticky, and place them on the nose pads on your glasses. The tape will both absorb sweat and keep your glasses from sliding.

★ **TISSUE**

A small piece of tissue wedged under the nose pads should prevent slippage, but be aware that it may impair vision.

LOST GLASSES

★ **BORROW OTHER PEOPLE'S GLASSES**

You may be able to find a pair of glasses from someone who has a similar prescription. You can borrow them when you hit.

★ **SQUINT**

Squinting actually increases your depth of field by blocking out excess rays entering the retina, allowing images that are fuzzy to become clearer.

★ **PINHOLE GLASSES**

Pinhole glasses block out excess rays and can improve vision. Draw two circles about the size of a pair of lenses on a piece of paper or cardboard. Use a pin,

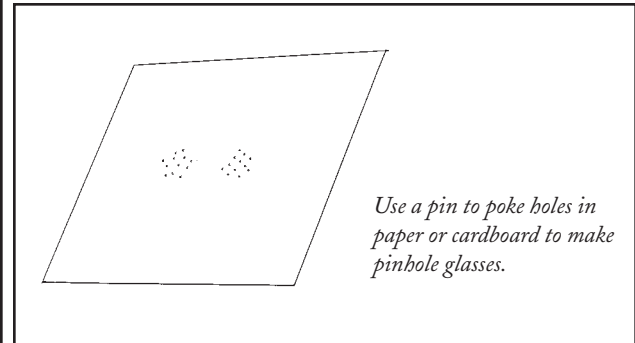

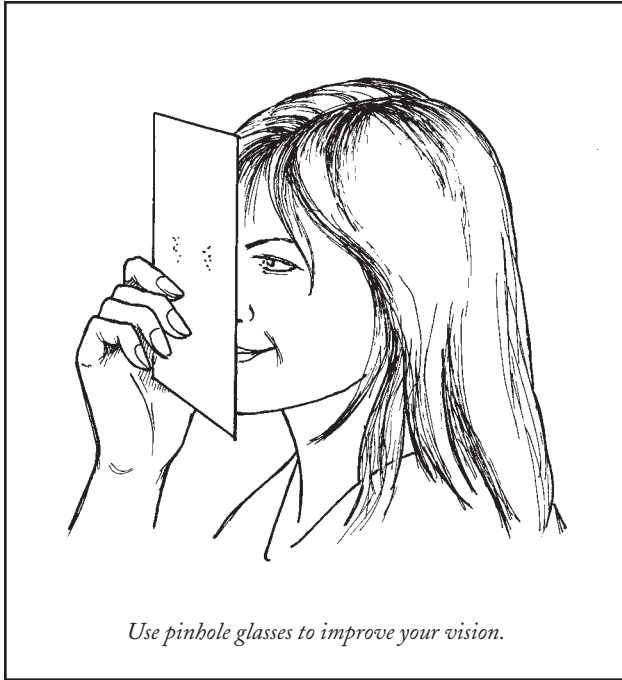

knife, or a tee to poke at least a dozen small holes in each area where you have drawn your circles. Look through your pinhole glasses to improve your vision.

GAMBLER'S GUIDE

GAME BETS

Bingo Bango Bongo—Each hole is worth three points: one point for hitting the green with the fewest strokes, one point for the player closest to the pin after everyone is on the green (it doesn't matter how many strokes it took to get there), one point for the player in the hole with the fewest number of strokes or to the first player in the hole. A monetary value is assigned to each point, and each player puts that amount in a pot. The player who has the most points at the end of the match wins the pot.

Pick-Up Sticks—Players wager a certain amount for the front nine, the back nine, and the match. Each hole a player loses gives that player the right to remove one of his opponent's clubs from play. The clubs can be brought back into play if that player then loses a future hole (but he cannot then take his opponent's club). Putters can be given "immunity." The winner of each set of holes (and ultimately the match) gets the pot.

Scotch Foursome—Also known as Foursome. Two teams bet a certain amount per hole. Pairs of players alternate shots from tee to green until the ball is in the hole. One player drives even holes and putts odd, the other drives odd holes and putts even. The team

who wins the match, the front nine, back nine, or the individual holes (whichever had been decided beforehand) wins the money.

Skins—Each player puts in a certain amount per hole to form a total per-hole pot, or “skin.” The player who wins the whole on a net basis (the score for that hole after adjusting for handicap) wins that hole’s pot. If any number of players tie, the pot carries over to the next hole, again carrying over until a single player wins a hole. If the 18th hole ends in a tie, the final “skin” goes to the player with the best overall score, a runoff going to the player who won the most “skins.” This gambling game is best for threesomes and foursomes.

Snake—The object of this game is to not “three-putt.” A player who “three-putts” first “holds the snake.” The snake is then held by that player until another player three-putts. At the end of the ninth and eighteenth holes, the player holding the snake must pay the other players a set amount. Combining this game with another gambling game makes life interesting—a player may hit around the green without getting on it to avoid a three-putt, but this may hurt him if another gambling game is being played at the same time.

SIDE BETS

Murphy—A player has declared a “Murphy” when he bets that he can get onto the green and into the hole in a certain number of shots.

Overs—If a player moans about his bad luck, he can be forced to take the shot again if you call an “overs” bet before the ball comes to rest. In this bet, you are betting against that player’s ability to do better. If the whiner makes a better shot, he wins. If not, you win.

Scruffy—Calling a “scruffy” is to bet that, despite a horrible tee shot, you can still make par.

Arnie—A bet that is won by scoring par without touching the fairway.

Bambi—A bet that is won by scoring par after hitting an animal.

Froggy—A bet that is won by skipping a golf ball across a water hazard.

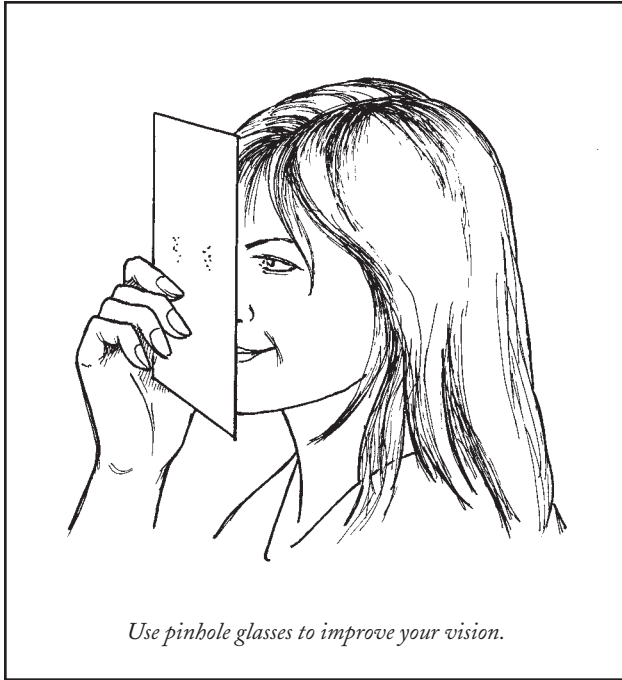

knife, or a tee to poke at least a dozen small holes in each area where you have drawn your circles. Look through your pinhole glasses to improve your vision.

GAMBLER'S GUIDE

GAME BETS

Bingo Bango Bongo—Each hole is worth three points: one point for hitting the green with the fewest strokes, one point for the player closest to the pin after everyone is on the green (it doesn't matter how many strokes it took to get there), one point for the player in the hole with the fewest number of strokes or to the first player in the hole. A monetary value is assigned to each point, and each player puts that amount in a pot. The player who has the most points at the end of the match wins the pot.

Pick-Up Sticks—Players wager a certain amount for the front nine, the back nine, and the match. Each hole a player loses gives that player the right to remove one of his opponent's clubs from play. The clubs can be brought back into play if that player then loses a future hole (but he cannot then take his opponent's club). Putters can be given "immunity." The winner of each set of holes (and ultimately the match) gets the pot.

Scotch Foursome—Also known as Foursome. Two teams bet a certain amount per hole. Pairs of players alternate shots from tee to green until the ball is in the hole. One player drives even holes and putts odd, the other drives odd holes and putts even. The team

who wins the match, the front nine, back nine, or the individual holes (whichever had been decided beforehand) wins the money.

Skins—Each player puts in a certain amount per hole to form a total per-hole pot, or “skin.” The player who wins the whole on a net basis (the score for that hole after adjusting for handicap) wins that hole’s pot. If any number of players tie, the pot carries over to the next hole, again carrying over until a single player wins a hole. If the 18th hole ends in a tie, the final “skin” goes to the player with the best overall score, a runoff going to the player who won the most “skins.” This gambling game is best for threesomes and foursomes.

Snake—The object of this game is to not “three-putt.” A player who “three-putts” first “holds the snake.” The snake is then held by that player until another player three-putts. At the end of the ninth and eighteenth holes, the player holding the snake must pay the other players a set amount. Combining this game with another gambling game makes life interesting—a player may hit around the green without getting on it to avoid a three-putt, but this may hurt him if another gambling game is being played at the same time.

SIDE BETS

Murphy—A player has declared a “Murphy” when he bets that he can get onto the green and into the hole in a certain number of shots.

Overs—If a player moans about his bad luck, he can be forced to take the shot again if you call an “overs” bet before the ball comes to rest. In this bet, you are betting against that player’s ability to do better. If the whiner makes a better shot, he wins. If not, you win.

Scruffy—Calling a “scruffy” is to bet that, despite a horrible tee shot, you can still make par.

Arnie—A bet that is won by scoring par without touching the fairway.

Bambi—A bet that is won by scoring par after hitting an animal.

Froggy—A bet that is won by skipping a golf ball across a water hazard.

GLOSSARY

GOLFSPEAK	TRANSLATION
Looks like I'm stuck on the beach.	I have gotten stuck in a sandtrap/bunker.
You're in the cabbage now.	You are in very thick rough.
That ball's dead.	You are in a position from which you are unable to reach the green.
Well, that's an elephant's ass.	That shot is high, but not very long—and it stinks.
What a goat farm!	This is a very poorly maintained course.
Stop being such a golf lawyer.	Stop constantly telling me the rules.
You left it right in the jaws.	You came just short of the cup.
Now I'm leaking oil.	Now my game is really falling apart.
Don't overcook it.	Do not hit your shot too hard.

You're in throw-up range.	Your putt is close enough to make, but long enough that you will probably miss it.
You burned a few worms on that one.	You have hit a very poor, low shot.
Get up on the dance floor!	Get up onto the putting green!
You're in the soup.	You are in a water trap.
I'm headed for the chopping mall.	I am playing a terrible round.
Nice banana!	That certainly was a big, looping slice!
I fried that egg.	I buried that right in the bunker.
I think I'll use my knife.	I think that I will take that shot with my one iron.
You whiffed that one.	You missed the ball completely.
I think I've got the yips.	I doubt that I can sink short putts.
I guess it's just the rub of the green.	You only have a certain amount of control.

THE EXPERTS

FOREWORD

Jerry Foltz, winner of the 1995 South Carolina Open, is a golf journalist and former touring professional who spent eight years on the Buy.com Tour. He is a weekly columnist for golfonline.com, and has been the on-course commentator for the Golf Channel since 1997.

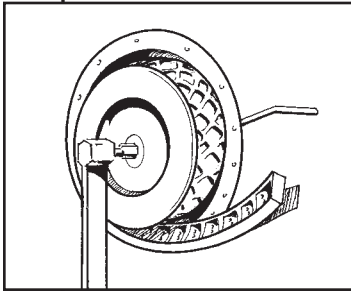

CHAPTER I: BAD LIES

How to Retrieve a Ball Lost in the Washer

Source: Frank Miller is a golf construction and industry consultant. He owns a sod farm and a golf green construction company in Kihei, Hawaii.

How to Tee Off in Front of a Crowd

Sources: Bruce Jackson of Inside/Out in Provo, Utah, is a specialist in performance psychology. His clients include athletes and business leaders • Jim Campbell is the Director of Golf, Cape Cod National Golf Club, Brewster, Massachusetts.

How to Retrieve a Ball Stuck in a Tree

Source: Michael Martinez is a professional tree climber and owner of Specialized Rigging and Tree Care, Inc., a company specializing in the care and maintenance of trees.

How to Retrieve a Ball from a Gopher Hole

Source: Frank Miller.

How to Scale a Fence to Retrieve a Ball

Source: Greg Gaffney is an eleven-year veteran of the Naples, Florida, police force, and an avid fence climber.

How to Play Out of a Water Trap

Source: Jim Campbell.

How to Play Out of High Saw Grass

Source: Mark Heartfield is the head golf professional at the Sankaty Head Golf Club in Siasconset, Massachusetts. In the winter he is director of golf at Orchid Island Golf and Beach Club in Florida.

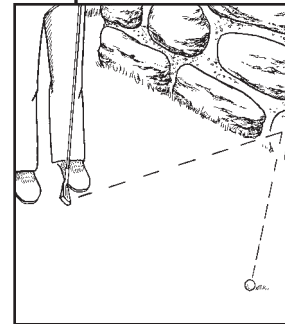

How to Carom the Ball off a Wall

Source: Andrew Campbell is the assistant golf professional at the Merion Golf Club in Ardmore, Pennsylvania.

How to Thwart a Cheat

Source: John Morgan is a professional gambler and a confessed golf cheat who lives in Oakland, California.

How to Stop Thinking about a Horrible Shot

Source: Randall McCracken is a golf pro at Willow Creek Country Club in Salt Lake City, Utah.

CHAPTER 2: EQUIPMENT DISASTERS

How to Stop a Runaway Cart

Source: Mr. X, who prefers to remain anonymous, is a technical representative and trainer for one of the largest golf cart manufacturers in the world. He has worked with electric, gas, turf, and industrial carts for 14 years.

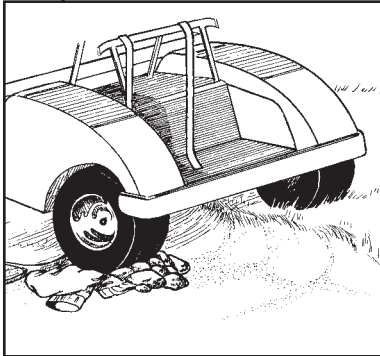

How to Get a Cart Out of a Sand Trap

Sources: Mr. X. • Chad Moore sells and services golf carts at Florida Southern Golf Carts in Brooksville, Florida. • Golf Cars, Inc. in the greater Philadelphia area, Pennsylvania.

How to Start a Dead Cart

Source: Mr. X.

How to Putt with a Driver

Source: Mark Blakemore is a Class A PGA professional with more than 19 years of golf instruction experience. He is the owner and operator of www.PGAProfessional.com, which features free golf tips and articles, handicap calculators, and other golf resources.

How to Drive with a Putter

Source: Mark Blakemore.

How to Keep Score without a Pencil

Source: Paul Attard is a PGA golf professional and is the head of golf at the Brooksville Golf & Country Club in Brooksville, Florida.

How to Get a Club Out of a Tree

Source: Warren Lehr is director of golf at Paa-Ko Ridge Golf Club in Sandia Park, New Mexico.

How to Survive If You Run Out of Tees

Source: Paul Attard.

CHAPTER 3: DANGEROUS ANIMALS

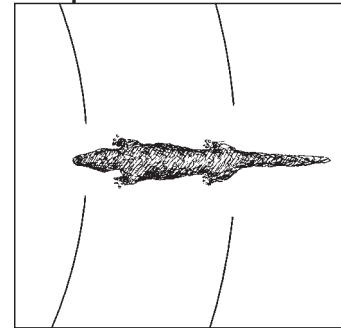

How to Deal with an Alligator Near Your Ball

Source: Kent Vliet, Ph.D., is a faculty member of the Department of Zoology at the University of Florida, Gainesville. He serves as the Coordinator of Labs for the biological sciences program and has studied alligator behavior for twenty years.

How to Deal with a Snake Near Your Ball

Sources: Joseph B. Slowinski was an associate curator of herpetology in the Department of Herpetology at the California Academy of Sciences in San Francisco. He studied venomous snakes in Myanmar (Burma), where he collected cobras, Russell's vipers, kraits, and sea snakes. • Guinevere Wogan is an assistant in the Department of Herpetology at the California Academy of Sciences.

How to Spot a Rabid Animal

Source: Centers for Disease Control.

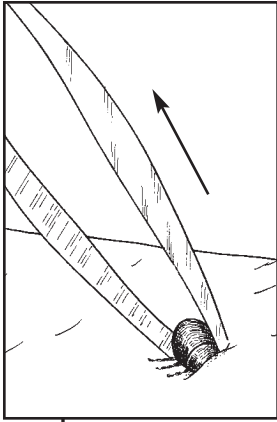

How to Remove a Tick

Sources: Glen Needham, Ph.D., is the codirector of the Ohio State University Acarology Laboratory. • Janet Tobiassen, DVM, is a small-animal veterinarian with a doctorate in veterinary medicine from Oregon State University. She is a member of the American Veterinary Medical Association and serves as the Veterinary Medicine guide at about.com (vetmedicine.about.com). • The Lyme Disease Network of New Jersey, Inc., www.lymenet.org.

How to Survive a Bird Attack

Source: Patty Sprott is an ecologist who disseminates scientific findings of the Long Term Ecological Research Network, a National Science Foundation-funded program. She has studied and written about terrestrial/aquatic interactions among animals, wetland turtles, and bird attacks for the Florida Fish & Wildlife Department. She is online at www.lternet.edu.

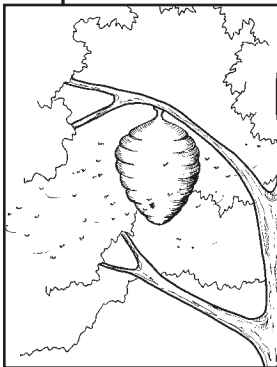

How to Survive If You Hit a Beehive

Source: Eric H. Erickson, Jr., Ph.D., is director of the Carl Hayden Bee Research Center, part of the USDA's Agricultural Research Service. He has 31 years of research experience and is the author of more than 150 scientific publications on honeybee biology and crop pollination.

How to Disarm an Irate Golfer

Source: George Arrington has instructed classes in self-defense for more than 25 years. He holds a fourth-degree black belt and formal teaching license in Danzan-Ryu Jujutsu and has also studied Karate, Aikido, T'ai-chi Ch'uan, Pa Kua, and Hsing-I.

How to Control Your Golf Rage

Sources: Lawrence Arnold, M.D., is a licensed psychotherapist who lives San Bernadino, California. • www.angermgmt.com is a website devoted to anger management. • Victor Bartok is a stress management specialist who lives in New York City.

CHAPTER 4: GOLFING EMERGENCIES

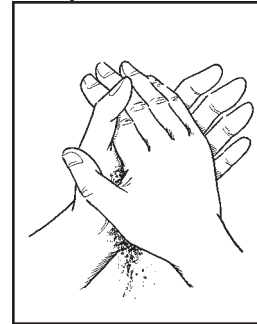

How to Prevent a Club from Flying Out of Your Hands

Sources: Wayne K. Clatterbuck is an associate professor in the department of Forestry, Wildlife & Fisheries at the University of Tennessee's Agricultural Extension Service in Knoxville. • Warren Lehr.

How to Avoid Getting Hit by a Ball

Source: Randall McCracken.

How to Survive Being Hit in the Goolies

Sources: Roger Rosen, M.D., is a general practitioner who lives in Philadelphia, Pennsylvania. • *The American Red Cross First Aid and Safety Handbook* by Kathleen Handal, M.D.

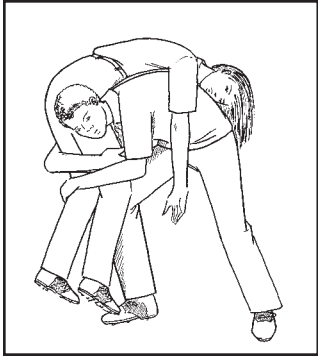

How to Carry an Injured Golfer

Source: James Li, M.D., practitioner in the Division of Emergency Medicine at Harvard Medical School in Cambridge, Massachusetts, is an instructor for the American College of Surgeons' course for physicians, Advanced Trauma Life Support. He is the author of articles on emergency practice in remote settings.

How to Treat a Sprained Ankle

Source: James Li.

How to Treat a Blister

Sources: Roger Rosen. • *The American Red Cross First Aid and Safety Handbook*.



How to Treat Poison Ivy, Poison Oak, and Poison Sumac

Source: Susan Carol Hauser is the author of *Outwitting Poison Ivy: How to Prevent and Treat the Effects of Poison Ivy, Poison Oak, and Poison Sumac*, and *Outwitting Ticks*. She teaches writing at Bemidji State University in Minnesota and is online at www.intraart.com/hauser.

How to Treat Sunburn

Sources: Roger Rosen. • *The American Red Cross First Aid and Safety Handbook*. • *The Complete Idiot's Guide to First Aid Basics*. • James Li.

How to Avoid Dehydration

Source: James Li.

How to Avoid Lightning

Sources: Dave Rust, Ph.D., is a lightning expert at the National Severe Storms Laboratory in Norman, Oklahoma. • John Ogren is the Warning Coordination Meteorologist for the National Weather Service and a specialist in weather safety issues. • *Thunderstorms, Tornadoes, Lightning . . . Nature's Most Severe Storms*, a joint publication of the National Oceanic and Atmospheric Administration, the U.S. Department of Commerce, and the American Red Cross.

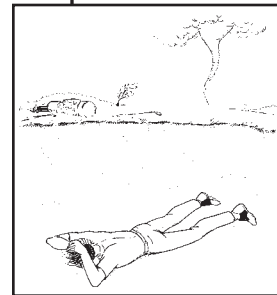
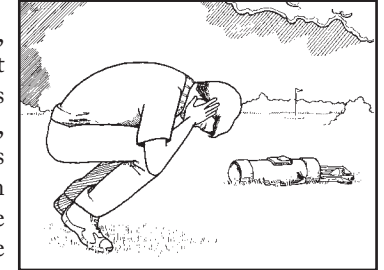

How to Survive a Tornado

Sources: Harold Brooks is head of the Mesoscale Applications Group of the National Severe Storms Laboratory in Norman, Oklahoma. He has researched tornadoes and their effects on people for 15 years. • Federal Emergency Management Agency. • National Oceanic and Atmospheric Administration.

How to Put Out a Cigar Brush Fire

Sources: The U.S. National Park Service. • www.firewise.org is a website devoted to fire-fighting techniques.



How to Cure a Golf Addiction

Source: Adapted from resource material provided by Narcotics Anonymous and Alcoholics Anonymous.

APPENDIX

Rules and Regulations

Sources: USGA Official Golf Rules. • *Rules of Golf* by Tom Watson. • *The Illustrated Golf Rules Dictionary* by Hadyn Rutter.

ACKNOWLEDGMENTS

The authors would like to extend their thanks and the promise of lifelong, good golf karma to all of the experts who contributed their knowledge and experience to this project. Without you we are nothing—or at least we’re a lot less knowledgeable.

Joshua Piven thanks all of the experts who contributed their time and golfing expertise, as well as the entire cast of the film *Caddyshack* for their inspiration, wisdom, and creative golf advice.

David “Fuzzy” Borgenicht thanks Jay Schaefer, Steve Mockus, Erin Slonaker, Terry Peterson, Brenda Brown, Joe Borgenicht, and the entire clubhouse at Chronicle Books and Quirk Productions. He would also like to thank his golf-nut grandmother, Helen Sandack, for not getting angry with him at age 10 when he “accidentally” hit her good golf balls into the road behind her house.

Jim Grace thanks his father, Bill Grace, for being an exceptional golfer, and an even better father. He also sends a huge “thank you” to the golf pros who took time out of their full summer days to answer his never-ending list of questions: Andrew Campbell, Jim Campbell, and Mark Heartfield. Finally, he would like to thank his wife, Lisa, and editor, Erin Slonaker, who now know more about golf than they ever wanted to.

The
WORST-CASE SCENARIO
Survival Handbook:
LIFE

By Joshua Piven and David Borgenicht
Illustrations by Brenda Brown



CHRONICLE BOOKS
SAN FRANCISCO

Copyright © 2006 by Quirk Productions, Inc.

All rights reserved. No part of this book may be reproduced in any form without written permission from the publisher.

Worst-Case Scenario® and The Worst-Case Scenario Survival Handbook™ are trademarks of Quirk Productions, Inc.

Library of Congress Cataloging-in-Publication Data available.

ISBN 10: 0-8118-9935-7

ISBN 13: 978-0-8118-9935-2

Manufactured in the United States of America

Typeset in Adobe Caslon, Bundesbahn Pi, and Zapf Dingbats

Additional research and writing by Piers Marchant

Designed by Frances J. Soo Ping Chow

Illustrations by Brenda Brown

Visit www.worstcasescenarios.com

Distributed in Canada by Raincoast Books

9050 Shaughnessy Street

Vancouver, British Columbia V6P 6E5

10 9 8 7 6 5 4 3 2 1

Chronicle Books LLC

85 Second Street

San Francisco, CA 94105

www.chroniclebooks.com

WARNING

When a life is imperiled or a dire situation is at hand, safe alternatives may not exist. To deal with the worst-case scenarios presented in this book, we highly recommend—insist, actually—that the best course of action is to consult a professionally trained expert. But because highly trained professionals may not always be available when the safety or sanity of individuals is at risk, we have asked experts on various subjects to describe the techniques they might employ in these emergency situations. **THE PUBLISHER, AUTHORS, AND EXPERTS DISCLAIM ANY LIABILITY** from any injury that may result from the use, proper or improper, of the information contained in this book. All the answers in this book come from experts in the situation at hand, but we do not guarantee that the information contained herein is complete, safe, or accurate, nor should it be considered a substitute for your good judgment or common sense. And finally, nothing in this book should be construed or interpreted to infringe on the rights of other persons or to violate criminal statutes; we urge you to obey all laws and respect all rights, including property rights, of others.

—The Authors

ABOUT THE AUTHORS

Josh Piven often ponders the meaning of life. What are we here for? What's it all about? What's the best way to clean up messy food spills? When not pondering, he is authoring the *Worst-Case Scenario Survival Handbook* series with David Borgenicht. He lives in Philadelphia.

David Borgenicht is a writer, editor, and thrill-seeker who prides himself on the fact that he is still alive. He is the co-author, along with Joshua Piven, of all of the books in *The Worst-Case Scenario Survival Handbook* series. He lives in Philadelphia with his wife and children, and his goal is to live forever—so far, so good.

Brenda Brown is an illustrator and cartoonist whose work has been published in many books and publications, including *The Worst-Case Scenario Survival Handbook* series, *Esquire*, *Reader's Digest*, *USA Weekend*, *21st Century Science & Technology*, *The Saturday Evening Post*, and *The National Enquirer*. Her website is <http://webtoon.com>.

Check out www.worstcasescenarios.com for updates, new scenarios, and more! Because you just never know . . .

ACKNOWLEDGMENTS

Josh thanks all the usual suspects, his co-author Dave, editors Melissa, Jay, and Steve, illustrator Brenda, and all the other Worst-Case “lifers.”

This book, like life itself, wouldn't have been possible without the hard work, participation, and occasional nagging of lots of other people. In particular, David would like to thank his editors—Jay Schaefer, Steve Mockus, and Melissa Wagner—designer Frances J. Soo Ping Chow, writer Piers Marchant, illustrator Brenda Brown, and the entire staff at Quirk Books and Chronicle Books. Life wouldn't be worth living without you.

INTRODUCTION

It's just the way life is—a series of unpredictable occurrences you can't control. And no matter how hard you try to prepare, no matter how many supplies you store, no matter how many plans you make, the unexpected always seems to be the only thing you can ever really expect.

Yet we continue to think we can nail things down, count on them staying the way they are, and then improve on them so we can have a better time and a nicer future. This tendency has been a characteristic of humankind since the dawn of man. We have always sought to build a better Mammoth-trap. All of our greatest discoveries and inventions, even the accidental ones, came from this uniquely human desire to figure out a better way to do things so we can reap the benefits. Fire, tools, the wheel, and domesticating animals, for example, were supposed to improve the life of early humans.

But what people consistently failed to take into account was that every invention or improvement, every decision or action, opens up a whole new range of unexpected possibilities on top of the old unexpected possibilities. Not only can't you plan on the old way to be dependable and safe, you now have new things that can go wrong, too. More eventualities to prepare for. In every aspect of life.

How is mankind to deal with these spiraling, ever-increasing risks?

The book you hold in your hands, *The Worst-Case Scenario Survival Handbook: Life*, is the answer.

This amazing book provides instant answers to more than 700 ways daily life can take a sudden turn for the worse. There you are, minding your own business, walking down the street when *POW!* you get a severe case of hiccups, or are chased by a pack of dogs, or realize you've taken an overdose of aphrodisiacs, or you see a cat stuck in a tree—the list of problems can go on and on. In these pages, you'll discover the one sure thing to do in the widest array of subjects yet tackled by the *Worst Case Scenario Survival Handbook* series. All areas of life are covered, with chapters on Health, Beauty & Fitness, Home, Pets, Sports & Hobbies, Jobs, Travel, Food & Cooking, and the Stages of Life from childhood to old age; from minor injuries to major ailments and fixing the kitchen sink. This may well be the only book that gives you the hands-on, practical advice to save your life, your marriage, your house, your dog, your job, *and* your dinner party.

Search by subject or in the index in the back to address a pressing problem, or read a little bit every day to bone up on your survival skills. There's not a single page here that wouldn't make you better prepared for the surprises that life brings.

As before, all the answers within come from experts in the subject at hand—doctors, beauticians, survival experts, sports therapists, psychologists, stunt people, FBI agents—people from all walks of life who have experienced the worst and lived to tell about it.

You can't control the uncontrollable, but you can be better prepared to deal with what comes. Never be complacent, always be vigilant. Look for new scenarios and updates on www.worstcasescenarios.com, and let us know what situations you encounter that are not in this book.

We have to help each other out. It's a jungle out there, right in your own backyard.

—The Authors

ACTOR/CELEBRITY

Trip on Red Carpet

Turn the stumbling step into a “spontaneous” dance move—the first step of the “Running Man” or a break-dancing lock and pop. Do not look back or glare at the carpet. Smile and keep walking.

Aggressive Paparazzi

Point behind the paparazzi and say “Look it’s [actress under 20 years old]!” Turn and move quickly in the opposite direction.

Forgot Award Acceptance Speech

Thank anyone you are usually obligated to spend time with at the holidays: spouse, children, parents, grandparents, great-grandparents, siblings, uncles, aunts, cousins, nephews, nieces, and beloved family pets past and present until the orchestra begins to play, indicating you should “wrap it up” and exit the stage.

Not on Guest List

Quietly whisper to the person next to you in line and ask them to exclaim to the doorman, “Do you know who this is? Do you have any idea who this is?!” Be sure you also whisper your name to the person next to you if you are not certain that he or she, in fact, has any idea who you are.

Agent Won’t Return Calls

Call the agency from a phone other than your own, pretending to be the most famous celebrity that your agent handles. Claim that you’ve just checked yourself into rehab. When the agent answers, identify yourself and demand a meeting in the agent’s office, where it will be harder to evade you.

Sex Video Released on Internet

Do nothing. There will be no way to control the situation. Another celebrity sex video is likely to be

leaked within weeks that will eclipse the attention paid to yours. Use this time to track down the leak and dispose of any other sensitive or embarrassing material you do not wish to be made public.

AILMENTS

Boil

Apply warm-water heat to the boil with a wet washcloth or a hot water bottle, and take a hot shower twice a day. After the heat treatment, rub zinc oxide cream onto the boil to help bring it to a head. Do not pop a boil. When the boil has formed a head, cover it with gauze and allow it to drain on its own. After drainage, treat the area with a topical antibiotic to prevent infection, then dress it with sterile gauze. Large boils require treatment from a physician.

Stye

Put a moist, hot compress on the stye for 15 minutes, 3 to 4 times a day, to bring it to a head. The stye, which is the result of an infection of an eyelash follicle, must burst and drain of its own accord. If you touch the stye, wash your hands with soap and water to prevent the infection from spreading. Styes typically disappear within 5 days; see a doctor for a more persistent infection.

Tooth Infection

Treat discomfort with an over-the-counter pain reliever until you can get professional dental help. Infection of the pulp of the tooth requires either root canal surgery or tooth extraction.

Sensitive Tooth

Use a soft-bristle toothbrush, and do not use tartar-control toothpaste. Seek dental care for continual, painful sensitivity, which is caused by exposed dentin in the tooth. A cavity or gum disease may be the culprit.

Cold Sore

Apply rubbing alcohol every 3 hours to dry the sore area and reduce the visible blister. Place a cold compress on the site to reduce swelling. Wash your hands thoroughly after touching the cold sore to prevent transmission.

Swallowed Bling

If you must retrieve bling, stay close to home or another area with a convenient, clean restroom. Exercise, and drink at least 8 ounces of water once an hour to help speed digestion. Eat meals normally. The human body generally digests and passes food completely within 24 hours.

Heartburn

Neutralize stomach acids with an over-the-counter anti-heartburn medication. To reduce future occurrences, eat smaller meals, eat more slowly, and avoid citrus, onions, peppers, tomatoes, high-fat and spicy foods, alcohol, coffee, and carbonated drinks. Persistent heartburn should be treated by a doctor.

Vomiting

Do not eat solid food for 12 to 24 hours. To avoid dehydration, drink small amounts of water, about 1 ounce at a time. Gradually reintroduce a small amount of clear liquid every hour, such as chicken broth, apple juice, lemon-lime soda, or ginger ale, to restore electrolyte balance. Do not attempt to eat solid food until you have not vomited for at least 12 hours, then try bland, easy-to-digest foods like bananas, rice (white only), applesauce, and dry toast. If vomiting returns, limit your intake to clear liquids and try again after more time passes. Avoid dairy products, including cheese and ice cream, for several days after the sickness subsides.

Lost Appetite

Make a ginger tea. Mix together the following ingredients: 1 teaspoon grated fresh ginger or 1/2 teaspoon powdered ginger; 2 cups hot water; 1/4 teaspoon peppermint leaf; 1/4 teaspoon anise seed; and 1/4 teaspoon cinnamon.

Growling Stomach

Try to burp in order to release trapped gas that may be contributing to the stomach noises. Keep your mouth closed. Snacking on something—especially carbohydrates—may help relieve symptoms, as will taking antacids. Eating mints or chewing gum will aggravate the situation by releasing more stomach acid.

Abdominal Cramp

Drink chamomile tea, or take a single dose of activated charcoal slurry, according to the product directions. Avoid solid foods until the cramping subsides.

Diarrhea

Drink water (not milk) and avoid fatty and greasy foods. Take a prescription or over-the-counter antidiarrhea medication containing loperamide, unless the diarrhea is due to food poisoning. Offer children the BRAT diet: Bananas, Rice, Applesauce, and Toast.

Constipation

Eat one of the following foods to relieve constipation: cabbage, papaya (fresh or dried), prunes, coconut (fresh), asparagus, or soy products.

Nausea

Drink 2 cups of freshly brewed ginger tea. Stir 1 teaspoon grated fresh or 1/2 teaspoon powdered ginger into 2 cups of boiling water. Ginger ales are not as effective as tea, as many do not contain natural ginger.

Morning Sickness

Eat 7 small, bland meals each day. Keep salted crackers on hand for snacking, and take 10 mg per day of vitamin B6.

Caffeine Overload

Caffeine cannot be eliminated from the bloodstream except naturally, over time, generally in 3 to 4 hours. To speed absorption and processing, eat a full meal containing fresh fruit and vegetables, and drink several glasses of water. Symptoms of excessive caffeine consumption include headache, twitching, irritability, and irregular heartbeat.

Low Blood Sugar

Eat 1 tablespoon of honey immediately. Honey contains 15 grams of “quick” carbohydrates that will raise blood sugar in 15 to 20 minutes.

Hives/Rash

Administer over-the-counter diphenhydramine as quickly as possible, then every 6 hours for 1 to 2 days. Do not wait for the rash to develop fully before treatment. Hives are caused by the body's release of histamines; they may come and go for several weeks, though typical outbreaks last hours to days.

Dizziness

Change positions slowly from a prone or seated position. Avoid jerky movements of the head. Take aspirin to increase blood flow to the base of the brain. Most causes of dizziness are not serious, though it may indicate arrhythmia, heart attack, stroke, or shock.

INSOMNIA

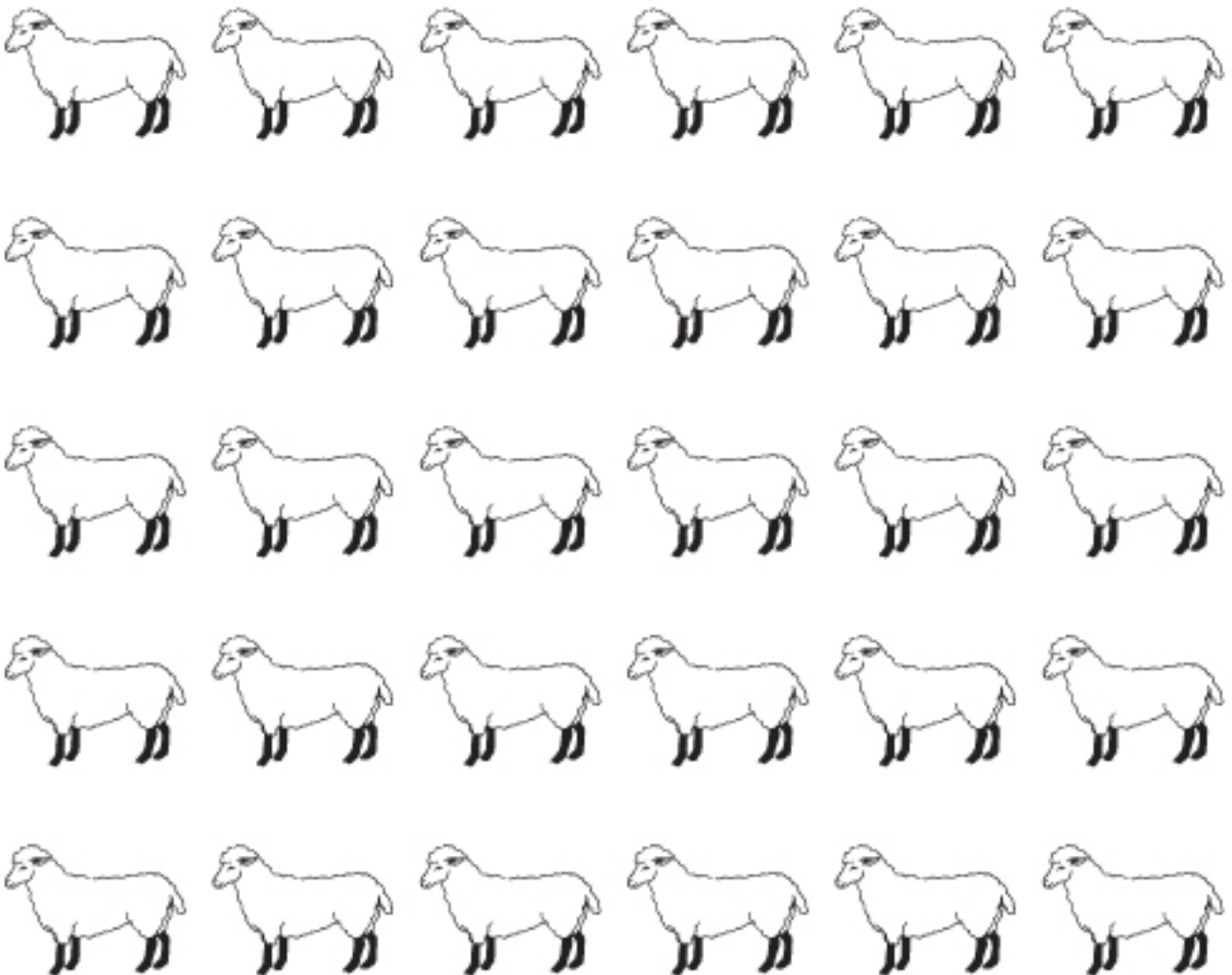

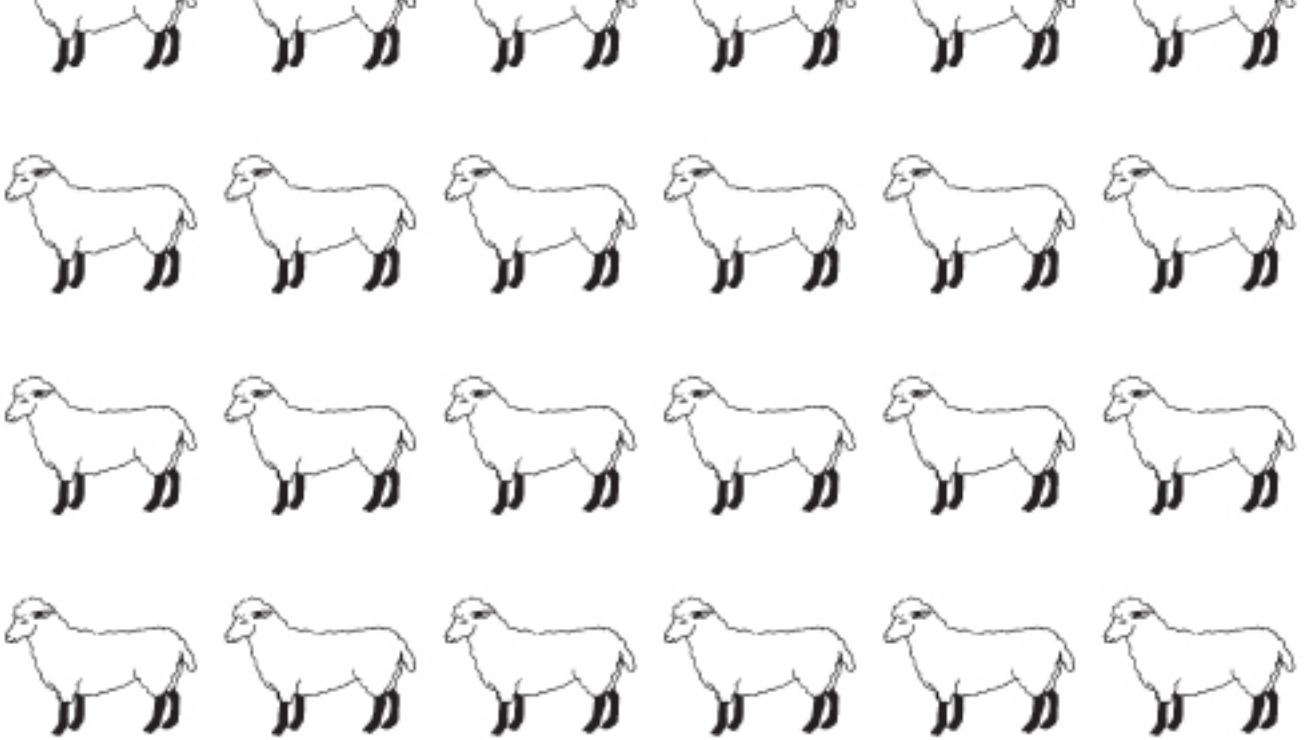

Take a warm bath; eat a bedtime snack; drink warm milk or herbal tea; cover illuminated clocks; lie on your back; rub your stomach; flex your toes. To prevent insomnia, avoid caffeine, nicotine, and alcohol. Light exercise or stretching an hour before bed can help relax muscle tension. Count sheep.

Amnesia

Look in a mirror and refamiliarize yourself with your appearance, age, and gender. Check your wallet for photographic ID to connect your face with a name, and look for indication of your home address. If you are at home—if your name appears on paperwork or prescription bottles within the house—stay there. Dial numbers preprogrammed in a mobile phone or found in a personal phone book, explain your situation, ask who the respondent is and if they can help. If you believe that you can find your way back, go outside and locate a newspaper box or vendor and read that day's newspaper to recover the date, the city and country you live in, and other circumstances of the day. Spontaneous temporary global amnesia—complete memory loss—is most common in middle-aged or elderly people and generally lasts less than 24 hours.

Migraine Headache

Consume a small amount of caffeine. Move to a quiet, dark room free of strong odors and lie down with a pillow supporting your head and neck. Place a cold compress on your forehead. Take nonprescription pain medication if available. Note: migraine triggers include alcohol, too much or too little sleep, stress, bright light, smoking, too much or too little caffeine, exercise, odors, birth control pills, skipping meals, MSG, nitrates, and menstrual cycles.

ringing in Ears

Place 1 teaspoon of rosemary or lemon oil in a vaporizer. Sit in a closed room with the vaporizer running for 1 hour. Vitamin A and C supplements may also be effective treatment for tinnitus not caused by disease, hearing loss, or wax buildup.

Earache

Take an over-the-counter decongestant or ear wax softener if the earache is not accompanied by fever and/or hearing loss. Gently press under each ear, then massage just under the edge of the jawbone to relieve pressure in the Eustachian tubes. See a doctor for treatment of earaches accompanied by fever, as a prescription antibiotic may be required to fight the infection.

Eye Twitch

Close eye. Massage lid. Reduce caffeine intake, and get some rest. Eye twitching is most often caused by fatigue and is generally harmless.

Sinus Infection

Take an over-the-counter decongestant, in pill or spray form. Use a humidifier to keep nasal passages moist, but do not allow rooms to exceed 50 percent humidity or you will encourage mold growth and dust mites.

HICCUPS



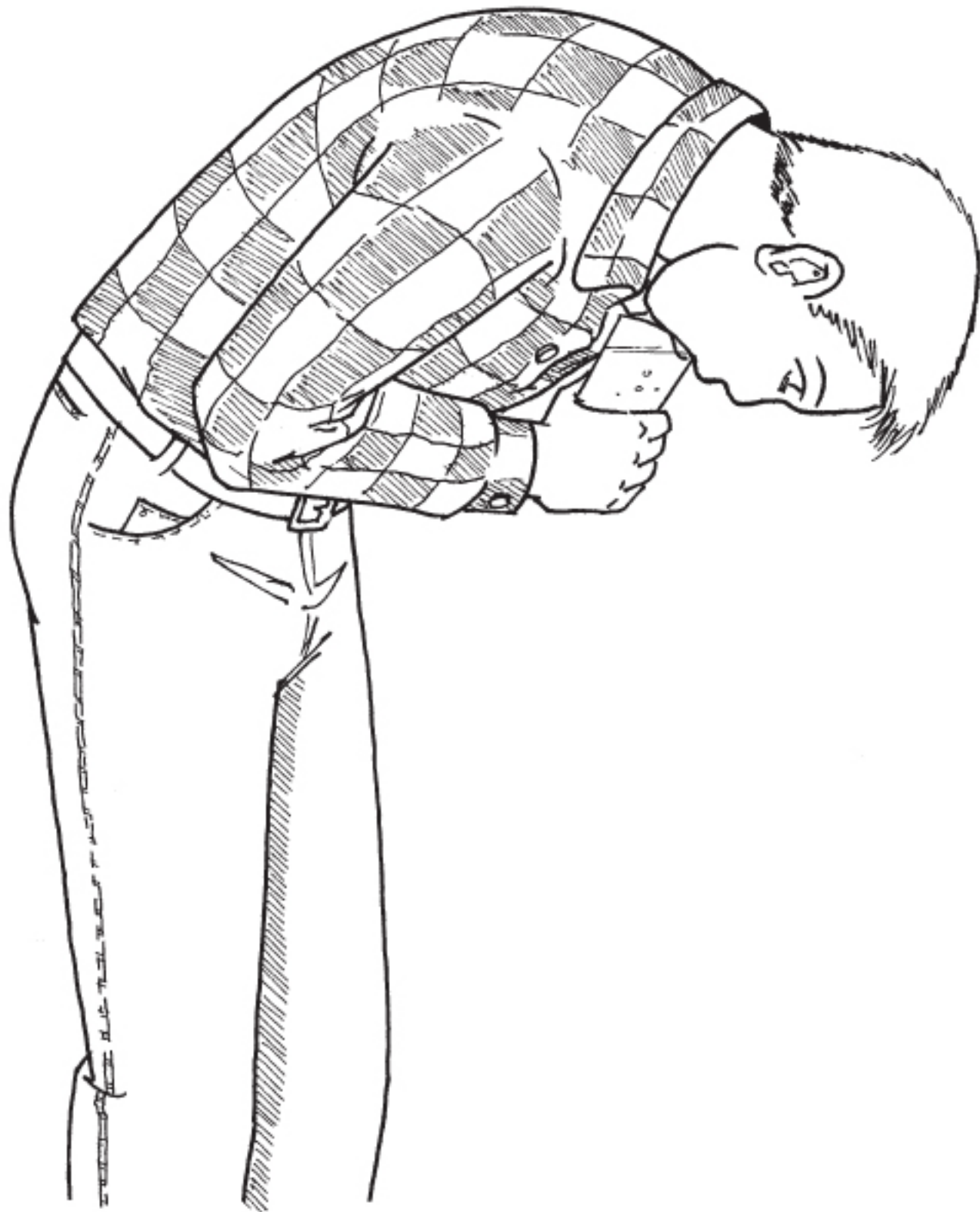

Fill a tall glass with water. Holding the glass in front of you, lean forward over the glass so that your mouth is on the rim farthest away from you. Tilt the glass so that the bottom moves toward you and the top away from you; drink the water as it moves toward the front of the glass.

away from you; drink the water as it moves toward the front of the glass.

Hay Fever

Remain indoors on windy days, especially if there has been little rain. Avoid touching or rubbing your face or eyes. Take an over-the-counter allergy medication with antihistamine and a decongestant, in either pill or spray form.

Dry Mouth

Chew the rind of a lemon or lime. Increase humidity in your home with a humidifier or vaporizer, especially at night. Avoid mouthwash that contains alcohol or peroxide, salty foods, dry foods, and foods and drinks with high sugar content, high acid content (fruit juices), alcohol, or caffeine. These ingredients will further dry out your mouth.

Charley Horse

Knead along the length of the muscle to increase blood flow in the area. Do not massage across the muscle. Stretch, drink water to rehydrate, and eat a banana to increase your potassium levels.

Heart Palpitations

Breathe deeply and exhale slowly. Reduce caffeine consumption. Yoga and meditation may also be effective.

AT A MUSEUM

Museum Legs

Stand on your tiptoes, extend your arms above your head, stretch as far as possible, and hold for 5 seconds. Slowly return to flat footing. Repeat 5 times. Standing with your legs 2 to 3 feet apart, bend your torso backward at the waist, then extend forward and attempt to touch the ground with your fingertips. Repeat. Note: These stretches will also relieve “museum back.” Limit duration of art viewing to 2 hour intervals.

Manet or Monet?

If you cannot get close enough to read the museum tag: Paintings of water lilies, hay stacks, cathedrals, bridges, or gardens are probably Monet. Paintings of a naked woman on a bed or at a picnic, a bar girl, a flute player, or French people in boats are probably Manet. Girls in frilly dresses holding umbrellas are a toss-up.

Eyestrain

Close your eyes and cover them lightly with your palms to block out light. Hold for 30 seconds, taking long, deep breaths. Resume museum viewing. At every sixth piece of artwork, blink lightly and quickly 10 times in succession.

Overcrowded Exhibition

Begin at the end of the exhibition, where crowds will be thinner, and work backward. Approach crowded works of art from the side, stepping closer to the artwork in small shuffling increments. Keep your arms crossed in front of you, elbows out, to prevent your chest from being compressed in the crowd crush.

Bored Child

Make a game out of noticing things that have nothing to do with the exhibition. Ask the child to count the number of people in the crowd who are wearing boots or black clothing. Promise to visit a part of the museum the child will enjoy more (mummies, dinosaurs) or leave the museum entirely after a short, set period of time—say, 10 minutes more. Give updates every few minutes and pick up your

viewing pace. Leaving on an upbeat note will make it more likely you'll be able to take the child to museums later on without resistance.

AT AN AMUSEMENT PARK

Stuck on Ride

Test the safety bar, strap, or harness to ensure it is still operational. If suspended upside down, fold the tops of your pockets upward and tuck in around any valuable items such as keys, wallet, or mobile phone to hold in place. Do not attempt to exit the ride. Await help.

Sick on Ride

Fight the urge to be sick until the ride reaches the outside edge of a turn or the apogee of a climb. Face in the opposite direction of the motion of the ride and vomit over the side of the car or into a corner on the floor of an enclosed car. Keep your eyes on a fixed point and your hands on the safety rail to reduce your perception of motion until the ride ends. Report the incident to a ride attendant.

Long Lines

Enter the park as soon as it opens in the morning and move immediately to the most popular rides first, consulting maps and brochures to plot the path of maximum efficiency. Visit popular rides at dinnertime, when lines are generally shorter. Make use of any appointment-time ticketing options made available by the park. Visit the park on a weekday while school is in session, if possible.

COSTUMED MASCOT INSISTS ON HUG





Keep a bench or child between yourself and the mascot. Shout “No!” and the mascot’s name, if known. If unable to escape, crouch low to the ground, as the heavy plush fur of the mascot’s suit may prevent him from bending down.

AT THE BEACH

Bitten by Crab

Place the crab back into the water to get it to release its grip. If the crab will not release its grip, pry its claw loose with your free hand and fling the crab away. It is very hard to pry a crab's claw apart. If the skin is broken, treat the injury as you would any puncture wound: Clean and dress, using antibacterial ointment.

Mobile Phone Falls in Water

Remove the phone from the water as quickly as possible and turn it off. Hold the phone so the keypad is facing toward the sand and remove the back cover. Take out the battery and dry it and all battery contacts thoroughly with a clean cloth or T-shirt. Remove the front cover and keypad. Using a hair dryer, blow hot air into the phone for at least 10 minutes. Allow the phone to dry overnight or longer, then attempt to switch it on.

Severe Sunburn

Get out of the sun immediately. Place strips of cool, wet cloth over the burn area and leave in place. Never put ice directly on bare skin or you risk freezing skin cells. Remove the cloths as they warm, apply a topical burn gel such as aloe vera, and re-cover with chilled cloths. Take an over-the-counter pain reliever as necessary. Stay indoors, or, if impossible, completely out of the sun.

SAND IN SWIMSUIT



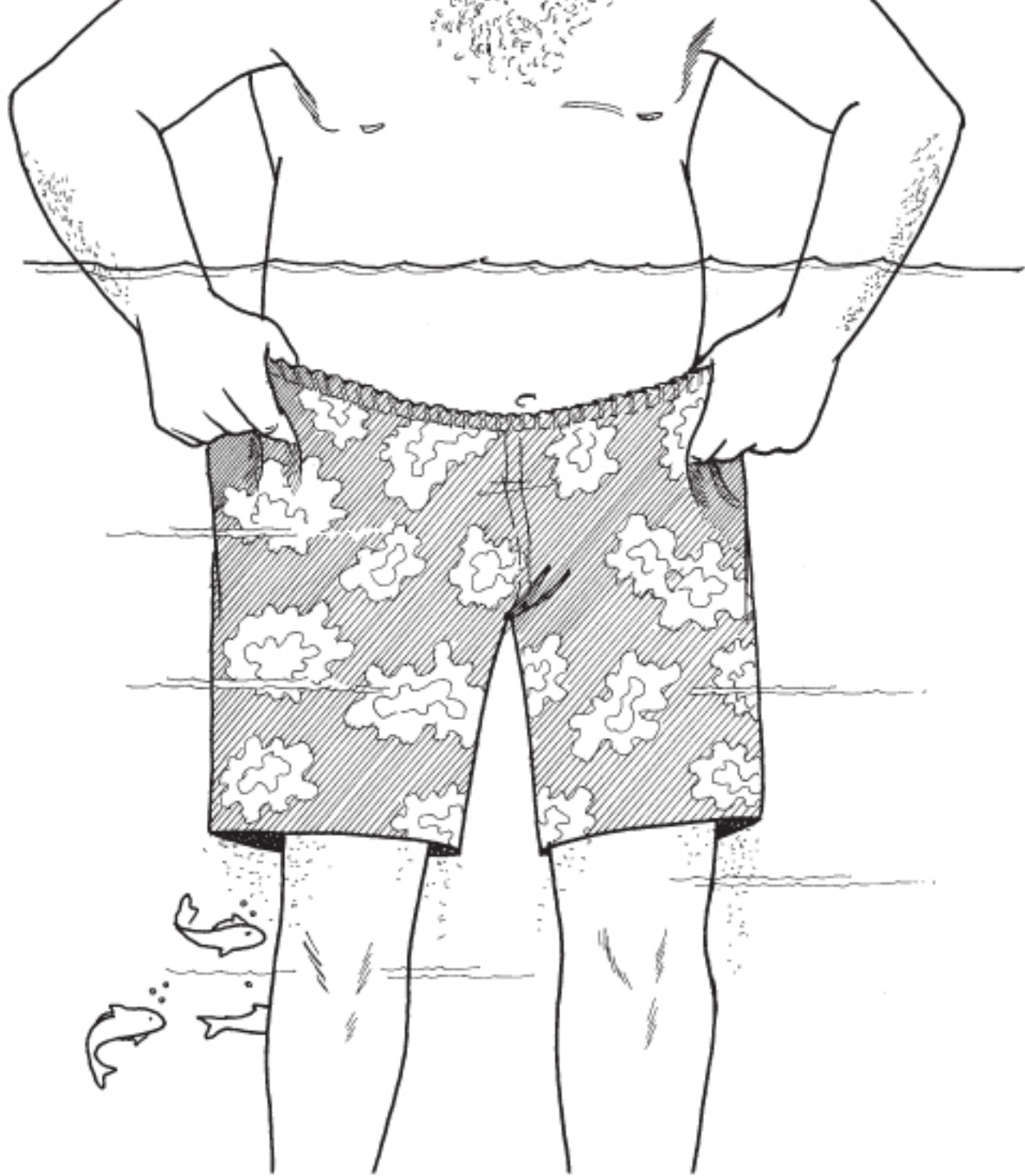

Wade into the ocean. Pull your suit away from your body, jump up and down, and shimmy from side to side to allow trapped sand to be washed away.

Immerse yourself in cold water. If immersion is impossible, spray yourself with cool water while fanning the skin. Stop cooling when body temperature falls below 102°F and seek medical assistance.

Lost Sunglasses

Borrow a mask and snorkel and check on the sea floor in the area where you were swimming most recently. Check under towel edges. Check on top of your head.

Emergency Sunshade

Lay a towel between the backs of two beach chairs, or dig a deep depression in the sand, cover it with a towel, and crawl in. Alternately, cover your body with wet sand. Re-wet the mound as the sand dries to maintain coating.

Stung by Jellyfish

Rinse the skin with seawater only—freshwater will make the sting worse. Pour white vinegar on the wound area to prevent additional toxins from being released, then remove the tentacles. Take an over-the-counter pain medication as necessary. Urinating on the wound is not an effective treatment; it may actually cause the nematocysts (stinging cells) to fire secondary venom.

Sand Flies

Stay in a windy area or sit in the path of a fan. Sand flies typically will not bite when there is a breeze or rapid airflow. The flies are also attracted to body heat—keep skin cool with frequent swimming.

Riptide

Swim parallel to shore, perpendicular to the current, for 25 to 50 yards, or until you are no longer being pulled out to sea. Do not try to fight the current by swimming directly to shore.

Hurricane

Immediately evacuate coastal areas to avoid storm surge, then get indoors. Avoid buildings with eaved roofs and exterior windows not covered by plywood. Remain in a windowless room at the center of the structure until the storm passes.

Tsunami

Move to high ground quickly, 40 to 50 feet above sea level, or to the fifth floor of a building. Climb a tree or low rooftop only as a last resort. Warning signs of an approaching tsunami include water quickly rushing out to sea, a loud roar, and shaking ground.

BABY

Cries When You Pick Up

Hold the baby close to your chest so it can hear your heart beat as you gently rock it back and forth. As you do this, hum low notes so that the buzz reverberates in your throat and chest. If this fails, place the baby in a basket, put the basket on top of your dryer, and turn it on. The resultant noise and rhythm will lull the baby into sleep.

Poops When You're Holding

Keep the baby at arm's length. Turn your face to the side and breathe through your mouth. Holding the baby firmly under its arms, hand it to the nearest available adult and exit the room.

Introducing Solid Food

Give the baby a plastic baby spoon to play with so she becomes accustomed to its feel. Mix rice cereal with milk or water in a 1 to 3 ratio until the mixture is smooth and runny. Fill half the baby spoon with the mixture and gently put it in the baby's mouth. With your patience, the baby will learn to keep the food in her mouth and swallow it rather than push it out with her tongue. Gradually give the baby more solid food, keeping track of what she likes and dislikes, and go with what she enjoys.

Diaper Rash

Clean the area thoroughly with water, without wiping, and let the baby "air out" before applying a zinc-based diaper cream. To prevent diaper rash, change the baby's diaper frequently, and quickly after defecation.

Teething Discomfort

Give the baby a cold teething ring. Store the ring in the refrigerator or freezer when it is not in use. You may also give the baby cold applesauce or yogurt. If the gums appear to be inflamed, wipe them gingerly with a dampened piece of gauze.

Won't Sleep at Night

Develop a very specific routine for putting the baby to bed: It can be as simple as a feeding, a story book, and a lullabye at a given time of the evening. If the baby still won't sleep, you may either do your best to ignore the baby's crying; or you may pick the baby up, comfort him, and put him in bed with you. Warning: Most parents believe very strongly in one of these solutions and are irrationally hostile to practitioners of the other solution. Don't ever tell anyone how you get your baby to sleep at night.

BARTENDER

Bar Fight

Alert the bouncer and call the police. Tell nearby patrons to keep away from the fight. Do not attempt to break up the fight yourself—one or both of the fighters may be armed.

Patron Makes Unwanted Advances

Claim you are married, but that you remove your wedding band so you don't scratch the glasses while washing them. Offer to introduce the patron to other single customers in the bar if you're reasonably sure the introduction will be well received by both parties. Beware that you run the risk of hearing both sides of the breakup story if things don't work out.

Patron Uses You as Shrink

Let the patron talk. Nod sympathetically. When asked for advice, rephrase the question as a question for the patron ("Well, what do you think?") and always agree with the customer. Solicit the input of other bar patrons, who will likely be free with their advice. Offer no opinions of your own or you will leave yourself open for updates. Make a show of keeping busy—cleaning glasses, cutting garnishes, and refilling the snack bowls—to avoid getting sucked in.

FLAMING COCKTAIL FIRE





Throw a wet bar rag onto the flames and spray water from the fountain hose to fight a flaming cocktail fire that has spilled and spread onto the bar. Advise patrons to step back.

Overcrowded Bar

Nod to waiting customers to acknowledge them and say “I’ll be with you in a second.” Glance up

and down the bar to take notice of the order in which the customers have arrived and try to tend to them in roughly that order. Take multiple orders at once, and think ahead for ways to consolidate actions and multitask. Start a beer pouring from the tap while reaching for a liquor bottle for another drink, and line up multiple drinks with the same base liquor for double pours. Always use both hands. Be sure all garnishes are precut at the beginning of your shift.

BASEBALL

Pop-Fly Fielding Collision

Go loose and roll backward on impact, keeping hold of the ball, if you have it, at all costs. Keep your concentration on the ball and be ready to make a play even if neither of you have been able to catch it. At the first sign of a pop fly, gauge your position and shout whether you'll be able to reach it, listening for shouts from other teammates. If you are called off, stop running and duck down and out of its path.

Team Is "Cursed"

Pack your squad with young players who don't know or feel less shackled by your club's tortured history. Invite the fans to take a more defiant and optimistic view of the situation. Hire a manager unfazed by superstition and bide your time.

Hit with Fastball

Twist your body to take the shot to the fleshy part of your upper arm or leg rather than on a bone in your hand or shoulder. Toss the bat aside and take your base. Show as little pain as possible, until you are back at the dugout. Apply ice to the bruised area.

Forgot Coach's Signals

Run aggressively for any opportunity you see to advance a base. If questioned, tell the manager that you thought you detected a flaw in the defense that you could exploit. If you are successful, there's no problem; if you fail, you can still claim to be doing all you can to win.

Bench-Clearing Fight

Tackle an opposing player on natural grass or infield dirt—stay off AstroTurf to avoid turf burn. Wrestle aimlessly until umpire takes control of the game.

Caught in Rundown

Scream at the opposing players as you run toward them to break their concentration. Stay on the baseline as you charge back and forth to avoid an automatic out. Hope for an error or an overthrow, or for a teammate running from another base to advance safely.

BASKETBALL

Loose or Tight Rim

Shoot the ball with a high, soft arc, aiming for the front of a loose rim with a small amount of back spin—try for a swish or contact with the front of the rim to break some of the ball’s momentum and nest it into the net. For a tight rim, drive the ball inside for closer shots, or bank a shot off the backboard to negate some of the rim’s lack of bounce.

Shooting Winning Free Throw

Follow your normal shooting routine precisely, concentrating only on your motions and shutting out any other distraction. Take long, smooth breaths, inhaling through your nose, exhaling through your mouth. Picture the ball going cleanly through the net. As always, aim for the front of the rim.

Avoiding Being Posterized

Jump up as high as possible and slam your hands onto the forearms of the offensive player to keep from getting dunked over in a poster photograph–worthy manner. Focus on breaking her grip and control of the ball rather than getting hold of the ball itself. Outside of the basket, try to cut off her path to the hoop by standing at an angle to the rim.



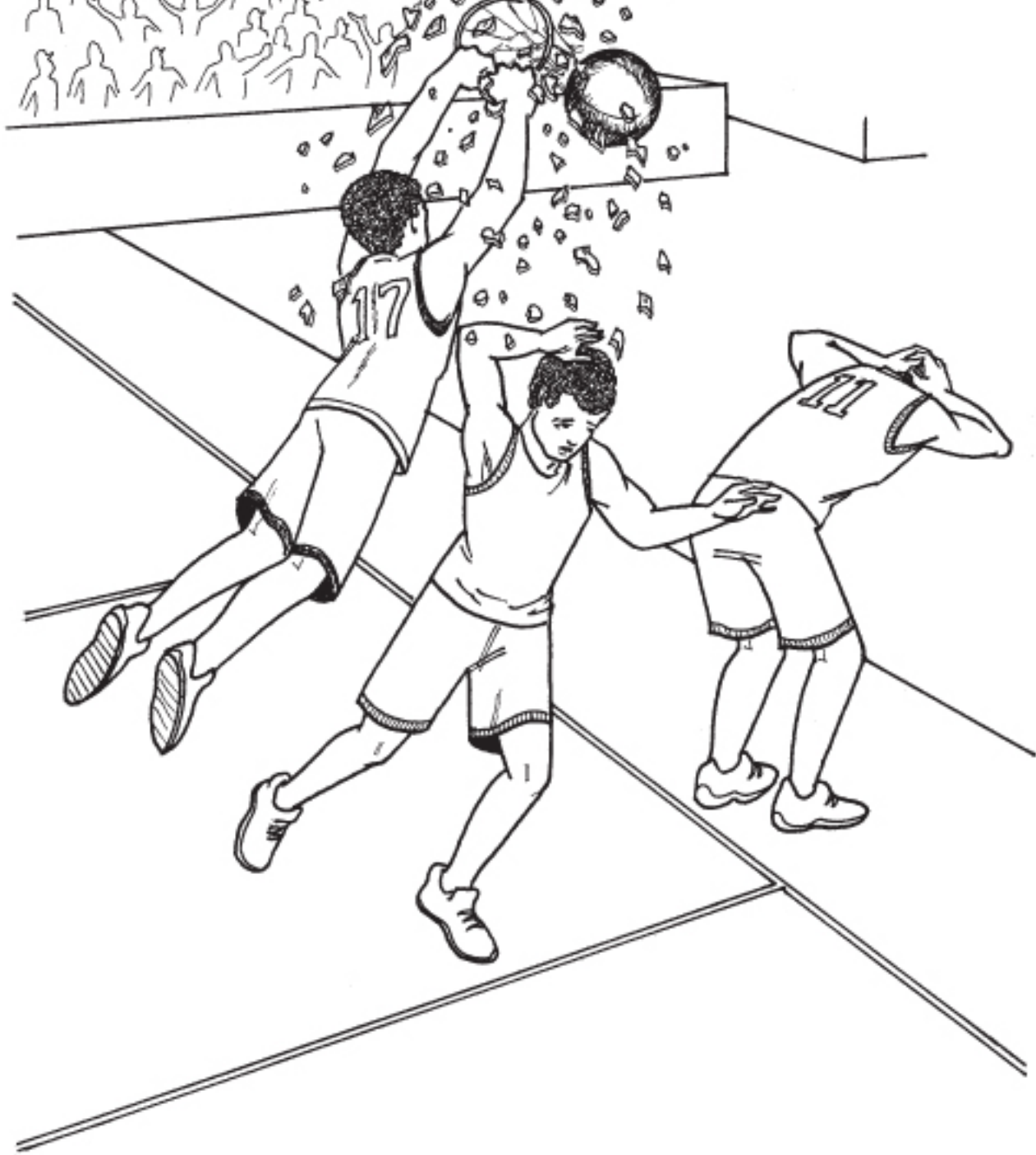

Step past the end line behind the backboard—the structure will come forward if torn off its moorings. Bend toward the floor and cover the back of your head with your hands.

Winning a Jump Ball

Time your jump to go up exactly following the ball as it leaves the referee's fingers. If you are

playing against a smaller player, wait for the ball to reach its full height from the ground before tapping it to a teammate. If you are playing against a taller opponent, back-tap the ball slightly before it reaches its apex.

Wearing Bobos

Play an efficient, hard-nosed, old-school game, keeping flashy passes and wild shots to a bare minimum. Be willing to take charges, play stiff D, and rebound like an animal. If you can sell yourself as a utility baller, you will still be given ample opportunity to play. You are better off wearing wack kicks and having a solid game than wearing top-of-the-line shoes and playing like a chump.

Taking a Hard Charge

Anticipate where your opponent will try to drive inside, beat him to that spot, and stand still. Cross your hands in front of your body, placing them squarely over your groin. Stand with your knees slightly bent, ready to roll backward at the first contact from the offensive player. When you fall backward, throw your arms out and in back of you to cushion the fall and exaggerate the force with which you were hit, to signify to the refs that a foul has been committed.

BIRDS

Loose in the House

Close the curtains and turn off all the lights. Birds will typically stay motionless in a dark room. Use a flashlight to locate the bird. Gently pick the bird up and return it to its cage.

Loose outside the House

Check all adjacent trees, bushes, and windowsills, whistling and calling the bird's name. Birds with clipped wings will not travel far, and caged birds tend to lose muscle mass and the capacity for skilled flight. Act quickly: Birds are targets for predators such as cats and hawks.

Won't Shut Up

Cover the bird's cage with a cloth and turn out all lights in the room. The bird should quiet down and fall asleep.

Parrot Curses

Reinforce acceptable word usage with food treats or toys. Hold a cookie while you teach the parrot to say "cookie," or cover its cage while you say "good night." While it is impossible to "unteach" the bird, eventually it will use only those words it hears frequently. Never keep a parrot in your bedroom.

BODY

Cellulite

Maintain a normal weight, and reduce your weight gradually if you are overweight. Exercise regularly (particularly resistance programs like yoga and Pilates), and reduce your consumption of alcohol, caffeine, and highly processed foods. Eat fresh fruits and vegetables, and drink plenty of water. Though there is no nonsurgical cure for cellulite, there is some evidence that the herb gota kola and aloe vera cream can reduce symptoms.

Sore Muscles

Apply ice packs to painful areas for 20 minutes each hour. Stretch the sore muscle areas thoroughly to reduce the lactic acid buildup that causes pain and increase blood flow and oxygen in sore areas. Drink at least 64 ounces of water daily, and take ibuprofen for severe localized pain.

Too Thin

Wear fitted clothing to give your physique shape and good lines; double-breasted jackets add bulk. Avoid pinstripes, which give the appearance of length, and tight-fitting pants, which will only accentuate thin legs. Pleated pants will add the illusion of girth, but baggy pants will seem billowy and should be avoided. Dressing in layers can add appearance of bulk. Wear flats, not heels.

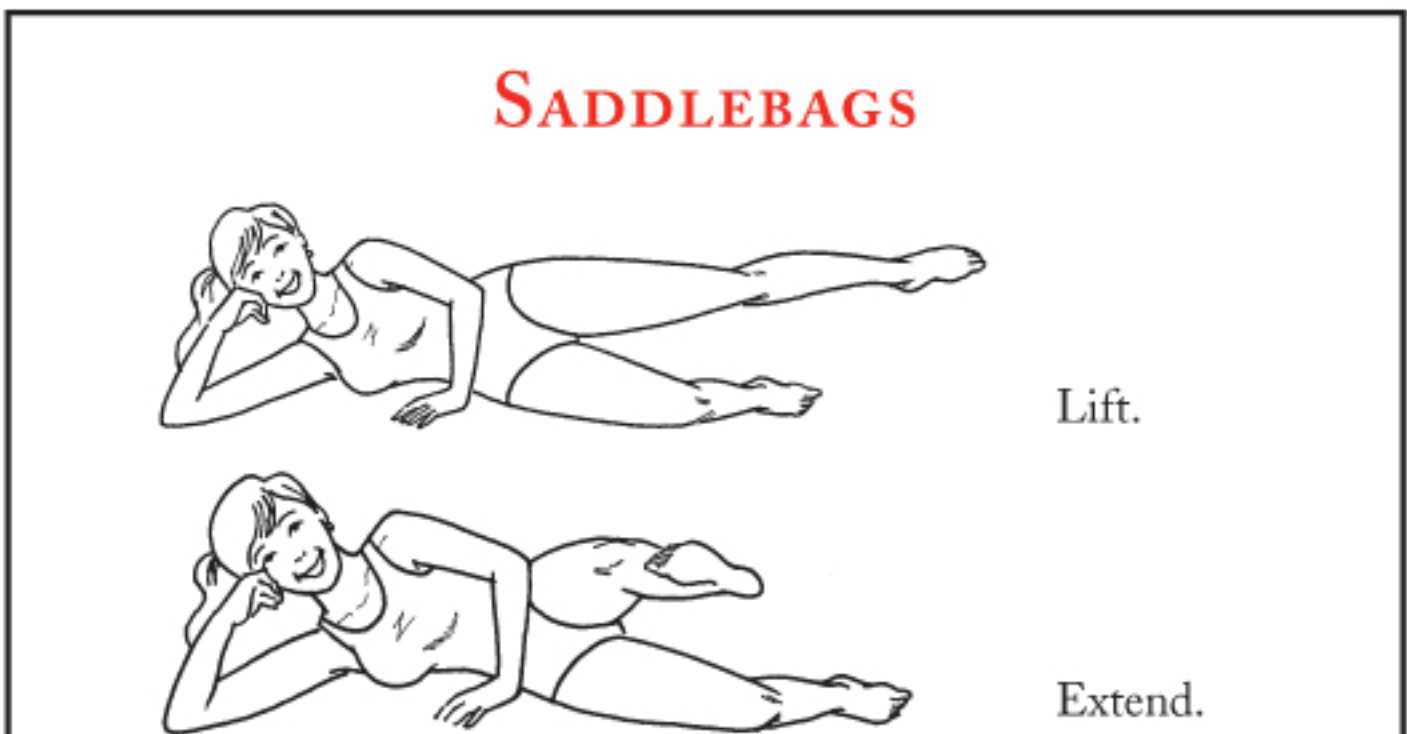



Extend.

front-to-back hip swing



Leg down.



Leg up.

side leg raise

Perform exercises to firm the hips and outer thighs: the front-to-back hip swing and the side leg raise. Perform two sets of 12 to 15 reps on each side, 2 or 3 times a week, with a rest day in between.

Draw attention to your face with a bright necktie or scarf. Wear loose but not oversize clothing, and use contrasting colors (dark shirt with lighter jacket) to provide a slim appearance. Avoid horizontal stripes, double-breasted jackets, and pants with pleats or elastic waistbands. For women, wear pants that cover your shoe tops to give your body a longer appearance. For men, wear suit jackets with side or double vents to avoid accentuating a large rear end.

Forgot Deodorant

Wash armpits with water and hand soap, then rinse and pat dry with paper towels. If soap is not available, place 2 mint teabags in hot water, dip in ice water to cool, wring out, then place one under each arm for 2 minutes. A wet sprig of thyme rubbed under the arms will provide temporary odor protection.

Excessive Perspiration

Apply antiperspirant containing 2 percent aluminum chloride to armpits, palms, feet, face, back, chest, or other problem areas. Wear loose-fitting, light-colored cotton clothing to help mask visible sweat marks.

BOWLING

Rank Rental Shoes

Line the bottom of each shoe with a flat fabric softener sheet. Be sure to tighten the laces so your foot doesn't slide in the shoe.

Fingers Stuck in Ball

Put the ball on the ground and twist your fingers from side-to-side to slip them out. If still stuck, use a little liquid (water is best; not beer or soda) to lubricate the joints of your stuck fingers. If still stuck, obtain grease from a grilled or fried snackbar item and rub it on your fingers as a lubricant. If that doesn't work, dunk the ball and your hand up to the wrist in a tub of ice water, wait for the finger swelling to contract, and free your fingers with a twisting motion.

Ball Dropped on Foot

Remove your bowling shoe and your sock to allow blood to circulate freely to your foot. Recline, elevate the foot over your head, and apply a cold compress. Try wiggling your toes: If difficult, you may have broken a bone, and you should go to the hospital for treatment, being careful not to put weight on the foot. If you can easily move your toes and the pain subsides relatively quickly, apply ice to the area and continue your frame.

DEALING WITH A 7/10 SPLIT

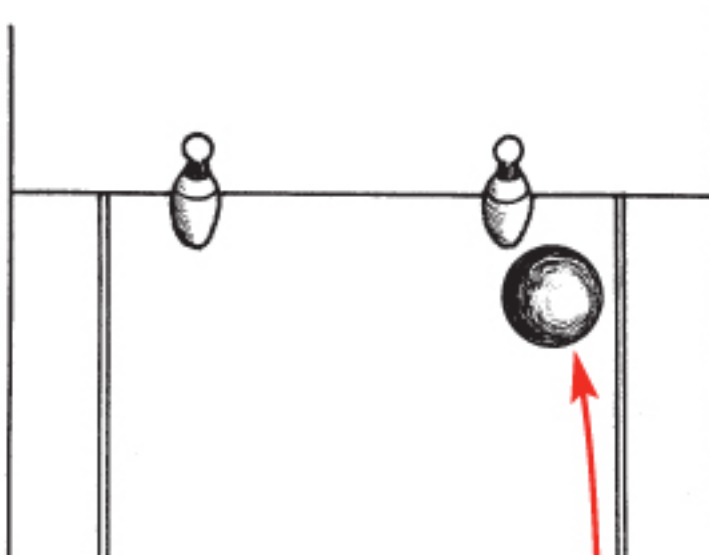

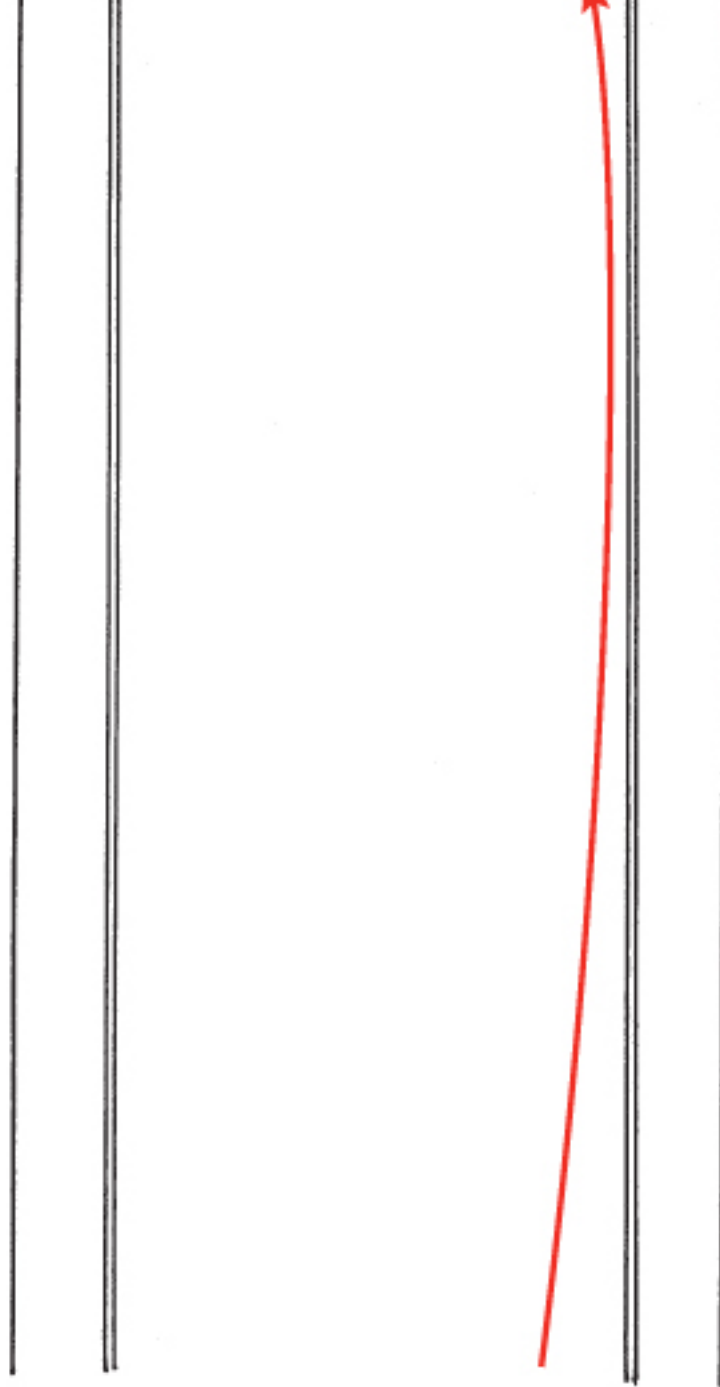

Aim for the far right of the 10 pin if right-handed, the far left of the 7 pin if left-handed. Throw to hit the pin as hard as possible, with significant hook. With luck, the struck pin will bounce off the back wall and knock over the other pin.

Align your left foot with the locator dot if you are right-handed, the right foot if you are left-handed. Square your shoulders to the foul line, and approach your delivery by holding the ball out and back past your hips. Swing the ball like a pendulum toward the pins, keeping your focus on the middle arrow on the lane. Release the ball with your fingers together and follow through with your arm extending toward the pins.

BY AIR

Impending Crash

Quickly make a mental note of the nearest exit, keeping in mind that it may be behind you. Buckle your seatbelt and remove high heels to avoid puncturing the emergency slide (if you are over water). Lean forward and place your head in your lap, then cover it with your arms. Follow instructions from the crew.

Severe Turbulence

Secure your seatbelt and look out the nearest window, focusing on the horizon. If the horizon is not visible, focus on a fixed object within the plane, which will be rising and falling at the same rate you are, to reduce the sensation of violent motion.

Jet Lag

Upon boarding the plane, set your watch to your destination time zone and follow the appropriate eating and sleeping schedule. Drink water to stay hydrated, and avoid coffee or alcohol while on board. Remove contact lenses and wear glasses to prevent drying of eyes. Wear loose clothing in layers so you can adjust to the temperature of the cabin. On arrival, keep yourself awake by staying outside and busy during the day and turn in no more than an hour or two earlier than you normally would.

Muscle Cramps

Get up once per hour and walk through the cabin to increase blood flow to muscles. Perform 5 to 10 deep knee bends and stretches in the galleys or near the lavatory. While seated, extend your legs as far as possible under the seat in front of you—lean the seat back for added reach. Remove your shoes, rotate your ankles, and flex your toes.

Canceled Flight

Call the airline's reservation system (or, better, your travel agent) on a mobile phone while waiting in line for rebooking; you may be able to get a new reservation before you reach the ticket desk. When possible, use a paper ticket, which can be endorsed to a different airline more easily than an electronic ticket.

Chatty Neighbor

Put on headphones or feign sleep until your neighbor gets the message. If you are in a row with three or more adjacent seats, get up and spend 10 or more minutes in the lavatory area of the plane, encouraging the chatty flyer to begin talking to the other person in your row.

BY BUS

Sleeping on Overnight Bus

Secure a window seat so that you can curl up against the side of the bus. Support your head with a neck pillow or a rolled-up sweater. Wear earplugs or noise-canceling headphones from a music player. Fashion emergency earplugs from rolled-up toilet paper (leave at least an inch of the paper outside of the ear canal for easy removal). Wear an eye mask or dark sunglasses, or tie socks around your head and across your eyes. Do not sit near the lavatory.

Arm Stuck in Door

Pound on the door with your free hand. Yell “door!” (Yelling “help” or “hey” will delay assistance.) Continue pounding and shouting. If you are outside the bus, drop any luggage and run alongside if possible until the bus stops.

Standing on Overcrowded Bus

Remove and carry backpacks before boarding, and stand with them resting on the floor and clutched between your feet and ankles once aboard. Slide a purse or camera around to the front of your person and keep one hand resting on it and holding the strap. If you are able to slide your bag, briefcase, or luggage beneath the seat of a sitting passenger and stand alongside, keep contact with the bag by touching it with your feet at all times.

SHARING SPACE WITH LIVESTOCK





Keep your arms close to your sides. Hold a book or magazine open and in a defensive position, ready to deflect an errant wing or pecking beak. Tie long hair back. Keep food items stowed away.

CAMPING

Rain

Set up your tarp at the first sign of rain. If your tent has rain flies, set a tarp under the tent to keep the ground under the tent dry. If your tent does not have a rain fly, set up the tent and put the tarp on top of it to keep the tent from saturating. Do not set camp in depressions, gullies, and other low spots where rainwater is likely to collect. Always seal your tent with seam sealer 24 hours before packing the tent for a camping trip.

Snow

Clear snow and ice from the tent site, if it is possible to do so. If clearing the snow is impossible, pile dry leaves under your tent before setting it up. A domed tent should prevent snow from accumulating on the tent roof and causing collapse. For further insulation, or if you don't have a domed tent, set up a weather fly by hanging or staking a tarp above the tent so that two sides rise higher than the others at an angle to allow snow to slide away from the tent. Drive plastic tent stakes into firm ground, or use steel spikes for ice. Don extra layers of clothing.

Animal Proofing

Establish camp at a remote, empty site: Animals accustomed to people are less afraid of them and may expect to find food in well-trafficked areas. Hang food and all cooking utensils from tree branches several feet off the ground. Leave your packs unzipped to prevent foraging animals from tearing them open in search of food odors. Keep all food items in a car, if available. Never keep food inside your tent.

Snake in Sleeping Bag

Pick up the sleeping bag from the bottom and dump the snake outside. If you are in the bag and feel a snake, avoid sudden movements. Very slowly work the bag down toward your feet as you pull your upper body and then legs out. Keep the bag rolled up and tied when you are not using it to prevent snakes from entering, and keep your tent flaps zipped.

Rattlesnake Bite

Wash the bite area with soap and water, then immobilize the bite area, keeping it lower than your

heart. If you are more than 30 minutes from emergency medical care, wrap a bandage 2 to 4 inches above the bite to help slow the venom. The bandage should not cut off blood flow: It should be loose enough for a finger to slip underneath. Do not make incisions near the bite or attempt to suck out the venom.

Starting a Fire without Matches

Construct a bow by running a taut piece of string between the ends of a sapling. Place a stick against and perpendicular to the string and twist so the string loops once around the stick. Holding the bow with one hand, place the bottom of the stick on a piece of dry wood. Holding a finger on either side of the stick to keep it in place, quickly move the bow back and forth, turning the stick and creating friction. Add straw or dry pine needles to the bottom of the stick as it heats up, until they catch fire.

CATS

Up a Tree

Obtain a bath towel and a ladder. Set the ladder in a stable position at the base of the tree, climb, and approach the cat while calling and speaking to it in a soothing manner. Wrap the cat in the towel to prevent scratching and descend the ladder. If the cat is too high, call the fire department.

Clawing Furniture to Shreds

Cover furniture ends and edges with aluminum foil or wide masking tape to create surfaces not as pleasing to scratch, or treat furniture with a citrus-scented spray, an odor cats tend to avoid. Rub a scratching post with catnip and place it near the furniture the cat likes to scratch. Place the cat near the scratching post and use your own fingernails to scratch the post, cuing the cat to the proper behavior.

Bringing Kills into House

Pick up the kill using rubber gloves or a shovel and dispose of it in a tight-seal outdoor trash can without fuss or scolding, which may be misinterpreted as attention or praise. Put collar bells on the cat to reduce its hunting effectiveness, decreasing the number of kills and thus kills brought into the house.

Lost

Check the house thoroughly: Cats can squeeze into tiny spaces, and the cat may be stuck somewhere inside. Walk the neighborhood, loudly calling the cat's name. Post flyers with the name, description, and a photo of the cat; your name and phone number; and note of a "reward" without mentioning the amount. Bring a flashlight to see an injured cat that might be holed up in a dark place. If unsuccessful, call nearby shelters and animal hospitals.

Drinks Antifreeze

Look for signs of poisoning, including excessive thirst and urination, vomiting, and uncoordination. Bring the cat to a vet or animal hospital immediately—do not induce vomiting. If you can locate the antifreeze, rinse the spill area thoroughly with running water, then scrub with detergent and rinse again to remove all traces. Consumption of a single teaspoon of antifreeze can kill a cat.

Pick up the cat. Gently move the leg into a more natural position, then tape or bandage the leg to a small piece of wood—such as a ruler—to create a splint and keep the leg immobile. Take the cat to a vet or animal hospital.

PERFORM THE HEIMLICH MANEUVER





Kneel and hold the cat in front of you, close to your chest. Place one forearm under the cat's front legs and hold him up and outstretched, facing away from you. Place the fist of your other hand just below the bottom rib. Give 2 or 3 quick, firm pushes inward to force the air out of the diaphragm and dislodge the object.

About to Give Birth

Make a “birthing box” in the final two weeks of the cat’s pregnancy. Use a cardboard box large enough for the mother and her kittens to recline in. Cut a large opening so the mother can enter and exit, at least 4 inches up the wall so the kittens can’t escape. Stack newspaper or towels in the box and place it in an out-of-the-way location. If possible, suspend an infrared heat lamp 3 feet above the box. In most cases, cats can give birth without human intervention. After the birth, the mother should cut the umbilical cords and tear open the kittens’ membrane sacs; offer your assistance if she does not do so on her own.

Won’t Use Litterbox

Clean the litter regularly, removing feces every 2 days and changing the litter once a week. If the cat still refuses to use the litter box, try changing the brand of kitty litter. Or, if you recently changed the brand, change it back.

Male Cat Sprays

Block the cat’s view of other male cats outdoors; the sight of these “competitors” may be causing the spraying behavior, which the cat uses to mark his territory. Close doors in front of screens to eliminate the odors of other males. Place several litter boxes around the areas where the cat is spraying,

and clean sprayed objects with an enzymatic cleaning product. Yelling or screaming at the cat may only encourage spraying.

Urine

Blot the stain with paper towels to remove as much of the urine as possible. Soak the area with white vinegar, then steam clean. If the odor persists, use a commercially available product created specifically for the purpose of removing urine odor.

Cat Allergies

Use an air purifier (preferably a commercial-sized unit) in the main living area, plus one in each bedroom. Vacuum regularly, making sure the vacuum filter is clean and the bag has plenty of room left. Brush the cat daily to remove loose dander. Bathe the cat once a month using a mild pet shampoo to remove proteins from cat saliva that may be an irritant.

Cat Scratch Disease

Check for a small bump or blister at the bite or scratch site, a low-grade fever, and swelling of the lymph nodes closest to the injury location. (An injury to the arm will cause the lymph nodes under the armpit to swell and become tender.) In most cases, symptoms will disappear without treatment in a few weeks—though lymph nodes may remain tender for months. See a doctor if you suspect cat scratch disease (caused by the *Bartonella henselae* bacterium), as antibiotics are sometimes necessary.

CHILD

“I Hate You”

Acknowledge her behavior and feelings by pointing them out to her without judgment (“I can tell you are angry that you can’t have ice cream because you are screaming at me.”). If the problem is that she can’t have something she wants, offer a choice of other permissible items or activities. Do not take the “hatred” personally—children experience emotions as all-encompassing from moment to moment, but such outbursts have no bearing on how she really feels about you.

Thumbsucking

Praise your child when she refrains from the habit. Talk to her often about how she is harming her teeth by continuing to suck her thumb. If this doesn’t work, wrap the thumb in adhesive tape or a glove, or tape a tongue depressor to the thumb so it won’t be flexible (and it therefore won’t provide the comfort the child is seeking).

Always Asks “Why”

Resist the temptation to just say “because.” Ask the child what he thinks the answer is if you grow weary of supplying answers yourself (or if you don’t actually know the answer). You may be amazed and entertained by the results. Write his questions down and find out the answers together by visiting a library or a museum.

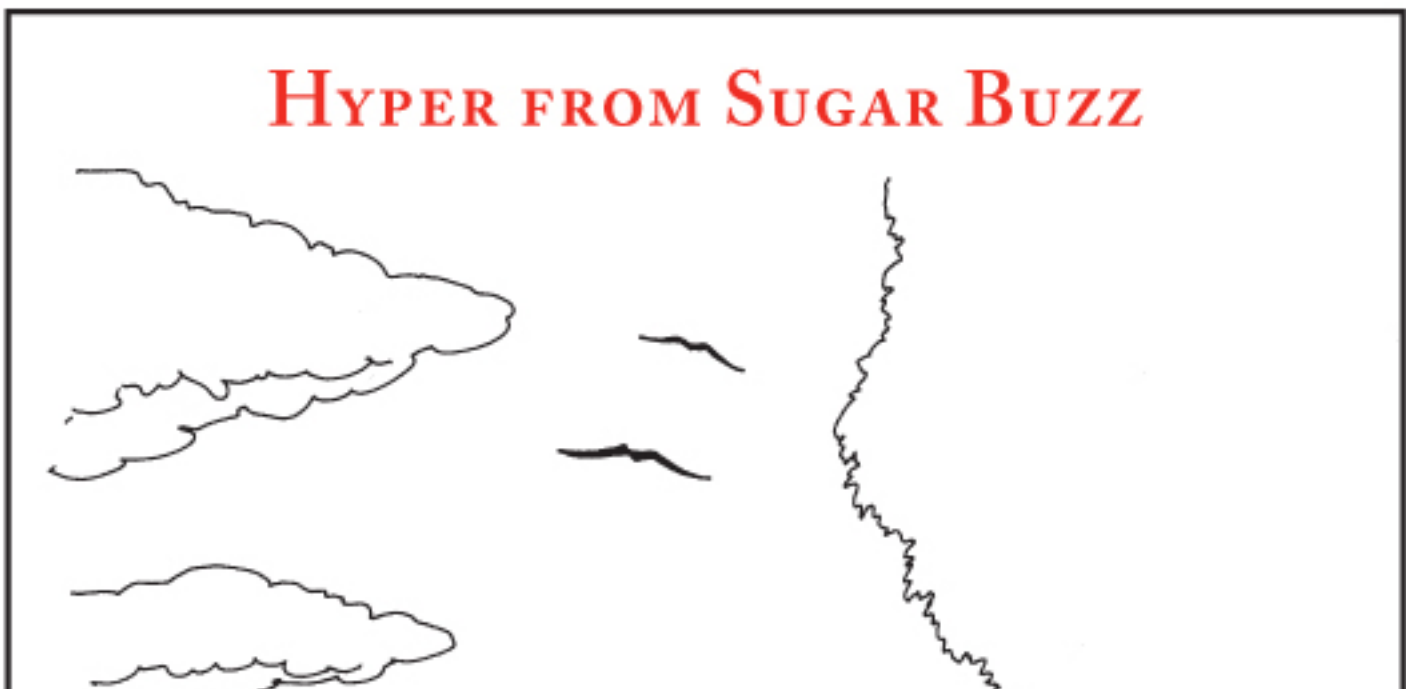

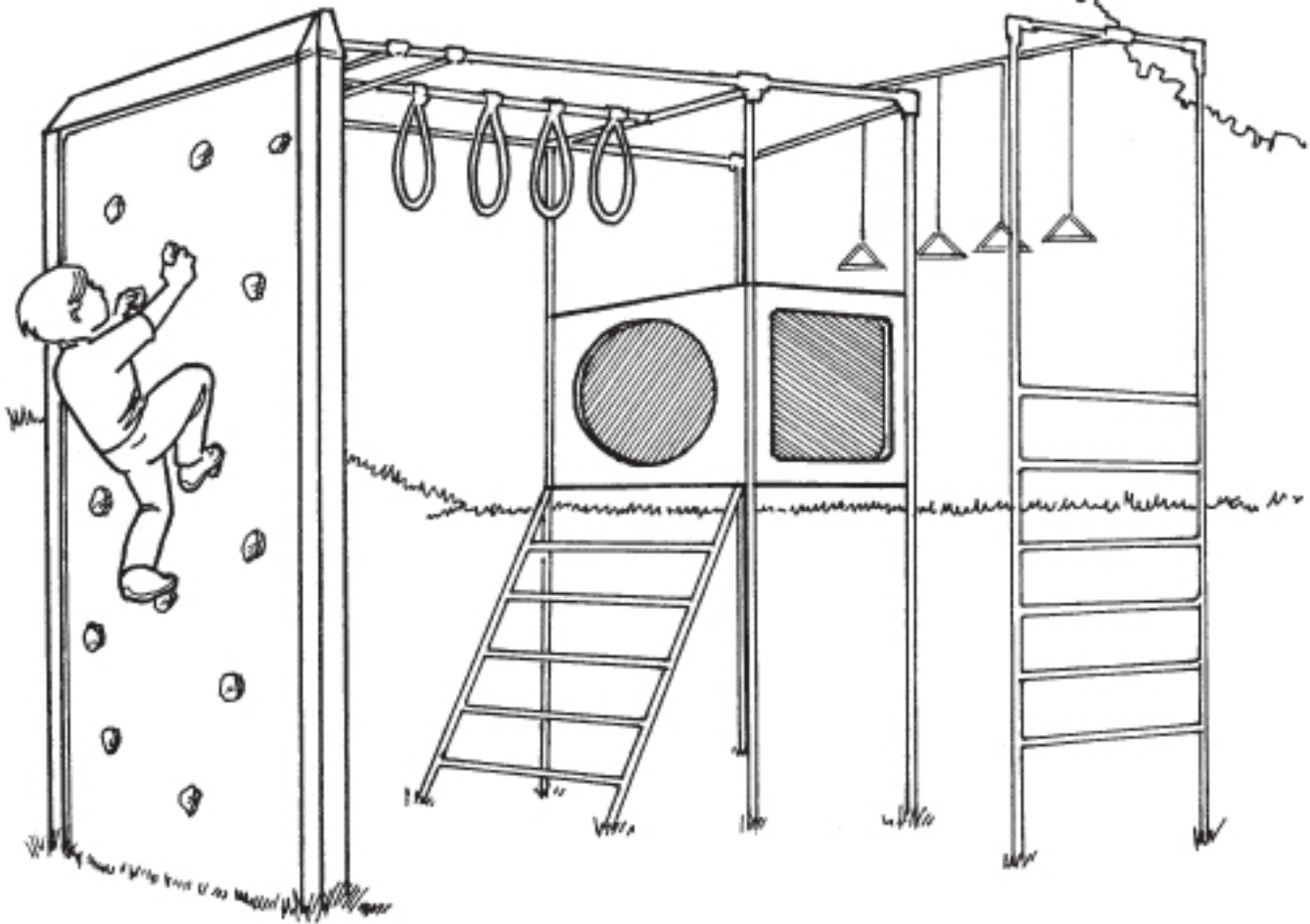

Take your child to a playground obstacle course and convince him to break the course's "world record" (make up a ridiculously short time). At the end of each run, announce that he is closer to beating the record and ask him to run it again. At signs of exhaustion, proclaim the record broken and take the child home to bed. Tame subsequent sugar buzzes by asking the child to return to defend his title against "challengers."

Sit on the bed with your child and, in a soothing voice, talk him through the process of relaxing each part of his body. If that fails, take him with you to watch late-night talk shows, infomercials, and made-for-TV movies until he can't take it anymore and goes back to bed on his own.

Won't Take a Bath

Spray boys with ultra-feminine perfume and girls with a smear of Marmite. Explain that the only way to get rid of those odors is by soaking in a tub for several minutes and using the soap and shampoo. If your child appreciates and/or is unconcerned about those smells, say that you know for a fact that the child's favorite cartoon character always bathes at night.

New-Sibling Jealousy

Give your child some responsibility toward the new baby. Make it her job to fetch new diapers and seal them with adhesive, or to protect the baby from falling leaves and twigs if you are walking outside. Praise the child profusely when she performs her duties successfully.

COOKING CATASTROPHES

Cake Doesn't Rise

Cut the cake into thin slices, fry it in melted butter, then coat it with powdered sugar and serve.

Cracked Cheesecake

Slice the cake in the kitchen before serving, or top with sliced berries or your favorite jam mixed with 1 tablespoon of liqueur to make it more spreadable. Allow the topping to seep into the crack, then add more topping to even the surface. To reduce cracks, place a pan of water on the oven rack below the cheesecake while it is baking.

Overbeaten Egg Whites

Stir in 1 extra egg white for each 5 you have already beaten. Beat until the whites are of the texture required for the recipe. Remove about 1/4 cup to correct for the extra white.

Meat Too Dry

Melt 1/2 stick of butter and mix with gravy or the pan drippings. Slice the meat thinly, place in a shallow baking dish, and smother with the mixture. Cover with foil and place in a 200°F oven for 10 minutes, then serve.

LOBSTERS ESCAPE

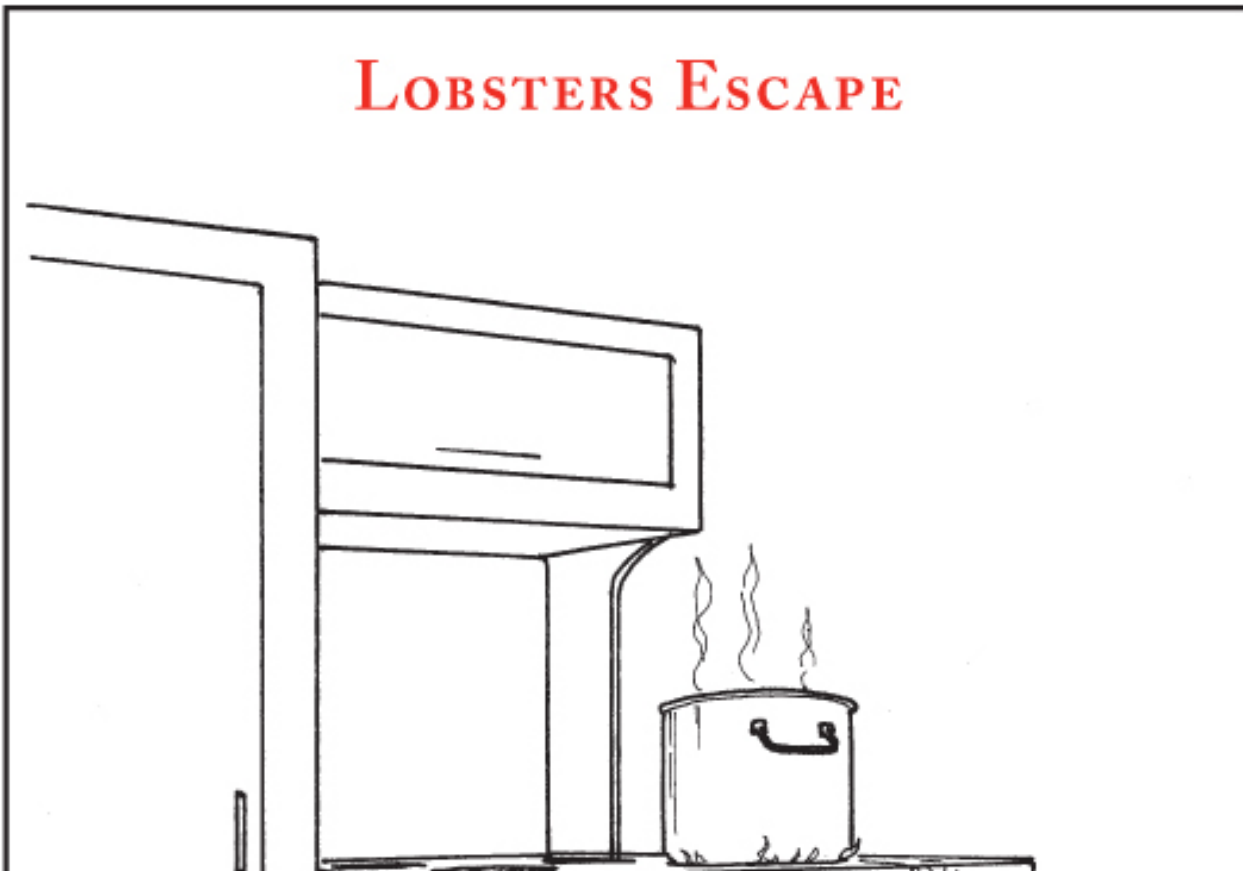



Close kitchen doors and cabinets to cut off escape routes. Wear oven mitts to protect you from the lobsters' pincers. Use a pot lid to herd the lobsters. Grasp each by the body from behind and place in a large, lidded pot of water, claws first.

Lumpy Gravy

Pour the gravy through a mesh strainer. To avoid lumps, combine the thickening agent (flour, cornstarch, arrowroot) with enough liquid to make a paste, then whisk the paste into the hot liquid to evenly distribute it.

Soup Too Salty

Add 2 raw, chopped potatoes to the soup, cook for 10 to 15 minutes, then remove. Honey can also help even out a salty taste, or adding more of the other ingredients. To avoid oversalting the soup, season it just before serving.

Sauce Too Thick

Whisk in broth (chicken, beef, or vegetable) until the sauce reaches the desired thickness, or pour the sauce through a strainer.

Sauce Too Thin

Add 1 to 2 tablespoons of cornstarch to some water. Create a paste, then whisk it into the sauce. Adding dry cornstarch directly to the sauce will create lumps. If you are making a tomato-based sauce, add 1 to 2 tablespoons of concentrated tomato paste and stir to evenly distribute.

Sauce Too Garlicky

Remove any visible garlic pieces using a slotted spoon or handheld strainer, then add honey to balance the flavor.

Brown Sugar Is Hardened

Place hard brown sugar in a microwave-proof dish and cover with a couple of damp paper towels. Microwave for 30 seconds to 1 minute, then check to see if the sugar has softened, carefully removing and setting aside partially loosened sugar with a fork and re-microwaving still-hard clumps. Repeat as necessary, watching closely to make sure the sugar does not melt.

Wilted Lettuce

Fill your sink with warm water. Submerge the lettuce for 5 to 10 minutes, then remove from the water. Dry the lettuce with a salad spinner or paper towels, cover the lettuce with a damp towel, and refrigerate for at least 30 minutes.

Soufflé Collapses

Cover the top with whipped cream or a very thin layer of chocolate pudding, and serve “baked pudding.” To prevent a soufflé from collapsing, use room-temperature beaten eggs, never open the oven door while the soufflé is baking, and place the soufflé on the lower oven rack to give it room to expand.

OUT OF INGREDIENT

Ingredient	Amount Called for	Substitution
Baking powder	1 teaspoon	¼ teaspoon baking soda plus ⅝ teaspoon cream of tartar
Butter, solid	1 cup	1 cup margarine or 1 cup vegetable shortening for baking

Butter, solid	1 cup	1 cup margarine or 1 cup vegetable shortening for baking
Butter, melted		Equal portion of oil
Buttermilk	1 cup	1 tablespoon lemon juice or vinegar plus enough regular milk to make 1 cup (allow to stand 5 minutes)
Cocoa powder	¼ cup	1 ounce unsweetened chocolate (decrease fat in recipe by 1½ teaspoons)
Cornstarch	1 tablespoon	2 tablespoons all-purpose flour
Cream, half and half	1 cup	⅞ cup whole milk plus ½ tablespoon butter or margarine
Cream, heavy (40% fat)	1 cup	¾ cup milk plus ⅓ cup butter or margarine (for use in cooking and baking)
Cream of tartar	½ teaspoon	1½ teaspoons lemon juice or vinegar
Garlic	1 clove	⅛ teaspoon garlic powder
Honey	1 cup	1¼ cups sugar plus ¼ cup additional liquid called for in recipe
Lemon juice, fresh	1 teaspoon	½ teaspoon vinegar
Mayonnaise	1 cup	1 cup yogurt or 1 cup sour cream
Molasses	1 cup	¾ cup sugar plus 1¼ teaspoons cream of tartar (increase liquid in recipe by 5 tablespoons)
Shortening, for baking	1 cup	1⅛ cups butter or margarine (decrease salt called for in recipe by ½ teaspoon)
Sugar, brown	1 cup, firmly packed	1 cup granulated sugar
Sugar, confectioners'	1 cup	½ cup plus 1 tablespoon granulated sugar
Sugar, granulated	1 cup	1¾ cups confectioners' sugar or 1 cup packed light brown sugar
Vinegar	1 teaspoon	2 teaspoons lemon juice

packed light brown sugar

Vinegar

1 teaspoon

2 teaspoons lemon juice

Yogurt

1 cup

1 cup milk plus 1 tablespoon lemon juice

CYCLING

Popped Bike Chain

Dismount and place just the top links of the chain on the smallest chain ring on your crank set. Raise the bike off the ground and turn the pedals forward until the chain catches back fully on the teeth of the chain ring, then adjust the gears so that you are in your original setting.

Lost Bike Lock Key

Cut four slits in the top of the barrel of a Bic pen and insert it into the cylindrical lock, turning clockwise, for an older U-lock. For newer locks and/or noncylindrical locks, use a pair of bolt cutters to snap the cable.

No Lights on Bike at Night

Strip down or don extra layers of clothing so that your lightest-colored garments are most visible. If you have a light-colored shirt or other garment, put it in a very visible place facing the cars behind you. If you happen to have or can locate aluminum foil, flatten it out and hang it from the back of your shorts or pants. Ride a route well-illuminated by streetlights. Sing loudly and make whooping noises.

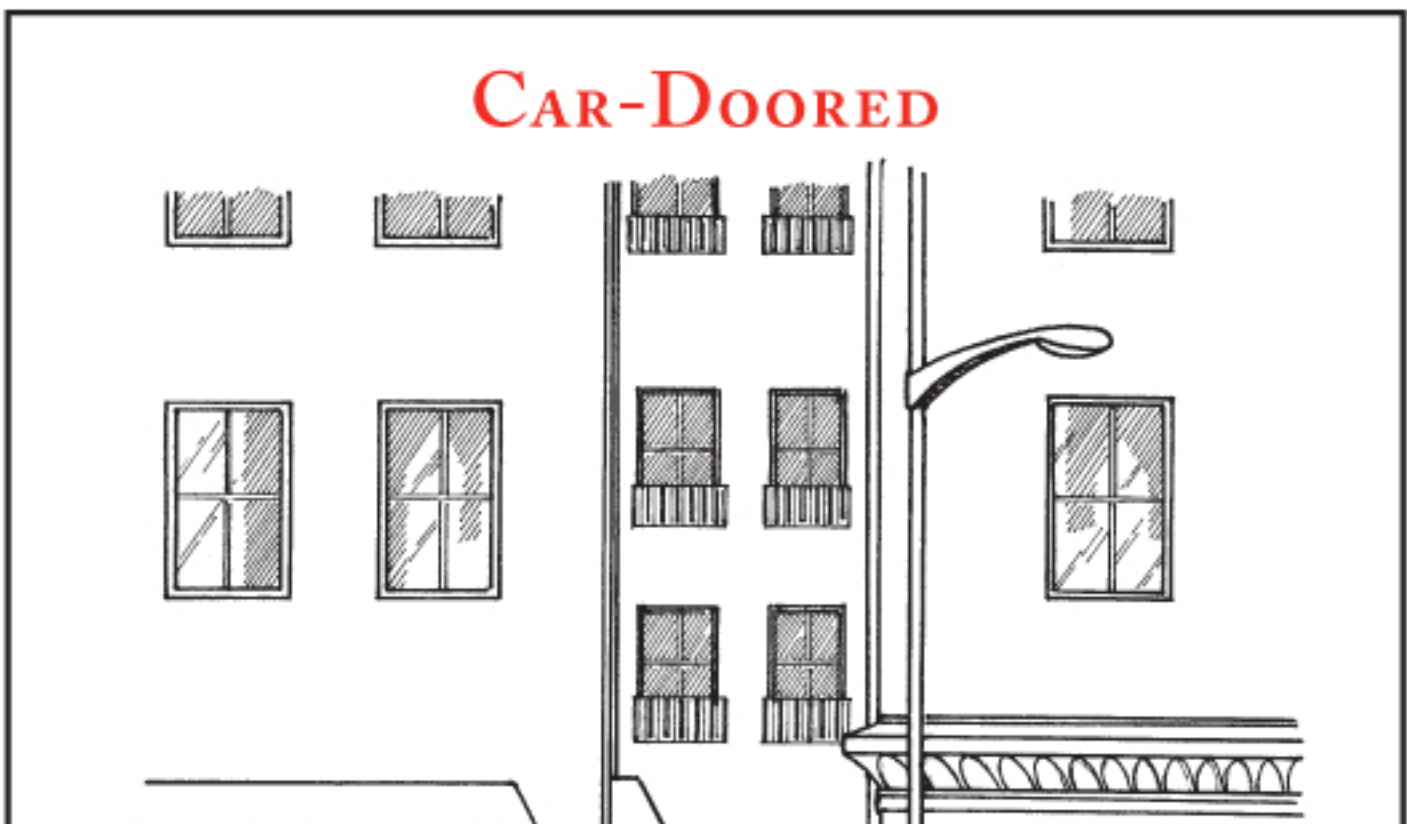

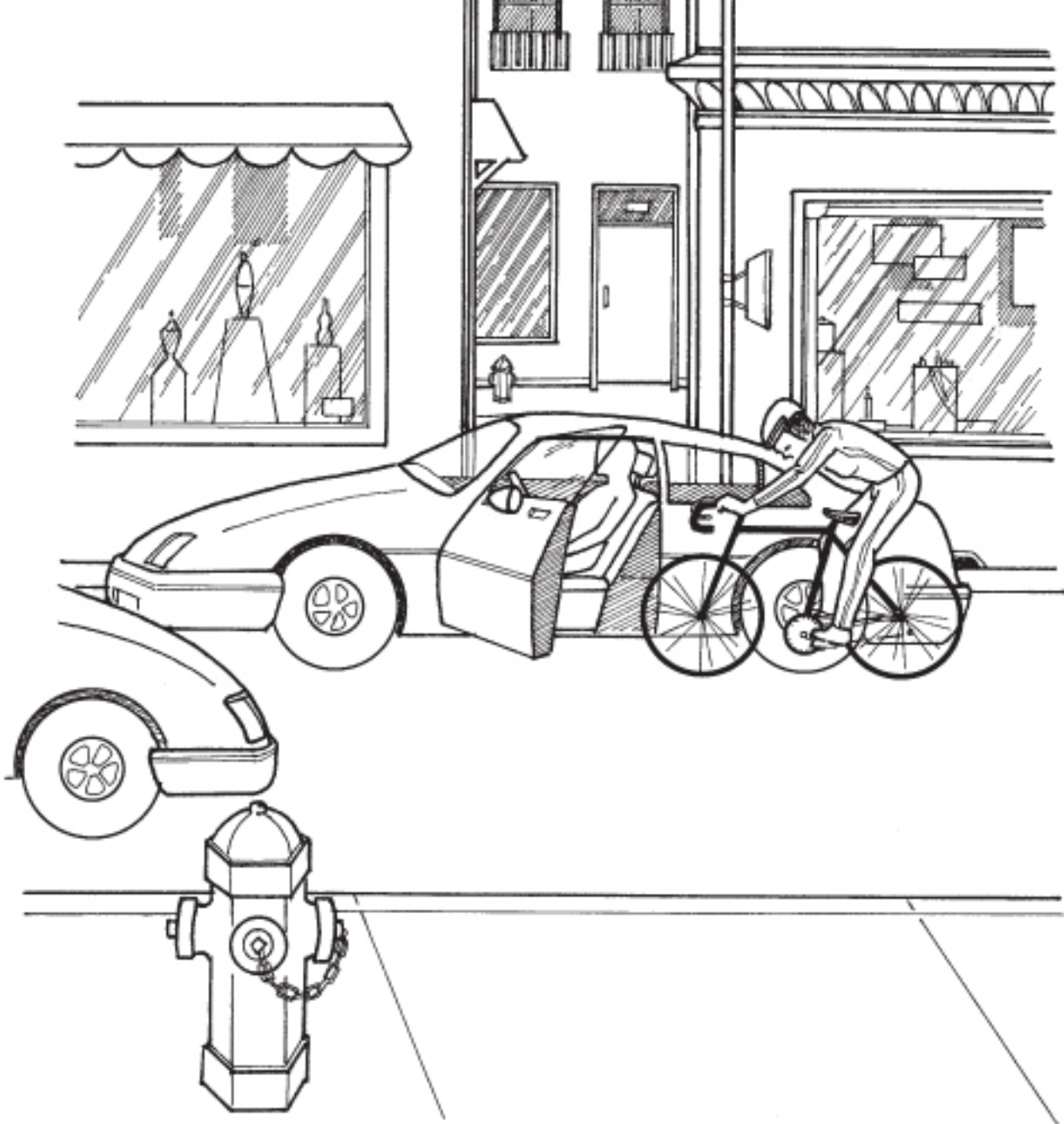

Throw your weight backward. Stand on the pedals and above the seat. Apply only the rear brakes. Turn slightly to the side to disperse the impact as you hit the door. If you land in the street, move immediately toward the curb to get out of the way of traffic.

No Bike Lane on Street

Ride in the street with the flow of traffic, at least 3 feet from parked cars. Watch for cars that have suddenly stopped in front of you or have just pulled in to park, as both are more likely to have doors

open into your path. Maintain speeds only at which sudden and complete braking is possible. Always wear a helmet when riding.

Shoelace or Pants Tangled in Chain

Brake to stabilize the bike and regain your balance, leaning off the seat until your feet are on the ground. Pull your bike off the road. While grasping the chain as close to your front derailleur as possible, roll it backward slightly until the chain is untangled from your garments.

DIETING

Relapse Binge

Forgive yourself and start over. Binging is common for dieters. Look at it as a temporary setback rather than complete failure. Gather any snacks left over from your binge; give them to others or throw them away. Replenish your refrigerator and cabinets with healthful food choices, and resume your diet.

Chocolate Cake

Do not take a bite: Remember, the first bite is the beginning of a serving. Avoid defeatist thinking (“I’ll never get thin anyway, so I might as well eat the cake”). However, dieting is not about deprivation, so eat a healthful dessert like fruit or nonfat yogurt in place of the cake. If you cannot avoid temptation, leave the table before the cake is served and return when everyone is finished eating.

The Munchies

Eat 5 to 6 small meals per day rather than 3 large ones—large meals tend to lead to a drop in blood sugar 3 to 4 hours after consumption, prompting snacking.

GUILT-FREE FOODS



unsalted pretzels

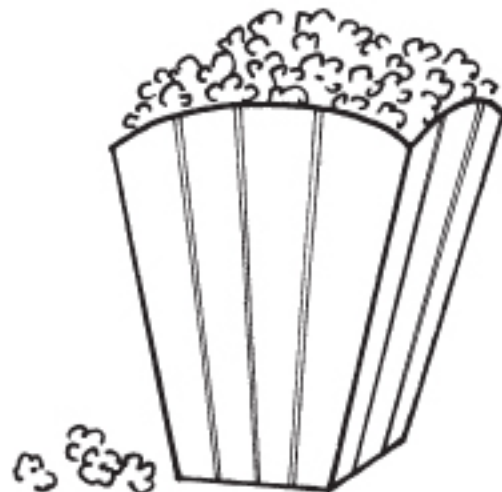

unbuttered popcorn



unbuttered popcorn



broccoli



rice cakes



mushrooms



bell peppers



cucumbers



water

Consume these foods without guilt.

DINNER PARTIES

Unexpected Guest

Act delighted. Add another place setting and chair to the table. If the chair is mismatched, sit on it yourself so the new guest does not feel out of place. If you are serving individual capons or steaks and are one short, divide portions in the kitchen out of sight of the guests and serve precut, or share a single portion with your co-host. Serve extra bread or salad to help rebalance portions.

Unexpected Vegetarian or Vegan

Invite the vegan into the kitchen and take inventory of the fridge and cabinets. Assemble any available food items free of animal products to create a cocktail party platter-like spread, including fresh sliced fruits and vegetables; mixed nuts; chips, bread, or crackers (free of lard or animal proteins) topped with salsa, peanut butter, or hummus. Vegans are generally accustomed to spending extra time gathering food, and often enjoy being resourceful.

Food Takes Longer to Cook Than Planned

Serve more cocktails. Delay appetizers or serve in courses. Serve salad as a separate course, followed by a “palate cleanser” of sorbet, cheese, fruit, or anything else you might have sufficiently onhand. Discreetly cover clocks with dishtowels or leafy potted plants.

Oyster Aphrodisiac Overdose

Eat plenty of garlic and onions to protect yourself from unwanted advances. Encourage the oyster eater to talk about baseball, taxes, or real estate.

Conversation Gets Heated

Disrupt the conversational flow by serving the next round of food, dessert, coffee, or another round of drinks. Tap the side of your glass with a fork and offer a toast to family, friendship, or togetherness. Solicit help from your dinner companions for some complicated, fictitious problem that can become the all-consuming focus of attention.

Inappropriate Toast

Drop or knock to the floor a utensil or unbreakable item and pretend to bump your head while retrieving it (rap the table with your hand), or feign a coughing fit. When your dinner companions ask if you are okay, hesitate to further distract attention from the thwarted toast, then say “Yes, I think so. Thank you. Let’s just eat.”

Post-Turkey Tryptophan Coma

Drink caffeinated beverages (cola, coffee, tea) and eat sweets (ice cream, fruit) to help you stay awake. If you cannot keep your eyes open, take a walk outside in the fresh air, which will help to revive you.

Seated Next to a Boor

Turn the conversation into a game. Allow yourself to take another sip of wine each time the boor says something offensive or clueless, or keep a running tally of each time he tells a story about himself. Try to ensnare other diners into the conversation by offering details from the boor’s tale for comment (“Matt, you’ve got a lawnmower, don’t you?”). Excuse yourself from the table—to the kitchen, restroom, or to get something from your car—and remain away from the table for as long as possible until the boor turns to another conversational victim.

Ejecting Bone/Gristle

Cover your hand with your napkin, bringing it to your mouth with a dabbing motion, and discreetly push the gristle into the napkin with your tongue. Do not spit, which will be audible. Excuse yourself and empty the napkin in the trash (if cloth) or throw it away (if paper), or replace on your lap but leave folded so gristle will not fall out. At the end of the meal, empty napkin contents onto plate and cover with napkin.

DOGS

Runaway

Instruct someone to remain at home in case the dog returns. Check the closest neighboring yards and areas that may be familiar to the dog from walks, then expand the area of search methodically to cover a ten-block radius and all nearby parks. Call the dog's name or whistle while conducting the search. Instruct the person at home to print "Dog Missing" flyers, including the dog's name, description, and photograph; your name and telephone number; and "reward" (do not specify an amount). Post flyers in the area if the search is unsuccessful. Supply all nearby animal shelters with the dog's description.

Poop on Shoe

Remove your shoe and seal it in a plastic zipper bag. Place the bag in the freezer for at least 3 hours. Remove the shoe from the freezer when the poop is frozen and chip it off with a flat-head screwdriver. Wash the screwdriver.

In Heat

Push the dog down immediately if the animal humps or mounts people or inanimate objects. Repeat as necessary and be consistent in discouraging this behavior. In many cases, mounting behavior is done to display dominance, though in some young dogs (male and female) it may be to relieve sexual frustration.





Cut or tear holes in a plastic shopping bag for the dog's paws and head. Use a kitchen- or yard-sized bag for larger breeds. Carefully slip the bag over the dog's head and ease the front and back paws through the holes.

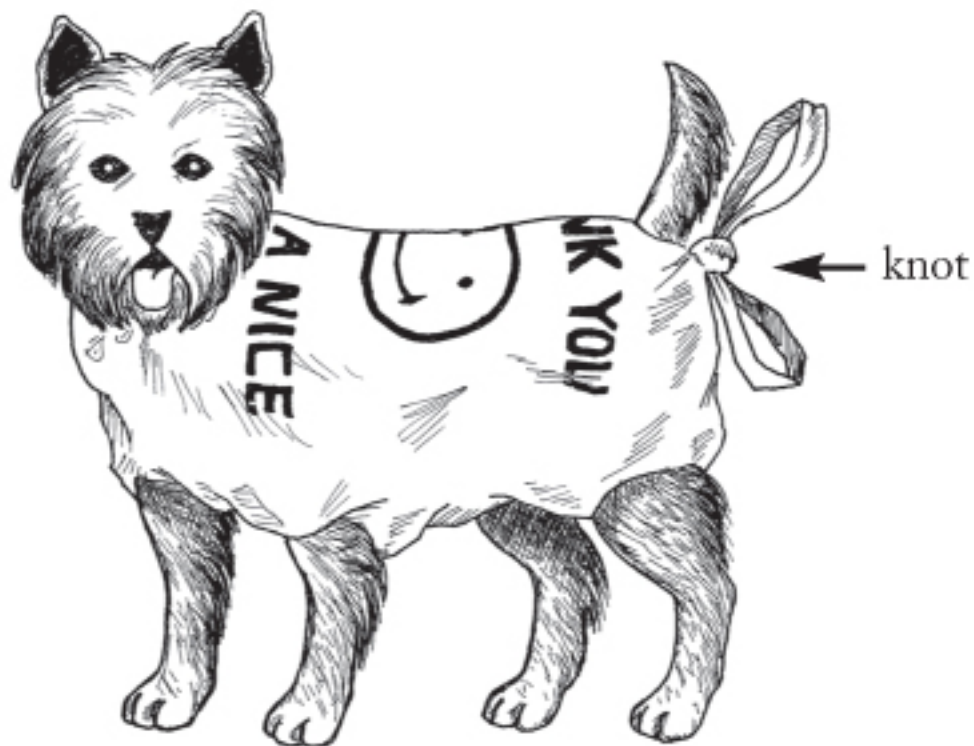

Tie the bag handles behind the tail for added security.

Wrap your hand with a long strip of masking tape, sticky-side out, to form a glove. Blot furniture using the front and back of the tape glove; discard and repeat. Also effective, if available: a lint brush or specially designed pet hair brush (available at pet stores), or a vacuum with an upholstery attachment. Brush the dog every day and dispose of hair to reduce the amount of shedding on furniture.

Barking During the Night

Bring the dog inside if it's yours; use earplugs if it isn't. Do not rile or further agitate the dog by yelling.

Dog Fight

Spray the dogs with a hose, dump a bucket of water on them, or use the straw end of a broom if no water is available. Avoid using your hands or you risk a bite.

Bites Visitor

Instruct the visitor to wash the bite with soap and warm water if the skin has been broken. Move the dog to another room and close the door. If the dog's rabies vaccination is up to date, the visitor should not require shots, but should monitor the wound for signs of infection. As the pet owner, you can be held liable for your dog's behavior, but a homeowner's insurance policy may cover you in the event of a bite.

Sprayed by Skunk

Mix a cleansing solution by combining 1 quart of 3 percent hydrogen peroxide, 1/3 cup baking soda, and 1 tablespoon liquid dish soap in a bucket. Place cotton balls in the dog's ears. Put on rubber gloves. Using a sponge, spread the solution evenly through the dog's coat, taking care to avoid getting it in the dog's eyes, nose, and mouth. Rinse with clean, cool water.

Rabies

Keep the dog away from humans and other animals and call animal control authorities immediately if you suspect rabies. You can contract rabies if saliva from the infected animal comes into contact with your eyes, nose, mouth, or an open wound. If instructed to take the dog to an animal hospital, protect your hands and arms with heavy gloves, long sleeves, and a sturdy jacket; place a muzzle on the dog's mouth; and crate it. Call your doctor if your dog is diagnosed with rabies.

Choking on Bone

Grasp the dog around the waist from the rear. Place your fist just behind the ribs and compress the dog's abdomen with 3 to 5 quick pushes. Repeat. Check the dog's mouth to ensure the bone has been completely removed. If you are unable to dislodge the bone, immediately take the dog to the nearest veterinary hospital.

Thorn in Paw

Hold the dog's paw between your knees. Using tweezers or pliers, take hold of the thorn and pull gently but firmly. Inspect the paw to be sure the thorn is completely removed. Clean any cuts in cold water. Apply a bandage. Do not attempt to remove glass or a firmly embedded object—prevent the dog from walking on the injury and take it straight to the vet.

ENERGY SYSTEM

Blown Fuse

Inspect fuses for blackened glass to identify the blown fuse. Pull out or unscrew the blown fuse and replace it with a new, properly rated fuse. If you cannot locate the blown fuse by visual inspection, test each fuse by swapping in the new fuse.

Gas Smell

Open all doors and windows. Make sure the range and oven are off and that all pilot lights are lit. Even if you find the source of the problem, leave the house for several minutes to allow it to air out. If you are unable to fix the problem on your own by relighting a pilot light or turning off the oven or range, call the gas company to report the problem and remain outside the house.

Pet Electrocuted from Chewing Wires

Do not touch the animal. Turn off the power at the fuse box: Look for a switch marked “master” or “main” and move it to the “off” position. Using a wooden broom handle, separate the pet from the wiring. Feel for a pulse. Take the pet to an animal hospital immediately for treatment if it is still alive.

BROKEN LIGHTBULB IN SOCKET

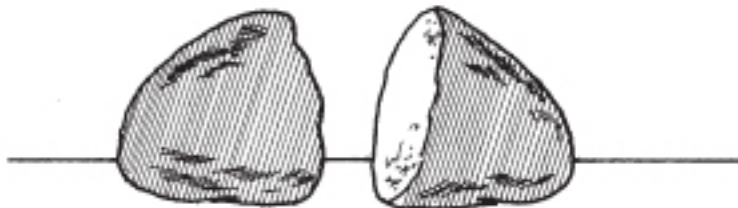

Cut a potato in half.



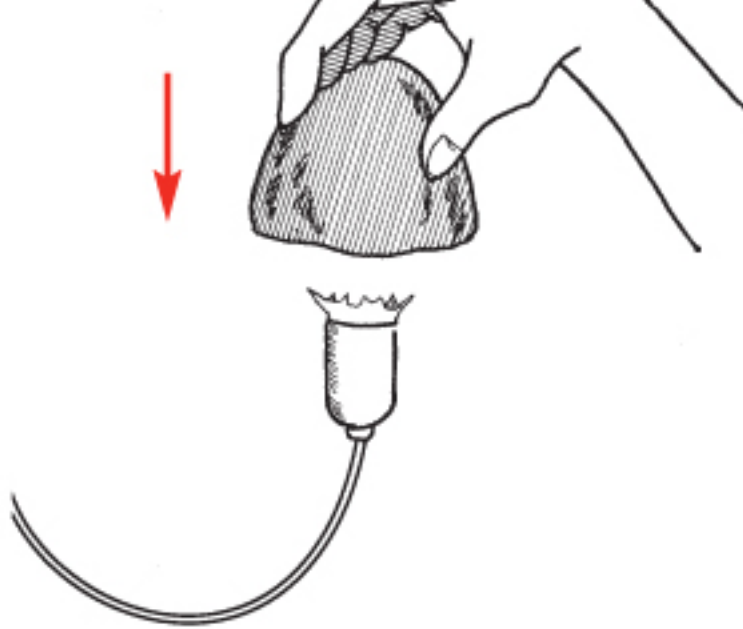

Shut off the power to the light, then place half of the potato over the broken bulb and firmly press down.

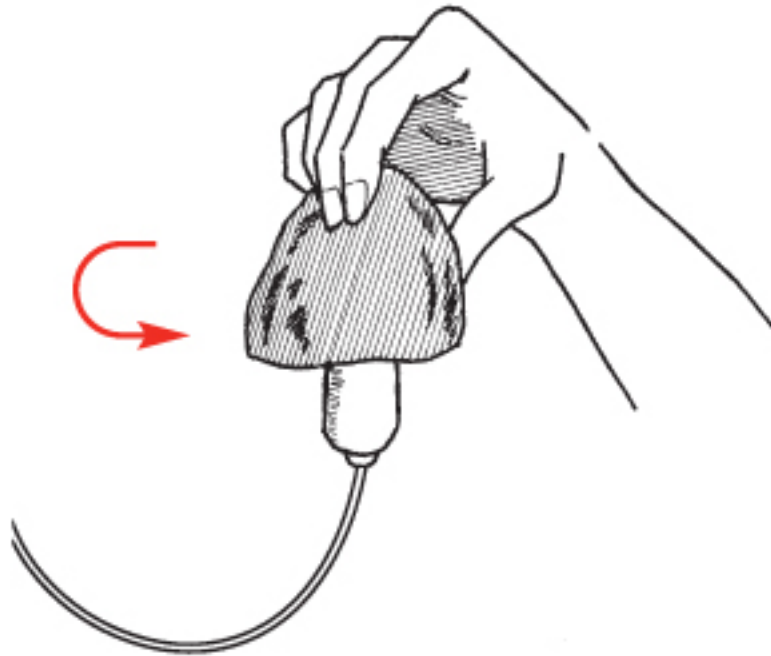

Turn the potato to remove the broken bulb.

Air Conditioning Blows Out in Hot Weather

Check the circuit breakers to determine if the breaker to the A/C system has been tripped—the system should be on a dedicated circuit. Move the breaker to the “on” position if it is off. If the system

does not have a dedicated breaker, turn nonessential appliances off, then restart the system. If the system does not turn on, open the windows, move to the lowest floor of the house, and keep your feet in a pot of cool water.

Heating Goes Out in Cold Weather

Check the pilot light if the system is a gas-fired boiler; if the light is out, relight. If the pilot will not light, make sure gas is entering the home by testing the range-top burners in the kitchen. If the burners light, the house has gas; call for repair. If the boiler is working but the house is cold, bleed air out of the pipes by opening the bleeder valve on the radiator on the top floor. For oil and electric heat, call for repair. Wear sweaters, hats, mittens, and scarves as necessary.

EXTERIOR

Clogged Gutter

Remove leaves and other debris from the gutter with a rake, broom, or gloved hands. Place plastic leaf traps over all unsealed downspout openings and cover all horizontal rain gutters with chicken wire to prevent future clogs.

Leaky Roof

Cover holes with sheets of plywood. Cover the plywood patches with a plastic tarp or a layer of thick plastic sheeting. Place strips of wood along each edge of plastic and nail in place, using one nail every 18 inches. Use as few nails as possible to avoid adding more holes to the roof than necessary. Seal cracked joints around protruding air vents and fans with plastic roofing compound.

Locked Out

Check for rear or side windows that may be unlocked. Press palms flat against the glass at the sides of the window frame and push upward. Alternatively, insert any available thin, sturdy implement into the base of the window and attempt to pry it open. If you must break a window for entry, break the smallest window possible that is still large enough to crawl through. Reach through the broken pane and open the window—do not crawl through broken pane.

Fall into Empty Pool

Lie still. Carefully test the movement of your arms and legs to ensure nothing is broken, and that movement is possible; leaf litter may have broken your fall. Sit up slowly, especially if you are dizzy or feel faint. Walk or crawl to the shallow end of the pool and climb out. If you cannot get to the shallow end, use a cell phone to call for help, or yell until a neighbor hears you.

Nosy Neighbor

Construct a wooden fence at least 6 feet high, with no more than 1/4 inch between pickets.

EYES

Foreign Object in Eye

Flush the eye with cool running water or saline solution to remove debris. If you are unable to remove the debris yourself, ask someone to wash their hands thoroughly, then use their fingers to remove the object from the white of the eye. Avoid touching the pupil, cornea, or iris. Seek medical attention if the object cannot be easily removed.

Bloodshot Eyes

Close your eyes. Place a cool washcloth over each eye for 15 minutes to reduce redness.

Lost Contact Lens

Rely on your good eye until you are able to replace the lens. Keep one eye closed, or wear an eye patch. For a less conspicuous solution, use a thick black marker to color the inside of the lens on a pair of sunglasses on the same side as the missing contact.

Contact Lens Slides behind Eye

Close the eye. Massage the lid until the lens moves back onto the cornea, or lubricate the eye with drops until the lens slides forward. The eye is a closed “pocket” and a lens cannot get lost or stuck behind the eyeball.

LOST GLASSES





Draw 2 circles about the size of a pair of lenses on a piece of paper or cardboard. Use a pin or the tip of a sharp knife to poke at least a dozen small holes inside the circles. Hold the paper to your face and look through the holes.

FACE

Pimple

Apply a warm compress to the pimple for 15 minutes. Remove, then place fingers on either side of the pimple and gently pull away. The pimple should expel its contents. If the pimple is not ready to pop, cover it with a dab of green-tinted makeup to conceal the blemish and counteract the redness.

Bags Under Eyes

Steep 2 bags of black tea in warm water for 2 minutes, then soak in ice water to cool. Squeeze out excess liquid. Place a tea bag over each eye for 15 minutes. The tannic acid in the tea will reduce the swelling.

Stuck in One Expression

Massage the facial muscles regularly. Apply moist heat or take nonprescription pain medication to relieve pain; practice relaxation techniques; and increase your intake of B vitamins. If paralysis or weakness interferes with normal eyelid function and blinking, keep the eye moist with artificial tears or eye ointments and cover with an eye patch. Bell's Palsy is a form of temporary facial paralysis caused by swelling of facial nerves, the exact causes of which are unknown, but which can be associated with head trauma or viral infection. Symptoms generally begin to subside in about 2 weeks.

Extra Chin

Wear scarves, ascots, or loose-fitting turtlenecks to disguise excess fat around the neck. Avoid shirts with tight, button collars. Wear collared shirts without a tie.

Blotchy from Crying

Apply a cool washcloth to the face to reduce swelling and redness. Both symptoms are generated by the increased blood flow and muscular effort of crying, two physiological nervous system responses to emotional distress. Lie down and take deep, calming breaths.

Chapped Lips

Apply beeswax or petroleum jelly. Wear lipstick or sunscreen. Drink lots of water, especially during winter months. Do not lick your lips, which may make them feel temporarily moist but covers them with irritating salivary fluid. Rub your index finger at the side of your nose and rub oils onto your lips if no other balm is available.

Shaving Cut

Dip a cotton swab in rubbing alcohol and dab it on the cut, or apply styptic pencil or powder. Both substances are astringents that cause the contraction of blood vessels. Alternatively, place small pieces of toilet paper on the cut to encourage coagulation. When bleeding stops, wet the paper thoroughly, then carefully peel it off the cut.

FEET

Plantar Wart

Apply an over-the-counter salicylic acid treatment and cover the wart with fabric adhesive tape. Leave the tape in place until it begins to fall off. Remove the tape and scrape off as much of the white (dead) tissue from the wart as you can. Repeat. If little progress has been made after several weeks, seek a doctor's help.

Athlete's Foot

Soak your feet in a solution of warm water and 1 tablespoon of tea tree oil 3 times per day until the condition disappears. Wear absorbent socks made from natural fibers, and change immediately if the socks become damp. Remove shoe insoles and allow them to dry overnight, and dust the insides of shoes with talcum powder.

Bunion

Wear shoes with ample room for toe movement. Choose shoes with flexible soles, heels less than 2 inches high, and about 1/2 inch of space between your longest toe and the tip of the shoe. Avoid high-heeled, narrow, or pointed-toe shoes. Go barefoot as much as possible. To treat pain from bunions, elevate your feet so they are higher than your heart and apply ice to the joint for 10-minute intervals several times an hour.

Blisters

Sterilize a needle by dipping it in rubbing alcohol or holding it over a match for several seconds, until red hot. Holding the needle parallel to the skin, puncture the blister at its edge. Apply gentle pressure to squeeze out the fluid, then cover the blister completely with a bandage.

Bruised Feet

Pad your shoes with shock-absorbing insoles. Stay off your feet as much as possible to allow the fat pads of the heels to heal and keep them from being further pushed from their place cushioning the heel bone. If your sneakers are old and their padding is compressed, replace them.

FERRETS

Litter Training

Confine the ferret to its cage except when it is out for short periods of play. Ferrets are fastidious about hygiene and will avoid soiling their sleeping areas. Provide a litter box in the cage, as well as nesting material or a sleeping tube and food and water bowl. If you observe the ferret relieving itself, pick it up and place it in the litter box. If the ferret continues to soil the other areas of the cage, increase the size of the litter box to at least half the area of the cage until the ferret learns that it must use the litter or soil his sleeping/eating space.

Dehydration

Administer a 1:1 solution of corn syrup and water, or honey and water. A ferret too sick to eat may be coaxed into drinking a 1:1 mixture of liquid nutritional formula and water. Ferrets have a fast digestive system, and should be hand-fed every 4 hours when sick or dehydrated.

Intestinal obstruction

Administer 2 inches of cat hairball laxative paste—available at pet stores—every 8 hours for 1 day if you suspect the ferret has swallowed a foreign object but is acting and breathing normally. If the ferret is exhibiting signs of intestinal distress (difficulty breathing, vomiting, seizures), take it to an animal hospital immediately.

FIRST AID

Spurting Artery

Fashion a loop from string, rope, or a belt. Place the loop above the wound, then tie it off. Place a stick inside the loop. Twist the stick to tighten the loop just enough that the bleeding stops or slows. Tie the free end of the stick to the body to prevent it from coming loose. Use of a tourniquet of this kind may result in loss of the injured limb and should be considered only as a last resort, and only to prevent death from blood loss.

Choking, Self

Stand facing a waist-high blunt object (back of a chair or table, tree stump, ledge). Bend over so the object touches your body 6 inches above your waist. Drop forward hard and fast, forcing the air out of your abdomen and up your windpipe. Repeat until the item is dislodged.

Choking, Adult/Child

Perform the Heimlich maneuver. Stand behind the victim, wrap your arms around the victim's waist, and make a fist. Place the thumb side of your fist against the victim's upper abdomen, below the ribcage and above the navel. Grasp your fist with your other hand and press into her upper abdomen with a quick upward thrust. Do not squeeze the ribcage. Repeat until the stuck object is expelled.

Choking, Infant

Perform the infant Heimlich maneuver. Lay the baby down, face up, on a firm surface, and kneel or stand at his feet; or hold the infant on your lap facing away from you. Place the middle and index fingers of both your hands below his rib cage and above his navel, and press into the infant's upper abdomen with a quick upward thrust. Do not squeeze the rib cage. Be very gentle. Repeat until the object is expelled. Holding the baby facedown and slapping his back may not dislodge the stuck object and should be considered only as a last resort.

Choking, Pregnant Woman

Perform the Heimlich maneuver for adults as indicated on page 37, with this exception: Place your hands above the victim's belly, across the chest, instead of at the abdomen. This method is also effective

for extremely obese victims.

Severe Burn

Stop, drop, and roll to extinguish open flame, or cover the burning area with a blanket to smother. Place the burn under cool running water to remove foreign material, cool the skin, reduce pain, and limit swelling. Remove clothing unless it is stuck to the burn. Cover with a clean, sterile dressing or a clean T-shirt; do not use a towel or other material with loose fibers. Call for help. Elevate a burned extremity to reduce swelling.

Chemical Burn

Irrigate the burn area with cool running water for 10 minutes. Meanwhile, gently remove the contaminated clothing. Try to limit additional exposure to the chemical agent. Cover the burn area loosely with a sterile cloth or T-shirt; do not use a towel or other material with loose fibers. Do not remove any fibers stuck to the burn. Bandage. Seek emergency medical treatment as soon as possible.

Heart Attack, Self

Chew one 325-milligram aspirin. Alert someone near you that you are having a heart attack and tell him to call for help. Stop all activity, lie down, and elevate your legs. Breathe, then cough, every 3 seconds until help arrives.

Heart Attack, Someone Else

Call for help, then begin CPR immediately.

Shock

Lay the victim on her back. Elevate the feet 6 to 10 inches, maintain an open airway, and control any obvious bleeding. Wrap the victim in a blanket to maintain body temperature. Call for help. Do not give the victim anything to eat or drink.

Fainting

Place the victim flat on his back on the ground. Elevate the victim's legs and feet 12 inches to

increase blood flow to the heart and brain. The victim should recover in less than 1 minute. Do not administer ammonia or other smelling salt-like treatments.

FISH

Cracked Aquarium

Mark the ends of the crack with a grease pencil and take a photo, then check the crack each day. If the crack is not growing or leaking, leave it alone. If it is, transfer all tank contents to a new tank as soon as possible. Empty the cracked tank, dry it, then scrape away the area around the crack with a razor blade. Apply acetone to the crack area with a paper towel, allow to dry, then treat the crack with a nontoxic silicone sealer suitable for aquarium use. Allow to dry overnight, then refill.

Dead Fish

Remove the dead fish with a fish net and discard (flush or bury). Clean the fish net with dish soap and rinse thoroughly. Place any remaining fish in a temporary holding tank or bowl and thoroughly clean the main tank with an aquarium-safe cleanser (available at pet stores) to minimize risk of transmission if the fish died of disease. Never clean aquarium glass with a household glass cleaner: Most contain ammonia, which is toxic to fish.

Jumps out of Bowl

Gently push the errant fish into a wet fish net—do not pick it up or you risk dropping the fish or damaging the gills. Return the fish to its bowl.

STUCK IN TANK DECORATION



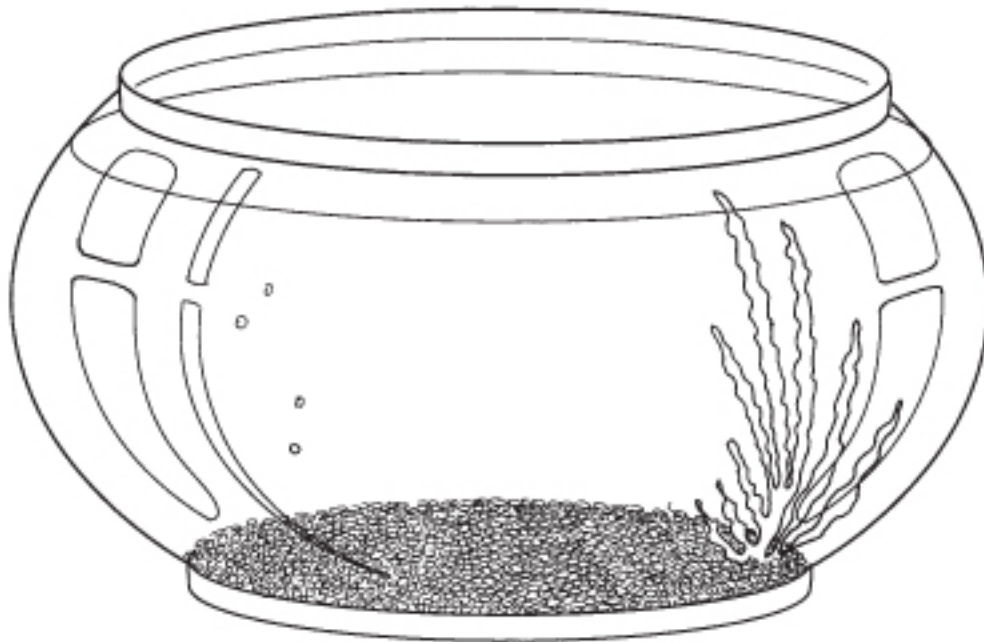
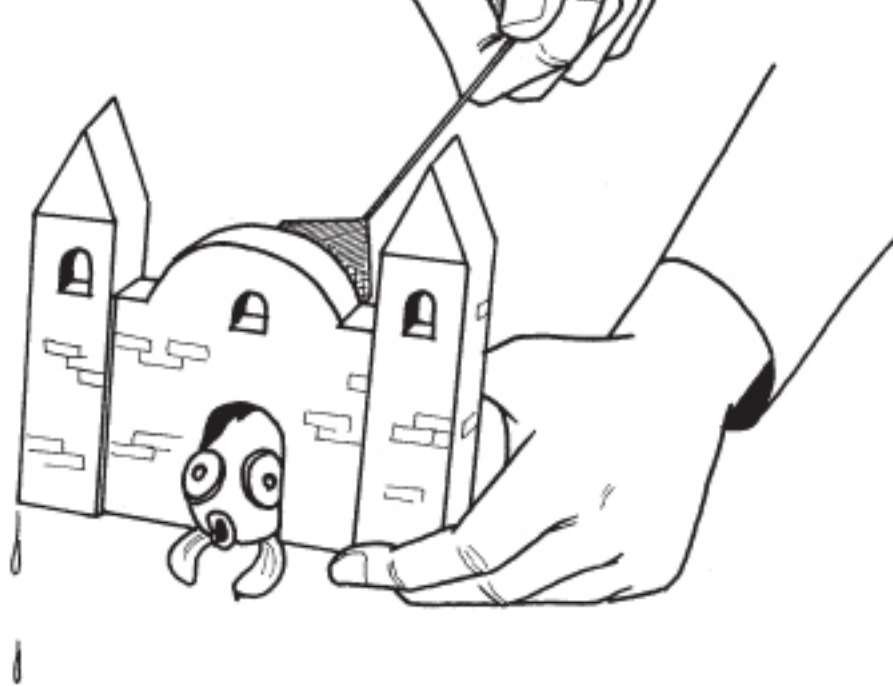

Gently push the fish from the rear using a fish net until it is able to swim free of the obstruction. If fish is still stuck, hold the decoration just above the tank and push the fish gently out and back into the water using a wet net.

Feed fish regularly. If fighting persists, separate fish into different tanks or partition the tank using a piece of glass. Fish fight due to overcrowding, being kept with too many of the same species, incompatibility (aggressive fish swimming with docile fish), or lack of food. Ensure the fish are compatible, have adequate space to roam, and are well fed.

Algae in Tank

Remove the tank from direct sunlight and do not light the tank more than 10 hours per day. Change the water, rinse the gravel, and clean the filter in the tank once a week to minimize nutrient growth. Green algae can be removed from tank glass by introducing an algae-eating fish such as the suckermouth catfish.

Cat Grabs Fish from Bowl

Scare the cat off—house cats will typically play with a catch before killing and eating it. If the fish is alive and appears to be uninjured, scoop it up with a wet fish net and return it to the tank. If it swims normally, leave it alone. If it appears to be injured and cannot swim, remove it from the tank, place it on a wet towel, and examine it for injury. Apply an antiseptic such as betadine to the injury site using a cotton swab, then return it to the tank. Do not keep the fish out of water for more than 1 minute.

Losing Scales

Remove any coral in the tank, as well as other objects with rough surfaces that may be causing the scales to rub off. Plecostomus catfish will occasionally eat the slime coating from some fish, causing scale damage. Remove the catfish to another tank, or partition the tank with a piece of glass to separate it from the other fish.

Freeze in Outdoor Pond

Make sure the water is at least 18 inches deep, and keep a hole in the ice to allow for gas exchange between water and air. Before the water freezes, reduce the fishes' metabolism and allow them to adjust to colder water by slowing the feeding schedule to once every few days, then once per week. After the thaw, resume feeding, but on a slow schedule as metabolism returns to normal, and until all ice has melted.

FISHING

Outboard Motor Fails

Position the crankshaft so the points are closed, pry open the breaker arm, and insert a clean business card between the contacts. Let go of the breaker arm, allowing the points to grip the bottom of the card, then drag the card through the contacts, cleaning them of oil and grime.

Boat Springs Leak

Place a flat life preserver weighted from the top over the hole as a temporary plug. Bail water out of the boat using any cup or container. Return to shore immediately.

Waders Full of Water

Stay upright to prevent water weight from tipping you over. Use your pole vertically to help maintain balance. Once on shore, either unfasten and remove the waders to empty the water or lie down on an incline and let the water drain past your chest.

Outdo Buddy's Fish Tale

Allow the buddy to finish his story. Select a quantifiable detail you wish to top (number or size of fish caught, leaping ability, length of fight) and increase by 30 percent. For mythic overtones, increase all factors by 100 percent, adding inclement weather and equipment malfunction.

FISHHOOK IN FLESH



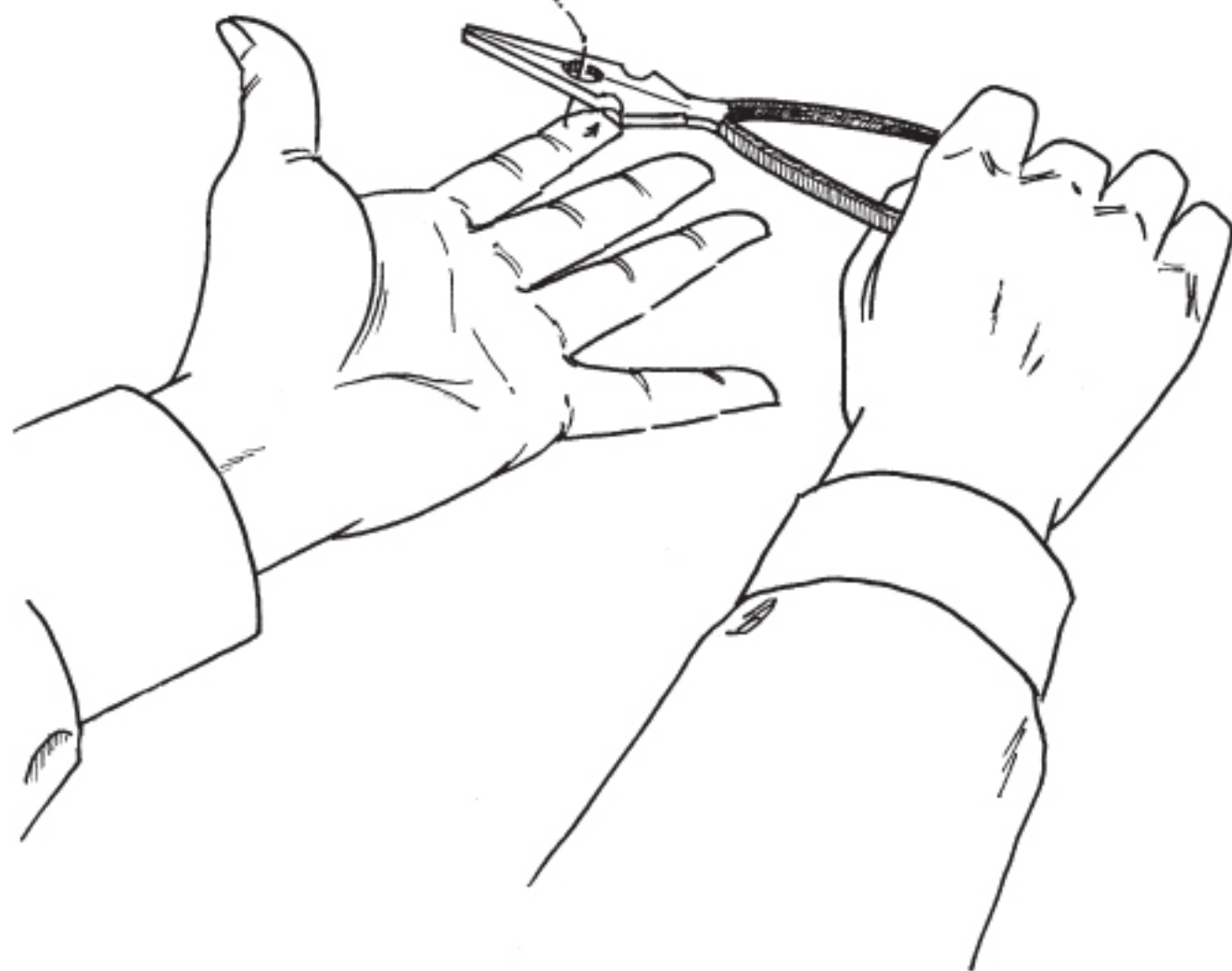

Clip off the end of the hook with a pair of needle-nose pliers. Pull the unbarbed end of the hook through the wound to remove. Apply antiseptic and dress the injury site.

FLOORS

Loose Tile

Remove the existing grout with a file, then regrout tiles smaller than 4 inches square. For larger tiles, file down the existing grout, pry up the tile, remove the adhesive and grout from the tile, and reattach the tile to the mesh backing on the floor using a commercial tile mastic. Regrout.

Flood Damage

Remove all furniture and small appliances from the home as soon as it is safe to do so. Allow them to air dry thoroughly and have them checked by a trained technician before using. Have the home's electrical and plumbing systems checked before using them. Clean floors, walls, and cabinets using an all-purpose detergent and hot water. Sanitize with a solution of 2 tablespoons of chlorine bleach mixed with 1 quart of cold water. The home should be inspected for mold by a professional home inspector or insurance adjuster as soon as possible.

Creaky Floorboard

Pour powdered soap or talcum powder into the cracks around the creaking board. Tamp into cracks with the edge of a piece of stiff cardboard. Test and repeat until the squeak disappears. For older flooring boards attached with visible nails, remove nails and replace with nails slightly larger in diameter.

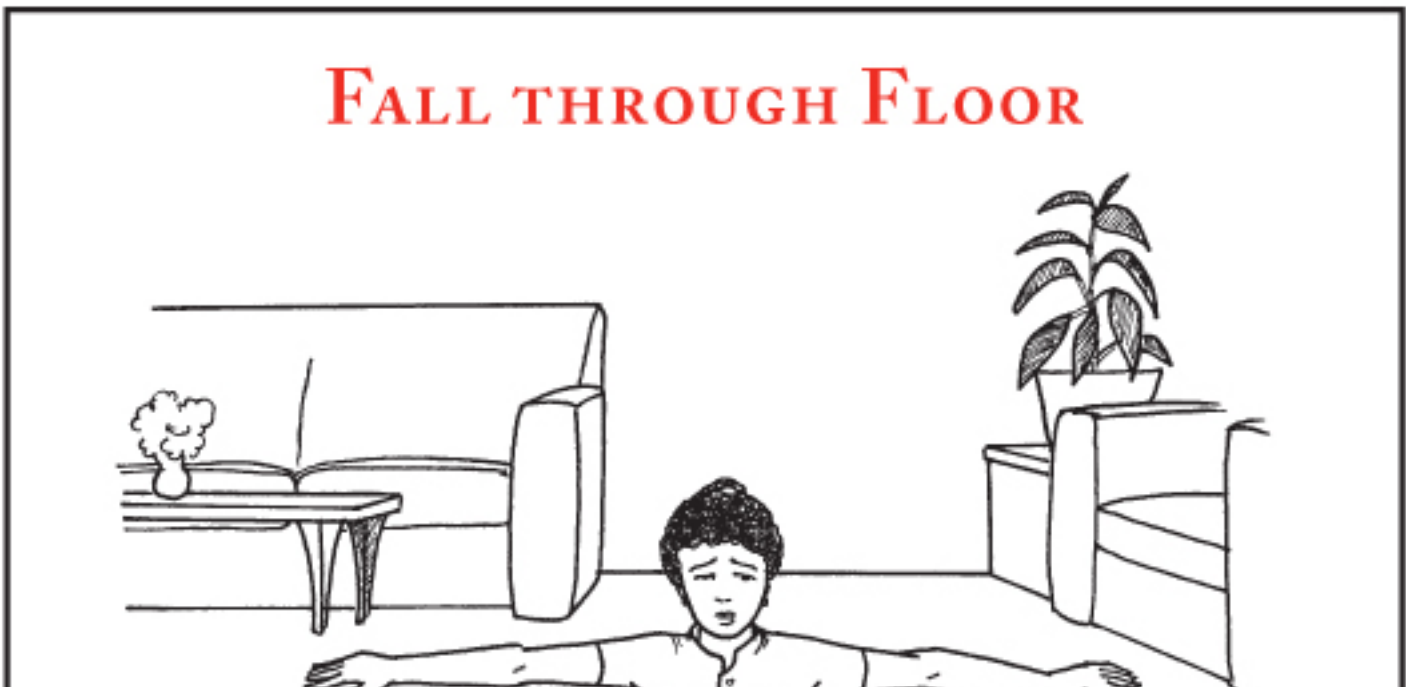

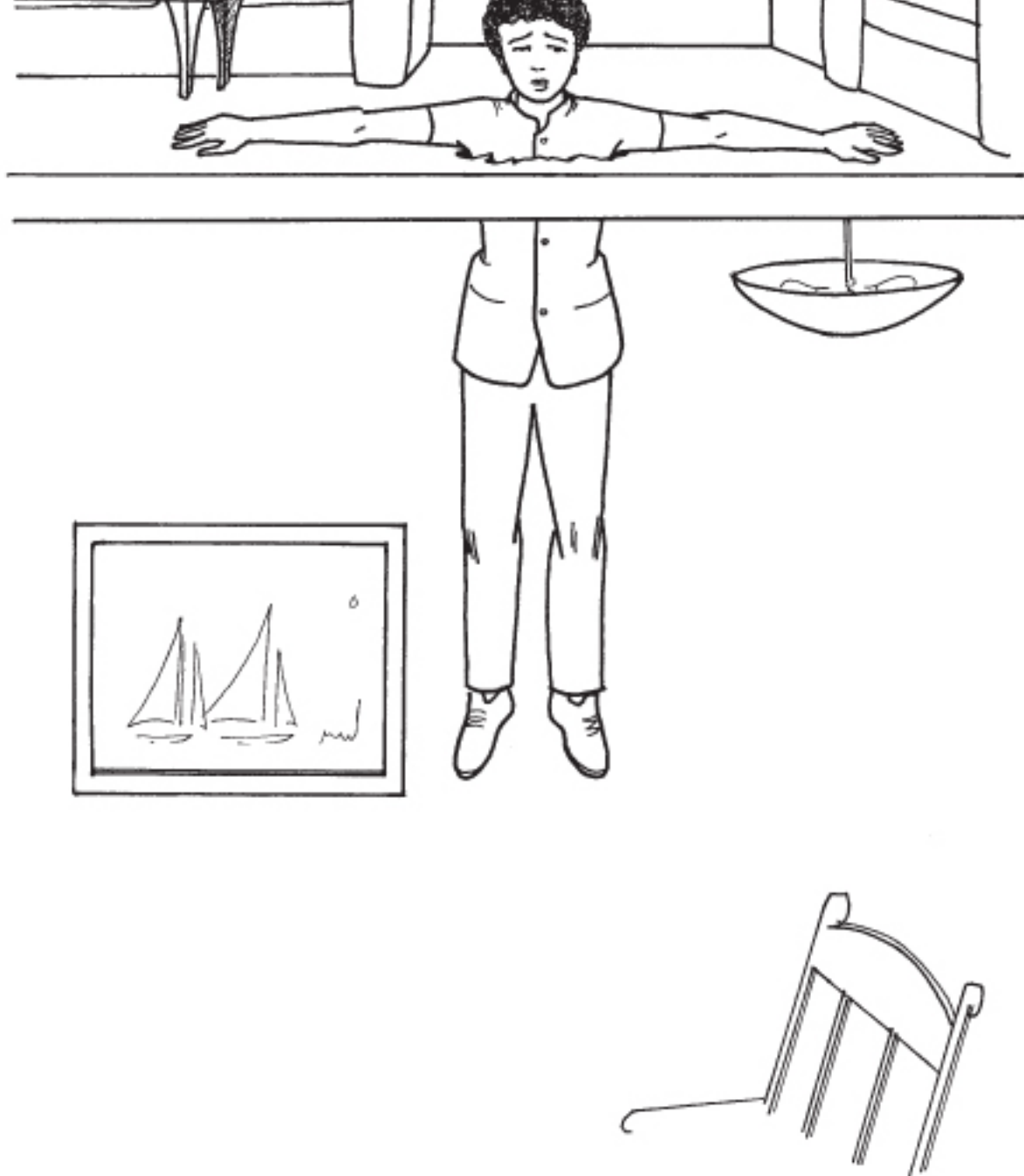

Spread your arms wide to distribute your weight across unbroken flooring. Place your palms down and push your body up and back, away from the hole. If you are in the hole up to your waist or farther, lean forward onto your forearms and push to raise as much of your body mass as possible above the hole. Repeat until free. Do not grasp at furniture legs above the hole or kick with your legs below.

FOOD

Food Is Too Spicy

Eat rice or bread to help remove spicy oils from your mouth. Suck on a lime or consume fruit juice containing citric acid, which acts as a solvent to pepper oil, or swish a small amount of an alcoholic beverage around in your mouth. Dairy products will also help neutralize hot oils. Water will not help—oil and water do not mix.

Presented with Exotic but Distasteful Delicacy

Cut the food into small pieces. Breathe through your mouth, not your nose, as you place the first piece into your mouth. Immediately move the food to the rear of your tongue where flavor receptors are less sensitive. If possible, swallow without chewing. Repeat until at least half the item has been consumed to avoid giving offense to your hosts.

Food Poisoning

Vomit and use the bathroom as necessary. Avoid taking antidiarrhea medications, which may prolong the presence of the pathogen in the gut. To replace electrolytes, consume sports drinks or make a rehydration drink: Mash a banana and mix it with 1 quart of water, 1/2 teaspoon of baking soda, and 1/2 teaspoon of salt. Repeat every few hours or until the sickness fades.

Montezuma's Revenge

Drink plenty of water to replace lost fluids. Take an over-the-counter antibacterial medication, if available. Lactobacillus bacteria (acidophilus and bulgaricus) are also effective: Drink fermented milk, such as buttermilk, and eat yogurt, which contains bulgaricus. Remain close to clean and convenient restroom facilities. Symptoms should pass in several days' time.

SAFELY ORDER WHEN YOU DON'T SPEAK THE LANGUAGE

Point to item(s) you wish to order. Point to slash-through and any item you do not wish to order.

Point to item(s) you wish to order. Point to slash-through and any item you do not wish to order.



NO

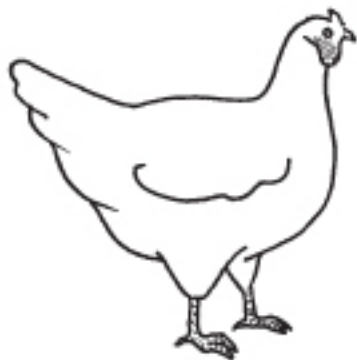

chicken



fish



pork

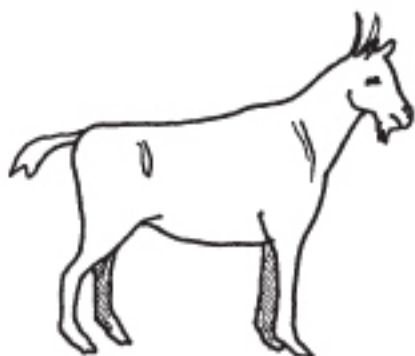

goat



mushrooms



garlic



tomato



chile peppers



onion



broccoli



goat



broccoli



beef



wine

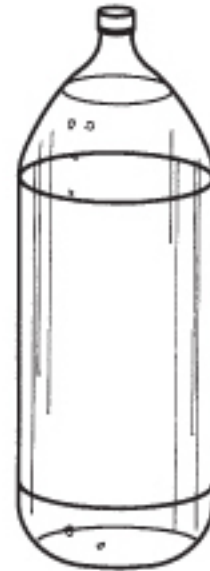

bottled water



beer



coffee



tap water



coffee

tap water



tea



iced water

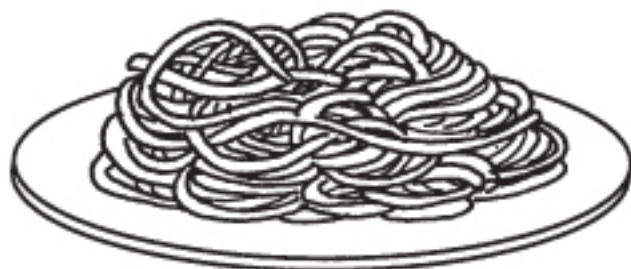

noodles



shrimp



egg



toast





fruit



pizza

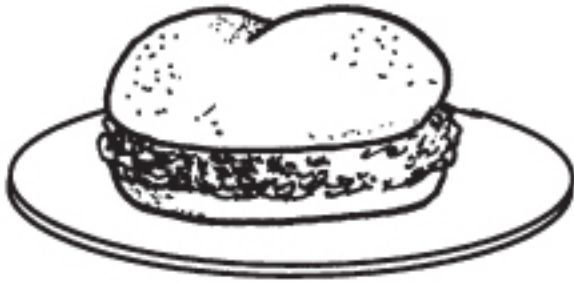

hamburger

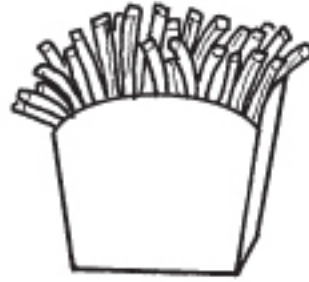

french fries

FOOTBALL

Taking a Hard Hit from a Linebacker

Position yourself low to the ground to present as small a target as possible. Relax as best you can as the hit comes. Lift your feet off the ground to avoid knee and ankle injuries. Land flat, letting the ground absorb some of the momentum, and exhale deeply. Then take a deep breath, jump back to your feet, and get yourself back to the huddle, showing no ill effects.

Kicking a Field Goal in a Blizzard

Clear the snow from the space around where you will be planting your foot and kicking the ball. Visualize the ball going through the uprights under perfect conditions, without any snow or wind. Keep the ball on a slightly lower trajectory than normal to reduce wind interference in flight, focus, and kick the ball with the clean purpose you would in practice.

Playing in Extreme Heat

Hydrate every 10 minutes, drinking approximately 1 quart of water per hour. Apply sunscreen on any exposed skin to prevent sunburn, which traps heat in the skin. Do not drink more than 1 1/2 quarts per hour, or you may induce hyponatremia (over-hydration); symptoms include fatigue, dizziness, and nausea. Avoid drinking alcohol for a full day prior to the game.

Pulled Hamstring

Ice down the entire affected area for 10-minute intervals and take over-the-counter anti-inflammatory medication. Do not return to play. Rest the muscle for a couple of days, then begin to gently stretch it out, stopping at the first sign of pain. Before working out, apply moist heat on the hamstring, and ice the muscle immediately following the workout. If it is not painful, you may run lightly with a shortened stride. Avoid sprinting until the injury is fully healed.

Concussion

Take yourself out of the game and back to the sidelines. Apply ice to the back of your neck to keep any swelling down. Get as much rest as possible, avoid overtaxing activities, and consult with your doctor. Do not drink any alcohol until your doctor has cleared you for normal activities again.

Forgot the Play

As a receiver, find an open spot on the field and wave your hands frantically to show the quarterback how open you are. If the play goes away from you, you have likely done no harm. If the pass comes your way, you will have made a brilliant ad-lib play, rather than having made a mistake.

Catching a Wet Football

Position yourself to catch the ball in the cradle of your arms, held close to your body rather than making a riskier reaching grasp for the ball. Don tactile receiving gloves if they are available.

Recovering Fumble in a Pile-up

Go fetal, surrounding the ball with as much of your body mass as possible, tucking in your arms, knees, and head. Close your eyes and stay clamped around the ball regardless of grabbing, wrenching, and elbowing at the bottom of the pile. Remain stationary until the ref completely un piles the bodies. Stand and hold the ball aloft triumphantly.

FURNITURE

Broken Chair Leg

Nail an upside-down toilet plunger to the seat to replace the detached leg. You may need to saw it to the appropriate height. Turn down nail points if they are sticking through the seat. Alternatively, remove remaining chair legs and place the seat atop an overturned bucket. Sit carefully.

Creaky Mattress

Turn the mattress over and test for creak. If the creak remains, rotate the mattress so that the head of the mattress is at the foot of the bed. Test. If the creak persists, place a phone book or small flat block of wood under the mattress at the creaking location to compress the springs and reduce noise.

Leaky Water Bed

Flatten a large cardboard box. Slide the cardboard under the mattress. Lay atop the mattress for several minutes, then check the cardboard for damp areas to indicate the locations of leaks—generally at the mattress seams or corners. Patch the holes using a dinghy- or bicycle tube–repair kit. Do not use the mattress for several hours to allow the patch to set.

CAUGHT IN SOFA BED

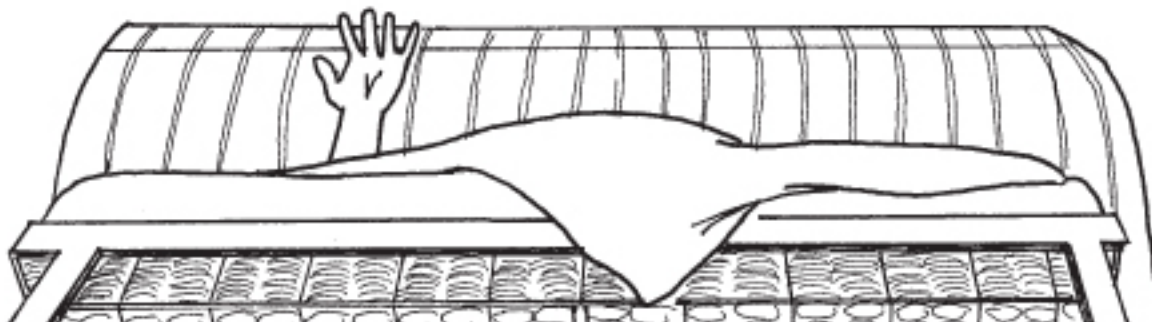

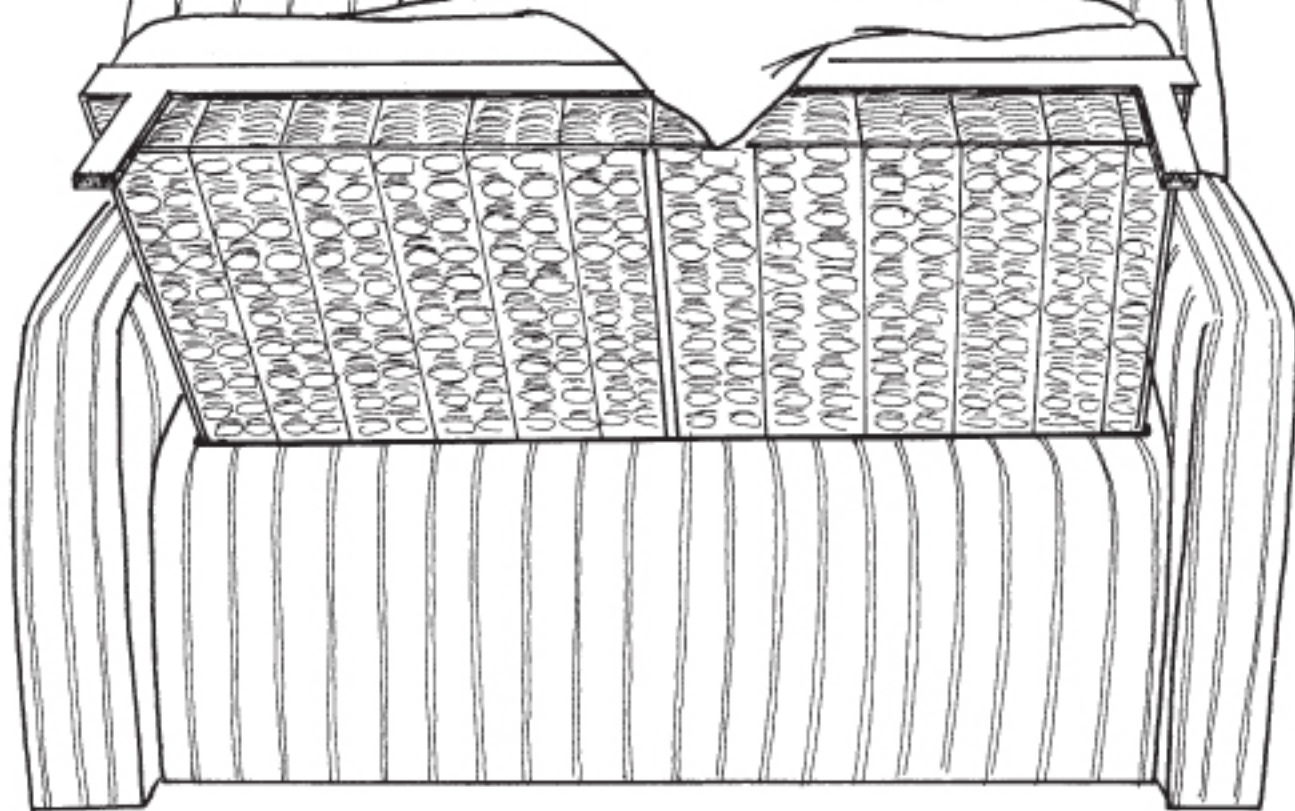

Grasp the top edge of the bed if your arms are free and pull your lower body away from the folding section. If your arms are pinned, dig your heels into the mattress and push to lift the folding section enough to shift position. Wriggle to the edge of the bed, grasp a sofa arm, and pull yourself free.

GARAGE

Box Avalanche

Duck and cover your head with your arms and curl into a ball on the floor. If a shelf has fallen toward you, stay as close to the shelf/wall as possible to avoid being hit by objects falling out as well as down.

Box Stuck in Rafters

Set an extension ladder under the rafter, climb up, and hand the box down to someone below if it is full of heavy materials. If the box is light and the contents aren't fragile, place a mattress on the floor and knock the box down with a telescoping lightbulb changer or two brooms held together with duct tape.

Bats Living in Garage

Turn on a bright light and leave it on all night, several nights in a row. The bats will leave of their own accord.

Carbon Monoxide Buildup

Do not enter the garage. Open the garage door with a remote opener to vent the gas. If the garage must be opened manually, open the door from the outside. Open any side doors if it is possible to do so without entering the garage. Wait 10 to 15 minutes, enter the garage, and turn off the car engine.

STUCK UNDER CAR

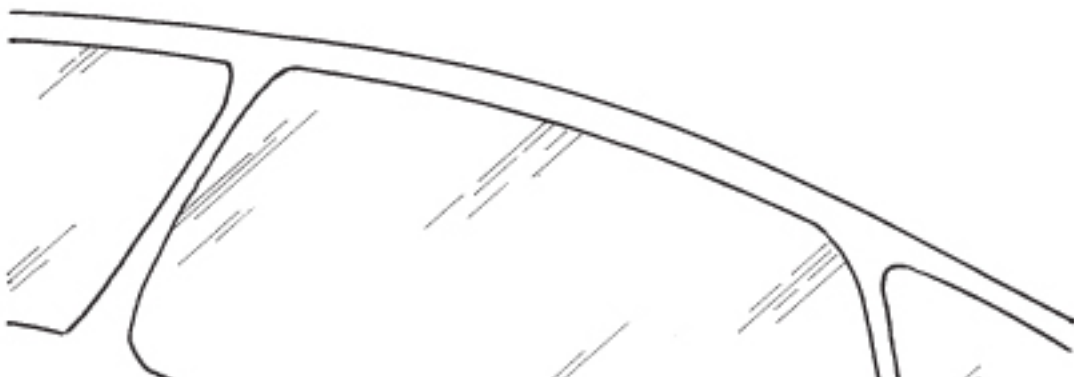

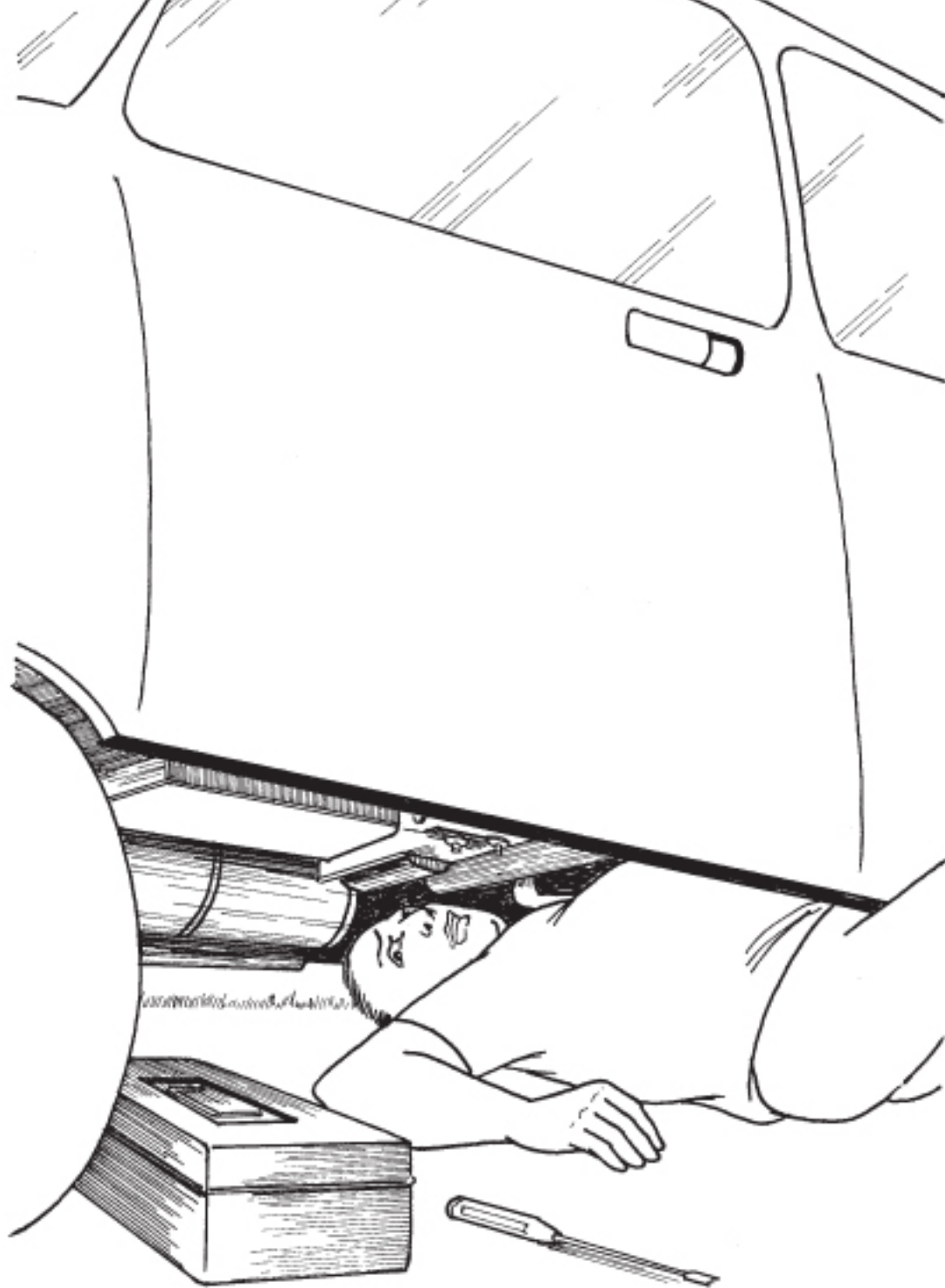

Suck in your gut, grasp the edge of the undercarriage of the car, and pull to drag yourself free. If you cannot hold in your gut for the length of extrication, suck in and pull or push toward the edge of car in small stages until free.

Garage Door Closes on Car

Stop the car immediately to limit damage. For a manual garage door, pull up on the handle and move the door to its fully open position. Electric garage door openers manufactured after 1993 should—if they haven't malfunctioned—have sensors that prevent the door from closing on a person or object and will automatically reverse the door to its fully open position when it strikes something.

Missing Tool

Think back to the last time you had visual or physical contact with the tool. Revisit the locations of major or minor tasks that may have involved the tool. If you believe the tool has been borrowed but not returned, confront potential suspects, including your children, spouse, relatives, and neighbors. If the suspect denies having possession of the tool, conduct an independent search of the suspect's room, car, home, yard, or garage. If the search is unsuccessful, ask to borrow, or simply borrow, a tool or item of equal value.

GOLF

Getting Out of a Sand Trap

Stand 30 degrees to the left of your target. Aim for the sand about 3 inches in front of your ball—to compensate for the cushioning effect of the sand—and swing with a slow, pendulum-like motion.

Pushing Ahead of a Slow Foursome

Line up a shot that sails directly over their heads. Apologize, saying that you were trying for the fairway, but that you forgot your glasses and are half-blind without them. Then ask to play through.

Ball Hits Bystander

Ascertain if an actual injury has occurred, apologize profusely, and offer to sign the ball for the bystander. Tell him it might be worth something someday—once you fix the hitch in your swing.

Releasing Frustration Without Throwing Club

Tense your entire body tightly into itself, clenching your fists, jaw, stomach, and shoulders for a count of ten. Then release, relax muscles, and exhale for a count of ten. Repeat as necessary.

Driving into a Headwind

Shorten your swing arc by widening your stance and choking down farther on your club to keep the ball low to the ground. Do not overhit—the resulting backspin will lift the ball higher into the wind.

Partner Inappropriately Dressed

Make your partner carry both bags. Appear as though you are consulting his advice, as you would a caddy, when in sight of club members. Have the partner “help” you line up angles and select your clubs. Be sure to tip him at the end of the round.

Sudden Thunderstorm

Listen for the thunder—by the time you hear it, lightning is likely only about 10 miles away. If stuck on the course, move to a point of low terrain away from trees, which can conduct electricity. If you feel your skin begin to tingle or hair stand on end, squat on the balls of your feet, place your hands over your ears, and lower your head to make yourself the smallest possible target should lightning strike. If you have a golf cart, get inside and sit out the storm. Do not touch the steering column or wheel.

GRILLING

Beer-Can Chicken Explosion

Remove chicken from the grill with long barbecue tongs and place on a platter. Once the can has detonated, the chicken poses no further explosive danger. Once the chicken has cooled, discard, as aluminum shrapnel from the can may have embedded itself in the chicken. Always open the beer can and take several big gulps before putting inside chicken. Pre-grease the can for easy removal.

Kabob Skewer Wound

Remove the food or marinade from the end of the skewer and pull the skewer from your body with one quick, firm tug. Irrigate the wound with a stream of cold water for 5 minutes; a small puncture wound should not bleed profusely. Carefully examine the wound. If any foreign material is lodged in the wound, seek medical attention. If the wound appears clean, apply pressure to stop bleeding, then wash with soap and warm water and bandage.

Apron on Fire

Stop, drop, and roll to smother the flames. For a smoldering apron, quickly remove and throw to the ground, away from any gas tank supplying the fuel for the grill or dry leaves in the yard. Stomp the apron wearing closed-toed shoes, or douse with water, beer, or soda. Do not stomp if you are barefoot or are wearing sandals or flip-flops.

Charred Meat

Remove the meat from the grill. Using a very sharp knife, cut 1/8 inch from the charred side(s), then return the meat to the grill if the interior is below 160°F. If the meat is overcooked, add melted butter to prepared barbecue sauce and smother the meat with the sauce. If the meat is extremely dry and overcooked, chop it finely and mix it with the sauce; serve on a bun or over rice or potatoes.

Barbecue Sauce in Eye

Use a clean turkey baster to flush the eye continuously with cool water until the pain subsides.

Grease Fire

Smother the fire with coarse salt. Immediately cover the grill, and make sure all vents are closed. Wait 30 seconds, then uncover slowly, holding lid at arm's length and watching for flare-ups. To reduce the chance of grease drippings catching fire, pile coals on one side of the grill and cook the food on the other.

Grill Tips Over

Right the grill, then pick up hot coals using tongs and return them to grill. Soak the ground in the area of the tipover plus several feet with water from a hose.

FISH FLAKING APART

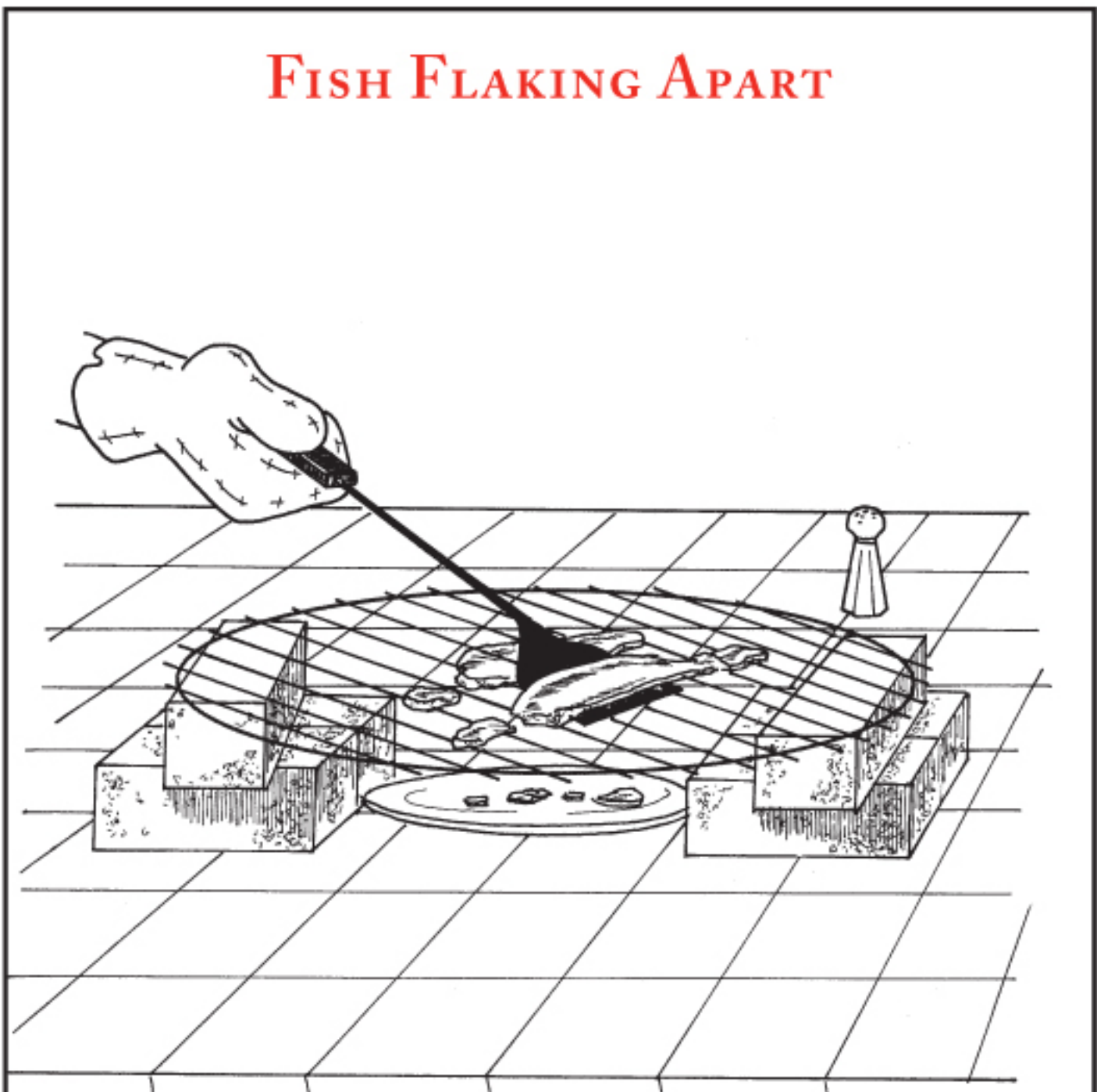

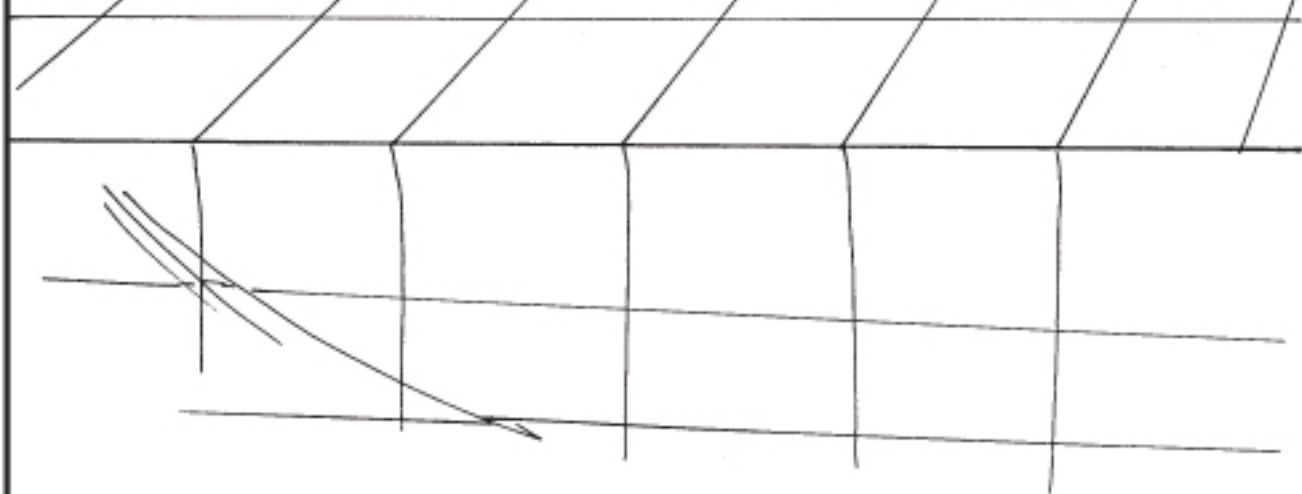

Remove the metal grill from the flame using barbecue mitts.

Place the grill between two stacks of two bricks, with the fish over an open center area. Place a pan under the grill/fish to catch flaking pieces, then remove remaining fish with a spatula coated in olive oil or butter. Garnish with lemon and serve as fish hash.

HAIR

Singed by Barbecue

Cut the hair above the singe line. Wash and condition to remove the burnt odor.

Bad Dye Job

Re-dye the hair, going darker rather than lighter. Using the ten-level system to classify hair color (1 is black, 3 is darker brown, 5 is medium brown, 7 is dark blond, and 10 is very light blond), choose a new dye color that is no more than two levels above the existing color.

Frizz on a Humid Day

Towel-dry your hair. Apply a small amount of olive oil or styling gel that contains oil to the palm of your hand and brush the product through your hair using your fingers. Do not use a brush or blow-dryer.

Hat Head

Wet the hair thoroughly, then restyle using hairspray or styling gel. Women with long hair can avoid hat head by pinning a small bit of hair near the crown into a bun before putting on the hat, then letting it free after removing the hat, so the hair on top will be full of body.

BIRD CAUGHT IN HAIR



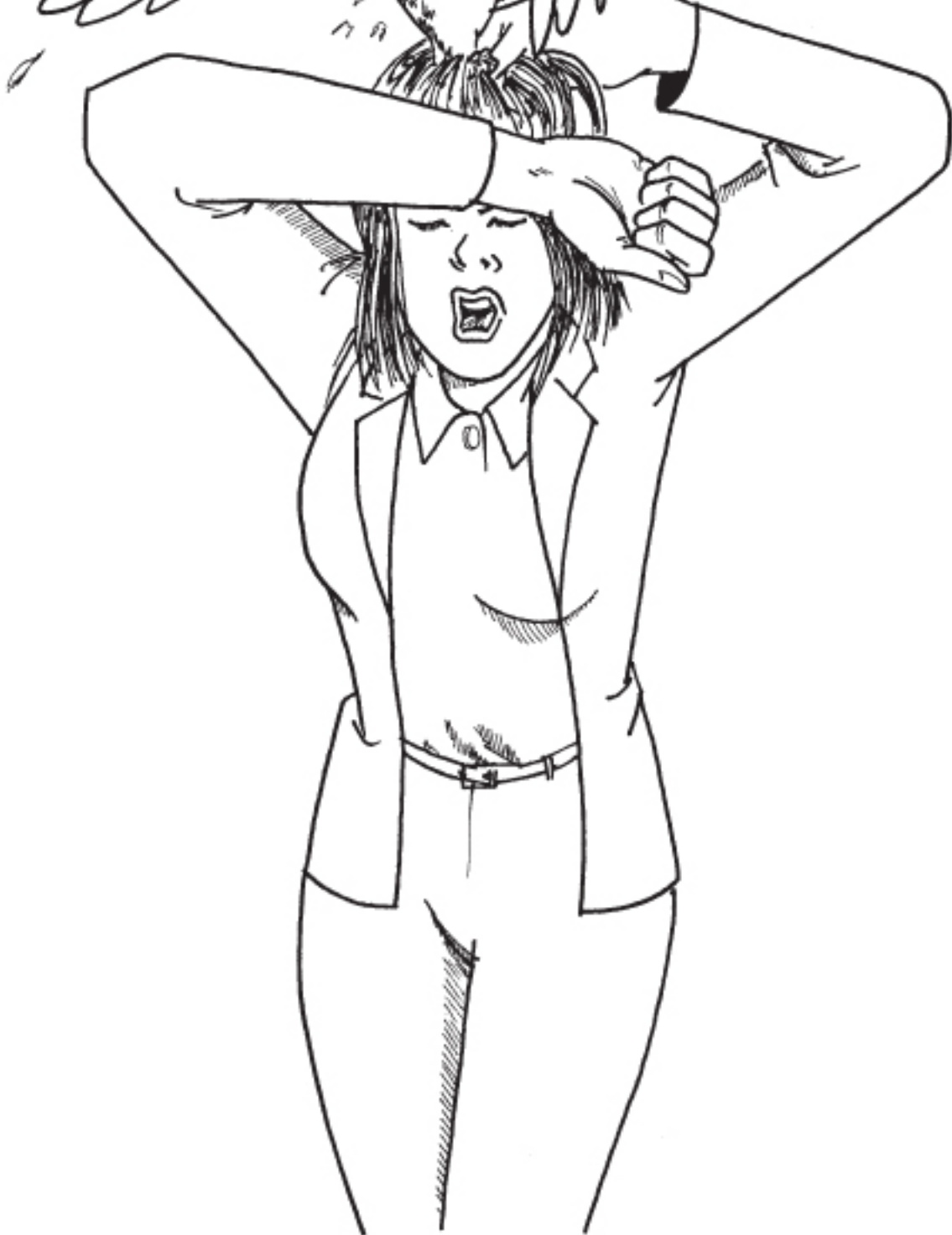

Shield your eyes and face with your arm. With your other hand, grab the bird's feet and legs from behind, pull it from your hair, and toss the bird lightly away from you. Do not attempt to grab the head or beak.

Retrieve the wig. Inspect and remove any debris from the hair if the wig touched the ground. Stand in front of a mirror, plate-glass window, or metal reflective surface. Reapply the wig or toupee tape, use other available tape curled on itself to adhere to the wig and your head, or just place the wig directly on your head. Realign the ear tabs and press the wire “stays” slightly in at your temples. Check your hair positioning in a reflective surface and secure with bobby pins or paper clips, if available. Elastic in off-the-shelf wigs will stretch and weaken after 3 to 4 months of daily use; it, or the wig, should be replaced to ensure a snug fit.

Smoke Smell

Spray a strong perfume into the air above your head, then walk in a slow circle while the scent settles on your hair.

Gum in Hair

Place several ice cubes in a plastic bag. Hold the affected hair away from the scalp and apply the ice bag to the gum for 15 to 30 minutes, or until it is frozen solid. Hold the stuck section of hair between the gum and the scalp, then break the frozen gum into pieces. Gently pull the gum pieces from the hair with your other hand. If the warmth of your hand thaws the gum, refreeze and repeat until all the gum has been removed.

Shampoo in Eyes

Turn the shower taps to cold and flush your eyes. If shampoo remains, rinse your eyes with saline drops or eye-safe contact lens solution. Wear a plastic sun visor when washing hair for extra protection.

Bird Droppings in Hair

Comb or brush the droppings from the hair, then wash the hair or rub the spot where the dropping landed with a cotton ball soaked with rubbing alcohol. Hold your breath while removing the dropping and wash your hands thoroughly after removal to avoid a potentially fatal infection from the *Cryptococcus* fungus found in some bird droppings.

HANDS

Broken Nail

File the nail to smooth ragged edges, then cover with an acrylic nail of the same length as your natural nails. If the cuticle is torn or bleeding, treat it with vitamin E oil before applying the fake nail.

Hangnail

Soak the finger in warm water for 15 minutes to soften the nail, then cut the hangnail with cuticle scissors or a nail clipper. Do not chew or tear at the hangnail or you risk injury and infection.

Broken Finger

Wrap a bag of frozen vegetables in a thin cloth, then place on the injured finger. Elevate the finger above the level of the heart to reduce swelling. If you cannot get to a doctor within several days, place the injured and one adjacent finger on a Popsicle stick or other flat, straight piece of wood and tape the fingers together and to the splint. Try to move the hand as little as possible.

Disguise Missing Finger

Insert a small piece of flexible tubing into the finger of a glove where the missing finger would be and wear regularly. Wear mittens in cold weather.

Fidgety Hands

Hold and squeeze a small rubber ball to keep fidgety hand occupied. Alternatively, hold a beverage.

Splinter

Sterilize a pair of pointed tweezers and a safety pin using rubbing alcohol. Grasp the exposed portion of the splinter with tweezers and pull to remove. If the splinter is buried, use a pin point to carefully scrape away several layers of skin until an end of the splinter is exposed, then grasp and remove with tweezers. Treat the wound area with topical antibacterial cream, then bandage. For

children, numb the area with an ice pack before removal.

HERMIT CRABS

Cannibalism

Separate crabs of significant difference in size to deter cannibalism. An aggressive crab may attempt to remove a crab from its shell and inhabit the loser's shell itself. If you hear "chirping" and notice one crab in a position slightly above the opening of another crab's shell, remove the aggressor and isolate it from other crabs.

Legs Falling Off (Molting)

Remove the crab from a shared habitat at the first sign of molting (missing limbs), clear gel-like new limbs, or a fishy odor) and place in an isolation tank with at least 6 inches of sand and several different sizes of empty shell. Molting crabs are vulnerable targets for other crabs when they shed and then regenerate their exoskeleton as they grow larger. Molting crabs prefer darkness, and will burrow deep into the sand or enter a large shell.

Naked Crab

Rinse the empty shell in water. Wash your hands. Pick up the crab and dip it in water to remove any debris. Using your index finger, gently curl, but do not force, the crab's abdomen into its shell. If the crab will not enter the shell, put it in an isolation tank with several shells of different sizes, including a new one the same size as the old one, and let it choose a new home.

Mite Infestation

Remove all sand substrate from the tank and discard. Disinfect all crab habitat toys by placing them in boiling water. Rinse the tank with warm water, then use paper towels to crush and kill any remaining mites, paying special attention to the corners, then rinse. Bathe the crab by placing it upside down in warm water. When it comes out of its shell, wet it thoroughly, then let it dry in another container before placing it back in its shell.

HOCKEY

Puck in the Stands

Duck and cover your head with your arms immediately if the shot goes awry. Keep your eyes on the puck at all times while it is on the ice.

Broken Stick during Game

Wave the broken stick end at your bench to alert your teammates of the situation, then drop the stick immediately: You are allowed to continue play as long as you do not keep hold of the broken stick. Skate directly to your bench and either grab a new stick if handed to you or, if play is intense, skate in to let another player dart onto the ice to replace you.

Fight

Grab your opponent's jersey and shoulder pads and yank them over his head. If you are both locked in, keep hold of your opponent's furthest arm (their likeliest punching arm) and keep your chin and nose tucked into your shoulder.

Absorbing a Check into Wall

Square your body to the wall to absorb the impact equally. Drop low to improve your leverage and push off the wall with both hands. Relax and stay loose when you are near the wall and be mentally prepared to take a hit at any time.

HORSEBACK RIDING

Horse Slips or Trips

Calm the horse by talking to it in a soothing voice and patting its neck. If the horse remains skittish, dismount and lead the horse for a short while until it regains its composure. Check the horse's feet to be sure it has not lost a shoe.

Crossing Water

Find the surest footing on the bank and let the horse stand on the bank for a few minutes to survey the situation. Ease the horse to the water in a calm manner, giving the horse ample rein and allowing it to proceed at its own pace. Gently squeeze the horse with your legs to nudge it forward, across, and up the other side.

Saddle Sores

Maintain an equal balance over the saddle and avoid a lot of bumping up and down. Wear long, rugged pants, ideally with some kind of spandex-type underwear underneath, to reduce chaffing.

REARING/BUCKING





Kick your feet out of the stirrups and release the reins. Throw your arms around the neck of the horse as it rears backward. Maintain your grasp and slide around the side of the horse, land on your feet, and push away from the horse to avoid being trampled. This maneuver is known as an emergency dismount.

HYGIENE

Rusty Razor Blade

Soak the razor blade in white vinegar or cola overnight, then sterilize the blade by rubbing it with a cotton ball steeped in rubbing alcohol.

Toothbrush Falls in Toilet

Scrub and soak the brush in hydrogen peroxide. Place in boiling water for 5 minutes. Replace the toothbrush at first opportunity.

No Toothbrush

Moisten a sheet of paper towel or tissue with water and use a kneading motion to work along the surfaces of your top and bottom teeth with your fingers. Inspect your teeth in the mirror to be sure all buildup has been removed. Scrape your tongue by moving your top row of teeth across it from back to front several times. Rinse your mouth thoroughly with water.

Emergency Toothpick

Edges of business cards, paperback or matchbook covers, menus, envelopes, a piece of paper folded into quarters, plastic-tipped shoelace ends, or CD jewel case corners may all serve as emergency toothpicks. Avoid using paperclips, pins, ballpoint pen nibs, or any other metal object.



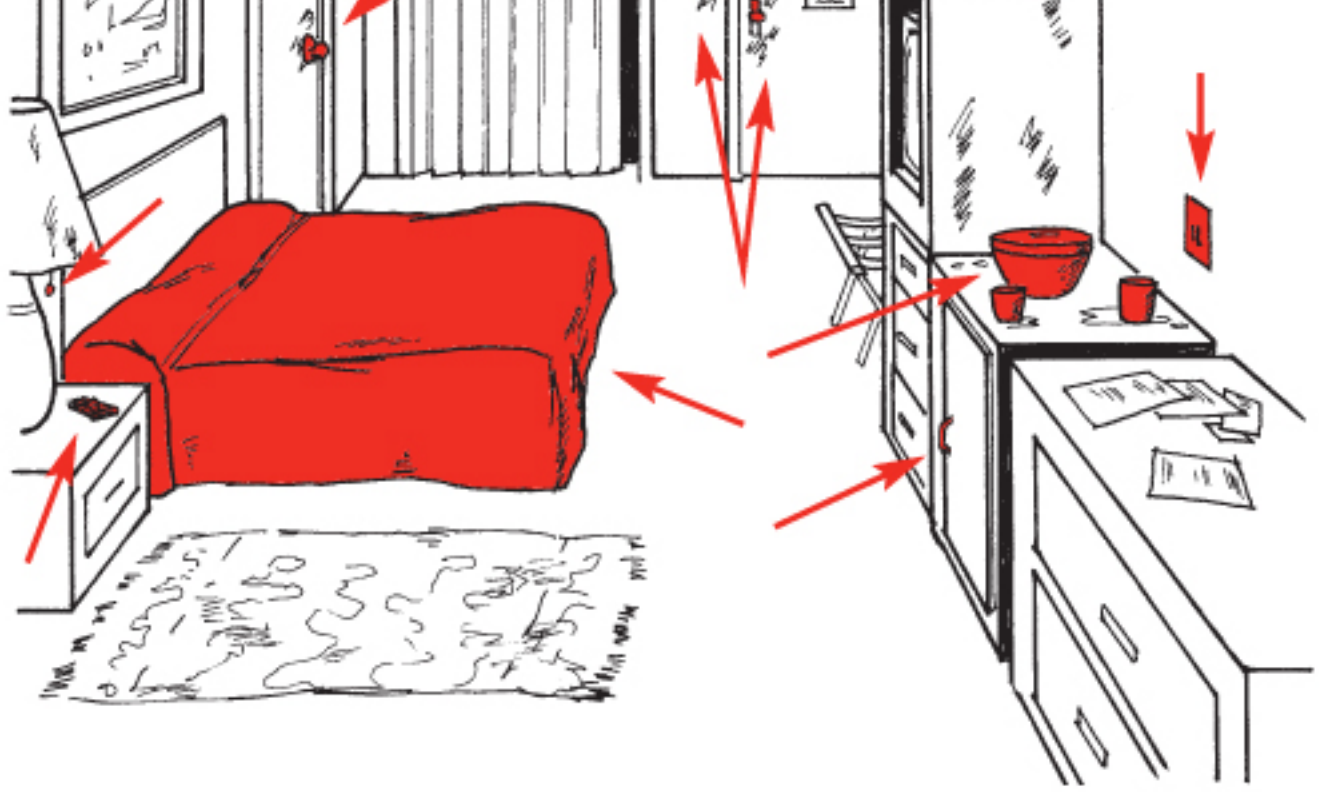

Do not come into direct contact with red hazard areas.



“Furry” Tongue

Scrape the top of your tongue with the edge of an upsidedown teaspoon to remove bacteria buildup. Place a small amount of antiseptic mouthwash in your mouth and brush your tongue and teeth for several minutes, then rinse. Brush your teeth and tongue with fluoride toothpaste.

Public Transportation

Sit as close to a door as possible to be near fresh air as it enters the bus or train car. If there are no seats available, maintain your balance with a wide stance. Wear gloves or encase your hands in a scarf to hold on to the bar or strap rather than using your bare hands.

Grimy Toilet in Public Restroom

Place at least 4 layers of toilet paper on top of the seat before using it. Wash your hands when finished.

Grimy Sink in Public Restroom

Pull the lever on the towel dispenser to lower a towel, then wash your hands. Rip off the dispensed towel and use it to shield your clean, wet hand while you pull the dispenser lever again and turn off the water faucet. Discard the towel. Tear off the second towel and use it to dry your hands. If no paper is available, use the ends of your shirt. Do not use the blow-dryer, which is a haven for germs.

No Toilet Paper in Public Stall

Call out to other occupants and seek their help in rolling or tossing paper to you from other stalls. Use disposable toilet-seat covers if available. If unavailable and there is no response from others, flush the toilet, partially open the stall door, and peer out. Move quickly to next stall to seek paper, or dash to the paper-towel dispenser, grab towels, and return to the stall.

Suspicious Buffet

Take food only from freshly filled containers. If you have doubts about how long the food has been sitting, wait until you see an attendant bring out a fresh tray. Avoid foods from the ends of the buffet, where the sneeze guard does not offer as much protection, or from below areas where the sneeze guard

is soiled. Avoid raw seafood and foods containing mayonnaise, which are often food poisoning culprits.

ILLNESS

Flu Epidemic

Remain indoors, away from other people. If you must go outside, wear an N95 surgical mask and rubber gloves. Avoid areas where large numbers of people congregate, including movie theaters, dorms, barracks, shopping malls, and large office buildings. Do not use public rest-rooms. Do not share towels, even with family members. Empty wastebaskets and wash hands frequently.

Smallpox Outbreak

Follow instructions from public-health officials. Individuals with the virus will be placed in quarantine, but avoid coming into contact with others to be as safe as possible. If you think you have been exposed, stay away from family members and contact the local public-health authority. Victims in the “rash stage” of the virus (usually about 17 days after exposure) are the most contagious.

Tourette's Episode

Ignore the behavior shouting, repeating words, coughing, throat clearing) until the episode passes. In rare instances, the victim may hit himself or others, bang his head, or display other dangerous behavior. In these cases, move the victim to a safe location, or remove all hard objects from the immediate area.





Rest. Drink plenty of fluids. Gargle with warm salt water for scratchy throat. Chicken soup may help fight infection through intake of salt, heat, and fluid. Zinc interferes with cold-virus replication in lab settings—zinc nasal sprays may reduce symptoms if used at first sign of cold. There is no clear evidence of colds being prevented or eased by echinacea or vitamin C, or being caused by overheating or chills.

Rocky Mountain Spotted Fever

Treat the victim with a doctor-prescribed antibiotic until the fever subsides and there is marked

evidence of improvement, usually 5 to 10 days after initiating treatment. Symptoms include fever, nausea, vomiting, muscle pain, lack of appetite, and severe headache. Later symptoms include rash, abdominal pain, joint pain, and diarrhea. The disease is only transmitted through the bite of an infected tick and is not contagious between humans.

Seizure

Remove furniture and other hard objects near the victim to protect her from injury. Do not attempt to restrain the victim or force a hard object into her mouth, or you may cause additional injury. Do not attempt CPR or mouth-to-mouth resuscitation during the seizure. If the victim vomits, turn her onto her side to prevent asphyxiation.

Seasonal Affective Disorder (SAD)

Expose yourself to a greater amount of indoor light, leave window shades up and blinds open, spend more time outdoors when the sun is shining, and take a vacation to a sunny locale. Symptoms of seasonal affective disorder include fatigue, sadness, sleep difficulty, increased appetite, carbohydrate craving, irritability, weight gain, lack of energy, anxiety, and problems concentrating during winter months.

Obsessive-Compulsive Disorder (OCD)

Begin behavioral therapy immediately upon recognition of symptoms. Early indicators of OCD include frequent and excessive hand washing, repeatedly checking the locks on doors, repeatedly counting to the same number, and arranging objects in a precise order. Treatment for OCD typically includes frequent exposure to the objects provoking the obsessive-compulsive behavior.

Agoraphobia Attack

Call a close friend or relative to accompany you outdoors. Relax, then imagine yourself opening the door, leaving the house, and walking outside. Concentrate on breathing and staying relaxed as you conquer each step in turn.

IN THE DESERT

Runaway Camel

Pull the reins gently but steadily in the direction the camel's head is pointing. Do not jerk or pull the reins straight back. If there is a saddle, hold on to the horn. The camel will eventually slow to a trot in the direction of the reins. Turn the reins further inward to walk the camel into a circle and stop. Jump off and keep hold of the reins.

Sandstorm

Wet a bandana and place it over your nose and mouth, then cover your head with a T-shirt or towel. Move to higher—even slightly higher—ground, or take available shelter such as the leeward side of a slope or hill. Turn your back to the storm direction. If you have and can reach a vehicle, back it into the wind to avoid pitting of the windshield.

Finding Water

Dig with a flat rock or other implement around fresh vegetation, in dry streambeds, or visibly damp areas where animals may have scratched to reach ground water. Wipe plants with a bandana or cloth to collect dew; wring out and drink the moisture. Watch for and follow birds, which may congregate near watering holes in arid land.

Navigating Without a Compass

The sun rises in the east and sets in the west. Clouds and weather patterns generally, but do not always, move from west to east. In the northern hemisphere, the sun is in the southern sky. At night, the last star in the handle of the Big Dipper constellation is the North Star: walking in its direction leads north. In the southern hemisphere, the sun is in the northern sky. At night, look for the Southern Cross—four bright stars in the constellation of a tilted cross. Walking toward a point 5 times the length of the longest axis leads south.

Jeep Stuck in Sand

Reduce air pressure in the tires by half. Jack up the vehicle, then pile sand under the wheels without traction. Tamp down the sand so it is compressed (wet it if sufficient water is available), then place sand

ladders, floor mats, or anything else at hand under the wheels to provide traction. Lower the truck, reduce the load and passengers, and drive out slowly.

IN THE JUNGLE

Lost in Jungle

Follow the path of a river: Most jungle settlements are on or near rivers. As you walk, turn over fresh vegetation to mark your trail, should you need to backtrack. Break up termite mounds and rub the dirt on your skin as a natural insect repellent.

Stalked by Leopard

Cross a river or other body of water to throw the leopard off your scent trail. Note that the water is not a safe area in itself—leopards hunt fish and are excellent swimmers. Leopards typically observe prey from trees and stay well hidden when stalking, so also avoid areas with large numbers of rodents or other small mammals that might be under surveillance.

Boa Constrictor

Do not struggle with or strike at the boa—it will only tighten its grip. Slowly and carefully uncoil the boa, from whichever end is within reach. If you attempt to control the head, hold it well away from your body to avoid being bitten—all snakes, including boas, have teeth.

DRINKING WATER FROM A VINE





Cut a deep notch in the vine as high up as you can reach. Cut the vine off as low as possible below the initial cut and let water drip into a container or your mouth. When dripping stops, make another cut at the top of the vine and repeat until the vine is drained. This method will work on any vine, though not all vines yield palatable water.

Swinging from a Vine

Select a thick green vine, or braid 3 or more slender vines to create a rope. Pull the vine sharply and test that it will support your full weight. Keeping both hands securely around the vine at all times, back

up as far as possible, then run and leap toward the place you wish to swing. Only release your grip on the swinging vine if you are completely over your target area.

IN THE OFFICE

Awkward Office Party

Lay the groundwork for an early departure. As soon as you walk in, circulate the room in a clockwise direction from the entrance, discussing with co-workers a circumstance that will allow for an early exit (your babysitter is double-booked, your pet is sick, you “feel a flu coming on”). If you are enjoying yourself by the time you reach the door again, stay; if not, keep right on walking.

Dealing with Office “Cassanova”

Establish a signal with a co-worker (e.g.: three short coughs) that will indicate that the co-worker should approach and “call you into a meeting” to escape the Cassanova’s advances. Keep a personal space buffer of at least two co-workers between you and the Cassanova in all employee group circumstances.

Dealing with Office “Comedian”

Steel yourself for the terrible punchline and gauge your reaction to the level of the Comedian’s need for approval, giving no more reaction than is minimally required—a quick groan for puns, an “ah” or “heh” for general purpose responses. Change the subject or walk away immediately.





Mention current weather or temperature, time of day, day of week, month, season, or approaching holiday, and wait for comment. Other subjects of common experience include popular television programs, local sports teams, and the state of being tired. If silence continues, stare at elevator walls or floor until it reaches your destination. Exit immediately.

Clingy Boss

Schedule vacations and absences at regular intervals and announce them well in advance. Wean

the boss of your presence beforehand by coming in to work early and leaving early—limiting your time in the office with her while still finishing your work. Work extra hard one day, call in sick the next. Your boss will see that your absence does not bring disaster. Be careful not to overdo it, or your boss may decide she doesn't need you at all.

Distant Boss

Loop yourself in on all e-mails and meetings related to your boss's work and discuss projects independently with colleagues to gain a better understanding of details your boss is hiding from you. Read everything that comes out of shared computer printers with her name on it. Display your increased awareness of circumstances to gain her confidence and in turn your inclusion on projects to a deeper level—but be careful what you wish for.

IN THE WOODS

Ankle Sprain on Trail

Tear a T-shirt into long, 4-inch-wide strips. Immobilize the ankle by wrapping it in a figure-eight pattern, up and over the ankle and back around the foot. Use a stout piece of wood to support your weight on the injured side. If the ankle is badly swollen, soak it in cold water for 15 minutes before wrapping.

Arm Caught Under Boulder

Push gently against the boulder with your free hand or by pressing your feet against it. Gently try to move the boulder in all directions. If the boulder does not move, cool the area of the arm under the boulder with ice to constrict blood vessels, then try to remove. If no ice is available, apply lip balm to the arm and carefully slide it out.

Bigfoot Sighting

Remain still. If you are carrying a camera, slowly retrieve it, use manual (not digital) zoom setting, and take as many photos at the highest resolution possible. The creature will likely flee quickly once it is aware of your presence. Do not pursue—it may behave unpredictably if chased. Take note of the creature's physical and behavioral traits, including height, smell, and speed and posture of movement. Photograph any footprints and mark the location so you can return later to take a casting of the prints.

THINGS YOU CAN EAT



Mallow: Eat leaves.





Mallow: Eat leaves.



Wild strawberry: Eat berries.



Chicory: Eat raw leaves, and boiled root. New leaves are best.



Dandelion: Eat stems, leaves, flowers, and/or root.



Prickly pear: Remove outer skin and spines; eat pads and fruits.

Charge a member of the pack to scare it and the others away from you. Throw sticks or rocks at the wolf closest to you. Wolves tend to attack the legs of their prey—kick out at any wolf that gets too close.

Bears

Back away slowly upon sighting any bear or cub. Do not run—this may draw attention and you cannot outrun a bear. Do not climb a tree: Most bears will either climb trees or swat at an object in them. If the bear charges, curl to the ground and play dead. If the bear attacks, strike sensitive areas such as the bear's eyes and nose with a rock, stick, or your hands. When hiking in bear country, wear bear bells or sing or whistle.

Making a Smoke Signal

Pile and burn dry grass, wet leaves, or an abandoned car tire in a clearing, continuing to feed the fire to create a smoke column that will be visible for miles. Strive for a consistent quantity of smoke—do not attempt to send a “message” by covering and uncovering the fire with a blanket, which risks smothering the flames or setting fire to the blanket. Await help.

INJURIES

Tooth Knocked Out/Broken

Pick up the tooth or piece of tooth by the crown (top), not the root. Rinse it under cool water, then place it back in its socket. If the tooth is broken or otherwise will not stay in place, put it in your mouth, between your cheek and gum to keep the root moist and protect the tooth from bacteria. Alternatively, place the tooth in the mouth of another person or in a glass of milk. Seek emergency dental care immediately. Do not transport the tooth dry or in water.

Broken Nose

Keep your head back and nose elevated to reduce blood flow to the injury site. Apply an ice compress to the nose to reduce swelling. Take ibuprofen or acetaminophen for pain.

Dislocated Jaw

Support the jaw to prevent further injury, either by holding the lower jaw in your hands or by placing a bandage under the jaw bone and tying it on top of the head. The bandage should be tight enough to hold the jaw in place, but not so tight that it cannot be removed quickly. Get to an emergency room as quickly as possible.

Cut/Severely Bitten Tongue

Rinse your mouth with a solution of one part hydrogen peroxide to one part water. Do not swallow the solution. Apply pressure to the tongue with a cold, clean, wet washcloth until the bleeding stops, then apply a towel-wrapped ice pack for 15 minutes. Small punctures will heal on their own, though severe lacerations may require professional treatment, including antibiotics to prevent infection.

Bleeding Gums

If the bleeding is an isolated incident, there may be a piece of food caught between the tooth and the gum. Floss to remove the item, then brush your teeth. Tie a knot in the floss to help dislodge a particularly stubborn object. Repeated or continual bleeding should be considered a serious medical problem and treated by a professional. Bleeding gums are generally due to infection of the gums and/or the bones supporting the teeth.

Split Lip

Apply pressure to the injury site with a cold, clean, wet washcloth until the bleeding stops. If the cut is deep and bleeding continues, seek emergency medical treatment. Avoid touching the laceration with food items to prevent pain and possible infection.

Black Eye

Sit down. Tilt your head back. Place a cold can of soda on your cheek (not your eye) for 5 minutes. Remove for about 10 minutes, then repeat until the swelling subsides. Other than the chill, there is no benefit from putting a steak on a black eye.

Concussion

Try to talk about the incident that caused the concussion. If you are unable to remember the event, the concussion may be serious. Treatment options vary based on the severity of the concussion. Immediate symptoms of serious concussions include amnesia, confusion, headache, loss of consciousness, nausea, and vomiting. However, symptoms may not be present, may be difficult to spot, or may have a delayed onset. Do not engage in any vigorous activity until you have been evaluated by a professional.

Cracked Rib

Place 5 strips of medical/athletic tape along the rib, spaced 1 inch apart, from the middle of the chest to the spine. Position 1 strip directly across the injured rib, 2 above, and 2 below. Immobilize the arm on the injured side in a snug sling to reduce pain and prevent the rib from shifting. Do not bend over, twist your body, or take deep breaths. Take an over-the-counter pain medication for discomfort, and seek medical attention. A single cracked rib that is not displaced will heal in several weeks.

Dislocated Shoulder

Immobilize the arm immediately to avoid extreme pain at the shoulder and to prevent further complications, including tendon, ligament, and nerve damage. The ball of the humerus must be put back into the joint socket, a procedure that should only be performed by a qualified medical professional to avoid further damage to the arm and shoulder. Seek emergency care immediately.

Torn Ligament

Sit down. Elevate the problem area above the heart, if possible, and apply an ice pack in intervals of 20 minutes on, 30 minutes off. Keep weight off the injured appendage, and seek medical attention. Longer-term treatment depends on the severity of the tear and its location. Generally, a partial tear will require immobilization of the injury, usually with a splint or cast, for a few weeks to several months to allow the ligament to heal. More serious tears generally require surgery.

Sprained Ankle

Take all weight off the ankle. Elevate the ankle above the heart, and apply an ice pack in intervals of 20 minutes on, 30 minutes off, to reduce swelling and pain. Immobilize the injury by wrapping it with a bandage in a figure-eight pattern, up and over the ankle and back around the foot. Seek medical attention to ensure that the ankle hasn't been broken or fractured.

BROKEN ARM

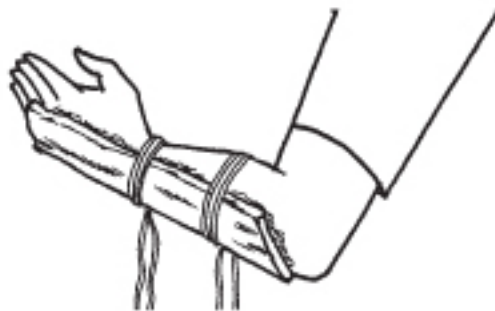

Immobilize the injury site with a splint extending to a joint above and below the break. Wrap the fracture in soft material (cloth, cotton, moss). Bind with firm material (branches, poles, boards, magazines) and tie with shoelaces to secure.





For fractures below the elbow, make a sling by securely tying together the sleeves of a buttoned-up shirt or jacket and slipping it over your head and around the back of your neck. Tuck the injured arm in the bulk of the jacket.



For fractures above the elbow, make a sling by running string or shoelaces around the back of your neck and tying them to the wrist of the injured arm. Place a pad of soft cloth material into the armpit.

IN-LAWS

Serve Terrible Dinner/Food

Develop a series of (fake) potent allergies to whatever it is they plan to cook. Alternatively, announce that you have a tremendously sensitive stomach and the only thing you can hold down is a bowl of cereal and/or a peanut butter sandwich. Eat before you arrive.

Criticize Career Choice

Ask the in-laws multiple, in-depth questions about their own careers. Become fascinated with their occupations, asking persistent sympathetic questions about the frustrations and real or potential downsides of their work. Express admiration for their abilities and perseverance, especially in the face of (point out a still more frustrating aspect of their profession). In doing so, you will have succeeded in distracting their criticism of you, expressing sympathy, and calling to mind painful doubts about their own careers all at once.

Not Good Enough for Son/Daughter

Alter your appearance for the worse bit by bit over a series of visits. Wear fake teeth, unflattering glasses, weight padding, wigs, blotchy or unexpected makeup. Cough frequently. After a few visits, arrive free of false afflictions and see how much more they appreciate you.

Joint Vacation

Get a separate bedroom, as far away from your in-laws' room as possible. Agree to spend either the day or the evening with them, while reserving the other half of the day as private time for you and your spouse. If your in-laws complain, tell them that with your careers and other obligations, you don't have enough time to spend with one another. When you are on your "alone" part of the day, go far away from the hotel.

Political Differences

Become a student of history. Meticulously study the historical impact of your in-laws' political leanings. Elicit political discussions with your in-laws, making it abundantly clear that you not only understand their positions better than they do, but that you also can pull up insightful historical

anecdotes to further prove your points. They will avoid political discussion when they see that arguing with you is no longer any fun.

INTRUDERS

Burglar

Call the police immediately. Give your exact location if you are calling from a mobile phone. Leave the house if you can do so without confronting the intruder. If you cannot get out of the house, stay where you are and lock the door. Alert the burglar that the police are on their way and wait for help to arrive.

Cockroaches

Eliminate all traces of excess moisture—roaches can go weeks without food but will die in less than a week without liquid. Stuff steel wool into the space around pipes to limit movement. Sprinkle powdered boric acid around cracks and crevices under the kitchen sink, but keep it away from areas where food is prepared and out of the reach of children or pets.

Guest Who Overstays Welcome

Declare a household emergency such as fumigation, severe mold remediation, or asbestos removal that requires all occupants to evacuate immediately. Alternatively, tell the guest you are going to paint their room and must remove all the furniture. Do not pretend to be leaving on vacation—the guest may offer to housesit in your absence.

BIRD IN HOUSE



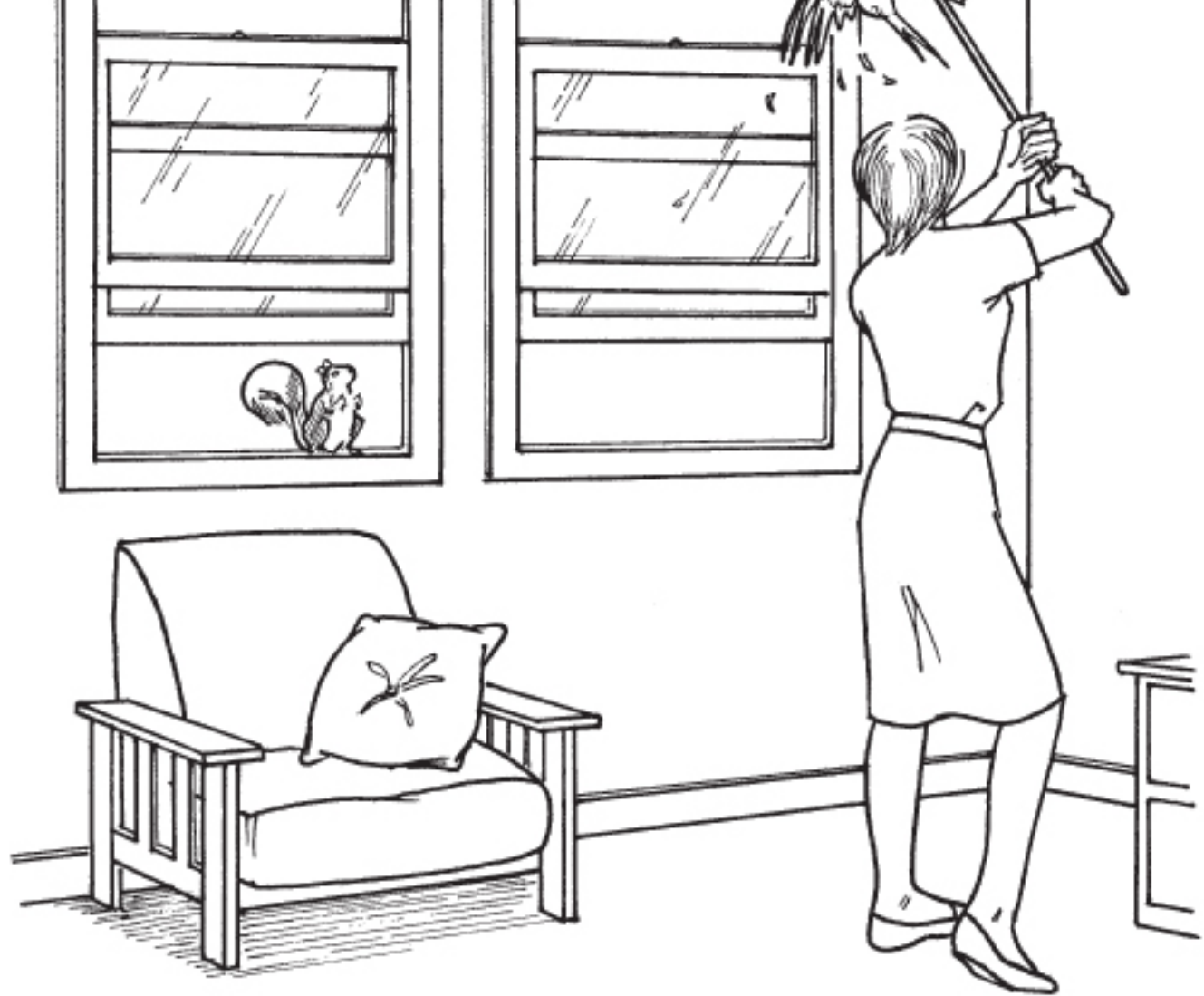

Use a broom to gently maneuver the bird into a room with a window and a door. Open the window, leave the room, and close the door. Wait for the bird to fly out. This method also works for stray squirrels.

Fill holes around pipes with steel wool to prevent mice from moving around the house freely, seal any holes in walls or to the outdoors, then humanely trap or kill using traps or commercial bait/poisons.

Squirrels

Locate the entry point, generally around eaves and downspouts or where branches come into contact with a structure. Seal the hole with close-knit steel mesh and roofing compound or metal flashing. Squirrels may find a new hole, necessitating professional trapping.

Termites

Move all untreated wood away from basement floors, walls, and window sills, which are all areas where termites enter structures. Termites should be controlled by commercial poison, applied by an exterminator.

Mold

Eliminate all sources of moisture, which mold requires to grow. Once affected areas are dry, scrub using household detergent and water and allow to dry completely; wear rubber gloves and an N95 respirator mask during cleaning. Seal with a commercial waterproofing agent. Mold in heating or ventilating systems or in areas covering more than 10 square feet requires professional treatment.

JOGGING

Heat Exhaustion

Stop jogging. Get out of the heat immediately. Rest in a shady place, and drink plenty of water or a sports drink. Wait at least 30 minutes before moving, or until the dizziness, weakness, headache, and rapid heartbeat subside.

Muscle Cramps

Massage and stretch to increase blood flow to the cramping muscle. Rehydrate yourself with water or a sports drink. Apply an ice pack to relax tense muscles. Later, if you still have pain or tenderness, use a warm towel or heating pad or take a hot bath.

Shin Splints

Use the R.I.C.E. treatment method: REST the legs by avoiding jogging; apply ICE to the shins for 15 minutes several times each day; COMPRESS the shins with a bandage to reduce swelling; and ELEVATE the legs above the head.

Lost

Retrace your steps, or ask a passerby for directions. If you are in a remote wilderness area, stick to a marked or well-traveled trail—or follow a road—until you reach a populated area.

CHASED BY PACK OF DOGS





Enter a car or nearby building as quickly as possible. Some breeds will tire after a short chase, while others may continue to chase you over long distances. Climb a tree only if you are able to get more than 4 feet off the ground.

Foot in Pothole

Put your weight on the good leg and use a stout tree branch as a temporary crutch. If available, use a bandage to bind the ankle tightly to compress swelling and limit foot movement.

Knee Gives Out

Sit down immediately to take weight off the knee. When immediate pain subsides, return home, walking at a slow pace, placing little weight on the knee. Place an ice pack on the knee for 10 minutes 3 or 4 times a day for several days, then apply heat treatments (ointments, soaks, heating pads) for several days. Take ibuprofen to reduce inflammation. Wear a knee brace or elastic bandage. Do not climb stairs unless necessary. A doctor may prescribe a cortisone injection and is likely to recommend strength training for the quadriceps.

KID

Dodgeball in Stomach

Curl your body inward with the impact of the ball. Stretch your arms outward, fingertips almost touching, to encircle the ball and try to catch it as it rebounds off your body—which will force your opponent out of the game.

Fell off Monkeybars

Cover your head and neck with your arms and try to guide your fall away from the bars and onto the playground's rubber padding, sand, or woodchips. Test movement of your arms and legs to be sure there is no sharp pain before getting up. If you have to cry, do so only to get the attention of a nearby adult who may assist you.

Blatantly Excluded from Game

Walk away from the competition. Do not hang around, watch, or play near the game, as it will only make you look pathetic and prompt abuse from the participants. Channel your feelings of insult and anger toward self-improvement, practicing the game at home with your family and on your own. The better you get, the more ready you'll be to contribute to a team when you have the chance.



HUNG FROM COAT HOOK

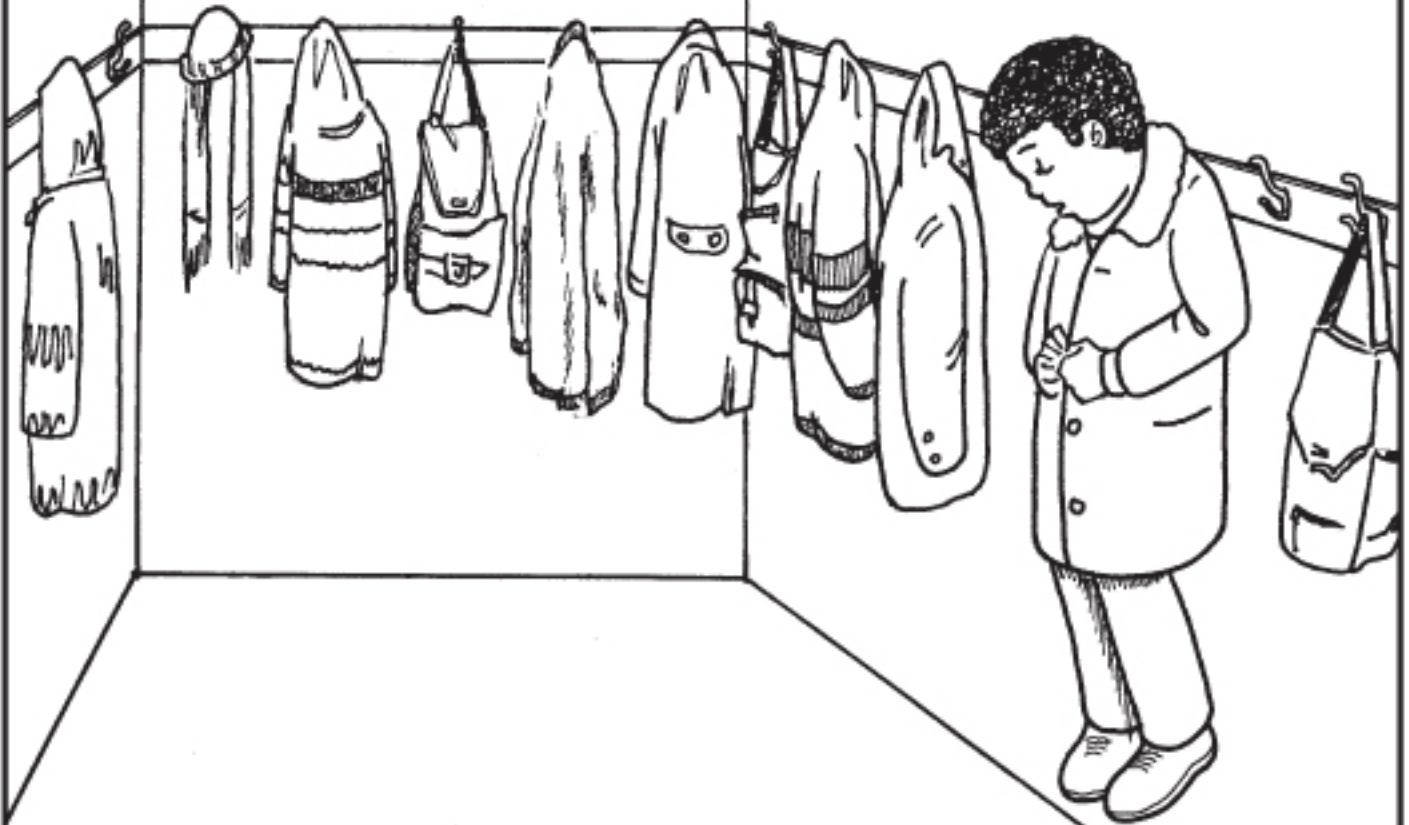

Unbutton your shirt or coat, starting with the top button, just enough to slip out of your garment and slide to the ground. Then unhook your clothes and put them back on. If you were hung by your coat, you just leave it there on the hook.

Homesick at Summer Camp

Live in the moment by concentrating only on those things immediately around you. Don't get

overwhelmed by grief by thinking of the things you miss from home. Pretend that you have been exiled to a foreign country or distant planet; take note of the strange new smells, sounds, terrain, food, and behavior of the locals so you can report back on them when you return home from your adventure.

Wet Pants

Hold a book, bookbag, or large toy in front of the affected area to cover it and move toward a liquid dispenser such as a drinking fountain, faucet, soda machine, or full standing container. Spill more liquid on yourself to mask the wet spot and make it larger, dribbling the liquid down the front of your shirt and pants. Publicly bemoan your own clumsiness and ask to be sent home to change clothes.

Sibling Blames You

Accept full responsibility for whatever you are being accused of. Grant that the sibling is right on every count and that you are truly sorry. Later, as your stunned parents try to decide your punishment, pull them aside and calmly explain that you had nothing whatever to do with the incident and simply acted to avoid a loud, messy conflict. Suggest that your sibling's troublemaking behavior might be a desperate cry for parental attention.

Grounded

Make the most of being stuck at home by learning important life skills that will help you down the road. For example, learn how to make a proper omelet (hint: the pan must be sizzling hot in order to cook the eggs as fast as possible) or how to maintain your balance in high heels, if appropriate.

Bad Report Card

Appear to be brooding, with a lot on your mind, on the day you bring the report card home. When confronted by your parents, show them the poor grades, profess deep disappointment in yourself, and offer to accept any punishment that will not cut into your study time. Spend a generous amount of time over the next few days locked in your room with books and papers spread out all around you on your bed. Only relent after your parents beg you to take it easy once in a while and enjoy being a kid.

Bully Picks a Fight

Ferociously attack the moment the bully's attention is directed toward you, without giving him any time to prepare. Savagely flail your arms and legs, landing as many blows in a short, controlled burst as

possible, all the while screaming at the top of your lungs. You might well get flattened, but in the future the bully will look for an easier, more docile target than what you've become.

Teacher Always Calls on You in Class

Develop a fake stutter and speak with long, awkward pauses between words so that the teacher is forced to help you finish your sentences. If she catches you speaking normally outside of class, explain that you only have difficulty when you are put on the spot in front of large groups of your peers.

Bad Lunch

Offer to trade the offending lunch items for food from classmates' lunches. Even if the trade does not yield an item you yourself wish to eat, the item might yet be traded again to another classmate for something you do want to eat. Try offering lunch "futures"—trading items to be eaten today for food you can bring in at a later date.

KITCHEN EMERGENCIES

Hand Cut with Meat Cleaver

Elevate the wound above your heart. Place direct pressure on the injury for 15 minutes. When the bleeding stops, dress the wound to prevent infection. Lacerations that are longer than 1/2 inch, are deep, or will not stop bleeding will likely require stitches.

Oven on Fire

Keep oven door shut. Turn the oven off. Though smoke may pour out of the vents, ovens are designed to contain heat and flame, and the fire should burn out after several minutes. Do not open the oven door for at least 5 minutes, or until you are sure the fire is out, as you will only add oxygen to the fire. Keep your face back from the oven when you open the door. If the fire continues to burn for more than 10 minutes, call the fire department.

Grease Fire

Turn the range off. Put on large oven mitts (to the elbow, if available), pick up the lid to the pan/pot and carefully slide the lid over the pan to smother the fire. If the pan does not have a lid, smother the fire with a cookie sheet, coarse salt, or baking soda.

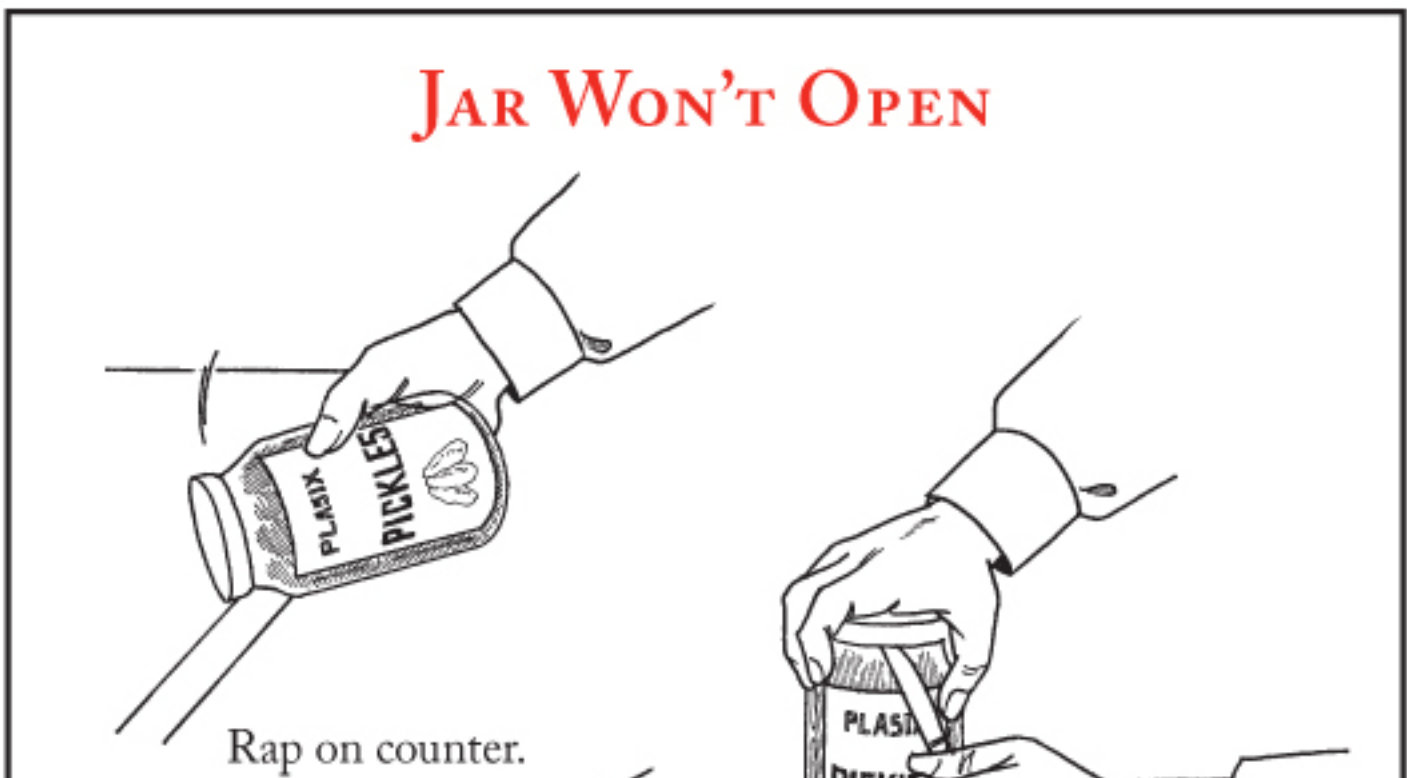

Rap on counter.



Hold under hot running water.



Pry lid with butterknife.



Use rubber band or towel
to improve grip.



Puncture lid to break seal.

**Try these techniques individually or together
to loosen a stuck jar lid.**

Gas Burner Won't Light

Lift the range cover and look underneath to determine if the pilot light on the line that feeds the burner

is still lit. If not, and if there is no ambient smell of gas, light a long match and touch to pilot light line opening to relight. Never leave a burner in the “light” position while lighting the pilot light. Never light a match if you smell gas in the house. Open window and doors, then get out of the house and call the gas company.

Hands Smell Garlicky

Rub your hands across a stainless-steel utensil under running tap water.

Hot Pepper Oil on Hands

Create a solution of 10 parts water to 1 part household bleach. Soak your hands in the solution until the pain subsides. Always wear rubber gloves while handling hot peppers to avoid contact with capsaicin oil, most of which is located in the fibers that hold the seeds to the pepper flesh.

Teary While Cutting Onions

Put the onions in the freezer for 10 minutes before cutting. Remove and promptly chop or slice. Avoid cutting into the potent root of the onion, which contains the highest concentration of the tear-inducing sulfur.

Garbage Disposal Clogged

Peer under the sink and press the reset button on the disposal unit. If the disposal still won't work, check the disposal motor for an Allen (hex) bolt in the housing and turn the bolt with an Allen wrench until the flywheel moves. If the clog remains, remove all items from the disposal and use the handle of a wooden spoon to move the impellers back and forth. Press the reset button. If the disposal is still clogged, use a purpose-specific disposal wrench to loosen the tension bolt and clear the jam.

MAKEUP

Mascara Running

Hold a cotton ball under each eye to catch the running mascara. Close your eyes and use two more cotton balls to remove any remaining traces of the mascara from the eyelashes.

Applying Lipstick without Mirror

Open your mouth. Using your dominant hand, position the tip of the lipstick in the center of the bow of your top lip, with one of the fingers of your other hand positioned above it as a guide. Draw a half heart from the tip of the bow, then trace the top of your lip out to the edge of your mouth, using your guiding fingertip to keep the makeup steady. Repeat on the opposite side of the top lip. Place the lipstick at center of your bottom lip and trace to the corner of your mouth. Repeat on the other side. Do not rub your lips together or color will smear outside of your lips.

Stains on Clothing

Apply heavy-duty liquid detergent directly on the stain, allow to soak for 30 minutes, then machine wash with hot water. For whites, add 1/2 cup chlorine bleach to the machine, using the automatic bleach dispenser if your machine is equipped with one.

MARRIED LIFE

Forgot Anniversary

Buy last-minute tickets to a tropical isle for the weekend. Make it seem as if your “forgetting” was only a setup so you could spring this wonderful surprise on your spouse when you hand over the tickets. Note that this will only work once. Bite your lip, pay off your credit card, and etch the date of your anniversary forever in your mind. Consider a tattoo.

Lacking in Romance

Surprise your mate with unexpected behavior—a passionate good-bye kiss instead of a perfunctory peck; dinner by candlelight; a bubble bath for two. Ask how your partner would rate your “love life” on a scale of 1 to 10—the mere fact of having the conversation should make your level of mutual satisfaction increase. If the pressure of romance is too great, agree to take turns initiating “intimacy.”

Nothing to Say at the Dinner Table

Tell your partner that you want to “talk about something different.” Ask open-ended, thought-provoking questions to elicit more interesting responses. Examples of such questions include: If you could spend a day with a celebrity, who would it be? What was your favorite childhood toy? What vegetable do you most resemble? Use your imagination and knowledge of one another.

Buying a House Together

Make separate lists of the features your ideal home would have before you start looking. Include basics such as “new construction” or “older home,” “near grocery store” or “near corner bar,” “in good school district” or “swinging, childfree neighborhood,” “close to my parents” or “as far away from his parents as possible.” See where your lists overlap to determine what’s important to both of you.

Surviving Pregnancy

Use the BABY mnemonic: BE patient—crying jags and emotional breakdowns are not uncommon during pregnancy for women or men. ASK often—“Is there anything you need?” “Can I massage your feet?” but not “Are you nuts?” or “Why are we doing this?” BECOME educated—for every book about pregnancy you read, read one about parenting to prepare for what’s coming next. YOU matter, too—find

the new balance that allows you all to remain individuals and still be a family.

Caught by Kids “Entre Act”

Shriek and cover yourselves completely with a bedsheet. If you have not frightened the children away, explain to them that they startled mommy and daddy and that good little boys and girls always knock before entering a room. If asked what you were doing, explain that such acts are only permitted between mommies and daddies, birds, and bees who love each other very much.

Winning an Argument

Agree with whatever your partner is saying wholeheartedly, and agree that your more reasonable position is wrong. Later, when his guard is relaxed, ask innocent-seeming questions for clarification, allowing him to undermine his ridiculous stance with further clarifications, until it is plainly obvious that your take is the right one. Do your best to make it seem as if he came to this conclusion himself, then agree with him.

Spouse Snores

Lift the nearest side of your spouse’s pillow until she turns onto her side. Alternately, flop around forcefully on your side until her sleep is disturbed and she turns over. Nudge with your elbow or a soft kick if more subtle methods do not yield results. Wear earplugs or noise canceling earphones if you are comfortable sleeping on your back. Encourage her to refrain from alcohol (which deepens snoring) and drink caffeine (which reduces snoring) before turning in for the night.

Spouse Crowds You out of Bed

Be the first to get into bed and stake out more than your usual turf by lying in the middle of the bed so that your partner occupies the space you leave available. Once he goes to sleep, move to your usual sleeping position and spot and place pillows between you in the open space to resist encroachment later in the night.

MATE

Caught Noticing an Attractive Stranger

Think fast—point out an item of the stranger’s clothing and mention to your partner that you think the color, style, or cut would look nice on her. Alternately, point out (or plausibly make up) a flaw in the stranger’s appearance, such as crossed eyes, bitten fingernails, a weird mole, or buck teeth, and ask if your partner noticed it, too.

Hates Favorite TV Show

Force your mate to watch a show so bad even you can’t stand it. Say it is your favorite show of all time and ask your mate to understand how important it is to you and your relationship. Then compromise slightly and tell your mate you won’t make her watch the truly awful show so long as you can watch your (real) favorite show instead.

Won’t Do Chores

Divide duties and post the list on your refrigerator. Tell your mate that every time you do one of his chores, he has to pay you for the service. Stagger the payments depending on the nature of the job: Taking out the trash might cost him \$5, while cleaning the kitty litter is \$10, and raking all the leaves outside is \$20. Use this money to buy yourself extravagant lunches and clothes.





Host a gender-stereotypical night to drive your spouse away. If female, invite “the girls” over to watch weepy films, gossip, and eat guilt-inducing snacks. If male, bring “the boys” over for an evening of cigar smoking, poker, whiskey, and sports argument. Once you have laid precedent, you can drive your spouse away at any time by announcing another “girl’s night,” but without having to actually host such an event.



MESSES

Dishwasher Floods Kitchen

Turn the dishwasher off, or close the valve on the water pipe that feeds it. Run the garbage disposal in the sink to eliminate any food items that may have caused a backup. Mop water from the floor. Empty the dishwasher, then run again on the rinse cycle to remove standing water. If flooding recurs, call for service.

Spilled Oil

Pour coarse salt on the oil, allow it to sit for several minutes, then wipe it up. Granulated table salt will also work, though it is slightly less effective, as will flour. After wiping, clean remaining oil with a bit of dish detergent and a paper towel. Do not use soap and water, which will only spread the spill.

Spaghetti Sauce on White Tablecloth

Scrape food particles from the tablecloth with the edge of a spoon. Mix 1 teaspoon of a mild, nonbleaching clothing detergent with 1 cup of warm water, apply, and blot the stain with a paper towel. If the stain remains, mix 1 tablespoon of household ammonia with 1/2 cup of cold water, then blot the stain. If the stain continues to hold, repeat blotting with the detergent/water mixture, then blot with a clean, wet sponge.

MIDDLE AGE

Midlife Crisis

Determine the nature of your distress. It is natural to feel some discontent with your life and question its meaning when you near the age of 40. Common triggers of existential anguish are financial troubles, death of a parent, feeling older, dealing with teenage children, impending retirement, and the “empty nest” syndrome. If you are near the age of 40 and want to leave your spouse or your job, buy an inappropriate car, or wear clothes marketed toward 20-year-olds, you are probably having a midlife crisis. Put off making life decisions until you regain your sense of balance.

Adjusting to Bifocals

Wear the lenses all the time for the first few weeks, even though you may not need them for everything you do. Look down only with your eyes—without moving your head—when reading, holding the reading material closer to your body so that you are looking through the lowest part of the lenses. To help your optometrist determine the placement of your corrective lenses, tell the doctor about the types of activities you participate in that require clear vision. Improperly placed lenses can cause accidents while walking, climbing stairs, and while driving.

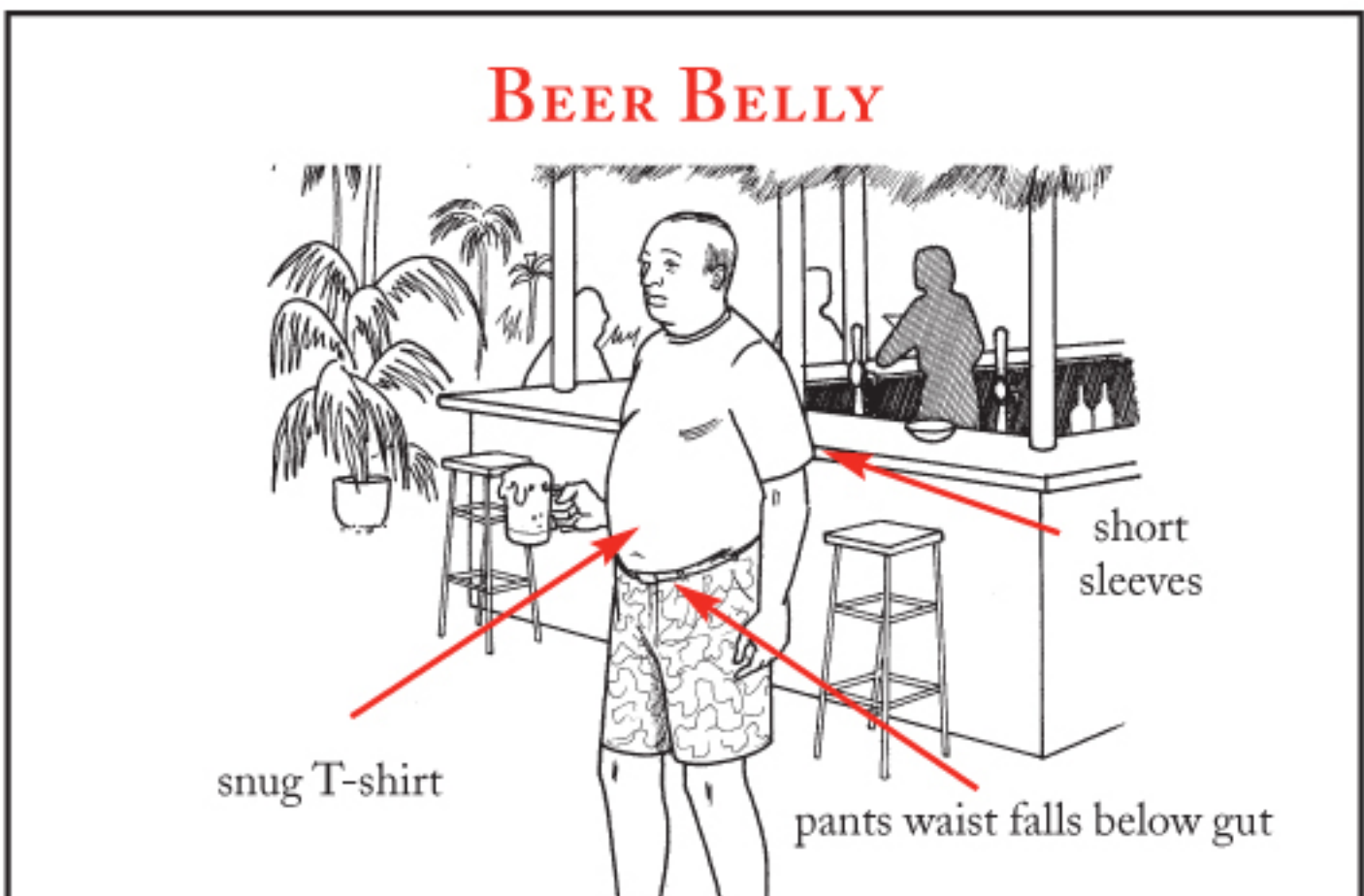

snug T-shirt

pants waist falls below gut



Wrong

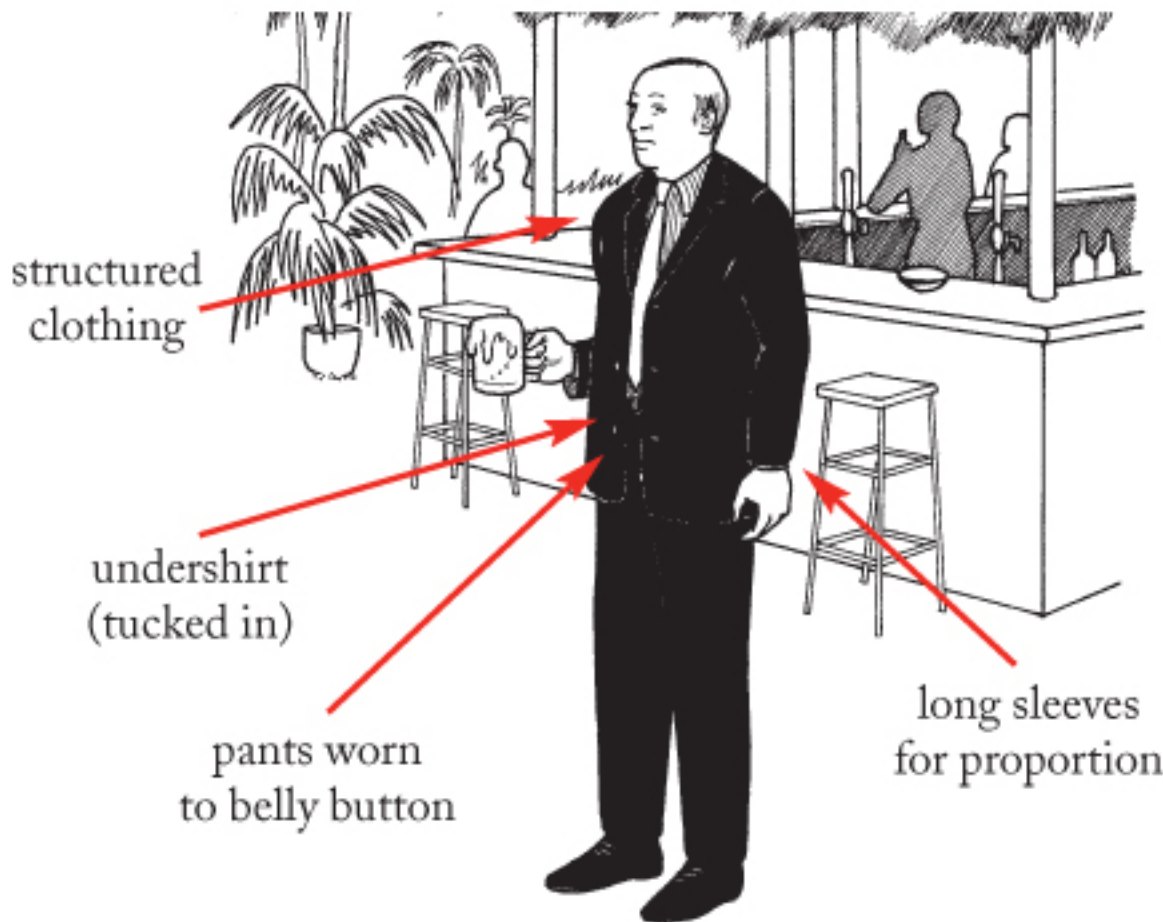

structured clothing

undershirt (tucked in)

pants worn to belly button

long sleeves for proportion

Right

Draw attention away from gut.

Hot Flashes

Avoid spicy foods and caffeine-laced drinks, which are common triggers for hot flashes. Keeping your weight down and exercising regularly can also help prevent hot flashes. Dress in layers to help manage your temperature, drink ice water, and keep the A/C on in your house, especially at night to help reduce night sweats. Put all your bulky sweaters and fleece garments into storage and celebrate the idea that your hands and feet won't be cold again for a while.

Going Bald

Reduce stress, maintain a healthful high-protein diet, and take multivitamins—temporary hair loss may sometimes result from illness, tension, or poor nutrition. For women, partial hair loss sometimes occurs after pregnancy or going off birth control pills, and more permanent hair loss after menopause. Perms, coloring, wigs, shawls, and hats can help mask symptoms. For men, shave entire head in advance of notable male pattern baldness.

Going Gray

Get the hippest, most avant-garde hair cut of your life. Do not dye your hair. Take on an air of sophistication by wearing fashionable black ensembles with dark capes and dark-rimmed glasses and laughing vigorously while drinking elegant flutes of dark wine in public.

Seven-Year Itch

Take comfort in the cliché of the situation: Recognize that it's normal for couples who are together this long to weather rough patches, and that feelings of discontent or restlessness are also normal when people perceive themselves in static long-term situations. Change a few routines. Pursue new hobbies and interests to make yourself more interesting, to yourself and to your spouse, and share them with one another.

Handling Being Called “Sir” or “Ma’am”

Preemptively refer to everyone by “sir” or “ma’am” first, before they say it to you. You will appear to have impeccable manners, even as your excessive courtesy unsettles younger service-industry workers.

MUSICIAN

Guitarist's Fingers Bleed

Apply a thin layer of superglue to your fingertips (also known as the “Stevie Ray Vaughan technique”). Reduce the weight of your string gauge if you feel it will not compromise your music.

Trapped Under Piano Collapse

Lie still. Your predicament will be obvious to stagehands and the audience in the front rows, who should come to your aid quickly. A typical baby grand piano weighs around 500 pounds, making it very difficult to move on your own, and in shifting your position you risk further injury. Keep your breathing regular and focus your thoughts. Replay the last few measures of the piece you were performing in your mind as you would in practice.

Smoke Machine Malfunctions

Keep the house lights low. Gather candles from table seating or the bar and arrange them on the stage. Unplug and play an acoustic set, seated on the stage floor or perched on stools. For your encore, plug in and play electric. Kick over the stool.

Emergency Earplugs

Fold a cocktail napkin in half twice lengthwise, then roll to form a cone. Lightly moisten the thin end of the napkin roll in water (not alcohol) and place snugly in the ear opening, leaving at least 1/2 inch of napkin clear of the ear to grasp and pull out after the concert. Repeat for the other ear.

Hecklers

Do not respond to the heckler's public taunts or muttered insults. If the heckler is close to the stage, most people in the audience will not have heard anything and any response will call attention to the comment. If the taunt was loudly audible, continue performing without acknowledgment. Even if the crowd has not paid to see you perform, human nature dictates that their sympathy will lie with you. Alternately, learn a few bars of “Free Bird,” the song most frequently requested by hecklers, and oblige the request.

Gargle with saltwater every 3 to 4 hours. Drink herbal tea with lemon and 2 tablespoons of honey afterward, and plenty of water throughout the day. Rest your voice by speaking as little as possible—communicate by writing notes and sending e-mail, IM, or text messages.

ON A CRUISE

Seasickness

Move to the center of the ship, as close to the water line as possible, but in a location with good fresh air circulation. Face your direction of travel and focus on an unmoving object in the distance, such as the horizon. Ginger drinks may help to settle the stomach, and prescription or over-the-counter seasickness remedies, particularly the scopolamine patch, may help with nausea. Rehydrate with water or sports drinks if vomiting occurs.

Crew Mutiny

Avoid revealing your allegiances and keep all options on the table. Do not sit at the captain's table. Do not fraternize with the crew. Stay away from the ship's lower decks, where crew members are quartered, to reduce risk of being captured and used as a hostage.

Sinking Ship

Put on warm clothing (long pants and a long-sleeve shirt) in case you are exposed to seawater. Never evacuate a cruise ship unless you are expressly told to do so by the crew: You are much more likely to be found with the ship than in the water. Stay on the ship and wait for rescue. Large ships take hours or days to sink, so help should arrive before the ship sinks. Put on a life jacket and wait for further instructions from the crew.

OPENING A COCONUT ON A DESERT ISLAND



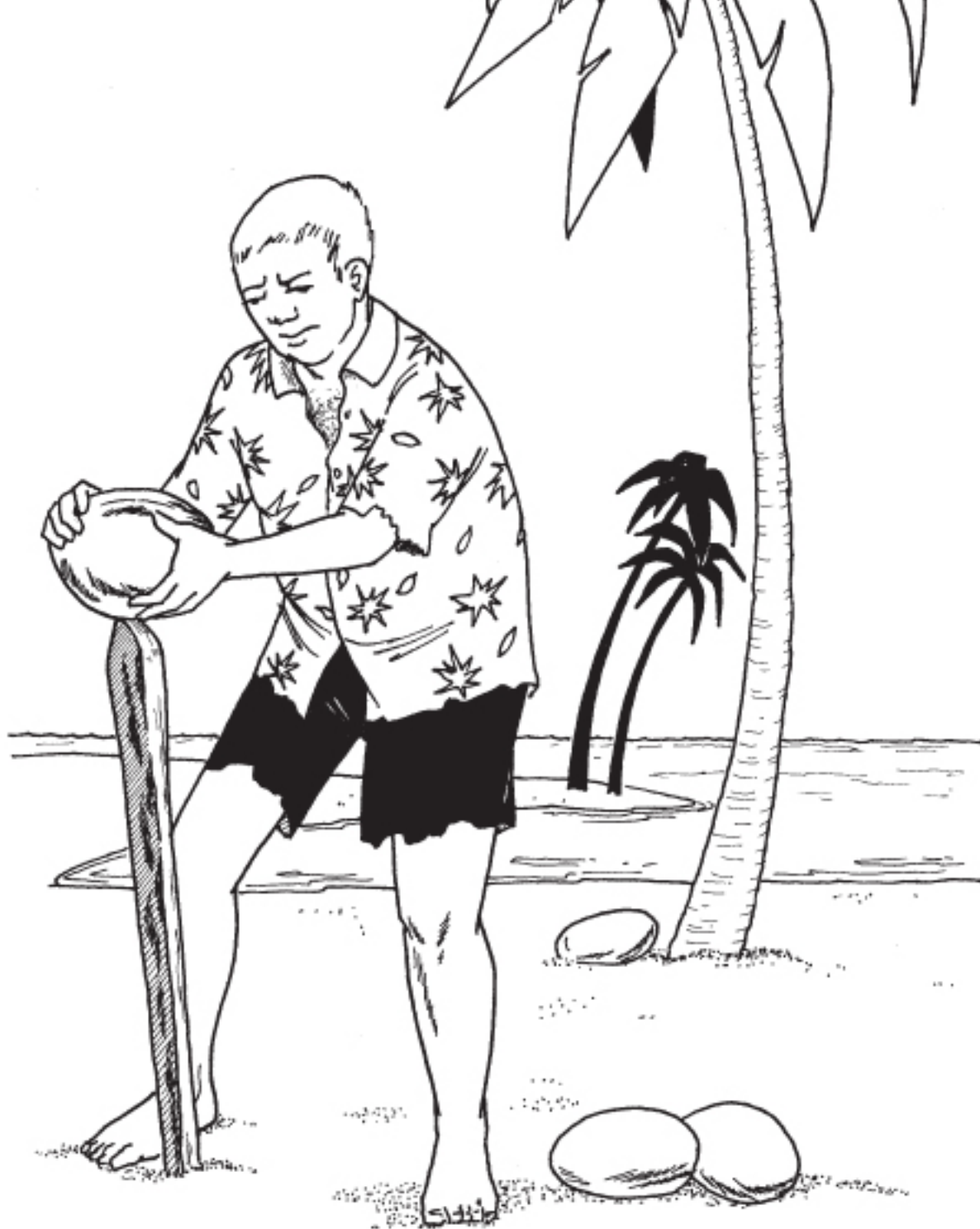

Drive the end of a stick into the ground and sharpen the top end. Slam the nut down on the point of the stick, using both hands to crack the outer fibrous covering. Smash the inner shell against a rock or tree.

Immediately yell “Man overboard, [port/starboard] side!” as loud as you can. The port side is the left side of the boat, as you face toward the bow (front). Wave your arms as high as you can to attract attention, and keep yelling. If you spot someone overboard, shout the same thing, throw a life preserver, and point at the person in the water until help arrives.

Norwalk Virus Outbreak

Wash your hands with soap and warm water frequently. Use disposable wipes, tissue paper, or paper towels when touching doorknobs, elevator buttons, toilet handles, faucets, light switches, and other objects handled by other people. Only eat food that is prepackaged and sealed or that is thoroughly cooked to 160°F for red meat or 180°F for whole poultry. Avoid eating raw foods. Drink only bottled water, or bottled or canned juice, soft drinks, or milk that you have opened yourself. Remain in your cabin and limit contact with other passengers and crew for the duration of the cruise.

ON SAFARI

Lions

Get inside a closed-top vehicle, roll up all windows, and drive to a safe location as quickly as possible. Lions typically will not attack humans unless starving or threatened, but they should be considered a danger when encountered in the wild. Lions may attack from any position and will enter water and climb trees in search of prey.

Charging Rhino

Run to and climb the nearest tree, raising yourself at least 6 feet off the ground—the height to which a rhino can typically strike with its horn. If you cannot get to a tree, run for thick scrub brush and get in as far as possible. If no other options are available, stand your ground, face the rhino, and shout. Rhinos may veer from loud noises.

Hyenas

Move children and infirm or elderly members of your party indoors or into a closed-top vehicle if you hear animal noises such as grunting, growling, giggling, or screaming, or notice hyenas advancing in groups of two or more. Though they are known as scavengers, hyenas are opportunistic predators and may attack humans if they sense an advantage in size or number. Avoid areas with fresh kills, especially at night, when hyenas typically hunt.

STAMPEDE OF GIRAFFES





Wade into the nearest body of water. Giraffes typically avoid water except for drinking. If you cannot reach water, climb a tree or seek available shelter. The giraffes' large hooves pose your most immediate danger.

ON THE ROAD

Overheating Engine

Put heat and blowers on full strength to draw hot air away from the engine. Pull over as soon as possible. Turn off the car and allow the engine and radiator to cool for at least 30 minutes. Cover your hand with a large, thick piece of cloth and slowly open the coolant reservoir cap. Add coolant or a combination of water and coolant mixed to a 1:1 ratio and drive to a service station, keeping heat and blowers on full power.

Children Fighting in Backseat

Distract bickering children and play on their competitive nature to see who can spot colors or types of cars or license plates first. Play yourself to increase their interest, but let them win or you risk their sulking. Do not threaten to pull the car over unless you are prepared to follow through on the threat. If you must pull over, do so at a rest stop or another safe location, never on the shoulder. Once stopped, let them run around to wear them out.

Carsick Child

Stop the car. Walk around with the child for several minutes, or until nausea passes. To prevent car sickness, adjust the child's seating position so he can see out the window. Remove reading material and handheld video games, and offer small snacks to distract from any symptoms.

Falling Asleep at the Wheel

Open windows to bring fresh air into the car. Turn the radio up to a volume louder than you're normally comfortable with, to a news or talk radio station (human voices may draw alert attention better than rhythmic or repetitive music, even if it is loud). Drinking coffee will keep you awake but may make you jittery and force frequent bathroom stops, prolonging your time in the car. Even a very brief cat nap in a safe area should make you feel more awake and refreshed.

Flooded Engine

Hold the accelerator pedal to the floor and turn the key to the "start" position. If the engine does not turn over, keep the pedal to the floor, turn the ignition off, then turn it back on. Repeat until the cars

starts. Once the engine turns over, release the pedal. The engine will run rough until the excess fuel is burned. Drive only after the engine runs normally. Use this method only for older cars with a carburetor and without fuel injection.

Brake Failure

Continue pumping the brakes to build pressure with any remaining brake fluid. Shift the car into the lowest gear possible. Gently pull up on the emergency brake using even, constant pressure, and steer the car to the shoulder as it slows to a stop.

DEER IN THE HEADLIGHTS





Brake firmly and blow your horn with one long blast to frighten the deer into action. Do not swerve or you will confuse the deer about which way to run. If you hit the deer, do not touch the animal; move the car off the road, set the hazard lights, and call the police. Drive using high beams whenever possible on dark wooded roads.

Ditching Psychotic Hitchhiker

Pull over at the first populated area, preferably an active gas station or truck stop with people visible outside. If the hitchhiker will not get out, take the keys and leave the car, then get help. Do not drive down a deserted country lane or to an abandoned farmhouse.

Evading a Maniac Trucker

Take a tight-radius turn at high speed: The trucker should be unable to follow. If available, call the toll-free number printed on the truck to report the trucker's dangerous driving—include the license plate number—or simply call the company office's main number and ask to make a complaint.

Talking Your Way Out of a Ticket

Apologize and ask for a warning. Do not make excuses for your behavior. Do not directly answer leading questions (“Do you know how fast you were going?” “Do you know why I stopped you?”) since your responses may be taken as an admission of guilt, and you should plead not guilty if you cannot get

out of the ticket. Instead, say “I’m not sure, officer.”

Black Ice Skid

Remove your foot from the accelerator. Do not brake. As you feel the wheels regain traction, slowly turn the steering wheel in the direction you want the car to move. Do not make sudden movements of the wheel. Drive using low headlight beams during an ice- or snowstorm to increase visibility.

Fire Under Hood

Pull over, turn the engine off, and get out as quickly as possible. Do not open the hood. Move to a safe location at least 100 yards from the burning vehicle and call for emergency help.

Flat Tire

Remove the hubcap and loosen the lug nuts or bolts while the tire is firmly on the ground. Set the jack under the jacking point just in front of the tire for a rear flat or just behind it for a front flat. Jack the car up. Remove the wheel and replace with the spare. Tighten the bolts slightly. Lower the car and finish tightening the bolts one after the other in a star pattern while the wheel is held stable by the weight of the car against the ground.

PARENTS

Unannounced Arrival

Quickly make a hotel reservation—for yourself. Tell your parents you're extremely happy that they've come, because now you can cancel the housesitter you'd scheduled for your weekend trip to the ocean/lake/desert. Give your parents a detailed list of all the things that need to be monitored and taken care of while you're away (plants, lawn, dog/cat/fish/gerbils, kids), pack your bag, and leave.

Critical of Lifestyle

Ascertain some of your parents' personal heroes, be they musicians, artists, political figures, or athletes. Study the childhoods of these people until you find one with an offbeat lifestyle choice—ideally, similar to your own, but barring that, at least peculiar. Cite this example whenever your parents raise their complaints.

Condescending

Fight fire with fire. Lord over them any advantage you may have, be it age/looks/physicality or freedom/irresponsibility. Serve them “underappreciated” wine gleefully and take them to esoteric, complex foreign movies by directors whose names are eight syllables with a single vowel.

Rude to Your Mate

Call your parents and tearfully explain that your mate is considering dumping you because of them. Say that you only hope you are never as mean-spirited with your own children, whom they will never meet as long as they keep up that kind of behavior.

Pressure to Have Grandkids

Take in a few dogs and cats from the local animal shelter. When your parents come to visit your menagerie, explain that you are preparing yourself for eventual parenthood by taking care of other lifeforms first, as you've read it's an excellent preparation for children of your own. Ask your parents to animal sit as much as possible.

Nag You to Move Home

Tell your parents you're really thinking about it because then you won't have to work or cook/clean, and you could fully devote yourself to online poker tournaments.

Call Three Times a Day

Ditch your current phone number and get a new one without telling them about it. Have your voicemail set to pick up after the smallest amount of rings possible, or cancel it altogether (tell your parents it's a cost-cutting move). If possible, assign your parents their own ringtone so you don't accidentally take their calls.

PIERCINGS

Infection

Leave jewelry in place to avoid premature closing of the piercing, which may trap the infection. Keep the area dry and free of potential irritants like hair or clothing. Treat the piercing daily with rubbing alcohol and a topical antibiotic (for body piercings) or an antiseptic mouthwash (for oral piercings). Infection may require treatment with antibiotics, so seek medical attention if it exhibits swelling, yellow pus, heat at the piercing site, or inflammation. White discharge from a piercing is normal during healing and is not a sign of infection.

Hole Heals

Have the piercing redone. Leave jewelry in the hole until the wound heals completely. Depending on the body part, this can take anywhere from 4 weeks to 6 months.

Hide from Parents

Wear clothing that effectively covers the area. For ear piercings, wear your hair long. For eyebrow piercings, wear large sunglasses with thick plastic frames. For a tongue piercing, speak as little as possible.

PLUMBING

Flooded Basement

Remove water less than 1 inch deep with a wet vacuum. For deeper water, pump out using a commercial pump. Use a rotating floor fan to dry the area. Replace all wiring if the water has reached outlet level. Have all basement-level mechanical systems (furnace/boiler, hot-water heater) checked by trained professionals before using.

Frozen Pipe

Turn on the water at each tap, one at a time, to isolate the frozen pipe. The water will not run out of the tap connected to the frozen section. Once you have located the frozen pipe, turn off the water supply where it enters the property to reduce the risk of a flood if the pipe is cracked. Access the pipe and heat the frozen section with a hair dryer, then turn on the main water supply. When the frozen section is thawed, the water will begin to flow.

Burst Pipe

Immediately turn off the water where it enters the property. Turn on all taps until the pipes are empty. Locate the broken section. Cut out and remove the broken pipe section using a pipe cutter or hacksaw. File down burrs. Replace the section with a threaded slip-on coupling. Turn on the water and inspect the site to be sure fix holds.

Clogged Sink

Remove all dishes from the sink. Place a toilet plunger over the drain opening, pressing down to form a tight seal, and plunge several times. If the clog does not clear, feed the metal tape from a tape measure into the drain and push up and down to clear the clog. If the clog remains, don rubber gloves, place a bucket under the sink trap (the “J” shaped pipe under the sink), remove the trap using a plumber’s wrench, clean out, and replace. Commercial drain cleaners may work, but their high sulfuric acid content can damage pipes.

Ring Lost Down Sink

Shut off water tap. Peer down the drain with a flashlight. If the ring is visible, retrieve it using the end

of a wire hanger bent into the shape of a hook. If the ring is not visible, place a plastic bucket underneath the sink trap (the “J” shaped pipe under the sink) and remove the trap with a plumber’s wrench. Wearing rubber gloves, empty the trap contents into the bucket and look for the ring. If the ring is not in the trap, it is not retrievable.

Septic Malfunction

Immediately stop using disposals, toilets, and washing machines. A washing machine alone may add 60 gallons per cycle to the septic tank. Have an expert check the drain field and the water level in the tank, then pump it out and repair as necessary.

Toilet Won’t Stop Running

Turn off the water supply to the toilet; turn it back on before each use. To troubleshoot the problem, remove the toilet tank cover and, while the water is running, inspect the flapper to ensure it falls to completely cover the gasket to the toilet; it may be caught on the chain or have come off its mounting bracket. Press the flapper onto the gasket and hold. If the tank fills and the water stops running, the gasket is worn and should be replaced. If the toilet still runs, replace the entire fill mechanism.

Rat in Toilet

Close the toilet lid immediately and weight it down with a heavy object. Attach a straw to the end of a funnel, feed the end of the straw into the gap between the toilet seat and the bowl, and slowly pour 1/2 cup of chlorine bleach into the toilet through the funnel. Wait 15 minutes, or until you do not hear any movement in the bowl, then flush. The rat should be small enough to exit through the waste pipe the same way it entered.

Stuck in Toilet

Turn off the water supply to the toilet. Flush to empty the bowl. Spray dishwashing liquid into the toilet bowl around the stuck body part and pull to remove.

RESTAURANTS

Lost/Canceled Reservation

Maintain your composure. Calmly and politely tell the host the day and time you called to make the reservation, and the name of the person you spoke to. Express disappointment, saying that this is your favorite restaurant and you'd made the reservation to celebrate your promotion/anniversary/birthday/release from prison. If the restaurant cannot accommodate you, ask the host to get you a table at another restaurant nearby.

Seated at Worst Table

Have a drink at the bar. Ask the maitre d' if you can give the table to the next waiting guest and wait for the next available table, or ask that your table be moved to a more suitable location.

Birthday Party at Next Table

Ask that your entrées be served when the birthday party is finishing their dessert if it is impossible for you to be reseated elsewhere in the restaurant. Sing along loudly when the cake is served, then ask that you also be served a piece.

Can't Pronounce Menu Items

Describe the item you wish to eat by noun only: You'll have the fish, the beef, the chicken, the ravioli, the mer-lot, or the special. Point to the line item on the menu to aid in identification and help distinguish between multiple preparations. Alternatively, wait for your dining companions to order, or point to food served at another table, and say "I'll have what she's having."

Candle on Table Lights Menu on Fire

Drop the menu onto the tabletop and knock over glasses of water, wine, and beer until flames are extinguished. If you haven't yet been served any drinks, cover the flaming menu with an upside down dinner plate and press to cut off oxygen and extinguish the flames. Announce to the other patrons not to order the "menu flambé."

Leave the restaurant if you have not ordered your meal. If you have already ordered, ask to speak to the manager and explain the situation. He or she should address the waiter immediately and resolve the conflict. If the situation is not resolved to your satisfaction, do not leave a tip. If the service charge is included in your tab, pay with a credit card and dispute the service charge with the card issuer.

RETAIL SALES CLERK

Monotonous Music Loop

Enlist your co-workers to plant “earworms” in each others’ heads by naming songs that stick in mind due to their insidiously catchy melodies. Especially infectious songs include: “Y.M.C.A.” by the Village People, “Who Let the Dogs Out,” by Baha Men, and “It’s a Small World After All.”

Sale Scrum

Angle your body sideways to slide between shoppers and move to the edge of the crowd. Try to keep a merchandise rack between yourself and the sought-after items. If you are caught in the mob, keep your arms folded defensively across your chest to protect your breathing area. Stay on your feet or you risk being trampled.

Shoplifter

Watch for attentive behavior—shoplifters will be highly attuned to the activities of employees and other shoppers. Look for bulges in clothing, several layers of clothing, or shoppers who enter the store with seemingly empty bags. Shoppers who walk with strange or jerky movements may also be concealing items. Make your presence known, keep your merchandise well organized so you can detect missing items, and regularly monitor dressing rooms.

Maintaining a Smile

Practice the following sequence in the mirror to strengthen smile muscles, holding each step for 10 seconds: 1) move corners of mouth back, keeping mouth closed; 2) part lips slightly to expose edges of teeth, keeping corners of mouth even; 3) raise cheeks laterally and widen smile—teeth are now fully exposed; 4) relax to step 2; 5) relax to step 1. Repeat several times before your shift to limber up and after your shift to cool down.

Leg Cramp from Standing

Lift and straighten the cramping leg outward to stretch the muscles, pointing the toe, flexing and rotating the ankle. Massage the cramped muscle for 30 seconds. Shake and stamp the leg. Walk it off by pacing for a few minutes. To help stave off cramps, eat calcium-rich foods, avoid drinking soft

drinks, and flex and rotate your legs and ankles once an hour. Stretch your muscles by performing deep knee bends and touching your toes.

RODENTS

Lost in the House

Call the animal's name (if it knows it) or use a familiar squeaky toy to get its attention. Close all interior and exterior doors and search the house systematically, keeping doors closed and blocked with a towel under the door-frame even after searching a room to keep the animal contained. Check inside cabinets, under appliances, and in and under couches. Place a container with food, water, and a blanket or cloth the animal has used before just outside your front door, in case it manages to get outside. Consider setting a humane rodent trap to recapture your pet without injuring it. Crate other pets, especially cats and dogs, until the rodent has been located.

Gnawing at Cage

Move the animal to a glass cage, or use an empty aquarium. Alternatively, experiment with a larger mesh cage so the animal feels less confined. The mesh openings should be small enough that the animal's head cannot get caught.

Bitten by Rat

Clean the wound with soap and water, apply an antibiotic ointment, and dress the injury site. Get a tetanus booster if yours is not up to date, and monitor for symptoms of rat bite fever, including fever, chills, rash, sore throat, and aching in joints. See a doctor if symptoms develop.

SENIOR CITIZEN

Shrinking in Stature

Buy shoe lifts or sturdy, wide-heel platform shoes or boots. Style your hair upward and wear shirts, sweaters, and coats that are slightly too small for you, allowing your wrists to show more than usual. Vertical striped clothing can also add the illusion of height. Lift weights and exercise regularly to gain some muscle mass to make up for the lost size.

Hairy Ears

Trim hair with an electric shaver or nose and ear hair trimmer with rotary blades. Do not use scissors, which risk puncture injury, and avoid using fixed-blade razors, which are more likely to scrape the sensitive skin at the edge of the ear.

Forgot Grandchildren's Names

Wait for the children to refer to themselves and take note of the names they use. Give the children nicknames, such as “Dusty” or “Blondie”—try to make them memorable, perhaps based on a physical trait, so you can use the nicknames in the future. In a real jam, “Kiddo” is a good catch-all for any grandchild. Avoid nicknames that might be considered cruel, such as “Tubby” or “Jughead.”

Dentures Won't Stay in Place

Get the dentures refitted with a new lining. If you have to use a fixative, start with a minimum amount of adhesive around the perimeter of your denture. Gradually work up from there until you find a comfort zone.

Age Spots

Apply an alpha hydroxy acid gel to reduce the coloring. Wear hats and long-sleeve shirts when outdoors, and use a liberal amount of high-SPF sun block daily on your face and hands to protect your skin from further damage. Age spots have more to do with the sun—skin pigment buildup from previous tanning—than with age, and are benign. Because some melanomas resemble them, have your doctor look at them during your annual checkup.

Make sure the hearing aid is properly inserted. Check the volume, as it may be turned too high. Remove scarves or hats covering the aid; sound can bounce off these garments and cause feedback. Feedback can also occur if the hearing aid no longer fits to the ear; over time, the shape of the ear can change, causing the aid to become loose. Call your audiologist for refitting.

OUT-OF-CONTROL MOTOR HOME

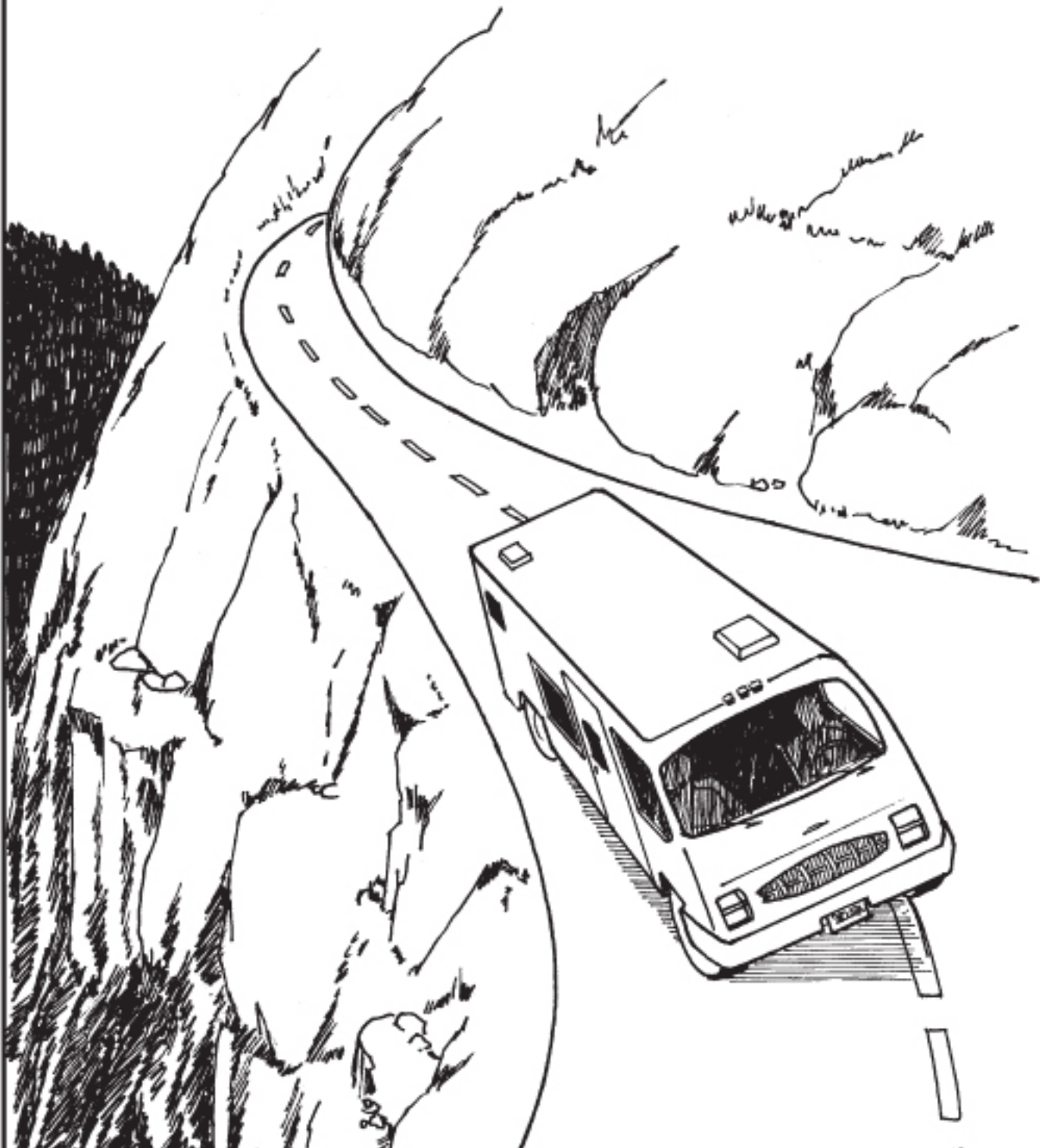

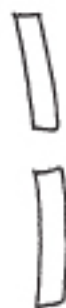

Steer into a skid. Apply even brake pressure and shift into second or third gear to help slow the motor home. If possible, use an incline in the road to help naturally slow the vehicle even further; pull to the side of the road with your hazard lights on, and slowly pull up on the emergency brake, continuing to apply regular brake pressure, until you come to a complete stop.

Controlling Hyperactive Grandchildren

Have a breath-holding contest. Encourage the children to take slow, deep breaths—in through the nose and out through the mouth—as they prepare for the contest. Have them do this for several minutes. Dim the lights or close the curtains. Run your hand through their hair or give them a light massage on the shoulders as they are practicing their breathing. If they are still hyper after the contest, take them outside and hold a sprinting contest until you've worn them out.

Filling Time During Retirement

Rediscover your childhood hobbies. If you liked playing baseball, start following your local team and keeping an official scorecard. If you always wanted to be an astronaut, buy a good telescope and track the configurations and movement of the stars and planets. Discover new, ongoing activities that can be creatively or emotionally rewarding, such as gardening, artistic activities, or volunteer work.

Getting Your Kids to Take You In

Prove to your kids that you will remain independent and autonomous. Offer to cook meals, babysit, help clean, and do laundry when you're around; travel as much as possible to stay out of their hair. Suggest gently that you aren't looking for a place to spend the rest of your years, but a home base for

when you're between exotic trips.

Selecting Retirement Home

Choose a place you find comfortably challenging, either physically or mentally, to keep yourself spry. Spend time at each prospective residence, talking to the residents, to get a real sense of how it operates and what the general vibe is. Ask if you can spend a night there to see how things really work. Avoid any place whose primary "recreation" is the TV lounge.

Planning Your Funeral

Shop around. Think about what you've liked and disliked at funerals you've attended. Make a list of the things that are important to you. Do you want to be buried or cremated? Do you want music played? Are there any specific words or poems you want read? Then record your decisions for your family. You are the only one who knows if you have a preference between the tiki or cherry caskets; express yourself now, while you still can.

SINGLE LIFE

Hot Tub Rash

Use an over-the-counter anti-itching ointment such as hydrocortisone. Allow the rash to breathe and dry up; do not seal it with a dressing. Do not go back into a public hot tub or pool—or share clothes or towels—until the rash has healed and disappeared, as you will remain contagious until it goes away. Always shower with soap after hot-tubbing.

Ticklish When Making Out

Slow your movements and maintain solid rather than brushing contact so that your partner will mimic your approach. Move your partner's hands to her sides or lap.

Sweaty Palms

Spread talcum powder or cornstarch over your palms before going out. Bring along two folded-up handkerchiefs with additional powder, keeping one in each jacket or pants pocket. When you feel your hands dampen, put them in your pockets and grab hold of the hankies with a quick, fist-clenching motion, as if you're searching for loose change or your keys. If the problem persists, use a special, unscented palm-and-heel antiperspirant.

CAUGHT IN MOSH PIT AT CONCERT



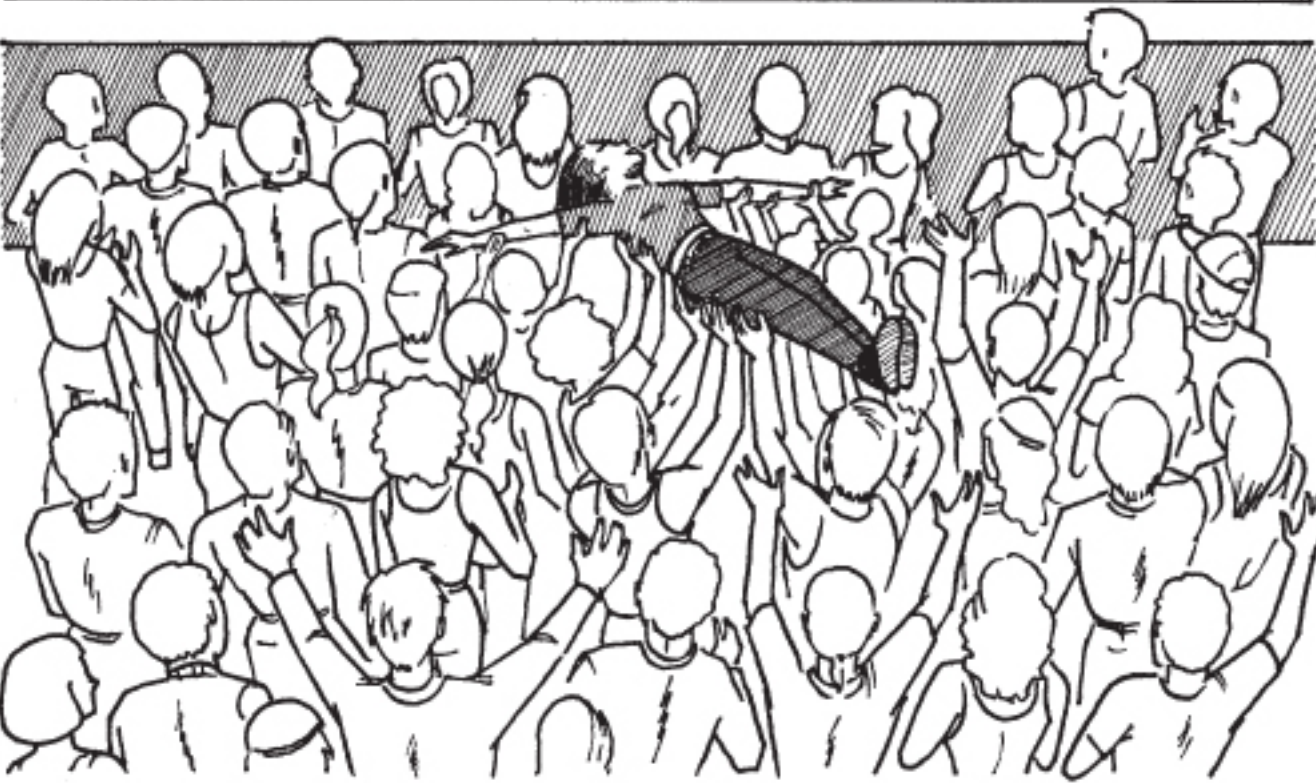

Go limp if you have been hoisted aloft. Keep your arms outstretched. You will likely be deposited on your feet once the song or set ends. If standing in the pit, keep your arms in front of your chest, bent slightly, palms out, to give yourself a breathing cushion.

Date Stands You Up

Remain upbeat and confident, bantering in a humorously self-effacing manner with the bartenders and/

or waitstaff. If you are in a bar, take a seat at the counter and chat with fellow patrons. If you are at a restaurant, look to see if there are any other single diners who seem interesting to you. If so, casually approach them and ask if they would enjoy some company.

Date Won't Stop Talking about Ex

If you still consider the date a prospective partner, announce that from now on, you will respond to any mention of the ex with a statement about a subject that does not interest her (e.g.: “I really never felt like Bob could open up around me.” “When you add an air-ram to a '68 Charger you can make 25 more horsepower, but you have to swap the exhaust or you'll blow a seal”). If you no longer consider the date a prospect, say that your cellphone just rang in vibrate mode and “take a call” from your brother/sister/cousin, whose boy-/girlfriend has just walked out. Explain that you are urgently needed elsewhere.

Date Leaves with Someone Else

Revel in the fact that you have just been spared anywhere from 3 to 12 months of heartbreak, regret, and self-loathing. Approach sympathetic-looking singles in your vicinity to make the best of the situation.

Date Always Expects You to Pay

Make reservations at a fine restaurant, let your date order whatever he would like, and then order the smallest, most inexpensive appetizer you can find on the menu for yourself. If your date asks you why you made such a small order, explain that you want him to enjoy a fine meal, but that you can only afford to pay for one dinner. If your date relents and offers to pay his half, order your entrée and enjoy the rest of your experience; if your date doesn't try to make amends, tell him you have to go to the bathroom, leave the premises, and don't look back.

Date Wearing Too Much Perfume/Cologne

Dampen a cloth or napkin and tell your date she has a little dirt on her neck. Use the napkin to wipe as much of the offending perfume/cologne as possible. If the strong scent remains, or if the odor is coming from the wrist area, try to take the date somewhere frigid, like a chilly movie theater or a slow walk outdoors at night. Perfume is intensified by heat, so making the body colder will help to reduce the power of the fragrance.

SKIING

Collision with Another Skier

Wait until you come to a stop, lie still, and assess your injuries before moving. Wiggle your toes and fingers, hands and feet, arms and legs, making sure everything works before log-rolling back into a sitting position. Assess the condition of the other skier and take action as necessary.

Stuck on Lift

Zip up your coat, pull your hood down, bundle up, and sit close to your companion to share body heat. Do not attempt to jump off the lift even if it seems relatively close to the ground, or you risk injury from landing on unknown terrain or objects beneath the snow. Stay on the lift until it either goes back in motion or a rescuer arrives.

Frostbite

Get indoors and remove all wet clothing. Immerse the affected body parts in lukewarm water until the sensation gradually returns. Do not use hot water, as your skin will be numb to burning. Put on dry clothing layers and drink a warm beverage. Apply sterile dressing and warm compresses to the area, taking care not to rub against your skin.

Avalanche

Face down the mountain and use a freestyle swimming motion to stay atop the cascading snow as best you can. If you are buried, keep your arms and hands over your face to maintain a breathing space. Move your limbs and attempt to free your head of debris immediately after the avalanche stops coming and before the snow starts to pack down.

Skiing on One Ski

Hang your free leg over toward the remaining ski to keep your center of balance. Stay on your edges to control your speed and direction.

Snowblindness

Go indoors immediately. Rinse your eyes with cool, disinfected water. Apply cold compresses and cover your eyes for 24 hours. Cut small slits in gauze, place over your eyes, and cover with dark sunglasses to limit light entering your eyes if you cannot keep them completely covered.

Hypothermia

Warm yourself gradually by adding layers of breathable clothing such as wool and/or moisture-wicking fabrics. Increase your physical activity and take in warm liquids and high-sugar and carbohydrate foods. If you have a partner, utilize body-to-body contact to warm up. Avoid alcohol, caffeine, and tobacco, and wear only dry clothes.

SKIN

Bad Botox Injection

Get an additional injection in the lateral fibers of the forehead to counteract inadvertently sad (fallen brow) or quizzical (brow pulled upward) expressions. Reaction symptoms include weakness, nausea, fatigue, flu-like reactions, and rashes, most of which will pass without treatment within several days. Remain upright for 3 to 4 hours following injections to help reduce complications from the toxin spreading to muscle tissue not intended to receive it.

Too Much Collagen

Fill a plastic bag with ice, wrap the bag with a thin cloth, and hold it at the injection site to reduce excessive puffiness and swelling. Leave in place for 10 to 15 minutes, then remove. Do not apply ice directly to skin. Bruising and dots at the injection site will disappear without treatment in about a week.

Frostbite

Thaw frozen digits in lukewarm—not hot—water only if there is no chance of refreezing, which can cause severe tissue damage. Apply sterile dressing to the affected areas. If available, take over-the-counter pain medication to treat the burning sensation that accompanies thawing. Do not rub frostbitten skin directly or rub with snow. Avoid applying direct heat.

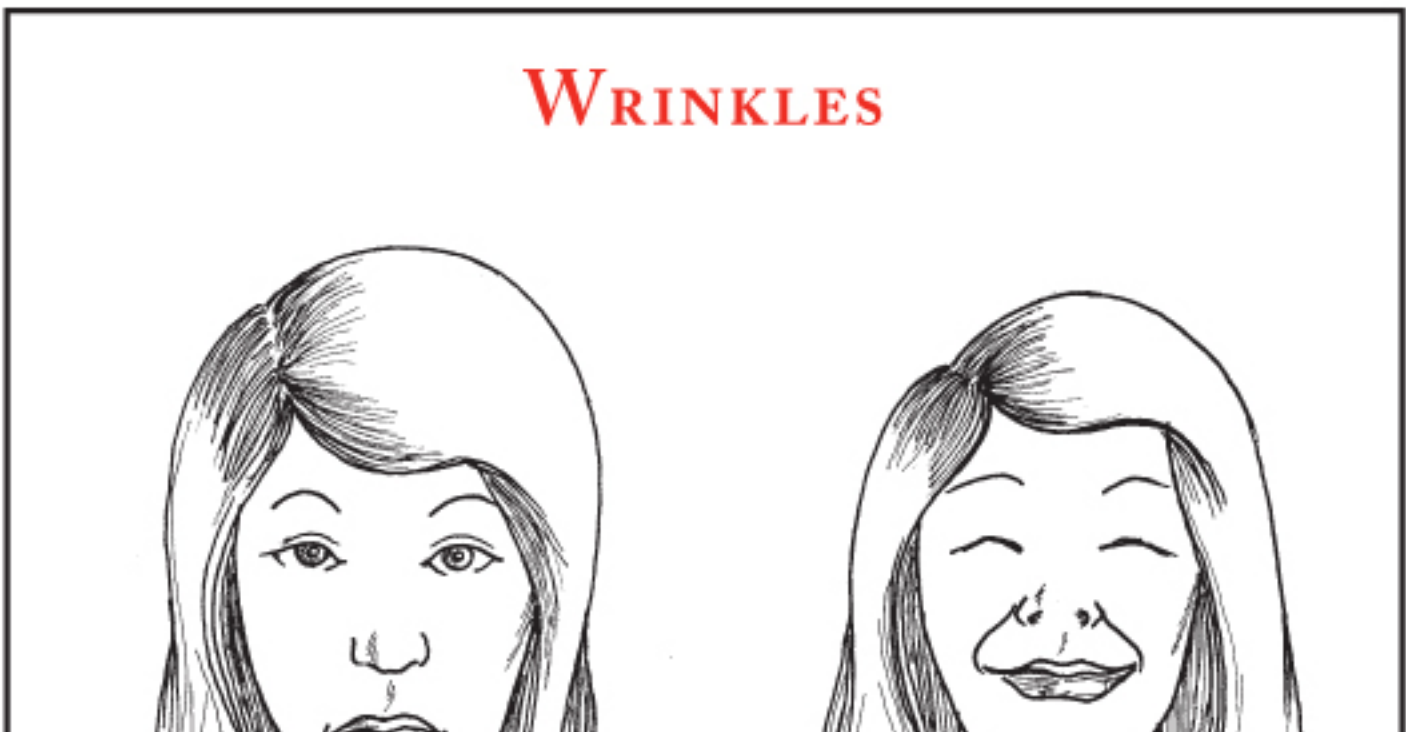



To prevent wrinkles in forehead and around eyes



To strengthen mouth muscles and prevent laugh lines



To mold chin and prevent wrinkles around mouth



To relieve tension created by previous exercise

Repeat this sequence of facial expressions for 5 minutes twice daily to help prevent wrinkles.

Scrub problem areas with a washcloth soaked in rubbing alcohol. Apply a layer of moisturizing lotion to counteract drying of skin from alcohol, then reapply the tanner.

Uneven Tan Lines

Dust the skin with a powdered bronzer, using a large makeup brush for even application.

Razor Burn

Apply hydrocortisone cream to treat irritation, but not more than twice a week or you risk thinning the skin. Avoid aftershaves and colognes that contain alcohol, which will dry the skin. To prevent razor burn, do not shave for at least 20 minutes after waking up to allow fluids that swell the surface of the skin while you're asleep to disperse; your skin will tighten, exposing more of the hair and allowing a better shave. Wet your hair for several minutes to soften it before shaving.

SNAKES/REPTILES

Lost in Air Ducts

Turn off heating/cooling system. Position a fan at a vent and blow cool room air into the duct. Position a hair dryer at a duct in another location and blow warm air into that duct. The snake should move away from the direction of the cool air and seek the warmed air. Be ready to grab the snake when it approaches the hair dryer.

Salmonella

Stay hydrated. Salmonella generally passes without treatment in 5 to 7 days. Wash your hands with soap and warm water thoroughly after handling the snake or any objects in its cage. The snake is more likely to harbor the bacteria in its intestine without displaying symptoms than to become sick.

Hypothermia

Place a heating pad at a low setting in the snake's cage. Fold a medium-size hand towel over the pad, then put your hand on the towel. If you cannot leave your hand in place for several minutes, the heating pad is too hot; turn it down and try again. Once the heat level is correct, place the snake on the towel.

DEPRESSION

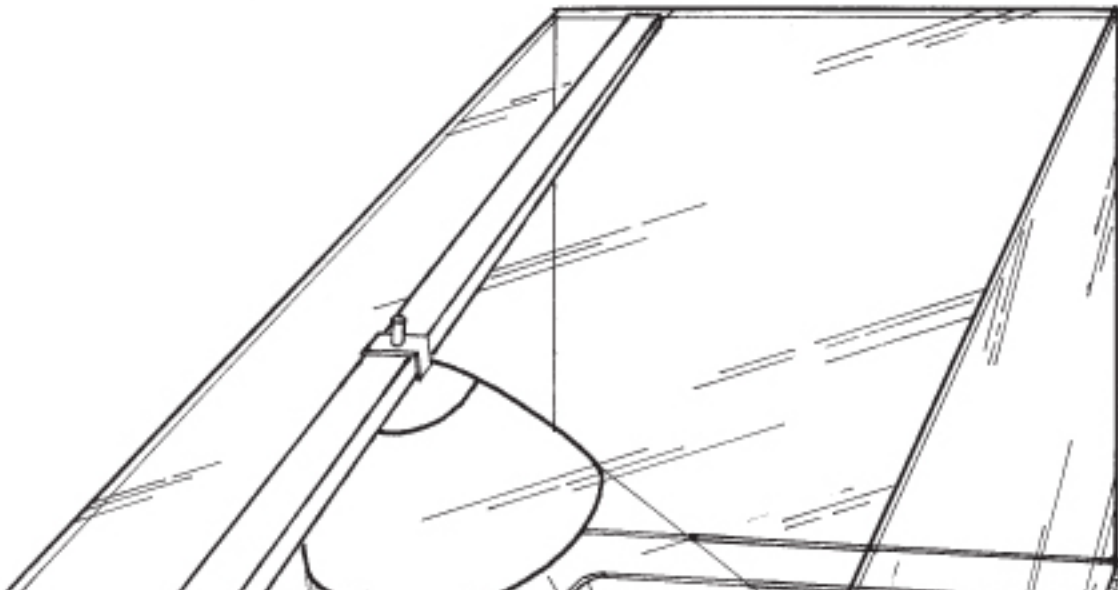

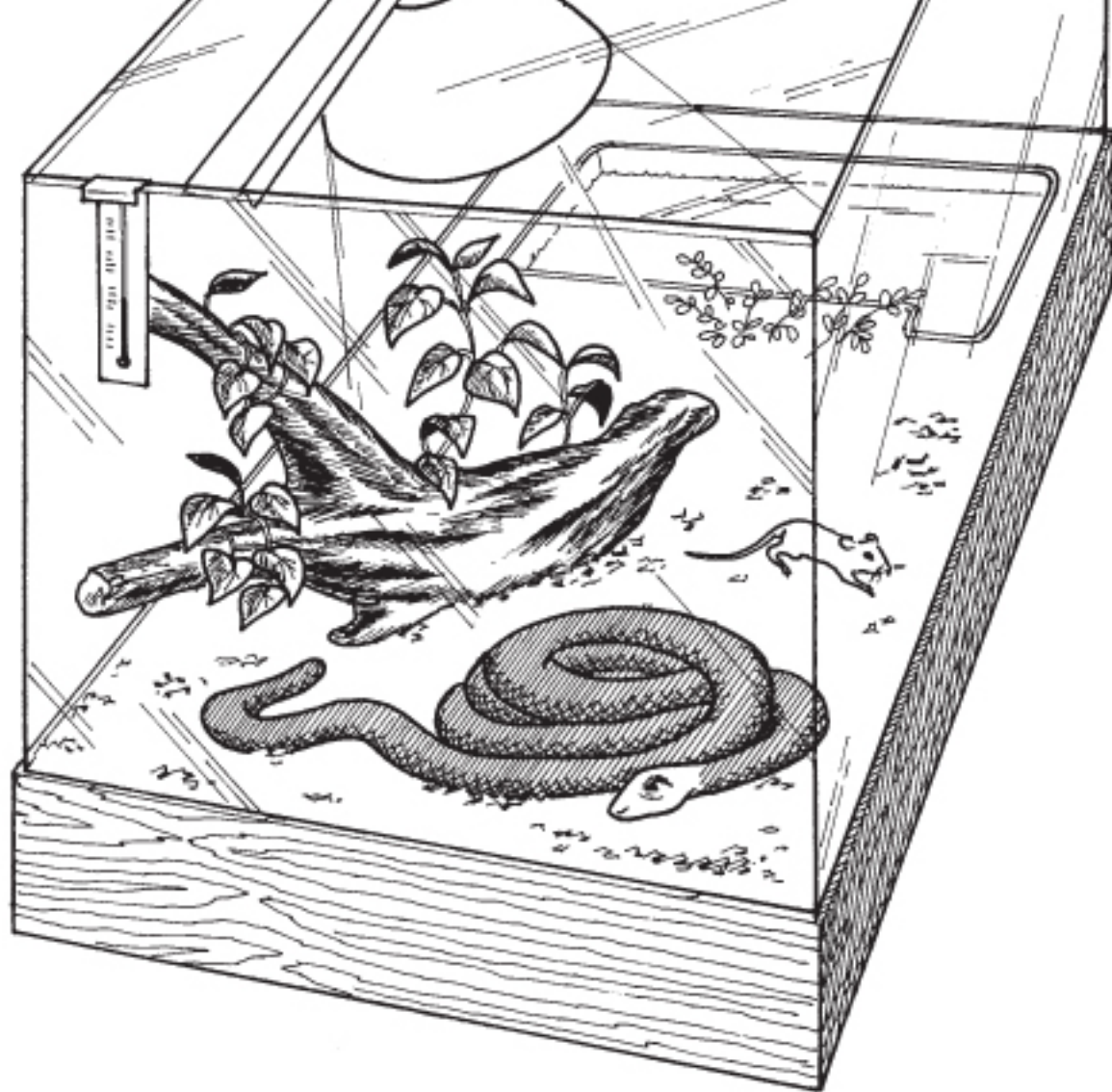

Increase the size of the cage so the snake can stretch out. Introduce objects that the snake can use as vertical climbing aids. Add a larger water container in which the snake can immerse itself, and make sure the cage is warm enough (80° to 85°F during the day, 70° to 75°F at night). If the snake refuses to feed, try offering a live food item (or a dead one, if the snake has refused live prey).

SOCCER

Soccer Hooligans in Stands

Hide or remove any clothing with clear team affiliation. Blend in with exclamations of noncommittal enthusiasm (“Yeah!” “Wooooo!”) and make your way slowly—to the bathroom if anyone asks—away from the rowdy section to safer ground from which to watch the match.

Evading a Slide Tackle

Maintain forward momentum and tap the ball slightly in the direction opposite and forward of the approach of the defending player’s slide. Extend your stride to hop clear of the tackle, stepping forward to retrieve the ball, which will have also kept your momentum.

Blocking a Penalty Kick

Ignore the kicker and focus on the ball itself. With the ball only 13 yards away, you will not be able to react after the ball is kicked. Time your lunge for the moment the ball leaves the kicker’s foot, making an educated guess based on the first split-second’s motion as to which side of the net to jump for. Extend your body horizontally across the face of the goal with arms outstretched, covering as much space as possible. Remember: The expectation is for a goal to be scored; if you are able to block the kick, you have performed a minor miracle.

Confronting a Referee

Maintain a respectful tone and make your point as clear-cut and as unemotionally as you can. Do not touch, closely approach, or threaten the ref. If you are having difficulty with a particular player, gently point out to the referee that the player needs to be watched closely.

Making a Header

Move into the ball’s line of flight. Bend your knees and arch your back. Tense your neck muscles and contact the ball with your forehead at a point directly over your eyebrows.

SPELUNKING

Headlamp Goes Out

Wait for as long as you are able to allow your eyes to adjust to the darkness (it can take as long as an hour for eyes to fully adjust from bright light to darkness). As you wait, visualize the features and path you have just traversed as far back as you can recall. Then retrace your steps carefully, moving slowly and with sure footing, using touch-contact with walls and other features you remember in the cave. Move toward light and circulating air. If you are carrying a cell phone or watch, use their glowing faces to offer some illumination.

Touching Something Furry

Back away slowly. Chances are that the creature you have touched is a hibernating bear. Quietly and carefully backtrack your way through the cave. If you hear noises of the bear(s) starting to wake up, turn and run until you are out of the cave and a good distance away.

Stuck in Narrow Passage

Slowly exhale to push all the air out of your body, then wiggle back and forth to squeeze your way through the passage. Dig and scrape at the walls of the passage to yield extra room, and strip off clothing and equipment that may be adding to your girth.

Pinned Under Fallen Rock

Dig at the edges of the rock with any available implement to break the wedge and shift the rock's weight. Use objects such as smaller rocks or sticks to brace the rock away from you. Ration resources and conserve your body heat. Remain calm and control your breathing. Send a companion for help, or, if alone, call out at intervals until rescuers arrive to investigate your disappearance. Always report your plans and expected time of return to others before embarking on an exploration.

STAINS ON CARPET

Red Wine

Blot wine with an absorbent cloth. Saturate the stain with club soda or cold water, blotting until no more wine transfers to the cloth. If the stain remains, apply a paste of borax or baking soda and water (at a ratio of 3 to 1). Smear paste onto stain with an old toothbrush and let dry. Vacuum, then repeat until no more stain can be removed.

Bleach

Sponge the stain immediately with cold water to remove as much acid as possible. Mix baking soda and water to make a paste (at a ratio of 3 to 1) and rub onto the stain. Scrub into carpet with an old toothbrush, then let dry. Vacuum, then repeat until no more stain can be removed.

Grease, Motor Oil

Use a dull knife or spoon to remove as much as possible. Blot remaining liquid with an absorbent cloth. Work shaving cream into the carpet with an old toothbrush. Wipe it off with a damp cloth, then sponge with cold water. If the stain remains, apply dry-cleaning fluid (be careful not to wet the carpet backing with it), then sponge the stain with a damp cloth.

Blood

Use a dull knife or spoon to remove as much as possible. Blot remaining liquid with an absorbent cloth. Sponge the stain with a sudsy mixture of liquid laundry enzyme detergent and cold water, then sponge with cold, clean water. If the stain remains, sponge with a mild bleach such as lemon juice or hydrogen peroxide (do not let it saturate the carpet), then sponge with cold clean water. Repeat as needed.

SUPERMARKET CLERK

Unattended Child Run Amok

Approach the child and ask if his name is John (or Jake or Jimmy—the name doesn't matter). Once the child corrects you with his name, say “Oh, that's it. I heard someone calling for [child's name] over in the produce aisle.” Ask the child who he is with and offer to help find them. When located, politely ask the adult to keep watch over the child.

Bulk-Bin Nibblers

Improvise a task that will keep you proximate to the bulk bins—rearrange cereal boxes front to back, then back to front again. The total average time shoppers spend in a supermarket is about 15 minutes (including checkout time), so you will not need to discourage nibbling with your presence for long before the nibbler's internal shopping clock urges him to move along.

Express-Line Cheat

Check the customer through the line to avoid the confrontation of turning him away to another more appropriate line. As you are ringing up the items, mention that the line has a limit to the number of items and that while you are ringing him through this once, you and the customers who are also waiting in line will appreciate his abiding by the rules in the future.

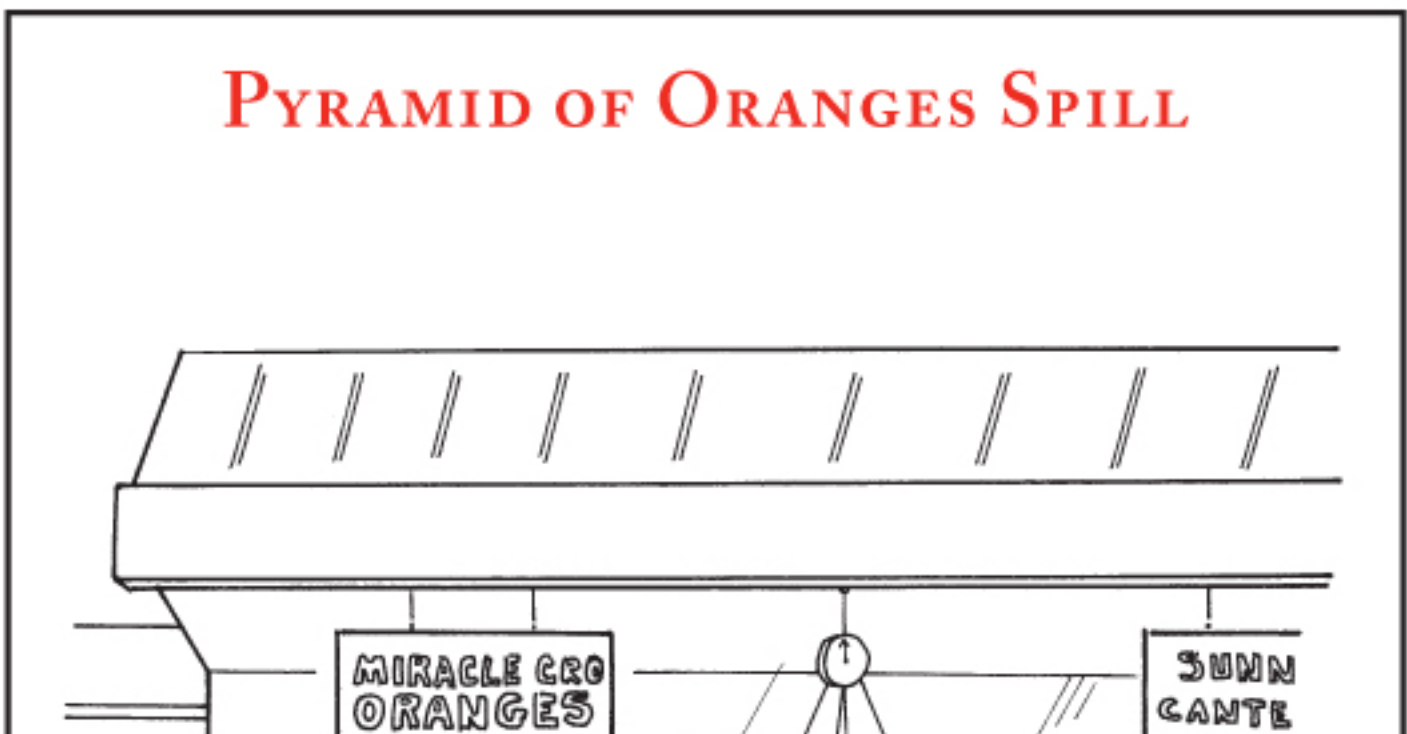



Dive to the floor. Cover as much horizontal ground with your body as you can to prevent oranges from rolling away to far corners of the store. Do not try to control the spill from the top of the display. The pyramid structure as devised in ancient Egypt is inherently stable and will naturally limit the fruit slide.

Spread the pennies out flat on the counter. Place the five fingertips of one hand on the surface of five pennies near the edge of the counter and sweep them in to your other hand and count “five” aloud. Repeat until all pennies have been counted, emptying the noncounting hand into your drawer after every 2 dollars’ worth of coins.

Paper Bag Tear

Grab as much of the top edge of the bag lip as possible with your free hand. Set the bag quickly onto the ground, cart bed, or bagging shelf. Open two more shopping bags, one inside the other, aligning the handles, and set it alongside the torn bag. Lifting from the bottom, raise the torn bag with its contents and ease it into the double bag. Heavy duty 70# weight paper gusset (pleated) grocery bags measuring a standard 12" x 7" x 14" can bear a load of 15 pounds if packed evenly and carried gingerly, but you should double-bag if you estimate the load to be more than 10 pounds to protect against torsion as the customer carries it by the handles.

SURFING

Shark Nearby

Limit your movement to smooth, easy motions. Paddle calmly but immediately back to shore, limiting your splashing to an absolute minimum. Keep sight of the shark at all times. Alert other surfers in the area to the shark's presence.

Battling Territorial Surfers

Wait your turn. Be patient and low-key. Do not drop in on another surfer or cut in on a wave. Surf secondary rather than main peaks. Be deferential without being clueless—competency breeds respect and acceptance.

Wipeout

Let the wave spin you until released—do not try to fight the wave. If you are pushed far under, find the surface by following your leash to your board above.

Unconscious Surfer

Keep the surfer afloat on your board and keep her airway open. Elevate her head as much as possible and paddle back in immediately. Get to the stable environment of shore before attempting to administer CPR.

SWIMMING

Swimmer's Ear

Carefully clean the ear canal and apply antibacterial eardrops or boric acid. In severe cases, you may put the drops on a small sponge and place the sponge in your ear canal to keep the medicine in place.

Green Hair

Wet your hair before swimming and work some conditioner into it. Slip on a tight swimming cap to keep your hair from coming in contact with the water, whose hard metals (copper and iron, for example) cause the color change. For already-green locks, use a chelating shampoo specially formulated for your condition.

Water Up Nose

Take a deep breath in through your mouth, then lower your head back under water and blow sharply through your nostrils. Raise your head above the water and repeat.

Swimsuit Lost in Turnaround

Calmly finish your lane and return. As you reapproach your suit, act surprised. This will demonstrate your dedication and intensity, which will stay with people longer than your direct embarrassment.

Swimmer in Other Lane Splashing

Time your lanes so that you go out when the offending party has reached the opposite side of the pool, allowing you to minimize your interaction. If the problem persists, pretend to have a coughing attack in her direction as you swim past.

Leg Cramp

Immediately flip over onto your back. Lift the cramping leg out of the water, rubbing it with one hand

while your other hand works to stabilize your position. If you are out in a lake, begin paddling back to shore in this position, remaining face up.

Surviving a “Polar Bear” Swim

Work up your adrenaline by yelling and screaming loudly before plunging into the icy water.

Bring an old blanket to sit on so your suit doesn't freeze to the ground. Wear aqua socks or something similar on your feet to avoid being cut by ice, and bring extra warm socks and layers of dry clothes for when you emerge from the water. Bring a thermos of a hot liquid to drink in case you get the chills.

TARANTULAS

Bites

Apply ice or a solution of meat tenderizer and water soaked into a cotton ball to the bite area. Tarantula bites are very weakly poisonous and generally do not induce a reaction.

Kicking Hair

Remove the hairs using a tweezers if they penetrate the skin. Treat with a local antibiotic and an anti-itch cream. Tarantulas sometimes kick barbed hairs from their abdomens as a natural defense mechanism.

Broken Leg

Do not attempt to set or treat a broken leg. The tarantula will shed the leg at the next molt and replace it with a new one.

Won't Eat

Use a heating lamp to ensure the cage is a constant 75° to 85°F. Make sure the water dish is full. A large tarantula can go weeks without eating before it molts, but it needs sufficient water to survive. Tarantulas that are not molting will sometimes not eat if they are too cool. Remove any leftover food bits from the cage to reduce the presence of mold.

TATTOOS

Infection

Have the tattoo examined by a doctor right away. A tattoo infection should be considered a serious medical emergency—it may be minor, or it could be something as serious as hepatitis or HIV. To reduce the risk of infection, make sure the tattoo parlor appears clean, sterilizes all equipment, has sinks with hot water and soap in the bathrooms as well as the studio, and that the staff wears latex gloves. If the shop uses disposable needles, ask the tattoo artist to remove the needles from sealed, sterile packaging while you watch.

Pain While Being Tattooed

Choose a fleshy area with some muscle tone—such as a bicep or the back of a calf—where tattooing is less painful. Avoid tattooing areas where skin is close to the bone, such as the wrists or ankles, knees, or along the spine or skull. Choose a simple tattoo that's mostly outline, with very little fill. Do not take pain medications or drink alcohol before the tattooing procedure to avoid thinning the blood, which can cause excessive bleeding and potentially alter the look of the tattoo. Wear headphones, chew gum, or bite a pencil to manage pain, or decide to enjoy it.

DISGUISE EX'S NAME WITH NEW TATTOO

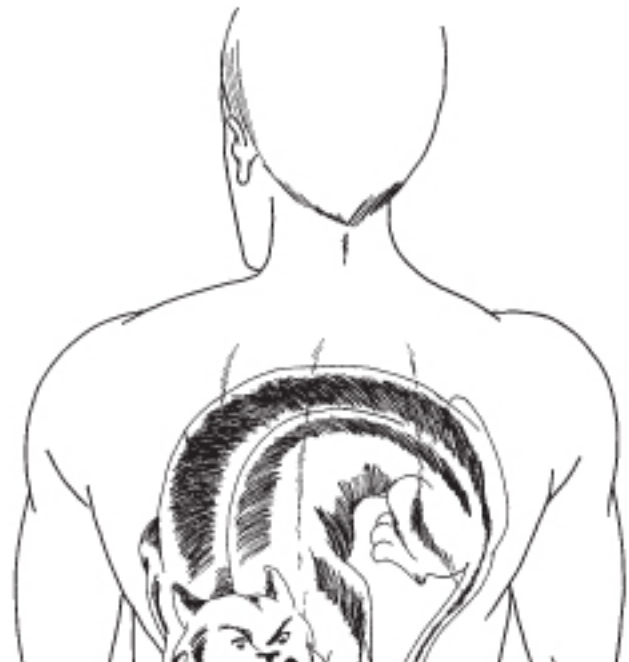
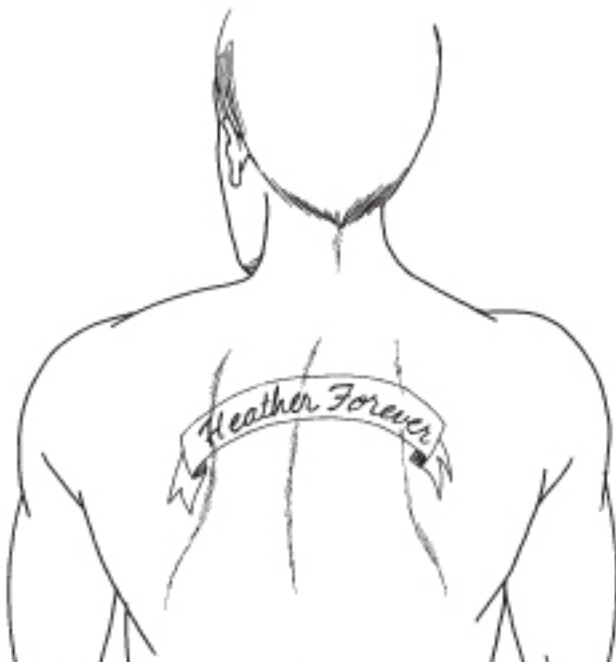



Cover with a more elaborate tattoo in darker ink. Incorporate some of the lines of the original tattoo.

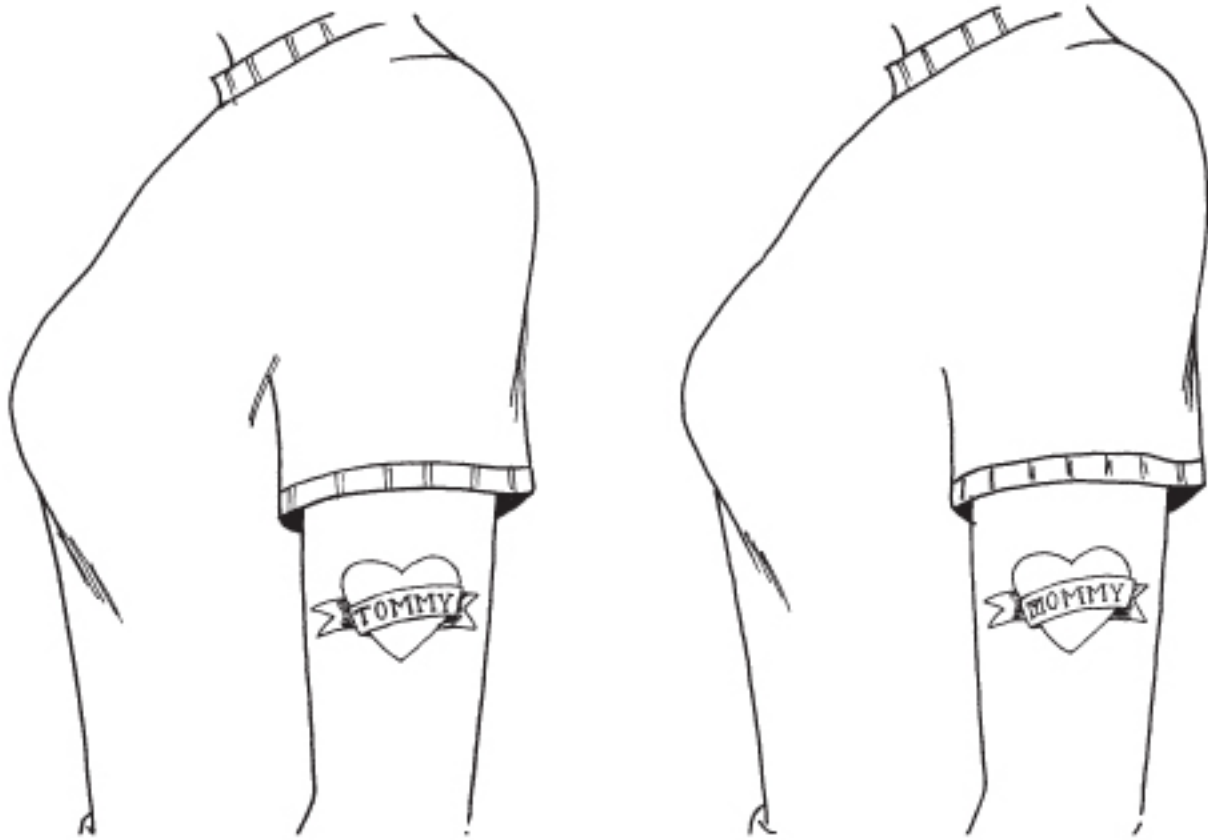

Alter the name to express more enduring sentiments.

TEENAGER

Friend Copies Your Style/Look

Perform a reverse retail fakeout. A friend who bites your style is likely to try to do so again. Offer to go shopping together, express interest in a tragic new style that you actually have no intention of ever wearing, regretting that you can't afford the new look just yet. Cite evidence from TV or in magazines of fools sporting the look and wait for the friend to take the bait.

Friend Steals Boyfriend/Girlfriend

Hint that your former flame had a recurring STD, so it's just as well that you are no longer an item. In the meantime, find someone your former friend had a thing for and do everything in your power to make him fall for you.

Meeting Date's Parents

Make direct eye contact. Speak clearly and refer to them as "Mr." and "Mrs." unless they ask you to do otherwise. Do not perform any complicated handshake unless initiated by the parent—a brief, firm shake with direct eye contact is sufficient—and do not hug or kiss parents unless they make the first move. Keep a distance of 3 feet. Turn off your mobile phone or pager before the introduction. Pet the family dog or cat. Let your date determine the exit strategy beforehand and follow her lead.

CAUGHT PASSING A NOTE IN CLASS

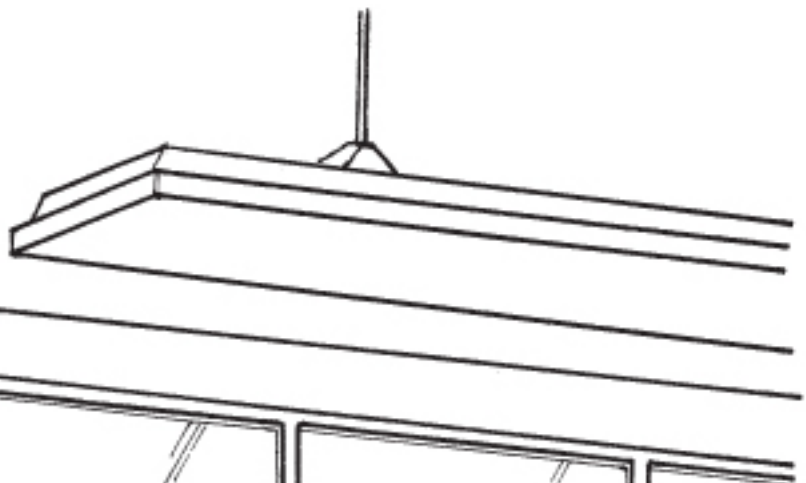

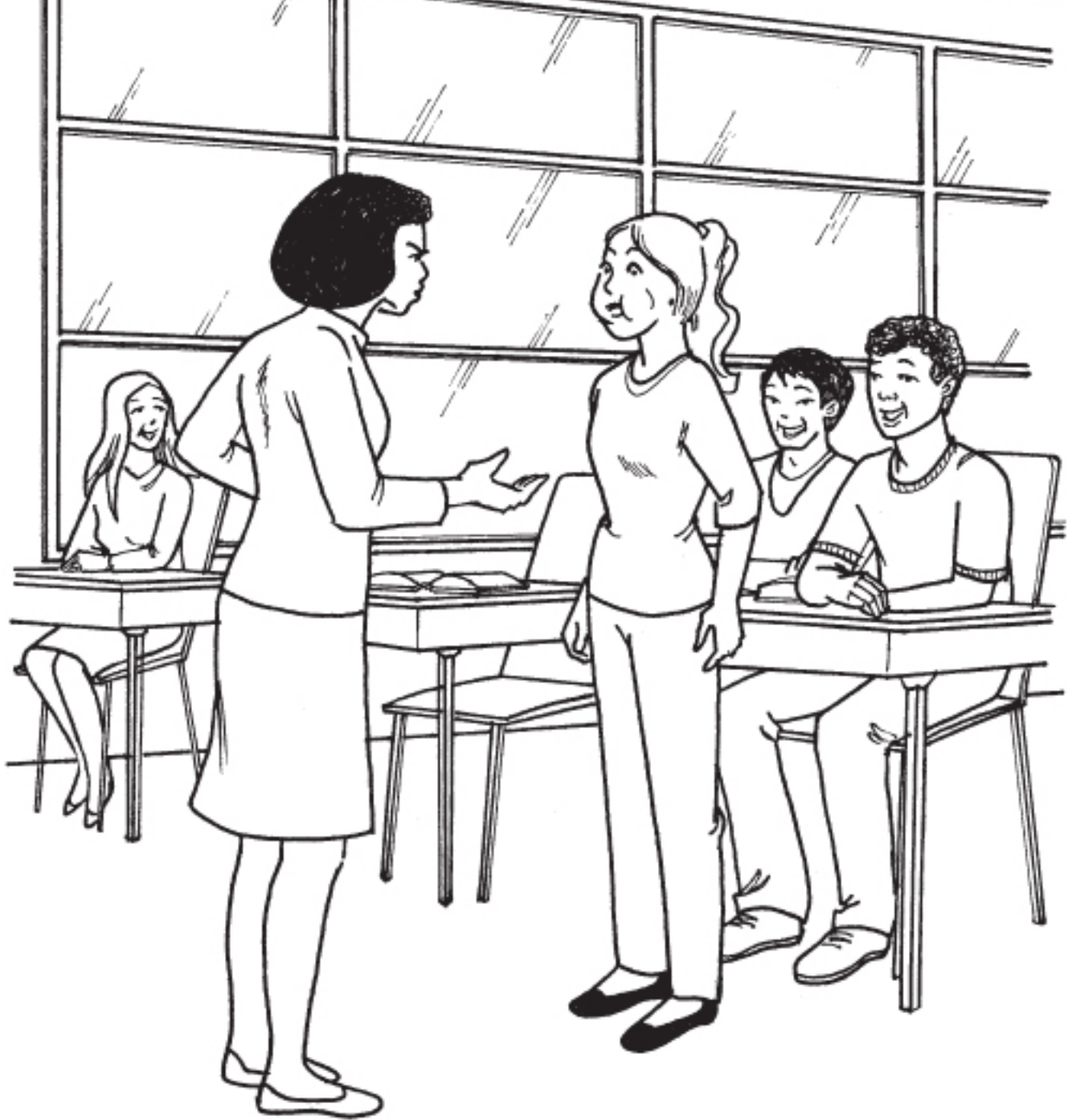

Swallow the note immediately. Do not give the teacher a chance to grab it and read it out loud. You are already in trouble for passing a note—there is no point in adding the humiliation of having it read to the class.

Cite greater independence granted to brothers, sisters, cousins, friends, and other kids in the neighborhood, on television, in movies, and literature as examples of the right and just state of personal freedom. Cut deals for incremental increases in independence in order to build trust. Ask for a one-time curfew extension of 15 or 20 minutes and come home within the limit before later asking to stay out an extra hour. Take it in small steps and they won't realize how far you've gotten until your new liberty has become the norm.

Embarrassing Parents

Limit the amount of time that you are publicly associated with your parents. Concede family time at a dimly lit, out-of-the-way restaurant your friends would never visit. When walking together in public, keep a few steps ahead of or behind your parents. If classmates are approaching, duck into a nearby shop. Exit after friends have passed.

No Driver's License

Explain that you'd rather not drive. Say that learning to drive is a waste of time since you will soon be moving to a big city with great public transportation. Explain that you are just doing your part for the environment, as it's better to walk, bike, and carpool. Meanwhile, do favors for or outright bribe multiple friends with drivers' licenses to be sure you have wheels whenever you need a lift.

No One to Dance with at Prom

Start a conga line. After that's finished, you should be flushed and sweaty as if you'd really been dancing for a while and you can take your seat without looking like you're being aloof.

Mono

Gargle with a warm saltwater solution 5 times each day to relieve your sore throat, and take ibuprofen or acetaminophen for achiness and fever. Avoid strenuous exercise, lifting heavy objects, or contact sports; get a lot of bed rest, especially when first diagnosed; and drink plenty of fluids. Do not share a glass, kiss, or otherwise share your saliva with anyone until you have fully recovered, possibly in 2 to 3 months. Symptoms of mononucleosis include sore throat, achiness, fever, fatigue, sensitivity to light, enlarged spleen and liver, and swollen glands in the neck, armpit, and groin. If you have mono and you feel a severe, sharp pain on the left side of your upper abdomen, seek emergency medical care immediately, as your spleen may have ruptured.

Stuck in Locker

Peer through the air vents and wait for a teacher to walk past, then knock and kick the door to get his attention. Ask him to fetch the janitor to open the lock. To entertain yourself as you wait, yell “Boo!” each time a student passes to see how many people you can freak out.

TEENAGER

Out All Night

Take the rest of the family out to breakfast so your teen comes home to an absolutely empty house. Spend the day having fun, shopping at the mall, going to an amusement park, watching movies. Come home late in the day and act like absolutely nothing happened. If they ask you where you were, snicker as if you have secret information.

Brings Home "Study Buddy"

Ask the pair what subject they plan to study. Express tremendous interest, saying that you always wanted to know more about it. Ask politely if they would mind if you sat in at the beginning, just to learn a bit. After you've established your presence in the room by asking a ton of questions, excuse yourself from their company. Return every half hour or so to seek clarification and ask additional questions.

Asks to Borrow Car

Determine what car-dependent errands you can entrust to your teen and hand him a checklist of the errands (shopping list, dry-cleaning pickup, car wash or maintenance service) along with the keys. If he accepts, count yourself lucky and maintain a short list of errands always at the ready for when he next needs wheels. If he refuses, you will have succeeded in keeping the car safely at home.

Listens to Disturbing Music

Borrow a couple of CDs from your teen for your morning commute. Listen to the CDs, then come home and tell your child you like the bands and want to hear more from them. Talk about how you can relate to the lyrics. Learn a few bars and sing them off-key. Suggest that the two of you go to concerts together. Your teen will either change his musical tastes immediately or you'll have something in common to talk about.

Wears Disturbing Clothing

Emulate your teen's style of dress the next time you go out as a family. Tell her you think the look is "fly."

Buy multiple, battery-powered alarm clocks, set them to the time you would like the teen to wake up (plus or minus a minute), and hide them in various places in the teen's room without her knowledge. Be sure that none are within reach of the bed. Call your teen's mobile phone. Bounce a tennis ball off her car to set off its alarm. Repeat for several weeks or as necessary until she has adapted to her early schedule.

TENNIS

Broken Racket

Play out the point with broken strings; you have no other option. As soon as the point is concluded, you may change your racket. If the breakage occurs during a first serve that is out, you may change your racket, but the server will get her first service to do over.

Court Has No Net

Affix a thin laundry line, string, or a combination of any available extension cords, shoelaces, jacket sleeves, or plastic shopping bags tied end to end to the court posts. Treat all balls that go under the rope as net points. If available, hang sheets, towels, or jackets over the line to form a wall. Alternatively, set a row of deck chairs along the net line and play over them.

Tennis Elbow

Stretch your forearm by extending your arm in front of you, bending your wrist down, and pulling your hanging fingers toward your chest with your other hand. If you can't give resistance without pain, you should stop playing and apply ice to the injured area for 10 minutes.

TREATING AN INJURED BALL BOY



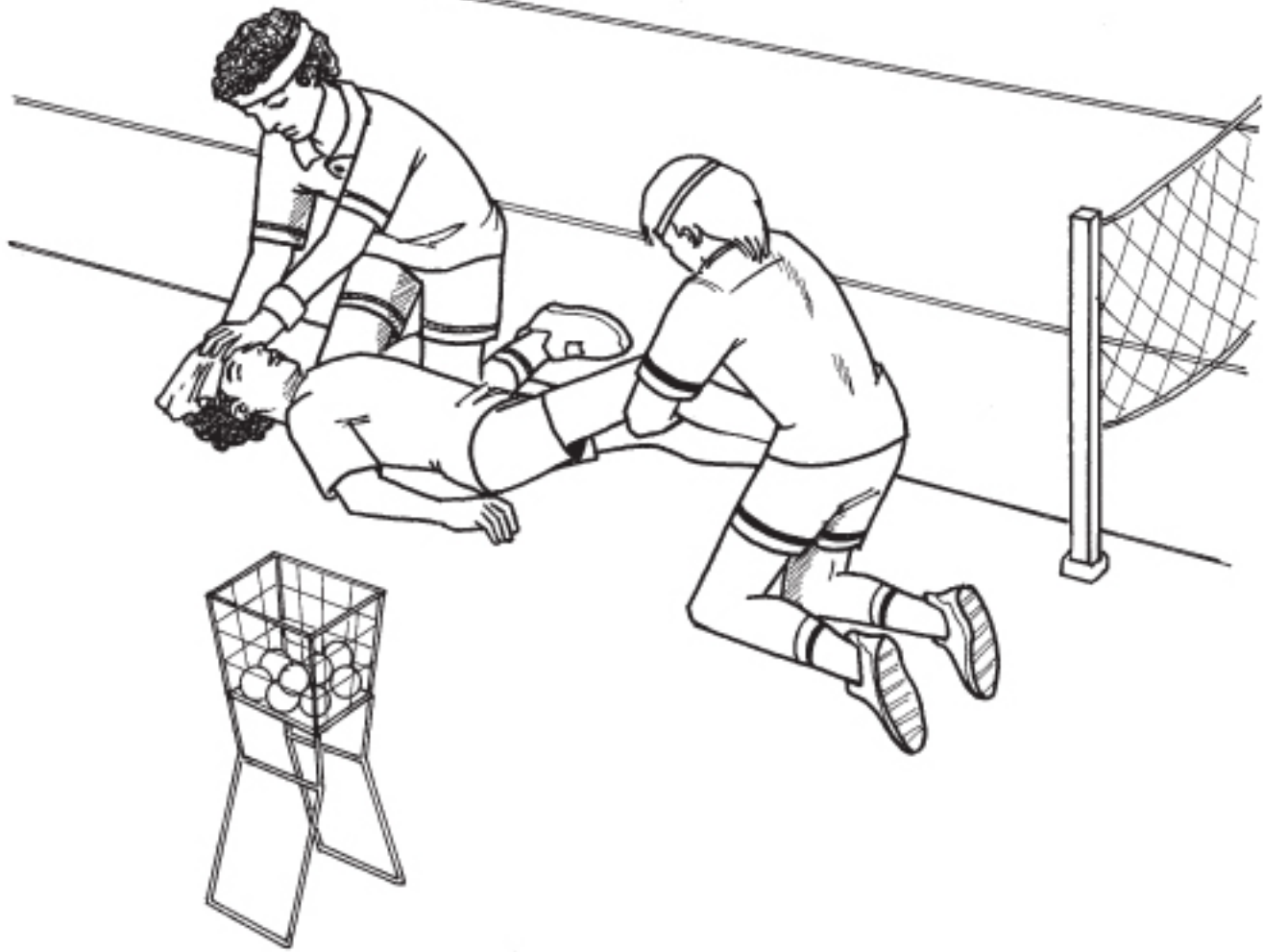

Elevate twisted ankles or wrists. Apply consistent but gentle pressure until medical help arrives.

Overcompetitive Opponent

Slow down. Use much more deliberate actions than usual at every turn to frustrate your opponent off his game. Take frequent water breaks. Check and recheck your racket strings. Ask your opponent friendly

questions about his service and strokes.

Returning 110 MPH Serve

Shorten the length of your return swing, keeping your follow-through to about 18 inches or so. Hit the ball as flat as you can, which will result in a faster return shot and turn incoming speed against the server.

THE GYM

Smelly Gym Shoes

Place a fresh dryer sheet in each shoe. Place each shoe in a sealable freezer bag overnight. The shoes should smell fresh in the morning.

Overbearing Trainer

Feign dry heaves to prove to the trainer that you've pushed yourself to your physical limit. Weakness and shortness of breath may also be effective in getting the trainer to lower his expectations, but these ploys could backfire and result in ever more strenuous attempts to toughen you up.

Trapped Under Barbell

Yell "Spot! Spot!" to get the attention of others who can lift the barbell off of you. If you can move, carefully slide your body so the weight is supported by your hands above your chest, rather than over your head, neck, or abdomen.

Dumbbell Dropped on Toes

Remove the dumbbell from your foot, then carefully remove your shoe and sock. If moving one or more of your toes causes sharp pain, it may be broken; sit down immediately to take weight off the leg. Ice the toe(s) for 15 minutes, then surround with cotton balls and tape to an adjacent toe. Walk slowly and carefully.

OUT-OF-CONTROL TREADMILL

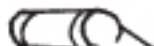

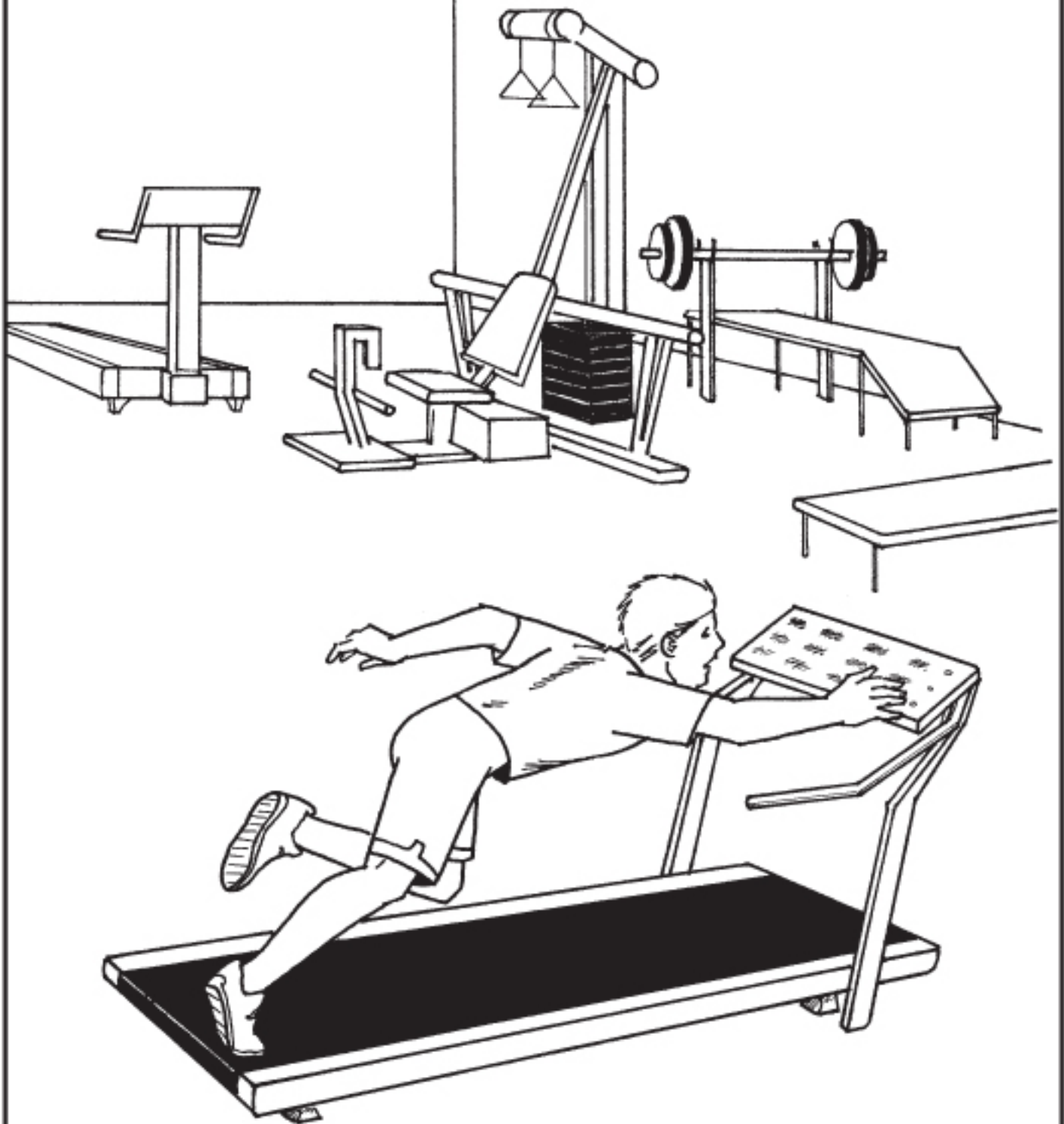

Sprint a step faster and lunge for the “kill switch” or yank the red power “key” from its socket on the control panel. If you cannot reach the control panel, keep pace as best you can and call for help.

Feeling Dizzy on Machine

Stop the machine and your workout immediately. If you are lying down, avoid sitting up too quickly, which may exacerbate lightheadedness. Breathe deeply and exhale slowly until the dizziness passes, then drink a cup of cool water.

Lost in Steam Room

Hold your hand out in front of you and walk until you touch a wall. Maintain contact with the wall and follow it around the room until you reach the door. Call out to other occupants as you move to avoid collision. Alternatively, wait a few moments for the steam level to disperse and quickly exit before more is introduced. Steam is created either by pouring water on heated rocks or channeled in through vents. If you are wearing glasses, remove them.

Avoiding Germs on Machine

Cover machine surfaces with fresh clean towels before touching. Hold folded-over paper towels in each hand before grabbing the machine's handle/bar, or wear gloves. Use a fresh set of towels for each machine. Do not touch your face with your hands until you have washed them thoroughly with soap and water after your workout.

WAITER

Spilled Tray of Food

Apologize profusely if the food landed on a customer and alert the manager; he should make an offer on behalf of the restaurant to pick up the dry cleaning tab. Meals affected by the spilled food should be replaced, and a free dessert offered to any nearby customers.

Table with Messy Baby

Ignore the mess at the table until the family with the baby leaves. If the mess is affecting other diners, offer to reseal them, or use a carpet sweeper or broom/dustpan to clean the area around their table.

Non-Tippers

Ask the customer if there was a problem with the food or the service. Say “Is there something we could have done better to make your meal more enjoyable?”

Table Doesn't Pay

Run after the customers and say they've “forgotten” to pay the check, giving them the benefit of the doubt. If they refuse or run, call the police.

Wrong Order Placed

Cancel the incorrect order, then tell the kitchen you need the new order “on the fly,” or right away.

Slow Kitchen

Apologize to your customers for the delay, but do not make excuses. Offer a round of drinks on the house.

Food Critic Arrives

Do not publicly acknowledge the critic in any way. On your next naturally occurring trip to the kitchen, alert the manager and chef. The manager should alert the other waitstaff as they return to the kitchen. They should be on their best behavior, but also not acknowledge the critic's presence as anything out of the ordinary.

Restaurant Is Mob Front

Stay as far as possible from any card games. Do not "ask permission" to use the toilet.

WALLS

Paint Spill

Scrape the spill area with a spoon or a piece of stiff cardboard to remove as much of the paint as possible. For acrylic paints, soak the area with clean, cold water, then blot with a clean cloth. Repeat until paint is removed. For oil-based paints, remove by blotting with mineral spirits.

Hole in Drywall

Cut the ragged edges of the hole with a matte knife to make a square or rectangular opening. Measure and cut a piece of replacement drywall and fit it into the opening. Affix painter's tape or gauze over the seams on all four sides of the replacement panel, then cover with a thin layer of spackle. Allow to dry. Sand smooth and paint.

Loose Shelf or Fixture

Remove the shelf from the wall. Insert appropriate-sized drywall spreaders or masonry/brick anchors, depending on the wall surface material, into the existing holes. Re-attach the shelf by screwing support screws through the spreaders/anchors fully until they open behind the drywall or spread and grab the masonry/brick.

Crooked Artwork

Place a level on top of the frame. Grasp the frame securely at both sides and shift the painting left to raise the right corner and right to raise the left corner, until the artwork is level. If artwork is hung on a nail or hook without the use of picture wire, remove the artwork from the wall and add a second nail to the left or right at the same level as the existing nail. Rehang the artwork.

Bleeding Walls

Call an exorcist. Wear a cross around your neck. If blood is seeping, don work gloves and wipe affected area with rags soaked in a solution of 1 part holy water to 4 parts tap water. Sprinkle stained areas with holy water. If blood is gushing or beds begin to levitate, vacate the house and do not reenter until the priest arrives.

WINDOWS

Painted Shut

Insert the blade of a putty or matte knife between the window and the sill sides. Move the blade along the edges to cut through the excess paint. Repeat on the other side of the window if it has been painted on both sides. Push the window firmly but carefully outward, then upward to open. If the window is still stuck, gently tap the upper edge of the window frame with a rubber mallet to loosen.

Body Part Stuck through Broken Window

Place a vase, pillow, or thick blanket around the body part, then pull it out of the window. Do not break the remaining glass in order to avoid flying glass shards and further injury.

Curtains Catch Fire

Open the window, tear the curtains off their support rod, and throw them outside, provided it is safe to do so. If you cannot open the window, or if the burning material may cause injury or additional fires outside, extinguish the fire with a bucket of water or with a household extinguisher.

WINE & SPIRITS

WINE HAS SEDIMENT



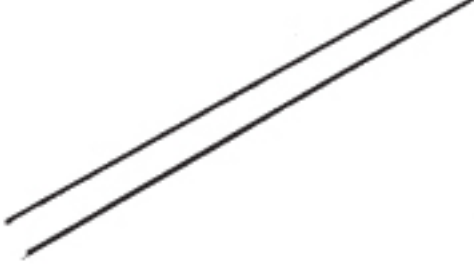

Let wine settle upright for 24 hours. Remove the cork and foil to expose the bottleneck. Pour the wine from the bottle to the decanter by candlelight. Stop pouring the wine as soon as sediment approaches the neck and discard the bottle's remaining contents.

YARD

Deer Eating Plants in Garden

Place coyote urine capsules around the perimeter of the garden, spaced no more than 10 feet apart. Coyotes are natural deer predators, and the scent of their urine is an effective deterrent. Avoid spilling urine on plants and flowers. Replace the capsules every few weeks, or as soon as the odor fades.

Rabbits Eating Plants in Garden

Grind dried red chile peppers to a fine powder using a mortar and pestle. Sprinkle the powder along seeded rows of plants and vegetables and around the bases of existing plants. Reapply chile powder after heavy rains or watering. Wash all vegetables before consuming.

Squirrel Stealing Bird Food

Drill a hole in the bottom of a very smooth metal salad bowl. Run the wire of the bird feeder through the hole so the bowl hangs directly above the feeder, upside down, and rehang the feeder. The bowl will prevent squirrels from climbing down the wire to the feeder. Make sure the feeder is far enough from the ground and other objects that the squirrel cannot leap to it from the sides or below.

Inoperable Sprinkler Head

Turn the water off. Turn the radius adjustment screw on the sprinkler head to the full “on” position. Remove the sprinkler nozzle and wipe away any visible dirt. Remove the screen under the nozzle and clean it. Turn the water on to flush all hoses, turn it off, replace the screen and nozzle, then turn the water back on.

Raccoons in Trash

Place refuse in metal trash cans. Secure the can lids with bungee cords. Rinse trash cans with ammonia once a week and sprinkle red pepper dust on and around the receptacles.

Poison Ivy

Rinse the affected areas with warm running water to remove as much of the urushiol oil as possible and reduce spreading of the rash. After several minutes, increase the water temperature until it is as hot as you can stand it, being careful not to burn yourself. The hot water releases histamines from the skin, providing temporary relief. Treat the rash with hot or cold packs, or cortisone cream, to relieve itching. Avoid using soap or scratching or rubbing the affected area, all of which may spread the oil and hence the rash.

Wasp's Nest

Put on protective gear. Layer clothing to include a long-sleeve shirt and zipped jacket, two pairs of long pants (jeans under sweat pants) tucked into two pairs of socks, leather shoes or boots, thick work gloves, and an insect veil. Spray the nest with a commercial aerosol containing pyrethrin and rotenone to paralyze the insects. When wasps are not flying from the nest, dislodge it from the house with a rake handle or dig it up from the ground (making sure to get all larvae). Burn the nest on a grill, or place it in a large sealable freezer bag and freeze overnight, then dispose.

Tree Falls on House

Inspect the inside of the roof from the attic or top floor. If the tree has damaged plywood or rafters, call a professional roofer. If there is no visible damage, the attic is dry, and the roof is not pitched, put on shoes with rubber soles and go to the roof. Working from above the tree, never below, use shears to cut off smaller branches and a bow saw to cut the trunk into smaller pieces. Remove the wood. Never use a chain saw on a ladder.

YOGA

Right/Left Confusion

Loosely tie a rubber band around your right wrist, or a shoelace around your left wrist. Remember the mnemonic “rubber band starts with R = right” or “lace starts with L = left.”

Slipping on Yoga Mat

Step off your mat and walk to the floorboards closest to the door. Find an area of dust and grit and place your feet and palms down, using the resulting traction to keep yourself firmly in place when you return to the mat.

Bad B.O. Next to You

Dab patchouli or perfume directly under your nostrils. Failing that, breathe in through your mouth and out through your nose.

Passing Gas

Pout your lips and exhale loudly through them at the exact moment you release your gas. Have the sound effect from your mouth continue for a second or two longer than your flatulence. If you draw attention for the noise, look blissful and focused.

STUCK IN PADMASANA





Take a calming breath. Inhale for a count of four, hold for a count of four, and exhale for a count of four, using your heartbeat as the counter.



Slip your closest hand beneath your top foot, placing your other hand below the knee of your top leg. Using the strength of your arms, lift and gently move the leg forward off your thigh and straighten the leg. Use your hands to lift and move your other foot until the leg is straight. Allow your muscles to relax before standing.

Leave the hot room and go outside to where the air is cooler. Drink fluids and hold your head between your knees until your dizziness goes away. End your session for the day.

Guru Coming on to You

Flail on every pose in as spasmodic a manner as possible. Whine and complain about each new motion and pretend to cry if anyone says anything to you. At the end of class, inform your guru that, while yoga seems like an acceptable diversion, people who devote their lives to it are obviously just wasting time. Tell him you have to leave early for your white supremacy meeting.

ZOO KEEPER

Pandas Won't Mate

Close the panda house and separate the male and female bears at the first sign the female has gone into heat. Reunite the pair when she is at peak fertility, which lasts for approximately 2 days per year. Meanwhile, show the male panda videos of other pandas mating to teach the proper behavior.

Llama Spitting

Allow the llama to calm down by keeping away from the animal for 15 to 20 minutes and advising patrons to do the same. Llamas spit to express displeasure, and will spit at other llamas as well as at humans. Move away if you notice the llama's ears back and nose up, signals that the llama may be ready to spit. If the problem is recurring, post a sign near the llama enclosure alerting zoo patrons to the llama's sensitivities.

Kicked by Zebra

Move back: Zebras kick with their hind legs when they are followed too closely, or with the front legs as a defensive measure. The zebra's powerful hindquarters can deliver a kick with force sufficient to break a crocodile's jaw.

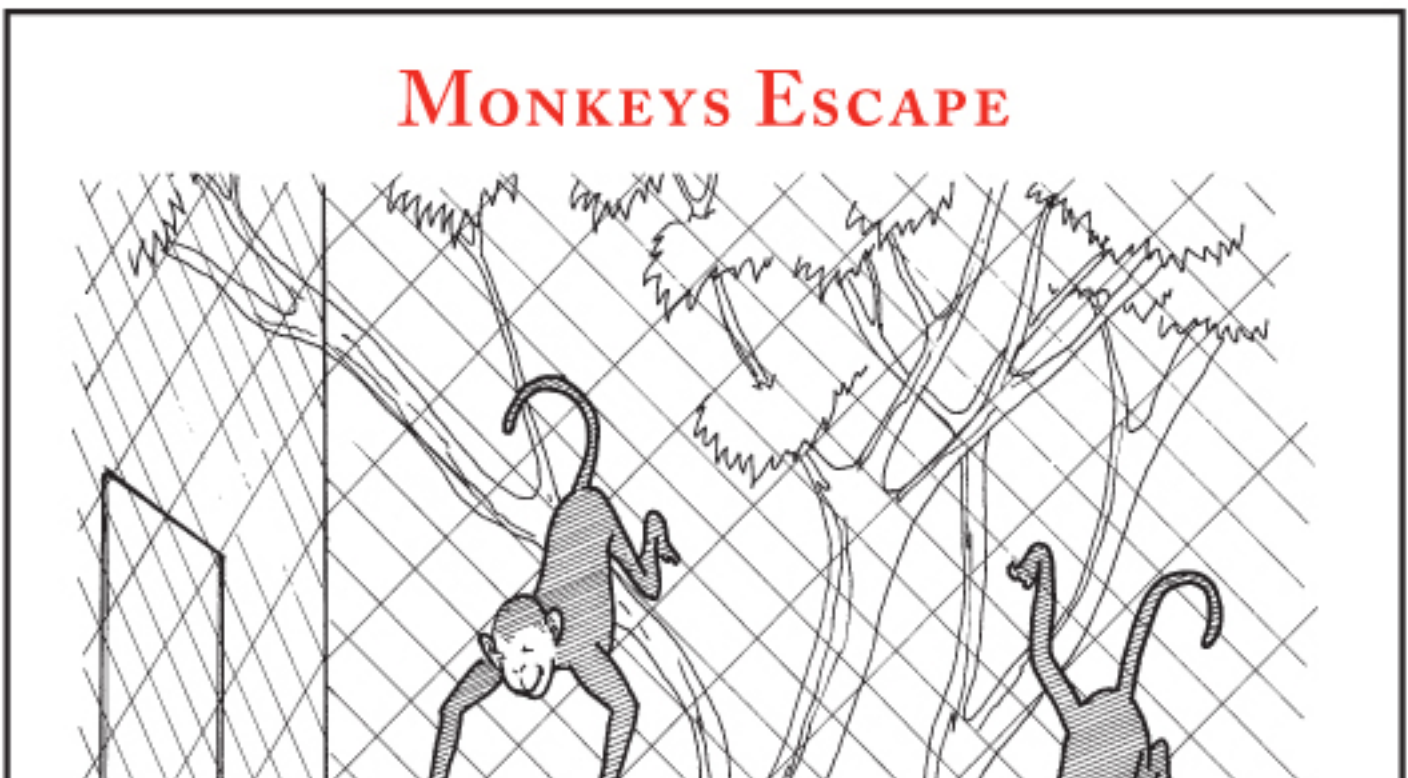



Secure the enclosure breach. Lure the monkeys back to their enclosure with ripe bananas, oranges, or other special treats, offering food by hand as well as in the cage. The benefit of recapturing them quickly will outweigh having “rewarded” their escape behavior. Use a tranquilizer if the monkeys refuse to return to their habitat.

Petting-Zoo Bite

Wash the bite with soap and water, lathering for 5 minutes even if the skin is not visibly broken.

Apply pressure to stop any bleeding, then apply an antiseptic (iodine, chlorhexidine, or alcohol). If skin is broken, encourage the patron to visit a doctor to be sure that they do not need a rabies or a tetanus booster.

SELECTED RESOURCES

African Wildlife Foundation
American Academy of Allergy, Asthma, and Immunology, National Allergy Bureau
American Academy of Otolaryngology—Head and Neck Surgery
American Heart Association
American Optometric Association
American Osteopathic College of Dermatology
American Society for the Prevention of Cruelty to Animals
American Society of Plastic Surgeons
Animal Management Inc.
Animals of Africa by Thomas B. Allen
Armed Forces Pest Management Board
AskDrSears.com
Audiology Awareness Campaign
Beaufort County Public Library, Beaufort, South Carolina
Berry Bros. & Rudd Ltd.
British Coatings Federation
The British Horological Institute
British United Provident Association (BUPA)
California Tan
Canadian Council on Animal Care
The Cat Owner's Manual by Sam Stall and Dr. David Brunner
Certified Horsemanship Association
CoolNurse.com
Cornell University Department of Crop and Soil Sciences
Centers for Disease Control and Prevention
Delaware Division of Public Health
Diabetes Services, Inc.
The Dog Owner's Manual by Sam Stall and Dr. David Brunner
DoItYourself.com
Eco Living Center
eMedicine.com

Epicurious.com
FDA Consumer magazine
Ferret News
Fodors.com
Genie of Fairview Door Co.
GlobalGourmet.com
GlobalSecurity.org
Good Housekeeping Heloise Household Helpline
Outwitting Poison Ivy by Susan Carol Hauser
HealthTouch.com
The Heimlich Institute
Hermit-crabs.com
How to Behave by Caroline Tiger
Illinois Department of Public Health
Iowa State University Extension Answer Line
LlamaWeb
Massachusetts General Hospital Burns Service
The Mayo Clinic
McMaster University Campus Health Centre
Medical College of Wisconsin HealthLink
Medicine.net
Merck.com
Michigan State University Panda Habitat Research in China
Modern Ferret magazine
National Ag Safety Database
National Institute of Arthritis and Musculoskeletal and Skin Diseases
The National Institute of Neurological Disorders and Stroke
National Institutes of Health: United States National
Library of Medicine
National Pollen and Aerobiology Research Unit, Institute of Health
and Social Care, University of Worcester, England
National Safety Council
Nemours Foundation
Newport Beach Fire Department Community Emergency Response

Team, Newport Beach, California
North Dakota State University Extension Service
OhioHealth
Ontario Dental Association
Palo Alto Medical Foundation
Pawprints and Purrs, Inc.
PetEducation.com
Prevention.com
PopularMechanics.com
Portland Parks & Recreation, City of Portland, Oregon
PsychologyToday.com
Save the Rhino International
Silverado Vineyards
South Florida Ferret Help Line
State of Pennsylvania Department of Environmental Protection,
Bureau of Deep Mine Safety
Steven Tamaccio, owner of Estetica Salons, Philadelphia
Terminix Inc.
Texas A&M University System Aggie Horticulture Network
TheCarConnection.com
ThisOldHouse.com
Toronto Medical Laboratories and Mount Sinai Hospital
Department of Microbiology
U.S. Consumer Product Safety Commission
U.S. Food and Drug Administration
U.S. Environmental Protection Agency
The University of Illinois at Urbana-Champaign
McKinley Health Center
The University of Michigan Kellogg Eye Center
The University of North Carolina Highway Safety Research Center
University of Pittsburgh Medical Center
WebMD.com
WildlifeSafari.info
WomansDay.com

HOW TO TURN A WORST-CASE SCENARIO INTO A BESTSELLER

1 Have the right idea at the right time.

The original concept for *The Worst-Case Scenario Survival Handbook* came from a perfect storm of influences—literally and figuratively. In 1998, when David Borgenicht (a writer and editor) had the idea, survival was in the air. Books like *The Perfect Storm* and *Into Thin Air* were on the bestseller lists. The media was starting to talk about the looming disaster of Y2K and the predicted breakdown of the world's computer infrastructure. Borgenicht read a magazine article about a man who'd been forced to land a plane after the pilot had a heart attack, and it made him think about classic action movie scenes and how he would face those situations. How should he react if he were face to face with a shark or if he had to jump from a building into a Dumpster? Knowing there were answers to these questions, he decided to write a book.

2 Develop a killer book proposal.

With a title, a few written scenarios, a rough design (that looked nothing like the finally published version), and an outline, Borgenicht took the project to the Frankfurt Book Fair, where he met with publishers in the hopes of selling the project.

3 Get it into the right hands.

After receiving offers from several publishing houses, Borgenicht selected Chronicle Books as the publisher for the work, because he knew “they’d know what do to with it.”

4 Find the correct co-author.

Now the book had to be written, illustrated, and designed. And Borgenicht knew he needed a good, strong co-author to research and pull it all together. Through a mutual friend, he met journalist Joshua Piven (though they had attended the University of Pennsylvania at the same time, they had never met before). The newly formed team began writing.

5 Don't panic.

Piven spent the better part of six months trying to convince experts that he wasn't just a prankster, and that he actually wanted the real answers to such questions as “How do you safely ram a car?” and “How do you perform a tracheotomy?” Working closely with the team at Chronicle, Piven and Borgenicht revised the manuscript until the tone was right. Next, Borgenicht's company, Book Soup Publishing (later renamed Quirk Productions, Inc.), designed and edited the book under Chronicle's guidance.

6 Be prepared—and when you're not prepared, react quickly.

The Worst-Case Scenario Survival Handbook was released in November 1999 with a first printing of 35,000 copies. With Y2K fears looming, people took

to the book quickly, and booksellers, reviewers, and clerks used this hook to sell more copies. The response from the book and specialty trade (including such chains as Restoration Hardware and Urban Outfitters) was tremendous, and Chronicle immediately went back to press. Soon, the authors were in demand in the media, and Borgenicht and Piven worked the circuit, appearing on numerous radio shows and giving many newspaper and magazine interviews. But they were out of stock over the holiday season—usually a momentum killer.

7 Remember that there's no such thing as small publicity.

Borgenicht and Piven did pretty much every radio, print, and TV interview that came up, and eventually the major media got word of the book. In February 2000, *New Yorker* magazine called the work “the book to have when the killer bees arrive.” In April 2000, *Time* magazine published a feature on the book, calling it “an improbable how-to manual.” In May 2000, *People* magazine published a two-page feature on Borgenicht and Piven, and *20/20* did a segment on the book, featuring experts demonstrating “How to Survive When Your Parachute Fails to Open” and “How to Wrestle an Alligator.” The next morning, Borgenicht and Piven appeared on NBC’s *Today* show, demonstrating “How to Kick Down a Door,” “How to Fend Off a Shark,” “How to Land a Plane,” and “How to Build a Fire without Matches.” The rainy day prevented the fire from actually lighting, and Al Roker handed Borgenicht a lighter. The book went to number one on Amazon that day.

8 Never forget that lightning rarely strikes twice.

The book began to hit bestseller lists, first appearing on the *New York Times*’s list in June 2000. And then lightning did strike again, with the publication of *The Worst-Case Scenario Survival Handbook: Travel*, and again, with *Dating & Sex*. All told, various titles in the Worst-Case Scenario series have spent more than 24 weeks on the *Times*’s list. Borgenicht, Piven, and their publisher are always extremely careful during thunderstorms, but they are also very hopeful about the lightning.

9 Have a plan.

The Worst-Case Scenario series is now one of book publishing’s most successful and recognized brands. The authors and publisher have parlayed one successful title into a series with more than 15 different books, several successful board games (from University Games), dozens of stationery and calendar products, a video game, a TV series (which aired on TBS in 2002), T-shirts, greeting cards, and translations in more than two dozen languages worldwide. The series shows no signs of flagging, and many future books and projects are in the works.

10 Remember that the best—or the worst—may be yet to come.

The authors have worked hard to keep the series true to the mission of the original handbook—to provide real solutions to extreme situations, and sometimes extreme solutions to real situations. In fact, the best of the worst may still be yet to come—you just never know.